

TV for Beginners - New Series

Practical Television

1/3

MAY 1956

AND TELEVISION TIMES

EDITOR: F.J. CAMM

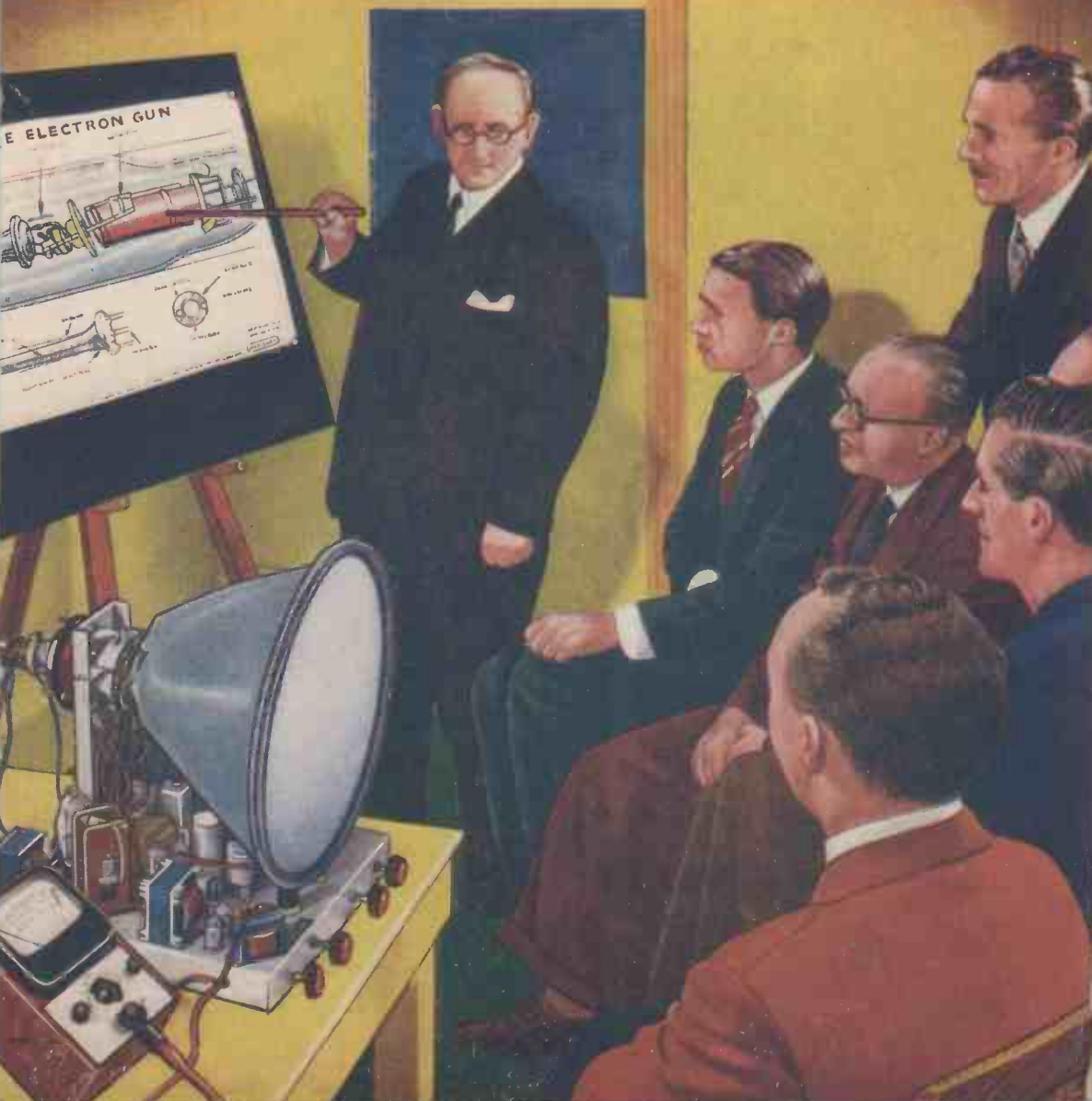

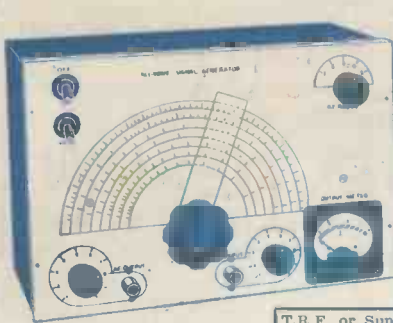

COMPLETELY BUILT SIGNAL GENERATOR

Completely built Signal Generator, coverage 120 Kc/s-320 Kc/s. 300 Kc/s-900 Kc/s, 900 Kc/s-2.75 Mc/s, 2.75 Mc/s-8.5 Mc/s, 8 Mc/s-28 Mc/s, 16 Mc/s-56 Mc/s, 24 Mc/s-84 Mc/s. Metal case 10 x 6 1/2 x 4 1/2 in. Size of scale 6 1/2 x 3 1/2 in. 2 valves and rectifier. A.C. mains 230-250 v. Internal modulation of 400 c.p.s. to a depth of 30 per cent., modulated or unmodulated R.F. output continuously variable 100 milli-volts C.W. and mod. switch, variable A.F. output and moving coil output meter. Black crackle-finished case and white panel. Accuracy plus or minus 2%. £4.19.6 or 34/- deposit and 3 monthly payments 25/- P. & P. 4/6 extra.

COMPLETELY BUILT T.V. CONVERTER

for the new commercial stations, complete with 2 valves. Frequency can be set to any channel within the 188-196 Mc/s band. I.F. will work into any existing T.V. receiver between 42-68 Mc/s. Input arranged for 50 ohm feeder, 6.750 as RF amplifier. ECC81 as local oscillator and mixer. The gain of the first stage, RF amplifier 10DB. Required power supply of 200 D.C. at 25mA, 6.3 v. A.C. at 0.6 amp. Input filter ensuring freedom from unwanted signals. Simple adjustments only, no instruments required for trimming. Will work into any

T.R.F. or Superhet incorporating Band switch, and wire-wound gain control. Fully screened in black crackle finished case, size 5 1/2 in. long, 3 1/2 in. wide, max. overall height 4 1/2 in. £3.18.6, P. & P. 2/6. A.C. Mains 200/250 v.

BOTH GENERATORS GUARANTEED FOR 12 MONTHS.

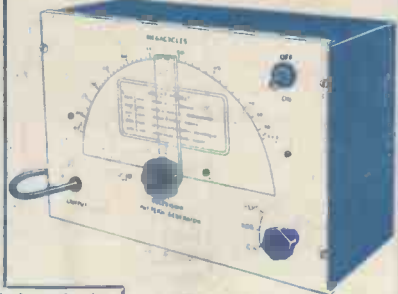

PATTERN GENERATOR

40-70 Mc/s direct calibration, checks frame and line time base, frequency and linearity, vision channel alignment, sound channel and sound rejection circuits and vision channel band width. Silver plated coils, black crackle-finished case 10 x 6 1/2 x 4 1/2 in. and white front panel. A.C. mains 200/250 volts. This instrument will light any T.V. receiver, accuracy plus or minus 1%. Cash price £3.19.6 or 29/- deposit and 3 monthly payments of £1. P. & P. 4/6 extra.

Line or Frame Oscillator Blocking Transformers, 4/6 each. Smoothing Choke, 250 mA, 5 henry, 8/6; 250 mA, 10 henry, 10/6; Wide Angle P.M. Focus Unit, Vernier adj., state tube, 15/-; P.M. Focus Unit for Mullard tubes with vernier adjustment, 15/-.

Ion Traps for Mullard or English Electric tubes, 5/-; Post paid. T.V. Coils, moulded former, iron cored, wound for rewinding purposes only. All-can 1 1/2 in. x 1 in., 1/- each; 2 iron-core All-can, 2 1/2 in. x 1 in., 1/6 each. These coil formers are suitable for the Prac. T.V. Converter.

Duobility 400 10kV working, 3/6. Primary, 300-250 v. P. & P. 2/-; 300-0-300, 100 mA, 6 v. 3 amp., 5 v. 2 amp., 22/6. Drop thro' 350-0-350 v. 70 mA, 6 v. 2.5 amp., 5 v. 2 amp., 14/6. Drop thro' 250-0-250 v. 80 mA, 6 v. 3 amp., 5 v. 2 amp., 14/6. 280-0-280, drop through, 80 mA, 6 v. 3 amp., 5 v. 2 amp., 14/6. Drop thro' 270-0-270 60 mA, 6 v. 3 amp., 11/6. 250 v. 350 mA, 6.3 v. 4 a., twice 2 v. 2 a., 19/6.

Semi-shrouded drop-through 380-0-380 120 mA, 6.3 v. 3 amp., 5 v. 2 amp., 25/-; Auto Trans. Input 200/250 H.T. 500 v., 250 mA., 6 v. 4 a., twice 2 v. 2 a., 19/6.

Auto Trans. Input 200/250 v. H.T. 350 v. 350 mA. Separate L.T. 6.3 v. 7 a., 6.3 v. 1 1/2 amp., 5 v. 3 amp., 25/-; P. & P. 3/-; Heater Transformer. Pri 200/250 v. 6 v. 1 1/2 amp., 6/-; 350-0-350 75 mA, 6.3 v. 3 a. (tap. 4 v. 6.3 v. 1 a.), 13/6. 500-0-500 125 mA, 4 v. C.T. 4 a., 4 v. C.T. 4 a., 4 v. C.T. 2.5 a., 27/6. 500-0-500 250 mA, 4 v. C.T. 5 a., 4 v. C.T. 5 a., 4 v. C.T. 4 a., 38/6. Chassis mounting or drop-thro', Pri. 110-250 v. Sec. 300-0-350 250 mA, 6.3 v. 7 amp., 6.3 v. 0.5 amp., 5 v. C.T. 0.5 amp., 4 v. 4 amp., 32/6. P. & P. 3/6.

3-speed TRANSCRIPTION MOTOR BY FAMOUS MANUFACTURER

Complete Kit of parts comprising accurately balanced precision made, heavy turntable with rubber mat, large constant speed condenser, starting motor base plate. Can be assembled in half-an-hour. **£6.19.6** A.C. Mains 200/250 v. Fully guaranteed Post Paid. Parts sold separately.

USED 9in. TUBE, 22/14C with ion burn, 17/6. Post paid. Used Mullard 9in. tube 22/17 and 18 ion burn. 25 - post paid.



A.C. mains 230/240 Comprising choke, power-factor condenser, 2 tube holders, starter, and starter-holder. (No tube or metal work supplied.) P. & P. 3/- 17/6.

20 watt A.C. or D.C. 200 250 v. Fluorescent kit, comprising trough in white stove enamel, 2 tube holders, starter, starter-holder and barretter. (No tube.) P. & P. 1/6. 12/6.

Three speed automatic changer by B.S.R. MONARCH current model. Will take 7in., 10in. or 12in. records mixed. Turnover crystal head. Cream finish. BRAND NEW. VERY LIMITED QUANTITY. A.C. Mains 200/250. £7.15.0. P. & P. 3/6

Line and H.I.T. Transformer, 9kV. Ferrocarr core. EY51 heater winding, complete with scan coils and frame output transformer and line and width control. 35/- P. & P. 3/-.

As above but complete with line and frame blocking transformers, 4 henry 250 mA, choke, 100 mfd. and 150 mfd. 350 wkg., 380 mA. A.C. ripple. £2.9.6. P. & P. 3/-.

Standard wave-chance Switches, 4-pole 3-way; 5-pole 3-way; 3-pole 3-way, 1/9 each; 8-pole 3-way 3/6; Miniature type, long spindle, 4-pole 3-way and 4-pole 2-way 2/6 each. 2-pole 11-way twin water, 5/-; 1-pole 12-way 5/- P. & P. 3d.

USED metal rectifier, 250 v. 150 mA., 6/8. Combined 12in. Mask and Isenticon perspex. New aspect, edged in brown. Fits on front of cabinet. 12/6. As above for 15in. tubes, 17/6.

Polishing Attachment for electric drills. 1in. spindle, chromium plated 5in. brush, 3 polishing cloths and one sheepskin mop mounted on a 3in. rubber cup. Post & pkg. 1/6. 12/6. Spare sheepskin mops, 2/6 each.

GARRARD RC/110 3-SPEED AUTOMATIC CHANGER

10 Records, turnover crystal head. BRAND NEW A.C. Mains 100/250 v. **£8.19.6** P. & P. 5/- LIST PRICE £14.10.0.

P.M. Speakers, closed field 3 ohm speech coil, 12in., 25/-; 10in., 25/-; 8in., 20/6; 6in., 18/6; 5in., 18/6. P. & P. 2/- each extra. 1,200 ft. High Impedance recording tape on aluminium spool. 12/6 post paid.

Valve Holders, moulded octal	250 mfd., 22 v. wkg. ...	1/6
Mazda and loctal, 7d. each.	16 mfd., 500 wkg. ...	3/3
Paxolin, octal Mazda and loctal, 4d. each. Moulded	8 mfd., 500 v. wkg., wire ends 2/6	
B7G, B8A and B9A, 7d. each.	8 mfd., 350 v. wkg., tag ends 1/6	
B7G and B9A moulded with screening can, 1/8 each.	100 + 150 mfd. 350 v. wkg. ...	4/6
32 mfd., 350 wkg. ...	280 mA., A.C. ripple ...	4/6
18 24, 35 wkg. ...	100 + 200 mfd., 275 wkg. ...	7/6
4 d., 200 wkg. ...	18 + 16 mfd., 350 wkg. ...	3/3
40 mfd., 450 wkg. ...	50 mfd., 180 wkg. ...	1/9
16 + 8 mfd., 500 wkg. ...	65 mfd., 220 wkg. ...	1/6
16 + 8 mfd., 500 wkg. ...	80 mfd., 150 wkg. ...	1/6
32 + 32 mfd., 350 wkg. ...	60 + 100 mfd., 280 wkg. ...	7/6
25 mfd., 25 wkg. ...	100 mfd., 12 wkg. ...	1/6
	50 mfd., 50 wkg. ...	1/9
	16 + 16 mfd., 450 wkg. ...	1/6
	100 + 150 mfd. 350 v. wkg. ...	4/6
	Miniature wire ends	
	moulded, 100 pf., 500 pf.	7d.
	and .001 ea. ...	7d.

Where cost and packing charge is not stated, please add 1/6 up to 10/-, 2/- up to £1 and 2/6 up to £2. All enquiries S.A.E. Lists 5d. each.

R. & T.V. COMPONENTS (ACTON) LTD.

23 HIGH STREET, ACTON, LONDON, W.3

PREMIER RADIO COMPANY

(Regd.) B. H. MORRIS & CO. (RADIO) LTD.

(Dept. P.T.) 207, EDGWARE ROAD, LONDON, W.2

Telephone :
AMBASSADOR 4033
PADDINGTON 3271

OPEN TILL
6 P.M. SATURDAYS

★ **Band Three (Commercial)**
For the Home Constructor

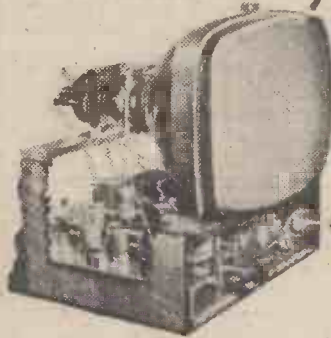

Instruction Book 3/6. Post
Free. Includes details of
both designs.

THE NEW PREMIER TELEVISOR 13 CHANNEL DESIGN

SUITABLE FOR USE WITH ANY POPULAR WIDE ANGLE TUBE

DESIGN 1. Includes a Multi-Channel Tuner (Channels 1-13) continuously variable 40-100 Mc/s and 170-225 Mc/s. The Tuner is supplied wired and tested and is complete with Valves, all connecting leads and fixing brackets.

THIS DESIGN MAY BE BUILT FOR **£31. 12. 2** (plus cost of C.R.T.)

DESIGN 2. Channels 1-5, tunable from 40-68 Mc/s.

THIS DESIGN MAY BE BUILT FOR **£26. 12. 2** (plus cost of C.R.T.)

- ★ Constructors who have built Design 2 (5 Channels) may convert their Receivers to Design 1 for £6; this price includes Multi-Channel Tuner, New Vision Input Coil and full instructions.
- ★ All Coils supplied for these two Superhet Receivers are PRE-TUNED, ASSURING ACCURATE ALIGNMENT and EXCELLENT BANDWIDTH.
- ★ Duomag permanent magnet focusing with simple picture centring adjustment.
- ★ Exceptionally good picture "hold" and interlace. ★ Noise suppression on both Sound and Vision.

The Televisor may be constructed in 5 easy stages : (1) Vision, (2) Time Base, (3) Sound, (4) Power Pack, (5) Final Assembly. Each stage is fully covered in the Instruction Book, which includes layout, circuit diagrams and point-to-point wiring instructions. The Instruction Book also includes full details for converting existing Premier Magnetic Televisors for use with modern wide angle tubes. All components are individually priced.

CONSTRUCTORS' BARGAINS

BAND III CONVERTER.

Coil kit by TELETRON, with circuit and wiring details, etc. For use with TRF or Superhet TV Receivers. ONLY 15/-.
Cascade coil kit 17/6. Drilled chassis 3/9, or slightly larger to hold power pack components, 6/- (postage on either 6d.).
Instruction leaflet only, 6d.

INDICATOR UNIT TYPE 6.—Contains VCR 97 tube with mu-metal screen, 4 valves EF50 and 2 of EB34, valveholders, CRT holder, condensers, resistors, etc. NEW CONDITION. ONLY 39 6 (carriage, etc., 7/6).

AMPLIFIER TYPE 293A or 208A.—As described in July, 1955, issue of *Practical Television*, for making a TV CONVERTER. Complete with 2 valves EF50. ONLY 10/- (post, etc., 2/-).

PYE 45 MC/S I.P. STRIPS.—Ready-made for London Vision Channel. Complete with 6 valves EF50 and 2 of EA50, and details of very slight mods. required. BRAND NEW. ONLY 49 6 (post, etc., 2/6).

J.F. STRIP 194.—Another easily modified strip for TV. Complete with 6 valves SP61, 1 of EA50, and 1 of EF36; also mod. data. ONLY 29 6 (post, etc., 2/6).

RECEIVER UNIT 159.—Contains 4 valves, 1 each EF50, EA50, SP61, RL37 and 24 v. Selector switch. ONLY 7/6 (post, etc., 2/-).

R.F. UNITS TYPE 26.—Complete with 2 valves EF54 and 1 of EC52, this is the variable tuning unit covering 65-50 mc/s (5-6 metres). BRAND NEW IN MAKER'S CARTONS. ONLY 27 6.

POCKET VOLTMETERS.—Read 0-15 and 0-300 v. A.C. or D.C. BRAND NEW. ONLY 18 6.

AVONINOR CARRYING CASES.—Size 6in. x 6in. x 2in. with long carrying strap. In high quality leather with press stud fixing flap. Made for UNIVERSAL Avoninor. BRAND NEW. ONLY 7 6 (post, etc., 1/-).

"ALL DRY" RECEIVER MAINS UNIT. If your battery portable uses midget 1.4 v. valves of the 1S4, IT4, IS5, 3S4 series; then this will save you pounds in batteries. Delivers LT & HT from normal mains. Manufactured by "AVO" for the Ministry of Supply. Fused on mains side, and ready to work. Size 8 1/2 in. x 5 1/2 in. x 3 1/2 in. BRAND NEW. ONLY 39 6.

E.H.T. TRANSFORMER.—Normal 250 v. Primary, with Secondary of 2000 v. r.m.s. (approx. 2,800 v. D.C.). A special offer of interest to all using the VCR97 or similar tube. Size 2 1/2 in. W. x 2 1/2 in. D. x 3 in. H. + 4 in. for tag panel, AN UNREPEATABLE SNIP, and well worth buying as an insurance against failure of existing E.H.T. supplies. ONLY 15/- (postage, etc., 2/-).

SPEAKERS.—P.M. 6in. less trans. 19/6; 8in. less trans. 16/6; 10in. with trans. 27/6 (post 2/-).

CHOKES.—10H 60 mA., 4/-; 5H 200 mA., 7 6 (post 1/-).

L.T. HEAVY DUTY TRANSFORMER.—Ex Admiralty. Has 3 separate windings of 5v.-0.5v. at 5 amps. and by using combinations will give various voltages at high current. BRAND NEW. ONLY 29 6 (post, etc., 2/8).

MODEL MAKERS MOTOR.—Reversible poles. ONLY 2in. long and 1 1/2 in. diameter, with 1 1/2 in. long spindle. Will operate on 4, 6, 12 or 24 volts D.C. ONLY 10 6 (post, etc., 1/-).

TRANSFORMERS.—Manufactured to our specifications and fully guaranteed. Normal Primaries. 425-0-425 v. 200 ma. 6.3 v. 4 a., 6.3 v. 4 a., 5 v. 3 a., ONLY 65/-; 350 v.-0-350 v. 160 ma., 6.3 v. 5 a., 6.3 v. 3 a., 5 v. 3 a., ONLY 47 6; 250 v.-0-250 v. 100 ma., 6.3 v. 6 a., 5 v. 3 a., ONLY 37 6. 350 v.-0-350 v., 150 ma., 6.3 v. 5 a., 5 v. 3 a., ONLY 37 6. 250-0-250 v. 60 ma., 6.3 v. 3 a., 5 v. 2 a., ONLY 21/-. The above are fully shrouded, upright mounting, 5.5 kv. E.H.T. with 2 windings of 2 v. 1 a. ONLY 29 6; 7 kv. E.H.T. with 4 v. 1 a. ONLY 39 6. PLEASE ADD 2/- POSTAGE FOR EACH TRANSFORMER.

E.H.T. TRANSFORMER FOR VCR97 TUBE.—2,500 v. 5 ma. 2-0-2 v. 1.1 a. 2-0-2 v. 2 a., 42/6 (postage 2/-).

Open until 1 p.m. Saturdays, we are 2 mins. from High Holborn (Chancery Lane Station) 5 mins. by bus from King's Cross. Cash with order, please, and print name and address clearly. Include postage and carriage on all items.



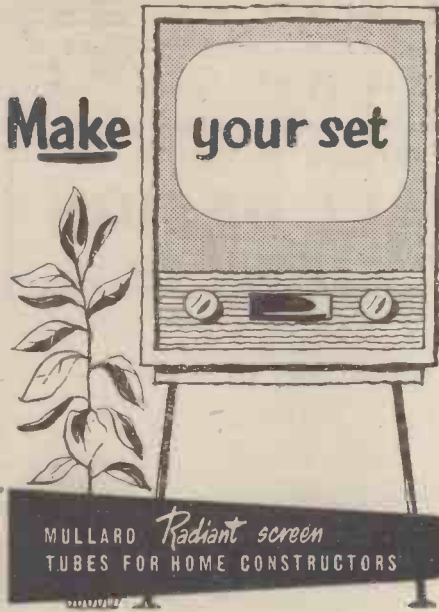

U.E.I. CORPN. THE RADIO CORNER, 138, GRAY'S INN ROAD, LONDON, W.C.1.

(Phone TERminus 7937.)



Make your set with a Mullard Radiant screen TV tube

If you are building a television receiver, leave nothing to chance: choose a Mullard Tube. Mullard Television Tubes owe their high reputation for performance, reliability and LONG LIFE to the unrivalled facilities for research possessed by Mullard and to the complete control of manufacture from the production of raw materials to the finished product. For practical evidence of performance and reliability, ask the people who use them.

- MW22-16  9 inch circular screen
- MW31-74  12 inch circular grey-glass screen
- MW36-24  14 inch rectangular grey-glass screen
- MW41-1  16 inch circular screen. Metal cone
- MW43-64  17 inch rectangular grey-glass screen



MULLARD LTD., CENTURY HOUSE, SHAFTESBURY AVENUE, LONDON, W.C.2

MVM350

For maximum reliability 'LECTROPACK' ETCHED FOIL ELECTROLYTICS

The Constructor depends upon the reliability of the components he uses. The fact that so many designers specify T.C.C. Condensers is evidence of their supremacy.

T.C.C. "Lectropack" Dry Electrolytic Condensers are robust yet compact and employ ALL-ALUMINIUM non-corrosive internal construction. The range below is a useful guide to the types available.

Capacity μF.	D.C. Volts		Ripple Current Max. M/A	Dimensions in inches		T.C.C. Type No.	List Price
	W/kg.	Surge		L	D		
60 - 100	275	325	450	4 1/2	1 1/2	CE 37 HE	16/-
60 - 250	"	"	530	4 1/2	1 1/2	CE 60 HE	28/-
100 - 200	"	"	650	4 1/2	1 1/2	CE 60 HEA	28/-
100	350	400	450	2 3/8	1 1/2	CE 10 LE	13/6
200	"	"	770	4 1/2	1 1/2	CE 36 LE	24/-
60 - 100	"	"	500	4 1/2	1 1/2	CE 36 LEB	23/-
60 - 250	"	"	500	4 1/2	1 1/2	CE 60 LEB	34/-
100 - 100	"	"	550	4 1/2	1 1/2	CE 36 LEA	26/-
100 - 200	"	"	700	4 1/2	1 1/2	CE 60 LEA	33/-
60	450	550	450	3 1/2	1 1/2	CE 38 PE	14/-
60 - 100	"	"	500	4 1/2	1 1/2	CE 60 PE	29/-



List 140c contains the extended range.



THE TELEGRAPH CONDENSER CO. LTD

RADIO DIVISION: NORTH ACTON · LONDON · W3 · Telephone: ACOrn 0061



Practical Television

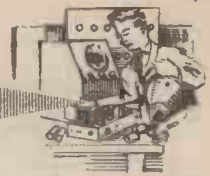

& TELEVISION TIMES

Editor : F. J. CMM

Editorial and Advertisement Offices: "Practical Television," George Newnes, Ltd., Tower House, Southampton Street, Strand, W.C.2. Phone: Temple Bar 4363. Telegrams: Newnes, Rand, London. Registered at the G.P.O. for transmission by Canadian Magazine Post.

Vol. 6 No. 70

EVERY MONTH

MAY, 1956

TelevIEWS

LARGEST AUDIENCE—BBC OR ITA ?

A REPORT recently issued by the BBC shows that the BBC and the ITA TV programmes were attracting audiences about equal in numbers at the end of the quarter closing on December 31st, 1955: The BBC is careful to point out that owing to its national coverage the total BBC audience was, on the average, about 20 times that of the ITA. The analyses show that among adult viewers in England whose sets were adapted to receive both programmes, the ratio amongst every 100 viewing was as follows: October—BBC, 57, ITA, 43; November—BBC, 56, ITA, 44; and December—BBC, 49, ITA, 51:

It is rather significant that in December when most viewers had greater viewing time owing to the Christmas holidays, the ITA audience was in excess of the BBC. The report goes on to say the average ITA evening audience in the quarter was 275,000 (about 235,000 in the first seven weeks and 325,000 in the last six weeks). The average BBC evening audience in South-east England—the area within which ITA transmissions can be received—was 1,525,000. The BBC figure for the rest of the country was over 4,000,000, making about 5,650,000 for the United Kingdom as a whole. Thus, the average BBC evening television programme was seen by 20 adults for every one viewing ITA.

The report shows that the "television public"—those with a television set in their homes—used them in the last quarter to about the same extent as in the corresponding quarter of 1954. Between 7.00 and 11.00 p.m. the typical viewer spent, on the average, two-fifths of his time, or just over an hour and a half each evening in front of his set. Those with a choice of programmes did not view any more, on the average, than those who had no choice. It is significant that the average evening adult audience for sound radio fell from 5,550,000 in the last quarter of December, 1954, to 4,800,000 in the last quarter of 1955, undoubtedly entirely due to the increase in viewing caused by the increase in the sale of TV receivers. No doubt, when ITV has a greater

coverage (at present it only serves the London area) the figures will be at least comparable to the BBC.

"BEGINNER'S GUIDE TO TELEVISION"

THE second article of our new series, the first of which appeared in the February issue, is included in this issue. It has proved extremely popular and is responsible for an increased demand for copies. If you wish to follow the series through there is only one way in which you can ensure it, and that is to place an order with your newsagent for the regular delivery of PRACTICAL TELEVISION each month, especially in these days when periodicals are not on sale or return, and many newsagents therefore do not risk stocking copies against chance sales.

SPECIAL NOTICE : PRICE INCREASE

WE greatly regret that the price of this journal, in common with the remainder of our Practical Group of Journals, is increased to 1s. 3d. as from this issue. This step, which has been taken with the greatest reluctance, had been deferred until the continued rise in the cost of paper and production left us with the only alternative of reducing the number of pages, and this we decided would not meet with the approval of our readers. Readers will, however, agree that, at its new price, the journal is excellent value for the quantity and quality of our editorial content, bearing in mind also the free Advisory Service which goes with it.—
F. J. C.

The printing dispute, which has prevented publication of this journal since the issue dated February, 1956, has been settled, and we shall now be able to publish normally. We greatly regret the inconvenience to our readers which this dispute has caused, but readers, we are certain, will appreciate that this break in publication has been due to circumstances beyond our control.

A Beginner's Guide to Television

A NEW SERIES

2.—THE CATHODE-RAY TUBE EXPLAINED

By F. J. Camm

I EXPLAINED last month that the cathode-ray tube was similar in many respects to a wireless (thermionic) valve in that it depended on its functioning upon the emission from the cathode (the filament) of a stream of electrons. This emission from a filament was first discovered by Thomas Edison the inventor of the phonograph. He observed that with carbon filament lamps the inside of the glass envelope became, after continuous use, coated with a film of carbon, and he assumed, therefore, that this must be due to a bombardment of carbon electrons emitting from the filament. It was Professor Ambrose Fleming, and others, who surrounded the filament with the grid to which these particles are attracted and surrounded the grid with a plate, so that the fluctuations in the frequency of the bombardment could, after amplification, be converted into sound. This same electronic emission is used to provide the scanning spot which by means of scanning coils can be made to scan the scene and to trace out the picture. Needless to say, it is the most expensive item in the construction of a TV receiver. It is costly to make, and the exhausting of all air from the envelope is much more costly than with a small wireless valve. Great care must, therefore, be taken of it. It is interesting to note that the pressure on a 17in. tube is nearly 1½ tons, on a 12in. tube 15 cwt. and on a 9in. tube 8½ cwt. With the miniature cathode-ray tubes, as used for projection television, the pressure is only 56 lb.

The screen of a cathode-ray tube is of great importance, and the material with which it is coated must be chosen according to the purpose for which the tube is required; that is to say, whether for radar, oscilloscopes, or television. For radar, long persistence of the trace is required and the colour of the screen is not of great importance, as long as the image is bright. For television, medium or short persistence is needed. Persistence of the trace is sometimes referred to as after-glow and it refers to the ability of the screen on the end of the cathode-ray tube to retain the image after the electron beam has been removed. You have, no doubt, noticed that after you have switched off your receiver, there is a slight after-glow before the screen becomes inert. Thus, for a TV tube, the screen material must be very sensitive, have a long life, produce a white trace with a minimum after-glow. When colour TV is introduced, there will be the additional problem of colours where the phosphors on the screen must be exact shades of red, green and blue to enable faithful reproduction to be achieved.

There are a large number of substances which will fluoresce when subjected to an electron bombardment. Phosphates, silicates and sulphides of zinc are widely used, and it is the practice to employ one of each as a base with the addition of another material known as an activator, which will modify its response to the activating beam.

This they do in two ways. They can modify the colour and the after-glow and they are then known

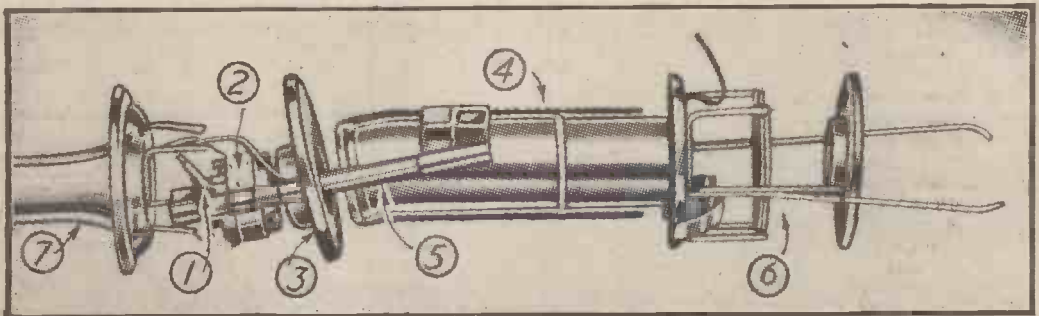

Fig. 7.—The essential elements of a modern ion-trap cathode-ray tube. The component parts are separately illustrated on page 437.

as "killers." Zinc sulphide when activated by silver will produce a deep blue glow. A copper activator will give a green trace, a tin activator an orange red trace, and a manganese activator a red trace. With TV, the screen must give an image which is as near white as possible, thus following the practice of the cinema and photography. To obtain this white trace it is necessary to mix at least two, and, if possible, three, of the basic colours. If the screen of some tubes is examined, when no picture is being transmitted, with the trace slightly out of focus, the individual colour of blue and yellow particles can be observed, but at normal viewing distances the screen appears quite white. Needless to say, the whole area of the screen must be so coated that the white is even throughout its area. The thickness of the fluorescent material is also important, for if the deposit is too thick the frontal brilliance is reduced, and if it is too thin it will have a very short life. Some modern tubes have an additional coating of aluminium particles on the screen, for two reasons. Firstly, the particles are arranged so that the luminant produced by the electron beam is projected forward, which gives an

welded on to the tube have been introduced. The glass is what is known as lead glass, and, of course, this carries the full H.T. voltage, unlike the normal all-glass tube. It is necessary, therefore, to exercise care when experimenting with the set outside of its cabinet because the front of the tube will not then be protected by the piece of plate glass which is fixed in front of all tubes.

The distance from the "gun" which "fires" the stream of electrons on to the screen, decides the angle of scan, and, therefore, the length of the tube. The early tubes only had a scanning angle of 50 degrees. Later, wide-angled tubes, however, have been produced giving a scanning angle of 70 degrees. This enables a much shorter tube to be made and the receiver to be housed in a more compact cabinet. Even shorter tubes are now being produced, having a scanning angle of 90 degrees.

A TV receiver employing a large cathode-ray tube is known as a direct viewing receiver, as distinct from a projection receiver, which makes use of a 2½ in. tube and an optical system which enlarges the picture. The optical system enables a much larger picture to be obtained, but only at the expense of brilliance, since it is not possible to amplify light. As the picture is enlarged, so the brilliance goes down. Projection receivers are indirect vision receivers. When we have discovered the method of amplifying light, as we can now amplify sound, many of the problems related to projection television will be solved.

The Tube Explained

I have already stated that the main essentials of the tube is the electrode system, in which an ordinary filament (the cathode) is heated by an electric current at a low voltage as a result of which a stream of electrons is emitted from the filament. The Wehnelt cylinder, named after its inventor, and sometimes known simply as the control cylinder, or the gun, completely surrounds the filament. This has a negative charge applied to it, the effect of which is to direct and concentrate the stream of emitted electrons towards the plate (anode), the circular disc mounted just in front of the filament. Incoming television signals applied to the control cylinder vary the potential accordingly, and result in an alteration in the intensity of the electron beam. A high positive voltage of from between 7,000 volts and 10,000 volts or more is applied to the anode according to the type of tube employed. The electrons are thus forced at tremendous velocity towards the plate, at the centre of which is a small hole. The greater proportion of electrons pass through this hole and reach the front screen, where their high velocity renders them visible as a spot on the fluorescent material coating the screen.

To enable the working of the tube to be better understood, it is probably best to explain the working of the electrostatic type, as, for example, the popular VCR97. This is superseded in all modern receivers, at the present time, by the electromagnetic tube, in which the deflector plates are replaced by two sets of scanning coils as will be explained later.

The two pairs of deflector plates are disposed at right angles to each other and placed alongside the path of the electron stream, between the anode and the screen, and with no voltage applied to either pair, the electron path is normal to the screen. An electrical charge given to either or both pairs of these deflector plates causes the electron path to be deflected and so to strike the screen at another point, the amount of

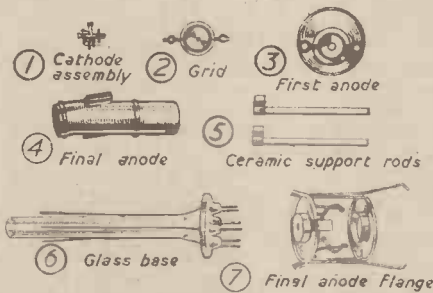

Fig. 8.—The elements which make up the cathode-ray tube. The references relate to the illustration on page 436.

increase in screen brilliance and secondly, it provides an effective safeguard against ion bombardment which rapidly destroys the active material. The cathode is, of course, the most important part of the tube. It is made of nickel in the form of a cylinder, but because this would not, in itself, provide a sufficiency of electrons, it is coated with a material which readily emits electrons. One of the coatings commonly used is barium-strontium carbonate, with a trace of calcium, bound with a nitro-cellulose medium in lacquer form so that it can be sprayed on to the surface of the nickel. It is usual practice for the screen and the tube envelope to be manufactured separately, then to be welded together. The screen is then coated, next the electrodes and then the assembly inserted. Evacuation of air and gases is now commenced. The tube is baked whilst evacuation is in progress so as to draw off surplus gases, and to assist the process, the electrodes are heated to a high temperature by an external source of H.F. radiation. This heating fires the "getters," which destroy any residual gases. This getter is usually of magnesium, and the resulting silvery deposit not only acts as a final absorbent of unwanted gases, but it also absorbs gases produced during its working life. An indication of the condition of the tube can be obtained from the getters. A tube which is becoming soft will show itself in a milky appearance of the getters.

In recent years, metal tubes with glass-fronts

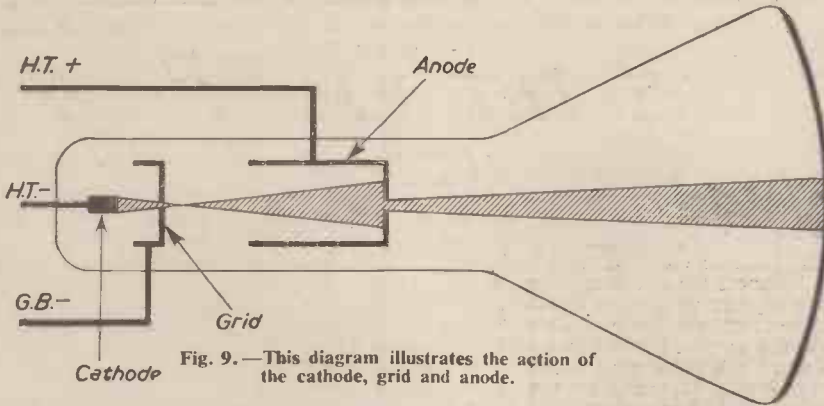

Fig. 9.—This diagram illustrates the action of the cathode, grid and anode.

diverted the required scanning distance the voltage suddenly drops.

This cycle of operations is repeated, so providing the saw tooth motion of the scanning spot.

The principle employed in the production of saw-tooth wave-forms is that of the charge and discharge of a condenser, in which the slow rise of voltage across the plates is made use

deflection being proportionate to the potential charges given to the plates.

It is by this means that the visible spot on the screen may be moved to describe any definite path within the space limits of the screen. With all scanning processes there is a primary and a secondary movement, the primary movement depending upon the number of strips dividing the picture and the picture frequency per second, and the secondary movement simply on the picture frequency per second. The number of lines in a television picture is, of course, constant at 405, and the number of frames per second is 50. With regard to the primary movement, the spot has enough movement at constant velocity from the top of which a quick return or "flyback" is made, and the process is then repeated, next to the line just following, the picture being scanned horizontally. This movement is termed "saw tooth" motion, and it is this horizontal scanning by a single spot of light, as already stated which gives the illusion of the picture on the screen. Each pair of deflector plates is connected to a separate frequency generator, and if a suitable voltage variation is applied to one pair of plates, the required primary scanning motion can be brought about. What is commonly known as a timebase circuit is included in all television receivers which is essentially a saturated diode valve, connected with a bias discharge tube and a fixed condenser in such a way that a uniformly increasing potential is applied to one pair of the deflector plates in the cathode-ray tube. The electron stream is thus deflected in a uniform manner, so that the spot describes a line on the fluorescent screen. A triggering action incorporated in the circuit so that when the electron

stream has been of to attract the light spot across the screen. The sudden discharge of the condenser allows the spot to return to its initial position in readiness for the following sweep. In the majority of oscilloscopes, only a single-line timebase is employed, the spot sweeping across the screen at a speed of several thousand miles per second, as already stated, and because of the persistence of vision, giving the illusion of a straight line without a break. In television, however, it is necessary to introduce a system which will prevent the spot from moving along its own track with every sweep, but yet will permit downward movement by an amount equal to its own diameter. In this way, a complete area of the screen is covered by the spot building up what appears to be a continuous area of light. So, it becomes necessary to employ two timebases, one to move the spot horizontally and the other to move it vertically. This is achieved in the following way. A condenser is charged, through a resistance from a source of D.C., and is abruptly discharged when a certain point is reached, and this is usually achieved by means of a valve which has reached saturation point.

(To be continued.)

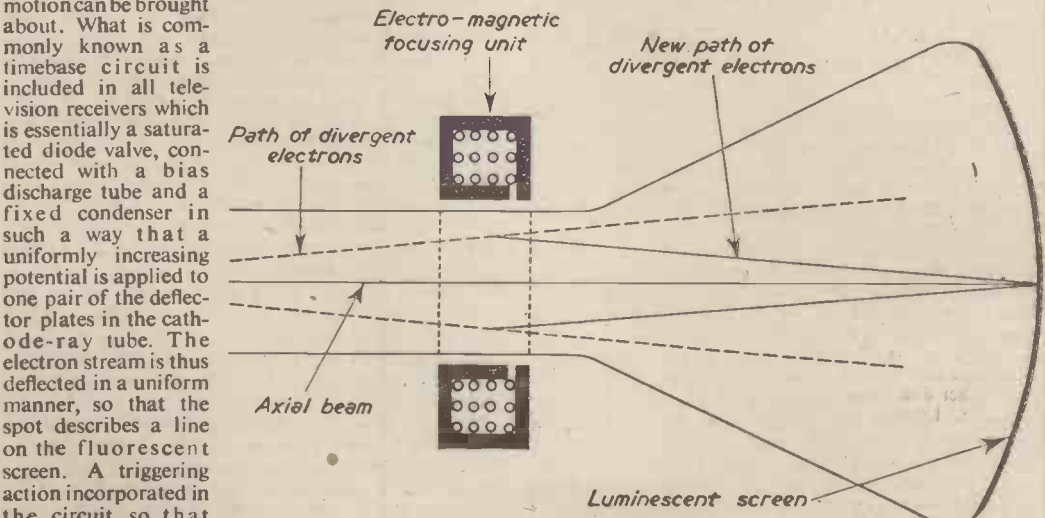
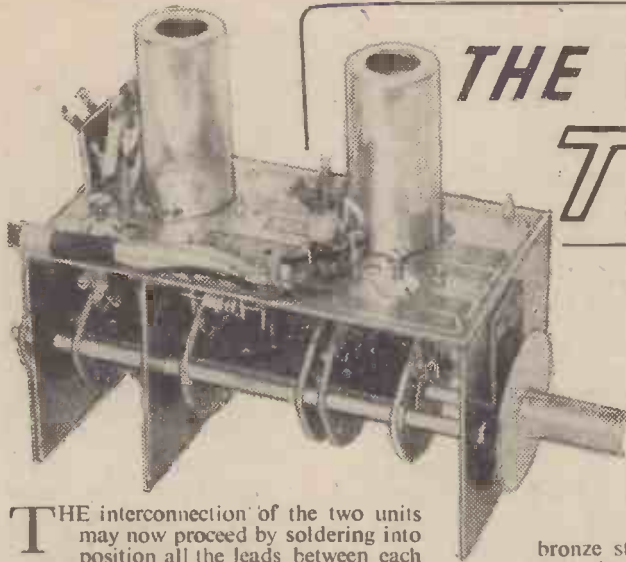

Fig. 10.—This shows the action of the focusing magnet on the electron beam. The action is just the same with a permanent magnet.

when the electron



THE V.M. TV Tuner

DETAILS OF A 3-STATION TUNER
DESIGNED FOR THE VIEW MASTER,
BUT WHICH MAY BE USED WITH
OTHER RECEIVERS

(Continued from page 411 February issue)

THE interconnection of the two units may now proceed by soldering into position all the leads between each wafer and its appropriate termination on the printed panel. When wiring the oscillator section a lead from the back of the oscillator fine tuner disc should be taken direct to the switch tag to which is connected C19.

At this stage a small two-way tag panel should also be fitted to the back of the tuner on to which the coaxial aerial feeder may be terminated. On this tag strip are also mounted condensers C1, C2 and resistors, R1, R2 which are then taken direct to the terminations on the top of the aerial coil, L1. This completes all the inter-unit wiring and the constructor is again urged carefully to recheck the assembly to ensure that no faults exist. If completely satisfied that everything has been done correctly the supply leads may be connected to the top of the coaxial feed-through condensers C22 for the heater supply and C17 for H.T.+ with a common chassis lead taken through a hole in the panel adjacent to C17 and soldered on to the underside of the panel. Finally, connect a short length of coaxial feeder to L13, clamping the feeder in position on the panel so as to prevent any strain being imposed on the coil terminations. The assembly of the tuner is now complete and it only requires to have its external screens fitted, then alignment carried out. The recommended screening box for the tuner shown in Fig. 7 will be seen to be made in two parts; the purpose of this is to enable the Band III coils to be adjusted through the gap remaining between the panel and the top of the screen. Only when this alignment has been carried out should the screen be finally assembled. Only one further item is now required on the tuner before alignment and this is the fine tuner disc mounted concentrically with the switch spindle. Dimensions for this tuner disc are given in the diagram and it may be made by soldering a disc of metal of the correct size on to the hexagon nut normally used for clamping the switch on to a panel and then soldering on a short length of tubing on to the other side of the nut so as to permit a knob to be mounted on it. To prevent too free a movement of the oscillator fine tuning control a piece of phosphor

bronze strip should be fitted on the front of the tuner (under one of the switch nuts) and arranged to press lightly against the back of the adjustable metal disc. In this way it will impart some friction against the disc and prevent it shifting in the event of vibration occurring. It will also make the adjustment of the oscillator somewhat smoother.

Before putting the tuner into operation it will now be necessary to connect up switch SW5. The exact method in which this is wired will depend on the signal strength of the respective transmissions. It has previously been stated that the maximum gain should always be obtained from the tuner, the gain of the I.F. amplifier being adjusted to give the correct level of picture. But this will only apply to those areas, such as screened or fringe areas, where the signal strength is on the low side.

Where, for example, a receiver is located in an area of high signal strength, particularly in a swamp area, then the gain of the tuner must be reduced to prevent overloading and cross-modulation. To give two examples of this type of arrangement. In North London the Band I signal from Alexandra Palace is excessive and can swamp many receivers whereas the Band III signal from the Crystal Palace is very much weaker. In this case, SW5, when switched to the Band I position would bring into circuit a variable resistor of such a value as to reduce the gain of the tuner, whilst in the Band III position the maximum gain would be obtained from the tuner (SW5 arranged to connect C5 to chassis) and the gain of the I.F. amplifier adjusted for the best picture.

If the receiver were operated in South London where the signal from the Crystal Palace could swamp it, then the controls would be reversed, the maximum tuner gain being obtained on the Band I position and reduced gain in the Band III position. It is also possible to connect C5 direct to the I.F. amplifier gain control in which case the tuner and I.F. gain will be controlled together. Whichever method is adopted the main idea to bear in mind is to adjust the gain on the two channels so as to give pictures of equal quality, brightness and contrast when switching from one to the other.

Alignment of the Tuner

If construction of the tuner is now complete and if, after cross checking, no faults have been found, arrangements for alignment can proceed. Before doing any actual alignment it will be necessary to make an insulated screwdriver from a piece of Polystyrene, Perspex or even a knitting needle, for the adjustment of the dust cores in the moulded coil formers, and also for adjustment of the Band III coils, which require to have the turns either opened out or closed together, depending on the inductance values. In addition, it will be helpful to have a resonance indicator when adjusting the Band III coils. This is best made by inserting into one end of a piece of systoflex, or other insulating tubing $\frac{1}{16}$ in. or $\frac{3}{16}$ in. in diameter, a small piece of an iron dust core as used for the adjustment of tuning coils, this need not be more than $\frac{1}{2}$ in. long. At the other end of the systoflex there is then inserted a short length of brass taken from a 6 B.A. or 4 B.A. screw. This tuning indicator is used in the following manner. If the dust core is inserted into a coil and resonance is found, then the turns of the coil require closing. If, however, the brass core has to be inserted for resonance, then the turns have to be opened out. Resonance will be clearly indicated by an increase in brightness or contrast of the picture.

The heater supply of the tuner requires to be 16 volts A.C. and the H.T. supply approximately 190 volts. The 16 volts A.C. supply must, of course, be obtained from a separate heater transformer. There should be no difficulty in obtaining a transformer with this output as similar transformers are readily available for use in A.C. mains trickle chargers. The 190 volts D.C. supply is best obtained from the View Master H.T. supply, a resistor of 3.5 K Ω being connected in series to reduce the voltage, and at the same time a decoupling condenser of approximately .01 μ F connected to chassis.

Two further points require to be seen to before alignment is actually commenced. In the first place,

to ensure the minimum effect from microphony on Band III, and it is only on Band III that it is likely to occur, it is necessary to ensure that the Band III oscillator coil is in no way springy. Though copper wire is not normally springy, the effect when it has been wound tightly on to a former and the wire stretched, is to harden it and to impart some appreciable springiness. The coil is best treated by placing a lighted match or other heat source immediately against it, if necessary repeating this several times. Any carbon deposit or dirt remaining on the coil after this treatment can be completely ignored. A further point to consider is that resistor R14 has been included to ensure an adequate bandwidth for the tuner. It need not, however, be included where the tuner is to be used with the View Master I.F. Amplifier modified according to the instruction published in the December issue of PRACTICAL TELEVISION, since a damping resistor is already connected across the first tuning coil. R14 may in these cases be deleted, the sensitivity of the tuner being increased very slightly.

The alignment procedure now to be described is based on the use of a signal generator, but if this is not available details will also be given for alignment on a radiated signal. This has been found to be relatively simple and straightforward, and with care a satisfactory performance can be obtained. Alignment on a signal can, however, only be done reliably so long as the I.F. amplifier has itself been aligned with a signal generator. Though it is not impossible to align both the I.F. amplifier and the tuner on a signal it must of necessity be an extremely lengthy and difficult procedure.

As incremental inductance tuning is used in the tuner it is essential that the alignment should first be carried out on the highest frequency channel, in this case Channel 9, with the wave-change switch in a fully clockwise position. With the tuner connected to the I.F. amplifier and the signal generator connected to the "test point" on the tuner, feed in a

signal of 36.5 Mc/s and adjust L12 for maximum output judging this by an increase in the brightness of the modulation bars on the face of the C.R.T. At this stage the opportunity may be taken of rechecking the alignment of the I.F. amplifier, which should conform to the instructions laid down on page 298, of the December, 1955, PRACTICAL TELEVISION.

The signal generator should now be connected to the input of the tuner and adjusted to a frequency of approximately 193 Mc/s, which is the mid-point between the Channel 9 vision and sound carrier frequencies. The tuner gain control should be at maximum, C18 in approximately the mid-position, the fine

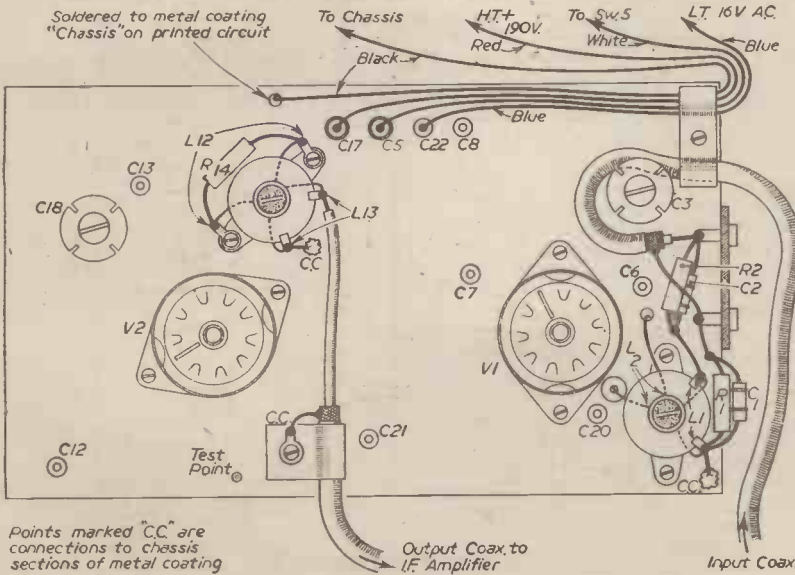

Fig. 9.—Top of panel wiring. The remainder of wiring is shown in Fig. 10.

Points marked "CC" are connections to chassis sections of metal coating

tuning control unscrewed by one complete turn, and the core of L2 half-way into the former. The output from the signal generator should be turned to maximum and the oscillator coil L10 adjusted with the aid of an insulated rod, checking beforehand with the resonance indicator to determine whether the coil requires to have its turns opened out or closed up. With the oscillator coil set approximately C18 may be adjusted to give the correct setting after which the grid and anode windings of the intervalve transformer should be similarly adjusted, now the dust core of L2 may be set for maximum output. In the case of the V2 grid coil there is little need for adjustment though in some cases an increase in signal strength may be obtained by reducing the size of the single loop or even by shorting it right out. As each coil is adjusted for maximum so the output from the signal generator should be reduced, since otherwise overloading will occur.

At this stage condenser C3 will have to be set. In the first place the adjustment is for maximum signal strength though subsequently when a picture

is being received it should be readjusted to a position which will be found close to maximum but which may then give some reduction in background noise. The size, spacing of the turns and positioning of L4 affects the position of the settings of both L2 and C3. If, therefore, either L2 or C3 tend to be at their limits, a slight readjustment of L4 will give a tuning position where resonance is more easily achieved.

If the signal generator is now set to 191.25 Mc/s a sound signal should be received. The oscillator trimmer C18 can very slightly be reset to give an increased output though L12 should on no account be readjusted as otherwise the sound output will be increased at the expense of vision bandwidth. All the above adjustments should now be repeated making certain that each circuit tunes satisfactorily.

The instructions above relate essentially for adjusting the tuner to Channel 9. Channel 8 then being automatically brought in by setting the wave-change switch to the mid position. Where, however, the TV tuner is primarily intended to be used in a

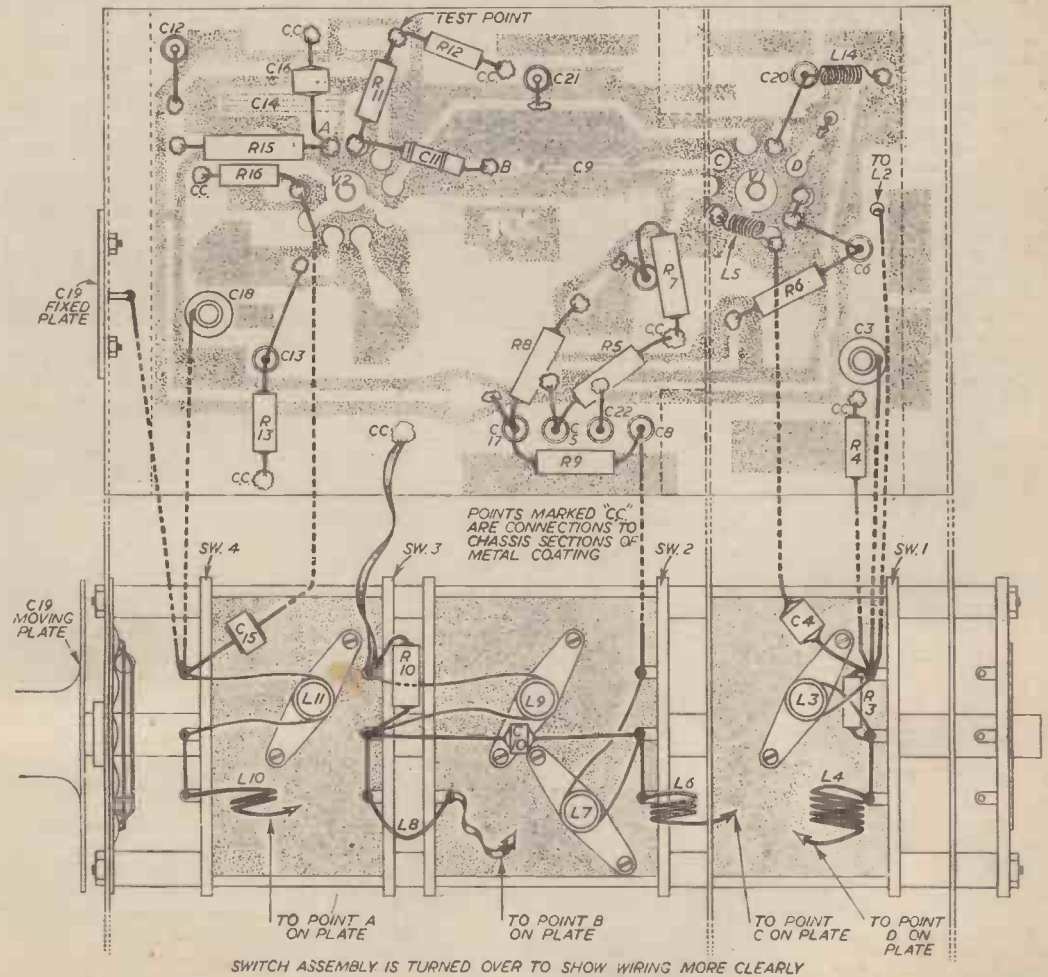

Fig. 10.—Essential wiring details—to be read in conjunction with Fig. 9.

Channel 8 area, then the switch should be set in the mid position before alignment commences. The respective coils are then adjusted exactly as specified above but with the signal generator set to a mid frequency of 188 Mc/s. Channel 9 will then be received with the switch in the fully clockwise position.

Instability

If, when adjusting the various circuits for maximum output, some degree of instability should be experienced, it will invariably be an indication that the de-coupling condensers which have been fitted have been badly soldered with the result that the capacity has fallen. It has been found in practice that C7 is most prone to cause instability in the event of a fall in capacity and this ill effect may readily be overcome by connecting a condenser of .001 μ F or .002 μ F capacity from the top of C7 above the printed panel directly to an earthed copper portion of the panel. It is essential if this is done that condensers should be connected with extremely short leads so as to minimise the series inductance and for this reason a ceramic disc or tube condenser is recommended.

With the Band III alignment complete the wave-change switch may be turned fully anti-clockwise into the Band I position and a very similar procedure carried out, though in this case the frequency fed from the oscillator will be dependent on the channel used but should in any case be approximately in the centre of the vision/sound channel. In the case of Channel 1, vision at 45 Mc/s and sound at 41.5 Mc/s it is best to set the signal generator at around 43 Mc/s. The oscillator coil L11 is then adjusted for maximum output, this being followed by L9, L7 and L3 respectively. The above adjustments may be gone over once again after which the alignment is virtually complete. It should, however, be possible to take the resonance curve over the complete R.F. and I.F. chain and thereby get an indication of whether the definition of the picture will be satisfactory.

Where a signal generator is not available then alignment may be carried out with the aid of a signal received from the transmitter, though as has already been mentioned, it is almost essential to have the I.F. amplifier correctly aligned. If the I.F. amplifier is correctly aligned then there will be little difficulty in obtaining a satisfactory performance and only in the fringe areas is any difficulty likely to be experienced mainly due to finding the signal.

Alignment on a radiated signal

With the aerial connected and the tuner and I.F. amplifier operating, set gain controls to maximum, and with the tuning indicator determine the resonance point of the Band III oscillator coil L11, adjusting this by spacing the turns and finally resetting the trimmer C18. Adjust the grid and anode windings of the inter-valve transformer, taking care to turn the gain control down to prevent overloading, then adjust L2 and L12 for maximum. The input circuit to the I.F. amplifier, i.e., I.F. amplifier V1 grid coil,

should now be set for maximum output, and finally C3 adjusted to maximum. At this point C3 may be reset off resonance to give an improvement in background noise and if necessary L2 also reset. If the reception of the Band III signal is now satisfactory the tuner may be switched over to Band I and again the oscillator coil adjusted to receive a transmission, then coils L9, L7 and L3 adjusted in that order for maximum signal strength. Occasionally a slight readjustment of the inter-valve transformer windings L7, L9, or even L3 may be found advisable to give a picture of improved definition. Finally, lock all dust cores with a small piece of molten wax to ensure that there is no subsequent movement. In the case of the ceramic trimmers no locking will be necessary as these are automatically locked by the spring nut.

So as to obtain the Band I and Band III signals with a single input to the tuner, it is essential that

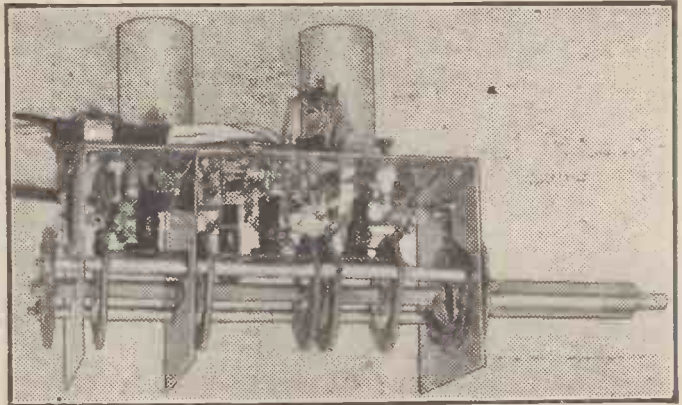

This view of the tuner clearly shows the metal strip connection from SW. 3 to CC.

either a combined Band I Band III aerial is used, or where maximum signal strength is required then separate aerials should be used, each aligned in a direction to pick up the maximum signal, the respective signals then being combined in a cross-over unit. A common feeder from the cross-over unit may then be taken directly to the input of the tuner.

Little has so far been said about the function of Switch SW5, which is the wafer fitted at the rear of the TV tuner. It was explained in the previous article that the purpose of this switch was to pre-set the gain on the respective channels so that when switching from one channel to another it would not be necessary to readjust sensitivity and contrast. It was also stated that it is usually best to operate the tuner at maximum output particularly when receiving weak signals, and therefore when adjusting the overall sensitivity of a receiver this is best done by controlling the gain of the I.F. amplifier. In this way the signal-to-noise ratio is improved and the background of the picture remains clean. Switch SW5 should therefore be connected to two or if necessary three separate variable resistors which may then be connected in series with the I.F. amplifier gain control whilst condenser C5 on the TV tuner is taken direct to chassis.

(To be continued.)

CONVERSION AT I.F.

MODIFYING THE SUPERVISOR, TELEKING AND SIMILAR CIRCUITS FOR BAND III RECEPTION

By W. J. Delaney

PRACTICALLY all of the Band III converters at present available or which have been described in these pages consist of a frequency changer preceded by some form of H.F. stage—either a straight H.F. pentode, or a cascode double-triode—and give an output at Band I frequency. Whilst these function very satisfactorily with the majority of receivers the performance lacks something when used with circuits such as the Supervisor or Teleking. Both of these receivers, as well as certain other models, employ two I.F. stages with broad-band characteristics, and

stage as possible. In addition to the B7G valveholder, you will need a single screened coil wound on a former of the same type as those used in the converters in the August and September issues. These may be obtained from any good radio dealer. Also required are the following:

- One 10,000 ohm $\frac{1}{2}$ watt resistor.
- One 100,000 ohm $\frac{1}{2}$ watt resistor.
- One 180 ohm $\frac{1}{2}$ watt resistor.
- Two 1,000 pF ceramic condensers.
- One standard coaxial socket.
- One B7G valveholder and adaptor plug (for power supplies).

The stage is wired as shown in Fig. 1, the anode pin of the new valveholder being joined direct to the anode pin of the frequency changer valveholder in the receiver.

The reason for mounting the valveholder close to the frequency-changer will now be apparent, this lead from anode to anode must be as short as possible.

The power leads may be joined direct to tags in the existing wiring or to the additional B7G valveholder and the adaptor plug joined to the leads on the new tuner.

The coil for the stage will consist of 50 turns of No. 36 enamelled wire, close wound, and positioned near the base of the former. The resistor should be

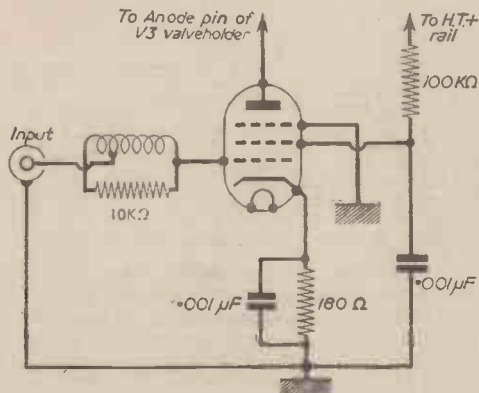

Fig. 1.—The additional I.F. stage for use with the conversion described here.

two R.F. stages. For various reasons there is little doubt that the most satisfactory form of "conversion" for receivers of this type is to replace the existing R.F. and frequency changer stages and inject the Band III transmission at the receiver's I.F., and by this means maximum performance may be obtained on both stations. The only drawback to this arrangement is lack of sufficient gain, as the converter will be one R.F. stage less than the existing arrangement. Tests which have been carried out with both the Supervisor and Teleking show that this failing may easily be overcome by adding another I.F. stage to follow the converter when the latter is in circuit, and such an arrangement enables the listener to utilise one of the several multi-channel tuners which are now on the market, as well as to employ an I.F. injection type of converter with its undoubted advantages. At this stage it must be pointed out, however, that although tests were carried out with a Teleking receiver we cannot, for obvious reasons, deal with servicing problems arising in this particular receiver and such enquiries must be addressed to the sponsors of the circuit. The following data, however, is applicable to any two-R.F. two-I.F. type of circuit—either home-made or commercial.

The New I.F. Stage

The first requirement is a new I.F. stage and this should be inserted as close to the frequency changer



The "Unsals" converter, which is recommended for the conversion of Supervisor, Teleking and similar circuits, for injection of Band III signals at I.F.

included inside the coil can and, therefore, be joined across the side wires of the coil. Make certain that it is joined across the ends of the coil—not from the tapping to one end. The tap is at the fifth turn from the “earthy” end of the coil.

Using Turret Tuners

The coaxial socket should be mounted close to the new coil can and the shortest possible lead used to connect it to the tapping on the coil. If a turret type of tuner (or other multi-channel tuner) is now to be used, the output lead from the tuner is plugged into the new coaxial socket and the existing R.F. and frequency changer valves removed from the set. One of these should be plugged into the new valveholder. A single aerial lead is then connected to the input

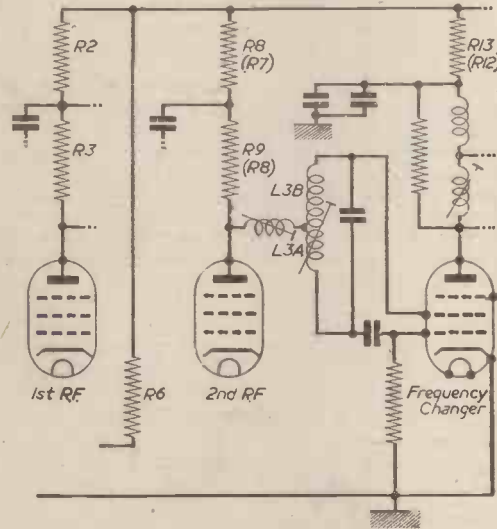

Fig. 2.—The R.F. and frequency changer stages of the Supervisor and Teleking. References for the latter are in brackets.

socket on the tuner, using a Combiner or Diplexer or similar arrangement preferably at the aerial end to combine two aeriels and thus enable a single length of feeder to be used. This then converts the receiver into a multi-channel tuner with three I.F. stages, and as the values given provide the additional I.F. stage with rather low gain there should be no noticeable increase in valve noise, but existing signals should be just as good as they were previously. It is necessary, of course, to tune the new coil and the output coil on the tuner to provide adequate band-width—usually tuning them one on each side of a required signal. Setting up is best carried out on the Band III signal, tuning the output of the tuner to about 10 Mc/s and the coil in the receiver to 12 or 13 Mc/s. As with most tuning, adjustments are best carried out on Test Card C, making certain that the adjustment holds for both Band I and Band III. It is easy to get an adjustment on one Band which will not be successful for the other, and switching from one to the other is desirable to obtain maximum performance. The tuner which we have found most satisfactory for this form

of conversion is the Valradio (Valradio, Ltd., New Chapel Road, High Street, Feltham, Middx., price £6), as this is of the incremental type, and the tapping points are set and fixed by the manufacturer with the result that there is only the output transformer to

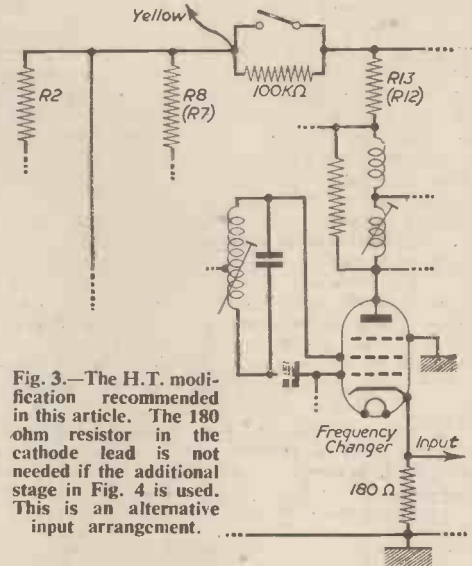
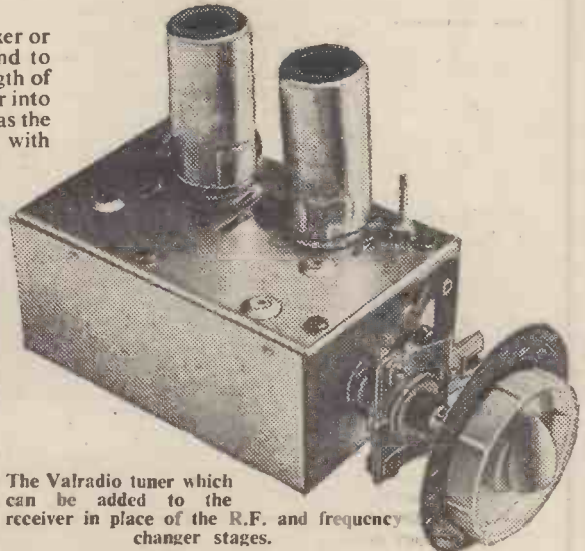

Fig. 3.—The H.T. modification recommended in this article. The 180 ohm resistor in the cathode lead is not needed if the additional stage in Fig. 4 is used. This is an alternative input arrangement.

trim—no other tuning points are provided. When using this tuner it will be found that one cannot turn to a given band and then return to the original band and find the signal present. At all times, when the central selector switch is operated, the outer trimmer should be turned in the opposite direction to recover the signal. This tuner is not of the 12 or 13 station type, but has continuous tuning from 40 to 100 Mc/s in four steps, and from 170 to 225 Mc/s in two steps. There will be found to be two tuning points with the Supervisor, but on only one will sound be present.



The Valradio tuner which can be added to the receiver in place of the R.F. and frequency changer stages.

The tuner is made in several models, and that required for the Supervisor or Telexing is the TP13P.

Conversion

For the simple conversion the most satisfactory unit we have found is the "Unisal" (price £6.10s.) made by Graham Taylor, Ltd., of 7, Stanhope Row, W.1. (This also is available in several models, the appropriate one for the receivers under review being Type D.) This consists of the standard cascade and frequency changer (with the usual ECC84 and ECF80 valves), which provide an output which can be tuned to the required I.F. It provides a remarkably "clean" picture and has a "fine" tuner. There is a four-pole selector switch in this unit and one lead connected to this switch is coloured yellow. To adapt the Supervisor for this unit an additional 100 KΩ half-watt resistor is required, and this is inserted in the H.T. feed to V1 and V2, and shown in Fig. 3. The lead marked "Input," and the 180Ω resistor in the cathode lead should be ignored for the time being. The R numbers here are those in the Supervisor, with the Telexing numbers in brackets. It will be seen that the yellow lead is joined to the V1, V2 side of the resistor, and one side of the appropriate switch is already joined to H.T. plus in the unit. Thus, when switched to Band I this additional resistor is short-circuited, but when switched to Band III the switch is opened, and the resistor thus reduces considerably the H.T. on V1 and V2. In addition to rendering these extremely insensitive, the reduction

of H.T. on V2 automatically reduces the screen voltage on the frequency changer and stops this oscillating. The Band III signal is then conveyed via the additional I.F. valve to the I.F. stages exactly as in the previous arrangement, using the channel tuner, the arrangement being identical for the two cases. The only difference in working is that with this arrangement the receiver performs exactly as in its present condition on Band I and the change to Band III cuts out the first three valves and provides a Band III signal with three stages of I.F.

The Band III aerial is plugged into the converter, and the Band I aerial is left connected to the receiver.

If a single aerial is employed with this arrangement, or two aerials are combined with a Diplexer or similar scheme, and thus have a single aerial feeder, this may be joined direct to the converter, and a separate length of coaxial lead joined to one of the spare tags on the selector switch mentioned. It will be found that the aerial lead on the converter is taken to the arm of one of the switch sections, and in the Band III position this is connected to the input coil on the tuner. In the Band I position there is a blank tag on the switch. Solder the new lead to this, connecting the screening to that round the existing coaxials on this switch, and drill a 1/8 in. hole in the side or base of the case (according to the position which the converter is to occupy in the cabinet). This new lead should then be provided with a coaxial plug and inserted in the aerial socket on the Supervisor, and thus a single lead may be employed.

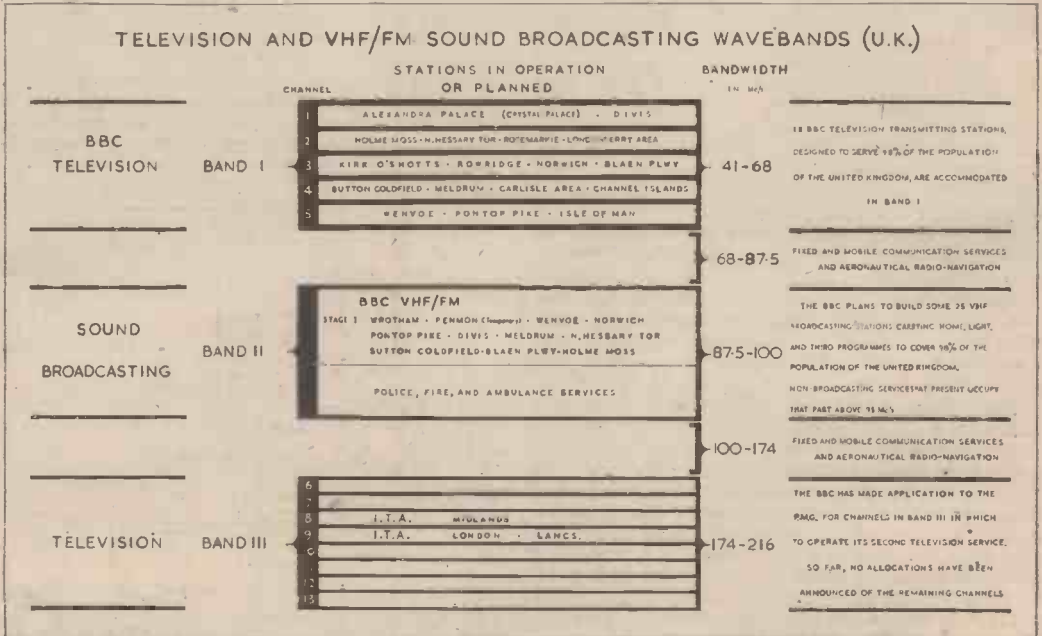

The accompanying diagram shows the present allocation of Bands I, II and III for V.H.F. sound broadcasting and television.

The BBC has applied for channels in Band III for its second television programme service, but the Postmaster-General has not yet announced any further allocation of channels in this band.

The chart does not show Bands IV and V, which

extend from 470-585 and from 610-960 Mc/s. These will in due course be divided into television channels, but the number of channels and their allocation are not yet decided.

BBC V.H.F. sound broadcasting stations at present in operation are Wrotham (Kent), Penmon (Anglesey—temporary), Wenvoe (near Cardiff—part completed) and Pontop Pike (near Newcastle-on-Tyne).

Servicing TELEVISION RECEIVERS

No. 18.—THE MURPHY V120C

By L. Lawry-Johns



THIS receiver is a console employing a 12in. Mazda CRM 121 tube and a superhet circuit. It is for A.C. mains only, and the chassis is not connected to one side of the mains as are the majority of more recent receivers, therefore it is a little more "safe" to work with except in the event of a heater to cathode insulation failure of the U403 valve. The heater arrangement of this valve is rather unusual since it is supplied from the primary side of the mains transformer as Fig. 1 shows. Therefore, if the fuse blows with the mains plug inserted one way round but not the other, or in the case of a three-pin connection, when the leads are reversed, change the U403. Without an earth connection, the chassis would just become "alive," and would thus constitute a danger to the unwary.

The vision I.F. circuits respond to a basic I.F. frequency of 13.5 Mc/s, whilst the sound I.F. is aligned to 10 Mc/s. The layout of the chassis is such that the valve bases, etc., of the vision/sound chassis are exposed when the rear cover is removed. Approximately half way down on the right side is the oscillator tuning core adjustment. Sound on vision and vision on sound can usually be removed by a slight adjustment to this core.

For the benefit of those not so well acquainted with servicing, sound on vision shows as an interference with the vision which is directly proportional to the sound intensity. Note that the volume control has no effect upon the trouble at all. This is caused by the vision stages responding to a degree to the sound signals, usually due to an incorrect oscillator setting. Obviously, if an incorrect oscillator setting can cause sound on vision it can also cause vision on sound when it is in such a position where the sound stages will respond to the vision signals. Whereas sound on vision causes the picture to be disturbed in sympathy with the sound modulation, vision on sound shows as a buzz which varies with the white picture content.

To revert back to the receiver, although the valve bases and wiring are exposed when the back cover is removed, the valves themselves are quite easily replaced, as the chassis is hinged and swings down-

ward. It is secured by a screw at each top corner, but the tube base and clamp must be removed so as to allow the chassis to be lowered. Care must be exercised as although the clamps may be swung clear, the top half is spring loaded, and should be eased over the tube base. Once the chassis is horizontal the valves may be removed if so desired.

Apart from an occasional dry joint or other poor connection to a valve base, this part of the receiver gives little trouble. The oscillator anode load resistor which on the earlier V114 and 116 receivers often became open circuit, thus causing loss of sound and vision, is on this model a larger type which rarely gives trouble (33 K. 1 watt). This can clearly be seen against the oscillator core adjustment and is distinguished by its size and orange colour.

A Sound Fault

On the lower part of this chassis will be found a 3.3 M Ω resistor, wired in conjunction with another resistor (3.3 K) and a 20 μ F electrolytic capacitor. This resistor (orange, orange, green), often increases in value and causes distortion of sound. This is due to the limiter diode working under restricted conditions and a replacement resistor temporarily shunted across the 3.3 M Ω will quickly verify the diagnosis.

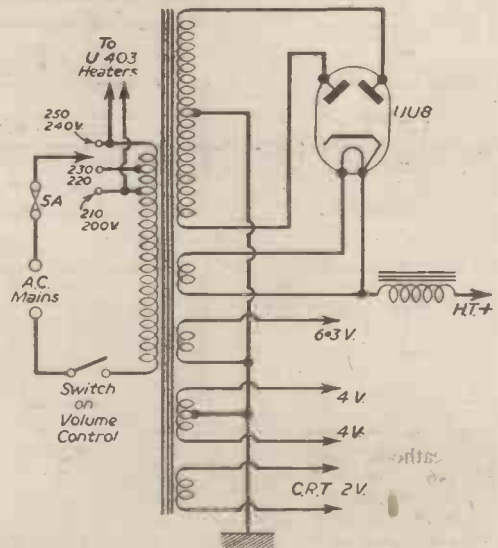

Fig. 1.—The power pack showing the V403 heater connections.

Video Detector and Amplifier

Still viewing the receiver from the rear, in the upper left corner is the 6D1 detector diode. This is a small valve with a three-pin base and a single wire top anode. Under this is another 6D1 which functions as the vision interference limiter. Between these is the valve base of the 6F12 video amplifier. The connections, and circuit, of the video amplifier do not follow common practice. The anode of the 6D1 detector is directly wired to the control grid of this valve and thus the input is negative going. The reason for this is because the video signals are fed to the CRT grid from the video amplifier anode rather than the cathode. Therefore a positive going signal is required. The anode load is a 10 K resistor and the signals developed across this are applied to the CRT grid via an H.F. choke which is shunted by an 82 kΩ resistor. Also connected at this point is the anode clip of the 6D1 interference limiter.

When the CRT starts to lose emission and the highlights tend to be "flattened," disconnection of this anode clip often restores some of the lost brilliance as more contrast can be used without the limiter operating and clipping the peak whites.

The signals at the video amplifier anode are, as stated, positive going and this is not the type of input required by the sync separator arrangement. Therefore, the input is derived from the cathode circuit of the video amplifier as shown, Fig. 2. The cathode load resistor is 1.8 kΩ and the resulting composite signals are applied to both anodes of a DD41. The input to the line timebase T41 oscillator control grid is taken from one cathode via a resistance capacitor filter, whilst the frame T41 is fed from the other cathode via a resistance choke network.

Line Timebase

Viewed from the rear the line timebase T41 and PEN46 are located on the top of the left side of the second chassis. Most of the troubles due to improper line lock, varying line oscillator speed, ragged picture, etc., can be cured by replacing the T41, whilst poor linearity, lack of width and kindred troubles are often due to the PEN46 losing emission. The voltage at pin 4 should be checked, however, as the screen dropping resistor (2.2 K) can vary in value. A voltage of some 230 should be recorded if the valve is working properly, or higher if the emission is low.

The booster diode and E.H.T. rectifier (U24) are located at the bottom of the chassis. As previously mentioned, the booster diode (U403) has its cathode taken to chassis. Its anode is indirectly wired to the cathode circuit of the PEN46. An 8μF electrolytic is wired in this circuit and if a complaint of poor width and linearity does not respond to PEN46 and U403 replacement, a new 8μF will nearly always cure the trouble.

A 1μF capacitor is wired in series with the line scan coils to prevent the flow of D.C. current which would effect an undesired horizontal picture shift if it were not blocked by the capacitor.

The U24 E.H.T. rectifier is fed from an overwind on the line output transformer and the resulting 6.3 kV D.C. at the cathode is supplied to the C.R.T. anode, smoothed by a 500 pF capacitor. The complaint of "No E.H.T., line timebase working," should direct attention to this capacitor if the U24 in in order.

When the timebase is working properly *negative* voltages between 35 and 40 should be read at the cathode of the PEN46 and U403 anode circuits.

Frame Timebase

This is of conventional design, a T41 oscillator feeding a PEN45 output valve. Once again, instability in a vertical direction, jittery picture, white horizontal lines at the top of the raster, etc., may usually be cured by T41 replacement.

This T41 and the frame PEN45 are on the *right* upper side of the second chassis. The small preset control mounted on the upper flange of this chassis is the frame linearity control which varies the spacing of the lines at the top of the raster.

A frame scan which is cramped at the bottom should call attention to the efficiency of the PEN45 valve although the presence of the 8μF screen decoupling capacitor, wired from screen to cathode, should not be forgotten and this should be tested for capacity. Voltages to be expected are: T41 anode 80 volts, PEN45 screen (pin 4) 190 volts, PEN45 anode (pin 3) 240 volts, with the cathode (pin 2) at approximately 10 volts.

Brilliance Control

This is a 50 K. brought out to the front panel and this varies the cathode potential of the C.R.T. With an expected grid voltage of 170 the cathode

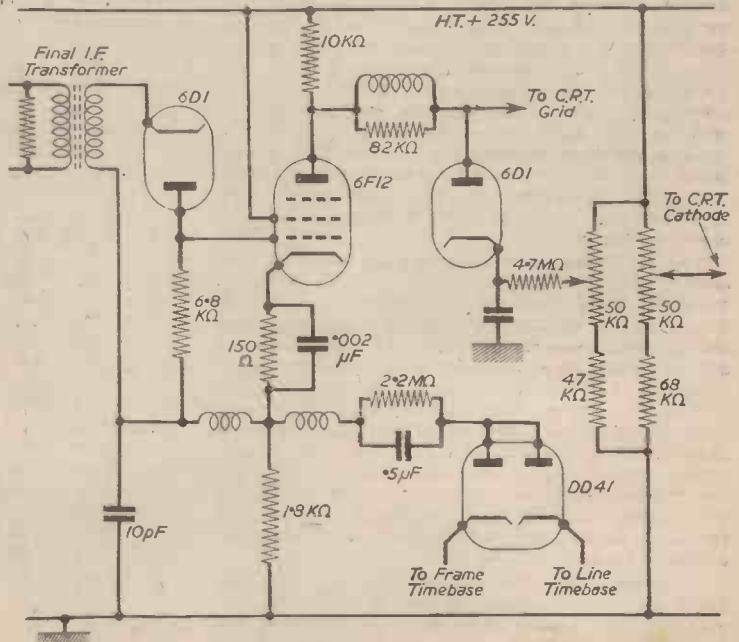

Fig. 2. —The video detector, amplifier and sync separator.

should swing from 250 to 175 approximately. The fact that the C.R.T. is grid modulated means that a cathode to heater short or leak will not impair the picture quality in any way. Therefore, if a tube is required, one with good emission but a heater/cathode short may be fitted and will give excellent results without modification of any kind. The symptom of maximum brilliance indicates a defect in the video amplifier stage and instead of 170 volts being recorded at the anode, something like 250 volts, which is approximately that of the H.T. line, will be found which indicates that no voltage is being dropped across the load resistor due to the 6F12 failing or being operated in such a way as to cut off the current. This could be caused by excessive bias or an open-circuited resistor.

The symptom of no brilliance at all indicates that the video amplifier is passing too much current. This may be due to the 6F12 being "soft" or again to a biasing fault in the cathode circuit. A less likely cause is for the anode load resistor to change its value and "go high." As previously stated, 10 K is the proper value.

In the event of a "No picture," "No raster" condition, it is always worth while to take a look under the chassis to check the condition of the U24. If it is "blue," it is quite possible for the valve itself to be at fault or for the 500 pF capacitor to be shorted or leaking badly. If no light at all can be seen, check the anode with a screwdriver blade for E.H.T. spark. If a spark is present check the U24 and if no spark is present concentrate on the line timebase, T41, PEN46, U403, etc.

Vision Stages

The aerial feeder cable should be of the screened balanced twin type; the use of coaxial is not advised.

The balanced input is taken to the tapped aerial coils and thence to the common R.F. amplifier, which is a 6F12 valve. This has a set of tapped coils in its anode circuit and these connect to the control grid of the 6C9 frequency changer, which is a triode heptode. The triode section is the local oscillator tuned by alternative coils and the oscillations are electron coupled by a grid in the heptode section, which is used as the mixer. The resultant I.F. signals appearing at the heptode anode 13.5 Mc/s vision, 10 Mc/s sound, are split by a transformer, which couples the sound signals to the first 6F12 sound I.F. amplifier and acts as a sound rejector in the grid circuit of the first vision I.F. amplifier. This 6F12 has the contrast control in its cathode circuit as well as a sound rejector.

The contrast, therefore, affects vision only, which is as it should be, and the sensitivity (preset screwdriver adjustment) controls both the vision and sound amplification of the common R.F. amplifier.

A second 6F12 vision I.F. amplifier follows the first and the output of this is transformer coupled to the cathode of the video detector 6D1, which has already been mentioned.

Sound Channel

The sound I.F. amplifier, which should have its coils peaked to 10 Mc/s, is coupled to the detector by the transformer in its anode circuit.

The detector is one diode section of a DD41. The other section is operated as the sound limiter and the anode of this is coupled to the volume control via a .05 μ F. capacitor.

The centre slider of this control feeds the control

grid of the sound output, PEN45, via a 47 K Ω grid stopper. Voltages to be expected at this valve base are: Anode 245, Screen 230 and cathode 7.5. The cathode bias resistor (180 Ω) is by-passed by a 50 μ F electrolytic. Fixed tone correction is by a 4.7 K resistor, and a .01 μ F capacitor in series shunted across the primary winding of the sound output transformer.

In the event of weak and distorted sound, don't forget the 3.3 M Ω limiter load resistor.

Mains Supply

A UU8 rectifier is used in a full-wave circuit, and all heaters except that of the U403 are fed from the various secondary windings. A piece of 5 amp. fuse wire connects one side of the mains to the voltage selector panel.

Failing C.R.T. Emission

As these sets have a good many years of service behind them and the majority have probably had replacement tubes fitted, a few words on extending the life of them will not be out of place. Booster transformers are readily available, which increase the heater voltage by a given percentage and by this means a useful period of good viewing is added to the normal life of the tube at an extremely reasonable cost. The booster transformer need not be of the isolating type and can be home-wound if desired.

Pye Demonstrate New Colour Television Developments

LARGE-SCREEN colour TV pictures using an all-electronic system were demonstrated for the first time in Britain recently.

The occasion was a lecture by Mr. B. J. Edwards, M.B.E., M.I.E.E., Technical Director of Pye, Ltd., to the Radar Association. The subject of the lecture was "Colour Television—Past, Present and Future."

Two units of completely new-equipment were used for the closed circuit demonstration. From a temporary studio in the foyer of the Northern Polytechnic's theatre a newly-developed colour camera produced pictures using a system of simultaneous colour presentation.

The pictures were watched in the theatre on a large 8ft. by 6ft. screen. The equipment that produced them was the very latest all-electronic colour television projector which Pye have been working on continuously for the past two years, and which was being demonstrated for the first time. The camera and the projector have been designed to operate on 625 lines.

The projection equipment consists of a projector, a screen and a control console which can be operated from up to 50ft. away from the projector, which is placed about 15ft. away from the screen in front of the audience. The pictures are produced by means of three projectors—green, red and blue—whose light is optically combined by a system of mirrors, using the largest dichroic mirror ever to be made anywhere in the world. (A dichroic mirror reflects light of one colour while transmitting light of another.)

The main features of the new colour camera, which employs an optical system that is unique in several ways, are its compactness, its use of a single lens focusing system, its large aperture and its very wide angle viewing.

"Viewmaster"—Improving Picture Quality

A READER'S SUGGESTIONS FOR OVERCOMING CERTAIN FORMS OF DISTORTION

By Henry A. Batten

JUDGING by queries which have appeared from time to time in the "Problems" columns of PRACTICAL TELEVISION a number of Viewmaster constructors' sets appear to suffer from non-linearity of the frame-scan. The writer's Viewmaster also had this fault which took the form of a sine-wave on the right-hand edge of the roster, thus causing all upright objects to appear "S" shaped.

Other constructors may be interested to learn of the events which ultimately led to tracing this fault and its subsequent cure.

As this non-linearity is always attributed to insufficient smoothing of the H.T., the mains rectifier (MR4) and associated condensers were replaced but without improvement. C55 was also changed, again without any improvement to the linearity. Incidentally, this latter condenser has proved to be most unreliable, frequently breaking down within a few minutes of replacement, and was eventually dispensed with, as readers will see later.

In an effort to secure better sync-locking the video strip was converted to super-heterodyne, the pre-amplifier was used as the first R.F. stage fed by a grounded-grid triode culled from the pages of earlier copies of PRACTICAL TELEVISION.

These modifications afforded an immediate improvement in picture strength as the Viewmaster

in question was being operated at sea-level at a distance of 96 miles from Holme Moss, but it afforded no improvement in linearity, the picture distortion still being apparent.

Because the audio side had been rather weak and sound interference very pronounced, it was decided to alter the sound strip to super-het also, as this was readily available at the oscillator; and another sound stage was added at the same time.

After these modifications had been completed a loud hum was heard (via the loudspeaker) which defied all efforts to cure it; but paradoxically it was this hum which led to tracing the cause of the picture distortion for it was noticed that when the frame hold R58 was altered the hum changed its tone in sympathy with the frame lock, and this led to the frame circuit being suspected. The frame transformer was replaced without improvement, so the H.T. to the frame transformer was disconnected and the hum disappeared.

Separate Power Packs

It was, therefore, decided to feed the sound, vision and brilliance from a separate power pack, which was constructed, and the H.T. from it fed into these sections alone. The existing connection between frame transformer and vision chassis was removed, and the other H.T. line from this tag was connected

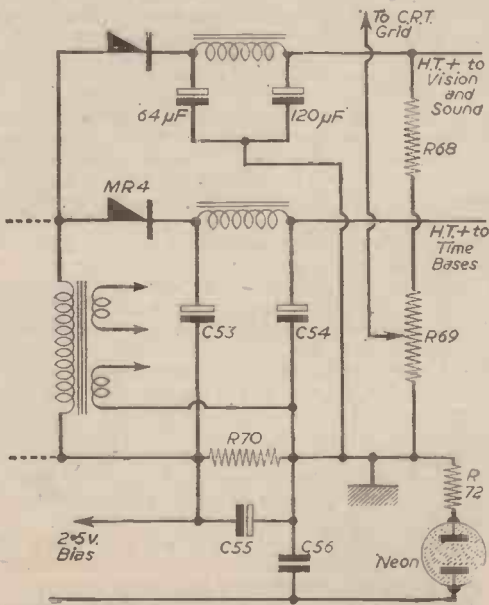

Fig. 1.—The separate power pack for Sound, Vision and Brilliance.

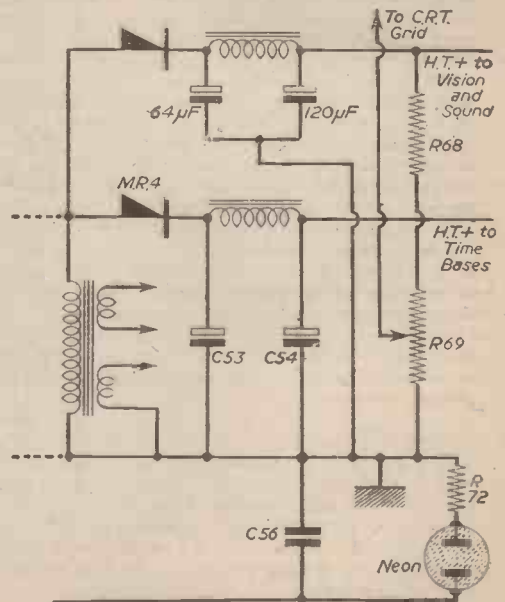

Fig. 2.—Modification to the Fig. 1 circuit.

on to the frame transformer to feed the line and frame timebases. The theoretical circuit is shown in Fig. 1.

On switching on an immediate improvement was noted in the picture linearity; all uprights were now uniform except for a kink at the bottom of the picture which was accompanied by a dark band; indicating lack of smoothing in some part of the circuit.

The power packs were changed over—the one now going to sound and vision, etc., was connected

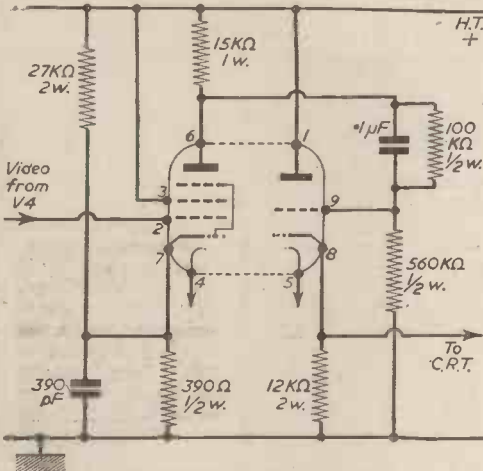

Fig. 3.—The improved Video stage.

to the timebases and vice versa, but as this did not remove the kink the only other component left suspect was C55, that condenser which is intended to smooth the 2.5 volts negative bias to the grid of the video output valve.

Hence it was decided to dispense with this condenser and a number of conventional video output valves and associated circuitry were tried.

It should be emphasised at this point, for the benefit of constructors who intend to experiment with the video output valve, that the writer's prime need in regard to this valve is maximum gain, bearing in mind the distance from the transmitter at which the Viewmaster was being operated. First C55 and R70 were removed (see Fig. 2), and the negative sides of C53 and C54 joined together. Then C16 on the vision chassis was short circuited, C15 and R19 thus going direct to chassis. Then V5 was biased by loading the cathode with a low value resistor, by-passed by a condenser of 500 pF. In fact, a number of different resistors and condensers were tried in the cathode, their values lying between 150 and 390 ohms, and 100 and 1,200 pF respectively, but although a picture of sorts was defined there was insufficient gain.

Similar experiments were made with a 6AM6, also an EF80 with the same results. A 6CH6 gave a good picture, but not enough whites, and use was also made of a triode pentode, PCF80, the picture being extracted from the cathode of the triode section according to accepted cathode-follower principles (see Fig. 3). This was the only valve that gave any real response, but unfortunately it had to be abandoned as sometimes a few lines of the picture would disappear when the signal was very weak.

So finally I went back to the EF50 as being the only valve capable of giving the required gain and band-width.

Battery Bias

The short-circuit was removed from C16, the cathode of EF50 V5 was again taken direct to chassis, leaving V5 in its original form, but without any bias to the grid. The problem then was how to bias the valve correctly without R70, C55, and their 2.5 negative bias, so it was decided to experiment with

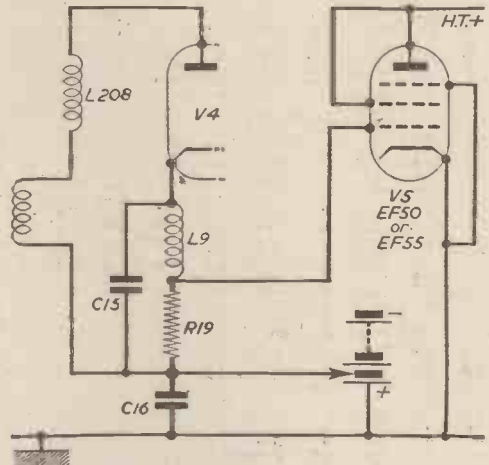

Fig. 4.—The final Video stage.

negative bias taken from a battery; an old 9-volt grid-bias battery being to hand, readings were taken from each cell and these showed that about 1.75 volts were available in each.

A short length of insulated wire was soldered to the nearest earth tag on the chassis, the other end being fitted with a wander-plug which was inserted into the positive side of the battery (see Fig. 4). A similar piece of wire was connected to the junction of C15, C16 and R19, at the point where the 2.5 negative bias had been applied from R70. This was fitted with another wander plug and inserted into the battery, negative side of the cell, thus applying about 1.75 negative bias from the battery instead of that which has been developed across R70. The results were most gratifying; all trace of picture distortion was gone, and the picture had all the whites that one could expect.

Later it was found that an EF55 gave even better results with 6 volts bias to the grid, and, as the EF55 is a direct replacement for the EF50 this valve was finally adopted.

I know that many constructors will be horrified at the suggestion to use a battery for grid bias; yet it was done for many years in radio battery sets with good results.

The advantages far outweigh the faults and the current consumption is negligible; a few microamps only, and, of course, when the set is switched off no current passes at all.

The components used in the auxiliary H.T. power pack are much the same as those used in the original, the only exception being that the two mains smoothing condensers were combined in one can for convenience.

(Concluded on page 476)



FOR VALVES—GUARANTEED NEW AND BOXED

0Z4	6/-	6F11	12/-
1A3	6/-	6F13	13/6
1A5GT	6/6	6F15	13/6
1A7	11/6	6G6G	4/-
1H5GT	8/6	6H6	3/6
1H5GT	10/8	6H7/GT	5/-
1N5GT	10/6	6J5M	6/6
1L4	6/6	6J6	7/6
1L5D	6/6	6J7G	6/6
1R5	8/-	6K6GT	6/6
1R5	7/6	6K7GT	5/6
1T4	7/6	6K7	5/6
1U5	8/-	6K7	6/6
2X3	4/-	6K8G	8/6
3A1	7/-	6K8GT	9/6
3Q4	5/6	6L1	10/6
3Q6	10/-	6L6G	9/-
3D6	5/6	6L7M	7/6
4A3	8/6	6N7	7/-
5Y4	8/6	6Q7G/GT	8/-
4D1	8/-	6A7GT	8/-
42	8/-	6A8GT	7/6
5U4G	8/6	6H7	7/6
5Y3GT	8/6	6H7	7/6
5Z3	8/6	6H7GT	8/-
6Z4G	8/6	6K7	5/6
6A7	10/6	6L1	10/6
6ASC/GT	10/6	6N7	7/6
6A7	6/6	6N7	7/6
6A65	6/6	6U4GT	15/-
6A65	6/6	6U5A	8/6
6A65	7/-	6U7G	9/-
6A65	5/-	6V6G/GT	7/6
6A66	7/6	6X1	8/-
6A65	8/-	6X3GT	7/6
6B1	5/-	7B3	9/6
6B5	4/-	7D7	3/-
6B5A	6/-	7C3	8/6
6B6	8/-	7C6	9/-
6B6W	8/6	7I7	8/-
6C4	7/-	7I7	8/6
6C6GT	7/6	7I7	8/6
6C6	6/6	7N7	8/-
6C9	10/-	7X1	8/6
6D3	7/6	75	10/6
6D6	7/6	77	8/-
6F60	7/6	80	8/6
6F61	8/6	807	6/6

8D3	2/9	EBC41	11/-	
9D2	3/9	EBF6	11/6	
9001	5/6	ECC41	8/6	
9003	5/6	ECC44	12/6	
9004	5/6	ECC45	13/6	
9006	0/-	ECH42	10/6	
951	2/-	ECH81	13/3	
952	2/-	ECL80	10/6	
953	3/6	EP22	8/6	
954	12/6	EP41	13/6	
955	12/6	EP42	13/6	
956	12/6	EP80	10/-	
957	10/6	EP86	10/6	
958	6/6	EI2	12/6	
959	6/6	EI41	11/6	
960	6/6	EI42	12/-	
961	6/6	EM34	11/6	
962	10/-	EM80	12/6	
963	12/6	EV51	12/6	
964	8/-	EZ40	10/-	
965	8/-	EZ41	10/-	
966	8/-	EZ80	12/6	
967	9/6	EI48	2/-	
968	9/6	EV91	7/-	
969	9/6	FW4/300	7/6	
970	9/6	G22	10/-	
971	7/6	G22	12/6	
972	7/6	H30	5/-	
973	5/6	HL2	5/6	
974	7/6	HL2SD	7/6	
975	7/6	HP21C	6/6	
976	8/6	KL33	8/6	
977	8/6	KT2	5/-	
978	8/6	KT3C	10/6	
979	8/6	KV66	10/6	
980	8/6	KW41	7/6	
981	8/6	KW83	8/6	
982	8/6	KZ41	6/-	
983	8/6	LP20	6/6	
984	8/6	MH4	5/6	
985	8/6	MP/FEN 5/-	7/6	
986	8/6	N78	12/6	
987	8/6	N70	12/-	
988	8/6	P41	9/-	
989	8/6	P15	5/-	
990	8/6	PEN25	8/-	
991	8/6	PEN46	9/6	
992	8/6	PEN220A	W17	8/6
993	8/6	PC34	13/6	
994	8/6	PCF80	13/6	
995	8/6	PCF82	12/6	
996	8/6	PCF83	12/6	
997	8/6	PL81	12/6	
998	8/6	PL82	11/6	

MAINS DROPPING RESISTANCES
 725 ohms Erie tap at 600 ohms each 1/3
 650 ohms taps at 375 ohms, 500 ohms, 5 ohms, 30 ohms ... 2/6
 770 ohms Mains Dropper for Midget Radios with a tap at 125 ohms, size 3in. long x 1in. dia. 1/3
 Dagole Mains Dropper 3A, cement coated with 2 sliders ... 3/9
 2 amp. as above, 1,500 ohms ... 5/9
 Green Vitreous Mains Dropper, 1,328 ohms, 2 taps ... 1/3
 Zenith Mains Dropper, 910 ohms 2/-

C R T ISOLATION TRANSFORMERS
 Type NR9
 Ratio 1-1.25 giving a 25% boost on secondary. Particularly suitable for High Definition Receivers. Four types available to cover most tube heaters.
 NR 9A, 2 volt; NR 9B, 4 volt; NR 9C, 6.5 volt; NR 9D, 10.5 volt; NR 9E, 13.3 volt.
 With Tag Panel and Solder Tags. 10/6 each.

Type NR12
 Mains input: 220/240 volts.
 Multi output: 0-2-1-6-3-7.5-10 and 13 volts.
 Input has two taps which increase output volts by 25% and 50% respectively.
 This transformer is suitable for most Cathode Ray Tubes in Medium Definition Receivers.
 The MOST versatile Low Capacity C.R. Transformer with Universal Output.
 With Tag Panel and Solder Tags. 21/- each.

Type NR14
 A most useful transformer for use with 2-volt Tubes with falling emission.
 Input: 220/240 volts.
 Output: 2-2-1-2-1-2-1-3 volts at 2 amps.
 With Tag Panel and Solder Tags. 17/6 each.

5TC RECTIFIERS
 RM 1 ... 3/10 RM 3 ... 5/-
 RM 2 ... 4/3 RM 4 ... 10/-

SMALL SUE-CHASSIS each
 With 2 valveholders for 954, 955 type of valves ... 5/-

PENCIL RECTIFIERS
 K 3/25 ... 5/8 K 3/50 ... 8/8
 K 3/10 ... 7/6 K 3/60 ... 9/3
 K 3/15 ... 8.2 K 3/100 ... 14/8

HEATER TRANSFORMERS
 Primary 230 v.
 Available: each
 2 volt 1 amp ... 4/6
 4 volt 1.5 amp ... 5/-
 5 volt 2 amp ... 10/-
 6.3 volt 1 amp ... 6/-
 2 volt 3 amp ... 7/9
 4 volt 3 amp ... 10/-
 6.3 volt 3 amp ... 5/-
 12 volt 7.5 amp ... 5/-



LOUDSPEAKER CABINETS
 This attractive walnut finished cabinet is available for 6in. or 8in. speaker units. Metal speaker fret, complete with back and rubber feet.
 6in. Type: Measures 8 1/2in. x 8 1/2in. x 4 1/2in. at base. Price 16/6 each.
 8in. Type: Measures 10 1/2in. x 10 1/2in. x 5in. at base. Price 20/6 each.
 5in. Type: Measures 6 1/2in. x 4 1/2in. x 7 1/2in. 16/0

YAXLEY TYPE SWITCHES

1 Pole, 4-Way	each	1/4
2 Pole, Change-over	each	1/3
3 Pole, 3 Bank, 3-Way	each	1/6
4 Pole, 2-Way	each	1/8
2 Pole, 3-Way with Black Knob	each	1/6
5-Way, 2 Pole, 3 Bank	each	2/-

CABLES, ETC.

Twin Flat Transparent Mains	3d.
Flex 14/0070	3d.
Screened Cable, Singles	6d.
Twins	7d.
Push Back Wire, 14 Strands	2d.
Semi A2 Special Co-axial Cable	7d.
Solid 1/0022	8d.
Stranded 7/0078	8d.

VOLUME CONTROLS, ETC.

Miniature Volume Controls	each	4/6
double pole switch, 2 Meg. r.		
Standard Controls, single pole		
switch, 2 Meg. r. and 1 Meg. r.		3/6

VALVEHOLDERS

B7G, B9A, B90, etc., Moulded	Types	each	9d.
EB3 with Screening Caps			1/6
Ceramic International Octal			1/-
Duodecal Paxolin			9d.

SPECIAL PURCHASE!
 G.E.C. Cabinet Loudspeakers, Cat. No. BC1953, 8in. P.M. Moving Coil Loudspeaker Unit, 2 1/4 ohms, with Volume Control. Price 60/- each.

PHIFCO ALL-IN-ONE RADIO METER
 Tests L.T. 0-6 v. A.C./D.C., H.T. 0-240 v. A.C./D.C., M/A 0-30. Black Bakelite Case. Internal Battery for Circuit Testing. Price 32/6 each.

VARIABLE CONDENSERS

3 gang .0005 mfd.	each	5/9
2 gang .00035 mfd.	each	5/9
2 gang .0005 mfd. with feet and trimmers	each	7/6
2 gang Midget with dust cover .00035 mfd. with trimmers	each	8/6
2 gang Midget .0005 mfd.	each	7/6



T.S.L. FERRO-MAGNETIC AERIAL ROD
 A length of Ferrite rod with full instructions for winding Medium or Medium and Long Wave Internal aeriels. 6/- each.

LOUDSPEAKER UNITS, ETC.

6in. Types by Elec., Lectra, Celestion, etc.	each	17/6
6in. Types by Goodmans, Rola, K. & A.	each	18/3
8in. Types by Goodmans, Plessey, R. & A.	each	19/6
10in. Types by R. & A., Celestion, etc.	each	25/8
6in. Water Speaker by Truvos, suitable for Car Radio, etc.	each	20/-
12in. Plessey Lightweight	each	35/-
12in. Diaphragm Speakers, Goodmans	each	19/6
4in. x 7in.	each	19/6
All above are P.M.C. Speakers. Standard 2-1 r. Speech Coil.		

TELEVISION TABLE
 Size of top 19 1/2in. x 19 1/2in. Height, 18in. Rounded feet which unscrew for transit. 40/- each, carriage 3/6.

CONNECTOR LEADS
 Red single lead with wander plug and socket. 4d. each.

Build this Excellent Kit for Yourself!
 Alpha 3 valve T.R.F. Kit
£5.10.0

★ Easy to Build.
 ★ Valves 6K7, 6K7, 6V0GT plus metal rectifier.
 ★ Walnut cabinet.

Full instructions, point to point wiring diagram, Circuit diagram and full shopping list etc. All components may be purchased separately.

ALPHA RADIO SUPPLY CO.

5/6 VINCES CHAMBERS VICTORIA SQUARE LEEDS!

TERMS: Cash with order or C.O.D. Postage and Packing charges extra, as follows: Orders value 10/- add 9d.; 20/- add 1/-; 40/- add 1/6; £5 add 2/- unless otherwise stated. Minimum C.O.D. fee and postage 2/3.

MAIL ORDER ONLY

NEW **AVO** Signal Generator



Regd. Trade Mark

FOR BANDS I, II & III ... ON FUNDAMENTALS



The "AVO" Signal Generator Type III

An inexpensive A.M. Signal Generator of entirely new design, for the Service Engineer. Provides six frequency bands covering 150kc/s—220Mc/s. Accuracy $\pm 1\%$.

150 kc/s — 500 kc/s
500 kc/s — 1.6 Mc/s
1.6 Mc/s — 5.5 Mc/s
5.5 Mc/s — 18 Mc/s
18 Mc/s — 70 Mc/s
70 Mc/s — 220 Mc/s

Continuous wave or modulated at 1,000c/s. L.F. signal available for test purposes.

A new type of attenuator, ensures close adherence of the output to the attenuator calibration. The instrument provides a force output of 250mV, whilst the following outputs are available via the attenuator:—

Minimum to 100 μ V, x 1, x 10, x 100, x 1000.
Output impedances—80 Ω , 200 Ω and 400 Ω .

List Price £29

This instrument operates on 100–120, 200–260V, 50–60 c/s A.C. mains. It is light and compact and employs double screening to ensure minimum radiation.

Full details available on request.

Sole Proprietors and Manufacturers:—

THE AUTOMATIC COIL WINDER & ELECTRICAL EQUIPMENT CO. LTD.
AVOCET HOUSE · 92-96 VAUXHALL BRIDGE ROAD · LONDON · S.W.1 Telephone: VIctoria 3404 (9 lines)



SG.5

NEW!

EXPERIMENTAL KITS in Radio, T.V. etc.

LEARN THE PRACTICAL WAY

Specially prepared sets of television parts (which you receive upon enrolment) with which we teach you, in your own home, the working of circuits and bring you easily to the point when you can construct and service a television set. Whether you are a student for an examination; starting a new hobby; intent upon a career in industry; or running your own business—this Practical Course is intended for YOU—and may be yours at very moderate cost.

EASY TERMS FROM 15/- A MONTH

A tutor is available to give individual help and guidance throughout the Course.

POST THIS COUPON TODAY

Please send me your FREE book on Practical Courses:

To: E.M.I. INSTITUTES, Dept. 138X, Grove Park Road, London, W.4.

NAME.....

ADDRESS.....

SUBJECT(S)..... MAY

EXPERIMENTAL OUTFITS:

TELEVISION—Instruction and equipment for building a Television Receiver.

BEGINNER'S RADIO OUTFITS—A course in basic principles.

ADVANCED RADIO OUTFITS—Instruction and equipment from which you build a Radio Receiver.

Also for Mechanics, Electricity, Chemistry, Photography, Carpentry, Draughtsmanship, Commercial Art, Amateur S. W. Radio, Languages.

E.M.I. INSTITUTES

The only Postal College which is part of a world-wide Industrial Organisation.

IC.55

COLOUR TELEVISION

THE FIRST OF A NEW SERIES DEALING WITH THE PRINCIPLES AND PRACTICE OF MODERN TELEVISION IN COLOUR

1.—THE THEORY OF COLOUR

By C. Grant Dixon

COLOUR television is undoubtedly on the way, and the forward-looking amateur would be well advised to prepare himself for this new and intensely exciting side to his hobby. The addition of colour to a television image is not a simple matter and the precise circuitry is beyond the scope of this series of articles, as a colour television service is not yet a reality in Great Britain. The proper understanding of the production of a coloured image involves a knowledge of the elementary principles of

a secondary colour: the other two secondary colours are magenta (red+blue) and cyan (blue+green).

The addition of colours in this way can best be shown by a piece of apparatus known as a colour triangle (Fig. 4). This consists of a white board with lamps at the three corners covered with filters of the appropriate primary colours. At the centre the board appears white by the addition of the three primaries, and at the middle of each edge is a secondary colour, yellow, cyan or magenta. It should be emphasised here that to get the correct effect the lamps should be adjusted to give the required proportion of light of each colour. For obvious reasons this method of mixing coloured lights is known as mixing by addition.

Paint and Light

Some readers will now be asking themselves whether the correct primaries have been quoted—do we not learn from our early years that "blue and yellow make green"? The answer to this dilemma is that the previous experiment with the torches was concerned with the mixing of coloured *light*, whereas when ordinary water colour *paints* are mixed a different process is involved—colour mixing by subtraction.

Let us take the case of a mixture of blue and yellow paints. The blue paint will reflect the blue of white light and absorb all other colours, but if it is an impure colour it will also reflect a little green as well. The yellow pigment will reflect all colours except blue; thus, when the two pigments are mixed the only colour which is reflected by both is green and the mixture appears green. The yellow pigment has absorbed blue light and the blue pigment has absorbed red, orange and yellow, etc., thus the resulting green is obtained by a process of subtraction. The small boy who mixes all the paints of his paint box together will get a dark grey or muddy

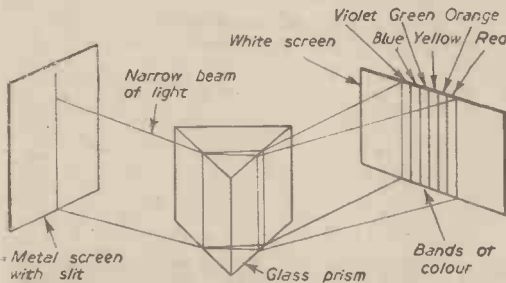

Fig. 1.—Producing a spectrum by means of a prism.

colour as such, and it is proposed to start with this.

It was observed by Newton in the 17th century that when a narrow beam of white light is passed through a triangular glass prism it gives rise to a band of colours, called a "spectrum," on a screen (Fig. 1). The white light is actually composed of all these colours, and if they are recombined they will produce white again. Now it is found that the human eye has only three sets of colour-sensitive cells and these correspond roughly with the three broad divisions of the spectrum—red, green and blue-violet. Therefore, as the eye analyses all colours into these three "primary" colours, it should be possible to use this principle to analyse the colours of a scene to be televised. This is actually the method which is used, and the three primary colours employed are usually referred to as red, green and blue. The opposite process of colour synthesis is often the cause of a little confusion as there are two ways in which colour mixing can be carried out. These processes are fairly easy to follow provided that it is always borne in mind that the addition of the three primary colours produces white, and that a coloured object always absorbs all colours except its own colour. Let us take two pocket torches and shine them on to a white screen, covering one with green Cellophane and the other with red Cellophane; the screen will then appear yellow, i.e., red+green=yellow (Fig. 3). Now if the third primary colour, blue, is added the screen will appear white: therefore yellow is said to be complementary to blue. As it is the sum of two primary colours, yellow is called

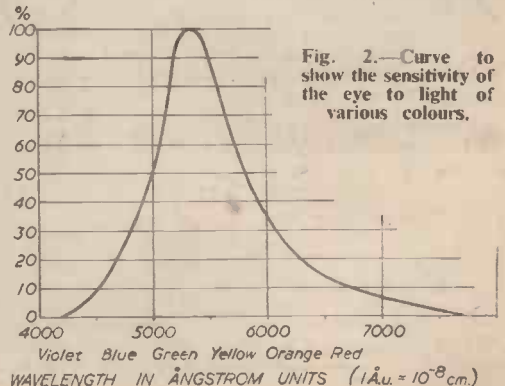

Fig. 2.—Curve to show the sensitivity of the eye to light of various colours.

colour because each pigment is subtracting light which the others are reflecting. On the other hand, the theatre-goer knows quite well that when all the

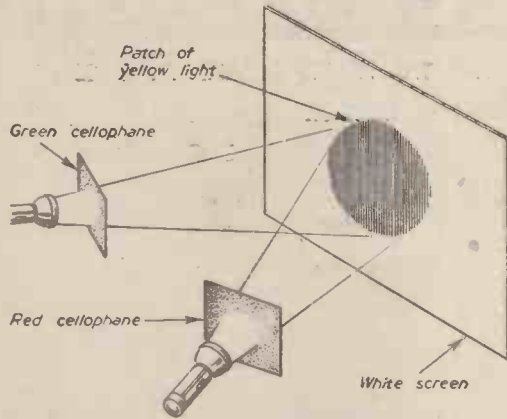

Fig. 3.—A simple demonstration to show the result of using green and red light.

coloured footlights are on the general effect is almost white; an example of colour addition. It is this process of colour addition which is almost always used in colour television.

Now as the spectrum is an analysis of white light into its component colours, it follows that it must contain all the colours that can possibly exist. This seems hard to believe at first as we are used to seeing such an unending variety of colours, but it must be realised that the spectral colours are pure colours and these can be diluted with white, or darkened with black, to give this infinite variety. The property which gives a colour its characteristic appearance is

called its "hue" and this is associated with a definite wavelength in the spectrum. To those accustomed to wavelengths of the order of, say, 5 metres and frequencies of 60 Mc/s it comes as a bit of a shock to realise that the wavelength of green light is .00005 cms. and its frequency is 600,000,000 Mc/s. If the colour consists of this frequency only, it is said to be a saturated hue; but if it is diluted with white light it is said to be unsaturated. Red is a saturated colour, but pink is an unsaturated colour and plainly there is a whole range of pink colours between white and red.

What about black? Black is not a colour at all, but merely absence of light, and a black paint is one which absorbs all, or nearly all, of the light which falls on it. Thus, when a colour is "darkened with black" it merely means that the colour is of lower intensity; that is to say, the light waves are of smaller amplitude. The best example of this is the colour brown which, surprisingly enough, is a yellow or orange of very low intensity. Now to specify a given colour in a coloured scene it is necessary to specify the hue saturation and intensity. But the intensity of light is what is recorded in a black and white photograph or television image, so the addition

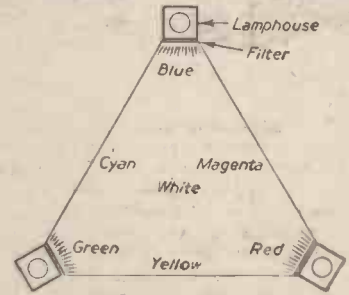

Fig. 4.—The colour triangle apparatus.

of colour involves specification of hue and saturation for every point in the picture. In the literature on colour television the brightness signal is referred to as the luminance, and the colour information, both hue and saturation, is called the chrominance signal.

By now the reader will have realised that hue and saturation can be found from the colour triangle previously referred to. A modified colour diagram—the C.I.E. chromaticity diagram—is usually employed to specify colours and a few notes on its properties will not be out of place, as the literature on colour television makes frequent reference to this diagram. It will be seen in Fig. 5 that instead of the three main primary colours placed at the corners of a triangle we have the whole range of spectral colours distributed along a curved line known as the spectral locus. The ends of this line are joined and this forms a closed diagram embracing all the colours that are physically possible. The points $x = 1, y = 0$ and $x = 0, y = 1$ represent hypothetical super-red and super-green colours by which one can describe the physically realisable colours. The actual derivation of the diagram is beyond the scope of this article, but the use of these hypothetical colours avoids troublesome negative colour conceptions when dealing with certain greens.

One interesting property of this diagram is that the value of the Y co-ordinate for any colour is a measure of the relative luminance of that colour.

(To be continued.)

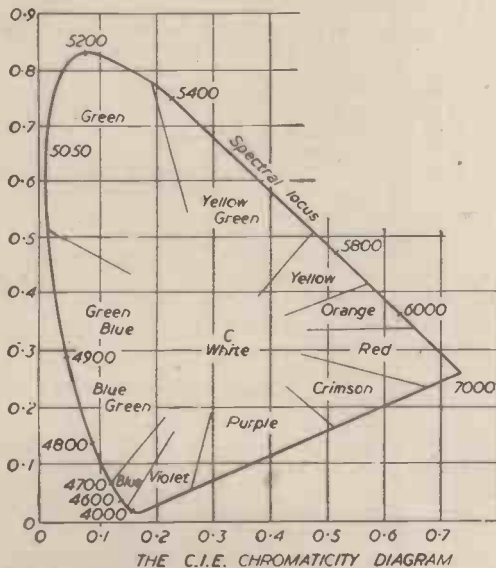

Fig. 5.—The approximate colours of various parts of the diagram are shown, but it should be understood that the colours blend one into the other and so any description is only an indication.



AN Oscilloscope FOR TV

A VALUABLE SERVICING AID

By J. Hillman

THE circuit of this oscilloscope is not original, but has several novel features particularly applicable to TV servicing (Fig. 1).

The timebase covers a range of from 6 cycles to 300 Kc/s and the X axis can be drawn out from a spot to approximately twice the diameter of the screen. The Y amplifier has four ranges selected by a switch giving direct, low, medium and high amplification, and to give an idea of the amplification with a 50 cycles test signal input and with the X amp control at halfway on Position 1, height of trace is $\frac{1}{16}$ in.; Position 2, $\frac{1}{8}$ in.; Position 3, $\frac{1}{4}$ in.; Position 4, $1\frac{1}{8}$ in.

An internal 50 cycles test signal socket is fitted, and this is useful for setting up the preset controls after the oscilloscope is made, and also for checking the oscilloscope to make sure it is working correctly at any given time.

Provision is also made for the following—grid modulation, external sync., external timebase X, power socket, beam switch, beam blanking switch and line output transformer testing.

Two of the above items perhaps need a further word of explanation as they are not normally found in an oscilloscope.

First, the beam switch is operated to enable the oscilloscope to be set up with whatever trace is to be observed, and then by putting the switch to the "off" position the trace is removed from the screen so that any other adjustments to the set can be made without any fear of burning the screen by leaving the trace on too long. The trace is simply brought back by moving the beam switch to the "on" position without touching any of the other controls.

Secondly, the line output transformer test enables transformer to be checked while still in the TV set, and without disconnecting or unsoldering any leads. This check is for shorted turns which are a common fault with line output transformers, and it can also be used to check the other coils in the output stage, such as the scan coils and width coils.

Construction

First cut (Fig. 2) a piece of aluminium 11 in. by 9 in., then mark off the various holes as diagram Fig. 3, and drill all holes before bending as drilling is much easier to do when the metal is flat.

In making the four bends a vice can be used, but the writer made all the bends by the following method without the use of a vice. First take a board roughly 1 in. thick, and cut it to just less than 8 in. by 10 in., and place the front panel on it so that the edge of the board lies flush with the mark on the panel where the bend is required. Next take a straight wood strip and lay its edge on top of the panel and hold down firmly with one hand. Use a mallet or hammer and tap down the protruding edge to make a right-angle bend.

A point to note is that if the corners are cut off the panel at an angle as in dotted line Fig. 2 the bend can be made more easily and neatly. Also note that in Fig. 3 a hole only $2\frac{1}{8}$ in. diameter is cut in it. The square shown is another piece of metal. This

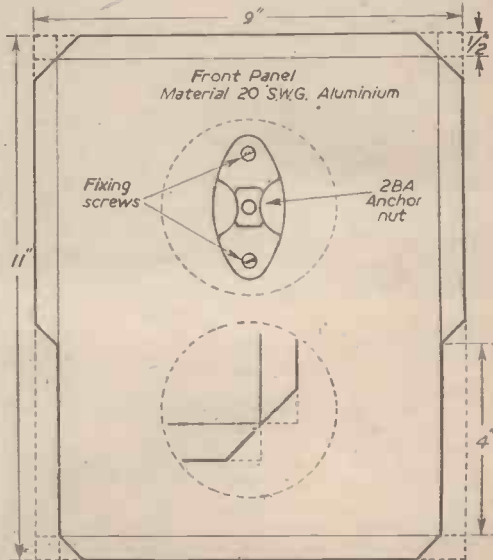

Fig. 2.—Panel cutting data and screw anchor detail.

is made of sheet brass and is cut as shown in Fig. 4. The four holes in the corners are drilled to take 2 B.A. screws and then a piece of thin sheet brass 1 in. in width is bent to form a collar as Fig. 5 and fits inside the circle of Fig. 4, where it is soldered into position. This is to hold the front of the C.R.T. in position. Next the completed holder is placed into the hole in the front panel and the four holes in the corner marked out so as to allow the holder to have its sides parallel to the sides of the front panel. If anchor nuts are available these are fitted next but if not, then another brass plate can be made to fit the other side of the panel and tapped 2 B.A. to take the screws holding the holder in position.

A piece of Perspex 3½ in. square is next marked out with two heavy scribed lines at right angles from the centre to form the base X and Y lines and then two diagonal lines more lightly scribed. The rest of the space is divided by evenly spaced lines lightly scribed as shown in Fig. 6. Indian ink is then smeared on the scribed side and wiped off with a cloth, leaving a marked transparency as in Fig. 6. The object of these lines is to enable the trace to be split up into measurable sections by the eye when comparing traces at different parts of a

circuit. The diagonal lines are useful when measuring phase angles.

Next a shield is made from aluminium to fit the front transparency to shield it from the light. After

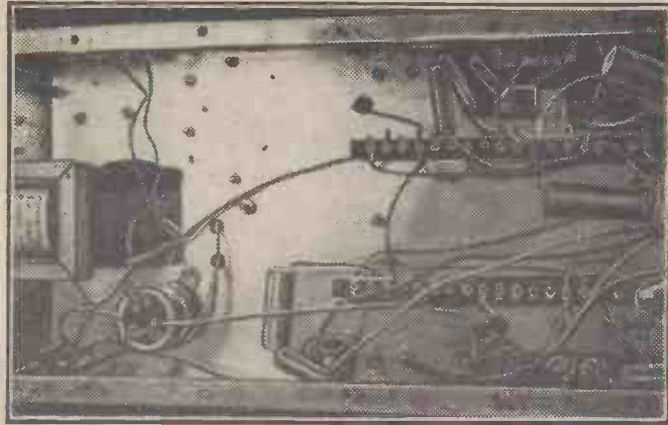

View of Underside of 'Scope.

marking out as in Fig. 7 and cutting away the shaded part the metal is bent round until the two tabs are over the two top holes on the front panel. Then the metal is cut away to give a rounded appearance and filed smooth.

Bushes are required for the four holes immediately below the C.R.T. hole in the front panel, and these are made from old volume controls obtained quite easily from any radio repair shop, where they are being thrown out continually. First cut off the shaft at point A, Fig. 8—that is, between the circlip and the brass bush. Next remove the back by levering up the metal tabs holding it and the central moving arm should now pull out easily. Next remove nut B and withdraw brass bush which is the part required. This bush is now fitted to the front panel as in Fig. 9.

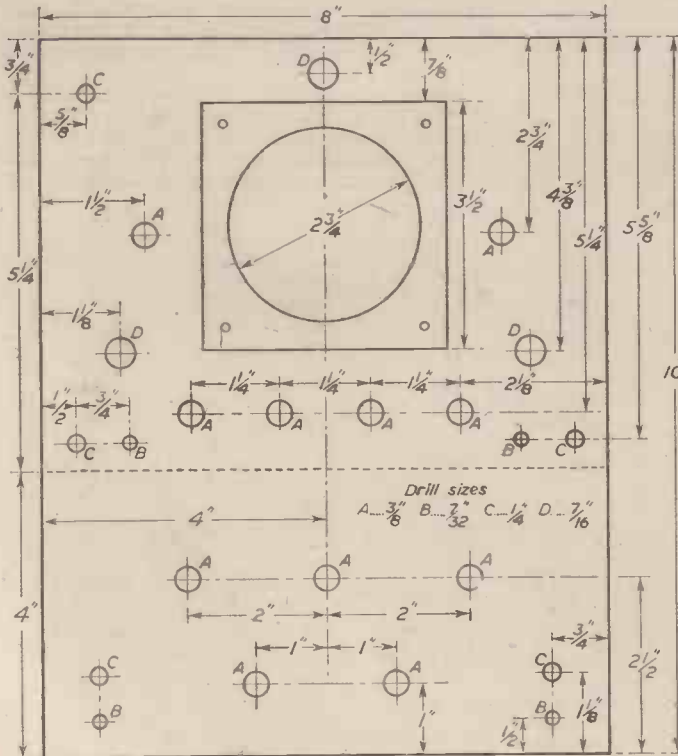

Fig. 3.—Panel drilling data.

10 The Chassis

For the chassis construction slightly different methods have to be used, due to the greater depth

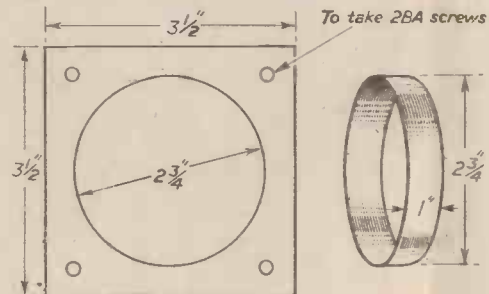

Fig. 4.—Tube mask (brass). Fig. 5.—Tube collar.

of the bend. The edge of the bench or table can be used on which to make the bend. First make bend at B, Fig. 11, then C, finishing C off with the hands to bring it to a right-angle bend. Next make bend A

Fig. 15B. These illustrations, together with those which follow, will be given in next month's issue.

Next make second potentiometer bracket as in Fig. 16 and the top, Fig. 17, two sides, Fig. 18, and bottom, Fig. 19.

Put rubber feet on the bottom plate so that oscilloscope can be set down on any polished surface without damaging it.

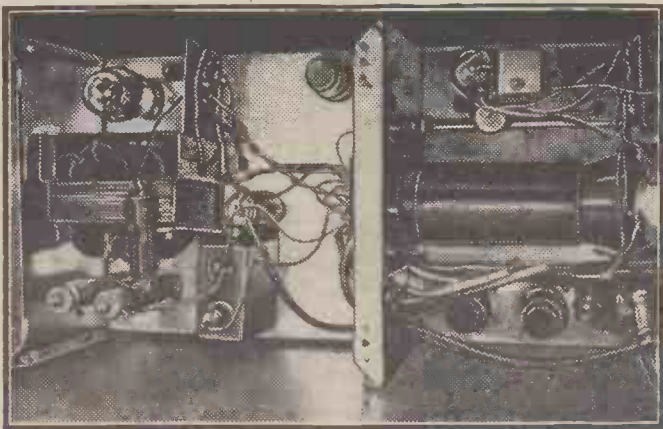

Plan View of the 'Scope.

and finish off with a hammer. Similarly bend D and the bends E, F, G, H, I. Next bend at J with the hands and finally at K with a hammer. Drill holes for 4 B.A. bolts, two to each corner, and bolt up, when chassis will look like the upper illustration in Fig. 11, with all the flanges inside to make a neat appearance. Bolt the front panel on to the open-sided end and a panel made as in Fig. 12 for the back.

The C.R.T. bracket, Fig. 13, is made next, and the holes marked A correspond to the measurements of identical holes on the front panel, except that the C.R.T. hole is only 1 1/2 in. diameter, just large enough to let the base of the tube through and to support it. The slot is cut to allow the coaxial leads free access to the components behind the C.R.T. panel.

The potentiometer bracket is now made as Fig. 15A, and the potentiometer holes are shown in

C.R.T. Holder

This is made from Perspex, about 3in. square and a pattern is first obtained by holding a piece of paper against the pins of the C.R.T. and rubbing gently until a mark is made on the paper for each pin. These marks are then cut out to allow the pins to pass through the paper, and the rubbing is next made at the spigot and cut out similarly. The pattern can now be marked out on the Perspex with a point of a compass and the holes drilled for the pins. These are 7/32in. and the metal wander-plug sockets are fitted in these holes. The spigot hole is drilled and filed to shape, and providing the work is carefully carried out the holder should be a nice fit on the tube.

One point to notice is that the holder must be square, as it is then easier to turn the tube when lining up the trace on the face of it with the horizontal line of the transparency on the front panel.

Test Lead

This is made up from coaxial cable 4ft. long, as will be shown next month. One end has 18 s.w.g. tinned copper soldered to it to act as a probe and is taped and insulated from the coaxial braiding which terminates in a crocodile clip.

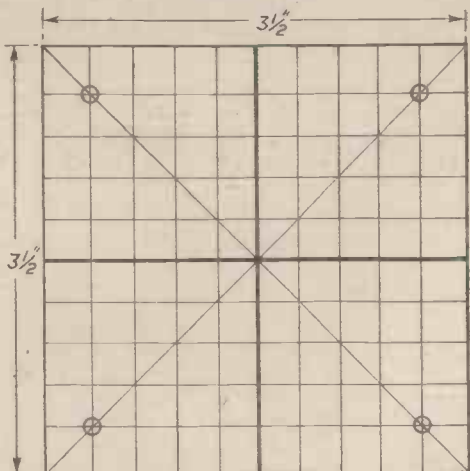
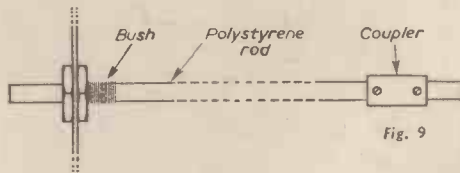
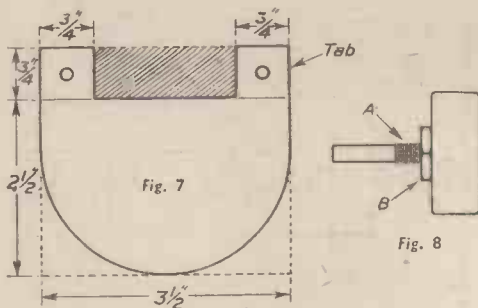

Fig. 6.—Graticule for tube face.



Figs. 7, 8 and 9.—Tube shield and method of making bush and extension spindle.

Wiring

The following leads were wired with coaxial cable:

- (1) Internal sync. lead from S4 to Y2.
- (2) Lead from S5 to Y1.
- (3) Lead from Pin 5 6SN7 to X at C.R.T.
- (4) Lead from X amp. to grid 6SN7.
- (5) Lead from S1 to Pin 2 C.R.T. and R13.

The condensers for the time-base are mounted direct on switch 2 and wafer S2B was nearest front panel, S2A next, finally S2C. These wafers were spaced about $\frac{1}{4}$ in. apart and the switch had six radial-spaced contacts.

The position of the mains transformer is important to prevent magnetic fields affecting the trace of the C.R.T. The core of the transformer should be in line with the C.R.T. axis as in Fig. 21. If the trace is being affected by the magnetic radiation, then

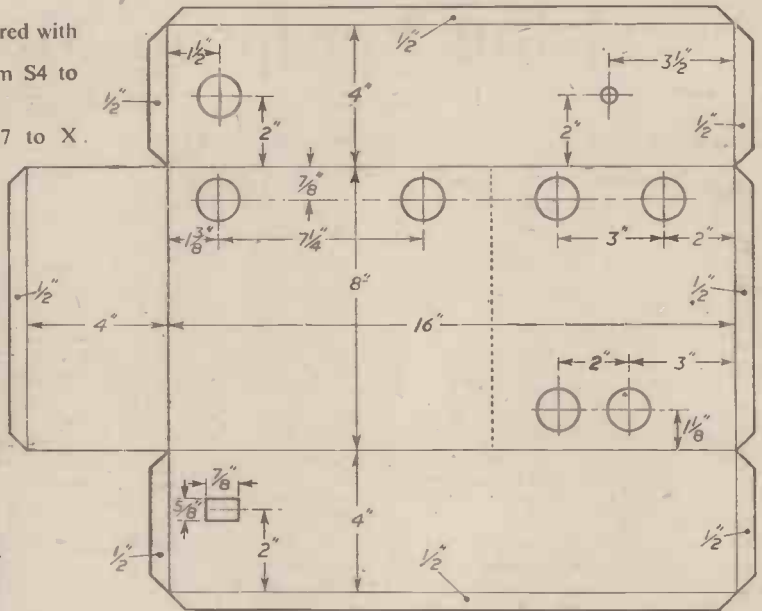

Fig. 10.—Drilling and bending data for the chassis.

the trace will appear as in Fig. 22. A mu-metal screen can be used to keep out most of the external magnetic fields, but is not essential if the transformer is placed properly.

The fixing of the mains transformer to the chassis will depend on the type and make used, but it is preferable to use an upright mounting type as this is more easily moved about on the chassis to get the correct mounting position.

(To be continued)

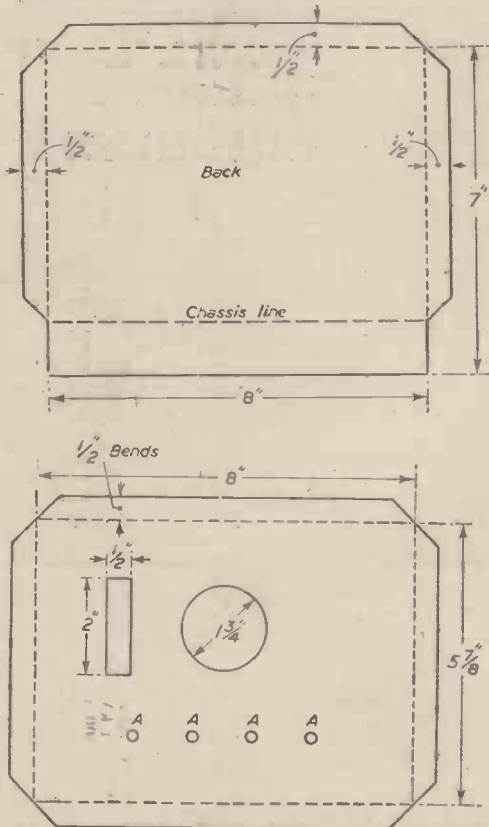

Fig. 12 (top).—Back of case.
Fig. 13 (bottom).—Rear tube support.

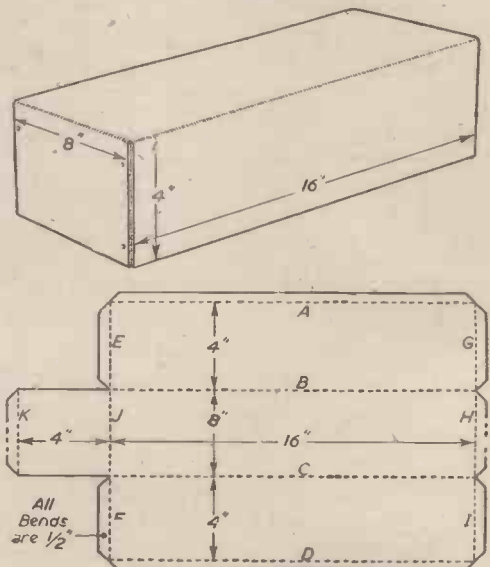

Fig. 11.—Chassis folding details and the finished chassis.

Servicing Ferguson Model 991T

FURTHER NOTES ON THIS POPULAR MODEL

(Continued from page 406 February issue)

SHOULD the sound be present with a raster but no picture, check V4, 5 and voltages, then crystal diode and associated circuit to V6 control grid.

Picture, but no sound.—Check speaker leads, V11, 12, 13 and 14, then output transformer primary winding.

Picture good, sound low and distorted.—Check valves, then R55 3.3 M Ω sound interference limiter load resistor.

Sound good, picture weak, poor contrast.—Check V4, 5 and grid components of V6 and then replace crystal diode inside final vision I.F. transformer can. Also check anode and screen resistors if voltages on these electrodes are low.

Extremely bright raster, brilliance inoperative or partially so.—Check V6 anode voltage. If low, remove cathode connection from pin 11 of C.R.T. base and recheck. If the cathode voltage of the C.R.T. is normal when disconnected, but drops when reconnected, suspect heater/cathode short in C.R.T. If this is present, install six-volt heater isolating transformer and join both heater leads to chassis after disconnecting from C.R.T. base. If C.R.T. is not at fault but V6 anode voltage is low, check anode circuit resistors and W2 cathode metal rectifier for: resistors high or open circuit; metal rectifier short circuit.

If all these points are in order, as evidenced by a correct reading on pin 11, check brilliance control for open-circuited track.

Inability to lock line or line hold unreliable.—If the condition has just arisen and has not been experienced before, check V15 EF80. A valve test will not do and replacement is the only certain check. Repeat with V16 if not successful. If the hold is still unstable, carry out the following procedure: Short R82 to chassis (150 K., see Fig. 3), and adjust line lock to its mid position.

The effect of shorting R82 is to produce a jumbled picture; this is because the line sync pulses are not reaching the timebase but are being shorted to chassis.

Then adjust L32, bottom core of flywheel coil can, until the line oscillator frequency approaches that at which, if the sync pulses were present, a locked picture would result. This condition is met when the picture appears to hover one way and then the other as the core is slightly turned.

Remove the short from across R82.

The picture should now lock, but it may be slightly offset on the screen. This should not be confused with an incorrect picture shift position. The picture may be centred by adjusting the top core of the flywheel sync coil can. This will move the picture horizontally one way or the other.

The line lock should not be rotated once this procedure has been carried out unless necessary. For instance, it should not be used for moving the picture sideways.

If trouble is still experienced, check R27 (2.2 M Ω) preferably by replacement. It is quite in order to

reduce the value of this resistor slightly if more reliable line lock can be achieved by this means. This is quite a large resistor and is coloured red/red/green.

Unstable frame.—A jumping frame can often be traced to a slightly defective ECL80 (V20).

For a persistently rolling frame, check V20 or V19 and then V18.

Frame cramping and other linearity troubles.—Check V20, then inspect the linearity components, especially the .05 μ F and the V20 pentode grid-leak (2.2 M Ω). Short out R116 or remove the short from it as necessary (see Fig. 1).

Sound instability.—Check push-pull ECL80's. A well-matched pair is often essential. Then check feedback capacitors and grid-leak resistors.

Similar Models

These notes may generally be used in conjunction with the 990T, 993T, 995T and 997T.

THE FOLLOWING VOLTAGES ARE INTENDED AS A GUIDE AND SOME VARIATION MAY BE EXPECTED.

	Anode	Screen
V1, 2, 3, 4 and 5	190	190
V6	150	194
V8	No test	128
V9	199	Cathode 500 (line transformer tapping) PY81
V11	190	170
V12	190	71
V13a	50	—
V13b	190	175
V14a	50	—
V14b	190	175
V15	175	175
V16	130	160
V18a	185	185
V18b	35	—
V19a	120	15
V19b	25	—
V20a	85	—
V20b	180	190

Eighth Edition

WIRELESS TRANSMISSION

An Ideal Book for the Amateur

By F. J. CAMM 6/-, by post 6/4

From

GEORGE NEWNES, LTD., Tower House,
Southampton Street, Strand, W.C.2



MAINS-MINI

Uses high-efficiency coils, covers long and medium wavebands and fits into the neat white or brown bakelite cabinet—limited quantity only. All the parts, including cabinet, valves, in fact, everything, £4 10/0, plus 3/6 post. Constructional data free with the parts, or available separately 1/6.

INTERFERENCE FILTER

To eliminate patterning and other interferences, also re-transmitting causing complications with neighbouring televisions. Two models—one high-pass cuts out frequencies above 45 m/c, the other low-pass cuts out frequencies below. Price 27/8 each, postage 2/6.

TRANSFORMER SNIP

11/6
Post 2/-
Fully shrouded—standard—200-250 v. primary 280-0 280 at 80 m.a. 6.3 v. at 3 amp., 5 v. at 2 amp.



MISCELLANEOUS BARGAINS

Valves.—Most types available, many at really bargain prices.
Coaxial Cable.—Cellular polythene—super low loss for Band III—11d. per yard.
200 m.a. Chokes, 8/6.
New Metal Screens for V.C.R. 97, etc., 5/6 per pair.
Resistors.—1 watt, 5d.; 1 watt, 6d.
American Microphone Inserts.—4/6 each.
1 mfd. Metal Cased Condensers.—3/- per dozen.
1,000 pf. Ceramic Condensers.—5/- per dozen.

GRAMOPHONE AUTO-CHANGER



The latest models by very famous manufacturers. 3-speed with crystal turn-over pick-up, brand new and perfect, in original cartons. Choice of four from £7/15/0, carriage, ins., etc., 7/6.

BAND III AERIAL KIT

"The Folded V" was described in the July number of this magazine. We tried this and found it to be most efficient. The kit comprises alloy elements and connectors, neat plastic centre piece and saddle for mountings. 8/6.
post 1/6.



ADDITA—BAND III CONVERTER

Any television receiver, whether superhet or straight, home constructed or factory built, which at present will receive B.B.C. will also receive I.T.A. if this converter is added. No modifications at all are necessary to the receiver. Simply plug in the aerial leads and connect to A.C. mains. The converter is in a neat metal case with provision for fixing to the side or the back of the set. Price £6 10/-, or H.P. terms available on request if required.



BUILD YOUR OWN CONVERTER

You can save at least £2 on the above if you build the converter yourself. Price of all components including stove enamelled case and even transfer for the front is £3 10/- or £4 10/- if mains components also required. Data are included free with the parts or available separately, price 2/6. State whether Midlands or London.

THE CASCODER

Of the several circuits used for Band III conversion at aerial frequencies, undoubtedly the most popular is the Cascode circuit. We can offer a very good converter suitable for any Band I to any Band III station, in a very neat, polished cabinet with fine tuning, on off mains. Band I-III contrast switches. Price £7 10/0, post and packing 2/6.



THE "CRISPIAN" BATTERY PORTABLE



A 4-valve truly portable battery set with very many good features as follows: Ferrite rod aerials; Low consumption valves; Superhet circuit with A.V.C.; Ready built and aligned chassis if required; Beautiful two-tone cabinet covered with I.C.I. Rexine and Tygan; Guaranteed results on long and medium waves anywhere. All parts, including speaker and cabinet, are available separately or if all ordered together the price is £7 15/0 complete, ready built chassis 30/- extra. Instruction booklet free with parts or available separately, price 1/6.

BAND III AERIALS

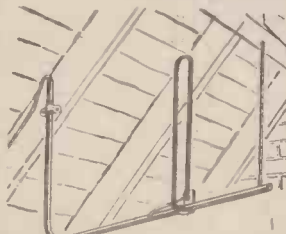

- 3 element array with swan-neck mast with "U" bolt clamp for fitting to existing masts from 1 1/2 to 2 1/2 in. dia. 41/6
- 3 element array with cranked mast and wall mounting bracket. 42/6
- 3 element array with cranked mast and chimney lashing equipment 65/-
- 5 element array with swan-neck mast and "U" bolt clamp for fitting existing mast from 1 1/2 to 2 1/2 in. dia. 52/6
- 5 element array with cranked mast and chimney lashing equipment 67/-
- 8 element array with swan-neck mast and "U" bolt clamp for fitting to 1 1/2 to 2 1/2 in. dia. mast ... 69/6

THE INDOOR

This is a 1 wave, 3 element array. Of all alloy construction, the aerial is completely assembled and ready for instant mounting in loft, bedroom cupboard, window frame, etc. Price 12/6, plus 2/6.

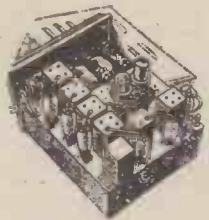

MADE FOR THE JOB

This ex-W.D. 10-valve superhet was designed to receive 200 megacycles transmission so it will require virtually no conversion to receive the commercial T.V. programmes. These contain 6 valves type SP61, and one each RL7, RL6 and EA50. Six IF transformers 12 Mc/s. band, and hundreds of other useful components. Price 59/6, plus carriage and packing 7/6. These receivers are unused and perfect.

BAND III PRE-AMP

In difficult areas it will be necessary to increase the signal level and this is the ideal unit for this purpose. It is A.C. mains operated and is fitted with input and output coax. plugs. Price 24/- post and packing 3/6.



THE ELPREQ E.H.T. GENERATOR

This is a made-up unit, power consumption 6.3 volt 8 amp. filament and approx 55 mA H.T.), contains three BVA valves. Output from 6 kV to 9 kV rectified with normal H.T. rail input but somewhat higher outputs can be obtained with higher H.T. supply. Dimensions are 6 1/2 x 4 1/2 x 7 1/2 in. Price 69/6, post, packing, etc., 5/-.



12in. T.V. CABINET—15/-

We are offering these for not much more than the cost of the plywood they contain. Many useful items can be made—record storage cabinet, H.F. loud-speaker case, book case, etc. Price 15/-, carriage 3/6.



ELECTRONIC PRECISION EQUIPMENT, LTD.

Post orders should be addressed to E.P.E., LTD., Dept. 5, 123, Terminus Road, Eastbourn.

Personal shoppers to one of these addresses please.
42-46, Windmill Hill, Ruislip, Middx. 152-3, Fleet Street, E.C.4. 29, Stroud Green Rd., Finsbury Park, N.4. 249, Kilburn High Road, Kilburn. MAIda Vale 4921.
Phone: RUISLIP 5760 Phone: FLEET 2933 Phone: ARCHWAY 1049
Half day, Wednesday. Half day, Saturday. Half day, Thursday.

TELEVISION TUBES

MULLARD ...	12in. £6.10.0	14in. £7.10.0	17in. £10.0.0	} Ex Stock
COSSOR ...	12in. £6.10.0	14in. £7.10.0	17in. £10.0.0	
EMITRON ...	12in. £6.10.0	14in. £7.10.0	17in. £10.0.0	

MAZDA. 12in. only £6.10.0. 14 Days Delivery.

All Tubes plus 12/6 carriage and insurance.

SIX MONTHS' WARRANTY

- Converter M.1. Midlands area, high gain, own power supply, built in crossover unit £9.9.0
- Converter M.2. Midland fringe area, own power supply £9.18.0
- Crossover Box. Low loss 12/6

Finished in Stove Enamelled Steel Case.

Terms to the Trade.

RE-VIEW (LONDON) LTD.

81, HIGH STREET : : MERTON, S.W.19

Telephone: CHERRYWOOD 3255

HENRY'S

(RADIO LTD.)

We have over 50,000 American and B.V.A. valves in Stock.
ALL VALVES NEW AND GUARANTEED

1D8GT	6AG7	10-6SG7M	6.6	12SH7GT	951	5-KT2	5/-
1G9	6B6C4	7.6	6X5GT	8/6	9567	6-PEN25	6/6
1R5	7/6	6CS5M	5	8SA7	8/6	12SCT 10-1298A	4/6
1S4	7/6	6J5GT	5	8SQ7	8/6	4-QP25	6/6
1S5	7/6	6J5M	5	8SN7GT	8/6	CV66	5-QP21
1T4	7.6	6AM6	9/-	8SL7GT	9/-	12SK7	8/6
1A7GT	10/-	6B8A	8/6	8SL7GT	9/-	12SR7	7/6
1A5GT	10/-	6B8E	10/-	8SK7	7/6	D1	5-SF41
1H5GT	10/-	6V8G	7/6	7C5	8/6	25A6G 10/-	D42
1N5GT	10/-	6V8M	7/6	7C7	8/6	25Z5	8/6
105GT	10/-	6J6	9/-	7H7	8/6	D63	5-U17
105GT	10/-	6AK5	9/-	7B7	8/6	EA30	2-U19
1Q5GT	10/-	6U5G	7/6	7S7	10/-	EB34	3/6
1L4	7/6	6K7G	6/6	8D2	4/-	EB33	6/6
1LN5	7/6	6KTGT	6/6	8D2	4/-	5U2	8/6
1LD5	7/6	6KGT	7/6	12C8GT	8/6	6.6	VP23
2X2	5	6K8GT	8/6	50B5	10/-	EF89	6/6
3A4	9	6C8G	6/6	60C5	10/-	EF90	6/6
3Q4	9	6H8GT	4/-	12H6	7/6	12.6	VR130A
3V4	7/6	6H8M	5/-	12K7GT	8/6	8.6	VP13C 4/-
354	7/6	6K8GT	9/-	12K8GT	8/6	8.6	VP13C 10/-
3Q5GT	10/-	6L8G	10/-	12K8GT	8/6	8.6	VR105 30
5U4G	8/6	12Z2 (6L5)	8/6	607USA	7/6	8.6	VF501 7/6
5Y3GT	8/6	6L7M	8/6	803	10/-	8.6	VR105 30
5Z3	8/6	6N7GT	7/6	805	35/-	8.6	VT280
5Z4G	8/6	6Q7GT	8/6	813	105/-	8.6	STV 280
6A7G	8/6	6RTM	8/6	12SA7GT	12/6	8.6	4-15-
6A6	10/-	6RTG	8/6	12SB7GT	12/6	8.6	10-13-
6C6	8/6	6S87M	7/6	12SQ7GT	8/6	8.6	10-13-
6D6	8/6	10-	8/6	8.6	900A	8.6	10-13-
6AC7	6/6	6S87M	7/6	12SB7GT	8/6	8.6	10-13-

SPECIAL REDUCTION FOR SETS OF VALVES

1A7GT, 1N5GT, 1H5GT, 1A5GT (or 1Q5GT or 3Q5GT)	40/-	Set
10 EF50 (Ex-Brand New Units), 5/- each	45/-	
10 EF50 (Red Sylviana ex-new units), 6/- each	55/-	
6K8G, 6KTG, 6Q7G, 5Z4G, 6V8G	37/6	
1R5, 1S5, 1T4, 1S4 (or 3S4 or 3V4)	27/6	

CRYSTAL MICROPHONE INSERTS



Ideal for tape recording and amplifiers. No matching transformer required.

OBsolete TYPES (Available from Stock)

ERC41 10/-	PL81	12/6	EF85	10/6
EY51 12/-	PL82	10/-	EF89	10/-
EP41 11/-	PY81	10/-	ECF82	15/-
EL41 11/-	RM80	10/-	PAB40	
EZ40 10/-	6X4	9/-		
EM34 10/-	PY82	10/-	8AU6	9/6
UL41 11/-	PCC84	12/6	11Z3	8/6
UY41 11/-	PCF82		12AX7	10/-
UF41 11/-		12/6	DK96	10/-
UCH42	12/6	12AT7	9/-	10/-
	12/6	12A7S	8/-	10/-
	12/6	12AT7	9/-	10/-
	12/6	12AU6	9/-	10/-
	12/6	12BA6	9/-	10/-
	12/6	12BE6	10/-	10/-
	12/6	12AH8	12/6	10/-
	12/6	35W4	8/6	10/-
	12/6	PCF80	15/-	12/6
	12/6	EBF80		12/6
	12/6	11.6		12/6

LATEST TYPES NOW IN STOCK

LP2	3/6	TDD2A8	6/0	U10	8/6
Z10LF	3/6	FW4500		DD14	5/-
P2	4/-		10/-	42SPT	6/-
ZISSG	4/-	FC13S	7/6	PENDD	
VP2	8/6		10/-	4030	12/6
SP2	8/6	FC13C	10/-	354V	5/-
VP2B	8/6	MS/PEN	ML4	7/6	
TP22	8/6		7/6	MU14	8/6

SEND 3d. for 28-PAGE ILLUSTRATED CATALOGUE

5, HARROW ROAD, PADDINGTON, LONDON, W.2

TEL: PADDINGTON 1008-9, 0401

TELENEWS



Television Receiving Licences

THE following statement shows the approximate number of Television Receiving Licences in force at the end of February, 1956, in respect of receiving stations situated within the various Postal Regions of England, Wales, Scotland and Northern Ireland. The numbers include licences issued to blind persons without payment.

Region	Total
London Postal	1,280,019
Home Counties	643,234
Midland	977,562
North Eastern	859,002
North Western	817,829
South Western	373,536
Wales and Border Counties	315,607
Total England and Wales ...	5,266,789
Scotland	341,899
Northern Ireland	40,578
Grand Total	5,649,266

During February the number of television licences increased by 110,654. 14,230,519 broadcast receiving licences, including 5,649,266 for television, and 291,740 for sets fitted in cars, were current in Great Britain and Northern Ireland at the end of February, 1956.

Colour TV Sales Offer

CBS-Columbia is offering to allow the full price of a used black and white television set as trade-in on one of its colour receivers, in what the company describes as an effort to "help create excitement about colour video in the minds of the public."

The offer applies to metropolitan New York, and the surrounding area, and northern New Jersey. It has gone into immediate effect. CBS-Columbia is the set-making division of the Columbia Broadcasting System. It is producing colour receivers that at the present time sell for \$895.

Australian Television

FOLLOWING upon a contract, announced last August, for the supply of all the transmitting and aerial equipment for the two

Australian Government-controlled television stations, Marconi's Wireless Telegraph Co., Ltd., now state that two further large orders have been received from their associated company in Australia—Amalgamated Wireless (Australia) Ltd. The new orders were placed by two independent Australian television companies.

The total value of Marconi television equipment to be exported to Australia on these three contracts alone amounts to more than £500,000.

Herald-Sun Television Ltd., have ordered a complete transmitting station, comprising a 10 kW vision transmitter, type BD.362, a 2½ kW. sound transmitter, type BD.311, an aerial and feeder system, programme input equipment, a combining unit, phasing

and monitoring equipment and ancillary units. A three-camera outside broadcast vehicle and complete technical equipment for two studios—one three-camera and one single-camera—are also included in the order, together with two sets of Telecine equipment.

It is understood that the Herald-Sun transmitter will be sited at a height of over 2,000ft. on Mount Dandenong, 20 miles north-east of Melbourne.

Film Library for TV

IN the largest release of films ever made to television, the entire library of R.K.O. Radio Pictures has been sold to the C. and C. Super Corporation, New York, a television syndication firm, for £5,428,571. The library comprises 740 feature films and 1,000 shorts, representing R.K.O.'s output for the last 30 years.



One of the O.B. vans purchased by the "Australian Herald-Sun" Television Company from Marconi's.

Camera for Atomic Energy Authority

A SPECIAL camera has been designed by Pye, Ltd., which is capable of being used inside an atomic reactor. It has now been completed and is ready for use at the atomic energy factory in Cumberland. The camera, which is based on normal industrial television equipment, has had to conform to certain rigid specifications, and as a result of the experiments which were carried out it was found that special

dangerous, the camera can be remotely controlled and is housed in a thin stainless-steel casing $3\frac{1}{2}$ in. in diameter and 30 in. long. The whole apparatus, involving the camera and its 75 ft. of cable, the control unit and the monitor, is mounted on a trolley so that it is ready for instant use.

Pye Television for Hungary

PYE LIMITED announce that through their agents, Messrs. Law, Wills & Company Limited, they have received an order from

amongst other things, similar equipment to that which is to be supplied.

New BBC TV and V.H.F. Stations

THE BBC regrets that, owing to the late delivery of equipment by the manufacturers, the permanent aerials at North Hessary Tor and Rowridge television stations will be delayed. The dates on which the service from these stations will become fully effective will, therefore, be April, 1956, for North Hessary Tor and May, 1956, for Rowridge. An interim improvement from North Hessary Tor was made in February.

For a similar reason the opening of the V.H.F. sound transmitting stations at Meldrum and Divis was delayed until March.

Colour Demonstration

A FIVE-DAY colour television demonstration was given from the 3rd to the 7th of April. This was arranged for the Study Group of the International Radio Consultative Committee, by the G.P.O., in conjunction with the Radio Industry Council and the BBC. The series opened with a special exhibition at the Dorchester Hotel at which eight well-known manufacturers showed receivers working both in colour and black and white, and for the purpose the BBC transmitted a special colour programme. All of the receivers were hand-made experimental models and it was emphasised that they will not be available to the public for some years yet. Except for the projection models they all employed the R.C.A. Shadow-mask tube and several of the valves used in the receivers were of American manufacture as there are no counterparts on the English market. The system employed, as already stated in these pages, was the American N.T.S.C. modified to suit the British 405-line standard. The pictures varied considerably from receiver to receiver, but it was emphasised that they are only experimental models to show that the American system can be modified satisfactorily for our standards.

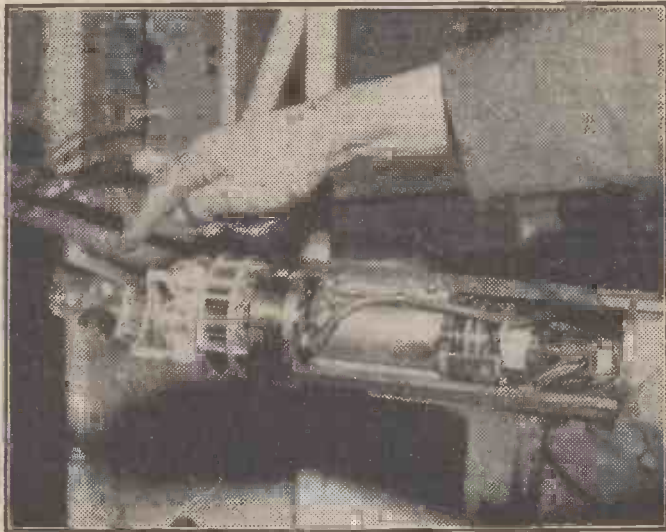

Close-up of the head of the new atomic energy camera showing the bulbs which provide the camera's own illuminations. In front is the movable mirror which enables viewing from all angles.

materials had to be used. The work which has been done by the engineers can be regarded as a triumph of mechanical engineering, particularly in view of the complex problems of design which had to be solved. For ease of manipulation the camera carries its own source of illumination, consisting of a series of four small bulbs grouped around the camera's lens. In addition, a system of mirrors enables sideways viewing to be obtained. As the equipment is to be used while the atomic pile is

Hungary to supply television transmission outside broadcasting equipment. It is understood that the equipment, which is the first to be ordered from Pye for use in Hungary, will be used when the Hungarians inaugurate their new television service later this year.

Negotiations regarding technical performance and delivery have been completed by a Pye representative in Budapest.

A Hungarian trade delegation recently visited the Pye factory at Cambridge and were shown,

The Editor will be pleased to consider articles of a practical nature suitable for publication in "Practical Television." Such articles should be written on one side of the paper only, and should contain the name and address of the sender. Whilst the Editor does not hold himself responsible for manuscripts, every effort will be made to return them if a stamped and addressed envelope is enclosed. All correspondence intended for the Editor should be addressed to: The Editor, "Practical Television," George Newnes, Ltd., Tower House, Southampton Street, Strand, W.C.2.

Owing to the rapid progress in the design of radio apparatus and to our efforts to keep our readers in touch with the latest developments, we give no warranty that apparatus described in our columns is not the subject of letters patent.

Copyright in all drawings, photographs and articles published in "Practical Television" is specifically reserved throughout the countries signatory to the Berne Convention and the U.S.A. Reproductions or imitations of any of these are therefore expressly forbidden.

RADIO SUPPLY CO. (LEEDS) LTD.

Dept., N.
32, THE CALLS, LEEDS 2.

Post Terms C.W.O. or C.O.D. NO C.O.D. under £1. Postage 1/- extra under 10/-; 1/6 extra under £1; 2/- under £3. Open to callers 9 a.m. to 5.30 p.m. Sats. until 1 p.m. S.A.E. with enquiries, please. Full list 6d.; Trade list 5d.

R.S.C. TRANSFORMERS

Fully Guaranteed.
Interleaved and Impregnated.
Primaries 200-250 v. 50 c/s screened
TOP SHROUDED DROP THROUGH
260-0-260 v 70 ma, 6.3 v 2 a, 5 v 2 a ... 16/9
350-0-350 v 80 ma, 6.3 v 2 a, 5 v 2 a ... 18/9
250-0-250 v 100 ma, 6.3 v 4 a, 5 v 3 a ... 23/9
350-0-350 v 100 ma, 6.3 v 4 a, 5 v 3 a ... 23/9
350-0-350 v 150 ma, 6.3 v 4 a, 5 v 3 a ... 29/9
FULLY SHROUDED UPRIGHT
250-0-250 v 50 ma, 6.3 v 2 a, 5 v 2 a
Midjet type, 2i-3in. 17/8
250-0-250 v 100 ma, 6.3 v 4 a, 5 v 3 a ... 26/9
250-0-250 v 100 ma, 6.3 v 6 a, 5 v 3 a
for R1335 Conversion 31/-
300-0-300 v 100 ma, 6.3 v 4 a, 5 v 3 a ... 26/9
350-0-350 v 100 ma, 6.3 v 4 a, 5 v 3 a ... 23/9
350-0-350 v 150 ma, 6.3 v 4 a, 0-4-5 v 3 a 31/6
425-0-425 v 200 ma, 6.3 v 4 a, C.T. 6.3 v
4 a, C.T., 5 v 3 a ... 49/9

FILAMENT TRANSFORMERS

All with 200-250 v 50 c/s Primaries: 6.3 v
1.5 a, 5/9; 6.3 v 2 a, 7/6; 0-4-6.3 v 2 a, 7/9;
12 v 1 a, 7/11; 6.3 v 3 a, 8/11; 6.3 v 6 a, 17/9

CHARGER TRANSFORMERS

200-250 v 0-9-15 v 1 a, 11/9; 0-9-15 v 3 a, 16/9
0-9-15 v 5 a, 19/9; 0-9-15 v 6 a, 22/9.

OUTPUT TRANSFORMERS

Standard Pentode 5,000 to 3 ohms ... 4/9
Small Pentode 5,000 to 3 ohms ... 3/9
E.H.T. TRANSFORMERS 200-230-250 v
2,500 v 5 ma, 2-0-2 v 1.1 a, 2-0-2 v 1.1 a
for VCR57, VCR58 ... 36/6

SMOOTHING CHOKES

250 ma 5 h 50 ohms ... 11/9
100 ma 10 h 250 ohms ... 8/9
80 ma 10 h 350 ohms ... 8/9
60 ma 10 h 400 ohms ... 4/11

SELENIUM METAL RECTIFIERS

G.E.C. 300 v 250 ma, 12/9; 120 v 40 ma, 3/9;
6/12 v 1 a F.W., 5/9; 240 v 50 ma 5/9, 6/12
v 2 a F.W., 8/9; 6/12 v 4 a, 16/9; 250 v 80
ma, 7/9; 6/12 v 6 a F.W., 19/9; 6/12 v 10 a,
29/9.

BATTERY SET CONVERTER KIT
All parts for converting any normal type
of Battery Receiver to A.C. mains 200-250 v
50 c/s. Supplies 120 v 30 v or 60 v at 40 ma.
Fully smoothed and fully smoothed L.T.
of 2 v at 0.4 a to 1 a. Price including circuit
49/9. Or ready to use, 9/9 extra.

**ALL DRY RECEIVER BATTERY
ELIMINATOR KIT.**—All parts for the
construction of a unit (metal-case
5 1/4" x 2 1/2") to supply Battery Portable
receivers requiring 90 v and 175 v. Fully
smoothed. From 003-250 v 50 c/s mains.
Price, inc. point-to-point wiring dia-
grams, 39/9. Or assembled and tested at
46/9.

**R.S.C. TA1 HIGH QUALITY TAPE
DECK AMPLIFIER.** For All Tape
Decks with High Impedance. Playback
and Erase Heads, such as Lane, Truvox
Adjustment to type of deck. Ready for
use by alteration of a **Use-ONLY**
resistor. For A.C. Mains

11 GNS

230-250 v, 50 c/s. Positive
compensated identification of
recording level given by Magic
Eye. Recording facilities for 15, 7 1/2 or
3 1/2 in. per sec. Automatic equalisation at
the turn of a knob. Linear frequency
response of ± 3 db, 50-11,000 c.p.s. Negative
feed-back equalisation. Minimum
microphony and hum. High output with
completely effective erasure and dis-
tortionless reproduction. Sensitivity is
15 millivolts so that any kind of crystal
microphone is suitable. Provision is
made for feeding a P.A. amplifier. Unit
can also be used as a gram-amplifier
requiring input of 0.75 v R.M.S. Carriage
7/6. Illustrated leaflet 6d.

EX-GOVT. UNIT RDF1.—Brand new,
cartoned. Complete with 14 valves,
including 5Z4G. Also mains trans. L.F.
choke rectifier, etc., etc. Only 29/6.
Carr. 7/9.

SMALL POTTED MAINS TRANSF.
Removed from New Ex-Govt. units.
Primary 0-200-230-250 v Secs. 250-0-
250 v 60 ma, 6.3 v 2 a, 5 v 2 a ... 11/9

CO-AXIAL CABLE (in.
75 ohms 14 36 ... 8d. yd.
Twin-Screened Feeder ... 11d. yd.
EX-GOVT. SMOOTHING CHOKES.—
100 ma 10 h 250 ohms Tropicalised ... 3/11
150 ma 6-10 h 150 ohms ... 6/9
150 ma 10 h 150 ohms ... 11/9
250 ma 10 h 50 ohms ... 14/9

E.H.T. SMOOTHERS

5 mfd 3,500 v can, 3/6; 5 mfd 2,500 v
Blocks (ex-Govt.), 2/11.

BATTERY CHARGER KITS.—Consist-
ing of attractive Green Crackle Case,
Transformer, F.W. Rectifier, Fuse, Fuse-
holder, Tag strip, Grommets, and Circuit.
For mains input 230-250 v 50 c/s 6 v 2 a,
25/9; 6 v or 12 v 2 a, 31/6; 6 v or 12 v 4 a,
49/9. Any type assembled and tested for
6/9 extra.

R.S.C. 6 v or 12 v BATTERY CHARGER

For normal A.C. mains
input 230-250 v 50 c/s.
Selector panel for 6 v or
12 v charging. Variable
charge rate of up to 4
AMPS. Fused, and with
meter. Well ventilated
case with attractive
hammer finish. Guarante-
ed for 12 months.
69/6. Carr. 2/6.

TV. CONSOLE CABINETS

Handsome well constructed with beautiful
figured walnut veneer finish. Size 40in.
high, 24in. wide, 20in. deep. For 15in. or
17in. Tube. Limited number at only 9gns

Above for callers only.
Table Model types with doors, 4 gns. 6/6
carr. Table Model, 12in. Tube, 29/9, 5/- carr.

BATTERY CHARGERS.—For mains
200-250 v 50 c/s. Output for charging 6 v or
12 v at 1 amp. In strong metal case. Only
25/9. Above can also be used for electric
train power supply.



**POST THE COUPON TODAY FOR OUR
BROCHURE ON THE LATEST METHODS
OF HOME TRAINING FOR OVER
150 CAREERS & HOBBIES**

PRIVATE AND INDIVIDUAL TUITION IN YOUR OWN HOME

City and Guilds Grouped Certificates in Telecommunications: A.M. Brit. I.R.E.
Examination, Radio Amateur's Licence, Radio and Television Servicing Certificates,
General Radio and Television Courses, Radar, Sound Recording, etc. Also Courses in
all other branches of Engineering and Commerce

The advantages of E.M.I. training. ★ The teaching methods are planned to meet modern industrial requirements. ★ We offer training in all subjects which provide lucrative jobs or interesting hobbies. ★ A tutor is personally allotted by name to ensure private and individual tuition. ★ Free advice covering all aspects of training is given to students before and after enrolling with us.

Equipment supplied upon enrolment and remains your property.

Courses from 15/- per month

POST THIS COUPON TODAY

Send without obligation your FREE book.
E.M.I. INSTITUTES, Dept. 138K,
43 Grove Park Road, London, W.4.

NAME

ADDRESS

5/59
SUBJECT(S) OF INTEREST

NEW LEARN THE PRACTICAL WAY. COURSES WITH EQUIPMENT
With many of our courses we supply actual equipment thus combining theory and practice in the correct educational sequence. Courses include: Radio, Television, Electronics, Draughtsmanship, Carpentry, Photography, and Commercial Art, etc.

EMI INSTITUTES

The only Postal College which is part of a world-wide Industrial Organisation.

CORRESPONDENCE

The Editor does not necessarily agree with the opinions expressed by his correspondents. All letters must be accompanied by the name and address of the sender (not necessarily for publication).

FAULT FINDING

SIR,—Surely your correspondent, G. F. R. Courtney (N.W.), on page 383 of the January issue of PRACTICAL TELEVISION, did not systematically disconnect every H.T. feed to discover a fault that would have been disclosed by the simple expedient of removing all valves and then measuring the resistance from each valve pin to chassis? In this instance the ohms reading would have been 0 instead of infinity, indicating a short-circuit to chassis.—J. A. CUSDIN (Eastbourne).

A TUBE FAULT

SIR,—I am 16 years of age and having recently taken up television as a hobby, I read through most of your magazine's back numbers. I noticed that considerable controversy existed over picture fouling and shadowing on VCR97 tubes. As one of mine exhibited the same fault I was very interested and carefully read through all the opinions on this subject; some said narrow-necked tubes, others misaligned deflector plates. As my tube was of ordinary thickness it ruled out the first point, but as I could not prove or disprove the other fault I had almost given up hope when I accidentally earthed the mu-metal screen. This cleared the cut-off completely. It appeared that the high voltages on the tube's electrodes induced an electrostatic charge on the screen, and the earthing enabled it to break away; one might even only have to earth it through a resistance to keep the charge negligible.

The charge seems to have repelled the beam in some way and as the charge was completely surrounding the beam it gave the effect of cut-off. P. KAY (Blockley).

SERVICING TV RECEIVERS

SIR,—There must be a lot of readers who, for various reasons, are unable to construct a TV set of their own, but have bought a well-known make ready-made, and like myself, taken out a TV insurance policy to cover any breakdown that may occur to the set.

My own set, which is now four years old, broke down during November last. The TV insurance company were informed who came and took it away for repair.

Now, after a lot of inquiries, I learn that my set is still being repaired, and it is now nearly 10 weeks since it was first taken away for repair.

I would like to know whether any other readers are experiencing any difficulty in getting their TV sets repaired promptly by the TV insurance companies. W. A. TANNER (Southall).

GROUND PLANE AERIAL

SIR,—In your August issue you had an article on ground plane aerials. I wonder if a three- or four-element version would be practicable in my area. Could you please give me the constructional details for such an aerial and could I use it inside the roof? What type of cable should I use? I have an Ekco 13 channel 1954 Radio Show model receiver.—R. JONES (Swindon).

[The author states:—A three element aerial should be sufficient and there is no reason why it should not

be used inside the roof. The dimensions for Sutton Coldfield are as follows: Director, 3ft. 9in.; active element, 3ft. 11in.; reflector, 4ft. 1in.; director spacing, 1ft. 8in.; reflector spacing, 2ft. 6in.; wire screen, 9ft. square chicken wire.

The elements should be of $\frac{1}{2}$ in. O.D. dural tube and should be joined at their bases to the screen with the exception of the active element, which is connected to the centre core of the cable. The braid of the cable is connected to the wire screen. It will be found to be convenient to clamp the elements to a cross boom of $1\frac{1}{2}$ in. dural tube.

In order to match the aerial to 80 ohm cable the active element should be folded twice. The cable should be of the normal 80 ohm coaxial type.]

A USEFUL HINT

SIR,—Here is a tip which may interest many of your readers of PRACTICAL TELEVISION.

I recently had a television receiver to repair and on switching on, the symptoms were: no brightness and E.H.T. O.K. I tested the tube, which was a Mullard MW.31.74, and found it had a grid to cathode short and an intermittent heater cathode short.

Here is what I did to cure the fault:—

1. Fitted a low capacity heater transformer, which cured the heater cathode short.
2. Disconnected the lead to the grid.
3. Strapped the grid to the cathode permanently.
4. Disconnected the lead which supplies the first anode voltage.
5. Connected the grid lead to the first anode.

The results were a good picture in focus but not quite as bright as a new tube.—C. RODGERS (Riddings, Derbyshire).

USING METAL RECTIFIERS

SIR,—Mr Cleland, in his article on metal rectifiers (February issue, page 393), decries the Greinacher circuit (Fig. 7) as exhibiting ripple and poor regulation. The properties of voltage doubler circuits reside in the relative (as well as actual) values of their components and those in Fig. 7 are unaptly chosen.

The A.C. feed condenser may alternatively be placed in the lead to the rectifier mid-tap when the circuit is known as the Cockroft-Walton doubler.

—L. D. STUART (Hornchurch).

NOISE LEVELS

SIR,—The following data may be of interest to other readers. I tried out several Band III converters—using R.F. pentodes. These seemed to give an unduly high level of noise on the picture, and I would have thought they would have been better than the more orthodox double-triode and pentode as there is one cathode less (two instead of three), and the cathode I thought was responsible for most of the noise. I then tried the orthodox D.T. and frequency-changer which gave much more gain, and then, in view of the extra punch available I found that I could turn up the contrast control on the receiver to maximum, reduce the gain control on the converter and the result was an extremely clean picture. Turning the set contrast control down, with converter gain full up, gave more gain.—G. HECKSHERE (N.W.).

Simple Adjustable Voltage Supplies

HINTS FOR THE EXPERIMENTER

By C. H. Banthorpe

WHEN experimental work is being carried out it is often necessary to have a source of variable voltage, either positive or negative or both and in some cases a variable or pre-set voltage has to be included in equipment. For such purposes the author has found the following circuits cheap and useful.

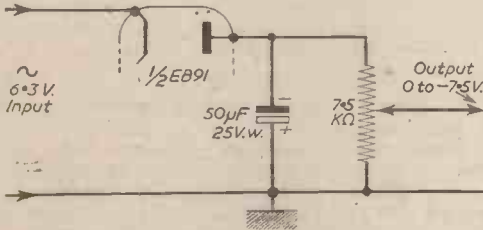

Fig. 1.—A simple source of grid bias.

The first, Fig. 1, is the cheapest of all and has been used as a source of grid bias. It uses the heater voltage as an A.C. supply and gives an output sufficient for most receiving type valves. If several different voltages are required then a tapped resistor network may be used or several potentiometers may be connected across the output.

Voltage Doubler

When the voltage is insufficient a voltage doubler circuit may be used as shown in Fig. 2. In both these circuits the polarity of the output may be reversed by reversing all valves and, of course, the electrolytics. The output voltages shown in Figs. 1 and 2 will be supplied under the condition given, i.e., 1 mA output current, but higher currents can be taken with an appropriate loss of output voltage. The makers of the EB91 give 9 mA as a limiting current, but, of course, almost any double diode, separate diodes or metal rectifiers may be used provided the makers' ratings are observed.

Higher Voltages

For higher voltages and currents the circuits of Figs. 3 and 4 are useful. Fig. 3 has been used for supplying a variable G2 voltage for gain control of a television receiver and for work on oscillators. In the circuit of

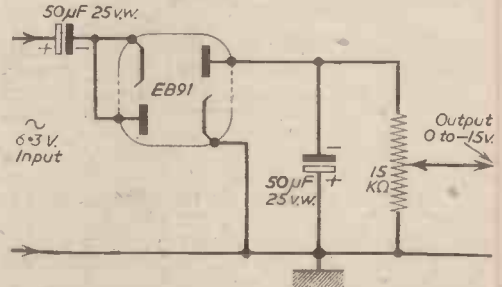

Fig. 2.—This arrangement gives increased voltage.

Fig. 3 fairly high peak voltages +ve and -ve are applied to the anode of the valve and to the potentiometer used for the output voltage control. A top anode valve such as the one shown is, therefore, desirable and a number of suitable alternative ones exist. The potentiometer should be one of good quality or breakdown of the track or between the track and bush may occur.

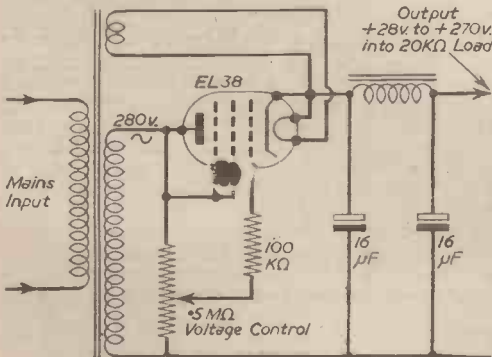

Fig. 3.—This circuit will provide higher voltages and currents.

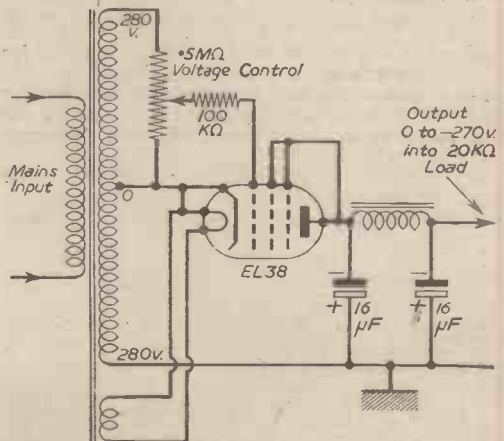

Fig. 4.—Another high power arrangement.

"PRACTICAL TELEVISION CIRCUITS"
 288 pages, 156 illustrations
 15/- net or 15/6 by post from :
 GEO. NEWNES LTD.
 Tower House, Southampton Street, Strand, W.C.2

BAND 3 T/V CONVERTER — 183 Mc/s-196 Mc/s £2-5-0 post free.

Suitable for London, Sutton Coldfield and Northern Transmission.



This Unit, comprising drilled chassis, 7in. x 4in. x 2½in., two miniature valves and met. rect., wound coils, res., cond., etc., is a slightly modified version incorporating variable oscillator tuning of the circuit shown in *Wireless World*, May, 1954. It has proved itself highly successful—over 4,000 sets have already been sold to buyers all over England. We invite you to visit us and see it in operation for yourselves. Suitable for most types of T/V Sets. T.R.F. or Superhet. Blueprint and circuit

details will be sent on application by return of post, 1/6, post free. Supply voltages required 200-250 v., 20 mA H.T. 6.3 v. 1 a. L.T. Power pack components to fit chassis as illustrated, 30/- extra. Complete set wired, tested and aligned ready for use 20/- extra. Band 1, Band 3 A/E switching can now be added, switch kit, 6/6. Full range of Band 3 aerials in stock. Adaptors from 7/6 per set, dipoles—in-door 6/6, outdoor with cable 13/9. Band 1-Band Cross-over filter unit, from 10/6. B.B.C. pattern rejection, 8/6.

B.B.C. BREAK-THROUGH FILTER. Tunable filter unit for

Volume Controls
Midget Edison type.
Long Spindles. Guaranteed 1 year. All values 10,000 ohms to 2 Meg. ohms.
No Sw. S.P. Sw. D.P. Sw.
3/- 4/- 4/8
COAX PLUGS ... 1/2
SOCKETS ... 1/-
COUPLER ... 1/6
OUTLET BOXES ... 4/8

80 ohm COAX CABLE
STANDARD lin. diam.
Polythene insulated.
GRADE "A" ONLY.
8d. yd.
SPECIAL — Semi-air spaced polythene, 80 ohm Coax jtn. diam.
Stranded core. Losses out 50%.
9d. yd.

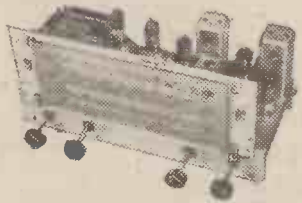

**ALL WAVE RADIOGRAM CHASSIS
THREE WAVEBANDS. FIVE VALVES.**
S.W. 26 m.—30 m. LATEST MIDGET
M.W. 300 m.—550 m. B.V.A.
L.W. 800 m.—2,000 m. 8P B.B.C.

TWIN FEEDER, 80 ohms, 6d. yd.; 300 ohms, 8d. yd.
MIDT SCREEN FEEDER, 80 ohms, 1/- yd.
50 OHM COAX CABLE 8d. per yd., lin. dia.
TRIMMERS, Ceramic, 4 pf. 70 pf., 9d. 100 pf. 150 pf., 1/3; 250 pf., 1/6; 600 pf., 1/9. PHILIPS Beehive Type—2 to 8 pf. or 3 to 30 pf., 1/3 each.
RESISTORS—Pref. values 10 ohms to 10 megohms.
CARBON WIRE WOUND
20% Type, 1 w., 3d.; 3 w., 25 ohms—1/3
1 w., 5d.; 1 w., 6d.; 10 w., 10,000 1/8
2 w., 9d. 15 w., ohms—1/9
10% Type, 1 w., 9d.; 3 w., 15,000—2/8
5% Type, 1 w., 1/-; 3 w., 33,000—2/8
1% El-Stub, 1 w., 2/-; 10 w., 40 ohms 2/3
WIRE-WOUND POTS.
Pre-Set Min. T/V. Type. Knurled Slotted Knob. All values 25 ohms to 30 K. 5/- ea. 50 K., 4/-; 100 K., 6/6. Ditto Carbon. Frack 50 K. to 2 Meg., 3/-.

Brand new and guaranteed. A.C. 200/250 v. 4 pos. W.T. svr. Mod. L. Gram. P.U. connections. High Q dist. core coils. Latest circuit technique, delayed A.V.C. and Neg. feedback. Output approx. 4 watts. Chassis 12½in. x 5½in. x 2½in. Glass Dial—16in. x 4½in. horizontal or vertical type available, lit by 2 Pilot Lamps, 4 knobs supplied, walnut or ivory to choice. Aligned and calibrated ready for use. Chassis isolated from mains. **PRICE £9. 15. 0** Carriage and Insurance, 4/6. 8in. or 10in. speakers to match available. Fresh-pull version of above, chassis to special order, £12/10/-, carr., ins., 4/8.

**BARGAIN VALUE IN
RECORD CHANGERS**
Recommended for above chassis
B.S.R. MONARCH—Latest Model 3 sp. Auto-Changer Mixer Unit. Famous Maghline, 7, 10 and 12in. Record Selector. Modern Cream Styling Dual Xtal Cartridge Stylus for Hi-Fi reproduction. As used by leading manufacturers. Bargain price.
£8. 19. 6 Carr. 4/6
Ins.

CONDENSERS—Mica or S. Mica. All pref. values. 3 pf. to 680 pf., 6d. each. Ceramic types, 2.2-3,000 pf., as available, 8d. each. Tubular, 450 v. Hunts and T.C.C., 5000, 1001, 1005, 01, 02 and 1, 30 v., 9d., 03, 1,500 v. Hunts Molded, 1 in., .25 Hunts, 1/6. 5 Hunts, 1/9. 1,500 v. T.C.C. (Stimples), 3/6. .001, 6kV., T.C.C., 5/6. .001 12.5kV., T.C.C. 9/6.
SILVER MICA CONDENSERS—10%. 5 pf. to 500 pf., 1/-; 100 pf. to 3,000 pf., 1/3. 1½ 1.5 pf. to 300 pf., 1/9. 615 pf. to 3,000 pf., 2/-.
ALUMINIUM CHASSIS—18 s.w.g. Plain, undrilled, folded 4 sides and riveted corners lattice fixing holes. Strong and soundly constructed with 2½in. sides. 2in. x 4in., 4/8; 8in. x 6in., 5/9; 11in. x 7in., 6/9; 13in. x 9in., 8/6; 14in. x 11in., 10/8; and 16in. x 16in. x 3in., 16/6.
CARBON MIKE INSERT—Superior quality type 2½in. x 1in. Brand new and boxed only, 3/6 each.
BRIMISTORS—CZ1 for 3A heater chassis, 3/6. CZ2 for 15 a., or 2 a., 2/6. CZ3 (Pilot Lamp), 1/6.
COPPER ENAMEL WIRE—1 lb. 14 to 20 s.w.g., 8/-; 22 to 28 s.w.g., 2/6; 30 to 40 s.w.g., 3/6.
SWITCH CLEANER Fluid, squirt epout, 3/9.
TWIN GANG TUNING CONDENSERS—375 pf. Midget, 6/6; ditto, with dust cover and trimmers, 8/6. .0005 mfd. Standard size with feet, 8/6;

NEW BOXED	VALUES	ALL GUARANTEED
1R3	7/6 6Q7	8/6 EF41 10/6 MU14 8/6
1M5	7/6 6BN7	9/- EF50 10/6 PC084 12/6
1T4	7/6 6N6	7/6 8Yv. 10/- PCF80 12/6
1A4	2/6 6X3	8/6 EG P80 12/6 PCF93 12/6
6B4	2/- 6X3	8/- EF50 10/6 PL51 12/6
8V4	8/- EA50	2/- Equip. 5/6 PL82 10/-
50A	3/6 EB41	10/6 EF80 10/6 PL83 12/6
324	8/6 EB435	12/6 EF86 13/6 PY80 11/-
6A6G	8/6 EB91	7/6 EF91 8/6
6AT6	8/6 EB23	8/6 EL41 11/6 PY81 12/6
6CH4	10/6 EB28	12/6 EL84 12/6 PY82 10/6
6B6M	8/6 ECR42	10/6 EM80 12/6 SP41 5/6
6K7	8/6 ECL80	12/6 EY51 12/6 SP61 6/6
6X8	2/- EF39	7/6 EZ40 10/- U23 5/6

SPECIAL PRICE PER SET
1R3, 1T4, 1M5 and 384 or 3V4 ... 27/6
6B3, 6K7, 6Q7, 6V6, 3Z4 or 6X3 ... 35/-
SPEAKER FRET. Expanded Bronze anodized metal 8in. x 8in., 2/3; 12in. x 8in., 3/-; 12in. x 12in., 4/3; 12in. x 16in., 6/-; 24in. x 12in., 8/6, etc.
TYGAN FRET (Murphy pattern).—12in. x 12in., 2/-; 12in. x 18in., 3/-; 12in. x 24in., 4/-; etc., etc.

ELECTROLYTICS ALL TYPES NEW STOCK
Tubular Wire Ends
25/25 v., 50/12 v. 1/9
50/50 v., 4/300 v. 2/-
100/25 v. 2/6
8/300 v., Dub. 2/6
8-16 450 v. Dub. 4/6
16/450 v. B.E.C. 3/6
16/500 v. Dub. 4/6
16/500 v. B.E.C. 3/6
16/350 v. Dub. 4/6
16/16 450 v. T.C.C. 5/6
32/350 v. B.E.C. 4/6
32/500 v. Dub. 5/6
32+32/350 v. B.E.C. 5/6
Can Types, Chps., 3d. ea.
8+8/450 v. T.C.C. 4/6
8+16/450 v. Hunts 5/-
16+16+8/350 v. 5/6
16+16/450 v. B.E.C. 5/6
16+16/450 v. T.C.C. 6/-
32/350 v. B.E.C. 4/6
32+32/450 v. B.E.C. 6/6
60/350 v. B.E.C. 6/6
60+100/350 v. 11/8
60+250/275 v. 12/6
94+120/275 v. 11/8
100+200/275 v. B.E.C. 12/6

SEMI-CONDUCTOR RECTIFIERS, E.H.T. TYPE FLY-BACK VOLTAGES—K3/25 2 kv., 4/3; K3/30 3.2 kv., 7/-; K3/45 3.6 kv., 6/6; K3/50 4 kv., 7/3 K3/60 4.8 kv., 12/6; MAINS TYPE.—RM1, 125 v., 60 ma., 4/-; RM2, 100 ma., 4/9; RM3, 120 ma., 5/8; RM4, 250 v., 275 ma., 18/-.

ENGRAVED CONTROL KNOBS for Jin. Fspindle. 1½in. diam. Walnut or Ivory. Gold filed. 16 Standard engravings, 1/8 ea. Plain knobs to match above, 1½in. dia. ea., 1½in. dia., 8d. ea. Superior Unmarked Knobs with Gold Ring. Very stylish and becoming highly popular. Walnut or Ivory. 1½in., 3/- ea.; 1in. 9d. ea. Pointer Knobs, Black with White Line 9d.

WEARITE "P" TYPE COILS. All ranges. 1 to 7, 2/8 ea. 10mho. Q Series Coils. Sing tuned. All ranges from 3/6. Full range popular Coil Packs. **C.R.T. BTR. ISOLATION TYPE**.—Low leakage with or without 25% sec. boost voltage. Ratio 1 : 1 or 1.25, 2 v., 4 v., 6 v., or 13 v., 10/6 ea.

Ditto with mains primaries 200/250 v., 12/8.
L.F. CROCKES—10 H. 65 ma., 5/-; 15 H. 100 ma., 10/8; 10 H. 120 ma., 10/8; 20 H. 150 ma., 16/6; Stimples, 30/6; Wound, 30/6.

ERSIN MULTICORD SOLDER 60/40. 18g., 3d. per yd.; 16g. 4d. per yd.; 11b., 2/6.

LOUDSPEAKERS P.M. 3 OHM. Richard Allen, 5in., 16/6; Celest., 17 in. C. Helm., 18/6; 7 x 4in. Elliptical, 18/6; 8in. Elac., 20/-; 8in. Goodmans special, 21/6; 10in. R. and A., 25/-; 12in. Plessey, 35/-.

RECORDING TAPE.—1,200ft. reels, Scotch boy, 30/-; good quality paper tape on Cylon graded reels, 12/8.
I.F. TRANSFORMERS, 465 kv/s
Brand-new ex-manufacturer's midget I.F.T., size 2½in. x 2½in. x 1½in., dust core tuning. Lita-wound coils, High Q. Bargain offer, 7/6 pair.

QUALITY FLUORESCENT FITTINGS
Ideal for home or workshop. 4ft., 200/250 v., complete with tube, ballast unit, etc., ready for use. Famous manufacturer's surplus offered at approx. half price. Starter switch type, 42/-. Quick start type, 47/6. Carr. and ins., 7/6 extra.

F.M. TUNER-UNIT (67 me/s—105 me/s) by Jason.—As tested and approved by Radio Constructor. Complete Kit of parts to build this modern highly successful unit, drilled chassis and J.B. dial, coils and cans. 4 BVA miniature valves and all components, etc., for only 28.10.0. post free. **SUPERIOR TYPE GLA88 DIAT**—Calibrated in Mc/s and edge lit by 2 pilot lamps, 12/6 extra. Illustrated handbook with full details, 2/- post free.

3 VALVE AMPLIFIER
With variable Tone and Volume controls, 3 Midget B.V.A. valves, 4 waste output. Neg. feedback. Chassis isolated from Mains. A.C. 200/250 v. A quality amplifier at an economical price. **PRICE £3.18.6**. Carr. 2/6. Wired and tested, 15/- extra. Circuit and instr., 1/6, free with kit.

T.R.S. RADIO COMPONENT SPECIALISTS (Est. 1946) 70 BRIGSTOCK ROAD, THORNTON HEATH, SURREY (THO 2188)

50 yards Thornton Heath Station. Buses 130A, 133, 159, 165 & 190

Listed above are only a few items from our very large stock. **Send 3d. stamp today for Complete Bargain List.**
Hours: 9 a.m.—6 p.m., 1 p.m. Wed. **OPEN ALL DAY SAT.**

Orders: C.W.O. or C.O.D. Kindly make cheques, P.O.s, etc. payable to T.R.S. Post/ packing up to 10d. 7d., 11d. 1/1, 3d. 1/0, 3/5, 2/-, 10/6, 2/6

F.M. TUNER



This tuner is based upon the very successful circuit published by Data Publications. We have made up models at all branches and will gladly demonstrate. Stability is extremely good and making and aligning most simple. Cost of all parts including valves, prepared metal chassis, wound coils and stove enamelled scale, slow-motion drive, pointer, tuning knob, in fact everything needed is £5 12/6. Data is included free with the parts or is available separately, price 2/-. Extra for fringe area model, 20/-.

THE CLEVELAND ORGANTONE

5 valve 3 waveband superbet covering Long, Medium and Short waves. Osram miniature valves—low loss iron coils—permeability-tuned I.F.S.—full A.V.C.—variable negative feed-back—gram. position—4 watts output—particularly fine tone. Chassis size 7in. x 7in. x 7in. approx. Tested in difficult areas, where exceptional results have been obtained. Price £11 10/0 or £3 18/0 deposit. Carriage and Ins. 10/-.

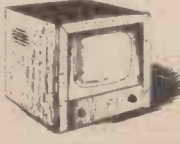

THIS MONTH'S SNIP 14" T.V. CABINET

14in. T.V. cabinet of the latest styling made for one of our most famous firms—beautifully veneered and polished—limited quantity—19/6 each. Carriage and packing 3/6 extra.

ELECTRONIC PRECISION EQUIPMENT LTD.

See page 461 for address

AM/FM RADIOGRAM CHASSIS



This is a 7-valve A.C. mains operated receiver. An exceptional performer on long, medium and short A.M. bands and on the new V.H.F. band. It is an ideal unit for a quality radiogram.

Special features include magic eye tuning indicator, extra long scale and pointer travel—latest circuitry employing full A.V.C. feed-back, etc., etc. Undoubtedly one of the finest AM/FM chassis available today. Chassis size 17 1/2in. x 6 1/2in. x 7 1/2in. Price £23 17/6, carriage, packing and insurance 20/- extra.

RECORD PLAYER £4 10/0

3-speed

Gramophone Motor

Latest rim drive 3-speed motor with metal turn-table and rubber mat. Small mod. makes speed easily variable for special effects and dance work.

Hi-Fi Pick-Up

Using famous Cosmocord HJ-G turn-over crystal. Separate sapphire for each speed. Neat bakelite case with pressure adjustment.

Special Snip Offer This Month

The two units for £4 10/- plus 5/- post and insurance, or made up on board as illustrated, £5 10/0 plus 5/- post.



T.V. TUBE SALE

17in. RECTANGULAR £7.10.0. 14in. RECTANGULAR £5.10.0. GUARANTEED 6 MONTHS.

Please enquire for 16in., 15in., 14in. round, at £5 each. 15 1/2 Ins. Carr. Extra. C.W.O. 8in. at 16/6. Ideal stand-by. 22.14-16-18 and 22.14C with slight burn. Incl. Carr.

T.V. 12in. CHASSIS 97.6. Complete chassis by famous manufacturer. R.F. E.H.T. Unit included.

Drawing FREE. Easily fitted to Table or Console model, owing to this chassis being in three separate units (Power, Sound and Vision, Timebase) inter-connected. THIS CHASSIS IS LESS VALVES AND TUBE, but see our catalogue for cheap valves. Our £5

Tube fits this Chassis. List of valves by request. Carr. 5/- London. 10/- Provinces. London models only. RADIO GRAM CHASSIS 29.9. Including 8in. speaker. 5 valve het. 3 w/band. A.C. mains, complete but less valves. All used, tested and guaranteed. Carr. 4/6. Drawings 2/6 or free with order.

"SUPER" RADIO GRAM CHASSIS. £6.17.6. 5 valve s/het. A.C. rim drive, 4 controls. Complete with high flux 8in. speaker and valves (octal). Size 8 x 10 x 14 1/2in. dial 10in. x 6in., switched all bands and gram. Full tone range. Carr. 4/6. 250 ma. CHOKE 3.9. Unrepeatable offer. Post 9d.

O.P. TRANSFORMER. 1.9. Salvage. Std. 2.5 ohms. Post 9d. COIL PACK. 3.9. Bargain parcel incl. 2 ganc conds., pair 465 L.F.s similar drawing and dial. Post 2/-.

MAINS TRANSFORMER. 5.9. 350-0-350v. 2 heaters 6v. and 5v. Post 2/-.

1 MONEY BACK
GUARANTEE

Tel: GRA 6677
DUKE & Co

CWO
OF
COD

621 ROMFORD RD. LONDON, E.12.

HANNEY OF BATH offers:—

MULLARD 3-VALVE 3-WATT AMPLIFIER. Gilson Output trans., 25/6; Mains trans., 35/-; Resistor/pot Kit, 25/-; Condenser, 23/6. Send for full list.

"WIRELESS WORLD" F.M. TUNER (May 1955) Osamor collect with IF's and RDT, 58/6. J.B. type U.102 variable. 14/6. ERIE condenser and resistor kits, low-loss valveholders and valves. Full list available.

MULLARD F.M. TUNER UNIT Denco drilled chassis, 21/-; collect with IF's, etc., complete, 44/-; J.B. U.101 variable, 10/9. J.B. SL.15 dial drive assembly, 25/6; condenser and resistor kits, valves, etc. Full list available.

OSRAM 912 F.M. TUNER UNIT Denco chassis with dial assembly, 37/6; Denco collect IF's and RDT, 44/9; 2 ganc variable, 17/6. Condenser and resistor kits, valves, etc. Full list available.

MAXI-4 Denco F.M. TUNER UNIT Chassis set, 7/6; Collect, 11/9; 10.7 Mc/s IF's, 6/- each; Ratio discrim. trans., 12/6; Phase discrim. trans., 9/-; Technical Bulletin giving circuit, point-to-point wiring etc., 1/9 P.F.

COILPACKS. Denco CP 4 L and CP 4 M 35/-; CP 3.870 pf and CP 3.500 pf., 44/9; OSMOR "Q" HO. 50/5; I.M. 40/-; Batt., 50/-; TRF. 40/-; HF stage for HO pack, 20/-; We stock COILS by Weymouth, Osamor, Wearite, Denco and R.E.P.

OSRAM 912 P.L.S. AMPLIFIER Erie resistor kit, 17/4; Erie 1 meg. pots, 4/6 each; TCC condenser kit, 55/-; PARTRIDGE components with loose lead terminations (includes packing charge), Mains trans., 65/6; choke, 34/6; output trans., 85/6; W.B. components. Choke, 18/9; output trans., 32/-; Denco drilled chassis, 14/6; Denco 912 plus printed panel, 7/6; pre-amp or passive chassis, 6/-; Full list available.

MULLARD 510 AMPLIFIER ERIE resistor kits, 27/-; TCC condensers, 45/-; Elstone mains trans., 36/-; Elstone output trans. (state 6,000 or 8,000 ohms), 45/-; Partridge components (loose leads), Mains trans., 65/6; output trans., type PFO (state 6,000 or 8,000 ohms), 35/6; smaller version type P.3667, 55/6; Denco drilled chassis, 19/6; Denco printed panel, 6/6. Full list available.

Denco WIDE ANGLE COMPONENTS. Magnavision chassis set, 37/6; Supervisor chassis, 51/6; Magnavision collect, 41/2; scan coils WA DCAI, 43/-; focus coil WA FCAI, 31/-; width and line in. controls WA WCI and WA LCI, 7/6 each; frame trans. WA FMAI, 21/-; line trans. WA LOTA, 42/-; frame blocking osc. trans. WA FBTL, 16/-; Send stamp for lists. Please add postage 2/- to all orders under £3. (Excess refunded).

L. F. HANNEY

77, LOWER BRISTOL ROAD, BATH

Tel.: 3811



UNDERNEATH THE DIPOLE

TELEVISION PICK-UPS AND REFLECTIONS

By Iconos

TECHNICAL CREDITS

THERE is one small point I must make about Rediffusion's filmed features: they often end with a series of technical credits to cameramen, editors, hairdressers, electricians, make-upmen, etc., etc., etc., which would be appropriate for an epic like "Ben Hur." Frankly, all we need to know with filmed subjects, apart from the cast, are the names of the author, the director, the art director (sometimes called "designer") and the cameraman. Viewers are possibly not very interested in any of these names, but their inclusion is a first-class incentive to the people concerned. Besides, the cameramen who master the not-too-easy job of lighting and composing their pictures for TV films deserve to be noticed. Time and time again we notice good photographic results on British TV films, followed up by the credit: "Photography by Lionel Banes." We have already become accustomed to the consistent clarity and high-key photographic effect appropriate to the cheerful American "I Love Lucy" series, achieved by Karl Freund. Other top-line and highly-paid American cameramen now engaged on filming for TV are: Nick Musuraca ("The Line Up"); Robert de Grasse ("Make Room For Daddy" and "It's Always Jan"); William Bradford ("The Adventures of Champion") and Phil Tannura ("The Burns and Allen Show"). The British cameramen, on the whole, still tend to make the following cardinal mistakes in filming for TV: photography dark and in too low a key; effect lighting too contrasty; background decoration too busy; camera movements too swift. These faults are often at their worst on the British commercials, which sometimes also suffer from poor sound tracks. However, it is not always the camera or sound technicians' faults if the results are below standard. Films

are projected on a mixed lot of equipment on both BBC and ITA programmes. There are Cintel and E.M.I. Flying Spot scanners used for 35 mm. and 16 mm., in addition to Vidicon, Station, and other camera tube scanners, and the results are very variable. On the whole, the flying spot type of equipment seems to give the most consistently good results. 35mm. film is still vastly superior to 16mm. film and is likely to become standard, excepting for news items and telerecordings for storage purposes. For newsreels, the 16mm. negative, with combined sound and picture, gives remarkable results and is often projected in its negative form by both BBC and ITA. This method is speedy and inexpensive and is entirely adequate for stop-press items. The chief fault is more in the unsteadiness of the results. Surely the film camera need not always be hand-held? There must be occasions when a tripod or even a unipod could be used.

SCRIPTS FOR CHELTENHAM

IN America, film studios do not encourage the submission of scripts by unknown persons. Indeed, some companies return them unread, with a courteous note of thanks stating this fact. So many hundreds are sent week by week that, sooner or later, a script will be submitted which is similar in story to a film actually in production, and the results might well be a court case and a suit for plagiarism, infringement of copyright or whatever the lawyers might call it. Fortunately, film and TV studios in Britain are not quite so suspicious of the intentions of would-be authors and do actually read their efforts. Nevertheless, a very small percentage of the scripts sent in are usable, either in part or as a whole. At the Cheltenham Literary Festival there was a competition for scripts of 60-minute and 30-minute TV plays. There were no less than 1,500 entries! It

seems that when the terrific job of sorting them out had been done and the prizes awarded, quite a few of them were really worth while. Two of them have already been produced on TV by the BBC: "Wilde West," by Elaine Morgan, and "That One Talent," by Joan and John Ormerod.

The latter play, which was in the 30-minute class, proved to be a quiet and sincere conversation-piece about a blind man's efforts to find an ideal companion to read to him. John Stuart, Jennifer Wright, Ann Castle, Viola Lyel and Barbara Leake all built up interesting characterisations in this playlet, which held the attention throughout.

"Wilde West," a 60-minute class effort, was of quite a different type, a "situation" comedy with some original twists. It depicts Oscar Wilde, on a lecture tour in the U.S.A. in 1882, stranded through an accident in a small middle-west town. The reactions of the corn-belt hicks to this extravagant and colourful personality evoked many chuckles, but would have induced more if the Oscar Wilde characterisation had been slightly exaggerated or played in a manner larger than life. Alec Guinness, Peter Ustinov, Charles Laughton or Robert Morley are types who would have provided the bite to the epigrams and highbrow talk, and bite it was that the direction lacked. I do hope that we see this play again at a later date, with suitable casting adjustments. In fairness, I must add that the actors who played the parts did extremely well with characterisations beyond their normal compass. Anyway, the Cheltenham Literary Festival has blazed a new trail for TV scripts, and I am sure that several more of the 1,500 entries for this competition will be seen in due course on BBC or ITA television.

MIDLAND TRANSMITTER

THE announcement by ABC-Television and Associated-TeleVision of their plans for the

Midlands TV transmissions indicates something more than programme details—it gives an idea of the general pattern of things to come on ITV all over the country. The rival contractors are evidently going to be rivals in name only, with close co-operation between them and fairly wholesale exchanges of both live and filmed programmes. There is every indication that this co-operation will be extended to the Granada TV

will figure in the ABC-TV's Sunday programmes from Birmingham.

THE BBC DISTRICT—LONDON, W.

THE successful use of old "live" theatres for TV in America, particularly in New York, encouraged the BBC some time ago to acquire from the Stoll circuit the Shepherd's Bush Empire, now known as the Television Theatre.

prospect of Walpole Park, which adjoins the site. Would not this be a good new BBC site name: "Walpole Park Studios"?

THEATRES FOR TV

AS for ITA companies' theatre acquisitions in London, AR-TV paved the way by snapping up that pint-sized music hall, the Granville at Walham Green, while A-TV bought the Wood Green Empire. Granada have taken over the Embassy Theatre, Swiss Cottage, though still using it for public performances from time to time, and I now hear that the Hackney Empire has been bought by one of the ITV companies. The music hall and theatrical profession mourn the passing of these live theatres, but they can take heart from the fact that they will be used for live television, and that television will call upon them to play their parts again and do their turns upon those same boards, in front of live audiences.

THE OLD "JUNCTION" THEATRE

THERE was a great deal of fuss made in the press and on radio about Sabrina's change of mind about appearing in "Home James," which was one of the first presentations made at the BBC's newly acquired theatre in Manchester—the Playhouse, Hulme, formerly Broadhead's Junction Theatre. This served to focus attention on a good (if somewhat under-rehearsed) music hall programme with Jimmie James and his stooges, Rawicz and Landauer, Thora Hird and a thoroughly good company. Corinne Grey took the Sabrina part at short notice—there was no dialogue to learn! I look forward to more shows from the old Junction Theatre, where I used to see the blood-curdling melodramas of Walter Howard many years ago. What about the BBC reviving some of them on TV, upon the very boards where they were first produced? "The Lifeguardsman" was the name of one of Howard's most popular thrillers, a drama in Ruritanian settings. "The Midnight Wedding" was another. With dialogue revised to modern style, they should have a wide appeal. They are not quite old enough for "period" treatment, as put over by AR-TV in Granville Melodramas, such as "East Lynne."

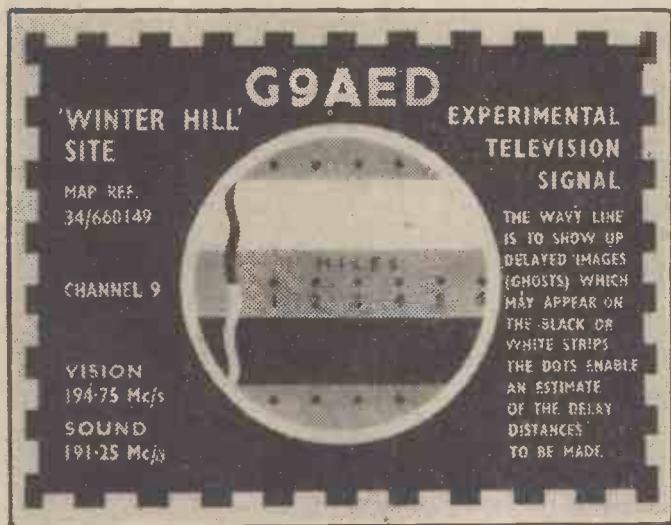

The Belling-Lee Test Card used for the Lancashire ITA Test transmissions

network in Manchester. Technical facilities are likely to be shared in both Birmingham and Manchester, where the usual crop of theatres and music halls are likely to turn over to TV. In Birmingham, the Theatre Royal has been taken over by A-TV and the Astoria by ABC-TV. In Manchester, the Capitol Cinema in Didsbury, which has unique theatrical facilities, including a revolving stage and a four-manual Christie organ, has been acquired by ABC-TV, and the studios which Granada are building in the centre of the city are also likely to be used by ABC-TV. Thus, Howard Thomas seems to be steering the ABC-TV organisation on a steady course, acquiring good programme material from other sources by negotiation and enabling his carefully recruited staff to concentrate on fewer programmes of the highest possible quality. I notice that A-TV's most popular successes, "Sunday Night at the London Palladium" and "I Love Lucy."

This is shortly to be taken out of service for refitting and bringing up to date, and in the meantime the King's Theatre, Hammersmith, will be brought into use. In the same area are the following BBC Television Studios: Riverside Studios, Hammersmith (which has been completely refitted with the most elaborate automatic lighting control devices), the TV Centre at White City, the Lime Grove Studios, Shepherd's Bush, and the latest acquisition of studios at Ealing, where filmed programmes will be concentrated.

By the way, the BBC can hardly call their newly acquired studios "Ealing Studios" in deference to that illustrious film-producing organisation, which is continuing its activities elsewhere. This studio is due to go into action for the BBC the very first day it is taken over by the BBC, and BBC technicians and staff are able to continue to operate much of the technical plant already installed there and gaze from their office windows over the pleasant



SOLDERING INSTRUMENTS

Sound jointing for the Home Radio Engineer

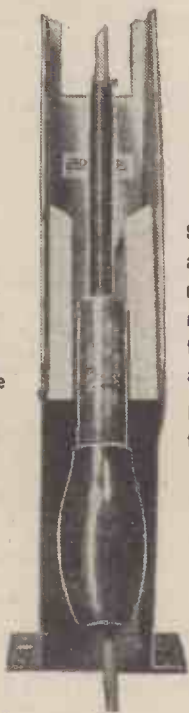

Illustrated Protective Shield (List No. 68)

$\frac{3}{16}$ " Detachable Bit Model (List No. 64)

Supplied for all volt ranges with no extra cost for low voltages.

Bit sizes $\frac{1}{4}$ " to $\frac{1}{2}$ "

Apply Catalogues:

Sole Proprietors & Manufacturers

HEAD OFFICE SALES AND SERVICE
ADCOLA PRODUCTS LTD.

GAUDEN RD., CLAPHAM HIGH ST.,
LONDON, S.W.4.

Tel: MACaulay 3101-4272.

HERE IT IS!

THE **NEW** 1956 EDITION

NEWNES

Radio and Television Servicing

FREE for 7 DAYS

THIS is the most complete collection of models ever assembled—it provides all the data, circuit diagrams and component layouts you need to service over 1,550 different models. The work covers Multi-channel T.V. receivers, Band III converters, Radios, Radiograms, VHF/FM receivers and adaptors, Portables, Car radios—and can pay for itself within a week of receiving it. Prove this by claiming Free Examination NOW!

1,550 POPULAR MODELS including LATEST RADIO SHOW MODELS

TELEVISION

SERVICING DATA for—Ace, Alba, Ambassador, Argosy, Baird, Banner, Beethoven, Bush, Champion, Cossor, Decca, Defiant, Ekcovision, E.M.I., English Electric, Ferguson, Ferranti, G.E.C., H.M.V., Invicta, K.B., McCarthy, McMichael, Marconiphone, Masteradio, Mullard, Murphy, Pam, Peto Scott, Philco, Philips, Pilot, Portadyne, Pye, Rainbow, Raymond, Regentone, R.G.D., Sobell, Stella, Ultra, Valradio, Vidor.

RADIO

SERVICING DATA for—Ace, Ambassador, Banner, Beethoven, Bush, Champion, Cossor, Decca, Denco, Defiant, Eddystone, Ekco, Etronic, Ever Ready, Ferguson, Ferranti, G.E.C., Grundig, Invicta, K.B., McCarthy, McMichael, Marconiphone, Masteradio, Mullard, Murphy, Pam, Peto Scott, Philco, Philips, Pilot, Pye, Rainbow, Raymond, Regentone, R.G.D., Roberts Radio, Sobell, Strad, Ultra, Vidor.

Owners said the last edition was worth a fortune! This New Edition is even more valuable. Prove it yourself by sending for Free Examination—no cost or obligation.

6 VOLUMES.
3,153 PAGES.
3,000 CIRCUIT, COMPONENT AND CHASSIS LAYOUT DIAGRAMS.
FREE 2 YEARS' ADVISORY SERVICE.

DON'T MISS THIS GREAT OPPORTUNITY

To: George Newnes, Ltd., 66-69 Great Queen St., London, W.C.2.
Send me Newnes RADIO AND TELEVISION SERVICING. I will either return it in 8 days or send 9s. deposit 8 days after delivery, then 10s. monthly, paying £9 9s. in all. Cash price in eight days £9.

Name.....

Address.....

Occupation.....

Signature (Parent's Signature if under 21).....

Place X where it applies

HouseOWNER	
Householder	
Living with Parents	
Lodging Address	

RTV 113

LASKY'S RADIO

12-CHANNEL TV TUNER

Famous make. Covers Bands I and III. Complete with valves EF80 and ECC81. Ceramic valveholders, finest quality components, precision made. Switch and fine tuning. I.F. output 30-25 Mc/s. Freq. coverage 50.87 Mc/s and 175-215 Mc/s. Supplied with full details and circuit diagram. Post 3/6. Knob, 2/9 extra. **39/6**

TELETRON BAND III CONVERTER COIL SET

For use with T.R.F. and superhet Band I TV sets. Uses two Z719. Circuit, wiring diagrams, alignments and full details with each set. Post 1/6. **15/-**

COMPLETE KIT to build the Teletron Band III Converter, including chassis, condensers, valves, etc., with full instructions and diagram. **48/6**

Mk. II COIL SET, cascade 17/6.
Mk. II CHASSIS (also takes power supplies), 6/-

OTHER TYPES OF CONVERTERS IN STOCK.

Open
all day
SAT.
Half day
Thurs.

LASKY'S (HARROW ROAD) LTD.

42, TOTTENHAM COURT ROAD, W.1.

Telephone: MUSEUM 2905.

370, HARROW ROAD, PADDINGTON, W.9.

LADBROKE 4075 and CUNNINGHAM 1979.

All Mail Orders to Harrow Road, please.

SPECIAL BAND III CONVERTER BARGAINS

All complete with own power supplies and for all channels.

"TELECOM" ... **£5.19.6**

"PROGRESS" ... **£6.19.6**

"CHANNEL" ... **£7.19.6**

Post 3/6

METER BARGAINS

2 1/2 in. Moving Coil. Brand new Microammeters F.S.D. 0-750 microamps, 15 ohms resistance. 21/-; 0-1.5 amps, 12 1/2; 0-200 v. A.C., rect. incorporated, 12 1/2. Dozens of other types.

COMPLETE PROJECTION UNITS

(Mullard). Consisting of optical unit and e.h.t. unit, complete with valves and c.r. tube.

LASKY'S PRICE **£21**

Carriage 2/- extra.

Limited Quantity only. Full details on request.

WIDE ANGLE 14-INCH CONVERSION PARCEL

Convert to big 14in. picture! Parcel contains brand new 14in. rectangular C.R. tube (famous make), 6.3 heater, 10-14 kV E.H.T. aluminium, 1 Ferroxcube line output trans. with width and linearity controls, Ferroxcube scanning coils, frame output trans., Ferroxcube focus magnet, duodecal base, 14in. mask, and suggested circuit diagram. **£18 5s.** LASKY'S PRICE, complete parcel.

Carr. & Ins., 25/-

All parts and C.R.T. available separately.

5-CHANNEL BAND I PRE-AMPLIFIERS

Famous make, brand new and unused. Contains one 6AM6 valve. Size 5 x 2 x 2in. List 45/-

LASKY'S PRICE **21/-**

Post 2/6.

IMMEDIATE DELIVERY, All Types, Band III Aerials

All Channels, 3-, 4-, 5- and 6-element outdoor, indoor and loft. A few examples:—

WOLSEY Minors indoor, 12/6.

KING PIN, indoor, 7/6.

AERIALITE 5-element loft, 42/6.

WOLSEY Combined Bands I III, 17/6.

AERIALITE outdoor for fitting to existing mast:

3-ele., 30/-; 4-ele., 36/6; 5-ele., 42/6

Chimney lashing and wall fitting equipment available, extra.

Co-axial Cable, semi-airspaced, yd., 9d.

Aerialax, yd. 10d. 300 ohms Feeder, yd. 9d.

Diplexes, 12/6. Wolsey Crossover Boxes, 15/-.

BAND 3 T.V. CONVERTER

FOR THE NEW STATIONS: LONDON, BIRMINGHAM,
MANCHESTER

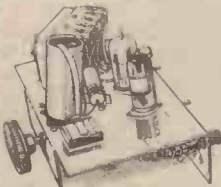

42/6

Post Free

Complete kit of parts, including valves EF80 and ECC85, with punched chassis 6 1/2 in. x 4 1/2 in. x 2 in. or metal box 9 in. x 4 in. x 3 in. (power required 200v. at 17 mA and 6.3v. 1 amp.) Power pack components to wire on chassis **20/-** extra.

Fully wired, with power pack, aerial tested and ready for use for **£4**, post free.

Suitable for superhet and T.R.F. for all channels 41.5 to 66.75 Mc/s, state I.F. or B.B.C. station.

Print showing full details sent on receipt of 1/6.

Come and see the working model.

(Components available for P.T. Band 3 Converter.)

GLADSTONE RADIO

56a, HIGH STREET, CAMBERLEY,
SURREY

Train for a wonderful
future in—

ELECTRONICS

Train to meet the need for pioneers in this expanding field.

Every day the demand for the expert in electronics grows. Radio, television, radar and the whole field of industrial automation are rapidly expanding, and the trained specialist assures for himself a well-paid career in this quickly developing profession. Here is your opportunity to enter for

3-YEAR COURSE IN TELECOMMUNICATION ENGINEERING

(including opportunity for nine months' practical attachment in E.M.I. Laboratories and Workshops). Final qualification is the City and Guilds Full Technological Certificate.

Next course commences on 11th September, 1956.

4-YEAR COURSE IN ELECTRONIC ENGINEERING

Intended for outstanding Science sixth-formers who are capable of training into future team leaders in scientific applications. Final qualifications are B.Sc. and City and Guilds Full Technological Certificate in Telecommunication Engineering.

Next course commences 2nd October, 1956.

E.M.I. INSTITUTES

Dept. 138 K, 10 Pembridge Square, London, W.2
Telephone: BAYswater 5131/2

The College associated with a world-wide electronics industry, including "His Master's Voice," Marconiophone, Columbia, etc.



Whilst we are always pleased to assist readers with their technical difficulties, we regret that we are unable to supply diagrams or provide instructions for modifying surplus equipment. We cannot supply alternative details for constructional articles which appear in these pages. WE CANNOT UNDERTAKE TO ANSWER QUERIES OVER THE TELEPHONE. The coupon from p. 473 must be attached to all queries, and if a postal reply is required a stamped and addressed envelope must be enclosed.

BUSH TUG12A

My set usually works perfectly, but on some occasions, when it is first switched on, only a third of the picture becomes visible on the screen. That is, one third of the top of the screen and one third of the bottom of the screen remains blank, and, of course, the picture in the middle of the screen is very distorted.

After a lapse of about 15 minutes the picture gradually becomes larger until normal vision is restored. This fault does not occur again until some days later, or even some weeks later.

We reported the trouble to our dealer and on the two days he visited us the set worked perfectly, and he reported that the set was in thorough order.

I should welcome your comments on this fault, which would appear at first to be caused by some fault in a valve.—L. Koerber (S.W.11).

At first sight this would appear to be a defect in the frame output valve (EL42). As there are two of these valves on the main deck, a quick but not always recommended check would be to swap them over. If now the sound at times becomes low or develops a hum, the height remaining constant, the fault will have been located, and the EL42 now operating as the sound output should be replaced.

ARGOSY T2

I get line ringing—vertical white lines in the left-hand quarter of the picture.

I have checked the width and line linearity circuits and can find no fault.

The damping R59, TC2 and C64 as per maker's service manual have been changed; most condensers and all valves in the line timebase fitted with new ECL80, PL81, PY81, EY51, but still no improvement. I may just mention the setting of TC1 is correct.—J. H. Wilson (Nr. St. Helens).

If adjustment to TC2 does not balance out the left-hand striations, the line scan coils may be at fault or the line PL81 may require a small magnet secured to the side and moved until the striations are balanced out.

Normally, however, if the lines are due to parasitic

oscillation in the line output stage they should vary their position with the operation of the line hold control.

FERGUSON 842T

Control stations appear to be satisfactory and there is continuity from these and their respective components. I have replaced the PL33 and EF50 with new valves. H.T. can be traced to the transformers which appear to be O.K. The PL38 line output valve gets very warm and has a bluish glow inside. The PL33 also gets fairly warm, but the EF50 frame oscillator is stone cold. Should this be so? The line trace on the screen seems to be modulated.—F. G. Pinner (West Wickham).

The PL38 should get hot and have a blue glow in it. You say you have traced the H.T. to the transformer, but have you tested the windings for continuity?

The EF50 should get warm and if it doesn't, either the valve is defective, the heater being shorted internally, or one of the heater wires is shorting to the other tag due to its being pulled too tight against the other heater tag.

Check EF50 voltages: Anode 20; screen 290. Also check C42 .01 μ F for short circuit.

G.E.C. BT4640

I am having trouble with the frame or frame amplifier stages of a G.E.C. television, type B.T.4640, tube 6703A. The trouble started by not being able to obtain sufficient scan to fill the tube. The maximum scan now obtainable is about a third of what it should be. The picture is central, leaving a blank portion top and bottom, and with plenty of width and brilliance. Most resistances and some of the condensers around the two valves, L63 and KT61, have been checked and also the frame output transformer and deflection coils checked and found in order. The main difference now appears to be the frame hold control, which when rotated only alters the height from a thick line to the usual scan of about a third of what it should be and does not alter the frequency. The picture remains quite steady and does not drift in any direction.—R. Blanchard (Nr. Ventnor).

Check the condition of the 1.5 megohm resistor which is in the anode circuit of the L63 oscillator valve; this often goes high in value and causes reduced frame scan. Check also the 32 μ F capacitor in the cathode circuit of the KT61 amplifier valve.

G.E.C. TYPE BT9121

In October last I wrote to you a letter in which I asked for details of how to modify a Type BT9122 G.E.C. television set for Channel 5 (Wenvoe).

The following is your reply:

"The set in question is a double side band London model and, therefore, would not be convertible for Wenvoe which transmitter uses single sideband technique."

Since receiving your reply I have read in your journal of various ways in which to modify older style double side band receivers, such articles having appeared in your October and December, 1955, issues at least the latest appearing on page 293 on "Alignment of TV Receivers."

I am still anxious to know whether it is possible to modify my set and, if so, the details or the reasons

why it is not possible to convert the set?—N. F. Cannan (Cardiff).

We would confirm that your receiver is a superhet with a sound I.F. of 0.456 Mc/s and a vision I.F. of 3.956 Mc/s, with the vision channel tuned and designed for double sideband reception. Apart from rebuilding the vision channel, altering its nominal frequency to something like 13 Mc/s, altering the sound channel and oscillator circuits to correspond, little can be done to permit satisfactory reception of an asymmetric-sideband signal. Unfortunately, the modifications involved are outside the scope of our advisory service to describe in detail, which would take several thousand words and detailed illustrations.

EKCO T.141.B

Can you please give me guidance on how to correct the two faults that have developed on my Ekco T.141.B set. The first fault is that the picture closes up to a thin bright line intermittently, some nights it is a good clear picture for about two hours and will then suddenly close up to the thin bright horizontal line; on other occasions the thin line is there as soon as the set is switched on and will open out to a picture, but after a time will close up again.

The second fault is the sound. This also fluctuates, sometimes I can get full volume and periodically the sound is just audible when the volume control is full on, and then suddenly it will blast out with full volume. I have changed the valves round and also fitted a new video valve and fitted an isolating transformer to the tube without any improvement.—H. Woodward (Nottingham).

The intermittent frame collapse indicates a defective frame oscillator or output valve. Almost under the tube neck, just to the right, are three valves. The rear two are concerned with the frame timebase and these should be checked. The fluctuating volume is due to a poor connection and the wiring to the valve bases, etc., on the right side sound strip should be probed to locate the cause of the trouble. Quite often an improperly seated valve will give rise to this trouble.

McMICHAEL 129SC

I have recently acquired a second-hand television receiver, McMichael Model No. 129SC, which was in really rough condition. I have replaced various components and now have both sound and vision working quite reasonably, but have reason to believe that the alignment of the vision I.F.s has been tampered with. I wonder if you could possibly give me any information regarding this. I understand that this model has a basic vision I.F. of 23.5 Mc/s, but do not know if individual coils are stagger-tuned in any way.—H. A. Edwards (Walsall).

The vision I.F. coils are tuned, as you say, to a basic frequency of 23.5 Mc/s, staggered to resolve the 2.5 Mc/s bars on test card C. The makers recommend the alignment of the sound section first, the correct oscillator setting is then made for maximum sound which, when the 59.5 to 61.75 Mc/s signals are injected into the aerial socket, automatically enable the correct I.F. signals to be obtained.

INVICTA MODEL 60

I wish to fit a new volume control to my set and understand that it is only a matter of getting an identical volume control to the existing one, from which the wires are unsoldered when it is removed, and

then resoldered to the identical points on the new one.

Is this correct, and should I get the new volume control from an Invicta dealer, or the company direct?—Hugh Wade (N.8).

It is a relatively simple matter to replace the volume control on your set. Provided you connect the replacement in the circuit exactly the same as the original, if necessary marking the wires with small tags, you will not come up against any undue snags.

It would be desirable to use an exact replacement part; this can be obtained from the manufacturer via your Invicta agent.

G.E.C. BT2147

I have a London Model G.E.C. BT2147 television, and I would like to know if it is double or single sideband tuning, also as it needs a new tube, can we substitute any other make for the G.E.C. 6505A that is now in the set?—E. J. Smith (St. Albans).

The receiver is aligned to the lower side band. This means it is satisfactory from all points of view, new transmission, conversion, etc. There is no direct equivalent to the 6505A (it has a 10.5 volt .3 amp heater and international octal base). The 6504A has a 6.3 volt heater at .5 amp.

To use this, employ separate 6.3 volt transformer (A.C. mains only) to supply the heater. Remove the original heater leads and connect them together through a 35 ohm 4 watt resistor, i.e., this resistor replaces the C.R.T. heater in the valve chain.

“VIEWMASTER”—Improving Picture Quality (Concluded from page 450)

In this instance, a 60-120 micro-farad unit being used.

The auxiliary rectifier was mounted immediately behind the existing MR4, two short pieces of metal strip about 3½ in. long being used to carry it. These were fitted on to the shaft of MR4, suitable holes having been drilled in each end to support the second rectifier, the nuts were first removed from MR4, and the metal strips slipped on to each end of the shaft, then the nuts were replaced and screwed up tightly.

The auxiliary condensers C53 and C54 (combined in one can) were mounted flat on the chassis in front of, and parallel to, the focus unit mounting bracket; and there is ample room for the 2 henry choke beside the existing choke underneath the time-base chassis.

The auxiliary H.T. pack is connected as follows:

A short length of insulated wire is soldered to the centre connection of MR4 and to the centre connection on the auxiliary rectifier, the end plates of which are joined as in MR4, and a long piece of insulated wire is taken from the second rectifier (as in the case of MR4) to the 60 µf tag of the auxiliary smoothing condenser. From there another wire is taken through the chassis to the auxiliary choke underneath. It will be necessary to drill a hole in the chassis for this purpose.

Another wire is then soldered to the other tag of the choke and this wire is brought out through the chassis to the 120 µf condenser tag and thence to the H.T. tag on the main tag strip to feed the sound, vision and brilliance control.

Constructors will find there is a considerable increase in the time-base voltage as the main H.T. pack no longer has to supply sound and vision, etc., and a 12in. tube is fully scanned thereby.

R.F. UNITS. Types 26 or 27, 27/6 (postage 2/6); RF24, RF25, soiled, 10/6; I.P. Amplifier 178, 16.5 mc/s. with valves, 17/6 (postage 2/-). R1355, new improved type, 37/6 (carr. 7/6). R1392A, 100/150 mc/s, 13 valves, used, good condition, £4 (carr. 10/-). Condensers, electrolytic: 13 samples, range 4 mfd. to 1,000 mfd., 7/6 (post free); Bak., tubular, 0.1/1.2 kV., 5/800V, 25/800V, 9d. each; .03/2.6kV., 0.5/3.5kV., .25/1.5kV., 1/- each; 1/2.5kV., 3/6; 1/3.5kV., 4/6. Responder, RDP1, new, 160/220 mc/s, 12 valves, 15/- (carr. 7/6), or ZC 8931, 9 valves, 30/- (carr. 6/-). R1355 I.F. strips only, complete, new with valves, 25/-, less valves, 12/6 (post 2/6). List and enquiries, s.a.e., please! Terms: C.W.O. Postage extra. Immediate despatch. **W. A. BENSON, 308, Rathbone Road, Liverpool, 13.**

DIRECT T/V REPLACEMENTS offer the most complete Handbook of T/V Components and Rewinds, price 1/-, T/V Components for all kit sets in stock. "Nuray" heater booster isolator for 2-volt C.R.T.'s, just plugs in, 27/6, plus 2/- packing and postage. 134-136, Lewisham Way, S.E.14. (TIDeway 3696-2330.)

B.S.R. MONARCH 3-speed auto-change units; new in maker's sealed carton; guarantee; complete with instructions, template, suspension springs. £9/15/1, carriage paid; immediate delivery. **TOMLINS, 127, Brockley Rise, Forest Hill, S.E.23.**

TELEVISION. 9in. models, £6/10/-; 12in. models, £15/-, all makes; working; carriage paid. **TOMLINS, 127, Brockley Rise, Forest Hill, S.E.23.**

GUARANTEED TELEVISION. 12in. models, first-class picture, 5-channel, £30 each, carriage paid. **THE GRAMOPHONE SHOP, 19-21, Brockley Rise, Forest Hill, S.E.23.**

LOUDSPEAKERS repaired promptly. **MODEL LOUDSPEAKER SERVICE, Bullington Rd., Oxford.**

ALL DISTRICTS.—Television Technicians as Technical Agents. Write. **TELEPATROL LTD., West 1st, Epsom, Surrey.**

SALE, 12in. Viewmaster TV. Holme Moss. Tallon console cabinet, unmarked, expertly constructed and in working order, not 2 years old, £25 or offers. 67, Milton St., Darlington, Co. Durham.

SEVERAL EARLY MODELS 9in. Television, complete, and mostly working, £5/5/- each; carriage paid. **TOMLINS, 127, Brockley Rise, Forest Hill, S.E.23. (FOR 3497.)**

R.F. UNITS, Types 27 or 26, 25/-; 25 or 24, 10/-; brand new with valves; post 2/6. **E.W.S. CO., 69, Church Rd., Moseley, Birmingham.**

ALL DISTRICTS. An opportunity exists for Television Technicians to establish a business of their own. The business can be commenced in first instance in spare-time, showing an all the year round increasing income. Write, giving particulars of age, training, test equipment, experience, to **TELEPATROL LTD., Federation House, Epsom.**

MAKING YOUR OWN? Telescopes, Enlargers, Binoculars, Microscopes, Projectors, or, in fact, anything that needs lenses. Then get our booklets "How to Use Ex-Gov. Lenses & Prisms," Nos. 1 & 2, price 2/6 ea. Also our stereo book, "3-D Without Viewers," price 7/6. Comprehensive lists of lenses, optical, radio and scientific gear free for request. **H. W. ENGLISH, Rayleigh Road, Hutton, Brentwood, Essex.**

SERVICE SHEETS, Radio/T.V., ex-dealer's stock; s.a.e. with inquiries. **F.I.E.L.D., 86, Oldfield Road, London, W.12.**

RATES: 4/- per line or part thereof; average five words to line, minimum 2 lines. Box No. 1/- extra. Advertisements must be prepaid and addressed to Advertisement Manager, Practical Television, Tower House, Southampton St., Strand, London, W.C.2.

MAINS TRANSFORMER, 3/9, 350-0-350v, 12v, 4v, heaters, primary 100-250v, make ideal auto trans., post 2/-; Mains Transformer, 5/9, 350-0-350v, 4v, heaters, primary 200-250v, post 2/-; Speakers, 8/9, 8in. standard 2-5 ohms P.M., ideal extension, post 1/9; Condensers, bargain parcel 2/6 per 100, assorted, good stand-by for all amateurs, p. & p. 2/-; Receiver No. 71, 6/9, ex-W.D., full of gear, resist., etc., works V.H.F. with drawings, post 1/9 (less valves); Transmitter No. 50, 6/8, ex-W.D. V.H.F. with coils, tuning, conds., fixed conds., resist., switching, etc., less valves, post 1/9. **DUKE & CO., 621, Romford Road, Manor Park, E.12.**

ENGRAVING.—Amateurs and trade surplus can be undertaken by getting in touch with A. G. **ENGRAVING, now at 292, Earlsfield Road, London, S.W.18. (Tel.: BAT 9897.)** Engravers to well-known makers of Electronic Equipment used by the Aircraft industry, A.W.R.E., etc.)

T/V IN PERFECT WORKING ORDER from £14, carriage paid; all makes; many sets suitable use anywhere. Impossible to show complete stocks here. Send s.a.e. for lists of latest bargains. 10in. Marconi £14, 9in. Ekco £15, 12in. Ekco £22/10/-, 12in. Ferguson £24. **THIS IS A GENUINE OFFER—NOT A "CATCH!"** 100s SOLD EVERY WEEK. Callers welcomed. **HIGH STREET RADIO, 284-6, High Street, Croydon, Surrey. (Phone: CROYdon 9015.)**

16IN. TUBE by famous manufacturer; brand new E.H.T. 14 K.V. Heater, 6.3 volts, 0.6 amp., guaranteed 3 months. £9/19/6, post, packing and insurance 22/6. H.P. terms available. E.H.T. and scanning components available. **R. & T.V. COMPONENTS (ACTON) LTD., 23, High Street, Acton, London, W.3.**

SITUATIONS VACANT
The engagement of persons answering these advertisements must be made through a Local Office of the Ministry of Labour or a Scheduled Employment Agency if the applicant is a man aged 18-64; inclusive, or a woman aged 18-59, inclusive, unless he or she, or the employment, is exempt from the provisions of the Notification of Vacancies Order, 1952.

T/V TESTERS.—Training opportunities. **Pye Limited** of Cambridge, one of the leading manufacturers in the Television industry, offer training to suitable candidates for testing and fault-finding on complex T/V transmission equipment. A 3-months' course will be given to selected applicants, who should have a sound training in the fundamentals of radio. Applications are welcome from men who have completed or are about to complete their service with H.M. Forces, and should be addressed to the **CHIEF ENGINEER, Pye Limited, St. Andrew's Rd., Cambridge,** quoting "T/T."

VALVES
GUARANTEED VALVES, boxed, 10P14, EL84, 11/-; 6P15, 10C1, EBP80, 9/-; 10F9, 10P1, 6P17, DH150, U404, 1H5, 1N5, DH77, 6AT6, 3524GT, 12K7GT, 12J7GT, 12K8GT, 6K8GT, 8/6; 6Q7GT, 6V6GT, 6V6G, 6P6G, 6SN7, 25Z6GT, 7/8; 6KTG, 6J5GT, 6U7G, 12SQ7, 12SG7, W. FEWELL, 19, Mapledene Rd., Dalston, London, E.8. (CLI 7882.)

ALL TYPES OF VALVES REQUIRED for cash. State quantity and condition. **RADIO FACILITIES LTD., 38, Cha'cot Road, N.W.1. (PRIMrose 9090.)**

TUBES & VALVES. Satisfaction assured or cash returned. Tubes: 17in. £6, 14in. £5, 12in. £3, carriage 10/-. Valves: PL81, PY82, PL82, ECL80, 20P1, 20L1, 10P14, 10C1, KT36, UL41 at 8/6; 6V6, 6P6, 6A8, 6K7, 6P12, 6L1, UCH42 at 6/6. **E. E. WISEMAN, 57, Glenthorne Road, Portsmouth.**

ALL TYPES of new radio valves wanted, small or large quantities; cash payment. **R. H. S. LTD. (T), 155, Swan Arcade, Bradford.**

EDUCATIONAL
BUILD YOUR OWN TV and learn about its operation, maintenance and servicing. Qualified engineer-tutor available while you are learning and building. Free Brochure from **E.M.I. INSTITUTES, Dept PT.58, London, W.4. (Associated with H.M.V.)**

I.P.R.E. Data for constructing TV Aerial-strength Meter, 7/6; 5,500 Alignment Peaks for superhets, 5/9; sample copy "Practical Radio Engineer," 2/-. Membership-examination particulars, 1/-. Syllabus of seven postal courses free and post free. **SECRETARY, I.P.R.E., 20, Fairfield Road, London, N.8.**

FIRST-CLASS TELEVISION and RADIO COURSES . . . GET A CERTIFICATE!

After brief, intensely interesting study—undertaken at home in your spare time—**YOU** can secure your professional qualification or learn Servicing and Theory. Let us show you how!

----- **FREE GUIDE** -----

- The New Free Guide contains 132 pages of information of the greatest importance to those seeking such success compelling qualifications as
- A.M.Brit.I.R.E., City and Guilds
- Final Radio, P.M.G. Radio
- Amateurs' Exams., Gen. Cert. of Educ., London B.Sc. (Eng.), A. M. I. P. E., A.M.I.Mech.E., Draughtsmanship (all branches), etc., together with particulars of our remarkable Guarantee of

SUCCESS OR NO FEE

- Write now for your copy of this invaluable publication. It may well prove to be the turning point in your career.

----- **FOUNDED 1885—OVER** -----

----- **150,000 SUCCESSES** -----

NATIONAL INSTITUTE OF ENGINEERING
(Dept. 462), 148, HOLBORN, LONDON, E.C.1.

RADIO AND TELEVISION COMPONENTS
All parts in stock for: **Viewmaster, Soundmaster, Teleson, etc.**
Easy Terms available.
21d. stamp only for Catalogue.
JAMES H. MARTIN & CO.
FINTHWAITHE, NEWBY BRIDGE, ULVERSTON, LANCs.

MODERN BOOK CO.

BRITAIN'S LARGEST STOCKISTS OF
British and American Technical Books

Radio Amateurs Handbook 1956
by A.R.M.L. 38s. Od. Postage 1s. 3d.
Basic Audio Course by D. C. Hoeller.
22s. 0d. Postage 8d.

Sweep and Marker Generators for
Television and Radio by R. G.
Middleton. 20s. 0d. Postage 9d.

The V.T.V.M. by R. Samuels. 20s. 0d.
Postage 9d.

Television Faults by N. Stevens.
5s. 0d. Postage 4d.

Color Television Standards by D. C.
Fink. 64s. 0d. Postage 1s.

Television Engineers' Pocket Book
by E. Molloy and J. P. Hawker.
10s. 9d. Postage 6d.

Modern Oscilloscopes and their
Uses by J. H. Rulter, Jr. 52s. 0d.
Postage 1s.

Practical Television Circuits by F. J.
Camm. 15s. 0d. Postage 6d.

Mullard 5 Valve 10 watt High Quality
Amplifier Circuits. 2s. 6d. Postage
4d.

Practical TV Aerial Manual for
Bands I and III by R. Laidlaw.
4s. 6d. Postage 3d.

Radio Valve Data compiled by "Wire-
less World." 3s. 6d. Postage 4d.

Please write or call for our new 1956
Catalogue.

**19-23, PRAED STREET,
LONDON, W.2.**

Paddington 4185. Open 6 days 9-6 p.m.

THE VALVE SPECIALISTS
Bentley Acoustic Corp. Ltd.

38, CHALCOT ROAD, N.W.1
Primrose 9090

1st grade goods only. No seconds or rejects.

02A	6/-	6U7	8/6	ACH/L	7/6	H63	12/6
1A5	6/-	6V6G	7/-	DDD 15/-	7/0	HK90	10/0
1C5	11/-	6V6GT	7/6	ACH/Pen	6/6	HL2	3/-
1D6	8/6	6X4	7/6	ACP/A	8/-	HL13C	7/6
1G6	8/6	6X5	7/6	ACVPA/1	10/6	HL23	10/6
1H5	11/-	6X7	15/-			HL33DD6/8	
1H4	6/-	6Z4/84	8/6	AP4	7/6	HL82	7/6
1LD5	5/-	6Z5	12/6	ATP4	3/-	HL1ADD	
1LN5	5/-	7AN7	12/6	AZ31	10/6		12/6
1N5	11/-	7B7	8/6	B309	9/-	HL133D12/6	
1R5	7/6	7C5	8/-	B319	12/6	KBK32	8/6
1S4	7/6	7D8	8/6	B313	7/6	KL3	9/-
1U3	7/6	7E7	8/-	CK623	6/6	KL35	9/-
2A3	12/6	7Q7	12/6	CK625	6/6	KT2	5/-
2C26	4/-	7V7	8/6	CV85	12/6	KT33C	10/-
2D13C	7/6	7Y4	9/6	D1	3/6	KTW61	7/6
2D21	8/6	8A8	12/6	D7	6/6	KTW62	5/6
2X2	4/6	8D2	2/6	DA90	8/6	KTZ1	6/6
3A4	7/6	9D2	3/-	DC32	11/-	L63	6/-
3A5	10/-	10C2	10/6	DAP91	7/6	LN152	11/6
3B7	8/6	10P1	11/-	DAP96	8/6	LN309	12/6
3D6	2/6	10L1D3	9/-	DMC90	10/-	LP2	2/6
3Q5	6/6	10P13	11/-	LZ319	12/6		4/6
384	7/6	12A6	6/6	DF91	7/6	ML4	5/6
3V4	8/6	12AH7	12/6	DF92	6/-	ML4	6/6
5U4	8/-	12AT7	9/-	DF96	8/6	MU12	8/6
5V4	10/-	12AT7	9/-	DH7	8/6	N610	10/6
5X4	10/-	12BA6	6/6	DL2	8/6	OC3	9/6
5Y3	8/-	12BE6	10/-	DK96	8/6	OD3	9/6
5Y4	10/-	12E1	30/-	DL2	15/-	PABC8015/2	
5Z3	8/6	12H6	3/-	DL35	11/-	PCC84	10/-
3Z4	8/6	12J5	6/-	DL72	7/-	PCF80	12/6
6A4	8/6	12J6GT	6/-	DL86	8/6	PCF82	12/6
6AB7	8/-	12K7	9/6	DL90	10/6	PCF85	12/6
6AB8	11/-	12K7	9/6	DL148	2/-	Pen25	2/6
6AC7	6/6	12U5G	7/6	EA50	2/-	Pen46	7/6
6AG5	6/6	12S4	8/6	EABC60		PL81	12/6
6AG7	12/6	128C7	7/6		10/-	PL82	10/6
6AG8	10/-	128T7	8/-	EAF42	12/6	PL83	12/6
6AK3	6/6	129Q7	8/6	EB34	10/-	PL84	12/6
6AK8	10/-	128R7	7/6	EB41	10/6	PM12M	6/6
6AL5	6/6	13VPA	8/6	EB91	6/6	PM2B	12/6
6AQ3	8/-	14E7	10/6	EBC3	12/6	PY80	10/6
6AT6	8/6	16A5	10/-	EBC33	7/6	PY81	10/6
6B5	6/-	123	10/-	EB41	10/-	PY82	10/6
6B7	10/6	19H1	10/-	EBF80	11/-	PY83	10/6
6BA6	7/6	19Y3	10/-	EC52	5/6	QP21	7/6
6B8G	4/-	20L1	12/6	EC54	8/-	QP22B	12/6
6B9M	4/6	20P3	11/6	EC62	10/6	QP25	6/6
6B9E	5/-	20Z4	8/6	EC63	9/6	QSL150/15	10/6
6B14G	12/6	25Z5	8/6	EC65	8/6		
6B36	8/-	27-	7/6	EC81	9/-	8D6	7/6
6BV6	8/6	30	7/6	EC82	10/6	8P2(7)	8/6
6BX5	10/6	30C1	12/6	EC83	10/6	8P4(7)	8/6
6BY7	10/-	30L1	12/6	EC84	12/6	8P61	3/6
6C4	8/6	34	7/6	EC85	10/-	8P82A	9/6
6C6	6/6	35L4	8/6	EC89	7/6	TH243	10/6
6C8	8/-	35Z4	8/6	ECF82	15/6	TP22	10/6
6CH6	6/6	35Z5	8/6	ECH35	10/6	TD6	12/6
6D6	6/6	35V1	12/6	ECF82	7/6	U17	7/6
6F6	7/6	41MTL	7/6	EC81	10/-	U22	10/6
6F6C	7/6	45Z5	12/6	EC80	11/-	U31	8/6
6F9GT	8/-	50C5	10/-	EP5	12/6	U50	8/6
6F9	7/-	50L6	8/6	EP36	4/6	U52	8/6
6F17	9/6	61BT	12/6	EP37A	10/6	U78	7/6
6F32	6/-	618PT	15/-	EP39	6/6	U81	12/6
6F33	9/6	62TR	10/-	EP40	17/-	UAF42	13/6
6G6	6/6	62V1	9/-	EP41	11/-	UBC41	10/6
6H6M	3/6	72	6/6	EP43	12/6	UCB42	11/6
6I6	5/-	74	7/6	EP48	8/-	UP41	10/6
6J6GT	5/6	77	5/6	EP60(E)	8/-		
6J6	7/6	78	8/6	EP64	5/-	UL41	11/6
6J7G	6/-	80	10/6	EP73	10/6	UL46	11/6
6K7R	8/-	83	8/6	EP80	10/-	UY4	10/6
6K8	12/6	150R2	12/6	EP85	10/-	VL84224	5/3
6K8GT	8/6	210LF	12/6	EP84	12/6	VP44	10/6
6L6G	9/-	240QP	10/6	EP89	10/-	VP(7)	8/6
6L7	7/6	807	7/6	EP91	7/6	VP(7)	8/6
6LD3	10/-	808	25/-	EP92	7/6	VP23	6/6
6N7G	7/6	813	7/6	EP92	8/6	VP41	7/6
6N7M	8/-	86A	15/6	EL4	17/6	VP33	10/6
6Q7	8/6	985	10/6	EL42	13/-	VT501	6/6
6Q7GT	9/-	956	2/6	EL81	15/-	X66	10/6
6R7	8/6	120C	7/6	EL84	11/-	XPW10	6/6
6R47	8/-	2101	10/-	EL91	6/6	XFY10	6/6
6R67	6/6	4033	12/6	EL64	10/-	XFY12	6/6
6R7	6/-	4783	9/6	EY01	11/6	Y01	6/6
6R47	8/-	7183	2/6	EY86	12/-	X801.5	4/6
6R7	6/-	7475	7/6	EZ40	10/-	Y63	7/6
6R17	8/-	8002	5/6	EZ41	11/-	Y65	10/6
6R7	8/6	8003	5/6	EZ80	10/-	Z77	7/6
6R7	7/6	8006	7/6	E30	5/-	Z719	10/6

CRYSTAL DIODES.—71L, GEX34, GG6E, M1, CG10E, all 7/- each.
All boxed. Full maker's guarantee. Post 6d. each. Insurance (optional) 6d. per order. Shop hours 9.30 to 5.30, Sats. 1 p.m. *Why not phone or wire that urgent order for immediate despatch O.O.D. *Complete list free 8.A.E.

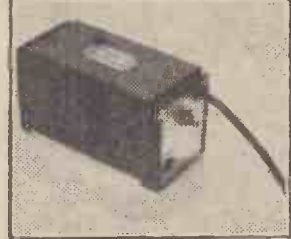

BAND III CONVERTERS

TYPE 30
For Band III reception with any type of receiver. A sensitive beautifully-designed unit completely enclosed with its own power supply. Price ... **£8.5.0** complete.

TYPE 32 SWITCH UNIT
A remote control for mounting in or on the television receiver permitting switching from B.C. to L.T.A. programmes with the Type 30 converter unit mounted in any convenient position. Price **£1.5.0** complete.

TYPE 33 CONVERTER
A sensitive low noise converter unit as the Type 30, but including remote switch panel for One Band I and Two Band III stations. Price ... **£10.2.6** complete.

Leaflets with pleasure on request.
SPENCER WEST LTD.
Quay Works, Gt. Yarmouth.

**NEW-MAX
ELECTRONICS LTD.**

220, Edgware Rd., London, W.2
Tel. PAD. 5607

Come and visit us. The Largest Electronic Bargains Store in London. We have large stocks of H.P. re-processed T.V. and Radio Sets, Radiograms, Reclaimed and guaranteed C.R. Tubes, 12in. £5, 14in. £6/10/-, 15in., £7/10/-, 17in. £9/10/-, p. and p. 10/-; Tubes with Heater Cathode Short, 12in. £2/10/-, 14in. £3/10/-, 15in. £4/10/-, 17in. £5/10/-, p. and p. 10/-. Surplus Valves, Components and Test Equipment, etc. etc. Also available all types and makes of new CR Tubes at list prices. Part exchanges welcomed! 12in. T.V. Set to suit any BBC channel-£28 inclusive carriage. Also Wanted: Electronic Equipment of Every Description. Best Prices Given. Phone, Write or Call.

TELEVISION COMPONENTS

in stock for the
P.T. SUPER-VISOR, TELE-KING, VIEWMASTER,
E.E. TELEVISOR and BAND III
and wide angle modifications
Price lists available on request to:

J. T. FILMER, Maypole Estate, Bexley, Kent,
Tel.: Bexleyheath 7267

WHY WASTE TIME

Give that set its best chance
FIT QUALITY COMPONENTS
Catalogue 1/-.

- Parts for the following:—
Manual
Osram "912" Amplifier 3/6
Mullard 10-watt Amplifier 3/6
The Coventry
2-watt Amplifier ... }
4-watt Amplifier ... } 1/-
6-watt Quality Amplifier ... }
The Coventry A.M. Tuner
Unit 1/-
Denco F.M. Tuner Unit ... 1/6

Complete Component Price Lists
will be supplied with each Manual.

COVENTRY RADIO
EST. 1925

189, DUNSTABLE ROAD,
LUTON, BEDS.
Phone: Luton 2677

News From the Trade

ADAPTOROD AERIAL CONVERSION SYSTEM

THE Adaptorod is mounted, by means of a spring-loaded clip, about the centre of the Band I aerial so that capacity coupling takes place between it and the inner ends of the Band I dipole.

The Band I dipole, consisting of a circuit tuned to a much lower frequency, will not respond markedly to signals of Band III frequency and in fact behaves as a choke to such signals. Thus, the coupling is virtually choke-capacity to the aerial feeders.

Accurate matching is achieved by tapping the Adaptorod a short distance above the centre or neutral point and it will be found that picture quality is extremely free from the multiple images which would result from ringing in the feeder cable due to mismatch.

Directional Properties

The Adaptorod, whilst essentially a dipole aerial, has some directional properties which come mainly from the interaction of the Band I aerial, serving to some extent as a reflector so modifying the polar diagram in such a way that by swinging the Adaptorod about the Band I aerial, a measure of ghosting protection can be achieved.

For the more difficult areas the addition of a director attachment (Trade name "Directorod") gives a polar diagram very similar to a three-element



aerial. The combination is known as the "Twinrod."

This gives a very marked forward gain and also provides an excellent front to back ratio which is of great value in such areas.

First class results have been secured with the Twin Rod up to 40 miles from the London ITA transmitter, whilst freak results have been reported up to 130 miles.

The Adaptorod costs 10s. 6d. and the Twinrod is 21s.—The Meadow-Dale Manufacturing Co., Ltd., The Dale, Willenhall, Staffs.

McMICHAEL CONVERTIBLE

McMICHAEL are the first to present this really modern and attractive way of converting an existing TV receiver to Band III. *The Converter is built in!* Whatever the make of the receiver (with few exceptions), by this unique method only a few minutes are necessary to transform it to an all-band model, and, at the same time, add to the home a piece of furniture. The set is just placed on the Convertible and plugged in. A main switch on the Convertible then controls both the set and the converter and a neon indicator glows when it is switched on. The price is 18 gns.—McMichael Radio, Ltd., Slough, Bucks.

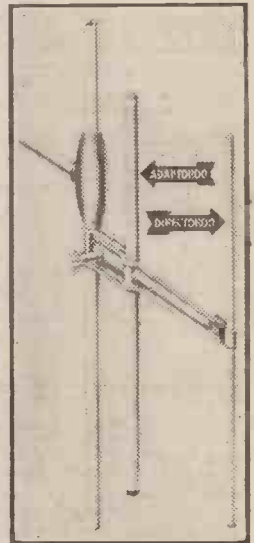

The Adaptorod aerial converter.

AERIALITE PRICE REDUCTION

AS from January 14th, the prices of aerial models 804 and 805 have been reduced by 12s. 6d. The retail price of each is now 804—£6 7s. 6d., and 805—£7.

Both these models are composite aerials having dipole and reflector sections for Band I and III (804) or five (805) elements Band III sections. They will cater for different locations of the Band I and III transmitters since the Band III section can be rotated with respect to the H aerial.—Aerialite, Ltd., Castle Works, Stalybridge, Cheshire.



This Convertible by McMichael consists of a Band III converter upon which the receiver may be stood.

QUERIES COUPON

This coupon is available until MAY 21st, 1956, and must accompany all Queries.

PRACTICAL TELEVISION, MAY, 1956



QUALITY TELEVISION COMPONENTS

SCANNING COILS, 6/10 KV. R.F., E.H.T. UNITS, E.H.T. and OUTPUT TRANSFORMERS, LINE FLY-BACK E.H.T. UNITS

Write for illustrated list (Publication 75)

Coil Kit of two for Aug "P.T." Band III Converter 5/-
Kit of three 7/6. Kit of four for October Band III Converter 6/-.

HAYNES RADIO Ltd., Queensway, Enfield, Middlesex.

AERIAL FITTINGS

FOR

Band III, Band I and Radio F/M.

Our increased range of Diecast Alloy Fittings include Band III to Band I Mast Couplers, Reflector and Director Rod Holders, Insulators (both "In-line" and "H" types), Masthead Fittings, Masts and Elements, Chimney Brackets, etc., together with useful Formulæ and Hints for constructing your own aerial quickly and cheaply. Send 1/- P.O. to cover the cost of catalogue and postage to:

FRINGEVISION LTD.

MARLBOROUGH, WILTS.

Phone : 657/8

LYONS RADIO LTD.

DEPT. MT.

3, Goldhawk Road, Shepherds Bush, London, W.12.

Telephone: SHEpherds' Bush 1723

BAND III CONVERTERS. Employing two valves these Converters can be used with T.R.F. or Superhet Band I T.V. receivers. Housed in smart walnut veneer cabinets and are entirely self contained with their incorporated power pack for operation from 200/250 v. A.C. mains. Installation instructions and maker's guarantee with each. PRICE 26.19.6. post 3/6.

BAND III CONVERTER KITS. (For Channels 7-14). Complete Coil Kit by Teletron Co. with circuit, point to point wiring diagram, alignment instructions, etc. Provides the basis for an efficient easy to make 2 valve Converter which can be relied on to give good results, thousands in the London area already in service. For use with T.R.F. or superhet Band I T.V. receivers. Mk I. 2-pentode version for "Service" area. PRICE 15.-. Mk. 2. Cascode-triode pentode version for the more difficult reception area. PRICE 17/6. post 6d. Ready drilled chassis 3/9. post 6d. Data leaflets only 3d. each, post 3d. (1 or 2).

HIGH FREQUENCY P.M. ELECTRO-DYNAMIC SPEAKERS. Specially designed to reproduce the high frequencies in the sound spectrum from 1.6 to 20 Kc/s. Connected across your existing speaker is sufficient to bring reproduction to life and for it to acquire a realism and sparkle previously unobtainable. Essential for the high quality reproduction of modern L.P. recordings, F.M. and T.V. transmissions. Can be used with any standard speaker, 2 to 15 ohms, and loaded up to 25 watts. Size approx. 2 1/2" dia. x 2". Full installation details with each speaker. PRICE 39/6. post paid. Fuller details available on receipt of S.A.E.

CASCADE TYPE TV PRE-AMPS

NOW PROVING VERY POPULAR

Manufactured specially to suit fringe and ultra-fringe conditions. In use 140 miles north of Kirk O'Shotts (check our position) and in many other distant locations and difficult reception areas. Complete in crackled steel case with built-in power-pack 200-250 A.C.

£5/5/- P. & P. 2/-

State channel used, or send 6d. stamp for illustrated details and some interesting fringe data.

ELECTRO-ACOUSTIC LABS.
TAIN-ROSS-SHIRE-SCOTLAND

"VIEWMASTER"

T.V. TUNER COMPONENTS

- 6 wafer Switch assembly ... 20/-
- Fine Tuner ... 4/-
- 3 Coil platforms ... 1/-
- Set of three metal brackets... 7/6
- Screen complete ... 5/-

All prices include postage

Send for complete list of radio and T.V. components. POST FREE.

AUDIO LTD.,

Tower Road, London, N.W.10.

VALVES

SAME DAY SERVICE

All Guaranteed New, and Boxed

1.4V. midget, 1R5, 1S5, 1U5, 1T4, 3S4, DAF91, D701, DR31, DL32, DL44, any 4 for 27/6	1A7GT 12/6	6SN7GT 8/6	DH77-9 8/6	HVR24 7/-
12/6	6U4GT 15/-	DK32 12/6	KT33C 10/6	
1C5GT 11/-	6V6G 7/6	DK92 7/6	10/6	
1D5 11/-	6V8GT 7/6	DL33 11/6	KT81 14/6	
1H2GT 11/6	6X4 7/6	DL35 11/-	KT83 7/6	
1NG1T 11/6	6X5GT 6/6	EABG909 8/6	MT14 9/-	
1R5 8/6	7B7 8/6	EB91 8/6	PG1 5/6	
1S5 7/3	7C5 8/6	EBC33 7/6	PCC8410/9	
1T4 7/3	7C6 8/6	EB4110 8/6	PCF80 9/9	
1T5 7/3	7H7 7/6	EBF80 10/6	PCF82 11/6	
3A5 9/-	75T 8/6	EC10 10/6	PEN45 18/-	
3Q5GT 11/6	7Y4 8/6	EC10C 10/6	15/6	
3S4 7/6	10F1 10/-	ECC81 10/-	PEN46 7/6	
3V4 8/6	10LD11 10/6	ECC810 8/6	PL38 23/9	
5U4G 8/6	10/6	ECC91 6/-	PL81 11/9	
5Y3GT 7/9	10P11 14/6	ECC85 12/6	PL82 9/6	
5Z4G 9/-	12A7 9/6	ECH42 11/9	PL83 12/6	
6AK5 5/-	12AU7 8/6	ECH42 11/9	PY80 10/-	
6AL5 6/9	12J7GT 10/6	ECH81 10/6	PY81 10/-	
6AM5 5/-	12KTGT 10/6	ECH81 10/6	PY82 9/6	
6AM8 7/6	12KTGT 10/6	ECL4010 10/6	PZ30 18/-	
6AQ5 7/6	12KBGT 12/6	EF37A 10/6	U22 10/6	
6AT8 8/6	12/6	EF39 6/6	U25 15/6	
6BA6 7/9	12Q7GT 9/6	EF40 18/6	U30 7/9	
6BB6 7/6	12Z3 9/6	EF41 10/6	U32 7/6	
6BW6 7/9	12Z3 9/6	EF42 14/6	U404 9/-	
6BX6 7/6	20L1 10/9	EF42 14/6	U404 9/-	
6C9 10/10	25L6GT 8/6	EF50 7/6	UAF42 11/9	
6F1 12/6	25Z4G 9/6	EF80 10/-	11/9	
6FG6 7/8	35L6GT 19/6	EF85 9/6	UBC41 9/6	
6F15 13/-	35Z4GT 8/6	EF96 13/6	UCH42 10/9	
6J6 8/6	35Z4GT 9/-	EF91 7/6	10/9	
6J7GT 7/6	50L6GT 8/9	EF92 5/-	UF41 9/6	
6KTG 6/-	18B2T 22/6	EL32 6/6	UL14 10/9	
6KTGT 6/-	DI 3/6	EL38 23/9	U07 11/6	
6K9G 8/6	D15 7/-	EL41 11/6	UY41 9/-	
6K8GT 9/8	DAC32 9/6	EY51 12/6	W77 5/6	
6L18 10/6	11 6/2	EZ40 8/6	X79 12/6	
6LD20 9/6	DCC90 9/-	EZ20 9/-	Y83 7/6	
6Q7GT 8/6	DF33 11/6	GZ32 15/-	Z77 7/6	

Postage 5d. per valve extra.

READERS RADIO

24, COLBERG PLACE, STAMFORD HILL, LONDON, N.16. STA. 4587

ALUMINIUM, LIGHT ALLOYS, BRASS, COPPER, BRONZE,

IN ROD, BAR, SHEET, TUBE, STRIP, WIRE, ANGLE, CHANNEL, TEE

3000 STANDARD STOCK SIZES

H. ROLLET & CO., LTD.

6, CHESHAM PLACE, LONDON, S.W.1.

SLOane 3463

Works:

36, ROSEBERY AVE., LONDON, E.C.1.

Branches at Liverpool, Manchester, Birmingham, Leeds.

"No Quantity too Small"

BARGAIN LIST NO. 12

Send now for our free Stock-taking Bargain List No. 12. Many unrepeatable items at greatly reduced prices.

SOUTHERN RADIO & ELECTRICAL SUPPLIES
SORAD WORKS, REDLYNCH SALISBURY

Telephone: Downton 207.



Forrest COMBINED BOOSTER AND ISOLATING TRANSFORMERS

Cheap and easy to fit to any Receiver they enable Tubes with low emission or with Cathode-Heater short to be used again. Supplied in any voltage from 2v.—13.3v.

OPTIONAL BOOST (12½% and 25%).

Price 21/- (Retail)

H. W. FORREST (TRANSFORMERS) LTD.

349 HASLUCKS GREEN ROAD
SHIRLEY, BIRMINGHAM. SHI. 2483

VIEW MASTER CONVERTER

All items for the View Master Converter as described in "Practical Television" can be supplied from stock. Full details are given in our special list which is available free upon request.

COIL SET AND METAL PARTS. Denco. Includes a ready wound set of coils, switch screens and metal cover. 30/-

SWITCH ASSEMBLY. Denco. Complete switch with fine tuner and coil platforms. 27/-

CONDENSER AND PRINTED CIRCUIT KIT. TCC. Contains all the condensers, printed circuit and valve holders. 43/-

RESISTOR KIT. We make up this kit with the specified LAB resistors. All labelled with value and position. 8/-

GAIN CONTROLS. Colvern CLR901 5,000 ohms. Three required. 3/3 each. Panel for mounting three controls. 1/-

VALVE SCREENS. Carr-Fastner. Skirt and screen. Two required. 1/3 each.

CO-AXIAL PLUG AND SOCKET. Belling Lee L604S Socket. 1/3. L734P Plug. 1/3

SOLDER. Ersin Multicore. Special for printed circuits. 2/6

VALVES. Mullard PCC84 24/4 Surplus 13/6

Mullard PCF80 25/9. Surplus 13/6

KNOB. Pointed knob for switch. 1/-

SUNDRIES KIT. Contains all nuts and bolts, flex. wire co-axial cable, copper foil and spring wire. 8/-

COMPLETE KITS. All above items supplied at one time.

KIT A. With new Mullard valves. 9.4.0. Credit Terms: Deposit £1.6.9 and seven monthly payments of £1.6.9.

KIT B. With surplus valves. £8.2.0. Credit Terms: Deposit £1.4.0 and seven monthly payments of £1.4.0.

PLEASE NOTE. These kits do not include the items needed for conversion of the View Master Sound/Vision Chassis. We can supply the chassis conversion kit for £2.0.0. Full details in our list.

SET OF TWIST DRILLS. Complete set of the correct size twist drill for drilling the Printed Circuit Panel. 10/-

WATTS RADIO

8 Apple Market, Kingston-on-Thames, Surrey.
Telephone: KINGSTON 4099.

ARTHURS HAVE IT!

LARGE STOCKS OF VALVES AND C.R.T.'S.

AVO METERS IN STOCK

Avo Model 7	—	—	—	£19	10	0
Avo Model 8	—	—	—	23	10	0
Electronic Test Unit	—	—	—	27	10	0
Electronic Test Meter	—	—	—	40	0	0
AC/DC Minor	—	—	—	10	10	0
★ Cosor Oscilloscopes Model 1052	—	—	—	104	0	0
" " " " " " " " " " " "	—	—	—	120	0	0

Full range Taylors Meters. List on request.

Leak—TL/IO Amplifier and "Point One"

Pre-Amplifier — — — Complete 28 7 0

F.M. Kit of parts £5 less valves. Ref. Radio Constructor July, 1954.

Jason F.M. Tuner Unit and Power Pack — 19 7 0

Chapman Tuning Units — — — from 16 0 0

Aerialite Band 3 Unit — — — 9 10 0

Latest type M.C. — — — 10 17 6

LATEST VALVE MANUALS

MULLARD, 10/6, OSRAM & BRIMAR No. 6, 5/- each,

OSRAM Part 2, 10/- Post 6d. each extra.

SCOPE SOLDERING IRON A.C./D.C. HEATING

TIME: 4 v. 6 sec., 6 v. 4 sec. 39/6.

TRANSFORMER for 200/230 v. 37/6.

Terms C.O.D. OR CASH with order and subject to price alterations and being unsold.

Est. 1919

Arthurs

PROPS: ARTHUR GRAY, LTD.

OUR ONLY ADDRESS: Gray House

150-152 Charing Cross Road, London, W.C.2

Temple Bar 5833/4 and 4765.

TELEGRAMS—"TELEGRAY, WESTCENT, LONDON."

CABLES—"TELEGRAY, LONDON."

"You can rely on Us" for . . .

ALL RADIO and ELECTRONIC COMPONENTS

One of Britain's Largest Stockists of all Leading Makes: Hunts, T.C.C., Haynes, Allen, Denco, Osmor, Weymouth, Morganite, Bulgin, Belling Lee, Teletron, R.E.P., Scotch Boy, Ellison, Elstone, Partridge, Wynall, Westinghouse, S.T.C., AVO, Taylor, Goodmans, J.B., Wharfedale, Wearite, Acos, etc.

Suppliers to: Ministries, Development Laboratories, Education Authorities, etc.

Some of the more difficult parts you may not be able to acquire:

Tapped Vol. Control, Linear C.T. ¼ mg., ½ mg., 1 mg., 7/6. Linear ½ mg., ½ mg., 1 mg., 6/6. Post 6d.
2 High Stab. ½ w. Resistors. 2% Range, 100Ω to 2 meg., 1/6 each. 1% Silver Micas up to 100 pf., 1/-, 280 pf., 1/2. 500 pf., 1/4. 1,000-5,000, 2/6. Post 6d.
Teletron Band III Converter—Punched Chassis, 4/-, Post 6d. Set of Coils and Circuit, 15/-, Band III Loft Aerials, 30/- plus 2/- carriage.

Thousands of Valves, Condensers, Resistors—Can We Help You?

MULLARD 510 and GEC 912 all specified parts and lists available.

Catalogue, Book Lists, S.A.E.

RADIO SERVICING CO.,

82, SOUTH EALING ROAD, LONDON, W.5.

Tel.: EAL 5737. Next Sth. Ealing Tube, 65 Bus. 1 p.m. Wed.

Recommend with confidence . . .

G.E.C.

ALUMINISED C.R. TUBES



7203A 14"

The G.E.C. 14 in. Cathode Ray Tube type 7203A has the following attractive features:—

- 1) Improved tube life and reliability.
- 2) A narrow beam angle *triode* gun giving:—
 - (a) Uniform focus over the entire screen area.
 - (b) Small spot size.
 - (c) Freedom from astigmatism.
- 3) A high reflectance aluminium backing to the fluorescent screen giving:—
 - (a) 70% increase in picture brightness.
 - (b) High contrast daylight viewing.
 - (c) Complete elimination of ion burn from both positive and negative ions.

Price £14.15.0

P. Tax £6.18.1

THE GENERAL ELECTRIC CO. LTD., MAGNET HOUSE, KINGSWAY, LONDON, W.C.2.