

The "SIMPLEX"—FREE BLUEPRINT INSIDE!

# PRACTICAL TELEVISION

AND TELEVISION TIMES

1/-

EDITOR  
F. J. CAMM

A NEWNES PUBLICATION

Vol. 4 No. 46

MARCH, 1954



## FEATURED IN THIS ISSUE

Fault Symptoms and Remedies  
 Future Trends of TV  
 Tape Recorded TV

Causes of Ion Burns  
 Is Projection the Answer?  
 Valves at U.H.F.

# THE 'SIMPLEX' TELEVISOR

PUBLISHED BY GEO. NEWNES LTD., TOWER HOUSE, SOUTHAMPTON ST., STRAND, W.C.2.

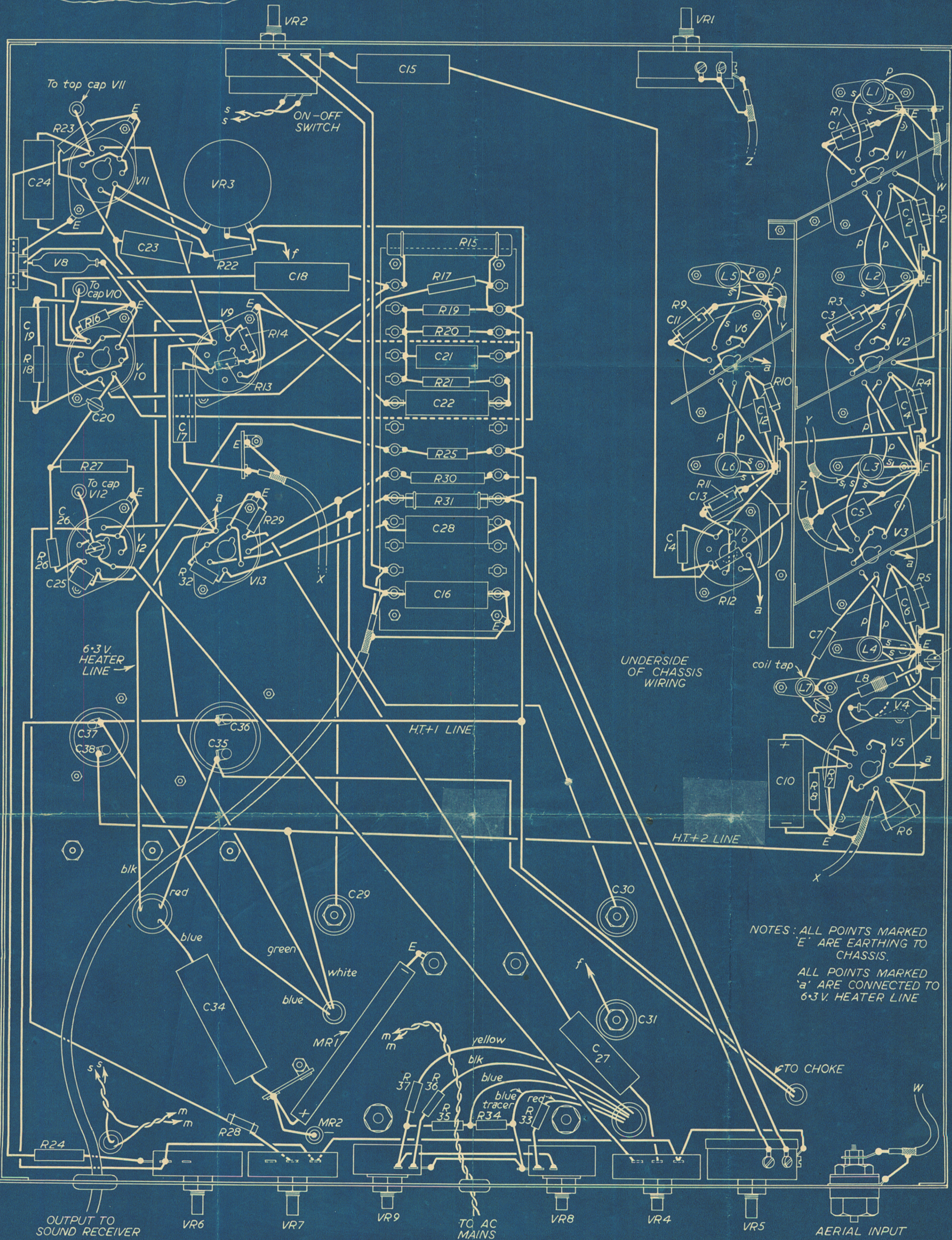
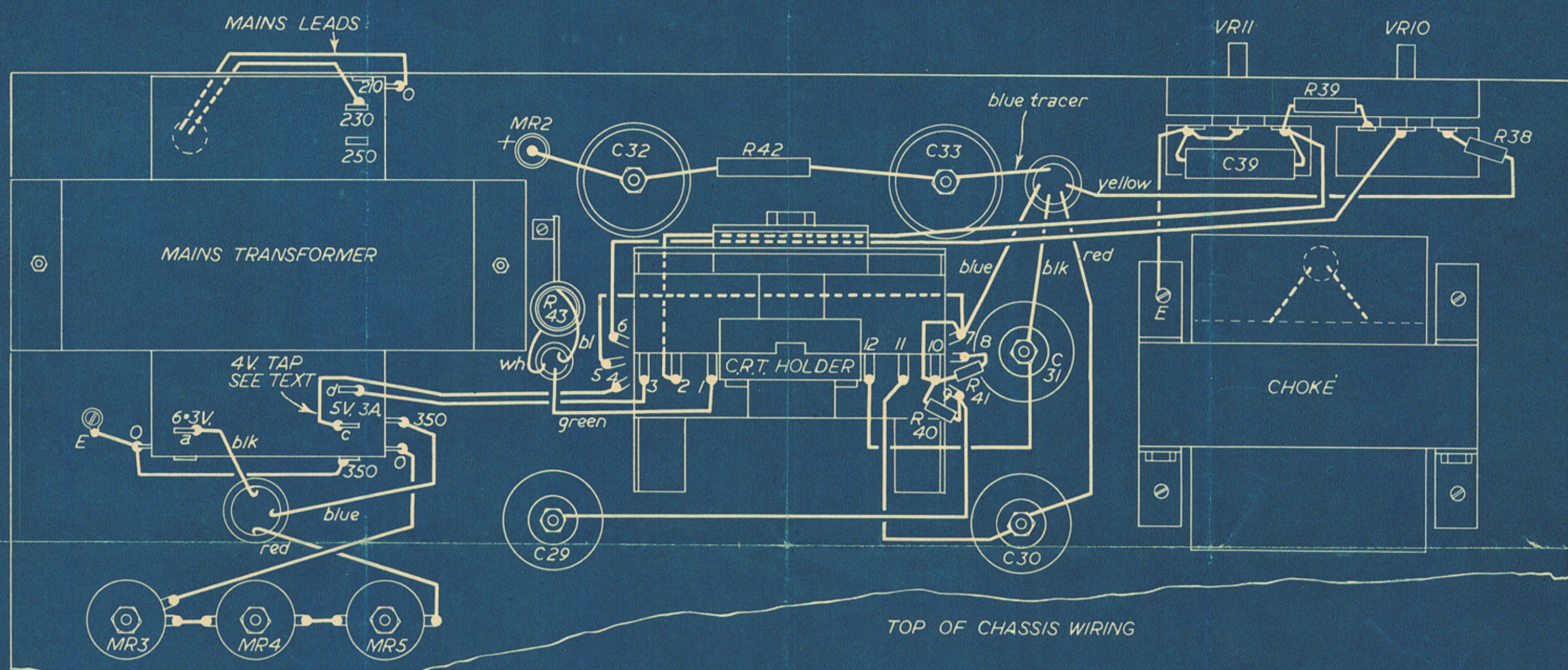

NOTES: ALL POINTS MARKED 'E' ARE EARTHING TO CHASSIS.  
ALL POINTS MARKED 'a' ARE CONNECTED TO 6.3V. HEATER LINE

# HOME BUILT TELEVISION

## SIMPLEX

STAGE 1. Vision and Sound Section.

**VALVES.** EF50, 7/6. EA50, EB34, 3/6 each.

**RESISTORS.** Kit of 12. All labelled, 4/-.

**CONDENSERS.** Kit of 16, 10/-.

500 pf. 5 pf. 15 pf. .001 mfd. 6d. each.

25 pf. .1 mfd. 9d. each.

25 mfd. 25 v. 2/-.

**POTENTIOMETERS.** 25k Carbon, 4/6.

2 meg. with SP switch, 6/6.

**COIL FORMERS.** Aladdin  $\frac{3}{4}$ in. with core, 10d. each.

Aladdin  $\frac{3}{4}$ in. with core, 9d. each.

**VALVE HOLDERS.** B9G, 9d. each.

EA50 and International Octal, 6d. each.

**SUNDRIES.** Pye Plug and Socket, 2/-.

Knobs. Set of two, engraved. Small, 2/4.

Large, 3/-.

**SUNDRIES KIT.** Contains all wire, cable, nuts,

bolts, Solder, Solder Tags, Tag Strips for the

whole set, 13/-.

STAGES 2, 3 and 4. Send for our fully detailed list.

## VIEW MASTER

### WIDE ANGLE CONVERSION

The fully detailed instructions for Wide Angle Conversion of the View Master are now available. These show how you can convert your View Master to use the latest types of 14in., 16in. and 17in. Wide Angle Tubes.

INSTRUCTION ENVELOPE, 3/6 post free.

**PRICE LISTS.** Our completely detailed Price List for Conversion and for the complete set are available free upon application.

### WE CAN SUPPLY FROM STOCK

all the components required for the standard or Wide Angle View Master.

### FULL HIRE PURCHASE FACILITIES

are available for complete or part kits. Send for full details.

**TERMS.** Cash with order or C.O.D. Postage extra on orders under £3.

### RETURN OF POST SERVICE.

## WATTS RADIO (WEYBRIDGE) LTD.

8 BAKER STREET, WEYBRIDGE, SURREY.

Telephone Weybridge 2542

 Tele: GRA 6677  
 MONEY BACK GUARANTEE  
 CWO OF COD  
 621 ROMFORD RD. LONDON, E.12.

**T.V.**

**TUBES.**—£5 12in. Not ex-W.D. C.R.M. 121B. And a few 9in. at £3. GUARANTEED PICTURE shown to personal shoppers. Checked and certified if sent by post. Insured, carr., 15/6.

**T.V.**

**METAL RECTIFIERS.**—Salvage, guaranteed. 350 v.-250 m/A, 8/9; 250 v.-80 m/A, 5/9. Post 9d.

**T.V.**

**COLOUR FILTERS.**—6/9. 15in., 10in. and 9in. only. Post 6d.

**T.V.**

**& RADIO INTERFERENCE SUPPRESSORS.**—Ex-W.D. These work. 8/9. Post 1/3.

**T.V.**

**ENLARGERS.**—9in., 50/-; 10in. and 12in., 70/-. Magnification  $1\frac{1}{2}$  times. Post 2/6. Clear or tinted for daylight viewing. No extra.

**T.V.**

**VALVES.**—Salvage and surplus. From 1/9. Latest pin type from 5/9.

**T.V.**

**CONDENSERS.**—30-30, 100 mfd.; 1,000 mfd., and various others.

**T.V.**

**O.P. TRANSFORMERS.**—Plessey. Salvage, 4/9. Post 9d.

**T.V.**

**AERIALS.**—New. Loft, 21/-, and Dipole, 35/- Carriage 2/-.

**T.V.**

**COAX. CABLE.**—Single, standard,  $\frac{1}{8}$  yd. and best, 1/9 yd.

SEND STAMP FOR FREE 1954 CATALOGUE.

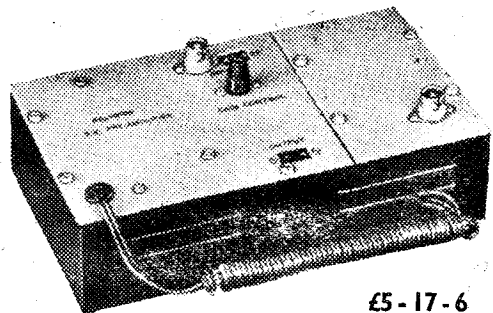

£5-17-6

## How do you view?

This single stage type "GC"

Pre-amplifier

## WILL IMPROVE YOUR VIEWING

if in the "Fringe" Area

Available for all channels.

A.C. mains 200/250 volts, 50 c.p.s.

Ask your dealer or send for leaflet to

**RAINBOW RADIO, BLACKBURN**

# MAINTAINING A REPUTATION . . . . .

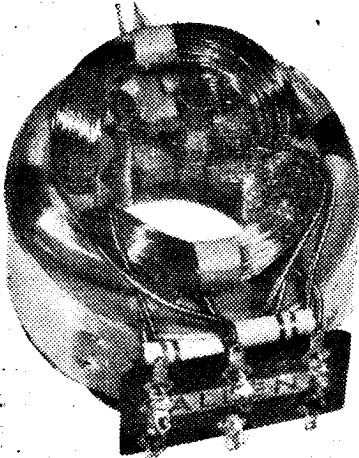

Deflector Coils type DC300/C. As specified for the "Teleking," "Supervisor" and "Magnavision." Conversion circuits for 14in. and 17in. C.R. Tubes available. Send 9d. and S.A.E.

Every day we read the words: "I am ordering Allen Components because they are so highly recommended by my friends."

We are proud of our reputation. Since we pioneered Wide Angle scanning some years ago we naturally carried on our policy of producing components designed to the highest specification and engineered to the closest tolerance. In these days of shortages and lowered standards such a policy is not easy to carry out and it has necessitated unreaxed attention to detail in all our departments. The result of this care is apparent in all our products, in which good workmanship is combined with high reliability.

May we suggest you ask your friends?

From all Leading Stockists.

## ALLEN COMPONENTS LIMITED

Crown Works, Lower Richmond Rd., Richmond, Surrey

Telephone: Prospect 9013

Send 9d. and S.A.E. for Circuit Diagram

### ARTHURS HAVE IT!

LARGE STOCKS OF VALVES AND C.R.T.S.

**AVO METERS IN STOCK**

Avo Model 7	—	—	—	—	£19 10 0
Avo Model 8	—	—	—	—	23 10 0
Electronic Test Unit	—	—	—	—	27 10 0
Electronic Test Meter	—	—	—	—	40 0 0
Valve Characteristics Meter	—	—	—	—	60 0 0
* Cossor Oscilloscopes Models	1052	—	—	—	104 0 0
	1049	—	—	—	132 0 0

Full range **Taylor's Meters.** List on request.

Leak Point One Amplifiers	—	—	—	—	28 7 0
Leak Pre-amplifiers	—	—	—	—	9 9 0
Leak Vari-slope Pre-amp. for Leak Point One	—	—	—	—	12 12 0
Leak Tuning Unit	—	—	—	—	35 6 3
Chapman Tuning Units	—	—	—	—	17 6 8

**LATEST VALVE MANUALS**

MULLARD, OSRAM, & BRIMAR No. 5, 5/- each.  
MAZDA 2/- each.

ART and SCIENCE in SOUND REPRODUCTION.

By F. H. BRITAIN, D.F.H., 2/6 each.  
Postage 6d. each extra.

Terms C.O.D. OR CASH with order and subject to price alterations and being unsold.

**Arthur's** Est. 1919  
 PROPS: ARTHUR GRAY, LTD.  
 OUR ONLY ADDRESS: Gray House,  
 150-152 Charing Cross Road, London, W.C.2  
 TEMple Bar 5833/4 and 4765.  
 TELEGRAMS—"TELEGRAY, WESTCENT, LONDON."  
 CABLES—"TELEGRAY, LONDON."



*Switch on to*

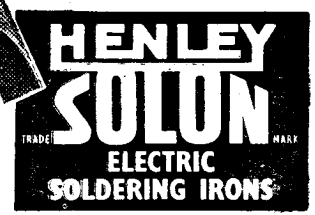

Solon's save time, reduce costs. Solon soldering is always clean, reliable and simple. Five models, in voltage range 100-250; each with 6 feet Henley flexible. 65 watt; oval tapered or round pencil bits. 125 watt; oval tapered or round pencil bits. 240 watt; oval tapered bit.

Write for Folder Y.10

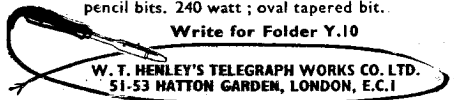

W. T. HENLEY'S TELEGRAPH WORKS CO. LTD.  
 51-53 HATTON GARDEN, LONDON, E.C.1

# HENRY'S

We have over 20,000 American and B.V.A. valves in stock.

## ALL VALVES NEW AND GUARANTEED.

**SETS OF VALVES**  
Ten EF50 (Ex-Brand New Units) 5/- each  
45/- Set  
6K8G, 6K7G, 6Q7G  
5Z4G, 6V6G, (or KT61) 37/6 ..  
1R5, 1S5, 1T4, 1S1 (or 3S4 or 3V4) 30/- ..  
TP23, HL33 DD, VP23, PEN25 (or QP25) 25/- ..  
6K8G, 6K7G, 6Q7G, 25A9G, 25Z5 or 25Z6G 37/6 ..  
12K9GT, 12K7GT, 12Q7GT, 35Z4GT, 35L8GT or 50L8GT 37/6 ..  
12SA7GT, 12SK7GT, 12SA7GT, 35Z4GT, 35L8GT or 50L8GT 37/6 ..  
PX25, KT33C, KT66, GU50 12/6 each  
PX25's Matched Pairs 25/- pr.  
TEN 6AM6 (EF91) 80/-

### CRYSTAL MICROPHONE INSERTS

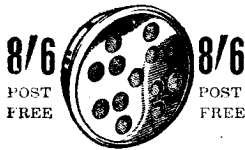

Ideal for tape recording and amplifiers. No matching transformer required.

### RECORDING TAPE

600 feet Reels 10/-  
1,200 feet Reels 17/6

0Z4A	7/-	6K7G	6/6	12SA7GT	8/8	EBC33	8/6	KT731	8/6
1C5	6/6	6K7M	7/6	12SQ7GT	8/6	EB36	6/6	KT85	12/6
1R5	8/-	6K8G	9/-	12S7G	7/6	EP39	6/6	GU50	12/6
1S1	8/-	6K8GT	9/-	12SH7	7/6	EK42	6/6	XP2V	4/-
1S5	8/-	6L6G	8/6	12SJ7	8/6	EP31	9/-	XH (L5)	4/-
1T4	8/-	10Z2	11/-	12SK7	8/6	EL32	7/6	VU111	4/-
1A7GT	10/-	6U5	7/6	12SR7	7/6	EP50	8/6	VU133	4/-
1C5	8/-	9U5G	7/6	1A7	8/6	EP50 (Red)	8/6	VU120 A	4/-
1L5	9/-	6L7	7/6	25Z4GT	8/6	SVL1	10/-	ST90	7/6
2X2	5/-	6N7GT	7/6	25Z5	8/6	EP51	10/-	7475 (VS70)	7/6
3V4	8/-	8Q7GT	8/6	35Z4GT	8/6	(Ex-Units)	8/6	CV66	6/-
8S1	8/-	6S1JGT	8/6	25A6	8/6	5/-	5/-	VK159/30	8/6
3Z3	8/6	6R7	8/6	35L6	8/6	SP2	8/6	CR510AX	5/-
5U4	8/6	6X5G	8/6	50L8GT	8/6	VP2	8/6	4-CP25	5/-
5Z4	8/6	68A7GT	8/6	42	8/6	TDD2A	3/6	AC3PEN	6/6
6A7G	6/6	68Q7GT	8/6	43	8/6	DK49	9/-	AC5 PENDD	6/6
6AC7	6/6	68G7	7/6	75	8/6	UL41	9/-	AC6 PENDD	12/6
6AG5	7/6	68H7M	7/6	78	8/6	UY41	9/-	PEN25	6/6
6A8G	8/6	68K7GT	7/6	87	8/6	4D1	4/-	PEN16	7/6
6AM3	9/-	68J7GT	9/-	895A	15/-	8D1	4/-	OP25	6/6
6B9	7/6	68N7GT	9/-	901	6/-	9D2	4/-	SF61	4/-
6C4	8/6	68S7	10/-	9002	6/-	10D2	10/-	SF41	4/-
6C5GT	5/-	68S7	7/6	9001	6/-	R1	8/6	HL23/DD	6/6
6C6	6/6	68V9GT	7/6	9094	6/-	DH1	5/-	VP23	6/6
6D9	6/6	7C5	8/6	9303	6/-	D12	5/-	VP41	7/6
6F9G	8/6	7A7	8/6	984	6/-	D83	5/-	V22	8/6
6G9G	6/6	7C7	8/6	953	6/-	KT2	5/-	ATP4	4/-
6H6GT	5/-	7H7	9/6	953	6/-	U2	8/6	TP22	8/6
6H6M	8/6	7B7	8/6	123A	7/6	U17	10/-	TR233	10/-
6J5GT	5/-	7S7	10/-	TZ4J	37/6	U19	10/-	4MP	7/6
6J5M	8/6	12A5	7/6	991A	50/-	Y63	8/6	425PT	6/-
6J6	9/-	12C3	7/6	EA50	2/-	P2	4/-	215SG	4/-
6AK5	9/-	12H6	8/6	EF54	8/6	MU14	8/6	M5/PENB	7/6
6J7G	6/6	12K7GT	8/6	(VR136)	6/-	PX25	12/6		
6J7M	8/6	12K8GT	8/6	EB34	3/6	KT33C	10/-	VT501	7/6
6K6	9/-	12Q7GT	8/6						

SEND POSTAGE FOR NEW 1954 COMPREHENSIVE 23-PAGE CATALOGUE: CONTAINING COMPONENTS & EX. GOVT. BARGAINS.

Please add postage up to £1. 1/-; £2 or over 2-/.  
Open Mon.-Fri. 9-6. Thurs. 1 p.m.

**R.F. UNITS**  
RF24 20-30 mc/s 15/- post free  
RF25 40-50 mc/s 18/6 post free  
RF26 50-65 mc/s 45/- post free  
RF27 65-85 mc/s 45/- post free  
ALL BRAND NEW WITH VALVES

**CATHODE RAY TUBES:**  
VCR57 or 57C, 35/-  
MU-METAL SCREEN, 10/-  
3BP1. Suitable for scopes and Tel. 25/-, carr. 3/-  
VCR139A (ACK10), 35/-, Lrand new.

### 62A INDICATOR UNIT.

Complete with 12-EF50's, 4-SP1's, 3-2A50's, 2-BB34, VCR57C with Mutual Metal Screen. Double Deck Chassis. 89/6. New Condition. Plus 7/6 Carr.

**No. 38 WALKIE-TALKIE TRANS-RECEIVER** complete with throat Mike, Phones, Junction Box, and aerial rods in canvas bag. Freq. range 7.4 to 9 mc/s. All units are as new and tested before dispatch. As supplied to Overseas Police Forces. 24-10-0.

### "182A" INDICATOR UNIT.

Complete with VCR57 and Screen, 3-EF50, 4-SP61 and 1-5U4G, 9 w/v controls. Ideal for TV or Scope. Brand New (less relay). In original cases. 67/6 plus 7/6 carr.

# Armstrong

Specialists in Chassis manufacture for over 20 years—offer to the enthusiast their

## 14" AND 17" TV.5. RANGE

—in Chassis form

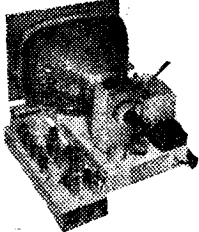

**BOTH** Models are similar in general specification, having 19 Valve Superheterodyne Circuits with Instantaneous 5-channel selector switching and aluminiumed rectangular, flat-faced Cathode Ray Tubes with tinted filter.

**THE CHASSIS THAT GIVES THE TRUE BLACK AND WHITE PICTURE**

Prices:

TV.5. 14in. Chassis, £54.0.3 (inc. P.T.)

TV.5. 17in. Chassis, £64.15.11 (inc. P.T.)

Also available in handsome Cabinet form.

**ARMSTRONG WIRELESS & CO. LTD.**  
TELEVISION

Wartlers Road, Holloway, London, N.7.

Telephone: NORTH 3213/4

## IT'S CHEAPER TO MAKE YOUR OWN TELEVISION AERIAL

We can supply parts enabling you to make an aerial to standard design, or to suit your own ideas.  
14ft. 16 S.W.G. 2in. HIGH TENSILE ALUMINIUM POLES. 47/6. C. and P. 3/6 extra.  
1/2in. 18 S.W.G. D/H ALLOY TUBING (lengths as required). 10d. per ft.  
1in. 18 S.W.G. D/H ALLOY TUBING (lengths as required). 1 1/4 per ft.  
**INSULATORS.** Unbreakable, waterproof (standard). 6/9 each. For "In Line" Aerials, 8/9 each.  
**MAST HEAD MOUNTING.** 2in. fitting, streamlined casting. 8/6 each.  
**AS ABOVE. 1in. FITTING.** Streamlined casting. 6/- each.  
**REFLECTOR AND DIRECTOR ROD HOLDERS.** High Quality Alloy Casting. 3/9 each.  
**BRACKETS. HEAVY DUTY, DOUBLE LASHING.** Improved type, complete with fittings. 45/-, C. and P. 2/6 extra.  
**AS ABOVE. SINGLE LASHING, LIGHTWEIGHT.** 1in. Pole fitting. 27/6. C. and P. 2/- extra.  
C.W.O. Packing and Postage 1/6 extra, except where stated.



ANGEL YARD WORKS, MARLBOROUGH, WILTS.  
Phone: Marlborough 605.

# A GOOD SET deserves a Mullard long life picture tube

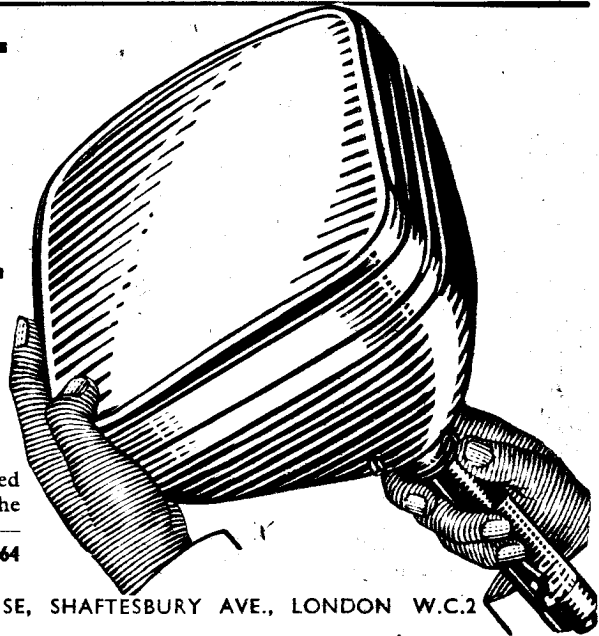

Technical Service Department will be pleased to send you Data Sheets describing any of the following Mullard Long Life Picture Tubes:—  
12" MW31-74    14" MW36-24    17" MW43-64



MULLARD LTD., CENTURY HOUSE, SHAFTESBURY AVE., LONDON W.C.2

MVM 262



## CONDENSERS

The abbreviated ranges of two popular types given here are representative of the wide variety of T.C.C. Condensers available.

### Hi-K 'PEARL' CERAMICS

Capacity pF.*	Wkg. Voltage		Dimensions		Type No.
	D.C.	A.C.	Length	Dia.	
1.0	500	250	3.5 to 7 mm.	5 to 7 mm.	SPG 1
10.0	500	250			SPG 1
33.0	500	250			SPG 1
150	500	250			SPG 1
330	500	250			SPG 1
470	500	250			SPG 1

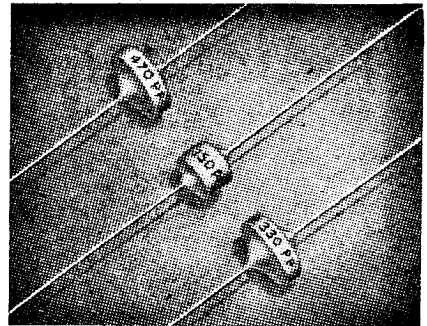

### Hi-K MULTIPLE TUBULAR CERAMICS

Capacity pF.*	Wkg. Voltage		Dimensions		Type No.
	D.C.	A.C.	Length	Dia.	
2 x 500	500	250	10 mm.	4.5 mm.	2CTH 310/W
2 x 1000	500	250	10 mm.	4.5 mm.	2CTH 310/W
2 x 1500	500	250	15 mm.	4.5 mm.	2CTH 315/W
2 x 2200	500	250	22 mm.	6 mm.	2CTH 422/W
3 x 500	500	250	15 mm.	4.5 mm.	3CTH 315/W
3 x 1000	500	250	15 mm.	4.5 mm.	3CTH 315/W
3 x 2200	500	250	22 mm.	6 mm.	3CTH 422/W

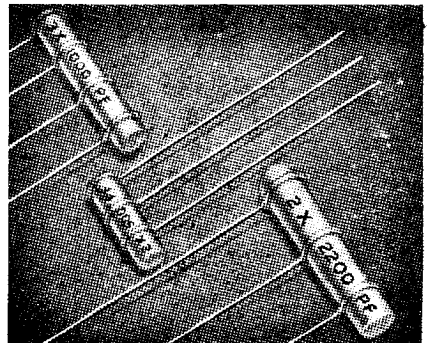

\* Guaranteed not less than stated values at 25°C.

**THE TELEGRAPH CONDENSER CO. LTD.**

Radio Division: North Acton, London, W.3. Tel: Acorn 0061

# PRACTICAL TELEVISION

## & "TELEVISION TIMES"

Editor: F. J. CAMM

Editorial and Advertisement Offices: "Practical Television," George Newnes, Ltd., Tower House, Southampton Street, Strand, W.C.2. 'Phone: Temple Bar 4363.  
Telegrams: Newnes, Rand, London.

Registered at the G.P.O. for transmission by Canadian Magazine Post.

Vol. 4 No. 46

EVERY MONTH

MARCH, 1954

### TELEVISIONS

## The P.T. "Simplex"

**T**HE free blueprint in this issue is of the very simplest type of TV receiver, ideal for the beginner and for those with limited purses. It has been designed around the central idea that everyone owns a radio set, and to reduce the cost, therefore, use is made of the speaker and the amplifying stages. Of course, readers who wish to build the "Simplex" as a complete receiver will find that they are able to do so for the expenditure of another £5 or so. In later articles we shall show how this may be done.

The "Simplex" makes use of the popular VCR97 and it enables all to enjoy the advantages of television. It is an ideal receiver for the beginner and for the experimenter. It will be seen that it is accommodated on one chassis, thus economising in space.

The "Simplex" is bound to be as popular, if not more so, than our Argus, and readers may build it in the confidence that it will work satisfactorily and is backed by our Free Advice Service.

### Teletape

**A**S announced in last month's issue, video recording on magnetic tape has already been successfully demonstrated in America, but no company engaged in teletape research is yet prepared to release any details for the basic reason that patents covering the intricate processes have not yet been granted. It will be some months before background information is available.

Although the principles of recording TV on magnetic tape have been settled, a number of mechanical problems are still under study. The chief of these is how to preserve the tape which runs at the almost unbelievable speed of 25ft. per second, or alternatively how to reduce this speed.

### TV and Mobile Radio

**T**HE Assistant Postmaster-General recently announced the frequencies which are to be made available to television, and in that connection the Mobile Radio Users Association, through their President, Sir Robert Renwick, say it is

clear from this statement that many users of mobile radio will be affected.

These users will not, of course, wish to obstruct the right of the public to alternative television programmes, but certain conditions seem to them to be of paramount importance. The Association considers that each user must be allotted a frequency at least as good as the one which he has vacated, that there must be reasonable security of tenure in the new frequency, say ten years, and that there should be some compensation for the expense to which users will be put for the adaptation of existing equipment.

### More About Slot-machine TV

**A**PROPOS slot-machine TV films mentioned in our November issue, it should be explained that the Tele-Meter system requires no dialling, no monthly bill, only cash in the box attached to the TV set. The new system is backed by Paramount which owns sixty per cent. of the shares in the new system. It intends to transmit its latest pictures over the system to 400 homes in Palm Springs, California. The films transmitted will be the same as those shown at the two local cinemas, who will be paid part of the receipts. The price is likely to be slightly in excess of cinema charges. The American sponsors of the scheme feel it will provide an answer to the commercial TV argument in this country since the films contain no advertising. It is thought that coin boxes would eliminate the BBC's annual licence fee as well as the BBC deficit. Commercial TV stations in America sold 19,000,000 dollars, or nearly £7 million, more advertising in the first seven months of last year than in the same period of 1952. New commercial TV stations are starting up everywhere and the number of viewers has increased by millions; those same millions who did not go to the cinema in America last year.

America thought that 3-D films would be the answer to the TV competition but it seems apparent from results that 3-D is not a commercial success.—F. J. C.

# FAULT SYMPTOMS

THE CAUSES OF COMMON FAULTS, AND METHODS OF CORRECTION

By Gordon J. King, A.M.I.P.R.E.

(Continued from page 399, February issue)

**P**ENTODE valves are widely adopted in modern television receiver design for separating the sync pulses from the composite video signal. Diodes are also employed, but these will be considered later. A pentode sync separator used in Etronic ECV1527 and ECV1523 series receivers is shown in Fig. 30. This circuit is representative of many employed for this function, and as will be seen is not unlike a normal amplifier stage—or, at least, until we come to look at the component values!

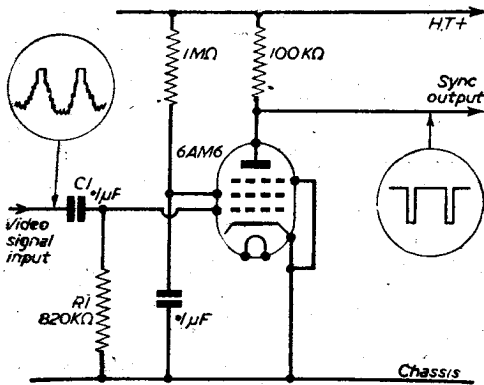

Fig. 30.—A sync separator of conventional design as used in Etronic ECV1523 and ECV1527 series receivers.

In this section of the receiver the component values are purposely arranged to introduce distortion into the output voltage so that it corresponds to only a part of the input signal. The high value screen-grid resistor, for instance, provides a short grid-base to the valve. Or in other words it arranges the valve's operating conditions so that the composite video signal at the control grid drives the valve well into current cut-off in one direction, and easily into grid current in the other direction.

In practice it is generally—but not always—the vision content of the signal that drives the valve beyond cut-off, whilst the tips of the sync pulses initiate grid current. This effect is illustrated diagrammatically by Fig. 31, where we can see that such a style separator demands a negative-going picture signal (positive-going sync pulses) for successful operation. It is of use, therefore, for the type of circuit that uses cathode modulation of the picture-tube.

The circuit shown in Fig. 30 is supplied from the video stage feeding the cathode of the picture-tube, and during the positive-going sync pulse portion of the video signal capacitor C1 charges due to grid current through R1. During the picture portion of the signal, however, discharge current flows through the grid resistor R1 from the capacitor C1, and it is an important characteristic of the circuit that the total charge flowing as grid current exactly balances the

discharge current for a steady operating condition to be set up. This action tends to restore the D.C. component of the composite video signal, which would otherwise be lost due to the isolating effect of the coupling capacitor C1.

The need for retaining the D.C. component of the signal is equally as important in sync separation as in the video output stage. This is clearly illustrated by Fig. 31, where it can be seen that the operating point of the limiter valve must remain stable irrespective of video signal amplitude. This is possible with signal forms containing the full D.C. component which, as we can see from Fig. 32a, would resolve with the bottoms of the sync pulses all resting on a common reference line.

With the D.C. component removed, however, the signal forms would tend to settle down so that the areas enclosed by the waveform on each side of the reference line were equal, as shown in Fig. 32b. It will be seen that the three signal forms illustrated represent signals (x) during one line of typical picture, (y) during the whole of one black line, and (z) during the whole of one white line. A line (shown dotted) corresponding to the operating point of the limiter (sync separator) can thus be drawn through the signal forms of (a) so that the picture content always lies above it, and the sync pulses of equal amplitudes lie below it. In (b), however, this is clearly not possible owing to the variations in position of the sync pulses according to the picture signal content. We can see from this, therefore, that it is of little use to feed a sync separator valve with a signal lacking a D.C. content.

Generally speaking the operating conditions of the sync separator valve are far from rigorous. For instance, a valve with impaired emission often works

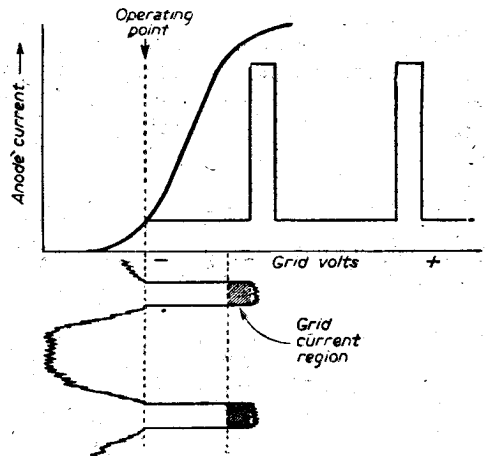

Fig. 31.—Illustrating the operating conditions of a typical sync separator.



well in this stage, and it can sometimes be of economical benefit if a valve, which has been working heavily in some other section of the receiver, is interchanged with the sync separator which, it often follows, retains its optimum emitting qualities for a longer period than valves operating in other sections—the two valves concerned must, of course, be of the same type!

The general cause of weak "holds," sometimes coupled with "pulling on whites," due to a fault in the sync separator stage itself, can generally be located to a variation in the value of an associated component, or components. The anode screen and grid resistors have a bad habit of enlarging in value; this is probably aggravated by their relatively high values and low wattage ratings. It does not always follow, however, that a single resistor is the prime cause of the effect, for a gradual deterioration in the efficiency of the sync separator can frequently be traced to the cumulative effect of an increase in value of all the associated resistors. Often, when examining a sync stage for impaired performance, it is noticed that, say, the screen resistor is a little high in value; this is replaced with an almost certain feeling that the trouble has been found. On test, however, results may prove most disappointing, for even though a slight improvement may be evidenced the trouble might still be present to some degree, and elimination may not be complete until a careful check of the other resistors has been made—probably to reveal that they also read higher than normal—and replaced where necessary.

A diminutive leak in the coupling capacitor can play havoc with the operating conditions of the stage. A component defect of this nature allows the application (from the video output valve anode) of a positive potential to the control grid of the sync valve, and, apart from causing very unstable "holds," provokes excellent conditions for "pulling on whites."

**Ragged Verticals**

Some receivers give excessively ragged line synchronising when operating on medium or low signals, particularly when the signal-to-noise ratio is low.

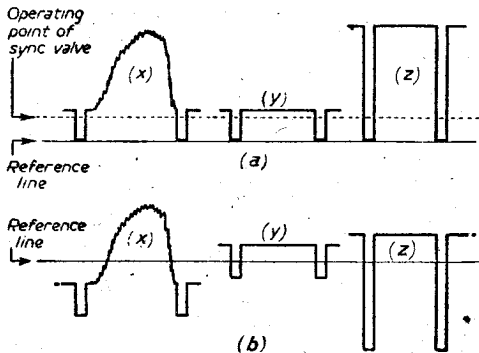

Fig. 32.—The three waveforms at (a) are shown at (b) lacking the D.C. component.

This is due to the fact that a small signal from the aerial is accompanied by appreciable cosmic and impulsive noise, which is added to the picture wave-

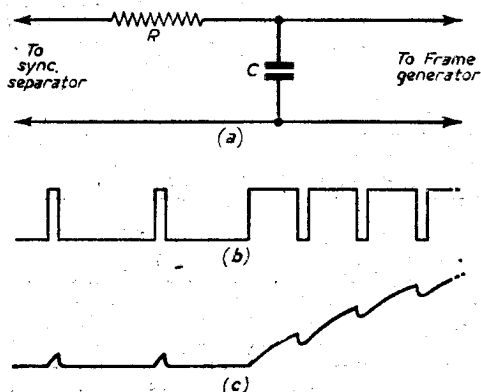

Fig. 34.—The basic integrator circuit is shown at (a) and the line and frame sync pulses at (b), (c) is the output waveform across C.

form including the tips of the sync pulses. If the anode signal of the sync valve is derived from the tips of the pulses it will be mainly noise. Such noise arriving at the line generator just before it is due to "fire" can produce an irregular start of line-scan, and be reflected in the form of ragged vertical picture content. Furthermore, in severe cases the noise may affect the actual "firing" of the generator and show up as a black line or tear across the picture; this is sometimes known as tearing on lines.

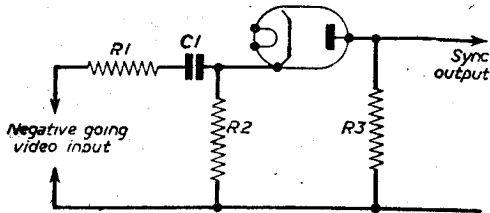

Fig. 33.—The basic circuit of a self-biasing diode sync separator.

To reduce this occurrence to a minimum it is essential that the tips of the sync pulses drive the sync valve well into the grid-current region so that the noise in the pulse tips is clipped, due to this action, and a clean pulse edge is fed to the line generator (see Fig. 31). We have already seen that this is provided by operating the valve with low screen and anode potentials, and thus achieving a small grid base.

If the signal applied to the sync valve is small, however, the resulting grid current may be insufficient for successful clipping and ragged verticals may result. Alleviation in this connection can sometimes be obtained by altering the values of R1 and C1 (Fig. 30). Their product must be kept high, though, and an enhanced clipping action can, in certain cases, be acquired by increasing the value of R1 to the region of 2-3 megohms, when, instead of returning it to the chassis, as in Fig. 30, it should be connected to a small positive potential to increase the grid current flowing.

**The Diode Sync Separator**

Although less efficient than the pentode or tetrode, the diode is sometimes adopted to the function of sync separation. In modern circuitry, however, it is not usual for a diode to be used on its own, for generally a pentode is also employed, and the diode simply enhances separation of the frame pulses—

sometimes operating in the form of a frame pulse shaping circuit, or the so-called interlace filter. From the operating aspect the diode is arranged to perform a switching action to cut-off or limit the composite video signal at a given voltage.

For the sake of completeness, and to assist experimenters who may possess a receiver using a diode separator, we will examine the basic circuit of just one of the more popular style of separators of this nature. Fig. 33 depicts such a circuit, which is also endowed with a feature for automatically securing a bias voltage for the diode. The cathode of the diode is A.C.-coupled, via R1 and C1, to a negative-going video signal. This means that the diode will conduct only when the composite signal has fallen to its nearly maximum negative value. This is, of course, during the sync pulse period. Cathode current flows and causes a volts drop across R2 which charges C1.

After a few cycles an equilibrium condition is reached, and the quantity of electricity which C1 loses, through R2, each line of picture is equal to the quantity gained during the sync pulse. Such a function, combined with suitable value component values allow the diode to remain non-conductive over the whole of the picture portion of each line, and only the negative ends of the sync pulses overcome the self-generated standing bias. The pulses are thus developed across R3, and are fed through suitable networks to the appropriate generators.

We can clearly see from this description that direct video coupling is not demanded by this style of circuit. This being due, of course, to the self D.C. restoring action, initiated by the charge and discharge of C1 through R2. This system, in fact, follows very closely the action of the grid circuit of the more modern type of pentode sync separator.

#### No Frame Lock—Line Hold Normal

Although it is generally the frame hold which suffers first should a slight defect develop in the sync separator stage proper, the symptom of a weak or no frame lock can be—and often is—due to a fault after the sync separator. A combination of circuits is employed after the sync separator to aid in a means of separating the line pulses from the frame pulses, this function being essential for successful operation

of the frame generator, and to provide a good interlace performance.

In some receivers the line and frame pulses from the sync separator are applied to a resistor capacitor combination arranged as shown in Fig. 34a. Such an arrangement is known as an integrator circuit and, owing to its predetermined time constant, enables adequate discrimination to be made between the 10 microsecond line pulses and the 40 microsecond frame pulses.

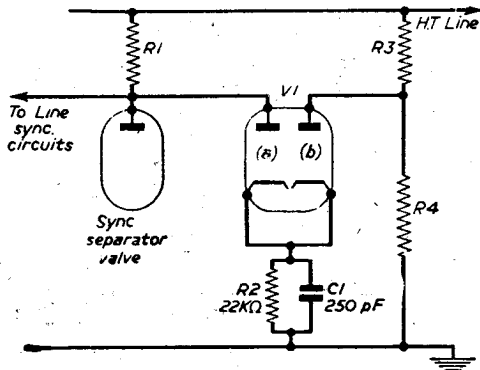

Fig. 36.—A frame pulse separator circuit.

The effect of feeding both line and frame sync pulses (Fig. 34b) into an integrating circuit is illustrated diagrammatically at Fig. 34c. It will be observed that the short duration line pulses are distorted and greatly reduced in amplitude, since they have little effect on charging C through R. However, the first of the series of frame pulses, due to its longer duration, charges C to an appreciable value, and it discharges only slightly before the next pulse arrives. The subsequent pulses charge the capacitor to an even greater value and so on, resulting in a build-up across C, which at some critical value "fires" the frame generator.

At one time this method of frame sync pulse coupling was extensively employed, and the circuit of Fig. 35 shows such an adoption in the Etronic ECV1523 series receivers. For clearness the sync separator and frame generator stages are also included. The integrating circuit comprises the RC combination R1 and C1, and, as will be noted, C1 is also in series with another, 0.02 μF capacitor. This facilitates the frame sync pulse feed, and at the same time provides the correct time constant for the blocking oscillator transformer secondary circuit; both capacitors in series function as a D.C. block.

If a weak frame lock should be experienced in conjunction with a circuit of this nature, and provided the line lock is firm, the fault is most likely to be in R1, going high in value—although, as previously indicated, the sync separator stage could be responsible and should always be borne in mind. A leaky C1 may provoke a similar symptom without unduly affecting the function of the frame generator, but should it go open-circuit, or increase in value to any large degree, then the performance of the generator is bound to be impaired, probably so that insufficient picture height and the correct generator frequency are unobtainable by normal operation of the appropriate controls.

Some receivers, particularly those of comparatively

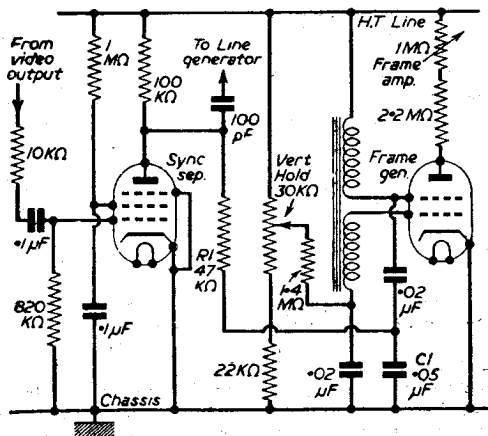

Fig. 35.—The sync separator and frame generator stages of the Etronic ECV1523 series, showing the method of frame sync feed.

recent design, do not rely wholly on an integrating circuit for separating the frame sync pulses from the combined line and frame pulses. In place of a simple integrating arrangement a valve, usually a diode, is employed in the form of a frame pulse separating circuit. A circuit after this style is depicted at Fig. 36, which, although comparatively simple, is very effective.

Both line and frame sync pulses are developed

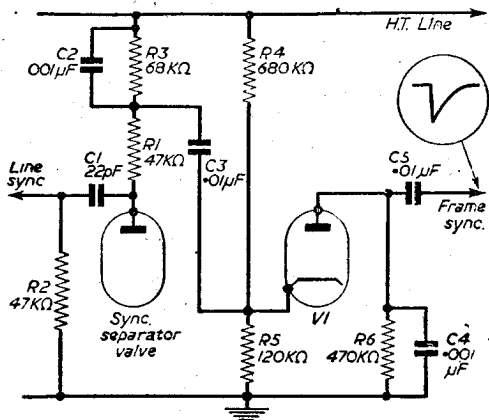

Fig. 37.—A frame pulse shaper circuit by G.E.C.

across the sync separator load resistor R1. The direct connection from the anode of the sync separator to the anode of diode (a) renders the diode conductive only during the time when no sync pulses appear across the load resistor R1. Thus, during the picture content of the signal a positive potential is developed across R2, which charges C1 to the H.T. line potential.

The anode of diode (b) is also held at a positive potential by reason of the potential divider R3 and R4, but is arranged to be less positive than its cathode, and of a consequence is non-conductive. On each line sync pulse the anode potential of diode (a) falls below its cathode potential, and the valve is held at cut-off for the duration of the pulse. During the time C1 commences to discharge through R2 the potential across the combination does not fall sufficiently during a line pulse for diode (b) to become conductive, due to the relatively large time constant.

During the longer duration frame pulses, however, the cathode potential falls below that on the anode and the valve conducts. A series of desirably sharp frame sync pulses is thus developed across R4, and any "back-lash" from the line timebase and line sync pulses is completely blocked from the frame generator by the inclusion of a circuit of this simple mode.

Another circuit of similar nature, and used by the G.E.C. in their BT2147 series receivers, is shown in Fig. 37. Here a single diode valve is employed, the cathode of which is positively biased by a potential-divider comprising R4 and R5. The resistor capacitor combination, C2 R3, in the anode circuit of the sync separator valve, is arranged so that the line sync pulses are severely attenuated by it, while to the frame sync pulses it represents a satisfactory load.

Thus the negative-going frame sync pulses, which are mainly developed across the combination, are fed via C3 to the diode cathode. The valve is,

therefore, provoked to conduct during the frame sync pulse period only, resulting in a rise of potential across R6, and the charging of C4. Since these components form a relatively large time constant the 10 microsecond interval between successive frame pulses has little effect on the discharge of C4. A single clean-cut frame pulse (as illustrated) is thus produced and is transmitted via C5 to the frame generator.

Sometimes, instead of valve diodes, crystal diodes are employed in interlace filter circuits. The Pye model FV1 series, for instance, adopts crystals, and the relevant network is illustrated by Fig. 38. The principle of operation is very similar to that already described and needs no further comment.

We can clearly realise, then, that on a receiver exhibiting the symptom of no frame lock little problem is presented in establishing the cause. In receivers using valves or crystal diodes these should be checked before extensive circuit diagnosing is carried out. Crystals appear to lose efficiency or go open circuit much more rapidly—in this type of circuit anyway—than their valve counterparts. The first symptom is generally that of poor frame hold—check crystals!

Potential-divider and time-constant resistors and capacitors often drift in value and give rise to a weak frame lock. Certain resistors in this section possess comparatively high and critical values for optimum circuit performance. Do not just assume that the value is "near enough" correct; if in any doubt at all, have the components accurately checked for value—and in the case of capacitors also check for insulation—or better still replace any dubious component which may be in the critical value zone; it pays in the end.

Always keep in mind that a gradual reduction in the efficiency of the frame hold may be due to the cumulative effect of an alteration in value of a number of components. This sort of symptom is more likely to occur after the receiver has been in constant use for three years or more.

Other causes of no frame hold sometimes occur to bewilder the experimenter. Poor winding insulation in the frame blocking oscillator transformer often offends in this respect. An Etronic ECV1523 series receiver was recently examined by the writer for

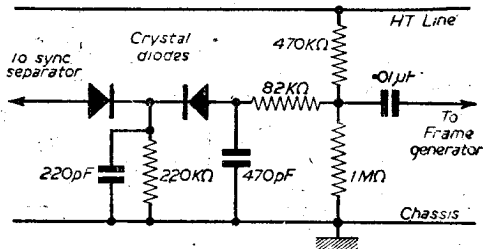

Fig. 38.—The interlace filter network of the Pye FV1 series receivers.

lack of frame lock, and the cause was eventually proved to be due to a slight leak between the primary and secondary windings. The most unusual feature of this symptom was the fact that frame scan linearity and amplitude appeared to be little affected by the defective component—it was observed, however, that operation of the frame hold control varied the frame scan amplitude more than generally expected on this model.

(To be continued.)

# FUTURE TRENDS

AN OUTLINE OF SOME OF THE DEVELOPMENTS WHICH MAY BE SEEN  
DURING THE NEXT TWELVE MONTHS

By W. J. Delaney (G2FMY)

**P**ERIODICALLY we review the developments which have taken place and also attempt to look into the future. Unfortunately, most manufacturers put an iron curtain round their research laboratories in an endeavour to steal a march on their rivals, and thus it is not possible to gain any idea as to what lines are being pursued. However, the forthcoming commercial broadcasts, and the news that the BBC will be opening stations to provide alternative programmes, shows what developments may be expected at least in one direction. Existing receivers are all designed to cover only five channels, some older receivers being for only one channel or one station. Obviously, therefore, with the opening of any new station outside the present television channel (45 to 65 Mc/s) some modification will be essential, and in most cases the receiver itself will not be suitable for alteration. At least one commercial receiver now available for general use has a continuously-variable tuner covering the above range, whilst others have five-position switches or plugs and sockets so that any one of the five stations may be tuned.

The only way to use any of the present receivers on bands other than those for which the receiver is designed will obviously be by means of a unit connected between the aerial and the receiver. This will be more or less standard practice up to a point. There is no difficulty in making a frequency-changer stage in which the aerial circuit is tuned to the desired station and the oscillator section is so arranged that the received signal is converted to the frequency for which the receiver is designed—or, if a five-signal receiver is being used, any one of the five channels could be used. Certain small difficulties might arise, but are not insurmountable. Where the new station is situated at some distance the usual H.F. stage or stages could be included in front of the frequency-changer.

## Adaptors

Such an adaptor or pre-tuner would, of course, have to be completely self-contained, that is, with its own power pack as the majority of commercial receivers make use of the A.C./D.C. technique and thus a suitable heater supply cannot be easily tapped-off. Furthermore, no extra H.T. current is available in most receivers without running into difficulty due to under-running the timebases. This means that the pre-tuners are going to be rather bulky and also expensive, as a mains section will have to be included. A further complication may arise due to the fact that the two units (new tuner and old receiver) have to be linked together, and in A.C./D.C. technique it may in some cases be possible for the mains to be short-circuited or cross-linked to introduce troubles.

One further complication is that it may eventually be found that the new transmitters will employ frequency-modulation for the sound channel, and

in such a case the sound section would have to be complete and some means found of connecting it to the existing loudspeaker or to the audio section of the existing receiver.

## Aerials

It will be seen that, until full details are released as to the frequencies actually to be employed, and the localities where the new transmitters will be situated, as well as to the form of sound modulation to be employed, no actual idea can be gained as to the form to be taken by future receiver designs. But linked with this problem is that of aerial design. Already certain BBC stations are utilising horizontal polarisation, and it is highly probable, we are informed, that the proposed new commercial transmitters will utilise the same form of polarisation. Existing aerials are designed for one station, and therefore for new stations new aerials will be needed. If more than one station is within range more than one aerial will be needed, and thus one may visualise the future aerial as an elaborate array of horizontal and vertical elements. To add to this complication, the aerials are directional and would thus need to be rotated for individual stations. In America most

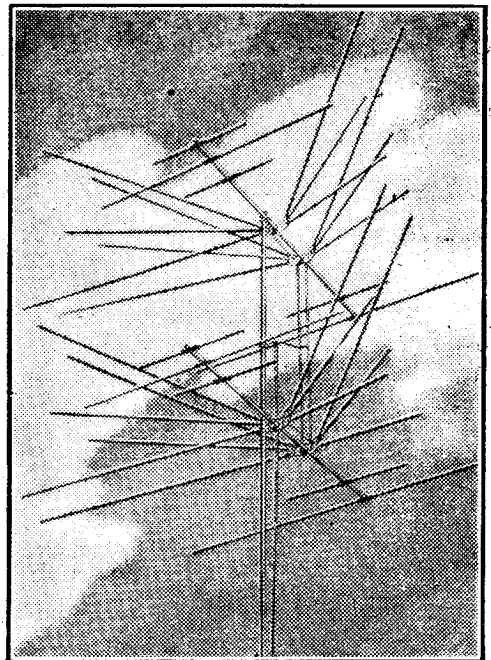

Will aerials of this type soon appear on English homes? This is a well-known American array.

elaborate aerials are in use, one of which is illustrated on page 442. These aerials are motor-driven and in the house a neat unit is placed on the television receiver and the aerial is remotely controlled, a dial or illuminated strip showing the direction in which the aerial is pointed.

**Colour**

One further complication in visualising the receiver of the future is colour. Elsewhere in this issue will be found an article which discusses the use of projection. As every amateur cinematographer knows, a picture in colour looks hopeless unless it is brilliantly illuminated. A monochrome picture can be viewed even if it is very dull, but with colour, especially if the scene is one bathed in sunlight, it looks most unnatural unless a very bright light is behind the picture, and thus projection would appear to be of little use for colour pictures. Added to this is the problem of the actual tube. The type of tube now being used in the American colour broadcasts makes use of a perforated screen between the gun and the actual tube face, and it would appear impossible to make this type of screen to fit a 2in. tube, such as is employed in projection receivers. Therefore, colour is almost certain to call for direct-viewed tube arrangements, and costs at present in the U.S.A. limit the tube to one of 15in. diameter. From details so far released it would appear that

there is a distinct possibility of making an adaptor which could be added after the video circuits of existing receivers for use with a new picture tube to produce colour, that is, if we eventually adopt the system now authorised in America. There is, of course, the possibility that our own research engineers may hit on some other scheme, or that it will be found that the American arrangement will not lend itself to modification for our present standard of definition. There is little possibility that the new commercial transmitters will improve their definition in view of the difficulty of receiving other definitions on existing receivers, although a complete break-away might take place to bring the system in line with the standard Continental arrangement. Such a change might result in a development of the time-bases whereby a switched circuit would enable one to use either 405 or 625 lines—but this would be a further complication which in turn would result in increased production costs and dearer receivers. As has often been pointed out in these pages, however, the home-constructor is at an advantage with all new developments as he can modify or adapt his receiver to take care of new ideas, whereas the user of a commercial receiver is restricted to using the receiver without modification. The Radio Show is still some way off, but no doubt some manufacturers will be showing "modern" receivers adaptable for various stations, F.M., and, shall we hope, colour!

# MULTI-CHANNEL TUNERS

## SOME SUGGESTIONS FOR THE EXPERIMENTER

WITH the introduction of an alternative BBC programme and commercial television, receivers will be required to select any one of several stations at the turn of a knob. Since Band 1 (45-66.75 Mc/s) is reserved for the main BBC programme, most receivers will be required to receive only one station in this band. For those viewers on the fringe of two stations, however, it is useful to be able to select either, according to which is strongest at the time. In Band 3 (160-220 Mc/s) it will be a great advantage to be able to tune in all of the channels.

In order to cover such a wide range of frequency it will be necessary to use a superhet circuit. The basic circuit to be considered in this survey consists of one R.F. stage, a mixer, and an oscillator.

The basic methods of station selection are as follows:

- (1) Switched Inductors, using a Yaxley switch.
- (2) Switched Inductors, using a coil-turret.
- (3) Ganged Variable Inductors.
- (4) Ganged Variable Condensers.

**Using a Yaxley Switch**

This method will be familiar to most constructors as the most common way of switching tuned circuits. Three sets of coils are used, each set

being connected to a separate bank of the switch and screened from the others to prevent instability.

The obvious arrangement is to have a set of three coils for each channel, and to select the appropriate set by means of the switch as shown in Fig. 1a. Alignment is carried out by selecting each channel in turn and adjusting the three coils for best results. The coils are tuned by brass or iron cores for Band 1 stations and by spreading the turns for Band 3 stations.

In Fig. 1b is shown the alternative method of switching the coils. Here a tapped coil is used, the sections being progressively shorted out by means of the switch. The coils are air-cored and of small diameter. They are wired directly across the tags of the switch and are tuned by adjusting the spacing of the turns. Alignment is carried out by first tuning

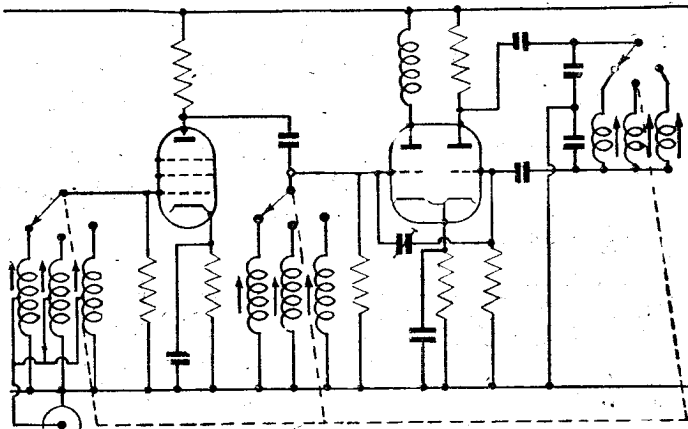

Fig. 1 (a).—Typical circuit for station selection by means of coil-switching.

the highest frequency channel with only one coil section in circuit, then select and tune the other channels in order down to the lowest frequency, when all of the tapped coil should be in circuit.

It is best to short-circuit the unused coils since they may resonate with stray capacity and act as wave-

Yaxley switches, should be fitted to the shaft to ensure accurate registration of the contacts when a station is selected.

The circuit of a turret tuner is similar to that shown in Fig. 1a, except that both ends of the coils are switched. To align a turret tuner each channel is selected in turn and its three coils adjusted for optimum results.

Although some mechanical skill is required in the making of a turret tuner its construction should not be beyond the capabilities of the average experimenter. One disadvantage of coil turrets is that they tend to be rather bulky and so do not fit conveniently under a receiver chassis.

**Ganged Variable Inductors**

Here only one coil is used in each stage, its inductance being varied by means of either movable slugs or a movable tapping point.

In the first method the three coils are mounted in a line and a shaft composed of alternate iron and brass sections passes through them as shown in Fig. 3. At the end of the shaft is cut a screw thread which runs in a tapped bearing so that when the shaft is rotated it moves axially through the coils. The coils must then be set so that the brass parts of the shaft move through the coils in synchronism.

The second system is shown in Fig 4. The coils are wound with bare wire and insulated from the brass

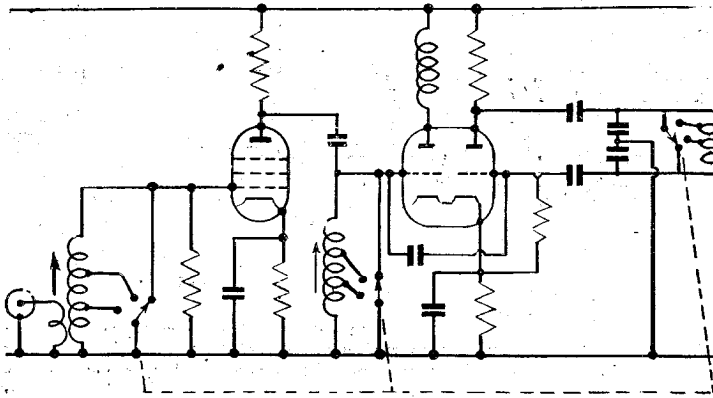

Fig. 1 (b).—Tapped inductors are used in this circuit.

traps if left open-circuited, thus causing attenuation of the received signal. Layout is very important, otherwise wiring to the switch may be too long, thus causing loss of efficiency. The longest wires should be to the low-frequency coils, since their effect will then be less than at the higher frequencies.

**Coil Turret Tuners**

Coil turrets are very popular in the United States where they are used to cover up to 12 channels in Bands 1 and 3. The coils are mounted in an eight- to twelve-sided drum as shown in Fig. 2. The drum is made up of two end plates, between which are fixed eight to twelve slats of perspex or Tufnol. On each slat are fixed the three coils corresponding to one of the available channels. Six studs are fixed to each slat and make contact with six spring contacts which are mounted on, but insulated from, the frame. The studs must stand out sufficiently so that the springs do not foul the edges of the drum. Metal discs are fixed inside the drum to screen the three sets of coils from each other. There are, of course, many other ways of making a coil turret. The side and end views of a typical turret are shown in Fig. 2. A click-stop mechanism, similar to that used on

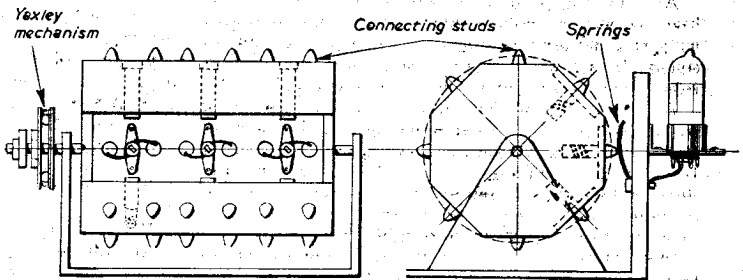

Fig. 2.—Suggested design for a coil turret.

shaft. One end of each coil is soldered to the shaft and so earthed, whilst the other end is fixed under a wire ring which acts as the grid connection for the coil. A sliding contact bears on the turns and moves along the coil as the shaft is rotated.—S. A. MONEY.

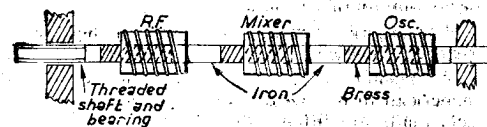

Fig. 3.—Adjusting a set of coils by means of variable cores.

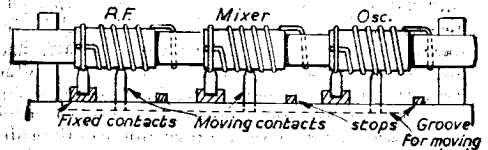



Fig. 4.—Mechanical details for tapped inductors.

# IS PROJECTION THE ANSWER TO LARGE SCREEN T.V.



SOME INDICATIONS OF THE TREND IN DESIGN OF  
LARGE SCREEN TELEVISORS

By B. L. Morley

**T**HE recent article on Projection TV raises the query as to whether it is the real answer to bigger pictures for the home.

When viewing a projection television set designed for the home one is at first struck by the flatness of the picture and its comfortable size. The picture has a minimum width of about 16in., and this size adds a realism to the scene which is quite unobtainable with the direct-viewed 12in. tube. A head and shoulder shot is produced almost three-quarters life size and the effect can be very favourably compared with that of the home cinema.

The flat screen is a very good point in its favour. We are used to viewing pictures on a plane surface, not only at the local cinema but also in photographs, picture magazines and the like, and the flat screen of the projector seems to make scenes more "real."

Another big point in favour of the system is the low cost of tube replacement. We can obtain almost as large a picture by using a 17in. tube, but as pointed out in the article, the replacement costs of the larger tube is about three times that of the projection type.

A further favourable point is that reflection from the surface of the screen is practically nil and one can enjoy viewing with normal room lighting untouched. It is better if the light is shielded somewhat, and diffused lighting is undoubtedly the best form for viewing; nevertheless, the picture can be comfortably viewed with the normal room lights fully on.

One feature which is rather surprising is that in spite of fears to the contrary the line structure is not over-prominent, and when one is used to it, it becomes almost unnoticeable at viewing distances which have been accepted as the optimum for 12in. tubes.

The interlace of the system must be very good to obtain that condition.

## Critical Examination

However, after the initial effect of the large size and flat appearance of the picture has worn off one begins to become more critical. In spite of the ingenious optical system the picture is sadly lacking in contrast. By contrast we mean the difference between the blacks and the highlights of the picture.

In the photographic world the quality of a picture is assessed on the contrast range and overall brilliance. In a good picture the blacks should be really black and the white parts (or highlights as we call them) should be really white.

When viewing the picture on a projection television the blacks do not appear really black, nor the whites really white. It is like viewing a directly-viewed tube when there is sunshine in the room, or when the brilliance control is turned up too high and the contrast too low; the range from peak black to peak white is too shallow.

The overall effect is that the picture appears flat from the contrast point of view: it lacks the sparkle and brilliance of the directly-viewed tube.

When considering the quality of a picture it is not sufficient to think only of contrast; tonal range must also be considered.

It is possible to get good contrast yet a poor picture. This effect is noticeable in areas of high signal strength where attenuators are not fitted in the aerial system. The controls have to be reduced to a minimum in order to avoid making the screen too brilliant; the result is a soot-and-whitewash effect which has plenty of contrast, but there is a lack of intermediate tones.

A shallow contrast range results in a picture which is composed mostly of a dark grey (representing black) and a light grey (representing white), while a long contrast range shows a true black, a true white and many intermediate tones between these two extremes.

Where there is good contrast it is usually possible to obtain an adequate tonal range; where the contrast is shallow then the tonal range is short and the picture lacks quality.

In the view of the writer the quality of the picture on a directly-viewed tube is superior to that of the projection model, and the trend of design will favour the use of larger tubes.

A preview of things to come can be obtained from a survey of the American market. Whether we like it or not the Americans are at least five years ahead of us in their development of TV, and large tubes have been commonplace for some years.

The largest directly-viewed tube on the American market is one which is 30in. in diameter!

A recent survey of the television sets sold by American firms reveals that 36.5 per cent. of all the sets made are fitted with 17in. tubes, while 27 per cent. have 20in. tubes. Projection televisions represent 0.5 per cent. of those available.

(Continued at foot of next page)

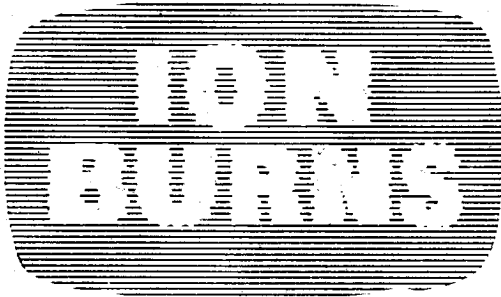

## THEIR CAUSE AND A SUGGESTION FOR REDUCING THE ILL-EFFECTS

By P. Dodson

**A** DARK patch in the centre of the C.R. tube is usually a sign that the tube has developed ion burn. Burns vary in size from about 1in. in the case of a slight burn to as much as 2in. or 3in. in bad cases.

The burn is brought about by the formation of negative ions, which under the influence of the E.H.T. voltage strike the screen in a concentrated area. After a period of use this continual bombardment of the centre of the tube screen produces a dark patch. Ions which originate within the neck and flare of the tube produce burns about 2in. or 3in. in diameter. The majority of burns, however, are usually smaller and originate within the gun of the tube. The ion trap was introduced to prevent this type of burn.

### Minimising the Effects

Whilst it is not possible to remove a burn, its ill-

## IS PROJECTION THE ANSWER ?

(Concluded from page 445)

Twelve inch tubes represent 0.75 per cent. of the total, while the smallest directly-viewed tube (10in.) represents 0.5 per cent.

A table is given below showing the tube sizes used in commercial receivers and the percentage of the total number of the models made.

Note that this list represents different models, not the number of sets made. At the time of compiling the list 422 different models using different sized tubes were available, and of this total 146 were 17in., while 110 were 20in.—this represents approximately 36.5 per cent. and 27 per cent., respectively.

### TUBE ANALYSIS

Tube used	% of total	Tube used	% of total
Projection	... 0.5%	19in. ...	... 4.25%
10in. ...	... 0.5%	20in. ...	... 27.0%
12in. ...	... 0.75%	21in. ...	... 2.0%
14in. ...	... 1.0%	24in. ...	... 5.5%
16in. ...	... 6.25%	30in. ...	... 0.25%
17in. ...	... 36.5%		

From this table it would appear that projection television sets are not favoured in the United States. Projection has been tried, but has not proved popular, viewers being content with a 17in. or 20in. tube for normal home reception.

A further point to be considered is the angle of view. A directly-viewed tube can be looked at from extreme angles; this is especially true of the flat screen type such as the English Electric or

effects can, to a certain extent, be minimised. It is observed that the lower the E.H.T. voltage for a particular tube the more prominently a burn shows up. Increasing the E.H.T. voltage to the maximum allowed by the makers of the tube will improve matters considerably. For instance, the author has a 9in. Mullard tube (not fitted ion trap) which has a 2in. burn in the centre. With the E.H.T. at 6.5 kV (minimum) the dark patch is quite prominent. Stepping up the E.H.T. to 9 kV (maximum) the burn is barely visible, even on the lightest scenes.

### Flyback E.H.T.

In some receivers the maximum available E.H.T. voltage is little above the minimum working voltage of the C.R. tube. By stepping up the E.H.T. voltage to the maximum permitted by the makers of the tube a more brilliant picture can also be obtained.

To-day the majority of receivers derive their E.H.T. from the line flyback. It is a simple matter to add a booster. An article on this subject appeared in March, 1953, issue, namely, "Flyback E.H.T. Booster."

In conclusion, a word of warning. Increasing the E.H.T. voltage will result in reduced scan. An increase in amplitude can usually be obtained by increasing the H.T. voltage to the line output valve, but care should be taken not to exceed the normal rating of the valve.

In some circuits, changes to the line output stage such as this, or attempts to increase the drive by modifying the oscillator stage, may introduce linearity difficulties, but in most cases these will not be insurmountable.

Mullard 16in. The angle of view of projection models is very restricted, there being a very marked fall in the overall brilliance when viewed other than directly in front of the screen.

The merits and demerits of the two systems can be tabulated as below :

Projection	Directly viewed
Picture is large.	Larger tubes can be used and are likely to become available soon.
Picture is flat.	Perfectly flat pictures not yet possible though near approximations can be obtained.
Tube replacement inexpensive.	Tube replacement is expensive.
Not available to the amateur.	Available to the amateur.
Low contrast range.	High contrast range.
Picture lacks brilliance.	Picture very brilliant.
Range of tones short.	Tonal range long.
Restricted angle of view.	Wide angle of view.
Soft X-ray emission.	Does not emit soft X-rays.
Extremely high E.H.T.	Moderately high E.H.T.
Expensive R.F. supply for E.H.T.	E.H.T. can be derived from line flyback.

Where it is desired to obtain the maximum quality, in the picture, a directly-viewed tube is by far the best; the trend of development appears to favour the larger tube. Until the problems of contrast and tonal quality in the projected picture are improved the writer does not think that this form of viewing will become popular.



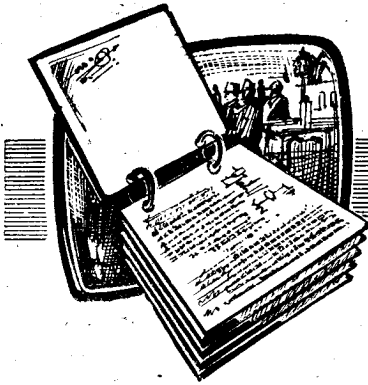

# Pages from a TELEVISION ENGINEERS Notebook

## 14.—FURTHER D.C. RESTORING CIRCUITS

GENERALLY, the vision detector stage is directly coupled to the video amplifier, this valve being biased to a suitable part of the characteristic by a cathode resistor, or a negative grid source derived from some part of the H.T. supply. The direct coupling overcomes the problem of D.C. restoration, but it is possible to feed the video amplifier through a condenser coupling if the bias resistance is removed, as restoration then takes place at the grid-cathode input circuit. Bias is obtained from the flow of grid current, and the operating conditions are roughly as shown in Fig. 1, where the  $I_g/V_g$  characteristic of the valve is shown, together with the  $V_g/I_a$  characteristic of the tube. It is seen that the latter is directly fed from the video anode, and restoration is then automatic.

The bias produced at the grid of the amplifier is in proportion to the peak amplitude of the signal, shown here to be negative-going in sign. Two signals are considered as before, one predominantly white, the other predominantly black, and the method of bias fixes the black level of both forms so that the tips of the sync pulses just draw grid current. The resulting valve anode current is as shown in the figure, and the resulting beam current of the tube is clamped about the normal black level. It is noticed that the effective bias on the tube, which is that derived from the brightness control potentiometer R3, is such that with no signal input the tube is biased rather beyond cut-off. Actually, of course, this effective bias is the net result of the voltage across R2 and R3, these being in opposition.

A necessary condition for the proper functioning of such a stage as this is that the screen of the video amplifier be fed from a bleeder network, as shown, and that the current drawn by this chain is four or five times as great as the actual screen current; i.e., if the screen current is 2 mA, then the bleeder itself should draw, say, 10 mA, which means a total resistance of about 25 k $\Omega$ . A reduced screen voltage is necessary to protect the valve when no signal is applied, as the screen dissipation may otherwise be exceeded. A disadvantage in this is that the output of the stage is reduced to about one-half of its normal (cathode-biased) state.

The necessity for a stable screen voltage is best shown by considering a case where a variation can occur. In Fig. 2 is shown a circuit where the screen is fed from a simple series resistance; on the left of the figure is drawn the  $I_g/V_g$  characteristics of the valve with three different forms of vision signal applied to the grid.

Now these differing signals produce differing amounts of bias, as shown. As the bias in a particular instance is increased above zero, the screen current will fall and the voltage will rise, with the result that for any particular bias condition the anode current available over the grid cycle is greater than in a case where the screen potential is completely stable. The three  $I_a/V_g$  characteristics corresponding to the bias conditions under consideration are shown in the figure, with the resulting anode currents drawn to

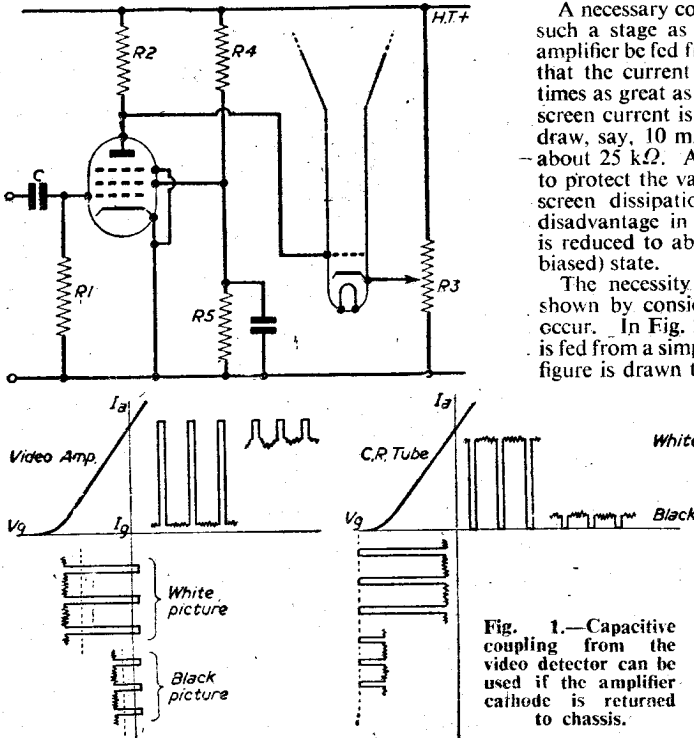

Fig. 1.—Capacitive coupling from the video detector can be used if the amplifier cathode is returned to chassis.

the right. From this it is at once evident that though the black level is clamped in the grid of the amplifier, it is not so clamped in the anode circuit, and the advantages of the restoration are lost, in spite of the direct tube coupling.

From the constructor's point of view, this form of circuitry has many disadvantages when compared with the diode systems previously discussed, the chief one being the fact that the grid of the tube is quite likely

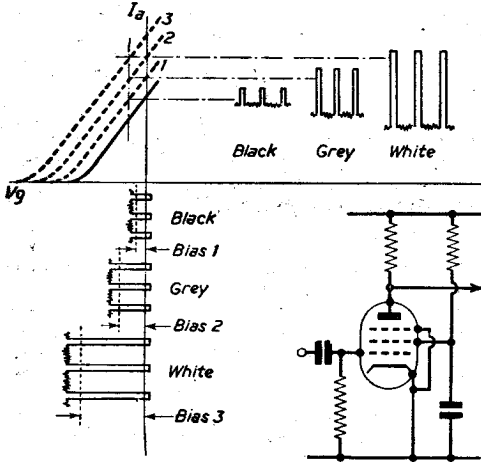

Fig. 2.—Showing the loss of D.C. restoration when the screen voltage of the video amplifier is not stable.

to be at H.T. potential during the warm-up period of the amplifier valve. Overcoming this difficulty means the use of a delayed heater supply to the tube, or a slow warming rectifier supplying the H.T., neither of which methods are completely satisfactory. With the diode restorer circuits, the grid of the tube is always negative relative to the cathode, whether the warming period is long or short, and this circuitry is obviously better for the amateur constructor who has the high price of the C.R. tube to bear in mind.

**Low-frequency Boost by Restoration**

An interesting aspect of D.C. restoration is its application to the boosting of the lower video frequencies, so enabling an even response to be obtained down to at least frame repetition frequency. Consider again the circuit of Fig. 1. Although this circuit uses grid-current bias and direct tube coupling, the theory of what is to follow will apply equally well to the diode systems.

In Fig. 3 a normal square-wave video signal, assumed to represent a picture half-black, half-white, is considered to be present at the grid of the video amplifier. A poor low-frequency response in the circuit as a whole, however, has resulted in distortion, which is shown as a "droop" in the otherwise level parts of the waveform, as at a-c, d-f, etc. When the edge a-b of the wave appears at the grid of the amplifier, the tip of the sync pulse (which here is effectively peak-white to zero level in amplitude) just draws grid current. As the rest of the wave progresses, the excursions into grid current region by each sync pulse becomes greater and greater (due to the droop of the wave), and the valve bias is consequently increased.

This increase in bias is such that the tip of each sync pulse only draws as much grid current as the initial pulse, with the result that the anode current output is effectively restored to the original square-wave form.

When that portion of the square wave lying between c-e arrives at the amplifier grid, the bias already existing on C leaks away only gradually through R1 and by a proper choice of the time-constant CR1, the frequency compensation effect can continue. As the wave slopes away from the zero-bias axis of the valve, the decrease in the bias should be such that the decay follows the slope of the wave; this means that the time-constant CR1 must be made equal to the equivalent time-constant that caused the droop in the square wave. The tip of each sync pulse in the c-e interval will then draw grid current, and the resulting anode current will again be square in form.

If CR1 is less than the equivalent time-constant causing the distortion, but still large compared to the line period of 1/10125 seconds the bias will fall at a faster rate than is actually required, or rather, will try to fall at such a rate, but cannot do so in practice because the sync pulses would otherwise extend beyond the zero-bias axis. If CR1 is very much greater than that causing the droop in the wave, the D.C. restorer will not function in its manner of reinserting the low-frequency components, and the picture definition will suffer, or synchronising will become erratic.

There is one other important point to bear in mind when choosing the value of CR1, and this concerns the change in picture background. The time-constant must be short compared with the most rapid background change likely to be experienced; in practice, a

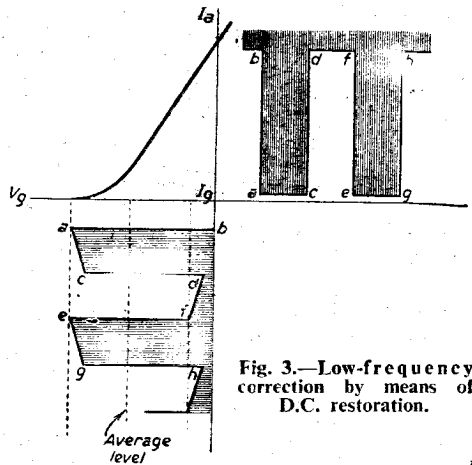

Fig. 3.—Low-frequency correction by means of D.C. restoration.

value of 0.05 second is usually satisfactory, so that if R is made 1 mΩ, C will be 0.05 μF.

It should be remembered that this form of low-frequency compensation is very limited in its action, and only very small distortions will be corrected. For very severe conditions the wave droop is large and can no longer be considered linear.

**WIRELESS COILS, CHOKES AND TRANSFORMERS**

8th Edition now ready. Price 6/- by post 6/4.

# VALVES AT U.H.F.

A REVIEW OF RECENT DEVELOPMENTS

By S. Simpson

**T**HE news that the proposed commercial television transmitters will operate at V.H.F. brings into prominence the question of receiver design at these frequencies. Very little has so far been done in the way of television receiver construction in this country at the frequencies concerned, and it is highly probable that new techniques may be developed. Aerial design is, of course, only one aspect of the matter, and many of the valves specially designed for V.H.F. and U.H.F. work may come into more general use if and when the new transmitters open up. The following data is, therefore, offered for the use of those who may wish to carry out experimental work in the design of wide-band receivers suitable for television reception on much higher frequencies than are at present employed.

Not so very long ago the satisfactory operation of radio-communication equipment on frequencies of 60 to 120 Mc/s was considered quite an achievement in this and many other countries, but it is indicative of the trend of development that 120 Mc/s operation is now regarded as a commonplace affair. To-day the thoughts and experiments of the development engineers here and abroad are centred on the centimetric field where dipoles have given way to parabolooids, inductors have become straight tubes, and capacitors are only noticeable by their absence in any form with which we have become familiar. Perhaps the most remarkable change in the appearance of typical Kilo-megacycle range equipment lies in the valves used to generate oscillations.

Before considering these tubes, as they are now called, one may ask: What has brought about this concentration on ultra-high frequency operation? Radar, of course, was a very important contributory factor, and the war years saw rapid expansion in this field of U.H.F. Recently, the radio links which carry the BBC television programmes to the north, and the now famous experimental TV relay from France to this country, have drawn public notice to some of the work that goes on behind the scenes in the large radio concerns. Communication interests are now closely watching centimetric radio activities; in this sphere would seem to lie the answer to the problem of trans-continental telephonic communication in areas where it is impracticable, either for reasons of distance or physiography, to use the orthodox land-lines over the entire route.

These, very briefly, are a few of the reasons behind the recent impetus given to research in the Kmc/s field, but such developments would not have been possible without the introduction of new high-power tubes specially designed to work at these extremely high frequencies—tubes which, to the average reader who recognises a valve by its type number or its base, can be rather awesome at first glance. It is hoped in this review to throw some light on the method of operation of these tubes, to say why they were necessary, and to give a summary of the present position in their development.

## Tetrodes at U.H.F.

For several years tetrodes and pentodes were the valves mainly used on V.H.F., and even up into the

U.H.F. range the triode was—and still is—used with good effect. As the frequencies increased, however, so the dimensions of the electrodes decreased in order to reduce their effect on the tuned circuits, and the overall effect was a reduction in power which could ill be spared because of the high R.F. losses at U.H.F. in the materials from which the electrodes were made. The call has been for greater power to overcome these losses, and it became apparent to development technicians that new designs and new methods of valve operation would first have to be sought before the real work in the Kmc/s range could begin.

New designs were evolved, but the method of electron control is not new. In the closing years of the 19th century several European scientists discovered that powerful magnets could sway electrical discharges in evacuated tubes, and they were quick to realise that the glowing rays of "matter" in their Geissler tubes had similar properties to those of an ordinary current-bearing conductor. Our present-day scientists were also quick to realise that in the "freak" behaviour of the evacuated Geissler tube lay a possible answer to the problem of cathode current control, and one excellent result of their investigations has been the "Magnetron."

## The Magnetron

Early in the era of magnetically controlled valves this tube provided many of the answers to the centimetric engineer's problems of obtaining reasonable powers at U.H.F. As will be seen from Fig. 1, in construction it is quite unlike the orthodox negative-grid valve. The cathode is an electrically heated hollow tube with end caps which serve to concentrate the cathode emission in a zone of high efficiency. The anode is a circular copper block in the form of a drum surrounding the cathode, from which it is adequately spaced. In the anode block are eight holes, in the same axis as that of the cathode; the holes extend right through the drum, and on one side of each cylindrical hole a slot is cut which extends radially towards the cathode. The arrangement of holes and slots is termed a "cavity resonator."

The method of operation depends on the effect of an intense magnetic field from a permanent magnet on the field produced by an electric current, and also on the fact that the resonators will oscillate quite readily

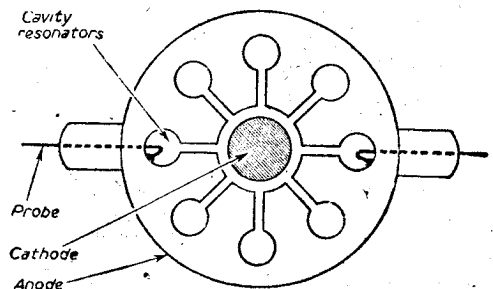

Fig. 1.—Section of a Magnetron construction.

at a frequency dependent on their physical dimensions, which can be altered by external mechanical means. Electrons, forming the current upon which the magnet will act, leave the cathode (held highly negative) en route to the earthed anode block. Some of these electrons will reach the anode region, and in doing so come under the influence of the permanent magnet which gives the tube its name. At this stage the path of the electron is bent away from the anode, and the electron follows a course which is the resultant of the two forces pulling on it. In addition, the electron has to contend with an oscillating field due to the R.F. energy in the cavity of the resonator. Two things can now happen to the electron: (a) it may arrive out of phase to assist the oscillations, in which case it is immediately swung back by the magnet to the cathode, or (b) it may swing into step with the oscillations in such a way as to part with its energy in assisting them, before coming to rest on the anode.

In this tube lay the first solutions to many of the difficulties found with the negative-grid tube. Anode/cathode potential could be quite high, since anode/cathode spacing had little or nothing to do with frequency of oscillation. In the negative-grid valve, the spacing affected transit-time, and as a result the frequency obtainable. The Magnetron cathode could be as large as was considered necessary, since here also size did not affect frequency. Greater emission was there for the asking—and with it greater power. In this respect a pleasant surprise lay in store for the research engineers; it was found that the heater current could be cut off once the tube had started operation, but cathode current continued because of the secondary emission, due to the heating of the cathode, by the repelled electrons.

The tube is relatively easy to cool compared to lower-frequency tubes of the same power capabilities, and it has proved reliable in operation. The wavelength obtainable can be as low as 0.5 cm/s., as was more or less expected. What was rather unexpected was the enormous power realised from the Magnetron, a typical experimental result being 5 mega-watts at 10 cm/s., and efficiencies in the region of 70 per cent.

The Magnetron, splendid performer as it was and still is, has proved to be only the forerunner of several other "cavity"-type tubes, prominent among them being the "Klystron."

### The Klystron

Difficulties in tuning arrangements, the liability to sudden change in oscillation mode of the Magnetron, and the need for heavy magnets, are perhaps the main reasons underlying the introduction of the Klystron. Here again magnetic fields can play a part in the functioning of the tube, but only to assist in focusing the electron stream passing through the valve. The general arrangement of a Klystron takes the form as shown in Fig. 2.

A cathode, the emission from which is prefocused by an electrostatic shield, is placed in alignment with a "cavity resonator," a form of hollow cylinder containing two gaps through which the cathode stream must pass. This resonator is termed the "buncher." The electrons in their travel now pass into the "drift-tube" and finally enter a second cavity resonator, referred to as the "catcher."

The operation of the tube is somewhat as follows: Electrons leaving the heated cathode are prefocused at the shield, and in some cases further focused

magnetically, resulting in a very sharp beam. The electrons now pass into the buncher through the first aperture. Between the first and second apertures of the buncher is the U.H.F. oscillatory field, and its effect is to retard or speed up the incoming electrons depending on the instant of their arrival as related to the phase of oscillation.

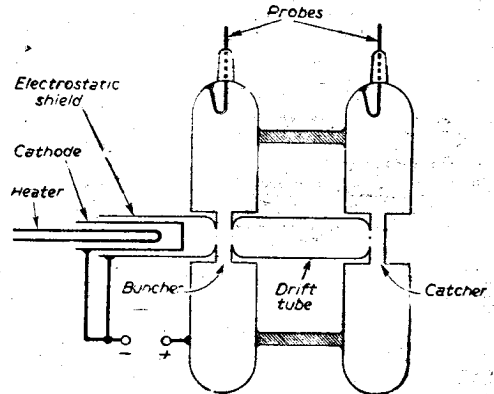

Fig. 2.—A typical Klystron arrangement.

The usual method of appraising the bunching action is to consider an electron—the "idle" electron—which arrives at an instant when the R.F. field neither assists nor opposes its transit. The idle electron will move across the gap, out of the second aperture and into the drift-tube at a speed dependent on the pull of the catcher. If now a second electron arrives at an instant when the polarity of the field assists the catcher, then that electron is hurried along and will overtake the idle electron somewhere in the drift-tube; the two electrons will then proceed together along its length.

Considering a third electron which arrives at an instant of retarding polarity it will be slowed down and eventually overtaken by the next electron which is now, at the completion of the R.F. alternation, an idle electron moving under catcher influence only.

There is, therefore, a tendency for the electrons leaving the first resonator to crowd together in groups, or bunches; thus the term "buncher." By the time the electrons have "drifted" to the far end of the drift-tube the bunching is very pronounced, and they now emerge from the tube to pass through the single aperture into the catcher in sharp pulses, timed to assist the oscillations already existing there.

A very small power will cause the bunching and subsequent pulsing. In effect, because of the flick excitation at the resonator the Klystron can be considered as a Class C amplifier, and in common with Class C operation it is possible to tune the catcher to a harmonic of the input frequency. The Klystron has the advantage, however, of greater output at high harmonics perhaps not so readily developed in the negative-grid valve.

In common with the Magnetron the output can be taken from the Klystron by means of a probe, or into a waveguide designed for the operational frequency. For use as an oscillator the output is coupled back to the input by means of a short, internal loop, and under these conditions the tube is most useful at frequencies in the 3,000 Mc/s range.

SET OF VALVES

Ten VR91 (EF90) Valves, ex-brand new units, 6/- each, 45/- set. 6K8G, 6K7G, 6Q7G, 5Z4G, 6V9G, 37/6 set. 1R5, 1S5, 1T4, 1S4 or 3V4 or 354, 30/- set. 6K8G, 6K7G, 6Q7G, 25A6U, 25Z4G, 37/6 set. 12K8G, 12K7G, 12Q7G, 35Z4GT, 35L6GT, or 50L6GT, 37/6 set. Ten 6AM6 (EP91), 75/- set.

T.R.F. or SUPERHET

This Cabinet gives your radio a commercial finish.

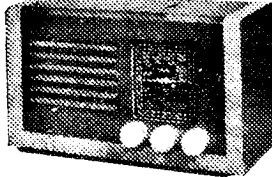

Complete with drilled chassis, dial drive and drum, backplate, spring, pointer. Size 11 1/2 in. x 7 in. x 6 in. Price 27/6 each.

Filament Transformers. All 230v. input.

6.3 v. 1.5 amps, 5 4 ea.; 2 v. 1 amp. 4 - ea.; 2 v. 3 amps, 7 4 ea.; 5 v. 2 amps, 9 - ea.; 6.3 v. 1 amp, 5 - ea.; 6.3 v. 3 amps, 9 - ea.; 12 v. 75 amps, 5 - ea.

Penode Output Transformers, by A.W.F., 4 - ea.; Multi Ratio type, 6 - ea.; 351 Type, 2 6 ea.; Goodman's, 4 9 ea.; Rola Midget, 3 9 ea.; Rola Type Standard, 3 9 ea.; 6V6 or 6L6 Push-Pull Transformers, 10-12 watts, 25 6 ea.

I.F. Transformers Special Order 465 Kcs IP's, 6 6 per pair. RAPT 455 Kcs, Standard, 12/- pair.

VALVES

Table listing various valve types and prices, including 5V4, 5V3GT, 6X5, 5Z4G, 6A7, 6A8G, 6A8GT, 6A7G, 6A6G, 6A5G, 6A4G, 6A3G, 6A2G, 6A1G, 6B4, 6B3, 6B2, 6B1, 6C6, 6C5, 6C4, 6C3, 6C2, 6C1, 6D6, 6D5, 6D4, 6D3, 6D2, 6D1, 6E6, 6E5, 6E4, 6E3, 6E2, 6E1, 6F6, 6F5, 6F4, 6F3, 6F2, 6F1, 6G6, 6G5, 6G4, 6G3, 6G2, 6G1, 6H6, 6H5, 6H4, 6H3, 6H2, 6H1, 6I6, 6I5, 6I4, 6I3, 6I2, 6I1, 6J6, 6J5, 6J4, 6J3, 6J2, 6J1, 6K6, 6K5, 6K4, 6K3, 6K2, 6K1, 6L6, 6L5, 6L4, 6L3, 6L2, 6L1, 6M6, 6M5, 6M4, 6M3, 6M2, 6M1, 6N6, 6N5, 6N4, 6N3, 6N2, 6N1, 6O6, 6O5, 6O4, 6O3, 6O2, 6O1, 6P6, 6P5, 6P4, 6P3, 6P2, 6P1, 6Q6, 6Q5, 6Q4, 6Q3, 6Q2, 6Q1, 6R6, 6R5, 6R4, 6R3, 6R2, 6R1, 6S6, 6S5, 6S4, 6S3, 6S2, 6S1, 6T6, 6T5, 6T4, 6T3, 6T2, 6T1, 6U6, 6U5, 6U4, 6U3, 6U2, 6U1, 6V6, 6V5, 6V4, 6V3, 6V2, 6V1, 6W6, 6W5, 6W4, 6W3, 6W2, 6W1, 6X6, 6X5, 6X4, 6X3, 6X2, 6X1, 6Y6, 6Y5, 6Y4, 6Y3, 6Y2, 6Y1, 6Z6, 6Z5, 6Z4, 6Z3, 6Z2, 6Z1.



VALVES AND COMPONENTS

PENCIL RECTIFIERS K255, 5 8; K249, 7 8; K245, 8 2; K250, 8 8; K260, 9 8; K2100, 14 8.

SENERCEL RECTIFIERS RMU, 3 9 ea.; RME, 4 2 ea.; RMB, 5 9 ea.; RMA, 16/- ea.

METAL RECTIFIERS 12 v. 4 amp., 1 6 ea.; 12 v. 1 amp., 4 6 ea.; 2 v. 1 amp., 3 - ea.; 250 v. 4 5 ma., 6 9 ea.; 250 v. 7 5 ma., 7 6 ea.; 200 v. 60 ma., 7 6 ea.

FULL WAVE TYPES 12 v. 1 amp., 4 9 ea.; 12 v. 2 amp., 8 - ea.; 12 v. 3 amp., 13 - ea.; 12 v. 5 amp., 18 - ea.

VCR 97 TUBES complete with Screen and Base, 29 9 ea. Carriage and Packing, 3 -.

Wire Wound Volume Controls 5K; 2000 Ohm, 1 000 Ohm, 2 000 Ohm; 5K Ohm; 10K Ohm; 20K Ohm; 25K Ohm; 50K Ohm; 100K Ohm.

Finish Your Receiver By Fitting Engraved Knobs This set for the spindles, available Cream or Ivory as follows: "Focus," "Contrast," "Brilliance," "Brightness," "Brilliance On Off," "Wave Changing," "On Off," "Tuning," "Volume," "S.M.L. Gram," "Tone," "Vol. On Off," "Radio-Gram," "Bass," "Trebble," "Record-Play." Price 1 6 each. Plain knobs to match, 1/- each.

GUARANTEED NEW AND BOXED

Table listing various electronic components and prices, including resistors, capacitors, and other parts.

Pre Type Co-axial Plug and Sockets, 8/d. per pair. 1 1/2 watt Resistors, all sizes. Latest types, 3d. ea. Loctal Valve Holders, Paxolin, 3/4 ea. 4 M.M. Sleiving, Black only, 4d. per yd. Rubber Grommets, ass'tl., 6d. per doz. Crystal Diodes, wire ends, 1 8 ea. Yaxley Switch, 1 pole 7-way, 1 8 ea.

GOODMANS 10in. LOUDSPEAKER 15 Ohm Speech Coil. Only a few at this price, 29 -.

Moulded Mica Condensers .01 mfd., .001 mfd., .002 mfd.; .003 mfd.; .005 mfd.; .0001 mfd.; .0002 mfd.; .0003 mfd.; .0001 mfd.; .0005 mfd.; .0008 mfd.; 29 pf.; 50 pf.; all 4/4d. ea.

SPECIAL OFFER CO-AXIAL CABLE Best quality grade "A" -cable solid 1 022 70 ohms, 7 1/2 yd. Best quality Grade "A" cable stranded 7 007 8, 8 1/2 yd. Best quality Grade "A" cable air spaced 1 038, 1 - yd.

TRUVOX MODEL S99 18in. Heavy Duty Speaker. Last available List Price approx. £11. 15/2 Speech Coil. 15 to 20 watts, 5 gms.

Ex-Government Volume Controls Available in the following sizes: 50K Ohm; 60K Ohm; 2K Ohm; 5K Ohm; 10K Ohm; 20K Ohm; 25K Ohm; 50K Ohm; 100K Ohm; 200K Ohm; 4 meg.; 4 meg.; 4 meg.; 2 meg.; all 12/6 ea.

RECEIVER I132A

Contains EK32, 4 EF39, 6H6, 6J5, 3 SP1, P61, in good condition. Fitted with tuning meter, slow-motion drive and dial. Complete, with Circuit Diagram, 47/6 each, carriage, etc., 7/6.

LOUDSPEAKERS

all 2 to 3 gms. Plessey 3in. round type for personal portables, 12 9 ea.; Elac 3 1/2in. square type, type 3 09, 13 6 ea.; Elac 4in. Speaker, square type, with 5in. fitting, 13 9 ea.; Elac 5in. round type 5/04, 12 3 ea.; Goodmans 3in. round type, 14 9 ea.; Goodmans 3 1/2in. round type, 13 6 ea.; Plessey 6 1/2in. round type, 12 6 ea.; Truvox 6 1/2in. Wafer Speaker 1 1/2in. deep, 20 - ea.; Plessey 8in. lightweight type, 15 - ea.; Plessey 10in. lightweight type, 19 5 ea.; Rola 4in. type Z101B, 28 - ea.; Electroson 10in., 18 6 ea.; Truvox 12in. type BX 11, 49 8 ea.

THE "SIMPLEX" SHOPPING LIST.

Table listing various electronic components and prices under the heading 'THE "SIMPLEX" SHOPPING LIST', including vision and sound sections, resistors, capacitors, and other parts.

TERMS: Cash with order or C.O.D. Postage to be added to orders as follows: 9d. up to 10/-; 1/- up to 20/-; 1/6 up to 40/-; 2/- up to £5. MAIL ORDER ONLY. Send 6d. in stamps for illustrated catalogue.

WHEN ORDERING PLEASE QUOTE "DEPT. P.T."

ALPHA RADIO SUPPLY CO. 5/6 VINCES CHAMBERS, VICTORIA SQUARE, LEEDS 1.

# CLYDESDALE

Bargains in Ex-Services Radio and Electronic Equipment

## INDICATOR UNIT TYPE 62A WITH EF50's

ASK FOR D/H808 **79/6** Each CARRIAGE PAID

## INDICATOR UNIT TYPE 62

ASK FOR D/H526 **£3.19.6** Each CARRIAGE PAID

## INDICATOR UNIT TYPE 62

ASK FOR D/E774 **49/6** Each CARRIAGE PAID

## INDICATOR UNIT TYPE 6

ASK FOR D/H524 **79/6** Each CARRIAGE PAID

## INDICATOR UNIT TYPE 305

ASK FOR D/H943 **£3.19.6** Each CARRIAGE PAID

## 5CP1 CATHODE RAY TUBE

ASK FOR D/H529 **19/6** Each CARRIAGE PAID

## INDICATOR UNIT TYPE 6H

ASK FOR D/E777 **89/6** Each CARRIAGE PAID

## REPRINTS FROM "PRACTICAL TELEVISION"

Components Price Lists Free on Request.  
 The "Beginner's Receiver" modifying the R3170A, April to July ... 1 6  
 The "Beginner's Timebase" ... 1 6  
 Economy Television, modifying Ind. 62 ... 1 6  
 Argus Television, data and blueprint ... 2 6

### BEGINNER'S T.V.

Mains Transformer ... 32/6 each  
 Smoothing Choke ... 15/6 each  
 Output Transformer ... 9/6 each  
 Crystal Diodes ... 5/3 each

### THE BEGINNER'S TIMEBASE

Mains Transformer ... 20/- each  
 E.H.T. Transformers ... 50- & 45/- each  
 Smoothing Choke ... 15/6 each

### POWER UNIT TYPE 285

Ready made for T.V.  
 A.C. Mains. Input 230 v. 50 c.p.s. Outputs  
 E.H.T. 2 K.v. 5 m.a. H.T. 350 v. 150 m.a.  
 L.T. 6.3 v. 10 a. and 6.3 v. 5 a. Fully smoothed  
 and rectified with valves VU120, 5U4G,  
 VR91 (1F50), plus cond., resistors, etc.  
 ASK FOR D/H947 **£4.19.6** Each CARRIAGE PAID

## ION TRAP MAGNET ASSEMBLY

Mfg. Surplus.  
 Type IT/6 by Elac for 35 mm. tube neck.  
 ASK FOR D/H919 **2/6** Each POST 3d. EXTRA

## I.F./A.F. AMPLIFIER UNIT R1355

In Transit Case.  
 With valves. I.F. frequency 7.5 mc/s. Dim.: 18 x 9 1/2 x 7 1/2 in. Used, good condition.  
 ASK FOR D/E70B **32/6** Each CARRIAGE PAID

## R.F. UNIT TYPE 24

In original carton.  
 Switched tuning 20-30 mc/s with valves, etc.  
 ASK FOR D/H500 **22/6** Each POST PAID

## R.F. UNIT TYPE 25

In original carton.  
 Switched tuning 40-50 mc/s with valves, etc.  
 ASK FOR D/H947 **22/6** Each POST PAID

## R.F. UNIT TYPE 27

With broken dial.  
 Variable tuning 65-85 mc/s., with valves, etc.  
 Used, good condition.  
 ASK FOR D/E771 **39/6** Each POST PAID

## RECEIVER UNIT R3601

ref. 10DB6037.  
 ASK FOR D/H493 **39/6** Each CARRIAGE PAID

Order direct from:

# CLYDESDALE SUPPLY CO. LTD.

2, BRIDGE ST., GLASGOW, C.5. Phone: SOUTH 2706/9  
 Visit our Branches in Scotland, England and Northern Ireland.

## DO YOU GET AN ANNOYING PATTERN ACROSS YOUR SCREEN?

If this is due to break-through by a nearby transmitting station, connect a LABGEAR ANTI-SWAMP FILTER to your set.

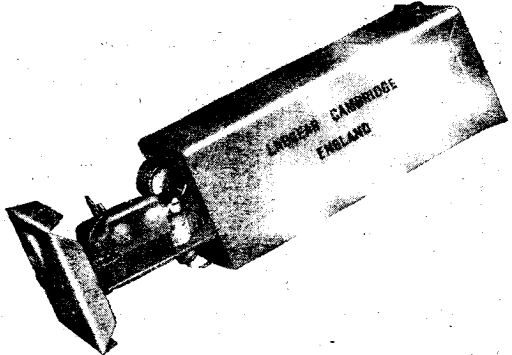

Makes an outstanding improvement against interference from transmitters on frequencies lower than the TV channels. One required for co-ax aerial feeders, two for balanced twin-lead. Price 10/6, plus 9d. P.P., only, direct from:

**Labgear (Cambridge) Ltd.**  
 WILLOW PLACE, CAMBRIDGE.  
 Tel. 2494—2 lines.

# ADCOLA

REGISTERED TRADE MARK  
 (Regd. Trade Mark)

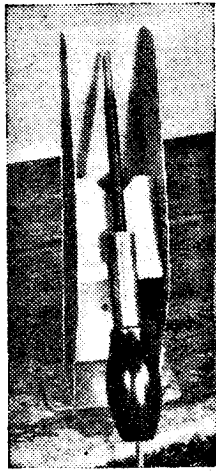

## SOLDERING INSTRUMENTS

FOR SUCCESSFUL HOME CONSTRUCTION AND ALL SOUND EQUIPMENT SOLDER JOINTING

"STANDARD MODEL," as ILLUSTRATED, 25/6  
 Any volt range supplied. 6/7 to 230/250.

3/16" dia. bit Standard Model  
 Equally suited to daily or intermittent use

Made in England  
 Registered Design  
 (British, U.S.A., Foreign, Patents)  
 Export Enquiries Invited

Shields as illustrated 10/6 extra.

WRITE DIRECT TO

**ADCOLA PRODUCTS LTD.**  
 Sales, Offices & Works: CRANMER COURT, CLAPHAM HIGH ST., LONDON, S.W.4. — MACaulay 4272

# TELEVISION ON TAPE

FIRST DETAILS OF SUCCESSFUL RECORDING OF BOTH MONOCHROME AND COLOUR TV

**R**ECORDING of television pictures on magnetic tape in colour and in black-and-white was publicly demonstrated for the first time in December by the Radio Corporation of America at its laboratories in New York in a preview of new techniques that will simplify the entire art of making pictures in motion.

Brig. General David Sarnoff, Chairman of the Board of RCA, said that this new method of recording sight is similar in basic respects to tape recording of sound. He described the achievement as the first major step into an era of "electronic photography," in which motion pictures in colour or black-and-white will be produced quickly and economically, without any photographic development or processing.

Two years ago, on the occasion of his 45th anniversary of service in radio, General Sarnoff asked the scientists and research men at the RCA Laboratories to give him three presents to mark his 50th anniversary in 1956. He asked for a video tape-recorder, an inexpensive electronic air-conditioner without moving parts, and a true amplifier of light. The recording demonstration represents their answer to his first request. Research is in process on the other two items as well.

"Magnetic tape recording of television programmes as shown," said General Sarnoff, "has great possibilities, first for television broadcasting and, later, for national defence, for the motion picture and theatre industry, for industry in general, for education, and for home entertainment.

"While this electronical video tape equipment is still in the developmental stage, the basic principles and principal elements of the system have been tested and confirmed. We are confident that it is only a matter of time, perhaps two years, before the finishing touches will bring the system to commercial reality.

"It is essential for the future of the television art that video tape recording be introduced to give the television industry a practical, low-cost solution to programme recording, immediate playback, and rapid distribution. Video tape will be important for black-and-white broadcasting; it will be essential in the creation of a full colour television service.

"According to our present estimates, the cost of recording a colour television programme on magnetic tape would be only five per cent. of what it would cost to put it on colour film, since the tape can be re-used."

## Advantages Over Film

General Sarnoff, declaring the development had far wider horizons than its immediate purpose in TV broadcasting, pointed out advantages of magnetic tape over ordinary film.

"Magnetic tape requires no chemical processing," he said. "The pictures can be viewed the instant they are taken, which adds new flexibility in making motion pictures. An unlimited number of copies of magnetic tape recordings can be made quickly. Recorded tapes can be preserved indefinitely for

historic reference, or, if desired, can be electronically 'wiped off' and re-used again and again.

"With further development of video tape techniques, numerous possibilities will open up. Small portable television cameras are already in wide use in industry, in stores, in banks, in schools and colleges. Low-cost television cameras that work like satellites off home television receivers are ultimately possible. Eventually, low-cost video tape equipment of simpler and more compact design than the studio-type equipment shown at this demonstration can be made available as attachments for these cameras.

"The all-electronic chain of portable television camera, video tape recorder and standard television receiver, would make a convenient and versatile system for making amateur as well as professional motion pictures. It will speed the preparation of newsreels and will be a useful tool for news reporters. The tape would not have to be sent away for processing with its attendant delays and extra costs. In the home, the tape equipment could be used for home movies or connected to the television set to make a personal recording of a favourite television programme."

## Highlights of Demonstration

In the demonstration, a colour television programme originating in National Broadcasting Company studios in Radio City, New York, was beamed by radio microwaves across the 45-mile span to RCA's David Sarnoff Research Centre at Princeton, New Jersey.

This programme was seen as it arrived. At the same instant, RCA's tape recording system recorded the television picture on a strip of magnetically coated plastic tape as thin as paper, and one-half inch in width. During part of this transmission, both the live programme from the microwave radio relay and an immediate play-back of the magnetic tape recording were shown.

As soon as the tape reel was rewound it was played back and the recorded television pictures appeared on two RCA colour television receivers which were viewed by a large group of press representatives who witnessed the demonstration.

The colour programme transmitted from New York originated in studio 3-H of NBC. It consisted of two dramatic presentations—one in a Victorian setting and the other a modern Christmas Eve scene in an American home. Featured in both was Margaret Hayes, motion picture and television actress. Production was under the direction of Herbert Swope, Jr., of NBC.

In the first part of the demonstration, previously recorded magnetic tapes were run through the equipment. This phase included the reproduction of both black-and-white television pictures and colour television pictures that had been beamed over the same New York to Princeton microwave link at an earlier date.

The same apparatus handled both the recording and play-back of the tape for both the colour and

black-and-white tests. This relatively compact experimental equipment was developed by a seven-man team of RCA research engineers consisting of Dr. Harry F. Olson and William D. Houghton, who head the development programme, and Maurice Artzt, J. T. Fischer, A. R. Morgan, J. G. Woodward and Joseph Zenel.

### Recording Methods Compared

Outlining the need for tape recording techniques, Dr. E. W. Engstrom, Vice President in Charge of RCA Laboratories Division, explained the complications involved in conventional kinescope recording of television pictures.

"When a television programme is recorded by kinescope (picture-tube) recording methods," he said, "the pictures pass from the television camera through most of the television system to be reproduced on a small picture tube. A special motion-picture camera then photographs the programme on motion-picture film. The film must be chemically processed and, usually, a print made before the pictures can be reproduced. The reproduction requires another installation in which a television camera tube picks up the scene from a motion picture projector for re-broadcast.

"The current kinescope recording process is a roundabout and costly approach," Dr. Engstrom said. "It is time-consuming, with film processing time running to several hours in most cases. And the quality may be limited, since the pictures must encounter all the hazards of both the television system and the photographic process.

"In going from the electrical signals of the camera to the signals for re-broadcast by a television transmitter, kinescope recording requires four separate intermediate pictures to be formed, two by television and two photographically. There is no fundamental need for these intermediate steps.

"Magnetic tape recording, in contrast, stores the electrical signals directly as they come from the television camera. No processing, electronic or photographic, is necessary before the tape is played back. A single compact piece of equipment, which handles both recording and reproduction, will do the job of two complex installations needed with photographic methods."

### Savings with Video Tape

Comparative estimates of operating costs (which include payroll, cost of tape or film and amortisation of equipment) are highly favourable to tape methods. Although magnetic tape to-day costs more per minute of programme time than 35 mm. colour film, the fact that tape needs no processing before play-back compensates for the expense of raw tape. Engineers pointed out that what makes the savings on tape so great is the fact that the programme can be electronically "wiped off" and the tape re-used; in most normal operations it would be re-used many times.

Recording black-and-white programmes on film is estimated to be at least five times as costly as it would be on  $\frac{1}{2}$  in. magnetic tape, assuming that the tape would be re-used many times. In making copies for distribution to television stations, a half-hour's programme could be taped for less than \$15 per copy, provided the tape is re-used many times. (These figures, of course, refer only to the cost of

producing the recorded tape, and not to the cost of the programme.)

Even greater economies are estimated for making the original *tape* recording of colour television programmes, which under normal operating circumstances, could be handled for only five per cent. of the cost entailed in colour *film* recording. In making copies on tape that is to be used over and over again, a tape recording of a half-hour colour programme would cost roughly \$20.

### How Video Tape Works

RCA's method of video recording is similar, in basic respects, to the techniques used to record speech and music with present-day magnetic tape sound equipment. Electrical signals are impressed through a recording head—a small horseshoe electro-magnet—on to the magnetically treated surface of a plastic tape. As the tape is drawn across the recording head, the head continuously changes the magnetic polarity of the magnetic oxide particles on the tape so that they become a compact code of the original signal.

For play-back, the tape is drawn across the same, or a similar head. The magnetic "shorthand" on the tape causes an alternating current to flow in the windings around the reproducing head. The reproduced current closely duplicates the original signal.

Although the principles are similar, the engineering problems are not; audio recording is to-day an easy task compared with video recording. The reason is that audio signals are in the range of 20 to 20,000 cycles per second; while video signals range up to 4,000,000 cycles per second. And colour television signals, as now formulated, must carry at least twice as much pictorial information as black-and-white. Besides, video tape must carry the associated sound signals.

Among technical video tape problems already solved by RCA, or approaching solution, are:

#### 1. High-frequency Recording Heads

RCA research has resulted in specially developed recording and reproducing heads which respond to frequencies many times above the cut-off point for the recording heads used in sound recording on magnetic tape. This means that the speed of the tape across the head has been brought within manageable limits. The equipment demonstrated had a tape speed of 30 feet per second. Advanced equipment now under construction will move the tape at a lower speed, and with time further reductions of tape speed appear likely.

#### 2. Size of Magnetic Tape Reels

The magnetic tape reels of the present laboratory equipment at the demonstration were 17 in. in diameter and recorded four minutes of a television programme. RCA is working now for a reel 19 in. in diameter which will carry a 15-minute programme.

#### 3. Electronic Amplifying and Equalising Circuits

Recording and reproducing amplifiers have been designed to handle the signal inputs and the signal outputs. These take into account and compensate for the characteristics of the heads and the magnetic tape materials when recording the very wide bands of frequencies used in television. Further development is 'in progress to obtain even better response characteristics.



**4. Constant Speed Tape Transport Mechanism**

Since even small variations in the speed of the tape and in the pressure at which it bears on the head can create noticeable effects in the picture, it has been necessary to devise precision apparatus to control accurately the speed of the tape at the recording and reproducing points. The laboratory video tape equipment controls these many times more accurately than is necessary in magnetic tape recorders for sound. Even greater precision in regulating speed and pressure appears possible through research which is now under way.

**5. Assignment of Tape Channels**

For video tape recording of colour television with the RCA system, five parallel channels are recorded on a single magnetic tape  $\frac{1}{4}$  in. in width. There is one recorded channel for each of the primary colour signals (red, green and blue), for the synchronising signal, and for the sound signal. For black-and-white

recording the tape carries two recorded channels, one for the video signal and the synchronising signal, and one for the sound signal. For black-and-white television, a  $\frac{1}{4}$  in. wide tape would suffice.

In the demonstration of colour television recording on magnetic tape, the five recorded channels were obtained from the output of a colour television receiver. In reproducing from the recordings the tape supplied the three primary colour signals direct to the three electron guns of an RCA tri-colour picture tube, the signals needed to synchronise the scanning, and the signal which carried the sound.

To re-broadcast a colour television programme from a tape recording as demonstrated, it is necessary to combine the three primary colour signals with the synchronising signal to form a composite signal to send to the transmitter. While this operation is not yet ready for demonstration, Dr. Engstrom said that it is the subject of current development that will provide the necessary apparatus to produce this result.

# Television Interference Suppression

## DETAILS OF CONSTRUCTION OF SOME SIMPLE SUPPRESSORS

By A. E. Lofting

**A**T TV frequencies electrical interference requires special apparatus for it to be eliminated. The usual capacitor suppressor is of little use at these frequencies, mainly because radiation occurs from the foil and leads of the capacitor. Inductors, too, must be carefully located for the same reason. For instance, they must usually be screened and connected as close as possible to the associated capacitor. But first, a word describing a special capacitor for this work and then its connection to the inductor.

A capacitor is required having very short leads and also screened in some way. Such a capacitor has been produced and is known as a "bushing-capacitor." The design is illustrated in Fig. 1. It consists of a tubular "Hi-K" (high dielectric constant) former, on which are two silver coatings. The outer coating is connected to the fixing thread, the inner is connected to the central current-carrying conductor. Thus, the interference on the conductor is suppressed as it flows into the capacitor and no radiation takes place. If this capacitor is mounted through a metal plate or box by means of its screw thread and nut, any interference on a conductor passing through it will be screened off. Also, an inductor can be connected to the capacitor lead on the screened side of the plate to provide a high

impedance to any residual interference present on the conductor. This residual interference could be radiated by the inductor turns, so a metal box is placed around the inductor. A simple suppressor using the above features is shown in Fig. 2.

**Commutators**

Apparatus using commutator motors, which produce T.V.I., such as hair dryers, sewing machine motors, etc., are sometimes difficult to suppress. This is mainly because the motors used have only a bakelite casing, and so interference is radiated even though a suppressor is fitted an inch or two from the motor. The reduction in interference by fitting a suppressor in close proximity to the motor is in many cases sufficient, but for the really powerful interferer the motor must be screened. This can be done with copper gauze formed into the required shape and soundly soldered along the joints, and connecting this screen to the earth lead of the apparatus. This screen will not look half so bad as it sounds, and if painted black can have a professional appearance. The most satisfactory method of connecting a suppressor to a screened motor is to fit the suppressor into a metal box, this box being within the screen of the motor.

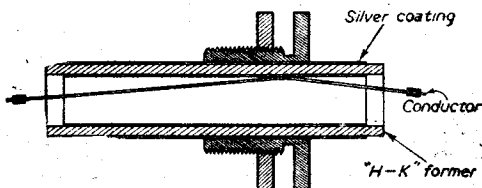
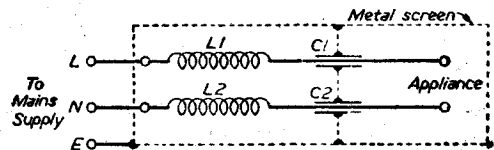

Fig. 1.—Details of construction of a "bushing capacitor."



C1 and C2 = 2000 pF (Bushing type)  
L1 and L2 =  $\frac{3}{8}$ " dia. by  $1\frac{1}{2}$ " long, 22 SWG, close wound, air core.

Fig. 2.—A simple suppression circuit.

**Portable Apparatus**

A suppressor to be fitted on portable apparatus, for instance, in the handle of a hair dryer, or in the actual lead of an electric hand-drill, must have very small dimensions. For these purposes a tuned suppressor is found to be satisfactory, particularly if the interference is concentrated on a narrow band of frequencies. Circuit and actual diagrams of this suppressor are shown in Fig. 3. One of these arrangements is placed in each of the power leads of the apparatus. The capacitor is of unique design,

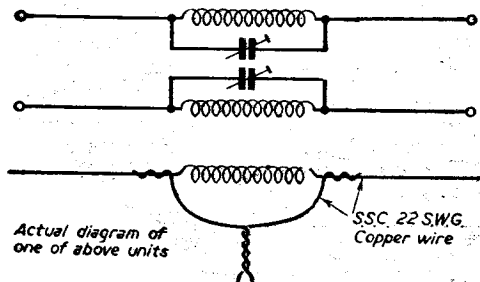

Fig. 3.—Circuit of a suppression unit with practical diagram.

consisting of two single silk-covered copper wires wound around each other. The value of capacitance is varied by twisting more, or fewer, turns together. The insertion loss at the resonant frequency of the suppressor is very high, about 80 db., but the frequency range is very narrow. Fig. 4 shows the insertion loss against frequency for a typical suppressor. Because of the narrow bandwidth it is difficult to tune to any required frequency without special apparatus.

**Typical Figures**

As a guide, Table 1 shows approximate resonant frequencies for values of "L" and "C" within the TV and H.F. broadcast bands. The exact frequency can be obtained by adjustment of the "capacitor," when the suppressor is *in situ*; this is to allow for cable lead properties. Due to the high selectivity the tuning up

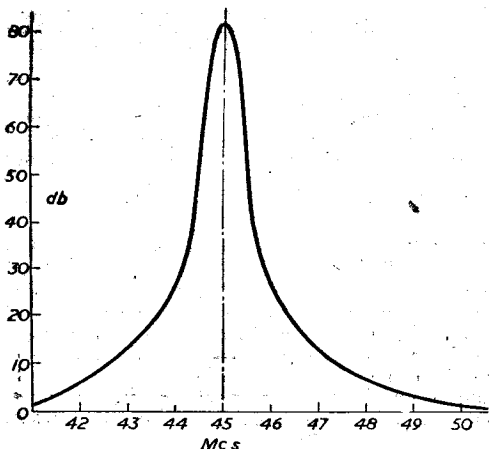

Fig. 4.—Curve of insertion loss plotted against frequency.

is critical and a "hit or miss" process, and a more practical suppressor is shown in Fig. 5.

The insertion loss, though not so high as for the tuned suppressor at its resonant frequency, is high and fairly constant over the frequency range 40-70 Mc/s., being between 38 and 46 db. Suitable capacitors are silvered mica or "Hi-K" ceramic dielectric types, providing they have an A.C. working voltage of 250 (i.e., can withstand a 2,250 volt D.C. charge for one minute). The inductors are self-supporting enamelled copper wire, the gauge depending on the current to be passed. The wire is first close wound over a rod of 0.1in. diameter for a length of 1/4 in., the former then being removed and the coil varnished. Both coils can be placed side by side if the windings are in the same direction, but a small air gap should be left between them. All components are small enough to be soldered together and supported by the wiring. For general small appliances a 1 amp. model is adequate, using 22 S.W.G. With hair dryers, which may require 2.5 amps., the wire should be 18 S.W.G. using a winding former of 0.125in. diameter.

**Interference Pick-up**

Interference can reach receivers by two methods, first by direct pick-up on an aerial, feeder cable or receiver chassis and, secondly, by the mains cable entering the set. A suppressor connected in the leads of an interfering appliance will prevent or

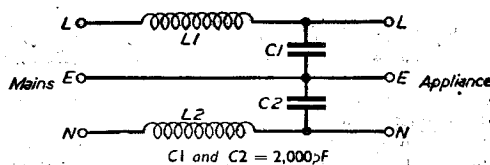

Fig. 5.—Circuit of a more practical suppressor. A table of turns for the coils is given on the right.

reduce the direct flow of interfering current into the cable, but the cable after suppression can pick up radiated interference and do as much harm as before. Therefore, screening of appliances is of prime importance and should be used wherever possible in conjunction with any of the above-mentioned suppressors. Here is a numerical résumé of the points to be considered, in this order:

Mc/s.	Turns
30	15
40	13
50	11
60	9.5
70	7.5
80	6
90	5
100	4

Coil, 1/4 in. mean diameter, on paxolin tube former, close wound 24 turns.

"Capacitor," each twist occupies 1/4 in. in length.

1. Screen, if possible, the appliance and connect this screen to a reliable short earth lead.
2. Place a suppressor as near as possible to the appliance, to the nearest inch! If it is not connected nearer than 10ft. from the appliance, it may just as well be left out for all the good it will do.
3. Use bushing capacitors in a suitable suppressor.
4. Where space is limited use a tuned or miniature suppressor.

## OUR FREE BLUEPRINT RECEIVER

## The "SIMPLEX"

Receiver

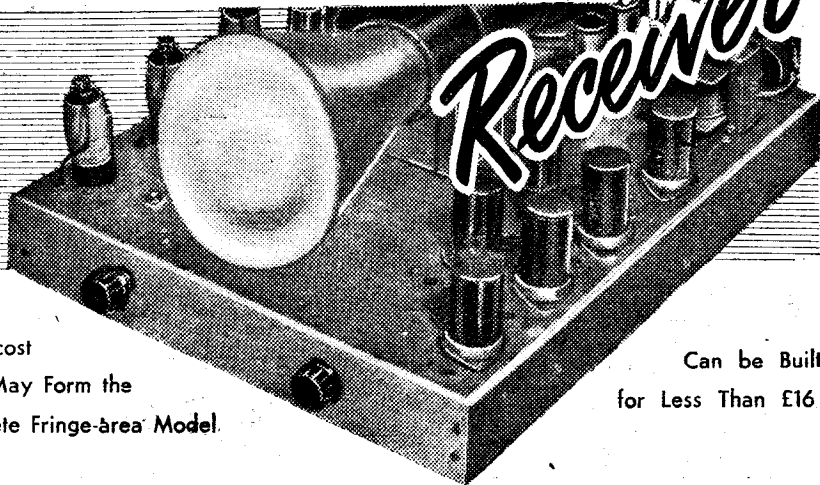

A 13-valve Low-cost Receiver Which May Form the Basis of a Complete Fringe-area Model.

Can be Built for Less Than £16!

**T**HERE is a constant and lively demand for constructional details of a television receiver which is low in cost and is easy to build. In order to meet the demand we have published, from time to time, details for the construction of inexpensive televisors. However, there is no doubt that many prefer to build from a blueprint—especially when undertaking this class of work for the first time, so this new design has been produced. It is inexpensive, easy to construct, and is backed by the service of our Free Advice Bureau.

The novice should be able to undertake its construction with every confidence.

#### Costs

It is not possible to gauge accurately the total sum required to build the televisor; market prices are inclined to vary from time to time. It can be said, however, that with prices current at the time of going to press it can be built for less than £16. This includes every item.

The use of good ex-Government parts such as valves, resistances, etc., is not barred. If the constructor wishes he can purchase an indicator unit such as those in the No. 6 series, to supply the C.R.T. and various components, but it is very important that if such a measure is adopted, all condensers should be thoroughly checked.

Another important point is that construction has been arranged in four stages, and the shopping list has been compiled so that components can be bought for each stage. The total cost is thus spread over the whole period of construction.

#### Special Features

In order to attain the low cost we have departed in some measure from the more orthodox design. Perhaps the most striking point is that no sound

output stage is included. Sound is tapped off from the vision section, amplified by one valve and then, after passing through the detector, is fed out of the televisor via a screened cable. The cable is intended to be connected to the pick-up sockets of a normal broadcast receiver.

By adopting this method, money is saved by excluding an audio amplifier, audio output stage, and a loudspeaker.

Some constructors may prefer to have the sound output stage built in and the design has been arranged so that there is room (and power) available for the inclusion of such a stage, if desired.

Another feature is that as the televisor has been designed to work primarily within the service area its range can be extended by the use of a pre-amplifier. Again there is room (and power) for the inclusion of a pre-amp.

The chassis has been made large and roomy. There is no difficulty in wiring up the components, and for servicing and preliminary tests the chassis will stand comfortably on its side so as to allow access to the components beneath.

Every component has been fitted where it can be got at easily.

No mains transformer has been used for E.H.T., a Cockroft-Walton multiplier taking its place.

A further important feature is that a long-term view has been taken in the design. Sooner or later the constructor's thoughts turn to the use of a larger C.R.T. The timebase and layout of the chassis has been so arranged that the conversion can be made easily, there being ample room for the new components and use being made of the existing timebase.

#### Circuit Description

The circuit is given on page 458. This can be termed the basic circuit as the constructor can add a

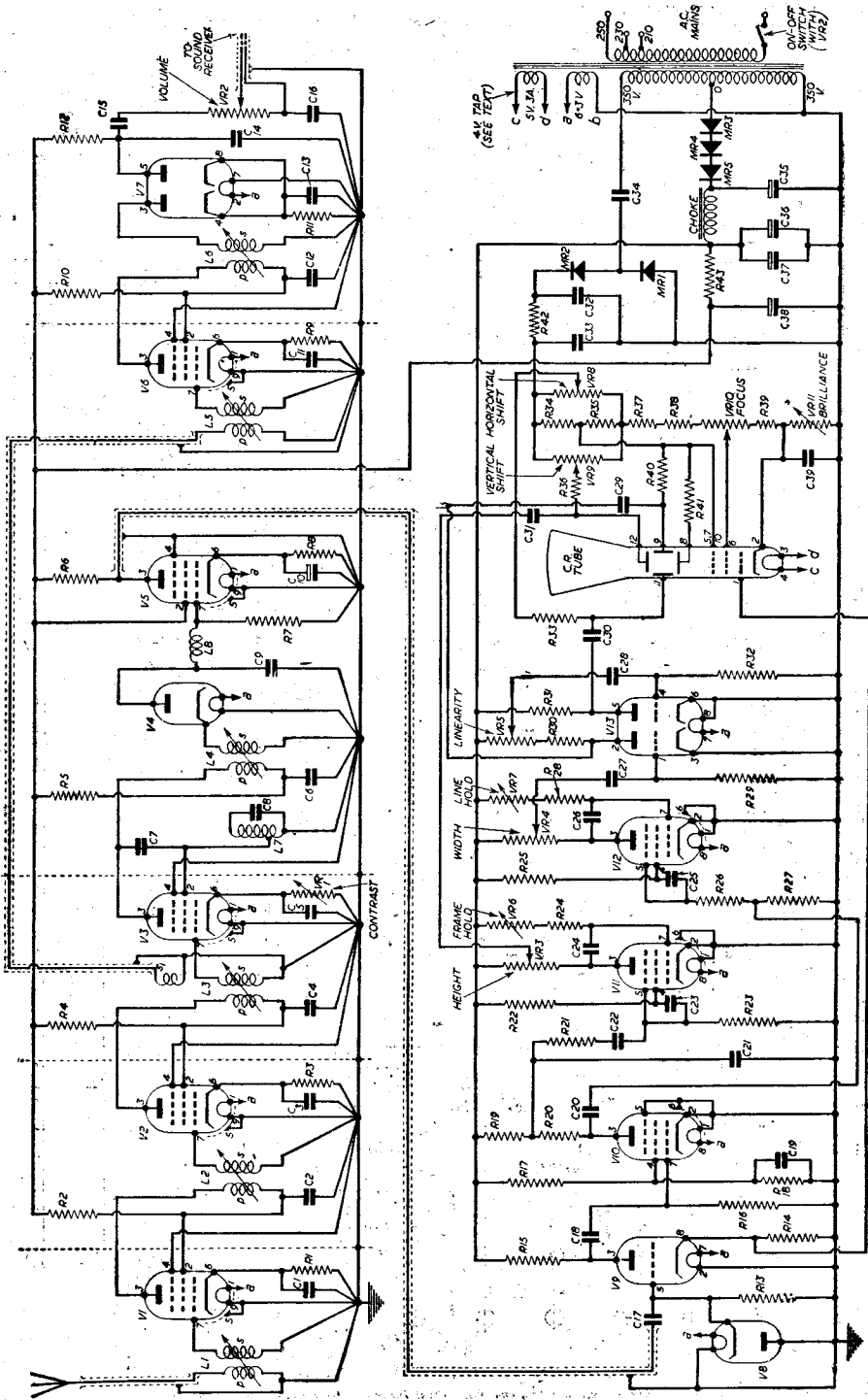

Valve types:— V1, V2, V3, V5, V6=VR91 (EF50); V4, V8=VR92 (E450); V7=VR54 (EB34); V9=6J5; V10, V11, V12=VR65 (SP61 or SP41 with 6.3v. heater); V13=6SN7; C.R. tube=VCR97 or VCR517.

Fig. 1.—Theoretical circuit of the "Simplex" receiver in its simplest form. A blueprint showing the layout and wiring is included free with every copy of this issue.

power output stage and/or pre-amp if he desires. Details of these will be given later.

The vision receiver comprises three R.F. stages; straight-forward R.F. amplification is used and maximum gain and stability is obtained by common earthing points and the close coupling arrangements of the R.F. coils.

The gain of V3 is made variable by VR1 in the cathode circuit and this forms the contrast control. Its operation does not affect the sound volume.

A sound rejector is incorporated in the anode of V3 and provides adequate sound rejection on the vision in conjunction with the sound coupling coil on L3.

The detector is arranged with a negative-going

output. The bias on V5 (the video valve) is, therefore, very light and the scheme automatically limits spots caused by car ignition interference, removing the need for a spot limiter.

In order to obtain maximum gain from the circuit the cathode resistor of the video valve has been decoupled with a 25μF condenser. It was considered that the extra gain was more valuable than a possible increase in quality by using a smaller condenser, as the circuit allows a very pleasing picture to be obtained with a narrower bandwidth than is used with larger tubes.

The output from the video valve is taken directly to the input of the timebase via the coupling condenser C17.

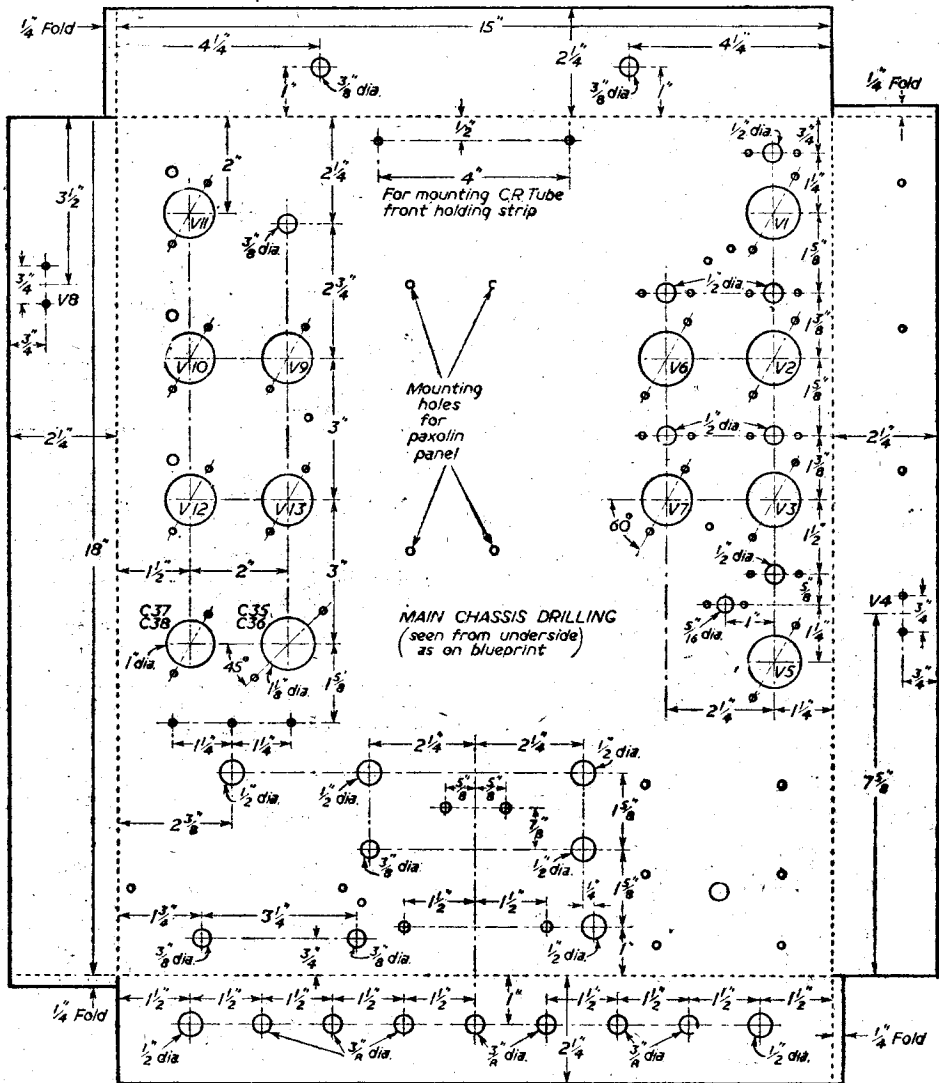

Note: - V7, V9 to V13 apertures are 1/16 dia. for octal bases. V1 to V3, V5, V6 apertures are 1/8 dia for B9G bases. All small holes for securing components are 1/8 dia.

Fig. 3. — Details of chassis construction.

### The Sound Section

Sound is taken from L3 by the coupling coil and is fed to the sound R.F. amplifier V6. Detection is accomplished at the double diode valve V7, the second half of this valve serving as a noise limiter.

Audio output is taken from this point through the volume control VR2. It should be noted that this control has been isolated from the chassis so that the sound output can be safely linked to an A.C./D.C. type of broadcast receiver.

A single-pole on/off switch has been incorporated with the volume control.

### The Timebase

The timebase is coupled to the vision receiver via the condenser C17. D.C. restoration is effected by the diode valve V8 and the signal is then fed into the phase-splitter V9.

Picture signals are taken from the cathode of V9 to feed the grid of the C.R.T., while signals of opposite polarity are taken from the anode to feed the sync separator V10.

Note that V9 can be any triode or pentode strapped as a triode provided its heater current does not exceed 0.3 amps. at 6.3 volts.

V10 is the sync separator valve and its cathode is taken directly to earth; thus the D.C. level of the signal is retained automatically.

Frame sync pulses are taken from the anode load resistor R19 and are then fed via an integrating circuit to the frame oscillator V11.

Line sync pulses are taken from the anode load resistor R20 and fed via a differentiating circuit to the line oscillator V12.

The frame oscillator is a standard Miller Integrator circuit and its output is taken via the coupling condenser C31 to the horizontal deflecting plate of the C.R.T. The frequency of the oscillation is made variable by VR6 which locks the raster to the sync pulse; the control is labelled "Frame Hold."

Control over the amplitude of the output is obtained by VR3 and this is labelled the "Height Control."

V12 is the line oscillator which functions in a similar manner to V11. The frequency is varied by VR7 (Line Hold) and amplitude by VR4 (Width). Note that this control works in conjunction

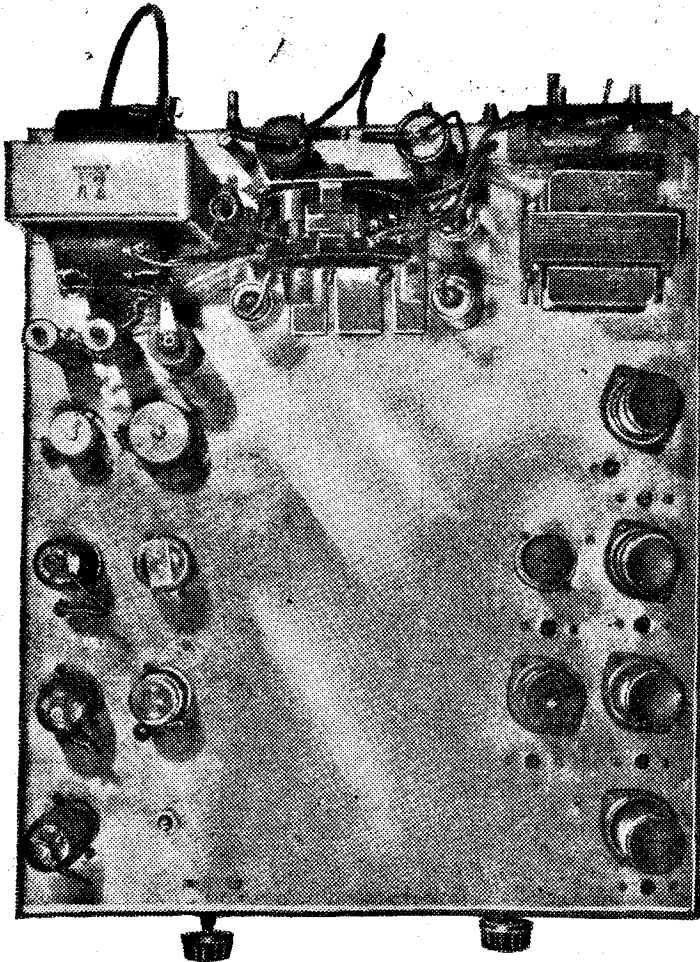

Plan view of the chassis showing the spare space allowed for sound or pre-amplifier stages.

**A Full-size Blueprint  
Adaptable Receiver is  
every Copy of**

with VR5 (Linearity) to obtain correct proportions in the width of the picture.

V13 is the line amplifier. The first half of the valve is fed directly from the line oscillator and the second from a small portion of the output of the first valve. Each anode will therefore have voltage outputs in opposite phase to feed opposite deflector plates via C29, 30.

Note that with this timebase, locking to the sync is very good especially in the case of the line circuit, the setting of the line hold control being not over-critical.

### Power Supply

Half-wave rectification has been used to supply H.T., and this method has allowed the other half of the 350-0-350 winding to be utilised for E.H.T. At the same time, employment of metal rectifiers has enabled the winding provided for the rectifier heater to be made available for the C.R.T.

Extra smoothing of the H.T. is provided by the use of large

capacity condensers and their rating quoted as 450 volt. working must be adhered to.

Between the top end of the H.T. winding and earth we now have 700 volts; this is multiplied by MR1, MR2, C34 to just under 1,500 volts for E.H.T. Smoothing is accomplished by R42 and C33.

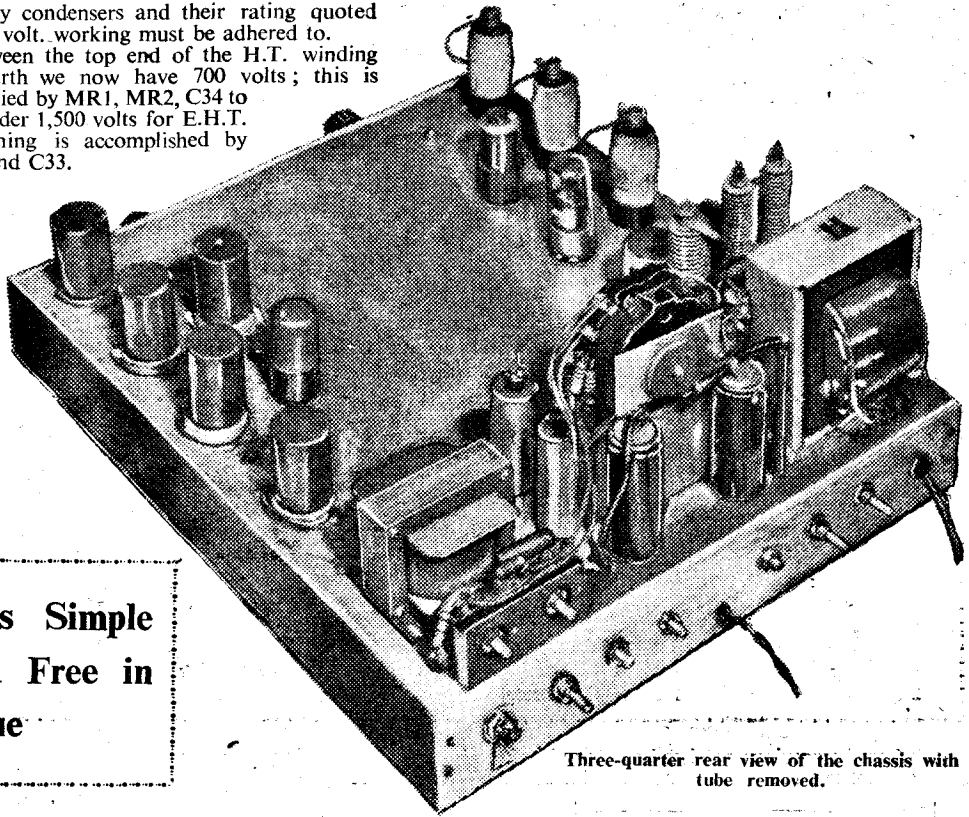

Three-quarter rear view of the chassis with tube removed.

of this Simple  
included Free in  
this Issue

E.H.T. is fed to the C.R.T. via the bleeder network R34, 35, 37, VR10 (Focus), R39, VR11 (Brilliance), and bias for the deflector plates has been obtained from the high potential end of the network. One horizontal plate and one vertical plate has variable bias to enable the raster to be correctly centralised;

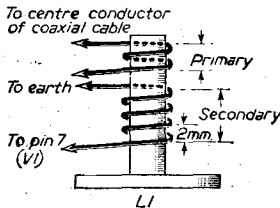

L1 and L6 wound similarly

Primary, 22 SWG. (approx.) insulated wire close wound. Secondary, 22 SWG (approx.) bare wire turns spaced 2mm.

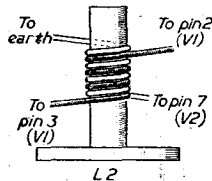

L3 and L4 wound similarly

Both windings 28 SWG (approx.) enamelled and silk covered. Adjacent turns must touch.

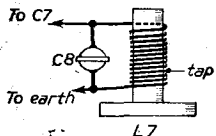

28 SWG enamelled and silk covered wire, close wound.

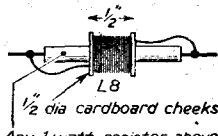

Any 1 watt resistor above 10KΩ (See text.)

Fig. 2.—Details of the coils.

COIL WINDING DATA

Coil	Channel	Channel				
		1	2	3	4	5
L1	Primary ...	2	2	2	1½	1½
	Secondary ...	8	7	6	5	4
L2	Primary ...	8	7	6	5	4
	Secondary ...	8	7	6	5	4
L3	Primary ...	8	7	6	5	4
	Secondary ...	8	7	6	5	4
L3	Sound Coupling Coil	2	2	2	1½	1½
L4	Primary ...	8	7	6	5	4
	Secondary ...	8	7	6	5	4
L5	Primary ...	2	2	2	1½	1½
	Secondary ...	10	9	8	7	6
L6	Primary ...	2	2	2	2	2
	Secondary ...	10	9	8	7	6
L7	(not necessary for Alexandra Palace)	12	11	10	9	8

this is done by VR8 and VR9 which are therefore labelled the "Shift Controls."

One important point to note is that the C.R.T. requires a voltage of 4 volts for its heater. The transformer specification gives the voltage of the winding as 5 volts. At the time of the design there was no transformer on the market giving the necessary voltages though quite a number of different makes supply the 5 volt.

It is a very simple matter to alter the 5 volt winding to give 4 volt, and full instructions will be given later.

**Staging Construction**

Construction is completed in four stages. It is possible to purchase the components for the next

It is very important that the wiring is carried out really efficiently. It is not good enough to use solder to hold wires together; each wire should make firm metallic contact with its tag and the solder used afterwards merely to seal the joint and keep out air.

It is also very important to solder each tag as the work on that tag is completed to avoid leaving "dry" joints.

Keep all wiring short and direct, and in the vision and sound stages wire the components as close to the valve pins as possible.

Use 22 S.W.G. wire and employ wire with various type of colour insulation. This enables checking to be made quite easily.

**STAGE 1—VISION AND SOUND SECTION—LIST OF COMPONENTS**

- |  |  |
|--|--|
| <b>Valves :</b>                                    | 1 25 $\mu$ F 25 v.                               |
| 5 EF50   | (All 350 v. wkg. unless stated otherwise.)       |
| 1 EA50   | <b>Potentiometers :</b>                          |
| 1 EB34 (6H6)                                       | 1 25 K $\Omega$ carbon                           |
| <b>Resistors (<math>\frac{1}{2}</math> watt) :</b> | 1 2 M $\Omega$ carbon with S/P switch            |
| 7 4.7 K $\Omega$                                   | <b>Coil Forms :</b>                              |
| 3 220 ohms   | 6 Alladin $\frac{3}{8}$ in. with iron dust cores |
| 1 68 ohms  | 1 Alladin $\frac{1}{2}$ in. with iron dust cores |
| 1 2 M $\Omega$                                     | <b>Valveholders :</b>                            |
| <b>Condensers :</b>                                | 5 B9G  |
| 8 500 pF   | 1 EA50   |
| 1 5 pF   | 1 International octal                            |
| 2 15 pF  |  |
| 1 25 pF  |  |
| 1 0.001 $\mu$ F                                    |  |
| 2 0.1 $\mu$ F                                      |  |

- Sundries :**
- 1 Pye aerial socket and plug
  - 1 chassis, 15in. by 18in. by 2 $\frac{1}{2}$ in. (or aluminium sheet to make—see text)
  - 5 aluminium screens (see text)
  - 2 knobs
  - 1 yd. 80 ohm coaxial, 2 yds. twin screened cable
  - 7 yds. 28 S.W.G. enamel- and silk-covered wire
  - Bolts and nuts, 6 B.A. and 4 B.A.
  - 7 two-point and 1 three-point tag strips
  - 22 S.W.G. wire coloured insulation for wiring
  - Multicore solder
  - 6  $\frac{1}{2}$  in. and 6  $\frac{1}{2}$  in. rubber grommets
  - 8 soldering tags for 4 B.A. bolts

stage when the previous one has been completed, and thus the cost can be spread over a period if desired.

Before starting the work on each stage check that all the components for that stage are to hand.

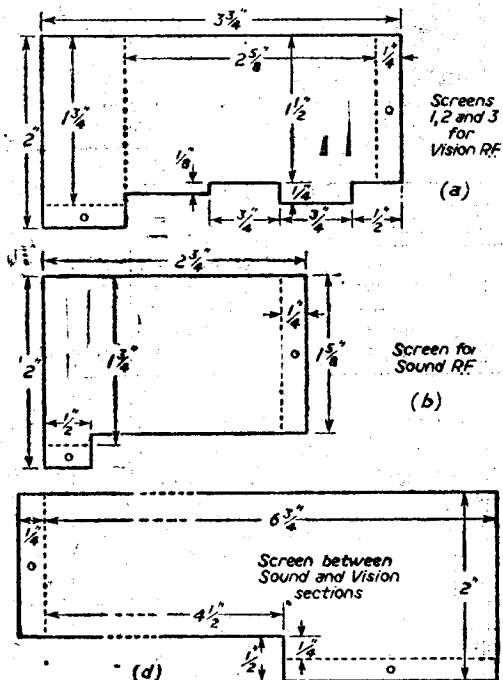

Fig. 4. — Details of chassis screens and tube support.

**STAGE I**

**Making the Chassis**

The chassis is made from 22 S.W.G. aluminium sheet. Fig. 2 gives the dimensions together with the positions of the valveholders and the more important holes. The smaller bolt holes can be marked out as the work proceeds, using the valveholder, etc., as a template.

(To be continued)

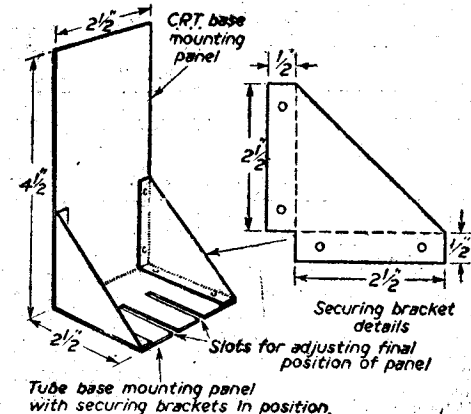



**MAINS MIDGET RADIO**



This is an excellent little radio in an attractive cabinet to which can be affixed transmitters, thus making it extra suitable for nursery or child's bedroom. The circuit is a T.R.F. for A.C. mains operation. All the parts—bakelite cabinet, valves, knobs, back—in fact, everything, will cost you only £3.15, plus 2/6 postage. Constructors' data free with the parts, or available separately at 1/6.

**MULTI-METER KIT**

The Multi-meter illustrated measures D.C. volts, D.C. m-Amps and ohms. It has a sensitivity of 200 ohms per volt and is equally suitable for the keen experimenter, service engineer or student. All the essential parts, including 21n. moving-coil meter, selected resistors, wire for shunts, 8-point range selector calibrated scale, stick-on range indicator and full instructions for making, are available at a kit price 15/-, plus 9d. post and packing.

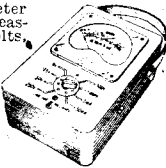

**MAKE A RADIO**

Using our parts in one evening you can make an all-mains 4 valve radio with bakelite case then you will be giving a £12 present which costs you only £6.1.6, or £3.2.0 deposit and 12 monthly payments of 11/6. (Carriage and insurance 6/-)



**THE SUPERIOR 15in.**

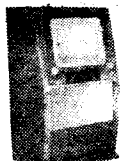

Up to the minute. Big Picture TV for only £37 10/0. A 20-valve television for the amateur constructor, all components, valves and 15in. Cossor Cathode Ray Tube cost £37.10 plus £1 carriage and insurance or £12.10 deposit and 12 monthly payments of £2.11/6. Constructor's envelope giving full details and blueprint 7/6. Returnable within 14 days if you think you cannot make the set.



**CHASSIS ASSEMBLY**

3 colour, 3 waveband scale covering standard Long, Medium, and short wavebands, scale pan, chassis punched for standard 5 valve superhet, pulley driving head, springs, etc., to suit. Scale size 14in. x 9 1/2in. Chassis size, 15in. x 5in. x 2in. deep. Price 15/-, plus 1/6 post. Note: This is the one that fits our 37/6 table cabinet.

**HUGE NEW PURCHASE**



We have purchased another large quantity of the Collaro Auto Record Changer, type R. C. 3/521, three speed suitable for all types of records and with the latest type crystal pick ups.

Buy one this month as you will not be able to again at this special price of 11 gns., plus 7/6 carriage and insurance. H.P. Terms £4 deposit and balance over 12 months.

**L. M & S. SUPERHET RADIO** by Beethoven

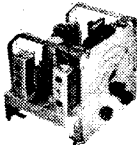

Chassis size approx. 9 1/2in. x 7 1/2in. x 8 1/2in. Fully aligned and tested—110-240 volt A.C. mains operation. Large, clear edge—1 1/2 dial. Three wavebands. Complete with five Mullard valves and Rola loudspeaker ready to operate. Special cash-with-order price this month £9.17.6 carriage and insurance 7/6. H.P. terms. £3 deposit balance over 12 months.

**THE SIMPLEX for £5 deposit**

Constructors' Price send for detailed Price List. H.P. Terms available. Deposit £5. Balance over 12 months.

**THE ELPREQ NOBLEMAN**

A 70 Gn.

**RADIOGRAM**

direct from makers

for only

**40 Gns.**

or £14 deposit

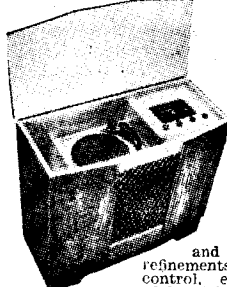

A beautiful piece of furniture, yet a most up-to-date radiogram—figured walnut lined sycamore—radio raised to comfortable level—compartment for records—5-valve AC mains superhet, covers long, medium and short waves—all latest refinements, negative feedback, tone control, etc.—large multi-coloured edglet dial—latest Collaro three-speed auto-hanger with the famous "Studio" pick-up—plays all types of records perfectly.

Don't miss this offer. Write or call to any depot to-day.

**A NEW DELIVERY**

**THE LAST FEW**

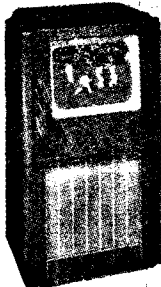

The Cabinet is suitable for television using tube sizes varying from 12in. to 17in., its overall dimensions being 3ft. 5in. high, 1ft. 4in. deep, 1ft. 10in. wide. It is complete with plywood back and "Bowler Hat." Originally made for a very expensive television and really good quality. Unrepeatable. Offered at £7.5 carriage, packing, etc., 12/6. Note: These are cut for 12in. tubes, but the holes for the controls are not drilled.

**ELECTRONIC PRECISION EQUIPMENT, LTD.**

Post orders should be addressed to:—**ELPREQ HOUSE (Ref. 14), HIGH STREET, WEALDSTONE, MIDDX.**

Personal shoppers however must call at:—**42-46, WINDMILL HILL, RUISLIP, MIDDX.** Phone: RUISLIP 5780. Half-day Wednesday. **152.153, FLEET STREET, E.C.A.** Phone: CENTRAL 2833. Half-day, Saturday. **28, STROUD GREEN ROAD, FINSBURY PARK.** Half-day, Thursday.

**226 FLUORESCENT LIGHTING**  
40 WATT

Complete kit comprises Hi-craft 40 watts control unit, starter lamp, lamp holders, clips and wiring diagram. Price less tube 22/6, plus 1/6 post. With tube 30/- carriage and insurance 3/6. Tubes 7/6 each, carriage free, minimum quantity 6 tubes.

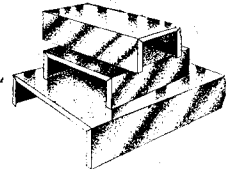

**BLANK CHASSIS**  
18 S.W.G. Aluminium

7 x 3 1/2 x 2	3/9
9 1/2 x 4 1/2 x 2 1/2	5/-
10 x 8 x 2 1/2	5/6
10 x 5 1/2 x 2 1/2	5/6
10 x 9 x 3	7/-
12 x 9 x 2 1/2	7/6
14 x 9 x 2 1/2	7/6
14 x 10 x 3	7/9
16 x 10 x 3	8/3
16 x 8 x 3	7/9
11 1/2 x 10 x 3	7/6
16 x 12 x 3	8/8
19 1/2 x 9 x 2 1/2	8/3
20 x 10 x 3	10/-
21 1/2 x 9 1/2 x 2 1/2	10/6

**GREATLY REDUCED CATHODE RAY TUBES**

**VCR97.** Brand new and unused, ideal for 'scope, etc. Price 12/6. Carriage and insurance 5/- extra.

**VCR517.** 6in. guaranteed full picture. 20/6 plus 5/- carriage and insurance.

**VCR139A.** 2 1/2in., 32/6 big quantities, and white.

**VCR138.** 3 1/2in. electrostatic short persistence, suitable for T.V. and ideal for 'scope work, 37/6 plus 3/6 carriage.

**VCR112.** 5in. electrostatic, persistence not known, 15/- each plus 5/- carriage, etc.

**CV996.** 6in. electrostatic, persistence not known, 15/- each plus 5/- carriage, etc.

**CV1140, CV1590, CV1546.** All 12in. magnetic long persistence £4/10/- plus 10/- carriage.

**SERVICE DATA**

100 service sheets, covering British receivers which have been sold in big quantities, and which every service engineer is ultimately bound to meet. The following makers are included: Aerodyne, Alba, Bush, Cossor, Ekco, Ever-Ready, Ferguson, Ferranti, G.E.C., H.M.V., Kolster, Brandaes, Lissen, McMichael, Marconi, Mullard, Murphy, Philco, Phillips, Pye, Ultra. Undoubtedly a mine of information invaluable to all who earn their living from radio servicing. Price £1 for the complete folder.

Our folder No. 2 consists of 100 data sheets covering most of the popular American T.R.F. and superhet receivers "all dry" etc. which have been imported into this country. Names include Sparton, Emmerson, Admiral, Crossley, R.C.A. Victor, etc. Each sheet gives circuit diagrams and component values, alignment procedure, etc., etc. Price for the folder of 100 sheets is £1. Post free.

# RADIO SUPPLY CO. (LEEDS) LTD.

Dept. N.,  
32, THE CALLS, LEEDS, 2.

Post Terms C.W.O. or C.O.D. No C.O.D. under £1. Postage 1/1 charged on orders up to £1; from £1 to £3 add 1/9; over £3 post free. Open to callers 9 a.m. to 5.30 p.m. 5a.s. until 1 p.m. S.A.E. with enquiries, please. Full list 5d.; Trade List, 5d.

## R.S.C. MAINS TRANSFORMERS (GUARANTEED)

Interleaved and Impregnated. Primaries 200-230-250 v 50 c/s Screened.

TOP SHROUDED, DROP THROUGH	SMOOTHING CHOKES
250-0-250 70 ma, 6.3 v 2.5 a ... 12 11	250 ma 7-10 h 200 ohms, Fully Shrouded 16 9
260-0-260 70 ma, 6.3 v 2 a, 5 v 2 a ... 14 11	250 ma 3 h 100 ohms ... 11 9
350-0-350 80 ma, 6.3 v 3 a, 4 v 2.5 a ... 15 11	100 ma 10 h 375 ohms ... 7 9
350-0-350 80 ma, 6.3 v 2 a, 5 v 2 a ... 17 6	30 ma 10 h 400 ohms ... 5 11
350-0-350 100 ma, 6.3 v 4 a, 5 v 3 a ... 23 11	60 ma 10 h 400 ohms ... 4 11
350-0-350 100 ma, 6.3 v 4 a, 5 v 3 a ... 23 11	50 ma 40 h 1,800 ohms Potted ... 8 11
350-0-350 150 ma, 6.3 v 4 a, 5 v 3 a ... 29 11	
350-0-350 150 ma, 6.3 v 2 a, 6.3 v 2 a, 5 v 3 a ... 29 11	

FULLY SHROUDED UPRIGHT

250-0-250 v 60 ma, 6.3 v 2 a, 5 v 2 a, 5 v 3 a ... 16 9	Standard Pentode, 5,000 to 3 ohms... 4 9
250-0-250 v 100 ma, 6.3 v 4 a, 5 v 3 a ... 25 9	Standard Pentode, 7,000 to 3 ohms... 4 9
250-0-250 v 100 ma, 6.3 v 6 a, 5 v 3 a, for R1338 Conversion ... 28 9	Push-Pull 10-12 watts to match, 6V6 etc., to 3-5 or 15 ohms ... 16 9
300-0-300 v 100 ma, 6.3 v 4 a, 5 v 3 a ... 25 9	Push-Pull 15 watts to match 6L6 etc., to 3 or 15 ohms Speaker ... 22 9
350-0-350 v 70 ma, 6.3 v 2 a, 5 v 2 a ... 18 9	<b>BATTERY SET CONVERTER KIT</b>
350-0-350 v 100 ma, 6.3 v 4 a, 5 v 3 a ... 25 9	All parts for converting any type of Battery Receiver to A.C. mains 200-250 v 50 c/s. Supplied 120 v 90 v or 60 v at 40 ma, fully smoothed and fully smoothed L.T. of 2 v at 0.4 to 1 a. Price, including circuit, 48 9. Or ready for use, 7 9 extra.
350-0-350 v 150 ma, 6.3 v 4 a, 5 v 3 a ... 33 9	<b>BATTERY CHARGER KITS.</b> —For mains input, 200-250 v 50 c/s. To charge 6 v Acc. at 2 amp, 26 9; to charge 6 v or 12 v Acc. at 2 amps, 31 9; to charge 6 v or 12 v Acc. at 4 amps, 49 9. Above consist of transformer, F.W. Rectifier, Fuse, Fuseholder, Steel Case and Circuit. Or ready for use, 6 9 extra.
350-0-350 v 250 ma, 6.3 v 6 a, 4 v 8 a, 0.6 to 2 a, 4 v 3 a, for Electronic Engineering Televisor ... 67 6	<b>ALL DRY RECEIVER BATTERY SUPERSEDER KIT.</b> —All parts for the construction of a unit (housed in metal case 5-4-1/2 in.) to supply 90 v 10 ma, and 1.5 v 250 ma. Fully smoothed. From 200-250 v 50 c/s mains. For 4-valve receivers. Price inc. point-to-point wiring diagrams, 35 9. Supplied assembled and tested, at 42 6.
425-0-425 v 200 ma, 6.3 v 4 a, C.T. 6.3 v 4 a, C.T. 5 v 3 a, suitable Argus Televisor, etc. ... 49 9	<b>CHASSIS (16 s.w.g. Aluminium) Receiver Type.—</b> 7-4-1/2 in., 3 3; 10-5-1/2 in., 3 9; 11-6-2 1/2 in., 4 3; 12-8-2 1/2 in., 5 3; 16-8-2 1/2 in., 7 6; 20-8-2 1/2 in., 8 11; Amplifier type (4 sided), 12-8-2 1/2 in., 7 11; 16-8-2 1/2 in., 10 11; 14-10-3 in., 13 6; 20-8-2 1/2 in., 13 6.
450-0-450 v 250 ma, 6.3 v 6 a, 6.3 v 6 a, 5 v 3 a ... 65-	

FILAMENT TRANSFORMERS

All with 200-250 v 60 c/s Primaries; 6.3 v 1.5 a, 5 0; 6.3 v 2 a, 7 6; 0-4-6.3 v 2 a, 7 9; 12 v 1 a, 7 11; 6.3 v 3 a, 9 11; 6.3 v 6 a, 17 9.
--

CHARGER TRANSFORMERS

All with 200-250 v 50 c/s Primaries; 0-9-15 v 1.5 a, 13 9; 0-9-15 v 3 a, 16 9; 0-9-15 v 6 a, 22 9; 0-15-15-24 v 3 a ... 22 9
--

E.H.T. TRANSFORMERS

2,500 v 5 ma, 2-0-2 v 1.1 a, 2-0-2 v 1.1 a, for VCR97, VCR517, ACR2X ... 35-
5,000 v 5 ma, 2 v 2 a ... 39 6

## EX-GOVT. BLOCK PAPER CONDENSERS

4 mfd 1,500 v, 5 9; 0.1 mfd plus 0.1 mfd 8,000 v, common negative isolated, 11 9.
---

EX-GOVT. SMOOTHING CHOKES

50 ma 5-10 h ... 2 9
70 ma 5-10 h ... 3 9
100 ma 10 h 150 ohms Tropicalised ... 6 9
100 ma 10 h 150 ohms Tropicalised ... 9 6
200 ma 20 h 250 ohms Tropicalised ... 12 9
250 ma 3 h 50 ohms Potted ... 7 11
250 ma 15 h 250 ohms Tropicalised ... 14 9
250 ma 10 h 100 ohms ... 16 9

## EX - GOVT. E.H.T. SMOOTHERS

0.25 mfd 8 Kv. 1 1/11; 0.1 mfd 2,000 v. 1 1/11; 0.25 mfd 5,000 v. 3 9; 0.5 mfd 3,500 v. 3 6.
--

NEW VALVES (EX-GOVT.)

Each	Each	Each
1T4 8 9	607G 9 11	35LGT 9 9
1S5 8 9	6SN7GT 8 11	35ZGT 10 6
1R5 8 9	6SK7 6 11	SG215 4 9
3SA 9 6	6SG7 6 9	EASO 2 9
5Y3G 8 11	6V6G 8 9	EF50 5 9
5U4G 10 6	6X3GT 8 9	EF96 5 9
5Z4G 9 6	6U7 6 11	BF91 9 9
6F6G 7 9	6D2 2 11	EB1 8 9
6J5G 5 9	9D2 2 11	MS PEN5 9
6J6 9 6	12K7GT 10 6	HL2 2 9
6J7G 7 6	12Q7GT 10 6	SP1 3 9
6K7G 6 11	12SC7 6 11	VU130A 2 11
6K8G 11 6	15D2 5 3	

## R.F. UNITS TYPES 26

—Brand new. Cartoned, 49 6, plus carr., 2 6. (CATHODE RAY TUBE (EX-GOVT.)—VCR517, Guaranteed full Picture, 29 6; Carr. 5/- extra.

## SILVER MICA CONDENSERS

—5, 10, 15, 20, 25, 30, 35, 50, 60, 100, 120, 150, 180, 200, 230, 300, 340, 400, 470, 500, 1,000 (.001 mfd), 2,000 (.002 mfd), 5d. each, 3 9 doz. 1 type.

## VOL. CONTROLS (standard long spindles)

All values, less switch, 2 9; with S.P. switch, 3 9; with D.P. switch, 4 6.

## ELECTROLYTICS

—Tubular 8 mfd 450 v, 1 11; 16 mfd 450 v, 2 11; Can 8-8 mfd 450 v, 3 11; 8-16 mfd 450 v, 3 11; 16-16 mfd 450 v, 4 11; 32-32 mfd 350 v, 5 6; 32-32 mfd 450 v, 5 11; 64 mfd 450 v, 4 9; 64-120 mfd 350 v, 7 6.

## SIMPLEX VALVES

Complete 39/- set (13)  
0.1 mfd 2.5 kv. 2/6 Condensers each.

- CONDENSERS.—B.E.C., 450 volt wkg., 8 mfd., 2 6; 8+8 mfd., 3 9; 16-16 mfd., 4 6 each. Dублиер, 500 volt wkg., 16 mfd., 2 9; 32 mfd., 5 3.
- RESISTORS.—Carbon 1 watt, 4/6 per dozen.
- POTENTIOMETERS.—All values, 2/6 each.
- PYE PLUGS AND SKTS.—1/- per pair.
- COAXIAL CABLE.—1/2 in. dia., 80Ω, 8d. each.
- FLEX WIRE.—4d. per yd. Twin Screened Cable, 8d. per yd.
- C.R. TUBE HOLDERS.—3/6 each. V.C.R.97 Tubes.—35/-
- KNOBBS.—6d. each. GROMMETS.—1/6 dozen.
- VALVE SCREENS.—1/- each.

## VALVES

SP61 2/6	SP41 2/6	EA50 2/-	EB31 2/-
EP50 (VR91) 2/6	5Z4 8/6	5Z3 8/6	DL 2/-
EF8 6/6	6X4 6/6	EF39 6/6	DI 2/-
EC52 5/-	EC35 4/6	EC39 6/6	ECC32 5/-
EB33 7/6	U22 7/-	EL32 7/-	VU39 8/6
5U4G 9/-	VR37 6/-	U19/20 8/6	PW4 500 8/6
PK25 12/-	CV135 8/6	VR116 4/-	VR21 2/6
VR27 2/6	6AM6 8/6	7193 3/-	954 3/-
955 5/-	1S5 7/-	1T4 7/6	1R5 5/-
154 7/6	6K7 6/-	354 7/6	199A 5/6
6AC7 7/6	CV188 6/6	647 9/6	GSK7 5/-
TT11 8/-	(STAB) 5/-	5133 5/-	KT41 7/-
Pen220 2/6	HL2K 2/6	6J5 5/6	CV193 10/6

## VINER'S (Middlesbrough) Radio Government Surplus Electrical

26, EAST STREET, MIDDLESBROUGH  
Telephone: MID 3418.

# The solder for all HOME TELEVISION CONSTRUCTOR SETS

Designers of television constructor sets know that the efficiency of their equipment depends on the solder used by the constructor—that's why they recommend Ersin Multicores for trouble-free, waste-free soldering. Ersin Multicores, the only solder containing three cores of extra-active, non-corrosive Ersin Flux, is obtainable from all leading radio shops. Ask for Cat. Ref. C.16018, 18 S.W.G. 60 40 High Tin Television and Radio Alloy. The size 1 Carton contains 55 feet of solder, costs 5/-.



## Ersin Multicores Solder

In case of difficulty in obtaining supplies, please write to: MULTICORE SOLDERS LTD. MULTICORE WORKS, MAYLANDS AVE., HEMEL HEMPSTEAD, HERTS. • Boxmoor 3636 (3 lines).

# Instrument Accuracies

USEFUL POINTS TO REMEMBER WHEN CONTEMPLATING THE PURCHASE OF MEASURING EQUIPMENT.

By Trevor G. R. Dowsett

**T**HE choice of apparatus is often decided upon without a proper knowledge of the figures, regarding accuracy, to which the apparatus is claimed to conform. The particular piece of equipment which radio and television workers most often acquire is probably the universal test meter.

Some of these have no figures stated regarding the accuracy. In this case, it is necessary to apply to the manufacturer of the instrument for the accuracy that can be expected. Others are marked B.S.1, which stands for British Standard, first grade; or, only F.G., first grade. These instruments are manufactured according to British Standard 89.

The effective range of an instrument with linear or nearly linear divisions is from the full-scale value down to a tenth of the full-scale value, inclusive. In the case of instruments where the scale is greatly compressed near the zero, the effective range is from the full-scale value down to a quarter of the full-scale value, inclusive. Instruments, except those with printed scales, are calibrated at the major divisions only, and the intermediate graduations are marked according to the law of the scale.

For a multi-range, first-grade, D.C. moving coil ammeter or voltmeter the accuracy is 1.2 per cent. of the actual value indicated, when this is between the maximum value of the effective range and half the maximum scale value. When the instrument is indicating a value between half the maximum scale value and the lower limit of the effective range, the accuracy is 0.6 per cent. of the full-scale value.

In the case of multi-range, first-grade, rectifier voltmeters, the accuracies in the above cases are, respectively, 3.5 per cent. and 1.75 per cent., when used on an alternating current of which the waveform is approximately sinusoidal. The accuracy of a rectifier instrument falls off as the waveform of the current under test departs from a sinusoidal form and when a phase difference occurs between the harmonic components.

The table below, from "Metal Rectifiers for Electrical Measuring Instruments," published by the Westinghouse Brake and Signal Co. Ltd., 82, York Way, London, N.1, gives errors to be expected on distorted waveforms.

Percentage Harmonic	Phase Displacement	Percentage Meter Error
10 per cent. 2nd. ...	0°	-0.5
20 per cent. 2nd. ...	0°	-2.0
10 per cent. 3rd. ...	0°	+2.7
20 per cent. 3rd. ...	0°	+4.4
30 per cent. 3rd. ...	0°	+5.0
20 per cent. 3rd. ...	180°	-9.2

It is possible for the conditions, as indicated by the last set of figures, to exist when measuring the magnetising currents of induction motors and transformers.

### Errors

Errors will be introduced when the rectifier impedance is an appreciable proportion of the total circuit impedance. This is the reason for low-

range rectifier voltmeters, of the order of 10 volts and less, having non-linear scales, unless a voltage step-up transformer is utilised to overcome this. In current measurements, the effect of the rectifier impedance is reduced when a current transformer is used to increase the range of the instrument.

From a study of the accuracies it will become plainly evident why it is better practice to use an instrument as near full scale as is practicable. It is possible when a first-grade, multi-range, rectifier voltmeter is used to measure 4 volts A.C., on a range having 5 volts full-scale deflection, for an error of  $\frac{3.5 \times 4}{100}$ , 0.14 volts to exist. Therefore, the voltage

under test can be between 3.86 volts and 4.14 volts, which represents an error of 3.5 per cent. If the same instrument is used on a range having 20 volts full-scale deflection, the error can be  $\frac{1.75 \times 20}{100}$

0.35 volts. Under these circumstances the voltage under test can be between 3.65 volts and 4.35 volts, which represents an error of 8.75 per cent.

Bearing in mind that the voltage across, or current through, valve filaments and heaters is normally recommended to be within 5 per cent. of the rated value, it is obvious that the measurement of 4 volts on the 20-volt range is not to be recommended.

Where rectifier instruments are used with current and voltage transformers, an additional error must be taken into account. The actual error depends upon the class of transformer that is used with the instrument, a fact that is not normally stated by the manufacturer of first-grade test gear, but which should be obtainable on inquiry. There are six classes of transformer, two being laboratory patterns that come under the appropriate specification, which is British Standard 81.

The sections of a multi-range test meter which measure capacity, inductance, resistance and output, when the latter is taken through an isolating condenser, do not come under B.S.89 as regards accuracy.

The accuracy of instruments manufactured to conform to B.S.89 is often considerably better than the figures quoted in the specification, but these serve as a standard to which manufacturers can produce equipment.

### Sub-standard

Besides first-grade meters there are also sub-standard instruments manufactured to B.S.89. Sub-standard meters, which have S.S. marked on the scale, are normally made only as laboratory instruments and not as universal test meters.

Extracts from B.S.81: 1936, "Instrument Transformers," and B.S.89: 1937, "Indicating Ammeters, Voltmeters, Wattmeters, Frequency and Power-Factor Meters" are reproduced by permission of the British Standards Institution, 24, Victoria Street, London, S.W.1, from whom official copies of the standards can be obtained, priced 4s. and 3s. 6d., respectively.

# "H" versus the Multi-element Array

SOME DETAILED ANSWERS TO RECENTLY PUBLISHED DATA ON THIS IMPORTANT SUBJECT

CONSIDERABLE interest has been aroused by the article under this heading in our December issue, and a large correspondence has ensued—both from readers and from the Trade. In view of the importance of the matter the following detailed notes from the technical sales manager of Messrs. Belling & Lee will, no doubt, prove of interest. Attention is also drawn to the two letters on the subject published in the Correspondence pages of last month's issue.

"I was somewhat interested in the article by M. R. Harknett on the "H" versus the Multi-element Array" in the December issue.

I feel that it would be as well to point out some facts of this position and I must mention that these facts can be very easily demonstrated by correctly performed tests.

It is, of course, ridiculous to hold that no improvement is available when a three-element aerial is erected in place of an "H." An increase of gain of less than 1 db can, by direct comparison of pictures, be seen on a TV set, and it is important to remember that the difference in decibels between black level (30 per cent. modulation) and peak white (100 per cent. modulation) only represents a change of 10 db in level.

On normal commercial arrays the gain of a three-element array is some 3 db above an "H" aerial. This is a figure measured at the input to the receiver and therefore any arguments based on difficulty of matching are invalid.

However, it is the case in practice that a three- or four-element array using the heavy elements universally employed has a centre impedance of between 20 and 30 ohms, and this makes matching admirably simple and accurate, using either a folded dipole

(4 x centre impedance), a  $\frac{1}{4}$ -wave coaxial transformer, or "delta" or "tee" match. There is, of course, no difficulty in correctly matching a 10 ohm or lower impedance array to a 70 ohm cable, if this were necessary, and such arrangements are often used on special aerials on high frequency communication systems.

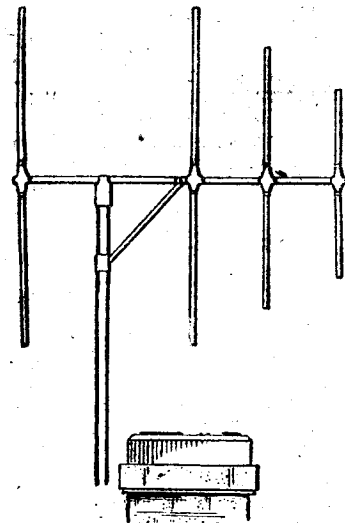

A Multi-element array.

## Feeders

Referring to

to the feeder arrangements, it is dangerous to compare one aerial system using coaxial, and another using balanced cable. The form of feeder is, in practical cases, controlled by the receiver, and the use of the incorrect type may result in a loss of up to 6 dB, as well as heavy interference injection, due to mismatch at the receiver.

As the majority of receivers demand coaxial cable, this is used normally, but there is no objection to using twin-balanced feeder on the majority of multi-element arrays, (a  $\frac{1}{4}$ -wave transformer may be either coaxial or balanced).

It is, of course, true that, in theory, somewhat more interference will be injected due to the use of an unbalanced cable with a balanced aerial provided that the receiver end is correct but, in practice, this effect is insignificant in practically every case. It should be further pointed out that an aerial manufacturer designs an aerial complete, and this means with its pole, thus the stated performance does include any effects (and these are usually very minor) caused by the mast.

## Costs

Regarding cost of arrays, it is wise to examine a typical aerial price list with the following results:

List price of a  $\frac{1}{4}$ -wave "H" aerial, with 12ft. mast and chimney lashing, channel 1. £8 15s.

List price of a three-element array, with 12ft. mast and chimney lashing, channel 1. £11 15s.

These two prices are, as can be seen, in the ratio of 1.34/1 and not 5/1 as has been stated.

Erection costs should be the same for either type and if these are included the ratio is still further reduced.

The cost of feeder cables, again from typical modern price list, is as follows:

70-80 ohm, unscreened twin balanced, 6d. yd., list.

70-90 ohm, screened twin feeder, 1/6 yd., list.

70-80 ohm coaxial cable, solid dielectric, 1/3 yd., list.

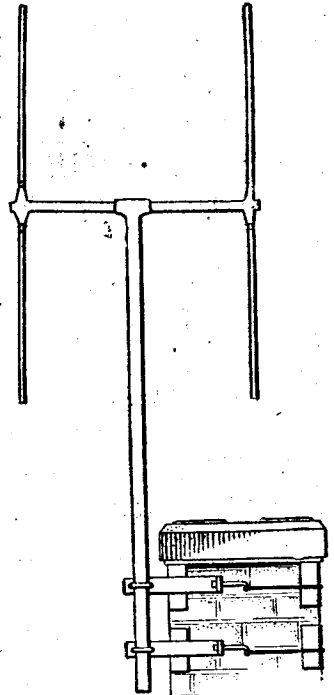

A typical "H" aerial.

(Concluded on page 478)

**CABINET** as illustrated, 11 1/2 x 6 1/2 x 5 1/2 in. in walnut or cream, complete with T.R.F. chassis, 2 wave-band scale, station names, new waveband, backplate, drum, pointer, spring, drive spindle, 3 knobs and back. 22/6. P. & P., 3/6.

As above with Superhet Chassis, 23/6. P. & P., 3/6.

As above complete with new speaker to fit and O.P. trans., 35/- P. & P., 3/6 with Superhet Chassis, 36/- P. & P., 3/6.

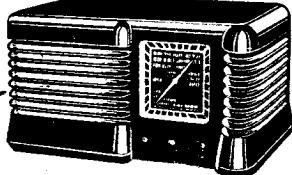

Used metal rectifier, 230 v. 50 mA., 4/6; gang with trimmers, 6/6; M. & T.R.F. coils, 5/-; 3 obsolete Ex-Govt. valves, 3 v.h. and circuit, 6/6; heater trans., 6/-; volume control with switch, 3/6; wave-change switch, 2/-; 32 x 32 mfd., 4/-; bias condenser, 1/-; resistor kit, 2/-; condenser 10, 4/-.

**M. & L. Superhet Coils** with circuit, 6/6; iron cores 465 IF's, 7/8; min. gang, 5/6; volume control with switch, 4/-; wave-change switch, 2/6; heater trans., 7/6; 4 v.h. 1/6; 4 obsolete Ex-Govt. valves, metal rectifier and Xtal diode with circuit, 14/6; 25 x 25 mfd., 1/-; 16 x 16 mfd., 3/3; condenser kit (17), 7/6; resistor kit (14), 3/6.

Used 4 valve plus metal rec. A.C. mains, 200/250 superhet. Valve line up 6K8, 6K7, 6Q7 and 6F6. Medium wave in mahogany cabinet, size 14 1/2 x 9 x 7 1/2 in. These have been checked and are in first-class working order, and have a first-class performance. 6 1/2 in. P.M. speaker. P. & P., 5/-, £3/19/6.

Used 5 valve A.C. mains 200/250 3-wave-band superhet. Complete in outstanding walnut cabinet, size 22 x 14 x 10 1/2 in. Valve line up, 6K8, 6K7, 6B8C, 6F6 and U50 rec. 8 in. P.M. speaker. In first-class working order, £7/19/6. P. & P., 12/6. We have a few of these in A.C./D.C. price as above.

**All dry A.C. mains battery unit,** 200 250 v. Metal case size 8 x 5 x 3 in., by famous manufacturer incorporating Westinghouse metal rectifiers, 3,500 mfd., 16+24 mfd., mains trans., 3 smoothing chokes, output 90 v. 10 mA., 1.4 v., 25 amp. P. & P., 2/6, 39/6.

**COMPLETELY BUILT SIGNAL GENERATOR.** Coverage 110 Kc-320 Kc/s., 300 Kc/s-900 Kc/s., 900 Kc/s-2.75 Mc/s., 2.75 Mc/s-8.5 Mc/s., 8.5 Mc/s-25 Mc/s., 17 Mc/s-50 Mc/s., 25.5 Mc/s-75 Mc/s. Metal

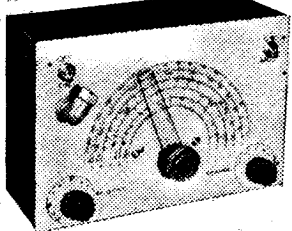

case 10 x 6 1/2 x 4 1/2 in., size of scale 6 1/2 x 3 1/2 in., 2 valves and rectifier. A.C. mains 230-250 v. Internal modulation 400 c.p.s. to a depth of 30%. Frequency calibration accuracy plus or minus 1%. Modulated or unmodulated R.F. output continuously variable 100 milli-volts. Black crackle finished case and white front panel. P. & P., 4/-, £4/5/0. 34/- deposit, three monthly payments of £1.

Terms of business: Cash with order. Dispatch of goods within three days from receipt of order. Where post and packing charge is not stated, please add 1/- up to 10/-, 1/6 up to £1, and 2/- up to £2. [All enquiries and list, stamped addressed envelope.

**G.E.C. High Impedance Plastic Recording Tape** by famous manufacturer, 1,200 feet complete on spool, 17/6. 600 feet, 8/-. Both items post paid.

**Amplifier Case,** black rexine covered, leather carrying handle, chrome plated corners, rubber feet, felt lined, detachable lid. External dimensions 13 1/2 x 13 1/2 x 9 1/2 in. £1. P. & P., 2/6.

**Pr. 200/250 v.** secondary 3, 4, 5, 6, 8, 9, 10, 12, 15, 18, 20, 24 and 30 volt at 2 mps., 13/-.

**Drop thro'** 290-0-290, 200 mA., 6 v. 5 amps., 5 v. 3 amps., 27/6.

**Heater Transformer,** Pri. 230-250 v. 6 v. 11 amp. 6/-; 2 v. 21 amp., 5/-; 2 v. 21 amp. and 6 v. 6.6 amp. E.H.T. insulated, 8/6; C.P. each 1/-.

**R.I. MAINS TRANSFORMERS,** chassis mounting feet and voltage panel. Primaries 200/250.

300-0-300 60 mA. 6.3 v. 1 a., tapped at 4 v. 6.3 v. 2 a. tap 4 v., 13/6.

350-0-350 75 mA. 6.3 v. 3 a. tap 4 v. 6.3 v. 13/6.

350-0-350 70 mA. 4 v. 5 a. 4 v. 2.5 a., C.T., 18 6. P. & P. on the above transformers 2/-.

500-0-500 125 mA. 6.3 v. C.T. 4 a. 6.3 v. C.T. 2 a. 5 v. C.T. 2 a., 27/6.

500-0-500 120 mA. 4 v. C.T. 4 a. 4 v. C.T. 2 a. 5 v. C.T. 4 a., 27/6.

500-0-500 250 mA. 4 v. C.T. 5 a. 4 v. C.T. 5 a. 4 v. C.T. 4 a., 49/6.

P. & P. on the above transformers 3/-; 32 mfd., 350 wkg. .... 4/-

16 x 24 350 wkg. .... 4/-

4 mfd., 20 wkg. .... 1/3

32 mfd., 450 wkg. .... 3/6

16 x 8 mfd., 500 wkg. .... 4/6

16 x 16 mfd., 500 wkg. .... 5/9

8 x 16 mfd., 450 wkg. .... 3/9

32 x 32 mfd., 350 wkg. .... 4/-

32 x 32 mfd., 350 wkg. and 25 mfd. .... 6/6

25 mfd., 250 wkg. .... 11d.

250 mfd., 12 v. wkg. .... 1/-

16 mfd., 500 wkg., wire ends .... 3/3

8 mfd., 500 v. wkg., wire ends .... 2/6

8 mfd., 350 v. wkg., tag ends .... 1/6

50 mfd., 25 v. wkg., wire ends .... 1/6

100 mfd., 350 wkg. .... 4/-

100+200 mfd., 350 wkg. .... 9/6

16+16 mfd., 350 wkg. .... 3/3

Ex-Govt. 8 mfd. 500 v. wkg., size 3 1/2 x 1 1/2 for .... 2/6

60+100 mfd., 280 v. wkg. .... 7/-

16+32 mfd., 350 wkg. .... 6/-

50 mfd., 180 wkg. .... 1/9

65 mfd., 220 wkg. .... 1/6

8 mfd., 150 wkg. .... 1/6

60+100 mfd., 280 wkg. .... 8/6

50 mfd., 12 wkg. .... 11d.

32+32 mfd. min. 275 wkg. .... 4/-

50 mfd., 50 wkg. mid. wkg. wire ends .... 1/9

Miniature wire ends moulded 100 pf., 500 pf. and .001 ea. .... 7d.

**By a famous manufacturer, fully shrouded mains transformer, input 200/250 secondary 250-0-250 175 mA. 6.3 v. 7 amp. 5 v. 3 amp., pp 3/-, 35/-.**

**By a famous manufacturer, fully shrouded push-pull transformer, PRI 6,000 ohms, SEC 15 ohms, pp 2/-, £20/-.**

**By a famous manufacturer, fully shrouded choke, 15 Hen. 180 mA., pp 2/-, 15/-.**

**By a famous manufacturer, fully shrouded choke, 5 Hen. 120 mA., pp 2/-, 8/6.**

**BATTERY CHARGER KIT,** comprising metal case 5 x 4 1/2 x 4 1/2; trans. 200/250 v. and metal rec. Will charge 6 or 12 v. battery at 1 1/2 amp., 19/6. P. & P., 2/6.

**Output Transformers.** Standard type, 5,000 ohms imp., 2-ohms speech coil, 4/9; Miniature type 42-1 3/3; Multiratio 5,500, 7,000 and 14,000 2 ohms speech coil, price 5/6. 40 watt push-pull 6V6 matching 2 ohms speech coil, 7/-.

**Used C.R.T. Tubes.** Heater cathode short 9in., 45/-; 12in., 75/-; Ion burn, 9in., 35/-; 12in., 55/-; P. & P. on each 7/6.

**Trimmers,** 5-40 pf., 5d.; 10-110, 10-260, 10-450 pf., 10d.

**Combined 12in. Mask and Esecuteon** in lightly tinted perspex. New aspect, edged in brown. Fits on front of cabinet, 17/6. P. & P., 2/-.

**Frame Oscillator Blecking Trans., 4/6.** Smoothing Choke, 5 henry 250 mA., 8/6. 250 mA. 3 henry, 5/-; 250 mA., 10 henry, 10/6.

**P.M. Focus Unit** for any 9 or 12in. tube cept Mazda 12in., 2 with Vernier adjustment, 15/- P. & P., 1/6.

**P.M. Focus Unit** for Mazda, 12in., with Vernier adjustment, 17/6. P. & P., 1/6.

**Wide Angle P.M. Focus Units,** Vernier adj., state tube, 25/- P. & P., 2/-.

**Energised Focus Coil,** low resistance mounting bracket, 17/6. Plus 2/- P. & P.

**Scan Coils,** low line, low impedance frame, complete with O.P. transformer, 17/6. P. & P., 2/-.

**Ion Traps** for Mullard or English Electric tubes, 5/-, post paid.

**Line and E.H.T. Transformer 9 Kva.** using ferrocort core complete with built-in line and width control. Mounted on small all-chassis. Overall size 4 1/2 x 1 1/2 in., EY18 rec. winding, 27/6. P. & P., 2/6.

**R & A T.V. Energised 6 1/2 in. Speaker** with O.P. trans. 6V6 matching, field coil 175 ohms. Requires a minimum 150 mA. to energise, maximum current 250 mA., 15/- P. & P., 2/-.

**T.V. Coils** for re-winding purposes only, moulded former, single iron core, size 1 1/2 x 1 in. Aluminium can, 1/- ea.

**T.V. Coils,** two iron cores, moulded former, aluminium can, size 2 1/2 x 1 in., for re-winding only, 1/6 each.

**T.V. Sub Assembly,** all-chassis, 12in. x 3 in., with frame osc., line osc., 12 mid. 275 wkg. Metrosil 8 condensers, 4 resistors and tag panel, 15/- P. & P., 1/6.

**Extension Speaker Cabinet,** in contrasting walnut veneers, size 15 x 10 1/2 in. Will take 6 1/2 in. speaker, 17/6. P. & P., 2/-.

**Volume Controls,** Long spindle less switch, 50K, 500K, 1 meg., 2/8 each. P. & P., 3d. each.

**Volume Controls,** Long spindle and switch, 1, 1 and 2 meg., 4/- each; 10 K, and 50 K, 3/8 each. 1 and 1 meg., long spindle, double pole switch, miniature, 5/- P. & P., 3d. each.

**Standard Wave-change Switches,** 4-pole 3-way, 1/9; 5-pole 3-way, 1/9. Miniature 3-pole 4-way, 4-pole 3-way, 2/6.

**Valveholders,** Paxolin octal, 4d. Moulded octal, 7d. EF50, 7d. Moulded B7G, 7d. Loctal amphecol, 7d. Loctal pac, 4d. Mazda Amphecol, 8d. Mazda pac, 4d. BXA, B9A amphecol 7d. B7G with screening can, 1/6. Duodecal paxolin, 9d.

**Twin-gang .0005 Tuning Condensers,** 5/-; With trimmers, 7/6.

**Midget .00037 dust cover and trimmers,** 8/6.

**P.M. SPEAKERS**

					with less
3 1/2 in.	...	...	...	...	trans. with
5 in.	...	...	...	...	13/6
6 in.	...	...	...	...	16/6
8 in.	...	...	...	...	16/6
10 in.	...	...	...	...	15/-
10 in.	...	...	...	...	19/6

Post and packing on each of the above, 1/6 extra.

**Truvox BX11 12in. P.M. 3 ohm speech coil** 45/- P. & P., 3/6.

**Crystal pick-up with Sapphire Trailer Needle,** with volume control, 23/- P. & P., 1/-.

**D. COHEN, 23, HIGH STREET, ACTON, W.3.** (Opposite Granada Cinema)

Hours of Business: Saturdays 9-6 pm. Wednesdays 9-1 p.m. Other days 9-4.30 p.m.

**Volume Controls** 80 ohm CABLE COAX  
 Midget Edison type. Long spindles. Guaranteed 1 year.  
 LESS SW. S.P. SW. 3- D.P. SW. 4- 49  
**ALL VALUES**—10,000 ohms to 2 Megohms.

**STANDARD** 1/2 in. diam. Polythene Insulated. REDUCED PRICE  
**Q.D.** A YARD NOT E.C. Good.  
**COAX PLUGS**, 12 each.  
**SOCKETS** 12 each.  
**LINE CONNECTOR**, 12.  
**OUTLET BOXES**, 48.

**BALANCED TWIN FEEDER** per yd. 6d. 80  
**TWIN SCREENED FEEDER** per yd. 1- 1/2 ohms  
**50 OHM COAX CABLE**, 84. per yd. 1/4 in. dia.  
**TRIMMERS**, Ceramic. 30, 70, 90, 100 pf. 150 pf. 1.3; 250 pf. 1.8; 600 pf. 1.9.  
**RESISTORS**—All values: 1 w., 4d.; 1 w., 6d.; 1 w., 8d.; 2 w., 1-; Ex stock.  
 1 w., 1/2; 2 w., 2/; 16. 7-day service.

**WIRE-WOUND RESISTORS**—Best Makes Miniature Ceramic Type—5 w., 15 ohm to 4 K., 19; 10 w., 20 ohm to 6 K., 2.3; 15 w., 30 ohm to 10 K., 2.9; 5 w. Vitreous, 12 K. to 25 K., 3-.

**WIRE-WOUND POTS**, 3 WATT, FAMOUS MAKES  
 Pre-Set Min. TV. Type. Standard Size Pots, 2 1/2 in. Knurled, Slotted Knob. Spindle. High Grade. All values 25 ohms to 30 K. (50 K. and 100 K.) All Values, 100 ohms to Carbon Track, 3- each. 50 K., 5.6; 100 K., 6.6.

**O.P. TRANSFORMERS**—Small tapped pentode. 3 P. Heavy duty 70 ma., 4.8. Ditto, tapped, 4.9.  
**L.F. CHOKES** 10 h. 65 ma., 4.6. 20-25 v. 100 150 6 ma., 12/6. 5 h. 250 ma., 15- 15 h. 190 ma., 10.6.  
**LYNX** choke, 3 h. 250 ma., 12.6.

**MAINS TRANS.**—Made in our own workshops to high grade specifications. Fully interleaved and impregnated. Heater Trans., tapped prim. 0-200 v. 250 v., 6.3 v. 11 amp, 7/6; ditto 6.3 v. 3 amp, 10/6; ditto, 12 v., 2a amp, 7.8. 350-0-350, 89 ma., 6.3 v. 4 a., 5 v. 2a, ditto 300-0-300, ditto 250-0-250, 21-. Viewmaster, auto type 3-85. Telexing, 30-. Lynx, 30-. Coronet, 30-. Super View, 30-.

**SOUNDMASTER SPECIALS**—Mains Trans., 35-. L.F. Choke, 10.6. O.P. Trans., 5/6. Envelope, 6.6.

**GOODMANS WIDE ANGLE DUOMAG TYPE FOCUS UNIT** with centraliser, 35-; Elac ion traps, 3/6.

**Brand New Collaro Autochanger, 3-speed Model. SR5251. Twin High Fidelity Heads. For 7in., 10in. or 12in. Records. Sprung Mounting. Superb Quality. List £10.10-.**  
 Our Price 9/9s., post free.

**Ediswan 78 r.p.m. Single-Recorder Gram Unit, High Impedance Magnetic Pick-up. Press lever start for 10in. or 12in. records, auto stop. Listed 7 gns. Our Price £4 10. Post free.**

**G.E.C.**—High coercivity recording tape, 1,200 ft. reels, 19/6.

**WOODEN WALNUT CABINET**—12in. x 7in. x 5in. complete with punched chassis, TRF or superhet dial, back-plate, drum, drive, spring, pointer, etc., 28/6 plus post 2/.

**TYANA**—Midget Soldering Iron. 200/220 v. or 230 250 v., 14/11. **TYANA TRIPLE THREE**—Complete with detachable bench stand, 19/6.

**NEW SOLON MIDGET IRON**—25 w. 19/6. IDEAL FOR RADIO CONSTRUCTORS.

**C.R.T. HEATER ISOLATION TRANSPARENTER**—Low leakage winding with 25% sec. boost, 2 v. 10/6; 4 v., 10/6; 6.3 v., 10/6; 12 v., 10/6.

**TAG STRIPS**—2- or 3-way 22; 4- or 5-way, 3d., 6-way, 4d.; 9- or 10-way, 6d.

**T.V. AERIALS**—Full range popular types in stock. Aerialite, etc. All channels. Indoor loft type Tav. T. 13/6. Outdoor single dipole, 37/6. 11-type with chimney flashings, etc., 92/6. X-type Dublex, 71t. mast and chimney flashings, etc., 88/6. Fringe models available. Ask for quotation.

**TOGGLE SWITCHES EX-GOV.** "On-Off" 9d. Erin M-core solder 80-90, 166, 5/6 1 lb.; 4d. yd. 1/4 wire 18 to 22 s.w.g., per yd., 2d. PVC Connecting wire, 10 colours. Single or Stranded 24. yd. B7G Valveholder and Screening Can., 1/6. V-holders, octal, pax., 4d.; moulded, 6d.; EF50, B7G, 9d.; moulded, 9d.; ceramic, 1-; BNA, BBA, 1-; B12A (CRT), 1/3, etc. 2 K. 5 w. H.D. w/w Tots, 4/6. 10 K Colvern w/w Pot, 1/4 in. spindle, 3/6.

**"REGENT" LIGHTWEIGHT XTAL HAND MICROPHONE**—Super quality, high sensitivity, chrome finish. Listed 2 gns. Our price, 29/6. BRAND NEW AND BOXED.

**SIMPLEX TELEVISION**  
 All parts in stock, detailed price list available.  
**SPECIAL STAGE-BY-STAGE OFFER**

<b>STAGE 1. VISION AND SOUND.</b>	<b>STAGE 3.—POWER SUPPLY.</b>
7 Valves ... 30-	2 Resistors ... 2-
12 Resistors ... 3-	5 E.T.C. Rectifiers ... 27/6
16 Condensers ... 9-	5 Condensers ... 23/6
2 Potentiometers ... 6-	1 Choke ... 10/6
7 Coil formers with cores ... 4/6	1 Transformer ... 35-
7 Valveholders ... 3/6	(Not Ex-Govt.)
Sundries ... 22/6	
<b>STAGE 2.—TIME BASE.</b>	<b>STAGE 4.—C.R.T. NETWORK.</b>
6 Valves ... 28-	9 Resistors ... 4-
20 Resistors ... 8/6	1 Condenser ... 6d.
15 Condensers ... 12/6	4 Potentiometers ... 10-
5 Potentiometers ... 12/6	Sundries ... 18-
6 Valveholders ... 2/6	
Sundries ... 1/6	

**COMPLETE SIMPLEX KIT** (less tube) 12 gns.

**NEW BOXED VALVES GUARANTEED. ALL**

1A5	5/6 6/47	8/6 12SH7	5/6 EP50 Equip
1R5	8/- 6/63	9/6 13A9	9/6 5/6
1S5	6/6 6/67	6/6 3A16	10/6 British
1S4	3/- 6/83	9/- 3Z4	10/6 Sylvania
1T4	3/- 5P28	10/6 0Z4	8/6 Red
384	9/- EF80	10/6 50L6	9/6 EP81
3V4	3/- 6/16	10/6 807	10/6 EP92
5D4	9/6 6P25	15/- 6Z52	15/- BL22
6B4	10/6 6Q7	9/6 9001	7/6 703
6Z4	9/- 68A7	8/6 9006	7/6 EV54
6X4	7/6 68H7	8/6 CV6	3/6 EV91
6AG5	7/6 68L7	9/- 6E118	8/6 HV R2A
6AM6	9/- 68N7	11/- DK91	8/- MS PEN. 6/6
6AT6	10/6 61.5(Y63)8	10/6 6P11	8/- PY80
6B8	7/6 6V6	8/- DAL91	8/- PY81
6BA6	8/6 6X5	9/- DL92	9/- PY82
6BE6	10/6 6AK5	10/6 DL94	8/- PEN25
6BW6	10/6 787	9/6 6E148	4/6 6P11
6CG	7/6 813	9/- 6A50	2/- 122
6D6	7/6 912	6/6 6AL5	7/6 VP2
6P6	9/6 12A6	7/6 EB91	7/6 VR116
6P12	9/- 12AX7	10/6 EB93	9/6 ECL50
6G6	6/6 12K7	10/6 EC91	7/6 2515
6H6	3/6 12K8	10/6 EF96	7/6 2526
6J5	7/6 12Q7	10/6 EF99	9/- 2524

Huge Stock B.V.A. Valves at 1951 low tax prices.

**SPECIAL PRICE PER SET:**  
 1R5, 1T4, 1S5 and 384 ... 30/-  
 6K8, 6K7, 6Q7, 6V6, 5Z4 or 6X5 ... 37/6

**VIEWMASTER**—12 valves, £6 10. With EY51, 57. TELEKING—17 valves, £9 10-. LYNX—17 valves 89. CORONET—4 valves, 45-.

**SCREENED GRID CAPS** Int. oct., 6d. each.

**FUSES**—1/4 in. all values 60 ma. to 10a., 6d.  
**ALADDIN FORMERS** and cores, 1/4 in., 8d.; 1/2 in., 10d.  
**SLOW MOTION DRIVES**—Epicyclic ratio 4:1, 2.3.  
**INT. CABLE CABLE PLUG** (S-pin), with cover, 1-20 250 VOLT SELECTOR SOCKET (2in. x 1in.), with Plug 1- EXT. SPEAKER VOL. CONTROL 10 ohms wirewound long spindle, 3-.

**LINE COR.**—2in., 100 ohms per foot, 3a., 60 ohms per foot, 2-way 1.6 a yards, 3-way 1.8 a yard.  
**SLEEVING**—Various colours, 1, 2 mm., 24; 3, 4 mm., 3d. yd.; 6 mm., 6d. yd.

**MAINS DROPPERS**—(2in. x 1 1/2 in.) Adj. sliders 3 amp, 750 ohms, 2 amp, 1,000 ohms, etc., 4/3.  
**WAVECHARGE SWITCHES**—2 p. 2-way, 3 p. 2-way, 2 6/2; 2 p. 6-way 4 p. 2-way, 4 p. 3-way, 3 p. 4-way, 1 p. 12-way, 3/6.

**CRYSTAL DIODE**—Very sensitive. G.E.C., 3/6. B.T.H. 2/6. H.R. PHONES (High quality American make), 15/6 p.

**CONDENSERS**—New stock best makes, .001 mfd. 6KV. T.C.C. 5/8. Ditto 12.5 kv. 9/6; 2 pf. to 500 pf. 6d.; .001, .005, .01, T.C.C. 500 v., 1/4 Sprague 500 v., 6d. N.S.P. 500 v. 1 mfd. 350 v. Micamould Tub., 9d.; Hunts Midseal 500 v. .05 mfd. and 1 mfd. 1-; 25 mfd., 1.6; .5 mfd., 1/9.

**SILVER MICA CONDENSERS**—10%. Ex stock. 5 pf. to 500 pf. 1-. 600 pf. to 5,000 pf. 1.3.

**DITTO** 1% (7-day service). 1.5 pf. to 500 pf., 1/9. 515 pf. to 1,000 pf., 2-.

P. and P. 6d. £1 orders post free. Lists 3d. ALL MAINS TRANS—1- extra.

**ELECTROLYTICS ALL TYPES NEW STOCK**

Tubular Wire ends	Can Types, Clips, 9d.
1275 v. B.E.C.	2- 16,450 v. T.C.C. 3/6
2450 v. B.E.C.	2- 16,450 v. Dubilier, 4-
4350 v. Dubilier	1/6 22,350 v. B.E.C., 4-
4500 v. Hunts	2- 60,350 v. T.C.C. 6/6
8450 v. B.E.C.	2/3 250,350 v. B.E.C. 8/6
8500 v. Dubilier	2/8 84,16,450 v. B.E.C., 5-
10,300 v. Dubilier	2/6 84,16,500 v. Dubilier, 5-
16,300 v. Dubilier	4- 60,350 v. T.C.C. 6/6
84,300 v. Dubilier	6/6 164,16,450 v. B.E.C., 5/6
16,350 v. B.E.C.	3- 16,16,500 v. Dub., 6-
32,350 v. Dubilier	4- 32,32,375 v. Dub., 4/6
32,300 v. Dubilier	5- 32,32,350 v. 4- 22,35 v.
32,432,500 v. Dub.,	7/6 in same can B.F.C. 6/6
50,500 v. Dubilier	1- 60+100,350 v. Hunts. 11/6
25,25 v. Plessey	2- 9

**SPECIALS**—Can Types. 1,000 mfd., 12 v., 3/-; 1,000 mfd., 12 v., 5-; 1,000 mfd., 5 v., 4/6; 5 mfd., 700 v. Hunts, 6/6. 5 mfd., 5.5 kv., 5/6; 1 mfd., 25 kv., 4/6.

**SENTERCEL RECTIFIERS. E.H.T. TYPE FLY-BACK VOLTAGES.** K-35 2kv., 4/6; K310 3.2 kv., 5/-; K315 3.6 kv., 6/6; K350 4 kv., 7/3; K3100 8 kv., 1/6; K3160 14 kv., 18-.

**MAINS TYPE.**—RM1, 125 v., 60 ma., 4-; RM2, 100 ma., 4/9; RM3 120 ma., 5/9; RM4, 250 v., 275 ma., 16-.

**KNOB, GOLD ENGRAVED**—Walnut or Ivory, 1/4 in. diam., 1/8 each. "Focus," "Contrast," "Brilliance," "Brilliance-On-Off," "On-Off," "Volume," "Vol.-On-Off," "Tone," "Tuning," "Trebble," "Bass," "Wavechange," "Radio-gram," "S. M. L. Gram," "Record-Play," "Brightness," Ditto not engraved, 1 each.

**COILS**—Wearite "P" type, 2.6 each. Osamor "Q" type, adj. dust core, 3.6 each. All ranges.

**REACTION COND.**—0.001, .0005, .0003 mfd., 3/6 each.

**SURPLUS MAINS TRANS.**—Prim. 0.200-250 v.; Sec. 275-0-275 v., 60 ma., 6.3 v. 3 a., 6.3 v. 1A, 10/6; ditto, 200-0-200 v., 80 ma., 6.3 v. 2 a., 6.3 v. 1 a., 12/6. Oscilloscope Transf. Prim. 0.200 v. Sec. 50 v., 15 ma., 5 v. 2 a., 5 v. 2 a. 4 v. 1 a., 17/8.

**VIBRATOR TRANS.**—6 v. input, 230 v. 50 ma. output, 9/6. P. & P. 1/-.

**BATTERY CHARGER**—200-250 v. Output 6 v. and 12 v. 11 amp., in steel case, complete with case and leads, ready for use. OUR OWN MAKE FULLY GUARANTEED, 35-; P. & P. 1/-.

**CHARGER TRANS. PRIM.**—0.200/250 v. Sec. 6.3 v. 15 v. 1A, 13/6; 2a., 16/-; 3a., 18/6; 4a., 21/-; 6a., 28-.

**FULL WAVE BRIDGE SELENIUM RECTIFIERS**—6 or 12 v. 11 amp. 8/9; 2 a., 11/3; 3 a., 12/6; 4 a., 15/-; 6 a., 23/6. P.W. only 6 v., 1 a. (3 v. only A.C.), 5/6.

**A.C. HYDROMETER**—Brand new ex-Govt. Unbreakable. Packed in metal case, 7in. x 1 1/2 in. dia., 4/6.

**H.P. MIDGET CHOKES**—14 M.H., 2/6 each.

**BRIMSTORS**—CZ1 for 3 a. heater chains, 3/6. CZ2 for 15 a., or 12 a., 2/6.

**COPPER ENAMEL WIRE**—1 lb. 14 to 20 s.w.g. 2/-; 22 to 28 s.w.g., 2/6; 30 to 40 s.w.g., 3/6.

**SWITCH CLEANER** Fluid, squirt spout, 2/9. 10 oz. tin.

**5in. RADIO SCREWDRIVERS**—Sheffield made blade, 2 1/2 in. x 1/4 in. Ins. handle, 5,000 v., 41d. ea.

**TWIN GANG TUNING CONDENSERS**—,0005 mfd. midget with trimmers, 8/6, 375 pf. midget less trimmers, 6/6; .0005 Standard size with feet less trimmers, 8/6; ditto, sold, 5/6.

**COPPER PLATED AERO RODS**—1 dia., 12in. long, pushed together fitting, 2/6 per doz.

**LOUDSPEAKERS P.M., 3 OHM.** 5in. Plessey, 12/6. 8in. Gostimus, 13/6. 6in. Gostimus, 14/6. 8in. Lectra, 15/8. 8in. R.A., 17/6. 10in. Plessey, 25-. 12in. Truvox, 55-. 8in. G.E.C. Energised 70Ω field with trans, 19/6.

**T.R.S. RADIO COMPONENT SPECIALISTS**  
 THO 1665  
 Buses 155 or 68 pass door.  
**307, WHITEHORSE ROAD, WEST CROYDON.**  
 Mail Order: 71, MEADVALE ROAD, EAST CROYDON.

**I.F. TRANSFORMERS**  
 465 Kc's Slug tuning. Miniature Circular Can, 2 1/2 in. 1/4 in. diam. Fits octal V-holder cut out. High Q and good bandwidth. By Eye Radio. Two mounting feet.  
**BRAND NEW 6/9 PAIR**

TELEVISION PICK-UPS AND REFLECTIONS

# UNDERNEATH THE DIPOLE

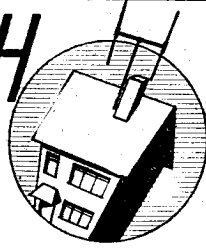

By Iconos

THE whole world of entertainment seems to be in a state of upheaval and chaos, almost overwhelmed with the multitudes of technical "gimmicks" which may—or may not—catch the fancy of the public. Technical developments follow one another with bewildering rapidity in almost every field of entertainment. Colour television, magnetic tape recording of colour and black-and-white TV, perfection of integral-tripack colour photography, long-playing records, sound reinforcement for auditoria, mobile ice rinks for theatres, fluorescent stage costumes, electronic cameras—and so on, *ad infinitum*. How very simple those crystal-set days used to be, when the morning journey on the leisurely 8.10 steam train to town was enlivened with pleasant arguments on the relative merits of zincite-bornite, treated galena or Dayzite as a means of picking up 2LO and John Henry calling. Nowadays the 8.25 electric flyer gets there much quicker, scarcely allowing enough time to discuss the advantages (or otherwise) of frequency modulation, whether *Hamlet on Ice* is as effective as the Helpman ballet version of the great play, or how long a long playing record should play.

## THE PLAY IS THE THING

THERE weren't many railway compartment differences of opinion on TV's version of the Terence Rattigan play *The Deep Blue Sea*. The smooth, technical presentation reinforced the sensitive directorial touches of Julian Amyes' production, in which the principal parts were played by Googie Withers, Kenneth ("Genevieve") More and Robert Harris. This was a serious and adult dramatic work about human relationships, in which the consummate skill and craftsmanship of the playwright demonstrated that the power of the pen was more than equal to the cramping effect of the small television screen. One's faith in the future of the television play was restored. What a wonderful shop window it is, giving stage and film producers opportunities of spotting new talent in the small parts, while savouring and exploit-

ing to the full the virtuosity of the well-known and much experienced artists. Even the rather poor TV plays like *The Gift* serve their purpose, too. This little play, with John Slater in the principal part, had an amusing theme which would have adequately served a ten-minute revue sketch with a black-out ending. Instead, it was stretched out to about an hour, and not even the beautifully-spoken lines of John Slater as the clerk-turned-poet could sustain it. More important was the appearance of Frances Hyland as the hospital nurse who attended him. The importance of her performance was due to the moving interpretation of a part which offered few opportunities in dialogue, notwith-

standing a record number of superb close-ups. The lovely features of Miss Hyland, her poise, her restraint and her lovely voice must have registered the name "Hyland" in the minds of millions of viewers that Sunday night. I shouldn't be at all surprised if her telephone was kept ringing by inquiring impressarios on the Monday morning, following her performance in that very little play, *The Gift*! As a matter of fact, this is precisely what happened.

## TV ON MAGNETIC TAPE

I MUST admit that at one time the idea of recording TV pictures on magnetic tape seemed to me to be impossible. I visualised the tape travelling at about fifty miles a minute. And yet it is now an accomplished fact, demonstrated last month by R.C.A., at Princeton, New Jersey, U.S.A. Using half-inch tape carrying five magnetic sound channels, satisfactory recordings of colour television have been made and reproduced, with tape travelling at about 25ft. per second compared with the 15 or 7½ in. per second used for

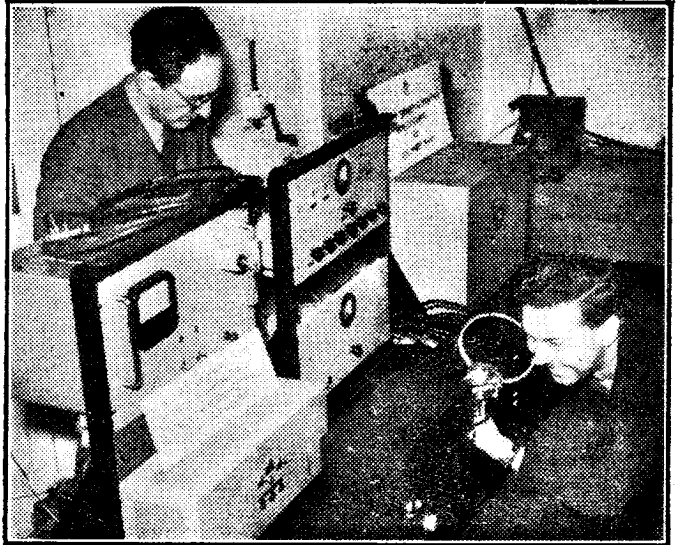

Two technicians from the Post Office Engineering Department (Radio Branch) seen setting up an Experimental Flying Spot Scanner producing television signals of standard waveform from 35 mm. film transparencies at the TV Exhibition.

high-fidelity sound recording and 90ft. a minute for sound film. The frequency response to be dealt with on magnetic tape has risen from a top limit for sound of about 15,000 cycles per second up to a new high level of 4,000,000 cycles per second. At present the

equipment is operated with reels 17in. in diameter and records up to four minutes of a TV programme. The R.C.A. research men hope to have the system on a fully developed commercial basis within two years, with an objective of a 19in. reel carrying a 15-minute pro-

gramme. The  $\frac{1}{2}$ in. magnetic colour-picture tape carries four picture tracks and one sound track, all in parallel. Thus, the tape can be cut and edited quite easily, as the sound is not in advance of the picture, as is necessary with sound films.

# Television in the U.S.S.R.

## FIRST DETAILS OF THE RUSSIAN DEVELOPMENTS

**R**EPORTS have been received from time to time that the Russian television system has reached a high standard, even so far as colour, which has reportedly been seen on the big screen. The first authentic information, however, came to hand only during the latter end of January and the accompanying illustrations show scenes in the studios and in a typical Russian home. The first thing which is noticeable is the rather simple type of camera, judged by either British or American standards, and the second, the small picture on the receivers. No information is forthcoming, however, as to whether this is a standard type of "people's" receiver, or a low-priced model in a general market. Another interesting point is that the camera operator in the ballet scene, which is an adagio from Don Quixote (danced by the

Stalin prizewinners, Balabina and Bergvadze), is a woman. Other photographs of studio scenes show a similar type of camera and no zoom lenses or even the larger type of telephoto can be seen in these.

The microphone appears to be hung from a simple type of boom and contrasts strongly with British and American apparatus. Studio lighting, too, appears to be rather simplified, but whether this is due to greater efficiency in camera equipment, or to lack of funds, cannot be ascertained.

The receivers would appear to be either 7in. or 9in. models, and again it is not possible to ascertain whether they include radio as well as television, but in one illustration there are six standard control knobs on the lower edge of the cabinet, and these may be the usual linearity and hold controls, brought out as manual controls.

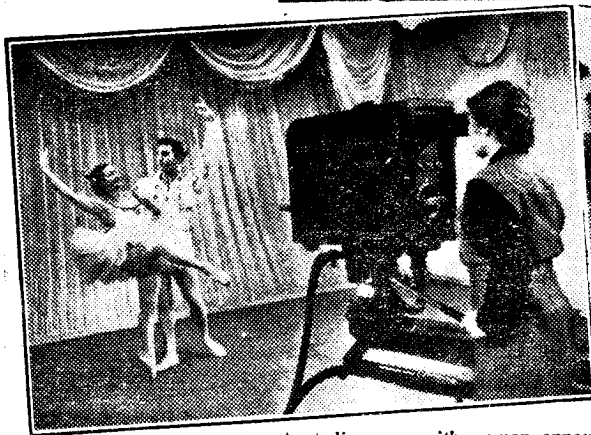

A studio scene with woman announcer in Moscow, a ballet scene in Leningrad, and a domestic scene in Kiev.



**DE LUXE TV. CABINETS.**  
Our new 1954 Mark II model.

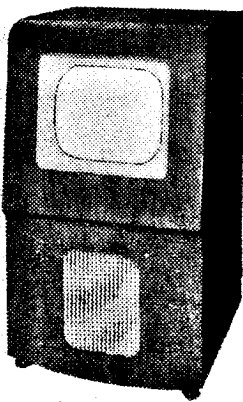

For 12in. C.R. tubes. Finished in beautiful figured walnut veneer, with either light, medium or dark polish. Supplied complete with mask, glass, back, speaker baffle and fret, castors and C.R.T. neck protector. Inside dimensions: 16 3/4in. deep, 17 1/2in. wide, 28in. high. Overall height 32in. and width 18 1/2in.  
**LASKY'S PRICE, £8/10/0.** Carriage 12/6 extra.  
This cabinet can be supplied with aperture for 16in. or 17in. C.R.T. at no extra charge, but the mask and glass will be omitted.

**SPECIAL C.R.T. OFFER**

Brand new and unused 12in. ion trap cathode ray tubes. 6.3 volt heater, 7-9 Kv. E.H.T. 35 mm. neck. Black and white picture. By famous manufacturer. PERFECT. £12/19/6. Carriage and insurance 15/- per tube extra.

**P.M. LOUDSPEAKERS**

All with 3 ohms speech coil  
2 1/2in. 15/- 4in. 9/6 6 1/2in. 15/-  
3in. 14/6 5in. 14/6 8in. 15/-  
10in. 17/6 12in. 49/6  
All loudspeakers offered are first grade and of highest quality construction. Many other types in stock. Send us your requirements.

**DINGHY AERIALS, WITH REFLECTORS**

Umbrella type, with wire mesh reflector.  
**LASKY'S PRICE, 5/-.** POST FREE.

**R.1132.A RECEIVERS**

Frequency coverage 100-124 Mc/s. 11 valves: 1 VR65, 1 VR66, 4 VR53, 2 VR54, 1 6J5, 1 V570, 1 VR57. Large tuning scale with slow motion drive. 0.5 mA. tuning meter, R.F. and L.F. gain controls, jack sockets for line and 'phone. Totally enclosed in metal case, with handles. Size: 18 x 10 x 11in.  
**LASKY'S PRICE, Less Valves, 20/-.** Carriage, 7/6 extra.

**SPECIAL BRAND NEW T.C.C. TV. CONDENSERS.**

32+100 mfd. 450 v.w. Type CE15PE. Price, 7/6.  
.04 mfd. 12.5 kv. Type CP59VO. Price 7/6.

**LASKY'S LINE FLYBACK E.H.T. TRANS.**

7-9 Kv. with EY51 heater winding, 19/6.

**C.R.T. Rear Neck Protector, 2/6.**

**CRYSTAL DIODES.** Wire ends, 1/6.

**WX6 WESTINGHOUSE** Miniature rectifiers. Wire ends, 1/6 each.

**MANUFACTURERS' SURPLUS TV. COMPONENTS**

- Wide Angle Scanning Coils, Low imp. line and frame ... pair 19/6
- Scanning Coils, 35 mm. Low imp. line and frame ... 12/6
- Frame multi ratio output trans. ... 10/6
- Focus Coil. 35 mm. electro magnetic ... 12/6
- Line or Frame B.O. transformer. Auto ... 4/6
- Wide Angle Frame B.O. trans ... 10/6
- P.M. Focus Magnets. With vernier, 35 mm. Tetrode ... 15/-
- Triode ... 17/6
- Wide Angle P.M. Focus Unit. For all 38 mm. tubes. With vernier and picture shift. Ferroxdure ... 25/-
- PLESSEY**
- Scan coils per pair ... 25/-
- Width Control ... 6/6
- P.M. Focus Magnet. Less vernier. 35 mm. ... 12/6.

**Co-Axial Cable.** 70-80 ohms impedance.

Single core, 8/- doz. yards.  
Twin Screened, 12/- per doz. yards.

**PLASTIC ESCUTCHEON SAFETY MASKS**

- Incorporating dark screen filter.
- 12in. Round Face ... 12/6
- 12in. Double D. Round Face ... 15/-
- 16in. for metal tubes ... 25/-

**TRIPLEX DARK SCREEN FILTERS**

- 14 x 12 1/2 x 3/16in. ... 7/6
- 15 1/2 x 13 1/2 x 3/16in. ... 9/6
- Postage and packing 5/- per piece extra. (This charge is necessary owing to extra packing required.)

**ARMOUR PLATE GLASS**

- 16in. Actual size 17 1/2 x 15 1/2 x 1/4in. 7/11
- 15in. Actual size 16 1/2in. x 13in. x 1/4in. ... 6/11
- 12in. Actual size 13in. x 10 1/2in. x 1/4in. ... 4/-
- 9in. Actual size 9in. x 8in. x 1/4in. ... 3/-

**C.R. TUBE MASKS**

New Aspect Ratio.

- 12in. Soiled, black rubber... 4/6
- 12in. Soiled, white rubber ... 7/6
- 12in. New, cream rubber ... 15/-
- 12in. as above, for flat face ... 15/-
- 14in. Cream plastic... 12/6
- 15in. Cream rubber ... 17/6
- 17in. White plastic... 21/-

**LASKY'S RADIO**

Lasky's (Harrow Road), Ltd.,  
370, Harrow Road, Paddington, London, W.9

Telephones: CUNNINGHAM 1979-7214. All Depts.

MAIL ORDER AND DESPATCH DEPARTMENTS: 485-487, HARROW ROAD, PADDINGTON, LONDON, W.10.

Hours: Mon. to Sat. 9.30 a.m. to 6 p.m.; Thurs., half day, 1 p.m. Postage and packing charges (unless otherwise stated): on orders value £1—1s. Od. extra; £5—2s. Od. extra; £10—3s. 6d. extra; over £10 carriage free unless specifically stated otherwise. All goods fully insured in transit.



**THE SIMPLEX**

New EF50 valves. Red by Sylvania, 10/- New Ex. Government, 7/-.  
EA50 2/- 6J5gt 5/- SP61 3/6  
EB34 2/- 6SN7 11/6

**RESISTANCES**

All values 1/2 and 3/4 watt., 4d. each. Condensers. Tubular waxed, 350 v.w. and 500 v.w. all values up to 1 mfd., 6d. each.  
.1 mfd. 350 v.w., 9d. each.  
.1 mfd. 500 v.w., 1/3 each.

**VCR97 CATHODE RAY TUBES.**  
35/- each. Carriage and packing 5/- extra.

**6in. SCREEN ENLARGERS.**

Clear or filter type. LASKY'S PRICE, 17/6. Carriage 2/6 extra.  
**BASE FOR VCR97, 2/6.**

**HIGH VOLTAGE CONDENSERS**

.1 + .1 mfd. 3.5 kv. Price, 5/11 each.  
**WRITE FOR OUR SIMPLEX PRICE LIST.**

**SPECIAL OFFER**

Scanning coils, low impedance line and high frame, and electro magnetic focus coil, high impedance. For use with C.R. tubes with 36 mm. neck.  
**LASKY'S PRICE, 27/6.** POST FREE.

**RF.25 UNITS.** With valves. 19/6. Postage 2/6.

**R.F. E.H.T. OSCILLATOR COIL**

6-18 Kv. With heater winding for EY51. Circuit and full data supplied. PRICE 25/-.

**R.F. OSCILLATOR E.H.T. KIT**

Consisting of R.F. Oscillator coil with EY51 heater winding, EY51 rectifier, 6V6 valve and base. All necessary condensers and resistances. Full circuit and data supplied. PRICE 53/6 COMPLETE.

**VALVES. 10,000 IN STOCK AT THE LOWEST POSSIBLE PRICES.**

SOME EXAMPLES.

1T4	7/6	6AM6	7/6	6K7	4/6
1R5	7/6	6V6	7/6	MS/Pen	4/6
1S5	7/6	6E5	7/-	U50	7/6
1C5	7/6	6X5	7/6	UY41	7/6
354	9/-	6F6	8/-	VU120	2/6
1D5	8/6	6J5	5/6	KTZ63	6/6
5Y3	7/6	6K8	8/6	OZ4	6/-
5Z4	8/6	6R7	7/6		

**S.T.C. SENTERCELL RECTIFIERS**

RM.1	... 3/10	K3/40, 3.2 kv.	... 6/-
RM.2	... 4/3	K3/45, 3.6 kv.	... 8/2
RM.3	... 5/-	K3/50, 4.0 kv.	... 8/8
RM.4	... 18/-	K3/100, 8.0 kv.	... 14/8
		K3/160, 12.8 kv.	... 21/6

**ALLEN WIDE ANGLE COMPONENTS**

D.C.300.C	Ferroxcube scan coils...	39/6
GL.16	Linearity coil	... 7/6
GL.18	Width coil...	... 7/6
FC.302	Focus coil	... 31/-
FO.305	Frame o.p. trans.	... 21/-
LO.308	Line E.H.T. trans.	... 40/-
	Frame Blocking Oscillator trans...	15/-



OPEN TILL 6 P.M. SATURDAYS

TELEPHONES: AMBASSADOR 4033 & PADDINGTON 3271/2

# PREMIER RADIO Company

B. H. MORRIS & CO (RADIO) LTD. EST. 40 YRS.

THIS IS OUR ONLY ADDRESS (Dept. PT) 207 · EDGWARE ROAD · LONDON · W2 (THIS IS OUR ONLY ADDRESS)

### PREMIER — MAINS TRANSFORMERS

All primaries are tapped for 200-230-250 v. mains 40-100 cycles. All primaries are screened. All LTs are centre tapped

**SP175B**, 170-0-175, 50 mA., 4 v. @ 1 a., 4 v. @ 2-3 a. ... 25/-

**SP250B**, 250-0-250, 60 mA., 4 v. @ 0-2 a. 4 v. @ 3-5 a. ... 25/-

**SP300A**, 300-0-300, 60 mA., 6.3 v. @ 2-3 a. 5 v. @ 2 a. ... 25/-

**SP300B**, 300-0-300, 60 mA., 4 v. @ 2-3 a. 4 v. @ 3-5 a., 4 v. @ 1-2 a. ... 25/-

**SP350A**, 350-0-350, 100 mA., 5 v. @ 2-3 a. 6.3 v. @ 2-3 a. ... 29/-

**SP351**, 350-0-350, 150 mA., 4 v. @ 1-2 a. 4 v. @ 2-3 a., 4 v. @ 3-6 a. ... 36/-

**SP375A**, 375-0-375, 250 mA., 6.3 v. @ 2-3 a. 6.3 v. @ 3-5 a. 5 v. @ 2-3 a. ... 55/-

**SP501**, 500-0-500, 150 mA., 4 v. @ 2-3 a. 4 v. @ 2-3 a. 4 v. @ 2-2 a. 4 v. @ 3-5 a. ... 47/-

**SP425A**, 425-0-425, 200 mA., 6.3 v. @ 2-3 a. 6 v. @ 3-5 a., 5 v. @ 2-5 a. ... 67/6

**EHT Upright** for VCR 97 tube, 2,500 v., 5 mA., 2-0-2 v., 1 a., 2-0-2 v., 2 a. ... 37/6

### V.G.R. 516 C.R. TUBES

9in. Blue picture. Heater volts 4. Anode 4 Kv. In manufacturer's original carton.

**£3.19.6**

Plus 5/- pkg., carr., ins.

**VCR 517C**  
6 1/2 in. picture, this tube is a replacement for the VCR7 and VCR77. Guaranteed full size picture. **PRICE 35/-**. Plus 2/6 pkg., carr., ins.



**AUTO TRANSFORMER**, 50 watts. Input Output 0-110-210-220-230-240-250 volt. Plus 1/- pkg. & carr., 7/6.

**A.C.R.I. C.R. TUBES**  
(DIRECT REPLACEMENT FOR A CR 2X)  
5 1/2 in. screen, 4 volt Heater. This Electrostatic Tube is recommended as eminently suitable for Television, 15/- plus 2/6 Pkg., Carr. and Ins. Data sheet supplied.

RECTIFIERS			
E.H.T. Pentil Type S.T.C.			
Type	K325	650 v.	1 mA. ... 4/7
"	K345	3.2 kv.	1 mA. ... 6/-
"	K350	4 kv.	1 mA. ... 8/8
"	K3150	12 kv.	1 mA. ... 21/6
H.T. Type S.T.C.			
Type	RM1	125 v.	60 mA. ... 4/-
"	RM2	125 v.	100 mA. ... 4/6
"	RM3	125 v.	125 mA. ... 5/6
"	RM4	250 v.	250 mA. ... 18/-
L.T. Type. Full Wave.			
6v. 1 amp.	...	...	4/-
12 v. 1 amp.	...	...	8/-
12 v. 2 amp.	...	...	10/9
12 v. 4 amp.	...	...	15/-

**SPECIAL OFFER**  
**CRYSTAL HAND MICROPHONE**  
High Impedance. Excellent frequency response light weight gives very high quality results when used with tape recorder, amplifies for any type of P. A. equipment. Complete with screen lead and plug. 29/6. Plus 1/6 pkg. and carr.



**Ex. W.D. STEEL AERIALS**  
Also ideal for fishing rods—**BRAND NEW** 12ft. 3 4ft. sections of copper-plated steel highly flexible tapering 1in. to 1/2in. Brand new in container. Plug-in type, 6/9. Screw-in type, 7/9. Packing and carriage, 1/6. Insulated Base 3/-. Webbing waterproof carrying case with shoulder-strap, 2/6.

**T.V. WHITE RUBBER MASKS (CORRECT ASPECT)**. We can supply a specially designed White Rubber Mask for 6in. C.R. tubes at 3/6 each, 9in. White Masks, 9/6. 12in. White Masks, 16/11. For Round or Flat faced Tube.

**TERMS OF BUSINESS:—CASH WITH ORDER OR C.O.D. OVER £1**  
Please add 1/- for Post Orders under 10/-, 1/6 under 40/-, unless otherwise stated.

**THE NEW PREMIER TELEVISION**  
Wide Angle scanning, for 14in. or 17in. Tubes may be used with a 12in. Tube with minor modification. Tunable from 40-68 Mc's without coil or core changing, completely isolated from the mains.  
The New Time Base may be used with existing Premier Televisions to convert them to the latest type of picture tubes. All the individual components may be purchased for a total cost of £31/10/7 (less tube).  
Data booklet, 3/6 post paid.

**NEW!**

## EXPERIMENTAL OUTFITS

### LEARN THE PRACTICAL WAY

Specialty prepared sets of television parts (which you receive upon enrolment) with which we teach you, in your own home, the working of circuits and bring you easily to the point when you can construct and service a television set. Whether you are a student for an examination; starting a new hobby; intent upon a career in industry; or running your own business—this Practical Course is intended for YOU—and may be yours at very moderate cost.

#### EASY TERMS FROM £1 A MONTH

A tutor is available to give individual help and guidance throughout the Course.

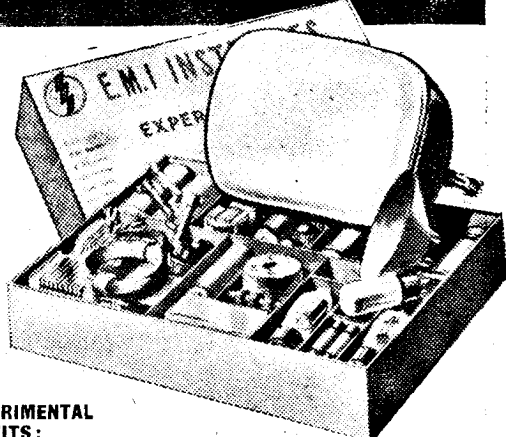

**POST THIS COUPON TODAY**

Please send me your FREE book on Practical Courses:

I am interested in.....

To: E.M.I. INSTITUTES, Dept. 138X, 43 Grove Park Road, Chiswick, London, W.4.

NAME.....

ADDRESS.....

**EXPERIMENTAL OUTFITS:**

**TELEVISION** — Instruction and equipment for building a Television Receiver.

**RADIO 1** — A course in basic principles.

**RADIO 2** — Instruction and equipment from which you build a Radio Receiver.

Also for Mechanics, Electricity, Chemistry, Photography, Carpentry, Draughtsmanship, Commercial Art, Amateur S.W. Radio, Languages.

**E.M.I. INSTITUTES** The only Postal College which is part of a world-wide Industrial organisation.



**Colour Tubes**

**P**RODUCTION of tubes for colour receivers began in America recently. The tubes will cost half as much again as those for black-and-white sets.

**Television Licences**

**T**HE following statement shows the approximate number of television licences issued during the year ended December, 1953. The grand total of radio and television licences was 13,268,270.

Region	Number
London Postal ...	870,069
Home Counties ...	324,801
Midland ...	588,324
North Eastern... ..	381,458
North Western ...	402,302
South Western ...	119,600
Wales and Border ...	137,931
<b>Total England and Wales</b>	<b>2,824,485</b>
Scotland ...	124,723
Northern Ireland ...	7,638
<b>Grand Total ...</b>	<b>2,956,846</b>

*The Editor will be pleased to consider articles of a practical nature suitable for publication in "Practical Television." Such articles should be written on one side of the paper only, and should contain the name and address of the sender. Whilst the Editor does not hold himself responsible for manuscripts, every effort will be made to return them if a stamped and addressed envelope is enclosed. All correspondence intended for the Editor, should be addressed to: The Editor, "Practical Television," George Newnes, Ltd., Tower House, Southampton Street, Strand, W.C.2.*

*Owing to the rapid progress in the design of radio apparatus and to our efforts to keep our readers in touch with the latest developments, we give no warranty that apparatus described in our columns is not the subject of letters patent.*

*Copyright in all drawings, photographs and articles published in "Practical Television" is specifically reserved throughout the countries signatory to the Berne Convention and the U.S.A. Reproductions or imitations of any of these are therefore expressly forbidden.*

**Low Suppressor Sales**

**I**T is feared that although sales of television receivers continue to soar, the number of suppressors

sold for cars becomes lower and lower.

One dealer in Sheffield complains that from a card of 24, only ten have been sold in the past two years.

**Swiss Order Equipment**

**T**HREE Emitron Mobile Microwave Links ordered by the Swiss Post Office are to be augmented by a further three complete units. These will be used in connection with the Anglo/European interchange of television programmes.

Emitron Links, which are extensively employed by the BBC, are used to relay outside television broadcasts from location to the main transmitter. They use a special type high power Klystron Valve—developed in E.M.I.'s Research Laboratories—which gives them an exceptionally long range. Two of these links were used by the BBC in their original link-up with France on the occasion of the first relay of French programmes to Britain in 1952.

**Television and Furniture**

**I**N France, furniture makers have foreseen that TV is going to have an effect that may benefit the furniture dealer. Viewers have to sit close around the set, which means that chairs must give the greatest comfort and the least encumbrance. Friends are invited in to see the TV programme, and the hostess likes to seat them on good chairs. This problem of getting much into little has become a fine art in France.

The annual furniture trade show, held each year in the furniture section of the Foire de Paris, May 22nd to June 7th, will this year show a number of clever novelties in furniture for the home.

**Two on One**

**A**N entirely new type of television receiver has been produced in the United States and demonstrated in New York recently. It is the Du Mont Duoscope, by which it is possible to receive two programmes simultaneously from

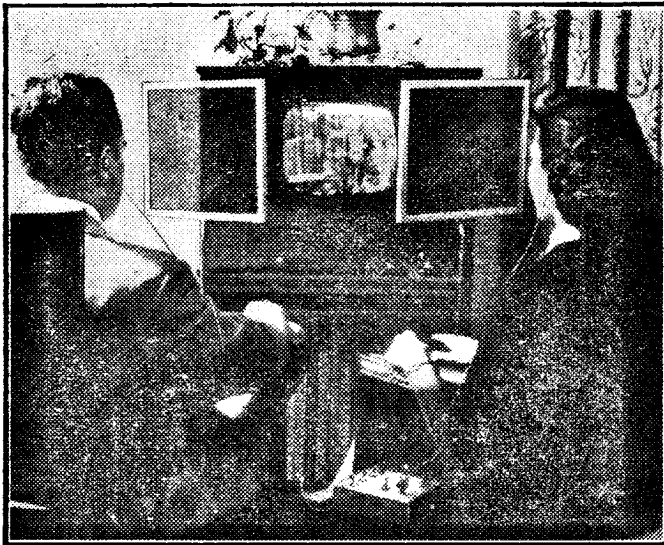

The new Du Mont Duoscope receiver enables two people to view different programmes at the same time.

two different channels, neither interfering with the other.

Two sound systems provide individual reception of audio signals accompanying each programme.

### Developments in Hungary

**D**EVELOPMENT of a television service in Hungary is making such steady progress that it is hoped to be able to give an on-the-spot broadcast of the traditional procession on May 1st. The first 625-line test transmission, using only a receiver-type antenna, was successfully received on a Soviet-type receiver 2½ miles away on December 17th.

The next step will be to instal the experimental antenna tower and equipment on Széchenyi Hill (1,430 ft.) one of the highest points in the Buda Hills west of the city. After that the permanent 500ft. antenna tower will be built and film transmissions will be replaced by studio programmes and live broadcasts.

### First African TV Station

**I**N December, the first TV station on the African continent was set up at Casablanca in Morocco. The station, which operates on 819 lines, has been supplied with a camera chain, a telecine camera and vision and sound transmitters by Pye Limited.

At the RCA plant in Lancaster, Pennsylvania, a double line of tri-colour TV tubes approaches an air exhausting machine to create a new vacuum.



The private company which has established this first African station received its concession from the Moroccan Government in 1951 and precedes both Algeria and Tunisia, where the introduction of television is planned by the Radiodiffusion-Television Francaise.

### BBC Appointment

**T**HE BBC announces the appointment of Mr. A. I. Bray, B.Sc.(Eng.), A.C.G.I., A.M.I.E.E., as Engineer-in-Charge, Television Outside Broadcasts (London).

Mr. Bray joined the engineering staff of the BBC in 1935 and was attached to the London Outside Broadcasts section. He transferred to Television Outside Broadcasts in 1936 and from 1940-46 he served in the R.A.F. and attained the rank of Squadron Leader.

Mr. Bray rejoined the BBC early in 1946 in the Planning and Installation Department and returned to Television Outside Broadcasts later in the same year, where he remained and held a number of senior posts in the London section until taking up his present appointment.

### New Zealand Experiment

**R**ECENTLY Mr. C. R. Thompson, a senior television engineer in Pye, left England for New Zealand, where he prepared a studio, complete with television cameras and transmitting equipment, which put out New Zealand's first television broadcasts.

Programmes, which were broadcast for about four or five hours a day, tried to show as many sides of television entertainment as possible. Mr. Thompson, who was responsible for the production and provision of programmes, produced about 45 minutes of variety in the evenings, together with light entertainment, ballet and quizzes at other times. The programmes were broadcast daily from the Wellington Show and In-

dustrial Fair, starting on January 7th and continuing until January 27th.

### Exchange with Italy

**A**LTHOUGH Italy's nine-transmitter television service covers an area inhabited by 20 million people, to date only 12,000 receivers have been sold.

Officials believe that within six months it will be possible to transmit direct programmes between Italy and this country, which means that viewers may well see the opening night of La Scala Opera House, Milan.

### Outside Unit for N.E.

**A**CCORDING to Mr. Edward Wilkinson, Newcastle station director of the BBC, a new outside-broadcast unit is to be made available for the North-East.

Mr. Wilkinson revealed this at a meeting of the Newcastle West Rotary Club when he said that, in the past, the North-East area had been sharing Scotland's O.B. unit, but the new one, with a crew of 30, would be more beneficial.

### North Wales Coverage

**T**HE BBC proposes to provide TV coverage for North Wales by boosting programmes from the Sutton Coldfield or Holme Moss stations.

This follows many complaints received by the BBC of bad reception in North Wales and cases of no signal reception at all in some areas due to the hilly terrain. The new station is expected to be sited at Towyn.

### Irak Trade Fair

**T**HE people of Irak will see television for the first time when it is demonstrated at the British Trade Fair at Baghdad in the autumn.

### BBC Moves House

**A**S the BBC will have moved their premises from Alexandra Palace to the White City by 1956, the former is now being used only as a transmitting station.

The removal of 1,500 tons of stage property and scenery to the White City is nearing completion and programme producers will be able to draw on these stocks for productions at Lime Grove studios, less than a mile away from the White City.

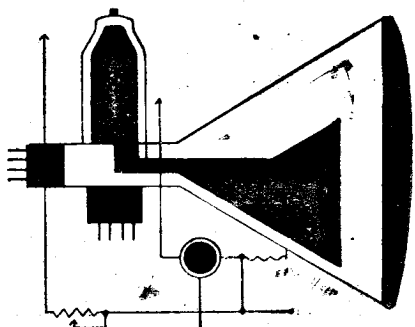

## Smith's for current "know how"

From Smith's shops and book-stalls you can quickly obtain technical books on the latest developments in circuit design, new components, methods and new theories. Books not actually in stock can usually be supplied within a day or so.

Smith's Postal Service can send books to any address at Home or Overseas. Lists of the standard works on any subject gladly supplied upon request.

# W. H. Smith & Son

FOR TECHNICAL BOOKS

HEAD OFFICE: STRAND HOUSE, LONDON, W.C.2

# AERIALITE AERIALS

are designed for

## HIGH PERFORMANCE



**AERFRINGE.** For long distance reception this range has the high electrical performance which is essential. The robust construction ensures long service even in the most exposed conditions. The range is available with 10' or 14' alloy mast and double chimney lashings or arrays only. Prices from £12.15.0 complete (Model 63).

**Model 63A.**  
Forward Gain  
8dB.  
Front/back  
Ratio 21.6dB.  
Acceptance  
Angle 55°.

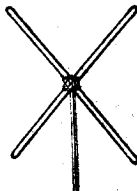

**DUBLEX.** Special folded-dipole construction plus driven array connections make the Dublex the highest gain aerial in this price bracket. The Dublex (as supplied to the B.B.C.) is available with 7', 10' or 14' masts or as an array only. The Dublex 77S (7' mast single lashing bracket) is £4.8.6 complete. (Mast and array is only 3.2 lbs.)

**Model 77.**  
Forward Gain  
6dB.  
Max/min  
Ratio 25dB.  
Acceptance  
Angle 96°.

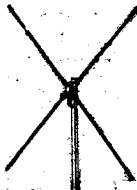

**UNEX.** Light in Weight, high in performance, the Unex combines excellent forward gain with robust construction at a low price. The cross-connected elements give a driven array which is extremely easy to erect. The Unex 83S (with 6' alloy mast, single lashing chimney bracket) is only £3.19.6 complete.

**Model 83.**  
Forward Gain  
3dB.  
Front/back  
Ratio 25dB.  
Acceptance  
Angle 176°.

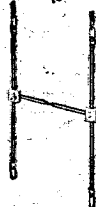

**AERFOLD.** Where conditions do not allow an outdoor aerial to be fitted the Aerfold provides a high gain aerial which has excellent directivity. It is easy to fit and by rotation, will eliminate or substantially reduce interference. Price £15.0.

**Model 71.**  
Forward Gain  
3.75dB.  
Max/min  
Ratio 40dB.  
Acceptance  
Angle 120°.

### ACCESSORIES

Coaxial plugs, sockets, connector boxes, matching boxes, gutter brackets, tile clips, lightning arrestors, etc.

### H.F. CABLES

All types, including coaxials, twin feeders and screened balanced twin. Applications cover T.V. and radio down-leads, etc.

### CONNECTOR WIRES

P.V.C. insulated single conductor and multi-strand types. Also, screened and sheathed electronic cables and H.T. connecting wires.

THE AERIAL'S RIGHT  
IF IT'S AN AERIALITE

# Aerialite LTD.

CASTLE WORKS STALYBRIDGE CHESHIRE



# CORRESPONDENCE

The Editor does not necessarily agree with the opinions expressed by his correspondents. All letters must be accompanied by the name and address of the sender (not necessarily for publication).

## STRANGE FAULT

**SIR,**—The following experience may be of interest and perhaps assistance to some of your readers.

For some time past my receiver had been developing an intermittent fault affecting both sound and vision. This took the form of a soft rustling or crackling on sound, accompanied by a flickering of the picture, with the occasional momentary appearance of black lines across the screen.

Careful examination of the indoor dipole in the bedroom above, the coaxial, and all stages in the receiver common to sound and vision failed to reveal any defect. It was not until my wife remarked that the interference seemed to coincide with high winds that I thought of looking outside the house and there, sure enough, was my neighbour's broadcast receiving aerial, a vertical wire hanging from the eaves, only a few feet from my bedroom window, on the inner frame of which was my TV dipole.

It took only a few minutes to establish the fact that it was this vertical wire, swaying in the wind, which was the cause of the trouble, and further investigation revealed an intermittent break in the wire, inside the insulation. My neighbour innocently remarked that he had been wondering for some time why he got such a lot of crackling on his broadcast receiver!

Perhaps someone can suggest a full technical explanation of the interference with my receiver. I can only assume that the vertical wire outside, which was roughly in the opposite direction to the transmitter from my indoor dipole, was acting as a parasitic reflector whose efficiency varied with its position and length, as determined by the intermittent make and break at the fault. Another possibility is the intermittent discharge of static accumulating from wind friction. It is possible to go on theorising indefinitely, but the fact remains that a most troublesome fault is now cured, and I am wondering if anyone else has been similarly puzzled.  
—H. B. GREGORY (Birmingham).

## CONVERTER FOR R1155

**SIR,**—I should like to obtain information to construct a converter for use with my 1155 receiver for the television sound programme and to house it in the casing now containing the A.V.C. and B.F.O. valve, the A.V.C. being transferred to the double-diode-triode used for detection and output.

I am wondering whether any readers have carried out such a modification successfully.—E. N. DRIVER (Hove).

## AUTOMATIC CONTRAST CONTROL

**SIR,**—In recent months there has been considerable interest in various forms of automatic contrast control. The writer has made various experiments with "gated" methods in which the gating pulse has been derived from the frame timebase and the circuit shown below for use with a grid-modulated C.R.T. was found to be the most successful.

The positive gating pulse is derived from the anode of the frame output valve. It is necessary to delay this pulse so that it coincides with the frame blanking period following the frame sync pulses and, to ensure that the valve does not conduct between the pulses, a D.C. restorer is connected between the suppressor grid and earth.

Positive-going video signal is coupled to the control grid of the gating valve through a condenser and D.C. restoration is provided for by fitting a GEX35 crystal. The potential divider R1 and R2 biases the valve and R2 is variable and used as the contrast control.

The components C1, C2, R3 and R4 are chosen so that the valve just conducts for the correct length of time; i.e., during the 10 blank lines at the top of the picture, and an oscilloscope connected at "X" is necessary when making these adjustments. The values shown are used in conjunction with Allan Components wide angle output transformer and circuit.

Signal strength can vary considerably without any change in contrast and even with very bad reception conditions, the circuit is also very effective in reducing aircraft "flutter."—E. J. SOUTHWARD (Beckermat).

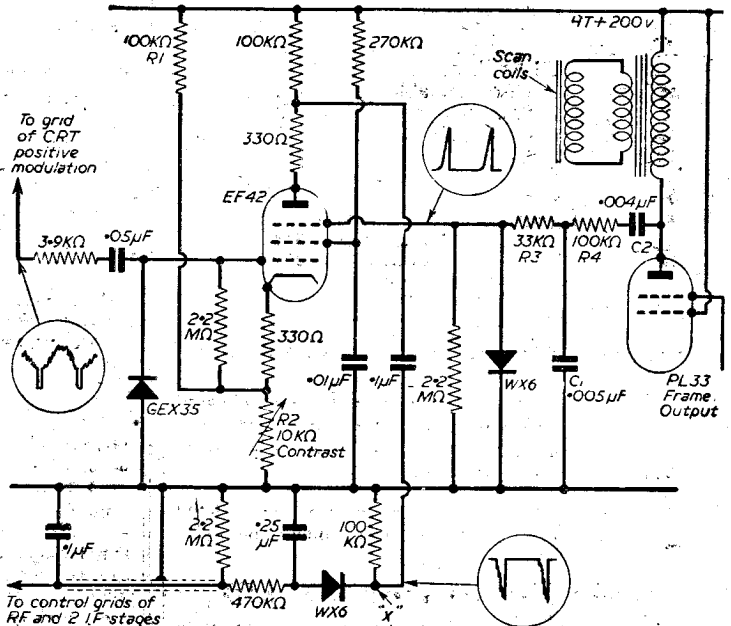

Circuit referred to in Mr. Southward's letter.

**INCREASING PICTURE SIZE ON A 6in. TUBE**

**SIR**,—Re Mr. R. A. Hill's article, in the December issue, on "Increasing Picture Sizes on a 6in. Tube," most VCR97 users, including myself, would have been very grateful had he given us some ideas for gaining extra scanning power from the timebases to scan the increased picture area. I am using two SP61s for line timebase and two SP61s for frame timebase, and whilst I have a very good picture, and good linearity and hold, I find it impossible with 425 volts on the T.B. H.T. rail and 2.5 kV. E.H.T., to even get a picture as big as 5in. by 4in.—nor have I come across any other VCR97 user who has obtained sufficient power to scan the whole of the tube. It is very easy if the E.H.T. is reduced to 1.7 kV., but brightness and focus suffer at less than 2.5 kV. I should be very interested to know if anyone has been able to scan the whole of the VCR97 tube, and, if so, have they any tips to offer?—E. G. WARDER (Darlington).

**USING RF27**

**SIR**,—Seeing my letter and your reply in PRACTICAL TELEVISION, for which many thanks, I thought you might be interested to know that the RF27 unit is now working perfectly.

Having received Wenvoe sound on a super-regenerative detector with an inverted L aerial I thought I should get the same aerial to work with the RF27. On your advice I made a rough dipole and mounted it on my shack and was at once able to tune in Wenvoe.

I have the unit now coupled to a detector plus output valve and the volume and quality is excellent.

By the way, I had to give up the super-regenerative detector owing to the interference it was causing not only on Wenvoe but also on 1,500 metres!—D. RALPH (Yeovil).

**SERVICING EXPERIENCES**

**SIR**,—I have been an enthusiast for over 20 years, and while I haven't any fancy letters after my name I pride myself on the ability to read a circuit from aerial to output, naming and describing the functions of each component and also to execute a neat and workmanlike repair.

On two occasions in the past I was offered part-time work by so-called reputable dealers and I was appalled at the dishonesty I met with. On one popular model television set I diagnosed a faulty video amplifier (EF50). When this valve was replaced the set functioned perfectly.

The dealer, however, insisted on replacing the tube; saying that he would be able to use the tube in another set. On another occasion I had to deal with a model which embodied an oscillator tuning control on the back. This set gave very poor sound with no picture. Apparently, the customer's little boy had turned this tuning control round and did not say anything about it. Although this job took only three or four minutes, the dealer's bill listed two new valves, new brilliance control and 10s. 6d. labour charge.

The last and most recent occasion was when I received a 12in. television for service which had been to a firm which has a very large shop in the West End of London. Their estimate amounted to £22 10s. On examination I found that the dust in the back of the set had not been disturbed and in my opinion the back had not been removed at all.—GEORGE FIELD (London, E.3).

**"VIEW MASTER" EXPERIENCE**

**SIR**,—I have always been very interested by your advice to correspondents in "Your Problems Solved."

My experience with View Master may be of interest. I had good results on London with 12in. CRM121 and Premier pre-amp.

Then when Truleigh Hill started I bought Corsor 15in. from "Elpreg" and a set of Kirk o'Shotts coils (not specified "Wearite"). I also increased E.H.T. using K3/100 as shown in your March, 1953, issue, page 457. I also carried out modifications to timebase to fully scan tube as described in more recent issue of View Master booklet.

I could not get the line to hold, tearing on whites being the trouble. I tried all the remedies suggested in your columns without success.

When talking to a very technical friend I described my efforts and, in passing, mentioned that the cores of the vision strip were all at least  $\frac{1}{2}$ in. high above chassis when peaked; two almost falling out. From his spares box he gave me two aluminium cores for these and brass for the others. The effect was astonishing; sound is now twice as loud, the picture perfect, contrast control has plenty of reserve power, none before. I have since heard he has helped two other View Master constructors the same way; all of us had used the same coils.

Hoping my experiences will be of interest to you and thanks for your interesting monthly.—A. W. LYONS (Worthing).

**'H' VERSUS MULTI-ARRAY**

(Concluded from page 466)

70-80 ohm coaxial low-loss semi-air spaced, 2/3 yd., list.

Thus, even taking the widest comparison, the ratio is only 4.5/1 and not 5/1, but it must also be remembered that the loss on the balanced cable is 4.5 db per 100ft. at 50 Mc/s, whereas the loss on the expensive low-loss coaxial cable is only 1.60 db per 100ft. at 50 Mc/s. If you want the most efficient cable you have to pay for it, as you do with anything else.

In defence of the article, I must mention that under certain rare conditions the general effects found on aerial performance are reversed. These effects are not widely understood and are the result of propagation anomalies and not failure on the part of the aerial. "Odd" results can be expected in areas where "ghosting" is severe, and where, in any case, the aerial is selected to give the best rejection of reflections, and on the South Coast, in the Brighton-Worthing area, here, before the opening of Truleigh Hill booster station, the only signal available was a much refracted one arriving from Alexandra Palace across the South Downs, and it was found that often a stronger signal, but one with poor resolution, was obtained on an "H" aerial.

Also, it must not be forgotten that if any aerial is installed within a wavelength or so of any conductive object, or even of any insulator of dielectric constant different from that of air, then the impedance, gain and polar diagram will be modified in a completely unpredictable manner, and to avoid this in any "fringe" installation it is important to support the aerial on a mast well clear of all surrounding objects.—A. HALE (Belling and Lee Ltd.).



The



# ELECTRONIC TESTMETER



This instrument has been developed to meet the growing demand for an instrument of laboratory sensitivity built in a robust and portable form, for use in conjunction with electronic and other apparatus where it is imperative that the instrument should present a negligible loading factor upon the circuit under test.

The instrument consists basically of a balanced bridge voltmeter. It incorporates many unique features and a wide set of ranges so that in operation it is as simple to use as a normal multi-range testmeter.

The instrument gives 56 ranges of readings as follows:—

**D.C. VOLTS:** 5mV. to 250V. (Input Resistance 11.0 megohms.)  
25mV. to 10,000V. (Input Resistance 110.0 megohms.)  
**D.C. CURRENT:** 0.5 $\mu$ A. to 1 Amp. (250mV. drop on all ranges.)  
**A.C. VOLTS:** 0.1V. to 2,500V. R.M.S. up to 2 Mc/s. With diode probe external 0.1V. to 250V. R.M.S. Useful measurements can be made up to 200 Mc/s, the applied voltage being limited to 100V. above 50 Mc/s.

**A.C. OUTPUT POWER:** 5mW to 5 watts in 6 different load resistances from 5 to 5,000 ohms.  
**DECIBELS:** -10db. to +20db.  
**CAPACITANCE:** .0001 $\mu$ F. to 50 $\mu$ F.  
**RESISTANCE:** 0.2 ohm to 10 megohms.  
**INSULATION:** 0.1 megohm to 1,000 megohms.

**£40** Size: 12 $\frac{1}{2}$  ins. x 9 ins. x 5 $\frac{1}{2}$  ins.  
Weight: 12 $\frac{1}{2}$  lbs.

The instrument operates on A.C. mains, 100-130V. and 200-260V., 50-60c/s

Write for fully descriptive pamphlet.

The instrument is quickly set up for any of the various tests to be undertaken, a single range selector switch automatically removing from the circuit any voltages and controls which are not required for the test in question.

Sole Proprietors and Manufacturers:

**The AUTOMATIC COIL WINDER & ELECTRICAL EQUIPMENT CO. LTD.**  
WINDER HOUSE • DOUGLAS STREET • LONDON • S.W.1 Telephone: VICTORIA 3404/9

E.T.M.3



## GUIDE TO NEW TYPES

The following notes are a convenient reference to new types introduced during recent months

### VALVES

- Z309** Short base high slope R.F. pentode video amplifier. Slope 15 mA/V. Heater 12.6V 0.3A or 6.3V 0.6A. Base: B9A.
- Z719** Short base R.F. pentode. High input impedance. Slope 7.4 mA/V. Heater 6.3V 0.3A. Base: B9A.
- N329** Output pentode for sound and frame time base output stages in transformerless television receivers. Heater 16.5V 0.3A. Base: B9A.
- U43** Miniature wire-in television EHT rectifier. Indirectly heated P.I.V. 17 kV. Heater 6.3V 90 mA.
- Z729** Low hum, low microphony A.F. pentode for use in early stages of high gain amplifiers. Hum level 1.5 $\mu$ V. Heater 6.3V 0.2A. Base: B9A.
- N727/6AQ5** Beam tetrode. Heater 6.3V 0.45A. Direct replacement for American 6AQ5. Base: B7G.
- W727/6BA6** Variable-mu R.F. pentode. Heater 6.3V 0.3A. Direct replacement for American 6BA6. Base: B7G.
- X727 6BE6** Heptode. Direct replacement for American 6BE6. Base: B7G.
- U709** Full wave, indirectly heated 350V 150mA rectifier. Heater 6.3V 0.95A. Base: B9A.

### CATHODE RAY TUBES

- 7201A** 14" rectangular all-glass tube. Flat aluminised screen, Grey filter glass face. Heater 6.3V 0.3A. EHT 10.8-14kV. Base: B12A.
- 7101A** 12" circular tube. Aluminised screen. Maintenance type only. Direct replacement for 6703A and 6704A. Heater 6.3V 0.3A. EHT 6-8kV. Base: I.O.
- 7102A** 12" circular tube. Aluminised screen. Direct replacement for 6705A and 6706A. Heater 6.3V 0.3A. EHT 7-10kV. Base: I.O.

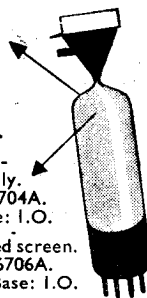

### BARRETTTER

- 305** Barretter. 0.3A. Voltage range 40-90V. For the regulation of heater current in transformerless television receivers. Base: E.S.

### GERMANIUM-DIODE

- GEX34** High level vision and sound detector and sound noise limiter. Direct replacement for GEX44/1 (discontinued), Colour code red/orange/yellow.

# U.E.I. CORPN.

THE RADIO CORNER, 138, GRAY'S INN ROAD, LONDON, W.C.I. (Phone TERminus 7937.)

## "SIMPLEX" PARTS

**ALUMINIUM CHASSIS.**—18in. x 15in. x 2 1/2in. 17/6.

**TRANSFORMER.**—350-0-350 v. 150 ma.; 6.3 v. 5 a., 5 v. 3 a., tapped at 4 v., ONLY 32/6. (Postage 2/-).

**RECTIFIERS.**—RM3 5/9 ea., K3/40 7/6 ea.

**VALVES.**—EF50 6/6, SP61 4/-, 6SN7 11/6, 6J5 5/6, EB34 3/6, EA53 3/6.

**VALVEHOLDERS.**—B9G/EP50; 10d., I.O. and M.O. 6d., Diode (EA50) 6d., VCR97 2/6.

**VCR97 TUBE.**—Tested full screen, 42/6.

**CONDENSERS.**—Electrolytics 25 mfd. 25 v. 1/10, 16 x 16 mfd. 450 v. 7/-, 32 x 32 mfd. 450 v. 6/-, 1 mfd. 2,500 v. 4/6. Mica, silver mica, and tubulars, 350 v. 6d. each.

**POTENTIOMETERS.**—All values preset 1/9 each, long spindle 3/-, with switch, 4/6.

**RESISTORS.**—1 watt 4d., 1 watt 5d., 1 watt 6d., 1.5 K. 5 watt, 1/6.

**COIL FORMERS.**—1in. 8d., 1in. 10d.

**SPEAKER.**—6in. ROLA P.M. with trans. 17/6 (postage 2/-).

All Components Brand New and Unused. Full Price List available on request.

## VALVES

1G5	6/6	6SS7	7/6	1T4	8/-
1G6	6/6	7A7	8/6	1R5	8/-
1E7	6/6	7C5	8/6	5Z4	10/-
1LH4	8/-	7F7	8/6	5U4	10/-
1LN5	8/-	7W7	8/6	6AC7	6/6
1LA	7/6	12H6	8/6	6X7CT	5/6
2B7	8/6	12J5	6/-	807	7/6
3A4	8/-	12AH7	12/6	ECH35	12/6
3B7	8/6	12SG7	7/6	EA50	3/6
6AG5	7/6	12SK7	8/6	EBC33	8/6
6AK7	9/6	12SR7	7/6	EB34	3/6
6B4	7/6	28D7	7/6	EP36	6/6
6B3	7/6	32	7/6	EP39	6/6
6C3	8/-	36	7/6	EP50	6/6
6G6	6/6	50Y6	8/6	Red	
6H5	5/-	58	8/6	Sylvania	8/6
6K5	9/-	1622	11/-	EF35	12/6
6L7	7/6	1625	7/6	EK32	6/6
6N7	7/6	1626	4/-	EL32	7/6
6R5	8/6	1299A	7/6	SP61	4/-
6U5	8/6	VR150/30	8/6	MU14	10/6
6V6	10/6	VR137	5/9	RL37	6/-
6SA7	8/6	KT41	8/6	VS70	7/6
6SG7	7/6	KT2	5/-	964	6/-
6SH7	7/6	VP23	6/6	955	6/-
6SJ7	8/6	HL23DD	6/6	9003	6/-
6SK7	7/6	TP25	8/-	9004	6/-
6SL7	9/-	1S5	8/-	931A	50/-

**RECEIVER R 3118.**—A further supply of the very popular unit we sold out of a few months ago. Ideal for conversion to TV, having a built-in A.C. Mains Power Pack for 180-240 volts. Is tremendously powerful, employing 7 I.F. stages of 12 mc/s with 4 mc/s band-width, and has 16 valves: 6 of VR65, 4 of VR92, 2 of VR196, and 1 each VR137, P61, 5Z4 and Y61 "Magic Eye." In new condition, ONLY 97/6 (carriage, etc., 7/6).

**TRANSFORMERS.**—Manufactured to our specifications and fully guaranteed Normal Primaries. 425-0-425 v. 200 ma. 6.3 v. 4 a., 6.3 v. 4 a., 5 v. 3 a., ONLY 50/-, 350 v.-0-350 v. 160 ma., 6.3 v. 5 a., 6.3 v. 3 a., 5 v. 3 a., ONLY 42/6; 250 v.-0-250 v. 100 ma., 6.3 v. 6 a., 5 v. 3 a., ONLY 32/6, 350 v.-0-350 v., 150 ma. 6.3 v. 5 a., 5 v. 3 a. ONLY 32/6. The above are fully shrouded, upright mounting, 5.5 kV. E.H.T. with 2 windings of 2 v. 1 a., ONLY 72/6; 7 kV. E.H.T. with 4 v. 1 a., ONLY 88/6. PLEASE ADD 2/- POSTAGE FOR EACH TRANSFORMER.

**E.H.T. TRANSFORMER FOR VCR97 TUBE.**—2,500 v. 5 ma. 2-0-2 v. 1.1 a. 2-0-2 v. 2 a. 37/6 (postage 2/-).

**INDICATOR UNIT TYPE 62A.**—A two deck chassis job, this contains VCR97 Tube with mu-metal screen, 12 valves EF50, 4 of SP61, 3 of EA50, and 2 of EB34. IN NEW CONDITION IN MAKER'S TRANSIT CASES. ONLY 99/6 (carriage, etc., 10/6).

Open until 1 p.m. Saturdays, we are 2 mins. from High Holborn (Chancery Lane Station), 5 mins. by bus from King's Cross. Cash with order, please, and print name and address clearly. Include postage as specified and on Component Orders under £2.

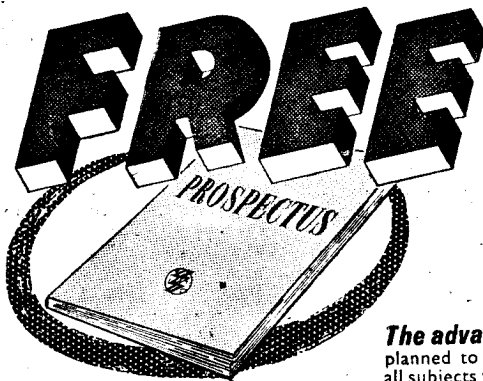

POST THE COUPON TODAY FOR OUR BROCHURE ON THE LATEST METHODS OF HOME TRAINING FOR OVER 150 CAREERS & HOBBIES

**PRIVATE AND INDIVIDUAL TUITION IN YOUR OWN HOME**  
City and Guilds Grouped Certificates in Telecommunications: A.M. Brit. I.R.E. Examination, Radio Amateur's Licence, Radio and Television Servicing Certificates. General Radio and Television Courses, Radar, Sound Recording, etc. Also Courses in all other branches of Engineering and Commerce.

**The advantages of E.M.I. training.** ★ The teaching methods are planned to meet modern industrial requirements. ★ We offer training in all subjects which provide lucrative jobs or interesting hobbies. ★ A tutor is personally allotted by name to ensure private and individual tuition. ★ Free advice covering all aspects of training is given to students before and after enrolling with us.

**NEW LEARN THE PRACTICAL WAY.**  
With many of our courses we supply actual equipment thus combining theory and practice in the correct educational sequence. Courses include: Radio, Television, Electronics, Draughtsmanship, Carpentry, Photography, and Commercial Art, etc.

**Courses from £1 per month**

**POST THIS COUPON TODAY**

Send without obligation your FREE book. E.M.I. INSTITUTES, Dept. 138K, 43 Grove Park Road, London, W.4. Phone: Chiswick 4417/8.

NAME \_\_\_\_\_  
ADDRESS \_\_\_\_\_  
SUBJECT(S) OF INTEREST \_\_\_\_\_

**EMI INSTITUTES**  
The only Postal College which is part of a world-wide Industrial Organisation.

# YOUR Problems SOLVED

*What we are always pleased to assist readers with their technical difficulties, we regret that we are unable to supply diagrams or provide instructions for modifying surplus equipment. We cannot supply alternative details for constructional articles which appear in these pages. WE CANNOT UNDERTAKE TO ANSWER QUERIES OVER THE TELEPHONE. The coupon from p. 485 must be attached to all queries, and if a postal reply is required a stamped and addressed envelope must be enclosed.*

## VCR97 VARIATIONS

I have a VCR97 rig using the "beginner's timebase" circuit using 6SN7s (as I had them available) in the outputs of line and frame. My E.H.T. is derived from a doubler circuit and is 2,480 volts on calculation from current flowing in network. With key of tube at 12 o'clock there is full scan right off each edge on frame, and line can only be scanned to within  $\frac{1}{8}$  in. of edge of tube. Increasing the pot. feed control just reduces this further with serious cramping up of picture at right side. Timebase H.T. is 420 volts. On reducing E.H.T. by inserting a resistor in series with secondary of transformer full line scan can be obtained with picture right off each edge of tube. By experimenting I have found by reducing E.H.T. to 1,960 volts I can fully scan tube and the edge of picture is just visible at extreme edges of tube. I turn tube 90 deg. and find that on full E.H.T. I can fully scan tube on line, but more serious cramping occurs now on frame scan, and to obtain full scan on frame, E.H.T. has to be reduced to 1,820 volts. — Alex M. Gellatty (Dundee).

VCR97s vary in their response as they have been made by different manufacturers and it is possible that yours is one of the more insensitive type. The flyback condensers in frame or line oscillators can be increased in value to obtain greater scan, but there is then the possibility of foldover at either the top or the left-hand edge.

Further increase can only be obtained by increasing timebase H.T. or reducing the E.H.T.

## FOCUS DIFFICULTY

Could you help me with a focusing problem with my Viewmaster? With the old 12in. tube it was all right, but I have recently fitted a Cossor 15in. 85 tube and I cannot focus the tube all over. If I get the middle focused all right the corners and the bottom are blurred. Get the outside edges all right and then the middle is blurred. I have played for hours on end with the iron trap and focus magnets, but wherever the position, the tube will not focus the lines all over. I have stepped up the E.H.T. as quoted in June, 1951, issue of "Practical Television," but it is just the same on 9 kV. as it was on 6 kV. Is it possible that these tubes have a faulty screen coating and that is why they became manufacturers' surplus stock? — W. Herring (Birmingham).

The fault you complain of may be due to an unsuitable focus ring or to the position of the focus ring; we suggest, therefore, that you move the focus ring farther from the scanning coils by at least  $\frac{1}{2}$  in., then re-focus, and if there is no improvement then it will be necessary to try another type of focus ring.

## FRAME HOLD

I have an Ekco model T.164N and the frame hold has gradually deteriorated to such a degree that it is now impossible to find a setting on the control which will maintain a steady picture with any degree of certainty. At the same time the interlace has seriously deteriorated to the point when it has become obvious simply by looking closely at the screen.

Are these two faults likely to be the result of the same defect and, if so, could you suggest the most likely cause or causes? — E. Wood (St. Helens).

It is quite possible for the symptoms you describe to be the result of the same cause. Often a defect in the frame generator valve provokes the effects, and before you investigate further it would be advisable to test the valve by substitution. On the other hand, the fault may lie in the sync separator or associated frame sync pulse feed circuit. Check the valves concerned and ensure that the associated resistors have not altered in value. Ascertain that the frame hold control itself is up to standard.

## "LYNX"—USING EF54s

Would you be good enough to enlighten me regarding the EF54 valves of which I have quite a good surplus supply? As you know, by the numerous queries that I have sent you, I built the Premier 12in. television which is a T.R.F. circuit and the vision portion is far from satisfactory, being terribly short of gain and poor definition. I have given it up as a bad job and am very disappointed. Studying the circuit of the Lynx I am sure that the vision and sound portion of the set would go quite well with the Premier timebase and I would like you to confirm this before I make a start. Could you also tell me if I could substitute the 6AM6 valves for the EF54s as there is not a great lot of difference in the characteristics? If this should be impossible, could you recommend a good vision circuit that will go with this timebase without involving a lot of further expense? Hoping you may help me. — A. Parkin (Sheffield).

You can use EF54s in the Lynx circuit, but the mechanical alterations to accommodate the larger valves will have to be left to your own design. No coil changes are anticipated, but in practice you may find that alignment occurs with a particular core right in or right out of the former. In such a case you will have to add or subtract a few turns of wire accordingly to compensate for the different stray capacities.

The mixer circuit should be unaltered, of course, the double-triode being retained.

## INTERLACE FAILING

Will you please answer the following query as to the cause and cure of a fault which has developed in a Pye F.V.I.C. receiver?

The picture has, at intervals, developed a vertical wobble and appears to reduce in picture height. This cannot be rectified by any adjustment of the frame hold.

The ECL80 in the frame timebase has been renewed and this has helped to steady the picture, though not completely curing the fault.

When the set has been in use for a time there is a tendency for the picture to move out of centre vertically and there is a slight cramping of the picture at the bottom.

The interlacing, brilliance and contrast of the picture are extremely good.

Hoping that you will be able to answer this query and the facts will help. — F. Bullough (Accrington).

This fault is probably caused by one or both of the two small metal rectifiers used in the interlace filter circuit losing efficiency. These rectifiers are located underneath the chassis and generally covered by insulated sleeving. They are manufactured by Standard Telephones and Cables and known as M3s.

### USING "EMISCOPE" TUBE

Having acquired a 12in. tube, Emiscope Type 3/4s 8E13, I am hoping you will be able to assist me with some data concerning same.

My aim is to construct new timebase as in May to September issues of "Practical Television," "Conversion to Magnetic C.R.T."

I believe the tube is a tetrode as it has a seven-side contact base; five pins are in use with the usual anode connector on the graphite coating; this coating ends some 4in. to 5in. from tube face, leaving clear glass.—A. F. Rose (Dagenham).

The Emiscope Type 3/4 picture-tube is a 10in. triode intended for cathode modulation. The tube is designed for an E.H.T. of 4,000 volts, which produces a beam current of 350 microamps at peak-white. To drive fully a modulator swing of 23 volts is necessary, and for beam cut-off (3 microamps) a grid potential of minus 32 volts is demanded. It possesses a heater rated at 4 volts 1.3 amps.

The tube should prove quite successful as a basis for your experiments on magnetic conversion.

### VISION ON SOUND

I have now built five Viewmasters which are giving excellent results.

My latest one gives perfect sound and vision, but unfortunately I am being troubled with vision on sound. I know this is the fault as the hum varies with the picture content.

Which coils are likely to be causing the trouble?—J. Richardson (Fleetwood).

Vision interference on sound may be due to incorrect alignment of the sound receiver tuning coils, particularly L210 and L213, whilst some improvement may be obtained by increasing the spacing between these two coils so as to reduce the input.

### SOUND DISTORTION

I have a G.E.C. Model BJ5145 and am troubled with speech distortion at the low frequencies. People with deep voices lisp or speak with a chatter, same as happens on a radio when it is slightly off tune. Speech is quite normal with a high-pitched voice. If I increase contrast control it improves, but I then get a too-black and white picture, which is horrible. Can you say what is the cause of this, and is there something I can do to improve it? I am situated eight miles from Sutton Coldfield, with an outside single dipole.—J. Roberts (Birmingham).

You should first make certain that the sound distortion is not originating from the loudspeaker unit itself. Once you are certain of this point, the germanium crystal diode employed as sound noise limiter should come under suspicion. It often happens that a defect develops in this component to produce low audio frequency distortion of the kind you describe. Also check the resistors associated with this section, and ensure that the sound R.F. section has not drifted in frequency.

### RESIDUAL SPOT

I have a Peto Scott TV, Model TV 122M. The tube has a burn near the centre, and I have purchased a new one. Before I put the new tube in would you tell me if I can fit anything to prevent the new tube from getting the same type of burn. due. I think, to the spot remaining stationary for such a long time after I have switched the set off?

I am capable of fitting any modification to the set.—L. Henshaw (Derby).

You should be able to reduce the length of time the spot remains on the screen of the picture-tube after switching the receiver off by reducing the time constant of the E.H.T. circuit. This can generally be done by connecting three 4.7 megohm resistors in series across the E.H.T. supply. The resistors should be special high voltage working type.

### EARTHED E.H.T.

Will you please help me with my problem in reference to E.H.T. on a V.M. 12in. with a Mullard MW13-17 tube? I get a very good picture but there is a black line 1/2 in. wide top and bottom. When Test Card "C" is on the mask is full, but as soon as a picture comes on there is the black part top and bottom. The E.H.T. when I fit the rectifiers and condensers I get no raster at all, yet without the wire from V10 I can get a raster, so I cannot think it is a faulty part. Off the drawing can you tell me what to do? I have tried with all the resistors and condensers as advised in the View Master book.—G. Taylor (Rochdale).

Your trouble is that you have forgotten that the can of C45A is earthed and you are by-passing the E.H.T. circuit to earth. The can should be isolated from earth and connected to MR3A.

When you have done this you should find your E.H.T. sufficient and then you can adopt the remainder of the modifications to increase line and frame amplitude.

### WIDTH ADJUSTMENT

Using the 194 conversion for sound and vision as "Practical Television," dated October, 1951, I can get the raster O.K. in width, but only about 2 1/2 in. deep, with VR8 right "on". Turned "off," the width closes to a straight line. Is this a "cut off" tube (VCR97)? It was supposed to be tested before being sent as it was in a 62 unit. E.H.T. is 2.5 Kv. H.T. approx. 400 volts from 350-0-350 transformer.

Also the E.H.T. transformer has no negative connection as it is internally connected to the frame.—V. Ward (Birmingham).

We are not quite clear about your trouble. By width we mean the horizontal line and by height we mean the vertical line. VR8 controls the horizontal line and VR10 the vertical line.

Insufficient height may be due to "cut off" but it is rather unlikely. The point can be checked by operation of VR10 from minimum to maximum. If during this process the raster appears to "roll" into blackness at top and bottom then the trouble is most certainly due to "cut off." On the other hand, if you find that the raster just grows to 2 1/2 in. in height, and then will not grow further, the fault lies in the frame time base. Check that V9 is functioning on both halves and that there is good connection to the deflector plates via the coupling condensers.

Increasing C18 will increase height, but care must be taken to avoid fold-over at the top of the picture.

**"YOU CAN RELY ON US"**

**E.H.T. OSCILLATOR COILS AND UNITS**  
 Brandenberg coils waveound on Polystyrene formers. 6 to 9 kv. 39/-; 8-12 kv. 45/- . Coil and U25 valve mounted with anti-Corona wiring. 6-9 kv. 67/6; 8-12 kv. 75/- . Brandenberg E.H.T. Unit, complete in louvered case. 6-9 kv. 26/6/-; 13-17 kv. 29/9/- . Nera E.H.T. Unit, 8-12 kv. 26/10/- .

**T.C.C. E.H.T. SMOOTHING CONDENSERS**  
 .001 kV. 6/-; .001. 12/ kv. 10/-; .001 15 kv. 10/-; .01 6 kv. 10/-; .17 kv. 20/- . All Visconol types.

**E.H.T. RECTIFIERS**  
 Westinghouse. 35EHT35, 19/-; 36EHT40, 21/6; 36EHT45, 23/3; 36EHT50, 26/-; 36EHT100, 32/10. S.T.C. K3/40 3 kv. 7/6. K3/45 3.5 kv. 8/2; K3/50 4 kv. 8/8; K3/100 7 kv. 14/8; K3/160 12 kv. 21/6.

**H.T. RECTIFIERS**  
 RM1 60 mA., 5/3; RM2 100 mA., 5/9; RM3 120 mA., 7/- . All above are 125 v. (two in series for 250 v.). RM4 250 v. 2/5 mA. max., 21/-; 14D88, 11/-; 14A86, 20/4.

**METER RECTIFIERS**  
 1 mA. F.W. Bridge Westinghouse, 12/6; 12 v. 5 mA. H.W., 1/- (surplus).

**CHARGING L.T. RECTS.**  
 State 6 v. or 12 v., 1 a., 5/-; 2 a., 10/6; 3 a., 12/- . Full wave (Bridge), 4 a., 14/-; 6 a., 18/9.

**COILS**  
 All Denco coils stocked. Maxi "Q" dual purpose for plugging in B9A base or permanent mounting, 3/11 each. Wearite "P" coils, 3/- . All Osmor coils and coils-packs in stock. Osmor "Q" coils, 4/- each. All Weymouth coils stocked. Super midget iron cored "H" coils, 3/9 each. 3-wave superhet pair CS3W3, 12/3. M.W.L.W. T.R.F. pair CT2W2, 10/3.

M.W.L.W. H.F. choke HFCL1, 2/9. Mains suppressor choke, 3/3. Q2 I.F. filter, 3/9.

**TV COILS**  
 Wearite "Viewmaster" coils. London, 20/-; Birmingham, Holme Moss, Kirk o' Shotts, 28/-; Wenveo, 26/- . L9 choke, 2/- . Pre-amp. coils, 4/- the pair. Allen coils, TK1 to TK3, 53/4. Denco coils, L1 to L12AB, 33/- . Video chokes (Denco), 2/6 each. W.B. boost choke, 5/9.

**TV SCANNING COILS**  
 WB108, 33/3. Denco WA/DCAL, 43/-; Allen DC300, 42/- . Haynes S112, S914, S914H, 42/-; S27, 45/- .

**TV WIDTH AND LINEARITY**  
 Denco WA/LC1, 7/6; WA/WCL, 7/6. Allen GL18, 7/6; GL18, 7/6. Haynes VL5, 12/6.

**LINE O.P. TRANSFORMERS**  
 WB107, 32/6. Allen L0308, 40/- . Denco WA/LOT1, 42/- . Haynes TW6 126, 43/-; TW5/109, 43/-; T33, 48/-; T27, 132/6.

**TV FRAME O.P.**  
 WB106, 23/6. Haynes TK10/41, 38/- . Denco Allen F0305, 21/- .

**TV BLOCKING OSC. TRANSFORMERS**  
 Allen BT314, 15/- (frame). Denco WAFBTL, 16/- (frame). Haynes TQ132, TQ223, 13/- (line). TQ135, TA6, 18/6.

**FOCUS UNITS**  
 WB109/1, WB109/2, WB109/3, 22/6 (state tube). Elac R17/MK11, 28/6; R20/MK11, 30/-; R25/MK11, 32/6; W20/MK11, 50/-; W22/MK11, 52/6; W25/MK11, 57/6. Focus coils, Denco WA/FCAL, 31/- . Allen FC302, 35/- .

**VALVEHOLDERS AND CANS**  
 B7G, B9A, B8A, moulded with skirt, 1/- . Cans, 6d. I.O. moulded, 1/- . 3-piece can, 1/6. 7-, 5-pin moulded, 1/- . Mazda, 1/- .

**Q MAX CUTTERS**  
 Chassis punches without hammering. 1in., 1in. 10/3; 1in. 11in., 11in., 11in., 13/6 with keys.

**I.F. TRANSFORMERS**  
 Wearite M800, 21/- pair. Denco IFT11, 12/- pair. Olympic, 12/6 pair. Weymouth P4, 15/- pair. Wearite 501/502, 20/- pair. All 465 kc/s iron-cored.

**JACKSON SCALES**  
 S18, 27/6; S15, 26/6. Full vision, 13/- . Airplane, 13/- . Calibard, 21/- . Squares-planes, 12/9. Drums, 11in., 11in., 1/3; 21in., 21in., 1/6. Cord drive, 1/9. (State inside or outside.)

**TRIMMERS**  
 Best Cydon ceramic postage stamp. 470 pf., 9d.; 40-100 pf., 9d.; 50-150 pf., 9d. Chassis mounting, 20-250 pf., 1/-; 100-500 pf., 1/3; 150-700 pf., 1/3.

**WIRE-WOUND RESISTORS**  
 25, 33, 40, 50, 68, 100, 125, 150, 200, 250, 330, 400, 450, 500, 600, 680, 800, 1 k., 1.5 k., 2 k., 2.5 k., 3.3 k., 4 k., 4.5 k., 5 k., 6 k., 6.8 k., 8.2 k., 10 k. Max. 7-watt, 2/3; 10-watt, 2/9. Above are new Welwyn/Lab of small dimensions.

**WIRE-WOUND POTS.**  
 Colvern Preset 2 w. CLR901 100, 250, 500, 1 k., 2 k., 2.5 k., 3 k., 4 k., 5 k., 6 k., 25 k., 30 k., 3/2. Stand spindle 3 w. incl. 50 k. and 100 k., 6/4; 2in. diameter magnet 1 watt, 1in. diam., 25, 50, 100, 5/9.

Soundmaster, Viewmaster, Supervisor, Lynx, P.W. Televisor, Electronic, parts in stock. 1/2 Motek Truvox tape decks. Goodman Axton speakers, Celestion P4. Instruments Amplion, Taylor, Avo, Pifco. Tyana irons, 14/11. Adcola, 25/6. Solon oval bit, 23/8; pencil, 25/4. Solon New instrument iron, 18/9. Phillips pencil type neon voltage indicator, 5/- .

**CATALOGUE NO. 12 PRICE 1/- (Fully Illustrated)**  
**RADIO SERVICING CO.**

EALING 5737

82 SOUTH EALING ROAD, LONDON, W.5.

Next to  
 Sch. Ealing Tube  
 Station. 65 Bus.

**SOLDERING COSTS CAN BE CUT...**

★ **SOLDER TWICE AS FAST - AT FAR LESS COST!**

**TRIGGER-FEED**

**SOLDERGUN**

The Wolf Type 51 Soldergun with its trigger-feed action is indispensable to all modern assembly.

**SOLDERGUNS**

Off-straight easy-grip handle. Perfect balance. Solid construction. Low current consumption. Model for every purpose. Rapid constant heat.

**SOLDERING IRONS**

Identical as regards elements and bits to Wolf Solderguns but with round hard wooden handle with heat-deflecting skirt.

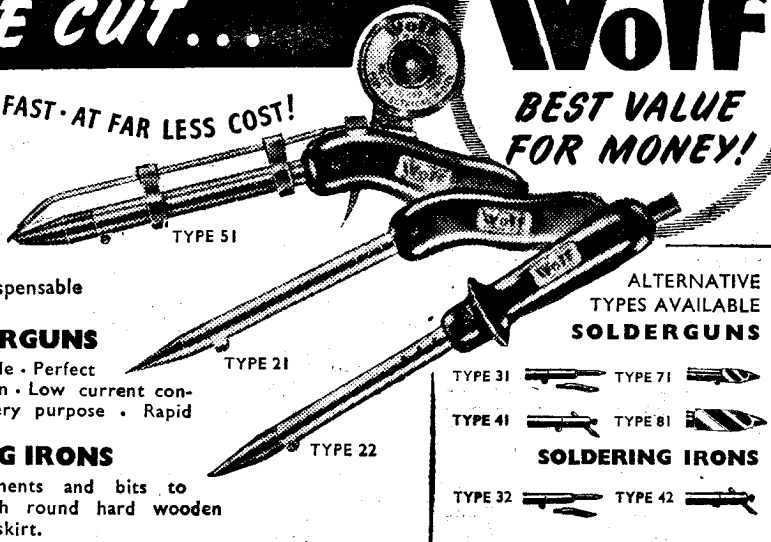

*It pays to Solder with*

★ Obtainable at all high-class stockists and ironmongers  
**WOLF ELECTRIC SOLDERGUNS AND SOLDERING IRONS**

**WOLF ELECTRIC TOOLS LTD., PIONEER WORKS, HANGER LANE, LONDON, W.5. TELEPHONE: PERIVALE 5631-4**

# FIRST-CLASS TELEVISION and RADIO COURSES . .

## GET A CERTIFICATE!

After brief, interesting study—undertaken at home in your spare time—YOU can secure your professional qualification or learn Servicing and Theory. Let us show you how!

### FREE GUIDE

The New Free Guide contains 132 pages of information of the greatest importance to those seeking such success compelling qualifications as **A.M.Bric.I.R.E., City and Guilds Final Radio, P.M.G. Radio Amateurs' Exams., Gen. Cert. of Educ., London B.Sc. (Eng.), A.M.I.P.E., A.M.I.Mech.E.,** etc., together with particulars of our remarkable Guarantee of

### SUCCESS OR NO FEE

Write now for your copy of this invaluable publication. It may well prove to be the turning point in your career.

FOUNDED 1885—OVER

150,000 SUCCESSSES.

NATIONAL INSTITUTE OF ENGINEERING

(Dept. 462), 148, HOLBORN, LONDON, E.C.1.

# THE MODERN BOOK CO.

BRITAIN'S LARGEST STOCKISTS of English and American Technical Books

- Radio Control of Models, by G. Sommerhoff, 5s., 0d., postage 3d.  
 Television and Radio Repairing, by J. Markus, 48s., 0d., postage 1s. 0d.  
 Television Test Equipment, by E. N. Bradley, 5s., 0d., postage 3d.  
 Basic Electronic Test Instruments, by R. P. Turner, 32s., 0d., postage 9d.  
 World Radio—Television Handbook edited by O. L. Johansen, 8s., 6d., postage 6d.  
 Outline of Radio, by R. S. Elven and others, 21s., 0d., postage 1s. 0d.  
 Sound Recording and Reproduction, by J. W. Godfrey and S. W. Amos, 30s., 0d., postage 9d.  
 Television Faults, by N. Stevens, 5s., 0d., postage 3d.  
 Television Principles and Practice, by F. J. Camm, 25s., 0d., postage 6d.  
 Radio and Television Receiver Troubleshooting and Repair, by A. H. Ghirardi and J. R. Johnson, 54s., 0d., postage 1s. 0d.  
 Television Picture Faults, by J. Cura and L. Stanley, 3s., 6d., postage 3d.  
 Television and F-VI Receiver Servicing, by M. S. Kiver, 32s., 0d., postage 1s. 0d.  
 Brimar Radio Valve and Teletube Manual, No. 5, 5s., 0d., postage 4d.  
 Edlswan Mazda Valves, 2s., 0d., postage 4d.  
 Radio Valve Data compiled by Wireless World, 3s., 6d., postage 3d.  
 Write or call for new catalogue.

19-23, PRAED STREET, (Dept. T.3),

LONDON, W.2.

PADdington 4185. Open all day Saturday.

# VALVES

All Valves Guaranteed.	24 Hours Service	
PY32 9/6	Y63 8/6	6SN7 9/6
6X5 7/6	42SP7 6/6	6L6 10/6
954 2/-	382A 9/6	757 9/6
6A50 2/-	35L5 9/6	787 9/6
5F41 3/6	2K2 6/6	797 9/6
5F61 3/6	42SP7 6/6	50L6 8/6
MSPEN 5/-	LP2 4/6	5U4G 8/6
VR137 4/-	KT24 4/6	46 8/6
30 9/6	HP101 5/6	ECL90 11/6
6C5 8/6	HD14 5/6	EF80 11/6
7C3 6/6	6U5 8/6	12K3 9/6
6K7 5/6	1T4 7/-	12K7 9/6
EF50 (Syl.) 1R5 7/-	8- 12K3C 10/6	
7- 354 8/-	8- EB91 7/6	
VR116 4/6	155 8/-	1F91 8/-
5Z4 8/6	6V6 8/-	41MTL 6/-
VR39 8/6	6K8 9/6	AR12 9/-
6Q7 9/-	EF39 8/6	12Q7 9/6

- ★ G.E.C. crystal diodes, 2 p.
  - ★ Pvc plug and sockets, 6d. pair.
  - ★ Chokes, 10 Henry 150 ma. 5/6. plus 1/- post.
  - ★ Co-axial Cable, 80 ohm per ft., 8d. yd. (not W.D.). Post 1/- per 12 yds.
  - ★ Twin Transparent Flex, 15 6 per 100 yds.
  - ★ RML 3 1/2, R.M. 3 1/2, R.M. 14 15-
  - ★ Egan V.C. W.S. 1 meg.-1 meg., 4/-
  - ★ FIL TRANSFORMERS—8.3 v. at 1 amp. Tapped at 200, 220, 240, 6.9, plus 1/- post.
  - ★ STANDARD O.P. Primary Current 50 ma. D.C. Secondary Current 250 ma. Impedance 5,000 ohms. Ratio 40:1, 5/9.
  - VR39 6d. post.
  - ★ MIDGET TELEPHONE Transformers, approx. 100-1. 1/3. post 2d.
  - ★ CONDENSERS.—Sprague 1-350. 8/- dz.
  - 01-1000 v.w., 8/- dz. Hunts, 2 mid., 500 v.w. 1/4.
  - 01-1000 v.w., 8/- dz. Hunts, 2 mid., 500 v.w. 1/4.
  - ★ REGENT Hand Mike (Crystal). Complete with screened lead and jack plug. 1/1.
  - ★ FUSES, 1 1/2 in. length. 1 A., 1.5 a., 2 a., 3 a., 5 a., 9 1/2 dz.
  - ★ L.T. REC. 12 v. 2 a., 10/-
  - ★ EPICULE DRIVES, 9d.
  - ★ JACK SOCKETS, Two hole fixing, 6d.
  - ★ MAINS DROPPERS.—One hole fixing. 2 a. 1,000 ohms, 3-750 ohms, 4/9.
- Post—9d. up to 10/-, 1/- up to 20/-, 2/- up to 10/-
- REX RADIO, 37, LOUIS STREET, LEEDS, 7.**  
 Mail Order Only. Catalogue 6d.

# LYONS RADIO LTD.

3, GOLDHAWK ROAD, Dept. M.T. SHEPHERDS BUSH, LONDON, W.12.

Telephone: SHEPHERDS Bush 1729

**THE "SIMPLEX"**—Send stamped addressed envelope for priced "Shopping" list. For an inexpensive way of buying good components see Indicator Unit described below and our Jan. and Feb. adverts. in "Practical Television."

**INDICATOR UNITS TYPE 182.**—Fitted with cathode-ray tube, type VCR357 (TV picture tested to ensure freedom from cut-off), 3 VR61's (EF30), 4 VR65's (SP61), 1 5U4 9-wire-wound pots, Mu metal screen for C.R.T., and a mass of other useful parts. In good condition. PRICE ONLY, 65/- Carriage 6/6.

**A.C. VOLTMETERS.**—Switchboard pattern, 5in. dia. M.I. type calibrated at 50 cps. 90 to 170 v. PRICE, 19/6. Post 2/-.

**CABINET SPEAKERS.**—8in. moving coil P.M. speakers fitted in wooden cabinet, less back, 18in. square x 8in. deep, with small carrying handle on top. In used condition, but speaker tested to ensure in good working order. **BARGAIN PRICE only, 17/6.** Carriage 3/6.

**SCREENED WIRE.**—Copper conductor 1048, permanoid insulation. Bargain clearance 12 yards, 5/9. 25 yards, 10/9. 50 yards, 17/9. 100 yards, 25/-.

**RECORDING TAPE.**—By well-known manufacturer, an unrepentable bargain. Buy now whilst the opportunity exists. 600 ft. reels, 9/6; 1,200 ft. reels, 18/-. Postage either size 1/-.

**D.C. VOLTMETERS.**—0-3500 v., moving coil, projection pattern with built-in resistance, 3 1/2 in. dia., basic movement 5 mA. Brand new. PRICE 25/-.

**H.V. CONDENSERS.**—0.1 mfd., 2,500 v. working, 3 1/2 in. x 1 1/2 in. dia., with fixing bracket, 3/6.

# TELEVISION RECEIVER CONVERSION

The type AC/4 unit permits receivers to be used for reception of other channels without re-tuning or alterations.

Type AC/4KL (New Brighton transmitter or Kirk o'Shotts on a London receiver).

Type AC/4WL (Wenvoe on a London receiver).

Type AC/4WB (Wenvoe on a Sutton Coldfield receiver).

Also available for all other conversions. The unit is complete with 5 valves and self-contained power supply unit. Price 15 gns. complete from your Dealer or C.O.D.

Type AC/3 neutralized triode PRE-AMPLIFIER without doubt the best Pre-amplifier available. Price complete, 10 gns. from your Dealer or C.O.D.

Illustrated leaflets, etc., on request.

# SPENCER - WEST

Quay Works, Gt. Yarmouth

'Phone: 3009. Telegrams: Spencer-West, Gt. Yarmouth.

# EVERYTHING FOR VIEWMASTER & SOUNDMASTER

**ELECTROLYTICS.**—150v. wkg. Gtd. New Stock), 4 mfd. 1/6, 8 mfd. 2/-, 16 mfd. 3/-, 8-8 mfd. 3/6, 8-16 mfd. 4/-, 16-16 mfd. 4/6. P.M. LOUD-SPEAKERS (3-ohms) 3in. 13/6. 5in. 14/6. 6in. 15/6. 8in. 18/6. 10in. 22/6. **GERMANIUM CRYSTAL DIODES** 3/6. B.I.C., 0.1 mfd. 3 kv. TV Condensers, 10/6. H.R. HEADPHONES, 18/6. SOLON. Miniature SOLID-STATE IRON'S, 19/6. 6in. B.N.L. ARCATS (for VCR37) 17/6. 10 in. 30 ma. SMOOTHING CHOKES, 5/6. 9in. Old Aspect CREAM RUBBER MASKS, 5/6. WEARTE "P" COILS, 3/-, ALL CHASSIS, 2/6. edget, 6in. x 4in. x 4 1/2. 8in. x 6in. x 6 1/2. 10in. x 7in. x 12in. 9in. x 7in. x 8in. 13in. x 16in. x 9in. 14in. x 14in. x 14in. ELAC FOCUS RINGS, R17 Mk. II 28/6. R20 Mk. II 30/-, R25 Mk. II 32/6. TRANSFORMERS (Mains Input, Standard Primaries, 250-250v. 80 ma. 0-4-8-30 A., 9-4-5v. 2 A., 19/6; Ditto but 350-0-350v., 19/6; 250-0-250v. 100 ma., 6.3v. 3.5 A., 5v. 2 A., 28/6; Ditto but 350-0-350v., 28/6. MAINS TRANSFORMERS for PRE-AMPLIFIERS, TEST-GEAR, etc. PRIMARY, 230/240v. SECONDARIES, 0-250v. 30 ma. (for 250v. from a half-wave rectifier), and 6.3v. 1 A. Price, new and guaranteed, 14/9.

ORDERS UNDER £1 please add 1/- P.&P. Orders £1 and over please add 1/9.

FOR INSTANT SERVICE—WRITE:

**CITY & RURAL RADIO**  
 101, HIGH ST., SWANSEA, GLAM.

Telephone: Swansea 4877.

# News from the Trade

## CHANGES OF ADDRESS

**T**HE Glasgow district office of this company has moved into new premises at 167, St. Vincent Street, Glasgow.

As from January 5th, 1954, all departments, including the cathode-ray tube service depot, operate from this address, the new telephone number being Central 2206.—The Edison Swan Electric Co., Ltd., 155, Charing Cross Road, W.C.2.

**T**HE offices, stores and despatch departments have been moved to larger premises at 418, Brighton Road, S. Croydon, Surrey (on the main Croydon-Purley Road). The telephone numbers are still CROydon 5148/9.

Bridge View Works in Borough Hill are now retained only as a manufacturing department, and all communications should, in future, be addressed to Brighton Road.—Osmor Radio Products Ltd., 418, Brighton Road, S. Croydon.

## NEW "HIS MASTER'S VOICE" 17IN. TELEVISION CONSOLE

**A** NEWCOMER to the H.M.V. television range is Model 1829, 17in. "Highlight" console receiver,

at the extremely competitive price of 87 guineas (including £23 4s. 10d. purchase tax).

Outstanding features of this latest "His Master's Voice" release include:

17in. aluminised Emiscope rectangular tube for daylight viewing.

Large picture area of approximately 150 sq. in. Inbuilt dark screen.

Stable fixed focus.

New and highly efficient interference limiters on vision and sound.

All user controls on cabinet front.

10½in. elliptical loudspeaker.

The modern style walnut cabinet is fitted with castors.

A fully descriptive leaflet may be obtained from the makers, The Gramophone Co., Ltd., Hayes, Middx.

## NEW MULLARD VALVES FOR BAND THREE

**M**ULLARD, LTD., announce two new valves which have been specially designed for use in domestic radio and television receivers at frequencies up to 220 Mc/s. These valves will enable sets to be designed for reception of transmissions in the V.H.F. Broadcast Band (Band Two) and the "Competitive TV" Band (Band Three).

The new valves are a double triode, type PCC84, and a triode pentode, type PCF80, both on the noval base. The PCC84 is specially designed for use as a "cascade" low noise R.F. amplifier, and the PCF80 is intended for use as a frequency changer following an R.F. stage employing the PCC84. Both valves have 0.3 amp. heaters, and are suitable for use in A.C./D.C. sets where the heaters are connected in series and the H.T. is as low as 180 volts.

The PCF80 triode pentode has been specially developed to meet the need for a simple high-performance frequency changer capable of operating with conventional television circuitry at 200 Mc/s. At this frequency the conversion gain is 20 dB in a typical circuit with a vision I.F. of 35 Mc/s (British Standards).

In order to minimise interelectrode capacitances and load inductances, the triode and pentode sections of the PCF80 are positioned side by side instead of one above the other, as in earlier Mullard triode-pentodes. A screen is placed between the two sections.

An experimental television tuner for 200 Mc/s with a vision I.F. of 35 Mc/s had the following performance figures:

Total gain from aerial to grid of first	
I.F. stage ... ..	39 dB
Image rejection ... ..	35 dB
Noise factor ... ..	8

Mullard, Ltd., Century House, Shaftesbury Avenue, W.C.2.

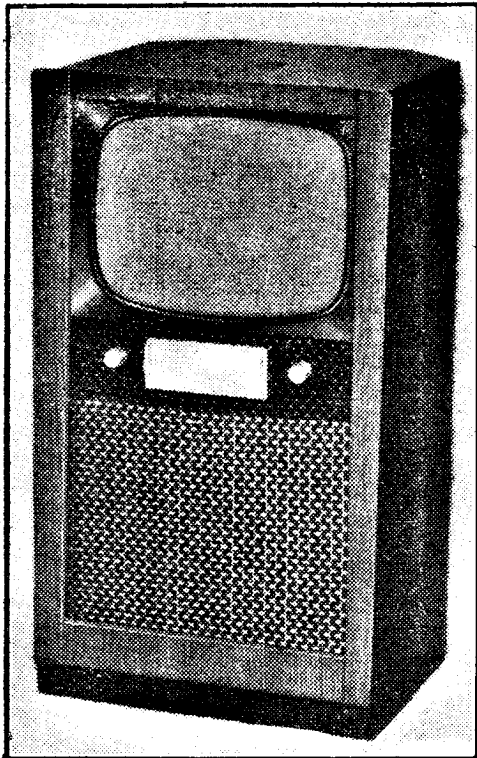

The new H.M.V. Model 1829.

## QUERIES COUPON

This Coupon is available until March 21st, and must accompany all Queries.

PRACTICAL TELEVISION, March, 1954.

**OUTSTANDING SCIENTIFIC BOOKS  
AT ONLY A FRACTION OF THE  
NORMAL PUBLISHED PRICES!**

*Join The*  
**Scientific  
Book Club**

**Members BUY Books published at  
10/6, 12/6, 15/- for ONLY 3/6**

Each month the Scientific Book Club brings to its members the fascinating story of the march of modern science, told in thoroughly dependable books by the front-rank scientific writers of our time—vivid, vital, constructive contributions to Man's unceasing struggle to solve the problems of the Universe. And, although the ordinary editions of these books are sold to the general public for 10s. 6d., 12s. 6d. and 15s., THE PRICE TO MEMBERS OF THE SCIENTIFIC BOOK CLUB IS ONLY 3s. 6d.

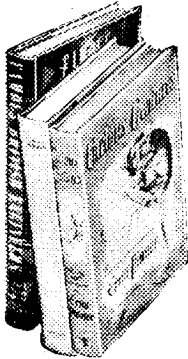

Remember, too, that Scientific Book Club selections are full-length and unabridged. They are printed on good quality paper, well-bound, with an attractive picture jacket. These are, we say with certainty, books that you will be glad to read, proud to own. The Scientific Book Club brings these great books to you each month; helping you to build up, at a sensational bargain price, a first-class collection of scientific books. *Now is the time to join!*

**SOME RECENT AND FORTHCOMING SELECTIONS**

—at only 3s. 6d. to members—include **EVOLUTION IN ACTION** by Julian Huxley (published at 9s. 6d.); **CURIOUS CREATURES** by Erna Pinner (12s. 6d.); **BUTTERFLY FARMER** by L. Hugh Newman (16s.); **DISEASE AND ITS CONQUEST** by G. T. Hollis (9s. 6d.); **INSECTS INDOMITABLE** by Evelyn Cheesman (12s. 6d.). *All wonderful value!*

**FILL IN THIS ENROLMENT FORM TODAY**

To the Scientific Book Club, 121, Charing Cross Rd., London, W.C.2.

I wish to become a member of the Scientific Book Club and agree to purchase the selected book issued each month to members at a cost of 3s. 6d. (postage 6d.). I agree to continue my membership for a minimum of six books and thereafter until countermanded.

\*I will pay for selections on receipt. *Practical Television*

Or if you wish to save time, postage and postal-order costs, you may send an advance subscription. Six months 24s. 6d.; twelve months 48s. 0d.

\*I enclose 24s./48s. (strike out amount not applicable).

\* Place ✓ in the space above, as required.

NAME .....  
(BLOCK LETTERS, PLEASE)

ADDRESS .....  
Overseas enrolments must be accompanied by an advance subscription.

024	6/0	6BW6	10/6	25Z1C	9/6
1A5GT	6/6	6AM6	8/-	35Z4GT	9/6
1C5GT	7/8	6N7	7/8	50L8GT	9/-
1L5N3	7/6	6G7	10/-	EB34.6H6	3/-
1R3	7/9	6S7	7/6		
1S5	8/-	6SL7	9/-	KT66	11/6
1T4	8/-	6SN7	10/6	VR53	7/6
1P11	8/6	6U5G	5/-	VR55	7/-
1625	6/6	6V8G	GT 8/-	VR8	7/-
2X2	5/6	6X3G	7/8	VR85.SP61	4/6
3D3	3/0				
4D1	4/-	12A6	7/-	VR91(SYL)	8/-
504G	9/-	12AT7	10/-		
5Y3G	8/-	12J5GT	5/-	VR150 30	
5Z4G	8/6	12J7	9/-		
6J3GT	5/6	12K7	9/-	VT52	8/-
6J3M	6/-	12K3	9/-	VU39	8/6
6K7C	6/-	12Q7GT	9/-	W77	7/6
6K8G	9/6	15D2	6/6	R3	8/6
6BW7	9/6	25L6GT	9/-		

Many other types in stock—your enquiry our pleasure.

**CONDENSERS.**—New Stock: 450 v. 8. 2. 6; 8 + 8. 4. 3; 16. 3. 6; 350 v. 8 + 8. 3. 6; 16. 2. 9; 275 v. 32 + 32. 4. 4; 25 35 v. 1. 6; 50 50 v. 2. 2; 10 70 v. 2. 2.

**NEW STOCK.**—01 T.C.C., 500 v. working. 8d.; 1 500 1500 v. working. 1/-; 1 350 v. working. 9d.

**VOLUME CONTROLS.**—1 meg. with S/P switch long spindle, 4/-.

**FILAMENT TRANSFORMERS.**—200-250 6.3 v. 1.5 amps. 5/9.

**RECTIFIERS.**—RML 3.6; RM2 4.-; RM3 4.9; RM4 14.-; 6.12 v. 2 amps. 6.6.

**SPEAKERS.**—8 in., 15.-; 8 in., 12.6; 10 in., 18.-; P.M. less transformer.

**SPEAKER TRANSFORMERS.**—Small Pentode, 3/9; Standard, 4.-.

**T.R.F. COILS** boxed with circuit 6.6 pair.

**EXTENSION SPEAKER CABINETS.**—61 in. 14.8; 8 in., 19.8.

**THIS MONTH'S SPECIAL OFFER.**—307's at 6.6 each.

C.W.O. or C.O.D. Postage 6d. under £2.

**ELECTRO SERVICES & CO.**  
242, Battersea Bridge Road, S.W.11.  
Battersea 2964 7155.

**COVENTRY RADIO**

**189, DUNSTABLE ROAD  
LUTON**

Tel.; Luton 2677

**COMPONENT SPECIALISTS SINCE 1925**

All B.V.A. and Tungram valves in stock  
**EDDYSTONE COMMUNICATION  
SETS AND COMPONENTS**

Short Wave Components Catalogue 6d.  
T.C.C., Hunts & Dubilier Condensers,  
Welwyn and Erie Resistors,  
Lab/Morganite, Erie, Dubilier, Colvern and  
Amplion Potentiometers,  
Denco, Osmor, Wearite and Weymouth  
Coils and Packs,  
Eddystone, Denco, Wearite and Weymouth  
I.F.'s,  
Woden and Elstone Transformers,  
Elac, Goodmans, Plessey, Rola/Celestion  
Speakers,  
Avo and Taylor Test Meters,  
E.M.I., Scotch Boy and Grundig Recording  
Tapes,  
Valradio Vibrator Convertors.

**SPECIAL OFFER**

Ready Punched 5-valve chassis, size 12 1/2 x 8 x 2 1/2, complete with attractive glass dial, 1 1/2 x 4 1/2, Reflector Plates, Pointer and Pulleys. Price 12/6, plus 1/- postage.

These are some of the components we stock. Send for our 50-page Components Catalogue, price 6d.



**"VIEWMASTER" Valves**, exact to specification, guaranteed new and boxed, set of 12 £6/2/6, post free; "Tele-King" 17in. Receiver, complete set of 17 valves, exact to specification, £8/19/6, post free; 6AM6, EF91, 6P12, Z77, 8D3, W77, EF92, EB91, 6A15, 12AX7, any 8 for 50/-, post 1/6; 1.4v Miniatures, 1S5, 1R5, 1T4, 3V4, 3S4, 1S4, DK92, DF92, DL93, 3A4, any 4 for 27/6, post 1/-; all valves guaranteed new and boxed. For individual prices and other types see displayed advert., cover iii. **READERS RADIO**, 24, Colberg Place, Stamford Hill, London, N.16. (STA. 4587.)

**VIEWMASTER A/P**, dismantled, 15in. new tube, spare 9in. tube; offer, the lot. Box No. 165, c/o PRACTICAL TELEVISION.

**T.V. AERIALS** in alum. alloy; single dipole with wall or fascia board mounting bracket and 18in. stand-off rod 1in. dia, 25/-; "H" dipole and reflector on 1 1/2in. dia boom, 45/-; 3-element folded dipole on 1 1/2in. boom, 70/-; cast alloy mounting bracket for "H" and 3-element, 8/6; std. co-ax., 75 ohm, 8d. yd.; semi-spaced, 1/6 yd.; complete chimney lashings for 2in. poles, single (1 bracket, 2 pole fixings, 16ft. wire), 25/-, double (2 separate brackets, 32ft. wire), 30/-; high tensile alum. alloy poles, 2in. dia, 10ft., 32/6, 20ft., 65/-; carr. on poles or aerials 5/- or both 7/6. Pre-amplifiers, single valve, high gain, with power pack 60/-, without power pack 30/-. **GLADSTONE RADIO**, Gladstone Place, Newton Abbot, Devon.

**BOOKLETS**: "How to use ex-Gov. Lenses and Prisms." Nos. 1 and 2, price 2/6. Ex-Gov. Optical lists free for s.a.e. **H. ENGLISH**, Rayleigh Rd., Hutton, Brentwood, Essex.

**VIEWMASTER 9in.** Pre-amp. Cabinet (London), good working order, £20, o.n.o. 20, Orchard Estate, Ely, Cambs.

**PREMIER 9in.** Magnetic H/M Model Console Cabinet, complete with spare valves, s/c coils, enlarger. Offers? Box No. 163, c/o PRACTICAL TELEVISION. **TELEVISION**, Coilssets, Lynx, Argus, AC/DC 3in. canned Formers, 2/3 ea. **BEL SOUND PRODUCTS**, Marlborough Yard, Archway, London, N.19.

**"RADIO UNLIMITED"** offers "Viewmaster" Valves, Components. Set valves £6/2/6, set coils, incl. choke, 17/6, Fil/trans, 35/-, Line/trans, 29/6, Frame/trans, 22/6, Choke 15/6; Erie Resistors, 1/2 watt, 3/- doz.; Wire/W Controls, pre-set 2/6, 3 watt 4/3, 4 watt 4/6; new waxed Conds., .01, .04, .002, .001, .005, 500v, 3/- dozen; Cored Solder, 4oz., 3/6; L weight Iron, 14/6; new Valves, 6AM6, 6A15, EF92, EF50, EL32, 6J7, 6K7, at 6/3; post free; 6BA6, 6BE6, 12A77, 6BW6, 3S4, 3V4, 7/- each, p/free; ECL80, EF80, 10L1, FL82, PY80, PY82, 9/9, p/free; EL33, 6J6, EL36, 2/-; GZ32, 16/-; EY31 11/6; 1A4, 1L4, 4/6 each; over 13,000 valves in stock. Lists free. Metal Recs. RM1 3/9, RM2 4/-, RM3 5/-, RM4 (TV Rec.) 15/-. **RADIO UNLIMITED**, Elm Road, London, E.17. (KEY, 4813.)

**A WINWOOD BARGAIN**.—Rev. Counters, manual or electrically operated by dry battery, 4v, totals 9,999, complete in case, with solinoid and battery, 6/6, post free; Battery Charger Transformers, 2, 6, 12v, at 1.5 amp., 11/6; L.T. Rectifiers, 12v-2 amp., 8/6; Valves, SP41, SP61, 6K7, 4 any type 17/6; "Regent" Crystal Hand Microphone, with lead and plug, 22/6, post free; Ger. Diodes, 1/6 each; Co-ax Cable, high grade, 7/6 doz. yds.; Cored Solder, 1lb. reel, 8/9. New lists ready. **WINWOOD**, 12, Carnarvon Road, Leyton, E.10. (Mail only.)

**RATES**: 4/- per line or part thereof, average five words to line, minimum 2 lines. Box No. 1/- extra. Advertisements must be prepaid and addressed to Advertisement Manager, Practical Television, Tower House, Southampton St., Strand, London, W.C.2.

**VALVES**: 6AM5, EL91, W77, 6X5GT, 6A15, 6AG5, 6U5G, 6AG5, 7/- ea.; 6C4, 6AM6, 6V6G, 6F6G, 6J5m, 7/6 ea.; 3V4, 6J7M, 6SN7GT, 6SL7GT, X66, 5Z4G, 6AK5, IW4/350, VR50/30, 8/6 ea. All less 5% per doz. or 10% over 50. **ANGLIN**, 160, Cleethorpe Rd., Grimsby.

**MST**, 32 in 8 sections, 2in. dia. steel, 8 guywires, pickets, etc.; bargain, 89, Woodside, Leigh-on-Sea, Essex.

**REAL BARGAINS**.—New TV Pre-amp. tunable 40-70Mc/s 80ohms in, invaluable fringe areas complete, offers over £3. Amazing new Pattern Generator, accurate 40-68Mc/s, full sync., etc., suitable checking bandwidth alignment, etc., in attractive case, offers over £4/10/-. All sorts other eqpt., e.g., Recording Amplifiers, Receivers, Chassis, Components, all new, to clear, cheapest prices. Enquiries with s.a.e. welcomed. **P. T. V. Cleland, Ashtead, Surrey.**

**TV WITHOUT MAINS**. Absolutely first-class picture plus DC circuit for lighting; as supplied to the B.B.C. Special AC/DC "Chorehorse" Generators, self-starting, compact, and complete AC 220/250 volts, 50/60 cycles, 250/350 watts AVC. Will run radios, vacuum cleaners, small tools, etc.; £47/10/-, plus 10/- delivery.—Below.

**STORAGE BATTERIES**, 12v. 75 AH heavy duty, 19 plates; separate cells in hardwood cases; finest possible specification, approximately present list; £7/17/6, plus 9/6 delivery.—Below.

**6v. 90 AH**, 15 plates, hard rubber cells; also suitable for cars, tractors, lorries; £3/7/6, plus 7/6 delivery. **TEDDINGTON ENGINEERING CO. LTD.**, Dept "C," High St., Teddington, Middlesex.

**BRAND NEW COMPONENTS** for Electronic Engineering Radiogram-Television; cost £17, accept £9/10/-, 73, Kenilworth Rd., Edgware.

**A QUANTITY** of Ekco Television Pre-amps, new (in packs), Model LGA.150 (Sutton Coldfield). Offers to Box No. 164, c/o PRACTICAL TELEVISION.

**50 SECONDHAND** Televisions always for sale; famous makes. **TOMLINS**, 127, Brockley Rise, Forest Hill, S.E.23. (FOR 5497.)

**BAND THREE**, Responder, 11 x 12 x 7in., 160 220 mcs. Valves: 6VR65, VR130, VR137, 2/VR92, 6 13 mcs. IFTs, new condition, 30/- (carr. 5/-); 1FTs, new, canned, 7 mcs (R1355), 1/6, 10/13 mcs 1/3; Metal Recs. STC, 240v, 30ma, 3/6; 270v, 80ma, 6/-; 600v, 30ma, 6/-; 12v, 1a, 1/9; all H.W. Aladdin Formers, cored, 1/2 or 1in., 9d.; R.P. 24 16/-; 25 20/-; 27 40/-; Meters, 2in. sq., 5 or 100ma, 7/-. Cash with order. S.A.E. for list or enquiries. Post extra. Immediate delivery. **W. A. BENSON**, 306, Rathbone Rd., Liverpool, 13.

**BENTLEY ACOUSTIC CORP. LTD.**  
38, Chalcut Road, N.W.1. *PRINCE* 9090

6B8M	5/6	6V6	7/-	EB91	5/6
6CDE	11/-	7C5	7/-	ECC33	10/-
6J5G	5/-	7C8	7/-	ECC81	8/-
6K7G	5/-	7H7	7/-	6AM5	5/6
6K8	8/-	7Y4	8/-	6BA6	7/-
6L7	6/-	12A77	7/-	6BE6	7/-
6N7	7/-	12AU7	10/-	6BW6	7/-
6R7	8/-	12AX7	7/-	UBL21	13/-
6SL7	7/6	12SQ7	8/-	UCH21	13/-
6SN7	8/6	50L6	8/-	UCH42	10/-

Post extra 2/4. P. Service, Refund Guarantee, S.A.E. Free List.

**LARGE QUANTITY**, ex-emp., working perfect with any Coil Pack. 465Kc IFTs, dust iron cored, bench superhet tested, pr. 4/6, p.p.; doz. prs. 42/-, p.p.; Var. Cond., all lin. spindles and 500 pf. p.gang, Single 1/6; Suprhet Twin, 3/6; 4 gang, 2/6 (post 1/-); brand new and Tested, 1/350, 2/6 doz., 20/- gross; Tropic 10/1000, 1/350, 1/500, 3/6 doz., 30/- gross; 32uF/450, 4in. x 2in. diam., 1/9 ea., 18/- doz.; B7G (1R5), ceramic Vholder, 8d. ea., 6/- doz.; 60m/- gross; packing free; post extra; s.a.e. full list. **THE RADELECTRIC CO.** (Prev. Radio Services) Lr. Bullingham, Hereford. (Phone: 4857.)

**BRAND NEW** EF91, 6V6G, 7/6, plus 4d. per valve post; Ceramicons 22, 47, 50, 75, 100 pfs, 5d.; miniature mica w. ended 220, 400, 1,000 pfs, 4/6 doz., 10/- each. Includes postage. **UXBRIDGE MAIL ORDER**, 279c, High St., Uxbridge.

**12IN. ELECTROSTATIC TUBES**, type VCR.131, brand new, suitable for T.V. Change your 6in. VCR97 for a 12in. and enjoy large pictures without even changing the base see PRACTICAL TELEVISION, Nov. '52). For callers only, a few at £4/17/6, RP 24 and 25 units, complete, 29/6; p.p. 2/-; RP 26 units, 39/6; p.p. 2/-. Ex-2. Block Paper Condensers: 1 and 2 mfd., all sizes and voltages up to 600 or 800 volts, 1/6 each; 4 mfd., as above, 2/6; 25, 5 and 1 mfd., at 2Kv-3Kv, 3/6; post on all condensers 9d. each. Many other bargains always available, why not pay us a visit? (Nr. Tube station, S. Wimbeldon.) **SERVIO RADIO**, 156-8, Merton Rd., Wimbeldon, S.W.19. (LIBerty 6525.)

**VIEWMASTER** Sound/Vision Chassis, assembled, aligned, and tested, with specified parts, £7/17/6; with alternatives, £5/15/-, and a still cheaper version, £4/4/-; Amazing value, send for details. Spot-wobble Deflection Coils, with suitable valve circuit and fixing instructions, 4/6; ex-Govt. Valves, tested, EB34, 2/-; SP61, 2/6; EF36, 3/9; EF50, 4/6. **MASSEY**, 58, Wakefield Ave., Hull.

**T.V. AND RADIO SERVICE SHEETS**, 2/3; Sdies/Loan List, 1/-; s.a.e. **RATEL**, 171, Norris St., Preston.

**SITUATIONS VACANT**

The engagement of persons answering these advertisements must be made through a Local Office of the Ministry of Labour or a Scheduled Employment Agency if the applicant is a man aged 18-64, inclusive, or a woman aged 18-59, inclusive, unless he or she, or the employment, is exempt from the provisions of the Notification of Vacancies Order, 1952.

**TEST GEAR MECHANIC** required by electrical component manufacturers for assembly and wiring of test equipment. Applicants must be able to read circuit diagrams and possess good knowledge of radio and valve technique; North Acton; superannuation scheme. Write, giving full details and stating wages required to Box 166, c/o PRACTICAL TELEVISION.

**EDUCATIONAL**

**I.P.R.E.** Data for constructing TV Aerial-strength Meter, 7/6; 5,500 Alignment Peaks for superhets, 5/9; sample copy Practical Radio Engineering, 2/-; Membership-examination particulars, 1/-; Syllabus of seven postal courses free and post free. **SECRETARY**, I.P.R.E., 20, Fairfield Road, London, N.8.

**WANTED**

**NEW VALVES WANTED**, small or large quantities, 3Q4, 6V6, 5Z4, ECL80, EF80, EY31, PL61, PY82, K761, 6L6N, VR150/30, 5R4, 80, etc., etc. Prompt cash. **W.M. CARVIS**, 103, North Street, Leeds, 7.

**PROVEN DEPENDABLE SERVICE**

**VIEWMASTER,  
SOUNDMASTER,  
TELE-KING, Etc.**

Guaranteed technical service before and after the sale by factory technicians. Brand new components sold individually or in stages exactly as specified by the designer. All orders are dealt with the day received. Individual price lists of revised prices are available free of charge as well as our 60-page illus. general catalogue No. 8.

**MANUALS.**—Complete with comprehensive plans: Viewmaster, 7/6; Soundmaster, 7/6; Tele-King, 6/-.  
**SOUNDMASTER COMPONENTS**

WB kit complete, £11/13/2; 3 Collaró motors, £5/15/-; Resistor/potentiometer kit, £2/7/6; T.C.C. Condenser kit, £4/3/-; Wearite kit, £7; Bulgin kit, £3/10/-; N.S.F. Switch kit, £1/15/-; Brenell Tape Deck kit, £13/13/-; W.B. Cabinet, £6; Mullard Valve kit, £5/10/2; Lustraphone C51 high-impedance dynamic microphone, £5/15/6. Components also sold in stages for easy construction. Ask for details.

**TELE-KING COMPONENTS**

TK/P Chassis and tag strips, 50/-; TCC Condenser kit, £7/4/2; TK/H Valveholders and plugs, 24/6; TK/R Resistor kit, 40/9; TK/VV Welwyn Pot. kit, 29/6; TK/VC Colvern Pot. kit, 19/-; TK-I-9 Coil kit, 44/6; LO308 Line/Scan Transformer, 40/-; DC300C Deflector Coil, 39/6; FC302 Focus Coil, 31/-; FO305 Frame Output Transformer, 21/-; GL18 Width Control, 7/6; GL16 Linearity Control, 7/6; BT314 Frame Blocking Transformer, 15/-; SC312 Smoothing Chokes, 21/-; OPI17 Sound Output Transformer, 15/-.

**VIEWMASTER**

All components, valves and tubes available ex-stock.

Postage and packing extra on orders under £2.

**SOUTHERN RADIO & ELECTRICAL SUPPLIES**

Sorad Works, Redlynch, Salisbury, Wilts.

Telephone: Downton 207

**A SELECTION from our GENERAL LIST**

**MIKES.** Acos Mic. 22-2 84/-; Mic. 30, 50/-. Rothermel 2AD 56, 63/-. Lectaphone C.17Z, 25/15/-, base extra 10/6.  
**LOUDSPEAKERS.** Goodmans Audiom 60, 23 12 8; Axiom 150 Mk. II, 218/5/6. W.B. HIGH FIDELITY, 3Ω coil, HF.610, 6 inch 50/6; HF.810, 8in., 62/6; HF.912, 9in., 67/-; HF.1012, 10in., 73/6; (15/2 available at 73/6).  
**COILS.** (State range required). Osmor Q 4/-; Weymouth H. 3/-; Wearite P. 3/-; Denco C TRF. 8 - pr.; Denco Maxi-Q 8/6; or miniature, 3 11/ with reaction 4 9. R.E.P. dual range high gain, 4/-; OSMOR Q Coilpacks, Type HO 48/-; LM. 40 - Bat., 50 - TRF. 40 - RFA 4 Station Tuning pack, 45 8.  
**I.F. TRANS.** (C.K.C.) Denco IPT. 31, 12 - pr.; IPT. 3, 15 4, pr.; Wearite M.800, 21 - pr.; Weymouth P.4, 15/-; pr.; P.3, 8 6 each; P.3A, 10 - each.  
**OUTPUT TRANSFORMERS.** 50 WATT POTTED De Luxe type to suit single or push-pull PX4, 6V6, 6L6 & KT66 valves. Optimum leads 4,000Ω to 10,000Ω. Eleven ratios 1:1 to 78:1, 47 3. Elstone MR T 4 w. multi-ratio, 8 9; Elstone MR 7, 7-10 w. multi-ratio, 18 9; MR.15, 15 w. multi. 41 6; MR.30, 30 w. multi, 49 6. Woden Williamson, Potted, WOT.23, 17 2 each, 26 10 - WOT.25 3 1/2 each, 26 18 6.  
**RECTIFIERS.** Brimar S.T. & C. RM.1, 5 3; RM.2, 5 9; RM.3, 7 -; RM.4, 7 -; DM.1B, 11 6; DM.2B, 12 6; DRM.8B, 15 -; KR.45, 8 3; KR.50, 8 9; K3 100, 14 8; Westinghouse 14AS6, 20 4; 14A100, 26 -; 56HT45, 23 8; 56HT20, 26 1; 56HT100, 29 5; 14D36, 11 7; W.X. & W.X.6, 4 - each.  
**TAPE DECKS.** Truxov Mark III, 223 2; Motek type K.44 with super sensitive heads, 217 17; TAPE, Emphase and Scotch Boy 1,900/-, 35 -; 600W. 21 -; Ferris 6, 600W. 26 6; 600W. 15 -; 600W. 16 -; Spare REELS, 1, 2, 3, 4, 6, 600ft., 2 6; 300ft., 2 3.  
**WIDE ANGLE COMPONENTS.** ALLEN. Teleging Chassis 50 -; Collett-CK & Super-Visor, 44 6; LO.305, 40 -; FO.305, 21 -; DC.300C, 39 6; FC.302, 21 -; GL.15 & 18, 7 6 each; SC.312, 21 -; AT.310, 20 -; OPI.17, 9 -; BT.314, 15 -; Denco Chassis Magnaview, 37 6; Chassis, Super-Visor, 51 6; Coilets, Magnaview, 41 2; WA/DCAI, 43 -; WA/FCAL, 31 -; WA/LCI & W.LI, 7 6 each; WA/FMAI, 21 -; WA/LOLI, 42 -; WA/FBTI, 16 -.  
**ELAC** Dynamic Positioners, Low Flux, 37 6; Medium, 39 6; High, 42 -; 100 tons, all types, 5 - each.  
**SUNDRIES.** Denco MFO.1 test oscillator, 75 -; AVO Universal A.C. D.C. Minor, 210 10 -; DECALB, standard, 4 9, post free. Amateer, 3 9, post free; J.R. Dial assemblers, SL.5, 26 6; SL.8, 27 6; TYANA Std. Irons, 16 9; ERLE RESISTORS, type 9, 1 w., 6d.; type 8, 1 w., 8d.; type 2, 2 w., 10d.; all listed values 10Ω to 10 meg. ERLE Silertex 19 watt w.w resistors, 25Ω to 10k, 2 - each.

Send 6d. stamps for our General List of components for Viewmaster, Soundmaster, Williamson Amplifier, Teleging, Magnaview (Brimar & English Electric large screen TV), Super-visor; Close touching Silver Micas, etc., etc. Please add 1/- postage to orders under 1£.

77, LOWER BRISTOL ROAD, BATH, TEL. : 3811

**OPPORTUNITIES IN TELEVISION**

144 pages  
**Free!**

Television offers unlimited scope to the technically qualified. Details of the easiest way to study for A.M.Brit.I.R.E., R.T.E.B. Cert., City and Guilds, Television, Television Servicing, Sound Film Projection, Radio Diploma Courses, etc., are given in our 144-page Handbook "ENGINEERING OPPORTUNITIES" which also explains the benefits of our Appointments Dept.

**We Guarantee "NO PASS-NO FEE"**  
If you are earning less than £15 a week you must read this enlightening book.

Send for your copy NOW—FREE and without obligation.

**WRITE TODAY!**

British Institute of Engineering Technology  
237, College House,  
29-31, Wright's Lane, Kensington, W.8. **BIET**

Introducing the: —



**TYANA TRIPLE THREE**  
MAKE SOLDERING A PLEASURE  
**SMALL SOLDERING IRON.**

Complete with detachable BENCH STAND 19/6  
The smallest high-power soldering iron. Length only 8 1/2; adjustable long bit dia. 3/16; mains voltages 100/110, 200/220, 230/250.  
The "STANDARD" Popular Soldering Iron now reduced to 14/11. Replacement Elements and Bits for both types always available.

**KENROY LIMITED**  
152/297 UPPER ST., ISLINGTON, LONDON, N.1.  
Telephone: Canonbury 4905-4663

**James H. Martin & Co.**  
for

"VIEWMASTER," "TELEKING," "SOUNDMASTER," "TRUXOV TAPE DESKS," Components, Valves, Cabinets, etc.  
Mail Order ONLY, Easy Terms available.  
**FINSTHWAITE, NEWBY BRIDGE, ULVERSTON, LANGS.**

**WATERLOO RADIO**

**METAL RECTIFIERS.**—Bridge 12v, 2 amp, 11 3; 3 amp, 12 6; 4 amp, 15 -; 6 amp, 23 6. Half-wave 125v. A.C. input, R.M.I. 60 mA, 3 9; R.M.2, 100 mA, 4 3; R.M.3, 125 mA, 5 3; R.M.4, 250v, 275 mA, 15 6.  
**VALVES.**—6AM6, 6CH6, 6BA6, 6BE6, 6BW7, 12BE6, 6C6, 6BW6, 3A4, 1U5, 1T4, 6AL5, W7T, N18, 6BJ8, 50C5, 185, 12AX7, 7 6 each. 3 for 20/-; 6K8gt, 12K8gt, 1R5, 5Y8, VR150 30, 6BH7, 9 6 each.

**CHARGER TRANSFORMERS.**—Input 200-250v, 50 c.p.s. A.C. to charge 6 or 12 volts at 1.5 amps, 12 6; 3 amps, 21 6; 6 amps, 29 6. Post 1/-.  
**LOUDSPEAKERS.**—3in., 4in., 5in., 14 6; 6in., 15 9; 8in., 10in., 22 6. Post 1/-.  
**GERMANIUM DIODES.**—2 - each.

35, Tenison Way (Waterloo Bridge Roundabout), London, S.E.1.

**ALUMINIUM, LIGHT ALLOYS, BRASS, COPPER, BRONZE,**  
IN ROD, BAR, SHEET, TUBE, STRIP, WIRE, ANGLE, CHANNEL, TEE  
**3000 STANDARD STOCK SIZES**

**H. ROLLET & CO., LTD.**  
6, CHESHAM PLACE, LONDON, S.W.1.  
SLOane 3463

**Works:**  
**36, ROSEBERY AVE., LONDON, E.C.1.**  
Branches at Liverpool, Manchester, Birmingham.  
"No Quantity too Small"



**Line and frame scanning** All information required by the home-constructor has been put together in this leaflet. If you are building a new set or converting with an 'ENGLISH ELECTRIC' metal C.R. tube, please let us know and we will gladly send you a copy.



# 'ENGLISH ELECTRIC' T901A

## BRITISH MADE LONG LIFE 16-INCH METAL C.R. TUBE

The tube around which the 'Tele-King,' 'Magnaview' and 'Super-Visor' circuits and 'View-Master' conversion circuits were designed.

\* The T901A is a suitable replacement for 16in. wide angle metal C.R. tubes used in A.C. and D.C. sets, without modification.