

PRACTICAL TELEVISION, MAY, 1950

NO. 2 OF THE NEW TELEVISION MONTHLY

PRACTICAL

9^D

EDITOR
F. J. CAMM

TELEVISION

A NEWNES PUBLICATION

Vol. 1 No. 2

MAY 1950



IN THIS ISSUE

Colour Television
The B.B.C. Television System
E.H.T. for the VCR97
Improving Video Response

Servicing Television Receivers
Commercial Sets Reviewed
Television Principles and Practice
A.P. Field Strengths

IMPORTANT TO 'Fringe' VIEWERS

Where the "H" Type Aerial is not good enough — use the Model 63 High Gain "Fringe" Aerial. Gives more than 8 db. gain over a half-wave dipole and 30 db. + back-to-front ratio. Spacing is 0.1λ and 0.15λ for the Director and Reflector respectively, reducing the input impedance to a very low figure. The impedance is then restored to the 80 ohm level by the use of a folded dipole. The Aerial is supplied with a 10ft. x 2in. Diameter Mast and double-lashing chimney fixing. at **£8 10s.** retail.

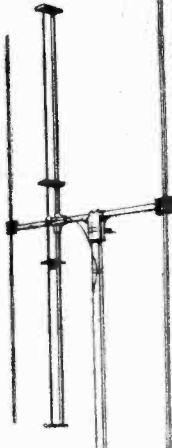

Excellent results in Bristol and many other "fringe" areas. Suitable cables for above are:—
 Cat. 476. Twin Screen Feeder, 1/6 yard.
 Cat. 341. Coaxial (Stranded Core), 1/- yard.
 Cat. 385. Low-loss Coaxial., 2/- yard.

MODEL 63

The well-tried Inverted "T" Loft Aerial can be relied upon to give excellent results within sight of the transmitter.

MODEL 53

Requires only two screws to fix and may be used as a "V" or "L" Aerial and can be mounted in a loft, attic, or upper room. Taking standard coaxial cable, the aerial is entirely non-directional. Price 25/-. Cat. 341 Coaxial Cable, 11-yard extra.

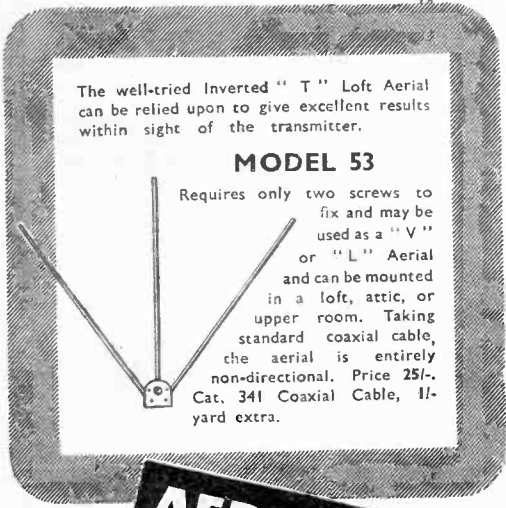

AERIALITE LTD.

**CASTLE WORKS,
 STALYBRIDGE,
 CHESHIRE, ENGLAND.**

WOLF ELECTRIC SOLDERGUNS

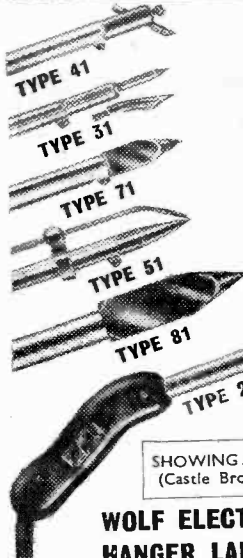

OFF-STRAIGHT EASY-GRIP HANDLE
PERFECT CONTROL
QUICKER HEAT UP
LOCALISED HEAT
LOW CURRENT CONSUMPTION
MAINTAINS CORRECT HEAT
A MODEL FOR EVERY PURPOSE

Obtainable from all leading tool merchants and factors. Write for **FREE** illustrated technical literature

SHOWING AT B.I.F. **STAND c603**
 (Castle Bromwich)

**WOLF ELECTRIC TOOLS LTD.,
 HANGER LANE, LONDON, W.5.**

The Solder which is recommended for the View Master and other Television Kits



As recommended by the designer, use only **ERSIN MULTICORE SOLDER**—the Solder wire containing 3 cores of non-corrosive Ersin Flux. 60 ft. of 18 S.W.G. High Tin Television and Radio Solder, 60/40 alloy, is contained in Size 1 Cartons, Cat. Ref. C.16018. Price 5/- retail.

Obtainable from all leading radio shops.
 In case of difficulty write to :

MULTICORE SOLDERS LTD.
 Mellier House, Albemarle Street, London, W.1. REGent 3411

TELEVISION PATTERN GENERATOR

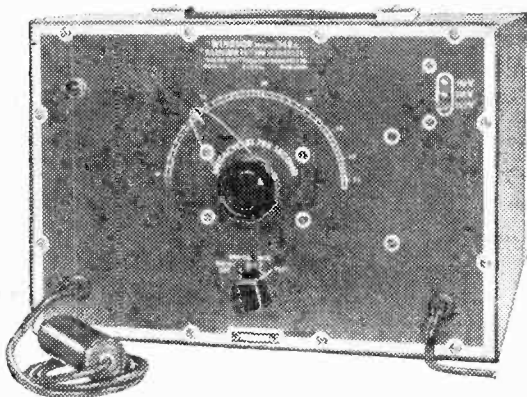

ALL WINDSOR & TAYLOR TEST EQUIPMENT IS AVAILABLE ON H.P. TERMS. SEND FOR DETAILS AND CATALOGUES

TAYLOR ELECTRICAL INSTRUMENTS LTD
419-424 MONTROSE AVENUE, SLOUGH, BUCKS, ENGLAND
Tel. SLOUGH 21381 (4 lines) - Grams & Cables TAYLINS, SLOUGH

MODEL 240 A SPECIFICATION

FREQUENCY RANGE
40-70 Mc/s, directly calibrated.

OUTPUT VOLTAGES
Approx. 50 mV., 5 mV. and 500 μ V., at end of a 75 ohm co-axial cable.

MODULATION
Horizontal bars, vertical bars, unmodulated.

POWER SUPPLY
100-125 and 200-250 volts
40/100 c/s.

LIST PRICE £14.0.0
EARLY DELIVERY

other products include:

- Multirange A.C. D.C. Test Meters
- Signal Generators
- Valve Testers
- A.C. Bridges
- Circuit Analysers
- Cathode Ray Oscillographs
- High and Low Range Ohmmeters
- Output Meters
- Insulation Testers
- Moving Coil Instruments

Are you building the **'VIEW MASTER'** — the Television Set you can build at home from standard parts?

Here for the first time is a Constructor Envelope which by means of 8 full size drawings gives the clearest and most detailed stage-by-stage instructions for building a Television Receiver. Failure is impossible. The accompanying 32-page booklet not only explains how the set works and gives a complete breakdown of the circuit, but also includes a most lucid explanation of Television.

You can build the "View Master" with complete confidence, knowing that it has been designed by W. I. Flack, Fellow of the Television Society, and sponsored by eight of the leading British component makers. Two models are available: Model A for London area, Model B for Sutton Coldfield area.

Constructor Envelopes price 5/- on sale at your local Wireless Shops or direct (5/6 post free) from "View Master", 10, Norfolk Street, London, W.C.2.



- Uses 12" or 9" C.R. Tube.
- Console or Table Model.
- 12 Valves only.
- Magnetic Focussing.
- Metal Rectification throughout.
- Automatic Interference Suppression.
- Easily aligned without instruments.

Where voltages are **HIGH**

... choose
'VISCONOL'
Cathodray Condensers

The 'Visconol' Process—exclusive to T.C.C.—means greater dependability and a longer useful life than ever before. It is the answer by T.C.C. research engineers to the insistent demand for condensers which will stand up to higher and still higher voltages. A selection from the range is given on right: full details on request.

- LOW POWER FACTOR
- COMPLETE DIELECTRIC STABILITY
- RESISTANT TO VOLTAGE SURGES
- AMPLE RATING AT HIGHER TEMPERATURES
- PROOF AGAINST BREAKDOWN OR FLASH OVER

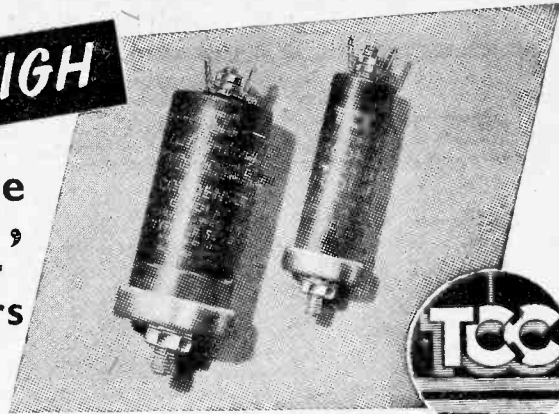

CAPACITY in Mfds.	MAX. WORKING VOLTS (at 60 C.)	DIMENSIONS IN INCHES		TYPE NUMBER
		Overall Length	Overall Diameter	
.0005	25000	5 1/2	1 1/2	CP57H00
.001	6000	2 1/2	1 1/8	CP55Q0
.001	12500	3	1 1/8	CP56V0
.002	18000	5 1/2	1 1/2	CP57X0
.0025	3000	2 1/2	1 1/8	CP55H0
.005	6000	3	1 1/8	CP56Q0
.01	6000	3	1 1/8	CP56Q0
.05	6000	5 1/2	1 1/2	CP57Q0

T.C.C. Condensers are exclusively specified in the View Master—the Television Set you build at home from standard parts. Constructor Envelopes (Model A, London, or Model B, Sutton Coldfield) 5/- each from all Wireless Shops.

Radio Division: **THE TELEGRAPH CONDENSER CO. LTD., NORTH ACTON, W.3.** Tel: ACORN 0061

★
WHY I CHOSE A
"STENTORIAN" FOR
THE "VIEW MASTER"

The W/B "Stentorian" Speaker chosen for the "View Master" after exhaustive tests. I selected it because it possesses an extremely small stray magnetic field and is obviously a product of designers and engineers who know their job.

H. J. Black



Stentorian

THE CHOICE OF THE EXPERT

WHITELEY ELECTRICAL RADIO CO. LTD. · MANSFIELD · NOTTS.

As in Radio— so in Television

Because television entertainment demands the highest grade of sound reproduction, it was natural that the designer of the "View Master" should specify a W/B Stentorian.

But there is also another reason. The magnetic field of a loudspeaker exerts a drastic influence on the operation of a near-by cathode ray tube. This magnetic field must therefore be controlled. In their search for best possible performance W/B engineers have studied such questions for over 20 years: and so were able immediately to produce an efficient special design.

Other W/B components are also incorporated in the "View Master"—high grade components helping to complete a first-class instrument.

W/B Television Speaker 27/6
with transformer

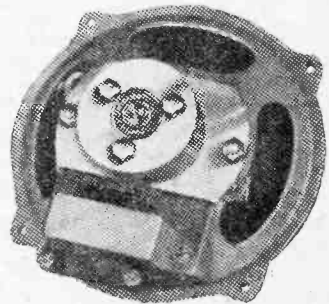

NOTE: This special speaker is an integral part of the "View Master" design. Any variation in the type of speaker or position of mounting may affect performance.

PRACTICAL TELEVISION

Editor : F. J. CAMM

Editorial and Advertisement Offices : " Practical Television," George Newnes, Ltd., Tower House, Southampton Street, Strand, W.C.2. 'Phone : Temple Bar 4383
Telegrams : Newnes, Rand, London.

Registered at the G.P.O. for transmission by Canadian Magazine Post.

Vol. 1. No. 2

EVERY MONTH

MAY, 1950

TelevIEWS

CHANGE IN ASPECT RATIO

AS from April 3rd a slight change was made in the shape of the picture transmitted by the B.B.C. Television Service. The height of the picture is now reduced in relation to the width in order to bring the proportions into conformity with standards being adopted elsewhere. As a result viewers have had to make a small adjustment to the height control of their receivers. Those who have not done so should remember that it is best to make the adjustment while the tuning signal which precedes every transmission is being radiated. The clock face will appear slightly oval until manipulation of the height control readjusts its circularity. All dealers have been instructed as to the method of making this adjustment for those non-technical viewers unable to do so for themselves. Even though the adjustment is not made the degree of distortion is practically unnoticeable. The clarity of the picture remains unchanged.

An illustration on page 64 shows the difference between the old and the new aspect ratio. The former is 5 : 4, whilst the new is 4 : 3, and it now accords with 16 mm. and 35 mm. films. The change has been brought about because it was impossible to transmit a film without the side edges being cut off, and the new ratio overcomes this.

There are two methods by which a 5 : 4 ratio picture can be adjusted to comply with the new ratio. In the first, adjust the width control to give a correct clock circle. The picture will be found to be approximately $\frac{1}{2}$ in. short at the top and bottom. In the second method adjust the height control to give full height and then the width control to give the correct circle, when it will then be found that the sides of the picture extend approximately $\frac{1}{2}$ in. beyond the edges of the mask. If the receiver is not fitted with width control the adjustment should be made by means of the height control until a true circle is obtained.

WIRED TELEVISION

THE first wired public television service will open in Gloucester in a few months' time when the residents will be able to purchase for 7s. 6d. a week the television programmes laid on by wire. This charge will include four ordinary radio programmes—three B.B.C. and one special programme as well as the television programmes.

Gloucester is 70 miles from Sutton Coldfield and

reception over the wired system will be free from all interference and there will be no loss of brilliance. The pictures indeed will be as brilliant as those within a mile from the transmitter. There will be only one selector knob to adjust, and an aerial will not be necessary. The system includes a master receiving station which picks up the programmes from Sutton Coldfield and redistributes them by wire throughout the Gloucester area. Receivers similar to a standard television receiver, in appearance at any rate, are installed in subscribers' homes.

TELEVISION AT BIRMINGHAM RADIO SHOW

AT the seventeenth National Radio Exhibition to be held at Castle Bromwich, Birmingham, from September 6th to 16th, special television demonstration rooms will not be provided as at Radiolympia. Instead exhibitors will be able to operate television sets on their stands. The communal television demonstration will be run on similar lines as at the 1949 show. The B.B.C. has promised full co-operation and various branches of the Government and the Services will be represented.

FIRST ISSUE O.P.

THE first issue of this journal went out of print within a few hours of publication on March 24th. Two large reprints failed to satisfy the demand and, to all those readers who were unable to purchase copies, we tender apologies with the explanation that much as we should like to do so production difficulties, as well as the paper situation, make it impossible for us to produce more copies. We have, of course, increased the print of this issue, but we would repeat that in order to ensure regular delivery it is necessary to place a regular order with newsagents. Periodicals to-day are not on sale or return, by Government Order, and unless a newsagent knows how many copies his customers require he is not likely to order copies on the chance of selling them.

We have received many hundreds of letters of congratulation from members of the trade and from readers of this and our associated journals. It is impossible for us to reply to them individually, so we here express sincere thanks to our readers and to the trade for their good wishes. Many of these letters have contained valuable suggestions, which are being carefully considered. The great interest in television is evinced by the large number of technical queries we have received.

F. J. C.

Stereoscopic and Colour Television

A Record of Some Early Baird Experiments and Details of Modern American Methods

TO obtain the complete illusion of reality in the transmission of images to a distance, the received image should have both colour and also depth—that is, stereoscopic relief. In 1926, when television was demonstrated for the first time, the little pictures shown by Mr. Baird were small and imperfect, and it might be thought that at that early date no effort would have been made to complicate matters by attempts to add colour or stereoscopic relief. Such experiments were, however, actually made by Mr. Baird as far back as 1928, when he showed television in colour to the British Association. A little later he followed this by an experimental demonstration of monochrome television in stereoscopic relief.

Operating Principles

It might be interesting briefly to review the principles employed in these first demonstrations, as they form the basis of present-day results. The monochrome television image was transmitted by scanning the image in a succession of lines. At the receiver a screen was scanned by a light spot, which varied its brilliance, depending upon the light and shadow of the picture. In the colour process three such pictures were transmitted—one red, one blue and one green, the three blending to give an image in colour. Stereoscropy was obtained by transmitting two images corresponding to a stereoscopic pair, and viewing them at the receiving station through a stereoscope.

Little was done to develop either colour or stereoscropy for many years. In 1936, however, Baird showed a 12ft. colour picture to a cinema audience at the Dominion Theatre, London, the picture being trans-

mitted from the Crystal Palace by wireless. This was followed, in 1939, by a demonstration of colour, using a cathode-ray tube in conjunction with a revolving disc—the method used to-day. Nothing whatever was done with stereoscropy until about 1942 when Baird set out to produce a high-definition stereoscopic image in colour.

The first experiment was applied to his 600-line two-colour apparatus. The red image was made to view the scene from a slightly different angle from the blue, so that the red and blue images constituted a stereoscopic pair, the receiving screen being viewed through glasses fitted with red and blue filters as in an anaglyph process. This, while simple, had the disadvantage that it was necessary to wear glasses, and that, as the colour phenomenon was used to effect the change-over from right to the left eye, neither the colours nor the stereoscropy could ever be properly rendered.

Frame Frequency

So far, the object in mind had been to produce a system capable of being transmitted through the existing channels available to the B.B.C., but in an endeavour to obtain as perfect a result as possible, it was decided to produce an entirely experimental apparatus regardless of existing practical limitations. In the apparatus demonstrated the frame frequency had been increased from 50 sec. to 150 sec., the scanning altered to a field of 100 lines interlaced five times to give a 500-line picture, successive 100-line frames being coloured green, red and blue. At the transmitter a cathode-ray tube was used in conjunction with photo-electric cells, the moving light spot being projected upon the scene transmitted. In

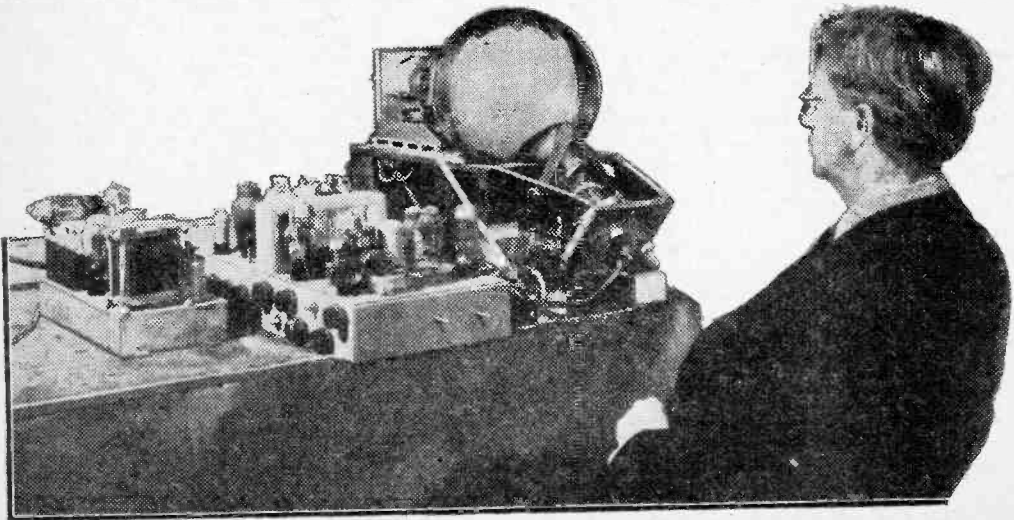

The complete "Telechrome" colour television set-up, with the late J. L. Baird "looking-in."

front of the projecting lens a mirror device, consisting of four mirrors at right-angles, splits the emerging light beam into two paths separated by a space equal to the separation of the human eye. By means of a revolving shutter, the scene is scanned by each beam alternately, so that images corresponding to the right and left eye are transmitted in rapid sequence. Before passing through the shutter disc, the light passes through a rotating disc with blue, red and green filters. Thus superimposed red, blue and green pictures blending to give a picture with full natural colours and transmitted for left and right eye alternately.

Pairs of Images

At the receiver the coloured stereoscopic pairs of images are reproduced in sequence and projected upon a field lens, alternate halves of the projecting lens being

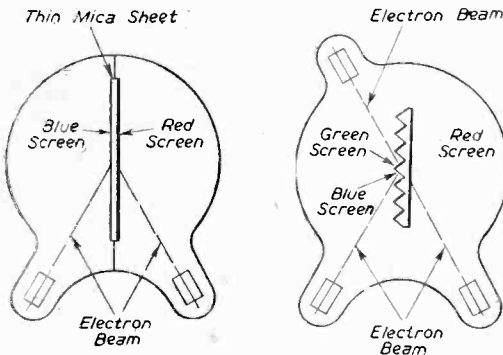

Details of the tubes used by Baird in colour experiments.

exposed by means of a rotating shutter, the image of the shutter being projected upon the eye of the viewer so that his left and right eyes are presented alternately with the left and right images, the combined effect being a stereoscopic image in full natural colours.

Stereoscopic television is an entirely British achievement, it has been shown nowhere but in England, and this was the first time that stereoscopic television in colour had been achieved.

Hitherto, coloured television had been accomplished by the use of rotating discs used in conjunction with cathode-ray tubes. In a later Baird apparatus the rotating discs were eliminated and the coloured television images produced entirely by electro-optical means.

Images corresponding to the primary colours blue, red and green (or blue-green and orange-red, where a two-filter process is employed), are reproduced side by

side in sequence on the fluorescent screen of the cathode-ray tube at the receiver. Lenses with their optical centres on perpendiculars through the centres of each of the three images, and at a distance from the images equal to the focal length of the lenses, project parallel beams on to a large lens separated from the receiving screen by a distance equal to its focal length. The pictures are thus caused to overlap on the screen; the arrangement is shown in the diagram as applied to a two-filter process.

Two Filter 600 Line

Demonstrations were given on receivers adapted to receive a 600-line two-filter transmission (blue-green and orange-red). The two images corresponding to the blue-green and orange-red components appeared in sequence one above the other on the flat face of a 10in. projection-

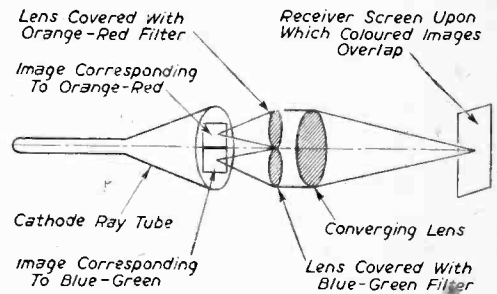

An electro-optical system for a two-filter process.

type cathode-ray tube operating at 26,000 volts. In the lens system, single lenses were employed (owing to the difficulty of obtaining special lenses at the time of the demonstration), and this entailed a certain loss of optical efficiency: the actual aperture has, nevertheless, the large value of approximately 3.5. Proper registering of the two pictures presented several initial difficulties, as great accuracy is necessary, but these experimental problems were finally solved and very accurate registration was obtainable. The system is, of course, equally applicable to the transmitter, but a revolving disc was still employed, the same transmitter being used both for the old-type colour disc and a new discless type.

Demonstration

Three different types of colour and stereoscopic receiver produced by Mr. Baird during the war were publicly demonstrated, ranging from a small popular model with a screen 5in. by 4in. to a de luxe model with a picture 2ft. 6in. by 2ft., the pictures being in natural

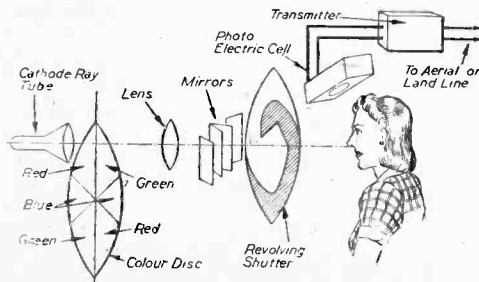
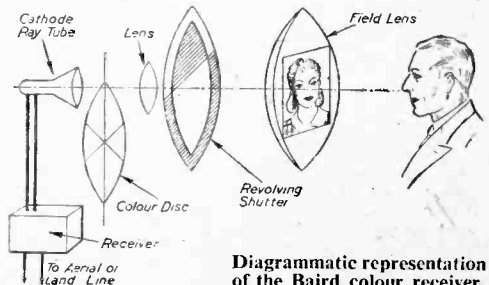

Diagram of the Baird colour television transmitter.



Diagrammatic representation of the Baird colour receiver.

colours, and by putting on special glasses the pictures became stereoscopic, acquiring depth and relief to a surprising degree, so that instead of looking at a flat surface, one appeared to be looking at a scene through a window.

The Pye System

The subject of colour has been brought prominently to the fore in recent announcements from the U.S.A., and in this country by the activities of the Pye Company. A special demonstration by the latter company was staged at Radiolympia last year, and they have carried out demonstrations both at hospitals and other institutions in this country and on the Continent. Technically, the process used (sequential presentation) is similar to that of the Columbia System of America. The picture build-up is of 405 lines, 150 fields per second, 75 pictures per second, interlaced 2 : 1. The colour presentation is by sequential additive colour scanning, achieved by synchronously rotating discs fitted with filters for the three primary colours and arranged in front of the camera pick-up tube and the receiving C.R. tube. This process produces 25 complete colour pictures per second with a bandwidth of 9 mc/s., a horizontal scanning frequency of 30,375 c.p.s., and a vertical scanning frequency of 150 c.p.s. Messrs. Pye emphasise that although they have now brought colour television from the laboratory stage to full commercial use, it may be many years before it can be used for broadcasting. They are, therefore, developing it mainly for use on closed-circuit systems, and experts who have seen the demonstrations are already planning to use it in teaching, in industry and commerce, in business and in merchandising. From the U.S.A., on the other hand, much technical information has been released, and demonstrations have been carried out over the air. Due to the wide bandwidth of certain colour systems, their adoption for home entertainment is rendered impracticable, and recently in the U.S.A. it was laid down that no permit will be issued for a radiated colour system unless the pictures can be picked up on normal television receivers and thereby give a black-and-white picture which must be as good as an ordinary black-and-white transmission. This ruling safeguards the viewer who is thus not faced with the possibility that sooner or later his set will be rendered obsolete or call for replacement.

Columbia System

The Columbia is one of the best-known American systems and there is keen rivalry between this and that of the R.C.A. In the Columbia system a wheel is rotated behind the camera lens and separates the three primary colours of the image. Thus the scanning tube receives successive images in the three primary colours and these are broadcast in the normal way. At the receiving end the usual process takes place, producing a black-and-white image on the tube end. In front of the receiving tube is another disc, similar to that at the transmitting end, and this is run in synchronism with the transmitting disc, with the result that the red image is viewed through the red screen and so on. A picture is thus built up which has all the colour and details of the original—but the two discs must obviously run in perfect synchronism.

R.C.A. System

The system used by the other big American company, R.C.A., utilises three tubes in both transmitter and receiver. In the transmitting system, dichroic mirrors split up the image into the three primary colours, and through lenses and filters each tube receives only one colour image. A special circuit which has been called an electronic switch picks out the images from the three tubes and radiates them in a given order, where they are picked up by a normal receiver and fed to a similar switching circuit. The character of the signals at this stage is such that the circuit is enabled to feed the impulses of the separate colours to the respective tubes, which are coated with fluorescent chemicals to produce red, green and blue pictures. The three separate images are then reflected by more dichroic mirrors to produce on the screen a single picture in the original colours.

C.T.I. System

A third system has recently been demonstrated which operates on quite different lines and which seems to have great promise. This system, which is being produced by a firm called Colour Television Inc., utilises a normal single-tube camera, in front of which are three lenses side by side. Behind these are colour filters, and as a result there appears on the scanning tube a series of three pictures, side by side, in the three primary colours. These are scanned normally and the radiated impulses picked up on a normal receiver. On the end of the picture tube there now appears the three pictures in line, and the face of the tube is coated with fluorescent material



Mr. Baird with his tube which he called the "Telechrome."

in three areas each capable of producing a red, a green and a blue picture. Between the tube face and the viewing screen are three lenses and these are so disposed that the three pictures are blended into one single image, which again has all the colour of the original.

The three schemes just described are illustrated diagrammatically on the next page, but it should be appreciated that these are only outline details and full technical data and circuit descriptions are not yet available.

3 American Colour Systems

Diagrammatic Illustrations of the C.B.S., R.C.A. and C.T.I. Systems

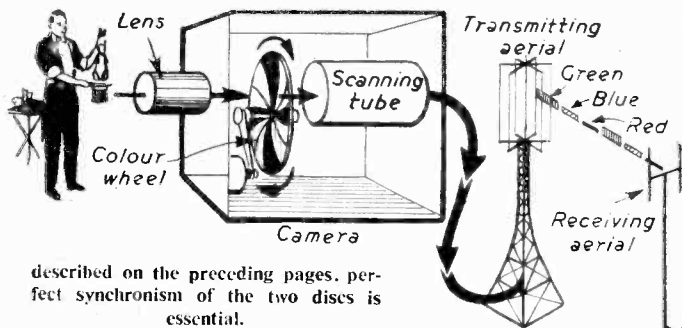

The system depicted here is that of the Columbia Broadcasting System (C.B.S.), utilising a rotating colour scanning device in front of the normal tube. As

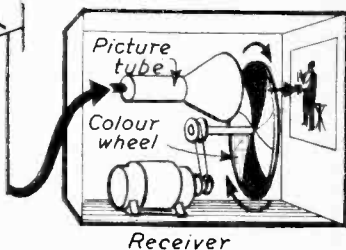

described on the preceding pages, perfect synchronism of the two discs is essential.

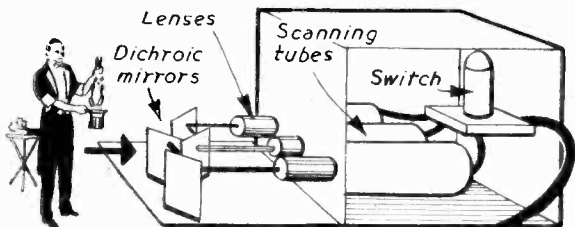

This is the arrangement used by the Radio Corporation of America (R.C.A.), in which three tubes are used, and at the receiving end one image is viewed direct, and superimposed upon it are the pictures from the two other tubes, the viewer seeing the three images superimposed. This would appear to be a somewhat bulky arrangement from the receiver point of view.

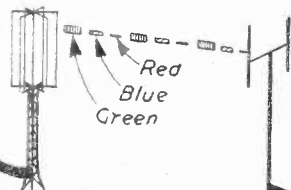
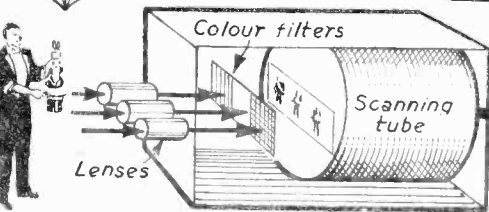
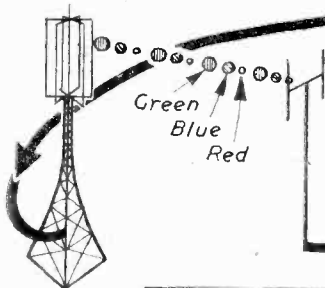

This is the latest system, developed by Color Television, Inc. (C.T.I.), in which three separate images are picked up on the single tube, and on the receiving tube the three images are produced side by side in areas where the screen material results in red, green and blue pictures. Three lenses combine these into a single picture on the viewing screen.

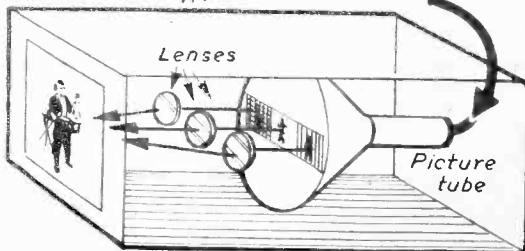

The B.B.C. Television System—2

A Detailed Explanation of the Working of the System by the Chief Engineer, D. C. BIRKINSHAW, M.B.E., M.A., A.M.I.E.E.

DURING a play, if at any time the viewers are seeing a particular part of the production via camera 1, then the production staff will already be viewing the picture from the camera which they intend to use next, by means of the second monitor and its associated channel. Thus the quality and composition of the picture can be adjusted in advance during the "pre-view," and many errors of presentation are thereby avoided. Similarly, pre-hearing facilities are available on sound.

Telecine

Mention must now be made of the important adjunct to all television productions, the telecine apparatus. Film is required for insert purposes in many productions, just as gramophone material is required for effects and other aural backgrounds. Each studio therefore has a telecine machine working on the continuous motion principle. In these machines the film moves steadily through the machine and not in jerks as in a cinema projector, and the blurring of the image which would obviously be produced by this motion is exactly compensated by an inverse movement of mirrors which are interposed in the path of the emergent optical beam. The machine therefore delivers a steady optical image from the moving film and this is projected straight into an ordinary studio camera. Operational control is, of course, brought up to the control gallery so that the producer has film on demand.

Having introduced the subject of film, we may perhaps now leave the studio and consider the question of the transmission of film as a separate entity, that is to say, film which does not form part of a studio production. Such includes news-reels, feature films, documentaries, etc. These are televised from a separate apparatus housed in the central telecine room. This is a new development, and the latest and most modern telecine apparatus has been installed, the apparatus having been made by Messrs. E.M.I. Limited, and Cintel Limited. In these machines the Iconoscope type of pick-up tube is not used, but the film is scanned by means of a flying spot developed on the screen of a special cathode-ray tube and a photo cell behind the film interprets the

varying light intensity which it receives as video-frequency current.

Central Control Room

Any programme originating in either of the studios or the central telecine room is fed to the central control room which acts as a monitoring and switching centre between what may be termed programme contribution and programme distribution. Thus if the evening programme starts with an item from Studio A and continues with an item from Studio B, then it is the central control room which effects the change-over of both vision and sound. The sound change-over is simple, but the vision change-over is a complex business, since it is essential not to interrupt the flow of synchronising signals, as otherwise receivers would get out of step during the change, and untidy presentation would result. Elaborate electronic apparatus therefore is needed to cover this point, and it is installed in the central apparatus room, adjacent to the central control room. This room also contains the master pulse generators which supply timing pulses to all Alexandra Palace programme contributing sources. The vision and sound outputs from the central control room proceed straight to the transmitters on the ground floor.

The vision transmitter may be divided roughly into four parts—the modulator, the radio frequency amplifiers, power supplies and the auxiliaries. The modulator is really a gigantic video-frequency amplifier receiving a video input of 13 volts amplitude and amplifying this to 2,000 volts. This is a considerable achievement bearing in mind that the range to be covered is from zero (D.C.) to 3 Mc/s. Moreover, the output power of this modulator is 2 kW. and the output impedance of the order of 200 ohms.

The radio-frequency amplifiers meanwhile generate R.F. current at 45 Mc/s per second which

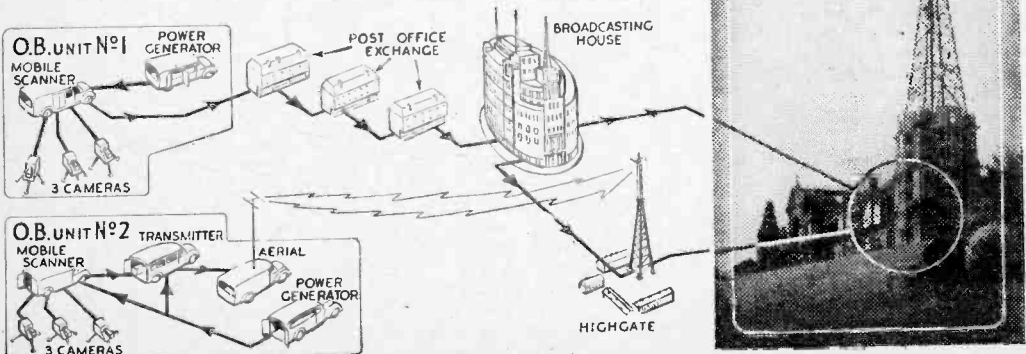

A diagrammatic representation of the outside broadcast set-up.

is modulated by the video-frequency signals provided by the modulator. During the white parts of the picture 17 kW. of R.F. energy at 45 Mc/s flow into the aerial feeder, whereas during the synchronising signals the output is almost zero. The 75 ohm concentric feeder then takes the power to the eight pairs of push-pull end-fed dipoles with reflectors mounted at the top of the 300ft. mast.

The power equipment for this transmitter follows fairly normal practice except that it is of exceptionally good regulation to allow for the faithful transmission of the D.C. component. It is also exceptionally well smoothed, and in fact, for the modulator, the 50 cycle A.C. mains are converted to 500 cycles in order to enable exceptional smoothing of the derived H.T. to take place without the provision of an inordinate weight of apparatus. The sound transmitter in a neighbouring hall is a straightforward 3 kW class A anode modulated transmitter operating on 41.5 Mc/s and supplying a similar feeder and aerial.

The central control room also feeds a vision output into the Post Office operated system of cables and beam radio station by means of which the video signal is sent to the new transmitter at Sutton Coldfield. The sound is transmitted on ordinary music lines such as the B.B.C. has used for many years. The Sutton Coldfield transmitter, being of later date than that of Alexandra Palace, is more powerful, the vision being of 35 kW at peak white on the frequency of 61.75 Mc/s and the sound being of 12 kW on 58.25 Mc/s. At Sutton Coldfield the mast is 750ft. high and employs an entirely different aerial design in which the aeriels, while still generating vertically polarised fields, create fields rotating horizontally.

Outside Broadcasts

An important and increasing amount of television production material is now furnished by the Outside Broadcast Television organisation which is based at the Palace of Arts, Wembley. Considerable modernisation of the equipment has taken place in the post-war period, and quite a variety of equipment is now available. At present the unit possesses mobile equipment made by Pye Radio, Ltd.; by Messrs. E. M. I., Ltd. and by Marconi Wireless Telegraph, Ltd. All this equipment is of portable type employing miniature valves and components, and is housed in specially designed vans, but if desired the apparatus can be removed from the van at the site of the outside broadcast and transported into a building in order to set up a control room. Each set of equipment provides for the use of three cameras and eight microphones. In the case of the Pye equipment, miniature super Emitrons are employed and these pick-up tubes are a development of the ordinary Emitron or Iconoscope type of tube in which the image is focused on a photo cathode, the emergent electrons from which bombard a mosaic settling up upon its surface a charge image. These tubes are more sensitive than tubes of the standard Iconoscope type. The E.M.I. equipment employs tubes termed C.P.S. Emitrons, in which the same principle of the charge and discharge of the mosaic is employed, but the practical operation of the tube is vastly different from the earlier Emitrons in that, by the aid of a very low velocity scanning beam, an unusually high sensitivity is obtained. The equipment provided by the Marconi Company uses the image orthicon, a type of tube largely developed in America and which possesses the highest sensitivity of any known type of pick-up tube. It is, therefore, especially suitable for scenes in which the lighting is expected to be dim and cannot be modified. The video signals generated by these equip-

ments at the site of the broadcast must be conveyed to the central control room, at Alexandra Palace, and this is done either through a system of special vision cables and circuits provided by the Post Office and which are set up as required for each broadcast, or alternatively by means of a radio beam operated by the B.B.C. For this purpose the Television Outside Broadcast unit possesses two 1 kW. transmitters operating in the 60 to 70 Mc/s band, although experiments are taking place which may well lead to the adoption of much higher frequencies. The aeriels for these transmitters are elevated into the air by means of a standard fire escape, a most convenient and speedy method. Mobile power generators also exist in case it is necessary to augment or substitute for the local electricity supply.

At present the Television Service provides some 20 outside television broadcasts a month which is a very creditable result, since it must be borne in mind that each television outside broadcast is in effect a substantial electric installation, erected, used and dismantled in a very few days, and a considerable amount of careful planning and negotiation with a number of separate bodies is necessary before each broadcast can be staged. The base at the Palace of Arts, Wembley, is now well equipped for the servicing and housing of the equipment.

There is a marked difference in the technique of productions of studio programmes and outside broadcasts. In the former, every move is planned and in effect an artificial spectacle is produced and broadcast. In the case of an outside broadcast the camera rather resembles an observer looking on at an event.

Provided the economic state of the country permits it, the next few years should see important developments. The B.B.C. is most anxious to extend the range of its television service by building further transmitting stations, and active work on these is already in progress. In the field of programme origination, the B.B.C. is acutely conscious of the limitations of its Alexandra Palace studios and has recently acquired premises at Lime Grove, Shepherds Bush, where the provision of a number of modern studios is now being planned.

DARK VIEWING

DO you view in complete darkness? If you have you probably use an old set. The brilliance of modern C.R. tubes renders this quite unnecessary. It is usually only necessary to screen the rays of the room lights from the front of the tube by means of a piece of cardboard overhanging the front of the set. Some American manufacturers fit their sets with a kind of telescopic "hood," formed by opening double-doors in front of the tube and sliding out a top screen. The longer the hood, the less external light will impinge upon the face of the tube and the better will be the picture when viewed in an artificially illuminated room or in daylight. This arrangement also reduces the reflections of room lights on the front glass of the set. Rooms illuminated with tungsten lights, especially when fitted with yellow or red shades, give the picture a blue aspect. This effect is less noticeable after the viewer has concentrated on the picture for a few minutes. The best viewing conditions are created by fitting a bluish tinted "daylight" type lamp behind the set, sufficiently bright to reflect from the walls and give a general illumination to the room without destroying any picture values. The colour of the picture then reverts to black and white. A greenish lamp is equally effective and is possibly more comfortable than a blue bulb. There is no doubt at all that viewing the modern brilliant pictures in complete darkness puts considerable strain on the eyes.

Building the "Viewmaster" — 2

An Amateur Describes his Experiences in Building this Popular Home-constructor Set

By ALAN CHISHOLM

TO complete the sound/ vision chassis, it only remains to mount the seven-way terminal strip (note the five centre terminals are flat) and to wire up the top of the chassis as shown on Chart 4.

From six of the Micadiscs will protrude the wires as fitted in Stage 1. The connecting wires should be looped as already described and soldered into position.

After removing the wood block, the sound/ vision chassis may now be set aside pending the construction of the power pack and time-base chassis.

I learn from the publishers that an H.F. stage has been designed for adding to the sound/ vision chassis, which will make it possible to obtain good viewing in the fringe areas. I will describe the unit and its incorporation into the "Viewmaster" in a later article.

Table Model or Console ?

If you intend making up your "Viewmaster" as a table model, you may proceed, after completing Stage 4, with the assembly of the components on the time-base and power pack chassis as instructed on the wiring chart for Stage 5. If, however, you favour the console model, as I do, then there is a certain amount of constructional work in building up a framework on which both the sound/ vision and time-base power pack chassis can be mounted as a double deck. For this work you will need a few additional tools usually to be found in the handyman's toolbox—a hacksaw, a file, a hand drill, a 5/32in. and a 3/16in. drill and a centre punch.

You can make the framework out of stout strip brass, but I decided against this for the following reason. To obtain rigidity, hard brass must be used, and this can only be bent at a right angle if it can be heated to a red heat and bent immediately. Even then there is a risk of fracturing the metal. Aluminium angle, 3/4in. by 16 gauge, however, is equally rigid, is easily filed, drilled and bent, and will also clear the earth lead rubber grommet and the five-way terminal strip holding-down screw without any filing for clearance.

Two lengths of aluminium angle are required each 33 1/2in. long. You may work on slightly longer material if you wish and trim afterwards. In this way any slight error in bending can be corrected so that both front uprights and both rear uprights are of equal height. By working the two lengths together and back to back (see Fig. 3), each should be identical when finished. Mark off from one end (or from a datum line scribed, say, 1in. from one end if using longer lengths) a distance of 10 3/4in., then a further distance of 13 1/4in. and finally a distance of 9 3/4in. At the two centre marks, right-angled "V's" must be cut or filed with the points of the V's centred on the two centre scribed lines and reaching to the flat.

Still held together, the two strips can then be bent at the "V's" to form right angles and the height of the uprights adjusted if necessary. The two longer uprights will be to the front and the shorter ones at the rear. Each upright must be bent back about 5 deg. at a distance of 3 1/4in. from the top to allow for the backward tilt

of the main chassis. These two "U"-shaped frames must then be marked off for drilling. Position each upright into the appropriate corner of the main chassis, square up with the top and carefully scribe the location of the holes to be drilled, using the existing holes in the chassis as a template. When all have been marked, centre punch and drill with a 3/16in. drill. This will give sufficient clearance with the 2 B.A. screws to allow for any misalignment. The frames may now be fitted to the chassis.

The overall distance over the frames from back to front should be 13 3/4in. If it is slightly more or less it does not matter, but the depth of the flange on the front and back plates, which have to be made for the purpose of supporting the sound/ vision chassis and the controls, will have to be adjusted accordingly. The distance between the inside edges of these flanges must be exactly 12in. (see Fig. 2). If less, the flanges will foul

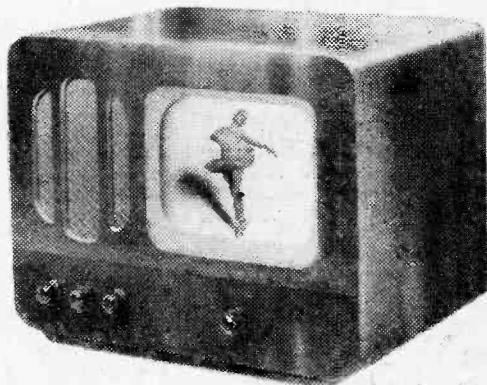

Fig. 1.—The table model in its specially designed cabinet.

components on the sound/ vision chassis and if more, there will be insufficient material to accommodate the holding-down screws. In addition, a semi-circular slot must be cut in the fold of the front panel in the position shown to clear the holding-down screw of the three-way aerial terminal strip.

Front and Back Panels

Both front and back panels are identical in size (see Fig. 5 for dimensions), the front panel, of course, being also drilled for four controls, the on/off switch now being located with the other controls instead of on the time-base/power pack chassis. Panels are secured by 2 B.A. screws and nuts to the uprights. If you can clamp them in position you may drill panels and uprights together, otherwise drill the panels first, offer up and mark out as previously indicated. There is more certainty, this way, that all holes will line up.

The sound/ vision chassis can now be laid in position

on the flanges, the holding-down holes marked out and drilled and the sound/vision chassis then removed to a safe place pending completion of Stages 5 and 6.

The cradle support for the front of the C.R. tube has to be located on the front panel of the main chassis, and two small angle brackets will be needed for mounting it. These brackets are easily made from 18 gauge aluminium cut to the shape and dimensions as in Fig. 6. Re-set the curve of the cradle to accommodate the 12in. tube. File away the left-hand bottom rear corner of the cradle (viewed from front) to clear the head of the holding-down screw of C54 clip. Position the cradle so that the top edges are level with the top of the main chassis, mark off and drill as necessary. The later Whiteley chassis already have holes drilled for the small brackets.

After fixing the cradle into position, the various components should be fitted as detailed on Chart 5. Remember that those capacitors fitted with P.V.C. sleeves are intended to be isolated from the chassis, and care should be taken to see that they are not pushed down too far in the clips, otherwise contact with the chassis might be made. Capacitor C51 is a case in point, as it may easily make contact with the lip of the chassis if pressed fully home. Do not tighten up the condenser-clip holding-down bolts before inserting the capacitors,

as those with P.V.C. sleeves can only be inserted by fully opening the clips.

If you experience any difficulty in starting the nuts on the holding-down screws of the transformer which are not too easily accessible, tap the nut into the end of a piece of soft wood and it can then be pushed down

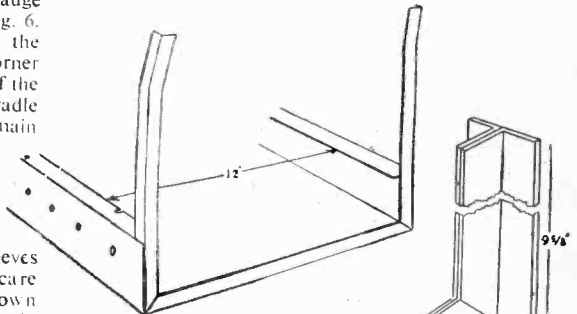

Fig. 2.—Spacing for the control panel.

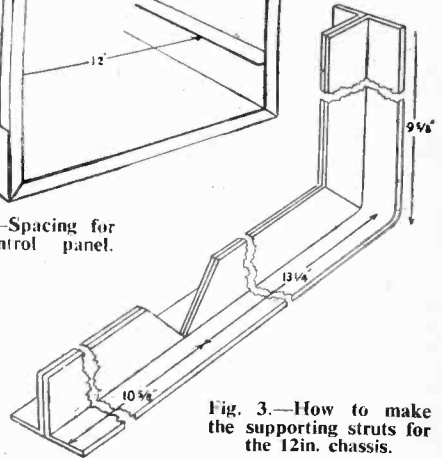

Fig. 3.—How to make the supporting struts for the 12in. chassis.

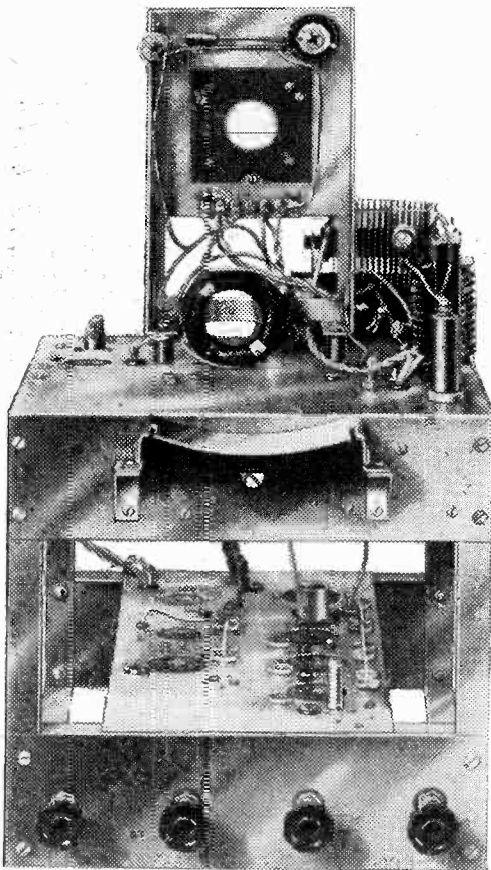

Fig. 4.—The chassis modified to take a 12in. tube.

into any awkward place, and the screw turned into the nut. This also applies to the locking washers.

“Earth”

In the following references to wiring, I may use the term “earth.” This will in all cases, unless otherwise stated, refer to the chassis, although strictly speaking it is not directly earthed.

Proceed with the wiring up of resistors and capacitors etc., as indicated on Chart 5—but for the time being omit the lead shown connected to R69, unless you are constructing the table model.

Stage 6 consists in mounting and wiring up the components on the top of the chassis. It is easier to make the connections to the line transformer before it is mounted. Use good quality flex, red and black rubber for preference, as this helps in identification when wiring up the C.R.T. rear support terminal strip. Allow an 8in. length for connecting to the terminal strip on the C.R. tube rear support, and a similar length for connecting to the choke and MR2, the lead to the latter being subsequently shortened to 4in. in length.

The assembly of the C.R.T. rear support should present no difficulty, but remember that with a 12in. tube the complete bracket must be raised by using four pieces of tubing, each 3/4in. long, as spacing collars.

The flex from terminals W and X to the frame transformer should be 11in. long. I detail the lengths of all flex leads because it is easier to cut them, bare and tin the ends and then connect them. The flex leads to the scanning coils should each be about 6in. long. Do not at this stage connect up to the scanning coils which are heavy and would prove a hindrance when turning the chassis over and over for wiring.

When attaching the width control, L14, by means of

the clip, do not over-tighten or the former may be distorted and adjustment of the iron core made impossible.

C.R.T. Heater Supply

The flex leads from the line transformer to the top cap of V10 and that to the C.R.T. from rectifier MR3 are approximately 6in. and 8in. long respectively. The heater leads to the C.R.T. socket from the transformer are 13in. long. Make certain, however, that you use the correct tapping terminals on the transformer for the type of C.R.T. employed. The third lead shown on the chart for Stage 6 as passing through the chassis with the heater leads, is the one previously omitted from Stage 5 (R69) and is connected later when both sound/vision and

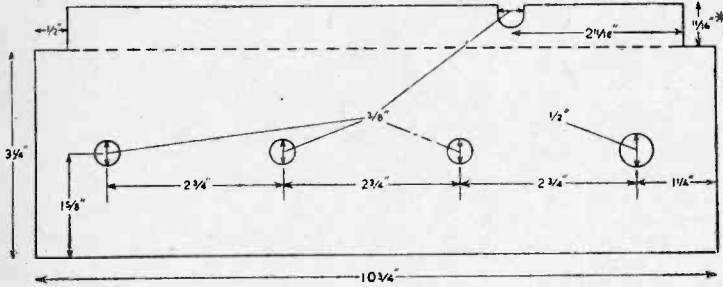

Fig. 3.—Details of panel and drilling for controls.

main chassis are assembled together and connected.

Passing to Chart 7, proceed with all the wiring-up including resistors and capacitors as indicated, but not any leads or connections shown between the main chassis and the sound/vision chassis, and that between the negative tag of C55 and the centre terminal of the frame transformer. This, of course, only applies if you are building the console, as otherwise the sound/vision chassis is attached to the main chassis before final wiring up as Stage 7.

For the console builder the time has now arrived to assemble the sound/vision chassis to the main structure. This presents no difficulty, but a little care is necessary in placing it in position to avoid possible damage to the wiring, especially the coils.

Now go back to Chart 5. Connect a 36in. length of connecting wire to the centre terminal of R69, cover with systoflex sleeving, tape it to the bottom right hand cross member, and to the right hand rear upright of the framework, pass it behind the heater transformer and out to the top of the chassis beneath rectifier MR4 and connect the free end to the appropriate tag of the C.R.T. socket. Also connect up rectifier MR5, capacitor C52 and resistor R71 to the correct socket tags according to the type of C.R.T. to be used and finally the heater leads already connected to the transformer. From the C.R.T. socket also, as shown on Chart 6, a lead passes to the junction of resistors R23 and R24 on the seven-way terminal strip on the top of the sound/vision chassis (Chart 4). This lead must be as short as possible, so bring it straight down from the socket (allowing for its ultimate position on the end of the C.R.T.) outside the chassis to its lower connecting point.

On to Chart 7 and the sound/vision chassis. Shorten the screened leads as necessary, push back and secure the braiding with fine wire and solder to the outer terminal of R29. The leads are connected as shown, but make certain that the lead to the grid of V7 via R31 is connected to the centre tag. Join up R5 and R69 and earth as shown on the chart, and also join the free end of R4 (Chart 3) to R5.

The twin feeder lead-in cable to the 3-way aerial terminal should be taped with a collar of cellulose tape under the chassis to prevent any possible direct pull on the connections.

Modifications

The lead from C16 (Chart 1) to the frame transformer is not made as shown. Instead, solder a wire to the centre of C16 on the top of the sound/vision chassis. Make the joint this way. Tin the tip of a piece of wire. Cut off a 3/16in. length of 18 gauge Multicore and drop into the centre hole of C16. Apply the iron and push in the wire when the solder flows. The other end of this wire (suitably sleeved) goes direct to the "O" tag

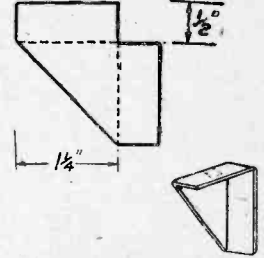

Fig. 6.—Supporting brackets to carry the cradle support for the 12in. tube.

of the mains transformer, supply side, i.e., O—200—220—240. Make certain it is the "O" or neutral tag.

The lead from Pin 1 (V4) passes through the grommeted hole. I suggested you should drill close to V4, straight up to the tag on the 3-way terminal strip (near V9) to which one end of C37 (Chart 5) is already connected.

Three leads from V5 remain to be connected; earth, pin 1; H.T.+, pin 2; and heater, pin 9. All three pass through the other additional hole drilled in the sound/vision chassis. Solder the earth wire to the centre tag of the 3-way terminal strip adjacent to V9. To the top tag of this same terminal strip (viewed as Chart 5 or 7) connect the lead from pin 2. The heater lead from pin 9 can be conveniently connected to pin 2 of V.9.

A final connection from R69 direct to the frame transformer through R68 completes the under chassis wiring, leaving only the scanning coils and the loud-speaker to be wired up. Before doing this, however, go over and check thoroughly all the wiring from Stage 1 to Stage 7, including values of resistors against the colour code. Check also that the H.T. and heater circuits are correct.

When you are completely satisfied that you have accurately carried out the instructions contained on the charts, wire up the speaker and scanning coils.

OUR QUERY SERVICE

OUR Query Service is available only to regular readers of this journal. A stamped addressed envelope should be enclosed when a postal reply is desired. In next month's issue we shall commence publication of a selection of replies to readers' queries of general interest. We cannot undertake to answer questions over the telephone, nor to modify existing television receivers. Queries should be as brief as possible, written on one side of the paper only and contain the full name and address of the querist. For publication purposes a *nom de plume* may be used.

TELEVISION PRINCIPLES AND PRACTICE

A Series of Articles Explaining the Fundamentals of Television
Transmission and Reception

By F. J. CAMM

THE frame synchronising signals comprise a train of two pulses per line, each occupying four-tenths of a line and having one-tenth of a line interval of black (30 per cent. peak) signals between them. At the end of even frames, the first frame pulse starts coincident with what would have been a line signal. At the end of odd frames the first frame pulse starts half a line after the preceding line signal. At least six frame signals are transmitted at the end of each frame, but the number may be increased to any number up to 12 pulses (6 lines). During the remainder of the intervals between frames, normal line synchronising signals are transmitted with black (30 per cent. peak) signals during the remaining nine-tenths of the line.

It will be noted that throughout the interval between frames (as during the whole transmission) the carrier falls from 30 per cent. to zero regularly at line frequency and in phase with the beginning of the normal line synchronising pulses.

The 15 per cent. interval between vision signals of successive lines, and the 10 lines interval between successive frames are minimum intervals used at the transmitter. During the initial development of the transmitter, certain transmissions may have longer intervals between lines and between frames, which lengthened intervals correspond to the transmission of a black border round the picture.

The 30 per cent. carrier is the "black level" below which no vision signals exist and above which no

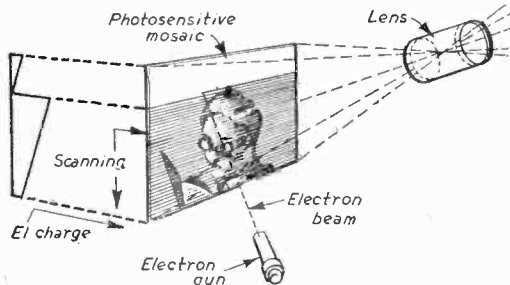

Fig. 4.—This diagram shows the principle of the mosaic scanning process.

synchronising signals extend. The mean black level of any transmission is 30 per cent. \pm 3 per cent. of peak carrier. The black level during any one transmission does not vary by more than 3 per cent. of peak carrier from the mean value of that transmission.

The residual carrier during the transmission of a synchronising pulse is less than 5 per cent. of the peak carrier.

The line frequency and the frame frequency are locked to the 50-cycle supply mains, and therefore will be subject to the frequency variations of the mains.

Interlacing

The diagram given last month illustrates the method of interlacing. The diagram shows the top and bottom portions on the scanned area with the distance between the lines, of course, very much enlarged. These lines show the track of the scanning spot, which moves

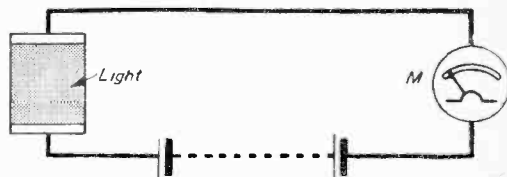

Fig. 5.—A simple selenium cell causing current changes in accordance with light intensity variations.

under the influence of a regular downward motion (the frame scan), with a quick return and a regular left to right motion (the line scan) and with very quick return not of course, shown on the drawing. The combination of these motions produce the slightly sloping scanning lines. Starting at A, not necessarily at the beginning of a line, the spot completes the line AB, returns to the left and traverses the line CD, then EF, and so on down the "dotted" lines on the drawing. At the bottom of the frame the spot travels along line CH and then starts at J and travels to K. At this point the return stroke of the frame motion begins and returns the spot to L at the top of the frame. A complete frame scan has now been made since leaving A, so that $202\frac{1}{2}$ lines have been completed, and the point L is half a line away from A. The downward frame motion now starts again, causing the spot to travel along LM, completing a single line motion JKLM. The spot then returns to the left and traces out line NO, which, due to L being half a line ahead of A, will lie between lines AB and CD. Similarly, the next line PQ will lie half-way between CD and EF. The spot now traces down the chain dotted lines to RS and finally traces out TU, at which latter point the frame return causes the spot to rise again to the top. When the spot reaches the top it will have completed two frames since leaving A, and, as two frames occupy the time of exactly 405 complete lines, the spot will return exactly to A, after which the cycle begins again.

From the foregoing, it will be seen that the complete picture is scanned in two frames, but as each frame

contains an integer number of lines, plus a half, the two frames will interlace. The system does not require the short return times shown for the line and frame scans, nor need the lines begin in the positions shown. Provided the line and frame traversals are regularly recurrent and have the correct frequency ratio (two frames—odd number of lines), an interlaced picture will be obtained.

The result of this interlacing is to provide a picture which is crisper and which possess much less flicker than a sequentially scanned picture of the same number of lines. Furthermore, by making use of a circuit which will more or less suppress the flyback—as described later, the double lines U-A and K-L in Fig. 3 may be to all intents and purposes obliterated and a picture comparable with a cinema picture obtained. At the critical focal point the individual lines may be seen when the screen is viewed at close quarters, but when it is found necessary to be close to the screen the individual lines may be almost eliminated by a slight out of focus setting without seriously impairing the sharpness of the received picture.

We have thus seen that the electrical transmission of a picture depends upon the principle of exploring the

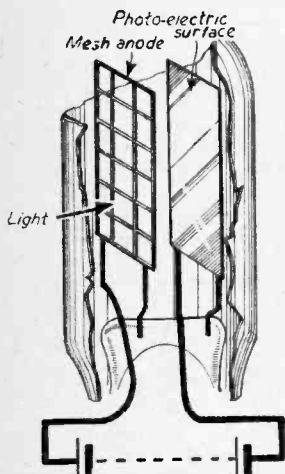

Fig. 6.—Details of a simple photo-electric cell.

sufficient degree the effect of a motion picture is obtained.

Transmission depends upon a light sensitive device, of which there are many, the most important being selenium, whose electrical resistance is affected by light. If we take a simple selenium cell which consists of a small plate of some insulating material such as mica or glass coated on one side with a thin even layer of the element and connected in circuit as shown in Fig. 5 with the electrodes making contact with each end of the selenium layer, the reading of the microammeter M will vary according to and with the intensity of illumination falling upon this medium. It will become greater as the light intensity increases and vice versa. The increase of current and the corresponding decrease in resistance of the selenium which accompanies an increase of illumination takes place more rapidly than does the decrease of current or rise of selenium resistance which accompanies a decrease of illumination. This time lag is the main disadvantage of the selenium cell.

Another light sensitive device is the photo-electric cell. When light impinges upon some substances such

as caesium, potassium and other of the alkaline earths, some of the electrons in the metal acquire high velocities and they break away from the surface and are emitted into the space surrounding the material, just as electrons

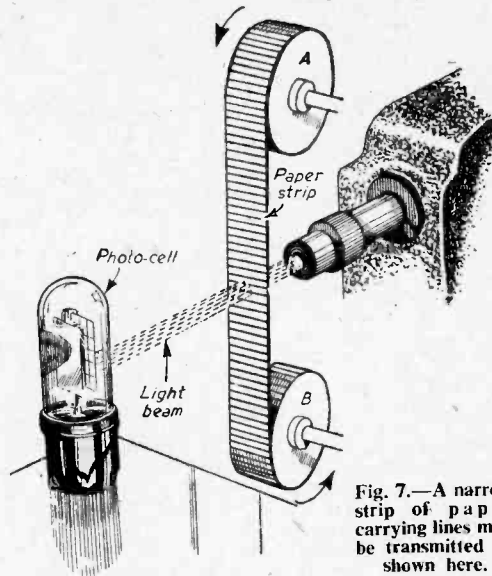

Fig. 7.—A narrow strip of paper carrying lines may be transmitted as shown here.

escape from a heated filament of a thermionic valve. Obviously, as the intensity of the light increases the rate of electronic emission will increase and a space charge is created over the surface of the material.

By arranging a cathode plate coated with caesium in an exhausted glass bulb with an anode consisting of a coarse metal grid facing its active surface, a photo-electric cell is formed. The anode is maintained at a high potential with respect to the cathode by means of an electrical source of power connected between anode and cathode. Hence, when light impinges upon the inner surface of the cathode the electrons released are attracted to the positive anode and a current flows round the external circuit as shown in the diagram. Obviously, as the intensity of the light increases, a greater number of electrons will be emitted from the caesium and therefore more current will flow in the circuit. The photo-electric cell is really a light controlled diode.

If we connect the photo-electric cell into a circuit similar to Fig. 5 it will behave in exactly the same way under the influence of light as a selenium cell. Its advantage over the selenium cell is that there is no appreciable time lag resulting from sudden changes of light intensity. Its disadvantage is that it is much less sensitive.

In order that the system of picture transmission can be more easily understood, assume that a strip of paper is marked out as in Fig. 7 and that it is to be transmitted. This illustration shows a simple piece of apparatus which may be set up, the paper strip being fed between the two spools and passing between a strong source of light and a light sensitive cell. The intensity of the light falling upon the cell as the strip moves from A to B will vary according to the shading of the strip, and these variations will be converted by the cell into corresponding electrical changes.

(To be continued)

E.H.T. for the VCR97

Another Interesting Circuit for the Experimenter

By T. W. DRESSER

THE VCR 97 cathode ray tube has been deservedly popular among builders of TV receivers for some time and the opening of Sutton Coldfield has merely stimulated the demand for this tube among those of us hitherto out of range of TV and whose pockets, in any case, are not deep enough to carry the luxury of a nine or ten-inch magnetic tube.

The VCR 97, at thirty-five shillings or so has brought television into many homes which would not otherwise have seen it and has also given much pleasure—and instruction—to the builder. With the help of one of the many booklets on the subject, the conversion of ex-radar gear into a viewing unit has not proved so very difficult and, in actual fact, probably the greatest number of snags have arisen in connection with the tube's E.H.T. supply. Until fairly recently the only source of high voltage available to the public was the transformer, either in a combined form supplying L.T. and H.T. to the valves as well as L.T. and E.H.T. to the tube, or as a separate unit supplying tube heater, rectifier heater and tube E.H.T. only, and many thousands of them have been purchased by TV enthusiasts. But, unfortunately, transformers of these types, for various reasons, are particularly prone to trouble in one way or another and it is not untrue to say that the percentage of breakdowns in them has been extremely high. It is a fact, too, that the cost of such transformers, together with the high voltage rectifier and smoothing condensers, is quite large. But, in the absence of any other reasonably easy method of obtaining E.H.T., builders had no option but to use them, despite their drawbacks.

The advent of R.F.E.H.T. units served to correct this position to some extent. They provided a reliable source of E.H.T., without many of the faults of the transformer and with the great advantage of being non-lethal. But again the cost of such a unit almost equals that of the transformers used previously! Many constructors, unable to meet such costs, preferred to use the step-ladder arrangement of metal rectifiers and this system has won many adherents in the TV field. Here, too, though, cost is a big factor. Metal rectifiers are not cheap, and if of selenium, are soon damaged by a comparatively moderate voltage overload.

Some months ago, faced with this problem of keeping down costs in obtaining the required 2.5 kV. for a VCR 97, the writer solved it by using a very old and

well-tried circuit with modern components, and the result exceeded all expectations both from a technical and a financial angle. As an indication of the unit's versatility, used in any one of three combinations, it will supply a rectified voltage of 700 to 2,500, either positive or negative as desired, at a cost of from five to thirty-five shillings; a figure considerably lower than that of most other E.H.T. systems. It does not involve the use of any out-of-the-ordinary components nor extended transformer H.T. windings, and functions with a minimum of small parts readily procurable from advertisers in this magazine or from any good class dealers. Moreover, physically, the entire "works" is less than a quarter the size of either the cumbersome transformer or even a modern R.F. unit.

THE CIRCUIT

As has already been stated there is nothing basically new about the circuit, which is a straightforward voltage doubler using two diodes, but the novelty—and decided cheapness—lies in the use of a 6H6 as the rectifier and in varying the output voltage by the choice

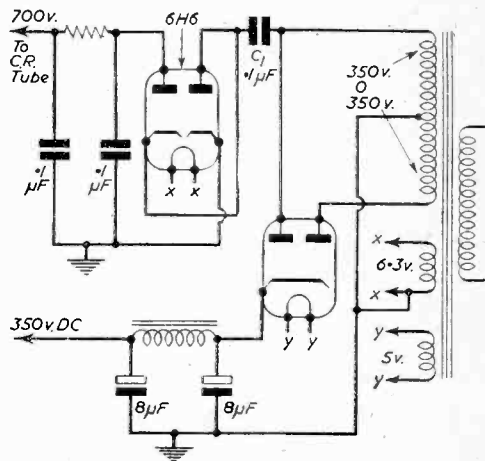

Fig. 2.—A circuit giving a lower voltage than that of Fig. 1, and suitable for an oscilloscope for instance.

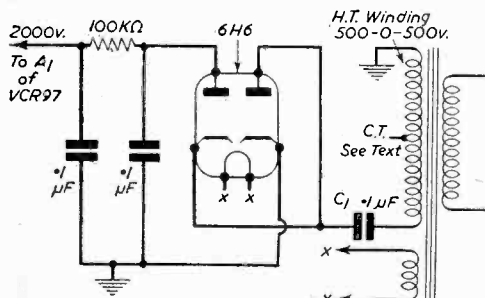

Fig. 1.—A circuit giving a 2,000 volt (negative) supply.

of an appropriate capacity for C1, as indicated in Table 1, which also gives the output voltage for any given value of condenser. It will be seen from the table that the rectified voltage can be swung between 1,200 and 2,100 by this means without any interference with the rest of the circuit and without in any way affecting the smoothing. A suitable circuit for use with a VCR 97, giving a negative 2,000 volts, is shown in Fig. 1. The maximum permissible voltage for this tube is 2,500 and as some readers may wish to use this rating they can do so either by raising the input A.C. to 1,200 volts R.M.S. or by increasing the capacity of C1 from .1 μF to .15 μF. If only some 600 or 700 volts are required for a small oscilloscope tube these can be secured from the circuit depicted in Fig. 2, which,

incidentally, will cost over and above the expenditure on the other necessary components. two shillings for an ex-Service 6H6 and perhaps three shillings for condensers !

Fig. 3 shows a circuit for 2,000 volts positive output, which may be found useful for various purposes.

It will be noted that in all these circuits the transformers are of quite standard type. But where the H.T. winding is centre-tapped, the tap should not be earthed in the normal manner except when used as in Fig. 2. A 500-0-500 transformer with the two halves of the windings in series as in Fig. 4, will supply the 1,000 volts input required to give 2,000 D.C. for a VCR 97, a 350-0-350 similarly will serve for a VCR 138, 3BP1 or a 5CPI, and so on. If the constructor does not wish to use a standard transformer, transformers designed for such uses as this, or complete kits of parts can very probably be purchased from advertisers in PRACTICAL TELEVISION at a reasonable price.

In conclusion, it may be considered by some readers that the heater-cathode insulation of the 6H6, really a

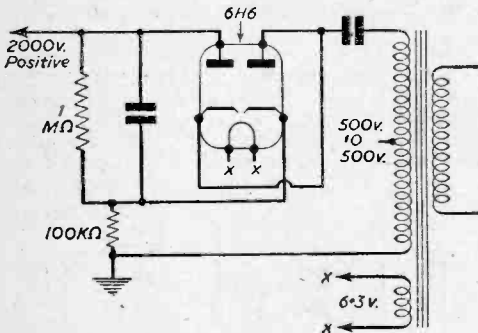

Fig. 3.—This circuit will give a positive supply of 2,000 volts.

signal diode, is unlikely to withstand such high voltages for any length of time. The writer would point out in reply that four such diodes have been in constant use supplying 2,000 volts to VCR 97's for over four months and still show no signs of cracking up ; proof enough that they will stand up to it. A long series of experiments seems to indicate that the point of danger is reached at about 1,500 volts, at which figure internal flashover occurred, though there was no evidence that the heater-cathode insulation had suffered even then.

A final word of warning. Do see that your condensers are rated to carry at least the voltages they will be

Value of CI	D.C. voltage output
.002 μF	1,200
.006 μF	1,800
.1 μF	2,000
.15 μF	2,450
All condensers 3kv working voltage.	

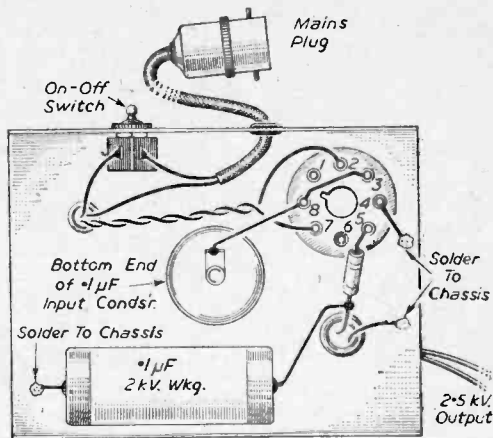
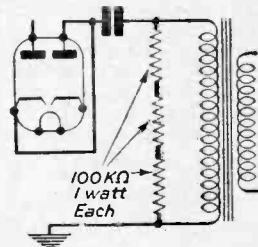

Fig. 4 (above).—Suggested layout for the circuit of Fig. 3, Fig. 5 (right). —Modifications to prevent flashover in the 6H6.



handling and preferably more than that. Don't expect an old paper condenser picked out of the junk box to act as a substitute ; that is neither fair to the rectifier nor the condenser, and will inevitably lead to trouble.

Where the input to the 6H6 is 1,000 or more volts, and the output is very lightly loaded, it is possible that readers may find flashovers occurring within the valve "pinch." This is due essentially to the input voltage approaching very close to the peak voltage, and the remedy is very simple. Fig. 5 shows the modification to be made where such flashovers occur. It consists of a high-resistance bleeder arrangement across the input and effectively stabilises the circuit without any appreciable voltage drops. In only one circuit arrangement out of quite a number the writer has used has this sparking occurred, but the explanation and cure may save readers some trouble if they encounter it whilst experimenting.

New Aspect Ratio

The diagram below shows the relative heights of the old and new picture used for television. It will be seen that a small area at top and bottom are now normally lost compared with the old picture shape, and details of this new arrangement will be found in the leader on page 51.

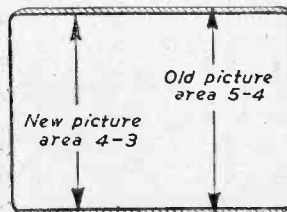

Old and new picture proportions. lost outside the mask.

Remember, that the space at top and bottom may be removed by adjusting picture width to obtain the correct proportions, in which case a small area at each side of the picture will be lost outside the mask.

The Future of Television

As Envisaged by LESLIE MITCHELL

SINCE the earliest days of the regular television service in this country there has been considerable opposition to it from many quarters. Sports Promoters, Impresarios, Theatre Managements and Film Companies have shown some unwillingness to support this lusty infant in its efforts to stand on its own feet. Generally speaking this bias has been produced by the fear that television is a rival form of entertainment which can only reduce takings at the commercial box office. It is a short-sighted view and not a very sensible one. On several occasions it has already been proved that far from reducing box office takings a television broadcast has roused further interest in the subject (whether in sport, theatre or films) and encouraged people to visit future performances. For those who wish to attract audiences from their homes what better shop window could they have than the TV screen? Any attempts to halt the forward march of this new medium of entertainment is bound to end in failure for its supporters are growing rapidly, and viewers will soon represent a considerable body of public opinion whose wishes will have to be respected.

But for the very reason that it is new it demands a new approach in the technique of presentation and production. It would certainly be bad policy for the B.B.C. to rely entirely upon full-length current feature films or plays from the theatre. These are not the stuff of home television, they are designed primarily for a large audience in the auditorium of a theatre, and, therefore, lack the intimacy so necessary in an appeal to

the average audience of five people sitting at home in front of their TV set. As anyone in show business knows, the size of a theatre and its audience is a very considerable factor where the method of presentation is concerned. It is a factor which as yet has not been fully examined or understood in television.

There are, of course, many occasions on which television has no alternative but to ape the films. This is obviously true of current affairs where Alexandra Palace has a considerable advantage over broadcasting and newsreels in that it can be both seen and heard



Leslie Mitchell

LESLIE MITCHELL

LESLE MITCHELL has the distinction of having made more Television appearances than any other person. He also made the first when the B.B.C. service was opened in 1936.

His name, of course, is chiefly associated with Picture Page and the Teen Age shows in which he combines an air of always being in complete command of the situation with a genuine interest in the person and subject being discussed. His skill is so consummate that the inexpert may be misled into thinking that the job of interviewing for Television is easy, instead of being one of the most difficult.

It is with sardonic pleasure that an incident can be recalled when the imperturbability of Leslie Mitchell was put to a severe test. It happened in 1939 when a new type of fire escape was being demonstrated in the grounds of Alexandra Palace. Leslie was given the task of rescuing Jasmine Bligh, a pre-war announcer, from the top of the Palace. A few minutes before the escape was to be extended to its full height Leslie took up his position on it, complete with microphone, to describe the sensation of being elevated to a considerable height within a few seconds. Jasmine Bligh was in her place and Leslie lay horizontally on the top ladder and waited for action. This was a long time coming and Leslie became increasingly conscious that a severe motor accident several years previously had left his left arm unwilling to withstand prolonged strain. So he decided to rest on the ladder for a second or two. At that moment the escape was put into action and the movement of the top ladder as it passed the one beneath it caused one trouser leg to be torn along its entire length. Away went Leslie into the air with one trouser leg flapping in the breeze!

It is typical of the man that in spite of his handicap he continued with his commentary, rescued the damsel in distress, and on his return to the ground remained imperturbable while waiting for an overcoat to shield his part nakedness.

simultaneously with the events themselves. Television's own newsreel has gone far to prove the necessity for filming many items for the benefit of latecomers and there will always, of course, be a demand for the documentary television programme using a mixture of film and studio material.

Two of the greatest difficulties on the technical side of studio production have been, and still are, presented by the lighting and the camera lenses. In films, which are shot sequence by sequence over a comparatively lengthy period, it is possible to set up completely different lighting arrangements for each position in relation to the film camera itself. Owing to the continuity of a television programme this is almost always out of the question. It is, therefore, not surprising that the viewer finds the quality of his picture changing quite considerably as he watches the screen. It will require not only ingenuity but a totally different form of lighting technique to solve this problem.

As television cameras have very little depth of focus, a considerable strain is put on the camera operator whose job it is to keep sharp an image reflected upside down on a frosted glass screen attached to the "head." Two people in close-up, standing slightly out of parallel with the

lens, present a picture in which one or the other must be out of focus. Usually with inadequate studio rehearsals, and sometimes faced by a flustered amateur who fails to remember his marks—those lines painted on the floor to indicate his correct positions—the camera man is too often faced with the task of getting a good picture from an imperfect setting.

But these are only some of many difficulties which will be solved in the near future as new technical equipment replaces the old, and as new and larger studios open up. To anyone who has seen the conditions under which complicated productions have been presented to the public, it is little short of a miracle that the programmes have maintained so high a standard of excellence.

So far as the film industry is concerned, quite different problems are presented by the screening of television pictures in theatres and cinemas. Here the reproduction of films by television transmitted to the various circuits is a distinct possibility. Experiments have gone on since before the war to prove that it can be done.

Demonstrations recently have been highly successful. Following the initial outlay the advantage would obviously lie in reduction of distribution costs. Stumbling blocks are the necessary Government approval for new wavelengths or the renting of coaxial cable from the G.P.O. for programmes under commercial jurisdiction in rivalry to the B.B.C.

In America where, of course, commercial programmes are the rule rather than the exception, commercial sponsors have been complaining that the television

programmes produced to advertise their products have, as yet, inadequate coverage of population to justify the expense. Some of them have already abandoned television and returned to commercial radio as being cheaper and far more effective publicity. True, the maximum range of television will have to be extended considerably, and by some other system than that of erecting subsidiary stations at comparatively short intervals. Experiments have been made with aerial transmitters carried in planes or dirigibles, but here again the cost is prohibitive and bad weather a deterrent. When this problem has been overcome many others will disappear with it.

Colour is already a possibility both here and in the United States, though there is little likelihood of seeing it in general use in Britain before 1955. From my own observations, a coloured picture on a moderate-sized television screen is very much easier on the eye than black and white. Not only does it make it easier to pick out detail but it is, of course, very much more attractive to look at. The solution to electronic colour reproduction is under constant research but nowhere have the results yet been judged sufficiently accurate for general use, though an American inventor in this country recently claimed that with the aid of a small attachment to the camera and receiver it would be possible to produce 100 per cent. results within a year. We shall see. But in this exciting pioneering stage anything may happen and it is unwise to scoff even at the seemingly impossible.

However it may change its scope in the future, television is here to stay.

Miller Time-base

LAST month the main features of this popular time-base were dealt with, together with some interesting circuits. With regard to Fig. 6, the valve V_2 should be similar to the type used at V_1 , C_1 and C_2 should be equal and about $.001 \mu F.$ at frame frequency and $.0001 \mu F.$ at line frequency. C_3 should have the same value as the coupling condenser used from the anode of V_1 to the other deflector plate.

The circuit works as follows: the output voltage of V_1 is applied via the coupling condenser C_1 , and the grid resistor to the grid of V_2 which acts as an amplifier and produces an output voltage at its anode 180 deg. out of phase with the input grid voltage. A large proportion of this voltage is fed back to the grid circuit via C_2 and tends to cancel the input voltage. When equilibrium is reached there is just enough voltage at the grid of V_2 to produce an anode output equal in value, but opposite in phase to the output of V_1 . In effect the grid of V_2 is at the centre of a voltage see-saw of which the anodes of the valves are the two ends.

Push-pull deflection is well worth adopting, since it gives twice the scan, which may be more than is needed. If so, the E.H.T. may be raised to produce a brighter picture with the original dimensions. Furthermore, trapezium distortion is avoided and the general focusing improved.

Our correspondence shows that the majority of constructors find the time-base the most interesting part of the complete television receiver, and accordingly wish to know more about the principles of operation, etc. Therefore we have arranged that a series of articles should be published in the near future dealing with the general principles of all the modern types of time-base and it is hoped that this series will be of use to constructors who wish to experiment with scanning arrangements both for ex-service and standard commercial tubes.

Book Received

"TELEVISION EXPLAINED," by W. E. Miller, M.A. (Cantab.), M.Brit.I.R.E. Third Edition. Published on December 20th, 1949, at 5s. net (postage 4d.), by The Trader Publishing Co., Ltd., and distributed by Hiffe & Sons, Ltd. Size $8\frac{1}{2} \times 5\frac{1}{2}$ —112 pages, including 59 diagrams and 17 photographs.

This is the third revised edition of this book, which meets the needs of those who want technical information of a straightforward nature on television.

The book is addressed to members of the public who, having some acquaintance with radio circuits, are equally interested in their television counterparts; to radio service engineers as a grounding in the circuitry they will encounter in maintaining television sets; and to students in radio and television at technical colleges.

The book is non-mathematical, and is written in simple language. In addition to television receiver circuits, aerials and aerial systems are fully explained, and receiver installation and operation are described and illustrated.

This new edition appears in improved format and contains much additional information on aerial systems, and, with the opening of the second television transmitter at Birmingham, some notes on frequency allocations and suppressed sideband working. Other sections of the book have been brought up to date, while actual photographs of picture faults, taken by the author specially for this edition, are included.

Contents include: Picture Faults Illustrations—Aerials—The Signal—The Receiver Outlined—The Receiver in Detail—Sync Separation—The Cathode Ray Tube—Scanning Circuits—Deflection Amplifiers—Power Supplies—Receiver Installation and Operation—Appendix I and II—Index.



E.M.I. INDOOR TELEVISION AERIAL

Neat • Unobtrusive • Low Price

Here is the ideal aerial for all owners of television receivers in areas where the strength of reception is adequate. The aerial is extremely efficient and works equally well with the majority of receivers. It takes but a *few minutes* to fix in a room or a loft—special fixing tacks are supplied. This unobtrusive aerial can be mounted by the side of a window or fitted beside doors, cupboards, stairs, etc. Its low price enables you to have aerials fitted in several rooms so that your television receiver can be used all over the house. The E.M.I. "Flexible Dipole" price—**25/-** complete (Type 1091 London Area, Type 1092 Midlands Area).

• Ask your local dealer for full information or write direct to:

E.M.I. SALES & SERVICE LTD.

DEALER DEVELOPMENT DIVISION,
HEAD OFFICE, HAYES, MIDDLESEX

S.S12a

Specified for the VIEWMASTER and supplied for a variety of purposes, Wearite Coils and Coil packs cover most of the needs of the constructor and the designs engineer.

Wright and Weaire Limited

138, SLOANE ST. · LONDON · S.W.1 TEL SLOANE 221415 FACTORY: SOUTH SHIELDS, CO. DURHAM

—*keen constructors choose*

THE DESIGNERS SPECIFY

V1, V2, V3, V5, V6
COSSOR 63 SPT

R.F. PENTODE

Price 17/6 plus 3/10 P. Tax

V4

COSSOR 6AL5

DOUBLE DIODE

Price 9/- plus 2/- P. Tax

V7

COSSOR OM4

DOUBLE DIODE TRIODE

Price 9/6 plus 2/1 P. Tax

COSSOR

for the

“VIEW MASTER”

and for the Pre-Amplifier

COSSOR 6AM6 R.F. PENTODE

Price 17/6 plus 3/10 P. Tax

LEAFLET giving full details of all Cossor Valves free on application to
A. C. COSSOR LTD., HIGHBURY GROVE, LONDON, N.5

CT20

*Exclusively
Specified*

for the

VIEW MASTER

TELEVISION SET

5  **WESTINGHOUSE** 
RECTIFIERS

(1) Vision interference suppression (WX.3) (2) H.T. supply (14A86) (3) E.H.T. supply (36EHT100) (4) H.T. boost and line flyback damping (14D36) (5) Sound interference suppression (WX.6). Price for the 5 RECTIFIERS £3 - 2 - 6.

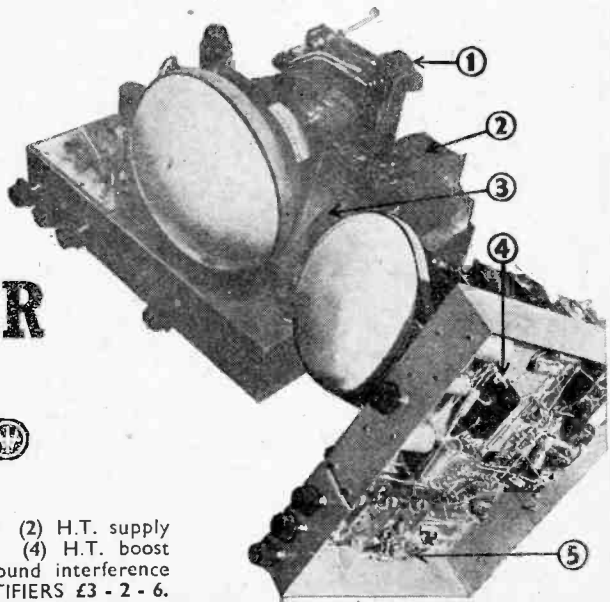

WESTINGHOUSE BRAKE & SIGNAL CO. LTD., 82 YORK WAY, KINGS CROSS, N.1

A.P. Field Strengths

ON the map below are shown the results of a survey of the field strength from the Alexandra Palace vision transmitter, which has been carried out by the B.B.C. Research Department. The survey has been extended well beyond the boundary of the nominal service area, in recognition of the fact that the rising popularity of television has led to the installation of receivers in areas of low signal strength.

The field-strength measurements, from which the contours plotted on the map have been derived, were made at several places along eight routes radiating

from Alexandra Palace, up to distances of about 60 miles. Whenever possible, places in open country were chosen, where there were no nearby hills or buildings that might produce reflected components of field strength which could give misleading results. In order to take account of the substantial variations in field strength that occur at these frequencies between points which are almost contiguous, a continuous record of the field strength at each place was made as the vehicle in which the measuring equipment was installed moved slowly along. The average value of field strength at each place



Note: Considerable Fading May Be Experienced In Areas Shown Thus [dashed line] Broken Contours Shown Thus [dotted line] Are Liable To Greater Error Due To Fading Conditions During Measurements

was then determined from these records. The aerial on the vehicle was 20ft. above the ground, and as the average height of television receiving aerials is nearer 30 than 20ft., the measured values were subsequently corrected to get the field strength at 30ft. above ground, these corrections being made on the assumption that the gain of the aerial increased linearly with height. All the measurements were made while the transmitter was radiating either normal programme or the "artificial-bars" signal, and the results were then multiplied by a factor to obtain the peak field strength, which corresponds to the white elements in the picture.

Town Results

Some additional measurements were made at each of the principal towns within the area. The field strength there was usually less than in the surrounding country by between three and six decibels, and this reduction should be remembered when using the contour map, since, to avoid undue complication, closed contour loops have not been drawn around the towns.

During the tests along the eight radial routes, the field strength was observed for a short period at each place in order to see whether there was any fading.

The shading on the contour map indicates the area within which considerable fading may be experienced. The boundary of this area cannot be precisely defined, but reception within and beyond the shaded area may be disturbed by fading that varies from slight to serious. Slight fading may occasionally be experienced within the unshaded area when reception conditions are particularly unfavourable, but in general reception in this area will be free from fading.

Sound Signals

During the survey some measurements were made on the field strength from the Alexandra Palace sound transmitter. These measurements showed that the ratio of the peak field from the vision transmitter to the field from the sound transmitter is about two to one, which corresponds, of course, with the relative transmitter powers.

The field-strength contours on the map represent average values and must not be interpreted too rigidly. Variations up to 10 decibels above and below the values shown may occur, the possible degree of variation being greatest in hilly or urban areas, and least in open flat country.

Improving the Video Amplifier

Some Facts About this Part of the Television Circuit—By D. CAVE

MANY readers who are building their own television receivers will, no doubt, include one video amplifier to amplify the picture signal and sync. pulses after demodulation. The video amplifier will be followed by a D.C. restorer and then a phase splitter to feed the C.R. tube and sync. separator. Fig. 1 shows the general type of circuit which may be used.

V_1 is the video amplifier valve, and is usually a pentode of high mutual conductance such as EF50 (VR91) or SP61 (VR65).

V_2 is a diode, and is usually one section of a twin diode such as EB34 (VR54). This valve is used as a D.C. restorer.

V_3 is a triode connected as a phase splitter to supply voltages of opposite phase for the sync. separator and the cathode-ray tube. It is usually a valve such as a 6J5 or even a pentode connected as a triode.

Now the function of the video amplifier valve V_1 is to amplify evenly a wide range of frequencies up to 3 Mc/s, if full advantage is to be taken of the high-definition B.B.C. programmes. Unless the higher frequencies from about $1\frac{1}{2}$ -3 Mc/s are reproduced satisfactorily by the video amplifier it will be difficult to get a sharply detailed picture. Any loss of the higher frequencies will cause a lack of definition which no amount of adjustment of the focus control will be able to correct.

It is important, therefore, to understand the working of the video amplifier at high frequencies and to learn the effect its associated circuit will have upon its working.

Because it is required to amplify a very wide range of frequencies evenly we must use a resistance (R_L , Fig. 1) as the anode load of the valve, since the value of a resistance does not alter over the range we are considering. Through this resistance will flow the

alternating anode currents up to 3 Mc/s, corresponding to the picture signal applied to the grid of the valve from the demodulator. These currents produce a potential difference across the resistance which is an amplified voltage of the signal on the grid. This voltage is applied via the condenser C to valves V_2 and V_3 .

If these were the only electrical components in this part of the circuit, all would be well; but, unfortunately for our requirements, the circuit contains many capacitances; each one quite small in itself, but all of them connected in parallel so that the total capacitance may be large.

In Fig. 2, the circuit of Fig. 1 is redrawn showing where these capacitances arise.

Stray Capacities

Condenser A represents the output capacitance of the video amplifier valve itself and is usually about 9 pF. B represents the valve holder capacitance, likewise F, and H, each being about 1 pF. C_2 represents the capacitance of the condenser C to chassis. Its value depends on the physical dimensions of C and may be about 3 pF. The capacitance introduced by the wiring of the circuit is shown at D and will be about 5 pF. E is the capacitance of V_2 and is 4.5 pF. for VR54. The input capacitance G of a triode V_3 used as a phase splitter will be about twice its anode-grid capacitance, say, 7 pF. This gives a total capacitance of about 32 pF.

Now these condensers are all in parallel with R_L because, from an A.C. point of view, the H.T. + line is at the same potential as the H.T. - line.

Thus, in effect, the anode circuit of V_1 is as shown in Fig. 3, where C_T represents the total of these small capacitances.

The effect of C_T , of course, is to by-pass the high-frequency components of the anode current away from R_L , and the bigger C_T is, the more it does so. It is all a question of what is called the reactance of C_T , that is, its opposition to alternating current. As the reactance of C_T gets less so more of the alternating anode current passes through C_T ; and the reactance of C_T gets less when the frequency is high and the capacity of C_T is large. The result of all this is that as the frequency rises so the voltage developed across R_L will fall, because the current through R_L is reduced by the by-pass action of C_T .

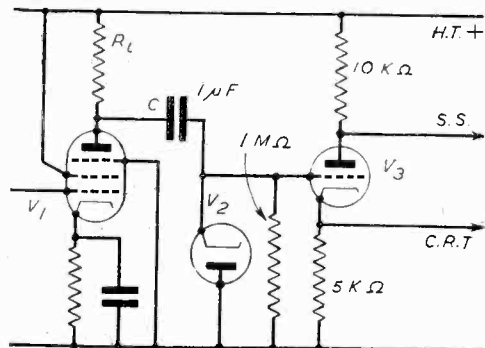

Fig. 1.—A typical video stage with D.C. restorer and sync separator.

To make sure that most of the high-frequency anode current passes through R_L , we must make the resistance of R_L very much less than the reactance of C_T at the highest frequency—say, about one-tenth of it. Then for good reproduction of 3 Mc/s, R_L should be approximately equal to $\frac{33,000}{C_T(\text{in pF})}$ ohms.

Low Gain

When C_T is about 32 pF., R_L will have to be approximately 1,100 ohms. If an EF50 is used as the video amplifier valve then the stage gain, given by multiplying R_L by the mutual conductance of the valve, will be about 7½. This value of gain is very low compared with the figure that could be obtained when using the same valve as an amplifier of audio-frequencies only; but we are forced to accept it due to the fact that the presence of C_T compels us to use a low value of R_L .

There are clearly two ways of improving matters.

(1) The introduction of one or more coils in the circuit so that their reactance partially offsets the reactance of C_T , since the reactance of a coil rises with increase of frequency.

This method is open to the objection that a tuned circuit will be formed, composed of the coil, R_L and C_T . A damped oscillatory current may be set up in this circuit when there is an abrupt change of voltage, say, from black to white in the picture. This will give rise to the well-known "black after white" effect, wherein the right hand edge of a dark object on a white background is outlined with one or more dark lines. Unless the coil is kept small in value this effect can be very pronounced.

(2) The reduction of C_T to a minimum by careful design of the circuit.

If the circuit of Fig. 2 is examined it will be seen

that the major capacitances are associated with the valves and the wiring—so the clue to the problem of reduction of C_T lies in choosing suitable valves and taking care of the wiring.

Thus instead of using an ordinary diode for V_2 choose one of the small types available such as VR92 (6.3 v.) or VR78 (4 v.). These have very low capacitances, which, in association with their special valve-holders, probably do not exceed 1½ pF. The single pin is the anode, whilst the central one of the trio is the cathode.

Further, instead of an ordinary triode, use one of the acorn types such as 955 (6.3 v.), readily available

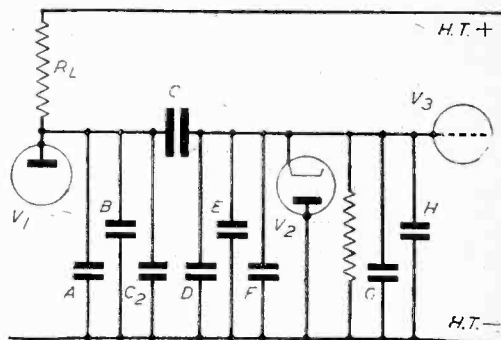

Fig. 2.—Stray capacities of the Fig. 1 circuit are indicated in this diagram.

now. This with its valve-holder has an input capacitance of about 3 pF. when used as a phase splitter. When viewed from the pip end of the valve the right-hand pin of the pair is the grid and the left-hand one is the anode. The central pin of the trio is the cathode. With these small valves a compact wiring may be

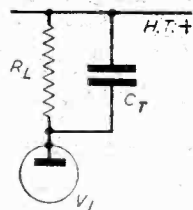

Fig. 3.—The various stray capacitances of Fig. 2 are shown here as C_T .

adopted thereby reducing the wiring capacitance to about 2 pF.

C_T is now about 19 pF, and in consequence $R_L = \frac{33,000}{19} = 1,800$ ohms approximately, giving a stage gain of 12 when using an EF50.

In actual practice, using these valves in the circuit of Fig. 1 and soldering condenser C connection direct to the grid terminal of the 955 valve holder and wiring the cathode terminal of the VR92 valve holder direct on to the same point, it has been found possible to resolve the 3 Mc/s lines in the morning test-card C when viewed on VCR517 whilst using as much as 8,200 ohms for R_L .

OUR COMPANION JOURNALS
 Practical Engineering, 4d. Every Friday
 Practical Mechanics, 9d. Every Month
 Practical Wireless, 9d. Every Month

"YOU won't find that anything has changed very much," said Norman Collins, Controller of Television, when I paid my first visit to Alexandra Palace recently. It was my first visit since 1939.

Norman Collins, the Controller of Television in this country, is a youngish, fair-haired man, who sits in an office which commands the best view in London.

"I will now do my Ruth Draper act," he said, as my wife and I came into the office I knew so well from the days when Gerald Cock was head man before the War: "If there was not a fog, if it wasn't after dark," said Collins, "you would have the most magnificent view that it is possible to get of London."

When Collins says that everything is more or less the same as it was on my first visit to Alexandra Palace in 1936, he is quite wrong. Like all experts he is too near to the job and cannot see the wood that is springing up for the trees that remain.

It is true that Alexandra Palace still remains a monstrous pile of horrible architecture casting its blight over our London planners. It is also true that they still only have the two studios down that

The PALLY

The MARQUIS OF DO Saw Recently on

very long corridor on the second floor which they had in 1936. The old corridor that I knew so well has been smartened up with a lick of paint.

Fortunately the charm remains. One is forced to the conclusion that only people with immense charm could possibly work in such monstrous surroundings. The whole place breeds informality. We came to the conclusion you could sit anywhere in Alexandra Palace, rather on the principle of the frog-footman in "Alice in Wonderland," for days and days and days—and nobody would ever presume to ask you what your business was.

The fact of the matter is that they are too busy to bother about extraneous people. And following their own psychology, they presume that everybody who is inside the place has some business or other and they just go around minding theirs and not caring much about his.

"You will not find much difference since 1936!" that is what Norman Collins said. I beg to differ.

Looking through my files of 18 years of writing for the Public Press, I find that my first reference to television was in 1932. It was not a particularly interesting reference, except that it happened to be an interview with a Senatore Marconi. Marconi expressed his opinion that the television which he had on his yacht from which he had televised a programme of his guests from Genoa harbour to a receiver in Genoa, would eventually become world-wide.

Then, again, looking through my files, I come to this which is dated November 8th, 1936. The heading is:

"First taste of Television.

"Then I watched Major Tryon, the Postmaster-General, inaugurate the Television Service.

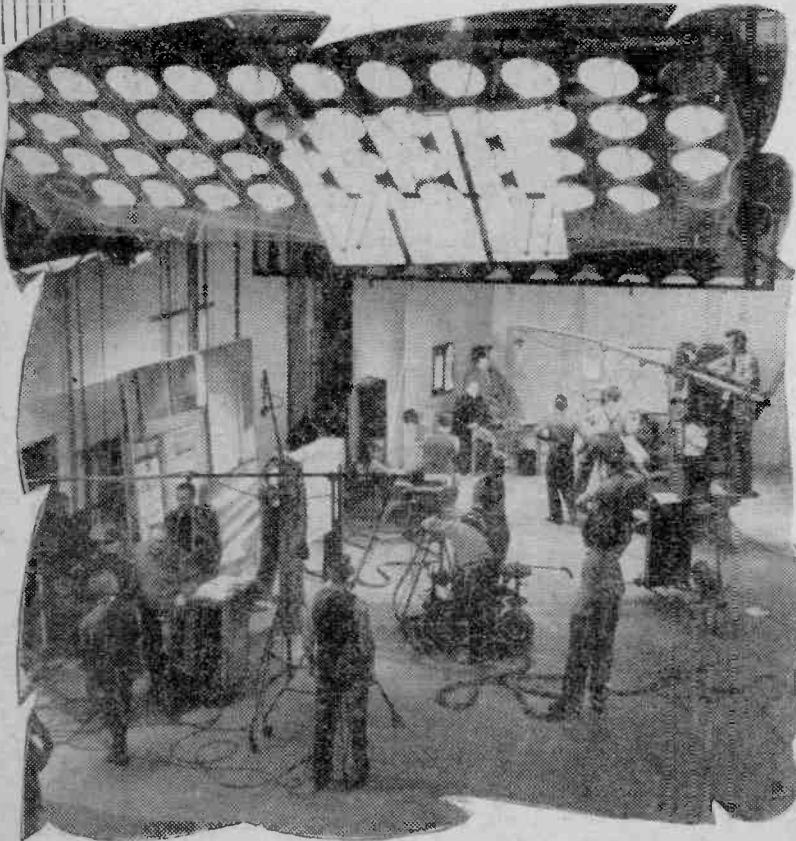

2 Post War SYNDROME

EGALL Describes the Changes he s First Post-war Visit to A.P.

"I must say that when they televise a newsreel (we saw Mollison's arrival) it gives one a peep into the future—the day when the direct televising of public events will make a set a necessity. Even in its present stage, television is not at all bad, but the screen is too small."

Apparently being somewhat interested in this new medium, on November 22nd, 1936, I wrote as follows:

"When I went up to Alexandra Palace to see them transmit the television, I was surprised to find that the studio was practically identical with a film studio."

[Note.—It still is.]

"The system they were using on the occasion of my visit does not give instantaneous transmission, but an artiste can be televised and then run quickly to a side room and see the picture going out to the public. The time-lag is one minute and six seconds.

"So it appears that the result of the Derby, for instance, would be known in Australia before the public in England could see the race on the Television."

We then skip to February 28th, 1937, in which I wrote as follows:

"It is surprising how many people in the West End of London have not yet seen television. My set is now installed in my house and it caused quite a lot of interest at my first house-warming party. The Alexandra Palace people, I believe, reckon that they now have about 1,000 viewers at each of their twice-daily transmissions and the denizens of the West End will probably remain among the last to see it. At three o'clock in the afternoon it is impossible for men, and at nine o'clock in the evening most of the West Enders are dining out or at the theatre.

"At the present moment my set is rather like a mountain bringing forth a mouse. No one could say that it is not a handsome piece of furniture; it is also a monument, whereas the screen is about the size of a shilling magazine. However, two dozen people can look at it at one time comfortably and the quality (at any rate on mine) is excellent."

In U.S.A.

Enough of this reminiscence; we will now go, post-war to the great United States of America, where they have a thing called "The

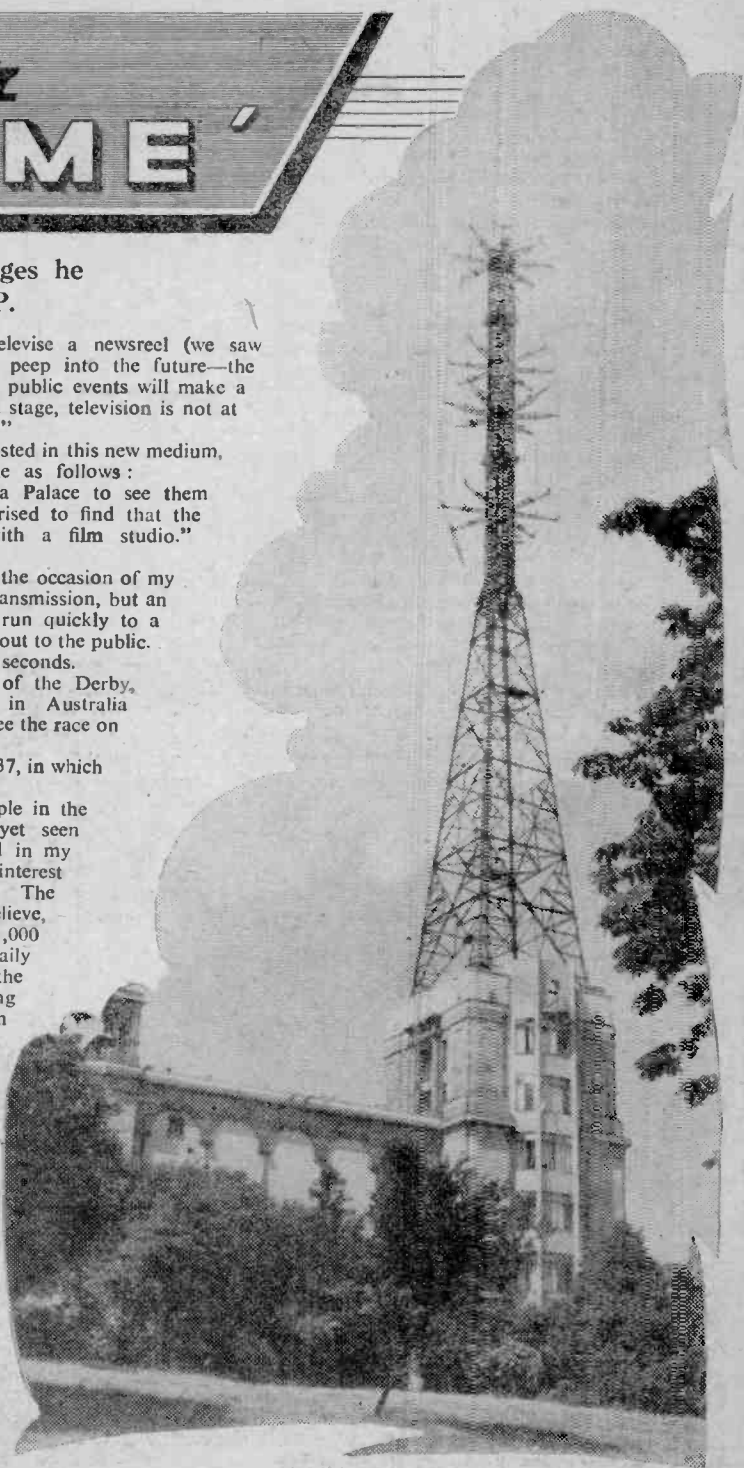

American Platform." And I was privileged to appear on it to the extent of 14,000 miles, last Spring.

The Americans had gone television crazy and New York had just been linked up with Chicago by co-axial cable and radio-relay. Now it is presumed that the people who spend their good money listening to lectures are a pretty-well-educated section of the American community. And yet I was continually asked, not what television was like in England, but whether we had any television yet in England?

I feel that there may have been almost a fiendish glint in my eye when I pointed out to them that we had television in the public service in 1936, that I had my own set in 1937 and was televised several times in 1939. Furthermore, that Mr. Baird showed me a demonstration of excellent colour television in 1942. All the Americans to whom I have shown my television in recent months say that not only is the quality of our transmission far better than theirs, but that the quality of the material put out is also far superior. A typical comment is: "I would far rather have one channel with first-class stuff on it than five channels, none of which are worth looking at."

An English friend of mine swears that in New York his host proudly showed him the great variety of pictures that five channels would produce on his set. It so happened that on every channel, on that particular afternoon, there was a football match. My friend asked, as he thought facetiously, whether they were all the same football match? Yes, they were.

Now, at Alexandra Palace they seem to be rather apologetic about what they call the confusion. It is rather like a film studio where, both in Hollywood and here, you get the impression that 95 per cent. of the people seem to be totally unnecessary, doing nothing, and the other 5 per cent. don't know what they are

doing. One is forced to wonder how a film is ever made at all. However, the television production, like the film, gets there somehow in the end, and very good it is when it does.

Now anyone who thinks that there is confusion at Alexandra Palace has just never had the horrible experience of visiting a television studio in New York. My wife and I played harmonicas on the Bob Ripley "Believe It or Not" show. We wasted three days rehearsing while an untold number of secretaries, producers, managers, script-writers and all the rest of it quarrelled among themselves and pulled the script to pieces and put it together again 20 or 40 times. The actual show was four days away when my wife said to Mr. Ripley: "If we practise for 20 years we will never be any better and we could not possibly get any worse. So for goodness' sake let us go and mind our own business and we'll see you at the show on the day!"

To this Ripley agreed, and all went well in spite of the fact that the car which was to fetch us at the hotel never arrived, and when we got to the studio nobody had ever heard of us or knew what we were supposed to do or where we were supposed to go. However, we made it, and I am sorry to have to relate that Bob Ripley died two days later, though I hope not entirely from the shock of our performance.

On arrival at Alexandra Palace on my recent visit I found myself in the hands of Mr. S. E. Reynolds, one of the producers. He took me up to the Producers' Gallery, rather like the control-room of a B.B.C. studio, where we were just in time to see Mr. Vernon Bartlett, ex-M.P. and political commentator, doing a commentary on the opening of the Canadian Parliament at Ottawa.

"I suppose Bartlett has learnt his script before he arrived?" I asked.

"Indeed, I hope he hasn't," said Reynolds. "It makes it much more difficult to add improvements during rehearsal."

In the control-room there are two television screens. The one on the left is pre-view and the one on the right is transmission. A young lady who at the moment was singing "Mademoiselle from Armentières" blended these two pictures into one whenever Mr. Reynolds said "Mix!" During this procedure Mr. Bartlett, the pictures, the "mixing," and indeed "Mademoiselle from Armentières" all functioned a hundred per cent.

Afterwards I climbed down from the gallery and said hullo to Bartlett. He asked me whether I had any suggestions to incorporate in his script. I said the only thing that had occurred to me was to emphasise a little more the drabness of the black and white of the Canadian Opening of Parliament compared with the colourful pageantry of the Royal Procession, with all the great officers of state in uniform, heralds, and the King and Queen at our Opening of Parliament in Westminster. Having got back in time to see the performance on my own set at home, I was somewhat flattered that Mr. Bartlett had adapted my remarks into his script.

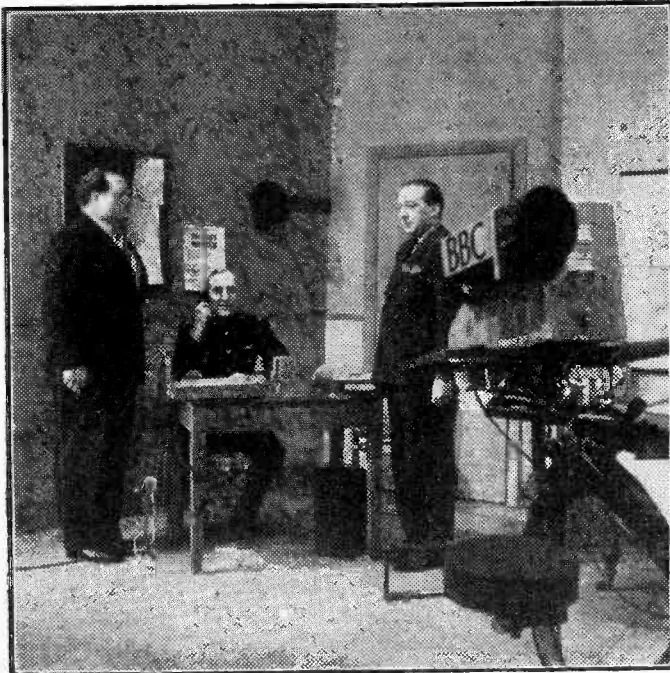

Richard Dimbleby, Jack Hulbert and the Marquis on the set.

Future Plans

After Vernon Bartlett's rehearsal Mr. Reynolds took me along to see the controller, Mr. Collins. On the way down that very long corridor which is such a feature of Alexandra Palace I asked him what he actually produced. "Oh, 'Picture Page,' 'Fashion,' 'Sports Side'—that is, inside sports—and what I call 'dabble' for the housewives."

Norman Collins, the controller, is also a novelist, and he works to a 24-hour schedule, in which he manages to do seven hours' writing every day. He wrote, among other things, "London Belongs To Me."

He told me a little about the new television studios in the former Rank studios at Shepherds Bush. "In a year," he said, "we shall have two fully equipped studios at Lime Grove and one by midsummer this year."

"There will be no excuse for dirty shirts on the television," I said. He looked puzzled for a moment, and then he said: "No, you're right; we will be entirely surrounded by laundries."

Among other interesting things, Collins told me that one of the studios at Shepherds Bush has a floor area of more than twice the combined areas of the two existing studios at Ally Pally. The total area of the two studios immediately planned for television is some 11,000 sq. ft.

Leaving Mr. Collins and his tight schedule, for which he informed us he was already one minute late, we got back to the long corridor just in time to meet that lovable character Jack Hulbert in his capacity of a sergeant in the Special Constabulary. Although in uniform, he was not on duty that particular evening at Alexandra Palace. (You never know, because I once saw him on point duty outside the Dorchester Hotel.) No, that evening he had brought some 25 of his stalwart colleagues to explain in a television show what the Special Constabulary is all about and what it does. That particular show was "London Town," under the auspices of Richard Dimbleby.

The Staff

In intervals of Jack Hulbert's rehearsal and the various other items in "London Town" I found an expert who told me that there are now some 254,000 television sets in use in this country. He agreed that that was probably a conservative estimate because it includes only those for which licences have actually been taken out. I said earlier on that there were reckoned to be 1,000 in 1936 and some 10,000 in 1939 when television packed up. Incidentally, Alexandra Palace was used during the war as branch of the Air Ministry. The general consensus of opinion is that the transmitters were used for some form of "jamming."

And here are a few items that I picked up during the evening:

The programme staff numbers about 300, of whom 25 are producers. . . . As already mentioned, there are two studios: (a) has four camera channels, and (b) has three. . . . Newest television make-up is lighter

than for films—aims at sun-tan effect. . . . A play usually takes a fortnight to rehearse.

At present the B.B.C. has no agreement with the three unions concerned, Equity, V.A.F. and the Musicians' Union, who have agreements with each other not to take action severally with the B.B.C.

Filming of a live play is technically easy and the film could be put on whenever a repeat of the play is wanted. Surely it is a question of paying the original actors adequately whenever the film is put on. If the actors took the long view they would probably gain in the end because it is much easier from the point-of-view of Alexandra Palace to dig out a film from storage than to transport a lot of actors to Alexandra Palace to do a repeat of a play.

The present high definition service is the development of the system used in 1936, when it was the first of its kind in the world. . . . System gives 25 complete pictures per second, but "interlacing" to scan the odd and even lines successively provides the equivalent of 50 pictures per second. . . . About 30 radio firms make television receivers.

In this article I have purposely not touched on the technical side of television at all. But there is, for those who are interested, a not too technical publication of the B.B.C. called "Television Service." It is well worth reading by those interested in how it all works.

And so we leave Ally Pally with its forbidding outside and its warmth of friendliness inside and get home just in time to see what the "confusion" that we have assisted at turns out to look like on our own screen at home.

Final verdict: First-class stuff, including the ice-skaters whom we hadn't, of course, seen—except for the radio "ham" who regularly switches on at 10 minutes to nine every night in my particular area. I wonder just how many viewers switch off when that weather chart comes on. I'm afraid I do.

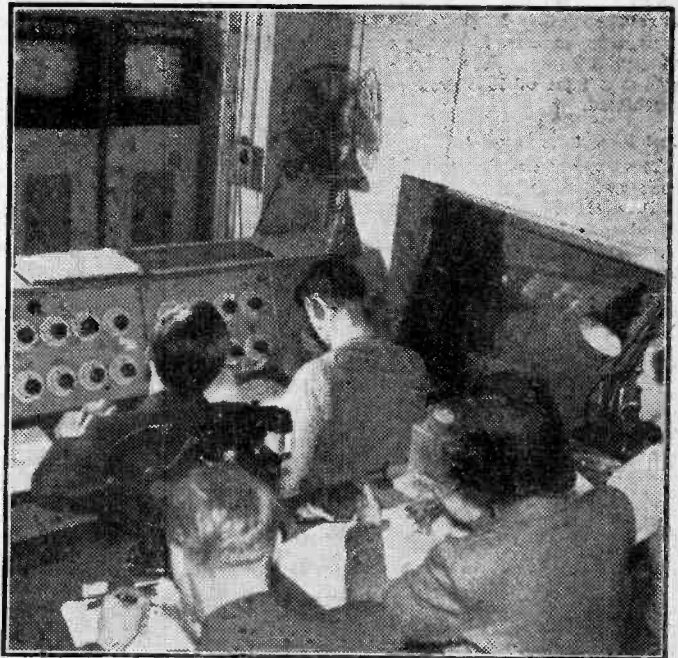

The main control room, with producer and assistants following the script.

THE BAIRD PORTABLE

A Test Report of One of This Season's New Models

THE first of this season's receivers which we have been able to test is the novel "no aerial" Baird receiver. This is, we believe, the first television receiver to be produced which does not normally require an outside aerial, and in which a self-contained type of aerial is included. There have been several attempts to produce portable types of receiver which could be carried from room to room without the necessity for running extension aerial leads, and it has been found usually that the aerial was not a simple feature to provide in cabinet form. Baird have overcome the difficulty by utilising part of the mains lead as a dipole aerial. The use of the mains lead as an aerial is, of course, well known, but the particular method adopted by Baird isolates the receiver and removes danger of damage, whilst also permitting of an efficient signal pick-up device. It was found on our tests that the unit, which is built into the mains lead, was susceptible to "body capacity" effects when the receiver was used under very poor conditions which called for the maximum setting of the controls, but under normal conditions the lead would obviously be so disposed that there would be no traffic near it to produce fading effects.

As may be seen from the specification below, the receiver is intended for A.C. mains operation only, and utilises a total of 17 valves with a 9in. tube cathode modulated.

Test Report

The receiver was first tested in our offices, which are built with all-metal partitions in a building of steel and concrete. With doors closed only the faintest signal could be obtained, but on reducing the screening effect by opening the doors a substantial increase was noticeable, proving that the aerial device was working

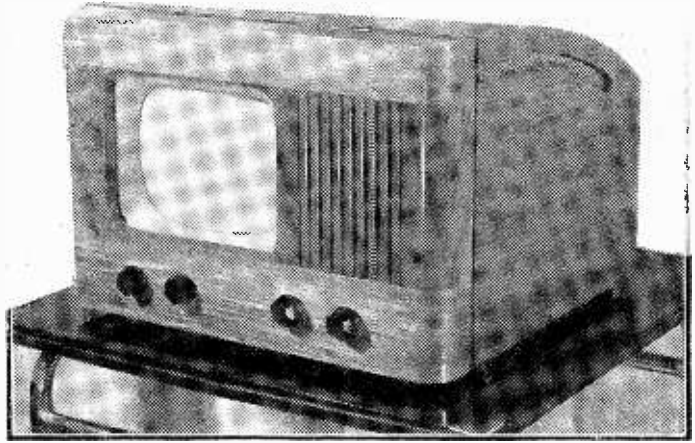

The smart appearance of the Baird may be judged from this illustration.

efficiently. An external aerial was then connected to the sockets provided and the mains aerial disconnected by means of the selector panel provided, when the receiver performed in a very efficient manner. There was ample control on the main controls provided, and a very good picture could be resolved without loss of synchronism in spite of the strength of the signal.

The frequency response was good and no fault could be found with the interlace. The 6.5 kV. EHT supplied to the tube provided a picture sufficiently brilliant to be viewed under normal room conditions, and the receiver was then taken out to Windsor for further tests. At this distance results were just as satisfactory as in the West End, and the quality of reproduction on the sound side was very good.

The receiver is light enough to enable it to be taken from room to room without undue strain, and the overall dimensions of the set are such that it does not call for a special table upon which to place it. The total mains consumption is of the order of 150 watts, and at £36 15s. this receiver represents very good value—especially for the flat-dweller.

SPECIFICATION

VISION and sound signals at carrier frequency are amplified by the 10F1 R.F. stage, providing a good signal to noise ratio, and are then applied to the 10F1 single valve frequency changer. The resultant signals at intermediate frequency are amplified by the first 10F1 I.F. amplifier. A rejector circuit in the cathode circuit of this valve separates the sound and vision signals which are then amplified in separate channels.

The vision channel consists of a 10F1 pentode transformer coupled to the diode detector, and this is direct coupled to a 10F1 video amplifier.

The vision signals from this valve are applied to the cathode of the cathode ray tube and also to an adjustable diode limiter which minimises the effect of ignition interference on the picture.

The sound channel comprises a 10F1 amplifier transformer coupled to a diode detector and a diode noise limiter. The audio amplifier is a triode connected 10F1 and a 10P13 output valve delivering 2.5 watts of audio power to the

loudspeaker. A high degree of negative feedback is used, so that in spite of the small cabinet in which the receiver is housed resonances are removed, and advantage is taken of the high quality television sound.

Synchronising pulses are separated from the video signal by a further 10F1 pentode and an EB.34 double diode. Accurate interlacing and stable line hold are obtained under conditions of severe interference.

Vertical scanning power is obtained from a 10P14 pentode driven by a 10F1 blocking oscillator, and horizontal scanning power is generated by a 20P1 oscillator, the flyback pulses from this valve being rectified by an EY51 rectifier and supplying the 6,500 volt EHT used on the cathode ray tube.

H.T. supply for the receiver is obtained from a U801 four path rectifier valve.

CABINET—Figured Walnut.

DIMENSIONS—Height 13½ in. Width 18½ in. Depth 17 in. WEIGHT—37 lbs.



ME? I ALWAYS USE 'EM!

After all, why take chances? If you're building a big job like this, use the best valves you can get, I say.

Me, I always use Mullard.

Mullard

THE MASTER VALVE



MULLARD ELECTRONIC PRODUCTS LIMITED,
CENTURY HOUSE, SHAFTESBURY AVENUE, LONDON, W.C.2

MVM/12

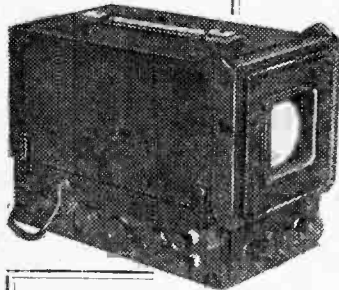

a real minor
OSCILLOSCOPE
with a major performance

Size : 6½" x 8½" x 12"
Weight : 13½ lbs.

Features :
COMPACT ROBUST PORTABLE
EASY TO USE IDEAL FOR THE SERVICEMAN
Price **£8/19/6** Carriage free U.K.

Specification :
Short Persistence 2½ screen. Green trace. Linear sawtooth generator with amplifier. Frequency range 5 to 50,000 c.p.s. Provision for internal or external synchronisation. Single stage Y amplifier. 200/250v 50 cycles supply. Black crackle stove enamel finish.
(Full details on request)

PROOPS BROS. LTD.

109/111 HIGH STREET, ESHER, SURREY

Telephone : Esher 3384

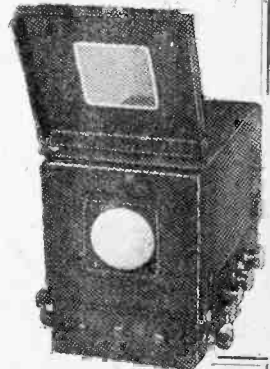

You're SURE to get it at

STERN'S

ESTABLISHED 25 YEARS

"VIEWMASTER" TELEVISOR

Complete range of all specified Components are in stock for either London or Midland Receivers.
 Full Wiring and Instruction detail with practical Component Layout available for 5/- (plus 3d. post).
Complete T.C.C. CONDENSER KIT. £6 15s.
 Individual Components can be supplied separately.
Complete MORGAN RESISTOR KIT. £1 6s. 9d.
 Individual Components can be supplied separately.
Complete W.B. CHASSIS OUTFIT, including Transformer, Choke, etc. £8 5s.
 Individual Components can be supplied separately.
Complete PLESSEY TRANSF. OUTFIT. £5 12s. 6d.
 Individual Components can be supplied separately.
Complete COLVERN VARIABLE RESISTOR OUTFIT. 19/3.
 Complete BELLING-LIFE ACCESSORIES OUTFIT. 7/6.
Complete WESTINGHOUSE RECTIFIER OUTFIT. £3 2s. 6d.
Complete WEARITE COIL & CHOKE OUTFIT. £1 2s. Midland. £1 10s.

All VALVES and any make of 9in. or 12in. C.B.T. can be supplied from stock.
 We will supply this TV Receiver by the separate specified Stages (send 3d. stamp for details).

THE "ELECTRONIC TELEVISOR."—Pull Wiring and Instruction Detail available for London 2/6. Midland 4/6 (plus 3d. post).

The Complete range of COMPONENTS and VALVES can be supplied from stock.
 Send a 3d. stamp for our COMPREHENSIVE STOCK LIST of valves, Coronas and Accessories. Please cover cost of post when ordering.

STERN RADIO LTD.
 109 & 115, FLEET STREET, E.C.4.
 Tel: CENTRAL 5814 and 2280.

THE VIEW MASTER

EASY TO BUILD television receiver

This television receiver can be built by the merest novice from a book of instructions complete with seven easy-to-follow diagrams. Packet of instructions Birmingham or London 5/6 post free.

Examples of individual assemblies as specified:

Plessey 72000 Line transformer	21/3
" 72001 Frame	18/6
" 72002 Width control	8/9
" 72003 Scanning coil	25/6
" 72004 Focus ring (Triode)	19/6
" 72005 Focus ring (Tetrode)	19/6
" 72006 Boost choke	5/-
" 72007 C.R.T. Supports (front and back)	14/-
Complete Set Colvern Potentiometers	19/3
" Wearite coils	20/-
" Rejector coils (B'ham only)	4/-
" TCC Condensers as specified	£6/15/-
" Morganite Resistors (B'ham & London)	26/- & 26/9
" Bulgin, Switch, tag strips, anode caps, etc.	12/6
" Westinghouse rectifiers	£3/2/6
" W.B. Including speaker, chassis choke and transformer	£6/15/-
Whiteley's Cabinets including mask and plate glass (9in.)	£6/17/6

Send for complete price list.

Please include sufficient for postage and packing when ordering.

Shop Hours: Monday-Saturday, 9 a.m. 6 p.m., Thursday, 9 a.m.-1 p.m.

TELE-RADIO (1943) LTD.

177, EDGWARE ROAD, LONDON, W.2.
 Phone: PAD 6116 or 5606.

BAFFLED ?

THEN LET US HELP YOU!

CONSTRUCTORS of home Televisors such as 'VIEW MASTER,' 'ELECTRONIC ENGINEER,' etc., have often encountered unexpected snags. If you are resident in the London area bring your troubles to us. We will issue a report and estimate for 10s. We know of no other firm offering such a comprehensive technical service to amateur TV constructors!

THIS SERVICE IS FOR PERSONAL CALLERS ONLY
 No correspondence entertained.

Everything for the Enthusiast

YOU can obtain ALL your TV requirements from us. A random selection from our huge and varied stocks:—
Aerials from 21/- Co-axial cable, 75 ohm, new and standard, 9d. per yard.
EF50 valves (VR91), new and boxed, 7/6 each, 45 Mcs "Pye" strips, less valves, 39/6 post paid.
R3084 Receivers, brand new with circuits and conversion data (London only), 59/6 carriage paid.
R1355 Receivers, R.F. Units, rectifiers and numerous other essential units and components in stock.
 All 'VIEW MASTER' parts, etc., always available.

PAY US A VISIT AND INSPECT AT YOUR LEISURE. A CORDIAL INVITATION EXTENDED TO ALL.



Not Just a Name—a Service!
CHARLES BRITAIN (RADIO) LTD.
 11, Upper Saint Martin's Lane, London, W.C.2
 OPEN ALL DAY SATURDAY

Shop Hours: 9-6 p.m. (9-1 p.m. Thursday). TEM. 0545

Build with
 the Best

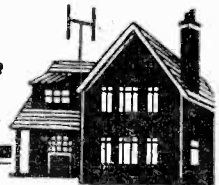

TELEVISION TRANSFORMERS & CHOKES

In choosing components the amateur constructor MUST have reliability and quality as his "safeguard" to success. That is why "SOMERFORD" components are outstanding in the field of home-built televisions.

GARDNERS RADIO Ltd

SOMERFORD, CHRISTCHURCH, HANTS.
 Telephone: Christchurch 1025

Please send me details of components for home-built televisions.

NAME

ADDRESS

Servicing Television Receivers—2

How to Locate Faults and Cure them in Commercial and Home-made Equipment

By W. J. DELANEY (G2FMY)

LAST month's notes will have enabled the mains unit or power pack to have been tested, and we thus pass on to the next link in the chain. We will suppose that the receiver has been switched on, has warmed up and the picture is visible, but there is no sound accompaniment. Obviously the fault is in the sound section, and this, of course, includes the loud-speaker. Many modern receivers have the first one or two valves in the vision receiver common to both picture and sound, tapping off from one of the video couplings to feed further stages in the sound receiver, or by using a separate oscillator where the superhet arrangement is employed. Consequently it will be unnecessary to test those valves which are common in this way, as the presence of a picture will indicate that the early stages are in order. The correct method of testing the sound-receiver is, of course, on exactly the same lines as with a standard broadcast receiver. Check H.T. and L.T. supplies at each valveholder, then, provided a modulated oscillator or signal generator is available, inject A.F. at the grid of the output valve and work back towards the early stages, substituting modulated R.F. from the detector onwards. Signals will, of course, cease at the stage preceding the fault, and then it should not be difficult to find either the unsoldered connection or the broken component. Remember, here, that in the absence of a valve-tester valves may be checked by substitution and by checking working voltages. For instance, the majority of modern television receivers employ one type of valve common to many stages. When arriving at a point where signals cease, remove the following valve and change it for one in an earlier stage. It is unlikely that two will have gone (unless there is a major fault which would most likely have put the entire receiver out of action), and signals will appear when the valve has been substituted. Alternatively, the voltage across the bias resistance may be measured and will indicate whether or not the valve is functioning. If it has failed due to broken heater or absence of H.T. feed to that stage, there will be no voltage across the bias component. Alternatively, the voltage drop across the anode load may be measured and will give a similar indication as to the state of the anode current.

Before making any tests inside a television receiver it is important to remember that the E.H.T. supply developed from the normal house mains can provide a fatal shock. If, therefore, this type of E.H.T. supply is fitted to the receiver, it is desirable to remove the E.H.T. rectifying valve before making any adjustments or tests inside the receiver. With fly-back or R.F. supplies, although these are not lethal they can provide a nasty burn, and therefore all connections inside this part of the circuit should be well protected, and an insulated type of anode connector should be used on the tube.

Tube and Time-bases

It is thus obvious that the sound-receiver is quite a simple job from a servicing point of view, and we now come to the most difficult parts of the modern receiver. Suppose that the receiver is switched on and, after warming up, sound is heard satisfactorily but there is no picture or raster. This may indicate a faulty tube

or faulty time-base(s), or failure of the supply to one or the other. Theoretically, when a picture tube is switched on and the time-bases are not working, there should be a spot on the tube. Remember that this spot is caused to move horizontally by the line time-base and vertically by the frame time-base. But failure to see even a spot may be due to one time-base being out of action. Most readers will be aware of the fact that when switching off some modern receivers a large spot remains in the centre of the tube for a short while whilst the tube cools. To avoid this some manufacturers adopt a circuit which causes the spot to fly off the screen face when switched off, and if this circuit arrangement is in the frame circuit then failure of part of the line time-base might result in the spot being thrown off the screen, but still giving a vertical scan. Similarly, a horizontal line may be obtained due to failure of the vertical time-base, and this may be held off the screen, so that it is necessary when no raster can be obtained to remember this little point.

No Scan

Fortunately it does not seem very common, and therefore failure of one of the time-bases will provide a suitable indication by revealing just a horizontal or vertical line on the screen—according to which base has failed. Therefore, with no sign of anything on the screen (but sound O.K.) look first to the tube supplies, i.e., L.T., H.T. (in the case of a tetrode) and E.H.T. Remember that E.H.T. can only be checked with an electrostatic voltmeter or a properly designed electronic test set. L.T. can usually be visual, as the end of the heater may be seen from the base end of the tube, and a comparison with any other visible valve will show whether the glow is adequate. A simple test set will enable the exact voltage to be measured, and if the tube is in order the connection back to the video valve and the brilliancy control should next be checked. The voltage across the brilliance potentiometer may be measured, or the voltage at the grid (or cathode) may be checked whilst the control is operated. Next, check that the feed from the video stage to the tube has not shorted to earth, as this may pull the picture right out. If all these points are in order, then the next step is the time-bases.

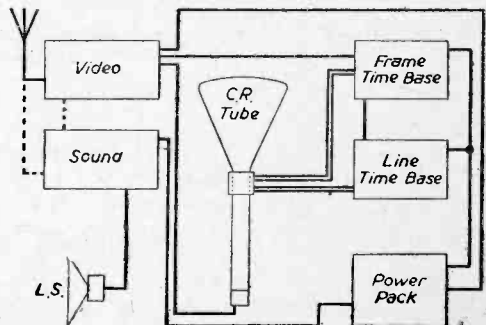

Diagrammatic representation of the standard television receiver.

Power Supply Again

The fact that there is no raster will indicate (if the previous tests have cleared the tube) that both time-bases have failed. As it is extremely unlikely that two valves or components in each would have failed together, the obvious first check is at the power supplies to these two sections. H.T. and L.T. will, no doubt, be common to both, and they may be checked in the manner already mentioned for other valves. Glowing heaters should be visible if the L.T. supply is satisfactory, and therefore the H.T. should be checked. Do not use an ordinary meter to measure the voltage at the anode of the line-amplifier valve, as very high voltages are generated at fly-back and, although these may not be used to provide E.H.T. in the particular set being tested, they may damage the meter. A simple test for the line time-base is worth while mentioning here. In the majority of receivers the line output transformer or choke "screams" at line frequency (10,125 cycles per second), and this is audible to all but the very elderly or partially deaf.

Absence of the whistle will indicate that the line oscillator is not working or that the amplifier has failed. In some receivers the blocking oscillator transformer may also howl and may be checked by using a length of thick postal tubing as a stethoscope, pressing it on the transformer whilst listening at the other end. However, as already mentioned, no scan of any sort will almost certainly be due to failure of either H.T. or L.T., and consequently is not difficult to locate. Finally we come to the indication of failure of the vision receiver or connection from video valve to tube. This will be shown by a good raster and sound-signals, but no picture and no variation of the tube brilliancy when the contrast control is turned from minimum to maximum. Again, tests, as in the case of a sound-receiver, with a signal generator or modulated oscillator is the quickest way of finding the position of the failure, applying modulated A.F. to the video grid and working back to the aerial with the change to modulated R.F. from the rectifier onwards. *(To be continued)*

New Emitron Mobile Control Room

THE latest major item of equipment to be supplied to the B.B.C. by Emitron Television, Ltd., is a mobile central control room for use on television outside broadcasts where more than three cameras are employed. This unit has just been delivered to the B.B.C.

The Boat Race was the first outside broadcast in which the unique control facilities provided by this van were utilised.

It provides overall control of up to four mobile O.B.

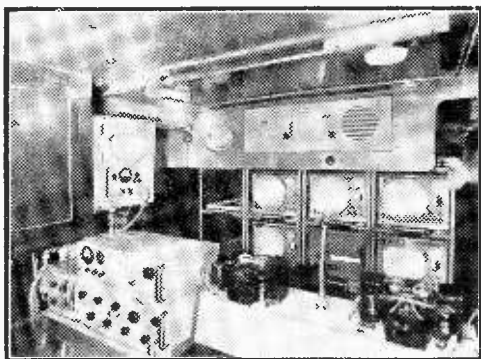

The interior of the new Emitron mobile central control van showing the view from the senior producer's desk. The central monitor tube in the rack displays the picture selected for transmission to Alexandra Palace, whilst the others on each side indicate the pictures received from the O.B. units controlled from this van. On the left is seen the sound mixing equipment.

units, each of which is normally equipped with three camera channels, thus providing, for the first time, direct control of all cameras by the senior producer on the site.

The selected picture and accompanying sound signals from each mobile O.B. unit are fed to the central control van, where the pictures are displayed on monitor screens. The producer then selects the required picture for transmission from Alexandra Palace.

Land-line or Radio

Provision is made for transmitting the selected picture and sound signals to the television station proper by either special land-lines or radio link.

Two-way communication facilities between the producer and his associates in the mobile O.B. units are provided by telephones and signal warning lamps. The interior fittings of the van are so designed that the mixing and monitoring gear is easily removable,

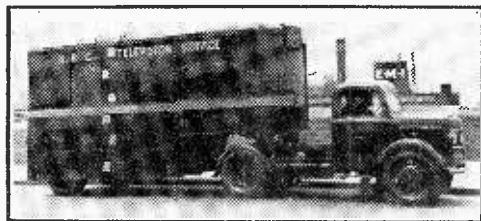

The complete O.B. van. Although an earlier model, the new control room is externally identical.

should it be inconvenient to retain the van itself at the site.

An interior view of this new Emitron van is shown on the left with an illustration of one of the Emitron O.B. units previously supplied which is externally similar to the central control van.

Future Stations?

THE number of new transmitting stations that can be built, says the B.B.C., in order to bring television to the Provinces, depends not only on economic conditions, but also on the extent of the frequency band that is allocated to the B.B.C. for this purpose. In accordance with the recommendations of the Atlantic City Conference of the International Telecommunication Union, a frequency band extending from 41 kc/s. to 68 Mc/s. is available, and the B.B.C. has prepared a plan which has been agreed by the Television Advisory Committee and the Radio Industry Council.

TELEVISION

? Job or Hobby?

E.M.I. who gave the world Electronic Television and designed and built much of the equipment for Sutton Coldfield, offer **POSTAL & ATTENDANCE COURSES** in Television.

Write for **FREE BOOKLET** giving full details of

HOME STUDY

Courses covering Radio, Television and Electronics

DAYTIME COURSES

PRINCIPALS & PRACTICE OF RADIO—1 year
TELECOM. ENGINEERING—2 years. (City & Guilds Final Certificate) · **ELECTRONICS ENGINEERING**—3 years. Including 1 year in E.M.I. Factories. (City & Guilds Full Technological Certificate) · **MARINE AND AIR RADIO OFFICERS' COURSES**

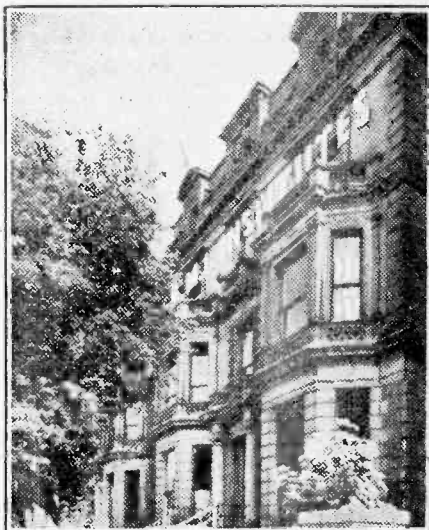

Our new premises at Pembridge Square

E.M.I. INSTITUTES



Dept. 138, 10 Pembridge Square, Notting Hill Gate, London W.2. Tel: BAYswater 5131/2

1.7

HENRY'S

E.H.T. TRANSFORMERS. Output 2,500 V. 5 mA., 4 V. 1.1 A., 2.0-2 V. 2 A. (for VCR97), 35/- only. Output 3,250 V. 5 mA. 6.3 V. 1 A. 2.0-2 V. 2 A. (for SCPI), 39/6. Output 4,000 V. 10 mA. 2.0-2 V. 2 A. 48/- only. Output 5,000 V. 10 mA. 2.0-2 V. only 60/-.

All input 230 V. and fully guaranteed.
VIEW-MASTER. TV CONSTRUCTOR ENVELOPE. As demonstrated at Radiolympia, contains eight full-size assembly and wiring diagrams, and 32-page illustrated booklet packed with technical information. All components required are standard. Envelope price 5/-, post free. State LONDON or MIDLANDS.

6 CATHODE RAY TUBES. VCR 97, electrostatic, non-persistent, individually boxed, ready for transit, 35/- each only. Postage and packing free. Side contact base for above, 2/-, 6 in. Masks for above. Not ex-Govt. but specially manufactured to give rectangular picture. Black, 6/6. Stone colour, 7/6.
TUBE ENLARGING LENS. For VCR97 or SCPI. Double your picture area without distortion. Easy fixing. Really amazing in performance. Only 25/-.

(Plus 2/6 postage and packing.)
5KV ELECTROSTATIC VOLTMETER. 0-5KV, panel-mounting, 3 1/2 in. scale, brand new, 50/- each.

R.1355 RECEIVERS. We have been fortunate in securing a further limited quantity of this now well-known receiver which needs no further introduction. Brand new and unused. Price whilst stocks last is 55/- plus 5/- packing and carriage.

R.1355 MAINS TRANSFORMER. 200/250 V. input. Outputs 250-0-250 at 120 mA., 6.3 V. at 6 A., 5 V. at 3 A. Fully shrouded top chassis mounting and guaranteed 100 per cent. Only 28/6.

No. 18 SET. RECEIVER PORTION. A four-valve superhet receiver operating from 6-9 Mc/s. (33-50 m.). Valve line-up 3 ARPI2 (VP23) and AR8 (HL23DD). Requires only 120 V. H.T., 9 V. G.B., and 2 V. L.T., in perfect condition, only 17/6, plus 1/6 packing and carriage. An absolute bargain. Suitable brand new headphones can be supplied at 3/6 per pair.

SEND STAMP FOR CURRENT COMPONENT LIST.

5, HARROW ROAD, LONDON, W.2

PADdington 1008/9-0401

For the best signal in "difficult" locations,

USE

PANDA Towers and Arrays. Our Standard 46ft. self-supporting steel lattice mast will put your array well over 50ft. high, and only a 4ft. base is required. Delivered from stock complete with foundation bolts and all instructions for assembly on the spot.

£32 10. 0.

ex warehouse.



No unsightly guy wires! Designed and built by skilled, experienced engineers. Special arrays also available to give best picture in "fringe areas."

PANDA RADIO CO.

58, SCHOOL LANE, ROCHDALE

PREMIER TELEVISOR KITS

FOR LONDON OR MIDLAND
FREQUENCY

NEW LONG-RANGE MODEL USING
VCR97 C.R. TUBE. £17. 17. 0

Five Easy to Assemble Kits are supplied:
 Vision Receiver with valves, carriage 2/6 £3/13/6
 Sound Receiver with valves, carriage 2/6 £2/14/6
 Time Base, with valves, carriage 2/6 £2/7/6
 Power Supply Unit with valves, carriage 5/- £6 3 0
 Tube Assembly, carriage and packing 2/6 £2/18/6
 This unit includes the VCR97 Tube, Tube Fittings and Socket
 and a 6in. PM Moving Coil Speaker with closed field for
 Television.

The Instruction Book costs 2/6, but is credited if a Kit for the
 complete Televisor is purchased.

Any of these Kits may be purchased separately; in fact, any
 single part can be supplied. A complete priced list of all parts
 will be found in the Instruction Book.

20 Valves are used, the coils are all wound and every part is
 tested. All you need to build a complete Television Receiver
 are a screwdriver, a pair of Pliers, a soldering iron and the
 ability to read a theoretical diagram.

WORKING MODELS CAN BE SEEN DURING TRANSMITTING
 HOURS AT OUR FLEET STREET AND EDGWARE ROAD
 BRANCHES.

NEW LIST NOW READY 3d.

PREMIER RADIO CO.

167 LOWER CLAPTON ROAD, LONDON, E.5.
 152/3 FLEET STREET, E.C.4.
 207 EDGWARE ROAD, W.2.

A Complete Range of Television Components

Line and Frame Scanning Assemblies.

Focus Coil and P.M. Units.

Line and Frame Output Transformers.

Line and Frame Oscillator Transformers.

Combined Line Output Transformers and
 E.H.T. Generators.

Width Control.

Video Correction Chokes.

Filament Transformers, E.H.T. Transformers
 and Smoothing Chokes.

Allen Components are specified for the
 Electronic Engineering Home Televisor
 and the range includes components suitable
 for use in the Viewmaster and all of the
 Popular Home Constructor Sets.

ALLEN COMPONENTS LTD.

1, Shrewsbury Road, Stonebridge, London,
 N.W.10

Telephone: WILLESDEN 3675-4901



TELEVISION RECEIVERS SCANNING AND FOCUS COILS

P.M. FOCUS UNITS

5/8 kv. R.F., E.H.T. UNITS

E.H.T. & OUTPUT TRANSFORMERS

Technical Publications post free.

"TELEVISION CIRCUITS" a booklet
 compiled for the Constructor, post free 1/6

HAYNES RADIO Ltd.,

Queensway, Enfield,
 Middlesex.

VIEW MASTER

SPECIAL OFFER.

Complete set of resistors for the View Master.
 Every resistor packeted and labelled with the value
 and number.

London or Birmingham 14/- the set.

All other components for the View Master are
 available separately except for the Westinghouse
 Rectifiers, which are only available as a complete set.

Full list of all View Master Components available
 upon request.

M. WATTS & CO.,

8, BAKER STREET, WEYBRIDGE, SURREY

Pre-Amplifier de Luxe. Consisting of power
 pack and two R.F.s. Built up and enclosed in case.
 £7 12s. 6d. carr. paid. **Voltage Doubling Unit.**
 Dispenses with high voltage transformers. Reliable.
 For 2.5 k.v. at 54/6. For 2 k.v. at 49/6. Diagram
 supplied with parts.

Pre-Amplifier Transformer. Prim. 200/250 v. Sec.
 230 v. at 30 mA. 6.3 v. at 1.5/2 amps., 15/6.
 Add Post.

F35X. Prim. 200/250 v. Sec. 350-0-350 v. at 250
 mA. 6.3 v. 6 amps., 4 v. 8 amps., 4 v. 3 amps.,
 0-2-6.3 v. 2 amps. Fully shrouded. 59/6.

H. ASHWORTH,

676, Great Horton Road, Bradford, Yorks.

Tel.: Bradford 71916.

LAWRENCES

Huge Stocks of T.V. Spares at Lowest Prices

New Cathode Ray Tubes type VCR 97, price 37/6.

Magnifying Lenses provide 9in. picture with 6in.
 tube, price 27/6.

New Bendix 36ft. self-supporting wooden masts,
 5in. dia., price £6.

Co-axial cable. State impedance. Price 9d. per yard.

Valves EF 50 at 6/6. VU 111 at 6/6.

Write us for all your requirements. Satisfaction
 guaranteed. Immediate attention.

61, BYROM STREET, LIVERPOOL, 3.



Emergency Lighting at Sutton Coldfield

ANY possibility of interruption of television in the Midlands through lighting failure at the Sutton Coldfield transmitting station has been eliminated by the provision of an emergency lighting battery.

This is a 240-volt battery and consists of 120 Chloride cells of the sealed-in type in glass containers. It is maintained in a permanently healthy and fully charged condition by trickle charging. Thus the full power of the battery is available at any time. In the event of an interruption of the mains supply from any cause the emergency battery is automatically and instantaneously brought into use to provide pilot lighting throughout the whole station.

There are two other Chloride batteries installed. One is a 30-volt battery of 15 cells of the sealed-in type, housed in the same room as the emergency lighting battery, for providing current for the electric clocks, and the other a 50-volt battery also of the sealed-in type for operating the internal automatic telephone exchange.

Baird Seeks Dollars

BAIRD TELEVISION, realising the unbounded opportunities presenting themselves in the marketing of their television receivers in the U.S. and Canada, are sending one of their executives, Mr. John Gale, on a mission of investigation and dollar-earning sales. John Gale, himself an inventor, and of wide experience in radio and television, is fully aware of the immense value of the name of Baird in North America.

John Logie Baird, as far back as 1927, transmitted television signals across the Atlantic regularly from Croydon to New York. Baird receivers of to-day are causing immense interest amongst U.S. visitors to this country. Nothing quite like the Baird non-aerial sets have been seen in the States, where there would be an immense demand from vast numbers of apartment dwellers. Denis Plimmer, the well-known American broadcaster, said

recently in a broadcast to the U.S.: "The neatest British-made job I have yet seen and one well within the range of modest purses is the Baird television portable."

R.C.E.E.A. Chairman

MR. V. M. ROBERTS, B.Sc., A.M.I.E.E., has been elected chairman of the Radio Communication and Electronic Engineering Association in succession to Mr. F. Stanley Mockford. Mr. K. S. Davies, B.Sc., A.M.I.E.E., is the new vice-chairman.

Mr. Roberts is manager of the Electronic and Sound Sales Department, British Thomson-Houston Co., Ltd., Rugby, and director of Multi-Broadcast (Engineering), Ltd. After student-apprenticeship and outside erection work with B.T.H., he joined the B.T.H. commercial staff in 1929, with a special interest in sound reproducer equipment. During the war he handled development and contract work in connection with radar and other equipment and since 1946 he has been responsible for the sales of B.T.H. radar, industrial electronics, special valves, cinema and cine equipment and radio relay. Mr. Roberts was vice-chairman of

the Radiolympia Organising Committee, 1949.

Mr. K. S. Davies is general manager, Electronics Division, Murphy Radio, Ltd.

Radio and Television at the Foire de Paris

RADIO will be represented at the Foire de Paris, the Paris international trade fair, May 13th-29th, by 225 exhibitors. Their stands will occupy more than 3,000 square yards.

Some 30 firms will be showing television reception sets (819 lines). Prices range from 70,000 francs to 150,000 francs.

Prices of ordinary sets will be about the same as last year, and French manufacturers maintain they are the lowest of any country, varying between 9,000 and 40,000 francs. Competition among makers is keeping prices low. They average only 10 times pre-war, whereas costs in general have risen 18 to 20 times.

There will be a noticeable tendency towards smaller receiving sets. One set, selling around 11,000 francs, will attract much attention—a five-valve set, with all component parts on the small scale. There is much improvement in quality and finish of spare parts.

The Foire de Paris, situated in its own grounds of 125 acres, will bring together in its 80 sections 10,000 exhibitors from France and some 25 other countries. Thursday, May 25th, will be Franco-British Day at the Foire de Paris, with a banquet in honour of British delegates.

Pye Equipment in U.S.A.

THERE was almost an "unofficial" stoppage of work in the "Picture Page" studio recently, when technicians rushed to examine sensational new equipment wheeled into the studio by engineers Bill Jones and Quentin Lawrence, of Pye Ltd., Cambridge.

The transmission set was so compact that Pye designers had managed to condense into little more than a suitcase electronics which used to occupy a whole room, and the new turret-headed camera was of proportionate dimensions.

The Editor will be pleased to consider articles of a practical nature suitable for publication in "Practical Television." Such articles should be written on one side of the paper only, and should contain the name and address of the sender. Whilst the Editor does not hold himself responsible for manuscripts, every effort will be made to return them if a stamped and addressed envelope is enclosed. All correspondence intended for the Editor should be addressed to: The Editor, "Practical Television," George Newnes, Ltd., Tower House, Southampton Street, Strand, W.C.2.

Owing to the rapid progress in the design of wireless apparatus and to our efforts to keep our readers in touch with the latest developments, we give no warranty that apparatus described in our columns is not the subject of letters patent.

Copyright in all drawings, photographs and articles, published in "Practical Television" is specifically reserved throughout the countries signatory to the Berne Convention and the U.S.A. Reproductions or imitations of any of these are therefore expressly forbidden.

The new equipment was not there for use, however, but to "star" in that evening's programme while Jones and Lawrence explained to viewers how they had successfully sold British TV equipment in the U.S.A. a few weeks ago. Until then, the American market, for a variety of reasons, had always been considered an impossible one for British manufacturers to break into.

Television Licences

THE total number of television licences current in Great Britain and Northern Ireland at the end of February, 1950, was 316,700.

Although the total number of licences decreased by 1,800 during the month, the number of television licences increased by 31,200.

Holme Moss Television Station : Building Contract

THE B.B.C. announces that the contract for the building work for the new television station at Holme Moss, near Huddersfield, has been awarded to John Laing and Son, Ltd., of Mill Hill, London.

The 35-kilowatt vision transmitter, the 12-kilowatt sound transmitter, the aerial and the aerial feeder system are being manufactured by Marconi's Wireless Telegraph Co., Ltd. A 750-ft. mast, similar to that at Sutton Coldfield, will be supplied and erected by British Insulated Callender's Construction Co., Ltd.

As recently announced by the Postmaster-General in Parliament it is hoped that this station will be completed by the middle of 1951.

Thermovent Heating at Sutton Coldfield

THE new Sutton Coldfield television transmitting station is heated throughout by Thermovent electric space-heating equipment (E. K. Cole, Ltd.), having a total connected loading of just over

operation with the B.B.C. Engineering Division.

B.B.C. Television Plans for Scotland

THE B.B.C. will build first a high-power television station at Kirk o'Shotts, near Harthill, where a site has been chosen and tested. In

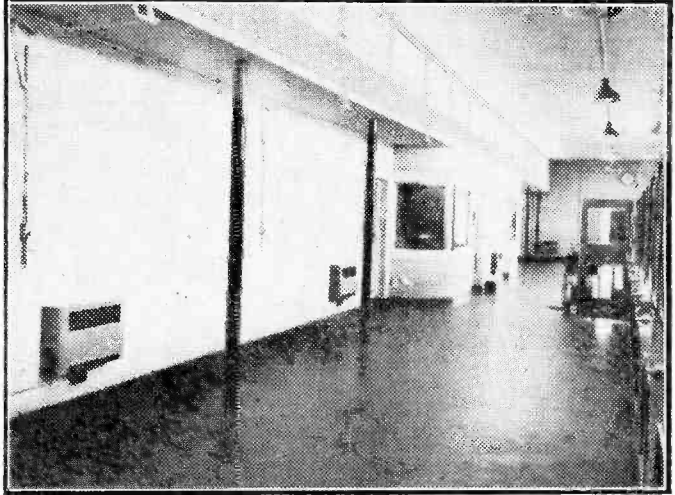

The main transmitter hall at Sutton Coldfield.

100 kW. In the transmitter hall a temperature of 65 deg. is maintained with type "S" metal-cased wall mounting Thermovents, specially modified to suit the requirements of the B.B.C.

The layout of the installation was designed by the Thermovent Technical Advisory Service in co-

addition, later on, it is intended to build a lower-power television station in Aberdeenshire.

High-power transmitting equipment has already been ordered for the Kirk o'Shotts station which will serve Central Scotland.

It is hoped that the station will be ready for service about the end of 1951, but progress will depend very largely on weather conditions.

First Televised Sermon

H.M. Tower of London Plans for Easter Day Service in Chapel Royal of St. Peter ad Vincula

THE first sermon to be televised in this country was preached by the Rev. C. B. Mortlock, F.S.A., Rector of St. Vedast, Foster Lane, London, at the parade service at 11 a.m. on Easter Day (April 9th) in the Royal Chapel of St. Peter ad Vincula in H.M. Tower of London. The service was conducted by the Rev. R. M. La Porte Payne, M.B.E., T.D., Chaplain of the Tower, and was attended by the Constable of the Tower (Field Marshal the Earl Wavell), who read the first Lesson; and the Major and Resident Governor of the Tower (Col. E. H. Carkett-James, O.B.E., M.C.). Warders attended in State dress.

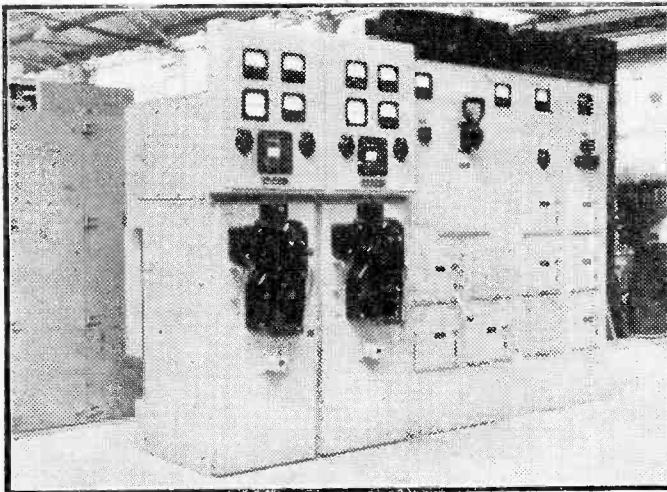

Another section of the Midland transmitter showing some of the "Brush" switchgear which is fitted there.

Viewmaster envelope for London or Birmingham, 5/6 post free. Sound/Vision chassis WB/200 complete with valveholders, screens, grommets and screws, 23/9. Power Pack/Time base chassis WB/102, complete with valveholders and grommets, 23/6. Chassis supporting bracket WB/101 complete with nuts and bolts, 5/9. Heater transformer WR 103, 36/-, Smoothing W/V 104, 13/6. Stereorian Loudspeaker, 25/3. Ediswan front and rear tube supports 72007, 14/9. Ediswan frame transformer, 19/6. Ediswan Line transformer 72009, 22/-. Ediswan scanning coil 72003, 28/3. Ediswan focus ring 72004, 20/6. Ediswan with control 72002, 9/6. Ediswan boost choke 72008, 5/9. Belling Lee mastis connector unit, J.707 with fuses, 9/3. I.C.C. type "Q" Neon Bulb, 3/6. Bulbin on/off switch, 4237, 1/6. Bulgin terminal strip, T17, T18, T22, 4/1d. T24 and T25, 10/1d. Bulgin plug and socket P24/T21, 3/3. Bulgin top cap connectors P41 and P90, 11d. each. Colvern variable resistors type CLR901 2K, 2.5K, 5K, 10K and 250 ohm, 2/9 each. Type CLR 099/22 5K, 5/6. Morganite type "Q" 100K and

250K, 4/6 each. Wearite coils—London or Birmingham, 2/- each. Wearite fitter coils, 2/- each. All T.C.C. condensers and Morganite resistors available at list prices. EB91, 6AL5, 6D2, D77, 8/7 each. EBC33, DH63, OM4, 11/7 each. EL33, KT91, 12/10 each. 6P25, 15/10. 6K925, 12/10. 6P28, 21/4 each. EF50 638PT valves, 21/4 each. Westinghouse Metal Rectifiers W36(MR1) and W33 (MR2), 2/5 each. 14-D-36 (MR2), 12/9. 36-EHT-100(MR3), 46/5. 14-A-80 (MR4), 22/-. Cathode Ray Tubes, 9in. G.E.C. 5014, Mazda (CRM9), Mullard MW-2214C. All £11.6.10 plus 5/- carriage 12in. Ferranti T12/46. Mazda CRM121, MW21, 14C. All £15.2.5 plus 5/- carriage. 12in. table model cabinet as illustrated in the "Viewmaster" Book £8.17.6 plus 5/- carriage and packing. Tallon console cabinet (also as illustrated), £12.10.0. Armour plate glass, Beads and fixing screws, 18/- extra. Four ball bearing castors with rubber tyres and screws, 15/- extra. A table model cabinet for use with a 12in. tube is available at £7 plus 18/- for armour plated glass, beads and screws and 5/- carriage. Conversion

assembly for mounting Sound/Vision chassis and Power Pack/Time base chassis, one above the other, for use in a console cabinet, 12/9. **ELECTRONIC ENGINEERING TELEVISOR.** Handbook and wiring diagram (Sutton Goldfield), 4/9 post free. AMC Scanning coils, 38/3. AMC Focus coils, 33/3. Aladdin coilformers with cores.—London, 10d.; Sutton Goldfield, 7d. Complete sets of coils and one choke for Birmingham or London, 19/9. Vision chassis, 23/6. Time base chassis, 20/6. Iane transformer, 7d. **PRACTICAL "WIRELESS" TELEVISOR** Set of 8 coils and one video choke for TRS Receiver, Birmingham, 18/6. **"WIRELESS WORLD" TELEVISOR.** Set of 20 coils wound to specification in polystyrene and high grade paraffin for Superbet Receiver, Birmingham, 51/6. **R.F. EBT UNITS.** Hasehurch designed to give 5-8 kv. EHT from 250-350 volts H.T. and 6.3 v. L.T. by means of 6V6 oscillator and EY.21 Receiver. High grade construction and mounted in metal case 4 1/2in. x 5in. x 5in. high. Tube Masks, 9in., 13/3. 12in., 22/-, finished in cream.

GOODS CAN BE SENT C.W.O. or C.O.D.

VALLANCE & DAVISON LTD., Dept. P.T.
144, Briggate, Leeds, 1. Tel. 29428/9.

ALLEN & GOULD

"Viewmaster" Televisor: Instructions, 5/-. Components supplied separately, or in kits as follows: Whiteley, 125/- T.C.C. London, 135/-, Midland, 140/-, Westinghouse, 62/6. Morganite (Incl. V.C.'s) London, 35/9, Midland, 35/-, Plessey, 112/6. Colvern, 19/3. Wearite Coils, London, 22/-, Windsor Coils, London, 18/6, Midland, 19/6. Electronic Televisor London Handbook, 2/6. Wiring diagram, 2/6. Midland Handbook and Wiring Diagram, 4/6. Chassis with valveholders, coil formers, etc., mounted: Vision, 22/6, Sound, 22/6. T/Base, 17/6. P Unit, 25/-. Gantries, etc., 9/- (please specify London or Midland). Designer approved components: Coils and chokes, London, 15/-, Midland, 17/6. Focus, 30/-, Scanning, 25/6. L/O Transformer, 25/6. Mains Transformer, 90/-, 4 kv Transformer, 67/6. 5 kv Transformer, 72/6. 5Hi Choke, 18/6. 10H Choke, 13/-, C.R. Tubes (sent in wooden crates) 9in., 226/9, 12in., 302/5. Please specify make, with one alternative if possible. Sundry items: Aladdin formers with core 5d. each, miniature ditto, 7d. each. P.M. Focus Rings, Mullard 9in./12in., 21/-, Mazda/Brimar 12in., 25/-, Other 9in., 12in., 22/6. Cream rubber masks, 9in., 11/-, 12in., 21/6. Coax 75d. lin., 8d. yd. tin., 9d. yd. Hundreds of other items, valves, etc., etc. Send for list T/V/7.

ALLEN & GOULD

5, Obelisk Parade, Lewisham, S.E.13. Phone: LEE Green 438

TELEVISION COMPONENTS

FULL RANGE IN STOCK FOR LONDON AND MIDLANDS VERSION OF **VIEW MASTER AND ELECTRONIC ENGINEER TELEVISORS**

Instructional Envelope, Circuit, 7 Plans with Point-to-Point Diagrams—**VIEW MASTER, 5/-** Instructional Book and Plans for Electronic Engineer Home-built Televisor 4/6

With **PRICE LISTS.**

COVENTRY RADIO

189, DUNSTABLE ROAD, LUTON, BEDS.

Vario
3-ELEMENT TELEVISION AERIAL
The finest Aid to T.V. Reception in The Fringe Areas

Regd. Design

Designed primarily for use in the fringe locations or where the signal to interference ratio is below average, the **VARIO** Television Aerial employs a folded dipole of the triple conductor type which effectively reduces the selectivity of the system and provides a reasonable match to a 75 ohm cable. It is no larger than a standard quarter wave spaced "H" type aerial but has a sharper directional characteristic, giving greater noise discrimination, a stronger, light and easily fitted. It is supplied complete with 10' mast with or without lashing equipment.

THE ONLY AERIAL OF ITS DESIGN ON THE MARKET

Write for prices etc. to:—
J. & S. NEWMAN LTD.
100, Hampstead Road, London, N.W.1
Tel.: EUSton 5176/7.

T/V TECHNOLOGY



Home Study will give you a fuller understanding of Television problems

Course 'A' provides a sound introduction to radio and television principles, deals with the principles of reception and transmission and includes the preliminary study of Mathematics, Electro-technics and Radio and Television.
Course 'B' offers a more comprehensive treatment of receiving equipment, deals in detail with modern principles of transmission and reception and contains the necessary introductory instruction in mathematics, electro-technology and radio.

The ICS also offer the following Courses in Radio:

- Complete Radio Engineering
- Radio Service Engineers
- Radio Service and Sales
- Advanced Short-Wave Radio
- Elementary Electronics, Radar and Radio

And the following Radio Examinations:

- British Institution of Radio Engineers
- P.M.G. Certificate for Wireless Operators
- City and Guilds Telecommunications

Wireless Operators and Wireless Mechanics, R.A.F.

For **FREE BOOKLET** and full details of these highly successful courses fill in and post the coupon below.

INTERNATIONAL CORRESPONDENCE SCHOOLS LTD
Dept. P.T.1.

International Buildings, Kingsway, London, W.C.2
Please send me particulars of your free booklet giving your courses

in

Name.....Age.....
(BLOCK LETTERS PLEASE)

Address.....

**BE CERTAIN OF SUCCESS
BUILD THE
"VIEW MASTER"
WITH SPECIFIED COMPONENTS
FROM
COULPHONE RADIO**

The Return of Post Mail Order Service*
★ Results equal to the best commercial★
receivers.
★ No knowledge of Television required.★
★ Easily assembled and aligned.★
**SEND NOW FOR
CONSTRUCTIONAL ENVELOPE ... 5/-**
**ALL SPECIFIED KITS AND
INDIVIDUAL COMPONENTS IN STOCK**

- FOLLOWING ARE COMPLETE KITS**
W.B. Chassis ; Speaker, etc. ... £6 5 0
T.C.G. Cond. ... M. £7. L. £8 15 0
Westinghouse Rectifiers ... £3 2 6
MORGANITE Resis. M. £1 6 0. L. £1 6 9
Q Type Pots, 100k, 250k... .. 9 0
BELLING LEE L707 Connector ... 7 6
G.E.C. Neon Lamp Type G ... 9 9
COLEBURN Wire Wound Resistors ... 19 3
BULGIN Panels and Switch ... 12 6
PLESSEY Focus Coils, etc. ... £5 12 6
WEARITE Coils ... M. £1 10 0. L. £1 20 0
BELLING LEE Twin Feeder, yd. ... 1 0
W.R. Table Cabinet, for 9in. Tube ... £8 17 6
TALLON 12in. Table Cabinet ... £7 17 6
TALLON 9in. Console Cabinet ... £13 2 6
TALLON 12in. Console Cabinet ... £13 7 6
VALVES. EF50 2/14. EB91 12/10. EL33
12/10. 6K25 12/10. 6P28 12/10. 6P28 2/14.
KT61 12/10. EY31 2/4.
C.R.T.'s 9in. £11 6 10
C.R.T.'s 12in. £15 2 5

GUARANTEED EX-GOVT. VALVES.
VCR37 6in. Tubes in original cases £1 12 6
EF50 7/6. 6AC75/- 6V6G 6/- 5Z4 6/- 6L6 9/6
6Q7 6/- EA50 3/3. 6KT6 6/- 6K3 6/6. 6J6 9/6.
5d. IN STAMPS WILL BRING YOU
64-PAGE CATALOGUE

**COULPHONE RADIO, DEPT. PT2
53, BURSCOUGH STREET, ORMSKIRK,
LANCS. Phone 987.**

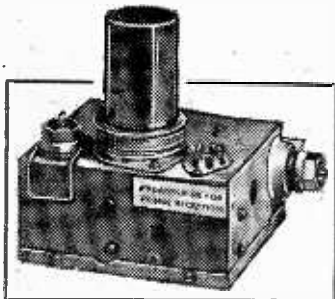

TELEVISION PRE-AMPLIFIER

Just the thing you have been looking for. This Ex. Govt. one-valve pre-amplifier is of very high sensitivity and makes an amazing improvement in vision and sound reception in all fringe areas. Available for Birmingham Transmission only. Ready for Instant Use.
Very small dimensions. Length 4in. Width 3in. Chassis depth 1 1/2in. Overall depth to top of valve 4 1/2in. Fitted with EF50 valve. Ideal for the inexpensive Television Receiver or the Electronic Engineering Television Set, and any set where 6V, L.T. and around 200v. H.T. can be obtained. Can be used on any commercial set if fitted by a competent TV engineer. C-A Input and Output Sockets, 3 connections only to Power supply. H.T. Common and L.T. Price less than that of a new EF50 valve.
15/- Postage 1/-

All Tested and Guaranteed before despatch. **PROMPT DELIVERY.** Obtainable only from **H.P. RADIO SERVICES LTD.**
Britain's Leading Radio Mail Order House
55, COUNTY ROAD, WALTON,
LIVERPOOL, 4 Tel.: Aintree 1445

**"YOU CAN RELY ON US"
FOR CLEAN COMPONENTS
AT COMPETITIVE PRICES**

IMMEDIATE DISPATCH
Best regards to our old friends and welcome to our new in "Practical Television"

MORE QUALITY BARGAINS :-

VALVES			
AZ32	...	9	150
CIC	...	8	1R5
CY31	...	8	3S4
COH35	...	8	5Z4
CL33	...	10	6V6G
DH63	...	7	6K5
DF3	...	8	6K7
EA50	...	2	12K8gt
EB33	...	7	25A6
ECC32	...	8	25Y5
EL35	...	9	25Y5G
EL33	...	7	25Z6G
EL33	...	10	25L6gt
EL32	...	6	35Z4et
ECH35	...	11	35L6gt
EF33	...	10	43
EF31	...	8	44
EF8	...	10	77
GZ32	...	10	78
IWA4	...	9	80
KTW61	...	7	41
6P28	...	8	39 44
SP4(5)	...	8	Post 6d. any quantity

The Above are NEW makers' valves

NEW BOXED EX-GOVT. VALVES

1C5gt	...	7/6	6L7 Metal	...	7/-
5Z4 Metal	...	7/6	6SA7gt	...	6/6
5Z3G	...	7/-	6SJ7gt	...	7/-
6C5 Metal	...	7/-	6SK7 Metal	...	7/-
6F6 Metal	...	7/6	6SL7	...	7/-
6F7G	...	7/6	6T5	...	6/6
6F7C	...	6/6	12F5 Metal	...	6/-
6G6G	...	6/6	12J5gt	...	6/-
6H6T	...	3/-	12K8 Metal	...	7/6
6J5G	...	6/-	12S7 Metal	...	6/6
6K25	...	6/6	12SJ7 Metal	...	6/6
6J7G	...	7/6	807	...	7/6
6J7 Metal	...	6/6	954	...	5/6
6J8G	...	6/6	955	...	6/-
6K7 Metal	...	7/6	9003	...	6/-
6K3	...	7/6	VC111	...	7/6
6L6G	...	10/6			

COILS
Medium wave iron-cored with re-
action (small) ... 3 6
TRF MW/LW matched pair with circuit
FORMERS
Aladdin 4in. with cores ... each 10d.
4in. Bakelite with adjustable iron
core ... each 9d.
FILAMENT TRANSFORMERS
210 240 v. to 6.3 v., 1.5 a. Small, with
green crackle finish ... 8 6
210 240 v. to 4 v., 3 a. ... 12 6
SPEAKER TRANSFORMERS
Super midget, to match 3S4. DL02, to
2 23 ohm. ... 4 3
L.A. SPEAKERS
2 1/2in. Celestion Midget, 25 6/8 ; 3 1/2in. 12 6/
5in. with dust cover, 9 9 ; 6in. Television
Type small magnet, 10 6 ; 6in. Goodmans.
12 6 ; 6 1/2in. Truvox with trans. 16 6 ; 8in.
Lightweight Television type, 15 6 ; 8in.
R & A. with pentode trans. 18 6 ; 10in.
Television type, 21 6 ; 12in. Truvox, 33 6.
ELECTROLYTICS
1 mid. 350 v. Midget for personals ... 2 6
4 mid. 350 v. All. tube ... 13 6
4 mid. 350 v. card. tubular ... 2 6
8 mid. 450 v. Midget ... 2 6
16 mid. 350 v. All. tube ... 2 6
16 mid. 500 v. All. tube ... 5/-
32 mid. 350 v. All. tube ... 3/-
8-16 mid. 450 v. All. tube ... 5/-
16-24 mid. card tube 350 v. ... 7 6
16-16 mid. 450 v. All. tube ... 7 6
32-32 mid. 450 v. All. tube ... 9 6
All new Electrolytics, NOT Govt. Surplus.
And, of course, we keep all the VIEW-
MASTER Television parts. Complete set
diagrams and booklet, 5/-
State—London or Birmingham
HAYNES COMPONENTS
for "Practical Wireless Telesior" stocked.
P.M. Focusing unit, R47.
Write, phone or call for
CATALOGUE No. 7, 21d. Stamp.

RADIO SERVICING CO.
444, WANDSWORTH ROAD,
CLAPHAM, LONDON, S.W.8.
Telephone : MACaulay 4155.
77, 77A Bus ; 26, 28 Tram. S.R. Station,
Wandsworth Road.

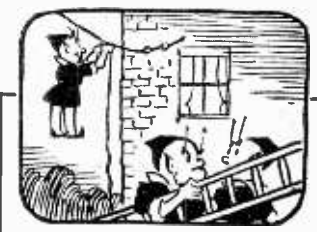

The "Fluxite Guins" at Work
"We must FLUXITE our aerial," said EH.
"Let's climb without further delay."
"I say, don't look now.
There'll be a fine row,
I've taken his ladder away!"

See that **FLUXITE** is always by you
—in the house—garage—workshop—
wherever speedy soldering is needed.
Used for over 40 years in Govern-
ment works and by leading engineers
and manufacturers. Of all ironmongers
—in tins, 10d., 1 6 and 3 -.

The **FLUXITE GUN** puts **FLUXITE**
where you want it by a simple pressure.
Price 2/6, or filled 3/6.

FLUXITE

SIMPLIFIES ALL SOLDERING

Write for Book on the Art of "SOFT"
Soldering and for Leaflets on CASE-
HARDENING STEEL and TEMPERING
TOOLS with FLUXITE. Price 1d. each.

**FLUXITE LTD., Dept. P.T.,
Bermondsey Street, London, S.E.1**

GEE BROS. RADIO LTD

FOR
**QUALITY COMPONENTS &
SATISFACTION**

Photo Electric Cells, Type CMG22... new.
21 - each. Midget 2-gang .0005 Tuning
Condensers, 7/6 each. Ceramic Valve-
holders BTG, complete with skirt and
screening can, 1/9 complete.
T.M.C. 1 7 Kv. Smoothing Condensers,
with clip. Size 5 1/2in. x 2 1/2in. 10 6 each.
Cathode-ray Tubes, Type VCR138—ECR
15 3 1/2in. short persistence complete with
Ni-metal screen and base. Tested, in
full order, 25 -.
The following are a few valves from stock,
of which we hold large stocks. VR91—
EP50, 7/6. VR92—EA50, 3 - VR78—D1, 3 6
6PTC Thyatron, 10/6. 807, 8/6. 5Y4G, 5/6
6K7GT, 7/6. ML4, 8/6. 5Z4 (metal), 7/6.
VR21—HL2, 3/-, ARP12—VP23, 5/-, VR53—
EP39, 7/6.
Metal Rectifiers, 250v. 100 mfa. half wave
5 - Standard 4in. co-axial cable, 80 ohms.
10d. yard. 32 mfd. 650v. Electrolytic
Condensers, 4 x 1 1/2 x 4 1/2in. 9 6 ea. 10 mfd.
750v. Paper Condensers, upright mounting
5 x 2 x 4 1/2in. 8/6 ea. Also a Full Range of
Osorn products in stock.
L.M.S. Coil Packs for mains (465 kc/s). 33 -
Superhet Battery Model for L.M.S. (465 kc/s)
37 6.
L.M.S. T.R.F. Coil Packs, 30 - . Also coils can
be supplied separately, 3 - each. Full
circuits supplied for all Coil Packs and
Coils.

Orders under 20/-, 1/- postage.
Over 20/- Post Free. C.O.D. 1/- extra.
GEE BROS. RADIO LTD.
15, Little Newport St.
LONDON, W.C.2
GER 8794

CHOOSING A RECEIVER

A Technical Review of the Main Features of the Majority of Commercial Receivers

MANY readers are interested in the main technical details of the commercial receivers now available, and require this information to enable them to decide on what make of receiver to purchase. We therefore give below the names and addresses of the principal manufacturers and an abridged specification of their products so far as we have been able to obtain them at the time of going to press.

In the table the second column indicates the maker's model number; the third indicates whether the model is a Console or Table set; the next column indicates whether the set is designed for AC or DC or AC/DC operation; the next column gives the tube size; the next

number of valves; next the type of time-base oscillator —i.e., Thyatron or Hard valve; the type of focusing is indicated by the next column, EM denoting an electro-magnetic focusing coil and PM a permanent-magnet; next is the total EHT applied to the tube, followed by the method of obtaining this voltage. FB indicates the use of the fly-back voltage generator, M that the EHT is derived from the normal 50 cycle mains supply and RF that the voltage is generated in a special RF oscillator circuit. Finally the last two columns show the rated sound output and the price. It should be remembered that some of the receivers incorporate normal broadcast tuning in addition to the television circuits.

Manufacturer	Model No.	Table or Console	AC or DC	Tube size (in.)	No. of Valves	Time base	Focusing	Tube EHT	E.H.T. Supply	Sound Output (Watts)	Price
Alba Radio (A. J. Balcombe), 58, Tabernacle Street, E.C.2	T331 (L)	T	AC	9	17	H	PM	5.7	FB	3	£ 51 8 8
	T431 (L)	C	AC	9	17	H	PM	5.7	FB	3	59 3 0
	T432 (L)	C	AC	12	17	H	PM	6.7	FB	3	74 11 6
	MT341 (M)	T	AC	9	16	H	PM	5.7	FB	3	51 8 8
	MT441 (M)	C	AC	9	16	H	PM	5.7	FB	3	59 3 0
	MT442 (M)	C	AC	12	16	H	PM	6.7	FB	3	74 11 6
Ambassador Radio (R. N. Fitton, Ltd.), Hutchinson Lane, Brighouse, Leeds	T.V.1	C	AC	12	18	T	EM	6kv	RF	—	105 0 0
	T.V.2	C	AC	12	15	H	EM	6.4kv	FB	—	69 10 0
	T.V.2/TM	T	AC	12	15	H	EM	6.4kv	FB	—	56 0 0
Baird Television, Lancelot Road, Wembley, Middlesex	T29 "Everyman"	T	AC	9	11	HV	PM	6½kv	FB	4	36 15 0
	T164 Portable	C	AC	9	17	HV	EM	6kv	FB	4	57 15 0
	"Townsmen"	C	AC	12	17	HV	EM	6½kv	FB	2	75 12 0
	"Countryman"	C	AC	12	19	HV	EM	6½kv	FB	2	89 5 0
	T163 Portable	T	AC/DC	9	16	HV	EM	6kv	FB	2	58 12 10
"Townsmen" with radio	C	AC	12	16+5	HV	EM	6½kv	FB	2	86 2 0	
Beethoven Electric Equipment, Ltd., Beethoven Works, Chapel Lane, Sands, High Wycombe, Bucks	Beethoven TV50 or TV50/M	C	AC	12	19	T	PM	5.5kv	RF	£.5	—
Bush Radio, Ltd., Power Road, London, W.4	TV11A	T	AC/DC	9	18	H	EM	7.5	FB	1	55 0 0
	TV12A	C	AC/DC	9	18	H	EM	7.5	FB	1	48 gns.
	TUG12A	C	AC/DC	12	18	H	EM	7.5	FB	1	78 gns.
	TV12B	T	AC/DC	9	18	H	EM	7.5	FB	1	48 gns.
	TUG12B	C	AC/DC	12	18	H	EM	7.5	FB	1	78 gns.
Champion Electric Corp., Champion Works, Seaford, Sussex	"Adelphi"	C	AC	12	14	H	PM	7kv	FB	—	£80 plus purchase tax
	T.V. "Luxor"	C	AC	11	19	H	PM	7kv	FB	—	£147 plus purchase tax and extra for Gram-unit if required.
Cossor, A. C., Ltd., Highbury Grove, London, N.5	917 (M & L)	C	AC	10	17	H	PM	7kv	FB	2	60 18 0
	916 (M & L)	T	AC	10	17	H	PM	7kv	FB	2	51 9 0
Denatron Radio, Ltd., Perfecta Works, Ray Lea Road, Maidenhead	TV24	C	AC	12	24	H	EM	6.5kv	RF	2	131 5 0
	K349 (including Radio and Gram.)	C	AC	12	34	H	EM	6.5kv	RF	9	plus 29 3 4 325 10 0 plus 144 13 4

Manufacturer	Model No.	Table or Console	AC or DC	Tube size (in.)	No. of Valves	Time base	Focusing	Tube EHT	EHT Supply	Sound Output (Watts)	Price
Decca Record Co., Ltd., 1-3, Brixton Rd., S.W.9.	101	C	AC	12	14	H	PM	7kv	FB	2½	£ 98 gns.
	Beau Decca	C	AC	12	30	T	EM	6kv	M	6	193 3 0
	Kenington	C	AC	12	38	T	EM	6kv	M	6	616 10 0
	Knightsbridge	C	AC	12	38	T	EM	6kv	M	6	573 15 0
Ekeo (E. K. Coe, Ltd.), Ekeo Works, Southend-on-Sea, Essex.	TSS8	T	AC	9	18	F-T	PM	7kv	FB	—	39 gns. plus 9 6 4
	TSC91	C	AC	9	—	L-H	EM	6kv	RF	—	50 gns. plus 11 18 11
	TSC93	C	AC	9	18	F-T	PM	7kv	FB	—	44 gns. plus 10 10 3
	TSC102	C	AC	12	18	F-T	PM	7kv	FB	—	50 gns. plus 11 18 11
	TS105 Combined radio/TV receiver	T	AC	9	21 inc. radio	F-T	PM	7kv	FB	—	45 gns. plus 10 15 0
	TSC113 Combined radio/TV receiver	C	AC	15	—	F-T	PM	12kv	FB	—	124 0 8 plus 28 4 4
	TS114	T	AC	12	18	F-T	PM	7kv	FB	—	45 gns. plus 10 15 0
	TRC124 Combined radio/TV receiver	C	AC	12	21 inc. radio	F-T	PM	7kv	FB	—	72 gns. inc. 14 0 3
Electrical & Radiological Instrument Co., Ltd., Eric Works, 54-56, Church Rd., Acton, W.3.	TV98	C	AC	12	23	H	EM	7kv	M	6	120 3 0
English Electric Co., Ltd., 28, Kingsway, W.C.2.	1550	C	AC	15	24	H Synchro-phase	PM	10-11 kv	Ring-ing Choke	3	115 19 11 inclusive of P.T.
Etronic (Hale Electric Co., Ltd.), Radio Works, Talbot Road, London, W.13.	HV.203 }	C	AC	10	15	H	PM	6kv	FB	—	68 5 0
	HV.203B }										
	HV.204 }										
	HV.204B }										
HV.203 and 203B. but with 12in. tube. 75 12 0											
Ferranti, Ltd., Hollinwood, Lancs.	T138 (L)	C	AC	9	16	H	EM	6kv	RF	4	62 10 0 Tax paid 74 15 0
	T129 (L)	C	AC	12	16	H	EM	7kv	RF	4	62 10 0 Tax paid 74 15 0
	T138M (M)	C	AC	9	16	H	EM	6kv	RF	4	62 10 0 Tax paid 74 15 0
	T129M (M)	C	AC	12	16	H	EM	7kv	RF	4	62 10 0 Tax paid 74 15 0
Ferguson Radio Corpn., Ltd., Great Cambridge Road, Enfield, Middlesex.	943T Midlands model, 953T)	C	AC	12	18	H	PM	8kv	FB	3.5	75 12 0 Tax paid 47 11 6
	941T (Midlands model, 951T)	T	AC/DC	9	18	H	PM	5/7kv	FB	2	47 11 6 Tax paid
G.E.C., Magnet House, Kingsway, London, W.C.2.	BT1091 B (L. and B.)	T	AC	9	20	H	EM	6.5kv	FB	2	54 2 8 inc. tax
	BT1093	C	AC	9	20	H	EM	6.5kv	FB	2	70 17 9 inc. tax
	BT9144 (L)	C	AC	14	25	H	EM	7.5kv	M	3	154 13 4 inc. tax
	BT9144M (B)	C	AC	14	25	H	EM	7.5kv	M	3	154 13 4 inc. tax
	BT3443 (B)	T	AC	9	24	H	EM	5.2kv	M	3	76 gns. inc. tax
	BT3839 (B)	C	AC	9	24	H	EM	5.2kv	M	3	85 gns. inc. tax
Gramophone Co., Ltd., Blyth Road, Hayes, Middlesex.	1805 }	C	AC	10	19	H	EM	7kv	M	5	†89 5 0
	2805 }										
	1806 }										
	2806 }	T	AC/DC	10	14	H	PM	5.5kv	FB	†	†46 8 0
	1807 }										
	1807A }										
2807 }	T	AC/DC	10	15	H	PM	5.5kv	FB	1	†50 5 4	
2807 }	T	AC/DC	10	15	H	PM	5.5kv	FB	1	†50 5 4	

† Inclusive of Purchase Tax.

Manufacturer	Model No.	Table or Console	AC or DC		Tube size (in.)	No. of Valves	Time base	Focusing	Tube EHT	EHT Supply	Sound Output (Watts)	Price†		
			AC	DC								£	s.	d.
Gramophone Co., Ltd. (Cont.)	1808	C	AC/DC	10	14	H	PM	5.5kv	FB	1	58	0	0
	2808	C	AC/DC	10	15	H	PM	5.5kv	FB	1	58	0	0
	1851	C	AC	15	22	H	EM	7kv	M	5	192	0	11
	2851	C	AC	15	24	H	EM	7kv	M	5	336	2	2
	1901 2901	C	AC	15	24	H	EM	7kv	M	5	336	2	2
Invicta Radio, Ltd., Park-hurst Road, N.7.	T105	T	AC/DC	9	19	H	PM	7.5kv	FB	2	55	5	9
	T107	C	AC/DC	12	19	H	PM	7.5kv	FB	2	81	0	0
McMichael Radio, Ltd., 190, Strand, W.C.2.	912 (London & S.C.)	C	AC	12	20	H	EM	7kv	FB	3½	91	16	11
	909 (London & S.C.)	C	AC	9	19	H	EM	7kv	FB	3½	69	16	0
	De-Luxe (London only)	C	AC	12	25	T	EM	6kv	M	4	226	11	0
Marconiphone Co., Ltd., Blyth Road, Hayes, Middlesex.	VT53DA	T	AC/DC	10	14	H	PM	5.5kv	FB	1	47	11	4
	VT73DA	T	AC/DC	10	15	H	PM	5.5kv	FB	1	47	11	4
	VRC52A	*	C	AC	10	22	H	EM	Trans 7kv	M	5	110	0	0
	VRC72A	C	AC	10	21	H	EM	Trans 7kv	M	5	110	0	0
Masteradio, Ltd., 10-20, Fitzroy Place, N.W.1.	612L	C	AC	12	17	H	EM	6kv	FB	4	64	3	1
	612LP	C	AC	12	18	H	EM	6kv	FB	4	66	6	0
	612M	C	AC	12	17	H	EM	6kv	FB	4	64	3	1
	6:2MP	C	AC	12	18	H	EM	6kv	FB	4	66	6	0
Mullard Electronic Products, Ltd., Century House, Shaftesbury Avenue, London, W.C.2.	MTS521	C	AC	12	20	H	EM	7-7.5kv	FB	2.5	102	18	0
	MTS684	C	AC/DC	9	18	H	EM	7kv	FB	2.5	60	18	0
Murphy Radio, Ltd., Welwyn Garden City, Herts.	V150	T	AC	12	15	H	PM	6kv	FB	—	54	0	0
	V120C	C	AC	12	18	T	PM	6	FB	—	71	10	8
	V118C	C	AC	12	19	T	EM	6.8	M	—	98	13	4
	V176C	C	AC	15	23	T	PM+EM	13.0	M	—	148	0	0
Philco (Gt. Britain), Ltd., 92, New Cavendish Street, London, W.1.	BT1410	T	AC	9	14	H	PM	6kv	FB	3	63	0	0
	BT1840	C	AC	12	18	H	PM	7kv	FB	4.3	113	17	9
	A1707	C	AC	12	17	T	EM	6kv	M	3.5	116	6	8
	A1708	C	AC	9	17	T	EM	6kv	M	3.5	77	3	0
Philips Electrical, Ltd., Century House, Shaftesbury Avenue, London, W.C.2.	385v	T	AC/DC	9	18	H	EM	7kv	FB	2.5	48	gns.	
	492v	T	AC/DC	12	18	H	EM	7kv	FB	2.5	65	gns.	
	683v	C	AC/DC	9	18	H	EM	7kv	FB	2.5	58	gns.	
	485v	C	AC/DC	12	18	H	EM	7kv	FB	2.5	76	gns.	
	520A	C	AC	12	20	H	EM	7 to 7.5kv	FB	2.5	98	gns.	
PROJECTION	799A	C	AC	Pic. 16in. x 12½ in. CRT.	TV 27 Radio 5 plus Tun. Induc	H	EM	25kv	RF	3	195	0	0
Pilot Radio, Ltd., 31-37, Park Royal Rd., North Acton, London, N.W.10.	CU34 (London)	C	AC	12	19	T	EM	6kv	FB	4	58	15	6
	CU35 (Birmingham)	C	AC	12	19	T	EM	6kv	FB	4	58	15	6
Portogram Radio Electrical Industries, Ltd., Preil Works, St. Rule Street, S.W.8.	TV1	C	AC	12	17	H	EM	7kv	FB	3½	85	0	0
	TV1/R	C	AC	12	19	H	EM	7kv	FB	3½	92	5	0
	TV1/RG	C	AC	12	19	H	EM	7kv	FB	3½	178	10	0

* Combined Television-Radio Receiver (three wavebands). † Combined Television-Auto-radiogram (three wavebands). ‡ Inclusive of Purchase Tax.

Manufacture	Model No.	Table or Console	AC or DC	Tube size (in.)	No. of Valves	Time base	Focusing	Tube EHT	EHT Supply	Sound Output (Watts)	Price *
Pye, Ltd., Radio Works, Cambridge.	BV20—Midlands)	T	AC/DC	9	19	H	PM	7kv	FB	2	£ s. d. 48 17 3
	LV20—London)										
	BV20C—Midlands	C	AC/DC	9	19	H	PM	7kv	FB	2	60 18 0
	BV21C—Midlands) LV21C—London)	C	AC/DC	12	18	H	PM	8.5kv	FB	2	76 gns.
Radio Gramophone Development Co., Ltd., Bridgnorth, Shropshire.	2351T	C	AC	12	23	T	EM	7kv	RF	4.5	140 14 0†
Raymond Electric Ltd., Brent Crescent, North Circular Road, N.W.10.	F49	T	AC	9	13	H	PM	7kv	FB	3	51 8 7
Regentone Products, Ltd., Eastern Avenue, Romford, Essex.	T15L	C	AC	12	14	H	PM	7kv	FB	3	76 gns.
	T15B	C	AC	12	14	H	PM	7kv	FB	3	
	TR20L	C	AC	12	24	H	EM	7kv	M	3	99 gns.
	TR20B	C	AC	12	24	H	EM	7kv	M	3	
Sobell Industries, Ltd., Langley Park, Nr. Slough, Bucks.	T120	C	AC	12	14+ rect.	H	PM	6.5kv	FB	3.0	79 16 0
	T90	T	AC	9	18+ rect.	T	PM	7	FB	2.5	56 14 0
Ultra Electric, Ltd., Western Avenue, Acton, W.3.	V600 LS	T	AC	9	19	H	EM	7kv	RF	3	54 0 0
	V6006 LF	T	AC	9	20	H	EM	7kv	RF	3	55 17 0
	V601 MS	T	AC	9	19	H	EM	7kv	RF	3	54 0 0
	V6016 MF	T	AC	9	20	H	EM	7kv	RF	3	55 17 0
	W700 LS	C	AC	12	19	H	EM	7kv	RF	3	77 3 0
	W7006 LF	C	AC	12	20	H	EM	7kv	RF	3	79 0 0
	W701 MS	C	AC	12	19	H	EM	7kv	RF	3	77 3 0
	W7016 MF	C	AC	12	20	H	EM	7kv	RF	3	79 0 0
	D700 LS	C	AC	12	19	H	EM	7kv	RF	3	125 0 0
	D7006 LF	C	AC	12	20	H	EM	7kv	RF	3	126 17 0
	D701 MS	C	AC	12	19	H	EM	7kv	RF	3	125 0 0
	D7016 MF	C	AC	12	20	H	EM	7kv	RF	3	126 17 0
L=London area. M=Midlands area. S=Standard area. F=Fringe area.											
Vidor (Burndept. Ltd.), West Street, Erith, Kent.	CN370	C	AC	12	19	T	EM	6.2kv	50	4	180 0 0
	CN4201	C	AC	12	17	T/H	PM	6kv	FB	4	161 5 0
	CN4202	C	AC	12	17	T/H	PM	6kv	FB	4	161 5 0
	CN390	C	AC	9	17	T/H	PM	6kv	FB	4	148 17 6
	CN391	C	AC	9	17	T/H	PM	6kv	FB	4	148 17 6
	CN405	C	AC	9	17	T/H	PM	6kv	FB	4	148 17 6
	CN406	C	AC	9	17	T/H	PM	6kv	FB	4	148 17 6

* Inclusive of Purchase Tax. † Exclusive of Purchase Tax.

RADIO EXHIBITION—1950

Main Details of this Year's Midland Show

SINCE it is national in scope the Castle Bromwich Exhibition, no less than the shows in London, will include every aspect of the British radio industry. There will be displayed not only broadcasting and the equipment required for broadcast reception (sound and vision) with all kinds of components and accessories; but manufacturers of transmission and communication equipment, radar and the applications of electronics for civilian, commercial and industrial use, will be welcomed.

The full co-operation of the B.B.C. has been promised; and it is hoped that other branches of the Government will also be represented.

Since the exhibition follows the inauguration of the Midland television service it is natural that the greatest emphasis will be placed on television.

A B.B.C. studio will be included. Here, visitors will be able to see "behind the scenes" the production and transmission of television programmes and some of their favourite radio programmes as well.

Items from the television programmes arranged by

the B.B.C. in the exhibition studio will be transmitted every day from the television transmitters at Sutton Coldfield and Alexandra Palace.

Arrangements will also be made for a communal demonstration of television reception where, after witnessing the production of the programme in the studio, visitors will be able to see the reproduction on the television screens.

Demonstrations

Special television demonstration rooms are not being provided in Castle Bromwich, but exhibitors will be able to operate television receivers on their stands, provided the sets are so arranged that the screens are not visible from the gangways—a condition which is necessary to avoid undue crowd congestion.

The exhibition control room will be arranged as an exhibit, as it was in London. In it visitors will be able to see the exhibition announcers, and also the engineers operating the programmes and the various exhibition services.

A public-address system will again be installed by the organisers completely independent of loudspeakers on exhibitors' stands.

FRITH RADIOCRAFT, LTD., offer the finest TV parts service in the Midlands! Now available from stock: Tallon 12in. Console Cabinets, "Viewmaster", £12/10/-; "Elect. Eng." £14/10/- (packed flat); "Whiteley 9in. Table Cabinet for "Viewmaster" complete with mask glass and engraved knobs, £6/17/6. White Masks round or flat ended, 12in. 2/6, 9in. 11/3, 6in. for VCR97, 7/6. PM Focus Magnets, Elac R17 21/-, R20 22/6, R25 25/-. Plessey 72004, 72005 19/6. Focus Coils, Denco 25/-, Allen 35/-. Scanning Coils, Denco 30/-, Allen 35/-. Plessey 25/6. Wireless World 35/-. Line OP Transformers, Denco 27/-, Allen 35/-. EHT Transformers Varley 4kv 67/6, 5kv 72/6, Woden 4kv 65/-, 5kv 72/6. Mains Transformers, Woden "EE" bottled £4/18/6, Varley "EE" £4/10/0. Chokes, Varley 5H 18/6, 10H 17/-, Woden 5H 29/-, 10H 17/-. Coils, "EE" London 15/-, B'ham 17/6. "Viewmaster" L 20/-, B 28/-, "WW" S'het. L or B, 42/6. Aladdin Formers with cores, large 10d., small 7/6. BTH Crystal Diodes, G.C. 11/3. SFC HV Rectifiers, H/200, 28/6. Edystone S/Statos, 25+25F, 7/6. Reliance Controls TW 100, 500 1k, 2k, 2.5k, 5k, 10k, 25k, 50k, 4/6. TW 100K, SG 150k, 2meg, 5/-. All above brand new, satisfaction guaranteed. Post free over £1. **FRITH RADIOCRAFT, LTD., Leicester.**

YOU will eventually insist on a Telesvisor with 9in. or 12in. white tube so why not start right and thus avoid waste. The Viewmaster (London and Midland) and Midland (London and Midland) circuits and tubes. Viewmaster Constructors' Envelope (L. or M.), with full instructions, circuits, diagrams and parts list, 5/-, Electronic Engineering Handbook (London), 2/6. Wiring Diagrams (London), 3/6. Combined Handbook and Wiring Diagram for Midland, 4/6. All parts available for both circuits, including Cabinets, Valves and Tubes. Full P.T. bargain list 2/6. We assure our television constructors the same unique service afforded to radio constructors in the past. N.R.S., 16, Kings College Road, London, N.W.3. (Primrose 8314.)

SPECIAL OFFER of ex-Govt. Paper Block Condensers, 10 mfd. 500v test metal case 3in. x 2 1/2 x 1 1/2 each, doz. lots 10/-; also 7.5 mfd. 400v, same size, 9d. each; 7.6 doz. guaranteed perfect Taylor Transformers, brand new, finest value, this is most popular model, Pri. 0.250 tapped and screened, HT 350-0-350 100ma. LT. 5.0-4-6 3v 4-5v. suit 4v and 6v valves, price 19/6; all P.W. and P. TV. Circuit Transformers available or made to spec., ask prices. All above sent post free or C.O.D. Satisfaction guaranteed. **G. A. TAYLOR**, 125, Manchester Road, Denton, M.C.

TESTED RADIO and TV Spares, cheap. Smoothing Chokes, 30H, 2/6; S/W Tuning, Ceramic, 15/160 pf, 1/6; Midget Components. List 2/6. CARTER'S, 67, Bell Lane, Marston Green, Birmingham.

MERCHANT NAVY and Air Radio, Day, Evening and "Radioerets" Postal Instruction. Apply THE RADIO OFFICER, The Wireless School, 21, Manor Gardens, Holloway, N.7. (ARC. 3694.)

VIEWMASTER & ELECT. ENG. KITS AT LOW PRICES. 30ft. TELESCOPIC T/V MASTS, STEEL, RUST-PROOFED. Plus Carriage 37/6 C.W.O. or C.O.D.

D. J. CLARKE,
2/4, Shortmead St., Biggleswade,
Beds.
Phone: BIGG. 2377

RATES: 3/- per line or part thereof, average five words to line, minimum 2 lines, Box No. 6d. extra. Advertisements must be prepaid and addressed to Advertisement Manager, Practical Television, 27, Tavoy House, Southampton St., Strand, London, W.C.2.

SUPREME RADIO, 746B, Romford Road, Manor Park, London, E.12 (Tel.: I.L.F. 1260). Est. 16 yrs. Fly-back type Line Trans. for use with EY51 valve, 22/6 ea.; P.M. Focus Rings, from £1; Ceramic EF50 Valve Holders, 6d. ea.; Retaining Rings for EF50 Valve Holders, 8d. ea.; B4C Valve Holders, Amphinol type, 9d. ea.; EA50 or D1 Valves, 3/- ea.; Metallum Cond., 0.002 mfd. 500v and 0.01 mfd. 350v, 9d. ea.; Midget Mica Cond., 0.0003 mfd., 0.0005 mfd. and 0.001 mfd., 6d. ea. 5/6 doz. or ass.; Equivalent set of Resistors for "Viewmaster," 15/9 set; Equivalent "Viewmaster," Mains Trans., 25/- ea.; 0.1 mfd. 2.5 kv insulated case cond. 3/6 ea.; CV102 Crystal Diodes, 2/6 ea.; small Group Panels with fixing feet and holding 6 1 watt Resistors and WX6 Westector, 9d. ea. 8/- doz.; Noise Suppressor Units consisting of 2 0.1 mfd. Conds. and Iron-cored Choke, 6d. ea.; Single Insulated Anchoring Tag Mounts, 6d. doz.; Aladdin Coil Formers with cores, 8 mm., 8d. comp.; 6 mm, 7d. comp.; 4-watt Resistors, 10 ohms, 22, 27, 47, 82, 120, 180, 250, 330, 390, 470, 560, 680, 820, 1 k-ohms, 3.9 k-ohms, and 10 meg-ohms, 1/9 doz., 18/6 gross, or ass. Many other radio and television bargain lines in stock. Terms C.W.O., no C.O.D. Send 6d. extra for postage orders under £5. 2/6. S.A.E. all enquiries and list.

VIEWMASTER and EE Televisors. All parts in stock. Model on show. **HG RADIO, 1330, Stratford Rd., Birmingham, 28** (SPR 2369.)

VIEWMASTER Home-Television Constructional Drawings, 15/- post free. Send for our lists of better-performing television and radio coils and components, also free circuits. **OSMOR RADIO PRODUCTS, LTD.** (Dept. P.T.C.), Borough Hill, Croydon, Surrey. (CRO 1220.)

VALVES, new/boxed: 6V6, 6K7, 6K8, 6Q7, 6F6, 6N7, L63, H63, 5Z4, 5U4, U50, KTW61, 25Z5, 80, 807, 184, 1T4, 1R5, 155, 354, 1C5, 6X5, 6J7, and many other types, all at 6/3 each, post free. Holders: Octal, 6/- doz.; B7C, 9/- doz.; EF50, 6/- doz.; w/switch, 3/9. Condensers, fresh stock, 8 mfd. 450v, 2/3; 8 x 8, 450v, 3/-; 8 x 16, 3/6; 16 x 16, 3/6; 32 mfd. 3/6; Dutil 8 mfd. 500v, 3/6; 16 mfd. 500v, 3/9. Sprague, 1, 350, 6/- doz.; .01, 1,000v, 6/- doz. Output Trans., 7,000 ohms, 3/6. Multi-duty, 42.6, New M. Speakers, Anti-rng field, 5in. 12/-, 6in. 14/-, 8in. 15/-, 10in. 17/6. Mains Trans., 350/350, 6v, 5v, 100 m/a, 24/6. Always an excellent selection of new surplus components at bargain prices. **RADIO UNLIMITED, Elm Road, Walthamstow, E.17.** Phone: KEY 4813. Orders dispatched same day. Trial will convince.

MANUFACTURERS' Samples, Radiogram and Television Cabinets; few only. Stamp details. **WALTERS, 501 Hale End Road, E.4**

P.W. TRF TELEVISOR, set of 8 Coils and Choke, 16/6; set of Chassis, all angles and tube supports, £4; Focus Rings, 25/- and 35/-; matched line Trans. and Defn. Coils, £3/15/9 pair; "EE" Timebase and P/pack Chassis, cadmium, 35/- the pair. Trade enquiries invited. **BEL SOUND PRODUCTS CO.,** Marlborough Yard, London Archway, N.19. (Tel.: North 1025.)

TELEVISION VALVES: EA50 3/-, EF50 4/-, L63 5/-, 807 6/6. Many other types available. EA50 Bases 4d., EF50 Bases 6d. R1225 Receivers with 2 8D2 valves (guaranteed). Ceramic Valve-holders, etc. In watertight metal bases; could be converted to Television pre-amp, only 10/-. Components supplied for P.W. and W.W. Televisors. Receivers P.W. and W.W. Televisors, please. **ELECTRAD RADIO, 64, Gt. Victoria St., Belfast.**

MIDDLEBROUGH—Large stocks of Radio Components at PALMERS, 114, Waterloo Rd. Callers only.

VIEWMASTER and E.E. Components, surplus Valves, E.H.T. Transformers, 5kv, 4v, 50/-, High-class job new Radios, from 6/- gns. P. KING, 3, Hartfield Crescent, Wimbleton.

VU120, 72, HVR2, KT44, 5/-; EF50, 3/6 and 5/-; VR137, TT11, 3/-; EA50, .01 5V, .01 2.5kV, 1/6. Iron Cores for TV Coils, 10d. dozen. Pipe-pin British EHT Valveholders, 5d. Money back guarantee. No C.O.D. S.A.E. lists. ANNAKIN, 25, Ashfield Place, Otley, Yorks.

S'NET COILS, 3WB 465KC, with diagram, 2/6 pair; Kit of Parts for Midget Coil Pack, L.M.S. (iron cored), 465KC, 9/6; IPT's, 6/- pair; ex-R.A.F. Output Trans., 9d., 1.1.1. 8/- sleeve, 6d. doz. yds., 16-16 x 350v Electrolytic, 2/6; .01 450v Tube, 2/9 doz. Send for cheapest list in England. **SUSSEX ELECTRONICS, LTD. (P.), Riley Road, Brighton, 7.**

YOU may have TV, but you'll still need a Personal Portable for the holidays. Build yours from "Personal Portables," the first book to give complete constructional data for a whole range of sets, 2/8 post free from BRADBOOKS, "Sennen, Penzance, Cornwall." "Portable TV" ready soon.

PRACTICAL WIRELESS Telesvisor, Aladdin Former, 10d., Coils 16/6, Chassis £4, Mains Trans. 68/6. Wireless World TV. Focus Coil 27/-. Deflector Coils 25/-. B.O.T. 9/-, Coils 52/6, Chassis 98/-. Mains Trans. 76/-. S.A.E. list. R. F. SHILTON, 19, Clarendon Road, Salisbury, Wilts.

EDUCATIONAL

TELEVISION Servicing and Theoretical (postal) Courses at extremely moderate fees are available from the Institute of Practical Radio Engineers, either for study or as reading matter only. Syllabus, post free, from the Secretary, I.P.R.E., 20, Fairfield Road, London, N.8.

TELEVISION—The Gothic Television Schol specialises solely in training in television. Principals: M.B.E., B.Sc., M.Brit.I.R.E., education committee members, etc. Courses assume no previous television knowledge and provide guaranteed training for Brit.I.R.E. and R.T.E.B. examinations. All tutors possess university degrees and/or corporate membership of professional institutions and are appointed individually to postal course students to ensure complete and thorough training. Numerous well-known companies have adopted the School's Basic Television Course as standard television training for their staffs. Moderate fees. Details from the Secretary, **GOthic TELEVISION SCHOOL, 13, North Ave., London, W.13.**

TRANSFORMERS
TO EXACT SPECIFICATION

"Wireless World" Telesvisor Line O/P and Mains, Williamson Amplifiers, Test Gears, Accumulator Chargers, etc., also to Your Own or Published Specifications.

E.P.D. TRANSFORMER PRODUCTS
31, Queenstown Road, Battersea, S.W.8.
MAC. 4180.

THE MODERN BOOK CO.

- Television Explained, by W. E. Miller, 5s. Postage 4d.
- The Principles of Television Reception, by A. W. Keen, 30s. Postage 9d.
- Television Simply Explained, by R. W. Hallows, 9s. 6d. Postage 6d.
- The Radio Amateur's Handbook 1950, by A. R. R. L., 20s. Postage 9d.
- Basic Television—Principles and Servicing, by Bernard Grob, 55s. 6d. Postage 1s.
- A Home Built Television for Sutton Coldfield Reception, 4s. 6d. Postage 3d.
- Introduction to Television, by A. Folwell, 9s. 6d. Postage 6d.
- A Home Built Television, 2s. 6d. Postage 2d.
- Superheterodyne Television Unit—London and Birmingham Areas, 2s. 6d. Postage 2d.
- Television, by M. G. Scroggie, 6s. Postage 4d.
- Radio, Television and Electrical Repairs, 10s. 6d. Postage 9d.
- Television—Programme and Production, by R. Hubbell, 15s. Postage 9d.
- Television Receiver Construction—London Area only, 2s. 6d. Postage 2d.
- Radio Valve Data, compiled by Wireless World, 3s. 6d. Postage 3d.
- We have the finest selection of British and American television and radio books in the country. Complete list on application.

19-23, PRAED STREET
(Dept. T.1.)
LONDON, W.2.
PADdington 4185.

RADIOLECTRON

22, FRANCES STREET,
SCUNTHORPE, LINCS.

All Specified Components Supplied
for

"VIEW MASTER"

"ELECTRONIC ENGINEERING"
and

"PRACTICAL WIRELESS"
TELEVISION RECEIVERS

Kits or Separate Components Supplied at
List Prices.

Terms: Cash with Order. Orders under
10/- 4d. Post. Over, Post Free.

You can master MATHEMATICS

If you wish to understand radio and television thoroughly you must know Mathematics. Our new Home-Study Courses make them really interesting and easy to learn.

T. & C. RADIO COLLEGE

Specialists in Home-Study Tuition
in Mathematics, Radio & Television.

Write for free booklet "T" to:—

R. Heath Bradley, T. C. R. C.,
50, Harland Road,

SOUTHBOURNE, BOURNEMOUTH.

RADIO EXCHANGE CO.**RECEIVER TYPE 3584**

A brand new receiver, containing 15 EF50's, six of which are in the famous "Pye" strip, tuned to 45 mc/s, and ideal for AP television. In addition, 1 EA50, 1 EF36, 1 EBC33, 2 SP61's, and 3 EBC34's, plus a midget 24v. motor, literally dozens of resistors, condensers, pots, etc., make this unit one of the greatest bargains ever offered.

COMPLETE with 23 valves,
in original wooden crates.
£5-12-6

UNUSED 1355 RECEIVERS in
original unopened crates, £3-10-
plus 5/- carriage.

RADIO EXCHANGE CO.
9 CAULDWELL ST., BEDFORD

CABOT RADIO

Television Pre - amplifiers (Midlands frequency)

All the models described below have self-contained power packs and operate from 200-250 v. 50 c.p.s. mains.

Model A. Two stage model using 6SH7 valves and having variable gain control. Price, including valves, £5/15/0.

Model B. One stage, using Mazda 6F1 valve. Has extremely high signal-noise ratio. Ideal for use with superhet type receivers. Price, including valve, £5/15/0.

Model C. One stage, using 6SH7 valve. High signal-noise ratio. Price, including valve, £4/17/6.

Model D. One stage using 6SH7 valve, but using a capacitor for series heating the valve instead of a transformer as in other models. Price, including valve, £3/17/6.

All obtainable from your dealer or direct from:

THE CABOT RADIO CO., LTD.
28, Bedminster Parade,
Bristol, 3.
Tel.: 64314

POST RADIO SUPPLIES

COPPER INSTRUMENT WIRE.
ENAMELLED, TINNED AND FUSE.
COTTON AND SILK COVERED.
LITZ WIRES. Most gauges available.
B.A. SCREWS, NUTS, WASHERS,
soldering tags, eyelets and rivets.
EBONITE AND LAMINATED BAKE-
LITE PANELS, TUFNOL ROD.
PAXOLIN TYPE COIL FORMERS AND
TUBES, ALL DIAMETERS.
PERMANENT DETECTORS.
CRYSTALS, EARPHONES, etc.
Latest Radio Publications. Full Range
Available.

Send stamped addressed envelope for
comprehensive lists. Trade supplied.

POST RADIO SUPPLIES
33, Bourne Gardens, London, E.4.

TELEVISION COMPONENTS

FOR THE

"Practical Wireless"
VIEWMASTER AND
E. E. TELEVISORS

ALWAYS IN STOCK

COMPONENT LISTS AVAILABLE
Prompt Postal Service

J. T. FILMER

MAYPOLE ESTATE, BEXLEY, KENT
TEL. Bexleyheath 7267

THINKING OF BUILDING A TELEVISION SET ?

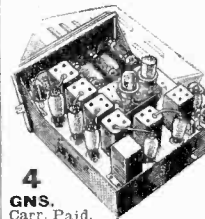

4
GNS.
Carr. Paid.

10 VALVE
1½ METER
SUPER-
HET. Ideal
for conversion
into
Television
Receivers.

I.F. 12 meg. Band width 4 meg,
Co-axial input and output sockets,
10 Mazda Mains type VR65 (SP61)
valves, 6.3 volt filaments.

Dept. P.T. WIRELESS INSTRUMENTS
(Leeds) Ltd., 54/56, The Headrow,
Leeds, 1. Tel.: 22262

TELEVISION PICK-UPS AND REFLECTIONS

UNDERNEATH THE DIPOLE

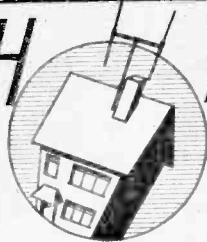

By Iconos

FRIDAY night may be the night when the ladies put their hair up, but on Sunday night, those who are television viewers let it down again. For on Sunday nights they receive their weekly ration of horror, ghosts, gloom and grand guignol. Sometimes the guignol is not very grand and viewers fail to stay the programme. Few of them survived T. S. Eliot's play "The Family Reunion," a self-consciously stylised story of a man haunted with the thought that he has killed his wife. Who, for the love of Mike, had the crazy idea of presenting this unpleasant, pinchbeck drama before the very mixed Sunday night audiences of London and Birmingham areas? And after the storm of indignation which it aroused, why was it repeated on the following Friday, the day after Election Day? Of course, the production of a play for television represents a considerable capital investment in artistes, scenery, copyright and so forth, and the spreading of such an investment over two nights' programmes is justifiable. Nevertheless, there should be a "reserve fund" created to enable the instant scrapping of those plays which irritate and annoy so many customers at the first viewing. Far better to improvise a variety programme or show an old film than to repeat an unsuccessful experiment. In the case of "Family Reunion," the play was completely unsuitable for the television medium and must have severely damaged the reputation of the author. For effective entertainment, horrors must be served up swiftly and sharply, holding the spectator breathless with tension. This unfortunate play had a different kind of horror—reminiscent of a long journey in a cattle-truck or a walk through rotting cabbage fields. Plays of this kind are suitable for the specialized audiences of the little theatres, patronized by weird long-haired men and wild short-haired women.

EXECUTIVE PRODUCER WANTED!

THE absence of any particular standard of taste in the choice of television plays betrays a lack of executive control at the Alexandra Palace. Norman Collins, the Chief T.V. Executive, cannot be expected

to "vet" every production that finds its way to the viewers' screens, and the bright young things who are producers seem to be left to their own devices. Some of them should be dropped forthwith. Of course, some of the experiments are successful—horror and all—but there remains the problem of sending the children to bed after the announcer has warned us that the play following is suitable for adults only. It would be so much simpler if all announcements of plays in the "Radio Times" and the press had some indication of suitability, such as "A," "U" or "H" after the title. Then one could be prepared for the worst. In the absence of censorship, there should be some special executive whose principal responsibility is to ensure that a reasonable standard of taste is maintained. Some television producers are inclined to ignore the masses in their wild efforts to appease the prickly taste of satiated critics.

SUNDAY NIGHT IS GLOOMY NIGHT

MY terms of reference from the Editor are to steer a middle course between technical and artistic reflections, underneath the dipole. It is therefore not my province to set myself up as a TV Play Critic. But before leaving the subject of "sour" plays, I must mention a few runners-up to the T. S. Eliot opus. *The Indifferent Shepherd* was an immoral play with a good moral, but which nevertheless gave offence. *Cheapside* was a depressing tale of the Great Plague and contained much unsavoury and censorable detail. The horrors of *Trespass* surpassed those of the sadistic *Rope*. No wonder Monday mornings have been particularly "Monday-morningish" lately. We want less of this gloomy stuff and more of the "Elusive Pimpernel" and *The Children Hundreds*. There is little enough to laugh about these days.

The craze for TV horror plays is not exclusive to British television. The Americans are putting them over in a big way, and are succeeding in sending both grown-ups and children to bed to dream of Draculas, hooded terrors, death masks and torture chambers. The result has been a revival of patronage at theatres and cinemas showing comedies! It's an ill wind!

THE B.B.C. NEWSREEL

THE B.B.C. newsreel continues to make progress and seems lately to contain more news and less items which might be classified as "magazine" items. The quality of both picture and sound—particularly the latter—has improved tremendously. Viewers would have quite a shock now, if they saw some of the first editions of the B.B.C. newsreel, particularly if projected on the early type tele-cine equipment. Photographic values are now absolutely first-rate, and the B.B.C. newsreel men have developed a first-class news story sense. The sound is not often "direct"—it is usually a commentary added afterwards with a musical background during the "dubbing" process. The B.B.C.'s new dubbing theatre at the Alexandra Palace is now in operation, enabling music, effects, commentary, or any other sound to be fitted and added to the edited picture story. R.C.A. sound track is used for the final print, but other "brands" of sound, including British Acoustic, Visatone and various magnetic systems have been used for prior direct recordings. The B.B.C. are now going ahead with recording sound in the actual picture camera, a process which places definite limitations on the sound quality. Normally, of course, sound is recorded on a negative entirely separate from the picture negative. Originally hampered by lack of good equipment, the public appreciation polls and the B.B.C.'s own Viewer Research Department have put the newsreel very high in order of popularity. And so—ever so slightly—the purse strings have been loosened in favour of the TV film section of the B.B.C. This success reflects much credit upon Philip Dorté, the Head of the Television Films Division.

Correspondence

The Editor does not necessarily agree with the opinions expressed by his correspondents. All letters must be accompanied by the name and address of the sender (not necessarily for publication).

VCR97 DEFECTS

SIR,—Many constructors seem to experience defects in the focusing of their VCR97 cathode-ray tubes. These appear to be due to astigmatism, i.e., by means of the focusing control the spot may be made to focus in either the horizontal or vertical planes, but not in both at once, thus giving the effect of an elongated spot.

This defect is common in radar sets, using the VCR97 tube, and an "astigmatism" control is usually provided. This applies on adjustable voltage to one pair of deflecting plates, usually the pair nearest to the screen, the X plate in the case of the VCR97, so that the spot is made to focus in both planes on the screen at the same time.

To set up this "astigmatism" control proceed as follows:

Turn the "astigmatism" control voltage potentiometer to minimum and focus the tube as sharply as possible by means of the main focus control. Next advance the astigmatism control somewhat and re-focus with the main focus control. Now advance the "astig." control a little more and proceed as before. Repeat until the focus is correct in both planes, i.e., spot circular or picture correct.

In my own home-built television set the "astig." potentiometer is connected across the receiver 350v. H.T. supply, and the variable voltage taken via 2m Ω resistor to the tube plates. By correct adjustment a perfectly focused picture is obtained.

Regarding the non-linearity of the Transistron-Miller time-base, this is almost entirely due to incorrect operating conditions. As a simple expedient a variable resistor of about 5,000 ohms maximum in the cathode circuit of the time-base valve usually enables fairly good linearity to be obtained, the resistor being adjusted for best linearity. Care should be taken that the deflection amplifiers do not introduce distortion, and that the time-base H.T. is sufficiently high.—M. A. WESTON (Wareham).

FIFTEEN-YEAR-OLD'S SUCCESS

SIR,—I should like to record my experience in television.

I am 15 years old and had experience only in building a large number of receivers and amplifiers when I decided to concentrate on television. Over a period of more than a year, components and units that were suitable were picked up cheaply. The tube unit, time-bases and synch. separator were built up on the chassis of an indicator unit, type 97, which contained most of the components, including VCR517 tube, to the circuits given with a well-known television kit. All this, including stripping, etc., took two days. The vision receiver took one and a half days and was built, in line fashion, to the *Practical Wireless* superhet circuit. Power supplies followed standard practice. Several sound

receivers have been built, but none proves capable of satisfactory results, owing to a local "dead spot." Three aerials have been tried, an "H" for London, an "H" for Birmingham and a three-element folded dipole for London—all these were home built. The total cost of the whole apparatus, including aerial mast, feeder, etc., was well under £18.

With this gear, London was received on most nights with the "H" aerial for the whole of January at good entertainment value. The Birmingham aerial was tried for a week, but there was only one fair night (we are 180 miles away). The folded dipole is now being used and, despite bad conditions, is giving good results on London.

There were quite a few snags—three valves had air in them and glowed purple, instability was present but the modified diode filter unit cured this at all but maximum setting of contrast. As soon as all the faults were remedied, everything worked perfectly and has been doing so up till now. No test gear or signal generator was used.

Despite the fact that we are in a valley, on a main road, nearly 80 miles from Alexandra Palace, I am convinced that results are well worth working for from the entertainment point of view. If anybody desires further details of equipment, etc., I shall be pleased to oblige.—A. J. BURTON, 239, Folkestone Road, Dover, Kent.

EIRE IMPORTS

SIR,—We would like to draw the attention of those of your readers who reside in Eire to the following facts.

Before sending to the United Kingdom to purchase goods it is advisable to apply to the Revenue Commissioners in Dublin Castle for an import licence, and consequent remission or partial remission of duty, as the full rate of duty renders purchase of radio equipment a very expensive business.

In addition, goods sent by rail are subject to a customs clearance charge, payable to the British authorities, which amounts to 6s. on an article weighing between 56 and 112 lbs., the minimum charge being 2s.

On three recent occasions small parcels, sent by post, have been returned to us, the addressee having refused to pay the duty demanded; the cost of the article was 15s. carriage paid, and the duty demanded was £5, plus a collection charge of 6d.

We feel sure that knowledge of these facts would prevent disappointment to those many of your readers who may wish to deal with the United Kingdom.—RADIO EXCHANGE CO. (Bedford).

BAD INSTALLATION

SIR,—I should like to report an instance of bad installation which I have met and which shows how very difficult it is to trace some types of fault. A commercial television receiver was purchased from a

well-known firm and duly installed. It worked satisfactorily for a time and then began to develop troubles. Service men were sent by the installers and made sundry adjustments which effected temporary cures. Eventually a new tube had to be obtained as the original burnt out. Troubles occurred from time to time with increasing regularity and finally I got a local man to look at it as hum on the sound side was getting too bad for comfort. He made adjustments in the morning of his visit, had to call again in the afternoon and make further adjustments, and in the evening had made a further rough check when he sat down to take some refreshment. He was idly glancing at the back of the set and suddenly noticed that the mains input adjustment had been set at 200 volts instead of 240. Apparently this had been done at the first installation and no one had noticed it when servicing the receiver. The plug was changed and the receiver is now working better than it has ever done and no further difficulties are expected. It shows how a simple thing can elude even critical eyes—presumably the service men taking the input for granted and trying to find a “developed” fault in the set.—R. GRIMBLE (N.W.9).

STABILITY AIDS

SIR,—I have built a number of experimental television circuits and have used, on the grounds of economy, the popular EF50 ex-service valve (VR91). I have bought very few which have proved defective, but for the benefit of other experimenters would like to give one or two hints which I have found by experiment. First, one or two types of EF50 valveholder have given rise to trouble due to insecure valve-pin contact. I now use always the wide type of locking ring, which holds the valve right down in its socket and prevents movement. I find these rings will enable any type of socket to be used without pin trouble. The second point is interesting. I used the valves in a time-base as oscillator, and in certain experimental equipment connected with lining up the receiver, and found that in some cases improved efficiency was obtainable when the suppressor grid was taken not to earth but direct to the cathode pin on the valveholder. In other cases I found just the opposite, namely, that better results were given when the G3 was taken direct to earth or the earth line. It is therefore worth while bearing this in mind in experimental work, and if results are not just what was expected, a change in the connection of G3 may prove worth while.—R. CHEESEMAN (Chingford).

AEROPLANE FLUTTER

SIR,—I live very close to an aerodrome, and experience considerable distortion of the picture when planes pass overhead. It is particularly noticeable that when the planes are flying “down the beam”—that is, in a line along that stretching from my aerial to the

Alexandra Palace—the trouble is much worse than when just flying at right angles. I tried some modification of the aerial system, and found that I got improved efficiency by erecting a horizontal aerial. I have fitted this about 2ft. below the bottom of the aerial and it is not connected to anything. It seems to act as a reflector which comes in phase at certain angles of interference, and it would be interesting to know if any other readers have carried out experiments in this connection. I believe that better results would eventually be obtainable with this form of interference suppressor than with any circuit changes.—L. WALDE (Hendon).

CONGRATULATIONS

SIR,—May I take this early opportunity of dropping you a line to congratulate you on your excellent new monthly, PRACTICAL TELEVISION. I think it is a first-class job throughout—fully up to your high standard.—GILBERT ADVERTISING, LTD.

A MESSAGE FROM NORMAN COLLINS TO “PRACTICAL TELEVISION”

In 1932 the first issue of Practical Wireless appeared, and ten years before that Amateur Wireless made its appearance on the bookstalls and was soon to be found in the bedroom-laboratories of half the schoolboys in the country. My own interest in radio matters began round about that date, when I completed an extraordinarily complicated set, built according to the then fashionable principles of unit construction, which relied on a crystal, two valves, and a loudspeaker which was ultimately discarded because the headphones placed in a basin proved to be rather louder!

It is significant of the progress that has been made that the schoolboys of to-day will be setting out confidently—and, I am sure, successfully—to build their own television receivers. Here, while applauding their enterprise and ingenuity, let me add one perfectly serious word of warning. The battery set which I built when I was fifteen contained hardly enough power to light the valves. The television sets with which the modern schoolboy will find himself confronted embody voltages high enough to kill a man.

It is therefore a public service which PRACTICAL TELEVISION will be rendering in educating the younger generation into a properly serious approach to the technical problems of television development. And it is good to think of this generation growing up equipped with the knowledge which will have a hundred-and-one uses in the world of their maturity. I therefore send my best wishes to PRACTICAL TELEVISION and to its readers.

NORMAN COLLINS,

Controller, Television.

SIR,—I have to-day received a copy of the first issue of PRACTICAL TELEVISION, and would like to offer you my congratulations on an excellent publication. I feel sure this will greatly stimulate the interest already being shown in the constructor market.—WHITELEY ELECTRICAL RADIO CO., LTD.

SIR,—I would like to congratulate you and your staff on producing such a fine issue, for the first of many more similar ones, and for the initiative in producing a new magazine so soon after the lifting of the restrictions.

PRACTICAL TELEVISION will play a great part in the development of television, and will be the medium which will link the industry with those who, in their small way, are helping in the establishment and furtherance of a science which will, very soon, influence the everyday lives of all of us.—JOHN GOODALL (N.12).

SIR,—It was with more than a little anticipation that I opened my No. 1 copy of PRACTICAL TELEVISION when I received it yesterday morning. I was not disappointed. This is the journal that all T.V. owners, would-be owners and electronic engineers should buy with the same regularity as they do their newspapers. Like its elder sisters, *Practical Mechanics* and *Practical Wireless*, it caters for both amateur and professional, the articles are up to the usual high-class standard of your publications, and I foresee a big demand for this new and fascinating book. I shall follow the Alan Chisholm articles keenly, for I am sure that I shall be smitten with that dread disease, “Constructoritis.” It will be interesting to learn for how many more “Workshop Widows” your new journal will be responsible. Please accept my sincere good wishes for the future of PRACTICAL TELEVISION.—ALBERT HAY (Gt. Missenden).

TRADE TOPICS

Elac P.M. Focus Unit

It is now well-known that a permanent magnet unit for focusing has the main advantage that current is saved in the complete receiver, and there is no focus drift which may be experienced in an electro-magnetic unit due to heating. The particular unit illustrated below is manufactured by Electro Acoustic Industries, Ltd., and is provided with three fixing bolts and three adjusting screws. It consists of the usual centre portion in the form of a circular magnet with end plates and a moving centre section. As the latter is withdrawn the gap is opened and a suitable field may be developed for the particular tube in use. Control over this section is effected by the knurled control knobs, and the picture may be centred by suitable adjustment of the nuts on the three fixing lugs. These are made long so that an existing support could be used and the unit adjusted to the

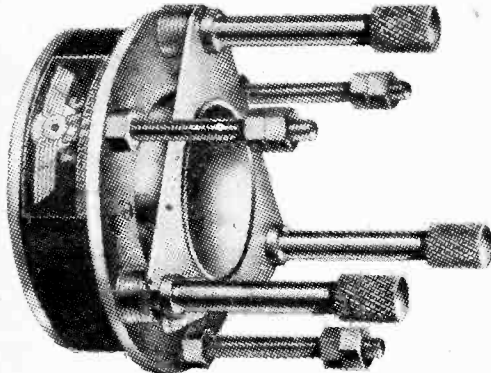

The "Elac" focus unit.

most satisfactory position in relation to the tube electrodes. This particular make of unit was employed in the "Practical Wireless" Television receiver and has been found perfectly satisfactory. To enable maximum adjustments to be made for triode or tetrode tubes three different models have been produced; one is of low flux specially suitable for tetrodes; the second for normal triodes with EHT up to 7kV. or so, and a third for tubes with up to 15 kV. EHT and those triode tubes which prove difficult to focus at lower voltages. The prices for the three models are, respectively 21s., 22s. 6d., and 25s.

Electro Acoustic Industries, Ltd.,
Stamford Works, Broad Lane,
Tottenham, N.15.

Mullard Noval Base (9-pin) Valves for Television

THE comprehensive range of Mullard valves for use in Television equipment has recently been extended to include two new types on the Noval (9-pin) base. These valves are the Triode Pentode ECL80 and the H.F. Pentode EF80. Both types offer special advantages

in the design of television equipment, and their general design and dimensions fall in line with 9-pin valves produced by American and European manufacturers.

The EF80 is characterised by a particularly high slope, and is primarily intended for use as a R.F. amplifier or mixer valve in television receivers.

Having separate triode and pentode sections, the ECL80 has a wide number of uses. As a result of this it is possible that it will enable manufacturers to reduce the number of valves in television receivers, and thus reduce the size of the equipment. Three straightforward ways of using this valve in television receivers are as follows:

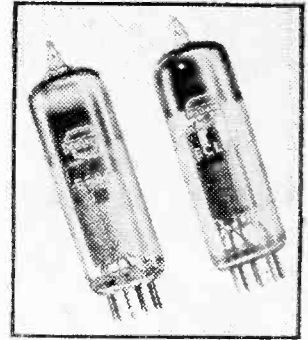

Two of the new Mullard Noval based valves.

1. Pentode section as synchronising pulse separator; triode section as line oscillator.
2. Triode section as frame oscillator; pentode section as frame output.
3. Triode section as L.F. amplifier; pentode as audio output valve.

Full technical data on these two new valves may be obtained from the makers.

Mullard Electronic Products, Ltd.,
Century House, Shaftesbury Ave.,
London, W.C.2.

Wolsey Aerials

AERIALS are available in many different styles to-day, and Wolsey Television, Ltd., have produced a complete range which pack neatly and may be erected by any handyman with satisfaction. At one end of the range is an indoor braided flex aerial, consisting of braided copper wire about $\frac{1}{4}$ in. wide, made into dipole form with a centre insulated portion carrying twin feeder. It may be attached to a wall, door or window frame and if extended without bending the lower portion the gain is almost identical with that of a standard dipole in the same position. Another type has two pivoted arms round a centre portion and may be adjusted to provide a "T," a "Y," an inverted "Y," an "L," or a straight vertical dipole. Other models consist of simple dipole, standard dipole with reflector, dipole with three reflectors and a folded three-element dipole. The makers can supply a leaflet showing the polar diagrams of the various types so that the most suitable aerial for any locality may easily be selected. Accessories such as poles, brackets and lashings are also available from the same firm. As an instance of prices, the braided aerial costs 16s. 6d., the standard dipole with reflector from £2 10s., and the folded three-element array £6 6s.

Wolsey Television, Ltd.,
75, Grésham Road, Brixton, S.W.9.

Published on the 22nd of each month by GEORGE NEWNES, LIMITED, Tower House, Southampton Street, Strand, London, W.C.2. and printed in England by W. SPEAIGHT & SONS, LTD., Exmoor Street, London, W.10. Sole Agents for Australia and New Zealand: GORDON & GOTCH (Asia), LTD. South Africa: CENTRAL NEWS AGENCY, LTD. Subscription rate including postage for one year: Inland and Abroad 10s. 6d. (Canada 10s.). Registered at the General Post Office for the Canadian Magazine Post. CONDITIONS OF SALE AND SUPPLY: This periodical is sold subject to the following conditions, namely, that it shall not, without the written consent of the publishers first given, be lent, re-sold, hired out or otherwise disposed of by way of Trade except at the full retail price of 9d.; and that it shall not be lent, re-sold, hired out or otherwise disposed of in a mutilated condition or in any unauthorised cover by way of Trade; or affixed to or as part of any publication or advertising, literary or pictorial matter, whatsoever.

LONDON OR BIRMINGHAM!

Here is an opportunity worth grasping,
build your own Television Receiver at
a price you can afford.

- Designed around common types of valves.
- No unusual types to obtain.
- Will suit 9in., 10in. or 12in. Tubes.

CAN BE BUILT FOR £20 (C.R. Tube)
Extra

Instruction books PRICE 5/- post free
Write today for further details.

PRE-AMPLIFIERS—WHY PAY MORE ?

Complete with valves, fully aligned and tested
One stage 30/- Two stage £2

PERM.	{	For Mullard C.R. Tubes.	Type FR1 21/-
MAGNET		For G.E.C. C.R. Tubes.	Type FR2 22/6
FOCUS RINGS	{	For Mazda C.R. Tubes.	Type FR3 25/-

HOUGHTON & OSBORNE LTD.
Electron Works, Thame, Oxon.

Telephone : Thame 182.

CLARITY—

like that other elusive quantity, Clarity, begins at home :
at your aerial, in fact. Many people who thought themselves
to be too far from the transmitter for clear reception of
television are now enjoying the programmes brought to
them by G.S.V. Long-range arrays (Prov. Pat.).

Similarly constructed to our transmitting arrays used
by the leading telecommunication manufacturers and installed
throughout the world, the high front-to-side and front-to-
back ratios of these aerials not only provide maximum signal
pick-up, but also secure against any interference from an
unwanted direction.

The TVFL Beam will ensure good reception in most loca-
tions some 200 miles from the transmitter, whilst the TVTL
and TVRL arrays are designed for fringe-area reception, or
use in nearer districts of low field-strength. A full range of
standard types is also available for local reception, and all
models are available for either London or Midlands frequency.

TVFL	Folded dipole, reflector and two direc- tors with 10ft. mast and stayed boom	£7 5 0
TVTL	Folded dipole, reflector and director, complete with 6ft. mast	£6 0 0
TVRL	Folded dipole and reflector, 6ft. mast	£4 10 0
TVH	Standard H.O.25 spacing, with 10ft. mast	£5 1 0
TVG	Ground plane for roof-space mounting...	£1 17 6
TVD	Standard half-wave dipole, various fixings	£1 17 6

The above prices are inclusive of packing and carriage ; our
technical staff is pleased to advise upon aerials for all
frequencies and applications.

G.S.V. (MARINE & COMMERCIAL) LTD.
395, HIGH STREET, CHATHAM, KENT
Chatham 3253/4

TV g.e.d. GK

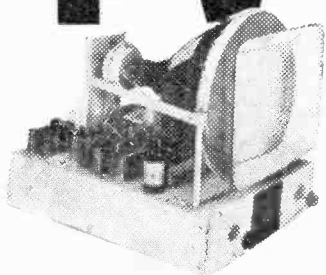

Model TV 20 inc. 12" Tube and 21 valve circuit operating on 200-250 volt A.C. mains with two main controls and SIX pre-set adjusters, completely enclosed E.H.T. unit and separate 10" loud-speaker.

Yes, Armstrong Television has been demonstrated to be absolutely efficient, particularly when used in the "fringe" areas, and all agree that the brilliant high definition in picture and excellent reproduction are worthy of the Armstrong tradition. Write now for complete specification.

Armstrong
THE CHASSIS PEOPLE

Armstrong Wireless & Television Co., Ltd., Warlters Road,
Holloway, London, N.7. Tel.: NORTH 8213

SOLE BIRMINGHAM AGENT :

Hayes Company, 1, Alcester Road, Moseley, Birmingham, 13.

THE TYPE "75" SIGNAL GENERATOR Model I

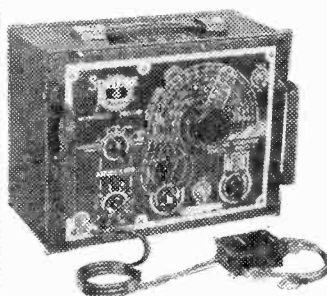

Frequency Range
Kc/s 110 to 50 Mega-
cycles. With cali-
brated extension
covering London &
Midland Television
frequencies, at over
60 Megacycles.

Modulation
400 C.p.s. sinusoidal.
Attenuator
5-step ladder, with
fine control.
Output
Switched via single
test-lead. RF and AF.
1 volt Max.
External
Radiation
Less than 1 micro-v.
For A.C. mains
operation. Complete
with Standard Dum-
my Aerial.



LIST **12½** GNS. SUBJECT.

EXCELLENT PERFORMANCE
ATTRACTIVE APPEARANCE
LOW PRICE
HIGH EFFICIENCY
INQUIRIES INVITED

SPHERE RADIO LIMITED
HEATH LANE, WEST BROMWICH, ENGLAND

SAVE YOURSELF POUNDS

If you send for our list before buying those parts you need, then you will save yourself plenty of both time and money. Our motto is **FAST SERVICE — LOW PRICES—BEST QUALITY.**

Alternatively if you need parts in a hurry and feel you can't wait for our list, then order us to send your requirement C.O.D. (you pay the postman). It is almost certain that we have what you want in stock and that our prices are as low if not lower than any other firm.

Also if you care to send 6d. (stamps or P.O.), then in addition to our latest list we will also send circuit details of a very neat little T.V. signal racer.



PRECISION EQUIPMENT

39 ELECTRON HOUSE, RUISLIP MANOR, MIDDX

“VIEW MASTER” COMPONENTS

MANUALS.—“Viewmaster” Manual, with full constructional details, circuits, full-size blueprints, photographs, aligning and operating data of an excellent modern television of guaranteed design which can be built in seven easy stages. 5/2 post paid. Please state London or Sutton Coldfield edition.

CHASSIS.—Sound/Vision fitted with 8 valveholders, rubber bushes and screws. London or Sutton Coldfield, 22/6 each. Power Pack/Time Base Chassis fitted with 4 valve-holders and rubber bushes. London or Sutton Coldfield, 22/6.

BRACKETS AND TUBE MOUNT.—Front and rear C.R. tube supports, 14/-; supporting brackets, 5/-.

METAL RECTIFIERS.—Complete kit of Westinghouse Rectifiers, 14A86, 14D36, WX3, WX6 and 36EHT100, £3/2/6.

TRANSFORMERS.—Plessey 72006 Line Transformer, 2/3. Plessey 72001 Frame Transformer, 18/6. Whiteley 103 Heater Transformer, 35/-.

CHOKES.—R.F. choke (L9), 2/-; Plessey 72006 Boost choke, 5/-; Whiteley 104 Mains Choke, 12/6.

SCANNING COIL.—Plessey 72003, 25/6.

FOCUS RING.—Plessey 72004 P.M., 19/6.

T.C.C. CONDENSERS.—“Metalme” CP119W .001 mfd. 2/2, CP305 .002 mfd. 1/9, CP335 .01 mfd. 1/10, CP33N .015 mfd. 2/-, CP33N .02 mfd. 1/9, CP37N .1 mfd. 2/3, CP36H .1 mfd. 200v. 2/4, “Metalpack” CP48N .25 mfd. 2/8, “Cathodray” CP55QO .001 mfd. 6,000v. 4/6, “Buffer” 647 .025 mfd. 600v. R.M.S. 2/6, “Moulded Mica” Type CM30 .0001 mfd. 1/2, 300 pF 1/2, 500 pF 1/6, .001 mfd. 1/9, “Micadisc” CM30 .0005 mfd. 1/6, “Ceramic” SCP4 2 pF 1/1, SCT1 10 pF 2/6, SCT1 47pF 1/9, “Electrolytic” CE30N 1 mfd. 350v. 2/6, CE30G 2 mfd. 150v. 2/6, CE30B 20 mfd. 12v. 2/6, CE10L 100 mfd. 350v. 14/-, CE10DA 250 mfd. 10/-, CE25AA 2,500 mfd. 619. Mounting clips 4d. each. Complete Kit of T.C.C. Condensers, London model, £6/11/5-. Sutton Coldfield model, £7.

POTENTIOMETERS.—Colverson CLR901 250 ohms, 2,000 ohms, 2,500 ohms, 5,000 ohms, 10,000 ohms, 2/9 each; CLR4089 5,000 ohms, 10,000 ohms, 3 watt, 5/6 each. Morganite Carbon, 250,000 ohms, 100,000 ohms, 4/6 each. Plessey Width Control, 8/9.

Postage and packing extra on orders under £2.

60-page Illustrated Catalogue No. 7, 9d. post free. List of Television Components and Aerials, 2½d. post free.

Southern Radio & Electrical Supplies
85, FISHERTON STREET, SALISBURY, WILTS.

Telephone, SALISBURY 2108.

U. E. I. CORPN.

The Radio Corner, 138, Grays Inn Road, London, W.C. 1
(Phone: TERminus 7937)

We offer below many items for the Television and Radio Constructor. Note them carefully—it will pay you.

RECEIVERS R.1355. As specified for “Inexpensive Television.” Complete with all valves and a copy of the booklet. New condition. ONLY 55/- (carriage, etc. 7/6).

RF UNITS TYPE 26 specified for Birmingham Station now all sold, but we can supply one of the other RF Units with full details of Modification, which has been fully tested some 70 miles from Sutton Coldfield. BRAND NEW IN CARTONS. ONLY 25/- (postage 1/6).

INDICATOR UNITS TYPE 6. As specified for “Inexpensive Television.” Complete with valves and VCR97 CR Tube. BRAND NEW IN CRATES. ONLY 90/- (carriage, etc. 7/6).
INDICATOR UNITS TYPE 62. Contains 16 valves SP61, 2 of EB34, 2 of EA50, and VCR97 CR Tube. ONLY 75/- (carriage, etc. 12/6).

TRANSFORMERS for “Inexpensive Television” can be supplied as follows: Time Bases and Vision Transformer. 350-0-350 v. 160 m.a., 5 v. 3 a., 6.3 v. 6 a., 6.3 v. 3 a. ONLY 36/-.
Sound Receiver Transformer. 250-0-250 v. 100 m.a., 5 v. 3 a., 6.3 v. 6 a. ONLY 27/6. EHT Transformer for VCR97 tube. 2-0-2v. 1.1 a., 2-0-2v. 2 a., 2500 v. 5 ma. ONLY 30/-, PC AGE 1/8 per transformer, please.

MAGNIFYING LENS for 6in. CR Tube. Bring up the picture size to approx. that given by a 9in. tube. First grade. Oil filled. ONLY 25/- (postage, etc. 1/6).

RUBBER MASK for 6in. CR Tube. Made of White Rubber, and designed to grip the tube. Opening gives picture size of 5in. x 4in., but is easily cut larger. ONLY 7/8 (postage, etc. 6d.).

10 VALVE 11 METRE SUPERHET RECEIVER. A ground control radar receiver, this will convert into a first-class Television Receiver for the fringe areas. Contains 6 valves SP61, 2 of EA50, and 1 each RL7 and RL18, and 6 I.F.T.s of 12 mcs. with 4 mc. bandwidth. BRAND NEW IN MAKER'S CARTONS. ONLY 59/6 (carriage, etc. 5/5).

RECEIVER R.3585. An ideal unit for conversion into a London Area Television receiver, as it contains a “Pye” 45 mcs. I.F. Strip and the following valves: 7 of EF50, 4 of SP61, 8 of EF36, and 1 each EB34 and EF39. BRAND NEW IN MAKER'S CASES. ONLY 90/- (carriage 7/6).

FULL DETAILS OF TELEVISION CONSTRUCTION from ex-Govt. Radar Units for Birmingham and London can be supplied for 1/9 (post paid). Everything available from stock. Price list enclosed. SEND FOR YOUR COPY NOW. Cash with order, please, and print name and address clearly.

M.O.S FIRST AGAIN!

to present

HIRE PURCHASE FACILITIES on components for the VIEWMASTER

We can offer HIRE PURCHASE FACILITIES on whatever your requirements are for VIEWMASTER parts. The following shows six different schedules available and the details of deposits and payments:—

	KIT	Period		Deposit		Monthly	
		6 mths	12 mths	£ s. d.	£ s. d.	£ s. d.	£ s. d.
Components less valves and tube		6 mths	12 mths	8 8 6	9 15 6	3 6 8	1 13 4
Components less valves and tube		6 mths	12 mths	10 0 0	12 0 3	4 4 11	2 1 11
Components and valves, less tube		6 mths	12 mths	12 0 3	16 9 10	2 1 11	2 13 3
Components and valves with 9in. tube		6 mths	12 mths	16 9 10	17 15 8	3 0 0	3 0 0
Components and valves with 12in. tube		6 mths	12 mths	17 15 8		3 0 0	

THIS first-class television receiver, which was demonstrated and acclaimed at Radiolympia, needs no detailed description by us.

We would say that the instructions are the most comprehensive, concise, and thorough that it has been our pleasure to examine. It is the receiver which YOU can construct and be sure of trouble-free operation.

Models are available for the

London or Sutton Coldfield Transmitters at no difference in cost.

This is YOUR receiver, giving a superb picture on a 9 or 12 inch black and white tube.

WRITE TODAY for full details.

M.O.S Mail Order Supply Co.,
The Radio Centre,
33, Tottenham Court Road,
London, W.1.