

TELEVISION

& consumer electronics

June 2008

Visit us online at www.televisionmagazine.co.uk

Price: £4.10

How to dispose of TV sets

**Review of the
'Blue ESR meter' kit**

**Young offenders learn
how to service LCD TV's**

Test case number 535

Much more inside....

**FAULT
REPORTS**
over 7 pages!

PC2400 I²C FIELD SERVICE PROGRAMMER

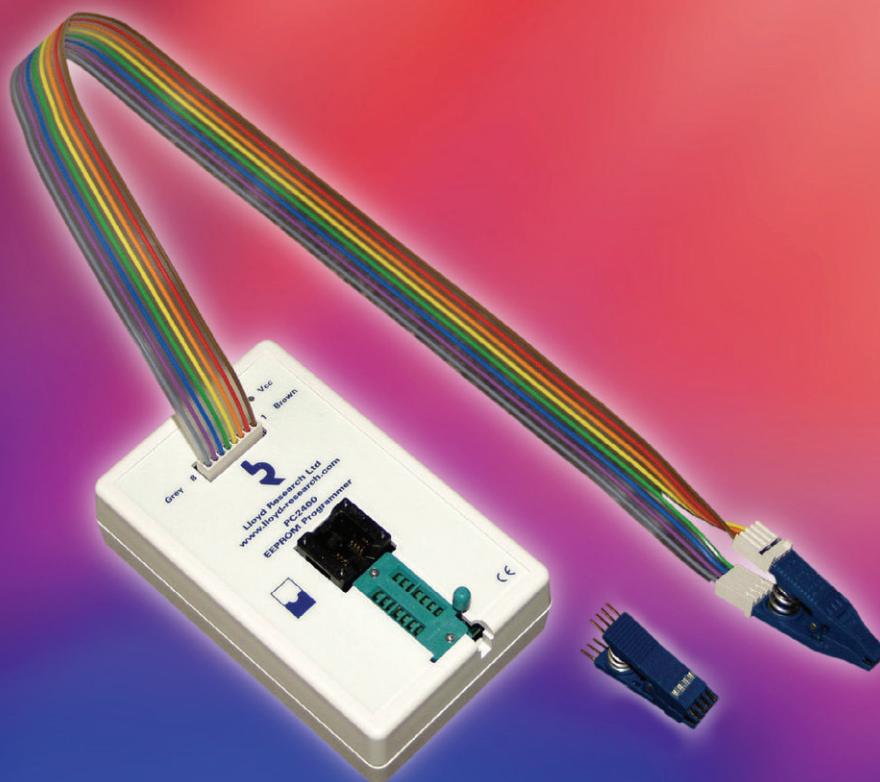

The PC2400 is ideal for reprogramming EEPROMs in TV sets and similar products. It is fitted with high-quality DIL and surface-mount (SO), zero-insertion-force (ZIF) sockets for programming components.

A special lead with clips for DIL and SO parts is provided for in-circuit programming.

• USB CONNECTIVITY

Works with modern PCs which do not have RS232 or Centronics ports

• PROGRAMS NVM 24CXX EEPROMs

Also programs other I²C parts

Displays checksum after all relevant functions

• OPTIMISED FOR IN-CIRCUIT PROGRAMMING

An LED is lit when correctly connected

Can program selected devices on the same bus

Automatically caters for different Vccs

Extensive protection against wrong connection

Master data can be downloaded from a file or another device

• OPTIMISED FOR FIELD SERVICE

Self-test facility to save time in case of a suspected fault

As the programmer contains no firmware, updates for new devices or facilities can be distributed by simply updating the PC program

Data can be read from a device and stored in a file

The device type can be automatically indicated from the data file

Easy-to-use file viewer with edit facility



EASY TO USE



SPECIFICATIONS

PHYSICAL

Dimensions: 115 x 75 x 35mm

Weight: 125g

ACCESSORIES

USB lead

In-circuit programming lead

8-pin DIL clip

8-pin SO clip

CD-ROM

Lloyd Research Ltd

7 & 7A Brook Lane, Warsash, Southampton, SO31 9FH England

T +44 (0) 1489 574040 F +44 (0) 1489 885853 progs@lloydres.co.uk www.lloyd-research.com

TELEVISION & consumer electronics

Publisher

Tony Greville - +44(0)1903 774481
info@televisionmagazine.co.uk

Consultant Editor

Rod Tie
info@televisionmagazine.co.uk

Designer

Danny Kosifou
info@televisionmagazine.co.uk

Subscription & Administration Manager

Sue Greville - +44(0)1903 774481
sue@televisionmagazine.co.uk

Sales Manager & IT support

James McElhatton - +44(0)1903 774481
james@televisionmagazine.co.uk

Data Manager

Rob McElhatton - +44(0)1903 774481
info@televisionmagazine.co.uk

Please note that we are unable to answer technical queries over the telephone and cannot provide information on spares other than that given in our spares guide.

Disclaimer

We work hard to ensure that the information presented in Television is accurate. However, Television's publisher - Acorn Media Communications Ltd - will not take responsibility for any injury or loss of earnings that may result from applying information presented in the magazine. It is your responsibility to familiarise yourself with the laws relating to dealing with your customers and suppliers, and with safety practices relating to working with electrical / electronic circuitry - particularly as regards electric shock, fire hazards and explosions.

Next issue, dated July, will be published on July 11th 2008.

Subscribers should see their copy within the third week of July.

5 Comment

Taking stock of our first six months

6 News

Reports and news from our industry by Steven Phillips

10 Letters

The return of this popular section

12 What a life

Educational and humorous tales from Donald Bullock

16 Test case

Test case number 535. Two mysteries to solve this month. Watch out for the ghost!!

17 Fault reports

A good selection of faults from our readers

23 Test case answer

All is revealed

24 Biography

This month the spotlight is on Michael Dranfield. He eats, sleeps and breathes "electronics"

28 ESR meter review

Geoff Darby comprehensively reviews this important piece of equipment

33 LCD TV training for young offenders

Fawzi Ibrahim delivers a course on servicing LCD televisions at a young offender's prison near Doncaster

34 Pipped at the post

Part two in the series by Donald Bullock

36 The dirty dozen

Mike Leach looks at the issues relating to TV disposal

38 Long distance television

Keith Hamer and Garry Smith report on recent sightings and help with the equipment you might need to receive signals

40 Day in the life

Pete Dolman crams plenty of technical information into his entertaining article

44 How to satellite DX

Roger Bunney reports on his findings from the month of April

47 Recruitment

Electronics engineers are desperately wanted

48 Lyons Den

Andrew Lyon suggests that we must put a value on service.

50 Memoirs

Arthur Jackson's light hearted and amusing stories

51 Web Service and Classified



News - page 6



The dirty dozen - page 36

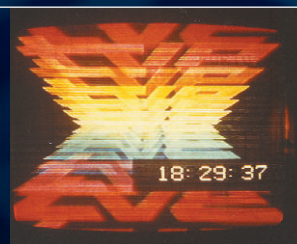

Long distance TV - page 38



Day in the life - page 40

Winners of The Queen's Award For International Trade 2007, Horizon Global Electronics is a UK Company established in 2001 specialising in the design and manufacture of hand held test equipment for the digital satellite and TV sector. Our strength lies in being able to find innovative solutions to leading technology issues.



HORIZON

For a reliable solution!



HDSM USB

- New graphics capable 128 x 64 pixel high brightness (adjustable) backlit LCD
- New Full Speed USB 2 interface with automatic driver download
- Full backwards compatibility with existing HDSM downloads
- New 3300 mAh battery pack offering in excess of 7 hours operation
- New nylon F connectors for maximum durability
- Faster processor with recall of last selection used
- New manual carrier configuration mode

- Twice the satellite setting capacity with 64 selections available
- Lock indication within 100ms of acquiring the satellite

HDSM USB PLUS (additional features)

- Easy to use Spectrum Display Mode
- QPSK Constellation Diagram (with zoom function)
- Histogram display with up to 9 simultaneous carrier measurements for single cable installations (SCR)
- Data Logging (upload installation measurement data to your PC)

HORIZON DIGITAL TERRESTRIAL METER (HDTM)

- Displays Signal Strength (RF level) with DVB-T indicator
- Fast and accurate Pre BER readings in real time for easier antenna pointing using the built in CODFM indicator for quality of service
- Can store up to 32 transmitter selections (via our web site downloads) a default of UHF 21 – 69 step through is preloaded

- Built in intelligent universal mains charger 100 – 240V AC (CE approved) with V delta detection for fast and then trickle charging
- Minimum run time of 5 hours with a full charge on the 2400 mAh NiMH battery
- Computer interface: Serial Port (Com 1-4) for upgradeable software on transmitters



Horizon Global Electronics Ltd, Unit 3 West Side Flex Meadow, Harlow, Essex, CM19 5TJ, UK
Tel: +44 (0)1279 417005 Fax: +44 (0)1279 417025 Email: sales@horizonhge.com

www.horizonhge.com



DUE TO OVERSTOCKING WE CAN NOW OFFER GENUINE UN-PICKED, FAULTY SKY DIGITAL BOXES DIRECT FROM THE RECYCLING CENTER AT ONLY £5.00 EACH.

Ideal for refurbishing, most boxes are black in colour either Pace, Grundig or Amstrad, older models for which most common faults have been well documented in Television magazine in the past.

U.K delivery £15. for up to 10 boxes, please enquire for off shore delivery as this usually costs more.

Also scrap pcb's and boxes for spare parts £1.00 each.

We do not have any Pace 2600c1 or Pace DS430N but would be interested in buying your faulty ones in any condition.

E mail. md@digifixltd.co.uk Web. www.digifixltd.co.uk

T/V ■ LCD ■ VCR ■ AUDIO ■ SPARES

**FLYBACK TRANSFORMER SPECIALIST
EXTERNAL LCD T/V POWER SUPPLIES
REMOTE CONTROLS ORIGINAL** 

Switches mains & tact & mode, Belts, Resistors, Fuses, Capacitors, Zenners, Back-up batteries, Idlers & clutches, Video heads, Ace heads, Styli & cartridges, Eproms plain & programmed, Opto-couplers, Bridge rectifiers, Pinch rollers, Turntable belts, Valves, Relays, Service manuals etc.

If you restore vintage T/V & Radio, or you have been told your part is N.L.A... please try us

**SERVICE KITS FOR
SATELLITE T/V
PLASMA LCD**

**LCD INVERTER
BOARDS**

**OTHER LCD &
PLASMA BOARDS
PLEASE ASK**

MOST CREDIT CARDS ACCEPTED

P.J.HILL

DISTRIBUTOR

E7 Northway Trading Estate,
Northway Lane, Tewkesbury,
Glos GL20 8JH
Tel 01684 296902 Fax 01684 294317
Email pjhil@btconnect.com



PUBLISHED BY

Television is published by Acorn Media Communications Ltd. Registered in England, registration number 5974690. Registered office, Ashurst, Ham Manor Way, Angmering, West Sussex BN16 4JQ.

COPYRIGHT

© Acorn Media Communications Ltd. All rights reserved. No part of this publication may be reproduced, stored or transmitted in any form or by any means without the written permission of the publishers.

All reasonable precautions are taken by *Television* to ensure that the advice and data published are reliable. We cannot however guarantee it and we cannot accept legal responsibility for it.

CORRESPONDENCE

All correspondence regarding advertisement should be addressed to the Sales manager, Television Magazine, Ashurst, Ham Manor Way, Angmering, West Sussex, BN16 4JQ. Editorial correspondence should be addressed to Television Editorial department, Ashurst, Ham Manor Way, Angmering, West Sussex BN16 4JQ.

BINDERS FOR TV MAGAZINE

Binders for your past magazines are now available. Please email info@televisionmagazine.co.uk for prices.

SUBSCRIPTIONS

Television magazine is not available in the newsagents.

All subscription enquiries should be addressed to Subscriptions Dept, Ashurst, Ham Manor Way, Angmering, West Sussex, BN16 4JQ.

Full subscription details and on-line payment facilities can be found at www.televisionmagazine.co.uk

SUBSCRIPTION RATES

UK one year	£46
Europe (EU) one year	£72
Rest of World one year	£78
Electronic copy one year	£36

Two and three year subscriptions are now available, please call +44 (0) 1903 774481 for details.

Cheques should be made payable to Acorn Media Communications Ltd.



With this month's issue of **Television**, our sixth, we are half way through our first year. Not a bad time, perhaps, for taking stock!

We can say at once that the re-launch has been, and is, a success. The little dreams that I held when I took the chancy decision to resurrect the title from its ashes, to make it once again a viable proposition, have come fulfilled.

Pretty well everybody has expressed delight at the resulting magazine's presentation: its design, its choice of trade coverage, the grouping and setting out of its features, its above-average quality paper, and the vibrant quality of its front page cover.

'Highly Professional in its Presentation' is one comment that has come our way. 'The Engineer's Club' is another.

My decision to try a re-launch of **Television** was not taken lightly. I repeatedly asked myself and those around me whether I was right in my belief that there existed, amongst its former readers, a widely-held and deeply-felt need for the magazine to rise from its ashes. If I was, a great deal of detailed planning would be needed, as would the concerted efforts and loyalties of my carefully assemble little team. And perhaps a little luck.

That we have managed to assemble the lot into one viable project is due to the efforts and contributions of many. Not least, the few who constantly burn the midnight oil here to put the magazine together. Then there are its advertisers, without whose support we couldn't exist, its long-standing writers and columnists, as popular with you all as ever, plus some additions to their ranks, who have clearly met with your approval; and lastly, and most importantly, its subscribers, yourselves, who form the magazine's engine, its reason for being.

If this sounds heady stuff, let me assure you that we at **Television** are not complacent. There is more to achieve. We are still building. We ask for your suggestions, your constructive criticisms and your letters to guide us. And above all, we need more subscribers; it will be to the benefit of the magazine and to all who cherish its continued existence if you work with us to recruit them. Can you think of a trade colleague who hasn't heard of our re-launch? Or one who hasn't yet 'got around' to subscribing? (It's so easy to 'put it off' for the moment). If so, please do mention us. Both management and readers alike need him - them - amongst our ranks!

In celebration of our success to date, our next issue will be a special double-sized Midsummer edition, combining the July and August magazines in full. Our usual writers have been asked to furnish it with two articles each, and all our normal features will be doubled. And we propose to publish a similar Midwinter Edition too, combining the December and January issues.

Apart from the magazines reaching you in advance of the two busiest periods in the year, this arrangement will enable our hardworking staff to enjoy (after working even more intensively than usual) a bi-annual holiday - a luxury they have had to forsake thus far in the re-launch of your magazine. Let us wish each other well for the future, and strive to nurture and confirm **Television** magazine as 'The Engineer's Club'.

Tony Greville,
Publisher



Bandwidth constraints “crippling” HD-DTT

Heavy bandwidth constraints are crippling digital terrestrial broadcasters and imposing barriers to their future HDTV offering.

This, research from Understanding & Solutions found, could result in just seven per cent penetration of high definition digital terrestrial television (HD-DTT) in the UK by 2012, with a similar scenario playing out across Europe.

Though consumers are still confused about high definition, the message is starting to get through and, in Europe, nearly 80 channels provide at least some HD content.



“Improvements in compression technologies like MPEG-4 AVC are making HD-DTT solutions a possibility,” said Graeme Packman, principal consultant at

Understanding & Solutions, “although only with a very limited number of channels. Further technological development will help breach the bottleneck, but it’s a slow

process requiring considerable international coordination.”

The UK is currently taking the lead in addressing some of these issues and has two separate sets of proposals.

The first is a formal proposal backed by the UK regulator Ofcom, and is going through a structured evaluation process.

The second route is a much more ambitious set of proposals from an independent expert industry group, officials from the DVB standards group, and the Digital Television Group, which could result in 40 HD-DTT channels becoming available.



Best Buy sets its sights on Europe

Best Buy, the world’s top electrical store group, is coming to the UK, after snapping up a 50 per cent stake in Carphone Warehouse’s existing retail business in a £1.1 billion deal.

Already a \$40 billion (£20bn) a year business in the USA, Canada and China, Best Buy said it is determined to be a giant in Europe’s electrical retail market.

Existing Carphone Warehouse stores are not expected to change branding or format, but the joint venture will see the opening of superstores carrying the Best Buy branding in the UK from next year.

Indeed, the company is expected to create up to 30,000 jobs in the UK.

The pairing of Best Buy and

Carphone Warehouse makes sense when it is considered that both companies expect growth in consumer electronics to be led by the convergence in entertainment, computing and communications.

A joint statement by the two companies said they formed the new retail venture “to accelerate their growth by capitalising on the European consumer’s evolving appetite for consumer electronics”.

Bob Willett, Best Buy’s international and chief information officer, said: “We’ve been successful with our business model and aspire to apply that model to one of the largest markets in the world.

“Yet we must do so carefully and with humility.”

Hutton announces consumer law change

Fundamental changes to UK consumer law are being planned by the Government.

Business Secretary John Hutton recently announced that the changes to consumer law are being made “to benefit consumers, reduce burdens for business and help enforcers”.

“Developed over decades and comprising more than 100 different pieces of legislation, the UK’s current system offers high standards of protection for consumers,” Mr Hutton said.

“But its complexity makes it

hard to understand and costs business an estimated £1.25 billion every year.”

He pointed out that the UK currently has specific rules for filling up coal bunkers and selling bird seed as well as laws governing imitation baby dummies and clothes with hood cords.

“It is clear that we must act to streamline these myriad rules to help consumers know and exercise their rights, cut red tape and target enforcement to weed out rogue traders.”





JVC to pull plug on TVs in Japan

JVC could become the first major Japanese manufacturer to pull out of the TV market in its home country.

According to a report in The Nikkei, JVC parent the Victor Company of Japan will stop making and selling flat-panel LCD TVs for the Japanese market this summer and concentrate instead on sales in North American, European and other overseas markets.

Victor spokesman Toshiya Ogata declined to comment on the Nikkei report although he acknowledged, to an Associated Press reporter, that such steps were under consideration.

Victor is Japan's sixth biggest flat-panel maker.

Recently it warned that it would lose Yen 47.8 billion (around £237.5 million) on sales of Yen 658bn in the year ended March 31.

In January, it predicted a loss of Yen 32.5bn on sales of Yen 680bn.

The Associated Press report blamed much of the loss on the company's TV business.

It also pointed out that other Japanese brown-goods makers have been forced to stop panel production or enter joint

agreements with rivals.

Pioneer recently announced it was to stop making plasma panels and buy them in from another manufacturer, but using its own technology.

Meanwhile, JVC is to stop making TVs in the UK at the end of July.

JVC Manufacturing UK (JMUK) - which employs 300 people in East Kilbride, Lanarkshire - had been producing CRT TVs, LCD TVs and related products, mainly for the UK and European markets.

The Scottish manufacturing site opened in 1987, however, JVC said the rapid shift from CRTs to flat panel displays in the CTV market has led to "a drastic fall" in flat-panel TV prices.

"JVC was forced to conclude that it would be difficult to continue production within the UK due to the resulting impact on profits," said a JVC statement.

The 25 per cent fall in JVC's UK-made products sold in the UK was another factor along with the development of production facilities in Eastern Europe.

ALBA LAUNCHES SD AND HD FREESAT BOXES

Alba has launched a range of both standard and high definition Freesat boxes under the Bush, Goodmans and Grundig brands.

"Our SD boxes target the 25 per cent of frustrated homeowners who aren't yet able to get free digital TV on their analogue TVs, purely because of where they live," a spokeswoman for Alba said.

"With our SD boxes they will be ahead of the UK digital switchover and benefit from the vast array of the new digital channels through their existing analogue TVs.

"Our HD Freesat digital boxes target consumers who have already upgraded their analogue TVs to HD-ready models and now want free high definition content to experience the impressive visual and audio quality of HDTV."

"Both target audiences don't want to pay for subscription TV channels or be locked into long term contracts.

"We're offering consumers an easy way to get free satellite digital TV."



Samsung boss in tax probe

Samsung chairman Lee Kun-hee, the son of the company's founder, has been indicted for tax evasion and breach of trust.



Nine other Samsung executives were also indicted, including vice-chairman Lee Hak-soo.

The move follows a 99-day investigation that cleared the company of allegations by a former employee that it had used slush funds to bribe prosecutors and government officials.

Mr Lee and Samsung had denied any wrongdoing. Neither Mr Lee or the other executive indicted were formally arrested.

If found to be guilty, Mr Lee could face penalty taxes and - anywhere between - five years and life in jail.



iPlayer to launch on Freesat

The BBC iPlayer will be available on free-to-view satellite service Freesat within a year.

According to a report in online technology magazine "The Register", although incorporating iPlayer and Kangaroo (the commercial version backed by ITV and Channel 4) is not much of a technical challenge.

The problem is the burden it will place on British internet service providers (ISPs). "The bigger concerns are with ISPs and capacity issues," Freesat commercial development manager Rhys Jones told The Register.

Indies snubbed in favour of the Co-Op

The digital switchover help scheme has bypassed independents – a supply contract has been awarded to The Co-operative Electrical Buying Group.

Eaga, a leading provider of residential energy efficiency and outsourcing services, which was appointed to run the digital switchover help scheme on behalf of the BBC, has awarded the contract to supply set-top boxes and digital televisions to The Co-operative Electrical Buying Group.

More than seven million people are likely to be eligible to convert their analogue



televisions to digital under the scheme.

The Co-operative Electrical Buying Group said it had received a massive boost after sealing a partnership to supply

digital TV equipment for homes across the country.

The buying group includes a number of societies, including The Co-operative Group, Midlands Co-op, East of England Co-op, Heart of England Co-operative Society and the Plymouth and South West Co-op, and supplies electrical items for their stores as well as the online retailer coopelectricalshop.co.uk.

The digital switchover help scheme will assist eligible households, including the elderly, people on certain disability benefits, and people registered blind or partially

sighted, to convert televisions to receive the digital service between now and the completion of the switchover in early 2013.

James Holland, chairman of the Co-operative Electrical Buying Group, said: "We are delighted to be supporting the work of eaga as part of the digital switchover help scheme, which is such an exciting project.

"As well as an endorsement of what the Co-operative Electrical Buying Group can offer, this deal allows us to work in partnership with a company whose ethical approach fits with our own as Co-operative businesses."

Sony unveils new TV ad

Sony has launched its new TV advertising campaign.

After three campaigns in support of Bravia, Sony has turned its attention to its award-winning digital imaging range.

The 90-second advert, which is entitled Foam City, promotes Sony's three digital imaging brands, Handycam, Cyber-shot and a, Sony's new digital SLR brand, for the first time.

Foam City was developed by Fallon London and utilises the

same creative team behind the popular series of Bravia adverts – the 'Balls', 'Paint' and 'Play-Doh' trilogy.

The advertising shoot involved the Downtown area of Miami being transformed into a foam-filled wonderland – with whole streets full of bubbles.

The world's largest foam machine was built especially for the advert, with more than two million litres of foam produced every minute.



The 'stars' of the shoot were Miami citizens, who were invited by Sony to experience 'Foam City', where cameras caught their every reaction to their new surroundings – especially when scooters, bikes and even a truck were driven through the foam-filled street.

PANASONIC UNVEILS FREESAT HD IDTV

Panasonic has launched the UK's first high-definition TVs with Freesat HD built-in.

The PZ81 series of plasma TVs, in screen sizes 42in, 46in and 50in, will be available in stores from June.

"Panasonic is delighted to be supporting the launch of Freesat which marks a major landmark in the development of digital television broadcasting in the UK," said Panasonic marketing director Andrew Denham.

"Freesat is the first platform to offer subscription free HD services, enhanced HD interactive services and future feature expansion including the addition of broadband internet applications."



More people turned on by DAB

More people are tuning in to DAB radio.

According to figures released by audience research body Rajar, DAB ownership is booming, up 40 per cent year-on-year with 27.3 per cent of adults now living in DAB households.

The figures for radio listening in the first quarter of this year,

revealed that 17.8 per cent of all radio listening is now on a digital platform, with DAB, at 10.8 per cent, bigger than DTV and internet listening combined.

Nearly 500,000 DAB radios were sold in the first quarter of this year, according to figures from the Digital Radio Development Bureau.



Brace yourself for switchover queries

The responsibility of saving shoppers from themselves when it comes to digital switchover is being transferred to retailers this month.

According to the recently introduced Consumer Protection from Unfair Trading Regulations, dealers have to warn customers buying analogue TV sets that they will not work beyond analogue switch-off in the region without the help of a set-top box or adaptor.

The regulations are being introduced to bring the European Unfair Commercial Practices Directive into UK law.

The intention is to harmonise legislation across the European Union preventing business practices that are unfair to consumers.

Guidance from the Office of Fair Trading (OFT) frequently

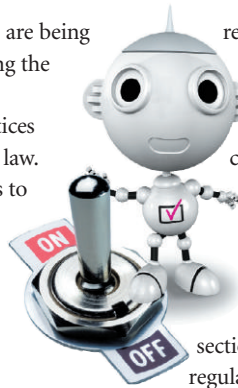

refers to TV sales in the lists of examples of what sort of behaviour would constitute a breach of the rules.

In terms of switchover, the OFT offers an example of a breach under section 7.18 of the regulations which relates to material information which is likely to cause the average consumer to change their mind

about a product.

The example breach cited is: "A trader sells audio-visual equipment. He omits to inform the consumer that a particular product includes only an analogue tuner, and of the implications in the context of the switch from analogue to digital-only television.

"This is likely to be material information that the consumer needs to make an informed decision," the OFT said.

Electricals leading non-food downturn

Electricals are nearly five per cent cheaper than they were a year ago and are still the driving force behind the continued downturn in non-food prices.

These continued their downward spiral in April – down 0.6 per cent year-on-year and falling faster than at any time since September according to the British Retail Consortium (BRC).

For electricals, the drop is more dramatic – down 4.8 per cent year-on-year and down 0.2 per cent on March.

Indeed, electricals and the clothing and footwear market (down 2.4 per cent) were the only non-food sectors still suffering from deflation, the rest of the non-food sector has seen price increases.

Stephen Robertson, director general of the BRC, said: "With

the UK being a major importer of Chinese products, retailers will have to absorb some of these increases which will inevitably put pressure on profit margins," the BRC said.

"Whether aggressive discounting will continue to drive sales at the detriment of margins or the recent deceleration of deflation will continue in the coming months will be of significant



Grade limits HD channel to Freesat

ITV executive chairman Michael Grade has revealed that his company's HD channel will only be available on Freesat.

Mr Grade revealed that the channel, which has not had its launch date announced yet, will initially be a prime time-only simulcast of ITV1.

Mr Grade said: "The launch of Freesat is the final piece in the digital jigsaw and will ensure that all viewers in the UK have access to free-to-air digital and high definition television."



He said the HD service would feature the FA Cup, England internationals and Uefa Champions League from next season.

"Now everyone in the UK can experience the benefits of digital television: more choice of channels, interactivity and the extraordinary picture quality of HD."

DSGi to shut 77 Currys.Digital stores

DSG International, the owner of Currys and PC World, is to reduce the number of its Currys.digital stores and cut its dividend as part of a revival plan.

It said 77 Currys.digital shops out of the 177 outlets would shut as their leases expire over the next five years. The closures are part of a major shake-up of DSG, which it hopes will cut costs by £50 million in 2008/09. The announcement came as DSGi reported a one per cent rise in like-for-like sales for the year to May 3.

DSGi's shares tumbled almost 12 per cent on the news.

DSGi has issued two profit

warnings this year amid a challenging trading environment as cash-strapped consumers struggle with higher household bills and mortgage repayments.

DSG's new chief executive John Browett warned that the deteriorating economic backdrop made it difficult to forecast business performance.

"Customers have become increasingly promotion and deal driven, impacting gross margins," he said.



In the post...

I was interested to read about Fawzi Ibrahim's suspected horror of the BRC 3500 power supply. In all fairness, the 3000/3500 was the first British designed TV to use a switch-mode PSU, and broke new ground, just like the 2000 series before it that was the world's first all transistor colour TV. That model also broke a few floor boards with its huge magnetically polluting mains transformer and isolated chassis. With its linear regulators it could double up as a radiator in winter. The reason for all this elaboration was the limited working voltage of the transistors BRC chose for the Line Output Stage.

What was wrong with it? It made perfect sense, just as everyone else had settled to a two transistor (2xBU105) line output stage with a thyristor PSU giving about 200V HT, or stuck rigorously to a PL509 and a PY500, BRC chucked out this surprise with an HT rail of 65V and a single ended LOP stage with some weird transistors (R2008 LOP and R2010 Chopper).

In Television magazine's previous guise, I wrote an article on servicing these wonderful devices back in the mid 1970's. Please excuse any inaccuracies as I no longer have any circuits for these monsters, and this is all from memory.

As I recall, the HT was rectified to give about 350V and applied to the chopper transistor. This remained passive until the 30V rail was up and running (TIP31A emitter follower. Base driven from a BIG (5W) 30V zener.) The supply was derived from a winding on an auto transformer and diode giving about 40V. The zener was driven from the



rectified video HT via a 10W resistor, 15K springs to mind. It had an electrolytic and a transistor in the bottom end as part of the monostable to delay starting of the chopper – called logically enough “delay switch”.

Once the 30V rail was up and running, the line oscillator would (might) start and then the chopper was supplied with pulses. The on time was controlled by varying the mark – space ratio of a monostable driven with these pulses, and a DC control loop.

It gave about 65V at 2.5A as the chosen line output device was (relatively) low voltage operating. There was a small choke and recovery (flywheel) diode in the circuit that acted as a flyback converter. With the high switching frequency (line rate), only a 2.2 μ F capacitor at 100V was used for the 65V rail smoothing.

Of course the video stages still needed a high supply, so a 200V rail was derived from the auto transformer and rectified in the usual manner.

Surprisingly, the LOP stage was usually fairly trouble free (for its day). The biggest problem I had with this stage was the emitter resistor. It was 1.5 Ω wire wound 5W and had a tendency to go high, usually to about 3 Ω . The LOP still worked, but as the DC across it was used for beam

current limiting, the screen was dark, or even cut off altogether. The two “jelly-pot” transformers were sometimes a source of trouble, one for scan, the other for EHT via a quintupler, or was it quadrupler? The A1 supply was normal – just a rectifier off the line Tx, then fed to each separate A1 control for greyscale adjustment on the flip-up convergence board. The 3500 had a much more elaborate convergence board, but the pots still caught fire regularly!

The PSU was another story! It was a power hungry box of tricks with a PCB below and lots of wiring above. It had rather a short lead with a nylon push-on edge connector at one side, and the PCB had at least one crimped type plug. Servicing was cramped at best! The whole board could be swung up and dislocated from the frame. By careful removal of the retaining screws, the lower PCB could be eased away until almost at right-angles to allow limited access to the print. The job clipboard came in handy to support it all. I have spent many a happy hour looking into the innards of the s boards in a customer's house, wondering what time I would get home that day!

When faced with dead set, the usual problem was the trip on the rear jumping out. This was a

“Littlefuse” thermal trip and also found its way into the Grundig 5010 and 6010, and in a similar (but three terminal) variety in the GEC valve chassis of the same era.

The course of action was, push the button. Did the big resistor on top give a little puff of smoke and get hot? If so, you had either a rectifier short circuit, chopper transistor short circuit or the crowbar protection thyristor was being triggered (or had gone short circuit itself).

As the LOP stage was so low voltage working, a rise in the HT to rectified mains (about 340V) would spell certain death to the R2008, for example if the R2010 went short-circuit. Therefore, the HT rail was protected by a 2N4443 thyristor, that was triggered if the DC went above 73V, monitored by a BZX61C72 zenner diode. Excessive HT triggered the thyristor and the trip jumped out or at least that was the idea.

Of course, if the zenner went short circuit, the thyristor tripped, sometimes killing the surge-limiter (4.7Ω?) and rectifier as well. On really bad days the R2010 would come out in sympathy and also kill the 2N4443, and rarely but it has happened the R2008 and the 1.5Ω. Once the customer knew about the little red button, it was not uncommon to find that the trip had self destructed too as they hopefully pressed it again and again trying to watch their favourite soaps. The gate of the thyristor had a 100μF capacitor on it to suppress transients and prevent nuisance tripping. After the zenner had died and the customer had had his finger on the button a few times, it never worked again, and the unwary engineer, wiping his brow with relief after finding the fault, would be back next day to attend a case of nuisance tripping, and usually ended up changing the PSU board for one that was just as bad, or slightly worse.

You could waste a couple of hours

on one of these babies! But anything was better than lugging a console 3500 with doors down six flights of stairs. Why did people on the bottom floor have 12” B & W portables, and inhabitants in the sky always had the big b*****s?

What did they do next? The easy 8000/8500 series, single BUX32 LOP and thyristor PSU just like everyone else, but why make things simple? The next offering was the infamous SYCLOPS 9000 series. Perhaps it should have been CYCLOPS. For sure it was a one-eyed monster with a synchronous line output and power supply all in one.

At first sight, it could not start until the line was running, and then again the line could not run until the HT was there, and it had to start before the HT was there. Chicken? Egg? Chicken? Egg? Eggin? Chick?

Then again, what about the Philips K7 series from Sweden, or the Skatic, Bang & Olufsen, Nordmende, Telefunken, Finlux, Grundig. Every one had its little quirks. Later on there was the Sony Trinitron electric fire, or was it just a silicon eater?

Andrew Denham

Dear Sirs,

I read your News article in the April issue which was implying that the switch over was straight forward and at worst would need the purchase of a digi box, if you still had an analogue TV.

I am in the London reception area so have time to modify/purchase my equipment. In the house are 2 TV's and 4 recorders (all analogue). The implied solution is the purchase of 6 digi boxes 'What about the cost/space'.

It is likely that the TV's could go digital in time but there's no reason to change at the moment – the programs available on Freeview do not appeal.

The reason for the 4 recorders is that very often there are several programmes that we would like to view but they are always on at the

same time. Hence the multiple time shifting.

With digital TV this becomes a nightmare as described above.

Do your contributors have a solution to this or could it form the basis for a future article?

Yours faithfully,

Roger Allen, Gt Missenden

Dear Sirs,

I have had numerous letters published on my experiences over many years mainly with television!

About 1964 in my first small shop, I had several second-hand TV's for sale. One day I had acquired a 9” EKCO mains/battery television portable (just!) with a dozen valves vibrator; the weight was considerable and the power consumption high, probably over 6 amps?

One customer expressed interest in its dual power ability and after some thought said:

“What batteries do I put in it?”

I once heard of a strange experience in a Midlands terraced house of the television that worked fine except on Mondays! A call on 2 days confirmed that this was correct, a very grainy picture on Mondays with all channels! Perfect on all other days.

The aerial was typical of the indoor aerial brigade who were often ruled by Councils or just attitude to outdoor installations! However it took some thought to reveal the cause – the set top aerial was only feet/inches to the neighbours kitchen and on the wall was a large metal bath which acted as an excellent reflector to the customers aerial! Wash day disturbed reception and inadvertently upset the next door television!

P H Bearman, New Barnet

Please send any letters or comments you may have to Television magazine, or preferably by email to info@televisionmagazine.co.uk



*The Tench or Doctor Fish
(Tinca tinca)*

What a life!

by Donald Bullock

I was looking after the shop – cos Steven and Paul had slid off at dawn for a day’s tench fishing. Greeneyes was to have come and shared the burden of the customers with me, but she’d slid off too, to look at a costume-thing in the town, that she’d seen earlier from a bus window. “It’s simply wonderful!” she’d said as I dropped her off on her way to somewhere called Mark’s. “And it’s not much over a hundred pounds. Not really!”

“But you’ve already got six or seven!” I said. “By the way, if you find the time, perhaps you’d have a look in the nearly new shop for a pair of bags for me; any shape or colour, don’t pay more than a pound.”

Now trapped in the shop I pulled a Matsui 28WN04 onto the bench and looked at the job card. ‘Loss of horizontal and vertical synchronisation’, it read. We used to just scrawl ‘no synch’, I mused.

Old problems

In my early days in the trade, ‘no synch’ was the very first fault I was given to tackle. At that time television was relatively new and Philips manuals gave a written circuit-description of how the set’s individual circuit stages worked. We read these avidly to increase our understanding, and thus our ability to repair the set and shine, and the knowledge we acquired stayed with us.

The all-important synch pulses leave the transmitter as part of the picture’s video waveform and travel via the receiver’s RF circuitry to the synch separator stage. The waveforms are easy to see on a scope. One of three fault conditions could then ensue. One was an absence of both the frame and line synch (no synch); another was an absence of frame synch only, and the third was an absence of line synch only. Of course, when the fault wasn’t

absolute, the screen display reflected the fact. The frame or the line synch, or both, weren’t stable.

Our quick and lazy way was to first change the synch separator valve. If this made no difference we’d then check the valve’s voltages, and when this didn’t help we’d reach for the scope to track for the incoming pulses at the valve’s grid. If they weren’t there we’d check back to see where they’d stumbled, but if they were present at its grid we then looked to see if they were emerging from its anode at sufficiently good amplitude, and follow them on.

In practice the symptoms on the screen weren’t always a simple and straight-forward guide. Some might remember the popular Thorn (BRC) 1500 series of monochrome sets, virtually all of which, sooner or later, developed synch problems. I still remember, after all the intervening years, that these were commonly caused by R47, which was a half-watt

resistor whose value, co-incidentally, was 47 kohms. Its job was to provide a reduced HT voltage to the valve's grid. It was, I suppose, under-rated, and ran warmly, and its resistance gradually rose in value as it cooked.

The first symptoms were an increasing deterioration in the set's frame synch performance; so that its picture began to slip downwards an inch or so, then recover. As the resistor's resistance increased, the frame synch weakened further, until the picture gently rolled in spasms. This could be alleviated by ever-more judicious adjustment of the set's frame hold control, which jutted through its back cover. But as the unfortunate viewer patiently adjusted away, the resistor's value continued to rise until the line synch became affected too. The picture would begin to twitch sideways, and then to continuously slip sideways whilst rolling as well, and it was then, at the latest, that we saw them in our workshop. The chassis was used under several badges, among them HMV, Ferguson, Marconi, D.E.R. and Alba, and since I enjoyed a lengthy production period of several years there were plenty about. And since the manufacturers meanwhile made no modifications to the stage, the sets continued to make the trade a good deal of easy money. Every time we lifted one onto the bench we half-anticipated the 'No frame synch' or 'No synch' on its card, and often we were reaching for a 47 kohm resistor before we had even taken the set's back off.

When transistors came the sets had much the same separate stages, but subsequent developments have made these, as well as valve sets, academic. The set I now had before me was a Matsui 28WN04, and it would be a little less easy to repair than those I'd been musing about, thanks to its using a so-called 'jungle' chip, IC201, which handled the entire vision and synchronisation signals.

Sausages and chips

Just as I was hoping that I wouldn't have the bother of changing the chip, the telephone rang. "Yup?" I said. "Mrs Sampson here!" barked the receiver. "I'd like you deliver me a pound of pork sausages with my usual piece of beef." I narrowed my eyes. Was it Ribby Ellis again, the practical joker? Yes, it would be, and a prat like him was all I needed. I smiled to myself. "Certainly, Madam!" I said. Then I got back to the Matsui set.

Still hoping it wasn't the jungle chip, I stealthily checked a couple of its associated condensers. The first, C227, a 2.2µf 50 volt electrolytic that was carefully hidden beneath its screening cover, had fallen to .002, while the other, C517, a 470 mfd 16 volt electrolytic, had deteriorated to 2 mfd. I replaced both items, and upon switching on, I was greeted with a solidly locked picture.

With the first job done, I made a cup of powerful tea and wished I was tench-fishing. But since I wasn't, and couldn't be, I just offered a cruel and silent prayer that the tench weren't biting and that the boys would soon be scrambling back in fear of being drenched by a sudden and heavy thunder-storm. I felt better now.

Pest problem

While drinking my tea I started musing on some of the customer-pests that we'd been free of, because they hadn't called in of late. People like the discontented Mr and Mrs Trew, who always wanted everything now and for nothing on account of them being Old Age Pensioners, and Major Hagger, the bristling and up-together ex-military man who thought today's society had gone to the dogs and wanted to hang or deport or birch practically everybody. Then I stretched my lazy mind to Mr. Ng, the pleasant, smooth and scheming specimen who lived so well and didn't know what

work was, and the masculine and crazed and over-smart Miss Pinhead. She was a traffic warden. Nuff said.

Then there was Egbert Crust, the thick but street-wise ass who walked as though he was riding an invisible and oversized bike. And so my thoughts rambled on, until they were interrupted by a seedy old couple who came battling with the door...

"Oh, that door was hard to push open!" whined the one in the trousers as he patted his arm.

"It didn't ought to be that hard, not for pensioners like us," cackled his dowdy little wife. I looked at them with ever-widening eyes! They were the Trews! Back again after so long!

"Our telly's gone wrong, Mr. Pillock," he said. "We didn't want to bring it here 'cos you don't seem to realise we're Old Age Pensioners." I nodded understandingly.

"When we bought it from Snoddies five years ago, that tall thin chap there said it wouldn't ever go wrong cos it had a transistor in it, but it did, so of course we went and had a good row with him, Anyway, he said he'd lost his screwdriver and recommended that we brought it to you." He pointed up the road. "It's in the car", he said.

"Snoddies' screwdriver?" I said. "In your car? Bringing it to me?"

They looked confused as I followed them out, and they walked me fifty yards up the road. The set was a bulky Mitsubishi CT32CW18D, and as I struggled back with it they both minced about in front of my feet, making me walk in breathless fits and starts. By the time I'd got it back to the workshop I was worn-out and sweating, but I manfully drew out a job card.

"What's up with it?" I asked, with my pen poised. They looked at each other.

"We were watching that Esther Rancid..." he said. Or was it Amy Winegum..."

I closed my eyes and thought of a peaceful lake, with tench floats gently sliding...

"No, Terry Wogan, it was," she interrupted. "I don't like him like I did!"

"What happened next?" I asked, boring into her rheumy eyes with mine.

"Ah, that Bruce Forsight chap came on. Got quite a Smart Alec, he has!"

"What - is - wrong - with - the - set?" I asked, at dictation speed.

"I think it's the transformer, but my husband thinks it's the valve," she said.

"It can't be the tube, 'cos the picture never went to a little dot," said the one in trousers. "Mind, my brother's did! What make set did he have, dear?"

I thought of the peaceful lake again, this time replacing the sliding floats with a vision of me jumping in. I flagged them down and leaned forward.

"How - do - you - know - this - set - is - faulty?" I asked, tapping smartly at its cabinet.

"Because it won't come on, o' course," she said, looking at me as though I was a fool. "It just blinks at us." I placed my palms together and uttered my thanks to the ceiling as I put my pen to the job card.

"I hope it isn't going to take long to do!" he scowled.

"And that it won't cost much," she added. "We're Old Age Pensioners, you know."

Having completed the job card I waved them out - just as Mr. Ng slid silently in. He looked at me, smiled, and started to weave his charm in his quiet and silky voice.

"I am being Mr. Ng," he purred. "I am bringing you my Denon CD player. Nowhere else would I be taking it! I am not getting what I want from it."

"Not getting what you want?" I said, cleverly. "Well, we can't have that, can we?" But even as I spoke I

saw that he looked very worried indeed.

"I am praying it can be being done quickly," he said. "Tomorrow I am going into hospital very early for a nasty operation, and I am wanting my dear wife to be having it to listen to. We are not having a wireless or television set." And he held his hand to his chest and winced as he looked into my eyes. I felt humbled.

"I'll have a look at it now!" I said. "Call back in an hour." And he went off biting his bottom lip. As he left, Egbert Crust bounded in on his invisible bike. He looked hot and bothered.

"Look, your Steven put up a digital aerial at my girlfriend's place yesterday, and it's made the sound faulty. He couldn't have used the right parts!" he blurted.

"I'm sure he would have left them with sound!" I said.

"Oh ah..." said Crust. "But the wrong part he fitted caused it to go, two minutes after he left. I've got the set in the car." So out to the car we bounded. He led and I followed, feeling I was an unwilling half of a busking double-act.

We got the set in and as he biked off without a bike, the bright-eyed old Major Hagger strode in, almost tripping over his own feet as he spun round to survey the departing Crust.

"Who the blazes was that?" he bristled. "My God! The sooner we get the birch and the cat-o-nine-tails back, the better! Anyway, fact is, old boy, my LG television set keeps flashing up a big black square, bang in the middle of the picture! Dashed if I know why! I don't suppose that a chap can birch his television set, though this flamer deserves it! Can you come and have a look at it?" I knew his address, raised a card, and promised him a next day call. I knew his set, too - an LG DI 28Z12. And, from what he'd told me, I thought I knew the trouble - we're getting a few like it of late with the same

symptoms - and replacing the megatext IC holder has always cured them, up to now.

Shop till you drop

Suddenly the telephone rang. It was Greeneyes. "I'm getting a taxi back," she trilled. "Oh, I managed to get the costume, and a really cute pair of canary shoes. And a leather and a most demure hat! You'll die when you see me in it! You'll want to take me out tonight! Where shall we go?" I held onto the counter. Canary shoes? Leather handbag? Demure hat?

"How much was it all?" I asked.

"Oh, not that much! Anyway, you've always said that happiness counts more than money! And in any case I paid with our card, not money! See you later!"

Now, where had I been before the robbery? Oh yes, I'd promised to have a go at poor Ng's CD player since he was going into hospital. Whatever else he was, I mused, he cared not for himself, but for his attractive English wife! I checked the player with a disc. Sure enough, it failed to play, so I opened it up and tried again, and after a few such tries I saw that the loading belt was slipping as its load reached maximum. A new belt cured it, and after giving it the usual clean-up I'd just got it together as he came in. As he softly beamed and paid, his wife came in from a neighbouring shop, smiling happily.

That was quick

"Oh, you've managed to get it done quickly, darling, just as you said you could!" she laughed, patting his arm. "Now we'll be able to take it, just as you'd hoped." Then she turned to me. "We're going to Devon tomorrow for a fortnight's well-earned holiday!" she said. "And he does so like ending the day with a one or two of his favourite songs from back home!"

"I am thanking you very much!" beamed Mr. Ng as they left.

"What a Life!" I mused, as I ruefully sat down. I looked at my watch. The day was rolling on, and I still had Crust's Philips to do. I lumbered it onto the bench as best I could and tried it. Sure enough, there was both sound and vision on analogue reception, but no sound at all on digital! I headed for the digital module, and sought out the 10Ω safety resistor 3528. A new one cured it, and it was to survive a soak test once I'd boxed it up.

I looked at my watch. It was just about time to go, and I was glad. The telephone rang and I snatched it up. "Yup?" I growled.

"Mrs. Sampson here!" barked a voice. "When are you coming with my sausages and beef?" She sounded genuine and shirty! Perhaps it wasn't Ribby Ellis! I had to think quickly.

"Sausages and beef?" I echoed. "We don't sell sausages and beef! Your telephone line must be playing tricks! This is Snoddies Television here. Now kindly get off this line and onto your incompetent butcher, you impudent pest!" And smiling in my satisfaction I smacked the receiver down.

It had been a rotten day. Everybody I'd hoped never to see again had made a bee-line for the shop on the very day I was on my own. Everybody, that was, except Miss Pinhead, the masculine traffic warden. I'd better clear off, I thought, before she comes barking in.

I switched everything off, went out, locked the door, and headed for my car. And there, writing out a ticket on the bonnet, was Pinhead, with her nasty mean face creased into a revengeful smile.

'Soft words turneth away wrath' I told myself. So I twisted my face into a false and oily smile and tried to copy Mr. Ng as I softly spoke.

"Ha-ha!" I ventured. "Am I in trouble? ha-ha!" She glared at me like a rabid vixen and showed me what she'd had for dinner.

"You are!" she barked. "Your bumper's over yellow paint, your tax disc has expired, and if you don't watch your step I'll have you for threatening behaviour! I've been hoping to get you since you charged me just for dropping a bit of solder on that loose wire in my DVD recorder!" And after taking some pictures of my car she pointed her camera at me.

"Smile!" she said.

To contact Donald Bullock please email enquiries@wheatleypress.com

The new 2007 Television Index/Directory will be available in June. Available on CD ROM and as a "download" product from the website

Packed with major articles and over 17,000 faults from the last nineteen years of Television magazine. This is a "must buy" for anyone in the trade

To reserve your copy or to receive full details of prices and content please email: info@televisionmagazine.co.uk

Test Case 535

Doc Colin goes ghostbusting on a 42" LCD - and get's to grips with a Techwood with a 'bad picture'. Find out the solutions to both these mysteries on page 23

Our retail shop manager Doc Colin is, as regular readers of Test Case will know, an expert on computers. He is also very good at devising sales promotions, and a recent one brought both these talents together in the form of a sales pitch, promoting various products, on a PC display. Incorporating text and images, it was designed to look like a page from a website even though the shop does not have a 'real' internet presence at this time.

Most large LCD screens have a PC video input, and two such sets in the shop window were selected to run Doc's 'webpage' while those around them displayed a rolling promotional movie supplied by a TV setmaker. With those alongside others showing the BBC high definition showreel the shop windows were busy and attractive indeed – and not too washed out because they face north at this location.

One day the computer's mains lead was accidentally disconnected, whereupon the two big front-window monitors went blank – or rather blue, the default in the absence of an input signal. Horror: highlights of the image which normally showed there appeared to be burned into one of them, a big 42" screen! Surely this sort of thing can only happen to phosphor screens? The TV was taken from the window and soon got onto the service bench, where careful examination showed that on any



evenly-illuminated picture a positive overlay of Colin's image was present like a ghost. A quite scary ghost, too, since the set's value was about £1000! Can you guess at the outcome of this scenario? Have any readers experienced it?

That day saw another LCD TV on the same repair bench, with a quite different mystery symptom. A very different make, too, one which as far as the workshop staff are concerned is itself a mystery – a Techwood, no less. When it came into the shop there was no remote control – it was said to be broken – and no doubt that a Sky zapper was the means of driving it. Further evidence of this was the dust visible on all the rear signal-input sockets except SCART 1. Certainly there was nothing doing on the terrestrial channels, and with no remote control and no instruction book, little was likely. Using the front panel keys the screen was got into AV mode, and a test card signal piped

into its SCART 1 socket. The image which came up on the screen was black and white, with a broken segment travelling vertically over it at a rate of about two or three seconds per pass. Since the only symptom on the job card was 'bad picture' Real Technician



phoned the owner, who confirmed that that was indeed the symptom, and that there was no remote control available.

Was this down to some horrible malfunction of the A-D convertor circuit inside this wonder-telly? Or could it be due to any kind of mains-rate ripple on a power supply line? That was the best suggestion of Real Technician, whose first action was to check the mains reservoir capacitor, relatively easy to find. The trusty ESR meter declared it OK. Soon Sage was on the job. He cured the problem with the aid of one item which was obtained from a supplier on the web. What was it? What was the fault? See page 23.

Fault finding reports

Save time and money by benefiting from the experience of some of the repair business's most respected voices

TV FAULT FINDING

PHILIPS GR2350/05GB

My trick telephone rang and I saw the name "George" appear. This was a great shock to me as my friend George had died the previous week and I hadn't changed the name in the phone. I answered it and his widow Jane was on the other end. "You've heard about George?" "Yes." "Well, I don't want to be a nuisance but two of our tellys have gone wrong." Resisting the temptation to remark the these things always happen in threes I asked what was wrong with them. "Both have a snowy picture." She said. George had bought two of these sets together a few years back and it seemed they had both gone wrong together. So I set off with my bag of capacitors and was soon inside admiring two sets both going and displaying good pictures. The sets had been relegated to the bedrooms now and the widescreen set in the front room was blazing away merrily with nobody watching.

In the bedrooms were the grandchildren watching cartoons on the cartoon channel and switching between this and the cartoon channel plus one! "I can't see anything wrong with these." "It only goes like this when you switch on." Said Jane, describing a wavy shape with her hands. "After the first half hour, they're alright once they've warmed up."

I noticed the central heating on full plus one and that the kids had put the fans on in an attempt to cool off. This was understandable considering that jumping around on the bed and

watching cartoons all day is very hard work.

"I'm not sure how you expect me to find the fault now you've had them on all day, but I can make an educated guess." I said, mopping the sweat now running down my face. "That's all right Pete, I'll make sure they're both turned off the next time you call round. Or would you prefer it if we brought them over for you?"

The following day they were on my sorry excuse for a workbench. Both sets showed a rippled picture which reminded me of the 33µF capacitors that go open circuit in the CP90 chassis. In this set they were 47µF 160v. One was completely o/c and the other wasn't far behind it. There were four other electrolytics quite close to the chopper transformer that had burst and were duly replaced. Both sets had suffered in exactly the same way and repaired using the same component count. After resoldering the line and power stages which is par for the course, or should be, they were pronounced fit and well again. Which is better than being pronounced George!

Graves

TV Ref:171

DAEWOO CP775 Chassis

"You've got a rozzers' knock!" said the delightful East London Lady who answered the door. "I like to make sure that you hear it." I replied. I was led to the front room where two Identical Daewoo sets

had been lined up. "They both went off wivvin an hour of each other!" she volunteered. "Me and my daughter bought 'em both on the

same day a few years back and now the f..." she paused to consider her words. "er, the things both went wrong on the same day as well." After the process of removing the back I began to check the line output transistor with my meter. "Shouldn't you wear turtles to do that?" It was my turn to pause while I worked out what she meant. Turtle doves = Gloves. "No, it's alright. There's very little in the way of power left in here." The transistor was dead short and so I prepared to unsolder it.

"You gonna do some welding now?" she enquired. I don't believe in insulting my customers or making them embarrassed so I continued along the previous line. "I've never heard that one before. Turtles! I've just worked it out." "You come from the East End an' you never heard of that one?" "They've changed the rhyming dictionary beyond recognition since apples and pears." "Dozy f. feller." By now I'd measured the transformer and that was shorting as well. I knew it was a waste of time trying to explain what I'd found to the lady because I could embarrass her and I didn't want to attempt any rhyming slang either. "Well, I know what's wrong with your telly." "What?" "It's f***ked!" "How much is it to un-f***k it?" She was completely unfazed as I knew she would be. "Cost of the transistor and transformer plus an hour." "Right. What about the other one?" I began the task of getting inside this set. "You've heard of Lionel's though, haven't you?" "Yes. Only because I get to see Countdown." The transistor

and transformer had both shorted in the second set.

'Ah! I've found what's wrong with this telly.' 'What?' 'This one's f**ked as well.' 'What? The same problem?'

'Yes.' 'Oh well. S'pose I'd better get 'em done.' She said and handed me a wad of notes. 'I haven't got the transformers with me. I'll have to go and buy them.' 'Yeah but you need money to get them don't cha?'

She paid for two lots of parts and labour without question. The following day I arrived with the bits and fitted them. Everything worked first time. She pulled out another wad of notes. 'How much do I owe ya?' 'No. You've already paid.' 'That was for the parts.' 'No. You paid for the labour as well.' 'Well,' she continued and pushed a note into my hand 'Thank you very much for un-f**king my tellys.' Spoken like a true lady. If only they were all like that!

Graves

TV Ref:172

Bush IDLCD27TV006.

his set would not come on and the front led was flashing ,there was no start up voltage at the end of resistor chain R304-R305 both 150KΩ but the resistors were o.k, a low bi directional reading was found across the reservoir capacitor C356,the fault was caused by the chopper control chip IC30 (ICE1QS01).

Michael Dranfield **TV Ref 180**

PHILIPS 14PV220.

Set dead was the complaint with this compact TV/VCR model and after confirming the mains switch at the side was on (a common oversight) this certainly seemed to be the case. When the cover was removed I quickly found that the primary side of the power supply was running and producing secondary outputs but when the HT rail was measured at the cathode of diode 6350(on the component side of the PCB for convenience)the normally 94v expected here was low and varying

between 60-65v.As with most combi sets servicing is difficult due to short cable lengths between the TV and VCR section so it was easier to remove the power/time base PCB for cold checks, the trouble was traced to diode 6342 (sbyv27-200) which was s/c, this component is a power supply secondary rectifier and provides a 14v supply, a replacement restored TV and VCR operation, this is one of the last models with the excellent turbo deck in its VCR section.

Arthur Jackson

TV Ref: 193

FERGUSON WF70401 /THOMSON 28WF45US. (ICC20 CHASSIS)

This set would switch on and produce a red led, when a channel was requested the led briefly turned amber and EHT was clearly evident but almost instantly the red led returned and error code 25 was produced as the line stage shut down. Problems of this nature are commonly caused by a fault in the line flyback or diode modulator stages with this chassis and when checked very dry/overheated connections were evident to capacitors CLO33 &CLO35, the value of both capacitors was normal and no fault was found with any related components so I resoldered them and retried the set, you've guessed it, the fault remained. The cure was to replace both capacitors which were obviously breaking down under more stressful working conditions, this didn't surprise me as I had found out the hard way previously.CLO33 = 510N,250V, CLO35= 510N,400V.

Arthur Jackson

TV Ref:195

Bush LCD27TV006

For a dead set with one of the power supplies not running get MODKIT 63 from Charles Hyde, the cause is usually just a short in the chopper control chip IC30 (ICE1QS01) pulling the start up voltage down across capacitor C356, the culprit

could also be the start up resistors R304 and R305 both 150KΩ, the give away to a faulty chip is a low bi-directional reading across C356 but as some other parts may also be faulty its easier to get the whole kit.

Michael Dranfield. **TV Ref:211**

BUSH LCD27TV006HD. (27"LCD TV)

A very disgruntled customer who had purchased this set from her local supermarket asked us to take a look at it when its suppliers didn't want to offer anything worthwhile by way of back up service, (how many times have we heard this, yet they seem to continue to sell electrical items thick and fast)! The complaint was of a dead set but when tested its stand-by LED was lit, attempts to bring it out of stand-by resulted in the LED starting to dim and flash approximately twice per second while a pulsing sound from the power supply was heard at the same rate as the flashing LED. When I opened the set up its power supply PCB looked familiar and indeed resembled some MAXIM sets I've seen, ESR checks on the secondary supply capacitors quickly found c330, (1000μF-25v) to be completely o/c, it was also visibly distressed. This component appears to be associated with the main 5v supply and its location under the heat sink of a regulator I believe causes it to lead a very hard life, a suitable replacement capacitor cleared the problem but the pasty and dull appearance of the lead free soldering does cause me concern about reliability, (this concern applies not only to this brand I might add.).

Arthur Jackson

TV Ref:212

Bush RF2185NTXSIL - BEKO Chassis

This set was just out of guarantee bought once again from a supermarket. The customer complained nothing would come on and the blue light on the fron of the

set was blinking. The first thing to do was to check for shorts in the line output stage but on small scree sets nowadays is rare. I decided to keep my finger on the channel change button continuously to force the set on and this worked a treat because after advancing boost control on the line output transformer I observed a distorted field fault. A quick check to confirm the L.T. supply was present on one of the pins of IC501 led me to make an order out for a TDA8359J integrated circuit. This restored the set back to working condition.

Philip Salkeld **TV Ref:219**

Philips 14PT121A/05 - GR1-AX Chassis

You know when you repair an old set and you know you are doing the wrong thing. This was typical, a customer brought me two televisions to repair. This particular one was dead, but you could hear the power going through. The line output transistor BUT11AF was short circuit and I could find no reason for its failure. Ran the set for a couple of days, then the customer took it away. Shortly after it came back in with the BUT11AF short circuit again. I pulled out the circuit diagram and noticed that one of my work mates had made a note about C2523 to change it from 6.8 mfd to 68 mfd 35 volts, it is on the +9 volt rail. This I did, replaced the BUT 11AF and ran the set for a fortnight, without any problems. Some jobs are just not worth it.

Philip Salkeld **TV Ref:220**

Sharp 51AT-15H

This set came in totally dead, the first thing I do is to check for dry joints in the line stage, followed by a quick check on Q601 the line output transistor, which proved to be short circuit. If no dry joints were evident there had to be a dry joint on the small panel mounted on top of the

scan coil assembly, and there was. When I switched on I fully expected a result but it was still dead. A cold check in the power supply seemed a sensible idea, where I found:-R701 5.6Ω 1/2 watt open circuit, Q701 BUZ80 chopper transistor short circuit, part number RH-TX0185BMZZ, D718 part number RH-EX0419BMZZ short circuit and Q702 BC338 part number RH-TX0217BMZZ emitter/base short circuit. This finally brought the set to life.

Philip Salkeld **TV Ref:221**

Hitachi 32 LD6200 LCD

The customer had complained he had lost his teletext. To remove the back you must first remove the stand. Once the back was removed there was no obvious cause for the fault. A phone call to Hitachi technical was most helpful. He suggested that the cause would be either IC32 or IC33, which is on the tuner printed circuit board. Both integrated circuits did not look nice to change, so I took the coward's way out. The set was in warranty so I ordered a new board, part number, VE-20186762. You have probably realised by now that VE stands for Vestel. Replacement of the whole board put matters right.

Philip Salkeld **TV Ref:223**

Thomson 28WS22U - IC17 Chassis

This set had suffered from lightning damage and you always suspect the worst. Off with the back to inspect the damage, the 2.2 amp internal fuse was blown along with two of the diodes in the bridge rectifier. I replaced all four, DP01, DP02, DP03 and DP04 with IN4007 diodes. Also, DP06 was short circuit, I fitted the versatile BYV95C diode. Further checks showed nothing amiss. Time to switch on and thankfully I was rewarded with good picture and sound.

Philip Salkeld **TV Ref:224**

Philips model 32PW9509/05 chassis EM5.3E

Repeated failure of line output transistor.

If the line output transistor 7421 (BU2520DX0 keeps on failing but only after a period of two to three months, check firstly that the tuning capacitor is not at fault by replacement. If this proves to be negative then replace a faulty Fly back transformer 5430 this restored normal operation over a long period of time.

John Coombes **TV Ref:225**

Philips model 32PW9509/05 chassis EM5.3E

No start-up.

If there is no start-up or no relay clicking with the blue LED flashing this would indicate that there is a loss of the 5 volt supply this can be traced to faulty transistor 7140 (BC847B) check by substitution.

John Coombes **TV Ref: 227**

Samsung model LE27S73BDX LCD

Digital lock-up.

To overcome this problem it is necessary to get into the service menu. To enter the menu power off then press the info button, menu and then mute then power on this will then display the service menu. Once in scroll down to RESET which will then restore LCD to the plug and play mode, resetting the digital tuning.

John Coombes **TV Ref: 228**

LG model RZ-42PX11 chassis RF043B Plasma.

No picture.

There maybe no picture but intermittently it will give vertical multicolour lines across the screen and the raster is snowy with loss of on screen display (OSD). This fault can be traced to the Y Drive PCBs but to ensure there are no further problems it is necessary to replace the Y Drive PCBs both top and bottom

but also replace the Y SUS PCB with all three PCBs replaced this will restore long term reliability.

John Coombes *TV Ref:230*

Samsung model LE-32R74BD

No digital channels.

If there are no digital channels but the analogue channels are alright check the solder connections between the Main PCB and digital PCB.

Aging mode.

To remove the aging mode function which usually occurs after removing the Main PCB to restore normal operation just press the volume button on the TV this will then disable the aging mode.

John Coombes *TV Ref: 231*

Panasonic model TX28PL1 chassis Euro4

Cuts out.

If the set suddenly cuts out after switch on check the frame stage, firstly check the frame output IC451 for dry-joints. If this proves to be negative then check diode D558 and resistor R559 (.33Ω) by replacement.

John Coombes *TV Ref:232*

Daewoo model DSC3210 chassis S

Switches off into standby mode.

The set can just go to standby after switch on this is due to faulty eeprom (24LC16B1B) but a replacement will restore normal operation.

John Coombes *TV Ref: 234*

Samsung LE 26/32/40 R74 series

The fault presented on several of these models, was that the tuning on analogue was limited, i.e. one could not tune all the way from UHF channels 21 to 68.

The easiest was to spot this is to put the menu into auto-search.

On digital, the result is usually no channels, or perhaps just one multiplex. Check for the presence of the 33v tuner supply on pin 5 of the

tuner module. If this has fallen to +5v, then the fault is usually the zener diode D1004, type SS34, which sometimes go S/C. The 33v supply is derived from IC1013, in a buck/boost circuit. Occasionally, the IC itself fails. The operation of this can be checked with a 'scope on pin 7 where a waveform at approximately 97Khz can be seen when correctly functioning.

Dave Stone *TV Ref:261*

Hitachi C2846TN

There was sound but no picture here, but thankfully no burning on this one. In cases like this it's helpful to turn up the A1 control (after carefully marking its original position, perhaps with a pinpoint burn from a soldering iron!) to see what shows. In this case it was a thin horizontal line due to the collapse of the field scan. This led to the discovery that there was no voltage at the field timebase chip. Feed resistor R710 was dry-jointed to the PCB land under a blob of glue.

Eugene Trundle *TV Ref: 269*

Hitachi C2565TN

A power-supply blow-up had taken place in this set: the mains fuse was burnt black inside, and power switcher transistor Q903, type BUT12AF, had gone short circuit. On the secondary side of the circuit crowbar zener diode ZD953 was shorted too. Plainly there had been an overvoltage just before the big bang! In Hitachi sets this is usually due to a problem in the potential divider of the set-HT circuit, and sure enough we found that R952 had changed in value from 68kΩ to 83kΩ. To get the set going again we had to replace that, mini pre-set VR951, the chopper transistor and the zener, then carefully adjust the pot for the correct HT level using a digital voltmeter. This sort of problem, which starts with poor reliability in a single resistor, here R952, has earned the trade many a pound over the years.

Eugene Trundle *TV Ref: 270*

SATELLITE FAULT FINDING

Humax model PVR8000.

Dead.

If the unit is dead and the power supply is ticking away check the diode D9 (RGP30) for short circuit.

John Coombes *Satellite Ref: 233*

VCR FAULT FINDING

Philips VR750/07

This machine seemed to behave perfectly well all the time the cassette remained in the machine. Once the tape had been ejected from it, however, shutdown followed immediately.

There was similarly strange behaviour when the cassette was re-inserted. It turned out that the end sensors' leads were bent, preventing proper sighting of the cassette LED. Re-aligning the sensors mechanically and cleaning the mode switch cured all the problems on this deck.

Eugene Trundle *VCR Ref:240*

Panasonic NV-HV61

The complaint here was of a squeaking noise during record and play modes. No problem could be discerned on test in the workshop until the machine had clocked up many hours' running. The 'squeak' then was very quiet and elusive, a little like the noises that chickens make in their throats! By gripping the tape near the capstan we found that the noise disappeared when the take-up reel was stopped, and also while it was running at full speed. Plainly the sound was generated by the reel-drive clutch, and then only while it was slipping, with both plates on the move.

We removed and dismantled the clutch, to find it polluted with white powder. A thorough clean of the felt and ribbed-plastic surfaces got rid of the clucking noise, and then a check of the take-up torque showed that we had not impaired the clutch's function.

Eugene Trundle *VCR Ref: 241*

Philips VR6585

The attached job card declared that the fault was no go at all: in fact the machine would take in and play a tape. The trouble was actually confined to the front panel display, which was completely unlit. Guessing that either its heater or accelerator supply was missing we went into the PSU section; sure enough Wickman fuse 1215 was found O/C. Its rating is 315mA, and its replacement immediately restored the fluorescent panel to life. The machine ran for many days in the workshop and we've heard nothing since it was returned to its owner, so we're guessing that the fuse died of old age....

Eugene Trundle **VCR Ref:242**

Samsung SV-221B

'The tape won't eject and the pictures are very bad' declared the owner of this machine. We found that a loop of tape was trapped in the deck, in fact caught around the take-up guide: this prevented full eject, and after a few seconds the cassette was retracted inside again. The cause of the tape-looping was a dirty mode switch. We cleaned it and re-tensioned its wiper contacts. The 'bad pictures' fault was the result of one head being dirty, polluted by the scrunched tape. It didn't take long to clean the head and upper drum and to cut and splice the tape. My splicing jig had accumulated a layer of dust!

Eugene Trundle **VCR Ref:243**

Philips 14PV170/05

The video deck was in trouble in this TV/VCR combi, with a very elusive fault. At rare intervals there arose a corrugation of the picture in horizontal bands, accompanied by a very quiet squealing noise from within the cabinet. Initially we suspected a sticky tape guide sleeve, a common cause of this sort of thing. This theory was disproved over a long period of testing when we

found the fault remained even with first the entry-, and then the exit-guide sleeve held fast with a tiny screwdriver. We then discovered that the symptom disappeared when the slightest reduction in back-tension was made by pulling the regulating pole to the right.

We thought we had really found a cure when we replaced the lever/pole assembly, but it bounced back into the workshop after a few days. It wasn't until we had replaced both the felt friction band *and the spool turntable* (with second-hand parts from a scrap machine!) that this one was finally laid to rest.

Eugene Trundle **VCR Ref: 244**

Samsung SV-633B

Another horrible intermittent fault! We were told that after about an hour's running the picture deteriorated, with rolling, mistracking and sound dropping in and out. When we had completed the fourth run-through of our *Sound of Music* tape we phoned the customer to try to glean more information. It emerged that they never played a pre-recorded cassette in there: in fact they only ever used the one tape, mainly for time-shifting. What a pity they took it out of the machine before sending it in – perhaps they thought we would steal it!

Testing now by making recordings and observing their playback, we saw the fault at last; after a while tracking was cyclically lost, along with all sound. Close examination of the ACE head assembly revealed the cause of this problem: the control-track head was deeply worn and grooved, such that the one pass of replay-only operation just maintained enough control track pulse amplitude, but the to-and-fro transfer of record and replay was borderline, pulse-amplitude wise. A replacement ACE head assembly put all to rights.

Eugene Trundle **VCR Ref: 245**

Samsung DVD-V5600

A VCR-DVD combi, this, with the fault symptom of complete failure. An oscilloscope test showed that the PSU stage was 'pumping' due to a current overload, and subsequent testing revealed that secondary-side rectifier D1SS16 was short-circuit. A replacement diode restored full operation.

Eugene Trundle **VCR Ref: 248**

HOME CINEMA FAULT FINDING

LG LH-C6235I

This is an all-in-one DVD unit, incorporating a disc player, VCR and a bunch of audio amplifiers. Its symptom was that it cut out after a run of about two minutes, even with nothing playing in it and no speakers connected. We found that 5V regulators IC705 and IC706 became too hot to touch within a very short time after switch-on.

The cure for this one is to reset the primary tap on the big mains transformer to 240V to take some of the stress off the LT regulators, which are actually wired in parallel. These must be replaced, and while the specified 1A types will now be just adequate to do the job, a better repair, perhaps, would be to fit the physically-similar 3A types available from (for instance) CPC and RS Components.

Eugene Trundle **HC Ref: 249**

AUDIO FAULT FINDING

NAD Model 402 Tuner

The display backlight lit up, but that was the extent of apparent life on this unit.

One power supply electrolytic was bulging, and another had leaked, so as a first move, these were replaced, but had no effect on the symptoms.

Voltage checks revealed a good level going into pin 1 of the LM7805 5v regulator chip, but only about 1v

coming out. It was stone cold, indicating that it was not in thermal foldback shutdown, so I went ahead and replaced it. This restored the 5v rail, and full normal operation.

Geoff Darby **AUDIO Ref:250**

Sony HCD - G1

The reported problem on this one was "one channel U/S". The owner had kindly taken the back off (literally!!) for me. When tried, one channel was low compared to the other, but otherwise, sounded fine.

A quick look at the schematics revealed a fairly straightforward signal path from the volume control IC to the hybrid output device. At the emitters of the mute transistors, Q302 and Q303, 'scope checks showed the signals to be equal in level, but at the input pins of the hybrid (1 and 15), there was a significant difference.

Between the mute transistors and the input pins, are a pair of 1µF series coupling capacitors. The one for the right channel, C314, was almost open circuit. A replacement restored full level drive to the hybrid, and balanced output to both speakers.

Geoff Darby **AUDIO Ref: 252**

Arcam Alpha 9

This high-end amplifier arrived on the bench blowing its T1.6A mains fuse violently enough to turn the inside of the glass completely black.

Initial checks showed there to be

nothing wrong in the power supply department, so I turned my attention next to the output FETs. Both of these

IRFP240 devices on one channel, were found to be short circuit drain to source. Once they had been removed from circuit, I was able to gently bring the amplifier up on a variac whilst checking the drive conditions on the bad channel, and comparing them to those on the good one. You can do this because FETs are, like valves, voltage driven devices with a very high input impedance at their gate terminals, so in general, the preceding circuitry doesn't really care - or even know - if they are in place, or not.

All checks indicated that other than the FETs themselves, there were no other issues, so I quoted the job, and on acceptance, went ahead and ordered up replacements.

Once these had arrived and been fitted, I again brought the unit up on the variac, whilst watching carefully for problems. There were none, and the speaker protection relays dropped in at the appropriate time.

With full mains applied, the amplifier was switched on and off a few times, before connecting speakers, and applying signal. Both channels had identical outputs, and the heatsink ran cool. A long soak test at various listening levels, proved that all was well, leaving only the bill to be written out ... !

Geoff Darby **AUDIO Ref: 253**

PA EQUIPMENT FAULT FINDING

Peavey PV-2600

This 'boat anchor' of an amplifier, with an output capability of 900 watts RMS per channel, or over 2kW in bridged mono mode, arrived on the bench with the complaint that its "B" channel had intermittent output. When tried, however, it seemed quite solid. Often, when PA amplifiers are claimed to be intermittent, but the fault doesn't show on the bench, the problem can be traced to intermittent switch contacts on insert or effects loop jacks.

However, as this item is just a high power slave, it doesn't have any such connectors.

A bit of further hunting around the back panel, revealed a pair of latching push button switches, 'hidden' behind small holes. Their declared functions were "Low Cut" and "150Hz x-over". When the tip of a small screwdriver was inserted through the holes to push each switch in turn, they were all found to be a bit 'touchy'.

A good squib of switch cleaner / lubricant forced into the body of each switch, followed by a vigorous 'working' of each one, affecting a complete cure.

Geoff Darby **PA Equip. Ref: 259**

Fault index by model

- Arcam Alpha 9
- Bush LCD27TV006
- BUSH LCD27TV006HD. (27"LCD TV)
- Bush RF2185NTXSIL - BEKO Chassis
- DAEWOO CP775 Chassis
- Daewoo model DSC3210 chassis S
- FERGUSON WF70401 /THOMSON 28WF45US. (ICC20 CHASSIS)
- Hitachi 32 LD6200 LCD
- Hitachi C2565TN
- Hitachi C2846TN

- Humax model PVR8000.
- LG LH-C6235I
- LG model RZ-42PX11 chassis RF043B Plasma.
- NAD Model 402 Tuner
- Panasonic model TX28PL1 chassis Euro4
- Panasonic NV-HV61
- Peavey PV-2600
- PHILIPS 14PV220.
- Philips 14PT121A/05 - GR1-AX Chassis
- Philips 14PV170/05
- PHILIPS GR2350/05GB
- Philips model 32PW9509/05 chassis EM5.3E
- Philips VR6585
- Philips VR750/07
- Samsung DVD-V5600
- Samsung LE 26/32/40 R74 series
- Samsung model LE-32R74BD
- Samsung model LE27S73BDX LCD
- Samsung SV-221B
- Samsung SV-633B
- Sharp 51AT-15H
- Sony HCD - G1
- Thomson 28WS22U - IC17 Chassis

Solutions to Test Case 535

This is the solution to test case 535 detailed on page 16

LCD screens have overtaken CRT types now in terms of workshop repair volume. Even so, unfamiliarity remains a problem at present, especially where, as with the Techwood, there's little or nothing available in the way of service data or spares. First, though, the image retention problem with the big shop-window LCD set...

It can happen that when the crystal molecules in an LCD cell are twisted to their utmost in displaying a bright white pixel, and the action is prolonged, the crystal becomes 'set', failing to return fully to rest, i.e. black, when the stimulus is removed.



Seldom is this a permanent defect; it generally fades away after a while, and so it was here. To everyone's relief the intruding image was gone after a few days. It



would have been far otherwise had the screen been a plasma type!

So we come on to the Techwood TV. If any reader knows of a source of spares or data for these, please contact Sage via the magazine. In fact there was nothing wrong with this set. It had somehow got switched into NTSC/60Hz mode, though Sage had to obtain a remote control zapper (subsequently sold on to the customer as part of the deal) to get it back into 50Hz scan mode. Few TV viewers realise the consequences – when service or repair is required – of losing a zapper, or letting its batteries rot inside it.

NOTICE BOARD

Please email your notices to: info@televisionmagazine.co.uk

HELP WANTED

With jvc sp-pws9 subwoofer which has no audio o/p this amp is part of the DVD cinema system ths9. Could purchase a working amp. If one available.

**Please phone Brian Long
01670 783192 or email
hendersons190@
btinternet.com**

WANTED

Good video head drum for **Philips N1500/N1502**. Also wanted for the later version of **Philips N1502**, Tape Servo pcb U221, or at least the IC RV4136DB for that panel. Alternative devices do not work properly. A scrap machine would be good too.

Colin McCormick, Plymouth, Devon.
www.video99.co.uk
colin@video99.co.uk (01752) 881652

WANTED!

Remote control for TARGA LCD.
Model num: LT 3020. New or used.
Not available from usual sources.

**Please contact Kevin Donohoe
on 02871280265(9-5),
07835660713(aft 5) or
e-mail bigrab1@ntlworld.com**

HELP

A Philips A10E chassis appears to have gone into Protection Mode. What is the procedure for resetting?

H R Cantwell
Replies to
info@televisionmagazine.co.uk

A profile of Michael Dranfield

by Donald Bullock

Michael Dranfield is a man obsessed. The condition first manifested itself when he was barely a schoolboy and he found himself obsessed by bright and vivid colours. He coupled this, at the age of ten, to an obsession with electronics, and happily nursed a supplementary obsession for exploring the contents of the local tip, which to him had a celestial value.

If all these obsessions seem surprising in one person, his later obsession with cars, at the age of twenty, would seem to be comparatively natural; until he explains that he currently owns and tinkers with three – each one a Fiat.

If he isn't obsessed by writing articles for this publication, he would seem to be hovering on its brink, for apart from writing for Television Magazine since 1985 he also contributes to a motor magazine and a further electronics publication.

He opened his first television workshop at the age of twenty, and quickly grew obsessed with work, and today, at the age of forty-three, he ends each long and busy day with the conviction that he hasn't managed to do enough. Since his condition is long-standing, it seems unlikely that he will recover, which suits him and his customers admirably.

Vivid Colours

"When I developed an obsession for bright and vivid colours at the age of six," he said, "I took to carrying a pair of cutters, and when my dad took me for walks I used to stop and snip out any colourful components from any

discarded equipment we encountered.

"Later, he took me to his club, where he played Bingo. This bored me, so I slipped out and found a big tip down the road. It was heaven! I used to snip out parts and panels, and take the valves out of dumped television sets, and I was soon in trouble at home for filling the house with junk. Then sadly, the tip was closed and grassed over.

"One day, when I was ten, my mum was buying me sweets at a newsagent's when I saw a displayed copy of Practical Wireless. She bought it for me, and I have regularly taken it ever since – that's thirty-four years!"

Soon after, the gift of a bicycle opened up a whole new world to him, for it enabled him to visit another tip, two miles away, on Sunday afternoons. The road had a very steep hill, but he managed to carry home the old monochrome sets he found by balancing them on the bike's crossbar and holding them there with his elbows.

"I couldn't pedal the bike, because my knees would have knocked the set off, so I straddled the saddle and 'walked' it up the hill, and reached its top exhausted. But I could then cruise down a succession of gradients to my home," he said.

Realising that he was obsessed with electronics, Michael's father built him a workshop in the loft (to get him and all of his bulky junk out of the way, I'd think) where, he says, he spent all of his time hooked on repairing television sets and radios and constructing equipment (including test equipment) with the help of the array of magazines he

now regularly took, which included Television Magazine.

First shop

At twenty he opened his first repair-shop, and also bought batches of retired sets and renovated and sold them. His abilities and enthusiasm came speedily recognised, and both the public and local dealers flocked to use his services.

Six years ago, when digital boxes cost £399 each, he obtained and refurbished faulty ones and sold them from £150 upwards, and soon he was able to invest the profits in a range of costly servicing equipment, including a highly expensive surface-mount rework machine.

He is, of course, disenchanted with the falling prices of consumer products, and points out that a new microwave oven can be got for only a few pounds less than the cost of a new magnetron. However, he says that he is still busily making money and insists that a realistic approach can bring any bright and capable engineer a bounty.

"Discovering how much a customer wants to pay, in the present trade climate, is essential," he said. "A man recently brought me a Daewoo video recorder which refused to rewind, a common fault on this model, and said he'd spend no more than twenty pounds on it, since he could buy a new one from Argos for £39. I accepted the job, undid four screws to get the top off then undid three more to get the deck out. I cleaned the mode switch and reassembled it – five minutes work altogether. I charged the customer £15, and he was delighted. Had I quoted

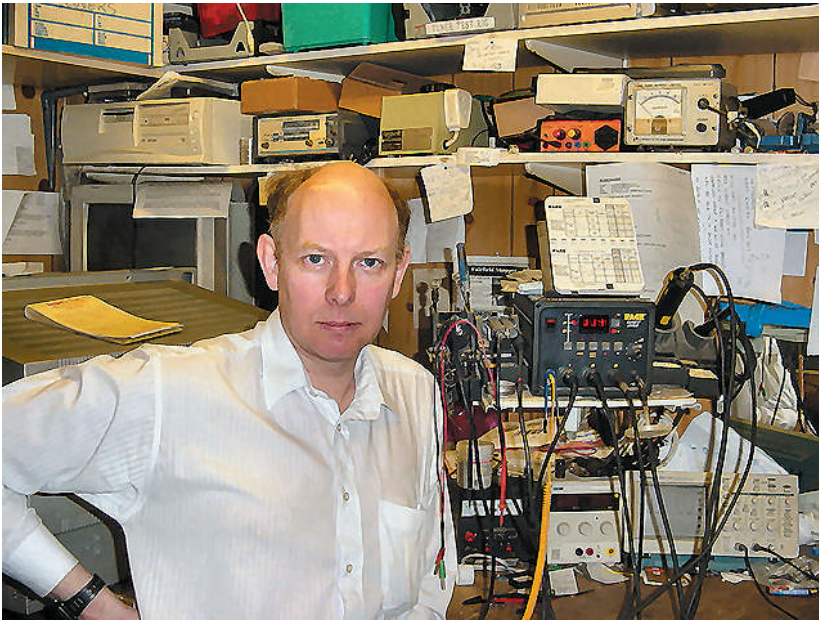

him a high price he'd have stalked off and I'd have made nothing!"

Business booming

Michael says that although all the area's surrounding repair shops have now closed down, his business is booming, and he is hard put to keep up with all the work he gets. People now bring him sets from two neighbouring towns which are 26 and 20 miles away. And he regards the new disposal legislation as a distinct advantage to him.

"The last thing people want to do is to pay to get rid of their retired television sets," he said, "they are pleased to give them to me, so I have a constant flow of free sets for renovation and re-sale!"

Michael has been happily married to Sheila for the past eleven years, and they have two children; Kate, seven and Anthony, nine, as well as Michael's step-daughter Lindsey, who is twenty.

I dared to ask this busy man what his hobbies were.

"I eat, sleep and breathe electronics," he said. "If I'm stuck on a set I take the service manual home and read it in bed! By the way, I've converted my loft space at home into a workshop, as there aren't enough hours in the day for me to finish all

my jobs at the shop."

But he was still talking about his job! What about his hobbies?

"Well, I like to mess about with cars! I own three Fiats, a Fiat Tipo, a Fiat Punto, and a Fiat Doble van. I'm a member of the Fiat Motor Club and have written articles for it. In fact, my 1990 Tipo was featured on the front cover of their magazine last summer. The best day of the week for me is Sunday, when I can red-line my Tipo on the open roads all the way to the tip at Glossop!"

Embarrassing moments

What were his most funny or embarrassing moments?

"I recall an unfortunate incident in the late 'Eighties, when I was carrying a repaired Ferguson television set from the workbench to the shop. Once there it slipped from my hands to the floor, fell over and its back flew off, just as a customer called to collect his set. "Which one is it?" I asked, and the customer pointed to the wreckage I'd just created!"

Michael then went on to talk about the time that a customer, whom we'd better call Mr Jones, declined his £60 quote for fitting a new magnetron into his microwave, and donated the machine to him. A few days later he

fitted a used magnetron into it, refurbished it, and added it to his display of goods for sale.

Later that day, when Michael was in the workshop and his lady assistant was watching the shop, Mr Jones, now doing the rounds looking for a replacement microwave, called to see what the shop had to offer, and quickly recognised the set he'd earlier dumped there. Only now, it carried a £30 price-tag. Half the repair price he'd been quoted. He lost no time in expressing his anger!

The assistant, knowing that Michael normally raided the tip for his stock, denied Mr Jones's claim, and, since the microwave was now working and guaranteed, Mr Jones ruefully agreed to buy it back. Whilst he was writing his cheque, the assistant slipped into the workshop and asked Michael if the man was right, that the microwave he was now buying had been his own – and Michael nodded.

Returning to the shop, the assistant took his cheque, and offered, in her embarrassment, to obtain a free user-manual book for him.

"I don't need another – I've got the original one at home!" he growled as he picked up the microwave to take it back home.

Busy and happy man

Michael is a busily happy man. He describes himself as lucky, but there is more to it than that. He is extremely capable at his chosen job, and is a positive, logical and realistic thinker. His days of struggling home with his sets on his bicycle crossbar from the two-mile distant tip are well and truly over, but for all that he still has a problem that he hasn't yet managed to solve. "The days are too short!" he complains.

** We regret that an error occurred in last month's Profile of Fawzi Ibrahim. He taught at Willesden College of Technology.*

LG Boards and Spares



6912B22002C Projector Lamp
 Suitable for LG/Zenith, Mitsubishi , Philips , RCA ,
 Sagem Axium , Samsung , Thompson & Toshiba.
 Power Range: 100-120W - Ignition: 15-18kV
 Light Output Type: 5.200lm at 120W
 Average Life: 6000h @ 120W
Order Code : LG6912B22002C
Price : £ 115.00 + vat

6871VSNB03E Plasma Repair Kit
 Suitable for LG 42PX3RV / 42PX3DCV...etc
 Philips 42PF5520...etc
 Sony 42PV1 / 42PV1P / 42PV1A..etc
 Contains : 6871QCH053G (Control) , 6871QYH036D
 (Y SUS) 6871QZH041B (Z SUS)
Order Code : LG6871VSNB03E
Price : £ 30.00 + vat

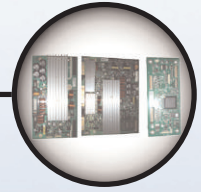

6871QDH066B PWB(PCB) Assembly
 6871QDH066B PWB (PCB) Assembly
Order Code : LG6871QDH066B
Price : £ 45.00 + vat

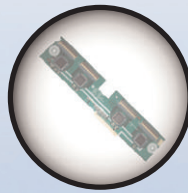
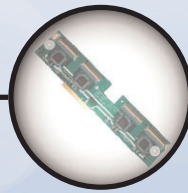

6871QDH067B PWB(PCB) Assembly
 6871QDH067B PWB (PCB) Assembly
Order Code : LG6871QDH067B
Price : £ 45.00 + vat

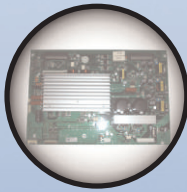

6871QYH029A PWB(PCB) Assembly
 6871QYH029A PWB (PCB) Assembly
Order Code : LG6871QYH029A
Price : £ 125.00 + vat

6710V00151Y Remote Control
 6710V00151Y Remote Control
Order Code : LG6710V00151Y
Price : £ 15.00 + vat



LCD Invertor Boards

Part Number	Code	Price
6632L-0048C.....	INV02.003KR	£120.00
6632L-0066B.....	INV02.004KR	£105.00
6632L-0106A.....	INV02.010KR	£170.00
6632L-0117H.....	INV02.001KR	£105.00
6632L-0120E.....	INV02.002KR	£105.00
6632L-0189A.....	INV02.005KR	£97.00
6632L-0191A.....	INV02.007KR	£205.00
6632L-0193A.....	INV02.009KR	£310.00
6632L-0201B.....	INV02.008KR	£110.00
6632L-0211A.....	INV02.006KR	£80.00
6632L-0213A.....	INV02.011KR	£190.00
AB-A501-7.....	INV04.001R	£22.00
AB-A501-7-01.....	INV04.002R	£22.00
AB-A501-7-01.....	INV04.022R	£22.00
AB-A502-16.....	INV04.003R	£27.00
AB-A504-17.....	INV04.004R	£37.00
AB-A504-18.....	INV04.005R	£37.00
AI-0021.....	INV06.012R	£22.00
AI-0059.....	INV06.013R	£27.00
AI-0067.....	INV06.014R	£27.00
AI-0068.....	INV06.015R	£32.50
AI-0093.....	INV06.016R	£35.00
AI-0095.....	INV06.017R	£27.00
AI-0097.....	INV06.018R	£27.00
AIP-0108.....	INV06.019R	£27.00
AIP-0108.....	INV06.020R	£21.00
AIP-0122.....	INV06.021R	£27.00
AIVP-0006.....	INV06.026R	£40.00
AIVP-0001A.....	INV06.022R	£33.00
AIVP-0003.....	INV06.024R	£33.00
AIVP-0003 A.....	INV06.025R	£33.00
AIVP-0009.....	INV06.027R	£40.00
AIVP-0017.....	INV06.028	£40.00
AIVP-0017.....	INV06.028R	£40.00
AIVP-0017.....	INV06.029R	£40.00
AIVP-0026.....	INV06.030R	£48.00
AIVP-0026A.....	INV06.031R	£48.00
AIVP-0032.....	INV06.032R	£40.00
AIVP-0035.....	INV06.033R	£75.00
DAC-12M018B1F.....	INV03.001R	£62.00

Part Number	Code	Price
DAC-12M019A0F.....	INV03.002R	£66.00
DAC-12M019C0F.....	INV03.003R	£66.00
LI-2206.....	INV06.006R	£18.00
LI-1045.....	INV06.001R	£14.00
LI-1047.....	INV06.002R	£14.00
LI-1048.....	INV06.003R	£14.00
LI-2165.....	INV06.004R	£12.00
LI-2205.....	INV06.005R	£18.00
LI-4018.....	INV06.007R	£16.00
LIV-1050.....	INV06.008R	£12.00
LIV-2209.....	INV06.009R	£12.00
LIVP-6009.....	INV06.010R	£30.00
LIVP-6010.....	INV06.011R	£30.00
QF131V1.00.....	INV04.006R	£44.00
V0.21148.101.....	INV01.045R	£16.00
V0.88070.001.....	INV01.011R	£82.50
V0.88070.101.....	INV01.012R	£82.50
V0.89144.001.....	INV01.046R	£87.00
V0.89144.102.....	INV01.001R	£74.00
V0.89144.103.....	INV01.015R	£87.00
V0.89144.303.....	INV01.007R	£87.00
V0.89144.401.....	INV01.004R	£82.50
V0.89144.402.....	INV01.016R	£82.50
V0.89144.601.....	INV01.018R	£82.50
V0.89144.602.....	INV01.005R	£82.50
V0.89144.603.....	INV01.006R	£82.50
V0.89144.C02.....	INV01.009R	£87.00
V0.89144.C06.....	INV01.008R	£87.00
VIT70002.50.....	INV05.007R	£70.00
VIT70002.51.....	INV05.008R	£73.00
VIT70002.51.....	INV05.009R	£55.00
VIT70002.60.....	INV05.010R	£56.00
VIT70002.61.....	INV05.011R	£52.50
VIT71008.90.....	INV05.001R	£57.00
VIT71008.91.....	INV05.002R	£59.00
VIT71008.92.....	INV05.003R	£57.00
VIT71008.92.....	INV05.004R	£80.00
VIT71010.53.....	INV05.005R	£84.00
VIT71010.53.....	INV05.006R	£75.00
VK.21148.101.....	INV01.002R	£16.00

Part Number	Code	Price
VK.88070.101.....	INV01.041R	£82.50
VK.88070.102.....	INV01.042R	£82.50
VK.88070.702.....	INV01.039R	£65.00
VK.88070.703.....	INV01.040R	£65.00
VK.88070.901.....	INV01.003R	£65.00
VK.88070.S01.....	INV01.031R	£92.00
VK.88070.S02.....	INV01.032R	£92.00
VK.89144.103.....	INV01.044R	£87.00
VK.89144.701.....	INV01.022R	£87.00
VK.89144.A01.....	INV01.019R	£82.50
VK.89144.C03.....	INV01.010R	£87.00
VK.89144.E01.....	INV01.020R	£82.50
VK.89144.H02.....	INV01.026R	£87.00
VK.89144.H03.....	INV01.029R	£87.00
VK.89144.H05.....	INV01.027R	£87.00
VK.89144.H05.....	INV01.028R	£87.00
VK.89211.001.....	INV01.030R	£87.00
VK.8A183.001.....	INV01.037R	£100.00
VK.8A183.041.....	INV01.033R	£92.00
VK.8A183.081.....	INV01.038R	£100.00
VK.8A183.F01.....	INV01.034R	£92.00
VK.8A183.M02.....	INV01.035R	£140.00
VK.8A183.P01.....	INV01.036R	£250.00



Intergrated Circuits & Transistors

STK 392- 010 £ 7.00 + vat each Buy as a pair £ 6.00 + vat each	STK 392- 040 £ 8.00 + vat each Buy as a pair £ 7.00 + vat each	STK 392- 110 £ 7.00 + vat each Buy as a pair £ 6.00 + vat each	STK 392- 120 £ 12.00 + vat each Buy as a pair £ 10.00 + vat each	2SK 2651 £ 3.25 + vat each 5 or more £ 2.50 + vat each	2SK 3568 £ 3.00 + vat each 5 or more £ 2.50 + vat each
BU 4508DX £ 1.50 + vat each 5 or more £ 1.00 + vat each	FAN 7382 £ 2.50 + vat each 5 or more £ 1.75 + vat each	FDS 4559 £ 2.00 + vat each 5 or more £ 1.50 + vat each	FQPF9N50 £ 3.00 + vat each 5 or more £ 2.25 + vat each	FSD 200 £ 1.50 + vat each 5 or more £ 1.00 + vat each	ICE1PCS02 £ 4.00 + vat each 5 or more £ 3.00 + vat each
L 6562D £ 2.50 + vat each 5 or more £ 2.00 + vat each	P1014AP06 £ 6.00 + vat each 5 or more £ 5.00 + vat each	PC 817 £ 0.50 + vat each 5 or more £ 0.40 + vat each	STRG 6353 £ 4.50 + vat each 5 or more £ 4.00 + vat each	TLP 351 £ 2.50 + vat each 5 or more £ 2.00 + vat each	TPA 1517NE £ 6.00 + vat each 5 or more £ 5.00 + vat each

Plasma and LCD Wall Brackets

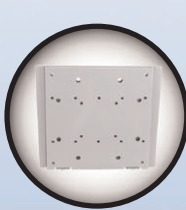

Simply fit one piece to the wall and other to the LCD and then simply slide the two pieces together
 Suitable for screen sizes 14" - 37"
 VESA 75 , 100 and 200 compatible
 Max Load 25kg

Order Code : LCDBKT15S
Price : £ 11.00 + vat
 Carriage Charged at £ 5.00 + vat

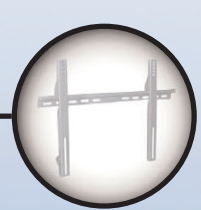

Simple but very robust wall bracket for mounting Plasma or big LCD televisions to the wall in one fixed position
 Display Size : 30"-50" - Max. weight : 60 kg
 Colour : Silver
 Distance between TV and wall 2,5 cm

Order Code : PLASBKT10S
Price : £ 20.00 + vat
 Carriage Charged at £ 5.00 + vat

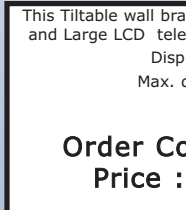

This Tilttable wall bracket can be used with most Plasma and Large LCD televisions with a 15 degree tilt action
 Display Size : 30" - 60"
 Max. display weight : 75kg
 ±15° Tilt

Order Code : PLASBKT1S
Price : £ 35.00 + vat
 Carriage Charged at £ 5.00 + vat

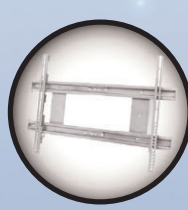

This plasma bracket can be used with most plasma and LCD televisions, due to its universal mounting possibilities
 Safe and heavy duty construction and easy installation
 Tilttable : No
 Display size : max. 61" (155cm) - Max. Weight : 80kg

Order Code : PLASBKT4S
Price : £ 35.00 + vat
 Carriage Charged at £ 5.00 + vat

HDMI Cables & Accessories

	Gold Plated Terminals - Double Shielded Cable - Supplied in attractive retail packaging		
<u>Length</u>	<u>Code</u>	<u>Price</u>	<u>Bulk Price</u>
1.5 m	HDMI1/Q	£12.00 + vat	£8.50 +vat
3 m	HDMI3/Q	£15.00 + vat	£10.00 +vat
5 m	HDMI4/Q	£20.00 + vat	£15.00 +vat
10 m	HDMI6/Q	£30.00 + vat	£20.00 +vat
15 m	HDMI7/Q	£50.00 + vat	£30.00 +vat
20 m	HDMI8/Q	£65.00 + vat	£38.00 +vat

Carriage charged at £ 2.00 + vat or £ 5.00 + vat for 3 or more

Bulk prices apply when 3 or more of the cables are purchased

Split a single HDMI signal without loss or quality of signal
 Supports HDCP , 720i, 720P and 1080P resolutions
 Available in 2 , 4 and 8 way
 For an optimal sound and image use the high quality HDMI cables above

<u>Item</u>	<u>Code</u>	<u>Old Price</u>	<u>New Price</u>
2 way	HDMIDIST2	£100.00 + vat	£65.00 + vat
4 way	HDMIDIST4	£150.00 + vat	£80.00 + vat
8 way	HDMIDIST8	New Item	£200.00 + vat

Carriage at £ 5.00 + vat

Grandata has moved !!

As part of our continued expansion , from the 1st January 2008 will be operating from our new premies in Ruislip.

Please make a note of our new address & contact numbers.

* Please add £1 p+p and VAT to all orders (Unless Otherwise stated) * All components are brand new * We accept payment by Credit Card ,Cheque & Postal Order * All prices quoted are subject to availability and may be changed without prior notice

E & OE

Unit D2 Braintree Industrial Estate ,
 Braintree Road ,Ruislip ,Middlesex ,HA4 0EJ

A review of the 'Blue ESR Meter' kit

by Geoff R Darby

For some years now, I have had a Bob Parker digital ESR meter in daily use in my workshop, and it has proved to be one of the most useful instruments that I have ever owned and used. It paid for itself within a few days of having it, and has continued to do so many times over, since.

It was originally designed by Bob in Australia, way back in 1996. Housed in a very solid – if a little utilitarian – case of approximately 7x13x4cm, the Mk I meter had a two digit red seven segment display, two 4mm sockets for test leads, and a single push button to perform on/off switching, and test lead resistance compensation (zeroing) functions. The majority of the front panel was taken up with a chart of expected worst-case ESR values for new capacitors.

The meter was capable of reading

ESR or low resistance values from 0.01Ω to 99Ω auto-ranging, using a low AC test voltage at approximately 100kHz, which made it able to test capacitors 'in circuit', without turning on semiconductor junctions in nearby circuitry. The ESR calculation and display control was carried out by a Z86 series microprocessor IC.

Sadly, Dick Smith Electronics, who had for several years been marketing kits for this meter world wide, stopped producing kits of all descriptions, which has made the Mk I meter difficult to obtain recently.

However, a while back, Bob hinted that an updated version of his meter might soon be released, with a new US based company handling kit production and sales. That company turned out to be AnaTek Corporation in New Hampshire [1] and the new version was to be called "The Blue ESR Meter", named for its

blue case, and lower power consumption blue LED displays. Other changes included a redesigned PCB, and a better regulator allowing the unit to work down to a battery voltage of just 5.5V. There are a couple of other differences as well, that I will come to later.

Arrangements were made with John Bachman at AnaTek, to supply a review kit, and this arrived just a couple of days later.

The box of bits

The kit comes packed in a stout cardboard box, and comprises several clear plastic bags containing 'general' components, an antistatic bag containing the ICs, a wrapped PCB, a wrapped case, a couple of leads, and a couple of labels – see Fig. 1.

The first thing that strikes you, is that there are no printed instructions. Instead, there is a paper slip directing you to the AnaTek website, where the latest version of the assembly / troubleshooting manual is freely available for download. At just over 1.6MB, this should not present a problem, but if you are limited to a dial-up connection, it will take you a few minutes to download. If you are seriously considering purchase of this kit, I would recommend downloading a copy in advance, to give you an idea of just what you would be buying.

The manual

The front page shows a picture of the completed meter, along with a list of



Fig. 1

features and specifications, and contact information for AnaTek Corporation. The next page is a computer-drawn circuit diagram for the meter, which is very clear, and fully annotated. The next page has a table listing all of the components in the kit, and the recommended assembly order. At a first look, I found this table confusing. It only made sense after reading the construction notes further on. Also on this page, is a list of the colour codes of all the resistors used, and some pictures and diagrams to help with identification of the transistor pinning and discrete LEDs used as decimal points.

The next page has a large and clear component overlay diagram for the PCB, and some notes about construction techniques and potential pitfalls. The following page starts on detailing the actual construction, and after reading the paragraph “Component Installation Sequence”, the previously mentioned table makes some sense.

There then follows some valuable advice on correctly identifying the various resistors used, some of which have a marking scheme which may be unfamiliar to you.

The next three and a half pages detail the actual construction, test and setting up, with good quality photos of each stage of the process. Remember that this is a pdf document, so if you want any of the photos larger to verify your work, you can simply ‘zoom in’ as far as you need to, without losing resolution. There then follows one and a half pages on the concept of ESR measurement, and how to use the meter for that purpose, as well as detailing some other uses, such as tracking down shorts on PCBs, and using it as a simple signal injector.

The final couple of pages detail how to use the built in diagnostics to trace problems with your construction, if the meter doesn't

work when you've finished building it. This section also contains information on a couple of modifications that you might want to carry out, with web references on where to find them, as well as additional help and usage hints.

All in all, I found the manual to be a well thought-out and presented document, which should allow anybody with reasonable soldering and constructional skills with this kind of project, to be confident that they will produce a working meter from the kit.

reference, on the overlay diagram.

From the overlay, it is then a simple matter to find the component location on the actual board, where the silk screened legend marks the component by value. This conveniently gives you a secondary check that the part you originally selected by value, is being correctly placed on the board. As each component was fitted, I scribbled it out on the overlay diagram, and ticked it off on the parts list / assembly table – see Fig. 2, taken after the 1% and 5% resistors had been fitted.

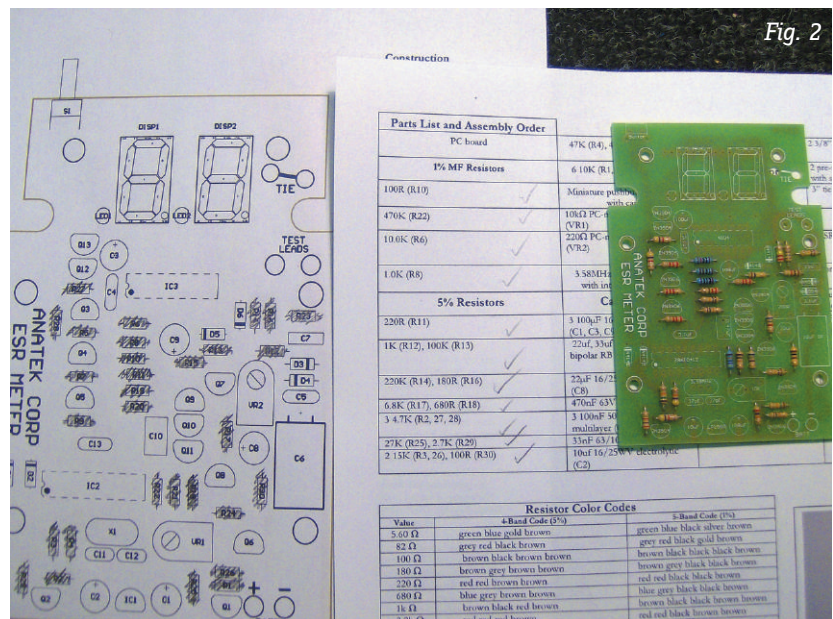

Fig. 2

And so, on to the build

Before starting to build the kit, I spent a while considering the best way to go about it, with a view to minimising the chance of errors creeping in. To this end, my first move was to print off an extra copy of the component list / assembly order, and component overlay sheets.

The assembly order table reads in columns from top to bottom, and left to right. It gives the component reference and value of each item to be fitted, starting with the 1% resistors, then the 5% ones, then the capacitors and so on. Once the appropriate component had been selected from the bag containing that category of parts, I then located it by component

A word of caution on selecting the resistors. The 1% type that's supplied, is quite difficult to 'read' for value by its stripes, and the assembly notes make reference to this. Although there is a special chart that clearly details the stripes to be found on each value of resistor supplied, I would strongly recommend that an Ohm meter is used to select the 1% ones. There are only four, but three of them are 100Ω, 1k and 10k, and it is very easy to mis-read brown stripes for black, and vice versa with the 5 band marking system that's used. It's actually not a bad idea to check all of the resistors by meter as you select them. No matter how good your eyes are, it's still easy to mis-read red for

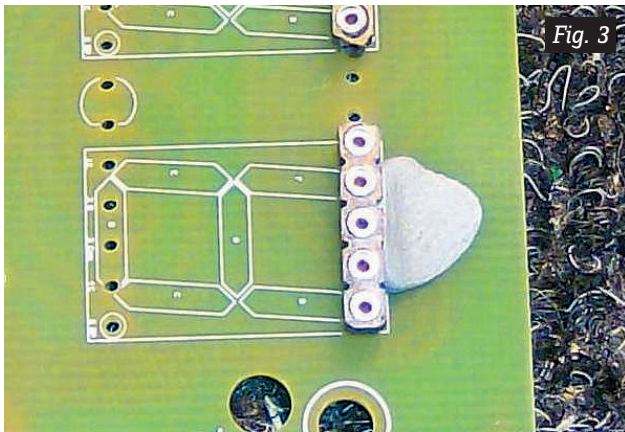

Fig. 3

orange, and for the few extra seconds needed to check each one by meter, you might save a lot of time re-checking your work, when the project doesn't work ...

Installation of the capacitors was quite straightforward, noting of course that the electrolytics have polarity, and must be mounted the correct way round, with the exception of C6, which is a bipolar type that can be fitted either way round.

The two types of transistor (2N3904 and 2N3906), did not have preformed leads on the ones supplied with the review kit, so had to be spread into a triangle to match the holes in the board. I understand that on the latest version of the PCB, the holes are now in line, and spaced to match the transistors being supplied. The D-line shape of the transistors, and their type numbers, are clearly marked on the board, to ensure that you get them the right way round. The diode positions are also clearly marked for type, and orientation, so should not cause any confusion.

The seven segment displays plug into socket strips. Fitting these strips is one of those jobs that needs three hands. The strips have to be completely flat to the board, and upright, to allow the displays to insert easily. It's hard to achieve this, when the board is upside down, and you're trying to stop the strips falling out, whilst attempting to tack-solder

board marking is not very clear on these, showing only a circle with a flattened side. The LEDs supplied, did not have a 'flat' on them, just the usual long and short leads.

There is a photo of the LED in the assembly manual, with an arrow pointing to the short lead. The accompanying text says, helpfully, "short lead" ...!! There is a note in the instructions, which says that the short lead should go towards the displays, so 'flat' = short lead. I feel that it would have been better if the board's silk screening showed either a diode symbol, or marked the holes as "a" and "k", with the manual photo relating this to the long and short leads, which LEDs always have.

When it comes to fitting the ICs, the manual copy which I downloaded, made reference to soldering in sockets for the ICs to plug into. It would seem that this is a 'leftover' from the Mk I meter, which did use sockets. In the "Blue" meter, the ICs are soldered directly into the board. I don't have a problem with this, but I can imagine that some constructors might prefer to have sockets in case they ever have to replace a chip. There should be no problem with fitting sockets, if that's what you wish, but I would recommend only using good quality 'turned pin' types.

The test leads are supplied ready assembled, and have to be fed through grommets in the case end panel, before being soldered straight

a pin! The job was made much easier by first securing the strips with a blob of Blu Tack – see Fig. 3.

Two discrete LEDs, which serve as decimal points, have to be fitted near to the displays. The

to the board, and tie-wrapped for strain relief. More on this arrangement later.

Except for the fitting of the ICs, which the instructions recommend that you don't do at this point, the basic electronic construction is now complete, and it's time to carry out some checks on your work so far. These involve measuring the current that the board draws, and checking the output from the regulator, and are fully detailed in the assembly instructions. Assuming that all is well, the ICs are now fitted. When the battery is reconnected, and the button pushed, a '-' should appear in the left hand display. And that's it for the construction, apart from fitting the board into the case.

Fig. 4 & 5 show the finished board, front and back, to give you an idea of what's involved, and the soldering skill level required.

If when you have finished construction, your meter does not work, there are some inbuilt diagnostics, which make use of the microprocessor and display, to help you troubleshoot the problem. Note, however, that the meter cannot be powered from its internal battery when using these, otherwise an "F2" error will always be returned.

My unit worked first time, so I did not have the opportunity to evaluate this feature, but I feel that it could be very useful to help find any errors that do creep into your work, or at a future date if a fault were to develop within the meter due to an unfortunate 'accident' – yes, even the most experienced of us have them...!

Calibration

There are two precision resistors supplied with the kit, in a bag marked "For alignment and test". These are used to adjust VR2 for accurate readings at either end of the measurement range. The procedure is fully detailed in the manual, and easy to do.

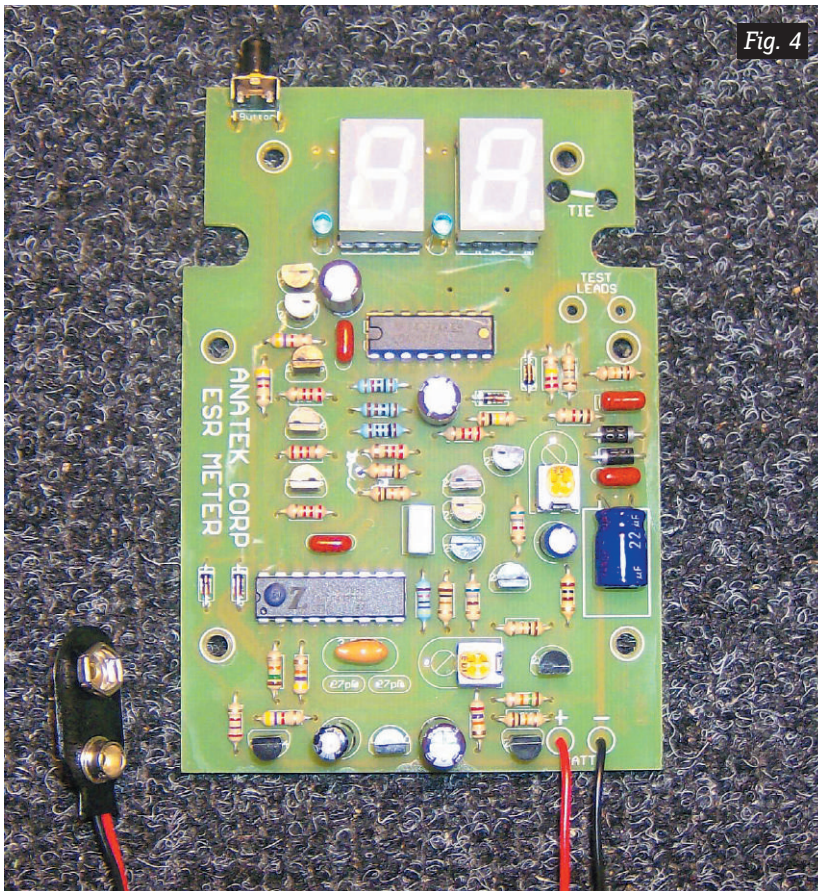

Fig. 4

The final adjustment is VR1 which sets the point at which a “battery low” warning is displayed. The easiest way to adjust this, is with a bench variable power supply and a digital voltmeter. If you don’t have such a supply, the notes detail a simple circuit using a transistor and a pot, to obtain a suitable variable source. Again, the adjustment procedure is fully detailed, and easy to do.

Final assembly

Once the calibration has been taken care of, the board can be assembled into the case with the six (not four as the manual says) screws, taking care to route the battery lead into the battery compartment. Finally, the top half of the case can be fitted, and the ESR ‘graph’ sticker attached.

In use

Anyone who has ever used an ESR meter, would probably agree that it is a ‘bit of a black art’. Finding caps that are bad, is as much intuition, as science, but a good ESR meter can certainly help to confirm your suspicions. To this end, the Blue ESR Meter is a creditable performer. With its auto-zeroing function, and clear digital display, it is very easy to use, as was the Mk I version. Although a degree of interpretation of the displayed value is still required, I think that this is easier to do when presented with an absolute value, rather than having to read it off an analogue meter scale. The graph of expected values on the front panel, is a useful guide to what a good capacitor should read, but for anyone who has never used an ESR meter, a good exercise would be to sit down for an hour with every new and used electrolytic that you can lay hands on, and just check them all to see the sorts of ranges of value that you get.

As with the Mk I version, capacitors can be checked ‘in circuit’ without nearby semiconductor junctions turning on and affecting

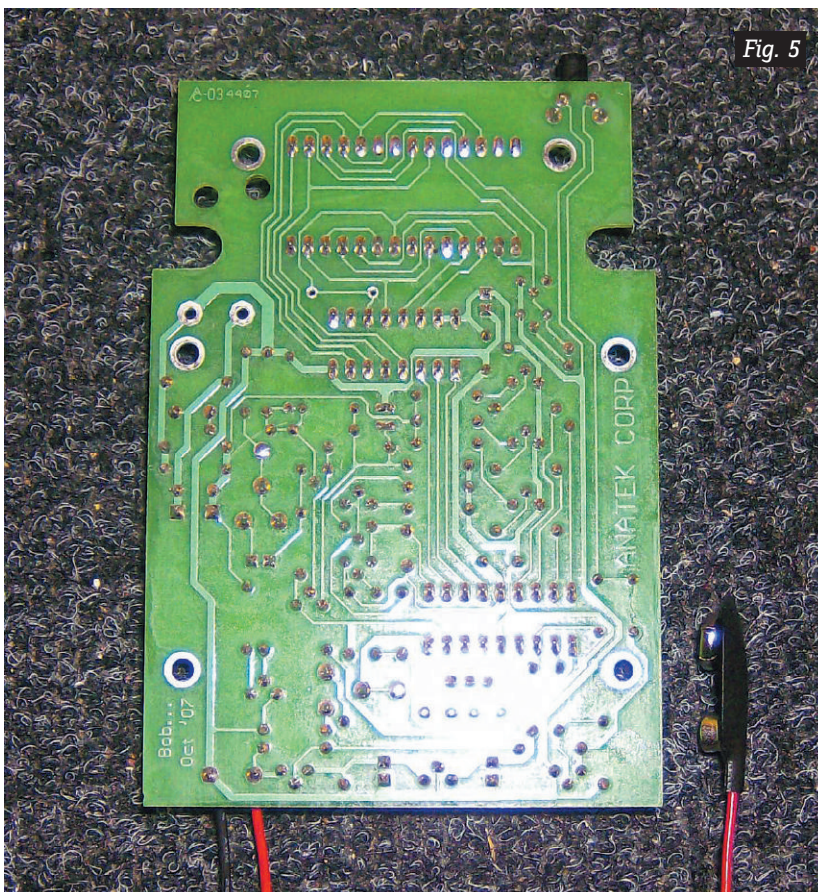

Fig. 5

the readings. A word of warning here though. The equipment that you are doing the test on must be switched off, and the capacitor that you are checking must be discharged. This is especially important for capacitors on the high voltage 'primary' side of switch mode power supplies, as there is no protection against high voltage abuse within the standard meter. There are, however, modifications available to implement a degree of protection at the expense of some functionality, when using the meter for purposes other than plain capacitor ESR measurement (checking the internal resistance of batteries, for instance). There is plenty of information available on protection, and 'alternative' uses of the meter in the manual, and on AnaTek and Bob's websites [1], [2]

Some practicalities

The evaluation kit that I was supplied with, came with shrouded 4mm plugs on the ends of the test leads. The thinking behind this, was that you would be able to use your favourite set of test probes with the meter. However, not a single set of any of the leads on my other workshop test meters, fitted onto these plugs. Suitable probes and clips are available as an extra, and John did send me a set of each to evaluate with the meter. They were very nice quality, but it still seemed to me that I would have liked the meter to have been 'ready to use' with suitable probes.

I have since been advised that this has been addressed by AnaTek, and the kit now uses a different 4mm connector on the leads, and comes complete with a set of test clips. As in my experience, an ESR meter is most used for measuring caps in-circuit, I think that supplying sharp-tipped probes would have been a better option.

If I am honest, on balance I preferred the 'standard' 4mm banana

sockets, which were fitted to the Mk I meter. These allowed virtually any test lead set – for instance the very good ones that I bought from Maplin – to be used. I can, however, see how there might be practical difficulties with fitting conventional test lead sockets to the front panel of the Blue ESR Meter.

My other slight niggle – and again, this is one of purely personal preference – is the front panel graph of expected values of ESR, drawn as five lines, each of which represents a range of capacitance values, plotted against the rated voltage of the capacitor under test.

Whilst this graph tells you exactly what you need to know, I feel that the original numerical chart on the Mk I meter, was marginally easier to read and interpret, given that the meter does have a digital readout.

Conclusions

So, do you need an ESR meter, and if so, should it be this one? Well, if you are engaged professionally, or even casually, in the repair of modern electronic equipment, where failure of electrolytic capacitors, particularly in switch-mode power supplies is extremely common, then I think that an ESR meter is a 'must have'. It can save many hours of frustrating dead ends, as faulty caps often show no external signs of distress, and maintain a correct capacitance value, even though their ESR may be 'out of the window'. For the hobbyist, it is probably more of a 'nice to have' instrument, bearing in mind that it is also a very good low ohms meter. Remember though in this regard, that it uses a high frequency test voltage, so is no use for measuring the DC resistance of coils and chokes. This AC test voltage does, however, allow the meter to be used as a very basic signal injector for AF testing, with RF harmonics of useable amplitude, extending out to 30MHz or so.

The second part of the question is a little more difficult to answer. There are a number of competing ESR meters on the market, at various price points. I think that the Blue ESR Meter kit, available from UK based company SOTA Beams [3] at £59.95 including EU postage, represents extremely good value for money.

If you are new to ESR measurement, then I can thoroughly recommend the "Blue" as a worthy successor to the original Mk I, which I always rated as being the easiest to use that I had come across.

As well as the value and user-friendliness of this meter, together with the large on-line community of users, the fact that it is available as a kit, is an added bonus for those who like to 'roll their own'.

It is an easy kit to build, and the satisfaction of producing a useful fully featured instrument at the end, is huge. If you are not confident enough to build a kit, all is not lost, as it is also available from SOTA Beams ready built, tested and calibrated, for £75.00, again including EU postage.

Acknowledgements

My thanks are due to John Bachman of AnaTek Corporation for supplying the evaluation kit, and to Bob Parker for taking the time to detail the differences and modifications over his original design, for me.

Web references

- [1] AnaTek Corporation, New Hampshire, USA www.anatekcorp.com
- [2] Bob Parker
<http://members.ozemail.com.au/~bobpar/esrmeter.htm>
(note: the "~" in the URL for Bob is important)
- [3] SOTA Beams Macclesfield UK
www.sotabeams.co.uk/BLUEESR.htm

LCD training for young offenders

by Fawzi Ibrahim, KFI Consultancy and Training

Something that we rarely hear about is the training and education for the 100,000 or so people incarcerated in our ever expanding prisons. I had an opportunity to see what goes on behind the high walls of one of the larger prisons, Mooreland Youth Offenders in Doncaster, when I spent two days delivering a course on servicing LCD televisions to those responsible for servicing the services' television sets. Although Mooreland is a low security prison, for an outsider, security was high with everything examined and checked. They even looked under the bonnet of my car. Mobile phones are taken away as, I was told, they are worth a few thousands pounds inside. The large empty spaces inside, the high imposing outside walls and internal fences, the discreet barbed wire, the tidiness and cleanliness, the silence interrupted only by the clanging sound of metal doors opening and closing gave the place a strange and eerie feeling. The surreal atmosphere was strengthened by the absence of curvature. Everything was at sharp/right angles: the imposing tall entrance, the wings housing the



inmates, the exercise yards and the open spaces not to mention the vast number of corridors.

The large servicing workshop doubles up as a training centre for the 450 inmates, average age, 22 years. The training in LCD became necessary when HMPS decided on an 18-month phase-out of its CRT receivers, replacing them with LCD sets. The 2-day course was thus devised to meet their needs covering the basics of LCD panels, their operation and drive requirements, video processing and formatting as well as digital reception including HDTV.

At the end of the two days, we looked at a faulty LCD receiver. Symptom: sound OK, no video. There was no sign of life on the screen on switch on. We placed a probe in the vicinity of the LCD backlight tube connector. The probe should pick up the 2000 odd volts, 50kHz driving signal. There was no indication of a signal on the oscilloscope. The AC-DC inverter was thus identified as the cause of the fault. A further confirmation would be to ascertain that a video signal was present right up to the LVDS connector.

While the service industry is in

decline in our current wasteful throw-away culture, in Mooreland TV workshop, nothing is wasted. When I say nothing, I mean nothing including the casings, and scan coils not to mention printed circuit boards. Everything is either used within the workshop or sold for re-cycling. The workshop is responsible for looking after 80,000 television receivers, mainly small 15 inch sets, scattered across the UK. The training is hands-on, learning-by-doing and inmates are encouraged to take a City & Guilds qualification.

Listening to the manner in which, on arrival, all inmates are given an assessment of their educational and medical needs and the manner in which they are provided with help in improving their literacy and the opportunity for training in a variety of skills including one-to-one tuition where necessary, I couldn't help wondering that had such help been available to these young people before they strayed into drugs, crime and anti-social behaviour, they might not have gone inside in the first place. But things being what they are, I have nothing but admiration of the hard work and dedication of those who work in the prison education service.

Pipped at the post!

Part 2 of Donald Bullock's story of a superior audio recording system that lost its way

The year was 1930, and J A Miller, of Flushing, New York, in his quest for a superior sound recording system, was comparing the two existing systems with which he was familiar – those of the new ‘Talkie’ movie-films, and the shellac-based 78 rpm gramophone records of the day.

Movie sound tracks

He considered that the optical film movie-track system was burdened by the limited emulsion technology of the day, the limitations imposed by the film’s essential light-sensitivity during recording (which dictated the exclusion of any extraneous light), and the complexity and bulk of its photo-electric recording method. He added to this the time-consuming necessity of chemically developing, ‘fixing’, washing and drying of both the negative and the positive films before its sound track became accessible.

But the system had one cardinal advantage, and this lay in the fact that it offered lengthy continuous recording possibilities, making it eminently suitable for recording, say, a lengthy classical music rendering or a long wireless programme in their entirety. Further, the film, after its albeit lengthy processing, could be easily edited, the speed of the medium could be varied according to the required frequency response, and it remained linear throughout the length of its recording.

Gramophone records

The gramophone record system he considered to be riddled with disadvantages. It was capable of only

very short recordings; three minutes on a ten-inch disc and five minutes maximum on the more cumbersome twelve inch disc. And its discs were easily breakable. As was the case of the movie-film system, the sound captured by the gramophone system was unavailable until the ‘Master’ wax had been plated by electrolysis, moulds made, and discs pressed from them.

Further, the gramophone record process scarcely lent itself to editing at any stage. Any such attempts would entail skilful and time-consuming re-recording and more lengthy re-processing stages which would compound their distortions and markedly increase their background noises.

Progressive deterioration on playback

Another negative factor was that sound taken from the gramophone records of the day deteriorated progressively from the start of a record to its finish. There were two separate reasons for this. One was caused by a characteristic in the recording of the sound, and aggravated in the playback, and the other was caused not by the recording method, but by the design of the playback machines.

The first deterioration is the progressively falling frequency response of the sound, and this is easily understood when it is borne in mind that this is related to the speed at which the medium – in this case the record groove – passes the cutting stylus. At the outer edge of the continuous groove, at the beginning of the record, each revolution presented over 30 inches of track to

the cutter, but as the track wound towards the record’s centre the track length progressively diminished to a minimum of perhaps about ten inches. Thus, the frequency response of sound progressively reduced as the record spun and the deterioration was evident upon its playback.

The second is to do with the difference between the cutting of the record and its playback. In the cutting of the record, the wax-cutting stylus was mounted on a rod which traversed the central diameter of the wax platter, and was gradually directed along the rod (i.e. across the wax) by a progressing worm-threading action. Thus, during the disc cutting, the travelling stylus remained strictly at right angles relative to the groove.

But on the domestic playing machines – the gramophones – this ideal arrangement was dispensed with in favour of a cheaper, less scientific, and simpler method – that of mounting the sound-box on a swinging-arm whose other end was secured to a fixed pivot, so that it gathered its sound in a fan-shaped sweep at a progressively varying angle.

The effects of this were twofold when the disc was played. The first was that it imposed a phase distortion by seeking to recover the modulated signal with an increasingly skewing sound-box as opposed to the right-angled cutter, whilst the second will at once be apparent to anyone who has ever played a shellac record with the usual hardened steel needle.

The needle progressively wears as it plays the record, and the wear can be easily seen by merely looking at its



Leica Model 3f Camera



Oscar Barnack, the Leica's designer



35mm film with Optical Sound Track



Django Reinhardt, the gypsy genius

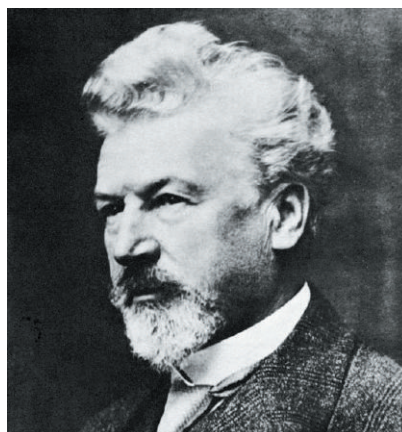

Ernst Leitz



Original Edison Cylinder Phonograph



An original HMV Horn Gramophone



Close-up of Shellac 78 rpm Record Label



Shellac 78 rpm Record

tip after it has played one side. It resembles a tiny razor-sharp chisel, and to use it to play a second side would ensure serious and irredeemable damage to the record track. But to refer only to the first side being played: with the needle's progressive wearing to its chisel-edge all the time, and with its angle of presentation to the groove increasing with each revolution, the groove walls are being progressively gouged by the needle as it travels towards the centre of the record.

Miller's conclusions

In his final evaluation of the two systems, Miller sifted their qualities and faults. He favoured, for all its faults, the recording principle of the gramophone record's stylus-cut sound over the optical-track film system, but strongly disfavoured the restrictive and damaging impositions of its other characteristics.

However, he was impressed by the film sound track's capability of producing lengthy recordings, and

their editing propensities, but was seriously concerned by the numerous problems inherent in their photographic emulsions, and also their cumbersome and time-consuming methods of recording and recovering the sound.

If only he could conceive a way of merging the best of both systems...

Part 3 of Donald Bullock's 'Pipped at the Post' will appear in next month's issue.

The dirty dozen - a recycling problem

by Mike Leach

The disposal of TV sets used to be a straight forward affair. As far as the consumer is concerned, just simply leaving the set by the dustbin on a Friday morning would do the trick. The dustmen would arrive and the bin would be emptied as usual, but the TV would end up in the cab with the driver. Your scruffy pooch would have a good old bark at the back gate and whimper if the dustman didn't give his dumbbell a good old tug through the wrought iron railings. Job done!

Trade disposal was a little different but nonetheless easy. Local councils have always taken great pleasure in penalising the small business and small businesses have always wanted to get one over the council. So, instead of making a trip to the Town Hall to get a signed "chitty" by some crawling beaurocrat, (and paying the earth to do so) TV service departments would go down to the local tip, bung the bloke on the gate a couple of quid and make the short bumpy journey to the designated area of dumping. During this time one would often be forced off the track and overtaken by a council truck laden with bin men gesturing two fingered "Victory" signs at you from the cab windows. You knew when you had reached the dumping area as a large meteor like pit would be visible. The JCB in the distance was always motionless due to the council worker taking a tea break and the stench hit you before you opened the



window. Two of you could jettison the TV some distance after swinging it to and fro a few times; accompanied by a duet of "one-two-three-go!" The TV would bounce and somersault it's way down the pit with three or four scavengers chasing after it to haul it back up again. Happy days eh!

Politically correct dumping

These days there are several options available to discard an unwanted TV set. The consumer just has to take the set down to the local recycling depot and leave it with the recycling "executives" to do with as they please. If you are a trader you still have to jump through hoops at the town hall before you can take it though. Alternatively, if you have a large TV business and a lot of scrap then you have to have a row of multi coloured skips in your car park for the various

component parts of the set to be placed. Therefore you have to strip the thing down first, thereby taking great risks carrying a tube (or the glass of) to the relevant skip for glass only, the cabinet goes in the 'plastic only' skip and the chassis goes under the bench in case you need a part from it next week. I usually find that I only need a part after I've thrown the chassis away. I then spend endless time rummaging through the bin to see if it's still there.

There is another alternative to all this though. Many TV businesses I know of have their very own scrap man. This will be someone who deals in scrap TVs and will take away all of your unwanted write offs in a big van. Unfortunately though, some of these dealers are getting far too fussy. They don't like black cabinets and they don't like 4:3 aspect ratio sets. They don't like older wooden cabinet sets

and they don't like sets that have had the odd panel or two removed. So, out of a possible twenty scrappers they only end up taking twelve away. They pay you a few quid and clear off until the next time you beg them to come again. The eight sets they didn't take either end up back on the pile or you have to find another way of getting rid of them. My mate Mart, who runs a fairly large servicing business has a new scrap man. The trouble is that his van isn't big enough and he has to make two or three journeys just to take everything away. The previous guy, "Snooker Toothed Ronnie" (he only needed a white one for a full set!) would take everything with room to spare. So how do you get rid of the scrappers that the scrap men won't take? Not an easy question to answer. I had a problem myself recently and entered into a course of action which led me to the local dump, where I was greeted with open arms by the local bin men. Well, they certainly paid me a lot of attention!

A trip to the tip

One of my customers' left me with a Sony KV-28LS35 recently. It had suffered the usual problems: flashing red light etc and required a line output transformer. The customer decided they wanted a new, poor quality out of focus LCD set with built in digital blocking. I sent them off to the supermarket and reminded them of where not to call when they got the set home and wanted the focus adjusting!

After a certain amount of procrastination, I decided to play at being Joe Public and took the set down to the tip myself. I followed the directions to "householders waste" off the main road and branched off down a narrow lane and passed by all the signs which are designed to put you off and head in the opposite direction. Bold signs like: "NO TRADE WASTE - VANS, TRAILERS OR TOXIC SUBSTANCES!" Does this mean you

can't dump a trailer or you can't load up your rubbish on a trailer? Never did understand that. There was a line of fourteen huge skips side by side. Thirteen of them displayed a sign saying "DO NOT USE" and about ten cars were jockeying for three parking positions in front of the fourteenth. People were carrying things like heavy sideboards up the rickety metal steps adjacent to the skip and women were losing their shoes in the gaps as they climbed down after dumping their unwanted goods. I decided to wait my turn rather than get into a kerfuffle with other users, most of whom were much bigger beings than me! My turn eventually came round and I parked, got out and opened the tailgate of my estate car. Three dirty looking council workers were leaning against a small cage like skip (for "special" items!) by the portakabin office door, a fourth came up to my car. I decided to adopt "council worker language" rather than put on estuary English.

"What you got fella?" he boomed.

"Old telly boss - where d'ya wannit?"

"A telly eh....what's up wiv it?"

"Barbed and hooked mate," I replied, hoping this would suffice.

"It's what?" he said as the other three workers came over. One of them leaned over and peered into the back of my car.

"Cor, it's a Sony, what's the matter with it?"

"Bloke says it's barbed...better ask him yourself"

"It's barbed and hooked mate...you know..." I tried not to use the expletive and thought of something else: "My engineer man says it's Kaput!"

By this time more workers had come out of the portakabin holding their tea mugs to see what was going on. Ten of them were now staring at my Sony and an eleventh was standing on top of a load of rubbish in a nearby skip. The next time I



looked up a twelfth worker had joined the congregation: a small chap with bottle bottomed glasses and a safety helmet which was far too big for him. Only the lower rim of his spectacles was visible and his luminous yellow jacket was covered in mud. This bloke was obviously the boss.

"What's going on here...is that a Sony?"

"Yes," I replied, "it's broken - doesn't work"

"Praps wants a transformer," said the boss. "My mate can get them cheap". He gestured over towards the small cage like skip and two of the workers whipped it out of my car and placed it carefully into the skip.

I fled before they noticed there was no scart sockets or aerial socket on the back. I'd done my usual and removed the chassis for spares!

I've decided not to take this course of action again. Next time I think I'll put the set at the bottom of my drive with a price ticket on it for £25 and hope that somebody nicks it! Well you see bird tables for sale on driveways.

A couple of days after my adventure at the recycling centre, the customer who wanted the new set rang me up:

"We can only get BBC Parliament and E4; the picture has got square blocks all over it and the sound is like Norman Collier. Can we have our old set repaired please?"

Long-distance television

by Keith Hamer & Garry Smith

Long-distance TV reception during March was extremely quiet when compared with the previous month. Sporadic-E was noticeable by its absence and the generally unsettled weather put the dampers on tropospheric reception.

Reception round-up

While monitoring Channel R2 (59.25MHz) at around mid-morning on March 1st, a flurry of pictures suddenly appeared. The event was brief but the mingling of pictures meant that nothing could be identified. Other Band I channels were blank.

In the Algarve, the exotics began rolling in, according to Hugh Cocks. Spectrum TV, originating from the new crop of Band I transmitters throughout the Cameroon, began appearing daily towards late afternoon on Channel E2 (48.25MHz). Trans-Equatorial Propagation (TEP) usually appears around the Equinoxes, so March and September are the key months to exploit this mode of activity. Unfortunately, TEP is seldom received in northern Europe but it is still worth beaming the aerials to the south and keeping one's fingers crossed.

Hugh went one better with tropospheric reception from Mauritania on the 7th. The weak signal on Channel E10 was identified by comparing it with its satellite counterpart. This is a 'first' for Hugh. The transmitter location is thought to be in the Nouadhibou area with a direct sea-path of around 1,500km from the Algarve.

Sporadic-E reception

The current Sporadic-E season should be in full swing by the time you read

this column, lasting from May until early September. If you haven't yet taken the plunge, all that is required in the way of equipment is a receiver covering Band I channels in the frequency range of 48-70MHz. Some receivers have an extended range up to the FM band. This is useful as there are many Eastern European TV services transmitting between Band I and the FM band. Small-screen receivers with an appropriate tuning range can be obtained relatively cheaply but many users regard them as 'deaf'. Dedicated external tuners, such as the D-100 and D-500, feature variable vision I.F. bandwidth reduction. This makes noise-level images appear more prominent than when viewed via a normal 'wide' bandwidth receiver. The bandwidth can be set for the most pleasing results.

An aerial is required, the minimum being a dipole of around 2.5 metres in total length. Don't be tempted to 'make do' by using any old aerial. For instance, an FM array will not perform very effectively at Band I frequencies.

Further details about DX-TV converters and suitable aerials can be found at www.test-cards.fsnet.co.uk via the Internet or by telephoning 01332 381 699.

Sporadic-E signals arrive at a shallow angle so height is not an important factor but a minimum of around six metres is recommended, clear of local obstructions. If you have the space and means of mounting a rotatable multi-element beam, perhaps atop a simple pole mast, then go for it. An amplifier is not considered necessary as signals can be strong – excessively so in some cases during hectic openings.

Exotic reception

As more countries switch off their analogue outlets there will be a dwindling source of traditional DX signals, but don't let this deter you. For the current Sporadic-E season this summer, the emphasis is on the capture of 'exotic' signals from beyond Europe. The quieter European channels means that the door could be wide open for transatlantic reception, the key areas being South America, the Caribbean, Canada and the USA. But make the effort while you can as the USA will switch off most analogue transmitters in early 2009.

The lowest vision frequency used is 55.25MHz which is shared by European Channel E3 and the American Channel A2.

A Band I dipole with a reflector is adequate for such reception and can be beamed to the west for any signs of activity. Its reasonably wide capture area should be sufficient enough to alert you of signals over a wide arc. Results have been obtained with such an aerial mounted at six metres above the ground. Larger antennas will be more powerful but also more directional so bear this in mind as American and Canadian reception will peak to the north-east.

Transatlantic signals will generally be of the System 'M' standard, namely, 525 lines with a 60Hz field frequency. The vertical hold on the receiver will require adjustment to correct the fast-rolling images. Horizontal hold adjustment is not required as the line frequency is almost the same as a 625-line 50Hz system.

An external tuning system, as

visit our new website at: www.televisionmagazine.co.uk



A Russian TV news reader on 49.75MHz



A normal and reduced vision I.F. bandwidth comparison. The top receiver is fed directly from an incoming noise-level signal while the lower set displays the effect of bandwidth reduction via an external tuner



An aerial for transatlantic reception

described earlier, will help to lift the weaker signals from the noise. Also, a dedicated receiver preset to the 60Hz field frequency is beneficial as emerging images can instantly be recognised without having to fiddle to reset the control.

Remember, patience is required as Sporadic-E reception is totally random. Good luck and please send in any reports of your reception, particularly anything unusual.

Feedback!

Please send news, comments and any off-screen DX-TV photographs, particularly any unusual test cards and captions, to:

Garry Smith, 17 Collingham Gardens, Derby DE22 4FS.
Our E-mail address is: Television@dx-tv.fsnet.co.uk

If you are interested in archive TV, test cards and identification captions, check out our website at www.test-cards.fsnet.co.uk via the Internet.

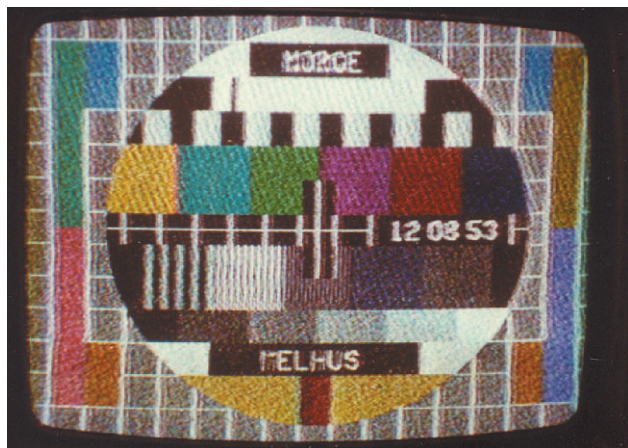

A Norwegian test card with transmitter identification breaks into colour on 48.25MHz

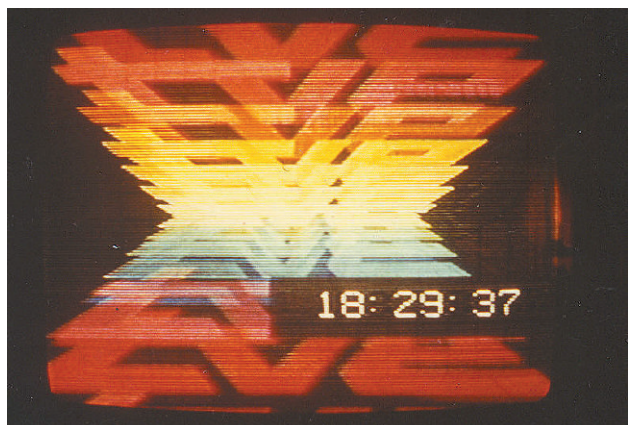

A fiery opening sequence from Spain via Sporadic-E

Day in the life

by Peter Dolman



“So please, oh please, we beg, we pray, Go move your TV set away, And in its place you can install, A lovely bookshelf on the wall.” Roald Dahl, *Charlie and the Chocolate Factory*.

Excuse me for asking, but has anyone seen the going of this so-called information age in which we rejoice? Whilst applauding the fact that 2008 has been named ‘the national year of reading’, I can’t help wondering where (apart from within the cosy confines of the local bookshop) meaningful information is to be found these days. Probably not out there in consumerland, where what passes for validity often turns out to be lightweight twaddle masquerading as wisdom. It seems that as time passes, people become ever more accepting of the pseudo-speak and hopeless helplines on offer, unwittingly gleaning less yet believing they are now informed. In an era rife with hype and confusion, to whom does one turn for clarity? An Engineer perhaps?

Or then again, perhaps not...take the other day for example. I was sitting in semi-darkness, trawling desperately through the ‘Introduction of Operation’ user handbook for a New Eyseshot video projector, whose rf section wouldn’t tune. As I was trying to disseminate the ‘Troubleshooting’ section (‘note: when connecting the power supply, ensure it is off for fear that the inside circuit is impacted directly with by’), old Willie Nutall, master of the misplaced acronym, stumbled uncertainly into my twilight world.

Quick as you could say ‘elf ‘n’ safety, I flicked the lights back on, spotting as I did so that he, too had a dreaded operating instruction booklet flapping in his grippers. “It don’t say what this means” he grumbled, pointing to ‘HD ready’ on its front cover. “Luckily, I knows it means High Density of course, but that’s not the point is it?” I thought about replying but decided

it was too early to enter into the discussion, so gazed thoughtfully down at a crevice in the floorboards instead. “Anyway” he continued, “I puts my old JCB up in the back bedroom, but now we don’t get the Telex proper on him...still, that’s neither here nor there. Thing is, I’ve got an ITT TV that needs a repair, see?”. At that, I pricked up my ears wondering what he meant, but not wishing to appear particularly thick I let him ramble on in the hope for more clues.

Eventually beaten, I ventured “did you say it’s an ITT, Willie?” “That’s what it says on the tin” he replied, making for his car. “Pod won’t work sometimes, guess it serves me right for buying a Jap one” he added mysteriously. Seconds later he returned with a JVC LCD set, emblazoned with the IDTV logo. “Here’s the pod” said Willie, setting the remote handset down. “Will it be PDQ or just your usual ASAP?”

Returning to the projector, I set about the task of removing its casing. Having shoehorned the undersized cover off its bursting interior, it soon became apparent that the manufacturer’s limitations in the linguistic department were eclipsed only by their lack of soldering skills, so after extracting the tuner I cleaned up the pcb and remounted it properly. Then, plunging the workshop into near darkness once more, I navigated through what passed for a menu; just as I found that I was now able to tune

the unit, a loud huff exploded from behind me. “How on earth do you expect a gal to work under these conditions?” came an exasperated voice from out of the gloom. “Not satisfied with deafening me with your so-called essential high power audio checks, you’ve now added engineering by candlelight to your repertoire. What’s your next torture...no don’t answer that, just put the lights up and give me a hand to understand this, will you?”

On her bench sat a Toshiba DVR35 DVDR /VCR combi, which had been producing sound but no vision since the owner’s attempt at tape copying. Dear Heart waved a flow chart in the air like a demented windmill. “I think the owner’s got it into progressive scan mode” she asserted. “But this chart is adding my brain. Look, it asks here; ‘Is there no ‘PSO’ mark on FLT...’ if the answer’s no, do so and so. Well sure as eggs are eggs, PSO is there on the front, so I guess what they’re actually trying to say is ‘Does ‘PSO’ show on the display...’ the answer being yes in this case. But because all flow chart branches that point over to the right are for the response ‘no’, a double negative has been used in the question to get it to fit the layout. Is it me, or is deciphering instructions getting as difficult as understanding the technology? I guess even top manufacturers have their hiccoughs. More to the point, I don’t see why the unit has to have a specific ‘progressive’ button stuck on its front in the first

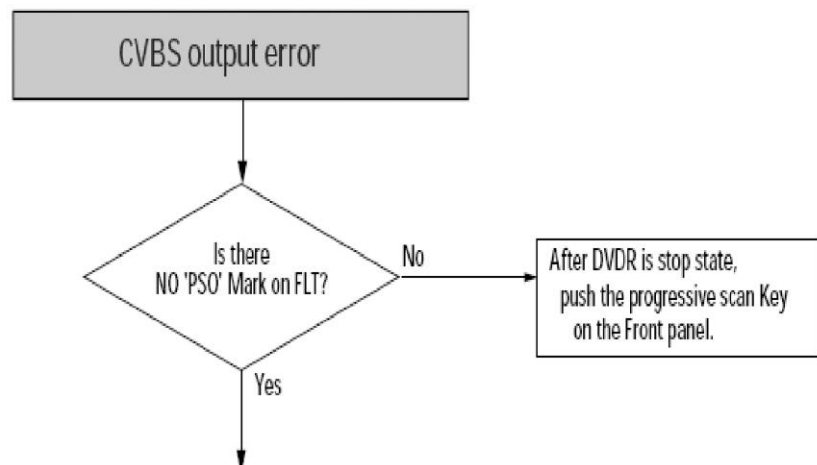

place, isn't that asking for trouble? Surely the option would be better hidden up a blind alley in the menu? And how come the screen goes blank when the poor owner accidentally puts it into progressive scan mode anyway?"

Exhausted from her diatribe she flopped back in her chair looking appealingly sulky. "Well, to answer your last point first, DVD progressive scan signals are available either in digital form from, say DVI or HDMI sockets, or in analogue form from the three Y, Pb, Pr component connectors" I replied. Because Scart doesn't support such signals, the standard 625 line interlaced vision output via that particular form of AV connection vanishes once this particular machine is placed in progressive scan mode". My companion looked nonplussed. "Well in that case, what would be really nice would be the provision of some kind of on-screen alert, via the Scarts and SVHS socket - in 576i format which I believe is now the preferred term - to caution the user who has a conventional set-up that his machine's now operating in progressive mode" she retorted. "Then again, I suppose that's a cost based decision; sort of blokey thing you'd identify with all too readily no doubt".

I pressed on, feigning deafness. "As for your first point, you may be right in saying that it's a bit too easy for the unwary to get these machines into the wrong mode by accident, but I think the button on the front method is preferable to designs that employ switching via the menu. With that approach, once you've OK'd the progressive scan option, your Scart fed on-screen displays can disappear or become shredded, meaning you can't then navigate your way back without connecting a monitor which supports progressive scan". My companion tossed her head airily. "I bet I could" she grinned. "You'd just need a cool head and a good

photographic memory. It's a girl thing don't cha know". She chewed her lip. "Actually, I have to admit to making that very mistake just the other day with a Daewoo DF-4150P VCR/DVDR- you remember, the combi whose owner believed to be endorsed by the BBC, just because it was advertised in the Radio Times! Anyway, that scared the life out of me and I knew you'd blow a fuse over it, so I somehow managed to find my way back to 576i even though the menu was flying all over the screen. Lucky, eh?"

With that she held in the progressive scan button for a few seconds, until 'setup' appeared on the front display. Then, powering the machine off and back on to restore the standard CVBS signal to the Scarts, she set about annotating her flow chart.

I'd just placed Willie's JVC on the bench when the door swung open and the savvy Justin Hope entered, followed by a number of menacing offspring. Striding forward he earnestly clamped his hand to mine, whilst simultaneously continuing a protracted Bluetooth-based conversation. "Yes, why don't we connect ear to ear tomorrow..." he announced into thin air as his unfettered brood began spreading out muddily into the four corners of the workshop. "And as team players, what I'd like is for you to start peeling the onion" he continued bafflingly. "Then we can all harvest the synergies by simply pushing the envelope". Unable to loosen his grip I shuffled politely, as an image of a close-knit group of agriculturally inclined chefs engaged in a lightweight version of pass the parcel floated before me.

With four children now out of sight, and the fifth spinning wildly on a nearby bench stool, Justin finally seemed to be terminating his conversation, agreeing to touch base with his invisible friend. Because there was no particular means for me

to pin point the precise moment of his transition from cyberspace to the here and now, I took my cue by the way he looked about himself, squaring his jaw to convey the strong but sensitive manner of man at one with the HM Government booklet of cool parenting - and also by the way he looked enquiringly at me, shaking my hand once again as if we were meeting for the very first time. "Peter" he gushed enthusiastically, releasing my withering hand and sliding a Pioneer DVR-520 DVDR-cum-HDD across the counter. "What I'd like is for you to look at this... hey, kids, kids, kids, come on over here and meet Peter. Don't now Honeysuckle, you'll break that creaky old stool".

One by one the little army regrouped, looking mutinous. Justin bade me closer. "Winter, this is Peter. Peter has to mend daddy's DVD... Winter has issues with aggression and attention span since my significant other cancelled the Sky subscription" he lamented whilst the child examined the contents of his right nostril. "Honeysuckle, stop that now, look this is Peter. Peter repairs all these things". He glanced in the direction of the audio bench. "Pity about the broken chair but Honeysuckle sometimes wishes to externalise her stress through activity and momentum. Bliss, Snell, Odin, this is Peter..."

Much later, as tranquillity gradually returned to our little world, we found ourselves jointly tracing the cause of intermittent loss of remote functions on Jack's JVC LT-23D50 LCD set. This required the skills of two people; an attractive one to fire the remote continuously and yawn periodically, and a rather less visually appealing specimen to wield the 'scope probe as the symptom came and went. The cause was soon traced conclusively. The remote's signal arriving at the main board could very occasionally be made to disappear as the somewhat heavyweight and inflexible ribbon

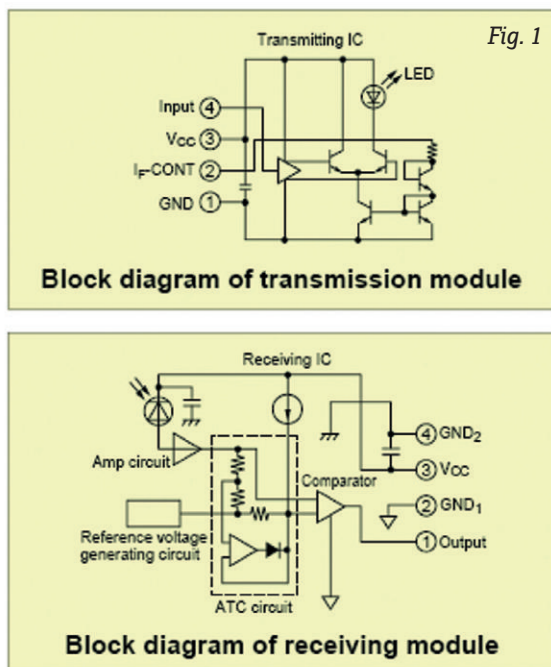

leads connecting it back to the small IR sensor panel were flexed. Poor plug crimping was responsible.

Whilst in the process of reassembling the set, I clocked the imminent arrival of the post, and hastily charged my companion with the task of connecting up the Pioneer, so that I could intercept a package with which I anticipated scoring major brownie points later on...

Moments later, the sound of a test DVD filled the room. Justin's complaint was that 'the synergy of his digitised audiovisual experience had become downgraded by acoustic lapses'. In other words, on occasions the digital audio signal via the fibre optical output momentarily disappeared; tricky to hear when you've got a zeppelin in one ear and a roomful of kids with issues in the other, but sure enough after a few minutes the problem occurred.

I noted that analogue audio from the rear phono sockets was unaffected, and on removing the TOSLink optical connector I could see that the characteristic red led illumination of the core remained constant. The unit utilises a 1-chip BGA codec IC for AV encoding and decoding. Digital audio in the form

of an SPDIF signal (Sony/Philips Digital Interconnect Format) is fed out via an IC buffer stage to drive the optical 'socket', and I was able to 'scope an uninterrupted pulse train at the input pin of this device, even during the audio interrupts.

Now I have to admit that I'd always assumed that if the end of the fibre glows red then it's an indication that data is present, but this unit proved me totally wrong on that count. Although I couldn't find any info

on the internal make-up of this specific connector (or 'transmitter' as it's termed), I did find some useful horse's mouth type data from a Toshiba site (they are the originators of TOSLink) regarding their range of optical transmitters and receivers. Refer to figure 1.

This shows the transmitter as an active device, employing differential drive to modulate an internal LED. A three pin version is also available, where an external LED feed resistor, (externally connected between pins 2 and 3 in the diagram) has been incorporated within the device, so I assume that's similar to the one employed in this Pioneer. Knowing something about what was contained inside made me realise that despite the led illumination, it was perfectly reasonable to suspect the transmitter itself, and sure enough, a replacement cured the problem. The Pioneer part number is JFJ1001.

I leaned back, pleased with the outcome of the day's labours, and as if by magic Dear Heart made an appearance with a welcome cuppa. Suddenly I remembered the package and although I hadn't had time to giftwrap its contents, decided to present it there and then with a

flourish. Her face was a picture as she tore off the brown paper, revealing a book, which the owner of the local bookshop had heartily recommended when I popped in there the other day to deliver a rather sizeable invoice for services rendered. I didn't know that much about its content, only that it was called 'Fascinating Womanhood' which sounded just the job. As she began flicking through the pages, her smile seemed to fade until her expression resembled that of the Ice Maiden. And then unexpectedly she slammed the book down on the bench with a splutter and was gone. Puzzled, I glanced after her, then my eyes alighted on the open page, entitled: 'Welcoming a man home from work'. Soon I found myself reading a passage or two as I waited for her to reappear:

'Have a cool or warm drink ready for him. Arrange his pillow and offer to massage his neck and shoulders and take off his shoes. Speak in a soft, soothing, pleasant voice. Let him talk first – remember, his topics of conversation are more important than yours. A good wife always knows her place. Never complain if he does not take you out to dinner or to other places of entertainment. If he is cross or irritable, never fight back. Listen to him. Don't ask him questions about his actions or question his judgement or integrity. Don't complain if he's late home for dinner, or even if he stays out all night. Count this as minor compared to what he might have gone through that day.'

I called out but there was no answer. Still, I comforted myself with the prospect of the brownie points I'd accrued, and of the pleasure I'd afforded her with my thoughtful little gift. Strange the way she'd nipped off like that I mused, something must have disagreed with her... maybe it was something she'd eaten. Picking up the book I made a mental note to thank the guy in the bookshop for his advice and sauntered off to find her...

Satellite DX

by Roger Bunney

Things ain't good in Zimbabwe! March 31st, preparations and voting in the 'democratic' elections across Zimbabwe with the anticipated images of local folk [possibly on cue] stuffing voting forms inside boxes at voting stations around the country. Two news feeds appeared over IS-12, 45° east as 'GCA' @ 11.518GHz-V and 'GLOBECAST' @ 11.526GHz-V [both 6111+3/4, see later]. And to April 1st with the 'democratic' election count that should have ousted Robert Mugabe and the elections were followed closely around the world.

News feeds were again carried into Europe over IS-12 @ 45° west with reports on now the day's elections went, not so well it seems. Both 'TELEMEDIA-CAPE' @ 11.518GHz-Vertical [Symbol Rate 5632 + Forward Error Correction 3/4] and 'GLOBECAST' 11.527GHz-V [6111+3/4] updated viewers to the evening's news programmes, though live feeds out of Zimbabwe were noticeably absent - the BBC used a live satellite phone video link for updates from the border - quality of this type of live insert has gradually improved in recent years. With a couple of recounts to delay any victory news for the opposition party. We reached the end of April with still no announcement.

April 26th, and a live programme carried by CNN with their reporter Robyn Kerno in Johannesburg at 1630hrs GMT, featuring a political interview, live phone Q and A interviews with reporters inside Zimbabwe and links into the 'Inside Africa' programme - cueing the VT tape rolls in London, off-air at 1756hrs. The J'burg circuit was linked by 'GLOBECAST' via IS-12 on the

familiar 11.527GHz-V [6109+3/4]. The above frequencies are the generally most used for content out of South Africa be it elections or sport! And while in African mode, the afternoon of April 27th saw a colour bar test pattern over IS-12 @ 11.515GHz-V [2893+3/4 + service identification 'SOUTHERN SUDAN'] and with the inlaid screen identification '2: SOUTHERN SUDAN TELEVISION'; this remained for some hours apart from the occasional loss of downlink signal. This same afternoon I checked out Express AM-22 @ 53° east for any news feed that occasionally pops up; nothing was seen but among some of the Russian cable TV programme downlinks I found one channel with perhaps the highest symbol rate currently on air - the music channel '1MUZ-COM' @ 11.047GHz-V [44950 + 3/4]!

Just after I sent the last column, a dramatic aircraft drama unfolded at Orpington, Kent Sunday afternoon of March 30th when a Cessna small jet suffered engine failure after taking off from Biggin Hill, Kent airfield at 1430 local time. The aircraft attempted to return to Biggin but fell from the sky hitting housing in Romsey Close. Amazing that no residents were killed or injured but all 5 persons aboard the jet were killed, two of them being well known in motor racing circles. A tragedy but could have been far worse. The TV news teams were soon on the spot; 'CNN PATH 1' providing live reports of damage, interviews with locals and a brief press statement from the recovery teams. As is the norm, CNN used Intelsat 10-02, 1° west for their news transmission, down linking @ 11.572GHz-B [5632+3/4].

'Shine a Light'. This sole caption

appeared on 2 downlinks early evening of April 2nd and I wondered if this might be preceding an evening religious convention outside broadcast [OB]. 'SAL' appeared @ 11.467GHz-V and 'SAL TEST 2' @ 11.6512GHz-V [both 5632+3/4] over Intelsat 10-02 @ 1° west. I was wrong, this was a major live OB at the Leicester Sq. Odeon, London for the film premiere of 'SHINE A LIGHT' with the Rolling Stones in attendance, appearing outside the Odeon as part of the movie glitterati attending the event, both Mick and Charlie Watts gave short 'interviews' though Charlie looked far from happy wrapped up against a very chilly wind! Cameras covered both the outside activity and handshakes inside the cinema; the sat truck switched off its dish output and departed at 20.00hrs.

Delighted to hear that Edmund Spicer [W. Sussex] has now invested in an 88cm tracking dish providing good results between 33° east to 30° west but 'drifts off' past those points with nothing past Intelsat 801 @ 31¹/₂° west. Hmmmm, a little fine-tuning, good spirit level and sighting compass needed perhaps, I recall my own efforts with a 1.5m dish, a book and minimal equipment, took absolutely ages!

A recent appearance over Atlantic Bird-1 [AB-1] @ 12¹/₂° west are the religious broadcasts from a production outfit 'HEAVEN VISION' that caption themselves as 'Christian TV for the Nations' and with 24 hours a day transmission, I've not checked but the programming seems present each time I check AB-1. Programmes appear to be orientated towards a Nordic audience albeit most of the programming is in the English language. Pop music and concerts feature heavily though all

seem to carry the message, any spoken word presentations can be rather punctuated as a translator repeats the address into an unknown Scandinavian language. Music shows encourage the audience to participate and overall programme quality/presentation is high though not with the gloss of the 'Glass Cathedral' services from California. Check out 11.414GHz-V [3699+3/4] and they can be contacted at: mail@visionheaven.com

Little peace in the Israel/West Bank/Gaza area of Palestine as bloodshed, revenge raids and bombings are very much part of daily life. As I write this on April 26th, there have been 2 killings at an industrial plant and bodies are being transferred from stretcher to coffin. 'SATLINK 9722' over Eutelsat W1, 10° east now appears on air round the clock with either 'APTN JERUSALEM' or 'AP RAMALLAH' test cards and captions carrying an alternating caption - 'Feeds @ 1145 1315 1645 1815'. The news feeds are often unedited and bloody. Last week a 'Reuters' cameraman was killed - following a Palestinian raid, Israeli



Israeli forces destroy Palestinian 4x4 truck



Palestinian freedom fighters



tanks retaliated. Pictures show 2 tanks advancing, one fires a shell and the flash is clearly seen, a second later the camera tumbles and it's black. That shell hit the cameraman; the next pictures show colleagues waving his smashed camera - the cameraman actually shot his own death. AP's 'SATLINK' feeder is usually found @ 10.986GHz-V [4167+5/6]. The BBC uses the 'BEZEQSAT EHA' feeder out of Jerusalem for their video packages and live interviews into 'BBC News' and 'BBC 24'. The feed is not present 24 hours but is usually active during main news periods and from time to time during daytime. If you hear a reporter calling 'can you hear me 24?' you'll know that a 'BBC' news feed/interview is upcoming! 'BEZEQSAT' appears on AB-1 often at 11.112GHz-V [4224+7/8] or a nearby frequency. Whereas most BBC feeds over AB-1 are in MPEG 4:2:2, 'BEZEQ' is often straight MPEG-2.

Roy Carman [Surrey] also notes the 'enthusiasm' for the European TV networks to include blood and death in their news programmes. A Portuguese RTP-TV camera crew arrived at a major motorway crash providing images of the wreckage before the bodies have been cut out - 25th March over W1 @ 11.002GHz-V [3255+3/4] - service ident 'PTRTP-24-EBU4'. Then on the 30th with a light helicopter crash and again a camera crew for 'Sky Italia' appear taking pictures of the wreckage as a large crane lifts the rotors off, there are 2 people dead as 2 empty body carriers await. These live images were down linked via Intelsat 901, 18° west

@ 11.102GHz-H [2894+7/8], service ident - 'Upod39MI@1'.

Folks from the European Space Agency [ESA] were ecstatic over midnight April 26th into the 27th when they saw their 'GALILEO GIOVE' satellite launch successfully into orbit courtesy of a Russian rocket out of Bakinour. This is the first satellite that will provide GPS servicing that isn't controlled/owned by the military and further satellite launches will build up a comprehensive network to create a major GPS global network. After the launch, control was taken by the ESA centre at Fucino, Italy. The launch was carried live over APTN's UP4 feeder on Eutelsat W1, 10° east @ 10.973GHz-V [4167+5/6].

A suspect was charged with the murder last year of the little boy Rees Jones at Liverpool on April 16th. He was shot while crossing a car park, its thought in error, in a yob gang feud, the bullet intended for another youth. The killing received intense media coverage and the evening of the 16th brought out 'GLOBECAST UK-137' for live report into 'BBC 24' and 'BBC NEWS' during the evening period on AB-1, 10.089GHz-V. A 2nd sat truck covered activity at the Merseyside main police station - 'SCOPUS-NET-TE GLOBECAST UKI 374' including a police press conference updating the media on the latest developments - SCOPUS @ 11.101GHz-V [both feeds 4224+7/8].

Sporting outside broadcasts, well there have been a few recently. The Liverpool v. Blackburn football match on the 13th April was covered by 'NDS Enc 5' using W1@ 10° east - 11.083GHz-V [5632+3/4]. That match played to a reasonable crowd, which wasn't the case at a Spanish regional match on the 19th when AB-1 relayed highlights of an evening match. 'ATM-4E-260V' using 11.156GHz-V [5632+3/4], the ground was all but empty but thanks to an enthusiastic sound technician it



Dolphins for Spanish TV

came to life when he played in sound effects of a large football crowd – really bizarre! The following day the Spanish TVE network ran an early evening ‘live’ insert featuring energetic dolphins at a large swimming pool – this over Intelsat 903 – 11.664GHz-V [4280+3/4] – ‘E47-C11V.1’. The large fish were jumping about and eventually stuck their heads onto the pool’s sidewalk demanding food; they almost seemed to be smiling at the camera! On the same satellite at 11.603GHz-V [6749+3/4 - ‘TCL_M04_E291_V1’] was another Spanish ‘sports’ OB of a traditional bullfight with the spectators baying for blood as the bull was being tormented to death. Such events are not to everyone’s taste but they are still carried on Spanish network TV.

Kevin Hewitt [Kent] however had greater successes with his sports receptions, concentrating on Eutelsat W3, 7° east on April 20th with the ‘Beach Volley Ball Nestea European Championship Tour’ on Gran Canaria. More fortunate in that it was the women’s team battling a hard fought match played out to loud pop music. Twin commentaries on Audio 1 [Spanish] and Audio 2 [English] – 11.107GHz-H [6666+3/4] in MPEG 4:2:2 – ‘MSAT10via 1’ over an Overon sat-truck. Later that same afternoon provided the Polish national broadcaster with the ‘Ekstraliga Speedway’, motorbikes in action at Bydgoszcz, 11.135GHz-V [‘TVP Bydgoszcz POL-11’]; a 2nd feed out of the ‘Ekstraliga Speedway’ was at 11.143GHz-V [both 5700+3/4; MPEG 4:2:0 - TVP RZESZOW POL

034]. Kevin uses a Quali-TV 1080 IRCI for his MPEG 4:2:2 signals.]

How not to organise an interview for the telly! It’s early April and a live satellite interview has been arranged. Eutelsat W2, 16° East is warmed up as ‘CBC MIDI D320 A’ prepares for the interview using 12.520GHz-Horizontal [5632+3/4] near a road junction in a quiet rural housing area. The interviewer welcomes the guest who arrives wearing a hood and turns away from camera, clearly not seeking publicity. As the interview starts the local Polizea appear in patrol car and a large PC wanders over, notebook out and questions the hoodie – perhaps he’s on the run – and then questions the interviewer, notes are taken. A Polizea WPC then appears from the patrol car and ushers the hoodie away. Having broken up the interview the Polizea crew drive off leaving a frustrated interviewer; all of this was carried by the satellite feed!

Digital news

Scandinavia. The Swedish parliament confirmed adoption of the later MPEG-4 format for their DVB-T transmissions early April and with several TV channels already operating in the new format – Discovery and the BBC World channels. At this time 5 multiplexes are operational and a 6th will open later this year and obtain full coverage by summer 2009. The Norwegian DVB-T service has now gone to MPEG-4 in readiness for HD-TV, both countries now being fully DVB-T.

Denmark meanwhile continues to expand its DVB-T system albeit slowly with a single MPX now in operation, another 2 following by November 2009 and the 4th a year later based on MPEG-2. Nearby Poland is switching her DVB-T tests from MPEG-2 to MPEG-4 as of now. France meanwhile hopes to launch HD during this year in MPEG-4. Round the globe and New Zealand

opened its first DTT service on April 14th though Prime TV [part of the Sky Network] are maintaining a distance until a minimum of 10% households have HDTV capability – the NZ\$2.5million annual network transmission charge doesn’t justify an earlier opening for Sky-DVB-T. NZ’s TV3 network has already been transmitting HD tests during March. There are concerns that the NZ ‘Freeview’ service via satellite uses MPEG-2 where-as the push will be for MPEG-4 if they ever go into HDTV. The suggestion therefore is to have parallel downlink streams of both MEP-2 and 4 prior to analogue switch-off.

Our old friend Bandula Gunasakera [Colombo] writes that local channel ‘DIALOG TV’ is piloting South Asia’s first DVB-T transmissions across Colombo, Sri Lanka. The single UHF channel transmission includes a 9 programme multiplex with 6 local language and 3 ‘foreign’ services.

A chill wind of economy is blowing through Japan’s state broadcaster NHK with plans to re-organise its radio and TV channels, reducing the numbers of radio and sat channels together with shedding staff.

The Czech broadcasting authorities will later this year start a digital awareness publicity campaign to the population as it plans the move from analogue into digital TV. The first regional DVB-T conversion will be autumn 2009 when analogue TV will switch off almost simultaneously.

DAB meanwhile expands very slowly. Holland has only 10 transmitters operating on channel 12C [227.360MHz]. Unlike the UK the Dutch have opted for quality and the lowest transmitted bit rate uses 128kbits/s, the most common parameter though 192 and 256kb/s have also been used. New Zealand is likely to opt into DAB [version TBA] for their digital radio but nothing will be on air until at least 2012.

RECRUITMENT

Electronics Engineers - Join A Winning Team! UK, Europe and Middle East

The Lektronix Group of Companies are the worlds leading provider of Industrial Automation repairs with an enviable reputation for the best in technical excellence and customer service.

Due to the huge demand for our services, and our future expansion plans, we need to employ additional engineers at all our workshops to keep pace with the additional work we are receiving.

We are looking for English speaking Electronic Repair Engineers, Electronic Repair Technicians and Electronic Component Level Repair Engineers in all the following locations:

- Walsall, UK
- Newry, Northern Ireland
- Brno, Czech Republic
- Bridgend, UK
- Katowice, Poland
- Dubai, UAE

Do you have an interest in electronics?
Have you any experience in the field of practical electronics?
Have you experience in Radio/Television/Home Electronics?
Does your hobby/interest include electronics?
Are you willing to learn new tricks – electronic engineering?
Do you want work in an exciting and challenging environment?
Do you have any experience with Machine Tool Systems - PLC's - Servo Drives
- Servo Motors - Monitors-VDU's - AC Drives - DC Drives - Temperature
Control - Digital Electronics – Analogue Electronics?

We offer a competitive salary and all the other benefits normal with a go ahead company.

Lektronix



Please Contact:
Mr Brian Stewart - Group Technical Director
Lektronix International Ltd, Unit C1, Lockside,
Anchor Brook Ind Park, Aldridge, West Midlands,
WS9 8EQ, United Kingdom.

For an application form please either:
Telephone +44 (0)1922 455555, or apply online
at www.lektronix.net/about/careers



**The new 2007 Television Index/Directory
will be available in June. Available on CD ROM and
as a "download" product from the website**

**Packed with major articles and over 17,000 faults
from the last nineteen years of Television magazine.**

This is a "must buy" for anyone in the trade

**To reserve your copy or to receive full details of
prices and content please email:
info@televisionmagazine.co.uk**

Every month AD Lyon sums up the highs and lows of life in the Oxford TV service trenches



The Lyon's Den

It was a fantastically sunny and warm Wednesday morning here in Oxford. The birds were singing their hearts out in the trees, bluebells were in full bloom in the nearby BBONT nature reserve and I was sat at my workbench with the door wide open enjoying life while listening to John Humphries giving Gordon Brown a dressing down on the today programme on Radio 4. I can't really believe that I have reached the age now where I find Radio 4 entertaining, it's odd isn't it how these things creep up on you. Last Saturday, when I was walking around B&Q with my wife I saw a greenhouse on offer in the garden section and I actually thought about buying it!! Why? I have absolutely no idea, and fortunately Sam was with me to remind me of all the window frames that need replacing, the walls that need repainting, the guttering that needs fixing and the million and one other domestic chores that she would like me to complete before I waste money on such frivolities, and she was probably right too. Having never done anything more as far as gardening goes than cut the lawn and pull out a few weeds, I probably wouldn't know what to do in a greenhouse.

"...I put a value on your service and you should do the same, never undervalue what you do"

Anyway I am digressing here from my original train of thought, which is something else that happens as you get a little older; concentration levels, for me anyway, seem to be diminishing by the day. So here I am sat at the workbench on this sunny morning and my mind is in neutral, and I start thinking about the way things in this trade are so different now to how they used to be. I know my history in this business does not stretch back as far as it does for many of you but I have still been in the game long enough to know that things are nothing like they used to be.

What has happened I wonder to the customers that used to appear on a regular basis? Well sadly I can answer that question, many of them have now died, others are in care homes, by its very nature our business tends to attract, or rather tended to attract older people, those who believed in getting broken things repaired rather than consigning them to the dustbin. What about the stock

faults that we used to be able to make good money from. This time of year used to bring out all the caravanning fraternity with their Nikkai baby 10s that needed a new regulator. These sets were a fantastic earner for us, easy to work on as they only had two faults as far as I can remember, one was the regulator, the other a diode somewhere in the line stage that went leaky. We haven't seen one of these sets for a couple of years now and I'm sure I'm not the only one who misses them. Then there was the infamous Philips memory battery fault, good money again could be made replacing batteries for customers returning from their holidays to find their TV had lost its tuning and colour whilst they were away. How long is it now since you replaced a backup battery?

Well here I was in this reflective, reminisce (if there is such a word and I don't think there is) mood when outside the door a huge Rolls Royce drew up, an unusual thing in itself but this time even more

strangely because the car appeared to have no driver!! After a couple of minutes the drivers door opened and out came a Zimmer frame followed a while later by a tiny little old lady so small that when she was seated in the car she could barely see over the dashboard. She struggled into the shop, walking was clearly a real effort for her, she was wearing a headscarf and I could see she was suffering from the effects of chemotherapy.

Despite all her problems though, she had a warm smile on her face and a cheery disposition. This lady who I'll call Mrs Bright was one of our oldest customers, if my memory serves me well I think she was the second ever customer who bought in a TV set for us to repair. I got her a chair so she could sit down in reception and made her a cup of tea (Despite what people think I can be nice). She told me about her illness, her husband's death, I told her about losing both of my parents within a few months of each other.

Eventually we got round to the subject of what had brought her into the shop and she said that on the back seat of her car were two TV sets that she had purchased from us about five years ago and that neither of them had worked after she had come out of hospital after her latest round of Chemo. "Would you be so kind as to fetch them in and repair them for me." Of course I would, I replied and I went out to the Rolls and on the back seat were two Philips portables, and both needed replacement backup batteries!!

Both of the sets were repaired by lunchtime, to save her coming back out again I offered to deliver them for her but she would have none of it saying that she had nothing to do and needed to keep going and feel that she was still useful.

About an hour later she was back in the shop to pick up the TVs. "Such a good service," she purred, smiling at me, "how much do I owe you?" Well we would normally charge £40.00 for

replacing a back up battery and as there were two of them the bill should have been £80.00 but as Mrs Bright was one of our oldest customers and was so utterly charming I gave her a bill for £40.00 for both sets together (see this is what I am talking about, this is what age does to you).

Mrs Bright's demeanour changed and she fixed an icy cold stare on me. "Don't be so utterly silly," she said in a stern uncompromising voice whilst pushing the invoice back across the desk towards me, "I'm simply not paying that amount now rewrite the invoice and charge me a fair price," she said looking offended by the first invoice.

Not knowing what to do and taken aback by the almost Jekyll and Hyde character change in her personality I tried to explain that the bill would normally be £80.00 for repairing the fault on both TV sets but that as a favour to her because she was a good customer I had only charged her for the repair on one set.

"Andrew," she said with her voice softening, "I did not get to own a sixteen bedroom house and drive around in a Rolls Royce by accepting charity from anyone. I earned my money fairly and honestly and now you have done the same and I want you to charge me accordingly."

I was shocked, she wasn't complaining that the bill was too high at all, she felt it was too low. I made another invoice for the second set and passed it across the desk to her.

She smiled, looked me in the eye again and shook her head then produced an invoice from her handbag that I had given her three years ago for changing the battery on one of the very sets I had just repaired again. The price was £40.00. Now she said if you charged me three years ago £40.00 for one set how all these years later can you charge me £80.00 for two?

I explained that the price of Televisions had dropped dramatically over time and that the price of

repairs has come down accordingly, but she was having none of it. "The price of Televisions in the shops is not relevant here, I have asked you to repair my own sets, not supply me with new ones. I put a value on your service and you should do the same, never undervalue what you do".

She paid me £100.00 in cash for the two back up batteries saying that if she wrote me a cheque she feared I might not cash it. There was no negotiating she was absolutely insistent.

The end of a strange day really and a valuable lesson to learn for all of us maybe.

AND FINALLY

I do believe in giving credit where credit is due. We hold service accounts with various manufacturers Toshiba, JVC, Loewe to name a few of the better ones. And we find the help that we get from the technical departments varies from reasonably good to very bad. One Manufacturer however stands out from the rest and I am going to amaze many when I tell you that it is Beko.

Beko make sets that I suppose you would describe as being in the budget end of the market, however, the sets are very very reliable. I am speaking from experience here, we have many Beko TV's on rental to hundreds of customers and rarely do we get a problem. On the odd occasion when one develops a fault, Beko Technical department are one hundred per cent helpful. On a personal basis many thanks to David at Beko Technical for the advice on lcd20lb450, the set is now working perfectly and is back with the customer. Which begs the question if Beko can do it, why can't many of the other major manufacturers be more helpful?

I'd be interested on your views and comments on manufacturers help lines or any other issues in the trade at the moment, please email me: ADL780@BTINTERNET.COM

Television would also be interested in your comments, please also email to info@televisionmagazine.co.uk

The TV Man

by Arthur Jackson

Many more memories of all things good and bad associated with the job have come to mind, though not in any particular order.

One thing is for sure and I think others would agree with me is that when the rental business was popular and thriving we got to cover a large part of the country and to meet many people from all walks of life; from the retired wealthy types for whom renting was ideal as they simply wanted to go to no effort when their set failed, to the everyday hard working people with large families who could budget things better with a coin meter fitted to their TVs, and felt safe in the knowledge that there would be no repair bills.

Personally I always preferred the latter type as they understood hard work and busy lives and didn't complain if we couldn't get to them on the day their set broke down.

Because of generally poor TV reliability and in our case having a few thousand coin meters fitted we would be calling with most customers several times a year and as a result came to know many of them very well.

We also tended to have generations of families renting sets from us, from grandparents to grandchildren and in many cases if I called at an empty house I would simply go to their sister/cousin or mother round the corner for a key. Usually to be told the door was open so go on in and when you're finished could you empty my meter before you go as I could do with a bob or two for the weekend if there's any left over!

This was never a problem but the drawback was that it meant phoning the office from the house to get the account details, the trouble with this was that often the reply would be "Ah Arthur, I'm glad you phoned in" no don't tell me? "Yes, I've got a few more jobs in your area, have you got a pen handy?" this was the nature of things with a family business.

For years our office staff would take calls from customers and then check if an engineer had other jobs in that area, if so they would ring around the houses to see if we had called yet and if we hadn't they would ask the customer to pass on the details of the additional calls when we arrived.

I remember on many occasions arriving at houses at seven or eight o'clock in the evening, maybe thirty miles from home to be reached by a piece of paper with three or four more jobs on it to be done when theirs and whatever others I'd left were finished, this probably sounds familiar to many.

As we covered such a large area with countless hills and valleys two-way radio systems simply didn't suit us and I often thought the idea of phoning jobs out to customers to pass on was quite ingenious. Nowadays most of us don't feel dressed without our mobile phones but it serves to remind us that what we didn't have we didn't miss.

Life wasn't at all primitive and other efficient methods of communication were sought out and put into practice, although to be honest I often cursed the soul of whoever came up with the ideas that contributed to yet another late night.

A colleague in our place came up

with the expression 'getting home in the side-lights or the head-lights' and it was common to be asked in the morning, "well how did your calls yesterday go, were you home in the side-lights?" often the answer would be "no chance, they're to clever in this office and seem able to predict my next call to leave messages for me, it was home in the head-lights for me again last night!"

While a lot of the day to day work was routine there would usually be a memorable event or character encountered most days. One such character was an old dear who rented a black & white ITT set from us with a ten pence coin meter fitted to it at the time, without fail I had to call with her at some point every month because the set was dead and every time it was because she had put so many coins into the meter that it went beyond the full mark and over the top thus cancelling the credit.

On every visit I explained the cause of the trouble and she never failed to reply "oh, I didn't know you could do that! I must remember not to do it again, oh and before you go could you tune it in for me as I can't get the home service?"

I'm sure I called with her more than a hundred times over the years and I can honestly say I don't think I ever had to take the back off the set once. Eventually she went to live in a nursing home where I'm told she lived till she was well over one hundred, fortunately there was no coin meter fitted to the set in the nursing home.

...story continues in the next issue!

WEBSERVICE

To reserve your space email: info@televisionmagazine.co.uk

Swires Research

www.swires.com



Swires Research produce high quality instruments for the television industry, including portable signal level meters and spectrum analysers for digital and analogue RF signal measurements.

Charles Hyde & Son Ltd

www.charleshyde.co.uk

Search for both original and copy spare parts in our extensive database covering:



Alba, Bush, Ferguson, Hitachi, LG, Saisho, Sanyo, Sony, Sharp, Panasonic, Philips, Samsung, Tascam, Teac, Toshiba, Yamaha and many more.

We have now added huge ranges of shop Sales items and Accessories.

Digi Repairs (UK & Ireland) Ltd

www.digirepairs.co.uk

- Specialists in the repair of Sky HD
- Fixed price repair charge to the trade
- Free collection on 2+ units
- 6 months warranty- no quibble.
- Turnaround time usually 48Hrs.
- Sales of new and refurbished boxes
- Freesat supplied.



Collection from anywhere in UK & Eire including Scottish Isles.
Tel: 02866 327293 or 04866 327293 from R.O.I

REFLOW.TV

Reflow.tv are specialists in the re-flowing and replacement of **BGA & QFP IC's** used in today's consumer electronics. From mobile phones to the latest plasma and LCD televisions.

Please see our web-site for more details.

www.reflow.tv 0845 833 5218

CLASSIFIED

To be included email: info@televisionmagazine.co.uk

REPAIRS

VESTEL LCD POWER SUPPLY REPAIRS

We can offer a fixed price repair service for the popular Vestel 17PW15 - 6, 17PW15 - 8 & 17PW15 - 9 series power supply modules, as fitted to major manufacturers' LCD TV sets including Hitachi, Toshiba & Sanyo as well as many 'badge' names.

Trade quantity discounts available.

For more details, call Geoff on **01604 812549 Monday to Friday 10am to 5pm** or e-mail mag.replies@ntlworld.com

SPARES

TIMELAPSE VIDEO RECORDERS SPARES
REFURBISH-NEW- SECONDHAND PARTS AVAILABLE
COMPLETE NON WORKING FOR SALE
ALL MAKES AND MODELS AVAILABLE

EX-EQUIPMENT FOR SALE:
TIMELAPSE VIDEO RECORDERS FROM 24 HR-960 HR
MONITORS-MULTIPLEXERS- CAMERAS ETC
GENUINE HITACHI HEAD TYPE HX10468
SUIT VTL2500,2300,1200,1100 NEW £49.00 + P/P+VAT.

WEB SITE:www.dtvvideo.co.uk

E-MAIL:admin@dtvvideo.co.uk

Fax: 0207 635 6161

All enquires via e-mail or fax only

SERVICE DATA

SERVICE MANUALS

Have you ever turned away work for want of a Service Manual? Have you ever bought a Service Manual and never used it more than once? Then why not join ...

THE MANUALS LIBRARY

For details and membership application form write, phone or fax:

HARVEY ELECTRONICS

43 Loop Road, Beachley, Chepstow, Mons, NP16 7HE

Tel/Fax No: 01291 623086

All credit cards accepted

SERVICE DATA

NEED HELP NOW?

Then ring the
★ **ELECTRON TECHNICAL HELPLINE** ★

Genuine help available to all repairers of
T.V. - V.C.R - SAT - AUDIO
(Inc Valves)

Over 30 years experience
and vast data base

9 Chapel Street, Donisthorpe,
Derbyshire DE12 7PS

0906 470 1706

Calls cost 60p per minute

www.televisionmagazine.co.uk