

NEWNES *Make-it-at-Home Magazine*

13

PRACTICAL MECHANICS

EDITOR: F. J. CAMM
NOVEMBER 1957



HOW TO MAKE-

A SINK UNIT
A GREENHOUSE

A TV FOR £10
AN EPISCOPE

OUTBOARD MOTOR
BOAT

GEIGER COUNTER
ELECTRIC PENDULUM
CLOCK

A CHILD'S GIG
A UKULELE

DAYLIGHT HOME
CINEMA, Etc. Etc.



What sorts
of springs
do you need?

Compression? Expansion? Long? Short?
Light? Heavy? Let Terry's BOXES OF ASSORTED
SPRINGS settle the question. Just the job for you
experimental people—a simply unlimited assort-
ment from our tremendous range of springs of
every variety. The 9 boxes shown here are only a
few—but why not let us send you a full list—
post free.



No. 760. 3 doz. Assorted Light Compression Springs. 1" to 4" long, 22 to 18 S.W.G., $\frac{1}{8}$ " to $\frac{1}{4}$ " diam. 6/6 each.

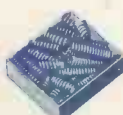

No. 98A. 3 doz. Assorted 1" to 4" long, $\frac{1}{8}$ " to $\frac{1}{4}$ " diam., 19G to 15G. 5/6 each.



No. 757. Extra Light Compressions 1 gross Assorted $\frac{1}{8}$ " to $\frac{1}{4}$ " to 2" long, 27 to 20 S.W.G. 15/- each.



No. 388. $\frac{1}{4}$ gross Assorted Small Expansion Springs $\frac{1}{8}$ " to $\frac{1}{4}$ " to 1 $\frac{1}{2}$ ", 18G to 21G. 9/6 each.



No. 758. Fine Expansion Springs. 1 gross Assorted $\frac{1}{8}$ " to $\frac{1}{4}$ " to 2" long, 27 to 20 S.W.G. 15/- each.



No. 466. $\frac{1}{4}$ gross Assorted Small Expansion Springs $\frac{1}{8}$ " to 1 $\frac{1}{2}$ " long, $\frac{1}{8}$ " to $\frac{1}{4}$ " diam., 21G to 24G. 6/6 each.

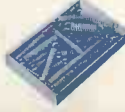

No. 753. 3 doz. Assorted Light Expansion $\frac{1}{8}$ " to $\frac{1}{4}$ " diam., 2" to 6" long, 22 to 18 S.W.G. 10/6 each.



No. 1024. 20 Compression Springs 12" long, $\frac{1}{8}$ " to $\frac{1}{4}$ " diam., 24G to 18G, suitable for cutting into shorter lengths; and 30 Expansions 1 $\frac{1}{2}$ " to 12" long, $\frac{1}{8}$ " to $\frac{1}{4}$ " diam., 22G to 16G. 24/- each.



No. 1013. 1 gross Small Coil Compression Springs, $\frac{1}{8}$ " to 1 $\frac{1}{2}$ " long, $\frac{1}{8}$ " to $\frac{1}{4}$ " diam., 24G to 19G. 6/- each.

Cut
production
costs with
TERRY
Wire
Circlips

(Square Section)
We can supply
from stock in sizes
from $\frac{1}{8}$ " to $\frac{1}{2}$ ".



* Really interested in springs? The 1957 Edition of "Spring Design and Calculating"—full of spring data—post free 12/8

TERRY'S

ASSORTED SPRINGS

HERBERT TERRY & SONS LIMITED • REDDITCH • WORCS

(Makers of quality Springs, Wireforms and Presswork for over a century)

HT21A

CONDOR

SLICED

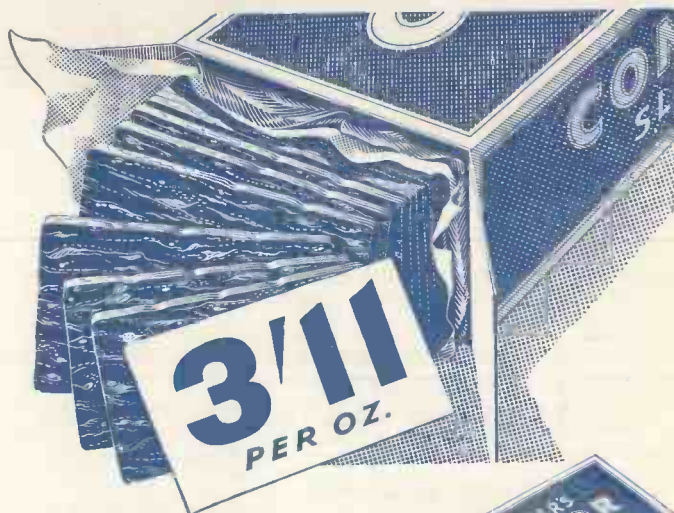

FOR QUALITY
FOR FLAVOUR
FOR AROMA
FOR CUT
FOR FRESHNESS



It's a Gallaher Tobacco

"ZYTO" DO IT YOURSELF TOOLKIT

A SET OF HIGH-GRADE TOOLS, FULL SIZE AND FULLY GUARANTEED, COMPLETE IN STEEL TOOLBOX WITH LOCKING HANDLES AND SLIDING TRAY



Delivered on
first payment of

£5'0'0

Balance in Eight
Monthly
Payments of 32/6

Cash Price
£16/10/0

CONTENTS

- | | | |
|---|---|---------------------------|
| 1 20" HANDSAW | 2 HANDLED BRAD-AWLS | 1 SET CRAMPHEADS |
| 1 10" BRASS-BACK TENON SAW | 1 PAIR PINGERS, 6" | 1 WIRE BRUSH |
| 1 STANLEY ADJUSTABLE IRON PLANE 9" x 2" | 1 7" FOOTPRINT PIPE WRENCH | 1 STANLEY HAND DRILL |
| 1 SET OF 3 HANDLED CHISELS, $\frac{1}{4}$ ", $\frac{1}{2}$ ", $\frac{3}{4}$ " | 1 3" PAINT-STRIPPING KNIFE | 1 SET TWIST DRILLS |
| 1 CLAW HAMMER | 1 PUTTY KNIFE | 1 SOLDERING IRON |
| 1 6" CABINET HANDLED SCREW DRIVER | 1 STANLEY RATCHET BRACE | 1 STICK SOLDER |
| 1 4" RATCHET ELECTRICIAN'S SCREWDRIVER | 1 SET FIVE FAST-CUTTING CENTRE BITS, $\frac{1}{8}$ ", $\frac{1}{4}$ ", $\frac{3}{8}$ ", $\frac{1}{2}$ ", 1" | 1 TIN FLUX |
| 1 CROSSPENE PIN HAMMER | 1 POINTING TROWEL BLADE | 1 MITRE BLOCK |
| | 1 PAIR COMBINATION PLIERS | 1 PAIR RADIO PLIERS |
| | | 1 JUNIOR HACKSAW |
| | | 6 SPARE HACKSAW BLADES |
| | | 1 NAIL PUNCH |
| | | 1 2' BOXWOOD FOLDING RULE |
| | | 1 INSTRUCTION BOOK |

ILLUSTRATED LEAFLET FREE ON REQUEST

S. TYZACK & SON LTD
341-345 OLD ST., E.C.1.

Telephone :
SHOREDITCH
8301

CASH OR TERMS

17in. T.V. CHASSIS, £19.19.6

Latest improved circuits. Higher E.H.T. (brilliant picture). Improved sensitivity (for greater range). Chassis easily adapted to any cabinet. 17in. rectangular tube on adapted chassis. All channels. 12 months guarantee on tube, 3 months on chassis and valves. Valve line-up (5 valves): 6SN7, 6V6, EY51, 2-6D2s. Others: 6L18, EL38, 7-6Fls. With 5 valves, £21.19.6. With all valves, £25.19.6.



TURRET TUNER 50/- extra. Ins. carr. (incl. tube), 25/- . Stace B.B.C. channels (and I.T.A. if Turret Tuner required).

14in. T.V. CHASSIS, TUBE & SPEAKER, £13.19.6

As above, with 14in. round tube. Less valves. 3 months guarantee. With 5 valves, £15.19.6. With all valves, £19.19.6. **TURRET TUNER 50/-** extra. Ins. carr. 25/- (incl. tube).

ELECTRIC CONVECTOR HEATER, 99/6



Winter isn't finished yet so you have still time to buy YOUR convector heater. Hotter and cheaper than oil. A.C./D.C. Switched for 1 or 2 k/watts. Illuminated grille. Ins. carr. 10/6.

ELECTRIC FIRES, 29/6.

Pencil element, 1 k/watt. Beautiful finish, lovely reflector. A.C./D.C. 200-250 volt. Post 3/6.

ELECTRIC FIRES, 17/6.

200-250 volt. 750 watt. Post 3/6.

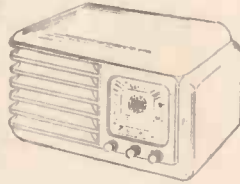

A.C./D.C. MIDGET RADIO, 99/6

CCH35, EF39, EBC33, CL33, 35Z4 or metal rec. 3 control knobs. Switched for gram. In attractive brown plastic cabinet, 15in. x 7 1/2in. x 9in. Ins. carr. 5/6

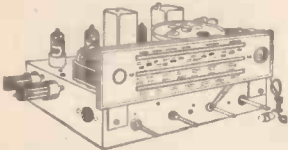

ARGOSY PUSH-PULL RADIOGRAM CHASSIS, 139/6

8 valve: 2-EBF80, 2-EL42, ECH81, EBC41, EZ80, EM34. Latest models. 3 w/and and gram. Switched. Over 10 watts output. Full tone range. 4 knob control. Size 14in. x 9in. x 7 1/2in. Less valves. Ins. carr. 5/6.

HEADPHONES, 1/9. Single earphone and headband. C-LR type. Ideal for crystal sets. Extension on radio, etc. P. & P. 1/3.

DUKE & CO. (Dept. 5), 621/3, ROMFORD ROAD, MANOR PARK, E.12.

RECTANGULAR T.V. TUBES (USED)

12 MONTHS GUARANTEE

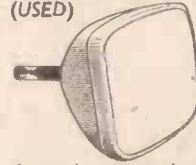

14" £5. 10. 0
17" £7. 10. 0

6 months full replacement. 6 months progressive. Made possible by the high quality of our tubes. Ins. carr. 15/6. **SPECIAL OFFER OF 14in.,—15in.,—16in. T.V. TUBES at £5. CONVERT YOUR 9in.,—10in.,—12in.—to the above sizes.** Details of how to "Do-it-Yourself" in our FREE catalogue. 12in. T.V. TUBES £6. Guaranteed. 15/6 Ins., carr. on all tubes.

Boxed VALVES 3 MONTHS GUARANTEE				
SP81 4/9	6N7GT 4/9	CV18 3/9	BF37 4/9	CV188, ME 3/9
1S5 4/9	6SG7 3/9	EB34 1/9	BF41 8/9	EBC33 6/9
3AB 3/9	7T 3/9	EB91 6/9	BF50 2/9	EF37A 4/9
4D1 2/9	8D2 3/9	ECC81 8/9	EL32 6/9	L410 1/9
6B8 3/9	8D3 7/9	ECH42 8/9	EL91 3/9	PEN46 7/9
6P12 7/9	12A U7 5/9	EP39 6/9	PEN45 6/9	PEN220A 3/9
6D2 6/9	12BE6 6/9	EP41 8/9	T111 6/9	T41 10/9
6H6M 1/9	2C22 3/9	EP91 7/9	EL37 1/9	VW48 9/4
6K7 3/9	12SJT 1/9	DP66 5/9	Z77 7/9	210VPT 5/9
		American Types. 75	UX. All at 3/9 each.	25RE
		-42 -78	80	6A7
			1D6	6C6
			6D6	
			Barretors 301 and 302 also at 3/9 each.	

BEAUTIFUL EXTENSION SPEAKER, 29/9

Complete, fitted with Bin. P.M. speakers, "W.B." or "Goodman's" of the highest quality. Standard matching to any receiver. (2-5 ohms). Flex and switch included. Unrepeatable at this price. Money back guarantee if not completely satisfied. Ins. carr. 3/-.



SPEAKERS, 12/9. Goodman's or Elac. High quality Bin. P.M. Money back satisfaction guaranteed. P. & P. 2/9. Export orders invited.

8in. P.M. SPEAKERS, 8/9. With O.P. trans., 10/- . P. & P. 2/9.

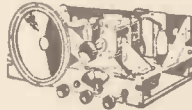

POPULAR RADIO OR RADIOGRAM CHASSIS, 39/9

3 waveband and gram. S/het. 5 valve (intnl. octal). Ideal for tablegram but still giving high quality output. 4 knob control. Bin. P.M. speaker, 7/9 extra. Set of knobs, 2/- . Size 12in. x 6in. x 7in. Less valves. Ins. carr 5/6.

RADIOGRAM CHASSIS, 29/9. 5 valve s/het. 3 w/and and gram. Including Bin. P.M. speaker. A.C. mains. Complete less valves: Front drive. Size 12in. x 10in. x 8in. Printed dial. Ins. carr. 5/6.

Tel.: ILF 6001-3. OPEN SATURDAY ALL DAY. Send for our Free 1958 Catalogue.

Permanent Magnets in action

The finest tool-rack you ever saw...

Make your own magnetic tool rack and keep your workshop tidy! This and many other uses of "Eclipse" magnets are shown in descriptive leaflets, available through your usual tool dealer.

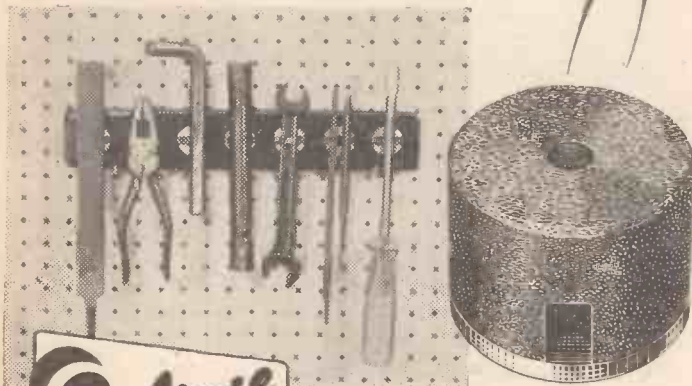

PERMANENT MAGNETS

Made by James Neill & Company. (Sheffield) Limited and obtainable from all tool distributors



The finest Engines for your models

Seven models available ranging from 0.46 c.c. to 5 c.c. Every one individually tested to the highest degree of accuracy and reliability to ensure the greatest possible speed and performance for your models.

Suitable for model aircraft, boats or cars.

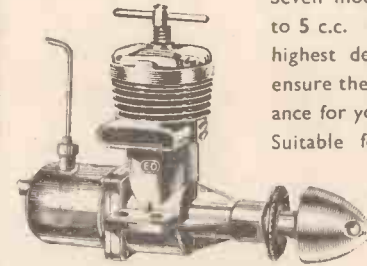

E.D. 1 c.c. "BEE"

BRITAIN'S MOST POPULAR DIESEL
Over 300,000 sold.

Price £2.14.9. Water-cooled model, £3.12.11.

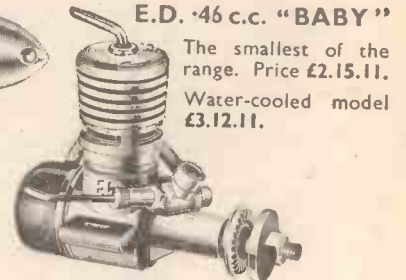

E.D. 0.46 c.c. "BABY"

The smallest of the range. Price £2.15.11.
Water-cooled model £3.12.11.

The range also includes:

E.D. 1.46 c.c. "HORNET" £2.15.11
Water-cooled model ... £3.17.10

E.D. 2 c.c. "COMPETITION SPECIAL" ... £3. 3. 3
Water-cooled model ... £4. 5. 2

E.D. 2.46 c.c. "RACER" ... £3.19. 0
Water-cooled model ... £5. 4. 8

E.D. 3.46 c.c. "HUNTER" £4. 0.11
Water-cooled model ... £5. 7. 1

E.D. 5 c.c. "MILES SPECIAL" ... £10. 4. 3
Water-cooled model ... £11. 6. 3

New illustrated list giving full details of all E.D. ENGINES, RADIO CONTROL UNITS, SPARE PARTS, ACCESSORIES, etc., free on request.

All prices include Purchase Tax.

Order from your model shop.

ELECTRONIC DEVELOPMENTS (SURREY) LTD
DEVELOPMENT ENGINEERS
ISLAND FARM RD. WEST MOLESEY, (SURREY) ENGLAND.

Training with I.C.S. THE WAY TO SUCCESS

The great and growing demand of today is for TRAINED men. Tens of thousands more are needed, but there is no worth-while place for the untrained.

Let I.C.S. Postal Tuition give you the specialised knowledge that marks you out for promotion to the best jobs—for SUCCESS! I.C.S. teaches you at home in your own time—expertly, quickly and easily. It is the world's largest and most successful correspondence school, offering courses for almost every branch of trade, industry and the professions.

ADVERTISING

Practical and Mail Order
Retail and Dept. Store
EXAMS: Advertising
Ass. I.P.A.

COMMERCIAL ART

BOOK-KEEPING & BUSINESS TRAINING

Accountancy
Costing
Secretarial
EXAMS: Chrted. Inst. Secs., Ass. of Cert. & Corp. Accts. Inst. of Cost & Wks. Accts. Inst. of Bookkeepers

ARCHITECTURE & BUILDING

Drawing & Designing
Quantity Surveying
Builders & Surveyors' Clerks
Construction
Air Conditioning
Heating & Ventilating
Woodworking

EXAMS: Roy. Inst. of Br. Archts. Inst. of Quant. Survyrs. Roy. Inst. of Chtd. Survyrs. Inst. of Bldrs. Inst. of Clerk of Works.

CIVIL ENGINEERING

Surveying & Mapping
Structural & Concrete Engg.
EXAMS: Inst. of Civil Engrs. Inst. of Mun. Engrs. Inst. of Struc. Engrs

MANAGEMENT

Foremanship
Indust. Management
EXAMS: Br. Inst. of Management. Inter Final & Cert. in Foremanship

ELECTRONIC ENGINEERING

Industrial Electronics
Electronic Computers

FARMING & HORTICULTURE

Arable Farming
Pig Keeping
Poultry Keeping
Farm Machinery (Maintenance)
Flower, Vegetable & Fruit Gardening
EXAMS: R.H.S. General

FIRE ENGINEERING

EXAMS: Inst. of Fire Engrs. Fire Service Promotion

GENERAL CERTIFICATE OF EDUCATION

Principal Subjects at Ord. or Advanced Level
Engg. Joint Board. Prelim.

MECHANICAL ENGINEERING

Subjects include:—
Welding, Fitting, Turning
Erecting, Jig & Tool Design
Production, Draughtsmanship
Maintenance, Diesel Engrs.
Diesel Electric Locomotives
Refrigeration
Sheet Metal Work, &c.
EXAMS: Inst. of Mech. Engrs. Inst. of Prod. Engrs. Soc. of Engrs. Inst. of Engg. Designers
Cert. in Foremanship

ELECTRICAL ENGINEERING

Illumination & Heating
Power House Attendants
Electricians'

EXAMS: Soc. of Engrs. C. & G. Cert. in Elec. Engg.

MOTOR ENGINEERING

Diesel Transport Engrs.
Owner Drivers'

PHOTOGRAPHY

A new Course incl. Colour Work

RADIO & TELEVISION ENGINEERING

Service Engineers'
Television Servicing & Engg.
Practical Radio with Equipment

EXAMS: Br. Inst. of Radio Engrs. C. & G. Radio Cert. P.M.G.'s Cert. in Wireless. C. & G. Telecoms. Engg.

SALES PROMOTION

Sales Management
Window Dressing
EXAMS: Inc. Sales Mangrs. Ass. United Comm. Travellers Ass. Dip.

WRITING FOR PROFIT

Free Lance Journalism
Short Story Writing

NEW 'LEARN-AS-YOU-BUILD' PRACTICAL RADIO-COURSE. Build your own radio receiver and testing equipment.

Moderate fees include all books

INTERNATIONAL CORRESPONDENCE SCHOOLS

Dept. 169D, International Buildings, Kingsway, London, W.C.2

Please send me free booklet on.....Age.....

Name..... Occupation.....
(USE BLOCK LETTERS)

Address.....

11.57

Addresses for Overseas Readers

Australia: 140, Elizabeth Street, Sydney. Eire: 3, North Earl Street, Dublin.
India: Lakshmi Bldg., Sir Pherozsha Mehta Rd., Fort Bombay. New Zealand: 182, Wakefield Street, Wellington. N. Ireland: 26, Howard Street, Belfast
South Africa: Dept Lr 45 Shorrmaker Street Cape Town

INTERNATIONAL CORRESPONDENCE SCHOOLS

HOX KITES, the one and only well-known R.A.F. dinghy antenna type, brand new in metal containers, complete with flying cord, 20/-, post 1/8.

MOTOR GENERATORS, U.S. mfr., totally enclosed, 4 1/2 in. long, 2 1/2 in. dia., input 27 v. 1.5 amps., output 285 v. at 60 mA., output from 12 v. supply is approx. 150 v., new, unused, 12/6, post 2/3.

TRANSMITTER RECEIVERS NO. 17, Mk. II, these are complete with valves, high res. headphones, hand microphone, instruction booklet, frequency range 43 to 61 Mc/s, range with simple aerial 5 to 8 miles, requires ordinary 2 v. and 120 v. batteries, these are brand new in sealed cartons, our price 50/-, carriage (inland only) 7/6.

HUGHES 12-VOLT SHUNT MOTORS, taking 1.25 amps. light, and up to 2 amps. on load, 5,000 r.p.m., external terminations for reversing, oil impregnated bearings, 1/2 in. shaft, size 3 1/2 in. long, 1 1/2 in. dia., weight 20 oz., a superior and powerful motor, original cost over £7, our price new, unused, 10/-, post 1/6; 2 for 20/-, post paid; ditto, fitted reduction gears, giving a final drive of either 160 or 320 r.p.m., state which required. 12/6 post 1/9; 2 for 25/-, post paid.



CHARTBOARD LAMPS, fully adjustable pattern, having 5 swivel points, providing light exactly where required, base can be screwed to bench, table or wall, fitted s.b.c. lampholder and shade, finish black and silver, total length 2 1/2 in., brand new in sealed cartons, 15/-, post 1/8.

MERCURY SWITCHES, 250 v. 10 amp., glass tilt type fitted brackets, specially made to give 8-second delay make after tilt, new boxed 5/-, post 7d.

"BAMBI" GARDEN SPRAYERS, also suitable for disinfectants, penetrating oil, lime wash, etc., made by Fisons Pest Control Ltd., consists of the special glass container holding 4 pints, marked in 1/2 pints, filler cap is a 1- or 1-oz. measure, adjustable webbing for shoulder or back, so that both hands are free. 40 in. flexible tubing to the polished brass syringe, with nozzle that gives a finely atomized spray. Scrap those messy old-fashioned sprayers that require buckets, hoses, etc., invest in a "Bambi," value to-day 45/-, our price new, boxed, 20/- post 3/6, 2 for 40/-, post paid.

MAINS BLOWERS, 200/250 v. A.C./D.C., 1 amp., 5,000 r.p.m., consists of the motor with attached enclosed fan, end funnel intake 1 1/2 in. dia., side outlet 1 in. x 1 in., plinth base 4 1/2 in. x 5 in., finish black crackle and aluminium die-cast, size overall 9 in. long, 5 in. high, 4 1/2 in. wide, weight 11 lb., a very superior blower, fraction of original cost, 25/-, post 3/6.

SHADED POLE MOTORS, 12-v. 50-cycles A.C., size 3 in. x 2 in. x 1 1/2 in., complete with 2 1/2 in. fan, made for lamphouse cooling, silent running, unused and perfect 10/-, post 1/6.

TELEPHONE SETS, consists of 2 combined microphones and receivers which when wired up with ordinary twin flex, provide perfect 2-way communication, excellent results up to 1 mile have been reported, self-energised, no battery required, price the 2 instruments new, unused, 7/6, post 1/3. twin P.V.C. 14/36 flex up to 300 ft. lengths at 1d. per ft.

MAGNETIC RELAYS 5C/649, 9-14 v., takes 1 amp. at 12 v., closes 40 amp. D.C. contacts, bakelite case enclosed with cover, new, unused, worth 30/-, our price 2/6, post 10d.; 24/- doz., post 2/8.

Send s.a.e. for current bargains lists.

Tel.: HAR 1306

MIDLAND INSTRUMENT CO., Moorpool Circle, B'ham, 17

THE TOOLS FOR THE JOB

AWAIT YOU AT MONDEX ON THE BEST OF TERMS

BURGESS ELECTRIC BANDSAW YOURS FOR ONLY

40/-
deposit & 8 mthly pmts of 50/- or Cash £19.7.6.

Built-in 1 1/2 h.p. A.C. motor. Will make intricate cuts as easily as it will saw heavy materials. Complete with baseboard. Fully portable. Leaflet on request.

YOURS FOR 10/- SELF-POWERED ELECTRO SAW

Handles like a fret-saw but infinitely faster. Can also be used as jig-saw. Built-in switch and lead. BSR's mains. Spare blades available. 10/- dep. & 5 m. ps. 10/6 or 56/- cash.

X-ACTO HOBBY CHEST

For light work and modelling. Knives, saws, clamps, sander etc., etc., in fitted cabinet. 10/- dep. & 6 m. ps. or 14/3 or 69/- cash.

BLACK & DECKER U-50B KIT

5" Sander/Polisher Drill Unit. Complete. Adaptable. Takes B & D Accessories. 15/- dep. & 6 m. ps. of 32/1 or 29.9.0 cash. U.1. DRILL—£6.19.6 or 10/- dep. & 6 m. ps. of 23.9.

THE NEW IDEA IN HOME WORKSHOPS

With a Selecta "Homemaster" and Bridges DR2T 1" Power Drill or new Wolf Quarter-master you have a modern versatile basic workshop. Accessories available, including 30" Lathe. Send for Brochure.

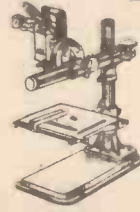

MONDEX FLUORESCENTS

Twin or single 2" units complete with daylight tubes. GUARANTEED. (P.P. 4/- either type.)

TWIN with 2 2"-20 w. tubes 15/- dep. & 5 m. ps. of 15/- or 79/6 cash.
SINGLE with 2 2"-20 w. tube 10/- dep. & 5 m. ps. of 11/- or 57/6 cash.

BSR MONARCH

4-Speed Autochanger Connects to radio or for building into a Hi-Fi Radiogram. Brand new. As advertised. Guaranteed. Direct from BSR's factory.



25/- dep. & 8 m. ps. of 25/- or 29.15.0 cash (P.P. 4/-).

ALSO AVAILABLE—Amplifiers, R.G. Chassis F.M. Tuners, Loudspeakers. Ask for lists.

Bridges, B & D, Wolf, Selecta, etc., all on terms—Send for lists.

EQUIP.	DEP.	MTLY	CASH
Selecta & DR2T	45/-	8 at 58/3	£22. 9.6
Selecta alone	30/-	8 at 37/6	£14. 10.0
Selecta Lathe	7/6	8 at 10/3	£ 3. 19.0
DR2T alone	15/-	6 at 26/8	£ 7. 19.6
Wolf Quarter-master	15/-	6 at 32/-	£ 9. 9.0

PICADOR 'PUP' Multi-purpose unit with cradle for 1" Drills. £7.18.0 or 15/- dep. & 6 m. ps. of 26/3.

MONDEX PRODUCTS LTD.
(Dept. PX/10)
5, GOSWELL RD., LONDON, E.C.1

The EMCO-UNIMAT

A portable, precision, machine tool

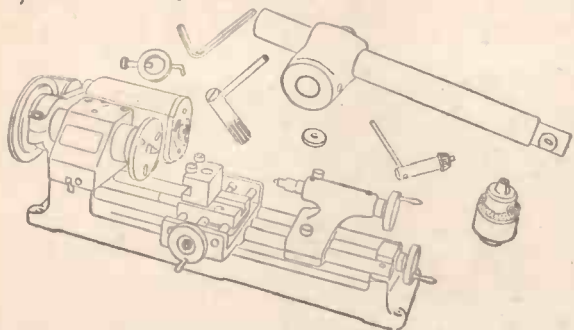

Only 16in. long, the Emco-Unimat is capable of several standard workshop practices to highly critical limits. The basic tool will buff, turn, polish, drill, grind and mill, and a full range of extra equipment vastly increases the scope of the tool.

SPECIFICATION

Centre Height, 1 1/4 in. Takes between centres 6 1/2 in. Hollow spindle admits 1/2 in. Drill chuck cap, 1/2 in. Chuck to drill table (max.). 4 1/2 in.

ADDITIONAL EQUIPMENT
 Jig Saw. SC Lathe Chuck. Circular Saw. Drilling Vice. Milling Table and Clamps. Flexible Shaft. Thread Chasing and Dividing.

CASH PRICE £27-17-6

EXTENDED CREDIT AVAILABLE
GENEROUS TERMS AVAILABLE TO MERCHANT STOCKISTS
J. & H. SMITH LTD.
 16 HARRISON ST. LEEDS 1. Tel. 21561

See the versatile Emco-Unimat at your local tool dealer, or write for fully descriptive literature to:



to-day the 'old hand' has a **THIRD HAND**

In days of old when knights were bowled—over, how useful the Mole Wrench would have been. Known to-day to thousands over the world as their 'third hand,' the Mole Wrench locks on to the job-in-hand and remains locked, tightly with both hands free—a 'third hand' that also serves as superpliers, clamp, hand vice and so on. Fitted with the quick release lever it is available in two sizes, 7in. for 12/6 and 10in. for 15/-, from Ironmongers, Motor and Motor Cycle Accessory Dealers. You'll be glad you bought!



If in any difficulty write to:

M. MOLE & SON LTD., BIRMINGHAM, 3

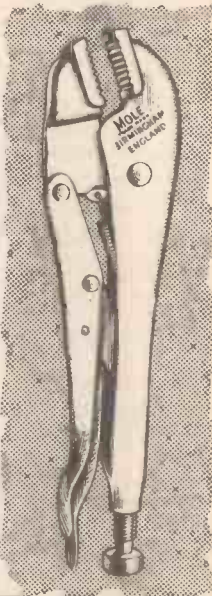

WATSON'S SPECIAL OFFERS



15/6
 Post 3/-

TANK COMMANDERS' PERISCOPES

11in. long with large wide angle object lens. A very fine quality instrument with binocular vision. Ideal for race meetings, etc.

TANK GAUGE UNITS designed for fixing direct to tank. 4 1/2 in. diam. 7in. Float arm reading E 1/2, 3/4, F. Easily adaptable to any tank. 22/6 each. Post 2/6.

TANK FILTER. 11in. long, 2 1/2 in. diam. For fitting direct to tank in place of existing filter cap. 12/6 each. Post 2/6.

SILENCERS. 18in. long, 3 1/2 in. diam., 1 1/2 in. inlet. Black finish. 17/6 each. Post 3/-.

"A.C." OIL BATH AIR CLEANERS. These are beautifully made units 9in. diam. with 2 1/2 in. or 2 1/4 in. fitting. Also 8in. diam. with 1 1/2 in. fitting. These are easily adaptable for any smaller fitting if required. New and boxed. PRICE 14/6. Post 3/-.

COIL SPRING BELTS. 1/8 in. x 12in. long extends to 15in. Any number can be joined together. 20 for 4/6. Post 9d.

EX R.A.F. TOOL BOXES. Size 14in. x 9in. x 8in. Dovetailed and metal bound. 9/6 each. Carr. 2/6. LARGER SIZE 24in. x 12in. x 10in. PRICE 13/6. Carr. 3/6.

SANTUN ROTARY SWITCHES, suitable for 30A 230 v. Panel fixing. 4/6 each. Post 1/4. LARGER SIZE 9/-. Post 1/6.

Hundreds of other bargains available. SEND 6d. Stamp for MONSTER LIST.

EASTERN MOTORS
 ALDEBURGH, SUFFOLK. Phone 51.

METALS AND ACCESSORIES

ALUMINIUM, BRASS, COPPER, STEEL, ETC.

Angle, Sheet, Tube, Foil, Strip, Channel, Rod, Bar, Wire, Moulding, Etc. Tin Plates, Silver Steel, Expanded Metal, Blanks, Rivets, Springs, Etc. Tools Drills, Taps, Dies, Screws, Etc. Formica, Perspex, Pegboard, Paxolin, Ebonite, Curtain Rail and Rod, Adhesives, Etc. and many other items for use in Home, Workshop, Etc.

LARGE or SMALL Quantities COMPARE our PRICES
 MAIL ORDER SERVICE (2d. stamp for list) IMMEDIATE DESPATCH

CLAY BROS. & CO. (P.M.B)
 6a SPRINGBRIDGE ROAD, EALING, W.5
 Phone: EALING 2215
 2 MINS EALING BROADWAY STATION, OPPOSITE BENTALLS

RANGEFINDERS for EXPERIMENTERS

Contains a host of optical equipment including two mounted Achro object glasses F.L. 1 1/4 in., Dia. 29 mm.—Pentag Prisms, narrow angle prism—intricate centre prism combination, prismatic window, 1/2 in. Ramsden eyepiece, etc. A wonderful "buy" for the telescope maker. Cost over £150.

55/-
 Carriage Free U.K.

CHARLES FRANK
 67-73 SALTMARKET, GLASGOW C.I
 Phone Bell 2106/7 Established 1907

NEW CABLES & FITTINGS

TOUGH RUBBER CABLES

	per yd.	25 yds.	50 yds.	100 yds.
1.044 Twin	8/6	15/-	27/3	53/3
1.044 3-core	11/6	21/-	38/8	75/6
3.023 Twin	11/6	19/6	35/-	68/8
3.023 T. & E.	11/6	23/6	42/-	82/6
7.029 Twin	1/5	31/9	56/6	111/6
7.029 T. & E.	1/9	38/6	70/3	139/-
7.044 Twin	2/8	60/-	106/-	210/-
Twin Lead, 50 yds.	3.029	69/3	7.025	110/9
VIR, 50 yds.	3.029	15/9	7.025	25/3
Earth Wire, 100ft.	7.029	12/6	7.029	7/8
Twin PVC Transp. Flex, 50 yds.	10/-			
Twisted, 25 yds.	12/6	50 yds.	22/6	TRS.
VIR, Lead Cables of all sizes. Holders, C.G., 8/-; Batten, doz., 12/-; Roses, Brown, 9/-; White, doz., 10/-; Jnc. Boxes, Sml., 11/-; Lge., doz., 13/-; Switches, 1-way, 18/-; 2-way, doz., 24/-; White Switches, 1-way, 24/-; 2-way, doz., 30/-; Flush Switches, 1-way, 18/-; 2-way, doz., 24/-; Ceiling Cord, do., 1-way, 5/-; 2-way, 6/-; 2 amp, 2-pin Sw. plugs and Taps, ea., 3/-; 5 amp, 3-pin Sw. plugs and Taps, ea., 5/6; 15 amp, 3-pin, ditto, A.C. only, ea., 6/-; Wood Blocks, 3 x 1, 5/-; 3 1/2 x 1, 7/8; 3 x 3 x 1, 6/6; 5 1/2 x 3 1/2, doz., 8/-; White, 3 x 1, 6/-; 3 1/2 x 1, 7/-; 4 x 1, 9/-; Cable Clips, Sml., 2/9; Med., grs., 3/8; 15 amp. D.P. Insulated Sw. fuse, 9/8; 21 amp. Ironclad 2-way 15A. Spltr., 13/6; 30 amp. Ironclad D.P. Switchfuse, 19/6; Metal 5-way Consumer Unit, 42/6; Sw. gear, Fusebls., Spltrs., all types. Lamp Bulbs, 15, 25, 40, 60 watt, 12/-; 75 watt, 15/-; 100 watt, 17/-; 150 watt, 24/-; 200 watt, doz., 30/-; Carbon Bulbs, 230 v. 16 C.P. doz., 20/-; Immersion Heaters, 3 Kw., 65/-; Single Car Cable, 10 yds. 3/-; 100 yds., 25/-; Conduit and Fittings, tin and tin, Industrial Reflectors, Tubular Heaters, Fluorescent Fittings, Time Switches, and all electrical equipment. Full lists on request. Single items supplied. Satisfaction guaranteed. Terms: Cash with order; carriage paid if over £4; orders of £20 or over less 5 per cent. discount. Open daily, inc. Sat. 9 to 6; Thurs. 9 to 1. Callers welcome.				

LONDON WHOLESALE WAREHOUSE
 165 (PM), QUEENS ROAD
 PECKHAM, S.E.15
 Tel. NEW Cross 7143 or 9890.

BASSETT-LOWKE announce

NEW SCALE LOCOMOTIVES

We can now offer standard locomotives in 'fine scale' style and with many additional refinements at little more than standard prices. These new locomotives will operate on coarse scale tracks.

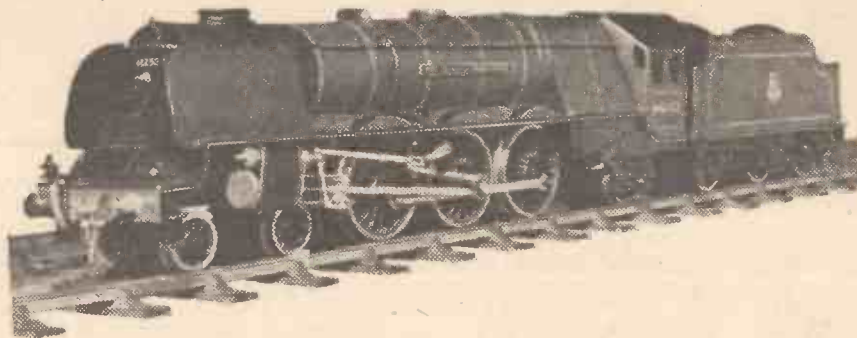

AND the TWO-RAIL SYSTEM

A striking innovation that will be welcomed by all model railway enthusiasts—a Two-rail Electric System with standard permanent way track units.

Three-rail and Two-rail Systems are now available. Standard 12 V.D.C. for indoor use and Standard 24 V.D.C. for outdoor use.

BASSETT-LOWKE LTD

18-25 Kingswell Street NORTHAMPTON

London: 112 High Holborn W.C.1.

Manchester: 28 Corporation Street, 4.



Our new 56-page (plus supplement) Model Railway Catalogue NOW READY price 2/-. We shall be glad to reserve you a copy on request.

FOR THE ENTERPRISING "PRACTICAL MECHANIC"

We offer the following sets of machined castings; Power Hacksaw, Drilling Machines, Hand Shaper, Compound Milling Table and Machine Vice.

These sets are obtainable with all the heavy machining carried out by us and each set can be finished with the aid of a 3½ in. lathe.

Full details of all the above 1/- post free.

E. W. COWELL LTD

SYDNEY ROAD · WATFORD · HERTS

BRASS, COPPER, DURAL, ALUMINIUM, BRONZE ROD, BAR, SHEET, TUBE, STRIP, WIRE

3,000 Standard Stock Sizes.

NO QUANTITY TOO SMALL.

List on application.

H. ROLLET & CO. LTD.

6, CHESHAM PLACE, LONDON, S.W.1

SLOane 3463

Also at LIVERPOOL LEEDS MANCHESTER BIRMINGHAM

MAKE MONEY — making casts with VINAMOLD

A grand spare-time occupation

WITHOUT any previous experience you can mass-produce any object, from a chessman to a candlestick, statuette or model ship, in plaster, resin, concrete, etc. . . . with "VINAMOLD" the flexible mould that gives the BEST results. Easy to work, can be used over and over again. Needs NO special equipment, provides a profitable and enjoyable spare-time occupation with minimum outlay.

Write for full details and instructions. Also available: Illustrated booklet describing "VINAMOLD," methods of heating and melting, preparation of models and moulds, etc. Price 1/6 post free, from:—

VINATEX LTD. (Dept. P.M.3), CARSHALTON, SURREY



TUNGSTEN CARBIDE TIPPED TOOLS

PLUGGING DRILLS

For clean round holes in brick, concrete, tiles, marble, etc., for all fixing jobs with Maso Plugs.

GLAZEMASTER

For drilling windows, mirrors, glasses, bottles, plate glass shelves, etc.

Write for Booklet P.M. Obtainable from your Tool Stockist and Ironmonger.

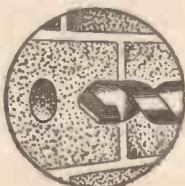

MASON MASTER

The Tradesman's Choice

Manufactured by JOHN M. PERKINS & SMITH, LTD., BRAUNSTON, NR. RUGBY
Tel.: BRAUNSTON 351-2



A FASCINATING HOBBY made Simple & Successful by means of this BOOK

Lampshade making can give endless fun, beautify your home and delight your friends. There are 83 practical and easy-to-follow illustrations and ideas to show you how to do it.

Published by C. Arthur Pearson Ltd., Tower House, Southampton Street, Strand, London, or obtainable from:

SAMUEL JONES & CO., LTD.

8/6



BUTTERFLY BRAND

SAMUEL JONES & CO., LTD.

Obtainable from all Booksellers or by requisition

SAVE ON REPAIRS WITH GLASS FIBRE

- Kit I—15/- Kit II—25/- Kit III—30/-
- Postage 2/-
- Kits for Cars, etc., £5-10-0, £9-10-0.
- Carriage Paid

These kits carry a comprehensive range of materials, with full instructions to suit all forms of car body repairs and model making.

"Glass Reinforced Plastics" Booklet, 1/9 inc. Postage.

WESTPOLE MOTORS LTD.

Westpole Avenue, Cockfosters, Barnet, Herts. Barnet 3615 & 9474.

OFFICERS' 4in1 MILITARY LAMBS WOOL LINED FULL LENGTH STORM COAT

These were limited issue for one short Antarctic convoy only. Full length Fawn Duck Stormproof Coat. Specification: 1. Outer Coat; 2. Separate inner proofing; 3. Woollen material lining; 4. Real lamb's wool top to bottom, natural solid leather backed. Double breasted, thoroughly waterproof, superb protection against rain, wind and cold. Neat, not bulky. High storm collar, wool cloth lined. Front double thickness, wind-proof cuff sleeves. 2 large pockets. Ideal motorists, outdoor workers, motor cyclists, town or country. Reduced price for sizes 34 to 42, only 52/6, p. & p. 3/6. Size 44 10/- extra. Sensational bargain—less than quarter of cost to manufacture.



NOW 52/6

1000 YARD DRUMS Assault Cable WIRE

Terrific Breaking Point

Genuine Combat field service telephone communication wire on a drum. Rustless as it is PVC covered.

Numerous uses include fencing gardens and fields, baling goods and heavy parcels, tough suspension lines for all purposes. Use instead of roping—neater, stronger and almost everlasting. Fixes almost anything. An essential article to have about the place. 1,000 yard drum, terrific breaking point, only 9/8d., carriage, etc., 3/6. Case of 6 carriage free. A Government surplus article that must have cost pounds to make, and our price is cheaper than string! Send quickly. **LISTS CLOTHING, WATCHES, TARPAULINS, TERMS.**



ONLY 9/6

THE ULTRA LENS AIDS PRODUCTION

This unequalled electric magnifier is of the most modern design and has proved its extreme and sustained usefulness to countless industrial firms engaged on minute examination of surfaces of every conceivable object.

Whether you are manufacturing, buying or selling, there are occasions when you have to submit some objects to a very close scrutiny. At these times the ULTRA LENS becomes indispensable.



Triple lenses ensure distortion-free magnification and eliminate the necessity for adjustment of focus. The focus is always perfect.

The ULTRA LENS achieves a six-fold magnification in a brilliantly-lit field which is shadowless.

Please ask your local Tool Shop, Jeweller, Optician, Scientific Instruments, Stamp-Dealer, or

Write for full particulars to

THE ULTRA LENS COMPANY

17c, Oxendon Street, London, S.W.1

Tel.: TRAFalgar 2055

WORLD WIDE RADIO RECEPTION

FOR THE AMATEUR RADIO ENTHUSIAST TUNE IN WITH THE MALVYN SINGLE VALVE SHORT WAVE COMMUNICATION RECEIVER

All-Dry Battery operated : Extremely low running costs : Band Spread Tuning : Attractive Front Panel : Full operating instructions included.

PRICE OF COMPLETE RECEIVER, 74/6 (Batteries and Phones Extra). Post Free U.K. Money Back Guarantee. Send S.A.E. to actual Manufacturers for Free Descriptive Literature.

MALVYN ENGINEERING WORKS

Radio and Electronic Engineers

Tel. : Hertford 2264 7 Currie Street, HERTFORD

HEADQUARTER and GENERAL SUPPLIES LTD.

(DEPT. PMC(25), 196-200, COLDHARBOUR LANE, LOUGHBOROUGH JUNCTION, LONDON, S.E.5. Open all Saturday. 1 p.m. Wednesday.

Make model buildings —



**as simply
as this!**

A new method—described in a new book on Pyruma Modelling. This shows how to turn empty match boxes into model buildings, by Pyruma 'Plasticraft.' It is one of the many methods of modelling in plastic Pyruma, shown in black and white and full colour pages, which enable you to build and finish in natural colours :—

**MODEL FARMS, RAILWAY STATIONS,
SIGNAL CABINS, AIRPORT BUILDINGS,
DOCKS, SHIPS, FIGURES, ANIMALS,
ASHTRAYS, BOOKENDS, DOLL'S
FURNITURE, PLAQUES, RELIEF MAPS,
ETC.**



is a ready-to-use material, cheap to buy locally, and easy to work by following the Instruction Book offered below. Pyruma dries or can be baked to stone-hard permanence, then painted in natural colours. Sold by local Ironmongers and Hardwaremen, Hobbies shops and Art material Dealers, in airtight tins from 1/6 upwards.

Send Coupon and 6d. P.O. (not stamps) for this NEW Book of instructions to :—

J.H. SANKEY & SON, L^{TD}

Established over a century
DEPT. P.M., ILFORD, ESSEX.

Enclose 6d. P.O. (not stamps) for PYRUMA MODELLING INSTRUCTION BOOK addressed to :—

NAME (block letters)

ADDRESS

ALL STEEL "54" DRAWER UNIT

DRAWER SIZE
11 1/2" long, 5" wide
3" high.

OVERALL SIZE
42" high, 36" wide,
12" deep.

Each drawer perforated with one free divider or plain-sided.

Extra dividers 4d. each. 54 cards free.

£16.16

DELIVERED FREE UK
Delivery from stock



Dark green stove enamelled



SEND FOR SAMPLE DRAWER WITHOUT OBLIGATION

N. C. BROWN, LIMITED
GREEN LANE WING
HEYWOOD, LANCS. Tel. 69018 (3 lines)

Mamod

MODEL STEAM ENGINES
FOR POWER AND RELIABILITY

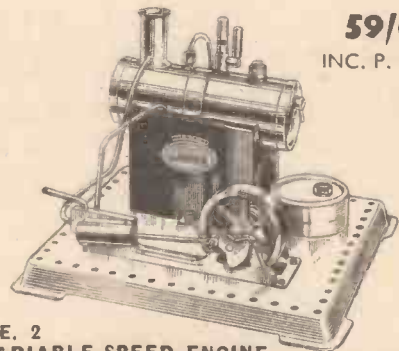

59/6
INC. P. TAX

S.E. 2
VARIABLE SPEED ENGINE

OTHER ENGINES from 27/6 to 96/6
WORKING MODELS from 7/6 to 16/8

Manufactured by

MALINS (ENGS) LTD.
25 CAMDEN STREET • BIRMINGHAM 1

EMI "HIS MASTER'S VOICE"

MARCONIPHONE · COLUMBIA

Announce NEW PRACTICAL WAY OF LEARNING AT HOME

NEW — completely up-to-date methods of giving instruction in a wide range of technical subjects specially designed and arranged for self-study at home under the skilled guidance of our teaching staff.

NEW — experimental outfits and lesson manuals are despatched on enrolment and remain the student's property. A tutor is allotted to each student for personal and individual tuition throughout the course.

Radio and television courses, with which specially prepared components are supplied, teach the basic electronic circuits (amplifiers, oscillators, detectors, etc.) and lead, by easy stages, to the complete design and servicing of modern Radio and T/V equipments.

If you are studying for an examination, wanting a new hobby or interest, commencing a career in industry or running your own full-time or part-time business, these practical courses are ideal and may be yours for moderate cost. Send off the coupon to-day for a free Brochure giving full details. There is no obligation whatsoever.

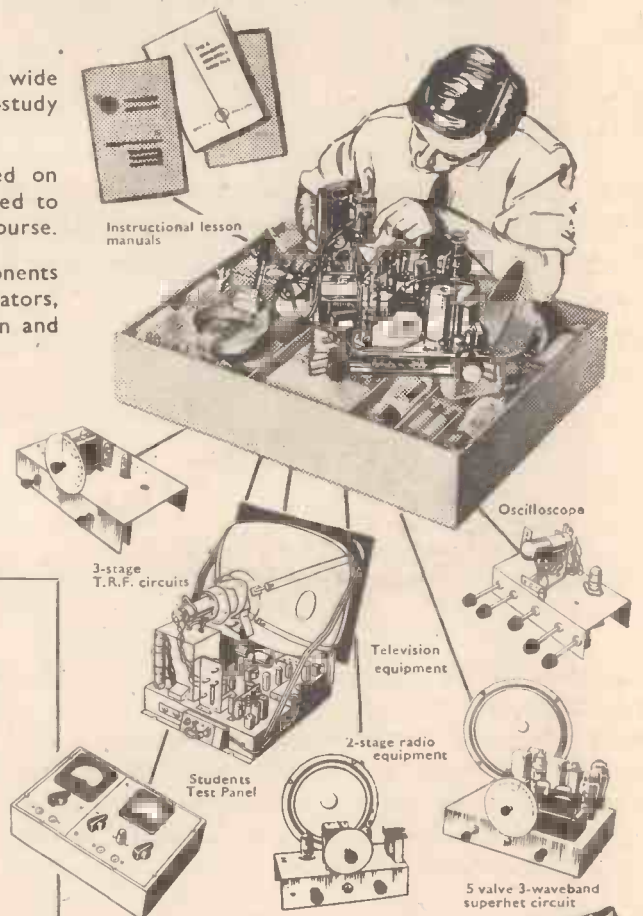

Courses with Equipment
RADIO · SHORT WAVE RADIO
TELEVISION · MECHANICS
CHEMISTRY · PHOTOGRAPHY
ELECTRICITY · CARPENTRY
ELECTRICAL WIRING
DRAUGHTSMANSHIP · ART, etc.

E.M.I. Factories
at Hayes,
England.



EMI INSTITUTES

Fill in for **FREE BROCHURE**

E.M.I. INSTITUTES, Dept. 144 x, London, W.4.

NAME _____ Age _____
 (if under 21)

ADDRESS _____

BLOCK
CAPS
PLEASE

I am interested in the following subject(s) with/without equipments

(Nov. 57) (We shall not worry you with personal visits)

IC.107

The only Home Study College run by a World-wide industrial organisation

THE 'MAGSTAT'

This is a precision bi-metal thermostat for the control of alternating currents of up to 1 amp. at 240 volts. The temperature range lies between minus 50 deg. F. and plus 250 deg. F. An ingenious magnetic snap action is incorporated which gives freedom from radio interference. The operating temperature is altered by rotation of the adjustment screw, clockwise for increase and anti-clockwise for decrease. Dimensions 2in. x 1/2in. x 1/2in.



PRICE : **5/6** each. Post 3d.

* SUPPRESSIT *

(TELEVISION SUPPRESSOR KIT)
For the suppression of Domestic Motor Driven Appliances. Comprises two chokes and two condensers mounted on a card with wiring instructions. Ideal for Vacuum Cleaners, Hairdriers, Sewing Motors, etc., up to 1 amp. Price 3/6, Post Free.

REPLACEMENT ELEMENTS

FOR DOMESTIC ELECTRICAL APPLIANCES

We stock over 200 types of element replacements for Fires, Irons, Kettles, Hairdriers, Toasters and Boiling Rings. Send for Catalogue.

WE HAVE A REPUTATION FOR HIGH QUALITY THERMOSTATS AND LIST SOME OF OUR STOCK ITEMS HERE :

THERMOSTAT. CS. Convector Thermostat for Space Heaters and Low temperature Ovens. 15 amps., 250 volts A.C. 40/80 deg. F. 25/-, post 5d.

THERMOSTAT. MB. For control of Electric Immersion Heaters up to 3 kW. 90/190 deg. F, 15 amps., 250 volts A.C. £2/0/0, post 9d.

THERMOSTATS. PF. Room Thermostat, 15 amps., 250 volts A.C. 5in. x 1 1/2in. x 2in. A beautiful instrument. Temp. ranges 30/90, 40/100, 40/80, 60/100 deg. F. as required. £2.0.0, post 6d.

THERMOSTAT. BW/1. 3 amps., 250 volts A.C. For control of hot-plates, vulcanisers, etc. 50/550 deg. F. 15/6, post 4d. We are only too glad to send illustrated leaflets on any of these Thermostats if you will send a S.A.E. stating which model interests you.

IMMERSION HEATERS

We can offer a wide range from 2 to 4 kW and in stem lengths 11in to 42in. Please send for our catalogue.

GREENHOUSE THERMOSTAT

Type ML. Constructed especially for the amateur gardener. The scale plate is calibrated "High-Medium-Low" and has a temperature range of 40-90 deg. F. Current capacity is 10 amp., 250 volts A.C. Differential 4-6 deg. F. Size 4 1/2in. x 2in. x 1 1/2in.

PRICE : 35/-, Post 6d.

Model PJ. Miniature Thermostat for control of domestic Electric Irons and special-purpose machines where space is limited. Capacity : 5 amps., 250 volts A.C. 1/2in. x 1/2in. x 1 1/16in. Single screw fixing. Price 9/3 Post 3d.

NEON INDICATOR SWITCH!

10/6d. Post free.

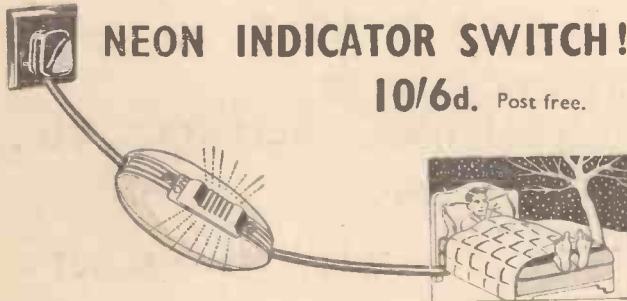

FIT THIS TO YOUR ELECTRIC BLANKET AND BRING IT UP TO DATE.

Double Pole Break, A.C.-D.C. Silver Contacts, Improved Cord Grip, Simple Wiring. Modern Streamline Styling in Cream Bakelite.

SUITABLE ALSO FOR ANY OTHER APPLIANCE WHICH REQUIRES A VISUAL INDICATION THAT IT IS ON (SOLDERING IRONS, ETC.)

THE TECHNICAL SERVICES CO.

SHRUBLAND WORKS BANSTEAD SURREY

Follow the **FLUXITE** way to Easy Soldering



No. 9. JOINING TWO SURFACES (2)

Having tinned both surfaces hold repair piece in position with corner of file then run reheated iron all over it until the solder of the two tinned surfaces remelts and fuses together.

FLUXITE is the household word for a flux that is famous throughout the world for its absolute reliability. In factory, workshop and in the home FLUXITE has become indispensable. It has no equal. It has been the choice of Government works, leading manufacturers, engineers and mechanics for over 40 years.



Fluxite Limited, Bermondsey Street, London, S.E.1.

G.M.59

You simply pour out these

NOVELTIES

with NEW LIQUID PLASTIC

Here's the hobby to make your spare time pay dividends. You simply choose your mould and pour out beautiful castings. We supply everything, including instructions. Start right away —no training needed. Send 3d. for exciting book and market details. No obligation.



QUALITY PLASTICS LTD.

Dept. P.M.12 · BRENTWOOD · ESSEX

SAW BENCH UNIT FOR 66/- — POST FREE!

Fit the S.G.S. High Speed Ball Bearing Circular Saw Unit

EMPIRE UNIT (illustrated) for saws to 12in. dia., **£3.6.**
ROYAL UNIT for saws to 16in. dia., **£5.3.**
EMPRESS UNIT for saws to 20in. dia., **£5.15.**

Any size to order. 1/2in. Drill Chuck, 14/- extra.

Also S.G.S. Ball Bearing Planer Units. 4 1/2in. size, £4.15. 6in., £6.15. 8in., £8.10.

"GENETIG" Wood turning Lathes, 18 1/2in., 24in. or 30in. centres, from £8.10

Write for full details of these and other lines.

S. G. S. ENGINEERS, Dept. P.M.I.

OLD COSTESSEY · NORWICH · NORFOLK Tel.: Costessey 327.



GREAT NEWS FOR ALL 'DO-IT-YOURSELFERS'!

WOLF

NEW!

QUARTERMASTER

HOME POWER EQUIPMENT



Matchless
**POWER·SPEED
SAFETY**

**SPECIAL
HIGH SPEED
POWER UNIT
—THE VERY
LATEST!**

- **MOST POWERFUL HANDYMAN UNIT EVER OFFERED**
- **FASTEST FOR SAWING, SANDING, POLISHING, etc.**
- **FULLY GUARANTEED**
- **RADIO AND TELEVISION SUPPRESSED**

WOLF

QUARTERMASTER HOME POWER EQUIPMENT

widest range of power operations—new attachments always being added.

Sanding, Polishing, Buffing, Sawing & Grooving, Woodturning, Fretsawing, Jig Sawing, Portable & Bench Drilling, Planing, Hedge Trimming, Engraving, Carving, Boot & Shoe Repairing, Cultivating, Weeding, etc.

Wolf, Britain's foremost makers of Electric Power Tools, introduce the "Quartermaster" range—the quickest and most powerful help in "do-it-yourself" jobs the handyman and the housewife has ever handled!

The Special High-Speed "Quartermaster" Power Unit is loaded with extra power. It supersedes all others for sawing, sanding, polishing, planing, woodturning, and other operations where power and speed make all the difference.

Wolf Home Power Equipment offers the widest range of "Do-it-Yourself" operations.

EASY TERMS AVAILABLE

WRITE TODAY for fully illustrated brochure to:—

WOLF ELECTRIC TOOLS LTD. DEPT. V1, HANGER LANE, LONDON, W.5

VALUABLE NEW HANDBOOK FREE TO AMBITIOUS ENGINEERS

Have you had your copy of "Engineering Opportunities"?

The new edition of "ENGINEERING OPPORTUNITIES" is now available—without charge—to all who are anxious for a worthwhile post in Engineering. Frank, informative and completely up to date, the new "ENGINEERING OPPORTUNITIES" should be in the hands of every person engaged in any branch of the Engineering industry, irrespective of age, experience or training.

**We definitely Guarantee
"NO PASS—NO FEE"**

This remarkable book gives details of examinations and courses in every branch of Engineering, Building, etc., outlines the openings available and the essential requirements to quick promotion and describes the advantages of our Special Appointments Department.

WHICH OF THESE IS YOUR PET SUBJECT?

MECHANICAL ENGINEERING

Gen. Mech. Eng.—Maintenance — Draughtsmanship—Heavy Diesel—Die & Press Tool Work—Welding—Production Eng.—Jig & Tool Design—Sheet Metal Work—Works Management — Mining — Refrigeration—Metallurgy.

AUTOMOBILE ENGINEERING

Gen. Automobile Eng.—Motor Maintenance & Repairs — High Speed Diesel—Garage Mngment.

WE HAVE A WIDE RANGE OF AERONAUTICAL COURSES AND COURSES IN FORESTRY, TIMBER TECHNOLOGY, PLASTICS, G.P.O. ENG., TEXTILE TECHNOLOGY, ETC., ETC.

One of these qualifications would increase your earning power

WHICH ONE?

A.M.I.Mech.E., A.M.I.C.E., A.M.I.P.E., B.Sc., A.M.Brit.I.R.E., A.F.R.Ae.S., A.M.I.M.I., L.I.O.B., A.R.I.B.A., A.M.I.H. & V.E., M.R.San.I., F.R.I.C.S., A.M.I.E.D., CITY & GUILDS, COMMON PRELIM., GEN. CERT. OF EDUCATION, ETC.

ELECTRICAL ENGINEERING

Gen. Elec. Eng.—Elementary & Advanced Elec. Technology—Installations Draughtsmanship—Supply —Maintenance — Design —Electrical Traction —Mining Electrical Eng.—Power Station Equipment, etc.

CIVIL ENGINEERING

Gen. Civil Eng.—Sanitary Eng.—Structural Eng.—Road Eng.—Reinforced Concrete—Geology.

RADIO ENGINEERING

Gen. Radio Eng.—Radio Servicing, Maintenance & Repairs—Sound Film Projection — Telegraphy — Telephony — Television — C. & G. Telecommunications.

BUILDING

Gen. Building—Heating & Ventilation—Architectural Draughtsmanship — Surveying — Clerk of Works — Carpentry and Joinery —Quantities — Valuations

WHAT THIS BOOK TELLS YOU

- ★ HOW to get a better paid, more interesting job.
- ★ HOW to qualify for rapid promotion.
- ★ HOW to put some valuable letters after your name and become a "key-man" quickly and easily.
- ★ HOW to benefit from our free Advisory and Appointments Depts.
- ★ WHERE today's real opportunities are... and HOW you can take advantage of the chances you are now missing.
- ★ HOW, irrespective of your age, education or experience, YOU can succeed in any branch of Engineering that appeals to you.

144 PAGES OF EXPERT CAREER-GUIDANCE

You are bound to benefit from reading "ENGINEERING OPPORTUNITIES," and if you are earning less than £15 a week you should send for your copy of this enlightening book now—FREE and without obligation.

POST NOW!

TO: B.I.E.T. 410A, COLLEGE HOUSE, 29-31, WRIGHT'S LANE, KENSINGTON, W.8.

Please send me FREE and without obligation, a copy of "ENGINEERING OPPORTUNITIES." I am interested in (state subject, exam., or career).....

NAME

ADDRESS.....

WRITE IF YOU PREFER NOT TO CUT THIS PAGE



Only 2d. stamp is needed if posted in an unsealed envelope.



410A, COLLEGE HOUSE,
29-31, WRIGHT'S LANE,
KENSINGTON, W.8.

Phone: WESTern 9861

THE B.I.E.T. IS THE LEADING INSTITUTE OF ITS KIND IN THE WORLD

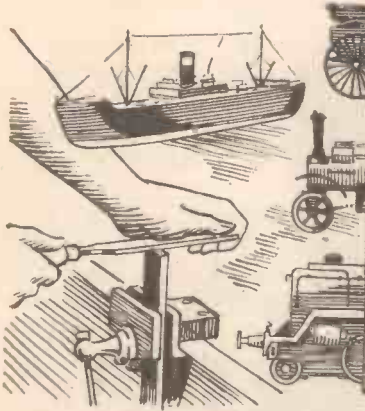

Practical Mechanics

Vol. XXV. No. 285 NOVEMBER, 1957
 "The Cyclist" and "Home Movies"
 are temporarily incorporated



FAIR COMMENT

OUR 24th BIRTHDAY

WITH this issue we enter the 25th year of continuous publication, with the exception of the issues missed owing to the printing dispute which, of course, affected most other publications as well. This issue is being widely advertised in the national press, and many thousands of new readers will join our ranks as a result. For their benefit, and as a refresher to those tens of thousands of older readers to whose service we have dedicated ourselves for the past 24 years, may we say that this journal exists to serve that ever-expanding public interested in making things, whether it be furniture, models, household appliances or experimental apparatus, in fact in anything which can be made at home. The scientific experimenter, the inventor, the photographic enthusiast, those interested in telescoping and microscopy, in scientific and mechanical developments, look to this journal for the very latest designs and information. The interests of this journal are wide and its circulation world-wide.

Our free advice bureau, staffed by experts in the various fields, gives advice on every topic within our compass. Every year thousands of letters are dealt with, and it is a source to which every reader can turn when he needs advice. This feature alone is worth far more than the annual subscription.

Readers will have seen the developments of the ideas born over 25 years ago for the production of a series of practical journals to cover the entire range of modern interests. Our first was *Practical Wireless*, and *PRACTICAL MECHANICS* followed a year later. Each was an immediate success, and the fact that one has passed and this one approaches a quarter of a century of service to readers confirms the accuracy of our judgment in embarking upon this venture in publishing. Other journals followed, until to-day there are six "Practicals"—*Practical Television*, *Practical Motorist* and *Motor Cyclist*, *The Practical Householder* and our recently launched *Practical Home Money Maker*, the second issue of which is now on sale and which, judging from the enormous demand and the fact that the first issue rapidly sold out, is an indication that once again we have produced a paper for a large market, hitherto not catered for. For there is no competitor for the *Practical Home Money Maker*.

We have pioneered this field and, of course, have created the inevitable imitators. Our Practical journals, however, maintain their premier positions in their respective fields, and continue to maintain the largest circulations. To new readers, therefore, a cordial welcome to this enthusiastic readership. To older readers, our gratitude for the loyal support you have extended to us for so many years.

A browse through past issues will indicate how the editorial policy has kept readers abreast of developments with exclusive information collected by our correspondents all over the world. I hope that new readers will follow the practice of the old and place a regular order for the delivery of this journal.

FREE 24-PAGE TROUBLE-TRACER FOR MOTORISTS

INSIDE every copy of the November issue of the *Practical Motorist and Motor Cyclist* is given a 24-page illustrated book on trouble-tracing for motorists and motor cyclists, and if you are a motorist you will find this book a useful guide to the tracing of faults in the engine, carburetter, ignition system, and the other parts of the mechanism which occur when you are on the road.

INDEXES AND BINDERS

INDEXES for Volume 24 will shortly be available at 1s. 3d. by post, and self-binders for 11s. 6d. When ordering the latter, please state the volume number you require to be blocked on the spine. We can supply binders for any volume of this journal, and indexes for most. Address your orders to the Publisher, address as on this page.—F. J. C.

Editorial and Advertisement Offices
 "PRACTICAL MECHANICS"
 George Newnes, Ltd., Tower House,
 Southampton Street, Strand, W.C.2.
 Phone : Temple Bar 4363.
 Telegrams : Newnes, Rand, London.

SUBSCRIPTION RATES

including postage for one year

Inland - - - - 20s. per annum.
 Abroad - - - - 18s. 6d. per annum.
 Canada - - - - 18s. 6d. per annum.

Copyright in all drawings, photographs and articles published in "Practical Mechanics" is specially reserved throughout the countries signatory to the Berne Convention and the U.S.A. Reproduction or imitations of any of these are therefore expressly forbidden.

CONTENTS

	Page
Fair Comment	63
Building a Greenhouse	64
Puzzle Corner	66
Building An Outboard Motor-boat	67
Electric Pendulum Clock	69
Double Bunk Beds	71
A Daylight Cinema	73
A Transistorised Geiger Counter	76
A Large Ukulele	77
A Simple Episcopo	79
An Attractive Child's Cot	81
Motorising a Sewing Machine	82
A Sink Unit	84
A 6in. Personal TV for £10	87
Painting Woodwork	90
A Radio Controlled Model of the Royal Yacht	92
Science Notes	96

JUNIOR SECTION:

Making a Designograph	99
An Easy to Make Waterline Ship Model	100
Marble Alley and Diving Submarine	103
Letters to the Editor	104
Trade Notes	108
Your Queries Answered	109
Information Sought	110

THE CYCLIST SECTION:

What I Think	5
Planning Next Year's Tour	6

CONTRIBUTIONS

The Editor will be pleased to consider articles of a practical nature suitable for publication in "Practical Mechanics." Such articles should be written on one side of the paper only, and should include the name and address of the sender. Whilst the Editor does not hold himself responsible for manuscripts, every effort will be made to return them if a stamped and addressed envelope is enclosed. All correspondence intended for the Editor should be addressed: The Editor, "Practical Mechanics," George Newnes, Ltd., Tower House, Southampton Street, Strand, London, W.C.2.

BUILDING A GREENHOUSE

A Simple and Cheap Method of Construction

By J. H. TAYLOR

THIS glasshouse shown in Figs. 1, 2 and 3 is 13ft. X 8ft. on plan, 5ft. high to the eaves and 8ft. high to the ridge and was built by an amateur who had neither the skill nor the time to make a large number of properly framed joints.

The original idea was based upon certain fundamental considerations which apply to any size of glasshouse built by this method. They are (a) speed; (b) prefabrication; (c) standardisation; (d) cost, all of which are inter-related.

Speed

All joints are made with standard 3in. X 3in. X 1/2in. steel flat angle and tee "repairing" plates, which can be obtained from any ironmongers, and tin brass screws. The screws must be brass. The use of a brace with screwdriver bit saved a great deal of time.

Prefabrication

The four sides and two gables were constructed on the garage floor, but the roof was built *in situ*. All painting was carried out inside the garage before erection. Working drawings were not prepared, but it was necessary to have some sketches with the principal dimensions marked.

Standardisation

The glasshouse was constructed from

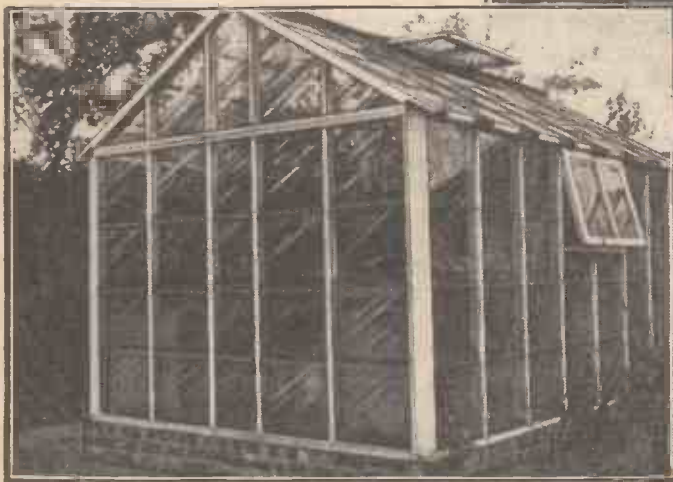

Fig. 1.—A view of the rear of the completed greenhouse.

timber of only two sizes, viz., 2in. X 3in., once rebated and 1 1/2in. X 3in. standard greenhouse bar (this is sold ready prepared, twice rebated and twice chamfered). If a smaller glasshouse is contemplated, 1 1/2in. X 2in. standard bar can be obtained, in which case 1 1/2in. X 2in. once rebated timber could be used for the other members.

Horticultural 24oz. clear sheet glass is sold by the box of 200ft. super in the

being able to obtain just about the right quantity of glass from two complete boxes each containing 100 squares, size 18in. X 16in.

Cost

All the foregoing considerations helped to cut down cost. The total cost of materials was

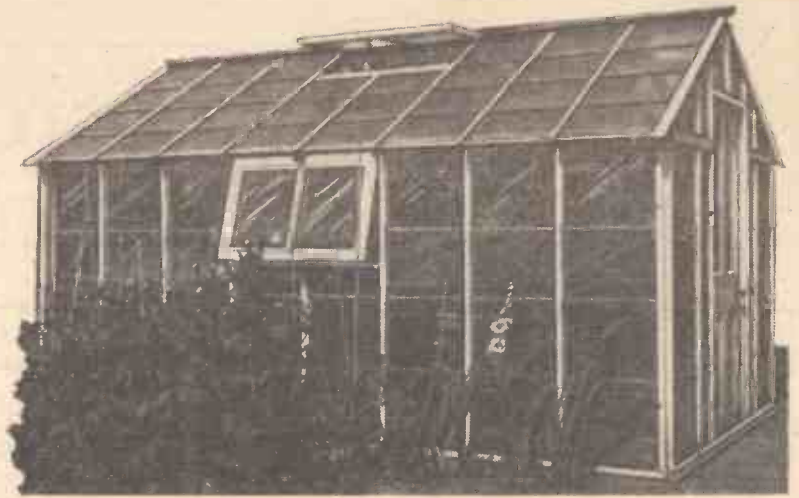

Fig. 3.—A three-quarter front view.

following standard sizes and number of approximately £35. squares per box, viz.:-

in.	in.	in.	in.	in.	in.
200—24	X 6	100—24	X 12	90—20	X 16
133—24	X 9	114—18	X 14	75—24	X 16
206—14	X 10	103—20	X 14	80—20	X 18
133—18	X 12	86—24	X 14	67—24	X 18
120—20	X 12	100—18	X 16	50—24	X 24

The glass size naturally governs the spacing of the bars and all dimensions of the 13ft. X 8ft. glasshouse were based upon

Construction

The first and most important item to be made was a three-ply template of the glass square size plus 1/4in. on the width. The reason for this will become apparent.

The two long sides shown in Fig. 4 are identical and sufficient glazing bar was cut to exact 5ft. lengths together with four 5ft. lengths of once rebated timber for the end members.

Metal tees were then screwed to the ends of each glazing bar and metal angles to the end of each end member.

Two 13ft. lengths of once rebated timber were then laid on the ground, to form top and bottom members, and the angle plates of one end member were screwed to same, making sure that the corners were square. The first length of glazing bar was then placed between the long members and the plywood template was placed in position in the rebates, as shown in Fig. 5, and the tee plates at the ends of the glazing bar

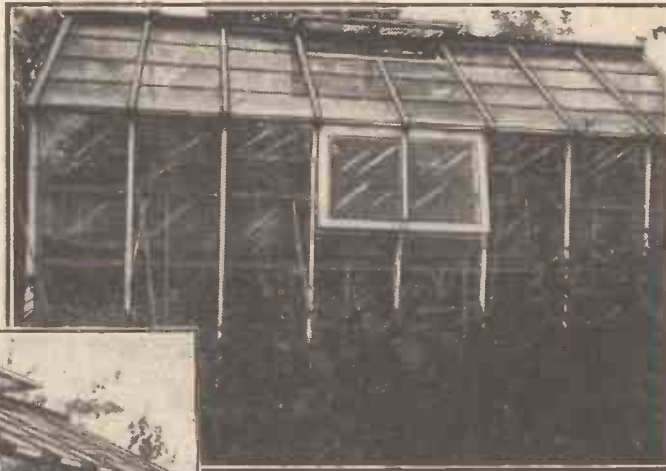

Fig. 2.—A side view of the completed greenhouse.

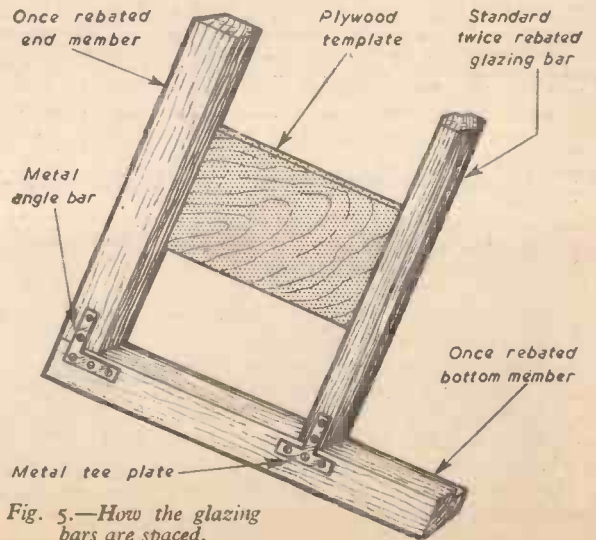

Fig. 5.—How the glazing bars are spaced.

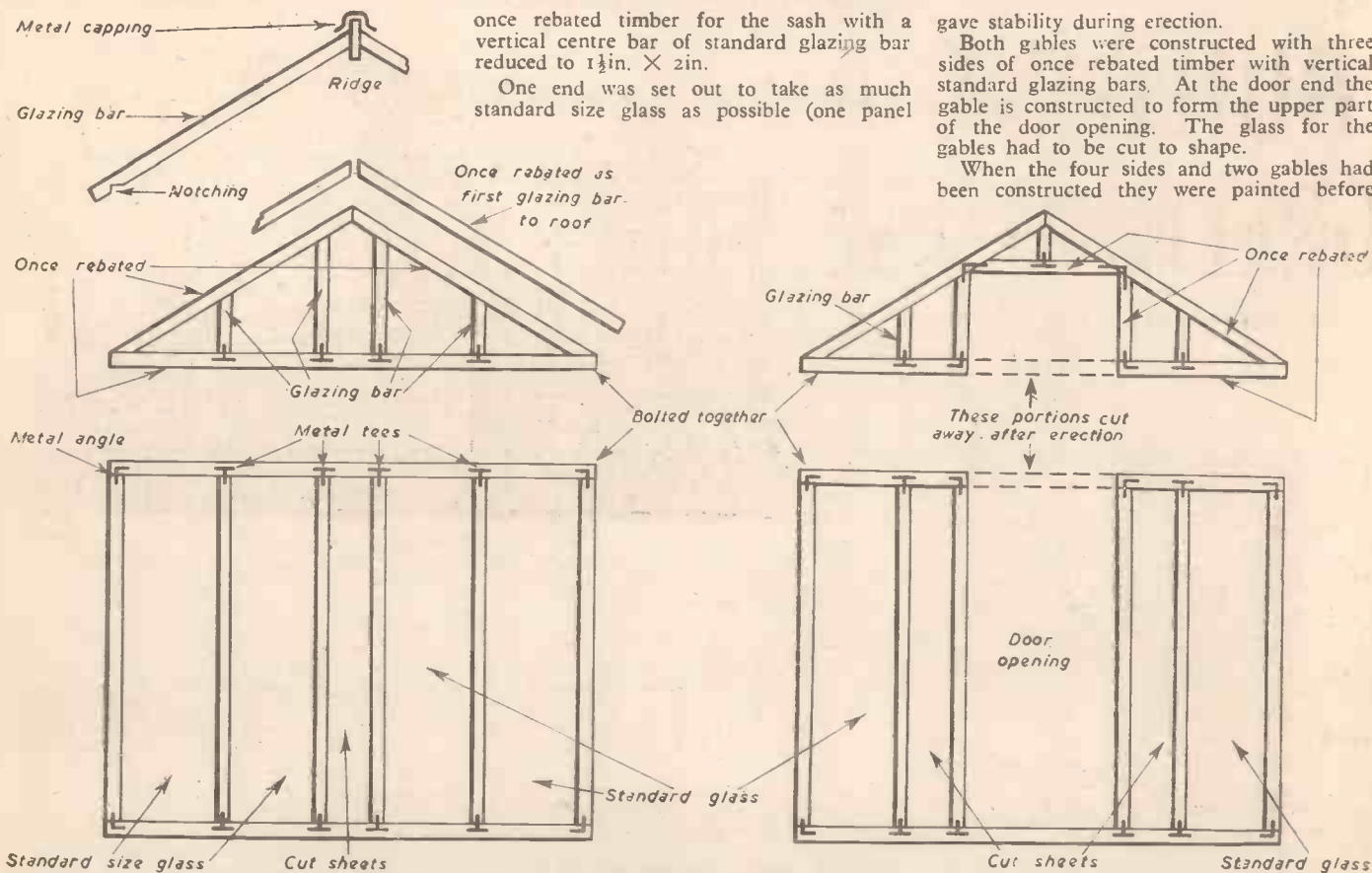

Fig. 4.—Constructional details of the sides, gables, concrete strip and brick curb.

erection. All surfaces were thus protected and the job was far easier than it would have been after glazing. The roof members were also painted before erection. All surfaces were primed and painted with two coats of white lead glasshouse paint. As all glass was backputted only, no face putties being used, it was considered unnecessary to paint again after glazing.

Whilst waiting for the slow-drying white lead paint to dry the foundation wall was constructed, as shown in Fig. 4. This consists of a 12in. X 6in. concrete (1-8) foundation with a 4½in. brick wall 6in. high. A strip of felt damp proof course was laid on the wall under the bottom timbers of the sides.

Erection

The erection commenced with the four sides being placed in position and bolted together. When glazed their own weight holds them down and they become much steadier. The gables were then bolted on to the short sides and a 1in. X 5in. ridge plate nailed in position.

The roof was constructed *in situ*, each slope commencing from one end with a 5ft.

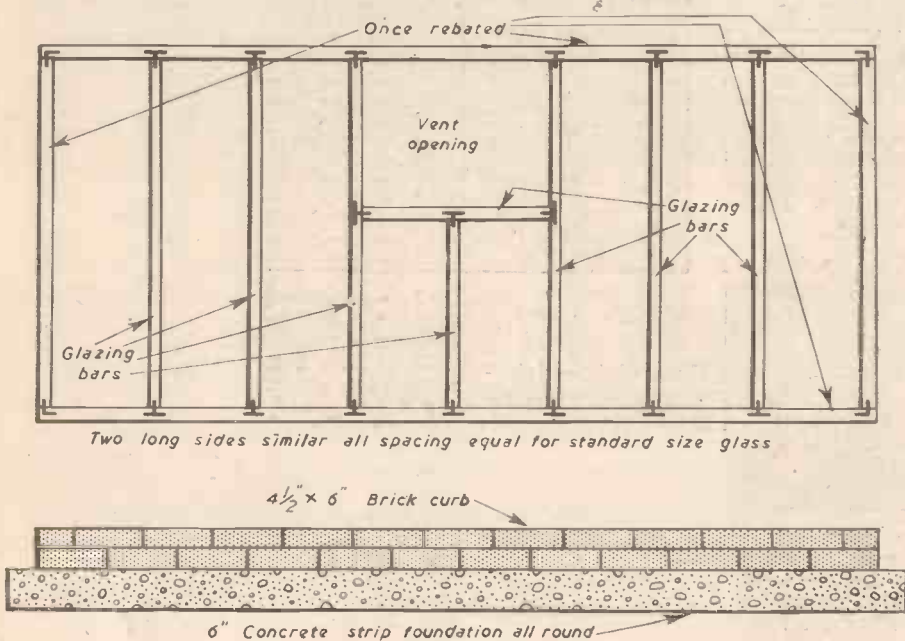

screwed to the long members. The other bars were fixed in a similar manner, using the template between each bar, and finally the other end member. The short surplus on the 13ft. lengths was then sawn off. To give additional strength a 3in. nail was driven through the long members into each glazing bar and end member.

Openings for the side ventilators were formed, as shown in Fig. 6, by cutting through and removing a portion of one glazing bar and fixing a horizontal bar with metal tees.

The side ventilators were constructed with normal mortise and tenon joints, using the

had to have cut squares) and the other short side was constructed to receive the door. Both ends are shown in Fig. 4.

The door used was a second-hand internal door obtained from a builders' yard for 15s., and the upper panels were cut out and fillets fixed to form glazing rebates.

In the short side with the door opening, the top member and the bottom member of the gable were carried across the opening and then both cut away after erection. This

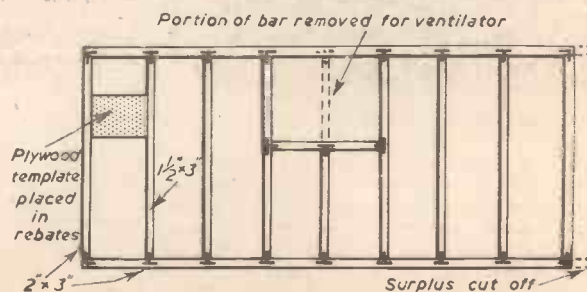

Fig. 6.—Laying out one of the sides and making the ventilator.

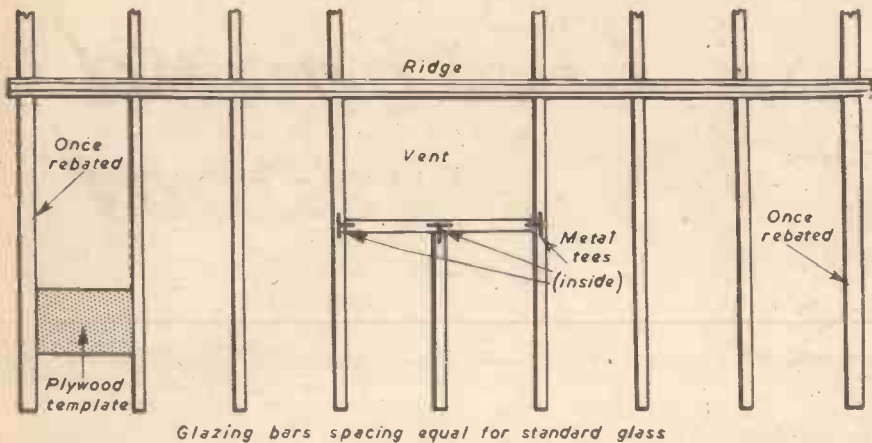

Fig. 7.—A half-plan of the roof.

Brackets fixing roof bars (2 brackets only per bar)

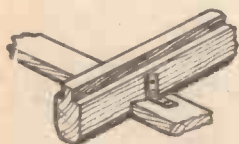
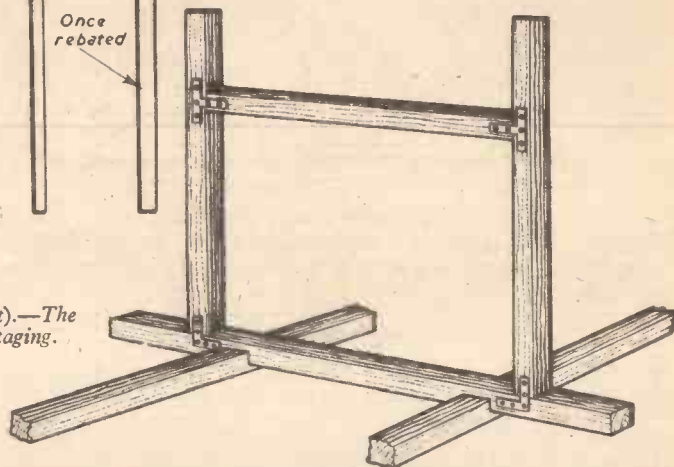

Fig. 8.—Fixing the roofing bars.

length of once rebated timber nailed on top of the gable (see Fig. 7). One 5ft. length of standard glazing bar was then offered up and accurately cut to fit against the ridge and notched over the upper side member.

Fig. 9 (Right).—The removable staging.



one bar on each side (with metal tee joints) to form ventilator openings, as shown in Fig. 7. Ventilators were made as previously described for the sides.

The unwanted members across the door opening were cut away and the door hung on three hinges. Battens to form stops were

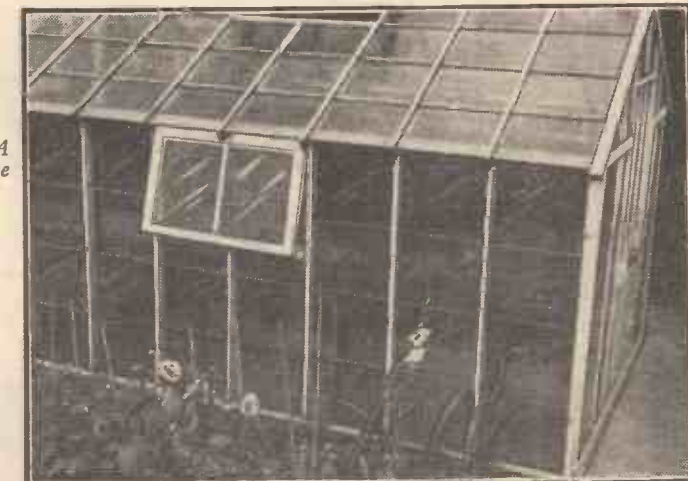
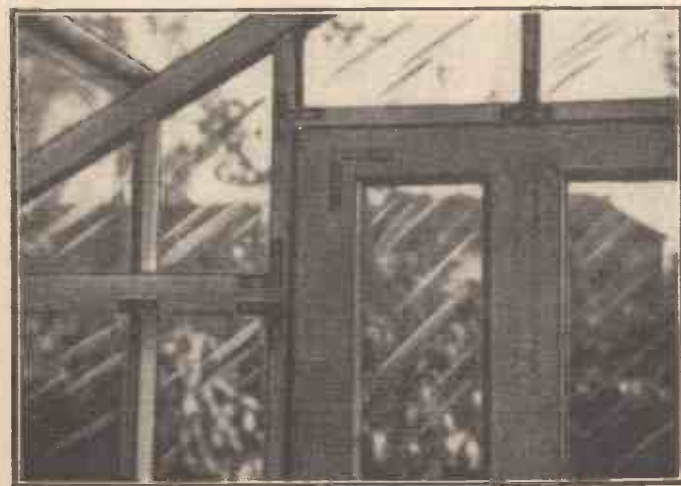

The first bar was then used as a template to cut the other bars. The bars were fixed with small metal angle brackets commencing from one end and using the plywood template as a guide for spacing. The rebates in

the glazing bars are rather small and it was found that the bar could not be nailed accurately enough, so brackets had to be used for fixing (see Fig. 8).

When the roof bars had all been fixed,

fixed to the door and ventilator frames. A new rim lock was fixed to the door and casement stays to the ventilators.

When the roof had been glazed there was a small gap between the glass and the upper side member and this was filled in with lengths of $\frac{1}{4}$ in. \times 2 in. batten. The ridge was covered with a strip of thin galvanised iron.

Removable staging in the glasshouse was constructed by using metal angle and tee plates for the joints, as shown in Fig. 9, and the whole construction has proved to be extremely rigid and serviceable. Two further views of the greenhouse are shown in Figs. 10 and 11.

Fig. 10 (Left).—A close-up view of part of the door end.

The result is your telephone number and your age this year or in this case the telephone number and age of PRACTICAL MECHANICS.

Can you explain why this should be so ?

Only the most elementary algebra is required, with a little rearrangement of the processes which were in the original form

purposefully mixed up so as to draw a red herring over an obvious sequence of facts.

Let x = telephone number.
 Multiply by 2 = $2x$
 Add 5 = $(2x + 5)$
 Multiply by 50 = $(100x + 250)$
 Add days in the year (365) = $(100x + 615)$
 Subtract M.P.'s (615) = $100x$
 Add 1957 and deduct birth year (which is the same as adding age).

Thus we have the telephone number with two noughts at the end (having multiplied it by 100), and these two noughts are replaced by the figures of our age, or in the case of the example the age of PRACTICAL MECHANICS.

Practically all of the "think of a number" problems can be solved by this simple means.

PUZZLE CORNER

AT quite an early age most of us ran into that kind of problem which invariably began "Think of a number . . . double it," and after a series of similar calculations you were told you had the number you first thought of. Here is a rather more ingenious version (worked with an example).

Write down your telephone or house number 4363

Double it	8,726
Add 5	8,731
Multiply by 50	436,550
Add the year (1957)	438,507
Add the number of days in a year (365)	438,872
Subtract the year of your birth (1933)	436,939
Subtract the number of M.P.'s (615)	436,324

Building an Outboard Motorboat

A Sturdy All-wood Craft, Ideal for the Week-end

the frames, of which there are six, and numbered consecutively from bow to stern. The frames are made in three simple parts, namely two side members and one floor member.

The sides are made from 2 1/2 in. X 1 in. mahogany and the floors 2 in. X 1 in. of similar material. The frames is a straight-forward job, but calls for accuracy and care.

be noticed that the sides are not at right angles to the floors, but at varying angles according to their position.

Reference to the drawings will also show that these frames are notched at various points, and it is here that the builder must be most careful to follow the plans, for the ease with which the boat can be subsequently assembled, and its ultimate shape, will greatly depend on the care exercised at this juncture.

Fig. 6 shows the first or No. 1 frame, which can be assembled and notched in



THE method employed in building this craft is technically known as seam batten carvel, that is to say, the planks do not overlap as in the clench-built method, upon which most small craft are built.

Fig. 1.—The motor, rudder bar and propeller assembly.



of the side members correct, which, of course, will automatically set themselves if the width at the top and bottom of the frame is correct.

The Side Members

The side members are screwed to the side of the floors with brass countersunk head screws, 1 1/2 in. long and number 8 gauge.

Before assembling them, however, it is as well to paint the surfaces which touch in order to preserve them and eliminate rot.

From the drawings of these frames it will

accordance with the drawing, after which the other frames can be taken in hand, great care being exercised in getting the angles of the side members correct, which, of course, will automatically set themselves if the width at the top and bottom of the frame is correct.

In setting these side members, it must be borne in mind that the dimensions of the top and bottom of the frame can be correct, and still have the angles wrong, if the structure is, as it were, "askew."

To prevent this, it is as well to tack a batten on to the floor member at its centre and at right angles, and measure from this. To make sure that the angles are correct, it is obvious that each side of the batten will produce equal dimensions, thus we are

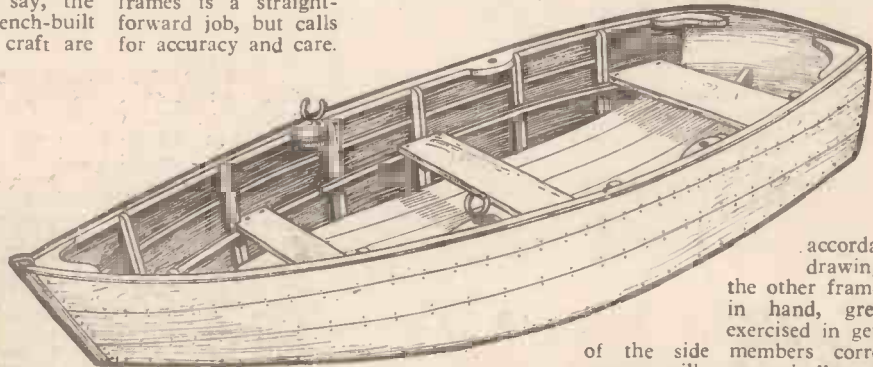

Fig. 2.—A perspective sketch of the finished hull.

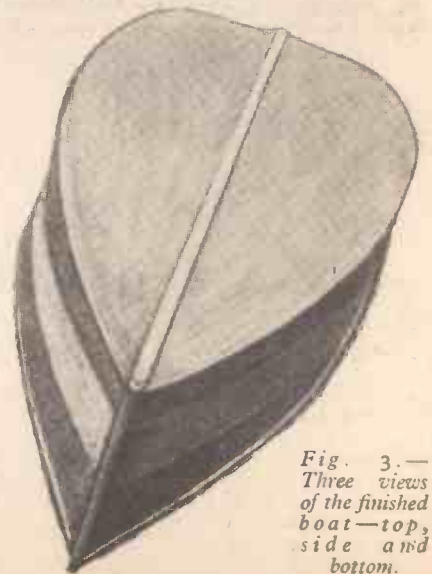

Fig. 3.—Three views of the finished boat—top, side and bottom.

In this method the planks butt edge on, but owing to the thinness of the material it is not possible to caulk them as would be the case in larger craft.

The seams are therefore rendered watertight by means of a batten running along them inside the boat, and to which the edges of the planks are nailed. This is known as a seam batten, hence the term seam batten carvel construction.

The craft, unlike a round bilge clinker boat, is not built on moulds and subsequently timbered, but is built up on a series of simple frames.

Although falling into a class of craft known as the "flattie," this boat is given a flare on its sides forward, and a tumble home stern which makes it resemble orthodox launch practice. The bottom, too, is curved in a direction fore and aft.

The first job to be taken in hand will be

Fig. 4.—A further view showing the boat's attractive lines.

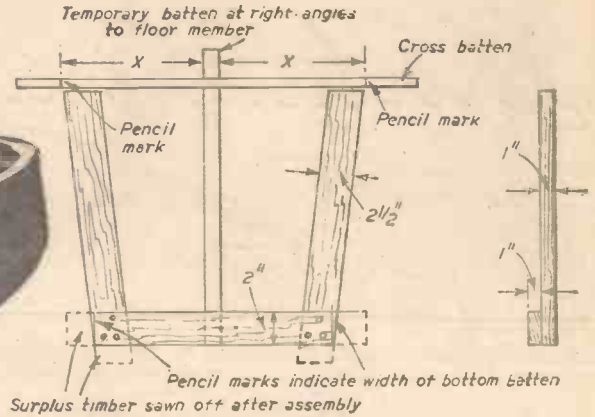
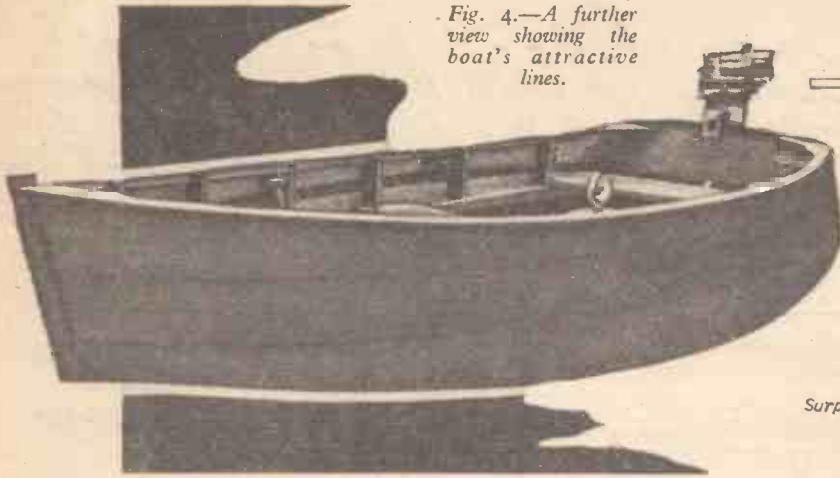

Fig. 5.—Details of the floor members.

working virtually in half-breadths, which is really the customary way in the boat building industry of showing dimensions which refer to the beam or width of a boat.

Fig. 5 shows how this is done, and also shows a simple way to make the frames up without error. It will be noticed

measured, of course, from the extreme bottom of the floor member, which again, in the case of frame No. 1, is 15in. Now tack another batten with its lower edge on this line, at right angles to the vertical batten and, consequently, horizontal to the floor member. If you measure along this

batten the width of the frame on top, which it will be seen is 1ft. 6in., again working in half-breadths, and mark these points with a pencil, it is obvious that the outer edge of the side members must cut these pencil marks. In the case of the floor, however, the outside edge of the side batten should cover up the pencil mark, except just at the bottom edge, whilst at the top the edge of the side member should just touch the part of the pencil mark on the lower edge of the cross batten (see Fig. 5).

The side members may now be screwed on to the floor, and any surplus timber sawn off.

This procedure is perhaps a little difficult to grasp, but a little study will show that it can be applied to all the frames,

irrespective of their angles, and avoids the necessity of complicating the drawings by giving the angles for each piece of timber used.

In Fig. 5 the notches are, of course, left out so that the construction can be clearly seen. In putting in the screws, care must be taken to see that they are not in the way of the chine slot on the extreme corners.

Figs 8 to 12 show the remaining five frames in which the principle of construction is the same, but the dimensions of slot posi-

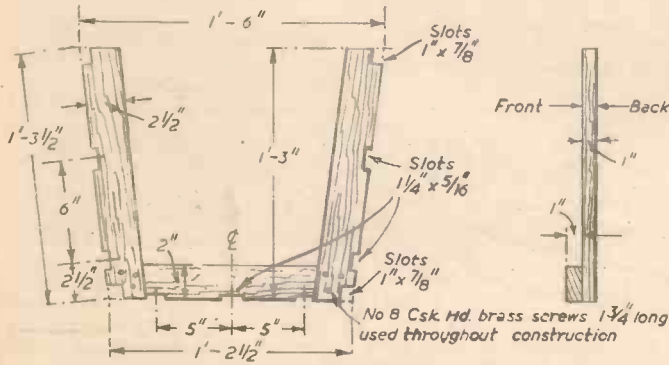

Fig. 6.—Dimensions of frame No. 1.

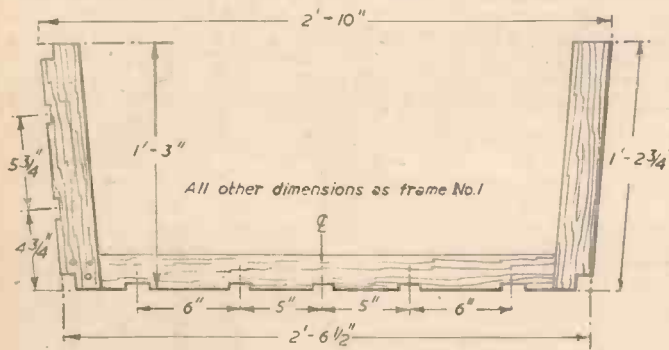

Fig. 8.—Constructional details of frame No. 2.

that owing to the angles made by the side members with the floors, the ends of any of the pieces used are not square, and therefore to avoid the necessity of marking off all these angles, which differ with each frame, it is better to use pieces of timber a few inches longer than necessary in the following manner.

The Floor

On the floor member mark off the bottom dimensions, which in the case of frame No. 1 is 1ft. 2 1/2in. Mark this off in two half-widths of 7 1/4in. each from a line marked on the centre of the piece of timber. It will now be possible to erect your temporary guide batten at right angles to the floor, and centrally on this line. Next lay the floor member and its batten flat on the bench or other level surface, and mark a point up the batten equal to the depth of the frame,

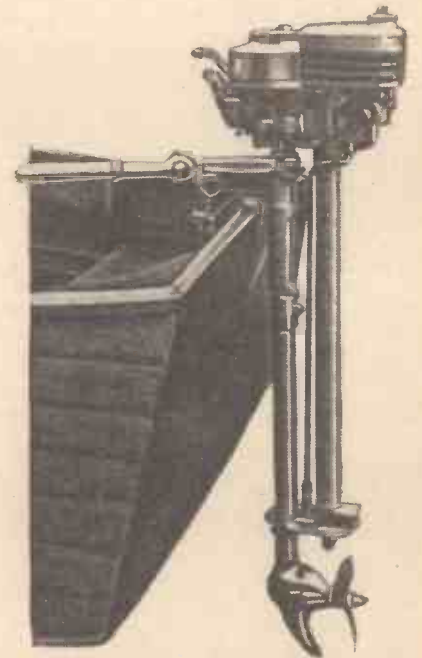

Fig. 7.—Close-up view of the propelling and steering mechanism.

tions and angles differ in each case, so that the drawings must be carefully studied to avoid error.

The frames, after construction, may be numbered and laid aside, although a little more work will have to be done on them later on.

(To be continued)

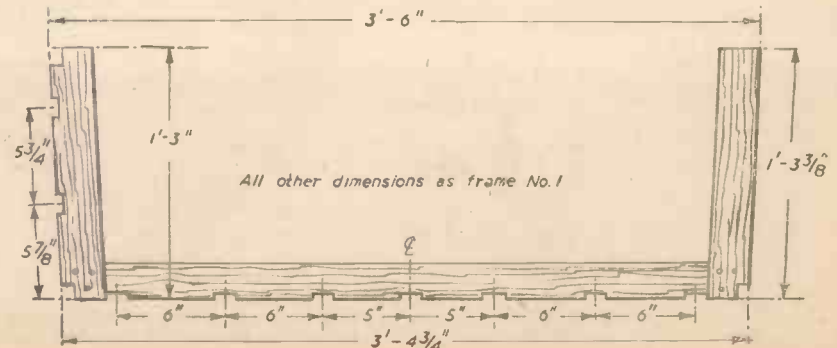
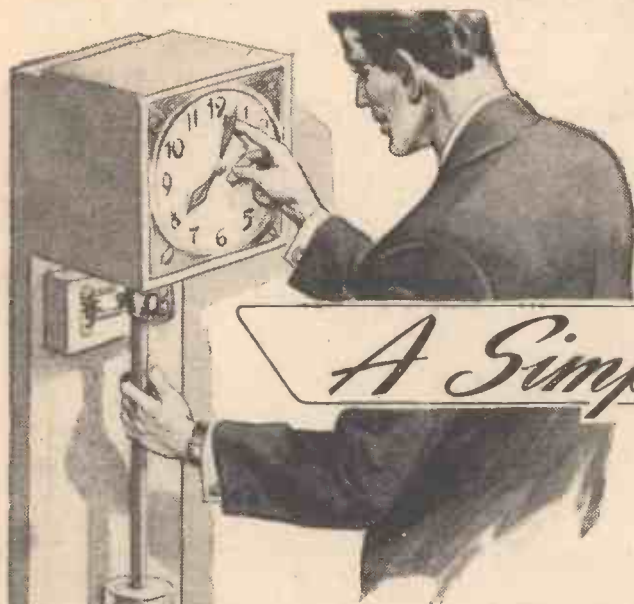

Fig. 9.—Frame No. 3.



A Simple Electric Clock

Details for Making an Accurate Timekeeper

By "HOROS"

AT the outset it will be as well to outline the principle underlying the action of the clock and detail the arrangement of the mechanism and purpose of each part.

Fig. 1 shows diagrammatically the complete mechanism

and the way in which the hands, H and H1, receive their motion, whilst Figs. 2 and 3 are intended to give some idea of how the clock will appear when the components have been assembled.

Referring to Fig. 1, A, B and C are three wheels mounted on independent arbors G, N and I. The wheel C rotates once each hour, from whence it follows that the arbor I carries the minute hand H1. Loosely mounted on the same arbor is the "cannon" J, carrying the hour hand H,

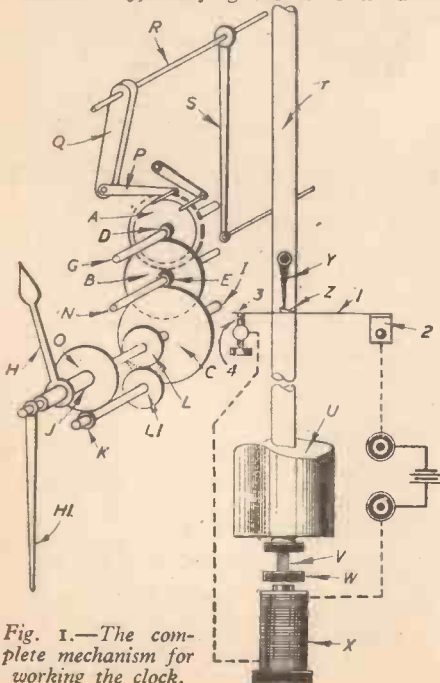

Fig. 1.—The complete mechanism for working the clock.

to which is secured the ratchet wheel A, driven by the gravity arm Q through the medium of the pawl P. The arm Q is secured to the arbor R, oscillated by a crutch rod S, and which is engaged at every alternate swing of the pendulum T. The combined weight of the arm and crutch rod must be adequate to cause the pawl P to propel the wheel A, whilst returning to their initial position after displacement by the pendulum rod.

Matters are so arranged that when the pendulum swings to the left it displaces S and, consequently, Q in the same direction, simultaneously the pawl P is withdrawn and picks up a tooth of the wheel A. The pendulum commences to swing towards the right, but is now followed up by the crutch rod and arm Q, the energy stored in the arm is now utilised in driving the wheel A one tooth forward, the movement in turn being transmitted through the wheelwork to the hands of the clock.

The Swing of the Pendulum

The scheme for maintaining the swing of the pendulum is as follows. An ordinary wooden pendulum equipped with a heavy "bob" U has a threaded extension V terminating in the armature W. Fixed rigidly beneath the armature is an electro-magnet X, so that the armature just swings clear of the

one end of J is attached to the wheel O, receiving motion through two similar wheels L and LI and a pinion K; the wheel L is driven by the arbor I. This group of wheels constitutes the "dial wheels."

The wheel C meshes with the pinion E of the arbor N; on the same arbor is mounted

electro-magnet. When, however, the arc of travel becomes reduced to a predetermined value, a small finger or trailer Y, pivoted to the upper portion of the rod T, fails to swing clear of a small, wedge-shaped block Z. This is attached to a light spring (1), one end of which is riveted to a bracket (2), whilst the free end of the spring is equipped with a contact (3), engaging a stationary contact (4). On the return swing of the rod T the finger Y having previously dropped into a nick in the block Z, levers down the spring and momentarily the con-

tacts are closed, and the magnet X is energised. When the contacts close, the leading edge of the armature (W) is just about to pass over the magnet cores, consequently the excitation of X attracts the armature and the pendulum is impulsed. An increased arc of travel of the pendulum results, so that the finger Y is again carried clear of the block Z for several swings of the pendulum.

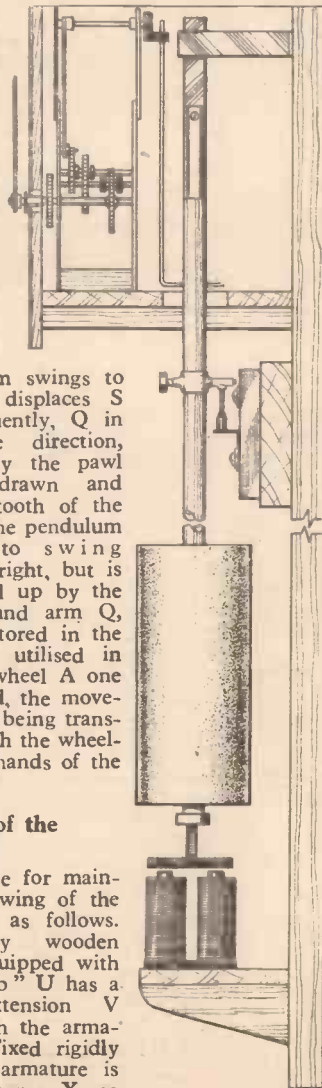

Fig. 2.—A sectional view of the clock.

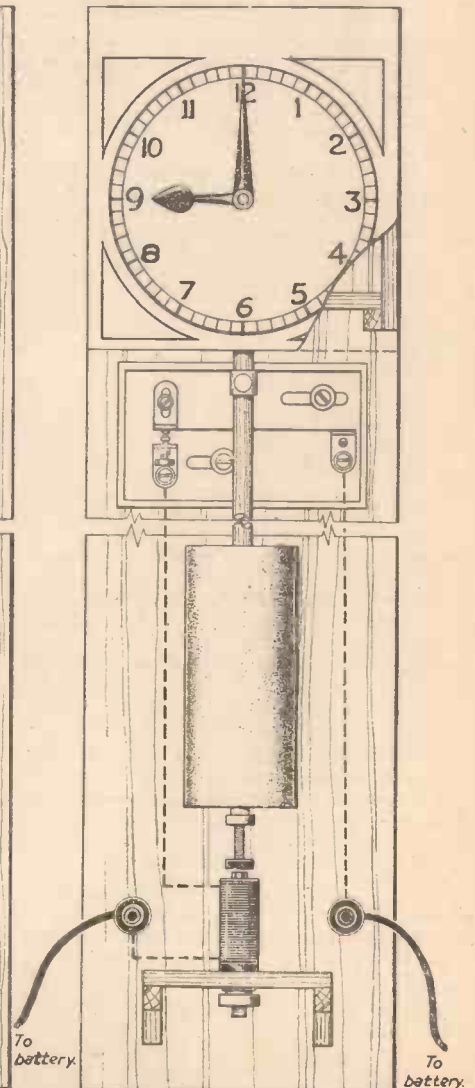

Fig. 3.—A front view of the clock.

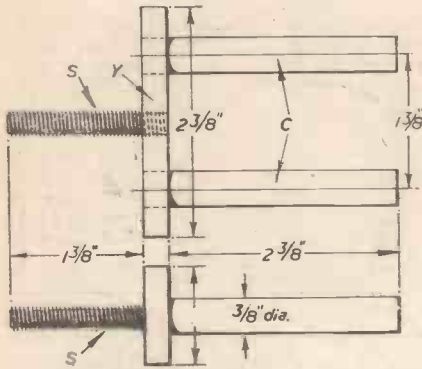

Fig. 4.—The soft iron yoke.

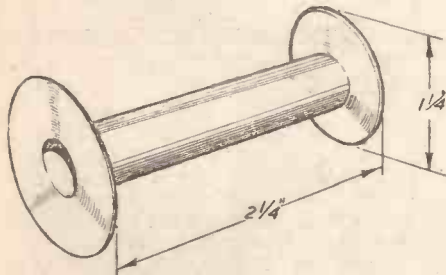

Fig. 5.—The bobbin.

Gradually, however, the swing becomes reduced and the finger again fails to clear the block Z, when the contacts are again closed.

This simple means of impulsing the pendulum is automatic in action and economical as far as current consumption is concerned, and two or three large 1 1/2-volt bell cells should run the clock for several months without any attention whatever.

The Electro-magnet

The soft-iron yoke Y (Fig. 4) has riveted to it the soft iron cores C, the ends of which are shouldered down and are a driving fit in the holes drilled in the yoke.

For securing the electro-magnet in position a screw or piece of threaded rod (S) is riveted to the yoke. Slipped over the cores are the bobbins (Fig. 5), these are wound with the magnetising coils.

The bobbins are easily built up from thin brass tube of a size to fit the cores snugly, and are completed by soldering to the ends of the tube, brass flanges in which a hole has previously been cut for the insertion of the tube. Before winding on the wire, wrap a couple of turns of note paper around the tubes and well brush with shellac varnish. To insulate the flanges, cut some discs of paper, of course, cutting the centre of the

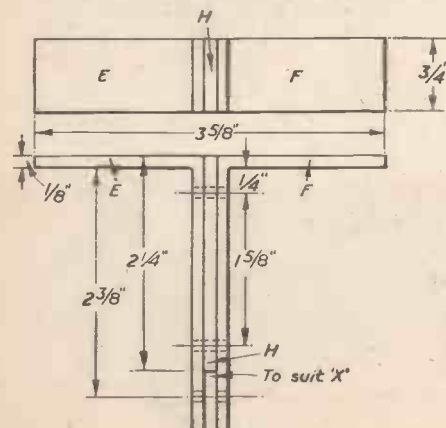

Fig. 6.—The suspension bracket.

disc for the tube; cut through one side so that the discs can be placed on the bobbin and then well brush with varnish. A couple of small holes may be drilled through one flange of each bobbin for threading through the ends of the coil.

Now proceed to wind on each bobbin as evenly as possible about 3 1/2 oz. of No. 30 single silk-covered wire; cotton-covered wire may be used. Be particularly careful not to reverse the direction of winding during the process. When the coils are wound, slip them over the cores and connect the finishing end of one coil with the starting end of the other, the two remaining ends of the coils should now be connected to a couple of dry cells to ascertain if there are any breaks in the wire; also, to check the pull of the magnet with a piece of soft iron.

Assuming the test is satisfactory, finish off the coils with a coat of some insulating varnish, and to give a pleasing appearance the coils may be covered with a piece of black velvet.

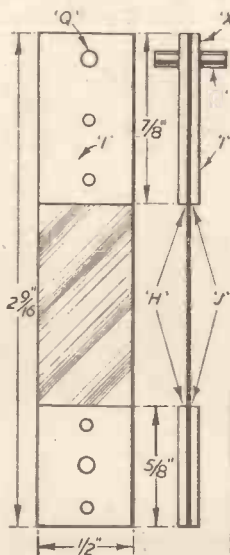

Fig. 7.—The distance piece.

The Suspension Bracket

Two pieces of steel or brass, E and F (Fig. 6) are bent at right angles and drilled with two holes for attachment to the backboard. Inserted between E and F is a distance piece H, a shade thinner than the thickness of the brass at X (Fig. 7). After truing up

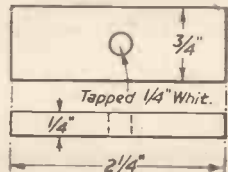

Fig. 8.—The armature.

the sides of E and F coming against the piece H, the whole is drilled and riveted together, ensuring that the top and bottom edges of the bracket are square and parallel. Carefully cut a "V" notch in the top edge of E and F to receive the suspension pin Q (Fig. 7).

If necessary, file out the cheeks of the bracket until the brass blocks of the suspension spring are a snug fit and will permit the pin Q to rest in the notches.

Armature

For the armature (Fig. 8) use a piece of soft iron. A centrally-drilled hole is tapped

(To be concluded)

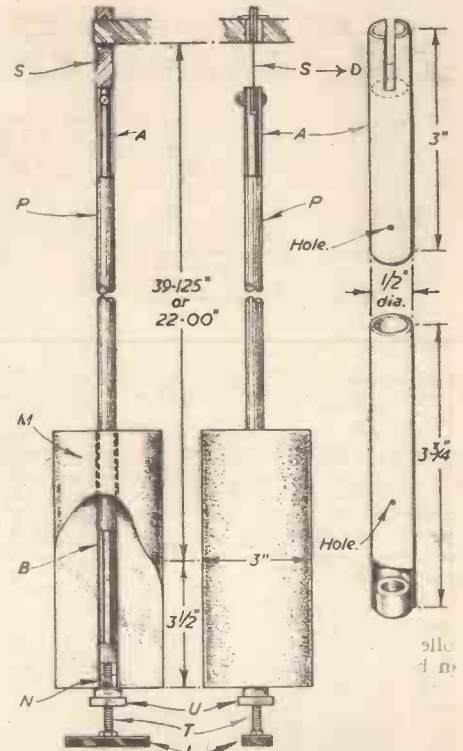

Fig. 9.—Details of the pendulum.

to suit the screwed rod attached to the end of the pendulum rod and is locked in position by a nut. It is as well to anneal the iron by allowing it to remain in the fire overnight.

The Pendulum

The pendulum is built up. The main portion P (Fig. 9) consists of a piece of 3/4 in. wooden curtain rod, the ends being fitted into pieces of brass tube, A and B.

The tube A is closed at one end with a piece of brass rod D, slotted to receive the suspension spring S, a small bolt and nut being the means of attachment. The rod is reduced to fit into the tube and a couple of small holes are drilled through the whole to receive rivets made from soft wire.

The tube B is attached to the rod in a similar manner, but before attachment a 1/4 in. brass collar N (or nut filed down) is driven into the end of the tube and soldered; screwed into the collar is a piece of threaded rod T to carry the timing nut U and the armature L. Sliding freely over B is the bob M which should weigh from 10 lb. to 15 lb., and may be of iron or lead.

Fig. 7 shows the method of attaching the suspension spring to the brass chocks I by means of small rivets.

The National Do-It-Yourself Magazine

PRACTICAL HOUSEHOLDER

EDITED BY F. J. CAMM

November Issue Now On Sale

The Contents Include Instructions for Making :

A loft ladder, a garden gate, a ground floor toilet, a room screen, a coal delivery hatch, a contemporary chair, an ironing board, a simple wardrobe, and a combined leg rest footstool and fireside stool.

ALSO

Repairing Burst Pipes with Plastic

Lock Repairing

Cutting Rafters

Continuous Burning Fires

Preparing Your House for Winter

DOUBLE BUNK BEDS

How to Obtain Increased Space in the Nursery

By C. F. CLARKE

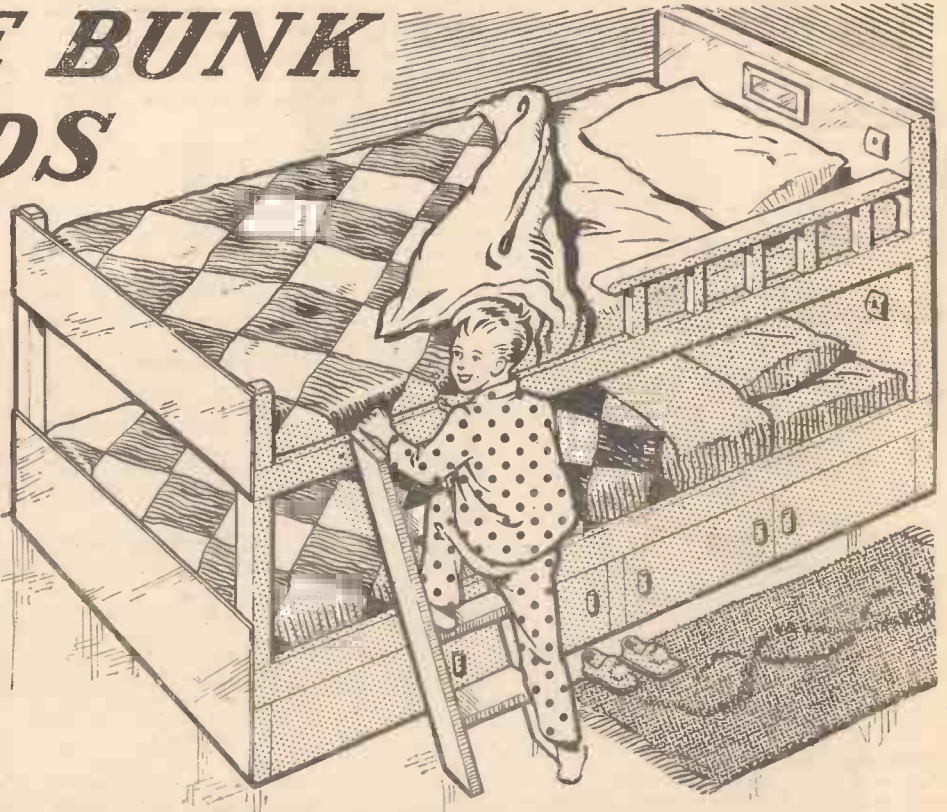

D OUBLE bunks are a great space saver. Children love the novelty, which never seems to grow stale.

The dimensions given in this article were chosen to suit the requirements of a particular room, and each bunk takes the normal 6ft. X 2ft. 6in. single mattress. The measurements may, of course, be varied both as to size of mattress and distance between bunks, but working to the sizes given will ensure a well-proportioned job.

Each bunk has its own electric light, controlled by a switch, so that either or both can be on at the same time. All the wiring connections are enclosed within the head boards, and there is no danger from children's inquisitive fingers.

Soft wood has been used throughout, and the finished work painted to match the bedroom. If hardwood is used, no doubt the thickness of the timber could be reduced, but it should be realised that strength and rigidity are of paramount importance.

The space under the lower bunk can be utilised to suit individual requirements. The

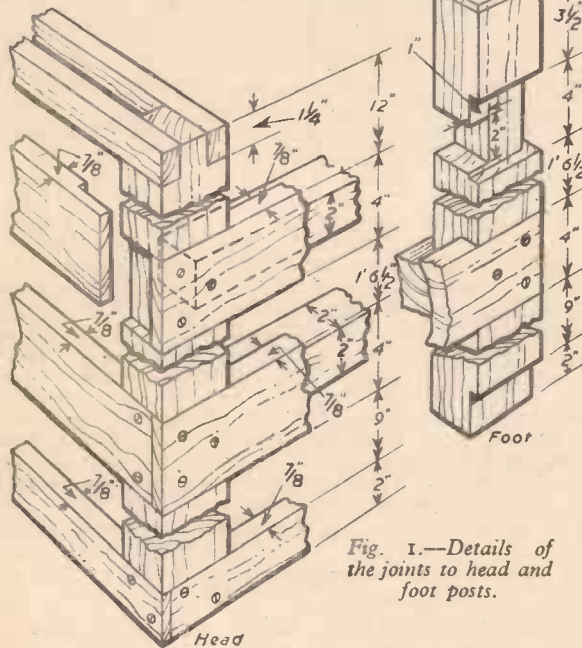

Fig. 1.—Details of the joints to head and foot posts.

writer has simply added four doors on the front, and the space is used for storing suit cases and similar gear, for which there never seems to be convenient accommodation in the average home. Drawers or sliding trays can, of course, be fitted as desired. The main timber requirements are given in the box at the foot of column 1 on the next page.

Construction

The construction is simple, and all constructional details can be seen in the sketches. All the joints shown in Fig. 1 are glued and screwed, using 12 or 14 gauge screws. Countersink the screws and fill the holes.

Electrical Requirements

One two-pin 5 amp. plug and socket.

Two single-pole switches (5 amp.).

Two batten lamp-holders with large bases.

Two pieces Crinothene (or similar material) sufficient to cover apertures in head board.

Two 15-watt bulbs.

The Crinothene (colour to taste) is stuck over the aperture on the inside of the head board. The size is not important, but 6in. X 2 1/2in. hole is adequate. A plywood frame can be fixed round the hole for a neater appearance.

Fifteen-watt bulbs are used. They have proved to be sufficient, and do not develop any great heat, which would be detrimental, being enclosed in the head boards.

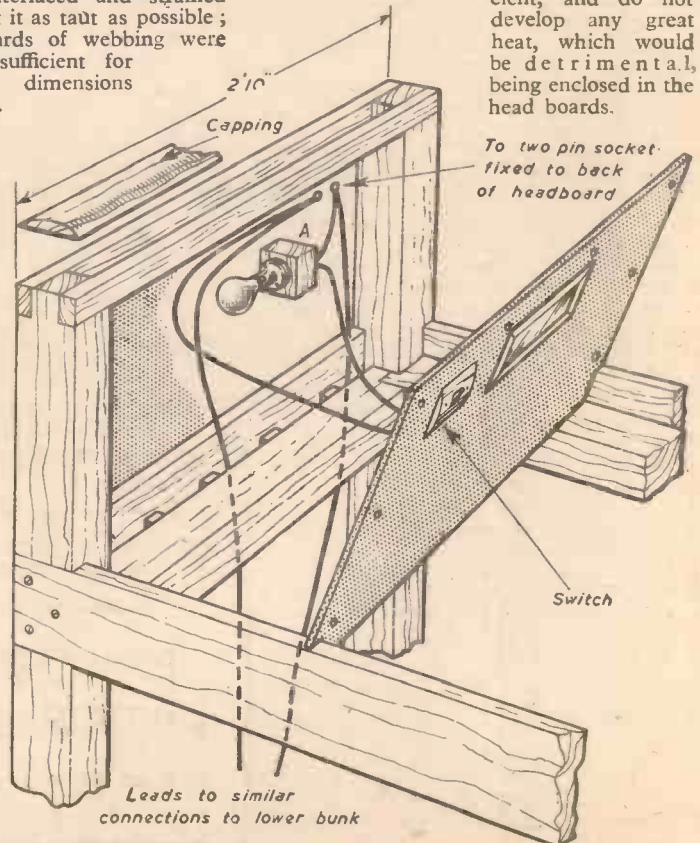

Fig. 2.—The electrical connections inside the headboard.

The wiring is simple, as will be seen from Fig. 2. The two-pin socket and plug allow for the supply to be disconnected when the bunks are moved.

The front side of the head board is screwed on to facilitate bulb changing.

Guard Rail on Upper Bunk

This can be varied to suit individual requirements. The writer used a 1½ in. × ¾ in. × 3ft. batten for the rail and five ¾ in. square posts 7¼ in. long. All these joints are dowelled and glued. The position of the rail where it meets the head board should be marked, and the piece of hardboard cut out, so that the head board can be removed.

Ladder

All that need be emphasised here is that care should be taken to get the housings for the steps at the correct angle, and

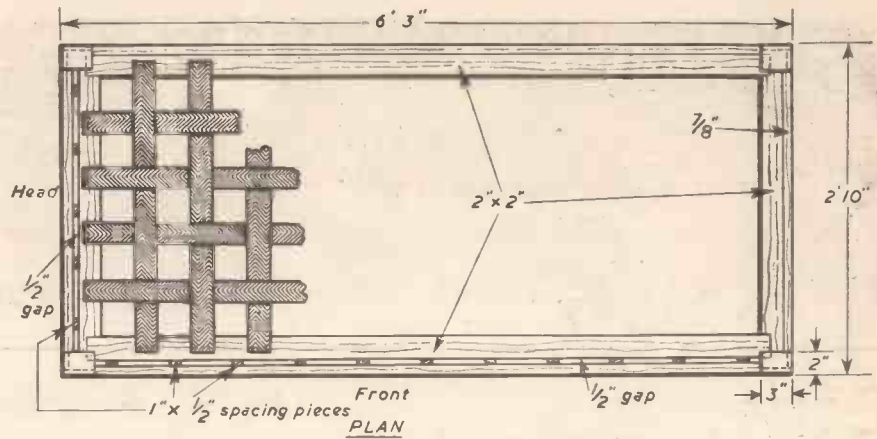
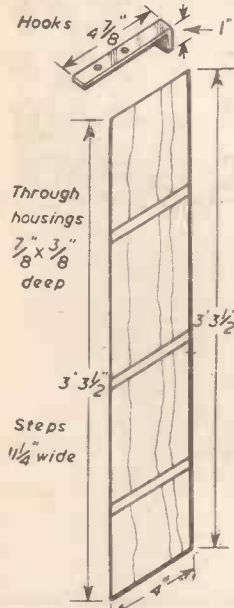

Fig. 3.—Plan of the mattress.



Suggested dimensions for ladder in 7/8 timber

Fig. 4.—Details of the ladder and a perspective view of the completed double bunks.

exactly the same on each side. The ladder should be hooked to the side to prevent slipping. Simple hooks can be made from strips of iron suitably bent and drilled (see Fig. 4).

Order of Work

(1) Cut all through housings in posts and

halved joints in flat end rails (see Fig. 1).

(2) Screw on the flat rails (these should not be glued at this stage).

(3) Insert 2in. × 2in. rails in housings and screw to flat rails (with 1in. × ½ in. spacing pieces on front and head rails (Fig. 3)).

(4) When assured that all the pieces fit, glue all rail joints, taking them off one at a time for this purpose.

(5) Cut hardboard to various sizes and secure in position with panel pins (except front head boards, which should be screwed).

(6) Tack on webbing, using three tacks at each end. Put on long lengths first and then interlace the cross-pieces. A 1 1 these must be well strained.

(7) Screw batten lamp-holders to wood blocks (A—Fig. 2) and secure to back panel of hardboard.

(8) Cut apertures for lights in head boards, stick on Crinothene, screw on

switches and complete wiring (see Fig. 2).

(9) Prime, stop all screw holes and paint two coats.

If the bunks are made to the dimensions given, children will be able to sleep in them until the early teens. Good quality mattresses will make the bunks as comfortable as the conventional bed.

Main Timber Requirements

Bunks				
2 posts (head)	3in. × 2in. × 4ft. 1½ in.			
2 " (foot)	3in. × 2in. × 3ft. 5in.			
4 rails	2in. × 2in. × 5ft. 11in.			
4 "	2in. × 2in. × 2ft. 6in.			
4 "	4in. × ¾ in. × 6ft. 3in.			
4 "	4in. × ¾ in. × 2ft. 10in.			
2 bottom rails	2in. × ¾ in. × 6ft. 3in.			
2 "	2in. × ¾ in. × 2ft. 10in.			

Ladder	
2 sides	4in. × ¾ in. × 3ft. 3½ in.
3 steps	4in. × ¾ in. × 11¼ in.

The dimensions for the hardboard to enclose the head, foot and back of cupboard are not given, as they can be measured up when the framework is finished.

A REALLY "PRACTICAL" CHRISTMAS GIFT

GIVE your practical friends a really "different" and acceptable Christmas present . . . send them a year's subscription for PRACTICAL MECHANICS. All through the year they'll thank you as each new issue brings them a fresh reminder of your good wishes.

So simple to arrange, too! Just send your friends' names and addresses, together with your own, and remittance*

to cover each subscription to Subscription Manager (G.1), George Newnes, Ltd., Tower House, Southampton Street, Strand, London, W.C.2. We will despatch first copies to arrive before Christmas, and send an attractive Christmas Greetings Card in your name to announce each gift.

* Rates (including postage) for one year (12 issues): U.K., £1; overseas, 18s. 6d.; Canada, 18s. 6d.; U.S. \$2.75.

A DAYLIGHT CINEMA

By T. FRIEND

A Back Projection Cabinet for Use in the Small Room

together with 2in. No. 12 wood screws. Details of assembly are shown in Fig. 6 and the completed cabinet should appear as in Fig. 1. The $\frac{1}{4}$ in. thickness each side of the plywood panel is filled at the centres with a false muntin of $2\frac{1}{2}$ in. \times $\frac{1}{4}$ in. redwood, as can be seen in Fig. 5.

The sliding top, the sliding shelf and the folding hood are all made from 9mm. ply-



THIS device is primarily designed for use in small rooms having no blackout curtains and the minimum of operating space. The completed daylight cinema is shown in Fig. 1.

The Carcase

This is constructed from 3in. \times 1in. redwood, dressed to $2\frac{1}{2}$ in. \times $\frac{1}{4}$ in. and grooved as required on one edge for 3mm. plywood panels. There are seven frames, details and dimensions of which are given in Figs. 2 and 5, and these are fastened

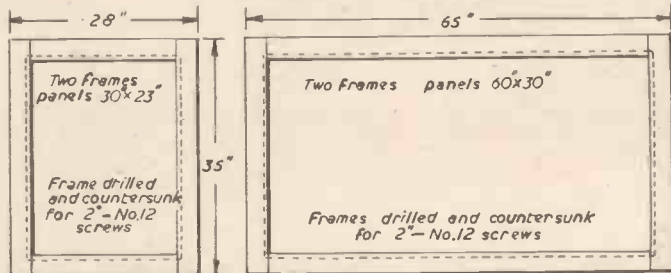

Fig. 2.—Top and bottom and two side frames.

wood to the dimensions shown in Figs. 3 and 4. The knuckles of the door hinges are set back about $\frac{1}{4}$ in. on the sides of the carcase so that when the door is open the back edge obscures the front edge of the carcase and prevents leakage of light across the

screen. The cabinet is mounted on 3in. solid rubber castors.

The Mirrors

These are of $\frac{1}{4}$ in. plate glass. They were surface silvered and varnished with an optical varnish made by I.C.I. and the whole of this work was carried out by a professional silverer. The method of mounting the mirrors is shown in Fig. 7. They are mounted on back boards made of 9mm. plywood as shown in Fig. 7 by means

CUTTING LIST				
No.		in.	in.	mm.
4	Plainedge	65	$2\frac{1}{4}$	$\frac{1}{4}$
6	"	26 $\frac{1}{2}$	"	"
6	One Edge	65	"	"
8	Grooved	35	"	"
4	Centre	28	"	"
2	For 3 mm.	26 $\frac{1}{2}$	"	"
4	For Shelf	6	"	"
4	"	18	$1\frac{1}{4}$	"
2	"	18	$2\frac{1}{4}$	"
4	False Muntins	60	$2\frac{1}{4}$	$\frac{1}{4}$
4	"	30	"	"
1	Plywood	60	60	9
2	"	60	60	3

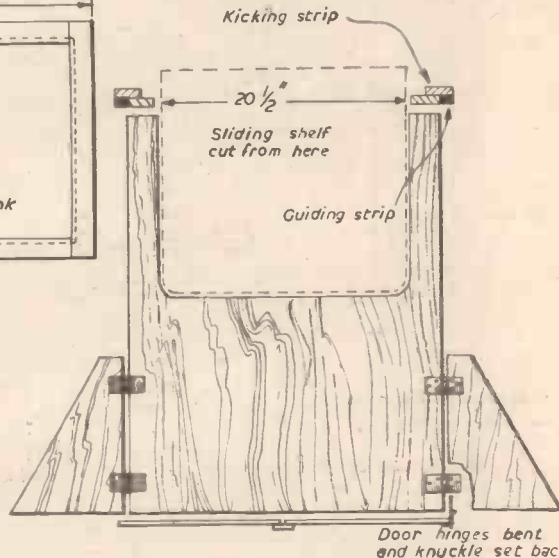
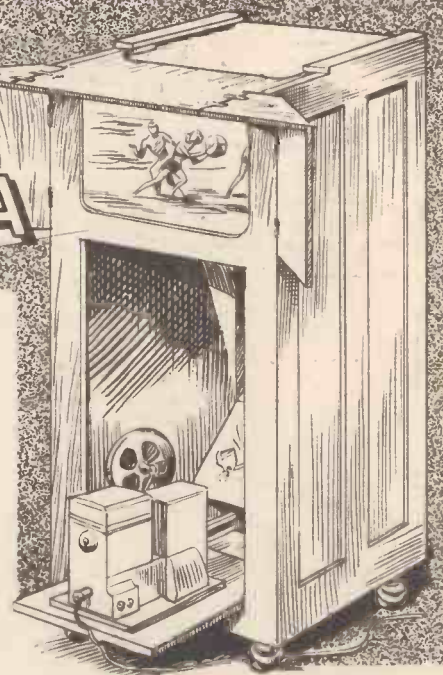

Fig. 3.—Details of the sliding top.

of $\frac{1}{4}$ in. thick wood strips. The back boards are fitted with two swivels and four locking bolts each. These fit into the sheet metal

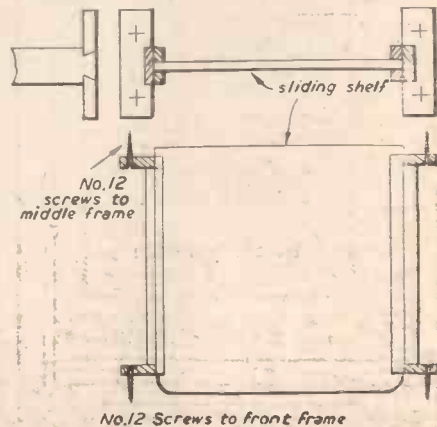

Fig. 4.—Plan and elevation of the sliding shelf. 1 piece $20\frac{1}{2}$ in. \times $20\frac{1}{2}$ in. \times 9mm. 4 pieces 6in. \times $2\frac{1}{4}$ in. \times $\frac{1}{4}$ in. 2 pieces 18in. \times $2\frac{1}{4}$ in. \times $\frac{1}{4}$ in. 4 pieces 18in. \times $1\frac{1}{4}$ in. \times $\frac{1}{4}$ in.

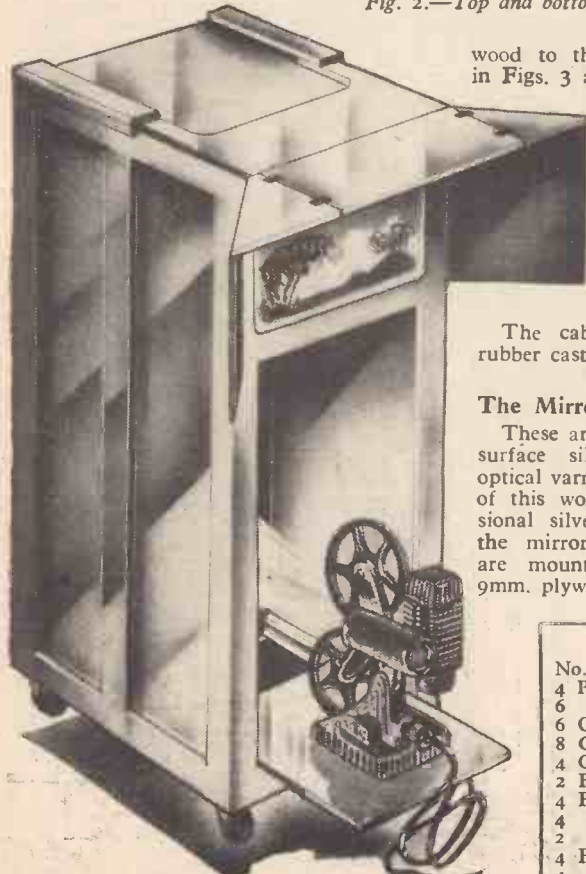

Fig. 1.—An artist's impression of the completed daylight cinema. The sliding top is shown here made in two pieces.

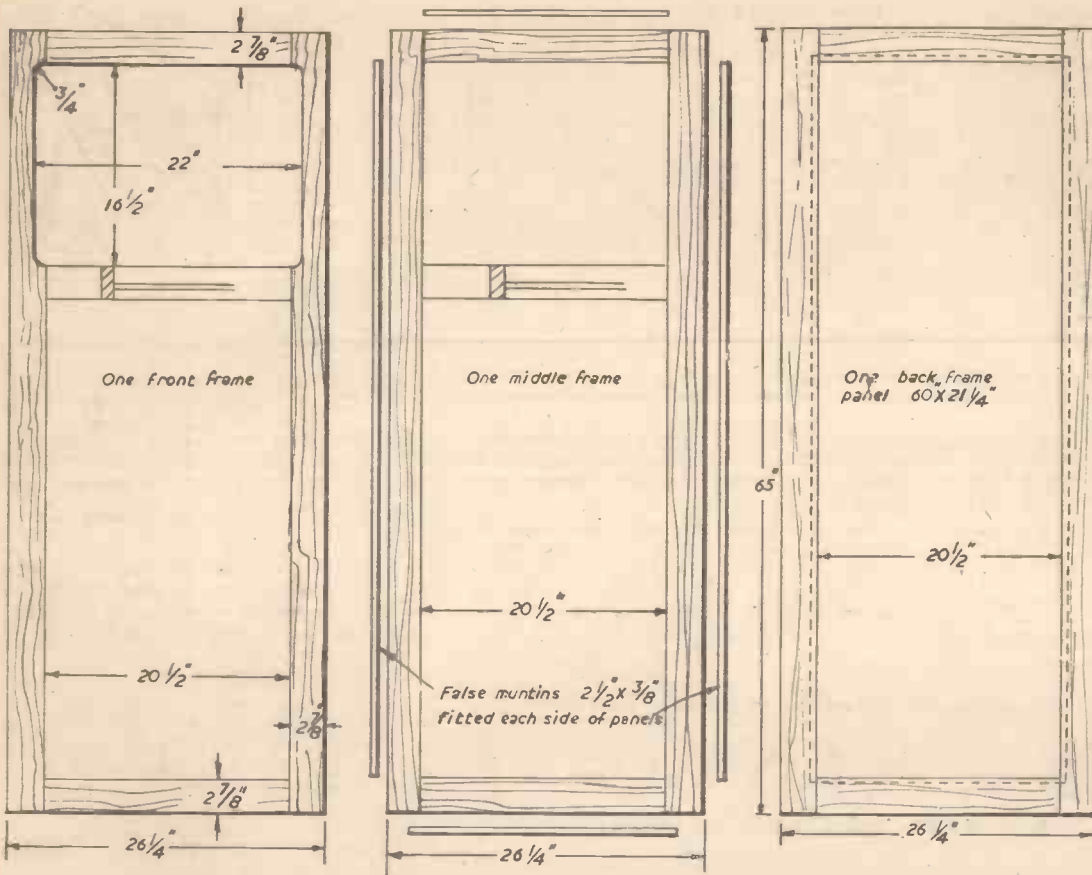

Fig. 5.—Details of the front, middle and back frames.

brackets shown in Fig. 8, each mirror pivoting on its centre swivel and being fixed by the locking bolts, shown in Fig. 9. Final adjustment is by means of these latter and the arc-shaped slots in the brackets.

It is essential that the mirrors are at 45 deg. and no amount of adjusting of one mirror will correct an error in the angle of the other mirror.

The mirror centres must be exactly in line with the centre of the screen.

The Screen

This is made of "Clearlite" translucent screen material supplied by The Perforated Front Projection Screen Co., Ltd., 43-49, Higham Street, Walthamstow London, E.17. The standard sized sheet of material, which is approximately 54in. X 18in., makes three screens.

The edges of the screen, which measures 24in. X 18in., are punched with an office punch at about 3in. centres and the screen is suspended by rubber bands on brass pins on the inside of the screen aperture.

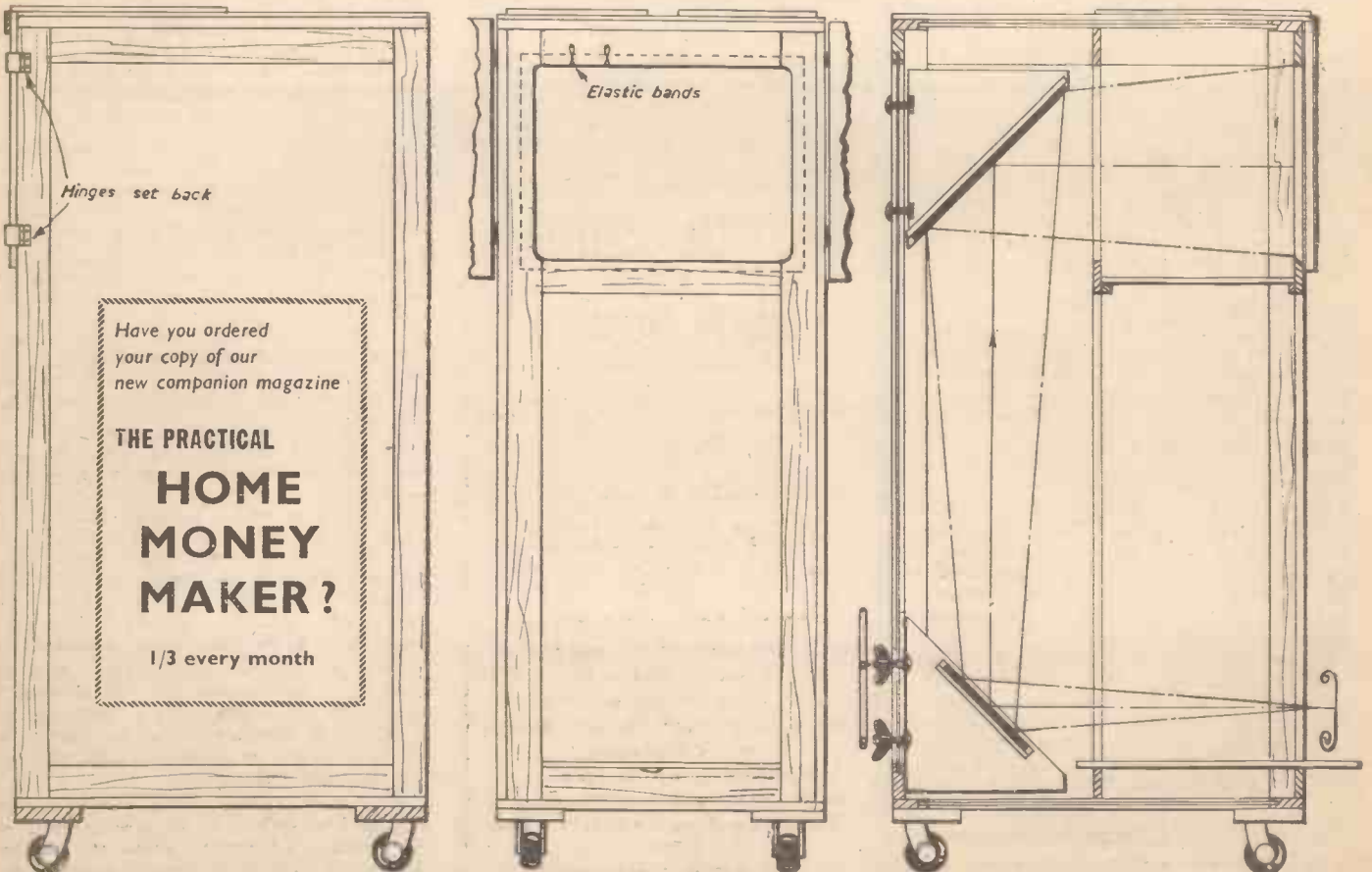

Fig. 6.—Side, front and sectional views of the daylight cinema.

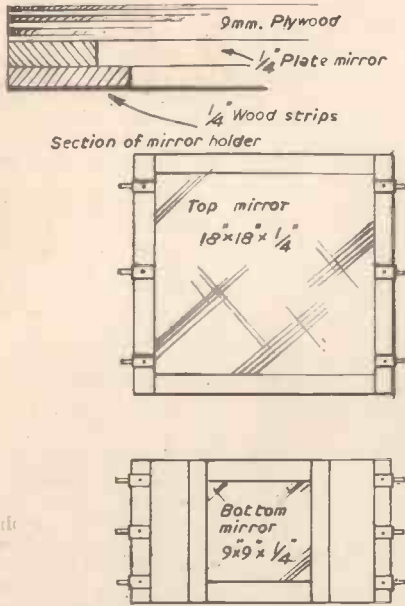

Fig. 7.—Details of mirror backing and pivots.

The slotted shelf together with the slotted holding bolts of the lower mirror provide for some adjustment in the "throw" and for differences in projector heights.

As described, the apparatus is suitable for a 4in. focal length 35 mm. strip film projector or a zin. focal length 16mm. cine projector. For a zin. focal length 35mm. strip film and for a 4in. 35mm. double frame projector, a higher shelf must be arranged.

A point the intending constructor should note is that mirrors intended for educational optical use only and not for domestic or office use can be purchased exempt from purchase tax.

The foregoing design was intended primarily to answer a reader's query which appeared recently in "Information Sought," but has been published here as being of interest to all those cinema projection enthusiasts with limited space at their disposal.

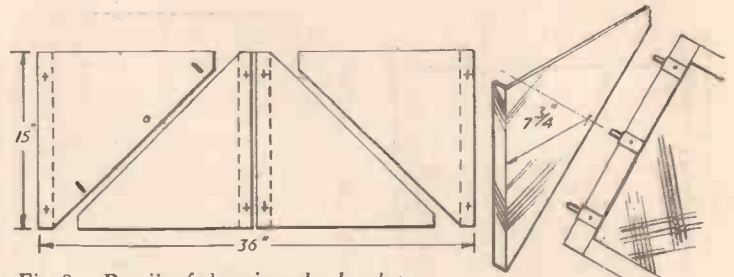

Fig. 8.—Details of the triangular brackets.

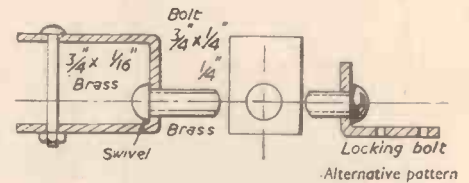

Fig. 9.—The swivels and locking bolts.

The design is intended to act as a basis for experiment as details and dimensions may vary somewhat according to the equipment used and materials available.

GLEANNINGS

Tractors for the Norwegian Army

A NORWEGIAN military expert said recently that in these days, when roads could be reduced very quickly to a shambles by long-range artillery bombardment, tractors would be the best means of transport. The modern tractor, like the tank, can travel practically anywhere and can leave the road when necessary.

Power Reactors

THE opening in October of the first power producing reactors in the world at Calder Hall, in Cumberland, was performed by H. M. The Queen. This opening is estimated to be a year ahead of the first American nuclear power reactor.

Underground Bicycle

TO enable miners to travel from the pit-head to the working face in German mines, a two-seater pedal-operated cycle on four wheels has been introduced. Made of aluminum alloy, the cycle weighs 66lb. and runs on rails in the mine.

Defective Rail Detection

DEFECTS in the railway track are tested for electronically in the U.S. by means of the Sperry Detector Car. Two petrol engines are used, one to drive the car and the other to power the rail current generators and an air compressor used to operate the pneumatic testing equipment.

Underneath the car, apparatus sets up an electrical field. Induction coils detect fractures, fissures and splits, which are recorded on a continuous paper tape by means of a sensitive pen. By this method defects are spotted without removing the rails and without disrupting the service.

The Electronic Computer Moves In

THE electronic computer is already taking its place in offices of the larger undertakings. The Post Office has recently placed

orders worth about £250,000 with two British firms for electronic computer and printing equipment to work out the pay rolls of the 112,000 engineering, postal, telegraph, telephone and office staff in the London area. It is estimated that its use will save up to £100,000.

A Powers Samas electronic computer, went into operation recently in the Regional Accountant's Office of B. R. Western Region. Its job is to compile the paybills of 10,000 railway workers in the Swindon area. The machine is fed with details of hourly rates

of pay, varying rates of overtime, details of bonuses and allowances. Then from the gross pay the machine deducts income tax, national insurance, etc., and arrives in the space of only two seconds to net pay.

A Machine to "Face" Letters Automatically

THE Post Office will shortly have a machine that will automatically examine letters presented to it in random order, and rearrange them to form a stack with all the stamps in the top right-hand corner of the letters ready for cancellation of the stamps and sorting. Scientists and engineers at the British Post Office research station have devised this machine, which is to be tested in the Southampton post office shortly.

The machine will have a number of "scanners" which will search for the stamps as the envelopes pass between them. It will then arrange the letters in separate piles according to the corner in which the stamp is found. At the same time, the scanners will differentiate between ordinary letters and those paid at the 2d. printed paper rate, and the machine will separate the two so that they can be dealt with independently. A stamp cancelling unit will be included in the machine so that letters emerge not only "faced" but with the postmark applied.

Working in collaboration with Messrs. Harrison and Sons, the printers of postage stamps, the scientists have now evolved a new technique which involves the use of stamps in which an electrical conductor is incorporated. A high voltage electric discharge penetrates the stamp as the letter passes through the machine and, traversing the electrical conductor, causes a "recognition" signal to be given to the machine.

The electrically conducting substance applied to the stamps is "Naphthadag," which, for the purpose of the Southampton trial, will be incorporated in the stamps in one or two lines, each about 1/32in. wide on the back under the gum.

Naphthadag-treated stamps will be put on sale in Post Offices in an area centred on Southampton a few weeks before the machine is ready to operate, so that the stamps have plenty of time to come into general use before the experiment starts.

PRACTICAL MOTORIST
AND
MOTOR CYCLIST
Edited by F. J. CAMM

November Issue Now On Sale
Price 1/3

FREE INSIDE EVERY COPY

24-Page Trouble Tracer
Booklet

PRINCIPAL CONTENTS

- Installing Fog and Driving Lights
- Servicing Bodywork
- Overhauling the Jowett 7 and 8
- Making an Average Speed Indicator
- Wheel Balancing
- Dismantling for the Reborn
- Get the Best from Your Wolseley 12
- Overhauling Francis-Barnett Motor Cycles
- Carburettor Maintenance

A TRANSISTORISED GEIGER COUNTER

Constructional Details of a Radiation Monitor

THE average commercial radiation monitor is primarily a measuring instrument, and is necessarily bulky and expensive. For simple purposes, such as the initial detection of the presence of uranium, a cheap and small counter can be made with one transistor.

rectified by the chain of capacitors and selenium rectifiers to give 400 volts for the Geiger-Muller tube, which is a 20th Century Electronics type G5H halogen quenched tube. This tube was chosen in preference to the cheaper alcohol-quenched tube because it operates at a much lower voltage, has a longer life and is not so easily damaged by excess voltage.

In the interest of economy and simplicity no automatic voltage control is provided. Instead, a variable resistor R3 controls the current to the transistor.

The 400 volts supply is applied to the G-M tube with the anode connected to the positive side. The anode in this tube is the centre wire and the connecting pin on the base is marked "A." When a gamma ray penetrates the tube and causes ionization, a pulse of current flows which is limited by the resistor R4. Capacitor C3 is charged up and a click is heard in the headphones. The headphones should be high-impedance types and the amplitude of sound depends on the size of C3. A larger value than 100pF produces more noise but allows larger pulses of current to pass through the G-M tube, with deleterious effect.

Constructional Details

The unit is constructed on a metal chassis that is joined to the lid of a metal box. The whole unit is made of 22 gauge tinplate. The outside dimensions of the box are 4½ in. × 1½ in. × 5¼ in., and a view of this is shown in Fig. 1.

A wiring diagram is shown in Fig. 3. The components are mounted on tagstrip which can be conveniently soldered to the chassis by the feet. If no facilities are available for cutting and

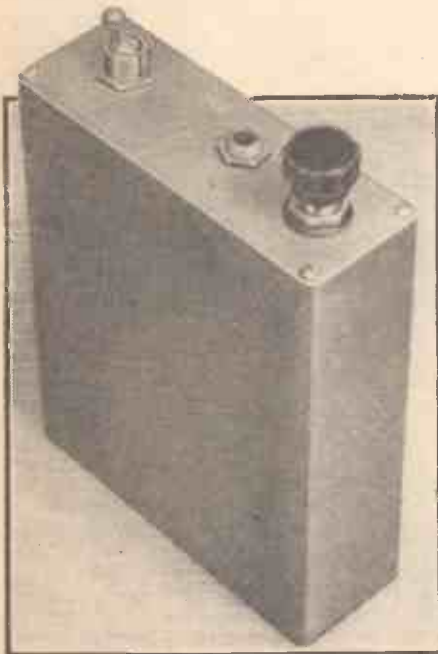

Fig. 1.—The geiger counter in its case.

Circuit Details

The circuit is shown in Fig. 2. A Mullard OC72 transistor oscillator converts the 4.5 volts of the torch battery to A.C. in the primary of the high step up radio transformer. The output of this is multiplied and

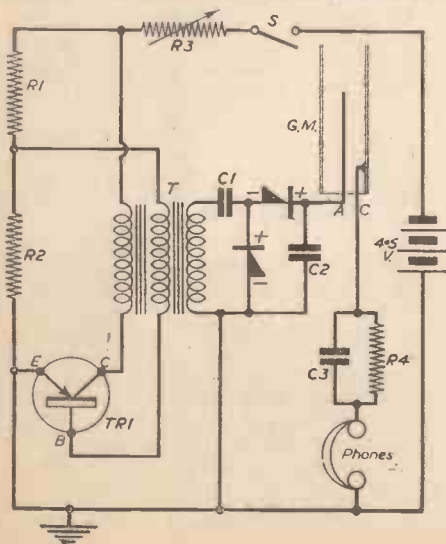
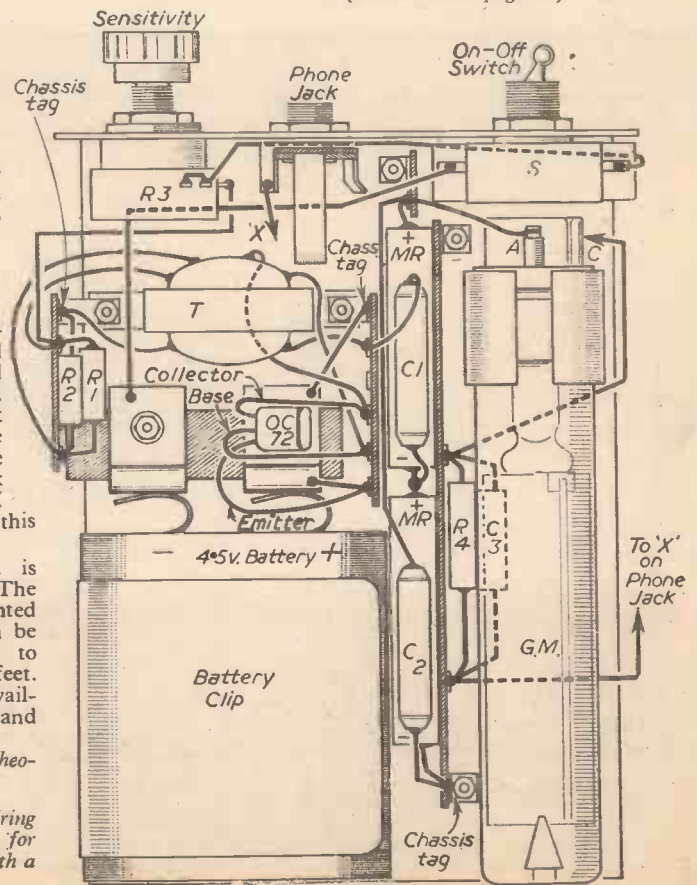

Fig. 2 (Left).—The theoretical circuit.

Fig. 3 (Right).—Wiring details. The collector for the OC72 is marked with a red spot.



bending sheet metal a plywood or Perspex sheet box would be quite suitable. Attention should be paid to good insulation of the voltage multiplier. Good capacitors should be used; wax-covered types are suitable only if perfectly clean on the outside. The Geiger-Muller tube is held in position by a capacitor mounting clip with the flanges cut away, or by a Terry clip. Sponge rubber sheeting is used to surround the tube at the mounting point to reduce vibration. Clips for connection to the pins are obtained from the sockets used in

(Concluded on page 80)

A Large Ukulele

The Tonal Qualities of this Chord Instrument Compete With Those of a Guitar

By A. POWELL

IT is the new shape which facilitates construction. There is no difficult bending of thin wood to form the sides. Straight strips of wood are used, which require only to be mitred at the corners. Although the side strips are cut from $\frac{1}{4}$ in. thick wood (the side strips on conventional-shaped ukuleles are often cut from veneer $1/16$ in. thick), this has very little effect on the resonance of the instrument.

The model has an excellent tone—in fact, its tonal qualities compete with those of a guitar. It is a pleasure to use the large ukulele. The many delightful, harmonious chords produced by ordinary-sized ukuleles are much amplified by the larger instrument.

One can, too, owing to the length of the steel strings, get a more sustained chord.

Front and Back Shapes

The elevation in Fig. 1 gives a good idea of the size and shape of the instrument. It also gives the names of the various parts. The original model was made from scrap plywood and deal. The pegs, however, require to be made from hardwood; soft deal is useless. Alternatively, it should be possible to purchase a set of four pegs, such as, for example, violin pegs.

The front and back of the instrument body should be cut from $\frac{1}{8}$ in. plywood. In the prototype a cheap "backing" plywood (alder) removed from an old cabinet was employed. It was somewhat rough and knotty in places, but after glasspapering smooth, with all crevices filled with plastic wood, it took an excellent polish, including the deal handle, head and body sides.

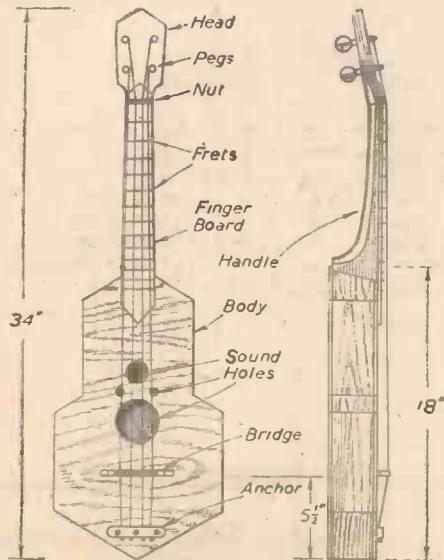

Fig. 1.—Front and side elevation showing the main parts.



Drawing the shape of the body front and back is all compass work, as shown in Fig. 2. It is largely a matter of ruling a line, ticking off the length (18in.) and then setting the compasses to scribe a 6in. radius. Without adjusting the compass, two further radii lines are scribed (see dotted lines), these lines, giving the "corners" of the shape where they pass through the 12in. circle.

The top half of the shape is found by setting the compasses to scribe an 8in. circle. Having obtained the shape of the front piece scribe the sound holes, then cut the wood

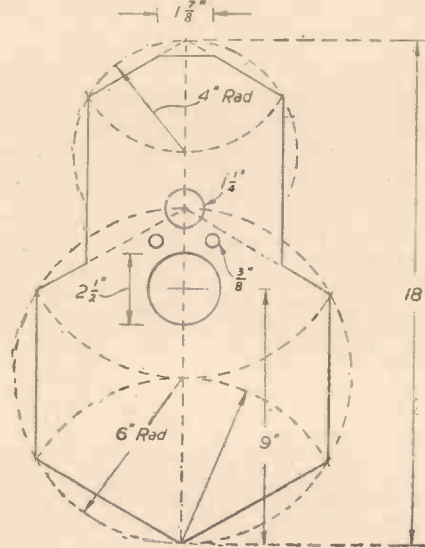

Fig. 2.—How to mark out the front and back piece.

to shape with a fretsaw. The shape can be cut with a fine panel saw, if the fretsaw is not available, the sound holes being made with suitable centre-bits which, by the way, should be used at both sides of the wood to make clean-cut holes. The back shape is identical to the front piece, except that it is pointed at the top and not made flat like the front. The back, of course, is minus sound holes. The front piece, when cut, can be used as a template for marking out the back shape.

Handle and Head Construction

The most difficult part about the construction of the ukulele is the handle and head. The latter has to be dowelled at an angle to the handle, following which the handle has to be built up to thickness.

The best way to go about the job is to prepare the handle and head shape from $\frac{3}{8}$ in. deal. The head (see Fig. 5) is not shaped up until it has been dowelled to the neck end of the handle. Have three $\frac{1}{4}$ in. dowel stumps in the joint, as shown in the section. Use a hot liquid glue, such as Scotch glue.

While the joint is setting, build the handle

to thickness at the shoulder end. This is done by rub-jointing on a 9in. and $5\frac{1}{2}$ in. length of $\frac{3}{8}$ in. wood (see dotted lines in Fig. 3). When the glue has set, the handle and its thickening pieces are roughly cut with a knife, and planed to an angle, this being seen in the shoulder section.

When bevelled, mark out the side shape in pencil, cut away the waste by paring, then bevel the underside of the work in the manner indicated, using a penknife, rasp and spokeshave. Note that the underside of the head is cut to taper about $\frac{3}{8}$ in. thick at the tip.

The Peg Holes

The four peg holes are bored with a $\frac{1}{4}$ in. bit, then "reamed" via the underside with a tapering round file of suitable diameter. This is to make a "tapered" hole so that the pegs will obtain the maximum grip. After tapering, it is advisable to countersink the "rims" of the holes a trifle at each side, using a rosehead countersink bit or a "poke" of glasspaper.

Fixing the Front

Before the body front can be attached to the surface of the handle at the shoulder end, a $\frac{1}{8}$ in. deep recess must be cut here so that the front will lie flush. The recess is 3in. in length.

Both the front and back body shapes should be cut from the plywood so that the grain runs across and not along the length. In other words, the grain runs crosswise with the length. This is advised in case the plywood is flexible in the centre.

A straight central pencil line should be ruled along the surface of the handle, and the body front piece. The latter is attached to its recess with glue and panel pins. Look

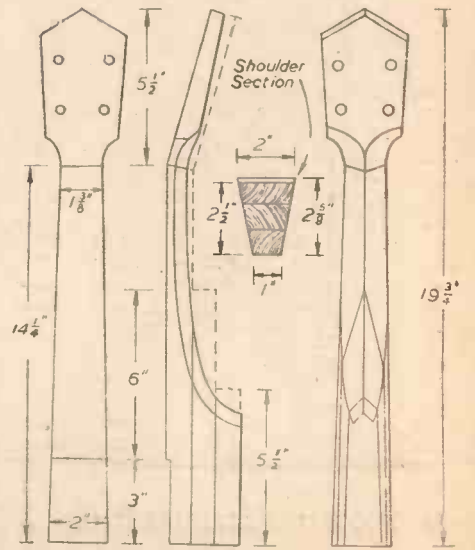

Fig. 3.—Constructional details of the handle and head.

along the length of both parts at eye level to ensure that the straight lines are in alignment, or else test with a straight-edged piece of wood, or by applying a stretched string. This test is essential; if the parts are not in true alignment, the strings will not be properly stretched over the finger board.

Adding the Side Pieces

A piece of deal 4ft. by 2½in. by ½in. will now be required. This provides sufficient material for making the body sides. In case of difficulty, a length of 3½in. wide by ½in. thick tongued-and-grooved board (sheeting) could be bought, free from cracks and knots as far as possible. The wood is cut to width, gauged to ½in. thick, then reduced by planing. It can be done easily enough with a smoothing plane, this allowing for any slight curvature in the wood.

Beginning at the bottom end, cut, mitre and attach two 6in.-long strips. A 60 deg. mitre block would be handy, but by having the strips cut squarely to size, the ends can be pared to the approximate degree of angle with a sharp wood chisel, then "trued" by trimming with a metal block plane.

The strips are glued and pinned to the interior side of the front.

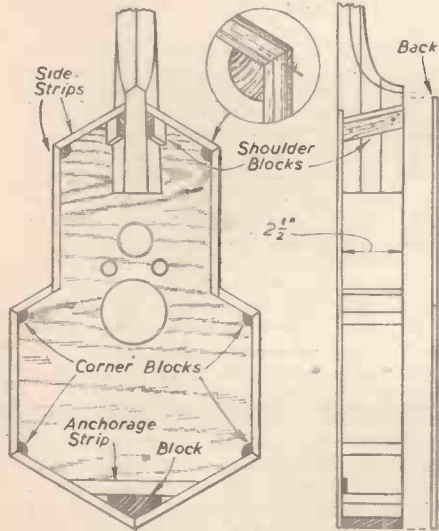

Fig. 4.—How the side strips are mitred around the front piece prior to adding the back part.

The work should lie on a flat surface. Continue to add the pieces until the shoulder end is reached. Here, owing to the bevel in the handle shape, care will be needed.

To ensure true fitting, place the back shape temporarily on the work. Rule a guide line from its top end to the end of the front. Attach corner blocks, keeping them 5/16in. inside to allow for the thickness of the side pieces (see constructional side view in Fig. 4). When all the sides have been attached, glue in the corner blocks as shown. When the glue sets, trim the wood and attach the back, but not before an anchorage strip is stuck to the inside of the front at the bottom, this strip being about ¼in. thick.

The Finger Board

The finger board is cut from 3/16in. birch plywood or plain wood, and should measure 15in. X 2in. Mark off the top "nut" piece, then the fret positions, using a small set square for the latter. It is then cut to the shape shown.

Glue the finger board on the handle so the nut end is level with the neck joint. If the wood has a tendency to rise, bind it on with tape. Nails should not be used.

While the glue is drying the body could be cleaned up. All nail heads are sunk with a punch and filled with plastic wood. Edges are trimmed, then the whole rubbed smooth with glasspaper.

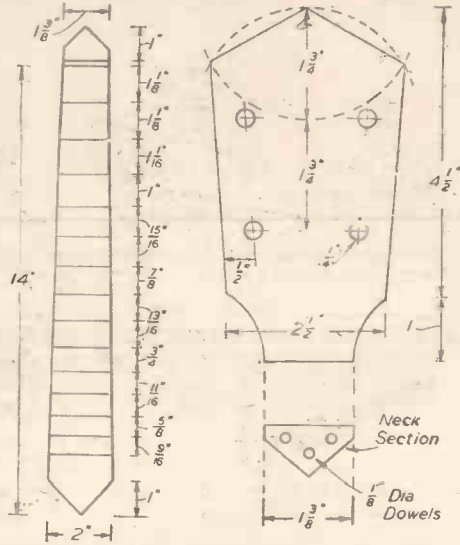

Fig. 5.—The finger board, with details of head.

Nut and Frets

The nut is a piece of bone or celluloid buckle measuring 1¼in. X ½in. X ½in. It is rounded at the top edge, then filed to make four string nicks (see Fig. 6). The prepared nut is attached behind the finger board with glue and its backing piece (see Fig. 7).

The frets are strips of black celluloid, about 1/16in. thick by 3/16in. wide. These strips are embedded in saw-cuts ¼in. deep. The saw-cuts are best made with a small hacksaw. However, to ensure neatness, the guide lines should be scored with a pen-knife, then "pared" slightly at an angle to make a groove for the hacksaw blade.

When fret positions are cut, tap in the fret material. Thin sheet brass could be used for frets, of course. The frets are—or should be—a force fit. When fitted, level them off with fine glasspaper held in a flat piece of wood. The frets should stand 1/16in. proud and the strings should "clear" them by 1/16in.

Anchor, Bridge and Pegs

Instead of having the strings anchored to

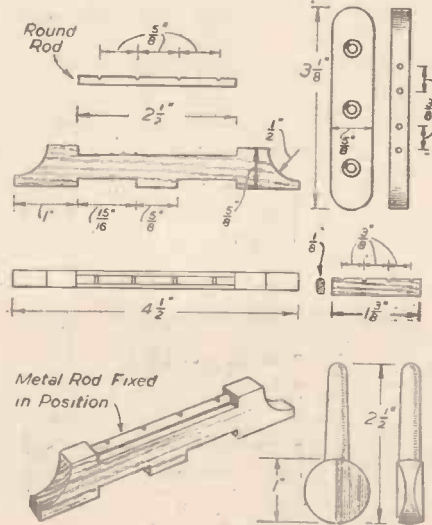

Fig. 6.—The bridge, anchor, and details of nut and pegs.

the bridge which results in a permanent fixture, and precludes adjustment along the "belly" of the instrument, the strings are attached to an anchor glued and screwed down.

The anchor is made from a strip of hardwood 3¼in. X ¼in. X ¼in., as shown in Fig. 6. It is bored for three fixing screws, and four 1/16in. holes made through the edges for the strings.

While three roundhead screws may be used it is better to use countersunk screws. The position for the anchor is shown at Fig. 1; it must be central with the body.

The pegs are cut from ½in. hardwood, then shaped as shown. The string holes should be ¼in. from the top.

The bridge is cut to shape from ½in.-thick hardwood, as shown. A 2½in. piece of ½in. dia. brass rod fits into the top recess tightly. The rod is filed to make string nicks ½in. apart.

Finishing

To finish off the woodwork, apply (with a soft brush) a thin coat of light walnut french polish to all parts of the work and allow to dry. Following this the wood is rubbed down with a fine grade of glasspaper. Brush on a second coat, allow to dry, and add a third application.

This applies to all the work with the exception of the finger board. The surface of this must be several shades lighter. Fol-

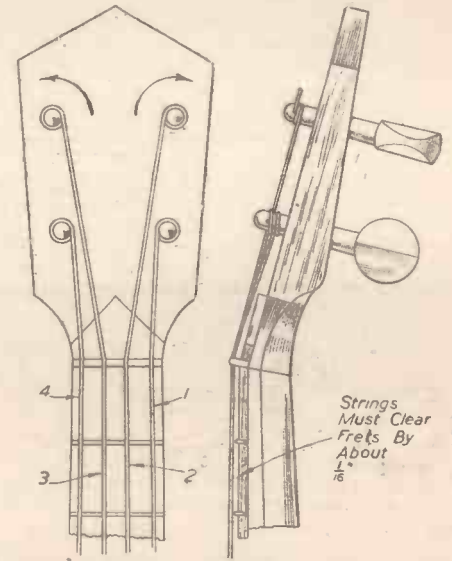

Fig. 7.—How the strings are fitted to their respective pegs.

lowing the third application, rub it down with fine glasspaper, then finish off by rubbing on a very thin polish.

The rubber is a piece of soft linen wrapped around a pad of cotton wool. Make the pad a conical shape so that it can reach all corners. You will find that polishing is much easier when the polish is thin.

Tuning

A half-set of guitar (steel) strings, i.e., the 1st, 2nd, 3rd and 4th string, the last two being covered, are required. The strings should be attached to their respective pegs in the manner indicated in Fig. 7.

The strings are tuned similar to the tuning of an ordinary ukulele, i.e., A, D, F-sharp and B on a piano. But the tuning is an octave lower. Further, the 4th string must be tuned an octave lower than written. It will be found that the majority of chords can be played by means of this tuning.

A SIMPLE EPISCOPE.....

Make this Apparatus and Show Your Snaps to Their Full Advantage

ALTHOUGH this episcope cannot be expected to compare with the results obtained by the manufactured article, it has the advantage of simplicity of construction and low cost of materials.

Size of Picture

The apparatus illustrated will give a very brilliant picture of 10in. \times 8in. at a distance of 3ft. from the original picture size of 2½in. \times 2in., this being increased to about 15in. \times 12in. at 4ft. 6in. Both these variations were obtained by suitable adjustment of the lens. The instrument will project quite a good picture at about 9ft. distance, but with the lens used, the recess in the lid would need to be 2in. to bring the picture closer to the lens.

This is one of the limitations of the instrument illustrated. If large aperture projecting lens is available, then it is possible a much larger picture space could be utilised without loss of definition. The lens used by the writer was a standard condenser lens combination of 4in. diameter, with the front lens removed. The remain-

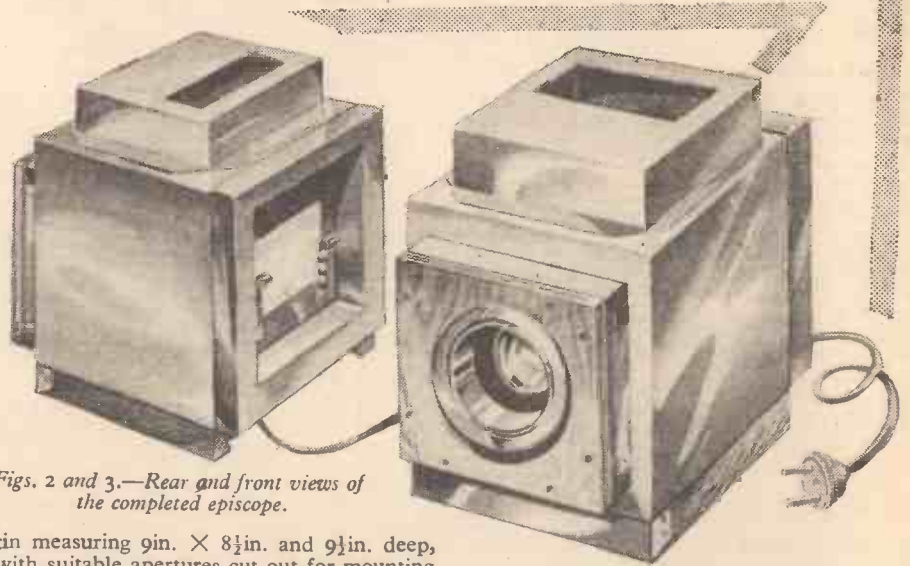

Figs. 2 and 3.—Rear and front views of the completed episcope.

tin measuring 9in. \times 8½in. and 9½in. deep, with suitable apertures cut out for mounting the lens and for the necessary ventilating passages. The latter consist of a tin superstructure soldered or riveted on top, with holes to allow escape of warm air. Similar holes are cut out of the bottom of the tin for the cool air inlet. The original lid of the biscuit tin is used for the picture aperture, which is arranged for in a tin recess fitted to the lid. A light screening tube, in which the lens itself fits, is fitted by a flange to the plywood panel, as shown. This panel itself is screwed to the wood frame fitted to the front of the biscuit tin.

A sectional view through the lamp house is shown in Fig. 4, and in three of the four corners electric bulbs can be seen in the adjoining view. The centres for the lamp holders will be found about correct for clearance of 100-watt

bulbs. For the purposes of current economy, lower wattage lamps can, of course, be substituted and the projected size of picture kept down to the smaller size previously mentioned. One of the corner lamps can just be seen inside the lamp house in Fig. 1. The lamps are, of course, wired up in parallel and, although the flex connections are shown inside, they might with advantage be taken outside, but in doing so care should be taken that any holes drilled for the purpose are suitably protected with grommets to avoid cutting through the insulation. Light lead-covered cable would prove advantageous if available.

Fig. 2 is a view from the back of the instrument, with a picture or print clipped in front of the aperture by means of the spring clips, which are small strips of tin or brass, turned over at their top ends and soldered at the lower ends. The pictures are inserted from the top, and adequate room should be available if the clips come half-way up the picture width, as shown. Fig. 3 is a view from the front of the instrument showing it connected to the lamp adaptor. This may be of the switch type for convenience. In Figs. 5, 6 and 7 are given constructional details of the various

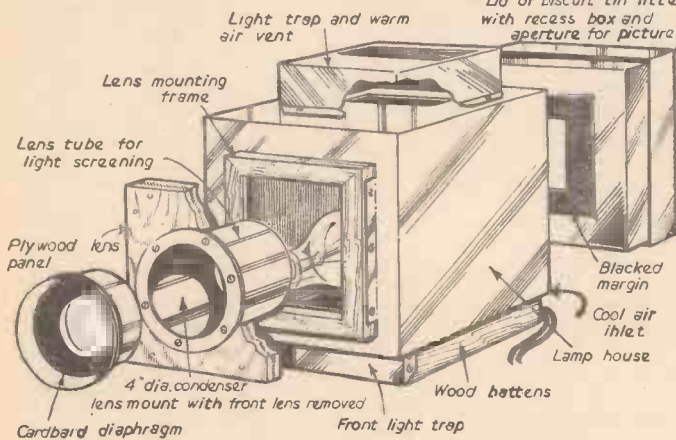

Fig. 1.—Exploded view of the instrument.

ing lens is approximately 5½in. focus, and the dimensions given are to suit this lens.

It was found necessary to fit a cardboard diaphragm, with an aperture of 2½in. diameter for good definition over the full picture space of 2½in. \times 2in.

Using a standard magic lantern lens, no diaphragm was necessary. The front lens only was used, and at 3ft. 6ins. a picture 10in. \times 8in. was obtained; at 6ft. a good picture of about 17½in. \times 14in. was projected. Again, suitable adjustment of the lens in relation to the picture was necessary. A suggested method of adapting a magic lantern lens to the condenser mount, both lenses of the condenser combination being first removed, of course, is seen in Fig 8.

Construction

Constructional details can be clearly seen in the drawings. Fig. 1 shows an exploded view of the instrument with the parts in their order of fitting. The main body, or lamp house, is made from a standard biscuit

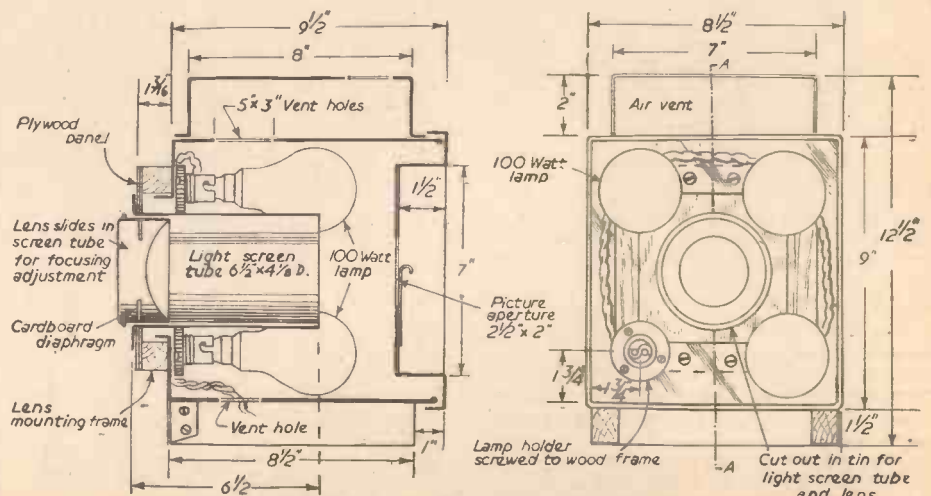
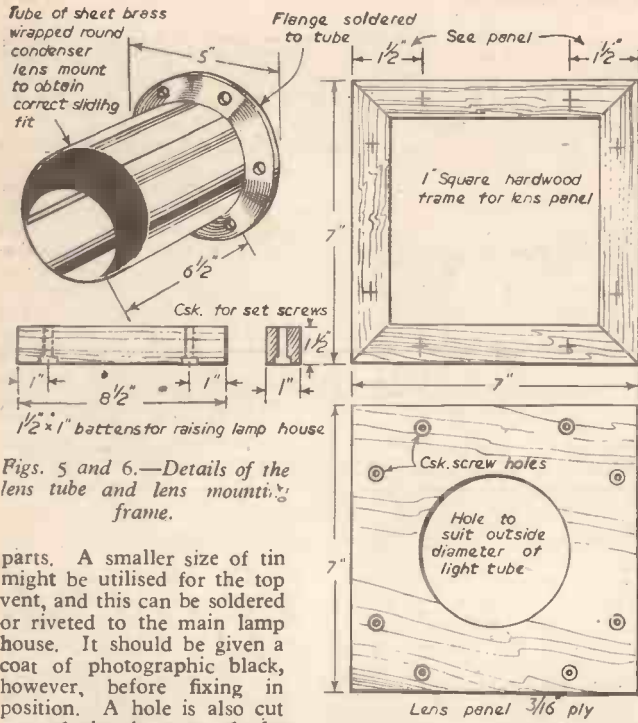

Fig. 4.—Section and end view of the lamp house.



Figs. 5 and 6.—Details of the lens tube and lens mounting frame.

parts. A smaller size of tin might be utilised for the top vent, and this can be soldered or riveted to the main lamp house. It should be given a coat of photographic black, however, before fixing in position. A hole is also cut out of the bottom of the tin to provide an air inlet, and the lamp house is raised upon two battens, as shown, with a strip of tin screwed to them at the front end to act as a light trap. As it was found difficult to screw these battens from the inside of the tin, set screws and nuts were used, the holes being countersunk, as shown. The front of the tin could, of course, be formed by a cross-batten of the

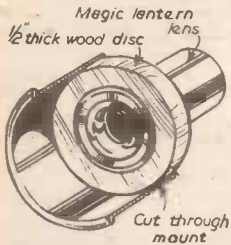

Fig. 8.—Details for mounting a magic lantern lens.

same wood section of 1 1/4 in. X 1 in. This might be an advantage.

The Light Screen Tube

This is important as it prevents direct light from the lamps striking the lens, and allows only that reflected from the picture to pass through the lens. The tube is made from medium gauge brass sheets, cut to size, and soldered to an end or front flange, drilled with fixing screw holes. If using the condenser lens combination, the best plan is to wrap the cut sheet of brass round the lens mount, spot solder at the two extreme ends, remove from lens mount and solder along the seam. The inside should be given a coat of photographic black to prevent reflections.

The optical system is shown in pictorial form in Fig. 9 and it will be seen that a mirror is shown at an angle of 45 degrees to the lens. This will correct the projected image by reversing right and left, and the screen will have to be one side of the epidiascope as shown. If projected straight on to the screen, the image as well as any lettering, will be reversed. Such a mirror could be readily fixed to the lens panel at the correct angle.

The reader may, of course, vary the sizes given, and much will depend upon the projecting lens available. Some reading magnifiers may be found suitable, but some

experiments should first be carried out to arrive at correct distances, and the largest aperture possible for good definition over the whole picture area.

If a biscuit tin is not available, the whole lamp house might be made up from sheet tinsplate. Riveting would possibly be easier than soldering. It is suggested that some form of reflectors might be incorporated to increase light concentration on the picture area. The simple air vent and light trap arrangement could be elaborated if desired, by fitting a further section above the first, when complete light trapping would be secured. Also the

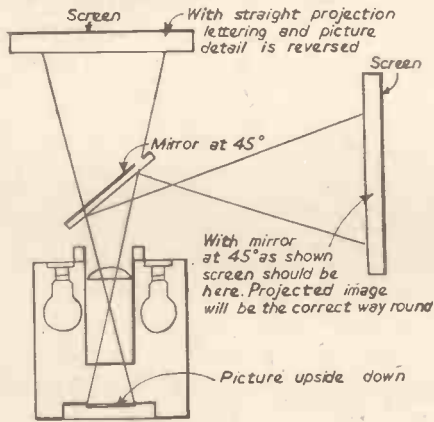

Fig. 9.—The optical system diagrammatically.

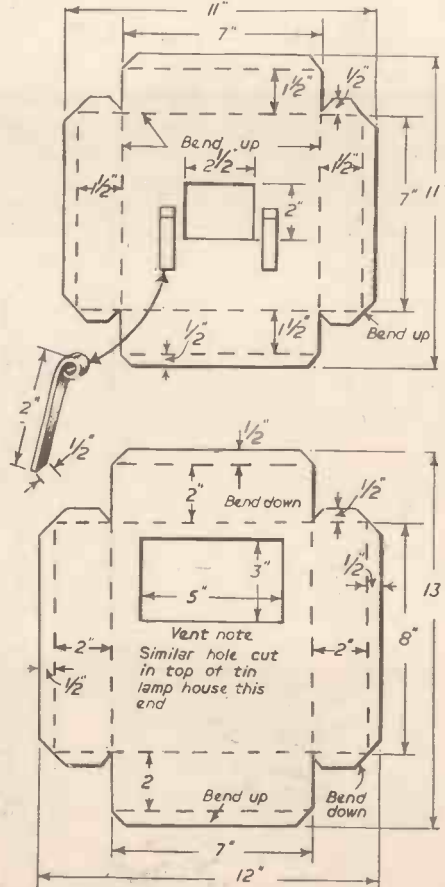

Fig. 7.—Details of the tinsplate picture recess and the top vent.

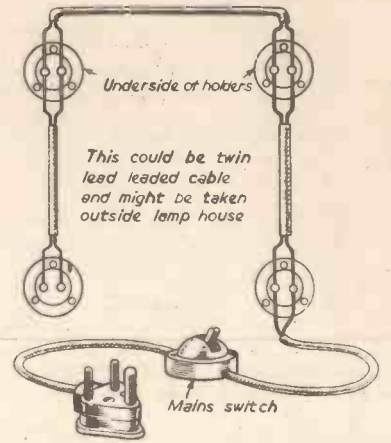

Fig. 10.—Wiring diagram.

bottom air inlet could be elaborated.

The black margin will be found to prevent reflection near the edges of the projected image. Switch off the lights as often as possible, both to save current and allow the lamp house to keep cool.

Finally, it is quite interesting to see the palm of one's hand reflected in full colour on the screen, and serves to demonstrate that this is not just an ordinary magic-lantern.

Blueprints for making a diascope are available under our Blueprint Service.

A Transistorised Geiger Counter

(Concluded from page 76)

standard television feeder connectors. Two spring clips fitted on a piece of Perspex make contact with the battery terminals. The clips used were the ones supplied by Mullard Ltd. as cooling fins for the OC72 transistor. The one on the positive (earthed) side of the battery also serves to mount the transistor. Wire in the potentiometer using the centre and one outer terminal so that maximum resistance is in circuit when the spindle is fully anti-clockwise. The transformer requires careful construction. If wound on a bobbin with cheeks there is a danger of short circuit turns due to wires slipping down the sides. For this reason interleaving is used on the high-voltage winding.

Testing

Before connecting the 4.5 volt torch battery and switching on make sure that the collector winding of the transformer goes to the negative battery terminal. The variable resistor should be turned fully anti-clockwise so that the full resistance is in circuit. Switch on and check the battery current, it should be about 10mA. Rotate the resistor control clockwise until the circuit control begins to oscillate. At this point the battery current should be about 20mA and the generated H.T. should be enough to operate the tube. Clicks should be heard in the headphones at the background count rate, which for the G5H tube is about 40 per minute. Convenient sources of radioactivity for testing are luminous watches and meters. If desired, samples of common uranium minerals can be obtained from Messrs. Geo-Electronics, 33, Edgcombe Street, Plymouth, Devon.

AN ATTRACTIVE CHILD'S COT

AN attractive drop-flap cot that can be dismantled in five minutes and stored in a small space when not required can easily be made by the average handyman with a limited number of tools. This cot, shown in Fig. 1, which is very practical in use, has been designed so that there are no awkward corners to collect dust. It takes a standard sized cot mattress with a small allowance for blankets, etc., and it can be constructed throughout with ramin or good quality softwood. Small trolley wheels can be fitted for easy movement.

The Ends

First mark off positions of joints on one 42in. x 1 1/4in. x 1 1/4in. piece as shown in Fig. 2, then from this square off the three other legs. Next take the two top cross rails and mark joints as shown in Fig. 2(a), taking care to keep all measurements accurate and using a marking gauge, which should be set at 3/8in. for all the joints of the end frames. The six other rail joints can now be marked off (see Fig. 2(b)) and all joints cut with a fine tenon saw, using a 1in. chisel to clean out the waste.

The two end frames are now ready for assembly, gluing and fixing joints with 3/4in. screws, after testing each corner with a set square. These are left for 24 hours to set and then the four pieces of hardboard, 36in. x 24in., can be fixed with 3/4in. panel pins, nailing to both uprights and cross rails at intervals of 4in. Finish and conceal joint ends by gluing and pinning the half-round beading to edge of framework, the top corners being mitred.

Fixed Sides

The 1/2in. diameter dowel rods are spaced at 4in. centres and it is more satisfactory if these positions are marked, starting from the centre of each 47 1/2in. piece and working towards the ends on the 3/4in. edge of the wood. Set the marking gauge at 7/16in. and

prick a hole at each pencil mark, this method giving a true centre for the 1/2in. dia. holes, which should be bored 3/8in. deep. There are several methods of gauging the depth of the holes, but the one that the writer found satisfactory was to bore a test hole in a scrap piece of the wood being used, counting the number of turns of the brace to reach a depth of 3/8in. This method requires no depth gauges or other tools. The 13in. dowel rods are now glued into position and fixed with 1/2in. panel pins.

Drop Flaps

The 47in. lengths are marked for jointing and drilling, as in Fig. 3, the 9 1/2in. dowel rods also being accommodated in 1/2in. deep holes. The six 8 1/2in. x 1 1/4in. x 3/4in. pieces are either dowel jointed or fixed with two corrugated joint fasteners. It is easier if the edges of the 30 1/2in. x 11in. hardboard are chamfered before being finally

fixed into position with 1/2in. panel pins on each side of the framework.

Assembly

The 3in. mild steel brackets are first screwed to the "fixed sides" as indicated in Fig. 3 and then to the cot ends, driving the screws well home, so that the sides are 15in. from the bottom of the legs.

The butt hinges are now fixed to the drop flaps, 12in. from the side, and then screwed to the sides of the cot.

The 2 1/2in. cabinet bolts, used for holding

(Concluded on page 107)



Fig. 1.—The completed cot.

An Item of Nursery Furniture You Can Make Yourself

By J. H. HOPE

LIST OF MATERIALS

- All timber finished sizes.
- Ends**
- 4 pieces 42in. x 1 1/4in. x 1 1/4in.
 - 8 pieces 24in. x 1 1/4in. x 1 1/4in.
 - 4 pieces Hardboard 36in. x 24in.
 - 4 pieces 42 1/2in. x 1 1/4in. x 1/2in. half-round beading.
 - 2 pieces 25in. x 1 1/4in. x 1/2in. half-round beading.
 - 32 screws 1in. x 6.
- Fixed Sides**
- 4 pieces 47 1/2in. x 1 1/4in. x 3/4in.
 - 22 pieces dowel rod 13in. x 1/2in.
- Drop Flaps**
- 4 pieces 47in. x 1 1/4in. x 3/4in.
 - 6 pieces 8 1/2in. x 1 1/4in. x 3/4in.
 - 4 pieces dowel rod 9 1/2in. x 1/2in.
 - 1 piece dowel rod 3/4in. x 12in. or 2 doz. corrugated joint fasteners.
 - 4 pieces Hardboard 30 1/2in. x 11in.
- Fillets**
- 2 pieces 47 1/2in. x 3/4in. x 1/2in.
 - 2 pieces 22 1/2in. x 3/4in. x 1/2in.
 - 2 doz. 1in. x 6 screws.
- Base**
- 2 pieces 47 1/2in. x 2in. x 1/2in.
 - 6 pieces 22 1/2in. x 2in. x 1/2in.
- Fittings**
- 8 Mild Steel Brackets 3in. x 3/4in. with 1in. screws.
 - 2 Pair 2 1/2in. Butt hinges.
 - 4 2 1/2in. Flat brass cabinet bolts.
 - 4 2in. diameter trolley wheels (if required).
 - Tube of Glue or Adhesive.
 - 1/2in. and 3/4in. panel pins.

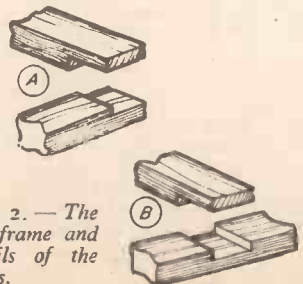
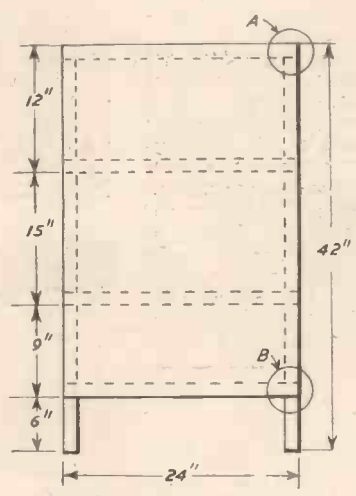

Fig. 2.—The end frame and details of the joints.

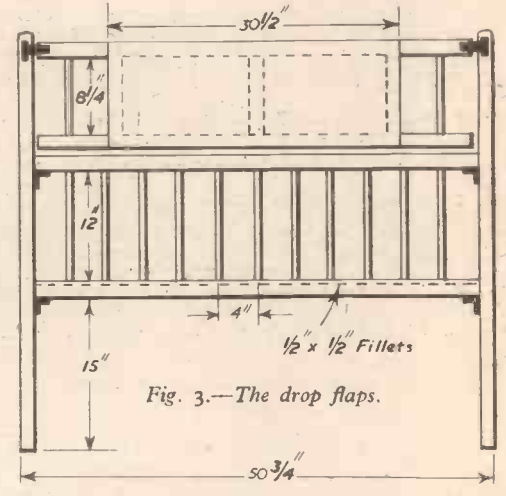

Fig. 3.—The drop flaps.

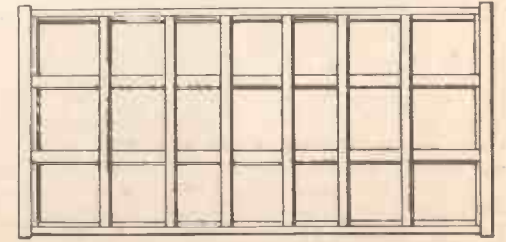
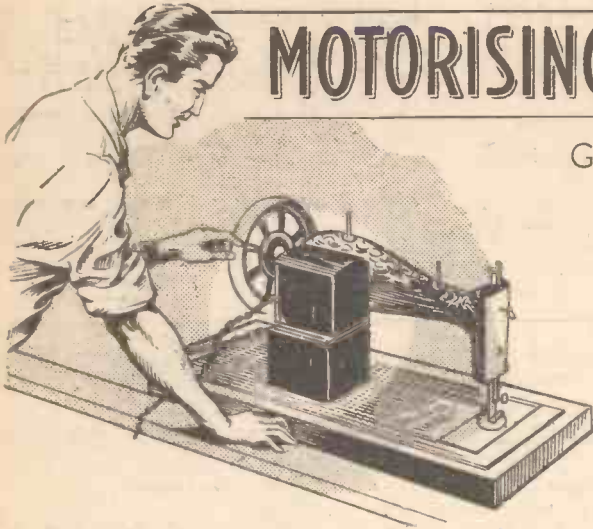

Fig. 4.—The mattress base.

MOTORISING A SEWING MACHINE

G. R. Thomson Tells You How to Take the Work Out of Your Wife's Dressmaking



THE motor used is from an old domestic vacuum cleaner rated at 230 volts. The speed was too high at this voltage so a step-down transformer was used to give 110 volts. This gives a maximum speed for the motor in excess of that required to drive the machine at its highest working speed, but leaves a little in hand should extra speed be required. Control is by a variable resistance operated by foot pedal and a smooth speed control is obtained by the method used. No sizes are given, since individual motors and sewing machines being converted will vary so much.

The Motor

This is from a cylindrical type of suction cleaner and has a circular flange round about

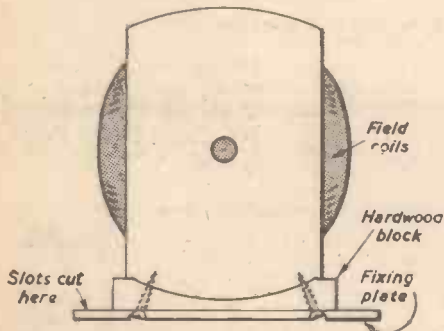

Fig. 1.—The transformer mounting.

the casing which must be cut away. Any type of motor of similar power would be equally suitable.

A hardwood block is cut and shaped, as in Fig. 1 and an aluminium plate cut to project about $\frac{3}{8}$ in. on either side of the block. The two are then screwed through into the main casing of the motor by marking through the drilled holes in the plate and

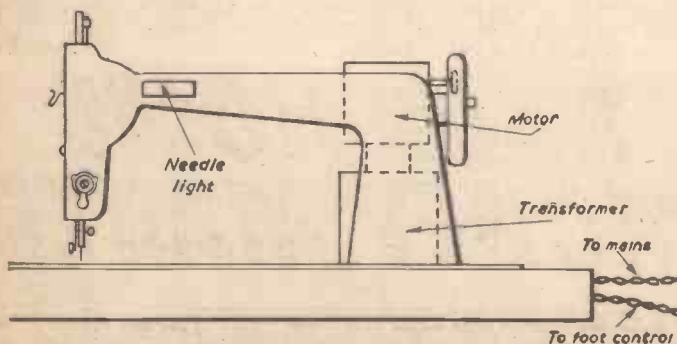

Fig. 2.—General layout.

block and drilling and tapping the casing. Slots should be cut in the bottom plate to facilitate adjustment of the motor when mounted on the machine. The field coils, pole pieces and armature should be removed from the motor case to prevent damage to windings while these modifications are being carried out. Two .001 μ F mica condensers rated at 2,000 volts,

and if the transformer is wound at home special attention should be paid to the insulating medium between primary and secondary. Failure of the insulation here will mean the motor becoming live at mains voltage and the advantage of a transformer from a safety point of view will be lost. An earthed screen between the two windings is another precaution and also helps to keep radio interference out of the mains supply. If the transformer is to be mounted behind the machine casing then a metal case should be made to cover it entirely. All metal parts should be bonded

together, including the machine, and earthed to the mains plug. A refinement is to wind on sufficient wire to give 6 volts for a needle light.

The Machine

Remove the machine and its bedplate from the old fixing and mount on a strong prepared upside down tray constructed of stout wood, i.e., $\frac{3}{4}$ in. plywood. This, of course, is if it is desired to have the machine portable. The tray should be larger than the bedplate by about 2 in. at the front and ends and 3 in. at the back to accommodate the transformer and motor. This latter measurement may vary with the size of motor and transformer used. The depth of the tray can be 2 in.

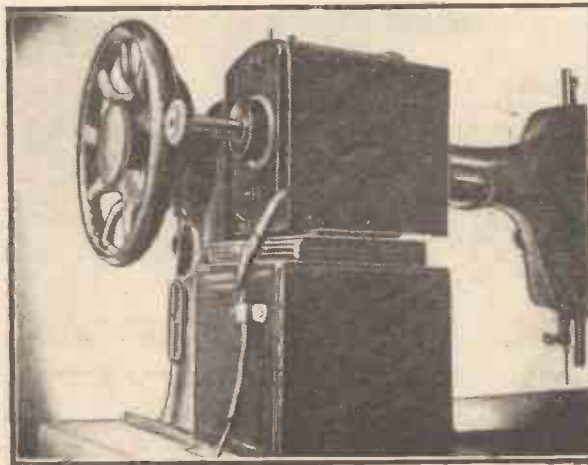

Fig. 3.—The completed modification.

connected from each brush to earth provide effective radio and television suppression.

In the motor used the commutator, brush-gear and field coils are exposed, so a covering plate should be made which will prevent any accidental contact of the live parts.

Reassemble the motor and fix a pulley of $\frac{3}{8}$ in. dia. to the shaft. On to the pulley is forced a rubber wheel from a well-known construction toy. This wheel bears on the hand wheel of the machine and is the drive.

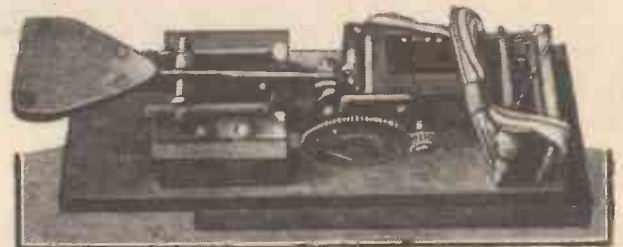

Fig. 4.—The foot control.

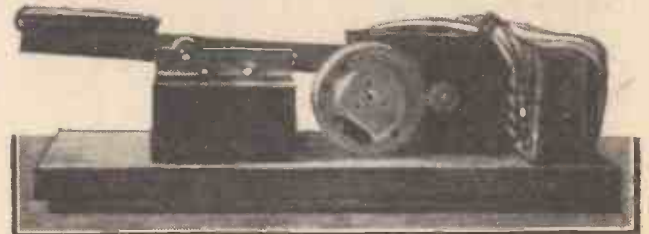

Fig. 5.—Side view of the foot control.

The Transformer

This is wound for 230 volts A.C. input and 110 volts output. The secondary should be wound with wire having the necessary thickness to carry the total current of the motor at its maximum speed on load. Insulation is impor-

tant, and if the transformer is wound at home special attention should be paid to the insulating medium between primary and secondary. Failure of the insulation here will mean the motor becoming live at mains voltage and the advantage of a transformer from a safety point of view will be lost. An earthed screen between the two windings is another precaution and also helps to keep radio interference out of the mains supply. If the transformer is to be mounted behind the machine casing then a metal case should be made to cover it entirely. All metal parts should be bonded

together, including the machine, and earthed to the mains plug. A refinement is to wind on sufficient wire to give 6 volts for a needle light.

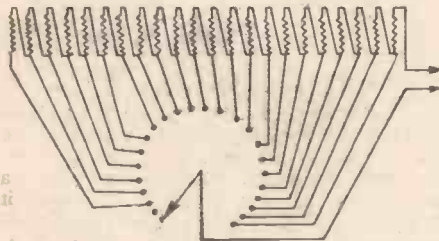
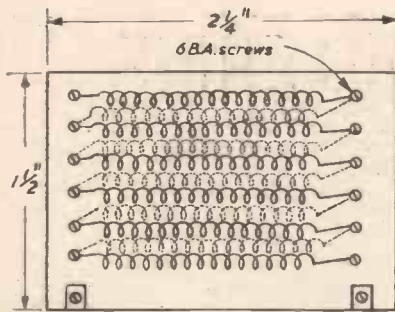

Figs. 6 & 7.—Variable resistor and method of wiring to switch.

Fig. 8. (Right).—Plan of foot control.

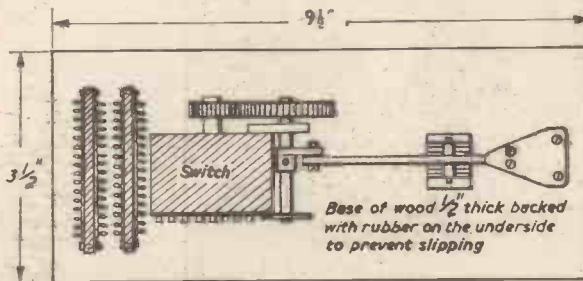

The foot control is a variable resistance operated through simple gearing and a lever movement, as shown in Figs. 4 and 5. The resistance consists of a rotary 24-position switch connected to a bank of resistance elements. There are twenty-two of the latter and they are made from two 1,000 watt

electric fire elements obtained from a well-known multiple store. These are really too heavy for the current taken by the motor, but they were used since they were convenient. Each spiral element was cut into eleven equal lengths, making 22 in all, and they were mounted on two asbestos panels, six on one side and five on the other. This is shown in Fig. 6.

The two resistance panels are mounted as shown in Fig. 8, together with the switch.

Mounted on the switch spindle is a 20-tooth gear wheel and engaging with this another wheel having 80 teeth. A quarter rotation of the larger wheel will therefore result in one complete revolution of the switch spindle. Actually the switch only moves through approximately 300 degs. and a pedal movement of 1/4 in. results in the full range of speed being covered. On the large wheel spindle is a fixed collar with a brass arm, as shown in Fig. 9. This is coupled by means of a link to the main arm. The pedal can be of 1/8 in. brass or steel and covered with a strip of rubber. After assembly the resistances should

be wired up to the switch, as shown in Fig. 7 and the connecting cable taken

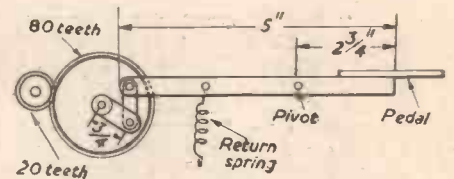

Fig. 9.—Side view of foot control mechanism.

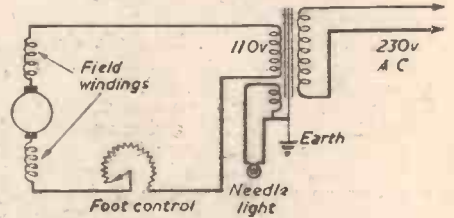

Fig. 10.—The circuit.

out at the back. A cover should now be made to cover the foot control, just leaving the pedal projecting.

Wiring of the motor and transformer can now be carried out as shown in Fig. 10.

Note that the last two switch contacts are left blank, so that in the foot-up position the motor circuit is broken completely. Gentle foot pressure completes the resistance circuit and the machine will operate slowly. Speed control, thereafter, is remarkably smooth and easy.

Once the wiring has been carried out the bottom of the tray should be covered over with a piece of plywood or hardboard to keep prying fingers away from the connections.

FIRST NATIONAL MAGAZINE EVER

FOR SPARE TIME MONEY MAKING

NO. 2
OUT NOW

NO. 2 OF THE NEW MAGAZINE FOR PLEASURE AND PROFIT

Practical HOME MONEY MAKER

EDITOR: F. J. CAMM

NOVEMBER 1957

1/3

PRACTICAL HOME MONEY MAKER is planned to help you add welcome pounds to your income . . . surely, quickly, enjoyably . . . in the comfort of your own home. It's packed with fascinating, earn-as-you-learn ideas which show you how to use your spare time for profit . . . how you and your family can make money in dozens of new ways . . . how to market what you make.

Some of the profitable hobbies covered in the early issues of PRACTICAL HOME MONEY MAKER

LEATHER HANDBAGS, PURSES AND WALLETS
RUG-MAKING . SOFT AND MECHANICAL TOYS
PLASTIC WARE . LAMPSHADES . JEWELLERY
POTTERY . ORNAMENTS . PHOTOGRAPHY
WEAVING . HOME KNITTING MACHINES
PICTURE-FRAMING . TICKET-WRITING . STAMP
COLLECTING . RABBIT BREEDING . POULTRY
BREEDING . AQUARIA . WOODWORK . NOVELTIES IN GLASS . BASKET WORK.

Practical HOME MONEY MAKER

Edited by F. J. CAMM

1/3 MONTHLY

MORE PLEASURE FROM YOUR LEISURE — MORE MONEY IN YOUR POCKET!

THIS unit was designed and built to take the Fisholow Model "YY," vitreous-enamelled, twin-bowl sink. Alternatively, the more expensive stainless steel Model "XX" could be fitted. This sink requires no draining board and permits a flat working top and, if it is purchased complete with a "basket waste" in one bowl and a plastic-coated, wire draining basket for washing-up purposes, it will be found extremely satisfactory and convenient in use.

The unit as built is 5ft. long, 2ft. deep (front to back) and 2ft. 11in. high, which gives a comfortable working height for the average woman, particularly when washing up. The sink is on the left, giving over 2ft. of working space to the right; but if preferred the construction could be reversed to put the sink on the right. The design is, in fact, capable of modification to suit varying requirements. For a restricted space, it could be reduced to 3ft. long to accommo-

A MODERN SINK UNIT

With a Twin-bowl Sink

By R. J. C. GOLDRING

be some delay in delivery, and then the services of a plumber should be arranged to be on call when the time comes for the plumbing to be installed. If an existing sink is to be replaced, then any cupboards or shelves underneath it should be removed in advance and preparations made to take the old sink out quickly at the right time.

General Construction

The plinth and framework of the unit as built were constructed from ramin, which

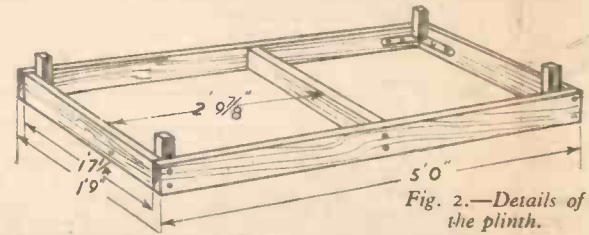
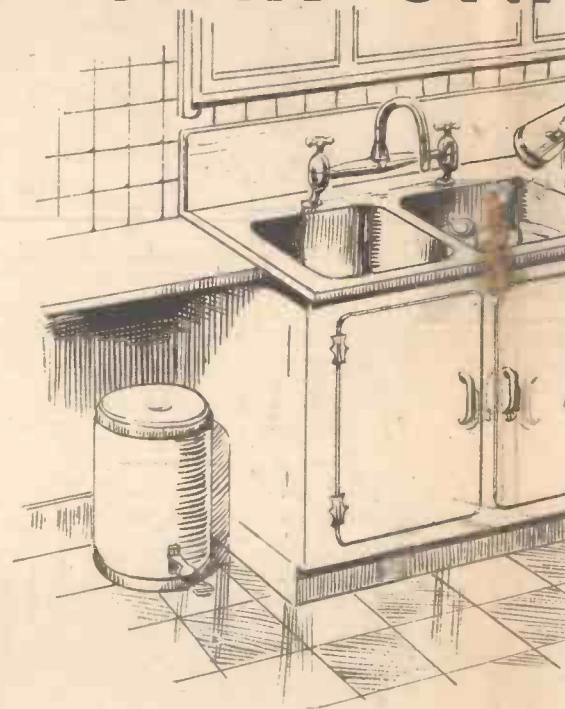

Fig. 2.—Details of the plinth.

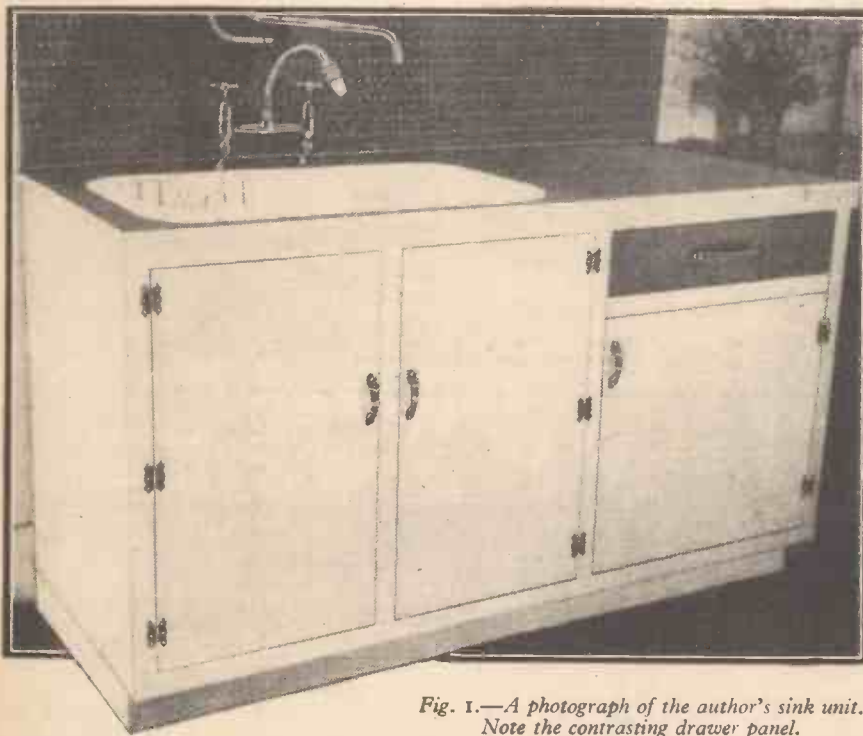

Fig. 1.—A photograph of the author's sink unit. Note the contrasting drawer panel.

date the sink only, or increased to 7ft. to give an equal working space both sides of the sink, with a consequent increase in cupboard and drawer space. If desired, the area under the working space (with the drawer omitted) is sufficient to accommodate an electric water heater of the Sadia "UBD" type.

Consideration should be given to the water supply and the type of tap or taps to be fitted. If only cold water is laid on, then a separate tap can be fitted for each sink bowl, but if a hot supply is available as well, a mixer tap with a swinging arm will be required. Actually, the unit as built was fitted with a mixer tap, although no hot water is connected to it, as the swinging arm is a desirable feature, and it is also an incentive to install a hot water system eventually! In such a case, of course, the "hot" side of the tap must be plugged to prevent the cold water going straight through!

To prevent too much dislocation in the kitchen, a certain amount of planning is desirable, especially if the unit is to replace an existing sink. First of all, the Fisholow sink itself should be ordered, as there may

have proved very satisfactory. The plinth is of 4in. x 1in. nominal (3 7/8in. x 7/8in. planed) and the framework of 1 1/2in. x 1/2in. nominal (1 1/8in. x 3/8in. planed). Panelling is 3/8in. hardboard and the construction is such that most of the edges of the hardboard are protected. The drawer, being a hard-worked portion of the unit, is of hardwood, the front of beech and the sides and back of mahogany. The drawer runners are also of hardwood. The top of the unit is 3/4in. Weyroc, covered in "Redimix" plastic flooring compound. No floor is fitted, as the kitchen floor serves equally well on which to stand buckets and bowls. Besides keeping the cost

down, the absence of a floor ensures that the unit is well ventilated, as there is a gap between the front of the plinth and the front bottom rail of the unit.

A floor of tongued and grooved boards is something the reader may like to add for himself.

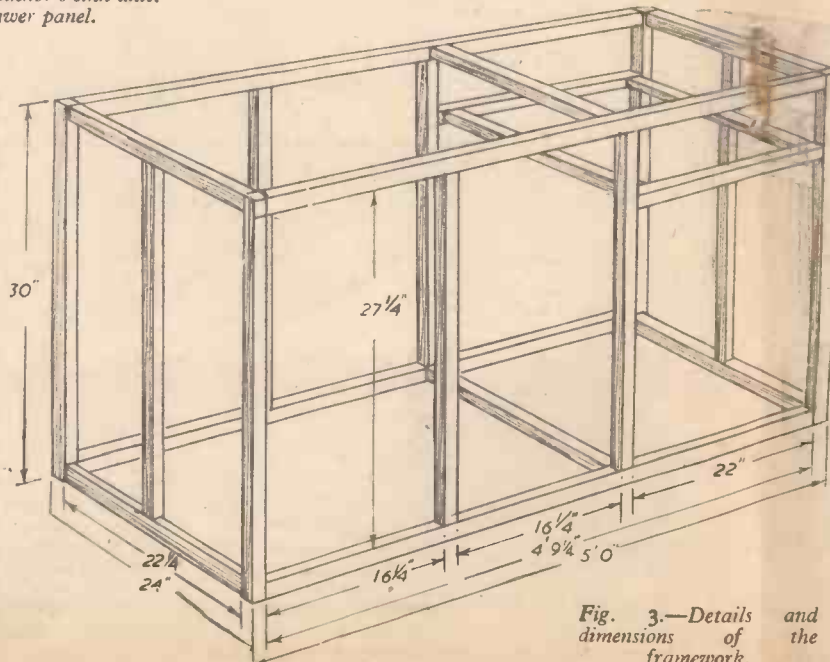

Fig. 3.—Details and dimensions of the framework.



Plinth Construction

Details and measurements are shown in Fig. 2. Butt joints, glued and screwed or doweled, are used and the corners may be strengthened with angle brackets or wooden blocks glued and screwed to the framework. If angle brackets are used, wooden pegs should also be screwed in the corners to protrude about 1 in. above the top, while if glue blocks are used they should also stand proud by 1 in. or so. These form locating

pins which hold the framework of the unit in position when it is lowered on to the plinth. When complete, the plinth should be treated with a suitable preservative and painted before the unit is assembled to it.

It should be noted that the front of the plinth is set back 3 in. from the front of the unit to provide a toe space and also ventilation as mentioned above.

Framework

The timber should be carefully selected, as it must be straight and free from twist.

The main frame consists of two identical end frames and front and rear frames, which are also identical and which are joined by top and bottom cross members and the drawer runners. Drawer guides and shelf supports are added after assembly.

The assembly of the framework is shown in Fig. 3, in which the measurements are for timber finished to 1 1/4 in. x 1/2 in. All joints are doweled and glued with waterproof glue, such as "Cascamite," and, although this involves cutting 80 dowels and boring 160 holes, it is considered that this is simpler and quicker than cutting half-laps or mortise and tenon joints. This form of construction has proved satisfactory in over a year's use.

Two 1/4 in. x 1 1/2 in. dowels are used per joint, and are inserted 1 in. into the ends of members and 1/2 in. into the sides of mating members. This ensures a good grip in the end grain and also that, where three members meet, the dowels do not "clash" inside the joint. Exploded views of the joints used are shown in Fig. 5.

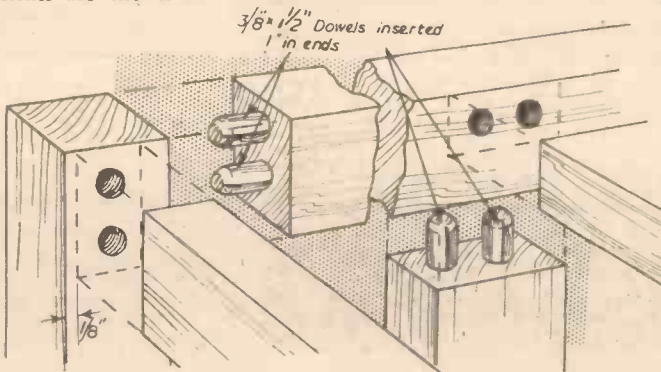

Fig. 5.—Details of the dowel joints.

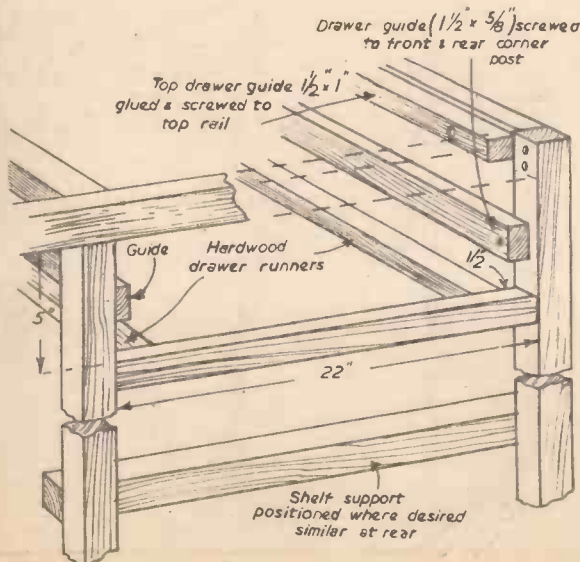

Fig. 4.—The drawer runners and shelf support.

The first job, therefore, is to cut the 80 dowels, 1 1/4 in. in length. Make a saw cut along each and slightly round the ends with sandpaper.

The timber should now be cut to length (except the corner posts, which should be left oversize until after the dowel holes have been bored), and precise trimming is essential to ensure the framework goes together accurately. The joints are then marked and, to ensure accurate positioning of the dowel holes, a jig or template of the type described in most carpentry books should be used. Note when marking the joints on the corner posts for the side frames that these are set in 1/4 in. to allow for the side panels. The dowel holes are then bored, using a bit gauge to ensure correct depth, and the dowels are inserted and glued into the holes in the ends of members and allowed to set.

Glue up and assemble the front and rear frames and knock

the joints tight with a mallet. Ensure the frames are true and leave to set. They may be cramped by tying lengths of cord around them from end to end and top to bottom and inserting wooden wedges under the cords to tighten them.

The framework is then checked by assembling the end frames to the front and rear *drv.* If no adjustments are required, dismantle and complete the assembly of the end frames by gluing the uprights to the top and bottom members.

The complete framework is then glued and assembled together and this can best be done by laying the rear frame flat on the floor; insert the ends, the top and bottom cross members and the drawer runners and then place the front frame on top and drive all the joints home. Stand the framework upright, check again for squareness, clamp up (with cords and wedges again) and leave to set thoroughly.

The drawer guides, details of which are given in Fig. 4, are then screwed to the framework. Note that the side guides are set back by half the thickness of the front uprights to allow for the front of the drawer and also to act as stops for the drawer. The

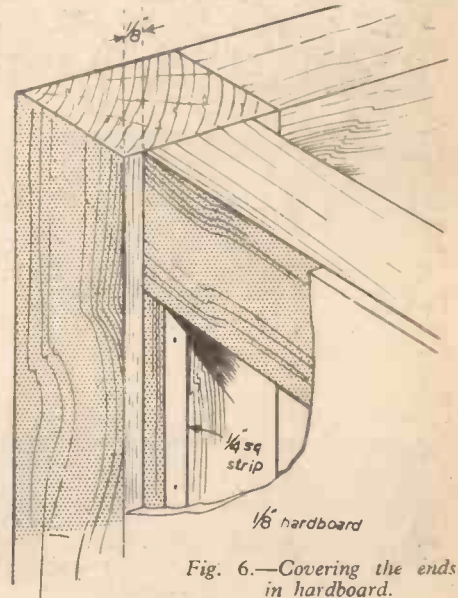

Fig. 6.—Covering the ends in hardboard.

top guide is screwed and glued to the top member of the end frame.

Supports for a shelf or shelves are then fixed across the front and rear frames, being screwed to the insides of the upright members, as shown also in Fig. 4. Their position is a matter of personal preference.

The Drawer

As it is considered that a drawer which is used frequently might as well be a good-looking piece of furniture, it was constructed in hardwood. The front is of 3/4 in. thick (finish) beech and the sides, back and partition are of 3/4 in. African mahogany type. The bottom is 3/4 in. ply, lined with green baize. The construction is shown in Fig. 8. A rebate is cut and chiselled at each end of the front as shown, and the sides are pinned and glued to it. The back is glued into grooves sawn and chiselled into the sides and the partition similarly glued into grooves in the back and front. The bottom (in two pieces) is supported on 1/4 in. square or quarter-round strip pinned and glued around the inside of the sides, back and partition, the ply being glued to this strip.

The Top and Fitting the Sink

Before cutting the 3/4 in. Weyroc to size, decide whether any overhang would be

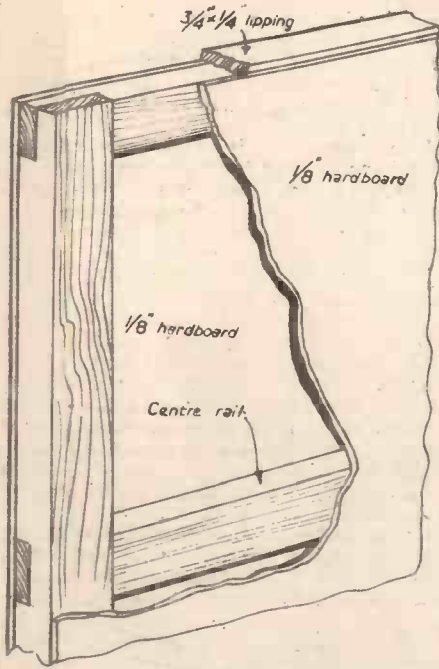

Fig. 7.—Details of door construction.

desirable (e.g., at the back to bring it flush to the wall); if not, it should measure 5ft. X 2ft. finished size. The edges are planed smooth and square and finished with a 3/4 in. half-round moulding pinned and glued all round. The moulding stands above the surface of the Weyroc by 1/16 in.—1/4 in. to contain the "Redimix."

Fitting the sink into the top is slightly tricky, as, if the holes are cut too large, the holding-down bolts on the sink will have nothing to bear against. Square a pencil line across the Weyroc coincident with the left-hand edge of the top cross member of the frame, thus indicating the area into which the sink must fit. Then place the sink upside down on this area, 2 in. in from the front edge and centralised from left to right. Sufficient space will then be left at the rear to fit the taps. Mark a pencil line all round the periphery of the sink. By measuring in from the outer edge of the sink to the sink bowls, it is then possible to mark in the position of the holes, but it is advisable first to experiment with a sheet of stout cardboard and thus produce a template. When the holes have been successfully cut out and a trial fit made, bore the holes for the taps.

Remove the sink and then cover the top surface of the Weyroc with the "Redimix" compound, carefully following the maker's instructions. This compound can be obtained in plain colours and marbled effects and, if properly applied, will provide an attractive, hard-wearing and waterproof surface.

When the "Redimix" is thoroughly hard, the top can be placed in position on the framework and small angle brackets screwed to the undersurface and to the framework to hold it in position.

The taps and sink are then fitted and the plumber called in to connect up. His work is simplified by the fact that the panelling and doors have not yet been fitted.

When the plumber has finished and the sink is tightened down, any gaps between its edges and the top may be filled with "Redimix" to prevent ingress of water. The sink unit can then be put into use, if desired, in advance of fitting the doors and panelling.

Panelling

The unit was panelled in 1/4 in. Celotex

hardboard, which was applied only to the ends. If desired, of course, the back could also be panelled, but this seems unnecessary unless the wall against which the unit stands is in bad condition.

The end panels extend from the top to the bottom of the unit framework, so that the top edge is protected by the moulding applied to the edge of the Weyroc top. As the end frames are let in 1/4 in., the panels are flush with the corner posts and are supported there by 1/4 in. or 3/8 in. square or quarter-round strip pinned and glued to the corner posts, as shown in Fig. 6.

After cutting the panels to size, they should be wetted on the backs and allowed to stand for 24-48 hours before fitting. They are then glued to the end frames and to the strips fixed to the corner posts with impact adhesive such as "Evostik."

Doors

The construction of the doors is shown in Fig. 7. They consist of a framework of 1/2 in. X 1/2 in. battens with a centre rail, the joints being simple half-laps, panelled each side with 1/8 in. hardboard. A 3/4 in. X 1/4 in. moulding is applied to the top, bottom and closing edges. This results in a slim, lightweight door which, if properly constructed, is perfectly rigid.

The stiles are cut 1/4 in. less than the height of the door opening and the rails 1/4 in. less

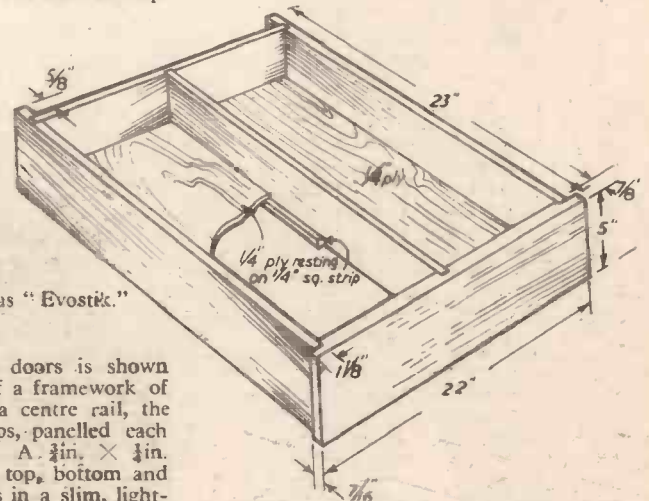

Fig. 8.—Construction of the drawer.

the edges, as mentioned above, the panel pins being punched well below the surface.

The resulting doors are thus the exact size of the openings, and it is only necessary to plane the moulding down slightly to obtain a perfect fit. The simplest method of hanging is with surface hinges, and these can be obtained in various designs and finishes which look very attractive. A great variety of catches is also available, from which suitable ones may be selected.

After initial fitting, the doors should be removed to enable both them and the framework to be painted.

Finishing

The framework and doors should be primed and undercoated and finished with one or two coats of hard-gloss or lacquer. The drawer, however, is given a coat of clear varnish, the natural finish of the beech front making a pleasant contrast with the remaining painted surfaces.

Finally, the doors are refitted and handles to choice fixed to the doors and drawer front.

Possible Modification

The construction could probably be improved upon, but it is simple and inexpensive to make and satisfactory and convenient in use. The design can be modified to suit varying requirements and the interior also can be modified by fitting extra shelves or drawers or by panelling in the portion which encloses the drawer and shelf.

As an alternative to the "Redimix" surface, plastic-coated Weyroc or Weyroc or plywood veneered with one of the laminated plastics such as "Formica" could be used. The "Redimix" was used by the writer because it was also being used to cover the kitchen floor.

The drawer can be subdivided further to suit individual requirements, and this can be easily done by means of a removable "eggcrate" type of assembly.

Finally, the two pieces of Weyroc cut out to permit fitting the sink can be padded or veneered with plastic, then, with screw-on wood or metal legs fitted, they make excellent stools or small tables.

LIST OF MATERIALS

- Plinth
 - Timber 1/2 in. X 1/2 in. nominal.
 - Front and back — 2 off 5ft.
 - Ends — 2 off 27 1/2 in.
 - Cross member — 3 off 19 in.
- Framework
 - Timber 1 1/2 in. X 1/2 in. finished size.
 - Corner posts — 4 off 30 in.
 - Uprights — 6 off 27 1/2 in.
 - Cross members — 6 off 22 1/2 in.
 - Drawer supports — 2 off 22 in.
 - Drawer runners — 2 off 22 1/2 in. (hardwood).
 - Drawer guides — 2 off 23 1/2 in.
 - Drawer guide (top) — 1 off 22 1/2 in.
- End Panels
 - Hardboard 1/4 in. thick — 2 off 22 1/2 in. X 30 in.
- Doors (2 left-hand same size)
 - Framework—1/2 in. X 1/2 in.—Stiles 4 off 26 1/2 in.
 - Rails 6 off 16 in.
 - Edge moulding—1/2 in. X 1/2 in.—4 off 16 1/2 in.
 - 2 off 26 1/2 in.
 - Panels—1/4 in. hardboard—4 off 16 in. X 26 1/2 in.
- Door (Right-hand)
 - Framework—1/2 in. X 1/2 in.—Stiles 2 off 20 1/2 in.
 - Rails 3 off 21 1/2 in.
 - Edge moulding—1/2 in. X 1/2 in.—2 off 22 in.
 - 1 off 20 1/2 in.
- Drawer
 - Front (Beech) 1/2 in. — 1 off 22 in. X 5 in.
 - Sides (mahogany) 1/2 in. — 2 off 23 in. X 5 in.
 - Partition (mahogany) 1/2 in. — 1 off 22 1/2 in. X 5 in.
 - Back (mahogany) 1/2 in. — 1 off 21 in. X 5 in.
 - Bottom (ply) 1/2 in. — 2 off 10 1/2 in. X 21 1/2 in.
- Top
 - Weyroc 1/2 in. — 1 off 5ft. X 2ft.
- Dowels
 - 80 off 1 1/2 in. X 1/2 in.
- Mouldings
 - 1/2 in. half-round for top.
 - 1/2 in. square or quarter-round for drawer bottom and end panels.
- Sundries
 - "Redimix" for top.
 - "Cascamite" and "Evostik" adhesives.
 - 8 off surface type hinges.
 - 3 off door catches.
 - 3 off door handles.
 - 1 off drawer handle.

A6 Personal TV for £10

THIS television receiver is not of the most up-to-date type, but is very cheap to construct and is being used successfully in spite of the small picture. For the constructor's "den" for the bedroom, and similar cases, it will offer a very good alternative set, and may also prove very useful as a basis round which to carry out experiments on vision or sound receivers, or even on timebases.

The Indicator Unit 62 or 62A is built on a two-deck chassis and provides most of the components for a vision receiver and timebase. The power unit is built on a separate chassis, as it thereby relieves the main unit of a great deal of weight and thus makes it easier to handle.

Fig. 1 shows the position of the main items, with the tube removed. The sound receiver is in the foreground; on the opposite side of the chassis is the timebase, while the vision receiver occupies the upper deck in the background. The EHT supply is contained in the unit at the back of the vision receiver, being fed from a mains plug fitted on the back of the unit.

Stripping the Unit

When the unit is received it is advisable to check the tube, if possible, under normal working conditions on a friend's televisor. If this is not possible, the filament should be tested and the base of the tube examined for looseness. Some of the dealers who sell this unit will change the tube if it is faulty.

The tube can be removed by undoing the screw fitted at the

How to Convert the ex-Government Indicator Unit 62

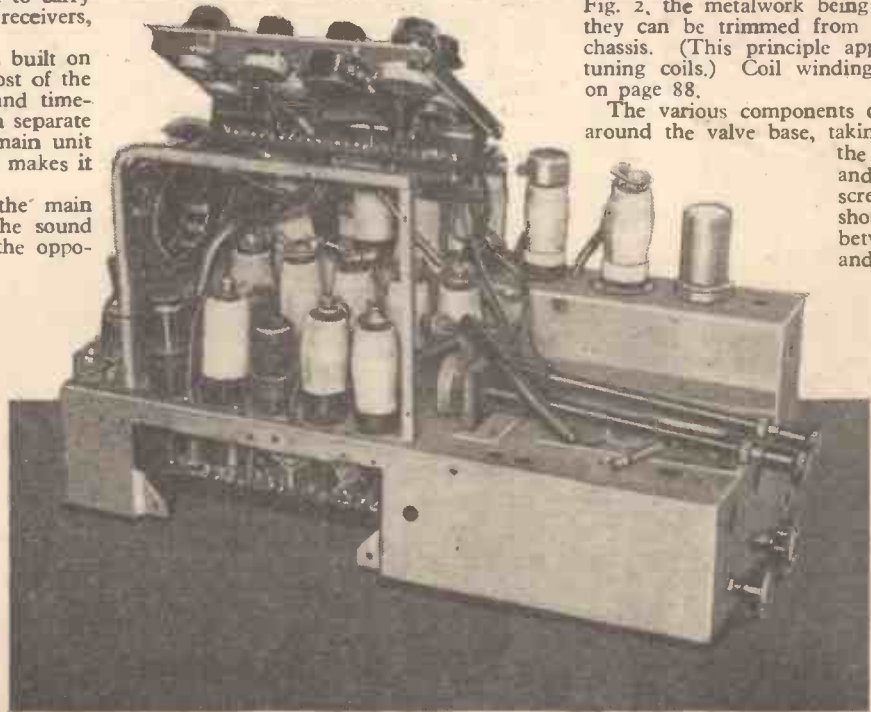

Fig. 1.—A view of the set with tube removed, showing the positions of the main parts.

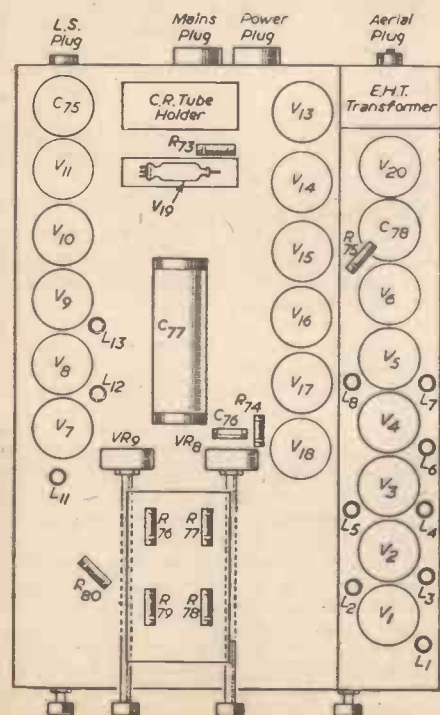

Fig. 2.—Layout of the chassis top.

bottom of the bracket which supports the tube holder; the bracket can then be drawn back. The potentiometer panel on the top of the chassis can then be swung back on its hinges by undoing its retaining screws, and the tube can be withdrawn from the chassis.

After removing the valves, the whole of the unit should be completely stripped with the exception of the valve holders, the tube holder, the 0.03μF 2.5kV condenser (which becomes C75), the D.C. restoring diode and the associated resistor on the top of the chassis (these become V19 and R73), the focus and the brilliance controls (which become VR9 and VR8), and the bleeder network (this becomes R76, 77, 78 and 79). Do not remove leads from C.R.T. holder.

Remove everything else from the chassis including the double-sided paxolin strip underneath the unit and the VR92 valveholder by its side.

The valveholder (see Fig. 2) in V20 position is removed and is replaced with a ceramic-based type for the EHT rectifier valve. The valveholder occupying the next position is removed for C78. The valveholder in V1 position is removed and replaced with one of the EF50 type. Change the valveholder at V10 position with that of V9. Change the valveholder at V13 position with that at V11. Remove all the potentiometers from the top panel. Remove the front metal (double) panel.

Finally, test all the condensers for leakage. This is important, as a leaky conden-

ser can cause some very puzzling faults.

The First R.F. Stage

The circuit diagram is given in Fig. 3. It uses an EF50 valve (V1) and provides a good signal for feeding into the sound and vision receiver. L1 and L2 are mounted under the chassis in the position shown in Fig. 2, the metalwork being drilled so that they can be trimmed from the top of the chassis. (This principle applies to all the tuning coils.) Coil winding data is given on page 88.

The various components can be grouped around the valve base, taking care to keep the leads short, and the metal screen, 2in. X 2in., should be erected between this stage and the first vision

R.F. stage. It will be found convenient to erect this screen after the components have been wired. The aerial connection is made on a Pye socket fitted at the back of the unit and a piece of co-axial cable is run from this socket to L1. The sheath of the cable should be earthed at both ends.

The Vision Receiver

Shown in Fig. 4, this consists of four R.F. stages using VR65 valves, which feed into the VR92 diode detector, whose out-

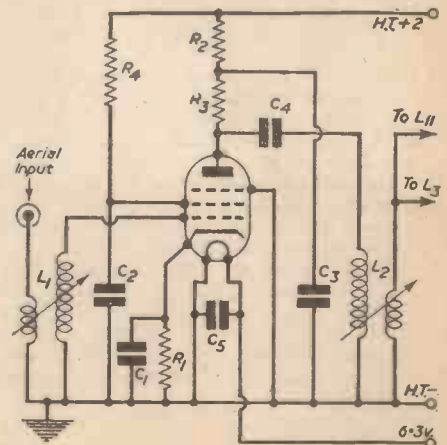

Fig. 3.—Circuit of the first R.F. stage.

be suitably labelled to avoid any errors. Before remounting the strip, the valveholder for V12 (originally removed from underneath the chassis) should be remounted towards the back end of the chassis (underneath). The strip can now be replaced and the wiring of the timebase completed.

C54 and R44 are mounted on a small paxolin strip fitted underneath the EHT transformer on the back end of the chassis. The strip should be fixed right at the bottom and well clear of the EHT leads. The connection between C54 and "A"

Note: Components marked* with an asterisk* are mounted on the tag strip (see text)

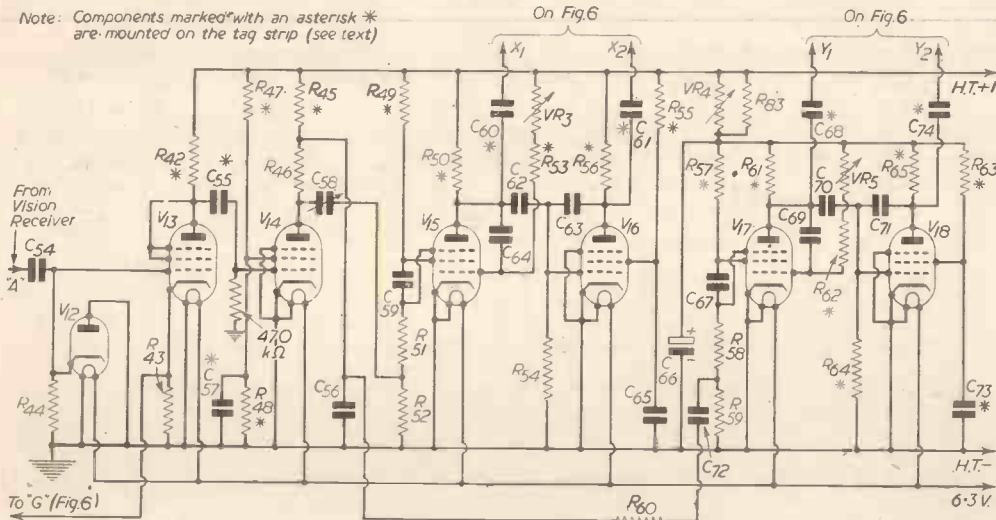

Fig. 5.—The timebase section.

(Fig. 5) should be made in coaxial cable, the outer sheath being earthed at each end.

The height of the picture is controlled by varying the HT applied to the anodes of the frame timebase valves. VR4 forms the control and is one of the 25 KΩ potentiometers previously removed from the top panel. It is shunted by a 1 watt resistor, R.83.

The connection to the deflector plates and to the grid of the CRT can be made by utilising existing wiring.

The Sound Receiver

Two R.F. stages using VR65s (V7 and V8) are transformer coupled, V9 is a VR54 and one-half forms the detector, while the second half is used for noise-limiting.

The output from V9 is fed into the first A.F. valve, a VR65 (V10), which is R.C. coupled to the 6V6 output valve, VII. VR2 is the volume-control. Screened leads and valve caps can be used, though they should not be found necessary.

Trimmers T1, T2 and T3 should be firmly wired and fixed so that they are easily accessible from the side. The coils are mounted in a similar manner to those in the vision receiver. When mounting these coils it will be found that the best method is to wind on the secondary, bolt the form to the chassis, and then wind on the primary.

Connection between L11 and L3 (Fig. 3) is made in coaxial cable, the outer sheath being earthed at both ends.

If the anode circuit of VII is disconnected while the valve is working, heavy current will flow via the screen, and the valve may be severely damaged. It is, therefore, wise to permanently wire the loudspeaker transformer in the circuit, detaching it from the loudspeaker if necessary and making connection between the transformer secondary and the speech coil via a plug and socket.

EHT Supply

The EHT transformer is mounted at the end of the deck containing the vision receiver (see Fig. 2). It will be noted that the positive EHT is earthed. The reason for this is to keep the peak inverse voltage from the transformer windings. When the negative is earthed, we have on the second half of the A.C. cycle (when V20 is not conducting) the potential across C78 (2.5kV) added to the inverse voltage (2.4kV) which appears across the windings of the transformer. This is the reason for many early breakdowns in EHT transformers.

Fig. 1 and R75 wired directly to the top terminal of the condenser, its remote end being supported by the insulated strip mounted on the supports of the potentiometer panel.

VR8 is already *in situ* and R75 is connected directly to it. R76, VR9, R77, R78, R79 will be found *in situ* and wired. R79 is earthed at one end and this connection is broken so that R80 can be inserted. C76 and R74 are wired across VR8, both components being supported by their own wiring. Care should be taken when fixing these two items so that they do not make contact with the chassis, or with the mu-metal screen of the CRT when it is in place.

The D.C. restorer V19 and associated resistor R73 are already *in situ* adjacent to the CRT base. The wiring can remain as it is except that the connections to the cathode and anode of the valve must be reversed, and any wiring between the cathode and heater must be removed.

C.R.T. Network

Bias for the deflector plates is obtained from the timebase HT supply. The coupling resistors R66, 67, 68 and 69 can be wired directly to the tube holder, R72 (2 watts) and R70 and R71 are mounted on the potentiometer panel. VR6 and VR7 form the shift controls for centralising the raster.

It should be possible to obtain even focusing over the whole of the raster, but if this should not be the case (some tubes are temperamental), the deflector plates 11 and 12 can be taken to separate shift controls. To do this disconnect R66 and 67 at their junction and from each other; connect two more 100 kΩ controls across the biasing network in a similar manner to VR6

Another benefit derived from earthing the positive is that the working voltage of the coupling condensers to the deflecting plates of the CRT need only be that of the timebase HT 450-volt working condensers provide a good safety margin.

One snag with this system is that the

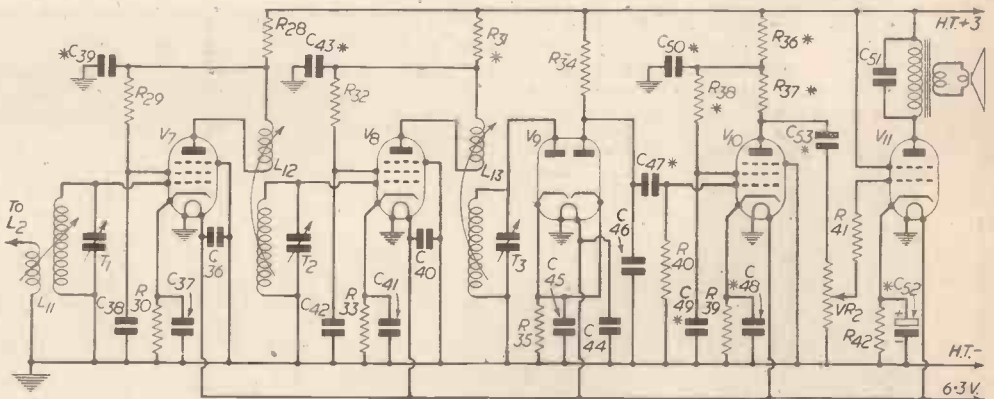

Note: Components marked with an asterisk* are mounted on the tag strip (see text)

Fig. 6.—The sound receiver section.

cathode and heater of the CRT are at EHT potential and must be carefully insulated from the earth. This feature is catered for in the layout of the 62 unit, but it is important to bear the fact in mind when handling the television when it is working.

All EHT wiring must be thoroughly insulated.

In the prototype the wires were first covered with plastic sleeving of sufficient diameter to contain the wire, and then covered again with another length of larger diameter.

Soldered terminations must be made with care, no stray ends being left to set up brush discharges.

C78 is mounted in the position shown in

and VR7. Connect the centre of one potentiometer to R66 and the centre of the other to R67. (This modification was made to the prototype as a refinement.)

Power Pack

This is made on a separate chassis. It relieves the unit of a great deal of weight, though it is possible to fit it on the existing chassis, provided a transformer of suitable size can be obtained. If this is done it should be mounted underneath the chassis at the front end, below the bleeder network. Metal rectifiers will have to be used and the whole carefully screened from the rest of the equipment. A separate chassis is recommended for the reasons given

(To be continued)

Painting Woodwork

MANY of the troubles which arise in painting on new work or the redecoration of old seem to spring from insufficient care in the preparation of the surface to be painted. The home decorator is perhaps more likely to err in this direction than his professional counterpart, and for this reason it is proposed to

With Particular Emphasis on Preparation
By "DECORATOR"

one of the proprietary brands of waterproof abrasive papers which are obtainable from any good ironmonger's or handyman shops. A convenient block should be made from a scrap of 1½ in. × 2 in. timber for small areas and a larger one for the bigger areas of paintwork, so that the sandpaper can be wrapped around it. This method is much quicker than if the paper is held between the fingers.

Having washed and rubbed down thoroughly, the whole surface should be well rinsed with clean, tepid water, and dried off with a chamois leather or a really absorbent sponge. Now the work must be thoroughly dried out before painting begins. The importance of a thoroughly dry surface cannot be over-emphasised; it is as important as a properly prepared surface, new or old. Quite apart from the water lodging in cracks and applied moulding in woodwork, where the rubbing down has exposed the bare woodwork below, moisture will be trapped and cause no end of trouble



Fig. 1.—Use of blowlamp and shave hook.

go through some of the "tricks of the trade" to help the amateur avoid the pitfalls.

Painting Over Existing Paint

Here one's job is perhaps a little easier, but nevertheless the same care should be shown and the same attention to detail that would be exhibited if the work were new. In cases such as this, it must first be decided whether or not the existing paint film is good enough to act as a foundation for the new covering. Is the film blistered or cracked? Has it run in wrinkles around the arrises of vertical members due perhaps to being too thickly applied in the first place? Does it look as though it will provide a firm, trouble-free base after the usual rubbing-down? Needless to say, if a change of colour in the new coat is contemplated, even if the new coat is a darker shade, then the old coat must be removed first of all.

If there is any doubt at all as to whether or not the old coat is a good enough foundation for the new, then it should be removed. The extra time and trouble in the early stages will pay for itself over and over again in the years to come.

Let us assume first of all that the original paintwork is sound and that the surface will "take" the new paint. The old surface must first be well washed down with warm water, in which has been dissolved some sugar soap. A brush with short, fairly sharp bristles is best for this job, since in addition to getting into all the crevices, it will tend to scratch the old paint film, thereby providing a key for the new. Care must be taken to ensure that the solution is not too strong, as otherwise the original paintwork will be softened, with unhappy results. Having given it a thorough washing to remove dirt and air-borne grease, the surface is rinsed off and rubbed down with

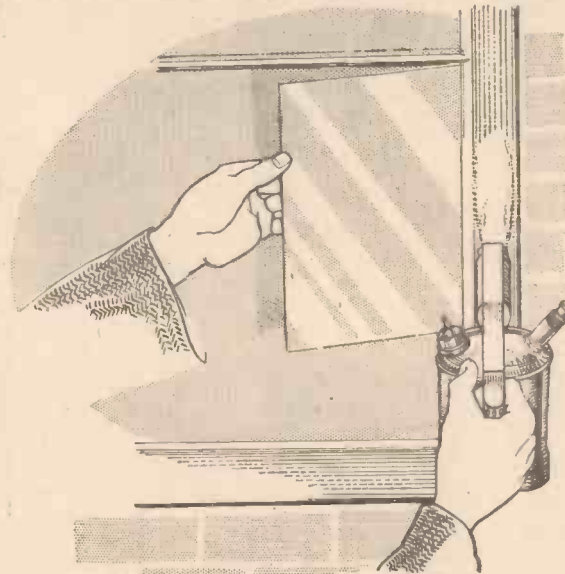

Fig. 2.—Use of blowlamp and metal shield.

unless it is allowed to dry out well.

Before starting the painting proper, the bare patches already referred to must be touched up with paint similar to the existing shade. If you have the original paint and it is still in good condition, it will be suitable after being thinned down with some turpentine.

Paint Removal

If the original paint surface is not a good enough foundation for the subsequent coats of paint it must be removed and the woodwork prepared and painted virtually from scratch.

There are two courses open to the man who wishes to strip off existing paint from woodwork: first, the old and well-tried blowlamp, or, secondly, the caustic and non-caustic strippers.

The Blowlamp

Operation is simple enough not to need



any description here, but it is well to remember to keep the flame on the move. A great many otherwise sound jobs of burning off are caused by the operator encountering a difficult patch of paint, scraping away at it with the scraper in his right hand whilst, in his left, the lamp is playing on one area for several seconds at a time with disastrous results.

A few tips to bear in mind are:

1. To work at the speed at which the paint can be scraped off rather than to soften a large area with the lamp and then have a much harder surface to deal with later on with the knife.

2. To work from the bottom of the job upwards. The heat rising all helps in softening off without making it too soft.

3. Always to burn off the mouldings and similar work first, leaving the adjacent flat surfaces until afterwards. This avoids scorching the latter where difficulty is encountered in shifting hardened paint in narrow crevices.

4. To scrape with and not against the grain of the woodwork.

5. To hold the knife at as flat an angle as possible and never to have it too sharp.

Figs. 1 and 2 show two further points to watch.

Once burned off, the woodwork should be inspected carefully and any holes or crevices filled. This done, the flat surfaces may be rubbed down with a medium grade sandpaper, a fine grade one being used on the mouldings. If it is desired to rub down wet, water should not be used. It is far better to use a mixture of linseed oil and white spirit (one to three or four) as a rubbing down



Fig. 3.—Straining paint through a filter.

agent and rinsing off with neat spirit. This has the merit of avoiding any likelihood of moisture in the woodwork affecting the subsequent paintwork.

Solvent Strippers

These, in many cases, are preferable to the blowlamp, particularly where casement windows are concerned or where an aspirant handyman-painter is not too sure about the blowlamp treatment!

The caustic stripper is an alkaline-based product consisting of, say, caustic soda solution mixed with a powder-vehicle to render it to a paste-form. This is then brushed or spread on to the surface to be stripped and by attacking the oils latent in the paint film the surface is softened and may be scraped off as before. When using a caustic stripper of this kind one cannot be too careful to ensure that the skin and easily damaged surfaces, furniture, clothing, curtains, etc., are adequately protected.

After scraping off, the surface of the woodwork is well washed down with water and it may be of interest to observe the "suds" which accompany this process. The reason for this frothing is that the action of the solvent upon the latent oils in the paintwork is to turn them into what amounts to soap. After thoroughly washing down, the woodwork should be "pickled" with a weak vinegar solution to neutralise any remaining alkalinity, as all must be removed before the paint is applied. As before, the surface must be allowed to dry out well and, the grain tending to rise, the woodwork will need sandpapering down well before further work is done.

Spirit-based, these solvents work on the basis of a volatile liquid, again in a vehicle, usually wax, which tends to "hold" the stripper so that the softening effects of the volatile contents can attack and soften the paint film. The non-caustic strippers are usually highly inflammable and care should be exercised as to smoking, etc., whilst applying them. After the paint has been removed, the whole surface is washed down with white spirit and rubbed over with a pumice stone.

Generally the strippers are not quite as good as the blowlamp for giving a first-class job and more than one application may have to be made if the paint is old and particularly hard. At the same time they are of great assistance where the nature of the work or the lack of skill on the part of the operator rules out the use of a blowlamp.

Painting New or Stripped Woodwork

In these days the period of "seasoning"

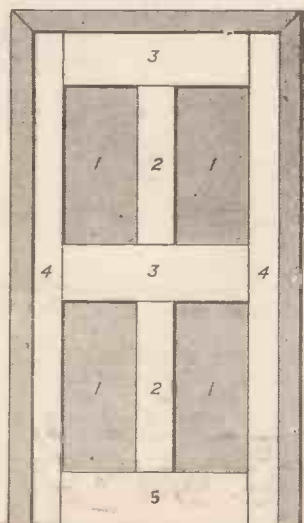

Fig. 4.—Painting sequence for panelled doors.

or drying out of the moisture latent in the growing tree is often shortened, with the result that quite a lot of unseasoned and semi-seasoned wood is perforce used in domestic work. For this reason care must be exercised so as to ensure that the timber is allowed to dry out as much as possible initially before any paint whatever is applied.

Knotting

Knotting is the term used to illustrate the painter's method of covering and sealing knot-holes in "raw" woodwork prior to painting. Knots are, of course, caused by the growth of branches in the original tree and are, as a result, centres of resin. This substance will exude through the applied paintwork, thereby spoiling the face, the action being strongest where there is exposure to the sun. Thus, all minor knots should be sealed off with two or three coats of the best shellac knotting, applied thinly and extending for an inch or so all round the knot. Alternatively, if the knots are bad misshapen ones, they should be cut out and filled with a proprietary filler, sandpapered afterwards to a flush surface with

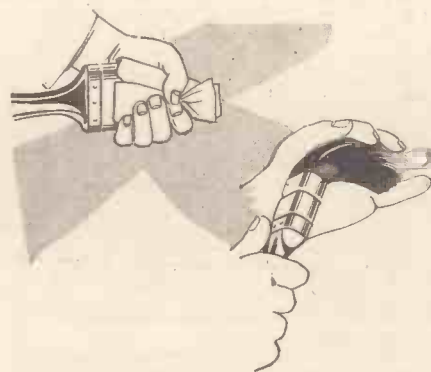

Fig. 5.—Drying off brushes after cleaning.

the surrounding woodwork. Aluminium, either in powder form on the tacky knotting or as thin foil to a badly affected area of knotty timber can also be used.

Priming

The familiar pink primer is made from a combination of red and white lead in a vehicle of raw linseed oil. Red lead dries out somewhat harder than does white lead, and although it is obviously desirable to have these hard-setting qualities in the priming coat, the proportion of red lead is usually between 10 per cent. and 20 per cent. to avoid shade difficulties in the finished (painted) woodwork. The paint should be applied with vigour, using a fairly stiff brush, care being taken to brush well into the crevices. Use enough paint to cover and penetrate the woodwork, but do not try to fill minute holes with primer. They should have been filled with a proprietary filler before painting was commenced. If the work being primed has an end grain section, i.e., the top of door stiles, window frames, etc., two coats of priming should be applied. External work should be double-primed also, preferably with one of the aluminium-based primers now on the market. With all these priming applications, enough of the best primer obtainable should be used, but care taken to remove all the surplus by "laying off" at edges and inside angles where it can otherwise collect and spoil the finished job.

Where priming over knots, as dealt with above, it may be necessary to apply a thin coat of, say, oilbound water paint over the shellac to give a key for the subsequent priming. On the question of cost, best pink priming paint costs about 77s. per gallon,

whilst aluminium priming for woodwork is 57s. 6d. This latter is definitely a good buy, where external woodwork is concerned, but care must be taken to ensure that the timber is well seasoned beforehand, as otherwise the "sealing in" effect of the aluminium paint might well give rise to trouble later on.

The actual number of undercoats is one which always comes in for a certain amount of argument whenever painters get together. With woodwork generally, the whole question revolves around the type of finish wanted and, of course, to the actual condition of the surface to be painted itself.

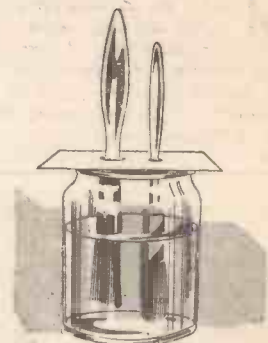

Fig. 6.—Method of suspending brushes in water when not in use.

Finishing Coats

On the question of application, the aim should be to spread as little paint as possible rather than apply thick and badly brushed-out coats which may appear dry but remain semi-liquid beneath. With woodwork, particularly, the whole painting must proceed on systematic principles with as little delay as possible if best results are to be obtained. The priming and undercoats will be applied so as to give the maximum amount of foundation for the finishing coat without ever being "thick," the application of the finishing coat will be perhaps more generous, but nevertheless not so much as to give rise to drips, runs, etc.

Method of Application

Cultivate a free action springing from the wrist. Nobody should need instruction in the holding of the brush, but a similar grip to the thumb-and-forefinger fountain pen grip will normally be used. The system of painting is, in the case of large areas, to apply about two to three square feet at a time, "laying off" each area into the next, so that adjoining areas are as one instead of painting larger areas wherein one portion of newly-applied paint is partially dry whilst the remainder is still in process of application.

Painting Indoors

When dealing with internal paintwork it will be found that the fireplace and the door are the most noticeable features in the average room. For this reason it is usual to paint the windows or picture rail first, then the door and mantelpiece, as the paint will then be working freely and uniformly. The skirting is the last portion to be dealt with. Naturally, one should endeavour to remove all finger plates, escutcheons and similar impedimenta from doors and windows before painting begins.

In the case of doors and french windows, or normal small casements for that matter, the edges are normally painted first. Painting is normally from the top downwards, in the case of flush doors, but where panelled doors are to be painted, the mouldings to the panels are dealt with first, then the panels proper. After this the muntins (the vertical portions between the panels) are painted, followed by the top and middle rails, then the two stiles, and finally the bottom rail (see Fig. 4). Some painters leave the stiles until the last. Figs. 5 and 6 show some useful hints for looking after paint brushes.

A RADIO CONTROLLED MODEL OF THE ROYAL YACHT

Part Three of a Series Describing the Construction of a 6ft. Long Boat, Electrically Driven

THE method used for supporting the gearwheels is clearly shown in Fig. 9, which appeared last month, and consists of a steel bar $\frac{1}{2}$ in. wide and $\frac{1}{8}$ in. thick, drilled at each end to drop over the rudder and motor shafts. It also carries the idle wheels which are secured by bolts through their inner ball races. A right-angled bracket is riveted to the arm and fixed by a screw to the deck beam. Thus to centre the rudder relative to the same position on the motor shaft, one has only to remove this screw, lift the arm and remesh the gears.

Superstructure

Only a brief outline of how the main work is carried out will be given. Small details can be left to the individual builder, but it must be emphasised that everything above deck must be as light as possible and to scale. The more details put in, however, the better the final result.

All decks and cabin sides are of $\frac{3}{64}$ in. plywood, stiffened with stringers and braced together by cross beams of $\frac{1}{8}$ in. thick wood where necessary. The "Britannia" has an upper deck with a covered promenade, then the shelter deck, followed by the bridge and signal decks. The upper deck is first cut out and this rests on the deck already fixed to the hull. On this is built the whole of the superstructure which extends from just forward of station 16 to as far aft as No. 1 and the whole lot can be lifted off in one piece to provide access to the machinery and radio gear. It fits neatly between the bulwarks, being guided into position by the lower portion of the davits and the supports which hold the upper and shelter decks together along their otherwise unsupported edges. Details of how these decks are held together and how

By G. W. PATTISON

the superstructure fits into the hull can be obtained by reference to Fig. 10 which shows a typical section.

Where no davits are present the metal

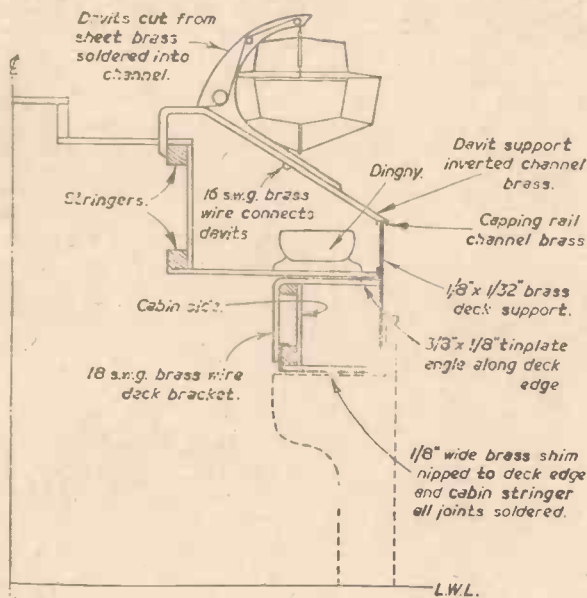

Fig. 10.—A typical section through the boat's superstructure.

deck supports are only carried up as far as the shelter deck. The edge of this is stiffened by a tinplate angle running its full length and as well as being soldered to the various brackets, this angle is drilled for the wire railing stanchions. These are soldered underneath the angle and filed off flush, their top ends being soldered to the capping rail.

The walls of the various cabins and state-rooms are planted on the upper deck, not forgetting the numerous alleyways which lead to some of the doors. These add greatly to the appearance and look much better than just marking out the doors on the cabin side. The walls of these alleyways can, in some cases, be used as cross beams, all unwanted wood being fretted out to reduce weight. To stiffen the cabin walls and secure them to the decks $\frac{1}{2}$ in. square stringers run their full lengths. One of the main difficulties is to preserve the camber when building up the various decks. All decks and other such woodwork not seen from the outside should be completely cut away leaving only a hollow shell, as can be seen in Fig. 11. Note that the after end of the shelter deck is raised and reached by three steps from the main part. This after end will therefore have to be fixed as a separate piece.

The shelter deck carries the Royal apartments, the top of the engine room and the bridge work. The cabin aft is of a peculiar shape and has a stairway on either side. The easiest way to build this is to cut out the the floor and roof from $\frac{1}{2}$ in. plywood, then remove the centre of each leaving only a rim $\frac{1}{8}$ in. wide. Glue one to the shelter

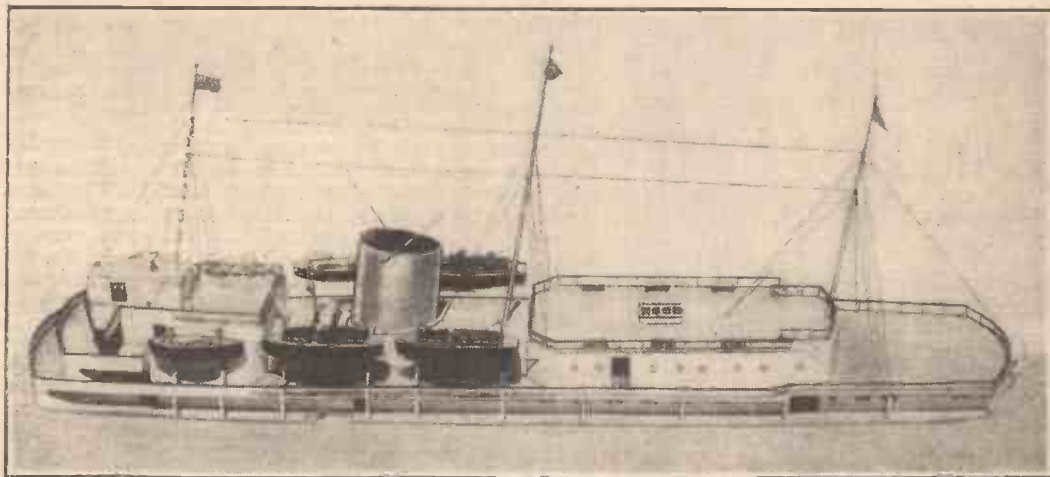

Fig. 12.—A close-up view of the superstructure removed from the hull.



Fig. 11.—An underside view of the superstructure.

deck and support the other on beams, then add the walls, alleyways and stairways and finally cover with another deck. A row of stanchions can now be driven in all around the edge of this deck to take the railings and capping rail. Seats are arranged round the edge of this deck and if made from thin brass and soldered to the capping rail will add support to the latter.

(Continued on page 95)

Mounted wheels and points made by CARBORUNDUM

CARBORUNDUM offer a complete range of mounted wheels and points in standard shapes and sizes. From large-scale sculpture in metal to model engineering, these tools find a thousand and one uses for small grinding and finishing

operations, in a wide variety of metals and other materials, ranging from hard steel to plastics. If you have a powered tool suitable for them, you will find these mounted wheels and points invaluable in your workshop.

Photo by courtesy of T. M. Birkett, Billington & Newton Ltd., Hanley, Stoke-on-Trent.



A mounted point made by CARBORUNDUM in use for weld-dressing on a screen by Mrs. Mitzi Cimliffe, the well known sculptor. The screen, designed for the new restaurant of the Liverpool store of Lewis's, was cast in aluminium bronze, in sections which were later welded into place.

Our mounted wheels and points—and other abrasive products for home workshop use—should be available wherever small power tools are sold. Please write to us if you have any difficulty in obtaining them.

Abrasive products by **CARBORUNDUM**

TRADE MARK

Short cuts for Handymen



FROM YOUR IRONMONGER OR HARDWARE STORE

THE RAWLPLUG COMPANY LIMITED - LONDON - S.W.7

MEND anything from crockery to cricket bats with Rawlplug DUROFIX, the colourless cellulose adhesive that's heatproof and waterproof. Strong, almost invisible join—for good!

RAWLPLUG DUROFIX

Tubes from 9d Tins from 2/9



MEND OR MODEL with Rawlplug Plastic Wood—pliable as putty, yet when dry—it's wood! You can saw, plane, sandpaper, paint or polish. Moulds to any shape; strong weatherproof.

RAWLPLUG PLASTIC WOOD

Tubes 1/- Tins from 2/3



DRILL BRICK, tile, cement, etc., with astonishing ease and speed with Rawlplug DURIUM-tipped Masonry Drills. Can be used in hand or suitable electric drills. Ideal for drilling holes for Rawlplugs.

RAWLPLUG DURIUM-tipped DRILLS

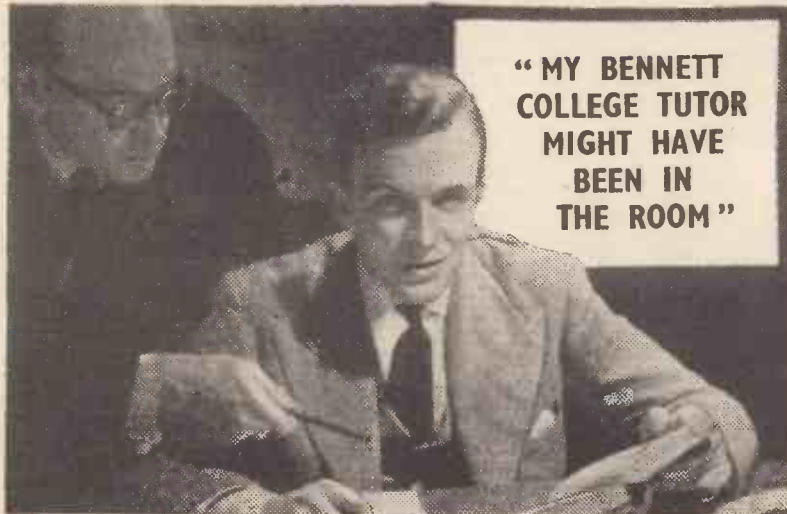
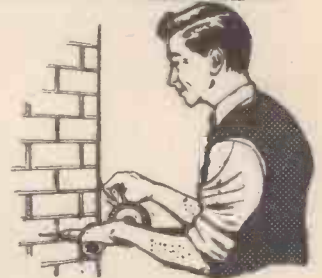

"MY BENNETT COLLEGE TUTOR MIGHT HAVE BEEN IN THE ROOM"

PERSONAL POSTAL TUITION

Every Bennett College student enjoys this friendly, intimate coaching right through his Course. A few of the Courses are listed opposite. Tell us your subject. We will send you The Bennett College Prospectus and the famous FREE book "Train your mind to SUCCESS." This will show you how you can advance to a better, finer future by Personal Postal Tuition. Fill in and post the coupon today.

WHAT CAREER DO YOU WANT?

- | | | | |
|-----------------|--------------------|--------------------|-------------------------|
| Architecture | Locomotive Eng. | Surveying | Languages |
| Building | Machine Design | Telecommunications | Mathematics |
| Carpentry | Mechanical Eng. | Television | Modern Business Methods |
| Commercial Art | Motor Engineering | Textiles | Police Subjects |
| Diesel Engines | Plumbing | | Salesmanship |
| Draughtsmanship | Power Station Eng. | Book-keeping | Shorthand |
| Electrical Eng. | Quantity Surveying | English | Short Story Writing |
| Electric Wiring | Radio Engineering | Geography | and many others |
| Forestry | Sanitary Science | Journalism | |

OR WHY NOT OBTAIN A QUALIFICATION?

- | | | | |
|---------------|-----------------|------------|------------|
| A.M.I.C.E. | A.M.I.Struct.E. | A.A.C.C.A. | A.C.C.S. |
| A.M.I.Mech.E. | A.M.I.Mun.E. | A.C.W.A. | A.R.I.C.S. |
| A.R.I.B.A. | A.M.S.E. | A.C.I.S. | A.A.I. |

GENERAL CERTIFICATE of EDUCATION & R.S.A. Exams.

To THE FAMOUS

BENNETT COLLEGE

(Dept. K.76 PT) SHEFFIELD

Please send me the Prospectus on.....
and my free copy of "Train your mind to SUCCESS."

NAME

ADDRESS

TOWN

AGE (if under 21)..... Please write in BLOCK letters.

Post this coupon NOW!

The engine room is made next and this also has an alleyway on the starboard side, then just ahead of this there is a large louvred panel for ventilation. Next comes the bridge work and signal deck with their curved fore ends and railed all round, the after part having open rails with the fore end screened and capped with a rail, this latter being achieved by extending the cabin walls to rail height. Fig. 12 gives some idea of the finished appearance.

Superstructure Detail

Doors leading into cabins or staterooms are of mahogany or teak, all cabin sides painted white with decks painted buff, lined and varnished. The cabin doors cannot be reached after the decks are fitted so they should be completed and varnished before fixing, similarly the walls of the alleyways should be painted right out. It is also far neater to impress the windows on the wood than to cut them out and glaze with celluloid. Such details must, therefore, be carried out as the work proceeds. To impress the windows a short length of steel rod is filed so that in section it corresponds to the shape of the windows. The end is ground off square and the rod used as a punch. When struck with a hammer it will leave a definite impression cut in the wood and after painting the cabin white these windows are filled in with pale blue and the top, say, left-hand corner, shaded with deeper blue.

Port holes are made in the same way except that the punch is made from round rod of the appropriate size. When a round window has to be impressed on a mahogany door the procedure is the same, except that a piece of blue-backed celluloid is inserted between punch and door before the blow is struck. When struck with a hammer a disc of celluloid is punched out and left embedded in the wood, where it remains. This, of course, is carried out after the door is completed and just before fixing.

Stanchions may be bought or turned with a form tool in a lathe, those shown, however, were simply made by driving panel pins into the wood at correct intervals and all left standing at an even height by using a gauge alongside. The nail heads were then rubbed over with a smooth file, fluxed and tinned leaving a small dome of solder on each. The channel brass capping was also tinned, placed

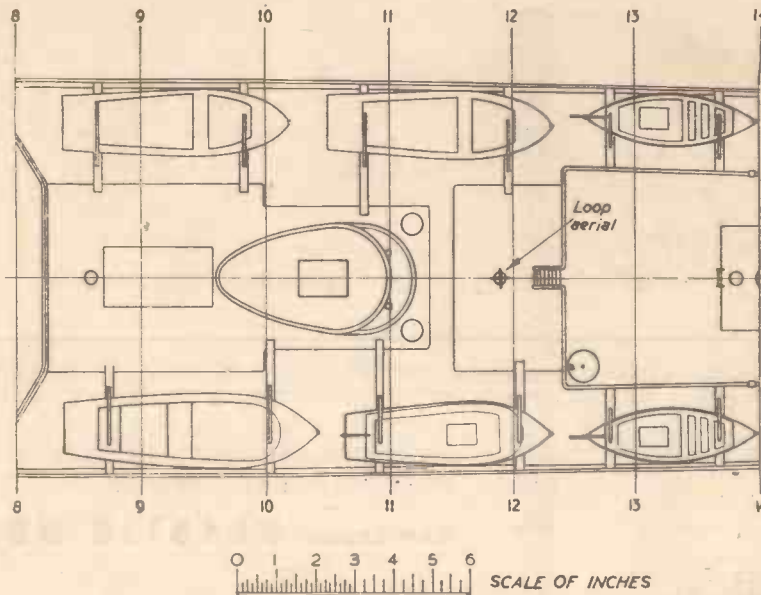

Fig. 13.—Midships plan showing positions of davits, boats, etc.

over the rails and heat applied. Below this rail the tubular ones were made by stretching linen carpet thread very tightly right round the outside of the stanchions, then touched where they crossed the stanchions with a spot of resin glue. Finally they were painted white and rail teak coloured.

The Boats

Each boat was shaped from a solid piece of wood, sanded smooth and covered with a layer of wet tissue paper completely enveloping it. It was further covered with three thicknesses of paper, torn from a magazine, each layer coated with resin glue. When hard the deck was filed around the edges, the hull slid off the mould, forming a feather-light hull. With glue applied to the edges of the gunwale, the hull was inverted on to a sheet of Bristol board

hole in a block of wood so that only the head protruded, this was turned and the three discs arranged round it. Heat was applied and the solder melted and united the lot. Once or twice the discs moved but eventually the required number of propellers were assembled. Painted royal blue with mahogany cabins and varnished decks, these small model boats looked first rate.

The boats carried in the davits consist of the Royal Barge, a motor cutter and a double-ended jolly boat on the starboard side, together with two power boats and another jolly boat on the port side. Underneath these, mounted on chocks on the shelter deck, are two motor dinghies and two sailing dinghies. Details of the

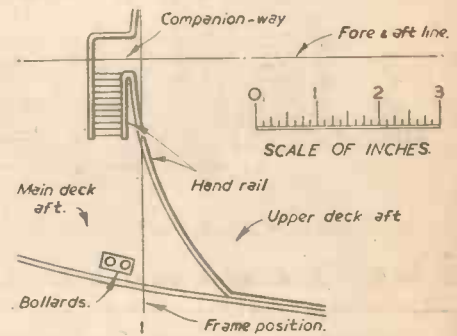

Fig. 16.—Details of the after companion way.

boats and their positions can be seen from Figs. 12 and 13.

Davits are made from channel brass similar to that of the bulwark rail. Details are given in Fig. 10.

The Funnel

This is of tinsplate conveniently cut from a large tin similar to that used for packing dried milk. First carefully remove the bottom, filing flush with the sides and leaving the folded rim on the outside. Then cut up the seam and bend the tin round a block of wood, shaped to the funnel dimensions, the rim now becoming the top of the funnel. Solder the joint up the after side and cut round the base until it stands at the correct angle. Stand it on a flat sheet of tinsplate and sweat all around the outside of the base. Trim away all superfluous metal until only an 1/8 in. rim is left around the base which will form a flange for fixing to the top of the engine room. A further rim is soldered inside the funnel about 1/2 in. down from the top and on this rests a balsa block carved to the shape of the dome and having a rectangular hole cut in its centre. If loosely fitted, it will float and act as a marker buoy should the boat meet with an accident and sink. A length of strong thread is attached to the dome with the other end anchored to an eye inside the funnel. Incidentally, the funnel makes an ideal handle for lifting the superstructure.

The various whip aerials (Fig. 14) are best made from steel wire, such as thin knitting needles, as this material does not bend. They can be arranged to fold horizontal when not in use and in this position were not so liable to damage. Masts are made from aluminium alloy knitting needles, carefully tapered to

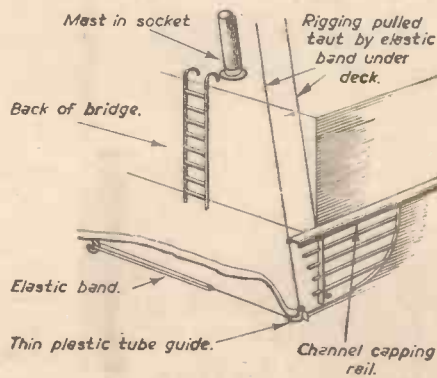

Fig. 15.—Method of securing the standing rigging.

and when dry trimmed to form the deck upon which was mounted the various cabins, etc. Pins were pressed into the bottom of the hull and each carried a miniature propeller. Quite a tricky little job, but very effective and adding to the appearance when the boat was slung from the davits. To make these small propellers three 1/16 in. dia. discs were punched out from brass foil, which had previously been tinned. The pin was dropped through a fine

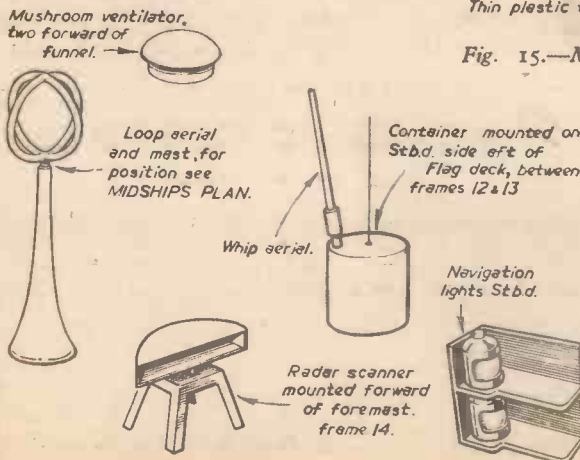

Fig. 14.—Some of the details on the superstructure.

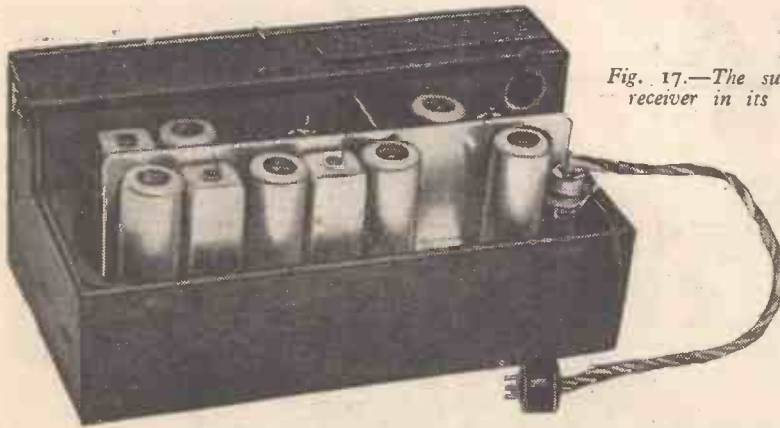

Fig. 17.—The superhet receiver in its box.

shape and fitted into deck sockets for easy dismantling.

The standing rigging is of strong linen carpet thread drawn taut below decks by springs or elastic bands. Details of this are shown in Fig. 15. Short lengths of plastic tube stripped from fine bell wire act as guides where the thread passes through the deck. For the aerial and other rigging which cannot be dealt with in this manner, thin elastic thread is used, when purchased it is usually white but can easily be dyed or stained a more natural colour.

Other details, too numerous to mention

can be picked out from the drawings and photographs. Such fittings as the radar scanner, engine room ventilators, hatches, capstans, etc., can easily be executed in wood or metal whichever is most convenient for the builder to use. Some hints are given in Fig. 14, and Fig. 15 shows in full the after companion which was not fully detailed in the half plan.

The Motor

The main propulsion motor is a Lucas type dynamotor with the high tension brushes removed and in the prototype the high

tension windings were also removed, but this latter is optional. The motor is coupled to twin propeller shafts by a gear box containing four gearwheels all on ball bearings. The propellers are three-bladed, 2in. dia., and have a pitch of 3in. They are geared down with a reduction of 1½ to 1. Although the motor is rated at 12v. it has ample power running on 10v. The main battery is of the lead-acid type with a capacity of over 10 amps. The reason for using a large capacity battery is that besides giving a long run to the driving motor it also supplies current for all the radio intergear and this is accomplished with a voltage drop. Otherwise separate batteries would be necessary.

The original receiver fitted to the boat was of the super-regenerative type with a single valve, but this was later replaced by a two-valve "Hill" receiver named after the designer. This latter is certainly an excellent receiver and can be recommended. It gave absolutely no trouble whatever during the time it was in use and only required a 30-volt H.T. battery to run it. Later, however, it was replaced by a super-heterodyne receiver. This, of course, has numerous advantages, the most important being that should several boats be equipped with superhets, they can all operate on the pond at the same time. The receiver is shown in Fig. 17. The construction of a superheterodyne receiver for model control was described in our May, 1956, issue.

(To be continued)

Science Notes

Satellite Observation Test

A SIMULATED earth satellite comprising a plumber's plunger equipped with a subdued flashlight was towed behind a plane at over 100 m.p.h. to test the ground observing teams. Two teams spotted the imitation satellite.



The English Electric "Thunderbird" at Farnborough. This is a surface-to-air guided weapon-system now in production, having an internal sustainer motor and four wrap-around boosts.

only the second conversation of its kind known.

Ultrasonic Echoes Detect Cancer

FROM Japan comes a report of a technique similar to radar detection for detecting cancer in the human body by means of pulsating ultrasonic waves. These are beamed into the body and bounced back from various internal structures. Echoes are recorded as wavy lines on a cathode ray oscilloscope, the strength of the echoes

indicating the state of the tissues. They are able to indicate brain tumours, gall stones, abdominal and breast tumours and trace the contractions of the large intestine. An inside picture can be produced which is impossible by any other means, including X-rays.

Slotted Wings for Aircraft

FROM America comes news of a method of reducing drag in aircraft by means of slots in the wings. These will be situated in positions where the smooth airflow is interrupted and will conduct the airflow through the wing. The reduced drag will mean an increase in the aircraft's range.

Small Earth Satellite

IT is planned in America to launch a "baby" earth satellite this month. It will have a diameter of 6.4in., will weigh 4lb. and, so that it can be tracked, will be equipped with a midget radio transmitter.



The Swiss have perfected timepieces that run on every conceivable source of energy. Here are three examples displayed at the Basle Watch Fair. The table clock on left works on the same principle as a transistor radio, using two microscopic transistors and four condensers; daily variations in temperature power the movement of the centre timepiece; the one on the right converts light into energy by means of a photo-electric cell located in its top.

Pole to Pole Conversation

SCIENTISTS at the South Pole and the North Pole have talked to each other by radio across some 11,200 miles. This is

ENROL With E.M.I.

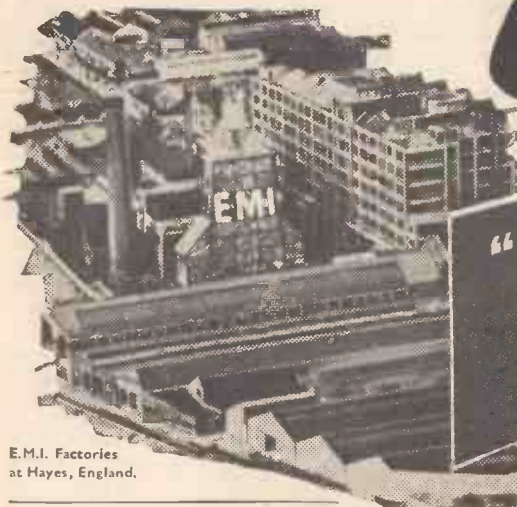

E.M.I. Factories at Hayes, England.

"HIS MASTER'S VOICE"
 MARCONIPHONE · COLUMBIA

to train for your
CAREER-HOBBY
OR NEW INTEREST

PERSONAL & INDIVIDUAL HOME TRAINING IN:—

Accountancy
 Advertising
 Aeronautical Eng.
 A.R.B. Licences
 Art (Fashion, Illustrating, Humorous)
 Automobile Eng.
 Banking
 Book-keeping
 Building
 Business Management
 Carpentry
 Chemistry
 City & Guilds Exams.
 Civil Service

Commercial Subjects
 Commercial Art
 Computers
 Customs Officer
 Draughtsmanship
 Economics
 Electrical Eng.
 Electrical Installations
 Electronics
 Electronic Draughtsmanship
 Eng. Drawing
 Export
 General Certificate of Education

Heating & Ventilation Eng.
 High Speed Oil Engines
 Industrial Admin.
 Jig & Tool Design
 Journalism
 Languages
 Management
 Maintenance Eng.
 Mathematics
 M.C.A. Licences
 Mechanical Eng.
 Metallurgy
 Motor Eng.
 Painting & Decorating

Photography
 P.M.G. Cert.
 Police
 Production Eng.
 Production Planning
 Radar
 Radio
 Radio Amateurs (C & G) Licence
 Radio & Television Servicing
 Refrigeration
 Sales Management
 Sanitary Eng.
 Salesmanship

Secretaryship
 Servo Mechanisms
 Shorthand & Typing
 Short Story Writing
 Short Wave Radio
 Sound Recording
 Telecommunications
 Television
 Time & Motion Study
 Tracing
 Transistors
 Welding
 Workshop Practice
 Works Management and many others

Also courses for GENERAL CERTIFICATE OF EDUCATION, A.M.I.H. & V.E., A.M.S.E., A.M.Brit.I.R.E., A.M.I.Mech.E., A.M.I.E.D., A.M.I.M.I., A.F.R.Ae.S., A.M.I.P.E., A.M.I.I.A., A.C.C.A., A.C.I.S., A.C.C.S., A.C.W.A., City & Guilds Examinations, R.T.E.B. Serv. Certs, R.S.A. Certificates, etc.

NEW!

Courses with PRACTICAL EQUIPMENT
 in RADIO · TELEVISION · MECHANICS

CHEMISTRY · ELECTRICITY · DRAUGHTSMANSHIP
PHOTOGRAPHY etc. etc.

COURSES FROM
15/-
PER MONTH



EMI INSTITUTES

POST THIS COUPON TODAY

To:— E.M.I. INSTITUTES, Dept. 144K, London, W.4.

NAME _____ Age (If under 21) _____

ADDRESS _____

I am interested in the following subject(s) with/without equipment _____

(Nov./57) (We shall not worry you with personal visits)



FREE

IC 106

The only Home Study College run by a World-wide industrial organisation

* Double the usefulness of
your **Myford**

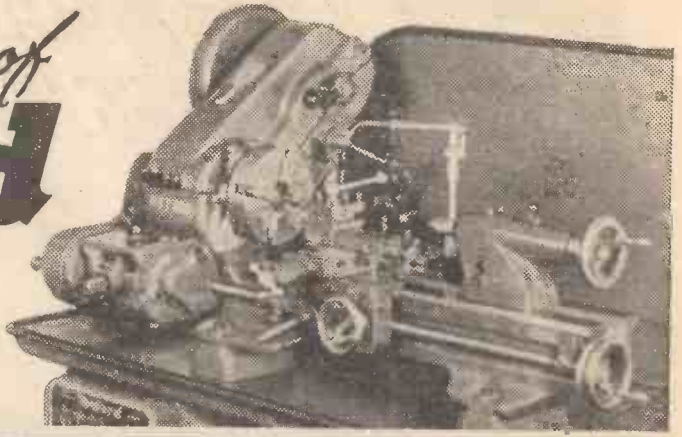

With these handy attachments!

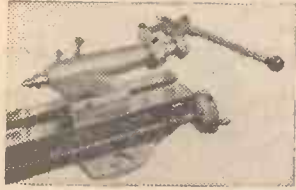

1640. LEVER OPERATED TAILSTOCK ATTACHMENT



1611. LEVER OPERATED COLLET CHUCK 1in. CAPACITY ADDITIONAL COLLETS STYLE 1027



1410. FOUR TOOL TURRET TAKES 1/4 in. SQ. CUTTER BITS



1629. TAPER TURNING ATTACHMENT SLIDE BASE 9in. LONG, WORKING LENGTH 6in ANGULAR MOVEMENT 10° EITHER SIDE OF ZERO



2A 1495. DIVIDING ATTACHMENT (WITH TWO DIVISION PLATES)



MA 63/1 VERTICAL SLIDE SWIVELLING TYPE

Many awkward jobs are within your easy reach, thanks to the range of over 50 Attachments and Accessories provided by the Myford Factory. Careful thought, coupled with research into the requirements of the most exacting user, has produced a series of easily fitted, interchangeable, precision-made extras such as no other comparable Lathe possesses. Write to-day to DEPT. 3/43 for fullest details.

MYFORD ENGINEERING CO. LTD., BEESTON, NOTTINGHAM, ENGLAND. Phone BEESTON 25-4222.
GRAMS: MYFORD, BEESTON, NOTTS.



SEE EARTH SATELLITE



AMAZING NEW OFFER

ASTRONOMICAL TELESCOPES 99/6 !!

See the Moon at Close Quarters, Examine the Immense Craters, Mountain Ranges, etc. Observe Saturn's Rings, Nebulae, etc., etc.

Specification. 2 in. dia. Length 39 in. Mag. 53 x Linear (equivalent 2809 x Area). Weight Approx. 2 lb. 2 oz.

Registered postage and packing including strong stowing cylinder with caps, 12/6.

Altazimuth Portable Clamp Stands. Extra 37/6, P./P. 2/6. Fixes anywhere.

Astro Kits. Self Adaptable Parts. "Do It Yourself." 63/-, P./P. 3/6.

High Power Eyepieces, 80 X, 28/-, P./P. 2/-, 106 X, 37/6, P./P. 2/-.

Astronomical Books, Charts, Guides, Maps, Revolving Planispheres, etc.

Stamp for Full Particulars. Photographs 1/- set (returnable). Lists and Terms. Made to order.

HOLMES, WILSON & CO.
SCIENTIFIC INSTRUMENT MAKERS
(Dept. PM28), Martins Bank Chambers, 33 Bedford Street, North Shields, Northumberland.

The Bestfriend "ZEPHYR" (M)
Motor and Accessories

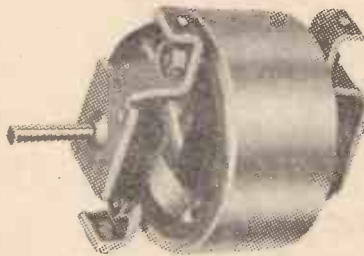

A silent, shaded pole motor, A.C. only, 200/250 volts, 2,600 R.P.M., 25 watts. 3 1/2" x 2 1/2" with double-ended spindle. Precision built and specially suitable where absolute silence is essential. Continuously rated and designed for use in construction of table and extractor fans, projector cooling units, fan heaters, cupboard airing devices, etc. An extremely high-class product,

designed by engineers with a quarter of a century of experience in motor construction. **37/6** Post Free

An anti-vibration stand for above motor. Horizontal or vertical mounting. Supplied in breakdown form for home constructors. 4 1/2" x 2 1/2" x 2". Three point suspension. **7/6** Post Free
Steel, Cadmium plated.

FANS
4 Bladed Metal 4" 5/-
BAKELITE 3 Blades 8" 7/6
Post Free

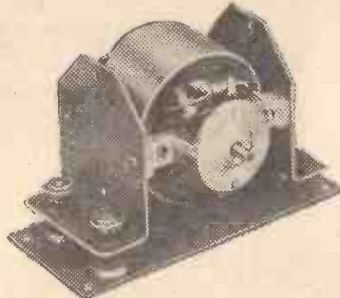

The Bestfriend Electrical Co. Ltd.,
BANSTEAD • • **SURREY**

Tel.: BURGH HEATH 1432



THE BUSBY BURNER
ON THE "BUNSEN" PRINCIPLE

(Complete with a pair of TONGS)

The ideal GIFT
for the practical
HOUSEHOLDER.

Suitable for Schools, Workshops.

CASH PRICE
5/9

TORCH & TONGS

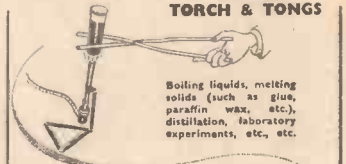

Boiling liquids, melting solids (such as glue, paraffin wax, etc.), distillation, laboratory experiments, etc., etc.

Glass blowing and bending, hard and soft soldering, brazing, annealing, hardening, tempering, forging, heating rivets, etc., etc.

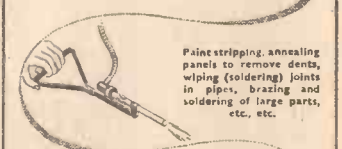

Pipe stripping, annealing panels to remove dents, wiping (soldering) joints in pipes, brazing and soldering of large parts, etc., etc.

A really portable blow pipe, easily carried in the pocket, or hung flat on the wall.



Obtainable from local Ironmongers or direct from makers on receipt of P.O. 4/- (including postage).

BUSBY & COMPANY LIMITED

BUSCO WORKS, PRICE STREET, BIRMINGHAM

Phone: ASTON CROSS 5096/7

MAKING A DESIGNOGRAPH

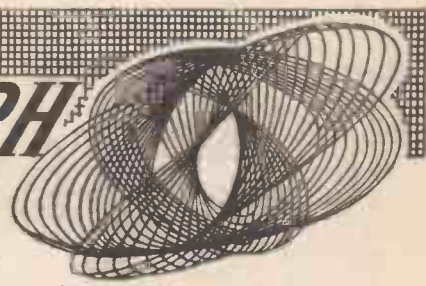
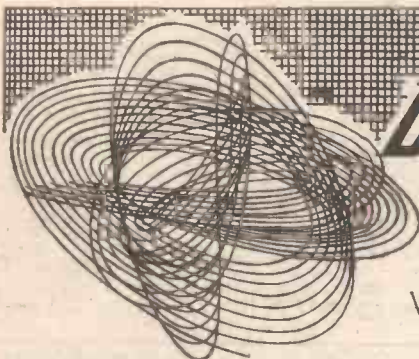

With Which You Can Make these Weird Contemporary Designs

By H. A. WYNE

clamping screw for the bridge piece and double arm which carries the pencil or glass pen. Fig. 3 is an exploded view giving details of this fitment.

In Fig. 4 details of the weighted penholder fitment are given, the centre brass part "d" being drilled to take a bolt for clamping the two lead blocks in position. These blocks are provided to ensure a suitable pressure being maintained on the pen or pencil point on the paper. The penholder is shaped from a small piece of brass and drilled to take the glass pen or pencil, which is clamped into position by means of a brass milled-head screw. One end of the penholder is filed to fit into a slot in the block "d" and is soldered in place. This is also drilled to take the ends of the double arm. The part D is made from hardwood and is slotted, as shown in Fig. 3, to take a

OUR SPECIAL SECTION
for the
JUNIOR MECHANIC

THE appliance shown in Fig. 1 is capable of drawing an infinite number of designs, and can be constructed with odd scraps of material which may be found in the scrapbox. The materials include part of a packing-case, three motor cycle spokes, a piece of broken hinge, a few screws and terminals from old electrical apparatus.

Details of Construction

The base as shown in Fig. 2 is made from the end of the packing case and measures 11 in. X 9 in. Mounted on it are the large grooved wheel, A, to which the paper for the design is fixed with drawing pins, and the two smaller wheels B and C. These are made of a double thickness of the thin sides of the packing case glued together with the grain at right angles. A handle, shaped from a strip of sheet brass $\frac{3}{8}$ in. wide and

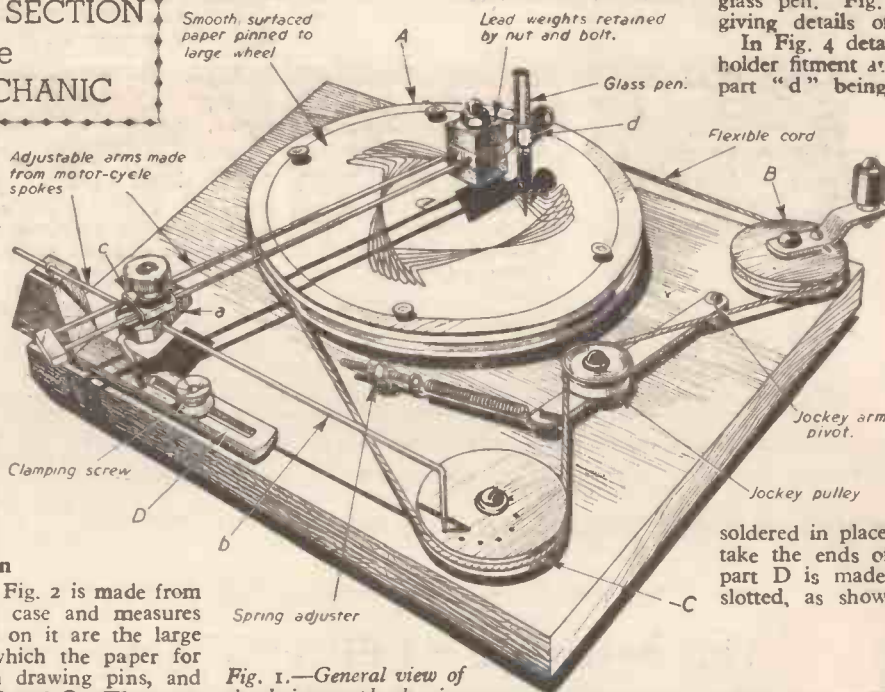

Fig. 1.—General view of the designograph, showing how the pattern is traced on the paper.

$1\frac{1}{2}$ in. long, is attached to wheel B, a small knob being fitted as shown in Fig. 1.

It should be noted that wheel A is mounted $\frac{1}{2}$ in. off centre as indicated in Fig. 2. Wheel C has a number of small diameter holes drilled partly through at varying distances from the centre of the wheel. The pointed end of the rod "b" engages in one of these holes when the appliance is operated. Each of the three wheels should be provided with a thin metal or wooden washer to raise them slightly above the surface of the base-board in order to eliminate unnecessary friction.

Adjustable Arms

The adjustable arms (see Fig. 1) are made from cycle spokes, the brass block "a" being drilled and fitted with a clamping screw for the rod "b" which is bent at right angles at one end, and pointed, as shown, to drop into one of the holes in wheel C, as already mentioned. The block "a" is also drilled to take a

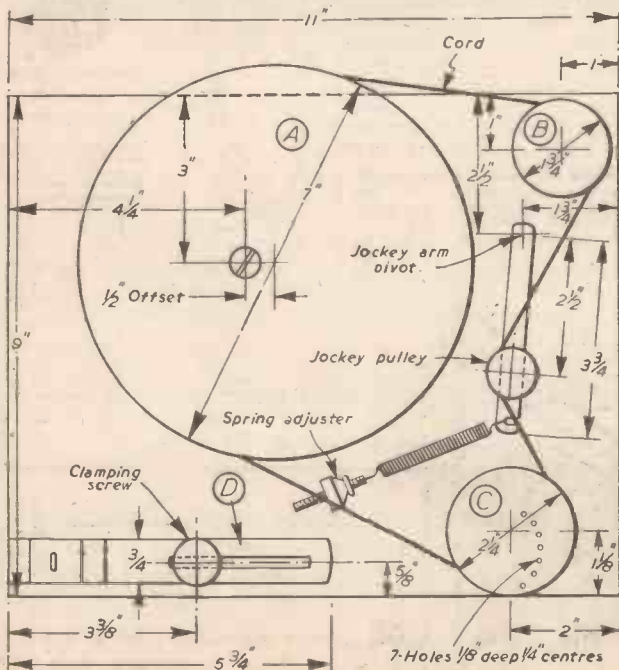

Fig. 2.—Plan of the designograph showing the layout of the various parts.

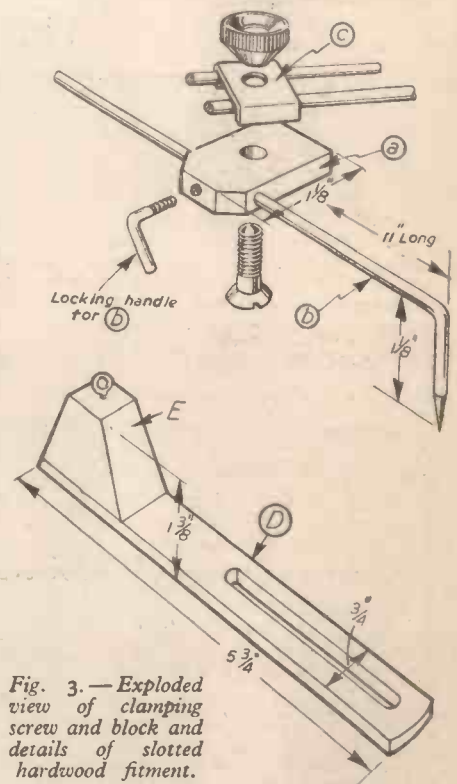

Fig. 3.—Exploded view of clamping screw and block and details of slotted hardwood fitment.

clamping screw. A shaped block E is glued and screwed to one end, and is provided with a small screw-eye in which the end of the rod "b" slides freely.

(Continued at foot of next page)

an easy to make Waterline Ship model

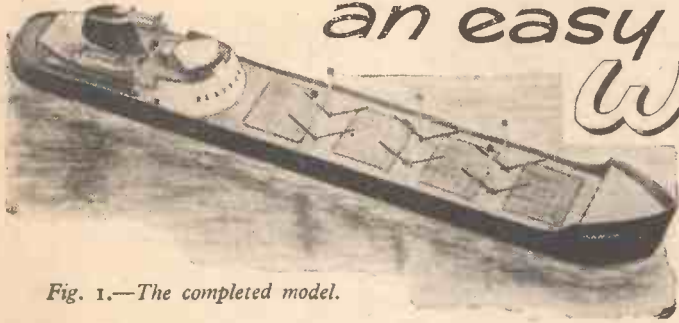

Fig. 1.—The completed model.

Turn Odd Scraps of Wood and Card and a Few Pins into this Modern and Distinctive Craft

MAKING waterline model ships is not difficult, but it does require a certain amount of care and patience. The usual methods have been somewhat simplified here, but by following these instructions a very creditable model may be produced.

Materials

The materials required include various

to the T-shape of the saloon and the front rail F is made of the same material glued in position.

The chart house, G, is made of wood and measures $\frac{1}{4}$ in. long \times $\frac{1}{4}$ in. wide \times $\frac{1}{4}$ in. high and the wireless cabin behind it should be made slightly smaller. The bridge roof, I, is cut to the shape shown in the plan, Fig. 2.

well. The derricks may be made from fine wire.

Assembly

Cut out the two sides of the vessel from thick cartridge paper to the shape shown in Fig. 4 and when all the parts are made they can be glued together; the positions of all the parts will be seen from reference to Figs. 2 and 3.

Press the davits through the holes marked in the boatdeck into the hull, being very careful not to split this, as they are very

The funnel is cut from a piece of wood, $\frac{1}{4}$ in. \times $\frac{1}{4}$ in. \times $\frac{1}{4}$ in. and shaped as shown in Figs. 1 and 2 with a penknife and sandpaper.

The boat davits are made from thin wire to the shape shown at K in

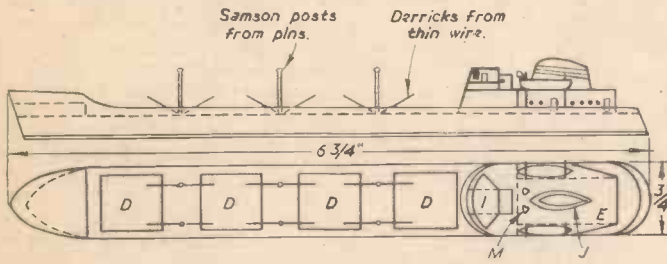

Fig. 2.—Side elevation and plan of the model.

sizes of strip wood, wooden dowels, thick cartridge paper, pins of assorted sizes, poster colours, clear varnish and brushes, glue, a sharp knife or razor blades, and a pair of small pliers.

Construction

Fig. 1 shows the model which it is proposed to construct and the first step is to make the hull. For this a piece of strip wood $6 \frac{11}{16}$ in. \times $\frac{1}{2}$ in. \times $\frac{1}{4}$ in. is required, and this is shaped as shown on the plan in Fig. 2 and marked A in Fig. 3. The fore-castle deck is cut from a piece of $\frac{1}{4}$ in.-thick wood and measures $\frac{1}{2}$ in. \times $\frac{1}{2}$ in. and is shaped as shown at B in Fig. 3.

The saloon is made from two pieces, one piece measuring $1 \frac{1}{16}$ in. \times $\frac{1}{2}$ in. \times $\frac{1}{4}$ in. and the other $\frac{1}{2}$ in. \times $\frac{1}{2}$ in. The two pieces are glued together after being shaped to form part C in Fig. 3.

The hatches (D) which are shown plainly in both Figs. 2 and 3 can either be made from thin card or from $1/16$ in. strip. The boat deck, E, is made of thick cartridge paper

Fig. 3 and the lifeboats (L) are cut from pieces of scrap wood $\frac{1}{2}$ in. long and shaped as shown. The ventilators are made from pins, with the heads bent over to form the shape shown at M. Some larger pins with the heads broken off can be used for the samson posts or fine nails, perhaps, if they look

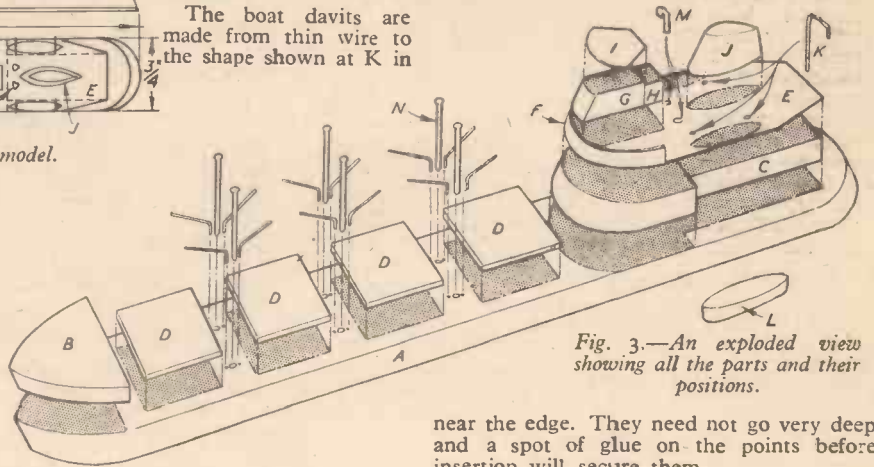

Fig. 3.—An exploded view showing all the parts and their positions.

near the edge. They need not go very deep and a spot of glue on the points before insertion will secure them.

Painting the Boat

It will be found easier to paint the super-structure and deck fittings before the sides are fitted. When this has been done the sides are complete, except for finishing off.

The most convenient paint to use has been found to be poster colours. These are quite permanent if varnished over with clear varnish.

The finish of the boat and the amount of fine detail included is a matter for the constructor's individual preference and it will, of course, be possible to improve on the details given here.

MAKING A DESIGNOGRAPH

(Concluded from the previous page)

Jockey Pulley

A brass jockey pulley is fitted as shown to take up the slack in the driving belt. This may consist of blind cord or similar material. An adjustable coiled spring is provided to maintain the necessary pressure for keeping the belt taut.

Four small rubber feet, screwed to the underside of the baseboard, complete the appliance which will produce an unlimited number of varying designs by simply altering one or more of the four adjustments provided.

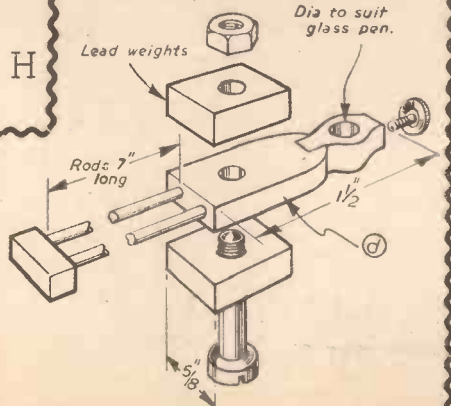

Fig. 4.—Details of the weighted penholder.

Model Boat Building

6th Edition

By F. J. CAMM

5/-, By post 5/8

From GEORGE NEWNES, LTD.,
Tower House, Southampton Street,
Strand, W.C.2

READERS' SALES AND WANTS

The pre-paid charge for small advertisements is 6d. per word, with box number 1/6 extra (minimum order 6/-). Advertisements, together with remittance, should be sent to the Advertisement Director, PRACTICAL MECHANICS, Tower House, Southampton Street, London, W.C.2, for insertion in the next available issue.

FOR SALE

HOUSE SERVICE METERS, credit and prepayment; available from stock. Universal Electrical, 221, City Road, London, E.C.1.

"PERSPEX" for all purposes, clear or coloured dials, discs, engraving. Denny & Company Ltd., 15, Netherwood Road, W.14. (SHE 1426. 5152.)

NUTS, BOLTS, SCREWS AND WASHERS for Mechanics, 2 B.A., 4 B.A., and 6 B.A. 7/- packet, 432 parts, post 1/4. Available Hex. Hd., Rd. Hd., Ch. Hd. and Csk. State which, 3 or more packets post free. 1,000 item list free. K. R. Whiston (Dept. P.M.S.), New Mills, Stockport.

CHEMICALS AND APPARATUS. Send 2d. stamp for catalogue and details of special offer. Scientific & Technical Supplies Ltd., Dept. P.M., 9, Wellington Circus, Nottingham.

TELESCOPE MAKING.—Non-Achro Object Glasses, 2 1/2 in. diam., 40 in. focus, 14/6; x 60 Ramsden Eyepieces, 15/6; s.a.e. for list of Achro O.G.s, Mirrors, Eyepieces. W. Burnet, Grand Sluice, Boston, Lincs.

FREE GIFT OFFER!

6ft. Flex. Steel Rule Value 2/6 with every Order of 15/- and over.

ELECTRIC DRILL ACCESSORIES

- 5 in. Sanding Pads with Arbor ... 4/8
- 5 in. Real Lambwood Bonnets ... 4/3
- 5 in. Sanding Discs (Assorted) 3/3 doz.
- 3 in. Grinding Wheels ... 3/10
- 3 in. Rotary Wire Brushes ... 3/9
- 3 in. Calico Buffs ... 2/-
- 3 in. Arbors for same ... 1/7
- Set Twist Drills (7/16"-1 in. Wavet) ... 4/8

Tungsten Carbide Masonry Drills:
Nos. 8, 10, 12, 5/6 ea.: 14, 6/-; 16, 6/6

Sets in Wavet, 1/2 in. Round Shanks:
Wood Boring Bits 1/2, 5/16, 3/8, 7/16, 1/2 11/-
Twist Drills, 1/2, 5/16, 3/8, 7/16, 1/2 13/-

POST FREE. ALL GUARANTEED BEST QUALITY. Free list of Other Bargains from: **THE TOOL SERVICE CO. (Dept. M.)**, 29 Arlington Road, Surbiton, Surrey

MAIL ORDERS.—New bargains, post 1/- extra under £1. Sets H.S. Drills No. 1-60 with stand, 50/-; Vanadium, 17 drills, 1/16in.-5/16in., 13/-; Dies 13/16in. 40 t.p.i. 5/32in., 3/16in., 7/32in., 1/4in., 3/4 each; Taps 40 t.p.i. 5/32in., 3/16in., 7/32in. 1/4in., 2/- each; Stillson Wrenches, 6 in. 4/6, 8 in. 6/-, 10 in. 7/6; Dies 1/2 5/16in., 7/16in. 40, 9/8, 7/16in. 32, 9/8; Hand Drills 1/2 in., 10/-; Breast 1/2 in., 27/6; Drill Chucks 1/2 in. No. 1 or 2 M.T., 10/6, superior, 16/6; Burner independent Chucks 1/2 in., 7/2- 4 in. 75/-, 6 in. 26/4 6/-; H.S. Small Milling Cutters, 6 different, 9/-; H.S. Tool Bits, 1/2 in. 1/6, 5/16in. 1/11, 1/2 in. 2/3; Vee Blocks 3 in. 6/-, 4 in. 7/6; Angle Plates 3 in. 6/-, 4 in. 10/-; H.S. Centre Drills, size 1/2 2/2, 3/2, 2/9, 4 3/-; Precision Drill Chucks 1/2 in. No. 2 M.T., 44/-; Machine Vices, 18/6; Wood Chisels, set 1/2 in., 1 in., 1 1/2 in., 1 in., 16/-, 12 different 1/32in.-9/16in., round silver steel, 10/-; Expanding Wood Bits, 1/2 in., 1 in., 1 1/4 in., 1 1/2 in., 7/3 in., 3 in., 19/-; Grimshaw, 7, Hal Street, Manchester, 18.

SEND s.a.e. for free list New Tools, Drills, Taps, Dies, Reamers, Milling Cutters, Thread Chasers, at bargain prices. A. King, 152, Halfway Street, Sidcup, Kent.

ONE COMPLETE ex-R.A.F. airfield G.E.C. speech Broadcasting Unit, total output 1,080 watts from 6 180-watt output units; complete with priority relay panel and emergency equipment; all in good condition, but less valves; price £260. ex-works. o.n.o. Whitetrade Limited, Maidstone Rd., Rochester. (Chatham 4638.)

SIN. MIRROR AND FLAT, £9/10/-; also 18 in. Mirror, 2 in. Astronomical Telescope, £15; High Power 2 1/2 in. Lookout Telescope, £9/10/-, and Davon Micro Telescope, in case, £12/15/-; Details: C. W. Mackett & Co., Mfg. Opticians, 51, Millers Road, Brighton.

PORTABLE TYPEWRITERS.—Deposit 40/-, balance gradually. Warranted Verney Clayton, Market Rasen, Lincolnshire.

"ETNA" UNIVERSAL OIL BURNER burns waste car and other waste oils, gas and diesel, etc. No fans needed, natural draught. Consumption down to fractions of a pint per hour; lit in a minute and no smell; no jets to make-up; easily cleaned whilst working; will fit most closed stoves; easily fitted for greenhouses and garages. Hot water systems, space heating stoves and most slow combustion stoves. Cheap to install. From £16 and £21 approx. Send 3d. stamp for further details. Etna Products (Manchester) Ltd., c/o, "Highland," Akrlington Green, Middleton, Manchester.

ELECTRICAL

ALL TYPES OF ELECTRICAL GOODS at extremely competitive prices, e.g. 5 amp. Twin Cable, 48/- 100 yards; Lampholders, 7/- doz.; 5ft. Battens, 5/6; quality and immediate despatch guaranteed. Request list. Jaylow Supplies, 93, Fairholt Road, London, N.16. (Telephone: Stamford Hill 4384.)

BRAND NEW BROOK ELECTRIC MOTORS

Single Phase. 1 h.p. 1,500 r.p.m. £7.10.0
1 h.p. 1,500 r.p.m. £9.12.6
1 h.p. 3,000 r.p.m. £9.12.6
1 h.p. 1,500 r.p.m. £11.0.0
1 h.p. 3,000 r.p.m. £11.0.0

Fully guaranteed by makers, approval against cash. Carriage paid mainland. State voltage.

P. BLOOD & CO. ARCH STREET, RUGELEY, STAFFS.

BRAND NEW guaranteed Electric Motors at lowest prices. 1 h.p. to 1 h.p. Ball Bearings, single-phase and three-phase; also Bench Grinders and Polishers. Ask for trade discounts. Gill, 48, High Street, Brighton, Sussex.

SPARES, REPAIRS, REWINDS. Replacement Armatures and Fields for most Vacs. and Drills. Emergency Rewinding Service to 30 h.p. available. Hodson (Croydon), Ltd. 75A, George Street, Croydon, Surrey.

MODEL ELECTRIC MOTORS. Amazingly powerful and economical. "Minimo" 8/3. "Maximo" 13/6. post paid, 3 to 6v and 3 to 9v. speed 4,500 r.p.m., size 1 1/2 in. x 1 1/2 in.; weight, 1 1/2 oz. Drives: Boat Propellers, 1 in. and 1 1/2 in.; Aeroplane, 5 in. and 8 in. Model Electric Motors (Dept. I), "Highland," Akrlington Green, Middleton, Manchester.

ASBESTOS RESISTANCE WIRE, 10, 30, 40, 65, 229 ohm. Per yd. 1/3. p.p. Semple, The Mount, Heswall, Cheshire.

FLUORESCENT LIGHTING FITTINGS for workshop and home. Complete range from 5ft. to 18ins. (also circular) at lowest prices anywhere. S.A.E. for illustrated leaflets and list of Control Gear Kits. Callers welcome. We are Fluorescent Lighting Specialists. E. Brill, Dept. C., 125A, Northcote Rd., London, S.W.11. (Battersea 8960.)

100 APPROXIMATELY good second-hand 3/5 watt moving coil Loud Speakers with output transformers in individual wooden box baffles; price 11/- each, post and packing extra. Whitetrade Limited, Maidstone Rd., Rochester. (Chatham 4638.)

PATENTS

PATENTING Services. Advice. Qualified agent, C. L. Browne, 114, Greenhayes Ave., Banstead, Surrey.

! A GOOD IDEA!
CAN MAKE MONEY FOR YOU
LET US ASSIST YOU
PROFESSIONALLY TO SELL YOUR INVENTION.
WRITE FOR FULL DETAILS.
PATENT DEVELOPING & MARKETING CONSULTANTS
16, Gere Court Rd., Sittingbourne, Kent.

EDUCATIONAL

LEARN IT AS YOU DO IT—we provide practical equipment combined with instruction in Radio, Television, Electricity, Mechanics, Chemistry, Photography, etc. Write for full details to E.M.I. Institutes, Dept. PM47, London, W.4.

FREE! Brochure giving details of Home Study Training in Radio, Television, and all branches of Electronics, Courses for the Hobby Enthusiast or for those aiming at the A.M.Brit.I.R.E., City and Guilds, R.T.E.B., and other Professional examinations. Train with the college operated by Britain's largest Electronics organisation. Moderate fees. Write to E.M.I. Institutes, Dept. PM28, London, W.4.

GRAMMAR SCHOOL Entrance Examinations. Free Attainment testing for children 7-13 1/2. Write for details of Simplified Postal Courses to the Registrar, Mercer's Correspondence College (Dept. CG3), 69, Wimpole Street, London, W.1.

TOOLS

THE NEW 1957 fully illustrated Catalogue of Hand Tools, Portable Electric Tools and Machinery. Now available, price 6d., postage 3d. Parry & Son (Tools) Ltd., Dept. P.M.6, 329, Old Street, London, E.C.1.

WATCHMAKERS

WATCH REPAIR SERVICE, unrivalled for reliability and speed, coupled with reasonable charges. Part jobs welcomed. Material supplied. Hereford Watch Co., 13, Caste Street, Hereford.

LEARN to be a Watch and Clock Repairer in your spare time and earn extra money at home. We can supply everything you need at unbeatable prices, including instructional books, Swiss watchmakers' tools, watches, watch and clock movements, lathes, cleaning machines. All spare parts for watches and clocks, etc. We also have a fine selection of musical box movements and kits. Send 9d. P.O. for bumper bargain catalogue. The Watchmakers Supply Company (Dept. P.M.), Carterton, Oxford.

WATCHMAKERS! Use genuine replacement parts. Catalogues of Tools, Parts, etc., free. T. G. Loader, Dept. B, Milstone Rd., Carterton, Oxford.

YOUNG & SON. Watch, Clock and Jewellery Repairs. Tool and Material Dealers, 133, London Road, Chippenharn, Wilts.

YOUR BROKEN WATCH repaired, 15/6; guaranteed 12 months. Send registered; quick delivery. Horologist, 69, Orchard Avenue, Lancing, Sussex.

PHOTOGRAPHY

PHOTO-ENLARGER Castings and Bellows for 35mm. 2 1/2 in. x 2 1/2 in. x 3 in., 35/- per set; s.a.e. for details. V. J. Cottle, 84a, Chaplin Road, Easton, Bristol, 5.

BELLOWS, Camera, Enlarger, Process. Industrial Collapsible Machine Guards. Beers, 4, St. Cuthbert's Road, Derby. (Tel: 41263.)

STAMPS

STAMPS.—Wonderful offer. Great Britain Queen Elizabeth II Coronation 4d. and 1/6 values, catalogued 4/2, entirely free to genuine applicants requesting to see my "Selected Approvals" and enclosing 3d. postage. White Stamp Dealer, Dept. 37, Eastleigh, Hampshire.

SITUATIONS VACANT

A.M.I.MECH.E., A.M.Brit.I.R.E., City and Guilds, etc. on "No Pass—No Fee" terms. Over 95% success. For details of Exams and courses in all branches of Engineering, Building, etc., write for 144-page Handbook—Free. B.I.E.T. (Dept. 967B), 29, Wright's Lane, London, W.8.

WOODWORKING

WOODWORKING MACHINES, all cast-iron constructed. Complete Saw Benches, 7 in., 24/15/-; 8 in., 25/10/-; 10 in., complete motorised, £30. Planers, 5 in., £12; Bowl Turning Heads, £4; with 8 in. Saw Tables, £7/10/-; Lathes, £7/10/-; Combination Lathes, £10/10/-; Motors, Pulleys, Belts, etc. 12 months' written and money refunded guarantee. 4d. stamp for illustrated booklet. James Inns (Engineers), Marshall St., Nottingham.

ARE YOU LOOKING FOR A RELIABLE FIRM for Timber, Plywood, Wallboard, Veneered Plywood. Call at our warehouse or send s.a.e. for price lists. N. Gerver, 2/10, Mare Street, London, E.8 (near Cambridge Heath (E.R.) Station. (AMHerst 5887.)

SAWBENCHES, 6 in., motorised, complete, £13. Multi-purpose, convenient for sanding, mortising, drilling, turning, dovetailing, polishing; 12 in. Joiner's Sawbenches, £12; motorised, £27; 12 in. Portable Petrol Sawbenches, £44; Saw Spindle Assemblies from 37/6. Planers, Engines, Motors; deferred terms. Send 1/6 for Handbook-Catalogue. Price list free. Beverly Products, Sturton-le-Steeple, 8, Notts.

HOBBIES

TOY & GAME MANUFACTURE. The world's first journal specifically devoted to the manufacture of toys, games, sports equipment and amusement novelties. Annual subscription £1/10/-, specimen copy 2/6. Techniview Publications Ltd., 125, Oxford Street, London, W.1.

MAKING YOUR OWN? Telescopes, Enlargers, Projectors or, in fact, anything using lenses. Then get our booklets "How to Use Ex-Gov. Lenses & Prisms," price 2/6 ea. Comprehensive lists of optical, radio and scientific equipment free for s.a.e. H. W. English, Rayleigh Rd., Hutton, Brentwood, Essex.

ILLUSTRATED CATALOGUE No. 13. Containing over 450 items of Government Surplus and Model Radio Control Equipment, 2/2, refunded on purchase of goods; 2/6 overseas sea-mail. Arthur Sallis Radio Control Ltd., Department P.M., 93, North Road, Brighton.

'SUPERMOLD'
REMODELABLE RUBBER FOR ALL FLEXIBLE MOULDS
1 to 10 lbs. 7s. 3d. per lb. Normal
11 to 55 lbs. 6s. 6d. per lb. or
56 lbs. and over 6s. 3d. per lb. Hard Grade
Liquid Plastic for casting also Ready Made Moulds. Send 3d. stamp for details.
QUALITY PLASTICS LTD.
DEPT. C2, BRENTWOOD, ESSEX

SEREN ASTRONOMICAL MIRRORS 12, Jeymer Drive, Greenford, Middx. Top-quality Parabolic Mirrors, Diagonals, Eyepieces, Spiders, focusing Mounts, Do-It-Yourself Kits, sold home and abroad; s.a.e. for details. (Airmail, 6d., British P.O.)

WINDCHARGER PROPELLERS. highly efficient, new, 45/- each. Windcharger Building Instructions, Drawings, 3/-; Pearce, Midtaphouse Works, Liskeard, Cornwall.

ALUMINIUM LAUNCH HULLS, 20 in., 3/9; 16 in., 2/6; postage 1/6. "Clyde" Plans and Fittings, lists 3d. Glassfords, 89, Cambridge Street, Glasgow, C.3.

CHEMISTRY

LOTT'S CHEMISTRY. Convert your laboratory by easy stages. Supplies of spare apparatus and chemicals are always available. Write to the manufacturers for current price list enclosing a stamped addressed envelope for 2d. Lott's Bricks Limited, (Dept. 9A), Watford, Herts.

(Continued on next page)

(Continued from previous page)

HANDICRAFTS

MUSICAL BOX MOVEMENTS 14/9 post free.

More new kits and tunes available from 21/6 complete. Please send 2d. stamp for FREE illustrated brochure.

The SWISSCROSS Co. (Dept. VI16), Winifred Road, COULSDON, Surrey

SAW SALES AND SERVICE

SAW SERVICE BY POST.—Circular Saws set and sharpened, 5d. per in. diameter; tensioned, set and sharpened, 8d. per in.; recut, 1/3 per in.; minimum charge per saw, 2/6. (Prices include return postage.) 48-hour postal service; cash with order.

Saw Sales.—Special offer. Circular Saws made to your requirements, e.g. 5in., 12/6; 6in., 15/-; state bore and if rip or crosscut tooth; cash with order; postage paid Dept. "C," J. A. Fowle, 18-22, Bell Street, London, N.W.1. (Established 1840.)

MISCELLANEOUS

AQUALUNG and Compressor Equipment, Ballraces and Miscellaneous Items. Lists 2d. Price, 157, Malden Road, Cheam.

"FORTUNES IN FORMULAS." 900-page American book of formulae. American technical hobby and other books covering every interest. Stamp for lists. Herga Ltd. (Dept. P2), Hastings.

SUPERTONIC SUNLAMPS, listed 27/10/-; 80 -/-; s.a.e. brochure. Scientific Products, Dept. I, Cleveleys, Lancs.

SMALL PADDINGTON FIRM wishes to contact local skilled Tool-maker with use of workshop for making parts, small tools, figs, etc., spare or part-time. Box 136.

STEAM CARS, Boats and Small Stationary Power Units are described in "Light Steam Power." Your copy and comprehensive illustrated lists of drawings, including Light Steam Car Power Unit, and Castings for 3/8" Light Steam Power, Kirk Michael, Isle of Man, United Kingdom.

WANTED, Myford or Coronet Lathic and attachments. Wills, Forest Houses, Braydon, Swindon.

BUILD YOUR OWN Refrigerator. Everything to make Built-in or Cabinet Refrigerator. S.A.E. for Sealed Unit List and Schematic Diagram, or 1/- (refundable) for 32-page catalogue, including details of free 4 cu. ft. Cabinet Diagram offer. Hire purchase available. Wheelhouse, 13, Bell Road, Hounslow. (Phone: HOU 3501.)

FORMICA OFF-CUTS—Formica Off-Cuts. Here's the opportunity to do worthwhile, interesting jobs in your home or as a profitable sideline. Just the thing for covering trays, tea trolleys, small benches, tables, making your own tiles, splashbacks, etc. etc. A good selection of bright colours and useful panels in every parcel guaranteed. Parcels at 30/-, carriage paid, are brought to your home. Make sure of your Formica Off-cuts, you're sure to be satisfied. Formica Adhesive, if required, is sold in most areas. If unobtainable locally, send 5/- extra for one tin. This also covers cost of postage, etc. For early despatch send P.O. 30/- only. to: Reeves, Plywood Merchant, 33, Front Street, Monkseaton, Whitley Bay.

FOR ALL YOUR STICKY TRICKY PROBLEMS The greatest advance in modern times. An entirely new CRYSTAL CLEAR adhesive that STICKS ALMOST ANYTHING TO ANYTHING, and never becomes brittle.



Plastic Cement. Tubes 1/6-2/9. Larger tins available. LURNBRIDGE LTD., LONDON, S.W.17 (Est. 1922).

Start your own Laboratory



with a LOTT'S CHEMISTRY SET

Enjoy the thrill of carrying out experiments with real apparatus and chemicals. The set is complete with full instructions and extra spares and chemicals are available for building up a complete student's laboratory. Here's a satisfying

and instructive hobby for any boy or girl with a scientific turn of mind.

Enquire of your Toy Dealer or write direct for price list of sets and spare apparatus, enclosing 2d. stamped addressed envelope.

LOTT'S BRICKS LTD · DEPT 9 · WATFORD · HERTS

ROGERS 31 NELSON ST. SOUTHPORT. 5in. Rubber Sanders, 1in. drive. 5/-; Abrasive Discs, 5in. Ass'd. doz. 3/6; Terminal Blocks, 12-way 1/3; Transformers, 6/12v. 20 amps. 38/6; Motorised Pumps 69/-; Thread Gauges, 28 arms 4/9; Whitworth Screws, 144 Ass'd 5/0; H.S. Drills, 12 Assorted, to 48 4/6; Fibre Washers, 144 Assorted 3/6; Meter Rectifiers, A.C. to D.C. 3/9; Self Tap Screws, 100 Assorted 3/-; Copper Rivets, 12 doz. Assorted 1/4; Saw Bench Tops, with ball race spindle, pulley, etc., 18in. x 10in. 52/6; Rectifiers, 6/12 v. at 6 amps. 18/-; Meters, 0-15v. or 0-25 volts M/c. 10/8; Air-Jacks, 5in. stroke 17/6; Boost Gauges for Car Use 6/9; Winker Units, 6or 12 volt 6/6; Circular Saws, 6in. 11/6; 7in. 13/8. etc. Races, Belts, Valves, Pulleys, Pumps, etc.

THE PEOPLES ARC-WELDER £15 12-0d. Complete with all accessories shown ready for plugging into 10amp socket. 200/250 V. A.C. mains. Infinitely variable control of welding current by hand wheel. Welds up to any thickness down to 28. Sheet, for the Motorist, Homeowner & Engineer. £15 12-0d. in 20 minutes. CANALS APPROX. 7/6 EXTRA DELIVERY. Lins. 10/- 2/- 2/- Standard Flux Coated Electrodes. One dozen of each supplied with Welder. Extra Electrodes 2/6 per doz.

HARMSWORTH, TOWNLEY & CO., Jordan Street, Knott Mill, MANCHESTER, 15.

SWISS Musical Movements from Metwood. Movements by THOR-ENS AND REUGE of Switzerland ranging from 1 tune/18 teeth—3 tunes/72 teeth are guaranteed for 12 months. POST TODAY for super 16 page illustrated Catalogue and Tune List (please enclose 2d. stamp for return postage) also plans to make your own Musical Box available. 1/3 postage free. P.O. please. METWOOD ACCESSORIES (PM11) 65, Church Street, Wolverton, Bucks. Importers and Manufacturers.

CHEMISTRY APPARATUS Send 3d. stamp for COMPLETE PRICE LIST. Booklets: "Experiments" 1/2; "Formulas" 1/2; "Home Chemistry" new ed. 2/9 (Post Paid.) BECK (Scientific Dept. A) 60 HIGH STREET Stoke Newington, London, N.16

BOWMONK FIREPROOF GARAGES. From £33.10.0 with FREE delivery. STEEL FRAMED—EXTENSIBLE. All garages fitted with anchors, shelf, door retainers. Yale lock. FREE site plans. LOWEST MONTHLY TERMS of any manufacturer including FREE "Peace of Mind" INSTALLMENTS INSURANCE. HINGED & OVERHEAD TYPE DOORS. FREE illustrated Catalogue & Prices from BOWSER, MONKS & WHITEHOUSE LTD. (Dept. ME3), Spring Gardens, DONCASTER

THE WORLD'S GREATEST BOOKSHOP FOYLES FOR BOOKS. FAMED CENTRE FOR Technical Books. STOCK OF OVER THREE MILLION VOLUMES. 119-125 CHARING CROSS RD. LONDON WC2. Gerrard 5660 (20 lines) Open 9-6 (inc. Sats.) Nearest Station: Tottenham Court Rd.

GOVERNMENT SURPLUS BARGAINS. TRIPODS. Unused, 38" long, only 5 lb. wt. Immensely strong. Carrying sling. Brass cap easily adapted to camera. etc., etc. Each 12/6, carriage 3/6. LOW VOLTAGE MOTORS with REDUCTION GEAR, approx. 4/1 (24-45-90) 6-12 v. D.C., 1 amp., ea. 15/-, post 1/6. MOTOR ONLY as above (dimensions 3" x 2" x 2") ea. 7/6, post 1/-; BATTERY CHARGING TRANSFORMERS, 10 v. & 16 v. A.C. (for 6 & 12 v. charging at 1 amp.), ea. 17/6, post 1/-; RECTIFIERS to suit above, ea. 7/6, post 3d. (These transformers & rectifiers will run the above low voltage motors.) BLOWER MOTORS, 24 v. D.C. Provide sufficient draught for Car Heater on 6 v. (12 v. preferably) controlled by variable resistance), ea. 25/-, post 1/6. VARIABLE RESISTANCES to suit for 12 v., ea. 3/6, post 6d. MOTORS, 200/250 v. A.C./D.C. FHP, approx. 80 watts. High speed. 1" shaft. (Converted ex I.L.A. generator 21- power about equal to sewing machine motor.) Useful addition to workshop, ea. 30/-, post 2/3. Send 3d. stamps for list of other Motors, Transformers, Pumps, Lamps, Switches etc., etc.

MILLIGANS 21, Harford Street, Liverpool, 3. Money Back Guarantee.

SPARKS' DATA SHEETS presents THE "331" A.C. SHORT WAVE 4-VALVE T.R.F. Rx. OUTSTANDING IN DESIGN & PERFORMANCE. Incorporates "Cathode-coupled Regeneration" which ensures Highest Efficiency. Selectivity, perfect Stability plus amazing ease of operation. Coverage 10 to 220 metres. Switched Coils. Separate Power Pack. 4.5 Watts Output. To show every detail of construction and point-to-point wiring in simplified form, the Data Sheet is 21in. x 22in. This, together with generous Instructions and Operational Notes, costs 3/6 Post Free. All Components and Chassis available. L. ORMOND SPARKS (M), VALLEY ROAD, CORFE CASTLE, DORSET.

EVERYMAN MUST HAVE A UNILEVEL. THE 3D 'LEVEL' PATENT PENDING. Price 7/6 BY POST ONLY POST FREE. Strong Plastic ★ Multi-way Spirit Level ★ 6" Rule ★ Complete in Plastic Sheath ★ Fits in pocket ★ Square & Protractor. POST TODAY CASH WITH ORDER. SOUTHWOODS (ISCA) LTD 15 NORTH STREET, EXETER

THE "DERMIC" OILER 5/9 Post Free. Use a "DERMIC" Oiler for clean and accurate lubrication of models, clocks, watches, sewing machines, typewriters, movie cameras and projectors and any delicate instruments or mechanism. Get one from your local Model or Tool Dealer or send direct to the actual manufacturers. S. & B. PRODUCTIONS, Orton Buildings, Portland Road, South Norwood, London, S.E.25. Phone: LIV 4943

BUILD YOUR OWN CANOE. Printed Illustrated Instructions 1/6. TYNE FOLDING BOATS LTD. 206 Amyand Park Road, St. Margaret's, Twickenham, Middx.

MODEL BOATS. Plans : Kits : Engines : Etc. 4d. in stamps for Lists. LAWRENCE MODEL SHOP 106, LAWRENCE ROAD, LIVERPOOL, 15.

A NOVEL MARBLE ALLEY

An Indoor Game to Make and Play this Winter

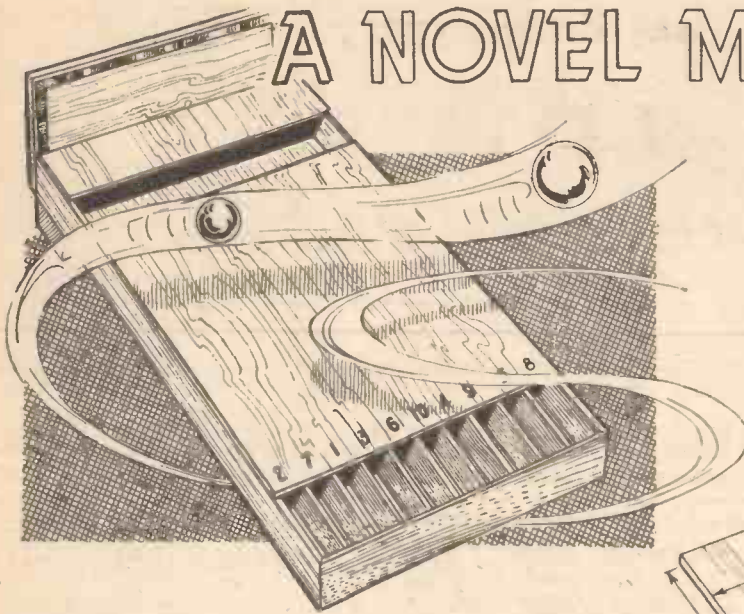

Fig. 1 (Left).—
The completed
marble alley.

from one end cut an opening $7\frac{1}{2}$ in. long \times $\frac{1}{2}$ in. wide.

Sloping the Board

Smooth the face of the top with sandpaper and fix it in position with the opening at the back by means of a few tacks on each edge of the sides. The alley can be completed by gluing a length of $\frac{3}{16}$ in. half-round beading along the top edges.

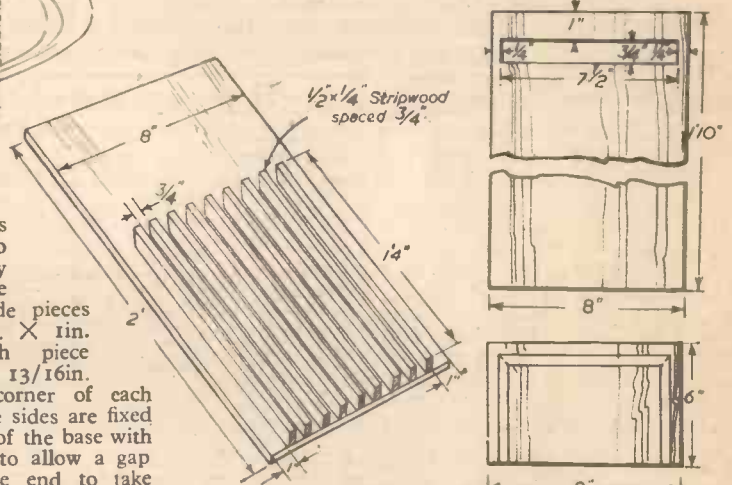

Fig. 2.—The base and stripwood divisions. Fig. 3 (Right).—Top and head board details and dimensions.

THE marble alley shown in Fig. 1 is quite different from the usual kind of game, where the marble is rolled on a board into holes at the back with a series of spikes in front as hazards. A glance at the illustration will convince the reader that a good deal of fun is to be obtained from the game, since the marble is rolled up the board and disappears in the slot at the back. The score is decided by the marble rolling into one of the divisions and reappearing in the front. You may decide to try for a ten only to be greatly surprised if the marble turns up in division one or two. There is a similar game commonly seen in amusement arcades. The alley is quite straightforward to make.

channels thus formed in order to provide a clear way for a small marble to roll. Two side pieces are cut from $\frac{1}{2}$ in. \times 1in. stripwood, each piece being cut 1ft. 11 $\frac{13}{16}$ in. long with one corner of each rounded off. The sides are fixed on the top edges of the base with glue, taking care to allow a gap of $\frac{3}{16}$ in. at the end to take the back piece. The front strip required is a piece of $\frac{1}{2}$ in. \times $\frac{1}{2}$ in. stripwood 8in. long. Fix this neatly to the front with a couple of small nails driven through into the front of the side pieces.

The Base Board

Commence by making the bottom piece indicated in Fig. 2. Cut a piece of $\frac{1}{2}$ in. wood 2ft. long \times 8in. wide and take care to get the sides square. On one end of the wood mark a distance of 1in. from either side and then make marks $\frac{3}{4}$ in. apart between this distance. On the marks thus made, neatly glue nine strips of $\frac{1}{2}$ in. \times $\frac{1}{2}$ in. stripwood 1ft. 4in. long parallel with the sides and with the $\frac{1}{2}$ in. width facing upwards, this being clearly shown in Fig. 2. All glue must be removed from the face of the

The Back

Due attention should be paid to the back, which can be decorated with a piece of moulding as shown in Fig. 1. First cut a piece of $\frac{3}{16}$ in. wood 8in. \times 6in. The moulding ornament is fixed in position with glue, and then the completed back is secured with a few small tacks driven through into the back ends of the side pieces. The top of the alley is illustrated in Fig. 3 and this is cut 1ft. 10in. \times 8in., taking care to get the sides square. A distance of 1in.

In order to give a slope to allow the marble to roll down with ease, a foot, 8in. long by 1in. thick by $\frac{1}{2}$ in. wide is glued on the bottom at the back. The top edge is cut with a slight taper to allow the foot to bed nicely on the bottom. A coat of stain should be applied which will add to the appearance of the finished alley. When playing the game the small marble used should be able to roll down between the stripwood easily.

If the marble alley is made in time for Christmas, it will make a useful present for a friend or alternatively could be employed as a party game.

A Diving Model Submarine

Made in One Hour. It Really Submerges!

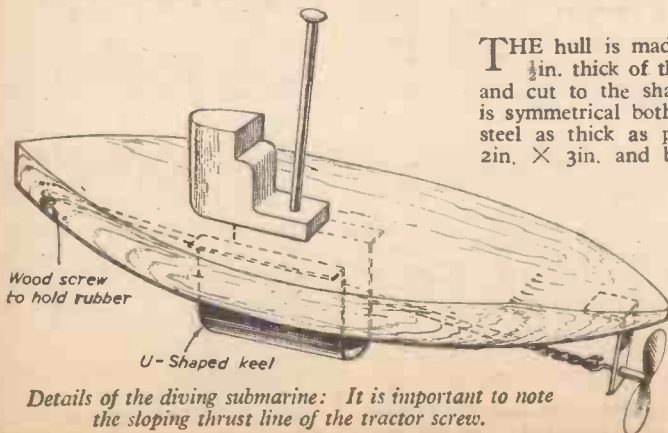

Details of the diving submarine: It is important to note the sloping thrust line of the tractor screw.

THE hull is made from any wood about $\frac{1}{2}$ in. thick of the dimensions 8in. \times 2in. and cut to the shape shown, noting that it is symmetrical both ways. A piece of sheet steel as thick as possible is obtained about 2in. \times 3in. and bent into a U-shape, this being fastened about halfway down the centre line to form the keel. A bracket is now made for the propeller shaft from sheet brass or iron, and a screw provided at the nose for the rubber motor. The propeller is made from tinplate and soldered to its shaft.

A small bush is made from tinplate to take the thrust. A conning tower can be made from wood or cork to the shape shown and a large nail will serve as a periscope. The rubber used for the motor may be cut from an old cycle tube. The model will have to be weighted until it just floats, and this can be done by putting washers over the periscope. When wound up in the usual way and placed on the water the model will first run on the surface for a second or two and then dive realistically until the power has run out. The diving action is due to the slope of the propeller lifting the stern.

THE "PRACTICAL MECHANICS"
HOW-TO-MAKE-IT BOOK
 12/6 (13/- by post)
 From George Newnes, Ltd., Tower House, Southampton Street, Strand, W.C.2.



Letters to the Editor

Address letters to The Editor, "Practical Mechanics," Tower House, Southampton Street, London, W.C.2.

The Editor Does not Necessarily Agree with the Views of his Correspondents

The Mantell Incident

SIR,—In recent correspondence on the "Mantell Incident," Major Ruppel's book "The report on the U.F.O's" is referred to for reference. The findings of Project Bluebook on the above case are stated therein. It appears that when the staff in the control tower were questioned later about Captain Mantell's last message they could not agree about the "It looks metallic and of tremendous size" part; in fact, no one was certain he ever said that.

They agreed about him saying, "I am going to attempt to reach its altitude, if I can't I will give up the chase."

The whole case hinged around the statement, "It looks metallic and of tremendous size." If he had said that then he must have got a reasonably close look at the object he was sent up to investigate.

The findings of Project Bluebook after much research were that there could have been a "Skyhook" balloon in that area, one was released a distance away and, due to upper atmosphere winds, could have been in that vicinity at that time. He was asked to investigate an object reported by hundreds

(Continued on page 107)

A SIMPLE LATHE BEARING

Details of a Useful Alternative

SIR,—It seems to me that the ideal bearing for your lathe (May issue of PRACTICAL MECHANICS) would be the bearing from an old bicycle front wheel.

The bearing could be clamped between two blocks of wood and fixed to the lathe bed, as shown in the sketch. The faceplate, etc., could easily be made by welding a cycle hub nut to each item.—K. H. FLINT (Leics).

(Right).—Suggested cycle hub lathe bearing.

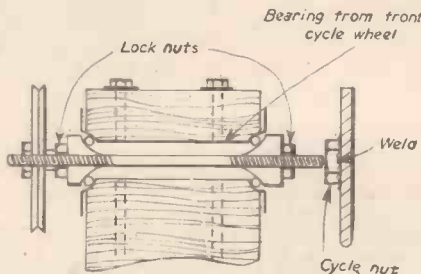

Puzzle Corner

SIR,—With reference to "Puzzle Corner" in the September issue, I should like to comment on the solution given. First, the statement that "the rope is pulling upwards with a force of 12lb. on the monkey" is incorrect. The upwards force on the monkey by the tension in the rope is 10lb. balancing the monkey's weight, it is the tension at the point where the rope passes over the pulley which is 12lb.

Furthermore no allowance is made for the fact that once moving, the weight will retain its momentum.

May I suggest that the same answer can be obtained, that the weight reaches the pulley before the monkey, by ignoring the weight of the rope?

To lift himself up the rope the monkey must exert a downwards force on the rope which will therefore cause the weight to accelerate upwards. During the exertion of the monkey (assuming constant pull), the weight will have uniform acceleration upwards, and the monkey, as it is of the same weight and is experiencing the same force, will have the same acceleration with respect to the rope, and therefore stay in the same place with the rope moving past it. When the monkey ceases pulling, the accelerations cease and the whole system carries on with the uniform speed gained up to then, i.e., the weight upwards and the monkey downwards.

Consideration of the weight of the rope gives a small ever-increasing acceleration in the same direction and will make the weight reach the pulley even sooner. If the rope is in the form of an endless ring the result is the same in that the weight will reach the pulley while the monkey will not rise above his original height in fact will almost certainly finish up lower down.—A. J. ROSKELL (Cheshire).

OUR ELECTRIC FENCER

How to Make it Even Cheaper

SIR,—I read with interest the description of an Electric Fencer in the August issue. It was a lucid and easily applicable article for the average farmer. To paddock graze on the recommended system, which is supposed to give 50 per cent. better utilisation of grass, requires a large number of fence posts and here I must disagree with your contributor in his last sentence where he says, "Metal posts, insulators and fencing wire may be purchased at a 'moderate' price."

According to their elaboration fence posts cost from 3s. 4d. to 4s. 3d. each and even on our small 40-acre dairy farm we use about 300. If you collect them every time you move the herd to another patch, a great deal of labour is involved. Moreover fence wire costs about 29s. for a 300 yd. coil.

Now, having made your own fencer, why not make your own fence posts? They are even more simple.

Dunlop and Rankin of Leeds provide 3/4 in. dia. straight black steel rod in lengths of about 18ft. to 20ft. according to what they have in stock. Price at the moment is about 55s. per cwt. and since it weighs about 0.37lb. per ft. we get 300ft. per cwt. A fence post must be about 30in. to 32in. out of the ground so with the pigtail and the underground portion it is best to cut the lengths at 45in.-46in. If the rod comes in 18ft. lengths you have a bit of waste, but the local blacksmith will weld two together for a few pence each. Anyway assuming you throw the short ends into the concrete when you are making some gate posts,

instead of buying them, you still get four posts per length. Sixteen lengths per cwt. gives 64 posts for 55s. or, say, 10 1/2d. per post.

Now you want insulation and this comes from B. I. & Callenders Cables. 0.40 i.d. by 0.040 wall thickness at 85s. per 100 yards. Chopped into 10in. length this adds about 3d. per post. This makes 1s. 2 1/2d. per post plus the painting with bright yellow synthetic paint at about 1d. per post. You can see posts this colour if the cows trample them down when the fencer is earthed by a piece of grass growing just too tall or the wind blowing a bit of hedgerow against it.

For the pigtail I use an old Austin seven wheel hub, but any flat disc with a piece of 1 1/2 in. to 1 3/4 in. o.d. pipe, 1 1/2 in. long welded on to the centre with a piece of 3/4 in. bar 1 in. long welded about 1/2 in. away from it, will do the job. Slip the insulating material over the 3/4 in. rod, lay it between the 1 1/2 in. centre stub and the 3/4 in. stop, slip a length of 1/2 in. i.d. water pipe over it till it reaches within 1 in. of the centre stub and just walk round the vice which is holding the jig in place. As you approach the stop after the first time round, just raise the water pipe handle a little to go over the top of the 3/4 in. stop and carry on for 30 deg. I can do fifty an hour.

There is available at the moment, "shorts" as they call them of galvanised "half-hard" wire at half price, i.e., about 42s. per cwt. from most scrap merchants. It is a bit more trouble to handle since it is springy, but, run out neatly, it cuts costs a lot.—K. McGRATH (Stockton-on-Tees).

ALUMINIUM

BRASS - COPPER

• SHEETS

• RODS

• TUBES

• MOULDINGS & SECTIONS

DETAILED PRICE LIST UPON APPLICATION NO S.A.E. REQUIRED

ALCOB METALS LTD.

367 EDGWARE ROAD, Paddington, London, W.2.

Tel. PADddington 2232 (3 lines)

FLUORESCENT LIGHTS



These are complete fluorescent lighting fittings. Built-in ballast and starters—stove enamelled white and ready to work. Ideal for the kitchen, over the workbench and in similar locations. Single 40. 4ft. 3in. long, uses a 40 watt tube. Twin 20. Uses 2 20-watt standard tubes. Price for either 39/6 each, with tubes. Carriage and ins. up to 150 miles 8/6. up to 250 miles 8/6.

Don't Be Caught Like This



CAR STARTER CHARGER KIT

All parts to build 6- and 12-volt charger which can be connected to a "flat" battery and will enable the car to be started instantly. Kit comprising the following:
Mains transformer 22/6
5-amp. rectifier 17/6
Regulator Stud Switch 3/8
Resistance Wire 2/-
Resistance Former 2/6
Mains on/off Switch 2/6
0-5 am. Moving Coil Meter... .. 12/6
Constructional Data 1/8
or if bought all together price is 52/6. plus 3/6 post and ins.

500-WATT ELEMENT

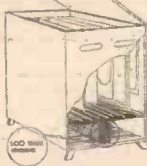

Totally enclosed in metal case. Size approx. 2 1/2 in. x 4 in. x 4 in. These elements are ideal for airing cabinets or similar devices, suiting A.C. or D.C. mains—200-250 v. Price 27/6 plus 3/6 carriage and insurance.

THERMOSTATS



Useful for the control of appliances such as convector, glue-pots, vulcanisers, hot plates, etc. Adjustable to operate over the temperature range 50-550 deg. F. 14 amp. 3/6; 5 amp. 8/6; 2 amp. QMB, 5/6; 15 amp. QMB, 15/-.

MULTI-SPEED MOTOR

Works off A.C./D.C. mains; fitted with gear-box gives any speed from 1 r.p.m. to 22/6. post and packing 1/6.



STOP! FREEZE PIPES! Wrap our heater cable around the pipes in your loft to prevent a freeze up. Minor Pack, 14 yds., 15/-; Major Pack, 21 yds., 22/-; With full instructions.

14in. T.V. CABINET



14in. T.V. cabinet of the latest styling made for one of our most famous firms beautifully veneered and polished—11 limited quantity—19/6 each. Carriage and packing 4/8 extra.

YOURS FOR £1.10.0 DOWN



The latest most up-to-date Record Player made by the famous R.B.R. company. Using Hi-Fi Crystal Pick-Up and fitted with every modern device. Definitely a record changer which will give years of trouble-free music. Not surplus but the current model. Price £8/10/0 or £1/10/0 deposit and 8 monthly payments of £1. carriage and insurance 5/-.

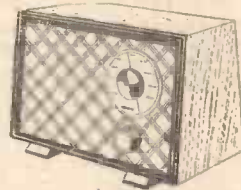

THE SKYSEARCHER

This is a 2-valve plus metal rectifier set useful as an educational set for beginners, also makes a fine second set for the bedroom, workshop, etc. All parts, less cabinet, chassis and speaker, 19/6. Post & ins. 2/6. Data free with parts or available separately 1/8. 3-valve battery version also available at the same price.

ALL MAINS AMPLIFIER



Construct a powerful three-valve mains amplifier. Ideal for dances, parties, etc. Complete less chassis, cabinet and speaker (available if required). Data 1/6 (free with parts). Price 19/6 plus 2/6 post & ins.

"CHIMELITE" 9/6



It is a hall light, as well as a double chime and you can make it in a couple of evenings for the total cost of only 19/6 including instructions, post 2/6—data available separately, price 1/8.

MAKING A SOLDER GUN



A 7-second solder gun of the type costing £2-£4 was described in August issue. Only two essential parts are required—(a) transformer and (b) push switch. These we can supply at 11/6, plus 2/- post. The rest of the parts you will have in your own "junk" box. Copy of the article concerned given free with the kit.

A.C./D.C. MULTIMETER KIT

Measures A.C./D.C. volts and ohms. All the essential parts including 2in. moving coil meter, selected resistors, wire for shunts, range selector switches, calibrated scale and full instructions, price 19/6 plus 2/6 post and ins.

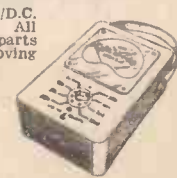

Wireless Set, No. 17. A complete transmitter receiver. Only 120 v. H.T. and 2 v. L.T. needed. New. Complete instruction book with each unit, with hand mike and earphones. Ideal farms, scouts. 44/61 mc/s. Price 39/6. Carriage 5/6.

One-Valve Amplifier, No. A.1271. Contains V.R.56. Two trans., Pot., 5 Condensers, 7 Resistors. In metal box. Can modify for player unit. 3/6, post 2/3.

Nife Cells. New. Superior to lead acid type. Almost indestructible, voltage 1.2 to 1.5 (fully charged). Size 3" x 2 1/2" x 1 1/2" approx. 7/6 each, post 1/-; 72/- dozen, carr. 3/6.

U.S.A. Transceivers. R.T.34. 17 valves, generator. New, perfect condition. £3. carriage 4/6.

Throat Mikes. New, boxed, British, complete with straps, cord and jack. 7/6, post 1/-; 36/- dozen.

Test Prods. New. 2ft. P.V.C. black prods, wander plugs, beautifully made. 3/6, post 6/-; 36/- dozen.

Speedometers with Resct. By Jaeger. 0-90 m.p.h. New. Half-moon shape, fitting size 7 1/2" x 3 1/2", chromed beautiful condition, price 25/-; List price about £7/10/-; Bargain, post 2/6.

P.O. Type Relays. All 3,000 type. Coils from 5 ohms to 3,000 ohms, up to 18 Blade assemblies. 5/6 to 10/6 each, post 9d.

Battery Chargers. New, our own make. Input 200/250, output 6 or 12 v. at 11 amps., trans. and rectifier mounted on wood base, ready for us, 29/6, post 2/-.

Intercom. Sets. Sound powered. Consists of two balanced armature earpiece microphones, 20" twin flex, all new equipment, suitable baby alarms, remote radio listening, car to caravan, communication, etc. Price 12/6, post 1/-.

Miniature Electric Motors. New. E.C.F. Tape recording type. 12/24 volts D.C. Fitted reduction gear, final speed 200 r.p.m., famous maker. Size 2 1/2" x 1 1/2" x 1". Suitable locos, research, price 15/-; post 1/-.

Battery charging M/c Voltmeter Tester. New in case. 3-0-3 and 30-0-30 volts, test prods included. 20/-, post 1/9.

Rear Car Lamp Assembly. By Lucas. New. Suit Humber 1956 or modern similar types, trailers, special. Contains red glass for rear light, double filament lamps for braking, lower section plain reversing, including leads housed in alum die cast case, dimensions 11" long x 3". Fraction of real cost. Price 30/- per pair, post 2/6; Send 6d. for new list. All communications to:

THE SCIENTIFIC INSTRUMENT CO.

16, Holly Road, Quinton, Birmingham, 32
Callers welcomed at Showrooms,
353, Bearwood Road, Smethwick.



A "FERROUS" ELECTRIC ARC WELDING SET will complete your workshop equipment. For joining and reinforcing, from approx. 11/6 up to any thickness, Mild Steel, Wrought or Malleable Iron. Type F.M.60 Heavy Duty complete with all equipment 190/240v. Single ph. 10/15 amp. (or domestic power supply) delivered free, ex stock. Cash (or C.O.D.) £23.10.0 H.P. Terms available.

Illus. leaflet from manufacturers.
FERROUS PRODUCTS (M.E.C.) LTD., Church Rd., Croydon, Surrey. CRO 8351/3

92,000 PIANISTS

have learned to play the piano beautifully with the aid of my POSTAL Lessons. Everything is so clearly explained that, even if you do not know a note, you will, with only half an hour's practice each day, become a proficient pianist in 9-12 months. Ordinary music; no freakish methods. I have taught over 92,425 pupils and I CAN TEACH YOU. Free Book and advice. Say if Beginner, Mod. or Adv. Please add stamp for postage.
Mr. H. BECKER,
456, The Hall,
Centurion Road,
Brighton, Sussex.

PORTASS LATHES

DIRECT PERSONAL SERVICE
LARGE DISCOUNT FOR CASH
NO INTEREST CHARGED
for easy terms.
CAN ANYONE DO BETTER?
1/- for Lists, please. Dept. P.M.
BUTTERMERE WKS., Sheffield, 8

ELECTRONIC PRECISION EQUIPMENT, LTD.

Post orders should be addressed to E.P.E. LTD., Dept. 1, 123 Terminus Rd., Eastbourne.
Post enquiries to Eastbourne with stamped envelope, please.
42-46, Windmill Hill, Ruslip, Middx. Phone: RUSLIP 7789—Half day, Wednesday.
152-3, Fleet Street, E.C.4. Phone: FLEET 2833—Half day, Saturday.
59, Strand Green Rd., Finsbury Park, N.4. Phone: ARCHWAY 1649—Half day, Thursday.
266, London Rd., Croydon. Phone: CROYDON 6558—Half day, Wednesday.

BATTERIES PAY AS YOU USE

GOLDEN R.G.W. VERY HEAVY DUTY. 2 years' unconditional guarantee with the new micro porous rubber separators! and new hard rubber container! 20/- 6v., 30/- 12 volts deposit and only four monthly payments 6v. 13/9. 12v. 23/9. Illus. catalogue free. Express delivery.
R.G.W. BATTERY COMPANY
164 High St., Brentford, London.
Tel.: Ealing 8711

ACCURATE HARDSHITTING
Webley
AIR PISTOLS
AIR RIFLES · ACCESSORIES
Write for catalogue WEBLEY & SCOTT Ltd.
106, WEAMAN ST., BIRMINGHAM 4, ENGLAND

Build for YOUR Future

REMEMBER! The skilled man is ALWAYS WANTED—and at high pay!

Choose your technical aid to success below—

7 days' FREE EXAMINATION

NEWNES
**CARPENTRY
AND
JOINERY**

SHOWS THE CRAFTSMAN'S METHODS



Newnes **CARPENTRY AND JOINERY** is produced for you, the man who means to become a fully-skilled craftsman, and hold a well-paid position. Every aspect of the work is dealt with comprehensively and concisely—from hand-work, machine woodworking and the construction of floors, roofs, partitions, staircasing and hand-railing, to complete structures. It contains the experience of qualified practical men—who help you to solve day-to-day problems, and implement your knowledge.

3 Volumes bound in blue Moroccoette.

836 PAGES.

1349 photos, illustrations, sectional plans, elevations.

12 Data Charts with Case.

2 Years' Free Technical Advisory Service.

HAND TOOLS: Timbers . Machines and Processes . Doors . Dadoes, Skirtings . Workshop Geometry . Windows, Blinds, Shutters . Panelling, Veneering, Staining . Stairs, Handrails . Church Fittings . Floors, Beams, Roofs . Gates, Fences, Sheds, etc.

NEWNES
**PLUMBING, SANITATION
AND DOMESTIC
ENGINEERING**

A PRACTICAL WORK BY EXPERTS

This important new work has been produced for the man who means to progress! Prove its value by sending for 7 days' Free Examination. Planning, Installation and Maintenance of Water Supply, Drainage, Sanitation, Heating and Ventilation in domestic buildings—all these activities requiring skilled craftsmanship are dealt with by experts. This comprehensive new work will help you gain a thorough knowledge of your immediate craft and allied activities.

4 Volumes bound in blue grained cloth.

1580 PAGES.

1331 photos and drawings.

36 Data Sheets and Charts with Case.

2 Years' Free Technical Advisory Service.

Deals with Tools . Leadwork . Roof Work . Pipe Jointing and Bending . Chemical Plumbing . Drainage Test . Sewage . Filments . Cold-water Services . Wells . Burst Pipes . Gas, Electric and Solid Fuel Hot-Water Systems, etc.



No Cost—No Obligation in seizing this opportunity

Claim FREE Examination NOW

Make your choice here

MARK X IN PANEL ON RIGHT

George Newnes, Ltd., 66-69 Great Queen St., London, W.C.99.

Send me the books I have selected, without obligation to purchase. I will either return the books in 8 days or send 7/6 deposit 8 days after delivery, then 15s. monthly until the total subscription price shown against title I have selected has been paid.

Name

Address

Occupation

Signature (Or Parent's Signature if under 21)

CJ1X/PDSX

CARPENTRY AND JOINERY
Subscription Price £6.10
Cash Price in 8 days £6

PLUMBING, SANITATION & DOMESTIC ENG.
Subscription Price £9.17.6
Cash Price in 8 days £9.10

Place X where it applies

HouseOWNER	
Householder	
Living with Parents	
Lodging Address	

GAMAGES

Exceptional Offer!

'FERROUS' ELECTRIC

ARC WELDING PLANT

If you are interested in joining or reinforcing Mild Steel, Wrought or Malleable Iron THIS IS AN OUTFIT YOU CANNOT BE WITHOUT. Suitable for Agricultural machinery, Heating and Ventilating engineering, Ornamental Iron or Blacksmith's work, Garage and maintenance work, Handicrafts or the Home Workshop. 190,240 volt A.C. mains for 10 amp. plug. For welding material of any thickness by repeat runs after preparation if necessary. Uses 14 s.w.g. electrodes. Air cooled. Robustly constructed and fitted with neat handles for portability. Size 15in. x 12in. x 10in. high. Weight 80lb.

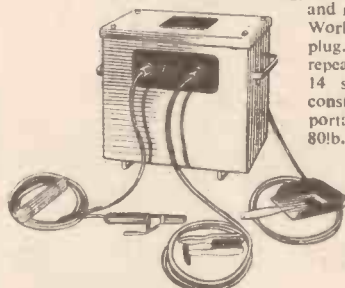

£23/10 Or 9 payments of 55/9

Carr. & Pkg. outside 50 miles of Holborn in Eng. & Wales, 15/- Scot. 22/6. Send for Illustrated leaflet.

'PICADOR' CARPENTERS' SQUARE

This precision combination set is suitable for Engineers, Motor Mechanics, Model Engineers, Carpenters, Handymen, etc., having many uses. The Square, Protractor, and Centre Head may be slid along the 12in. grooved, hardened and tempered steel rule and may be locked in any position. The Rule has graduations of 8ths and 16ths one side, the Protractor is graduated in one degree and gives a very quick, clear reading. A spirit level is fitted to the Protractor and Square.

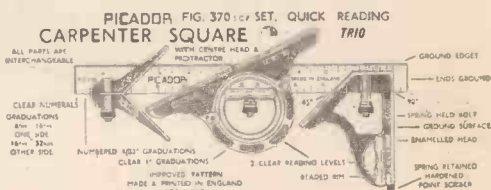

Post & Pkg. 1/6 outside our extensive van area. **COMPLETE COMBINATION SET 30/-**
★ Send for Gamages BUMPER Christmas Catalogue

GAMAGES, HOLBORN, E.C.1. HOLBORN 8484. Open Thursday 7 p.m.

MUSICAL Kits by



No. 3222

KIT 9/11

MAKE DELIGHTFUL PERSONAL GIFTS

MUSICAL TAVERN
A savings box which plays a tune when a coin is inserted. Musical Movement No. 2, 19/10 extra.

Charming, practical novelties which play the tune of your choice. Kits and musical movements from branches, etc., or post free. Other tunes available.

KITS CONTAIN ALL WOOD AND MATERIALS EASILY MADE UP WITH A FEW SIMPLE TOOLS

★ ★ ★
Choose from these tunes

- No. 1 Movement (18/3)
- N. Home Sweet Home
- O. Auf Wiedersehn
- P. Greensleeves
- Q. O My Papa

- No. 2 Movement (19/10)
- R. Happy Wanderer
- S. Teddy Bear's Picnic



No. 3152

KIT 6/11

CHALET MUSICAL CIGARETTE BOX.

Musical Movement No. 1, 18/3 extra.

Hundreds of exciting projects in HOBBIES' 1958 ANNUAL. Only 2/-, from Newsagents, etc., or by post 2/3.

To Hobbies Ltd., Dept. 072, Dereham, Norfolk. Please send (post free) items marked X.

- Kit No.
- Musical Movement (N, O etc.).....
- Hobbies' 1958 Annual (2/3)

NAME

ADDRESS

(Continued from page 104)

of people over a large area and as they concluded, Captain Mantell had never heard of, or seen, a "Skyhook" balloon, and died trying to reach its altitude which was far above his ceiling.

Also as regards Venus and the above case, Venus was in the sky but low at the time and was six times as bright as the surrounding sky. It is practically impossible to see a pinpoint of light at that brightness in daylight with the naked eye.

The whole findings on U.F.O.s by the project, was that 26 per cent. of the reliable reports they evaluated were "unknowns" and being classified as unknowns means they could not be accounted for by anything we know—which is different to a recent R.A.F. statement on Flying Saucers which said All objects seen can be identified as natural phenomena, hoaxes, clouds, miss-identification of aircraft, etc.—D. HARVEY (Essex).

Dexion in Small Quantities

SIR,—We were very interested to read of the home-made work bench described by Mr. E. Rosenstiel (S.W.15) in the September issue of your journal. May we be permitted to correct the statement he makes regarding possible difficulties in obtaining Dexion slotted angle in small quantities of less than 100ft. Our slotted angle products are now readily available in any quantity from distributors situated all over the country.—DEXION LIMITED (N.W.6).

Treating H.S. Steel

SIR,—Re your reply to J. Houfe (Leeds, 11) in the September issue, the following is a method which is foolproof.

To soften high speed steel for cutting or shaping, have at hand plenty of hot fine sand, sufficient to cover well the tool or tools to be softened. Heat the high speed steel slowly to "blood" red, then quicken the heating till the steel is white hot. Immediately bury the white hot steel in the sand and wait until the sand is quite cold.

To rearden the steel, repeat the same heating process exactly and then plunge the steel into a tank of thick oil, preferably whale oil. Care should be taken as the oil may blaze.

Never dip warm or hot high speed steel into water; this practice makes the steel brittle.

If Mr. J. Houfe wishes to cut soft work with high speed steel, the steel can be hardened by holding it in a draught of air.—O. M. ETCHHELLS (Sheffield).

SIR,—I should like to comment on the reader's query "Softening H.S. Steel" in the September issue of PRACTICAL MECHANICS.

This can be done by heating to as high a temperature as can be obtained with ordinary workshop equipment (rather more than a bright red), and quickly burying in plenty of lime, oak or boxwood sawdust. Some old toolroom men prefer the latter.

Very slow cooling is absolutely necessary, and naturally the time taken will vary with the size of the steel concerned. It may be too hot to handle after two days in lime!

Heating to a high temperature, and cooling in air will result in it being almost as hard as quenching in oil, or in an air blast.

High speed steel should never in any circumstances be quenched in water, if it does not fly to pieces it will be a mass of small cracks. Even the cooling of an H.S. lathe tool in water when grinding is frowned on by the makers of high speed steel.—"TOOL ROOM" (Bath).

A Home-made Bottle Dryer

Simply-made from Odds and Ends

SIR,—In reply to N. O. Thwaites (September, "Information Sought"), I submit my suggestions for a bottle dryer.

The device (shown below) consists of a metal tube about 1½ in. dia. × 2ft. 6in. long, into which are soldered six ½ in. dia. pipes 1½ in. long. The ½ in. pipes are provided with a brass pin 1in. long × ½ in. dia. ½ in. from the bottom.

The whole is fastened to a wooden base-board by two clips and the nozzle of an electric hair dryer pushed into the 1½ in. tube and made airtight by means of a rubber sleeve; a piece of an old cycle inner tube will do. The diameter of the hair dryer nozzle will determine the diameter of the large tube—a reducing piece may be required. The bottles stand over the small

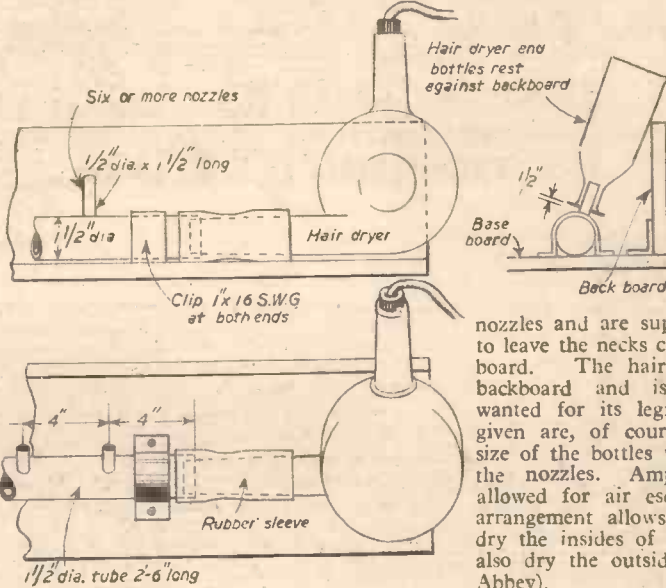

Mr. N. Dean's bottle drying apparatus.

nozzles and are supported by the brass pins to leave the necks clear and rest on the back-board. The hair dryer also rests on the backboard and is easily removed when wanted for its legitimate use. The sizes given are, of course, only nominal as the size of the bottles will determine the size of the nozzles. Ample clearance must be allowed for air escape at the neck. This arrangement allows the blast of hot air to dry the insides of the bottles, the heat will also dry the outsides.—N. DEAN (Waltham Abbey).

I.G.Y. DATA CENTRES

How Some of the Fields of Investigation Have Been Assigned

IN Russia two International Geophysical Year data centres are being set up one in Moscow and the other in Novosibirsk. At Moscow all the information gathered during the 18 months of the Geophysical Year on aurora and airglow, ionosphere physics, solar activity and cosmic rays will be housed.

The fields of meteorology, geomagnetism, longitude and latitude, glaciology, oceanography, seismology and gravity will be dealt with by the Novosibirsk centre.

A third centre is operated by a number of nations in Western Europe and the Pacific and is divided into a number of sub-centres. Geomagnetism is handled by Denmark and Japan, aurora by Sweden and Great Britain, airglow by France and Japan, the ionosphere by Great Britain and Japan, solar activity by Switzerland, Italy, Great Britain, France, Germany and Australia, cosmic rays by Sweden and Japan, glaciology by Great Britain. The World Meteorological Organisation will deal with meteorology. Seismology is covered by the International Central Seismological Bureau, Strasbourg.

The three centres will all exchange data collected.

Measurements and observations will be taken at more than 2,000 stations all over the world by thousands of scientists belonging to 70 nations.

The first step after this vast amount of data has been collected will be its compilation, filing and indexing, so that it is easily accessible.

All the various fields of research will also be investigated in America and universities and scientific organisations all over the country are taking part. In addition the U.S. is launching the earth satellites, which have captured public imagination, and this particular branch of vast fields of research being covered by the I.G.Y. is the project of The National Academy of Sciences.

An Attractive Child's Cot

(Concluded from page 81)

the flap in the upright position, are best fixed after the cot has been painted.

It is well worth the extra small cost to fit 2in. dia. trolley wheels, boring ¾ in. holes 2in. deep into the base of the legs. These wheels can be purchased at any chain store for about 1s. 6d. each.

Mattress Base

The ½ in. × ½ in. fillets are screwed into position flush with the bottom edge of the cot sides and the base made as shown in Fig. 4 using the 2in. × ½ in. softwood, forming halflap joints which can be glued and pinned.

Finishing

All square corners are chamfered and the whole of the finished article glass papered thoroughly. The cot is given two coats of lacquer using whichever pastel colour is preferred. This will make a good background for the animal transfers which can be fixed quite easily in a few minutes.

TRADE NOTES

A Review of New Tools, Equipment, etc.

THE UNILEVEL

The Unilevel and Case.

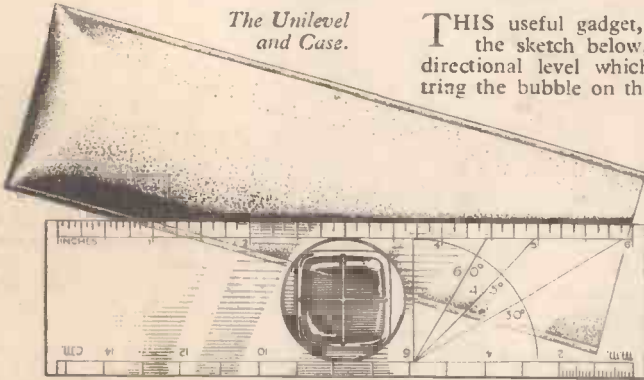

THIS useful gadget, as can be seen from the sketch below, consists of a multi-directional level which is worked by centring the bubble on the crossed wires. The level is set in a transparent plastic rule, graduated in both inches and centimetres. A carrying case is also supplied. The makers are Dorset Light Industries, Ltd., East Street, Bridport, Dorset. The price is 7/6 including postage.

that it is waterproof, resistant to oil, grease, petrol, moulds and fungi, etc., is clean, safe to handle, non-toxic, non-inflammable and does not become brittle with age. Polybond can be used as an integral part of cement and plaster mixes and is supplied in ready-to-use form straight out of the can. The price is 55s. per gallon.

Lightning Hose Clip

THE multi-size, non-strip hose clip shown below is produced by Elms Garage, Birmingham, 31. It is tightened by means of the screw, the thread of which meshes with the rack on the body of the clip. Two sizes only are needed, No. 1 covering from 2in. down and No. 2 covering from 1½in. to 3¼in. Trade prices are: for No. 1, 27s.

Tubular Fixing Collets

MADE by Simplex Products, Lambert's Yard, Hale Road Bridge, Altrincham, Cheshire, the Simplex tubular fixing collets are designed for fixing or straightening any kind of tubular post, e.g., clothes posts, bus stop signs, "halt" and other road signs, safety barriers, etc.

The device consists of two halves form-



The tubular fixing collets.

ing a "split" metal collet which locks together round the post to be fixed by means of locating pins, and completely encircles the post after it has been instated in the usual manner. It is then hammered down to produce the extra rigidity afforded by the "outer" conical shape of the collet wedging itself in the ground. For a leaning post, only one half of the collet need be used.

Special provision is made in each collet so that it may be raised for purposes of reinstating or reclaiming.

The collets are cast in malleable grey steel and treated against corrosion. They are available from stock in standard sizes—2in. at 5s. each (complete) collet and 1s. extra per half inch extra for larger sizes. Any odd sizes will be made to order.

World Oil Map

THE 1957 edition of the Petroleum Information Bureau's Wall Map is now available, price 2s. post free, from the above Bureau at 29, New Bond Street, London,

W.I. The world's oil-producing and refining countries, with relevant statistics for 1956, are shown.

"Polybond"

NEWLY introduced by Corrosion Ltd., 16, Gloucester Place, London, W.1, "Polybond," a plastic adhesive and bonding agent, is described as a universal binder for cement, concrete, bricks, plaster, asbestos, glass, metals, wood, most plastics, slates, tiles, building blocks and boards, fabrics, linoleum, etc.

It is an emulsion, and is thinned only with cold water. The makers claim

for three dozen, and for No. 2 36s. for three dozen.

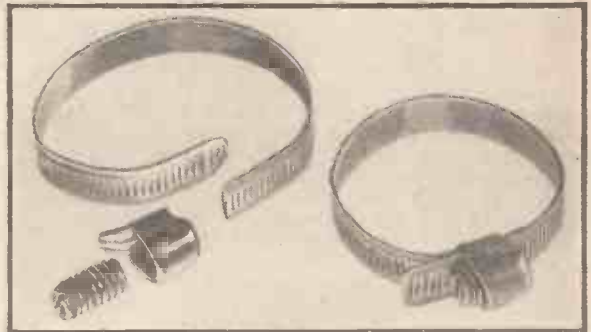

Lightning hose clips

NEW WOLF HIGH SPEED POWER UNIT

WOLF ELECTRIC TOOLS LTD. have announced the introduction of their new Quartermaster Home Power Equipment range.

The specially designed "Quartermaster" high speed power unit has been designed to give both a power "reserve" and a high running speed which is essential for efficient sawing, sanding, buffing, grinding, planing, wire brushing, etc.

The powerful continuously rated motor is of new design and the armature is precision balanced by electronic methods.

The double-pole switch has a trigger of insulating material and is fitted with a retaining button for locking in the "on" position.

The chuck spindle is mounted on a ball-bearing and a grease-packed, high-speed precision needle roller bearing is fitted at the commutator end of the armature shaft. The unit is supplied complete with built-in radio and television suppressors, three-jaw key chuck, chuck key and 5ft. of 3-core T.R.S. cable for £9 9s.

An extensive range of attachments and accessories is available and most of the Wolf Cub equipment can be used with the "Quartermaster" power unit—for bench use with the new QCS Bench Clamp Stand (39s. 6d.).

Literature covering the complete "Quartermaster" range is available from Wolf Electric Tools Ltd., Pioneer Works, Hanger Lane, London, W.5, or from tool merchants and electrical dealers.

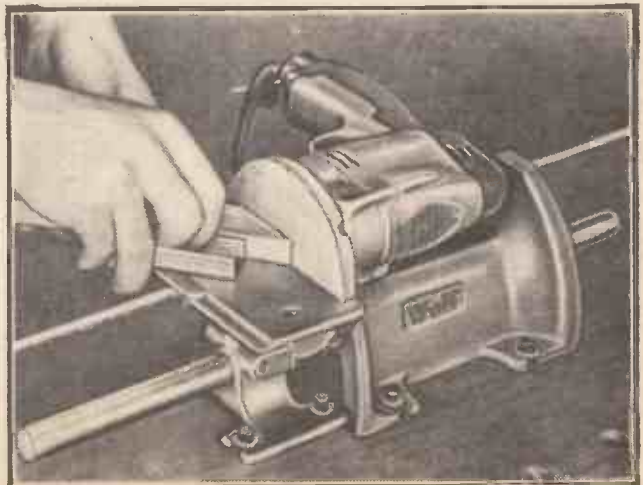

Quartermaster Home Power Equipment.

Your Queries Answered

Transparency Projector

I HAVE a large number of colour transparencies and to show them I want a small, compact back projector, with a screen approximately 12in. square. I have been told the method of getting such a large screen size is by using two mirrors. Is this possible? The transparencies are 35 mm.—W. C. Smith (E.11).

TO obtain a picture 12in. \times 12in. you will require approximately 18in.-24in. between lens and screen, according to actual size of 35mm. frame, and focal-length of lens. A shorter distance would be possible if the lens had a shorter focal length than about 1½in. to 1¼in., but such a lens might not cover the corners of the frame. The required lens-to-screen distance could, of course, be made up by using mirrors so as to reflect the light-rays back and forward, and a smaller containing case would then be possible. The lens should be near the slide. A lens intended for projection is recommended, with a short focal length and large aperture, for maximum brilliance. Some loss of light may be anticipated from the mirrors, which would require to be of high quality, to avoid distortion. A projector lamp would be best, with condenser and reflector. These may be purchased from photographic dealers. The more mirrors used, the smaller may the equipment become, but construction is likely to be difficult. The position and angle of the mirrors can be found by trial. The simplest method would be to use one mirror only, at the back of the box, reflecting the light forwards to a ground-glass screen on the front.

White Glass-marking Ink

I HAVE a constant use for small quantities of a white glass-marking ink and use at present a commercial preparation. Unfortunately the solvent in the preparation dries out rapidly and the solid content of the ink becomes unusable in a week or so, depending on how long the cap is off during use. There is no local stockist, and to get a single bottle entails a delay of two weeks or more.

Could you suggest a formula which could be made up as required? I do not wish to etch the glass. An ink which dries fairly rapidly when applied to the glass with a pen would be ideal.—E. R. Skinner (Oxford).

FORMULA for white glass-marking ink is as follows: shellac, bleached, 0.080 gms., alcohol, denatured, 0.820 gms., lithopone, dispersed, 0.100 gms.

Filter Unit

I REQUIRE a filter unit of about one foot square to extract dust. Also, what are the possible merits, practicability and level of expense of incorporating a small ultra-violet source in a small air duct for bacteriolytic purposes, that is to say, with a view to more or less sterilising the air current? In each case a small booth is being served by a duct of some 8in. square in section and the air is propelled in this by a fan comparable with the larger type "Ventaxia" window fan.—A. V. Light (S.W.10).

IF complete freedom from airborne bacteria is desired we suggest that you resort to the bactericide known as "Acryl 1," obtainable from Aerosols Ltd., 65, Old Brompton Road, London, S.W.7.

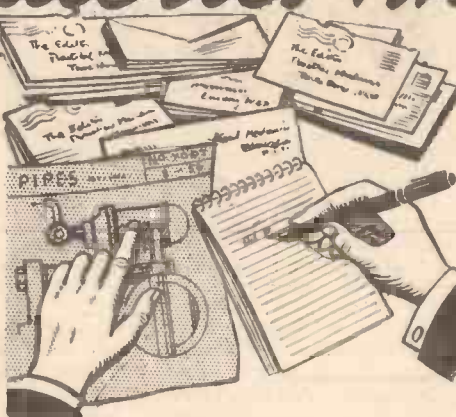

QUERY SERVICE RULES

A stamped, addressed envelope, a sixpenny, crossed postal order, and the query coupon from the current issue, which appears on the inside of back cover, must be enclosed with every letter containing a query. Every query and drawing which is sent must bear the name and address of the reader. Send your queries to the Editor, PRACTICAL MECHANICS, Geo. Newnes, Ltd., Tower House, Southampton Street, Strand, London, W.C.2.

As bacteria present will depend upon the efficiency, or more correctly, lack of efficiency of the air filtering device employed, it will be found, for most practical purposes, that freedom from bacteria can be secured by air

THE P.M. BLUE-PRINT SERVICE

- 12FT. ALL-WOOD CANOE. New Series. No. 1, 4s.*
- 10-WATT MOTOR. New Series. No. 2, 4s.*
- COMPRESSED-AIR MODEL AERO ENGINE. New Series. No. 3, 5s. 6d.*
- AIR RESERVOIR FOR COMPRESSED AIR AERO ENGINE. New Series. No. 3a, 1s. 6d.
- "SPORTS" PEDAL CAR. New Series. No. 4, 5s. 6d.*
- F. J. CAMM'S FLASH STEAM PLANT. New Series. No. 5, 5s. 6d.*
- SYNCHRONOUS ELECTRIC CLOCK. New Series. No. 6, 5s. 6d.*
- ELECTRIC DOOR-CHIME. No. 7, 4s.*
- ASTRONOMICAL TELESCOPE. New Series. Refractor. Object glass 3in. diam. Magnification \times 80. No. 8 (2 sheets), 7s. 6d.*
- CANVAS CANOE. New Series. No. 9, 4s.*
- DIASCOPE. New Series. No. 10, 4s.*
- EPISCOPE. New Series. No. 11, 4s.*
- PANTOGRAPH. New Series. No. 12, 2s.*
- COMPRESSED-AIR PAINT SPRAYING PLANT. New Series. No. 13, 8s.*
- MASTER BATTERY CLOCK.* Blue-prints (2 sheets), 4s. Art board dial for above clock, 1s. 6d.
- OUTBOARD SPEEDBOAT. 11s. per set of three sheets.
- LIGHTWEIGHT MODEL MONOPLANE. Full-size blue-print, 4s.
- P.M. TRAILER CARAVAN. Complete set, 11s.*
- P.M. BATTERY SLAVE CLOCK, 2s. 6d.
- "PRACTICAL TELEVISION" RECEIVER (3 sheets), 11s.
- P.M. CABIN HIGHWING MONOPLANE. 1s. 6d.*
- P.M. TAPE RECORDER* (2 sheets), 5s. 6d.

The above blue-prints are obtainable, post free, from Messrs. George Newnes, Ltd., Tower House, Southampton Street, Strand, W.C.2.

An * denotes constructional details are available free with the blue-prints.

filtering devices of high dust arresting capacity.

Dry fabric filters, such as are made by Vokes Ltd., Henley Park, Guildford, Surrey, should comply with the requirements outlined. However, this firm, as specialists in this field of engineering, are in a position to advise on any problem that is presented for their consideration. The efficiency claimed for the Vokes Dry Filter is 99.98 per cent., which means but little dust passing the filter and, in consequence, small danger of bacterial contamination of the air within the booths.

Concrete Posts

I WISH to make two concrete posts, each to carry a gate 6ft. high, with 5ft. span, made of 3in. \times 2in. wood.

What size posts do you suggest and what strength of mixture?—S. H. Boorer (Kenton).

YOUR concrete posts should have a cross section of not less than 12in., and it would be as well to increase this to 18in. below ground (18in. \times 18in.) and to a depth of 2ft. 6in., so as to give weight and stability. Height above ground can be to your own liking. Reinforce with four vertically placed steel or iron rods as normally used in this practice for each post. Pour a 3:1 mixture of ballast and cement. The shuttering can be done in sections if desired and thus build up to the desired height. There would be no need to soak them if the original slurry is moist enough. Do not have this too sloppy but nicely mobile.

Modernising Old Gilt Picture Frames

CAN you give me instructions on how to modernise gilt picture frames, i.e., light paint with gilt showing through?—T. Rose (Airdrie).

THERE are two ways in which the frames can be treated. If they are old frames which have already been gilded you have only to paint them with a broken white flat oil colour and, with dry soft rags, wipe off the paint from any projecting ornament which you wish to show as gilt. If the original gilding has lost its brilliancy the projecting ornament must first be regilded and then painted over and the paint wiped off. That is one way and the usual way.

The other method is to paint all over with white, or if it is a very quick drying paint, a portion at a time and having obtained a quantity of gold bronze powder lightly touch the relief work with a dry rag which has been dipped in the bronze powder. This must be done whilst the white paint is still tacky so that it will retain the powder. A variation of this method is to make a paint of the bronze by mixing it with cellulose lacquer and applying it by brushing with a soft brush lightly over the ornamental relief work.

Jewellery Mounts

COULD you please give me a short list of metals suitable for mounts for brooches and necklaces and powder compacts? Also the best material for dies for their respective material metal. Could you also tell me what metal is used for untarnishable jewellery?—L. Nuttall (Bolton, Lancs).

THE metal most used in the jewellery trade is brass, with various electro-plated finishes. Powder compacts are almost invariably stamped from brass sheet. Small

parts of intricate contour are, however, sometimes centrifugally cast in an alloy of lead and tin, using vulcanised rubber dies. Some high-grade jewellery items, produced in fairly large quantity, are cast in plaster moulds by the "lost-wax" process. Much of the so-called untarnishable jewellery items now on sale in the big stores—scarf rings, bangles, chain necklaces and the like—is made from aluminium wire which has been given a patented chemical dip treatment to produce the characteristic "rose-gold" colour. A proportion of cheap imported jewellery consists of moulded plastic material which has been electro-plated. Much "hand-crafted" jewellery is made from semi-worked-up material obtainable from craft shops, and we suggest that you get in touch with Fred Aldous, Ltd., Shude Hill, Manchester, if you are desirous of obtaining the same.

Rubber Masks and Animal Heads

PLEASE give me some information on the making and moulding of rubber masks and animals heads.—Eugène B. Chape (Coves, I. o W.).

UNLESS you are specially equipped for the purpose, you will not be well advised to attempt rubber moulding, which cannot be performed without heavy presses, steel moulds, and a steam-raising installation.

It seems to us very probable that flexible masks well suited to your purpose might be moulded from one of the newer plastic materials, which are more adaptable to small-scale operations. We suggest, therefore, that you contact suppliers of such materials, stating exactly what you propose to produce, for there is a very wide range of possible materials, and without exact knowledge of the product even the manufacturers will not be able to give you their best service. The two following firms may be able to help you:

I.C.I. Ltd., Plastics Division, Black Fan Road, Welwyn, Herts.

Scott Bader & Co. Ltd., 109, Kingsway, London, W.C.2.

Copper Plating

IN copper deposition, can the plating bath be switched off at night without spoiling the object? Can the plating time be speeded up in any way?—E. G. Swann (Tunbridge Wells).

IT is not essential to complete the plating in one continuous operation. Maximum plating rate, and minimum plating time, are obtained by using maximum current. However, the current should be kept at a very low value until the copper "flush" spreads over the work and, in any case, we suggest that it be limited to about 1.5 amps per square decimetre. Excess current may cause brownish, rough patches, particularly on edges and projections.

Installing Power Socket

HAVING built an additional room to my house I intend installing a plug in it for a kettle and iron. Could the supply for the room plug be taken from the one in the kitchen by connecting them in series? Where could I get pole finding paper or a neon tester?—L. Doyle (Danesfort, Eire).

WE are not familiar with the regulations of your local electric supply authority, but would make the following suggestions. If the original socket outlet was rated at not more than 15 amps it should not be connected to another socket outlet unless the current rating of the cables supplying the original socket outlet is equal to the current

rating of both socket outlets. In this respect it should be noted that a cable having conductors of 7 strands of copper wire of 0.029 in. diameter is rated at 15 amps only. However, cables rated at 10 amps, say, can supply two 5 amp socket outlets connected together in parallel.

The best system is to use three leads from the new socket outlet back to the supply point, supplying the two leads through separate fuses; or supplying the "live" side through a fuse only if the neutral point of the supply system is permanently and effectively connected to earth.

Neon test lamps are obtainable from: Runbaken Ltd., Deansgate, Manchester, 1. Neo Electrical Industries Ltd., Manchester, 4.

Pole finding paper may be obtained from Messrs. Armstrong & Co., Woodchurch, Ashford, Kent.

Model Yacht Steering Gear

CAN you please give me details of the general layout of a system of automatic steering for a model sailing yacht?—G. W. Burke (Bournemouth).

THE sketch below gives all the main details of a system suitable for a model yacht; this is a much simplified version of the Braine steering gear. A complete set of parts for assembling the Braine steering gear are available from Messrs. Bassett Lowke, 18-25, Kingswell Street, Northampton.

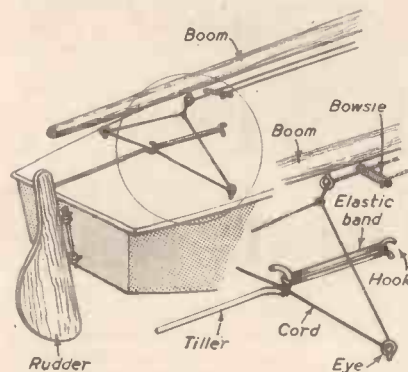

A simplified version of the Braine steering gear.

In the sketch above the elastic band keeps the rudder normally central. The port and starboard sheets are crossed over the deck, passed through screweyes and thence through an eyelet in the boom of the sail.

If the sail is blown over hard to, say, port by a gust of strong wind, the rudder is automatically put over so as to head the boat off the wind and back on to the correct course. Automatic steering systems should be dealt with more fully in a good book on model boat construction, one of which should be obtainable at your local library.

Rewinding Motor

IN your book "Wire and Wire Gauges" by F. J. Camm, you give in the table of B.S.I. standard sizes of annealed copper wires, current rating, amps at 1,000 per square inch.

Could you please explain how this rating is applied to the current carrying capacity of wires? I wish to rewind a motor taking a current of 0.65 amp, which, according to your book, would be between 21 and 22 gauge. It is obviously impossible to use this gauge of wire and some further information would be greatly appreciated.—B. A. Mugele (Sidcup).

THE table showing the currents which may be carried by various gauges of wire to give a current density of 1,000 amps. per square inch is merely intended as a

guide. It is by no means the universal practice for electrical apparatus to be designed to carry 1,000 amps per square inch.

For example, if you wanted to adopt a current density of 2,000 amps per square inch for conductors which have to carry 0.65 amp, the size of conductor selected would be the same as that required to carry half the current (0.325 amp) with a density of 1,000 amps per square inch, i.e., 24 to 25 s.w.g. To carry 0.63 amp at 3,000 amps per square inch the conductor required would be the same as needed to carry 0.22 amp at 1,000 amps per square inch, i.e., 27 s.w.g.

We presume that the motor is of the induction type and that each of the coils has to carry 0.65 amp, i.e., that the coils in question are in series with each other. In this case you could adopt a current density of 2,000 to 3,000 amps per square inch, say 26 s.w.g.; or 27 s.w.g. if the winding space is very limited. It is, of course, advisable to use the largest size of wire which can be accommodated in the slots with the required number of turns.

In the armature of a high speed series motor of small size a current density of about 6,000 amps per square inch is sometimes used this being permissible on account of the small size and efficient cooling, and also because such motors are often not run for prolonged periods. The armature of a motor has more than one circuit in parallel, generally there are two parallel circuits between the brushes. In this case if the armature current is 0.65 amp, each wire would have to carry 0.325 amp. At 6,000 amps per square inch 35 s.w.g. could be used. Larger wire, would be required in the field coils.

Information Sought

Readers are invited to supply the required information to answer the following queries.

Candle Making

PLEASE tell me where I can obtain moulds for casting candle wax, so that I can make artistic candle novelties in the form of beer mugs, apples, artistic figures, etc.?—P. J. McIvor (Dublin).

Steam Iron Element

I HAVE a steam iron of well-known make, the element of which has burnt out. The duty payable makes it impractical to send it back to the makers and I should be grateful if you would tell me how to replace the element and the substance in which it is embedded myself.—C. J. C. (Ireland).

Painting with Water

I ONCE saw a lecturer who illustrated his talk by means of what was apparently a prepared picture. As he made a point, he would touch the picture with a brush dipped in water and a colour would appear. He continued in this way until the picture was complete. Can you tell me how it was done?—A. H. HASLER (Australia).

Paraffin Flame Refrigerator

I HAVE seen a refrigerator which operates by the use of a paraffin flame, and wish to construct one on these lines. Could you supply me with a diagram of the circuit of the cooling liquid and tell me how it is laid out, and the liquid used?—G. LEWIS (Wilts).

“Unaccustomed as I am —

“I . . . er, er . . . a . . . don't know just what to say on the subject.”

“I wasn't expecting to be called on to speak.”

“Mr. Bell can tell you more about the idea than I can.”

“Er . . . that is not very clear, but that's the best I can do.”



Yet 4 Weeks Later He Swept Them Off Their Feet!

In a daze he slumped to his seat. Failure . . . when a good impression before these men meant so much. Over breakfast next morning his wife noticed his gloomy, preoccupied air.

“What's the trouble dear?”

“Oh . . . nothing, I just fumbled my big chance last night, that's all!”

“John! You don't mean that your big idea didn't catch on!”

“I don't think so. But, Great Scott, I didn't know they were going to let me do the explaining. I outlined it to Bell—he's the public speaker of our Company! I thought he was going to do the talking!”

“But dear, that was so foolish. It was your idea—why let Bell take all the credit? They'll never recognise your ability if you sit back all the time. You really ought to learn how to speak in public!”

“Well, I'm too old to go to a class now. And, besides, I haven't got the time!”

“I've got the answer to that. Where's that magazine? . . . Here—read this. Here's an internationally known institute that offers a home study course in effective speaking. They offer a free booklet entitled *How To Work Wonders With Words*, which tells how any man can develop his natural speaking ability. Why not send for it?”

He did. And a few minutes' reading of this amazing book changed the entire course of John's business career. It showed him how a simple and easy method, in twenty minutes a day, would train him to dominate one man or thousands—convince one man or many—how to talk at business meetings, lodges, banquets, and social affairs. It banished all the mystery and magic of effective speak-

ing and revealed the natural Laws of Conversation that distinguish the powerful speaker from the man who never knows what to say.

Four weeks sped by quickly. His associates were mystified by the change in his attitude. He began for the first time to voice his opinions at business conferences. Fortunately, the opportunity to re-submit his plan occurred a few weeks later. But John, this time, was ready. “Go ahead with the plan,” said the Managing Director, when John had finished his talk. “I get your idea much more clearly now. And I'm creating a new place for you—there's room at the top in our organisation for men who know how to talk!”

And his newly-developed talent has created other advantages for him. He is a sought-after speaker for civic, banquet and lodge affairs. Social leaders compete for his attendance at dinners because he is such an interesting talker. And he lays all the credit for his success to his wife's suggestion—and to the facts contained in this free book—*How To Work Wonders With Words*. For twenty-five years the Speakers' Service has been proving to men that ability to express oneself is the result of training, rather than a natural gift of a chosen few. Any man or woman can absorb and apply quickly the natural Laws of Conversation. With these laws in mind, the faults of timidity, self-consciousness, stage-fright and lack of poise disappear; repressed ideas and thoughts come forth in words that sparkle with brilliance, charm and power.

Have you an open mind? Then send for this free book *How To Work Wonders With Words*. Over 100,000 men and women in

all walks of life have found in this book a key that has opened a veritable floodgate of natural speaking ability. See for yourself how you can become a popular and dominating speaker! Your copy is waiting for you—free—simply for the posting of the coupon.

Send for this Amazing Book

Now Sent

FREE

THE SPEAKERS'
SERVICE

(Dept. PR/ESI)
Marple, Cheshire.

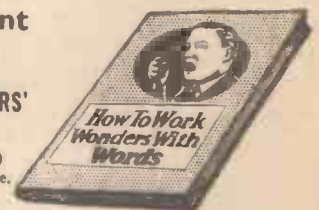

THE SPEAKERS' SERVICE

(Dept. PR/ESI), MARPLE, CHESHIRE.

Please send me my FREE copy of your inspiring book, *How To Work Wonders With Words*, and full details of your methods for speaking effectively.

NAME

(Please use Block Letters)

ADDRESS

.....
If you do not wish to use coupon, apply by letter.

BATTERY CHARGERS



Output up to 22v. 10 amps controlled by two 4-position rotary switches for fine and coarse control. Input 200/250 v. A.C. 50 cy., fused for A.C. & D.C., clear, scaled ammeter. Brand new. £17.10.0. carriage 15/-.

VACUUM PUMP. Brand New. 7 cu. ft. per min. 10 lbs. per sq. in. at 1,300 r.p.m. Rotary Vane type. 22/6 each, post 2/6.

VOLTMETERS for A.C. Mains 50 cy. reading 0 to 300 volts with clear 6in. dial only. 60/- also 2 1/2in. Flush Round type 25/-, post 1/6.

AMMETERS.—2in. Flush Moving. Coil D.C. 50-0-50. 12/6 ea. 2 1/2in. Flush Moving Iron D.C. 0/25. 7/6 each, post 1/6.

CIRCUIT TESTER in wood case 6in. x 6in. x 4in. 2 1/2in. Flush round meter 50 milliamperes, basic movement 10 mA, with leads. 10 ohm pot., provision for 1.5 v. batt. Ideal for conversion. 17/6, post 2/6.

AIR BLOWERS.—230 v. A.C. 57 H.P. 15in. fan. 6in. x 4in. outlet. Brand New. £25. Carr. in England 20/-.

PORTABLE BLOWER.—200/250 v. A.C./D.C. 300 watts with switch and leads. 1 1/2in. outlet. £5. Carriage 7/6.

RELAYS—HIGH SPEED.—1,700 + 1,700 ohms just the job for radio controlled models. 25 - each, post 1/3.



BULKHEAD FITTING. 9in. diam., flat tripod type, suitable for lamps up to 100 watt, complete with pushbar switch lamp-holder. Ideal for farm buildings, garages, greenhouses, etc. Brand new. 17/6, post 2/6.

CHARTBOARDS.—With pantograph arm, perspex scale, protractor head as used in the R.A.F. for navigation purposes. 17in. square. Brand new, will make a useful drawing board. 25/-, post 3/-.

VENT-AXIA FANS. EXTRACTION OR INTAKE.—Brand New. Silent running 200/250 volt A.C. 130-. 12 volt D.C. 90-, post 3/-.

ROTARY CONVERTOR.—Input 24 v. D.C. Output 230 v. A.C. 50 cycles 100 watt, 82/6. also available in metal case with switch. 105/-, carriage 7/6.

TELEPHONES SOUND POWERED. No batteries required. Just connect with twin flex for clear speech. Transmitter Receiver Units. 4/6 ea. Twin Flex. 4id. yd. Post 1/-. If 2 units are connected in series and one used for speaking and one for listening perfect 2-way conversation can be made.

GEARED MOTOR for the model maker. small and very powerful. 12/24 volt D.C. 4/3 r.p.m. 35/-, post 2/6. Will work from 230 v. A.C. mains with our transformer and rectifier. 17/- extra.

TELEPHONE SETS. MODERN DEK TYPE.—£5.17.6 per pair complete.

WALL TYPE also available. 2 complete units £5. Batteries 5/6. Twin Wire 2d. per yd.

MOTOR.—12 volt D.C. 1 1/2in. x 2in. approx. 3,000 r.p.m. with speed regulator in end cap. A precision job. 12/6, post 1/6.

VARIABLE RESISTANCE.—160 ohms, 2 amps. on 10in. Twin Ceramic formers with control handle. Suitable for dimming, etc. 35/-, post 2/9. Also 500 ohms 1.5 amp Log. 50/-.

CROSS POINTER METER with 2 separate 100 microamp movements. Brand New, 22/6, post 2/-.

VOLTMETERS, D.C.—0-20, 0-40, or 0-300, 2in. Flush, 10/6 each, post 1/6.

SWITCHES.—A row of 5 in a flush mounting bakelite moulding 5 1/2in. x 1 1/2in. x 2in. Ideal for model railways. 5/6, post 1/6.

H.E. ADPHONES.—High resistance, 4,000 ohms. Type CHR. 12/6 pr. Post 1/6.

HEADPHONES.—High resistance, very sensitive Balanced Armature. Type DHR. 17/6 pr. Post 1/6.

ROOM THERMOSTAT.—Adjustable 45 to 75 deg. Fahr. 250 volts 10 amp. A.C. Ideal for greenhouses. 24/6, post 2/-.

THERMOSTAT.—For frost protection, on at 34 deg. F., off at 49 deg. F., 11 amps. at 250 volts, adjustable, 4/6, post 1/-.

INSPECTION LAMP.—Fits on forehead, leaving hands free. battery case clips on belt. 7/6, post 1/6. Takes E.R. Battery No. 1215. 2/9, post 9d.

THRUST RACES.—13 1/2in. x 3 1/2in., 1/6. 15/- doz., post free.

L. WILKINSON (CROYDON) LTD.
19 Lansdowne Road, Croydon.
Phone: CRO 0839

You can depend on



SET NUMBER 535T

CYCLE DYNAMO LIGHTING SETS

... for complete reliability under all conditions. The set illustrated is a most up-to-date ultra Lightweight Model (the headlamp weighs only 5 1/2 oz.), it's the perfect answer for the modern cyclist who wants light without weight. Neat, compact and finished in chromium plate throughout it costs only 35/- complete.

H. MILLER & CO., LTD · ASTON BROOK ST · BIRMINGHAM, 6

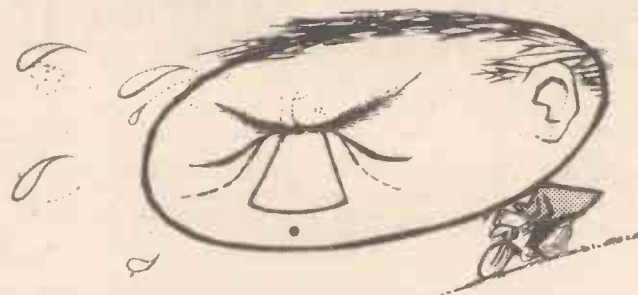

Do you pedal Downhill..?

—or do you replace the ball-bearings

B.M.B. "Ballpaks"



are clean and easy to handle. Each Ballpak contains more than sufficient high grade steel balls of the right size for hubs, pedals, brackets or head. Happy effortless cycling depends on maintenance—which includes regular replacement of ball-bearings.

TRADE NOTICE.
Genuine B.M.B. Ballpaks bear the famous Trade Mark and contain precision made steel balls only.

B. M. B. Ballpaks are obtainable from Cycle dealers every where.

Price 1/2 each



B.M.B. (Sales) Ltd HIGH STREET · CRAWLEY · SUSSEX

GALPINS ELECTRICAL STORES

408 HIGH ST. LEWISHAM LONDON, S.E.13

PLEASE NOTE :

I have now closed down my business in retirement.

Will all my customers, past and present, please accept my sincere thanks for their support and custom over the past many years and I can assure you that all future customers for transformers will receive full service and satisfaction from my successor given below.

From yours most respectfully,
E. J. GALPIN.

PLEASE NOTE :

All transformers as offered by the late Galpins Electrical Stores or special quotations can be obtained from my chief winder who has taken over this section of my business.

Please order, write or phone to

JEFFERY TRANSFORMER CO.

199 EDWARD ST. NEW CROSS LONDON, S.E.14
Phone : TID 4458



VOL. XXVI

NOVEMBER, 1957

No. 424

All letters should be addressed to the Editor, "THE CYCLIST," George Newnes, Ltd., Tower House, Southampton Street, Strand, London, W.C.2

Phone: Temple Bar 4363
Telegrams: Newnes, Rand, London

WHAT I THINK

By F. J. C.

The Late Sir Edmund Crane

THE late Sir Edmund Crane (Ted Crane to most of us) was a quite remarkable man. From a very humble start in the cycle industry, with a capital of a few pounds, his business expanded to the point where he was able to sell it for over three millions. His machines were sturdily built mainly for the utility cyclist, and he preferred to paddle his own canoe rather than be tied in his business methods to those which had been laid down by older established manufacturers through their union. Instead of exhibiting his bicycles at the Cycle Show, he preferred to run his own exhibition at the same time, for he was not then a member of the Manufacturers' Union, and membership was necessary before a manufacturer could be permitted to exhibit. The company was taken over by Tube Investments Ltd. and they continued to manufacture the Hercules bicycle.

He commenced making bicycles in 1911 with his brother Harry, with a capital of £25, and they worked for 16 hours a day in a three-roomed cottage, as self-employed persons. Their first week's output was about 20 machines. Edmund did the material buying and the selling of the machines. By 1922 they had opened a larger factory at Aston, and the output had increased to 20,000 machines annually. This increased until in 1939 they had made 6,000,000 bicycles. Thus passes another manufacturing pioneer. Although he was a member of the Centenary Club, and occasionally went on their cycling pilgrimages, it cannot be said that he was a keen cyclist, either as a tourist or time trialist. His main interest was business, at which he was remarkably successful.

The Lighting Laws

CYCLISTS should see that their machines comply with the law as it relates to lighting, specified in the Road Transport Lighting Acts, 1927/53, under which many new regulations have been made. The 1954 regulations, for example, make it compulsory that bicycles with or without a sidecar must carry a red rear lamp and a red rear reflector, each of which must be fixed on the centre line or to the off-side and not more than 1ft. 8in. from the extreme rear of the machine. Moreover, the highest point of the illuminated or reflecting surfaces must not exceed 3ft. 6in. from the ground, nor must it be less than 1ft. 3in. from the ground to the lowest part of the surface. In the case of machines such as juvenile bicycles, which are fitted with wheels not more than 1ft. 6in. in diameter, the minimum height is 12in. The reflectors must be fixed squarely to the line of motion, in other words, vertically, and it is compulsory to keep them clean. The law permits a combined reflector glass and

rear lamp. Rear lamps must have an illuminated area not less than 1 1/4 in. in diameter if they are circular. If of any other shape the area must be equivalent. In any case, it must be possible to inscribe a 1 in. diameter circle within the area. Everyone knows that under the 1927 Act a bicycle without a sidecar, as well as tricycles, must show a single white light at the front, and it must be "visible from a reasonable distance." It is also legal that when wheeled by a person on foot they do not need lights if the machine is wheeled as near as possible to the nearside of the road. A machine with a sidecar must have two front lights and may not be wheeled after dark without lights. It is important to remember that a motor-assisted bicycle is not considered as a cycle, the legal definition being that the cycle is a pedal bicycle or a pedal sidecar. Shortly, it will be illegal for a bicycle not to have lights when it is stationary.



Arguments About Braking

THE owner of a scooter was recently prosecuted for having an inefficient front brake. It was stated in evidence that with the brake hard on the machine could still be pushed along the road. It was admitted that his machine was up to manufacturers' standard, but nonetheless, the rider was fined. This means that every rider of that particular make is now liable to prosecution. It seems a pity that the police did not take action against the manufacturers, who are now in the invidious position of being liable to any of their customers for any fines they may pay on the score of poor braking, since there is an implied warranty when you purchase a machine that it complies with the law. In the case quoted, evidence was given that instructors at the Hendon Police College advised that maximum braking pressure should be on the front wheel. This is so contrary to standard practice that I wrote to the Metropolitan Police for supporting evidence, and I was informed that the instructions on braking given to students at the Metropolitan Police Driving School are:

1.—All braking should be carried out when the machine is upright and travelling on a straight course, using both brakes in conjunction with the gearbox.

2.—Select the best portions of the road on which to do firm braking.

3.—If in an emergency you must brake on a bend, use the rear brake only, but lightly and progressively.

4.—Avoid using the front brake when banked over, turning on wet, cambered surfaces or where the road surface is loose, greasy, icy, highly polished or covered with leaves.

5.—On a good, dry surface, at any speed, and for straight ahead braking, the distribution of total braking force required at each wheel to obtain minimum stopping distance is about 75 per cent. front and 25 per cent. rear, but on a slippery road surface maximum deceleration is obtained with a distribution of about 50 per cent. front and 50 per cent. rear. The percentages of braking are slightly different from those shown in the appendix to the report submitted by the Ministry of Transport Committee on Road Safety in 1952, which inquired into the problem of motor cycle accidents and advised measures for their prevention.

I do not think that many pedal cyclists will agree that maximum braking pressure should be applied to the front wheel, and my own rough assessment is that it should be two-thirds to the back wheel and one-third to the front. Perhaps my readers would like to debate the point.

The Cycle Industry

THE industry should adopt a more progressive policy. Bicycle design has been static for the past 40 years. There has been no basic improvement except perhaps in appearance since the original introduction of the safety bicycle. Flamboyant finishes appeal only to teenagers and those with a gipsy-like love for garishness and bright plating.

There is a section of industry—the retailers—who think that it is the price of bicycles which has caused the great drop in sales and they have appealed to the Chancellor of the Exchequer to give the industry some relief on the purchase tax on bicycles.

Now that the industry and its press are interested in mopeds, they should reflect on the judgment or lack of it of those who have severely opposed this vehicle.

Linenfold Panelling

I WAS amused to read the comments of a lady writer who was reporting on a visit to Lord Montagu's museum of bicycles. She was shown round the ancestral home and referred to the "beautiful linenfold panelling." It may have appeared beautiful to her, but perhaps she did not know that linenfold is an imitation panelling which is hung like wallpaper. To me it would seem anachronistic to see this modern imitation panelling in one of the stately homes of England!



Planning Next Year's Tour

Size of Party : The Daily Distance :
Accommodation : Cycle and Equipment

By
E. N. POWELL

THIS is a very wide subject and arrangements will vary a great deal according to several factors—the number in the party, the area to be toured and the capabilities of the riders.

Any cycle in working order can, of course, be used, but it is advisable to avoid both extremes of cycle equipment. A suitable gear and a comfortable position are essentials. A lightweight frame is suitable, but should be equipped with sturdy wheels and tyres. A comfortable saddle and efficient brakes have obvious merits.

Size of the Party

When issuing invitations to join a party



A happy group of tourists.

for a cycle tour, care should be exercised in choosing people with approximately the same views and aims. It would be hopeless to mix "potterers" and "speed merchants" or, say, people interested in cathedrals and others interested in the countryside. Many riders for this reason will only consider touring in pairs, but four is often considered the ideal number. It enables riders to travel side by side and gives everyone a change of companion.

It is worth remembering too that if accommodation is not booked in advance, it may be difficult to find enough beds for a large party. A small party is less of a nuisance to other road users and there is less chance of a disagreement starting a breakaway group.

By the time the party is made up, the area to be toured has usually been decided, and the next step is to meet, bringing all the available maps and guide books covering the area. The maps used should show the contours and be at least four miles to the

interesting tracks and minor roads leading to places which are probably seldom visited. Most of the finest views are situated away from the main roads.

The type of road to be traversed and the hills to be climbed are of paramount importance when estimating the daily ride and this information is only contained on a reliable large-scale map.

The Daily Distance

The greatest mistake in planning a tour is to overestimate the distance which can be comfortably ridden. Most keen cyclists can manage 100 miles in a day comfortably and have probably done so many times in the past, but it would be futile to try to ride this distance every day of a two-week holiday. Apart from the fact that there would be no time to visit the interesting places en

in. ch. A larger scale is even better for the initial planning and a 1 in. to the

mile, or 1 in. to the mile, Ordnance Survey map will give a really accurate and comprehensive picture of the district. A map of this large scale will show a number of

Meals are very often available at the hostel quite reasonably—2s. 6d. for each supper and breakfast. Members are required to do a small job of work in the morning before they leave, which might be sweeping a dormitory, peeling potatoes or perhaps chopping wood or washing up.

There are certain rules to be observed when staying at a youth hostel, but they are few and are certainly not restrictive.

Two of the chief advantages of staying in a hostel are the chance to meet others enjoying the same sort of holiday, fellow travellers who are only too willing to pass on information concerning routes, restaurants, etc., and to be able to join in the communal entertainment of the common room.

"B. and B."

A great variety of accommodation comes under the above abbreviation, and price and facilities available range from simple country cottage accommodation for as little as 7s. 6d. to inn accommodation at 15s. or more. Lists of addresses for bed and breakfast, including prices, are published by the cycling associations.

During the summer months it is advisable to book in advance at both youth hostels and bed and breakfast addresses, particularly at the week-ends.

What to Take

When travelling as a party, it is often possible to cut the amount of baggage carried, by avoiding unnecessary duplication, particularly of tools, spares, etc. Weight should be reduced as much as possible and only necessities carried. A large touring bag should hold everything for a two-week tour.



In the Youth Hostel dining room.

route, the day-by-day fatigue mounts up and the rider would be very tired indeed at the end of the fortnight. For a rider of this calibre, 50 miles per day is quite sufficient and a day or two without any riding at all would probably be found very welcome.

Accommodation

The cycle tourist has choice between two main types of accommodation, the youth hostel and the inn, restaurant or private house offering "bed and breakfast."

The youth hostel is the obvious choice for the tourist travelling on a restricted budget. The annual membership is not high—7s. 6d. for those under 21 and 15s. for those over 21. Members may then purchase a night's sleep for 2s. 6d. per night.

Clothes of nylon and drip-dry fabrics can be washed through and dried overnight and the wearing of these reduces the amount of spare clothing necessary. Never carry any weight in a rucksack when cycling—it becomes very uncomfortable.

SPECIAL OFFER

G.E.C., B.T.H. & WESTINGHOUSE GERMANIUM CRYSTAL DIODES

1/- each Postage 3d.
Diagrams and three Crystal Set Circuits Free with each Diode.

A large purchase of these fully GUARANTEED diode from the manufacturers enables us to make this attractive offer

COPPER INSTRUMENT WIRE ENAMELLED, TINNED, LITZ, COTTON AND SILK COVERED
All gauges available
B.A. SCREWS, NUTS, WASHERS, soldering tags, eyelets and rivets.
EBONITE AND BAKELITE PANELS, TUFNOL ROD, PAXOLIN TYPE COIL FORMERS AND TUBES ALL DIAMETERS

Latest Radio Publications. SEND STAMP FOR LISTS

CRYSTAL SET
INCORPORATING THE SILICON CRYSTAL VALVE
Adjustable Iron Cored Coil

RECEPTION GUARANTEED
Polished wood cabinet, 15/- post 1/3. A REAL CRYSTAL SET NOT A TOY

POST RADIO SUPPLIES
33 Bourne Gardens, London, E.4

THE FAMOUS HARRIS ELECTRIC WELDER

and Complete Kit
For Welding, Soldering, Brazing and metal construction & repairs in the home, on the car or cycle. Instant heat 6,000° F. Works from 6v. or 12v. car battery or transformer from A.C. mains. Complete kit of Welding Tool, 9 ft. cable, clip, carbons, cleaning fluid, fluxes, filler rods, goggles, instructions, hints. Thousands in daily use. As supplied to Depts. of H.M. Government, I.C.I., Standard Telephones, etc. Welds all Metals. Up to one-inch iron. **57/6**
C.O.D. IF REQUIRED.
Terms Available. (Post Free U.K. only)
HARRIS ENGINEERING CO. (Dept. P.M.18)
269 Kingsland Road, London, E.2.

SERIES III NUCLEAVE PRESS

CROPS RIVETS PUNCHES
Ask your Tool Dealer, or send for details to:—
Sole Manufacturers,
FITZNER LTD.
197-199, KINGS ROAD, KINGSTON-ON-THAMES

GENERAL CERT. OF EDUCATION
THE KEY TO SUCCESS & SECURITY
Essential to success in any walk of life! Whatever your age, you can now prepare at home for the important new General Cert. of Education Exam, on "NO PASS—NO FEE" terms. You choose your own subjects—Educational, Commercial or Technical. Recently announced big extension of subjects gives everyone the chance to get this valuable Certificate.
SEND FOR FREE 136 PAGE BOOK
Full details of how you can obtain the General Cert. are given in our 136-page Guide—Free and without obligation. Personal advice on request. Write today, School of Careers, Dept. 189, 29-31, Wright's Lane, London, W.8.
"NO PASS—NO FEE"

Buy this easy way

10/- DEPOSIT

Deposit refunded if not satisfied.

BY POST!

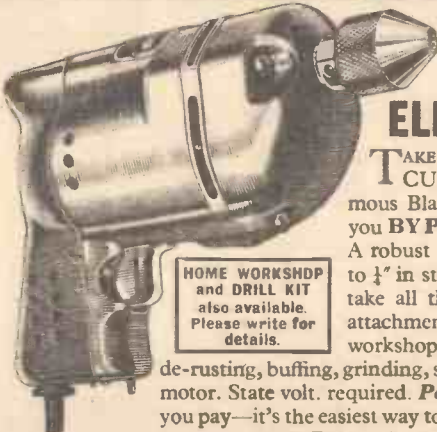

Cash Price **£6.19.6**
Fully guaranteed

1/4 INCH

ELECTRIC DRILL

TAKE advantage of this special CURRYS postal offer. The famous Black & Decker drill sent to you **BY POST** for only 10/- deposit. A robust power unit for drilling up to 1/2" in steel and 1/2" in wood. It will take all the many Black & Decker attachments to complete your home workshop. For sanding, polishing, de-rusting, buffing, grinding, sawing or turning. AC/DC motor. State volt. required. **Postal Terms:** Use it while you pay—it's the easiest way to buy on CURRYS gradual payment terms. Balance by 24 weekly payments of 5/11.

HOME WORKSHOP and DRILL KIT also available. Please write for details.

POST 10/- NOW TO—

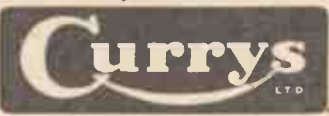

CURRYS LTD., DEPT. B.75
WORTHY PARK,
WINCHESTER, HANTS.
OR FROM ANY CURRYS BRANCH

YOU CAN BUILD YOUR OWN QUALITY TAPE RECORDER



with **ASPEN TAPE DECK and AMPLIFIER KITS**
Tape Decks, 2 Models, 2-speed twin track recording, finest motor, Ferroxcube heads, easy to assemble. All parts machined, drilled and punched. Full assembly drawings.
Compact Model 582, 8in. x 11in., kit, £8.5.0 Built and tested
Standard Model 782, 11in. x 15in., kit, £9.5.0 30/- extra.
RECORD-REPLAY AMPLIFIER KIT, £5.18.0.2 1/2 watt. Neon record indicator, etc.
POWER PACK for above, £2.18.6. Postage and packing extra.
E.D.S. of Nottingham writes:—
"The performance is equal to that of many of the more expensive recorders, and friends who have recorders of their own to whom I've lent some of my recordings are amazed at them."
Send stamp for full particulars to:
W. S. ASPDEN, Electronics, Back Clevedon Road, BLACKPOOL, Lancs.

The Famous "GUEISSAZ" SWISS MUSICAL BOX MOVEMENTS

The ONLY Movement with a 12 Months' Unconditional Guarantee
ONE TUNE, 18 TEETH, 18/- ea.
(As illustrated)
ONE AND TWO TUNE, 22 TEETH, Long playing, 28/- ea.
Movements up to 50 teeth in stock. Also fine quality Cigarette Boxes, Swiss Chalets, Stein Mugs, etc., ready to fit any Movement, from 15/-.
ALSO MANY TYPES OF KITS Including fine Grand Piano kit 33/- in solid Mahogany (Complete with movement), and the 'Mascot' self-winding door chime, 45/- complete.
Delivery by Return — Complete Satisfaction Assured
Illustrated Catalogue 1/- refunded on 1st order.
Send S.A.E. for free tune list.
Shop & Showroom: Woodlands Parade, Feltham Hill Road, Ashford, Middx.
M. MOSS & CO., Dept. PMI, Telephone: ASHFORD (Middlesex) 4465/3382



Develop Your Latent Talents
Pelmanism is Your Best Investment

YOU must have often asked yourself why you don't get what you want out of life. The answer is that your mind is a battle-ground where confidence and inferiority complex strive for control. When confidence has the upper hand things go well for you. In business, in social life, in affairs of the heart, your confidence brings success.

Then why are you not always confident? Over a million men and women have proved that confidence can be increased by Pelmanism and that inferiority complex can be conquered for ever.

Is your enemy here? Amongst the hindrances and troubles swept away for ever by Pelmanism are—

- Worry Procrastination
- Indecision Mind-Wandering
- Frustration Lack of Confidence
- Forgetfulness Unnecessary Fears

When you have cleared your mind of its difficulties and weaknesses, Pelmanism will tune your mind, sharpen and strengthen it and develop many of these stirring qualities—

- Initiative —Ambition
- Originality —Personality
- Concentration —Self-Confidence
- Earning Power —Reliable Memory

All qualities of the utmost value in every walk of life.

Practical Psychology applied to your own needs

Pelmanism is an education not from outside, but from within you. It makes all other education fruitful because it shows you how to use it. Unlike any other form of training, Pelmanism helps you to use all your power, your knowledge and your strength of mind and character, while others can use only a fraction of the dormant ability that they were born with.

The Pelman Course is fully described in a book entitled "The Science of Success" which will be sent to you, gratis and post free, on application to:—

PELMAN INSTITUTE
130, Norfolk Mansions, Wigmore Street, London, W.1
WELbeck 1411

POST THIS COUPON TO-DAY
Pelman Institute, 130, Norfolk Mansions, Wigmore St., London, W.1.
Please send me, gratis and post free, "The Science of Success"
Name
Address

Established over 60 years.
PELMAN (OVERSEAS) INSTITUTES, DELHI: 10 Allipore Road. **MELBOURNE:** 386 Flinders Lane. **DURBAN:** Natal Bank Chambers (P.O. Box 1489). **PARIS:** 176 Boulevard Haussmann **AMSTERDAM:** Prinsengracht 1021.

HIGHSTONE UTILITIES

SOLDERING IRONS. Our new streamlined iron is fitted with a Pencil Bit. 200/250 v. 50 watts, 11/6, post 1/-. Standard Iron with adjustable bit, 200/250 v. 50 watts, 13/6, post 1/-. Heavy Duty Iron, 150 watts, 18/6, post 1/6. All parts replaceable and fully guaranteed. Small Soldering Irons, for use on gas, 1/4, post 8d. Resin-cored solder for easy soldering, 6d. packets or large reels 5/-, post 9d.

EX-R.A.F. 2-valve (2 volt 81), MICROPHONE AMPLIFIERS as used in plane Intercom., in self-contained metal case; can be used to make up a deaf-aid outfit, intercommunication system, or with crystal set; complete with valves and fitting instructions, 20/-, post 3/-. Useful wooden box with partitions to hold amplifier, 2/- extra.

AMPLIFIERS, less valves, but containing resistances, condensers, transformers, switches, etc., 10/-, post 3/-.

SPARKING PLUG NEON TESTERS, with vestpocket clip, 3/3, and with gauge, 3/6, post 4d. S.R.C. Neon Indicator Lamps, for use on mains showing "live" side of switches, etc., 2/6, post 4d. Neon Indicator, complete with condenser (pencil type), with vestpocket clip, indispensable for electricians, etc., 7/6, post 5d.

BELL TRANSFORMERS. These guaranteed transformers work from any A.C. Mains, giving 3, 5, or 8 volts output at 1 amp. operate bulb, buzzer or bell. Will supply light in bedroom or larder, etc. PRICE 9/- post 1/-. **Similar Transformer** but with output of 4, 8 or 12 volts, 13/6, post 1/6. **Transformer** with similar output, but with fused secondary and earth terminals, 18/-, post 1/6. **BELLS** for use with either the above or batteries, 6/6, post 6d. **"Big Ben"** Chimes. Housed in Cream Plastic Case. Easily connected to give Two-Note Chime from Front Door, and Single Note from Rear. Operated from 6-9 volt Batteries or Transformer (shown above), 23/9, post 1/6.

CRYSTAL SETS. Our latest Model is a real radio receiver, which is fitted with a permanent crystal detector. Why not have a set in your own room? 12/6 post 1/-. Spare Permanent Detectors, 2/- each. When ordered separately, 2/6. With clips and screws, 2/10, post 3d. Special Crystal Diodes, 2/6, post 3d. Headphones, brand new, G. Brown, G.C. Brown, etc., 23/-, and super-sensitive, 30/- a pair, post 1/6.

HEADPHONES IN GOOD ORDER, 6/- Better quality, 7/6 and 10/-. Balanced armature type (very sensitive), 13/6. All post 1/6. New Single Earpieces, 3/6. Balanced armature type, 4/6 (two of these will make an intercom. set or Baby Alarm). Ex-R.A.F. earpiece, 2/6, all post 6d. Headphones, with moving coil mike, 15/-. Similar phones with throat mikes, 12/6, post 1/6. **Headphone Cords**, 1/3 a pair, post 3d. **Replacement Bands**, 1/3, post 6d. **Wire Bands**, 6d. (All Headphones listed are suitable for use with our Crystal Sets.)

HAND MICROPHONES with switch in handle and lead, 5/6. **Tannoy**, 7/- Similar instrument, moving coil, 8/6. All post 1/6. **Mask type** with switch, 3/6, post 6d. **Micro Buttons** (carbon), 2/-. **Moving Coil**, 3/6. **Transformers**, 5/-. All post 4d. each. **Throat Mikes**, 5/-. post 7d.

MORSE KEYS.—Standard size keys wired to work Buzzer or Lamp, 3/-, post 8d. Slightly smaller keys, 2/6, post 6d. **BUZZERS**, 4/3, Post 5d.

Terminals, brass 2BA, mounted on strip, 6d. pair. **.0005 Airstaced Variable Condensers**, 2/6, post 6d. **.0003 twin ring** with trimmers, 2/6, post 6d. **24 volt 15 mm. M.E.S. bulbs** for metal railways, etc., 1/- each, 10/- doz., post 4d. **Wander Plugs**, Brass, 1/6 doz., post 4d. **Fuses**,—1 amp 1 1/4 in. packet of 10, 2/6, post 4d. Also 150 mA. and 250 mA., same price. **Ex-G.P.O. Telephone Twin Bells**, with box, 5/-, post 1/6. **Single Telephone Bell**, 3/6, post 9d. **Magnets**, extra strong, 2in., 1/3, post 4d.

TELEPHONE HAND GENERATOR. G.P.O. type, giving 70 volts for ringing bells, etc., 8/6, post 2/-. Telephone hand comb sets, 12/6, post 1/6.

Bargain Parcels of really useful equipment, containing Switches, Meters, Condensers, Resistances, Pipes, etc., 10/- or double assortment, 17/6, creble, 25/-. All carriage 3/-. This country only.

METERS. 20 amp. 2in. m/c, 8/6; 20 v. 2in. m.c. 8/-; 150 v. 2in. m/c, 10/-; 3.5 amp. 2in. T.C., 6/-; 4 amp. 2in. T.C., in case with switch, 9/6; 100 mA. 2in. m/c, 7/6; all post extra. Meter units containing 500 microamp. movements, 9/-, post 1/6. Money refunded if not completely satisfied.

HIGHSTONE UTILITIES

58 New Wanstead, London, E.11

Letters only. New Illustrated List sent on request with 2d. stamp and S.A.E.

T.V. WITHOUT MAINS
PLUS DC LIGHTING AT THE FLICK OF A SWITCH
SPECIAL A.C./D.C. CHOREHORSE (AS SUPPLIED TO B.B.C.)
PETROL/T.V.O. SELF-STARTING

57.10.0
DELIVERY 1048



50% BELOW LIST

AIR COMPRESSORS AND ACCESSORIES
Compressed air equipment to professional standards, compressors only £5.17.6 upwards. Complete Stationary and Portable Plant from £29.17.6 to £134. Full range of Air Receivers Spray Guns and all Accessories.
Teddington Engineering Co., Ltd.,
29-31, High Street, Teddington, Middx. KINGston 1193

MAKE A RADIO

NO SOLDERING—only a screwdriver and pliers required. Easy-to-follow building instructions FREE with each kit. Send stamped, addressed envelope for further details.

"WINNER" CRYSTAL SET. Only 6 screws to fit. Can be built in an hour. **STANDARD kit, 15/6** post free. **DE-LUXE kit, complete** with high-grade headphones, aerial wire, etc., makes ideal present, **£2** post free.

"CONQUEROR" 1-VALVE SET. Receives 20 to 30 stations, 15 screws only to fit. **STANDARD kit, with valve and batteries, £2/2-** post free. **DE-LUXE kit, complete** with high-grade headphones, aerial wire, etc., **66/6** post free.

"CONQUEROR" 2-VALVE SET. For loudspeaker reception. **STANDARD kit, £4/5-** post free, loudspeaker **£1/4-** extra. **DE-LUXE kit, £5/12/6** complete.

HEADPHONES, 4,000 ohm, 18/-; or higher grade, 21/- post free.

Send your order to:
BLANCHARD'S RADIO
(Dept. PD7)
13 Gainford Gardens, Manchester, 10

UNRIVALLED IN ITS CLASS

The E.W. 2 1/2 in. x 10 in. lathe. Model "A" plain lathe, £17/-/- Fully convertible to back gear and screwcutting. Let us quote you. We specialise in this lathe and can still offer best credit terms. All accessories from stock. *Descriptive pamphlet & lists, etc., S.A.E.*

OUTBOARD CLUTCH-BRAKE
Fits on any Motor Shaft 1/2 in. or 1 in. dia. up to 1 1/2 h.p. This unit when fitted in place of normal Pulley on Motor Shaft saves continual starting and stopping of Motor. Suitable for Lathes, Shapers, and other Machine Tools. Price **£6/10-** or **£11/10-** Deposit and five instalments of £1. Carriage and Packing extra. *Details S.A.E.*

3/8in. HIGH-SPEED SENSITIVE POWER BENCH DRILLING MACHINE
Price **£6/10-** net, or 10/- Deposit and six monthly payments of £1, carriage and packing extra. *(S.A.E.) for specification and descriptive pamphlet.*

DRILLS : DRILLS : DRILLS
Sets of Drills and Auger Bits in Wallets and Cases. Competitive prices. Send for details. S.A.E.

WANSTEAD SUPPLY CO.
30 THE BROADWAY, WOODFORD GREEN, E86X

JOHNSON PRINT-A-SNAP PACK



With the Johnson Print-a-Snap pack you can make prints of the family's favourite pictures in a few minutes. No special skill is needed and you can work in any dimly-lit room. You use your own negatives, new or old, and you'll be astounded at the wonderful results you get. Costing only 3/6, post free, the Print-a-Snap pack contains full instructions, printing paper, chemicals and all you need to make 16 2 1/2 x 3 1/2 in. prints or 24 2 1/2 x 2 1/2 in. prints. Printing snap-shots at home is a fascinating and rewarding pastime and is the first big step towards taking up photography as a serious hobby. Why not start TODAY?

ONLY 3/6 POST FREE

Complete the coupon below, send it off with a postal order for 3/6 and you will get this amazing photographic kit plus a FREE BOOKLET on developing and printing, and a Johnson Outfits Leaflet.

BY RETURN POST!

TO : Johnsons of Hendon Ltd. (Dept. 20), Hendon Way, London, N.W. 4
Please forward by return of post the Print-a-Snap Pack for 2 1/2 x 3 1/2 in. or 2 1/2 x 2 1/2 in. negatives (ring round size required), plus your FREE BOOKLET on photographic printing, and the Johnson Outfits Leaflet.

NAME

ADDRESS

(Block capitals please)

I enclose P.O. for 3/6 (made out to Johnsons of Hendon Ltd. and crossed & Co.)

24 v. Blower Motors as used for Hedge Trimmer, 19/6. 10K6/115 12-24 volts as used for car heater, 31/-.

Transformers, input 200/240 v. Sec. capped 3-4-5-6-8-9-10-12-15-18-20-24-30 volts at 2 amps., 23/9, 17-11-5 volts at 5 amps., 23/9, 17-11-5 volts at 1 1/2 amps., 17/9, 7.3 volts, 2 amps., 9/6. 12 months' guarantee. Input 240, Output 16 v. lamp, 14/6. Also Output 200 v. 30 mA. and 6.3 v. 1 1/2 amp., 14/6. 25% Booster Transformers for T.V. Tubes, 14/6.

Selenium Rectifiers F.W. 12-6 volt, 100 mA. 4/-, 1A, 9/-, 3 A., 13/6. 4 A., 18/6. 6 A., 31/6. 16 A., 53/-, 250 v. 100 mA.-H. W., 12/6. 300 mA., 19/6.

Miniature 12 or 6 v. Relays 10 amp. Silver Contacts. SM, DM or SM and B, S.C.O, 9/3.

Special Transformer and F.W. Rectifier for 12 v. 1 A. output, 19/6.

Chrome Vanadium H.S. Steel Twist Drills. Sets of 9, 1/16in. to jin., 3/9. Sets of 7, full size, 6/-, Sets of 13, 10/-, All in wallets.

12 v. Ultra violet bulbs, A.C. or D.C. 5/- Rheostats, 12 v. 1 A., 2/6. 12 v. 5 A., 11/6. New 6 v. or 12 v. Vibrators, 4 Pin, 9/6. Fishing Rod Aerials. Sets of 3, 9/1. Plus 1/9 Rail Carriage. Bases 6/-.

Uniselector Switches 50 point 3 bank 50 v. D.C., 27/-, 12 v. 25P, 3 B., 27/-.

Miniature Model Motors. 12 v. 180 mA., D.C. 2in. x 1 1/2 in., 11/-.

New 24in. "T" Square. Ex M.O.S., 6/6.

Chrome Car Extension Aerials. 1ft. to 4ft., 13/6.

Nife Nickel Batteries. Practically everlasting, 1.2 v. 2.5 A., 2 1/2 in x 3in., 6/6. Ideal for models.

12/24 v. A.C./D.C. Reversible Motors, 1in. x 1/2 in., Spindle 2 1/2 in. x 1 1/2 in., 16/-. Relays. We can supply any D.C. voltage, and Contact Combination. All Carriage Paid in U.K. Lists Sent on Request.

THE RADIO & ELECTRICAL MART
309 Harrow Rd., Wembley, Middx.
Nr. The Triangle.
Telephone : WEMbley 6655.

32-page Booklet on STEAM FOR PROCESS

The Bulletin "Steam for Process" explains in clear words and pictures, most of the things an engineer ought to know about the use of steam for heating and process purposes. Copies free on request.

SPIRAX-SARCO LTD
(TECHNICAL DEPT.)
Cheltenham, Glos.

Wolf Cub ELECTRIC 5' DOWN DRILL



and 6 monthly payments of 24/-
CASH PRICE £6-12-6

This Electric Drill is the power unit for ALL Cub equipment. Drilling capacity: Mild Steel 1 1/4 in.; Hard Wood 1 1/2 in. Complete with 1 1/4 in. three-jaw chuck and Allen key and sft. cable. State voltage. Also available Home Workshop and other kits, all on easy terms.

Order now or send for free literature.

PARK LINES LTD. (Dep't. W28)
717-9 Seven Sisters Rd., N.15. (STA. 9211-3)

SUPER-ADEPT LATHES and Accessories

1 1/2 in. centres, 6in. between
Particulars on receipt of stamp.

F. W. PORTASS MACHINERY TOOLS, LTD.
Adept Works, 141a Nicholson Rd., Heeley, SHEFFIELD, 8.

MAKE SOUND JOINTS SIMPLY BY USING Multicore

ERSIN MULTICORE

Contains 5 cores of extra-active, non-corrosive Ersin Flux. Prevents oxidation and cleans surface oxides.

SIZE 1 CARTON
4 specifications for radio enthusiasts.

5/-

HANDYMAN'S CARTON

Suitable for 200 average joints. 6d.



Wherever precision soldering is essential, manufacturers, engineers and handymen rely on MULTICORE. There's a MULTICORE SOLDER just made for the job you have in hand. Here are some of them.

ARAX MULTICORE

FOR METAL FABRICATION
(Not wire-to-tag joints)

Contains 2 cores of Arax flux—so fast that even blued steel spring can be soldered without pre-cleaning. Flux residue is easily removed with water.

SIZE 8 CARTON
5/-

Handymans Carton 6d.



HOME CONSTRUCTOR'S 2/6 PACK

In addition to the well-known Home Constructors Pack (containing 19ft. of 18 s.w.g. 60/40 alloy) a similar pack is now available containing 40ft. of 22 s.w.g. 60/40 alloy especially suitable for printed circuits.



BIB WIRE STRIPPER AND CUTTER

The 3 in 1 tool. For stripping insulation without nicking wire, cutting without leaving rough edges, and splitting extruded flex. 3/6 each



MULTICORE SOLDERS LTD.,

MULTICORE WORKS, HEMEL HEMPSTEAD, HERTS. (BOXMOOR 3636)

THE "MINOR" 10 in 1

UNIVERSAL WOODWORKER



The "MINOR" lathe carrying a battery of three useful machines, any one of which may be operated without removing the others. ALL powered by ONE sturdy electric motor.



Showing the tilting saw-table with mortiser and planer ready for use. 7 in. saw with 2 1/2 in. cut. FINE, MEDIUM & COARSE SAWS AVAILABLE.



A view of the 4 in. planer with saw and mortiser ready for use.



Combination table being used for panel cutting. Easily adjustable for varying lengths.



Spindle moulding. Cutter block takes the place of the circular saw.



Combination table in use with sanding disc. This table has many uses.



Combination table in use with mortiser. Mortises from 1/4 in. to 5/8 in.

Announcement—See us on Stand 365, BUILDERS EXHIBITION, EMPIRE HALL, OLYMPIA (13th-27th NOVEMBER)

Send Stamp NOW for illustrated brochures to:

CORONET TOOL CO., Dept. PM, Mansfield Rd., DERBY

Over 75 years
experience and world-wide
reputation for quality

THORNTON

DRAWING INSTRUMENTS
MINERVA SERIES PROFESSIONAL QUALITY
TECHSET SERIES STANDARD QUALITY
KINWEST SERIES SCHOOL QUALITY



Write for
illustrated leaflets
and address
of your
nearest stockist to:

A.G. THORNTON LTD.
P.O. BOX 3, WYTHENSHAW, MANCHESTER

MANUFACTURERS OF FIRST QUALITY DRAWING INSTRUMENTS
P.I.C. SLIDE RULES AND DRAWING EQUIPMENT

Published about the 30th of each month by GEORGE NEWNES LIMITED, Tower House, Southampton Street, Strand, London, W.C.2, and Printed in England by W. Speaight & Sons, Exmoor Street, London, W.10. Sole Agents for Australia and New Zealand—Gordon & Gotch (A/sia), Ltd. Sole Agents for South Africa—Central News Agency Ltd. Subscription Rate (including postage): For one year, Inland 20s., Overseas 18s. 6d., Canada 18s. 6d.

"Practical Mechanics" Advice Bureau. **COUPON**
This coupon is available until November 30th, 1957, and must be attached to all letters containing queries together with 6d. Postal Order. A stamped addressed envelope must also be enclosed.
Practical Mechanics. November, 1957.

Free Guide — SUCCESS IN ENGINEERING

One of the following Courses taken quietly at home in your spare time can be the means of securing substantial well-paid promotion in your present calling, or entry into a more congenial career with better prospects.

ENGINEERING, RADIO, AERO, ETC.

Aero. Draughtsmanship	Elec. Draughtsmanship
Jig & Tool Design	Machine " "
Press Tool & Die Design	Automobile " "
Sheet Metalwork	Structural " "
Automobile Repairs	R/F Concrete " "
Garage Management	Structural Engineering
Works M'gmt. & Admin.	Mathematics (all stages)
Practical Foremanship	Radio Technology
Ratefixing & Estimating	Telecommunications
Time & Motion Study	Wiring & Installation
Engineering Inspection	Television
Metallurgy	Radio Servicing
Refrigeration	Gen. Elec. Engineering
Welding (all branches)	Generators & Motors
Maintenance Engineering	Generation & Supply
Steam Engine Technology	Aircraft Mainten. Licences
I.C. Engine Technology	Aerodynamics
Diesel Engine Technology	Electrical Design
Ordnance Survey Dr'ship.	

BUILDING AND STRUCTURAL

L.I.O.B.	A.I.A.S.	A.R.S.H.	M.R.S.H.
A.M.I.P.H.E.	A.A.L.P.A.	A.F.S.	A.R.I.C.S.
Building Construction	Builders' Quantities	Carpentry & Joinery	Building Inspector
Costs & Accounts	Surveying & Levelling	Building Draughtsmanship	Heating and Ventilating
Clerk of Works	Quantity Surveying		

GENERAL, LOCAL GOVERNMENT, ETC.

Gen. Cert. of Education	Common. Prelim. Exam.
Book-keeping (all stages)	A.C.I.S., A.C.C.S.
College of Preceptors	A.C.W.A. (Costing)
Woodwork Teacher	School Attendance Officer
Metalwork Teacher	Health Inspector
Housing Manager (A.I.Hsg.)	Civil Service Exams.

BECOME A DRAUGHTSMAN—LEARN AT HOME AND EARN BIG MONEY

Men and Youths urgently wanted for well paid positions as Draughtsmen, Inspectors, etc., in Aero, Jig and Tool, Press Tool, Electrical, Mechanical and other Branches of Engineering. Practical experience is unnecessary for those who are willing to learn—our Guaranteed "Home Study" courses will get you in. Those already engaged in the General Drawing Office should study some specialised Branch such as Jig and Tool or Press Tool Work and so considerably increase their scope and earning capacity.



★ OVER SEVENTY YEARS OF CONTINUOUS SUCCESS ★

NATIONAL INSTITUTE OF ENGINEERING

(In association with CHAMBERS COLLEGE—Founded 1885)
(Dept. 29)

148, HOLBORN, LONDON, E.C.1

SOUTH AFRICA: E.C.S.A., P.O. BOX NO. 8417, JOHANNESBURG
AUSTRALIA: P.O. BOX NO. 4570, MELBOURNE

132-PAGE BOOK FREE!
SEND FOR YOUR COPY

This remarkable **FREE GUIDE** explains:

- ★ Openings, prospects, salaries, etc., in Draughtsmanship and in all other branches of Engineering and Building.
- ★ How to obtain money-making technical qualifications through special **RAPID FULLY-GUARANTEED COURSES**.

MANY INTERESTING COURSES TO SELECT FROM!

A.M.I.Mech.E., A.M.I.M.I.,
A.M.Brit.I.R.E., A.M.I.P.E.,
A.M.I.C.E., A.M.I.Struct.E.,
A.M.I.Mun.E., M.R.S.H.,
A.M.I.E.D., A.F.R.Ae.S.,
London B.Sc., Degrees.

Fully guaranteed postal courses for all the above and many other examinations and careers. Fully described in the *New Free Guide*.

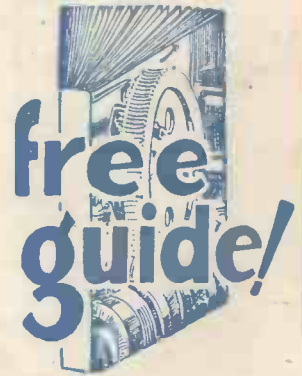

THE ACID TEST OF TUTORIAL EFFICIENCY SUCCESS—OR NO FEE

We definitely guarantee that if you fail to pass the examination for which you are preparing under our guidance, or if you are not satisfied in every way with our tutorial service—then your Tuition Fee will be returned in full and without question. This is surely the acid test of tutorial efficiency.

If you have ambition you must investigate the Tutorial and Employment services we offer. Founded in 1885, our success record is unapproachable.

**ALL TEXTBOOKS ARE SUPPLIED FREE
PROMPT TUTORIAL SERVICE GUARANTEED
NO AGENTS OR TRAVELLERS EMPLOYED**



Free Coupon

To: NATIONAL INSTITUTE OF ENGINEERING
(Dept. 29), 148-150, Holborn, London, E.C.1.

Please Forward your Free Guide to

NAME

ADDRESS

My general interest is in: (1) ENGINEERING
(2) AERO (3) RADIO (4) BUILDING
(5) MUNICIPAL WORK

(Place a cross against the branches in which you are interested.)

The subject of examination in which I am especially interested is

To be filled in where you already have a special preference.
(2½d. stamp only required if unsealed envelope used.)

FOUNDED 1885 - FOREMOST TODAY