

A MODEL OF A RACING CAR

NEWNES

1/-

PRACTICAL MECHANICS

EDITOR : F.J.CAMM

AUGUST 1953



AUGUST,
1953
VOL. XX
No. 236

PRACTICAL MECHANICS

EDITOR
F. J. CAMM

The "Cyclist," "Practical Motorist," and "Home Movies" are temporarily incorporated.

By The Editor

Fair Comment

PERPETUAL MOTION AGAIN

ACCORDING to reports in the newspapers, a Sheffield man claims to have discovered the secret of perpetual motion. I have no details of his invention except this report, which says that he has not yet been able to interest a manufacturer in his ideas, and that he has not actually made a complete machine for demonstration purposes. If we accept the belief that perpetual motion is impossible, we can understand why manufacturers are lukewarm or disinterested. For the Patent Office has on file dozens of inventions for perpetual motion, filed by inventors who have never made the devices. Had they done so they could have saved themselves trouble and patent fees. It must not be thought that the granting of a patent hallmarks the practicability of an idea. It merely gives its owner the exclusive right, for a period of 16 years, to exploit his invention free from competition. I recently carried out an investigation at the Patent Office to ascertain how long patents for perpetual motion had been kept alive by payment of the renewal fees. I did not discover one which had extended beyond two years!

An inspection of the specification and claims showed that, in most cases, the inventors were without the slightest knowledge of the first principles of mechanics, physics and mathematics. Anyone who understands the principle of leverage, for example, would not take out a patent for an unbalanced wheel, which is "constantly correcting its lack of poise and in doing so providing rotary motion." Even if it worked, the power it would develop would be infinitesimal, presuming the impossibility also that as a machine it was 100 per cent. efficient, that is to say, frictionless. All of the inventors, however, did not confine their invention to producing a machine which was 100 per cent. efficient. They claimed to have invented a machine from which more work could be obtained than was put into it. This is such an obvious impossibility that I cannot understand, in view of all that has been written on the subject, that anyone could waste

time on such a project. One inventor claims to have spent over 40 years "perfecting" his device, although no one has seen it working yet!

Perhaps the most famous of the perpetual-motion devices was the Orphyrus Wheel, which the inventor claimed worked for three days in a sealed room. He destroyed it in exasperation after he had failed to convince interested parties that it was not a trick. I strongly suspect that it was. The only details which have been published include a rough sketch which discloses no details. We recently published details of this old hoax in this journal.

Every year or so I receive letters from readers who have rediscovered the unbalanced wheel and the dynamo which drives the motor while the motor drives the dynamo. Regretfully I have to point out that even if the idea were practicable it is not patentable, having become in the passage of the years common property.

One inventor some years ago was so insistent that his unbalanced wheel would work that I made him up a precise model to the closest possible limits. He approved it piece by piece. It was not until the day of demonstration that he was finally convinced of my mathematical arguments which previously he had laughed to scorn.

While suggestions for perpetual-motion devices are interesting for purpose of discussion and as puzzles

as to where the fallacy lies, they should not be taken seriously.

WHAT IS A MACH NUMBER ?

AS aircraft approach higher and higher speeds and are daily the subject of articles in newspapers, the public is introduced to strange technical words which, originally part of the shorthand of the scientist, creep into current usage. Some of these newspaper articles use these words without explaining the meaning to non-technical readers. Such a term is *Mach number*. It is purely the ratio of speed considered divided by the speed of sound, say, 1,100ft. per second. The closer this number approaches unity or 1.0 the more it is obvious, that the original aerodynamic theory of the incompressibility of fluids applies.

Most valuable data on the possible behaviour of full-size aircraft is now obtained from tests on models in a wind tunnel and any possible bad features of design can be discerned and remedied at an early stage in the design. By means of a wind tunnel parts of an aircraft can also be tested—parts such as wing sections and fuselages, undercarriages and struts.

The basic aerodynamic theory of the flow of fluids round a body is based on the belief that the fluid is frictionless and incompressible and calculations based on this theory predict with reasonable accuracy the forces acting on it. Air, however, is not frictionless nor incompressible and the theory is, therefore, not exact. Adjustments need to be made in the formulæ. It is here that Mach numbers are a help. The critical Mach number of a body is that at which the velocity somewhere on the body first reaches the local speed of sound. At a Mach number just in excess of this critical value shock waves develop and with still further increase the shock waves cause what is known as flow break-away and rapid changes in drag, lift and pitching moment follow as a consequence.

In an article which we shall publish shortly dealing with the sound barrier, the value of Mach numbers will be explained in greater detail.—F. J. C.

SUBSCRIPTION RATES

including postage for one year

Inland	14s. per annum.
Abroad	14s. per annum.
Canada	13s. per annum.

Editorial and Advertisement Office: "Practical Mechanics," George Newnes, Ltd., Tower House, Southampton Street, Strand, W.C.2
Phone: Temple Bar 4363

Telegrams: Newnes, Rand, London.

Registered at the G.P.O. for transmission by Canadian Magazine Post.

Copyright in all drawings, photographs and articles published in "Practical Mechanics" is specially reserved throughout the countries signatory to the Berne Convention and the U.S.A. Reproductions or imitations of any of these are therefore expressly forbidden.

A MODEL of a RACING CAR

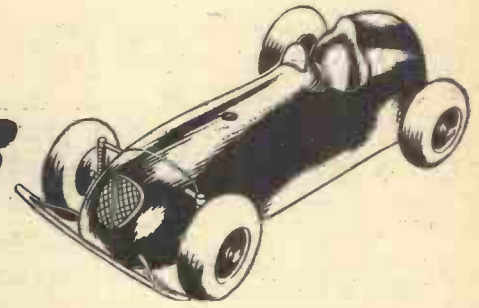

Constructional Details of a Realistic Model Powered by a Spring-driven Unit

By P. F. HAMM

IN the process of designing a working model several ideas on a single subject often present themselves. Their respective merits are considered and one selected for use. The writer has tried in the space at his disposal to record the alternative systems which could have been employed in the subject of this article.

Only the method used is considered in detail as it is not intended that they should be interchangeable, but more to illustrate the principles involved.

Chassis

Bend two lengths of 5/16in. O.D. duralumin tube to the shape shown at B in Fig. 1a. Plug the front ends tightly with plug C. Form the rear springs as in Fig. 4: it should be possible to do this without having to temper the steel. Insert into the rear plugs and force both into the ends of the chassis-tubes. Drill all plugs transversely 1/4in., carefully, to ensure accurate alignment when the cross ties are fitted. The chassis plate A (Fig. 1), cut from 1/16in. dural sheet, serves to mount the power unit, etc. Fix to the chassis with clips G. It is preferable to drill the various fixing holes as required to avoid inaccuracies which might otherwise creep in.

With suitable modifications I-section dural could have been used in place of tubing, or a flange formed on the chassis plate edges to give the necessary strength.

Front Suspension

All parts are shown in Fig. 2. An

accurate and polished fit between the sliding parts B and E is essential for sensitive response. The three parts D, E and F com-

prising each sliding member should be silver soldered and burnished. As the springs will expand a little wind on a mandrel slightly

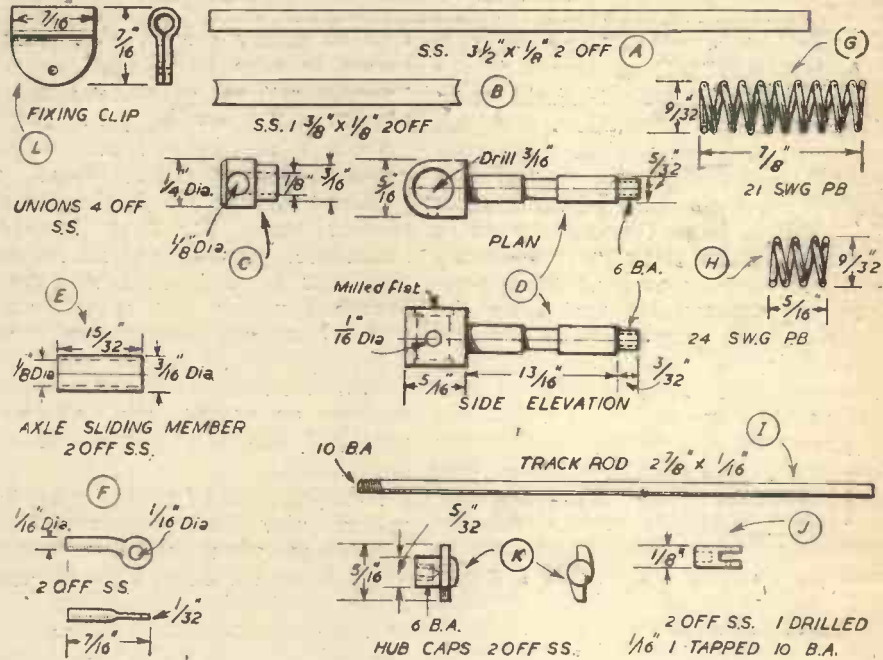

Fig. 2.—Details of front suspension unit.

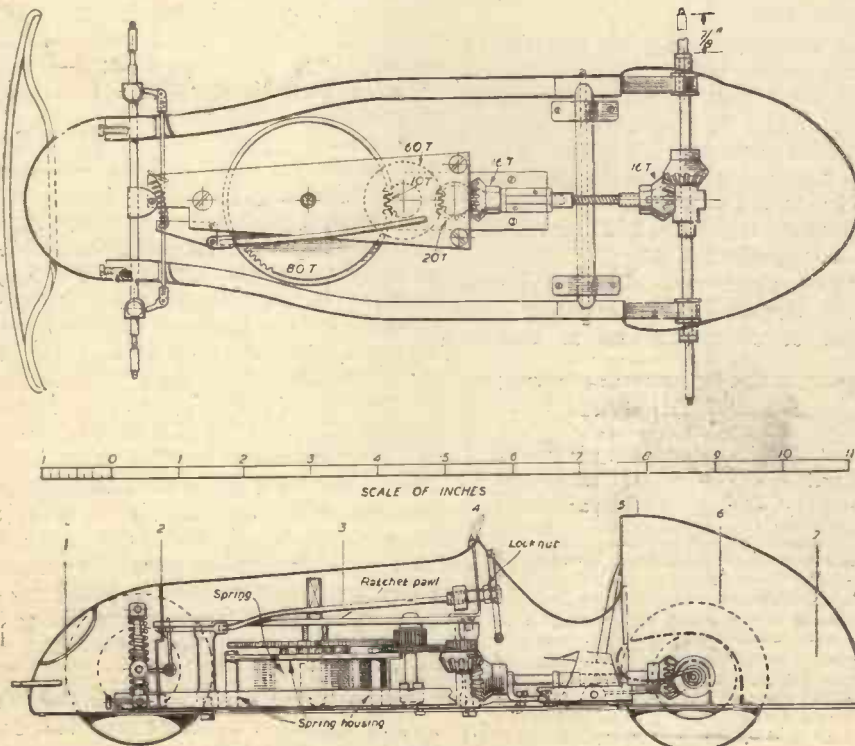

Fig. 1.—Plan and sectional elevation, showing the general layout.

smaller than the required diameter, using a hand drill or lathe to do so. Do not wind close and extend, but to the correct pitch. Assemble the box-like structure, lay on a flat surface and soft solder the upper two junctions. Insert the lower rod through the holes in the front chassis plugs and lock with 5 B.A. screws. The complete unit can now be fitted together with the springs, under sufficient tension to provide a static position about 1/4in. from the bottom. This form of independent springing was chosen for its simplicity, strength, and attractive appearance. Several types of suspension are drawn in Fig. 5, each having advantages in its own sphere.

Power Unit

This is basically the spring and housing of a large eight-day clock. A ratchet and pawl are fitted to facilitate winding. The gears used have a ratio of 24:1 which provides a performance of approximately 100 yards at 5-6 m.p.h. Matters can be arranged quite simply to accommodate a different ratio, thus enabling the constructor to vary the performance, or make use of existing gears. It is immaterial which way the final gear rotates as the direction of travel will depend on which side of its drive the rear axle bevel is placed. Once having the gear train complete the top and bottom plates need to be made up. It is advisable to employ a jig to find the centre distances. Four strips of metal 2in. by 3/8in.

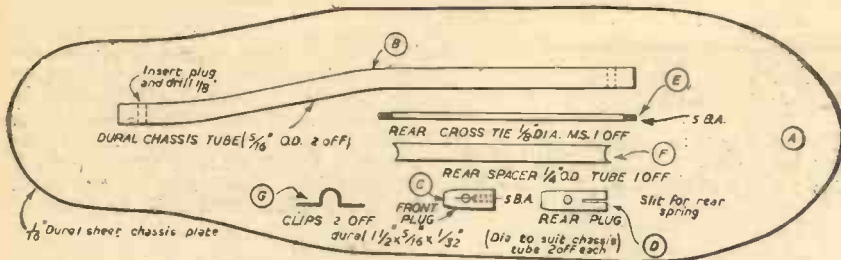

Fig. 1a.—Shape of chassis plate and details of fittings.

Note.—The total length of this top plate is 4½ ins.

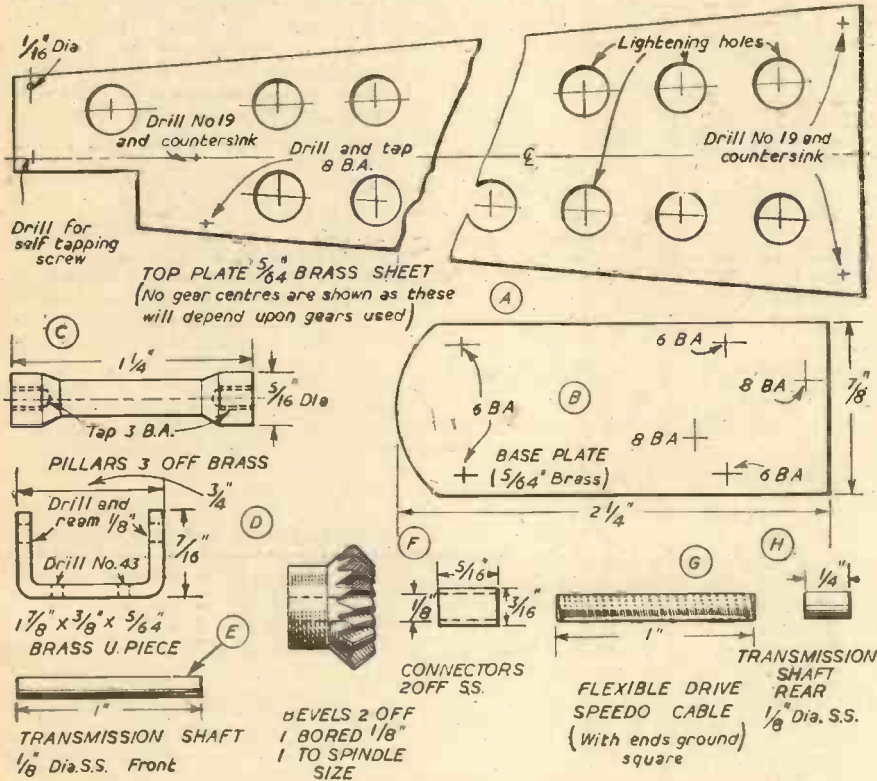

Fig. 3.—Motor bearing plates and transmission components.

are drilled and bolted together in pairs at either end of a threaded rod. Drill the opposite ends to spindle size starting with the smallest, insert a pair of gears and adjust until good meshing with .002in.-.003in. backlash is obtained. When satisfied mark off the centres on to the top plate with a centre punch. After all are marked clamp the top and bottom plates together and drill through, using an undersize drill and reaming to a smooth finish. If any spindle is too short do not extend but build up to it. This makes for rigidity. Fix the lower spring housing to the chassis plate with 4 B.A. machine screws. Align its centre hole with its counterpart in the top plate, clamp them together and drill the pillar fixing holes. Screw the pillars to the chassis plate. Fit the first gear, arbor, and housing omitting the spring, and screw the top plate in position. Careful adjustment with the gears in place will determine the position of the base plate when it can be drilled and screwed down. The gears should be quite vertical and rotate freely and the end gear should have its axis on the centre line. Fit the bevel, but do not secure as yet.

Transmission

This is by shaft drive, as shown in Fig. 1. Other methods which came to mind were:
 1. Chain drive in the horizontal plane running either side of the cockpit, with a sprocket and bevels at the rear. This is a satisfactory way if chain is available.
 2. By a series of idler gears. This is not good as it entails long bearing plates. In

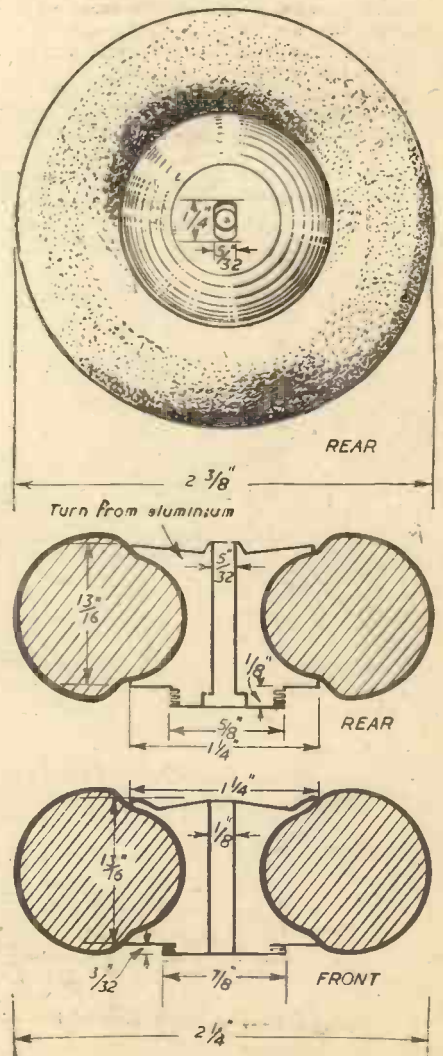

Fig. 6.—Wheels and hubs.



General view of the completed model.

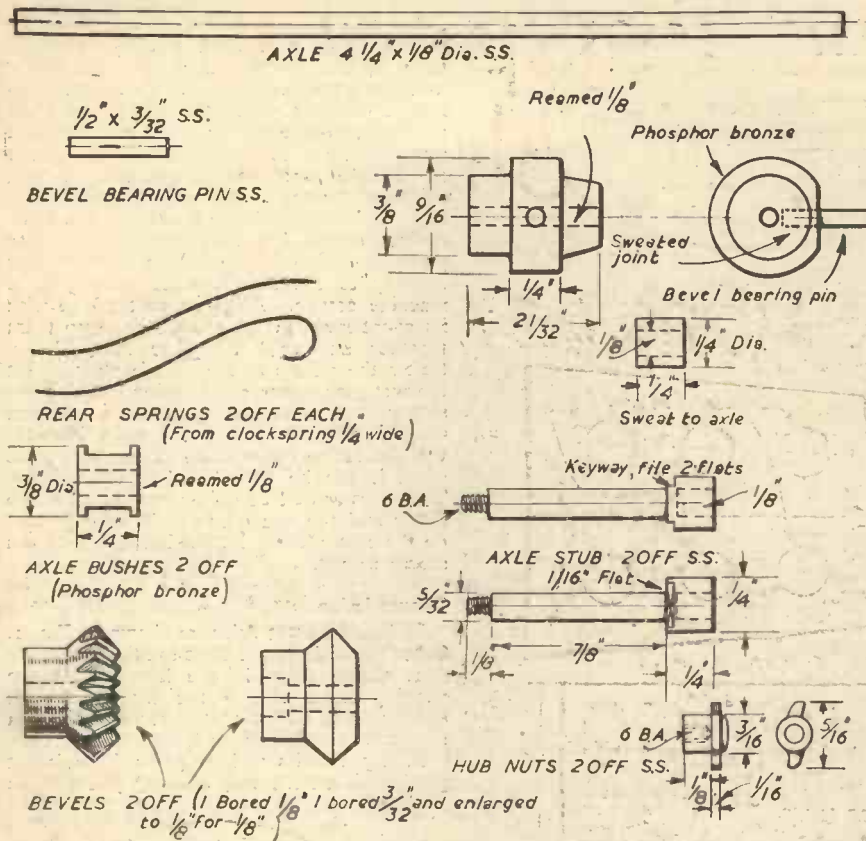

Fig. 4.—Rear axle details.

combination with the type of rear springing used some form of flexible transmission is necessary. To this end a short piece of "speedo" cable was incorporated and proved completely adequate. With certain types of

suspension, i.e., split rear axle, no flexibility is required. It was considered, however, that the track was insufficient to allow this method.

Assuming all parts to be made up, assemble

the U-bracket unit, soldering a bevel on to one end of the shaft E (Fig. 3) and a connector F on to the other, allowing .001in-.002in. endplay. Care should be taken to avoid running solder on to the bearings. Align this unit to the drive bevel and centre line and fix with 6 B.A. machine screws allowing .004-.005in. backlash. Remove drive bevel and gear and solder bevel to its spindle.

Rear Axle

Make up all parts relevant to this unit (Fig. 4) and assemble. Ream all the bearing surfaces. Accurate positioning of the peg is essential for free running. Due to a difference in pivotal point of the axle and transmission shaft, a slight amount of endplay is desirable between the bevels. Obtain this by trimming the transmission shaft H to a suitable length and when satisfactory, soldering in place. Rotation should be quite free.

In place of bevels a conrate wheel and pinion could be employed, both here and at the forward end.

Wheels

Cut a piece of aluminium rod slightly in excess of the hub width and mount on a mandrel. Turn to the section shown in Fig. 6. The curved part is best formed with a handtool. A file suitably ground at its toe will suffice. The keyways on the rear wheels are obtained with drill and scraper or a milling machine if available. The tyres are made by a simple method, using old cycle inner tubing. Find a rod of such a diameter that the cycle tubing needs stretching slightly to pass over it. The length of rubber is best determined by experiment as the wall thickness varies. With the rod inside roll the inner tubing back upon itself until a sufficient diameter is obtained, when it can be rolled off on to the hub. If the surplus rubber is stretched and cut close to the hub the end will retract from sight.

(To be concluded.)

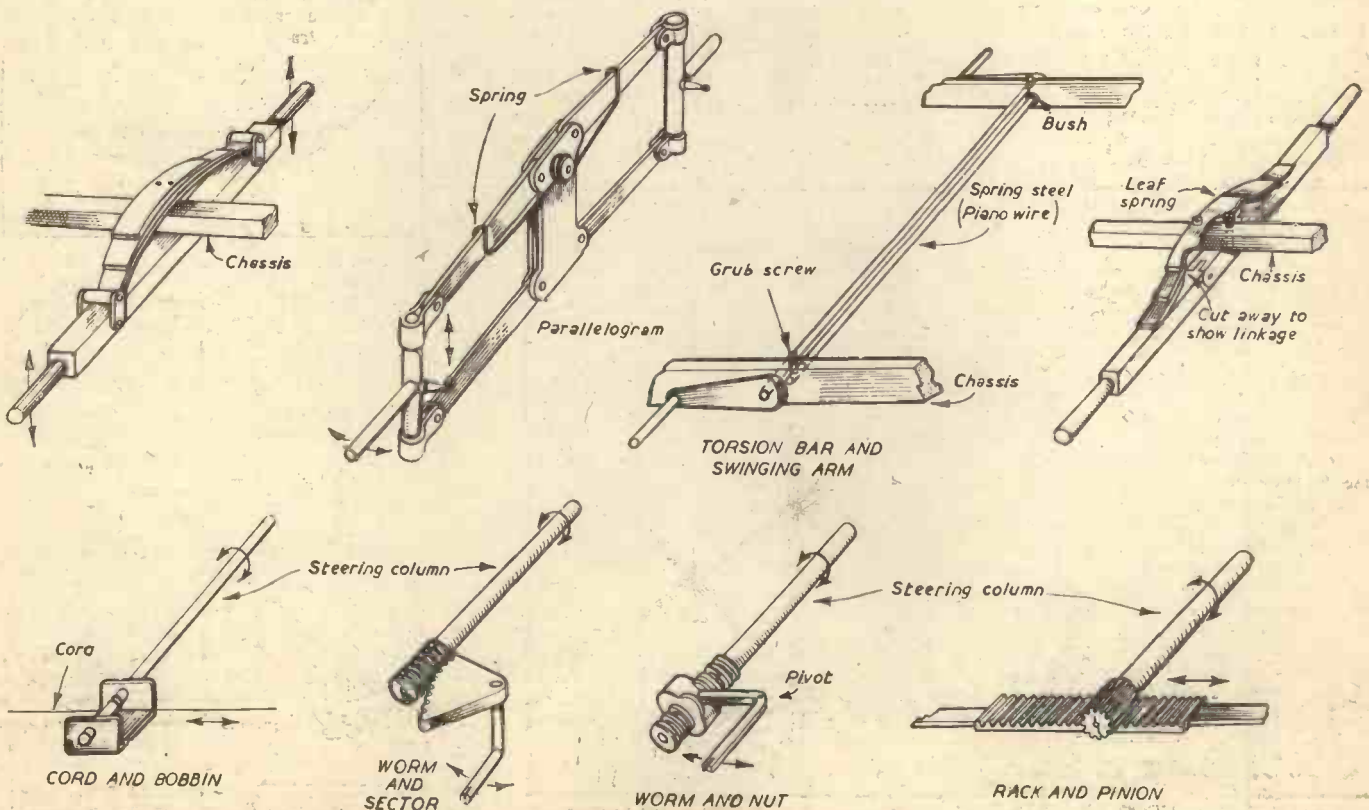
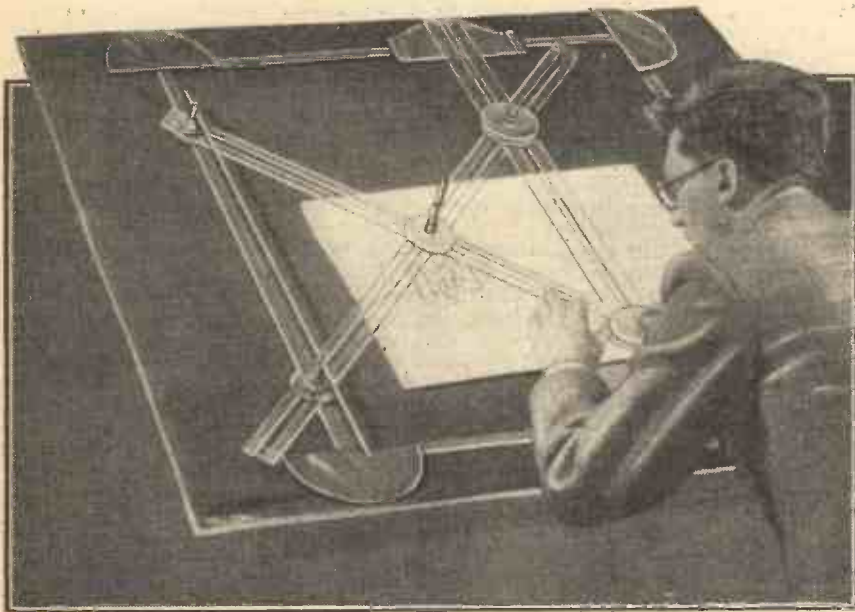

Fig. 5.—Alternative suspension systems and four types of steering mechanism.

Automatic Perspective Drawing Appliance

An Instrument for Producing Perspectives from Plans By K. HAUGHEY



The completed instrument in use.

THERE are several ways of representing pictorially an object having three dimensions. The most important of these projections is undoubtedly the one known as perspective, since it is the only one which concerns itself with actuality. In the past, however, perspective projections have to a certain extent been neglected, principally on account of their complex construction.

The instrument to be described in this article produces automatically, perspective drawing from plans. A knowledge of the rules of perspective may be some advantage to an operator, but such knowledge is not essential.

The instrument is intended for use on a level drawing board. It has a tracer point, and a drawing point connected thereto, by suitable relatively movable linkage. So that movement of the tracer point along the lines of a plan view on the board results in movement of the drawing point, in such a way that a perspective view, corresponding to the plan view, is drawn. Thus, assuming the article to be merely a surface, the drawing point will draw this surface in perspective. The article will generally be a solid, of course, and the surface referred to will therefore be, for example, the top surface of the solid. In order to give solid form to the perspective view, a further perspective view, this time of the bottom surface of the article, may be drawn by the drawing device at a location vertically spaced from the first perspective view. Corresponding corners of the two perspective views may be joined by vertical lines, thus giving solid form to the projection. The relationship of the links to each other and to the board may be adjustable to give a variety of viewpoints, with or without suitable adjustment of the paper on the board. By the use of suitable judgment, and/or measurements, perspective views may

be satisfactorily drawn—not only of simple subjects but complicated ones also.

To describe the instrument in more detail, the appliance consists of a frame and a "T" square (preferably guidable at both ends) which may run smoothly along two opposite sides of the frame. To a third side of the frame the ends of two links are pivoted. These links are allowed to cross, and their intersection is marked by a pivot. The intersections of these links with the "T" square are also marked by pivots. These pivots are displaceable along the members as a result of relative movement between the members. One of the pivots of the "T" square is adapted to carry a tracer point, and the pivot which marks the intersection of the two links is adapted to carry a drawing point.

When employing this appliance for drawing perspective views, one of the pivots on the frame (to which an end of one link is pivoted) is a point known as the *isocentre*, to which imaginary lines project from the

corners of the plan view. The other pivot on the frame is a vanishing point for imaginary lines from points whereat imaginary vertical lines, projected from the corners of the plan view, meet a line normal thereto.

The foregoing and other features of the instrument are incorporated in the construction, which is now described in greater detail, with reference to the accompanying diagrams.

Referring now to Fig. 1, the drawing appliance comprises a "T" square 1 guided at each end on a frame, 25, by crossbars, 2, 3, suitably engaging opposite edges, 4a, 4b, of the frame, which is adapted to be placed on a drawing board, 4; the straight edge, 5, of the "T" square has a slot, 6, in it, and has connected to it by pivots a pair of links, 7, 8. Each link, 7, 8, has a slot in it, 9, 10. The links are connected to the straight edge, 5, of the "T" square by pivots, 11, 12, respectively, extending through slots, 9, 10, and the slot, 6. The links, 7, 8, cross each other and are connected at the crossing by a pivot, 13, and the other ends, 14, 15, are arranged for sliding adjustment along the edge, 4c, of the frame, which is at the opposite side of the pivot, 13, to the "T" square. The ends, 14, 15, of the links, 7, 8, are pivoted to slide blocks, 17, 18, which are arranged for sliding along the edge, 4c, of the frame. Adjusting screws, 19, 20, are provided for fixing the blocks in adjusted position.

The pivot, 11, between "T" square and link, 7, carries a tracer point, 21, and the pivot, 13, at the crossing between the links 7, 8, carries a drawing point, 22. Pivot 12 incorporates an adjustable screw which may be secured to the "T" square, but allowing free movement of the link 8.

To take a simple example, suppose that it is desired to draw a perspective view of a rectangular block of which "A" is a plan view already drawn on a sheet of paper, "B" (Figs. 3 and 4), which is fixed on the drawing board, 4. The blocks, 17, 18, are fixed on the frame at the locations "VP" and "ISO," and the tracer point, 21, of the appliance is located, let us say, at one corner of the rectangle, as in Fig. 1, and is moved along the outlines of the rectangle. This results

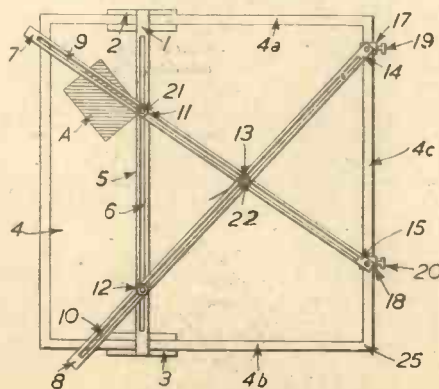

Fig. 1.—A plan view of the instrument.

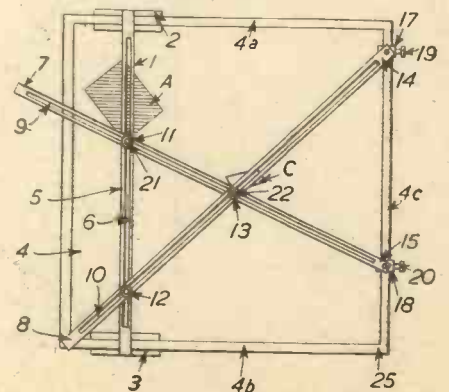

Fig. 2.—A similar view after operating the appliance to draw one line of a perspective view.

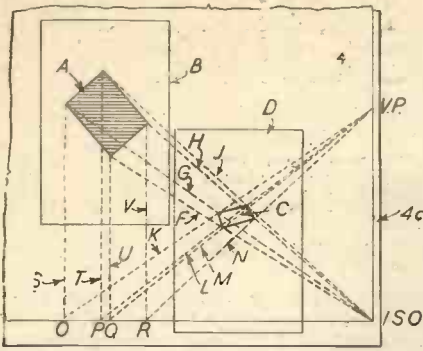

Fig. 3.—A diagrammatical plan view illustrating the principle on which the appliance operates.

in relative movement between the "T" square, 1, and the links, 7, 8, so that the drawing part, 22, draws a quadrilateral "C" (Fig. 2) on another sheet of paper, "D" (Figs. 3 and 4) which corresponds to the rectangle "A" but is smaller and has each pair of opposite sides converging towards its own vanishing point situated on a horizon line which extends through the point "VP" at right angles to the "T" square. This quadrilateral "C" is therefore a perspective view of the top surface of the rectangular block. If now the paper sheet "D" is moved from its initial position shown in Fig.

3 to a higher position shown in Fig. 4, the slide points, 14, 15 (or blocks 17, 18), are similarly adjusted along the edge, 4c, of the frame, and the movements of the appliance repeated, this will result in the drawing point, 22, drawing a further perspective view, "E" (Fig. 4). This quadrilateral "E," however, will have its opposite sides vanishing to the same points as before on the horizon line, such that the perspective view will be of the rectangle "A" at a front higher view point, and thus it will be, in effect, a perspective view of the base surface of the block. Because both the paper "D" and the points 14 and 15 are adjusted, the respective four corners of the two perspectives "C" and "E" will be in vertical alignment, so that at least the three vertical lines, f, g, h, may be drawn in, say by use of the "T" square, to join three of the corners, such that a perspective view of a rectangular block is thus produced.

The theory on which the appliance operates is illustrated in Figs. 3 and 4, from which it will be seen that the four corners of the perspective view "C" are on points of intersection between projected lines F, G, H and J from the corners of the plan view "A," to a vanishing point "ISO" (isocentre) coincident with the slide point 15, and projected lines K, L, M, N, from a point "VP," which is a vanishing point of said lines K, L, M, N from four points O, P, Q,

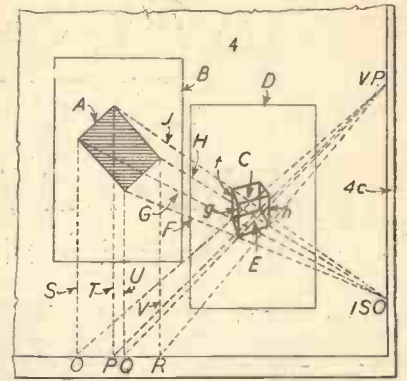

Fig. 4.—A similar view at a later stage in drawing a perspective view.

R, whereat vertical lines S, T, U, V, from the corners of the plan view "A," meet a lower horizontal line which passes through pivot 12 (Fig. 2).

It will be apparent that, by the nature of the instrument, vanishing points on the horizon are not used in the construction. For this reason, view-points which give rise to vanishing points falling well outside the drawing board may be selected without the slightest inconvenience.

Making Sundials

Instructions for Marking Out the Dial and Details of a Simple Alternative Type of Sundial You Can Make

IF you examine a sundial you will find that the angles between the hour lines are all different, and if you could compare dials from different parts of the country you would find the hour angles different. The whole setting-out, upon which the entire accuracy of the dial rests, depends on the latitude of the place.

Finding the Latitude

The latitude will usually be found marked in degrees on the right- and left-hand margins of a map, so that of your own locality may readily be determined quite near enough for our purpose. The following table, however, may be of assistance if a map is not at hand.

LOCALITY	LATITUDE
South Cornwall	50°
Southern Counties generally ...	51°
London	51½°
South Wales, South Midlands, Suffolk, Southern Ireland ...	52°
North Wales, North Midlands, Lincoln	53°
Lancashire and Yorkshire, Isle of Man	54°
Cumberland, Northumberland, Durham, Northern Ireland ...	55°
Glasgow and Edinburgh	56°
Fort William and Aberdeen ...	57°
Sutherland and Caithness	58°

The Gnomon

The first step in constructing the gnomon, or shadow sector, is to set out the triangle ABC (Fig. 1) on a piece of stout sheet brass or iron, being very careful to see that the angle at A is exactly equal to the latitude. The dotted lines show a more elaborately cut shape. The flanges f.f. are to fix the gnomon to the dial, and are bent at right-angles to it.

Marking the Dial

Fig. 2 shows how the dial plate is set out. First, draw the triangle ABC from Fig. 1, and with centre C draw two concentric circles. The inner one has a radius equal to AC, and the outer one a radius equal to AB. The quadrant PQ of the outer circle is now divided into six equal divisions as shown by the points k, l, m, n, o; from these, the radial lines (dotted in the diagram) are drawn to the centre C. These lines cut the inner circle at r, s, t, u, v.

A series of lines parallel with PC are drawn from the points k, l, m, n, o; and a series parallel with CQ from the points r, s, t, u, v. The intersections of these pairs of lines (dotted in Fig. 2) give the points D, E, F, G, H. Thus the line from k, intersecting the line from r, gives the point D, etc.

The fifth lines are now drawn through D, E, F, G and H to C and these are the actual hour lines. The spaces on the outer circle between P and Q may be marked off with dividers on the quadrant QJ. The central-line CQ represents noon, and the gnomon, being fastened by its side AC along CQ, with A at the centre of the circle, will throw a shadow along CQ at midday.

Having completed the setting-out of the hour lines, the whole system can easily be traced upon a horizontal dial of any shape or size. Since the southern half of the dial,

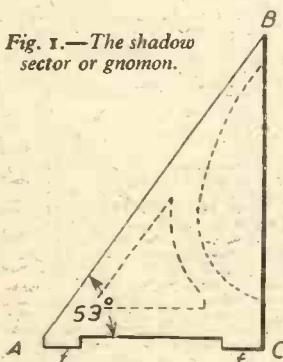

Fig. 1.—The shadow sector or gnomon.

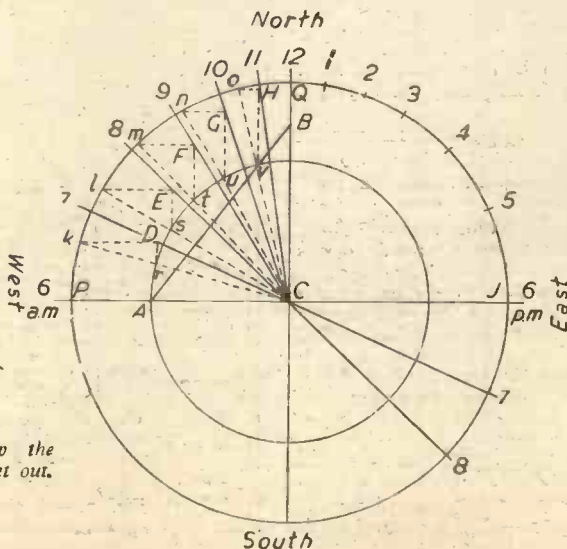

Fig. 2.—How the dial plate is set out.

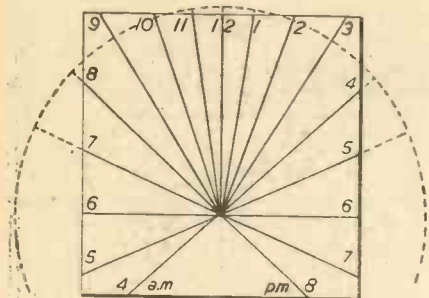

Fig. 3.—The hour lines below the centre of the dial.

latitude. It should be fitted with feet made out of $\frac{1}{2}$ in. sheet brass and soldered on in the position shown in Fig. 4, holes being drilled in the feet for fixing screws. Silver soldering will make a better job than soft soldering if it can be managed.

The Dial

The dial is made from a length of flat brass $\frac{1}{2}$ in. wide, $\frac{1}{4}$ in. thick and about 12 in. long. Round off the ends and engrave the divisions and figures as shown in Fig. 6. The best way to do this is to paint the metal all over with paint or varnish and then scratch away the paint where the lines or figures are bitten into the metal. Instead of using paint or varnish the strip may be made hot, rubbed all over with beeswax and allowed to cool. Whatever you use to cover the brass strip,

to the backbone as shown in Fig. 4, so that the double lines at 12 o'clock correspond with the thickness of the backbone. Solder in position with two angle pieces as shown in Fig. 7.

If the sundial is to be mounted on to a stone pedestal, undercut holes should be made in the stone and filled up with melted lead; then a hole drilled in the lead as big as the core of the screw so as to let the threads of the screw cut into the lead. Round-head brass screws should be used; iron screws would rust away completely in time.

To adjust the sundial it is necessary that the pointer should be arranged parallel to the earth's axis. The angle of the pointer is already correct, and all that remains now is to make it point due north. This is not so easy as might be supposed. The simplest and most effective method is to fix the sundial on a clear starry night, so that the pointer points directly at the pole star. A compass is not reliable for this purpose unless you are able to ascertain the variation, which is considerable. As a rough figure you may say that the sundial should be set about 17 deg. east of north as shown by a compass.

Adjusting the Sundial

It is hardly necessary, however, when fixing the sundial to aim at great accuracy, for even when this result is achieved, the sundial will never keep time accurately as a clock or watch. This is because the sundial shows true solar (i.e., sun) time and the solar day varies in length.

A sundial, of course, takes no account of the daylight saving scheme, and will, therefore, be an hour slow in the summer. There

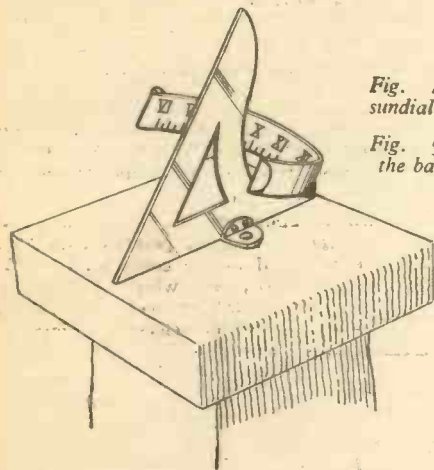
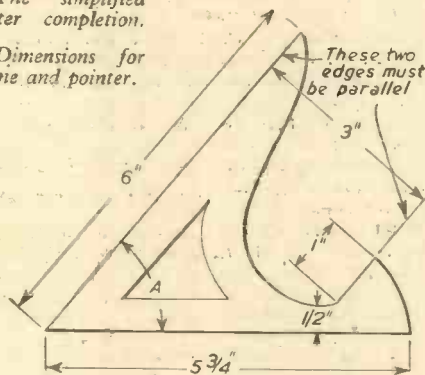

Fig. 4.—The simplified sundial after completion.

Fig. 5.—Dimensions for the backbone and pointer.



representing early morning and late evening, is of lesser importance, the springing point of the hour lines can be below the centre of the dial (Fig. 3). Sheet lead is useful for the dial, as the hour lines and figures can easily be engraved upon it.

Screw the gnomon down firmly on the noon line with the point A exactly at the intersection of the hour lines. Ensure that it is exactly vertical to the plane of the dial. The dial can be mounted on a wooden upright, but a concrete base or a brick pillar give a much better appearance.

It must be fixed at noon. Obtain correct Greenwich time and find the longitude. Suppose the latter to be at 2 deg. W. This means noon is 8 minutes behind Greenwich, so sun noon is at 8 minutes past 12. Turn the dial slightly until the shadow of the gnomon lies exactly along the noon line. Fix the dial firmly in position.

A Simpler Type of Sundial

Sundials may be seen in many forms, the shape and general arrangement varying considerably with the position which they are to occupy. Those on church walls and similar vertical surfaces must have their angles and markings calculated individually, for the pointer or gnomon has to be arranged parallel with the earth's axis, while the plane of the dial depends upon the direction which the wall faces. The angles of the hour markings have to be different in every case. The type about to be described is a much simpler proposition than the usual dial type.

The Backbone

The complete instrument is shown in Fig. 4. First of all make the backbone and pointer in one piece; cut it out of $\frac{1}{2}$ in. thick brass sheet with a fretsaw to the dimensions given in Fig. 5. Only a few dimensions are given but they must be worked to accurately. Where no dimensions are given the pattern may be drawn freehand. As in the type of dial previously described, angle A of the gnomon should correspond exactly to the

try it on a piece of scrap metal first and make sure that it does not chip off when scratched, for if it does this, you will get a rough and ragged result instead of clean sharp edges. Take care to cover the whole of the strip back as well as front.

Etching the Lines

For scratching out the lines a needle point will be rather too fine, but a good tool for the purpose may be made by grinding an edge to a broken piece of hacksaw blade. The lines should be etched into the brass with a solution of iron perchloride. Get about 1 lb. of this (it need not be pure) and dissolve in about half a pint of warm water, it dissolves very easily and makes a very dark coloured solution. You can (if a suitable non-metallic receptacle is available) either immerse the brass rod entirely in the solution or else mop the solution continually over the scratched surface with a camel-hair mop or a "blob" of cotton wool. Do not let the solution splash on to your clothes or it makes "iron mould" stains, which are difficult or impossible to remove. No damage will be done if the solution is wiped off immediately with a thoroughly wet rag. The solution will also make the skin rough and unpleasant if the fingers are dabbled in it freely, but it is not really harmful and a little washing soda will remove the roughness.

The etching solution should be allowed to act for about fifteen minutes and should leave a clean cut line bitten into the brass. Rinse away the iron solution with water, clean off the beeswax or paint with turps, and the brass strip will be ready for bending to its final shape as shown in Fig. 7. The radius should be drawn on a piece of paper with compasses, and the brass bent to follow the drawn line as accurately as possible. The curled ends add a little ornament, but may be omitted if desired.

Fixing the Engraved Strip

The engraved strip should now be fixed

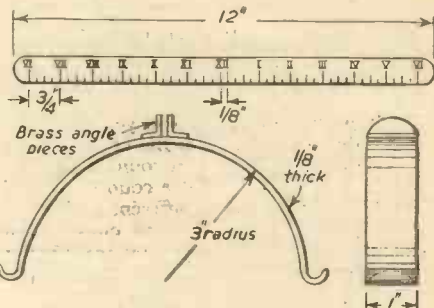

Fig. 6.—How the engraved dial looks.

Fig. 7.—The shape to which the dial is bent and the two angle pieces.

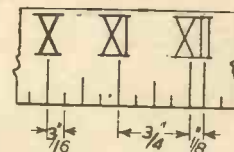

Fig. 8.—A half size view of a portion of the scale.

is no reason, however, why the dial should not be marked to suit "British Summer Time" if the reader wishes. It is only necessary that 12 o'clock should be marked I and one o'clock II, and so on throughout the scale.

FOURTH EDITION.
REFRESHER COURSE
IN
MATHEMATICS
By F. J. CAMM
8/6, by post 9/-

Making An Electric Washing Machine

Constructional Details of an Inexpensive and Labour-saving Appliance

By "HANDYMAN"

THE washing machine described in this article was built mainly of components obtainable from Government disposal stores and odds and ends from the workshop and household. No lathe was available, and it was designed so as to utilise only the simple tools in the possession of the ordinary handyman. The design was also adapted to utilise as much as possible articles and materials that were actually available in the writer's home but, no doubt, other articles and materials can be substituted in many instances.

The cost of the machine will, of course, depend to a large extent upon the amount of material available. The one described cost about £5, but this sum takes into account that most of the timber and plywood used was already in the writer's possession. The cost should normally be well under £10.

The machine was constructed about fifteen months ago, and has since handled, quite adequately, the weekly wash of a family of three persons. There were naturally "teething troubles" to be overcome, but the remedies for these have been incorporated in the description.

Fig. 1 gives a general idea of the arrangement of the machine, which consists of a framework into which is built a wash-tub. In the latter is an agitator which is given a backwards and forwards motion by means of a shaft, working in a gland, through the bottom of the wash-tub and driven by an electric motor.

Framework and Exterior Covering

The frame is composed of 2in. by 2in. timber, mortised so as to form a square cabinet. (This section timber was used because a supply was available, but timber of a smaller section would, no doubt, supply sufficient strength.) The frame consists of four uprights together with top and bottom bars. At approximately one-third of the height, there are four cross-bars, two of which serve to support the wash-tub bearer. The one shown in the diagram is cut away so as to expose the construction behind it.

When all the other work has been completed, plywood paneling can be inserted to complete the sides. Instead of panelling, however, one of the bottom apertures should be fitted with a door to allow easy access to the motor.

Other finishing work which will be required to the cabinet will be the provision of a top and lid. For this pur-

pose, the wash-tub when fitted, should protrude sufficiently above the top of the upper cross-bars to enable it to be flush with a plywood top, cut out so as to take the circumference of the wash-tub. Any cavity between the rim of the plywood top should be made good with plastic wood. To give a neat finish, $\frac{1}{2}$ in. by $\frac{3}{4}$ in. batten can then be fixed round the edges of the top so as to take a square lid made up of $\frac{3}{4}$ in. plywood,

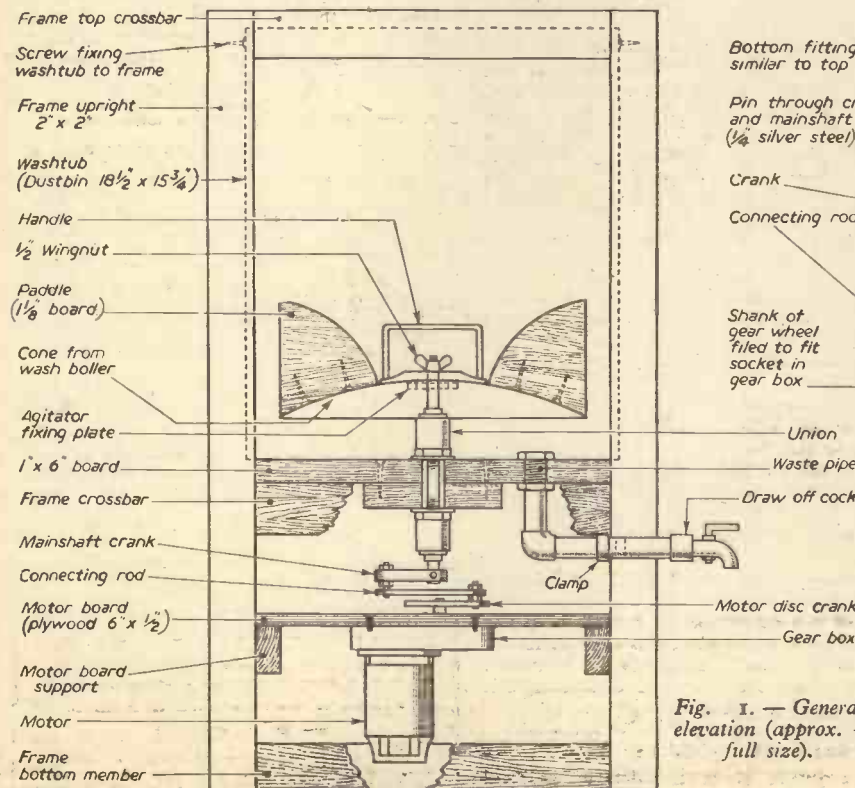

Fig. 1. — General elevation (approx. $\frac{1}{2}$ full size).

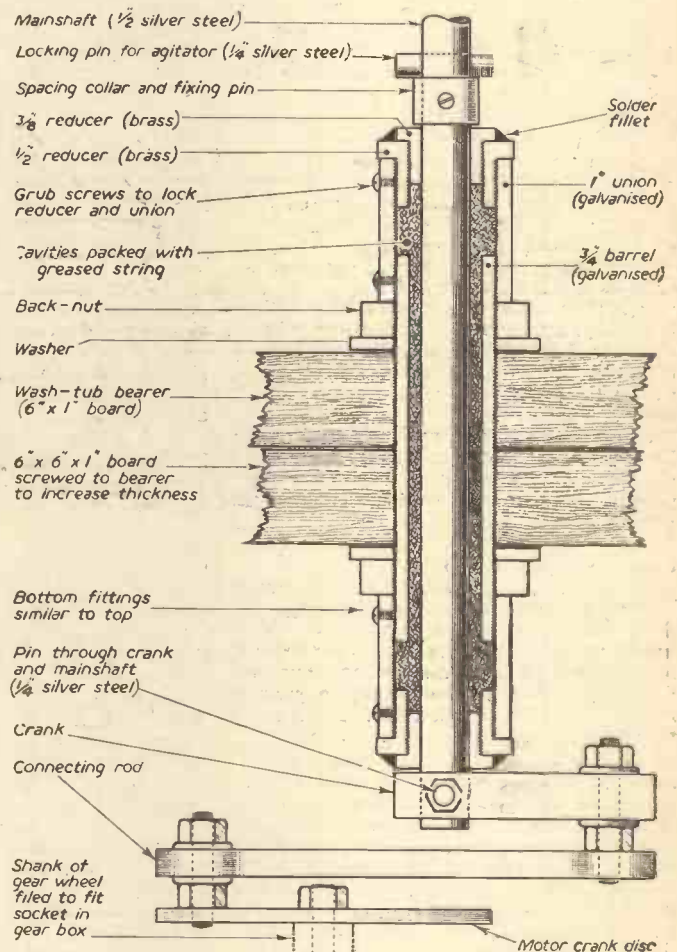

Fig. 3.—Main shaft assembly (approx. $\frac{1}{2}$ full size).

fitted with a lifting handle.

It should be explained that the machine described was designed to fit into a particular recess at the side of the sink in the writer's kitchen, and the general dimensions may be varied to suit the existing conditions—in fact, with a little ingenuity, the mechanism could, no doubt, be built into an existing gas or electric copper.

The Wash-tub

The vessel used in the present instance was a galvanised dust-bin, 18 $\frac{1}{2}$ in. high by 15 $\frac{3}{4}$ in. dia. (A copper cylinder, if available

would, of course, be preferable.) The handles were removed and all the seams made watertight by sweating where necessary.

To support the bottom of the wash-tub, a piece of 6in. by 1in. board is fixed across the middle of the frame from the top of one cross-bar to the top of the opposite one. This cross-piece should not reach the edges of the cross-bars, but sufficient space should be left to allow the plywood panelling to be inserted later on. To the middle of the underside of the cross-piece, another piece of board 6in. by 6in. by 1in. should be screwed so as to provide sufficient thickness to allow a secure fixing for the gland which is to take the main shaft.

Two 1in. dia. holes are then cut in the bottom of the wash-tub—one at the centre

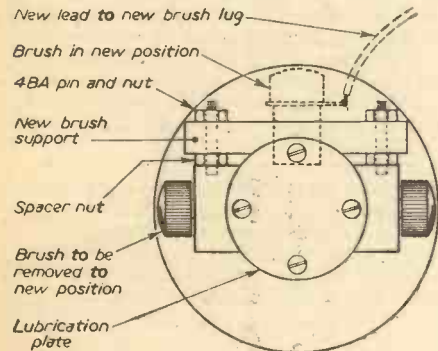

Fig. 2.—Rear of generator, showing conversion to motor.

to take the mainshaft gland and the other to one side to take the outlet pipe. The wash-tub is then placed in the frame and secured by means of woodscrews driven through the bottom into the cross-piece and round the top into the sides of the top cross-bars. Aluminium paint should be applied round the screwheads to make them watertight.

The holes in the bottom of the wash-tub should then be continued through the timber of the cross-piece.

Driving Shaft and Gland

The arrangement of these is shown in Fig. 3. The driving shaft is 3/8in. dia. silver steel, which is drilled and tapped to take the pins for securing the agitator, spacing collar (this is a piece of brass tube secured by a 6 B.A. pin) and the crank. The agitator locking-pin should be inserted and screwed hard home and the spacing collar fitted.

The gland is composed of ordinary hot-water service fittings. The central member is a piece of 3/4in. int. dia. galvanised barrel threaded outside. This is very tightly secured in the central hole by means of the back-nuts and washers. The faces of the top washer and the bottom of the wash-tub should be painted with aluminium paint to provide a waterproof joint. Before screwing on the 1in. galvanised unions, holes should be drilled in the sides at the top and bottom of these tapped to take two B.A. bolts to serve as locking screws. Each of the smaller reducers (3/8in. int. brass) should be reamed out to take the 3/8in. dia. shaft, and they should then be screwed tightly into the larger reducers (1/2in. int. brass) and secured round the rims with solder. One of the combined reducers is then screwed into the top union.

The gland is now ready to receive the driving shaft and the packing can be inserted from the bottom end of the gland. A liberal quantity of thick motor grease is first introduced into the space round the shaft, and round the latter string is then wound and forced up by degrees into the

gland by means of a long and fine screw-driver. Sufficient grease and string should be forced in to pack the cavity fairly tightly and when the bottom reducer is inserted and screwed home, it will probably be found that the shaft is a little stiff in rotating, but this stiffness should wear off when the machine is operated. If the packing of the gland is properly done there should not be the slightest leak when the wash-tub is filled with water. The gland is then completed by screwing home the four locking bolts in the unions. The object of fitting these bolts and also soldering the small to the larger reducers is to prevent any slackening when the machine is working. It was found that without these safeguards there was a strong tendency to slacken off however tightly the fittings were screwed. This tendency is, of course, facilitated by the presence of the grease in the gland.

The crank can be secured to the shaft by means of its pin. The draw-off pipe is of 3/4in. inside dia. galvanised barrel, provided with a right-angled bend and a socket to take the draw-off cock. The arrangement

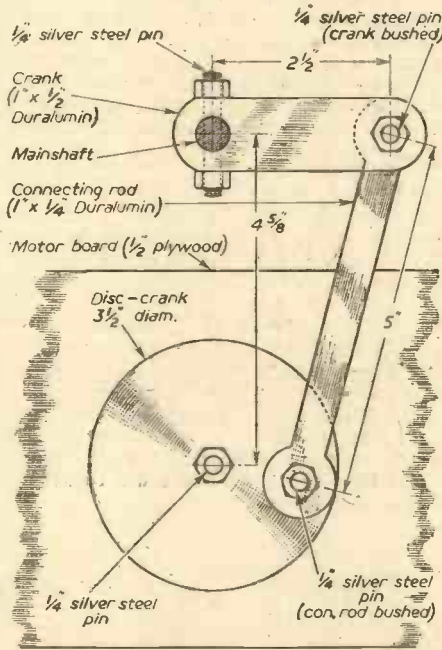

Fig. 4 (above).—Arrangement of drive to mainshaft.

Fig. 5 (right).—The agitator (approx. 1/4 full size).

will be clear from Fig. 1. The back-nut inside the wash-tub is cut down to half its thickness so as to reduce to a minimum the amount of water remaining at the bottom of the tub to be mopped out after use.

The Driving Mechanism

The motive power is provided by a Bendix-type hand generator (American Forces disposals) which are obtainable from surplus stores. The generator is operated by a handle through a gearbox giving a reduction of about 60/1. At the end of the driving shaft of the gearbox is a socket 1/4in. by 1/2in. by about 1/2in. deep into which the square shank of the

driving handle is bolted. This handle should be removed.

It is necessary to convert the generator to run as a motor. The voltages which it produces are 300 and 28 and only the low-tension side is used for the motor. The generator is first detached from the gearbox and the H.T. brushes and their seatings are removed. The armature is then removed and the leads to the commutator at the H.T. side are carefully severed with a safety-razor blade. The two leads from the field winding are then soldered together and bound with insulating tape. It is necessary to alter one of the brushes on the L.T. side to a position at right-angles to the other, and this is accomplished by bolting across the brush supports at the rear bearing a plate drilled at the centre to take the brush in its new position. Fig. 2 shows the rear of the bearing plate and method of fixing the new brush holder. The latter is a strip of 1in. by 1/4in. duralumin which is filed to the necessary shape to be accommodated in the space available across the top of the existing brush holders. The brush is secured in the new brush holder by means of a grub-screw inset at the rear (not visible in the drawing). A lug should be provided to take a lead to the brush.

The motor should be reassembled and tested by applying a current of 30 volts at about 2 amps. to the two brushes, when it should run at a very high speed and with considerable power. If the test proves satisfactory, the motor is ready for re-attachment to the gearbox, but before this is done it is advisable for the latter to be opened, and for an adequate supply of grease to be applied to the gears.

Power Transmission

It will be seen from Fig. 4 that this is accomplished by means of a disc-crank fixed to the driving socket of the gearbox, which transmits the power through a connecting rod to the crank on the driving shaft of the washing machine. The disc used in this particular case was one of the spring-gears of an old gramophone motor to which was still attached the hollow spindle which had accommodated the end of the spring. This spindle was cut down and then filed square so as to fit tightly into the square socket in the shaft of the gearbox. The hole in the latter was drilled out to 3/8in. and tapped

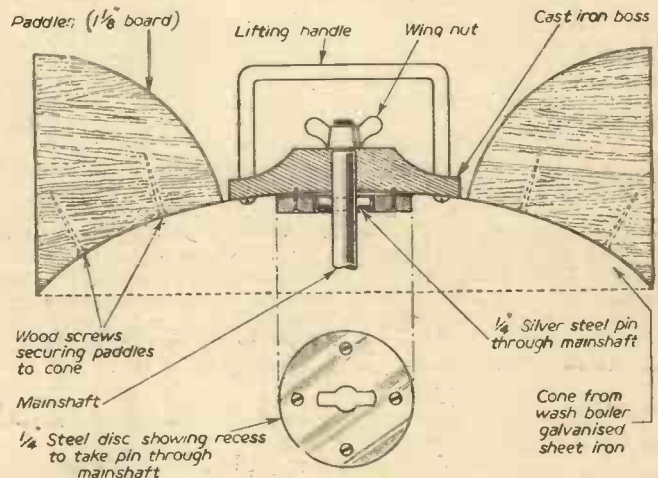

to take a silver steel pin so that the disc could be bolted firmly into position. The sizes and materials used in the construction of the connecting rod will be clear from the drawing.

It is now necessary to assemble the components in their places below the wash-tub.

To carry the motor and gearbox, a motor-board of 6in. by $\frac{1}{2}$ in. plyboard is constructed, the length being equal to the distance between the inner face of the frame uprights. The motor-board is supported by two pieces of 2in. by 1in. batten, screwed rigidly to the inside faces of the two uprights at such a height as will enable the connecting rod to be in correct alignment with the main-shaft crank. The motor-board is secured to its supports by means of four $\frac{1}{2}$ in. carriage bolts, but its correct position will have to be fixed before the holes for these are finally drilled.

It will be found that the main bearing in the gearbox projects about $\frac{1}{2}$ in. above the face of the latter, and a hole should be drilled in the exact centre of the motor-board to accommodate this, when the gearbox can be bolted securely to the board by means of the lugs provided. The four holes to take the $\frac{1}{2}$ in. carriage bolts should also be drilled in the motor-board at this stage. The disc is then bolted into position, the motor-board placed on its supports, the connecting rod placed on its two pins and secured by lightly screwing up the fixing nuts. The motor-board can then be moved backwards and forwards until it is in its correct position, when it can be temporarily secured by clamps to its supports whilst the positions of the mounting holes are marked

on the latter. With the motor-board in its correct position, it should be possible to rotate the disc by-hand fairly easily so that the power is transmitted to the crank through the connecting rod quite smoothly and without any jarring. If the centres of the main shaft and the driving disc are the distance apart indicated in the drawing, the mainshaft should have a backwards and forwards motion through about 60 deg., which at the speed given by the motor supplies adequate motion to the agitator.

The Agitator

The construction of this is made clear in Fig. 5. For the purpose of the turntable use was made of a galvanised sheet-iron cone of the type that is usually found at the bottom of most wash-boilers. To this are screwed four wooden paddles of the shape and size indicated (only two of these are shown in Fig. 5). It is necessary for the agitator to be easily removable so as to enable the bottom of the tub to be washed out, and for this purpose use was made of the device shown in the diagram—a circular steel plate bolted to the bottom of the cone with slots cut out at the sides of the central hole to take the locking-pin set in the mainshaft. To the top of the cone was bolted an old cast-iron boss from the workshop scrap-box. This was to increase the weight

of the agitator and also to strengthen the central joint. It must be emphasised that whatever arrangement is adopted the fixing of the agitator to the mainshaft must be designed to give the maximum possible strength, because when the machine is working the strain exerted by leverage at this point is very great. The lifting handle is of the type obtainable at surplus stores, with the arms extended if necessary by the addition of pieces of tube to give the necessary clearance. The agitator is secured to the mainshaft by means of a wing-nut.

Electrical Connection

The power for the writer's machine is provided by a main's transformer, with L.T. output of 30 volts 2 amps. To avoid conveying H.T. current to the machine the transformer is installed near the mains fuse box, and only the L.T. leads are taken into the kitchen to the machine. The wires are led into the machine through one of the side panels, but one lead is broken to take the on/off switch which is situated at the top of one of the upper panels.

The outside of the machine can be painted with a gloss finish to give a clean washable surface. As regards painting the interior of the wash-tub and the agitator, it is probably better to leave the interior galvanised surface untouched, but the wooden paddles on the agitator should, of course, be painted.

Shaded-pole Motors

Their Design and Performance

By A. G. R. DIXON

SHADED-POLE motors are an A.C. type only, and they are confined in the main to small sizes, and where only a weak starting torque will meet the case, such as fans. Although the writer has knowledge of them being used as electric gramophone motors, and even being put to use in washing machines with ratings of from 1/10th h.p. to 1/6th h.p.

Design

Shaded-pole motors invariably have stators of the "salient-pole" type, and are mostly to be found as multipolar for slow speeds, usually 4-pole for a speed of about 1,500 r.p.m.

Each pole is provided with a slot into which is fitted an endless copper band, the effect of which is to set up "eddy currents" in partial opposition to the main currents being set up in the pole. This produces a time lag between the magnetisation of the polar face as a whole, and that portion of it separated by the shading loop, resulting in a sliding flux across the polar face giving rise to a moderate starting torque which influences the rotor to motion.

The rotor is of the "squirrel cage" type, consisting of a slotted drum, carrying copper or brass rods in place of windings, these rods being shorted at either end of the rotor by rings of the same material.

Speed

The speed of this type of motor is governed by the frequency of the supply and the number of poles in the stator; the speed is given by the formula:

$$\frac{\text{Supply frequency}}{\text{Pairs of Poles}} \times \frac{60 \text{ secs. to produce}}{\text{revs. per min.}}$$

e.g., supply of 50 cycles per sec. with 4-pole motor will give a speed of:—

$$\frac{50}{2} \times 60 = 1,500 \text{ r.p.m.}$$

Allowance must be made for the efficiency of the motor and the drag on the rotor, and it is usually found necessary to allow 3 to 5 per cent. reduction in speed, so in all practical cases it will be found that the speed on load for this type of motor will be about 1,425 to 1,450 revs. per. min.

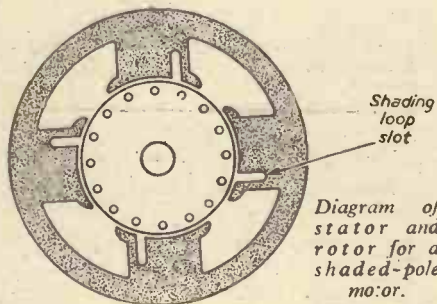

Efficiency

Shaded-pole motors consume heavy current for the horse power produced; in effect, a loss in heat of about 75 per cent. of current consumption is by no means uncommon, and this is quite heavy when one considers that a 1/10th h.p. shaded-pole motor will consume around 300 watts on load.

A comparative efficiency may be made using the following example:—

An ordinary 1/10th h.p. alternating current motor is usually rated as being approximately 45 per cent. efficient, consuming 170 watts, shown by the formula:

$$\frac{746 \text{ watts (being 1 h.p.)}}{\text{of motor}} \times \frac{100\%}{\text{of class of motor}} = \text{Consumption in watts.}$$

Using this formula, for the shaded-pole motor consuming 300 watts, we have (substituting consumption for class efficiency):

$$746 \times \frac{1}{10} \times \frac{100}{300} = 24.86\% \text{ eff. (approx.)}$$

Whereas a 1/10th h.p. is purely 74.6 watts, it will be seen that the remaining 225.4 watts is dissipated in heat within the motor.

Points on Construction

Owing to the heat dissipation of this type of motor it is advisable that the end shorting rings be either welded, or have the ends of the cage rods riveted over, as soldering is liable to come undone. With field coil connections, if welding cannot be undertaken, a high melting point tinman's solder should be used.

This type of motor is usually designed for a specific purpose, and is mostly inefficient unless used on the job for which it has been designed. While it will stall if overloaded, it will also run very hot if underloaded.

The main advantage of the shaded-pole motor is that, where a small rated motor is required they can be produced quite cheaply, because there is no such cost as starting windings, brush gear, etc., and their upkeep is negligible, faults being almost non-existent.

Motors having permanent magnetic poles are unsuitable for conversion owing to the fact that they have "permanent poles," whereas with shaded-pole motors it is required that the poles can have the magnetisation of the pole face altered, i.e., retarded, to give starting motion.

Other motors may be converted to shaded-pole, but for ease of construction it is advised that only salient-pole types be used, in this case the slots for the copper shading loops should be cut in the pole off-centre.

The rotor may be constructed from the old motor's armature, with copper rods inserted in the winding slots, fitted as previously mentioned.

EVERY CYCLIST'S POCKET BOOK
3rd. Edition
7/6, or 7/10 by post from the offices of
this journal.

The Preparation of Microscope Slides

Details for Mounting and Ringing and Making a Ringing Turntable

IN a recent issue of PRACTICAL MECHANICS details were given for the construction of a microscope. I built this and the finished instrument proved to be so fascinating that I decided to prepare permanent specimens of the objects examined. It is for those readers who have built this instrument, but who may not have the knowledge of the technique of making microscopic preparations, that this short article, which covers the essential facts, is written. It is not intended to cover the whole of the subject but merely to introduce it and to give readers a guide to books for more advanced study.

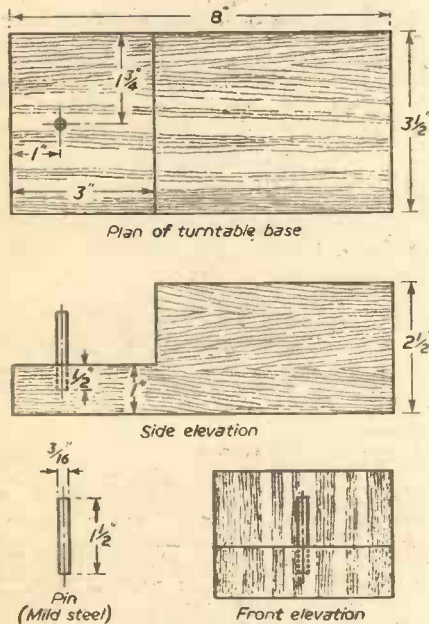

Fig. 1.—The base constructed from heavy wood block.

Slides and Cover Glasses

Objects for microscopical examination are "mounted" on strips of thin glass, 3 in. x 1 in. x 1/16 in. approx. and are protected from damage by thin glass slips which are generally 1/64 in. thick and can be obtained in circular or rectangular form; the circles are best for the amateur.

Mountants and Mounting

Many objects may be mounted in the dry state, but for others, such as small insects, thin slices of plant stem, and countless different things that it may be wished to examine, it will be found an advantage to have the objects in a liquid of some sort. Whenever this method is used, the liquid is called the mountant. Mountants range, according to their suitability for the job in hand, from ordinary water to resinous materials like Canada Balsam, etc. The actual technique of mounting is quite simple; the glass slip is thoroughly cleaned and a small quantity of the desired mountant is placed in the centre of the slip and the object is gently lowered into it and arranged in the desired position, using a needle. The previously cleaned cover glass is now very carefully lowered into place and the mount placed in a slightly warm

By S. M. CHARLETT, F.R.M.S.

place to allow any air bubbles to escape: If the mountant is of a resinous nature it must be left in a warm place for several days to allow the solvent to escape and leave the object imbedded in the solid resin.

Ringing

When the above stage is reached, i.e., when the mount is dry, the appearance may be enhanced and the life of the mount prolonged by making a ring of a waterproof substance around the edge of the cover glass. This process is known as "ringing" and is best done on a turntable made for the purpose. These are fairly expensive to buy and instructions are given for the construction of a suitable table which the writer has found invaluable for this sort of work.

The operation of ringing is quite simple; the slide to be ringed is clipped to the turntable and adjusted so that when the latter is rotated the cover slip still appears circular and does not wobble. A small camel-hair brush is then charged with the ringing agent. I prefer to use the black lacquer that one can obtain fairly cheaply from any good paint shop, and the turntable is set spinning at about 100 revs. a minute; it must not rotate too quickly or the ringing agent will be thrown off the cover glass. When the table is rotating properly the wrist is rested on the body of the table and the tip of the brush is applied to the edge of the cover glass and if the slide has been properly centred a neat ring will be made around the edge.

Although the details given are for a mount using a resinous mountant, the same details apply to a liquid such as water or a gelatine medium. The only precautions necessary are to ensure that all surplus liquid is removed from the edge of the cover glass, and to

apply the brush lightly to ensure that the glass does not slip.

For additional details of various mounting agents, etc., the reader is recommended to read Peacock's book "Elementary Micro-

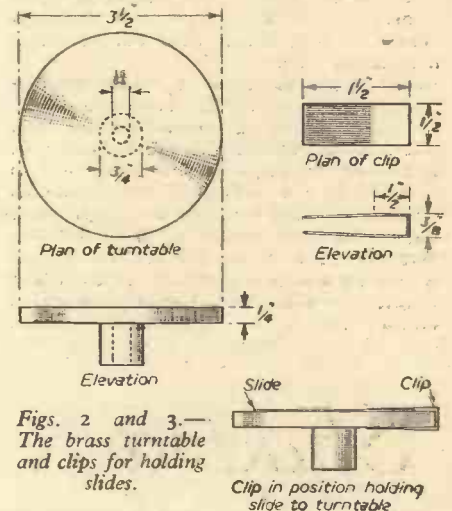

Figs. 2 and 3.—The brass turntable and clips for holding slides.

technique," which can be found in most public libraries.

The Turntable

The base is constructed from a block of any heavy wood to the sizes shown in Fig. 1. The actual table is made of brass to conform to the details given in Fig. 2, and any garage will turn it down for a small fee. The steel spigot should be erected as upright as possible to ensure true running. The clips for holding the slides to the table (Fig. 3) are of the simple push-on type.

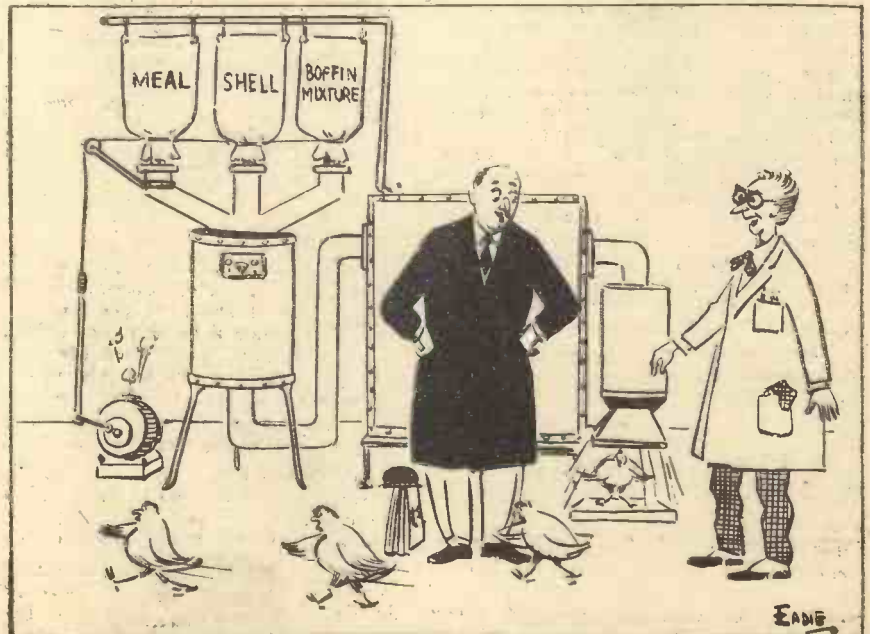

Says Boffin: "Something's gone completely haywire—the Ministry asked me for a synthetic EGG plant!"

LIGHT AND HUMAN VISION

1—The Brain in Action

The Various Functions of the Brain in Relation to the Eyes

By WILLIAM ELLWOOD

IT is not proposed to dissect the brain, only to give some inkling of its wonderful versatility when working in cooperation with its chief reporter "the sense of sight." It is not desirable to describe at length the technicalities of the eye, but there are two functions that must be briefly outlined in order to help us in our discussion on light and vision.

The first function is a purely psycho-optical one and is termed "accommodation." It is the ability of the *crystalline lens* (Fig. 1) to increase or decrease the curvature of its anterior surface. This is really due to the action of the *suspensory ligament* which is attached to the outer or anterior capsule layer of the lens. According to Helmholtz; when the eye is at rest, the suspensory ligament is in a state of tension, thus tending to flatten the outer surface of the lens. This enables the eye to view distant objects. When a near object comes under scrutiny the suspensory ligament relaxes, allowing the outer surface of the lens to bulge or increase its curvature. As this happens, the diaphragm called the *iris* contracts and the orifice or *pupil* in its centre becomes smaller, thus confining the incoming light-rays to the more highly refracting part of the lens. In this article we are mainly concerned with the manner in which the brain controls this "accommodating" function—the way it decides at what distance a viewed object is situated. Let us see what happens as the light-rays impinge on the light-sensitive membrane called the *retina*: As there is no intermediate image, a real image is formed on the retina, which is inverted (Fig. 2).

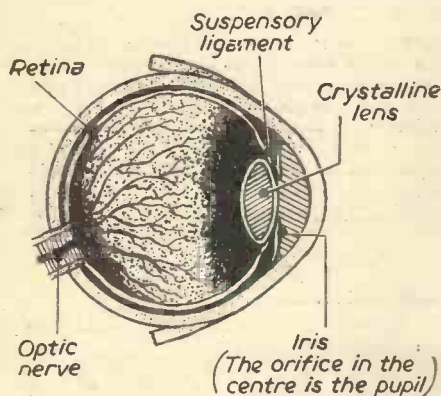

Fig. 1.—The human eye.

The brain receives this image and with astonishing speed rectifies and interprets it. Even so, it is not able to overcome the illusion of "perspective" contained in the image (Fig. 3) caused by the rectilinear propagation of light. But from its vast store of experience gained through the other senses—particularly that of touch—it knows that perspective is but an illusion. Indeed, the astuteness of the brain enables it to transform the apparent disadvantages of such an illusion, into distinct advantages. It uses it skilfully as a measuring rod of distances and magnitudes.

The second function of the eye we must deal with, seems to be rather a psycho-optical-um-psycho-physical operation. It is

termed "binocular vision" or depth perceiving vision. This helps the brain to distinguish whether a pair of apparently identical objects are really of the same size and at quite close range, or whether one is larger but appears the same size as the other due

view the object in its entirety. When the eyes view object "B" (Fig. 5), the angle θ remains the same as it was for object "A," and the retina receives the same size image of "B" as it did of "A"; but there is a difference. Angle θ_1 is greater than angle θ_2 with the result that the eyes converge less when viewing object "B" than

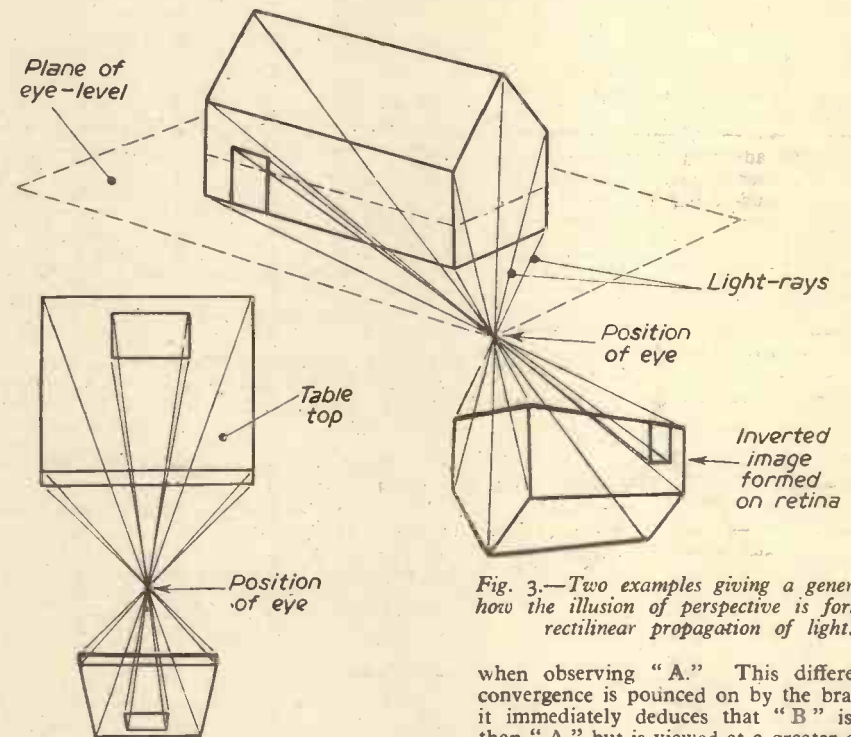

Fig. 3.—Two examples giving a general idea how the illusion of perspective is formed by rectilinear propagation of light.

when observing "A." This difference of convergence is pounced on by the brain, and it immediately deduces that "B" is larger than "A," but is viewed at a greater distance than "A," hence the similarity of size.

However, binocular vision has its limitations. If apparently similar objects are viewed at a considerable distance, the angle θ , becomes very small, and the difference in

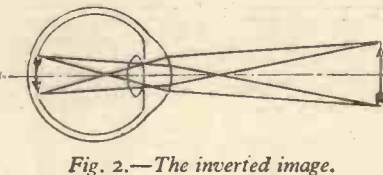

Fig. 2.—The inverted image.

to it being placed a little further away. The sketches will help to clarify the operation.

If the two eyes of a person view object "A" (Fig. 4), the angle θ subtended at each eye by the object, will be equal, and present the retina with an image of a certain diameter. The angle θ_1 which is contained between the lines of sight of each eye in relation to the object, dictates the extent to which the eyes must converge in order to

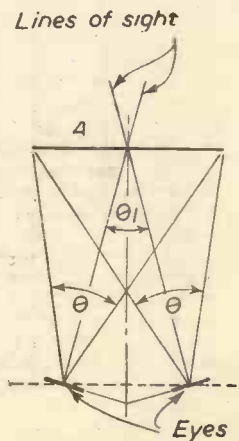

Fig. 4.—Excessive convergence.

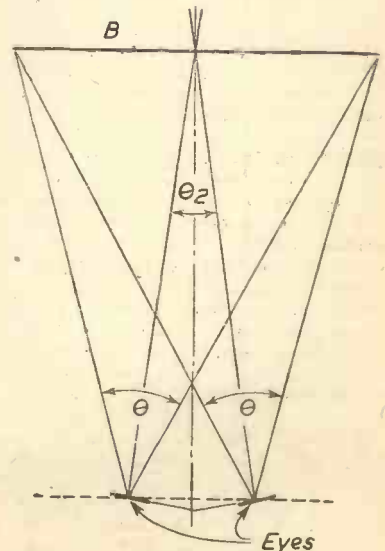

Fig. 5.—Moderate convergence

convergence of the eyes when viewing the objects is so minute, that the brain has difficulty in assessing the various distances and sizes. Be this as it may, the brain, ingenious mechanism that it is, does not admit defeat but presses into service its acquired knowledge of perspective.

If two white discs, "D" and "D₁" (Fig. 6), are viewed with no other objects visible and at a distance beyond the efficient range of binocular vision, the eye and brain would be defeated; but should the two isolated discs be set amidst other reference bodies that afford lines of perspective, such as in Fig. 7; the relative magnitudes may then be assessed by simple comparison. "D" is obviously very much larger than "D₁". We could mention, of course, the extra atmosphere through which light from "D" must pass, but for our purpose, it can be classed as belonging to the group of reference bodies and therefore is not present when we consider Fig. 6.

The decisions of the brain arrived at by this power of comparison, affect the suspensory ligament and the iris, which in turn control the curvature of the lens and the amount of light admitted to the retina.

If, in the general field of vision, light rays from an unidentified object enter the eyes, the brain becomes curious and instinctively takes note of the object, as, placed

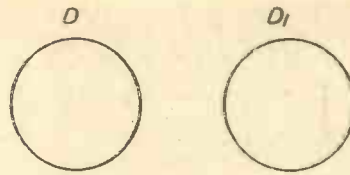

Fig. 6.—Two isolated white discs.

fairly close as suggested by binocular vision or distantly as judged by its position in the general pattern of perspective. Should the object be judged as a distant one, the brain causes the lens to decrease their curvature, thus allowing all available light-rays from the object to enter the eyes, to the exclusion of the majority of other sources of light. The brain thereupon makes its analysis.

As may be gathered from the foregoing, immediately a logical pattern of perspective is absent when viewing objects at a great distance, the eye and brain are in trouble. Such is the case when a small star or planet, relatively near and of moderate luminosity, is compared with a giant star at an immense distance and possessing great luminosity. The two may look identical. An appreciation of perspective is then rendered useless, and the brain approaches the problem from a new

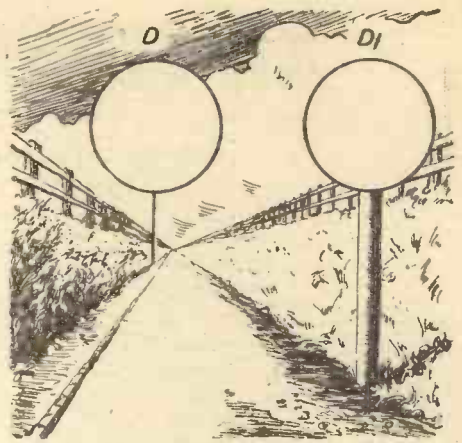

Fig. 7.—The discs set amidst other reference bodies.

angle. It relies more and more on reasoning; a much slower method than the former procedure, but a vastly more accurate one. We refer, of course, to the science of applied mathematics. For some years now the spectroscope has enabled the brain to ascertain the magnitude and other characteristics of numerous stars and nebulae—but this subject will be dealt with next month.

Details of the simple copying process



Copying Without a Camera

An Ingenious Idea for Copying Articles from Books Without Damaging Them

dealer, he could probably obtain a supply to order. Alternatively, any contrasty grade of bromide paper will give reasonably good results, provided it is not too thick.

The Method

Let us suppose that we require a facsimile copy of a page from a book. First lay a piece of bromide paper—sensitive side downward—on the page to be copied and hold it down with a fairly thick piece of glass. The glass may be weighted by standing a weight at each corner if necessary, so as to bring the bromide paper into close contact with the printed page. Arrange the assembly under an electric lamp, as shown in the illustration; all this must, of course, be done in the dark room by red light only. Make the exposure by switching on the electric lamp, thus exposing the bromide paper through the back. This, perhaps, sounds rather a silly thing to do, for obviously, the bromide paper will be "fogged" all over; but never mind that. Make a trial exposure, and when you get the exposure right you will find that although the paper is fogged, the part corresponding to the whole background is much denser than the lettering, which will be easily visible by transmitted light.

This depends upon several conditions, such as nature of copy, speed of bromide paper, thickness of bromide paper, the type of lamp used and the distance of the lamp. As an approximate guide, the exposure should be about three seconds, using contrasting bromide paper, on a clear copy from a magazine printed on good white art paper, with a 40-watt lamp at a distance of 30in. from the book.

After exposure the bromide paper should be fully developed in the usual manner, with

a foggy looking negative image as a result. This paper negative is then fixed, washed and dried.

Making the Positive

This is done by placing another piece of the same bromide in contact with the negative—emulsion to emulsion—and exposing in an ordinary printing frame through the negative. In fact, you just make a bromide print in the ordinary way. The exposure this time will take a lot longer than before, owing to the heavy veil of fog on the negative, something between 30 seconds and one minute will probably be about right for a first trial.

The Best Results

When this print has been properly exposed and developed in the ordinary way, a good clear copy of the original page should result. The best results are obtained from a good black image on smooth white paper; creamy-coloured rough paper will not be satisfactory. In such cases there will be an improvement if the first exposure is made through a slightly tinted yellow glass screen, but the colour must not be very deep, or no results will be possible.

This has not been tried, but probably a similar result to that obtained by using the screen could be achieved, by using an oil lamp for making the first exposure. This would necessitate considerable increase in exposure, but would probably give improved results.

Do not be discouraged if your first attempt is not satisfactory, and make several trial exposures on small pieces of paper before risking a full size sheet, otherwise your failure may become rather expensive.

At first sight it would appear essential to use a camera for copying such subjects as the page of a book by photography, but by making use of the method described below, it can be done without camera or film. It is called the "Player-type Process," after the name of the inventor and is very useful for copying articles from a book, to avoid the work of writing out the copy, or cutting out the article and spoiling the book. You may, for instance, copy an interesting page from a library book; it does not matter if the paper is thick or thin, or whether it is printed on both sides. Illustrations can be reproduced as well and it is possible even to copy photographs, although the results are not likely to be as satisfactory as a proper camera copy in such a case.

As we are not making use of film, we naturally require some other light sensitive material, and will use bromide paper. The most suitable for this work is thin paper made specially for the purpose with a very contrasty sensitive emulsion. If this paper is not stocked by the local photographic

Making Bellows

The Forming of Varying Shapes and Sizes

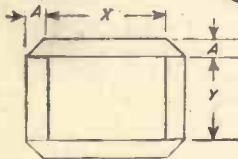
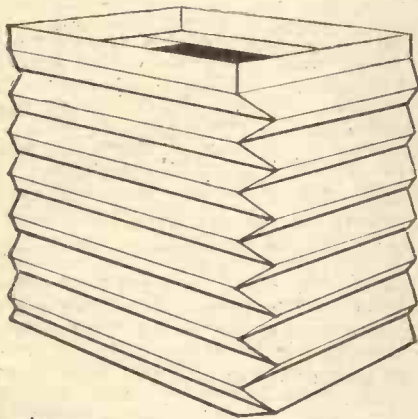

Fig. 1.—Two views of square bellows.

BELLOWS can be made from paper, stiff cloth, leather or imitation leather. Leather is undoubtedly to be preferred where cost is not a consideration. However, stiff cloth or even good quality paper can give good service.

It is possible to make bellows of practically any shape—square, oblong or any straight-sided figure provided it has an equal number of sides. Thus nearly round bellows could be made by increasing the number of sides as far as practicable. Straight-sided bellows (where the peaks of the folds on all the sides are in a straight line, whether the bellows are square or tapered), can be made from a single sheet of paper. Where a curve is wanted, or a change of taper required, more than one piece of material must be used, usually four, but this varies. The length of the flat sheet from which the bellows are to



Fig. 2.—Preliminary layout of the sheet.

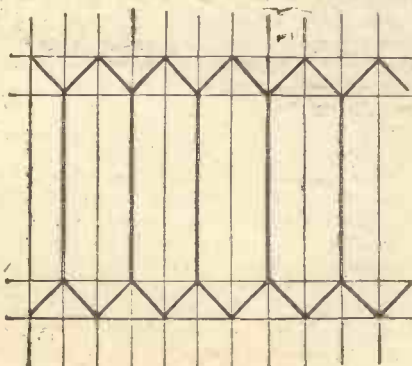

Fig. 4.—Method of marking out.

be made requires to be two and a half times the length of the extended bellows. They can be extended farther, but the folds may be displaced and will fail to collapse later.

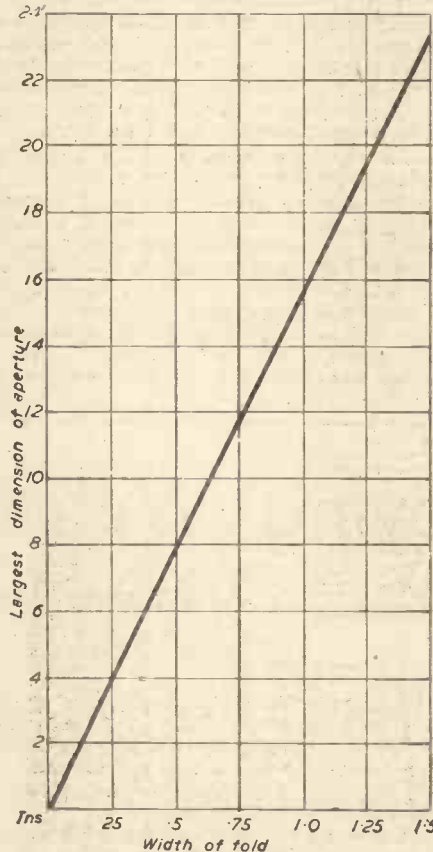

Fig. 3.—The fold graph.

Square Bellows

Fig. 1 illustrates a square bellows having internal dimensions of X by Y, and the preliminary layout of the sheet is shown in Fig. 2. The spaces "A" are equal to the width of the lines crossing them, which are equal to the depth of one fold. The fold-depth can really be anything, but the graph, Fig. 3, can be used for finding a convenient figure. The space "B" at the end of the sheet is a flap for securing to the other edge of the bellows, and can be any convenient size according to the material used, and is usually between 1/4 in. and 1/2 in. in width. These marking lines should be made lightly to avoid scoring where it will not be required. Having laid out the whole sheet, score in the diagonal lines and certain of the straight lines with a blunt edged tool, as shown in Fig. 4, the second lines being shown heavily. Then turn the sheet over and score the remaining lines, which are only straight ones, and although that side is not marked, the positions where the scores have to be made can be seen by the score marks already made on the other side. The second series of score marks are indicated in Fig. 4 by the faint lines. The side of the sheet shown in Fig. 4 is the inside of the bellows, and this should be remembered when making-up. The securing flap "B" must also be scored to

follow on, so that its "vees" fit the "vees" at the other edge. The flap can now be pasted up and the edges brought together, the sheet forming a tube, no effort being made at this stage to form the folds.

Manipulating the Folds

When the paste has set, stand the bellows on one end and manipulate the folds into position. Press the first scored lines inwards, and at the same time flatten the diagonal scores at each end. Then do the next lower pair on the adjacent sides, and so on down the tube. When the last folds have been done, place a piece of wood on the top and press downwards or leave for an hour or two under a heavy weight. The end folds of the bellows, instead of being creased diagonally, can be folded up square as shown at the top of Fig. 1, this allowing the bellows to fit either over or inside the framework.

Tapered bellows require a layout made on the same principles, but each side must be marked out individually from a line drawn down the centre of each side. The construction is shown in Fig. 5 and the completed bellows in Fig. 6. It should be noted that the strips "A" which form the corners of the bellows are parallel and all the diagonal creases are of the same angle, i.e., 45 degrees.

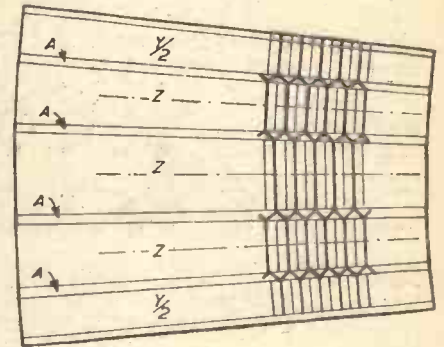

Fig. 5 (above).—The layout for tapered bellows.

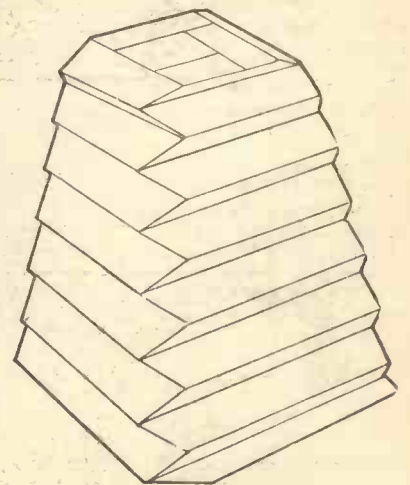
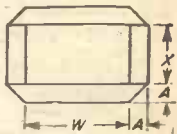
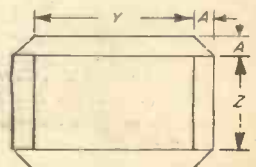

Fig. 6.—Completion of tapered bellows.



The Powers-Samas Handcraft Exhibition

By THE EDITOR

Mr. A. Holley's model yacht.



THE handcraft exhibition organised by the Powers-Samas Sports Club, associated, of course, with the well-known manufacturers of accounting machines, was held on May 16th and 17th at the Croydon works of that firm. It was our pleasant task to judge the model section, which was sub-divided into aircraft, transport and general models.

There were no less than 700 exhibits of extremely high quality, a tribute to the diversity of interest and versatility of the Powers-Samas employees. The judging was, indeed, difficult, and we found so many of the entries of equal merit that we awarded special prizes in the three sections we judged. In the ultimate, the first prize in the aircraft section went to Mr. C. E. Hayden for his 75 c.c. diesel and the second to Mr. E.

Morris for his solid-scale Gloster Javelin. Special prizes in this section went to Mr. A. Woodworth for his diesel-powered model aircraft and the second to Mr. E. Morris for his solid scale Vickers Swift. Highly commended were Mr. L. B. Loder, R. W. Bridger, W. J. Spellen, E. Morris and C. E. Hayden.

It will be seen that some competitors had more than one entry.

In the transport section, first and second prizes went to Mr. J. Gooch and Mr. J. Cochran respectively, for a model of an admiral's barge and a contractor's locomotive, with special prizes to Mr. A. Holley for a model yacht and Mr. W. R. Bridger for a 1.3 diesel-engine motor-launch.

Mr. R. Holme, R. W. Bridger and W. Marshall were highly commended. The general section was well supported with a wide variety of models, the result being that Mr. S. England took first prize for his model of a farm and camp, but this was so in merit to the model power hacksaw made by Mr. C. Quiney that we awarded another first prize, awarding also one second and two special prizes to Mr. A. Hinz; Mr. W. Plummer and Mr. V. Knight for models of a dolls' house, a zoo and a lantern clock respectively. Special prizes were awarded to



This model aeroplane and scale model admiral's barge were also seen at the exhibition.

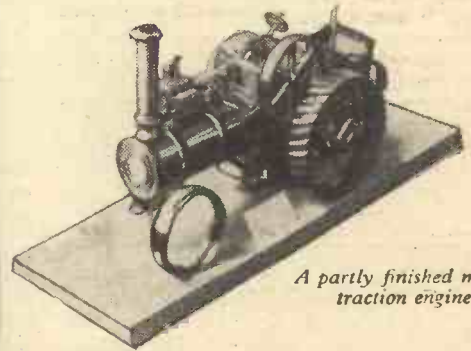

A partly finished model traction engine

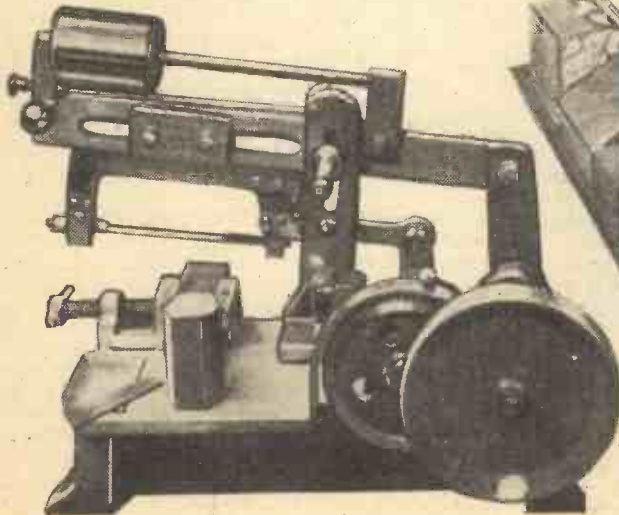

(Above) Mr. S. England's model farm and camp.

(Left) A model power hacksaw by Mr. C. Quiney.



Mr. C. Laidlaw for a photographic enlarger, Mr. B. G. Bellringer for a full-size saloon side-car body, Mr. P. Blizard for a kayak, and Mr. A. G. Orchard for a spring computer of great practical use and which is likely to be marketed. Highly commended were Miss E. W. Bishop and Mr. Bishop, Mr. S. Timms and Mr. R. Whiting.

The photographs on this page illustrate some of the prize-winning exhibits.

Car Battery Charging Control—1

The Dynamo, the Function of the Cut-out, and Compensated Voltage Control

By F. J. FULFORD

THE modern car contains a complete organisation for the production, distribution and consumption of electricity. It is very like a commercial generating station, with the houses, shops and factories replaced by the lights, starter and ignition system. The conditions of service are, however, more arduous than those met by the power station, since the dynamo speed cannot be controlled and no operator can be carried to compensate for fluctuations in demand from the consuming units. The engine-driven car dynamo will vary in speed from zero to 4,000 revolutions a minute, and its output will vary accordingly. The consumer demand will vary from summer to winter and from moment to moment. Electricity will also be required when the engine is stopped, so that a means of storage becomes necessary. With the introduction of a storage battery the position is simplified in that small variations in demand can be accommodated by the battery. It is now necessary to prevent the dynamo from burning itself out at high speeds, while giving an adequate output at low speeds and to maintain the battery in a good state of charge without allowing it to become either over- or under-charged. This control must be done automatically without requiring the attention of the driver.

The Control Unit's Job

The functions of the control unit can best be summarised as follows:

1. To prevent the battery from discharging through the dynamo windings when the dynamo voltage falls below that of the battery due to low speed.
2. To prevent the dynamo voltage rising to a dangerous level at high speed.
3. To prevent the dynamo current rising to a dangerous level.
4. To control the dynamo output current

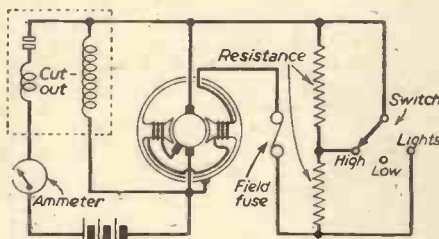

Fig. 2.—Third-brush dynamo circuit.

in accordance with the needs of the battery and other items of the electrical installation. These requirements may sound formidable, as indeed they are. Perhaps the average owner is not aware that so much is being done without his attention being required.

The Dynamo

The dynamo consists of two essential parts, the armature, and either magnets or other means of producing a magnetic field. On the armature shaft are built a set of soft iron stampings, so cut that grooves are left on the outer surface to take the coils of insulated wire. Each end of each coil is connected to a commutator bar. As the coils are rotated in the magnetic field, a voltage is induced in them which is rectified by the commutator and picked up by the brushes.

The magnetic field is provided by the field

coils, which are wound on yokes attached to the carcass of the machine. The field is fed with current from the main output.

Once the dynamo has been designed, there are only two means of altering its voltage. First, its voltage will increase as the speed of rotation increases. Since this speed will always be varying with engine speed, it is necessary to control the second variable if a steady voltage is to be maintained. This is the strength of the magnetic field. The stronger the magnetic field the greater the

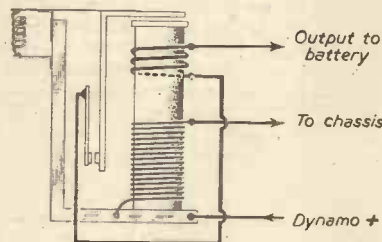

Fig. 1.—The cut-out.

dynamo voltage. It is therefore necessary to reduce the current flowing through the field coil as the rotational speed increases. Controlling the field voltage offers a ready method of making the dynamo output suit the needs of the moment, and this is the method adopted.

The Cut-out

The cut-out (Fig. 1) performs the first of the duties required of a control unit. It is a switch which breaks the circuit from the dynamo to the battery when the former is either stationary or rotating so slowly that its voltage is lower than that of the battery. The contacts of the switch are so arranged that they are held open by a spring. A coil, connected across the dynamo output, exerts a magnetic field, the strength of which depends upon the voltage across it. This magnetic field attempts to close the contacts against the pull of the spring. The strength of the spring is such that it is just overcome when the voltage of the dynamo is sufficient to give a small rate of charge. When this voltage is reached the contacts close. The coil which does this is wound on the core of the cut-out, and it is known as the voltage coil. There is also another coil wound on the same core, but made of a relatively few turns of much thicker wire. This is the current coil, and it is connected so that the current flowing from the dynamo passes through it when the contacts close. When current flow is from dynamo to battery, the magnetic pull of this coil is in the same direction as that of the voltage coil, and it helps to hold the contacts closed. If, however, the dynamo voltage drops below that of the battery because its speed is reduced or a fault has developed, the battery will start to discharge via the current coil and the dynamo. The current through the coil will now be in the opposite direction and its magnetic field will assist the spring to overcome the pull of the voltage coil and open the contacts, separating the dynamo from the battery.

The cut-out in no way affects the charging rate. It is purely an automatic switch

to disconnect the dynamo when its speed is not high enough to give an adequate voltage output.

Third Brush Control

One of the remaining functions of the control unit is to arrange that a desirable rate of output shall be produced by the dynamo when the engine is running at a normal speed. This was formerly done by introducing a third brush to the dynamo, to which one end of the field winding was connected (Fig. 2). In this arrangement an increase of speed did not result in a build up of voltage beyond a certain point, depending on the position of the third brush. The explanation of this is complicated, but it will be seen from the diagram that the whole output voltage is present at one end of the field winding, while the other end is tapped in a fraction of the way around the armature by the third brush. At low speeds the field receives a proportion of the output voltage, but at high speeds, distortion of the magnetic field is produced which reduces the field winding voltage. This is satisfactory in so far as it allows an output which rises fairly rapidly as the engine speed increases from tick-over, remains constant at medium speeds and falls slightly at high speeds. It controls the dynamo output with relation to speed, but takes no account of the demand of the electrical equipment for current. A manually operated switch has to be introduced which allows full output when the lights are in use but switches in a resistance to the field circuit in the "half charge" position. In the "full charge" position only half of the resistance is in use.

With this system control is not all that could be desired, and it is not fully automatic. It has now been swept away by an improved method of control, and is only found on older cars.

Compensated Voltage Control

In order to understand the operation of the more modern types of unit, it is necessary to understand what is meant by "inductance." A number of turns of wire wound on a magnetic former will appear, if introduced

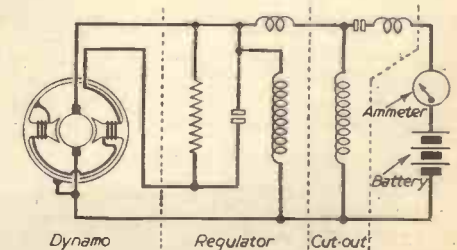
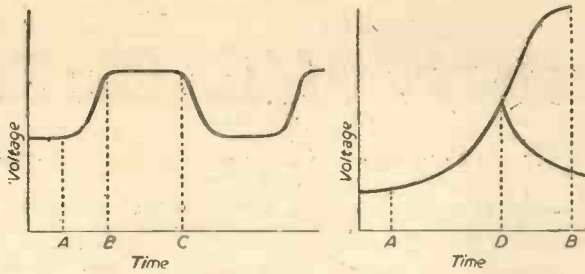

Fig. 3.—Two brush dynamo and regulator.

into an electrical circuit, to resent a change in the value of the current flowing in that circuit. If the voltage across the coil is raised, some of the current is stored in the magnetic field of the coil, and hence the current does not rise immediately. Similarly, if the current tends to decrease, some of the magnetic field collapses back into the coil, trying to maintain the current. Thus a change of voltage across a coil does not result in an immediate change of current, but there is a time lag. It will be realised that a dynamo consists of turns of wire wound on a magnetic former, and it behaves in this fashion. It has induc-

tance. It is the current in the field coil which is important in this instance, and a change of current will lag behind a change of voltage across the coil. The action may be likened to a petrol engine driving a heavy flywheel, in which the action of opening the throttle corresponds to increasing the voltage. The speed of the flywheel represents the current in the coil. If the throttle be opened, the speed of the flywheel will take time to build up, but when it has done so it will have stored up energy which will maintain the speed of the flywheel after the engine power has been reduced.

We now consider a dynamo circuit which contains a resistance in series with the field winding. The resistance may be shorted out by a switch. Assume the dynamo to be running, with the resistance in the circuit. The voltage across the field coil will be reduced by the resistance, and so the output of the dynamo will also be reduced. If the switch is closed, thus shorting out the resistance and allowing the full dynamo voltage to reach the field winding, a build up of current will occur in the field coil. This build up will not be sudden as was the increase of voltage, but will be delayed by the inductance of the circuit. In a practical circuit the switch is replaced by a pair of vibrating contacts, which bridge the resistance. It is now



Figs. 4 and 5.—Output voltage curves.

necessary to consider the contacts vibrating at a low speed, continually putting the resistance into circuit and shorting it out. This will be done, however, at a speed which will give plenty of time for the current to build up and reach a maximum each time, before the contacts open again. The output voltage will be something like that represented in Fig. 4, in which the time A-B represents the time required for the voltage increase on closing the contacts to be reflected as a current increase in the field coil. The current in the field coil, and hence the dynamo output, will rise and fall as the resistance is switched in and out. The rises and falls will not be

sharp, but will be gradual because of the inductance of the coil. This time lag is very important when it is considered what will happen if the speed of the contacts is increased to a point where the time of operation is shorter than that required for the current build up to be completed. Fig. 5 represents the build up part on a larger scale. Before, we were thinking of the contacts closing at A and opening again at C. Now, they are going to open again before the point B is reached, say at D. The voltage now starts to fall away again at this point instead of continuing up to B. The mean output voltage may be represented by a line roughly halfway between the peaks and troughs. The quicker the contacts open, the lower will the peaks be and hence the line of mean voltage will be lower. If it is arranged that the speed of operation of the contacts increases as the engine speed increases, the dynamo voltage may be held constant if the value of the resistance is correctly chosen.

(To be continued)

An A.C. Engraver

A Handy Tool for Working Off a 6-volt Transformer

By C. N. LARSSON

MANY readers have, no doubt, found the need to put their name on metal and plastic objects permanently and yet neatly. A small engraver working off a transformer seemed to be the answer to this problem. It was felt, however, that a heavier instrument working off the mains would be better for continuous work. Good results can be obtained using an engraver running off a 6-volt transformer, although the impression on the harder metals is not very deep.

The Frame

As will be seen from the illustration, the frame consists of two 1/2 in. aluminium rods bolted together at both ends. The top of each rod is tapped to take the screws for fixing the terminal strip. About 2 in. from the top each rod is filed flat so that the magnet can be firmly clamped in position. The length of the top bolt, which tightens the whole frame, depends on the size of the magnet, but it should be about 2 in.

The Magnet

The magnet used was taken from a burnt-out milliammeter. It was found that the magnet was separate from the pole pieces and while these were retained they were modified slightly. The magnet was first removed and then the poles were cut so that their faces were plane parallel instead of circular. However, any magnet will do, but it has to be fairly strong, and the smaller it is the less cumbersome will be the finished instrument.

The magnet is clamped in the frame as no attempt should be made to drill it, so that it could be bolted, as the heat and vibration produced would cause quite an appreciable fall in its strength.

A brass strip can be soldered across the gap on each side of the pole pieces. These strips stop the armature from falling out

from between the poles. If a magnet is used that has not got separate poles it would be better to clamp one long strip all round the magnet rather than solder on to it.

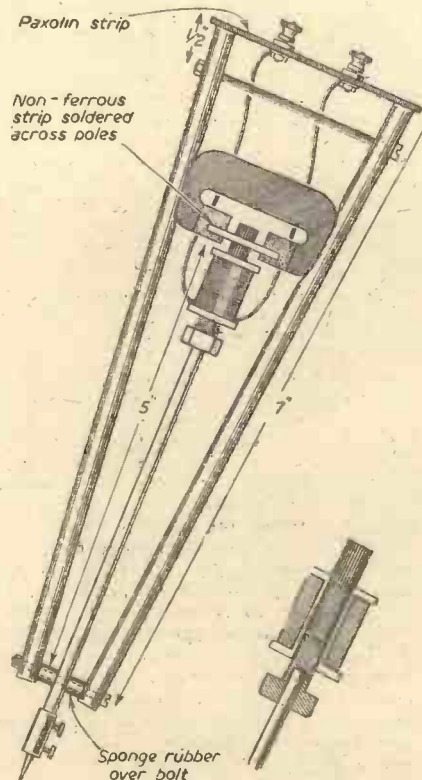

Fig. 1.—General view of the engraving tool.

Fig. 2.—Section of coil showing method of mounting.

The Armature

The armature consists of an electro-magnet mounted on a rod that is pivoted on the bottom bolt of the frame. One pole of the electro-magnet extends beyond the coil and lies loosely between the poles of the permanent magnet. The coil is connected directly to the transformer. An electro-magnet taken from an electric bell will answer the purpose, although if it has a solid iron core this should be replaced by a laminated one. The laminated core is made up of several pieces of iron wire, all insulated from one another. To make the core cut the wire to the right length, i.e., the length of the coil, plus length of the pole extending into the space between the poles of the permanent magnet. Give each wire a coating of shellac and then allow them to dry. Force as many of these pieces of wire into the coil until the whole core is tight and rigid.

The method of mounting on the rod will depend upon the type of coil used. The method used by the writer is shown in Fig. 2. The laminated core is not pushed right to the end of the bobbin and a bolt is screwed into the space left. A hole is drilled lengthways into the bolt and the rod soldered into it.

The armature pivots on the bottom bolt of the frame which passes through a hole in the armature rod. As the vibrations are at right-angles to the normal movement that would be allowed by the pivot, the hole through the rod has to be a little larger than the diameter of the bolt. To keep the rod in position while still letting it vibrate a pad of sponge rubber is placed on either side, between it and the frame.

The needle should be fastened as near to the pivot as possible. One of the easiest ways of doing this is to fasten a wire connector to the rod, the needle being clamped into the connector by a milled-head screw. A gramophone needle is quite satisfactory for the job.

To get a good impression on the metal, i.e., using a 6-volt transformer, the writer found that the coil was inclined to get rather hot. The current was therefore measured and found to be just over 2 amps. When choosing a coil the reader should be careful not to use one wound with very thin wire or it will probably burn out.

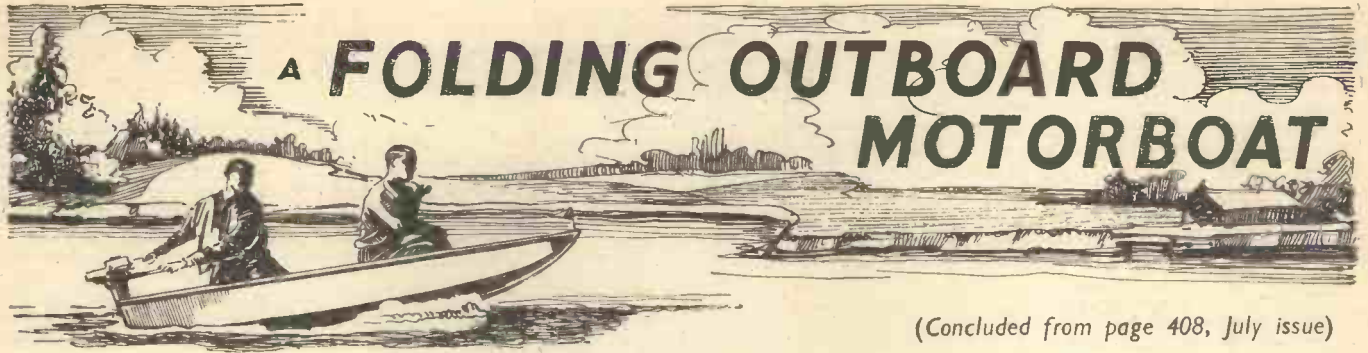

A FOLDING OUTBOARD MOTORBOAT

(Concluded from page 408, July issue)

An Easy-to-build Portable Speedboat Which Can be Constructed at a Very Low Cost

THE top edges are slotted in a similar manner to those of the stern board, but in this case two small holes are bored to receive the bolts which are used to retain the frame in position, and both holes and slots are protected from wear or enlargement by sheathing with thin brass as shown.

Constant reference to Fig. 5 (July issue), which shows the completely assembled boat, will facilitate the work at all stages. Having made the main items, the edges of all parts, including the sides and bottoms, should be given three coats of varnish, each coat being allowed to soak well in; this of course is to protect the wood from the action of water, for the edges are the most vulnerable parts of plywood.

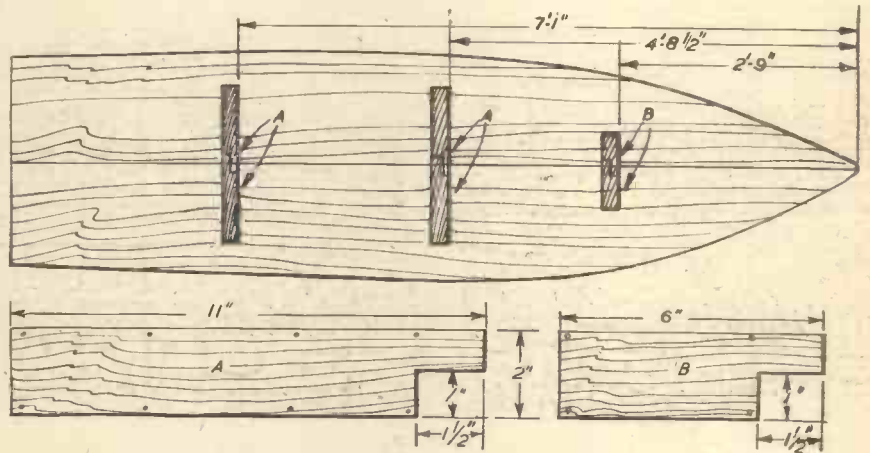

Fig. 9.—The positions of the locating tongues for holding the boat rigid.

Assembly

Take the two bottom halves and place them together on the floor in such a manner that the complete bottom is formed. Temporarily secure them by lightly tacking a few odd battens across at intervals of 18in.

and then turn the whole device over so that the battens are underneath. To make the hinged canvas joint cut a strip of canvas 2½in. wide and a few inches longer than the length of the bottom pieces.

This must be glued with marine glue (ordinary glue is useless) right along the seam so that an equal amount of canvas is on each half. Two battens of ¾in. by ¾in. hardwood are now secured along the edges of the canvas to within 2in. of the stern end with either rivets or screws spaced 2in. apart, but whichever method is adopted these fastenings must be driven dead tight so that the edges are watertight.

The Hinged Seam

The temporary battens may now be removed, and if the work on the seam has been properly done the two halves will fold down the curved edges, exactly registering. Fig. 5 clearly illustrates the principle on which this hinged seam is made.

The sides are hinged to the bottom in a similar manner, but a little surplus canvas is left between the battens to allow them to hinge inwards; the battens finish 2in. from the stern. Before making this seam, however, the shape of the boat can be formed and the parts held in position by fitting the metal hinges on the inner sides as shown in the assembled diagram, Fig. 5.

When all the seams are made, the front or bow of the boat where the four parts unite must be covered with a canvas cap as shown in detail A (Fig. 5), and the sides further protected by covering with shaped pieces of ¾in. mahogany. A brass eyelet is let into the top part to enable a painter or rope to be secured.

Locating Tongues

The locating tongues are to keep the boat

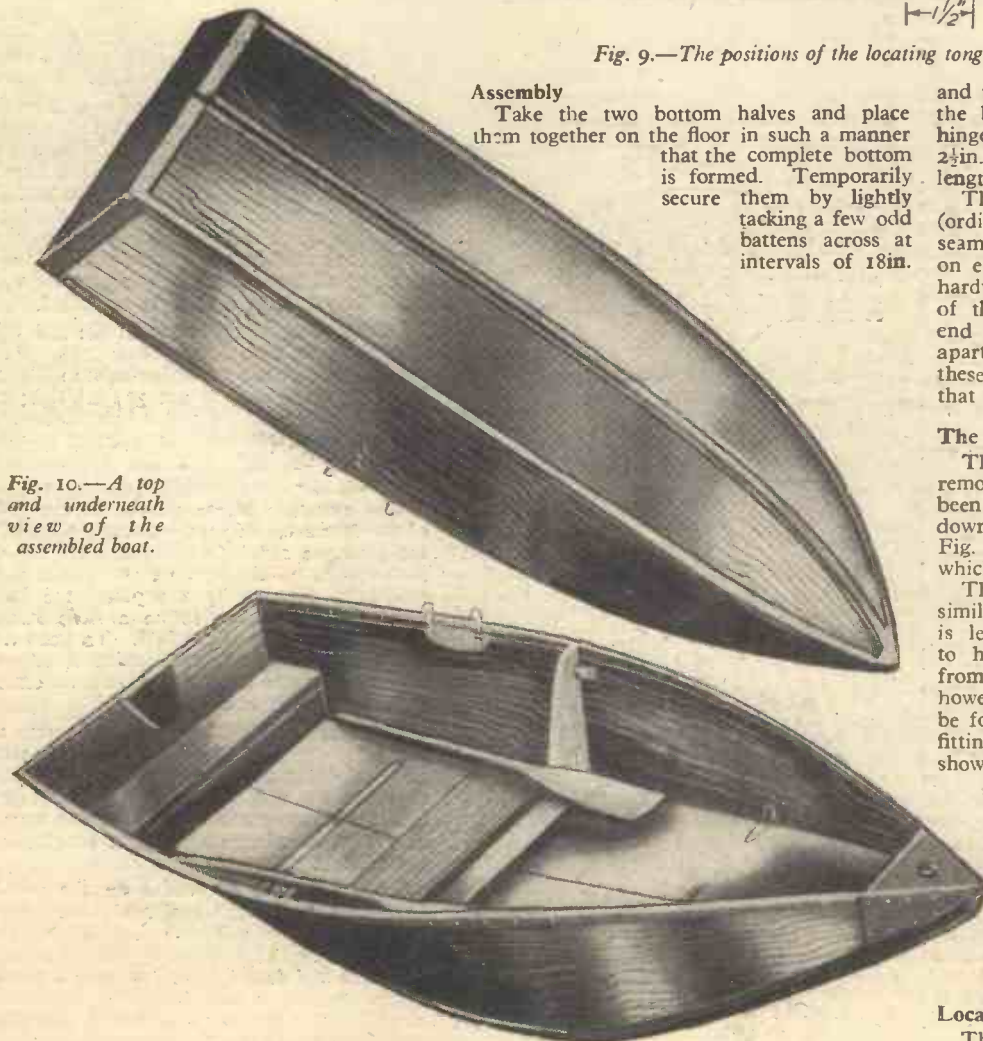

Fig. 10.—A top and underneath view of the assembled boat.

rigid, and these are shown in Fig. 5 and in detail in Fig. 9.

We may now fit the gunwales or inner and outer battens round the tops of the sides. These may be either through riveted or screwed separately according to the choice and skill of the reader. This is shown in Fig. 5.

We must now make a suitable groove or channel on each side of the boat at the stern to receive the stern board or transom, and this is accomplished by running two strips of batten $\frac{3}{4}$ in. (full) apart, from the top rail to the bottom of the sides; this will form a closed groove, into which the stern board is sprung, the notch therein fitting over the top rail. When these are completed the stern board may be placed in position, and similar grooves made for the frame or stretcher, and the holding bolts fitted. This frame is fitted by springing open the boat and dropping it in position, after which

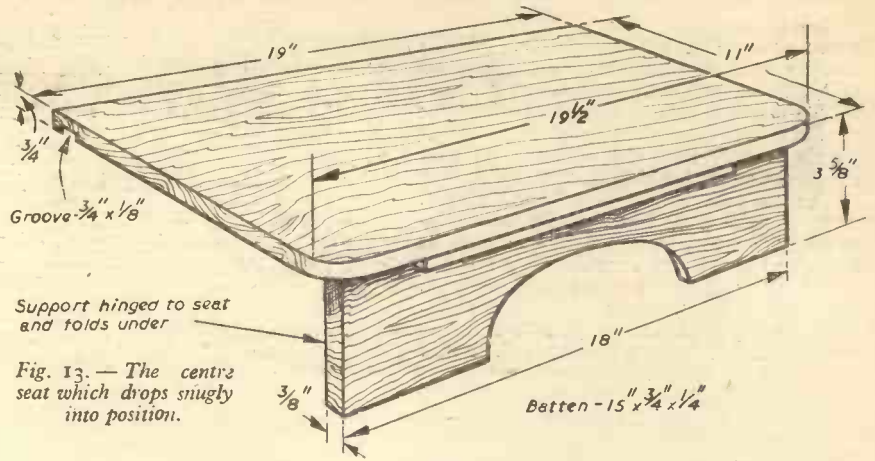

Fig. 13.—The centre seat which drops snugly into position.

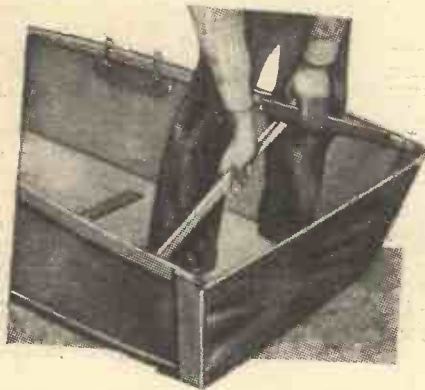

Fig. 11.—The sides of the boat are forced apart with the stretcher while the stern board and centre stretcher are placed in position.



Fig. 12.—The canvas nose-piece is clearly shown in this illustration.

the sides spring in and grip it, further assisted by shooting home the bolts. The boat should now assume its proper shape, and we must make the stern board watertight by fitting the canvas capping or false transom. This is done by making a canvas back, the edges of which are turned over the bottom and sides for 2 in. and glued, thus, with marine glue. Battens 2 in. wide are now screwed over them, which explains why our fore and aft seam battens finished 2 in. short of the stern.

The top edge of this canvas transom should be in some way strengthened either by stitching another piece about 1 1/2 in. wide along it, or making the back 1 1/2 in. over-size and turning the edge over.

The Seats

The seats require but little explanation, as they are clearly illustrated in the assembled diagram, Fig. 5. Details of the stern

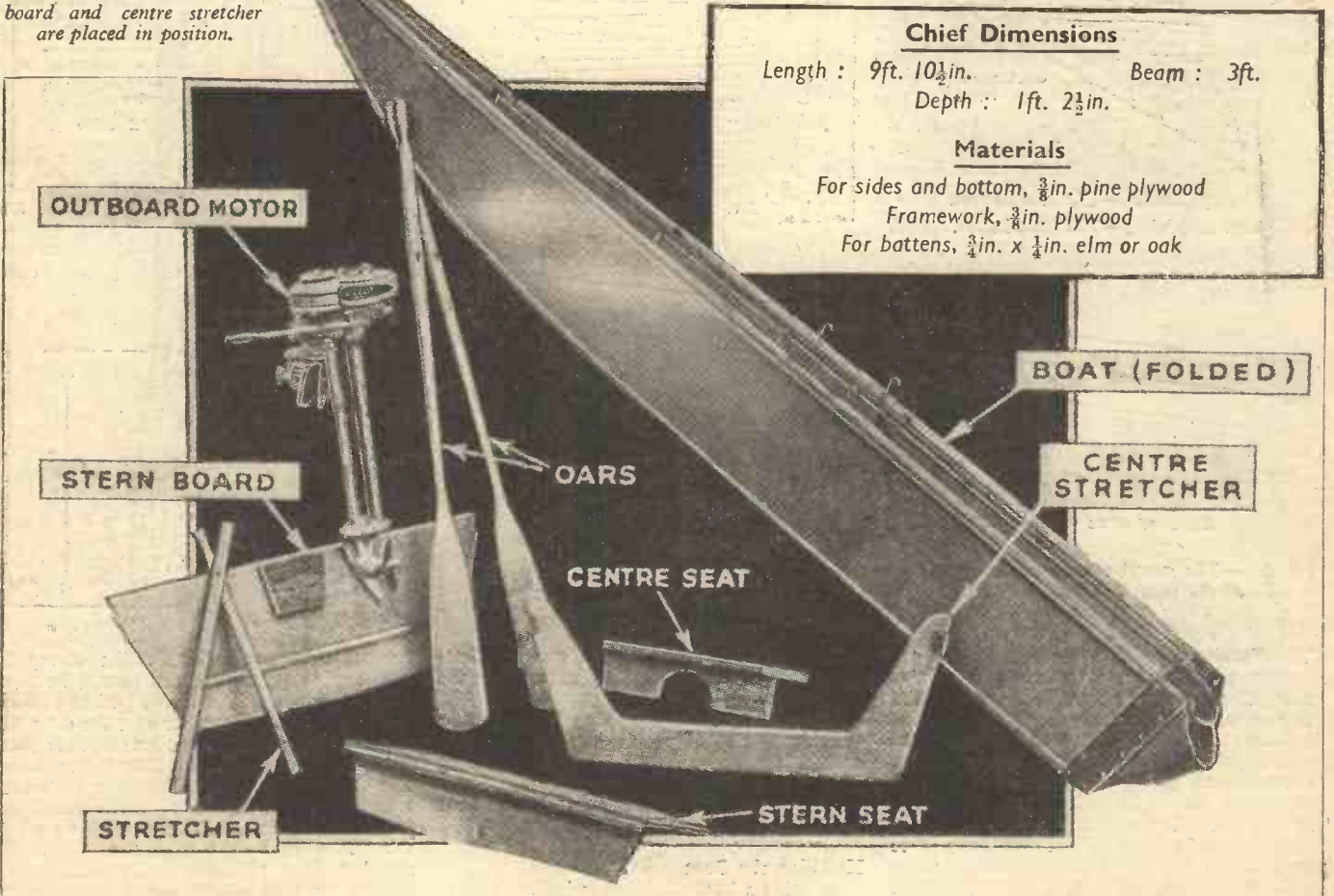

seat are given in Fig. 4. The leg is, of course, hinged to the seat so that it folds inwards so that when the boat is folded up it can be packed flat.

The groove in the rear edge fits over the batten on the transom, whilst a similar groove is cut in the front seat to fit over the frame or stretcher (Fig. 13).

The seats themselves are formed of $\frac{3}{4}$ in. plywood, whilst the legs are of $\frac{5}{16}$ in. plywood. The rowlocks, which may now be made and fitted, are constructed from $\frac{3}{8}$ in. round iron rod, and bent as shown in Fig. 8. One end, it will be seen, is bent at right-angles and passed through a hole bored in the side of the boat. The rowlock is held in position by a $\frac{1}{4}$ in. screwed staple.

The oars will require a screw eye fitted in them so that this eye can be passed over the hooked end of the rowlock and down the stem.

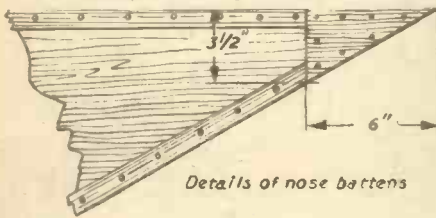

Details of nose battens

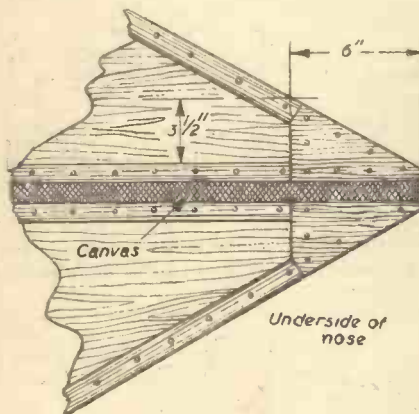
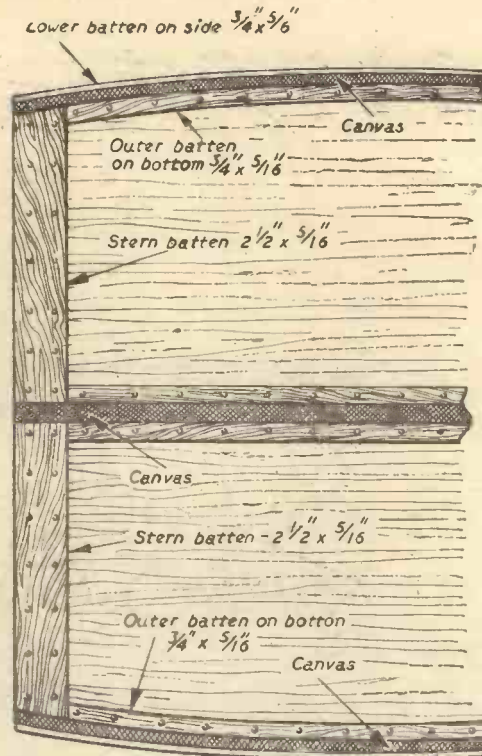
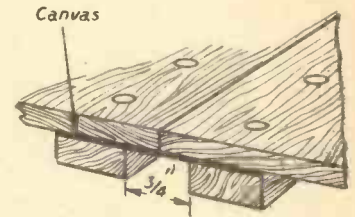

Fig. 17 (above).—The nose battens.
Fig. 18 (right).—The stern batten.



Note—All rivets on underside seams are at 2" pitch



Inner battens on bottom of boat

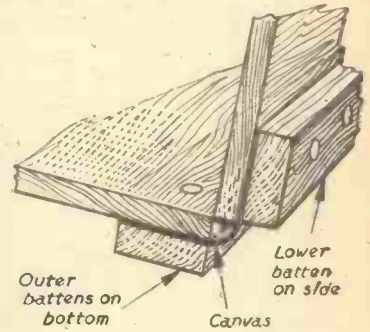

Outer battens on bottom
Lower batten on side
Canvas

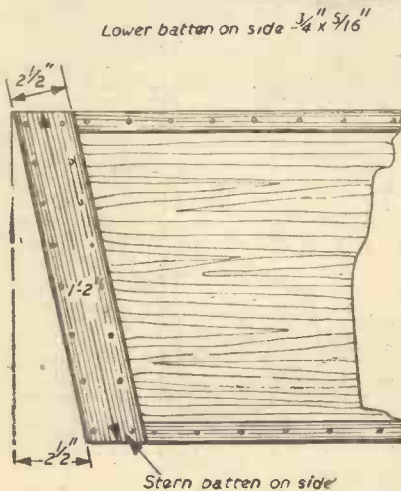

Stern batten on side

Fig. 14.—The underside of the boat showing the water-proof seams.

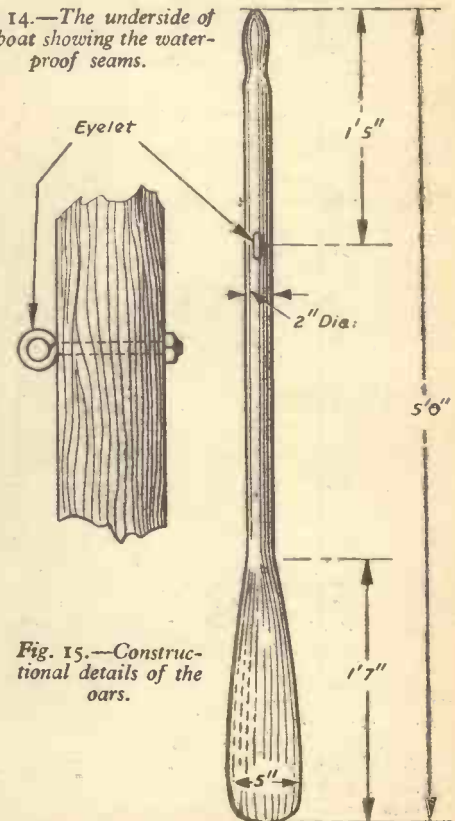

Fig. 15.—Constructional details of the oars.

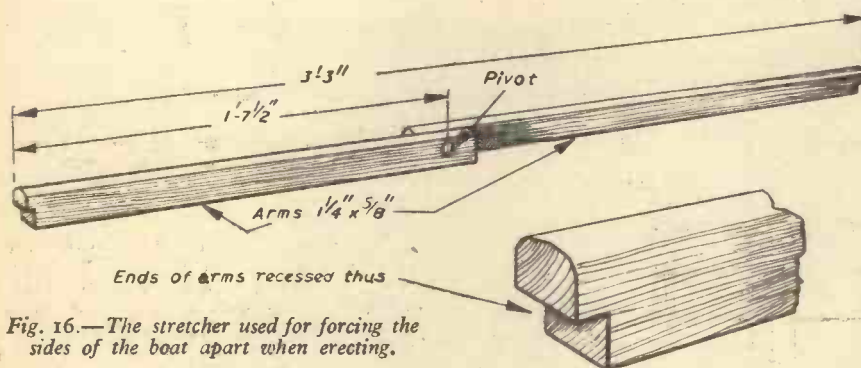

Fig. 16.—The stretcher used for forcing the sides of the boat apart when erecting.

The Rowlocks

Two rowlocks are fitted on each side so that alternative rowing positions can be given to suit the person rowing.

These rowlocks, also the frame bolts, etc., are, of course, mounted on protecting or strengthening plates of $\frac{1}{4}$ in. mahogany as shown in details C and D, Fig. 6. The location of all the fittings on the sides is also shown in Fig. 6. If the boat is to be used on salt-water, care must be taken that iron hinges, bolts, etc., are not secured

with brass or copper rivets or screws, otherwise corrosion will set in, caused by the salt spray.

The finish of the boat may be enamel or varnish. The latter is recommended, as enamel is prone to chip with constant folding of the boat.

Give three good coats of varnish with boat in the assembled position.

Handling the Boat

In using a boat of this description, it must

be borne in mind that, whilst strong for ordinary purposes, liberties cannot be taken with a folding craft. If used when bathing, it is inadvisable to clamber over the sides, and heavy persons should not lean against them.

Trim the boat well when under way—Fig. 1 is a very good example of correct trim with three adults aboard. Avoid too large an engine. A 1 h.p. engine such as the "Elto Pal" is adequate, and no extra speed will be obtained proportional to increased horse-power.

PHOTOFLOOD CONTROL

Constructional Details of an Easily-made Unit

By K. S. BAILEY

PHOTOFLOOD lamps can be controlled very simply, and their life more than doubled by the construction and use of this control unit, which is designed to avoid the use of resistances and uses only a minimum of switches to operate three lamps.

Description of the Circuit

The circuit utilises two series-parallel switches which must be ganged together to operate simultaneously. The remainder of the control unit consists of a single pole switch to act as an on-off for the mains and two lamp selector switches. One of these selectors is an on-off and the other a single-pole change-over. One, two or three lamps are selected solely by the operation of these two switches. The unit is so designed that the normal condition is to have the lamps in series. When the remaining "ganged" switch is operated the lamps are connected in parallel. In the unit constructed by the

lamps are put into parallel as shown in Figure 4.

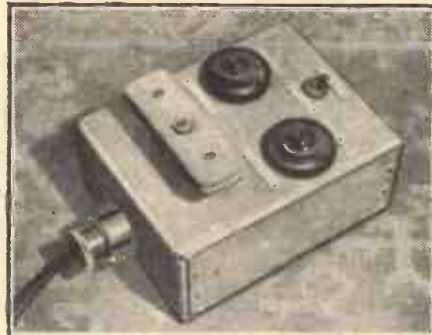

Fig. 6.—The completed unit and suggested layout for the switches.

So far, by the operation of one selector switch A, we have been able to select either two or three lamps in either series or parallel. To use one lamp only, switch B has to be opened which isolates lamps X and Y from the mains, and also place selector switch A in the position for *three* lamps. It will be observed that when the unit is in series, the lamp Z is off, and when in parallel, full on. This arrangement enables this particular socket to be used for enlarger control.

Construction and Assembly

For making and operating, the most convenient method is shown in Figure 5. The top of the box, which houses the whole unit, serves as the top guide for the operating tube, whilst a small bent-up bracket fastened to the loose bottom of the box serves as the bottom guide.

The box itself was made from 18 gauge mild steel plate. The spring shown in the section in Figure 5 is the means of return-

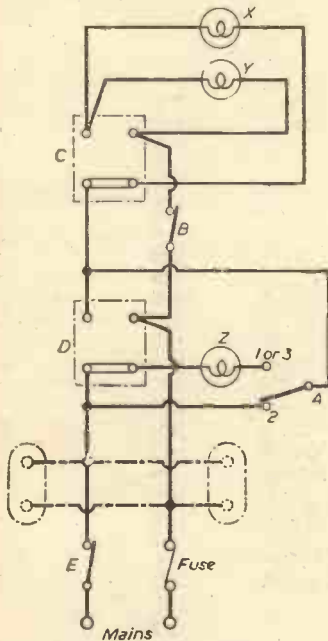

Fig. 1.—The circuit for two lamps in series.

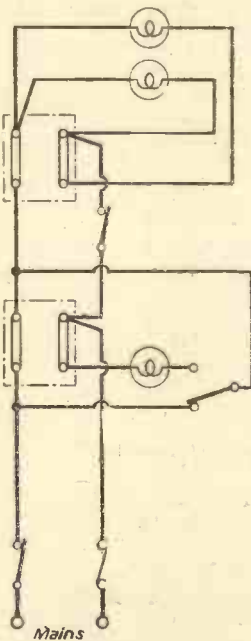

Fig. 2.—The circuit after operating switches C and D together.

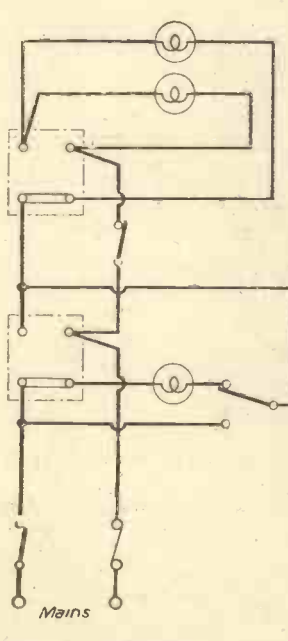

Fig. 3.—The circuit when three lamps are selected in series.

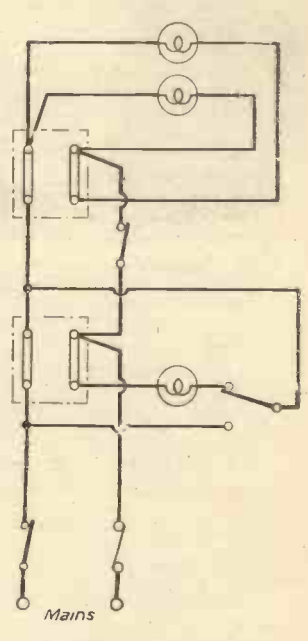

Fig. 4.—The effect of operating switches C and D—all three lamps are put into parallel.

writer, this latter switch is foot operated.

Figure 1 shows the circuit selected for two lamps in series. It will be noted that in this case, switch A (single-pole change-over) simply serves as a link for the mains across switch D. Lamps X and Y only, are now in series. On operating switches C and D together, the circuit will become as shown in Figure 2.

Figure 3 shows the circuit when three lamps are selected in series. Lamp Z now comes into operation. On operating switches C and D again, all three

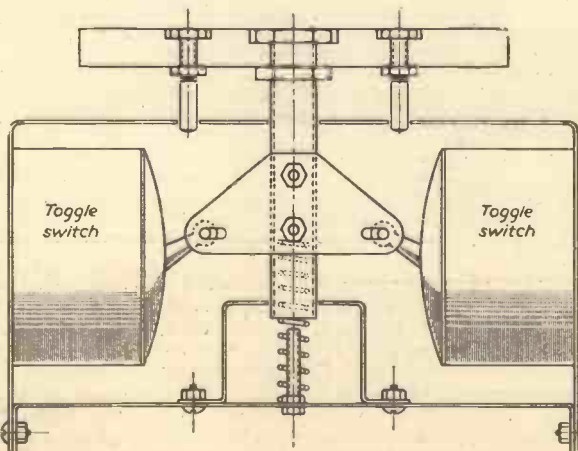

Fig. 5.—Foot-controlled switches for making and operating.

ing the switches to the series position after the pedal has been depressed. The knobs of the two switches should be drilled to take small bolts which work in slots in the operating arm, which is, in turn, bolted to the vertical tube which carries the foot pedal. The action should be as smooth as possible and free enough for the spring to return the two switches to the "up" position.

Figure 5 shows sufficient detail to construct the operating gear, or, alternatively, to develop from it a more suitable mechanism. Dimensions are not given, as these will probably vary according to the size of switches being used. The foot pedal may be made from a piece of wood of suitable size. The pins at either end of the pedal should just protrude into the box when the pedal is in the up position. Their purpose is to stop the pedal turning round.

The switches are 5-amp. type, and the

plugs and sockets 2-pin, 2-amp., but 3-pin plugs and sockets may be used, and so form an earth for the lighting equipment. Two further sockets as distribution points, and a 10-amp. fuse may be added as indicated in Figure 1. If these two distribution points are not added, the fuse need only be 5 amp.

If series-parallel switches are not available, double-pole change-over switches can be used just as successfully. A point to be watched is that, whatever type of switches are used, they should have an "off" position, i.e., series-off-parallel.

The photograph, Figure 6, shows the

finished job, and suggests a layout for the switches on the top of the box. As a guide, the overall sizes are 8in. long by 6in. wide by 3½in. deep. The socket shown at the end of the box is for connection to the house mains. The three outlet sockets for the lamps are situated at the opposite end of the box.

Wiring and Operating

Having assembled the switches and sockets in the box, they should be wired up with 5-amp. rubber-covered cable. All bare ends

of wire at connections should be insulated. If the mains earth lead is used, a tag should be soldered on to it. It can then be bolted to the case.

On completing the wiring, the unit should be turned face down, and the return spring inserted into the operating tube. The bottom support bracket, attached to the bottom of the box, should be threaded over the spring and tube, slightly compressing the spring, and the bottom of the box bolted on.

Now, the control unit is ready for operation. Connect to the mains, link up the photo-flood lamps and switch on.

Back to First Principles

7—About Pulleys

By W. J. WESTON

THE single grooved wheel fixed in a block, so that a cord or the like might pass over it, must have been among the first fruits of human ingenuity. Its utility consists in changing the direction of a force: i.e., a pull downwards lifts a weight upwards; a pull on one bank of a stream draws the raft to the other bank. The single pulley has no "mechanical advantage"; though it adds to ease, it does not increase power. Varied combinations of fixed and movable pulleys do give mechanical advantage, some combinations more than others.

The Problem

In a pair of pulley blocks (Fig. 1) there are three sheaves in each block, the weight of each block is 25 lb., and a weight of 245 lb. is hung from the lower block. The efficiency of the contrivance is 60 per cent. Find the effort needed to raise the weight and the pressure on the hook supporting the contrivance. (Neglect the weight of the rope.)

The Comment

In the upper block the pulleys are fixed; in the lower block the pulleys are movable. If, therefore, the weight rises one unit in height, the rope passes over the uppermost pulley by a length equal to six times that unit (equal, that is, to the total number of the pulleys, both fixed and movable). The force; that is, goes through a distance of six times that of the resistance. The force raises the lower block, 25 lb. in weight, in order to raise the 245 lb. weight.

The Answer

Mechanical advantage = 6; and, since efficiency is 60 per cent.,

$$W + w = 6F \times \frac{60}{100}$$

That is : 245 lb. + 25 lb. = 3.6F

The Force ∴ is (270 ÷ 3.6) lb. = 75 lb.

The pressure on the hook, therefore, is 245 lb. + 25 lb. (upper block) + 25 lb. (lower block) + 75 lb. = 370 lb.

The Problem

Find the condition of equilibrium for a system of pulleys in which each pulley hangs

in the loop of a separate string (Fig. 2), the strings being parallel and each attached to the beam. The weights of the pulleys are to be taken into account. If there are 5 pulleys and each weighs 1 lb., what weight will a force of 5 lb. weight support on such a system? What will be the total pull on the beam?

The Comment

In such a system there will usually be an added fixed pulley, which has no bearing upon the mechanical advantage, but which

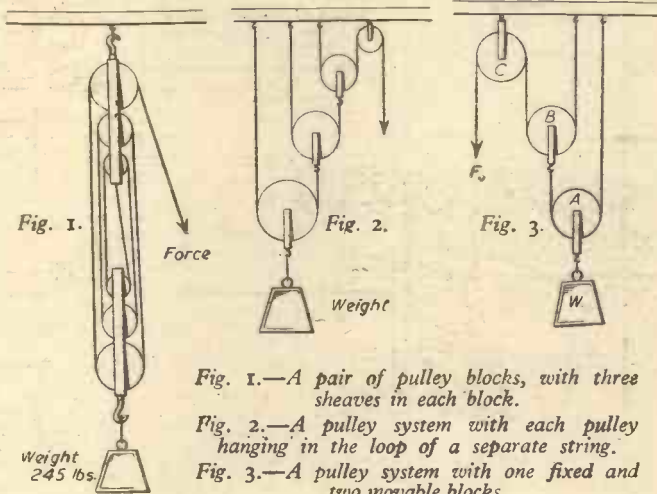

Fig. 1.

Force

Fig. 2.

Weight

Fig. 3.

Fig. 1.—A pair of pulley blocks, with three sheaves in each block.

Fig. 2.—A pulley system with each pulley hanging in the loop of a separate string.

Fig. 3.—A pulley system with one fixed and two movable blocks.

enables the force to be applied in a downward direction.

When the weight rises one unit the lowest pulley, too, rises one unit, and the string holding it goes two units to the right. The next pulley, therefore, rises two units, and its string goes four units to the right; and so on. The force, therefore, is multiplied 2ⁿ times, n being the number of movable pulleys.

The successive pulleys rise in this way: 1, 2, 4, 8 . . . 2ⁿ⁻¹, the total of which series is 2ⁿ - 1.

The Answer

Equilibrium is reached when $W + (2^n - 1)w = 2^n F$. (n being the number of movable pulleys and w the weight of each movable pulley).

Substituting the figures given in lb.

$$W + (32 - 1) \times 1 = 32F = 32 \times 5.$$

$$\therefore W = 160 - 31 = 129 \text{ lb.}$$

If we think of the force as being exerted upwards, overcoming therefore the work done on the pulleys, this is also the total pull on the beam.

The Problem

This is a system of pulleys (assumed to be frictionless) whereby an effort F raises a load W. Pulleys A and B are movable and weigh A, 2 lb., B, 3 lb. C is fixed. What is the velocity-ratio of the system? What is the mechanical advantage and the efficiency when a load of 1 cwt. is being raised? If there were n movable pulleys, each of weight w, what effort would raise a load W?

The Comment

As in the example above, the velocity-ratio—the comparison between the distance through which the force is overcome and the distance through which the force is exerted—is obtained by the formula 2ⁿ, n being the number of movable pulleys. This velocity-ratio would also be the mechanical advantage, but for the need to raise the pulleys in addition to the load. Some work done, therefore, has been an inseparable incident of the work we wish to do. This lost work is measured by 2 lb. (A rising one unit) + 3 lb. × 2 (B rising two units). The efficiency is what remains of the work we wish to do after deducting the incidental work.

The Answer

$$\text{Velocity-ratio} = 2^n = 4.$$

$$\text{Mechanical advantage} = \frac{112}{30}, \text{ since}$$

the Force needed to raise 112 lb. is obtained by the equation,

$$112 \text{ lb.} + 8 \text{ lb.} = 4F.$$

$$\therefore F = 30.$$

$$\text{Mechanical advantage is, therefore, } \frac{112}{30}$$

$$\text{or } 3.73.$$

$$\text{Efficiency is } \frac{112}{120} \left(\frac{\text{Load}}{\text{Load} + \text{weight of pulleys raised}} \right)$$

$$= 93\frac{1}{3} \text{ per cent.}$$

$$W + (2^n - 1)w = 2^n F.$$

$$\text{Therefore } F = [W + (2^n - 1)w] \div 2^n.$$

FOR THE MODEL MAKER
THE MODEL AEROPLANE HANDBOOK
By F. J. CAMM

312 pages

303 illustrations

12/6 (13/- by post)

Construction and Principles of all Types

and

MODEL BOAT BUILDING

Constructional details of Model Sailing and Power Boats. 5/- (5/6 by post)

From GEORGE NEWNES, LTD., TOWER HOUSE, SOUTHAMPTON STREET, STRAND, W.C.2

IS THERE A FLUX
AS GOOD AS
"FLUXITE"?



**Yes! FLUXITE
FLUID!**

So now we have
FLUXITE FLUID
as well as Paste!



... you can't buy
a better fluid



—so be sure it's

**"FLUXITE"^{REGD}
SOLDERING
FLUID**



Conforms strictly to the high standard of manufacture and quality that has made
FLUXITE the first choice of GOVERNMENT WORKS, ENGINEERS and INDUSTRIALISTS
for more than a generation.

Standard Sizes : 4 fluid ozs., 8 fluid ozs., 20 fluid ozs., 1 Gallon Cans.

YES... you can fit a REFRIGERATOR in your own kitchenette, even if you are short of available floor space.

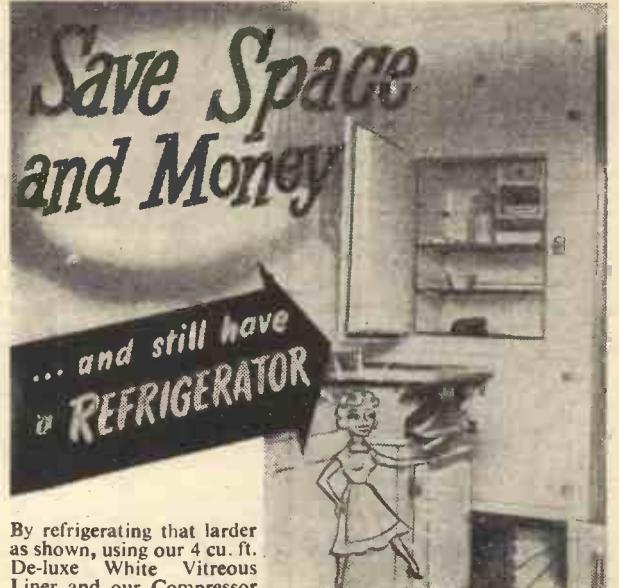

By refrigerating that larder as shown, using our 4 cu. ft. De-luxe White Vitreous Liner and our Compressor or Absorption (silent type) Units, you can have that much needed Refrigerator without taking up any more valuable space in that already small Kitchenette. Yes! and also add £150 to the value of your property.

We are Specialists who cater for all types of constructors, whether Machinists, Woodworkers, Mechanics, or just the Home Handyman.

Meet us at
**THE MODEL
ENGINEER
EXHIBITION**
Stand X & Y

Send stamped addressed envelope for our free 16-page Hints Booklet and Price List, which explains the various approaches to Home Constructed Domestic Refrigeration, "Built-in" or Cabinet, and lists over 100 of our Guaranteed Components from Castings to "Ready to Install" Units.

BRAID BROS. 50 Birchwood Avenue,
Hackbridge, Surrey.
Tel: WALLington 9309.

FREE THIS VALUABLE BOOK

which details the wide range of Engineering and Commercial courses of modern training offered by E.M.I. Institutes—the only Postal College which is part of a world-wide Industrial Organisation. Courses include:-

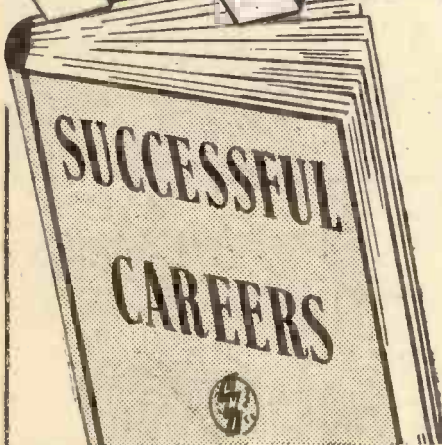

Mechanical Engineering
Gen. Mech. Eng.
Diesel Engines
Refrigeration
Metallurgy
Workshop Practice
Maintenance Eng.
Machine Tools & Metrology
Marine Eng.

Radio & Television
Gen. Radio & T/V Eng.
Radio & T/V Servicing
Radar
Sound Recording
Industrial Electronics
Advanced Radio
P.M.G. Certificates
Radio Amateurs Licence

Civil Engineering and Building
Civil Eng.
Building Construction
Heating & Ventilating
Sanitary Eng.
Surveying
Clerk of Works
Carpentry & Joinery
Builders Clerks

Production Engineering & Management
Gen. Prod. Eng.
Industrial Admin.
Works Management
Production Planning
Personnel Management
Time & Motion Study
Costing
Office Practice

Draughtsmanship
Eng. Drawing & Design
Tracing
Jig & Tool Design

Electrical Engineering
Gen. Elect. Eng.
Installations & Wiring
I.E.E. Theory

Automobile Engineering
Gen. Motor Eng.
High Speed Oil Engines
Garage Management

Aeronautical Engineering
Gen. Aero. Eng.
A.R.B. Licences
A.R.M. Certificates

Also Examination Courses for: — General Certificate of Education, B.Sc. (Eng.), Common Preliminary, A.M.I.Mech.E., A.M.I.C.E., A.M.I.Struct.E., A.M.Brit.I.R.E., A.F.R.Ae.S., A.M.I.P.E., A.M.I.I.A., A.M.I.M.I., A.M.I.H. & V.E., M.R.San.I., A.M.I.San.E., A.M.I.Munc.E., A.M.I.E.D., A.M.S.E., L.I.O.B. Also CITY and GUILDS Certificates in Mechanical, Electrical, Aeronautical, Automobile, Telecommunications and Structural Engineering; Refrigeration, Heating & Ventilation. Courses also provided for all branches of Commerce and Business Management.

EMI INSTITUTES
associated with
MARCONI PHONE COLUMBIA & H.M.V.
(His Master's Voice)

**COURSES
FROM
£1
PER MONTH**

NEW!
Home Experimental Kits now form part of the following courses: Draughtsmanship, Carpentry, Chemistry, Photography, Commercial Art, Radio and Electronics, etc.

POST NOW

Please send, without obligation, the above FREE BOOK.
E.M.I. Institutes, Dept. 144k 43 Grove Park Rd., London. W.4

Subject(s) which interest me _____

Name _____

Address _____

**HERE'S VALUE!
ELECTRIC MOTORS**

EXPORT SURPLUS
NEW 1/4 H.P. Made by world-famous Manufacturer. 220-230 Volt. A.C. 50 cycles. 1,420 r.p.m. Single phase. Continuous rating. Capacity start. Drip proof sleeve bearings. Solid base platform. Standard drive shaft. Similar to illustration. Complete with condenser. Usual Price, £8.
P & C PRICE 89/6 Carr./Packing 7/6.

PLASTIC MALLET
New and unused Ex-W.D. Surplus. Ideal Tool for The Workshop.
Post and Packing 1/- **1/6**
NEW HAMMERS
Ball-peine Hammers. Post and Packing 1/- **2/6**

1 AMP BATTERY CHARGERS
Also useful as Eliminator. New and fully guaranteed in leading maker's original carton. 200-250v. A.C. Charges 2, 6 & 12v. batteries & maintains 1 amp. output at all vol-**55/-** tages. (List Price 95/-). Post/Pkg. 1/9. Also 2 amp. De Luxe Model with Ammeter, 89/6 Carr./Pkg. 2/6.

NEW SMITH'S 8-DAY CLOCKS
Ex-R.A.F. Complete with TRIP Hands. Made to Air Min. specification. Model B. 2 1/2 in. dial in bakelite case. With 2 1/2 in. base. (Worth Double.)
Post & Packing, 1/6. **35/-**

NEW ALTIMETERS
Ex-Govt. Single Arm. 0-20,000ft. IDEAL FOR CONVERSION TO BAROMETER. **6/6**
Special reduction. Post & Packing, 1/-.

Send for free new illustrated catalogue.
PRIDE & CLARKE Ltd.
(Dept. P.M.), STOCKWELL ROAD, LONDON, S.W.9. BR1xton 6251.

10 Halden Branches
are ready to deal with your
Photo Copying on the spot

Every Halden branch is fully equipped and ready to produce photo copies of plans, deeds, documents, etc., by any of the usual processes. To the larger users, Haldens offer a range of the most modern equipment for the production of their own photo copies. In connection with the production of maps, Haldens are licensed by the Controller of H.M. Stationery Office to reproduce Ordnance Survey Maps in one colour.



Haldens
OF MANCHESTER

J. HALDEN & Co., 8, Albert Square, MANCHESTER, 2
Branches at: London, Newcastle-on-Tyne, Birmingham, Glasgow, Leeds and Bristol

THIS MONTH'S BARGAINS!!!

SOCKET SPANNER SETS.—Large size from 1 1/16-1 1/2. A.F. sizes contains 12 sockets and 2 extension bars in a strong steel case. Normal list price for this kit would be £15. Our price, 80/-, plus 4/- carriage and packing.

RADIO RECEIVERS, TYPE R109.—This is an 8-valve superhet receiver covering the following wave bands: 1.8 Mc/s—3.9 Mc/s, 3.9 Mc/s—4.5 Mc/s. Complete with all valves and vibrator pack. Built-in speaker, works off 6-volt batteries. No mains required. Ready to use at £6 each. Carriage and packing, 10/-.

TRUVOX HAND MICROPHONES.—A very robust job suitable for use with loud hailer systems. Ideal for your garden parties this summer. Price, 7/6 each, packing and postage 1/8 extra.

VALVES.—Type VU120A EHT. Television Rectifier. New and boxed. Price, 3/-, including postage and packing.

METERS.—0-100 m/a. 2 1/2 in. scale. Round. Flush panel mounting. This is a shunted meter, the basic movement being 21 m/a and with the shunt removed can be used as a voltmeter with a suitable resistance in series, of course. Calibrated 0-100. Details for conversion supplied if requested. Price, whilst stocks remain, 7/6 each, plus 1/8 postage and packing.

THROAT MICROPHONES.—Miniature American carbon type in moulded plastic/rubber. Slightly store soiled, but guaranteed in perfect working order. Price, 1/3 each, plus 6d. postage and packing, or 10/- per doz., post paid.

NAVIGATOR COMPASSES.—New, in strong wooden transit cases. Alcohol Fluxgate. This is a very fine instrument. Ideal for Cadets, etc. Limited quantity. Price, 50/- each, plus 3/6 postage and packing. Send S.A.E. for all enquiries please.

JEFFREY H. DAKIN

13 Church Road, Edgbaston, Birmingham, 15.

EDGbaston 2220

WATSON'S SPECIAL OFFERS

CHORE HORSE Generating Sets, 12-15v. 300w. Fine sets ready for operation. £17/10-. Carr. 12/6.
BATTERY CHARGER.—Metal rectifier type. Output 10a. 24v. Built to high service specification. £10/0-. Carr. 12/6.
INDICATOR UNIT.—Contains 34in. Cathode-Ray Tube, valves, condensers, resistances, etc. 37/6 Carr. 3/6.
R.F. UNITS.—Type 25, approx. 7in. x 5in. x 8in. Containing three valves, resistances, condensers, etc. 10/6. Post 2/-.
MICROPHONE TESTERS.—Contains 0-10v. Voltmeter, etc., in hardwood case. 19/6. Post 2/-.
PRESSURE GAUGES.—0-200lb. per sq. in., dashboard fitting, 2 1/2 in. diam. chrome rims. 14/6. Post 9d.
DINGHY MASTS.—Telescopic aluminium extends from 2ft. to approx. 9ft., light and strong. 8/6. Post 1/10.
INSULATED AERIAL STRAINERS.—Contains 40ft. strong flexible steel cable, insulators, connection shackle and adjusting strainer. 7/6 each. Post 1/6.
IMMERSION HEATERS.—Each with control switching giving 250w., 500w. and 1,000w. loading as required. Suitable for 220/230v. circuits. Substantially made and ideal for a variety of heating jobs. 35/- each. Carr. 3/-.
ASTRO COMPASS.—Precision observation instruments. Optical sight, four scales, two spirit levels, in transit case. 9/6. Post 1/6.
MINE DETECTORS.—A fine article with hundreds of uses for detecting concealed metal objects, etc. £4/10-. Carr. 8/6.
OH. SYRINGE.—Large capacity barrel 1ft. long, 2in. diam. with 1ft. flexible pipe extension. Price 9/6. Post 1/6.
POCKET SPIRIT LEVELS.—2 1/2 in. moulded case with protective cover. 1/6.
PRISMS. 1 1/2 in. face, optically worked, 25/- post 6d.
SILENTBLOC BUSHES.—2in. long, 1/2 in. inside, 1 1/2 in. outside diam. 2/6 for 4. Post 1/6.
CONDENSERS.—0.5 mfd. 1,500 volts D.C. Tested to 2,500v. D.C. 1/6. Post 6d.
BRASS BATTERY HOLDERS S.B.C.—15/- doz. Post 1/6.
V-ROPES.—"B" Section, 2 1/32" x 7/16in., 52in. overall. 3/6 each, 5 for 16/6. Post 6d.
Hundreds of other bargains available.
Send stamp for List.

EASTERN MOTORS,
ALDEBURGH, SUFFOLK. Phone 51

TAKE MY TIP—insist on

and be sure of
Craftsmanship and Quality

186. B. MECHANICS' VICE

126. 'G' CRAMP

189. WOODWORKERS' VICE

186. E FITTERS' VICE

104. STEEL SASH CRAMP

No workshop or handyman's bench is complete without a quality vice. When seeing your dealer, ask for WODEN Tools by name. He will be pleased to sell you "WODEN" because, in his experience, he knows that they are second to none for accuracy and perfect finish.

THE STEEL NUT & JOSEPH HAMPTON LIMITED
WODEN WORKS WEDNESBURY PHONE DARLASTON 351

ALPHA OFFERS

Throat Microphones—2 in box ... 1/8 box
G.P.O. type Jack Plugs ... 1/3 ea.
Bell Push with warning light ... 1/3 ea.
Car Bulbs, 6-7 v. 18 watts ... 1/3 ea.
Car Plug Suppressors ... 1/2 ea.
4 position Rotary Switch, 30 amp. ... 3/6 ea.
Single Gang, .0005 mfd. Condenser ... 2/6 ea.
Small Yaxley, 1 pole 8 way ... 1/3 ea.
Small Yaxley, 1 pole 2 way ... 1/- ea.
Fuse Holders ... 6d. per pkt.
Multicore Solder ... 6d. per pkt.
EF50 Ceramic Valve Holders with Screw Retainer Ring ... 10d. ea.
Loctal Paxolin Valve Holders ... 3d. ea.
B.I. Flex Art. Silk. Brded. 50 yds. 14/0076. Many uses ... 29/6 per coil
Wearite "P" Colls, FA2, PH2, etc. ... 3/- ea.
2 1/2 in. unit by Goodmans in Bakelite Case. Pastel shades, Blue, Cream, Pink, etc. 29/8 each.

REPAIR YOUR OWN SPEAKERS
Cone replacements available as follows:—
Rola 8Z and most other 8in. speakers with 1 pole piece... 5/- ea.
Rola 6Z and most other makes with 1in. pole piece... 4/6 ea.
Philco and R. & A. 8in. ... 5/- ea.
Philco and R. & A. 6in. ... 4/6 ea.
Post and packing on above 1/- ea.

VALVES

IT4	8/-	9D5	10/6	EF91	9/-
354	9/6	10C1	11/-	KTW61	8/9
3V4	9/-	20Z7	11/6	RC42	10/6
6F6G	7/6	35Z4	9/-	UF42	12/6
6F6M	9/6	35L6	9/6	UL41	10/6
6CG8	6/6	50L6	8/6	PEN220A	4/9
6H6	4/6	CV188	3/9	VR54	3/6
6J5G	5/6	DET7	10/-	VR150/30	
6J5GT	5/6	EF50	6/-	SP22	9/6
6L4	10/6	EF50 (Syl- vania)	8/-	Y83	9/6
6SA7	9/-	FW4500	9/-	SP61	3/9
6SH7	6/-	HL23DD	8/-	IR5	8/-
6SL7	6/9	MH4	5/6	IS4	8/-
6SQ7	9/-	MSPEN	5/-	IS5	8/9
6T1	12/6	VR57	8/-	EB041	11/-
6BE6	11/-	VR136	7/-	955	4/9
6C9	8/-	VR116	4/-	951	2/-
6F15	10/6	VR99A	13/-		

TERMS.—Cash with order or C.O.D. Mail Order Only.

Illustrated list available send 6d. in stamps. Postage 9d. to 10/-, 1/- to 20/-, 1/6 to 40/-. Minimum C.O.D. Fee and Postage, 2/3.

ALPHA RADIO SUPPLY CO.,
5/6, Vinces Chambers, Victoria Square, Leeds, 1.

An Electric JIG SAW

Constructional Details of a Handy Machine for the Home Workshop

By D. LYONS

THE top bearing is housed in a brass block and a $\frac{3}{8}$ in. tap screw secures the block to the bottom of the saw. Tap the $\frac{3}{8}$ in. screw into the end of the block and solder in position, cutting off the screw head and replacing it with a nut. Drill a $\frac{3}{8}$ in. hole through the two lugs for the screw to hold the bearing. Small washers are inserted between the lugs and centre part of the ball race to prevent binding when the screw is tightened up. If this block is made carefully, a good free movement will result, with no side play.

(Concluded from page 423, July issue)

sunk hole at one end is pushed down the main pipe. This rod, which acts as a plunger, must be an easy sliding fit in the pipe and is followed by a medium strength spiral spring. Pressure is applied to the guide through the spring by means of a long $\frac{1}{2}$ in. screw passing through the tapped hole in the spacer. This hole is the one used when setting up the cradle for welding. The other end of the $\frac{1}{2}$ in. screw fits in the countersunk hole in the

the top arm is a short spring. This spring is hooked into a small brass clip, caught under the bolt holding the strut, the other end being held by a $\frac{1}{2}$ in. screw in the spacer.

The function of this spring is twofold. First, it serves to counterbalance the weight of the saw frame and, secondly, it lifts the top arm clear of the cutting table should a saw blade break. No means of adjusting this spring is provided—it is just a case of obtaining the right spring.

The cutting table is made from stainless

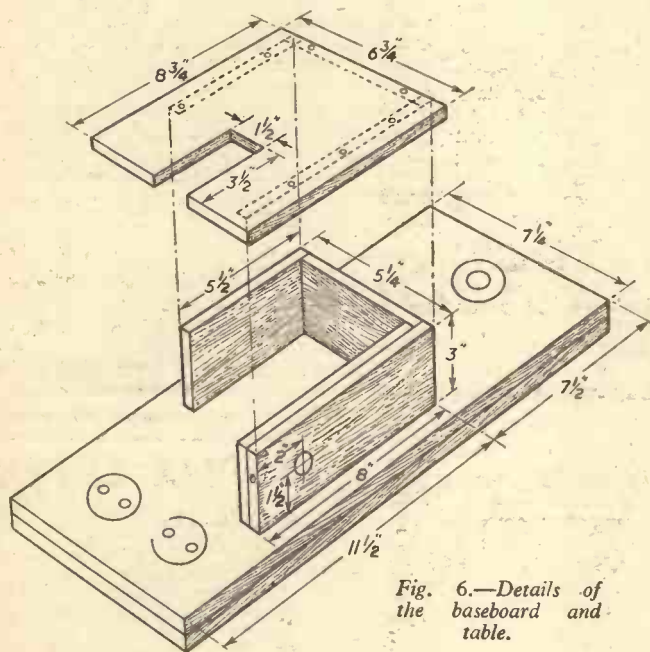
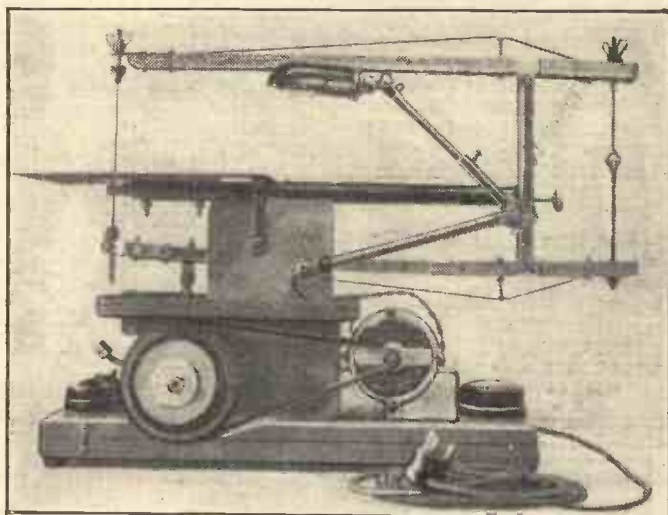

Fig. 6.—Details of the baseboard and table.



Side view of the complete machine, showing the motor and the belt drive.

Adjustable Guide

This was fitted as an afterthought but is well worth the extra trouble involved. It consists of a short length of pipe, fitted inside the horizontal tube of the cradle and adjusted from the back of the spacer. A small pulley bears against the back of the saw blade and revolves with the movement of the blade. It is spring-loaded and eliminates any tendency of the blade to twist or wander sideways.

The pipe is 6 in. long and must be a dead fit in the cradle, and this was achieved by patient filing and carborundum paste. After a good sliding fit has been obtained, cut the slot in the end of the pipe and fit a small steel roller about $\frac{3}{8}$ in. in diameter. A fine cut, about $\frac{3}{32}$ in. deep runs round the roller and engages with the back of the saw blade. Two slots are made to allow the bolts holding the cutting plate support to be replaced when the tube is in position.

When these bolts are tightened up it should still be possible to move the guide backwards and forwards for about $\frac{1}{2}$ in., with little or no twist sideways. Any tendency to stick must be removed.

When marking the slots for drilling check the position of the roller. It should be about $\frac{3}{8}$ in. clear of the back of the saw blade when the guide is pushed back against the $\frac{1}{2}$ in. bolts.

Before inserting the guide, a short length of brass rod $1\frac{1}{2}$ in. long and with a $\frac{3}{8}$ in. counter-

plunger. The hole is countersunk the whole diameter of the plunger to allow the screw to centre itself should it be withdrawn from the hole. Fit a small knob or milled wheel on the end of the screw for easy turning and drill a hole in the main pipe for oiling the guide.

Counterbalance and Worktable

At the back of the spacer and connected to

steel iron, by $8\frac{1}{2}$ in., but the size can be altered to suit personal requirements. Cut out a template from stout cardboard, the exact size of the plate and fit it in position on the cradle. Mark out the fixing holes and the centre of the saw blade and transfer them to the actual plate. For this size plate the slot is $\frac{1}{2}$ in. by $\frac{3}{8}$ in. and is $3\frac{1}{2}$ in. from the front edge to the centre of the slot. Two small angle brackets made from $\frac{1}{2}$ in. by $\frac{1}{2}$ in. strip support the back of the plate and are fastened to the sides of the cradle with tap screws. File the fixing holes in the brackets and the cutting table supports into slots, as this enables the saw slot to be accurately centred.

Drive and Main Bearings

The main bearing housing is made from a short piece of $\frac{1}{2}$ in. gas tubing, threaded outside to take two locking nuts and turned out at each end to hold the ball races (Fig. 5). These must be a good firm fit and are pressed into the recesses by means of a vice, using pieces of hard wood as protection against damage. The bearings used in this case are $\frac{1}{2}$ in. overall diameter and $\frac{3}{8}$ in. bore, but other sizes can be used so long as the pipe will take them. The size of the pipe can be increased if necessary, but it is not advisable to use bearings with a bore of less than $\frac{3}{8}$ in., as this would mean reducing the diameter of the shaft. In the case of the bearings already being a good fit in the pipe, the turning out of the recesses is not necessary. A shorter piece of tubing of smaller diameter can be forced into the main pipe to act as a spacer, but be sure the ends are dead true.

The shaft is a piece of steel rod, threaded $\frac{1}{8}$ in. at one end, and held in position by the

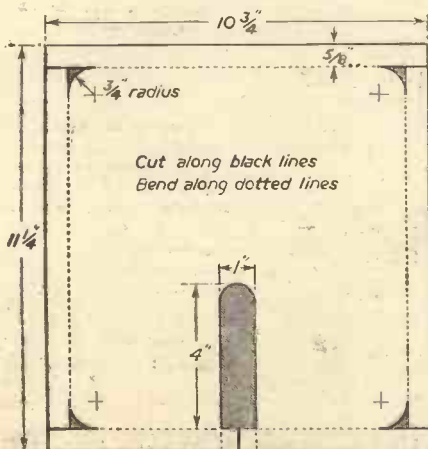

Fig. 7.—Blank for forming the metal tray.

driving disc and a $\frac{1}{8}$ in. nut. A spindle from a bicycle wheel could be adapted for this purpose, but it must be straight and a good fit in the bearings. Do not cut off the extra length from the shaft as this can be used for a sanding wheel or small emery stone.

The driving disc is turned on a lathe and secured on the shaft up against the ball race by a cotter pin or set-screw. Any tendency to bind on the ball bearings can be rectified by inserting a narrow washer between the two. A word of warning about the $\frac{1}{2}$ in. bolt in the edge of the driving disc. This must be steel to withstand the reciprocating force on the connecting rod, and whether it is tapped in position or secured with a nut and spring washer, it must be square to the circle it describes when turning. Any cone-shaped movement will transmit a sideways movement to the saw blade and cause the material being cut to vibrate.

The flywheel is an iron disc $4\frac{1}{2}$ in. diameter with a central hole to fit the screwed end of the shaft. The one in use at present is 1 in. thick, but this is not strictly necessary. Excellent results were obtained with a 4 in. by $\frac{1}{2}$ in. disc. The pulley can be made of brass and is tapped to screw on the shaft, hard up to the flywheel, where a nut and spring washer will lock the whole assembly. Do not tighten the nut between the bearing and the flywheel too tight, or you will put undue pressure on the ball races and find them rather stiff to turn.

Base

The base of the saw (Fig. 6) consists of seven pieces of $\frac{1}{2}$ in. plywood, glued and screwed together with countersunk wood screws, and the simple design should present no difficulty in constructing. Any kind of timber can be used, but the first consideration must be strength and solidarity.

The top section or table is made in the shape of a three-sided box, inverted and screwed to

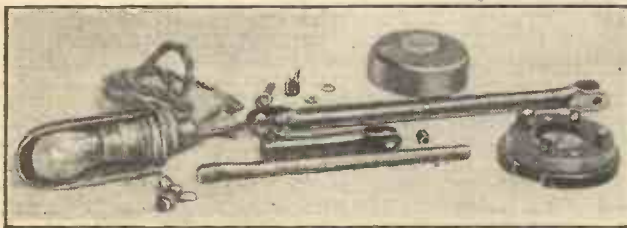

The component parts for the adjustable light bracket, including the lampholder, bulb and shade.

the baseboard. One side is shorter than the other to allow access to the connecting rod, and the other side is double thickness to hold the housing of the main bearing.

To make the baseboard, cut two pieces of $\frac{1}{2}$ in. plywood 19 in. by 7 $\frac{1}{2}$ in. and screw them together to form one board 1 $\frac{1}{2}$ in. thick. Plane the sides even, round off the top edges and corners, and fit four rubber door stoppers on the bottom to act as feet. Mark the outline of the table and the positions of the switches and terminal box, then separate the two halves of the base. Drill the holes for the wood screws and the wiring in the top half, then reverse it and cut a groove $\frac{1}{2}$ in. wide and $\frac{1}{2}$ in. deep between the switches and the terminal box. Screw the table in position and replace the bottom of the baseboard covering the groove and screw heads.

If desired, the bottom half of the base can be built as a shallow box and hinged to the top half, the inside being divided into sections and used for accessories and spare parts.

Cut the hole in the side of the stand and fit the main bearing in position with its two locknuts and washers. Slide the flywheel on to the shaft and mark out where it fouls the base and the table top. Cut this part of the woodwork away, leaving a $\frac{1}{2}$ in. clearance so that the flywheel revolves clear when seated back to the bearing.

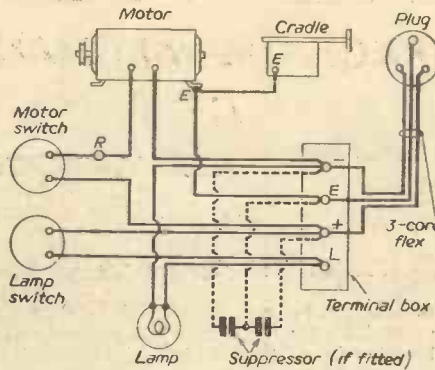

Fig. 8.—Diagram of connections for motor and lamp.

Assembly

Screw the saw unit in position on top of the stand and bolt the connecting rod to the bottom arm of the saw. Adjust the main bearing by means of the locknuts until the saw blade moves freely in the guide, or the centre of the cradle if no guide is fitted.

When the position of the bearing is definitely fixed and the locknuts are tightened hard down, the hole for the grease-pipe can be made. Drill a $\frac{1}{8}$ in. hole through the front edge of the stand and right into the bearing housing. Clear out any bits of metal and insert a short length of copper or brass pipe with a $\frac{1}{8}$ in. thread at one end. A small brass plate is fitted over the pipe and screwed to the stand, the pipe then being soldered to the plate. A nipple for an ordinary grease gun can be fitted if required, but if not, run a $\frac{1}{8}$ in. brass nut on the thread, leaving about $\frac{1}{2}$ in. showing, and fit a leather washer and cap. A small tube tapped to screw on the pipe and fitted with a plunger makes a very efficient grease gun.

Electrical Connections

Details of the connections are given in Fig. 8 and no difficulty should be experienced in the wiring. The switches and terminal box are ordinary bakelite types, and can be purchased at any electrical shop. Lighting flex is used for the general wiring and circular

three-core iron flex for the wandering lead.

The wires from the switches are run in the groove between the base boards and brought up through a hole in the centre of the terminal box. A small hole drilled in the back edge of the base runs into this hole and carries the three-core flexible to the terminals. All the other wires are taken through a hole in the side of the terminal box.

To make the adjustable light bracket, cut two pieces of light gauge brass tubing $\frac{1}{2}$ in. outside diameter and 9 $\frac{1}{2}$ in. and 3 $\frac{1}{2}$ in. long (Fig. 9). Make a 1 in. saw cut at each end of the 9 $\frac{1}{2}$ in. tube and one end of the 3 $\frac{1}{2}$ in. tube. Flatten these ends and open them out to form parallel lugs. Fit the two tubes together and drill $\frac{1}{8}$ in. hole through the four lugs, bolting them together with a screw and wing nut. A piece of $\frac{1}{2}$ in. bore tube $\frac{1}{2}$ in. long acts as a spacing piece between the lugs. Drill two $\frac{1}{2}$ in. holes at the other end of the long tube and bolt it to the side of the cradle, using $\frac{1}{2}$ in. of $\frac{1}{2}$ in. tubing as a spacer. A piece of $\frac{1}{2}$ in. tube is cut 6 $\frac{1}{2}$ in. long, one end opened out and pivoted to a nipple in the lampholder. Slide the other end inside the short $\frac{1}{2}$ in. tube and lock in position with a small screw set in a nut soldered on the tube.

When wiring the lampholder run the flex through the tubing, taking one turn round the spacers at each joint to allow for movement. The small shade is made from tin and is large enough to hold one of the small finger-type lamps.

Motor

Up to now no indication of pulley size has been given as this depends on the speed of the motor. The cutting speed is between 850 and 900 strokes per minute and excellent results were obtained with a portable drilling machine doing 860 r.p.m. In this case the chuck housing was used as a driving pulley, one of the same diameter being fitted to the saw.

Pulley Ratios

$$\text{Diameter of pulley} = \frac{\text{Motor Speed} \times \text{Motor Pulley}}{850}$$

For example, a motor with 2,000 r.p.m. and 1 $\frac{1}{2}$ in. pulley would require a saw pulley $\frac{2000 \times 1\frac{1}{2}}{850}$ or about 3 $\frac{1}{2}$ in. in diameter.

At present an old vacuum cleaner motor is being used, the drive being taken direct from the $\frac{1}{2}$ in. motor shaft to the 4 $\frac{1}{2}$ in. flywheel by means of a $\frac{1}{2}$ in. flat rubber belt.

The motor speed is 15,000 r.p.m., therefore:

$$\text{Saw Speed} = \frac{\text{Motor r.p.m.} \times \text{Motor Pulley}}{\text{Saw Pulley}} = \frac{15,000 \times \frac{1}{2}}{4\frac{1}{2}} = \frac{15,000}{17} = 882 \text{ strokes per min.}$$

As a further means of control a 300 ohms variable resistance (marked R in the diagram) is wired in series with the motor and this allows the speed to be adjusted to suit the material being cut.

BOOKS FOR ENGINEERS

By F. J. CAMM

- Screw Thread Tables, 5/-. by post 5/3.
- Refresher Course in Mathematics, 8/6, by post 9/-.
- Gears and Gear Cutting, 6/-. by post 6/6.
- Workshop Calculations, Tables and Formulae, 7/6, by post 7/10.
- Dictionary of Metals and Alloys, 10/6, by post 11/-.
- Wire and Wire Gauges (Vest Pocket Book), 3/6, by post 3/9.
- Screw Thread Manual, 6/-. by post 6/6.

- Newnes Metric and Decimal Tables, 3/6, by post 3/9.
- Practical Mechanics Handbook, 12/6, by post 13/-.
- Slide-rule Manual, 5/-. by post 5/3.
- Mathematical Tables and Formulae, 5/-. by post 5/3.

Published by
 GEORGE NEWNES, LTD., TOWER HOUSE,
 SOUTHAMPTON STREET, STRAND, W.C.2

GALPIN'S

ELECTRICAL STORES
408 HIGH ST., LEWISHAM, S.E.13
 Tel.: Lee Green 0309, Nr. Lewisham Hospital.
TERMS: CASH WITH ORDER. NO C.O.D.
 All goods sent on 7 days' approval against cash.

EARLY CLOSING DAY THURSDAY

EX-RADAR MAINS TRANSFORMERS. 230 volts input 50 cycles 1 phase, output 4,500/5,000 volts approx. 80 m/amps, 6.3 volts 2 amps, 4 volts 1½ amps, 2 volts 2 amps, these transformers are new immersed in oil, can be taken out of the oil and used as television transformers giving output of 10 m/amps, overall size of transformers separately 5½ in. x 4½ in. x 4 in. and 3 in. x 3 in. x 2½ in., price 75/- each, carriage paid.

MAINS TRANSFORMERS (NEW), input 200/250 volts in steps of 10 volts, output 350/0/350 volts, 180 m/amps, 4 volts 4 amps, 5 volts 3 amps, 6.3 volts 4 amps, 45/- each, post 1/6; another 350/0/350 volts 180 m/amps, 6.3 volts 8 amps, 0/4/5 volts 4 amps, 45/- each, post 1/6; another 500/0/500 volts 150 amps, 4 volts 4 amps C.T., 6.3 volts 4 amps C.T., 5 volts 3 amps, 47/6 each, post 1/6; another 425/0/425 volts 160 m/amps, 6.3 volts 4 amps, C.T. twice 5 volts 3 amps, 47/6 each, post 1/6.

MAINS TRANSFORMERS (NEW), 200/250 volts input in steps of 10 volts, output 0, 6, 12, 24 volts 6 amps, 42/6 each, post 1/6. Another as above but 10-12 amps; 55/- each, post 1/6; another, as above, but 25/30 amps, 75/- each, carriage 3/6; another input as above, output 0/18/30/36 volts 6 amps, 47/6 each, post 1/6.

MAINS TRANSFORMERS (NEW), suitable for spot welding, input 200/250 volts, in steps of 10 volts, output suitably tapped for a combination of either 2/4/6/8/10 or 12 volts 50/70 amps, 95/- each, carr. 7/6.

TRANSFORMERS SPECIALLY MADE TO ORDER, delivery 72 hours from date of order. Please let us quote you.

MAINS TRANSFORMERS, input 180/250 volts, output 435/0/435 volts, 250 m/amps, 6.3 volts 10 amps, 6.3 volts 8 amps, 6.3 volts 8 amps, 5 volts 6 amps, 65/- each; another, input as above, output 4,000 volts 2½ m/amps, 4 volts 1 amp., 2 volts 2 amps, 45/- each.

3 KILOWATTS DOUBLE-WOUND VOLTAGE CHANGER TRANSFORMERS, 110/230 volts or vice-versa, as new, weight approx. 100 lbs., £12/10/-, each, carriage forward.

LARGE STUD TYPE DIMMER RESISTANCE, 10 ohms, 9/18 amps, 32 studs, 35/- each.

CONDENSERS, 0.1 mfd., 6,000 volts working, 6/6 each.

ELECTRIC LIGHT CHECK METERS, useful for subletting, garages, etc., all for 200/250 volts A.C. mains, 5 amp. load, 19/- each; 10 amps, 22/6; 20 amps, 27/-; 25 amps, 32/6; 40 amps, 38/6; 50 amps, 46/6; and 100 amps, 57/6 each, all carriage paid.

MAINS TRANSFORMERS, 200/250 volts input, output a combination of 6, 12, 18, 24, 30, and 36 volts at 6 amps, 45/- each, post 1/6. **12/24 VOLT RECTIFIERS** at 4 amps, with suitable Mains Transformer, 200/230 volts input, 55/- each, except 12/24 volts.

MAINS TRANSFORMERS, 200-250 volts input, output 400/0/400 volts, 280 m/amps, 6.3 v, 8 a., 2 v, 3 a., 5 v, 3 a., 4 v, 2 a., 4 v, 2 a., the last two heaters insulated at 8,000 volts, 85/- each; another, 200/230 volts input, output tapped 0, 9, 18 volts at 4 amps, 25/- each, post 1/-.

6 or 12 VOLT RECTIFIERS at 4 amps output, complete with suitable transformer, 200/230 volts input, 45/- each, post 1/6.

MAINS TRANSFORMERS, input 200/250 volts, output 45/50 volts, 70 amps., suitable for arc welding, £15/- each; another 70 volts 50 amps, £15/- each.

EX-W.D. U.S.A. HAND GENERATORS, less winding handle, output 425 volts at 110 m/a., at 6.3 v., 2½ amps., complete with smoothing, 30/- each, carriage 2/6.

ROTARY TYPE RESISTANCES, stud S/arm type 10 ohms 3 amps., 17/6 each. (Other types in stock, please ask for quotation.)

D.C. MOTORS, 230 volts, 3 h.p., 3,000 r.p.m., in good condition, £3/5/- each; ditto Fan Motors, 230 volts D.C., 20/- each; 110 volts D.C., 17/6 each.

SMOOTHING CHOKES, 4 henries, 250 m/amps, D.C. resistance 120 ohms, 12/6 each.

METERS, Moving Coil, 0 to 14 amps., 18/6 each. Ditto, Moving Iron, suitable for A.C., 0 to 30 amps., 25/- each. Another moving coil, 100 to 250 amps. D.C., 35/- each, all 4 in. scale. (Others in stock, please state your requirements.)

ALL PRACTICAL MECHANICS VISIT



"The Model Engineer" Exhibition

ADULTS 3/- AUG. 19th-29th CHILDREN 1/6

NEW HORTICULTURAL HALL, WESTMINSTER
 Open from 11 a.m. to 9 p.m. daily

Whether you use a corner of the kitchen table or work in a well-equipped workshop, this exhibition is a must for all mechanical and modelling enthusiasts. Here under one roof you can see the world's finest models, latest trade developments and discuss the trends in your hobby.

Attractions and Features:

- ★ Over 250 wonderful scale models made by practical mechanics
- ★ Everything you need for the home workshop displayed on the trade stands
- ★ Demonstrations by experts in all branches of engineering and modelling technique to help you to produce mechanical masterpieces
- ★ Passenger-hauling scale locomotives on the S.M.E.E. live steam track
- ★ Club Stands and Demonstrations
- ★ Percival Marshall's Stand—a must for all modelling enthusiasts. Books, plans and magazines on all aspects of the hobby of model engineering
- ★ Miniature Grand Prix Track with scale F.2 cars racing at high speeds
- ★ Model Ships Manoeuvring under radio control on the large water tank
- ★ A fully working blacksmith's forge

How to get there:

The New Horticultural Hall is in Greycourt St., S.W.1.
 By Bus: 11, 24, 29, 76, 134: ask for Army and Navy Stores. 2, 36, 36A, 57, 69, 169, 178, 185: ask for Rochester Row. 3, 59a, 77, 77a, 88, 159: ask for Horseferry Rd., 10, 46: ask for Royal Horticultural Hall.
 By Tube: to St. James Park via Circle or District Line.



ORGANIZED BY **"THE MODEL ENGINEER"**

PHOTOGRAPHIC ENLARGER TIMER

A first-class clockwork timer, constructed from an ex-Govt. unit giving 1 to 16-second exposures with each winding. Complete with Foot Switch, Calibrated Dial, Focusing Switch, Ready for connection to the mains and enlarger.

50/- Post and Packing 2/6.

TRANSFORMERS
Primaries. All 220 to 240 volts 50 cys.
Secondaries. 4 v. 3.5 A., 10/6; 2 v. 5 A., 25/-; 9.75 v. 5 A. and 20 v. 500 m/A., 25/-; 40 v. 3 A. and 104 v. 1.5 A., 25/-; 50 v. 250 m/A. and 4-0-4 v. (C.T.) 5 A., 20/-; 2 x 120 v. 400 m/A. and 50 v. 50 m/A., 30/-.

VENTAXIA EXTRACTION FANS, £30-250 v. 50 cys. Bakelite cased. Silent Running, 70/-.
ACFIL PUMPS.—These pumps enable you to fill all accumulators on the bench with the carboy at floor level. Brand new, only 30/-, post 2/-.

P.M. SPEAKERS.—In cases, ideal for extension speakers, 6 in., 30/-; 5 in., 17/6. Postage 2/-.

LAMP HOUSES with pair of 6 in. condenser lenses and focusing mount, suitable for flood or spotlight, £4.

CINE PROJECTORS 16 mm.—"Ensign" silent, complete with Dallmeyer 2 in. Superlite lens, transformer and carrying case, £27/10/-.

GB MODEL L516.—Sound, complete with valves, lamps, lens, speaker, resistance, £55.
B.T.H. MODEL S.R.B.—Sound, complete, £75.

METRO-VICK AUTOTRANSFORMERS, 230/110v., 500 watt, totally enclosed, £4/10/-.

PHOTOFLOOD LAMPS, "Ekco" 1,000 watt, 220/230 volt, 10/- each. Post 1/-.
 Or in original cartons of 12, 85/-, Post free.

PROJECTION LAMPS,—115v. 750 w. Prefocus. Brand New, 25/-.

RESISTANCE MATS.—Make ideal heating mats for Aquariums, Photographic solutions. Print dryers, etc. Mains voltage, 150 or 620 watts. Black heat, size 10 in. x 6 in., 2/6. Post free.

HAND GENERATOR or Battery Charger.—8 volts D.C. at 4 amps. contained in a strong metal case with automatic cut-out, very useful where no mains are available, could be converted to a wind charger. Only 30/-, Carriage 5/-.

BLOWER MOTORS.—Dual voltage, 12/24 10 KB/115, recommended for car heaters, 21/-, post 2/-.

BALL BEARINGS.—No. EE2, 1 in. x 1 in. x 3/8", post free.

THRUST RACES.—13/16 in. x 1 in., 1/6, post free.

VOLTMETERS.—0-300 A.C. Moving Iron 3 in. Flush or Surface Type, 25/-; 0-300 Flush D.C. Moving Coil, 10/6; 0-20, 2 in. Flush Moving Coil, 7/6; 0-40, 2 in. Flush M.C., 10/6; post 1/-.

BATTERY CHARGERS "WESTALITE." Input 100/250 v. A.C. Output 12 v. 16 amps., variable metered output, fused, worth £34. Our price while they last, £15. Carr. & Pkg., 15/-.

ACCUMULATOR CHARGERS, 230 v. A.C. in black crackle case with fuses and meter, 8 and 12 volts at 4 amps. Bargain Price, £4/19/6. Pkg. and carr., 5/-.

RECTIFIER UNIT.—Input 230 volts. Output 12-0-12 volts 1 ampere, 50/-, packing and carriage, 5/-.

PORTABLE TEST METER.—Just the job for the home constructor, in neat case, 6 in. x 5 in. x 4 in., reading 1.5, 3, 150 volts, 6 and 30 m/A. D.C., 5 k. and 25 k. ohms, 25/- each to clear. Post 1/6.

AERIAL RODS.—12 in. long, 1 in. diameter. Any number of sections can be fitted together, 2/6 dozen, 6/- for 3 dozen, 11/- half gross, 20/- gross, £6 per 1,000.

SLOW MOTION DIALS.—6 in. Scaled 0-100, reduction 200 to 1 or direct, ideal for wavemeters, signal generators, etc. Our price, while they last, 5/6. Post 1/-.

FLASHING SWITCH UNIT with 6 contacts. Full rotation 60 seconds, operated by a Sangamo Synchronous Motor, 230 volts A.C. 2 watts. In metal case, 3 in. x 2 1/2 in. x 2 1/2 in., 15/-, Post 1/-.

STUART PUMPS.—230 volt A.C. motor, will lift 400 gals. per hour 15ft., £11/18/-; larger size, 1 h.p., £25/10/-, Carriage 7/6.

PUMPS FOR GARDEN FOUNTAINS, £10. Ex stock, send for further details.

SWITCHES.—A row of 5 in a flush mounting bakelite moulding, 5 1/2 in. x 1 1/2 in. x 2 1/2 in. Ideal for model railways, etc., 5/6. Post 8d.

24 VOLT MOTOR with reduction gear and cam-operated switches, 15/6, post 1/-.

Send 6d. in stamps for comprehensive list giving full details of Potentiometers, Condensers, Resistors, Telephone Key Switches, Rectifiers, etc.

WILCO ELECTRONICS
 264, LOWER ADDISCOMBE ROAD, CROYDON.

CLYDESDALE

Bargains in Ex-Service Radio and Electronic Equipment

VENT AXIA 6in. FAN Ref. 5A/2905
 Input 24v. D.C. or 40v. A.C. Moulded Plastic Fan housing assembly 7½in. dia. (Max.), 8in. long, made in two interlocking sections suitable for mounting in a circular aperture and completely self-contained, mounted on metal frame 17½in. x 8½in. With suppressor unit SC/870 Input through 2 p. Chassis Plug.
 IN TRANSIT CASE.
 ASK FOR £3/19/6 CARRIAGE PAID
 No. A/H869 Each PAID

AS ABOVE USED CONDITION
 ASK FOR £2/19/6 Each
 No. A/H869A. CARRIAGE PAID

AIR POSITION INDICATOR UNIT. Mk. I Ref. 6B/248
 Contains: 4 Rev. Counters with reset knobs, each reading 0-9999 Revs., also Small Selsyn Motor, Dial Lamp 24 v. 6 w., D.B.C. with holder, On/Off Toggle Switch, Push Switch, plus a host of gears and worm drives. Unit mounted on Die-cast Aluminium Frame with metal casing. Overall size, 12in. x 8in. x 6in.
 ASK FOR NO. 39/6 Each CARRIAGE PAID
 A/H913

MORSE PRACTICE BUZZER SET
 Compact self-contained Morse practice set mounted on 6½ x 6½ x ½in. base-board. Requires 4½-volt battery for which clamps are provided: headphones can be used instead of audible note provided by fitted buzzer.
 ASK FOR NO. 5/6 Each POST 9d.
 A/EIX

WE CARRY A FULL RANGE OF CYCLE ACCESSORIES. Enquiries invited.

PLOTTER FIELD, MK. IV. Ref. OS 739A
 A precision-made protractor unit, first-class condition, in soiled leather case, with carrying strap. Comprised two moving cross-arms with individual lock device. Cross-bearing scales marked 21-65 length, each 12½in., attached to two Protractor Scales 0-180 degrees, 9.5/16in., between centres (max.) will form any combination of internal angles, on two interlocked straight edge bases scaled 0-3500, fully extended a perfect 25in. length straight edge, closed 15½in. long, can be locked at any position. Case Dimensions: 16 x 5½ x 2in.
 ASK FOR NO. 9/11 Each POST PAID
 A/H864

ROTARY PUMP Ref. 5U/2492
 24 V., D.C., 2.5 amps
 ½in. bore inlet, ½in. bore outlet, 4½in. flange for connecting to tank. Ideal for pumping oil, petrol, water etc. Diecast constructions with brass rotor blades. Dim. 4½in. x 7in. x 7½in. Weight 5lb.
 ASK FOR NO. 35/- POST PAID
 A/H944

A.C. MAINS 200/250 VOLTS GRAMOPHONE MOTOR
 Fitted with 9in. turntable and electrostatic screen, mounted on a metal plate approx. 14½ x 14in.
 ASK FOR 67/6 Each POST PAID
 No. A/H319.

Still available: for use as **UNIVERSAL ELECTRIC MOTORS**
 Motor Generator, type 28...each 25/-
 Motor Generator, type 29...each 25/-
 Motor Generator, type 30...each 19/6

Order direct from:—
CLYDESDALE SUPPLY 2, BRIDGE STREET CO. LTD. GLASGOW - C.S.
 Phone: South 2706/9 Branches in Scotland, England and Northern Ireland

Here's the NEW AQUALUX

MUFFLE FURNACE FOR "BOTTLED GAS" OR COAL GAS

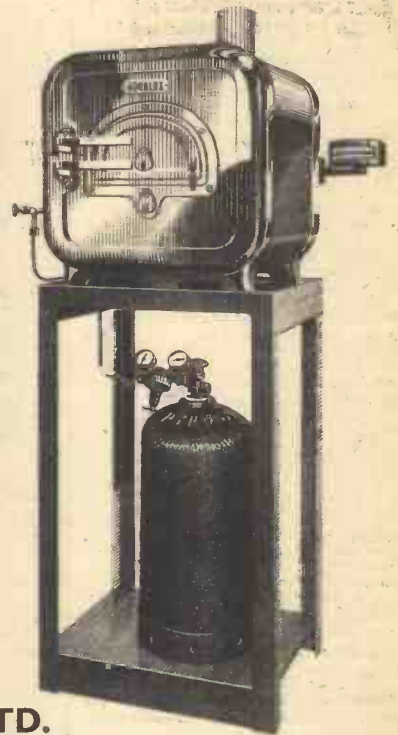

These highly efficient furnaces, thousands of which are in service on coal gas, have now been modified and fitted with the remarkable Aqualux P.H.C. burners. These burners, the result of much research, will burn all the modern paraffin hydro-carbon gases such as Propane or Butane and generally available throughout this country under one of the trade names such as Calor, Pyrogas, Bottogas, or Scottish Rural Gas, etc. Type 'A' for temperatures up to 1,000 deg. C. Type 'B' for temperatures up to 1,250 deg. C. Each available in 5 sizes.

Send for technical literature.

AQUALUX LTD.
 113, EMILY ST., BIRMINGHAM, 12. Tel. CALthorpe 1164



BENNETT COLLEGE can help you to success through personal postal tuition

THOUSANDS OF MEN in important positions were once students of The Bennett College. They owe their success to Personal Postal Tuition—The Bennett College way. You have the same chance to qualify for a fine career, higher pay and social standing.

One of these courses will lead to your advancement

- | | | |
|-------------------------|-------------------|---------------------|
| Accountancy Exams | Shorthand | Mathematics |
| Auditing | English | Public Speaking |
| Book-keeping | General Education | Police Subjects |
| Commercial Arithmetic | Geography | Salesmanship |
| Costing | Journalism | Secretarial Exams |
| Modern Business Methods | Languages | Short Story Writing |

- | | | |
|------------------------|---------------------------|---------------------|
| Agriculture | Engineering Drawings | Road Making |
| Architecture | Forestry | Sanitation |
| Aircraft Maintenance | Locomotive Engineering | Sheet Metal Work |
| Building | Machine Design | Steam Engineering |
| Carpentry | Mechanical Engineering | Surveying |
| Chemistry | Mining | Telecommunications |
| Civil Engineering | Motor Engineering | Textiles |
| Commercial Art | Plumbing | Wireless Telegraphy |
| Diesel Engines | Power Station Engineering | Works Management |
| Draughtsmanship | Press Tool Work | Workshop Practice |
| Electrical Engineering | Quantity Surveying | and many others |
| Electric Wiring | Radio Engineering | |

GENERAL CERTIFICATE OF EDUCATION : R.S.A. EXAMS.



SEND TODAY for a free prospectus on your subject. Just choose your course, fill in the coupon and post it.

TO THE BENNETT COLLEGE (Dept. H. 76), SHEFFIELD.

Please send me free your prospectus on :

SUBJECT.....

NAME.....

ADDRESS.....

.....AGE (if under 21).....

PLEASE WRITE IN BLOCK LETTERS



A Uruguayan issue showing the Rio Negro bridge.

Bridges on Stamps

The Third Article on Thematic Stamp Collecting

By H. V. A. HOWARD



Australian 3d. issued March, 1932, showing the Sydney Harbour bridge.

TO complete my trilogy on thematic stamp collecting as related to communications, I have selected bridges as a suitable subject to follow bicycles and locomotives, which formed the subject of my two previous contributions. Of course, aeroplanes and ships are also methods of communication linking the postal services of the world, and a great deal could be written about the philately of both. Ships, of course, are older instruments of travel than aircraft, the first aerial post from Hendon to Windsor, with Gustav Hanel as the pilot, taking place in 1912.

There are not many stamps which feature bridges as the main motif and as far as I have been able to trace from a comprehensive stamp catalogue there are only between 30 and 40. None of them is expensive so the collector who wishes to obtain a complete set of bridge stamps will find that he is able to do so for £2 or so. I suggest that he collects unused.

He will not find that this collection embraces every type of bridge, for bridge types vary from arch bridges, which are built of stone and consist of a series of semi-elliptical arches supporting the roadway; suspension bridges in which the roadway is suspended upon chains, steel cables or bars, which pass over high piers built on each side of the river; cantilever bridges consisting of two beams projecting obliquely upwards from opposite banks or piers; girder bridges consisting of steel girders placed horizontally on perpendicular supports; movable or bascule bridges, such as Tower bridge, in which the roadway can be raised in two sections and the projecting portion is balanced by an inner portion (the latter descending into a kind of well when the former is raised), to pontoon bridges which consist of a line of boats, barrels, etc., on which planks are laid. The latter, of course, are only temporary affairs and a development of the old ford. However, a sufficient number of bridge types are featured on stamps to make such a collection interesting, and I feature a few on this page. Probably the most famous is the Australian stamp on which is an excellent reproduction of the famous Sydney Harbour bridge. This was issued in March, 1932. Then there is the Eire stamp showing the Shannon Barrage. This was issued in October, 1930, in celebration of the completion of the Shannon hydro-electric scheme.

In 1934 the Dominican Republic issued a stamp showing the San Rafael suspension bridge—a really attractive stamp of one centavo denomination. The Moyen Congo, in the French Colonies, in 1933, issued a one franc stamp with an excellent illustration of the Mindouti Viaduct, whilst in 1933 the

Princes' Aqueduct appeared on a 5 centimes Haiti. Eritrea issued a stamp showing a railway bridge (unnamed) and the Principality of Monaco in the early 20's issued a stamp showing the Monaco viaduct and the St. Devote.

Rumania in 1928 issued a stamp featuring the Cernavoda bridge over the Danube. Some stamps I have mentioned are illustrated here. They are in free supply from all of the stamp dealers.

A fascinating facet of the thematic stamp collecting is that it soon starts enthusiasts on a course of study on a particular subject and bridges are no exception. In our own country the Thames bridges are, perhaps, the most famous and starting in their proper order, that is to say with the bridge nearest to the sea, we have the Tower bridge, London bridge, Cannon Street railway bridge, Southwark bridge, Blackfriars railway bridge, Blackfriars bridge, Waterloo bridge, Charing Cross (railway and foot—Hungerford bridge), Westminster bridge, Lambeth bridge, Vauxhall bridge, Grosvenor Road railway bridge, Victoria bridge (Chelsea sus-

Newcastle. The latter, being modelled on the lines of the Sydney Harbour bridge though much smaller in size.

The tubular suspension bridge over the Menai Straits on the Chester and Holyhead railway was designed by Stevenson and Fairbairn. It is 1,510ft. in length and was completed in 1850. The Brooklyn suspension bridge over East River, connecting Brooklyn with New York, is 5,990ft. long and was completed in 1883. At Calcutta is the famous pontoon bridge designed by Sir Bradford Leslie, probably the longest floating bridge in the world; whilst the Clifton suspension bridge over the Avon near Bristol (formerly Hungerford bridge over the Thames near Charing Cross) was designed by the famous Brunel of locomotive fame, being 700ft. in length and completed in 1864.

The first railway bridge over the Firth of Forth was designed by Sir John Fowler and Sir Benjamin Baker, completed in 1889 and is 8,290ft. in length.

The Grosvenor single-span stone bridge over the Dee at Chester is 340ft. long and was completed in 1833 from the designs of Harrison. Kew bridge, which connects Brentford with Kew, is 1,300ft. long, was designed by Sir Wolfe Barry and built in 1903. London bridge is 1,000ft. long and was built in 1831.

The bridge connecting Newcastle with Gateshead was designed by Robert Stevenson, built in 1849 and is 1,400ft. in length.

The famous Niagara suspension bridge was designed by Roebling and built in 1855. The St. Lawrence (Quebec) cantilever bridge across the St. Lawrence is 3,200ft. long. Its construction commenced in the early part of this century, but in 1907 a part collapsed during construction and the Canadian Government undertook the task of completion, which occurred in 1917.

The railway bridge over the Tay in Scotland was completed in 1887, designed by Barlow and is 10,500ft. in length; The Tower suspension and bascule bridge was completed in 1894 and was designed, as was the Kew Bridge, by Sir Wolfe Barry. It is 800ft. long.

The famous cantilever bridge across the Zambezi, 700yds. below the Victoria Falls, was completed in 1905, being designed by Mr. G. A. Hobson; it is 600ft. in length.

I give these brief details of some of the world's most famous bridges to show the interesting avenues of research into which the philatelist is drawn once his interest is whetted. No matter whether it is subject or country which attracts, these historical byways exist and the stamp is the lure. The educational value of philately, therefore, is apparent.



The Principality of Monaco stamp on the left shows the Monaco Viaduct and the St. Devote.

Princes' Aqueduct on a 5 centimes Haiti stamp is shown on the right.



pension), The Albert suspension bridge, Battersea and Battersea railway bridge, Wandsworth bridge, Putney railway bridge, Hammersmith suspension bridge, Barnes railway and foot bridges; Chiswick bridge, Kew and Kew railway bridge, and Richmond bridges.

Some of the most famous bridges of the world include the Sydney Harbour bridge, already mentioned, which has a total length of 2 1/2 miles, the centre span measuring 1,650ft., five approach spans being provided on each side. The total weight of steel used was 53,000 tons. Other examples of this type are the well-known Hellgate bridge, New York, and the new Tyne bridge at



(Left)—Eire 2d. issued October, 1930, showing Shannon hydro-electric scheme.

(Right)—Moyen Congo in the French Colonies issue, showing the Mindouti Viaduct.



(Right)—The Cernavoda bridge over the Danube; the stamp is Rumanian.



LETTERS TO THE EDITOR

The Editor does not necessarily agree with the views of his correspondents.

Wimshurst Machine Details

SIR,—I was interested in the article on building a small Wimshurst machine in your June issue, and I am wondering if one or two comments of mine might be of interest.

I have had a good deal of experience with these machines, although not with one that had smaller discs than 18in. diameter. If, however, a smaller one works to scale the size and number of the tinfoil sectors mentioned in the article, are likely to be unsatisfactory.

With only eight large sectors per disc, the larger machines are never self-starting and always have to be started off with a charged rod held as described (or, better, held near the point where the sectors meet a brush). Also, the machine is not self-maintaining when used with Leyden jars: immediately a spark passes the machine goes dead and has to be re-started with the charged rod.

Using about 16 sectors per disc the machine will maintain its performance and continue to pass sparks as long as one turns the handle, but is only rarely self-starting. With 30 sectors it will start of its own accord, except on very damp days, and there is no gain in performance by increasing the number of sectors beyond this number. As a guide to the sector width, the total length of insulated space between the sector level with a comb and the sector touching the brush nearest to that comb must be greater than half the length of spark the machine can produce, otherwise a discharge jumps from the comb to the brush via the sectors. Incidentally, the sectors should be attached to the plates by means of shellac, since nearly all other adhesives are conductors to a small degree, and it is very difficult indeed to keep the space between the sectors free of smears of it.

A further point is that the use of jam jars for making the Leyden jars is almost certain to result in failure. Modern commercial window glass or bottle glass has too low an insulation as a rule to be of use for this purpose. I have made a considerable number of Leyden jars from this material and about nine out of every ten were completely useless, even when carefully dried, and the few that did work were extremely poor owing to leakage. I have, however, been consistently successful with ordinary laboratory beakers made of "Hysil" glass.

Finally, the use of cork as a holder of the centre rod is very undesirable, since this halves the leakage path of the jar. A stopper shaped from paraffin wax gives a far better performance.—R. E. C. DAVIES (Tenterden).

Anemometer Improvements

SIR,—With reference to the article "Making an Anemometer," in the May issue of PRACTICAL MECHANICS, may I suggest a few improvements and comments.

The anemometer, as stated in the article, should be placed as high as possible and clear of obstruction—to be correct, 33ft. above any obstruction. In this case reading it becomes difficult. A simple method now in common use for overcoming this difficulty is to fit a spring contact on one side of the dial. As the pointer comes round it pushes the spring contacts together and an electrical circuit is made which can be made to sound a buzzer

or work an electric counter-mechanism at a distance from the anemometer. The only connection between the two being a length of twin wire. The high ratio of gearing between the cups and the pointer reduces the retardation effect of the closing of the contacts to the minimum. Indeed, it is so slight as to be negligible.

The bottom bearing of the anemometer is improved if the steel block is drilled for a short distance and a small ball-bearing inserted in the hole; the tip of the spindle is then ground flat, preferably hardened, and allowed to rest on the ball-bearing, the drill hole being a size slightly larger than the spindle tip.

The top bearing would also require some protection from rain. It is better to fit a length of tube permanently to the case and terminating at the top in a ball race, through which the spindle passes. In this way the spindle is supported at its top end near the cups, otherwise "whip" might develop in a high wind.—M. H. HODDINOTT (Chester).

Einstein's Theory

SIR,—With reference to Mr. C. W. Carr's correspondence in the May issue of PRACTICAL MECHANICS, might I point out that this is an elementary navigational problem.

Using a right-angled triangle for simplifying a navigational problem.

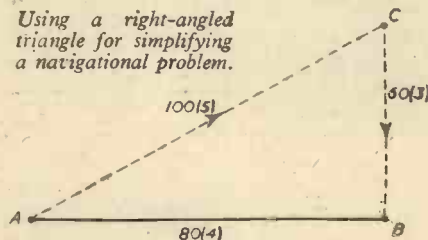

A. B. is course made good
A. C. is course set
C. B. is drift due to wind speed

To simplify matters we can make use of the three, four, five right-angled triangle (see diagram) and suppose wind speed to be equal to 60 knots, distance between points equal to 80 miles and air speed of plane to be 100 knots.

When flying across the wind it becomes apparent that if the plane is pointed to a position 60 miles to windward of its destination it will, after one hour, have travelled 100 miles through the air, and been blown off its course 60 miles to leeward, thus arriving at its destination in one hour.

The same holds good for return journey, making a total time of two hours for the two journeys.

When flying parallel to wind its speed over the earth will be equal to 100 (air speed) \pm 60 (wind speed) depending upon whether it is flying with or against the wind.

Thus in the former case its speed will equal $100 + 60 = 160$ knots and so the distance will be covered in half an hour, and in the second case its land speed will equal $100 - 60 = 40$ knots, and therefore the distance of 80 miles will take two hours to be covered.

Therefore, the two journeys together when flying parallel to wind total two and a half hours' flying time, whereas across wind the total is only two hours.

I hope that this will clarify the matter for your correspondent.—A. M. Cook (Fareham).

SIR,—Your correspondence on Einstein's Theory is most interesting, but I would assure Mr. Carr that Michelson and Morley were perfectly correct in that a journey and return, against and with a flow stream, takes longer than a transverse course.

All they did prove, however, is that there is no discernible movement through an aether, at the earth's surface.

I have long had a private theory that an aetheric cloud or "atmosphere" could surround matter and travel with it through the general aether. This would explain the M-M negative result, and also the otherwise anomalous fact that radiation reaches the earth at constant velocity from all directions. It would leave the Doppler Effect and Spectroscopy undisturbed, since they are solely concerned with frequencies, not wave velocities.

It is rank heresy to suggest existence of an aether when the greatest minds have jettisoned the idea, but if the said minds could give any satisfactory explanation of what cosmic radiation really is, and how countless millions of horse-power can be transmitted from the sun alone, by nothing through nothing, we should be more impressed. To call them "electromagnetic" waves means nothing, because no one knows what a "magnetic line of force" is, anyway. Not even the great Einstein himself, though we can almost see it, with some iron filings.

Now that radar echoes are attainable from the moon, the Michelson-Morley experiment could be reconducted upon an extra-terrestrial base-line, if the moon's distance could be measured with sufficient exactitude by acute parallax simultaneously.—F. O. BROWNSON (Bedford).

Interplanetary Space Travel

SIR,—In my letter on interplanetary space travel, which was published in the May issue, the symbol α (varies as) has been omitted by the printer. This obviously confuses the import of parts of the letter.

Lines 4 and 5 should read: . . . is only concerned with gravity as air resistance $\propto V^2$ and $V=O$.

Line 33 onward should read: . . . available from a constant fuel consumption varies inversely as air pressure; the total thrust being . . .

The latter statement is a slight modification of the original letter. Thrust does not "vary as" but "varies inversely as" air pressure; thus, in this case the symbol α is inadequate.—WILLIAM ELLWOOD (Hatfield).

SIR,—It is important that the letter of S. W. J. Land, in your issue of April, 1953, on "Interplanetary Space Travel" should not pass without comment.

Mr. Land starts so many hares that it would need a long article to make a full reply, for the sake of other readers who may be confused by Mr. Land's ideas, I will, however, be as brief and explicit as possible.

On the point of the vacuum flask and the deduction that space travellers would be cremated alive. At first sight this seems the *coup de grâce* of space flight. But Mr. Land shows that his admitted unscientific mind does not understand the behaviour of a vacuum flask. Heat can escape across a vacuum by radiation, that is why the walls of the flask are silvered, the vacuum only removes the possibility of large heat transfer by conduction and convection. A space ship in interplanetary space could be made to radiate heat away into space. See the articles on "Cold" and "Radiation" in the *Encyclopaedia Britannica*, also the classic article by Prof. Poynting "Radiation in the

(Continued on page 481)

READERS' SALES AND WANTS

The pre-paid charge for small advertisements is 6d. per word, with box number 1/6 extra (minimum order 6/-). Advertisements, together with remittance, should be sent to the Advertisement Director, PRACTICAL MECHANICS, Tower House, Southampton Street, London, W.C.2; for insertion in the next available issue.

FOR SALE

LOOK OUT. New P.D.5, 3in. precision, screwcutting, back-gear, tumbler reverse, split nut, apron, setover. com. rest, £22/19/6; cash or terms. Stamp please. Portliss, Dept. P.M., Buttermere Road, Sheffield.

NEW HOOVER, 1/6th h.p., 1425 r.p.m., drip proof capacitor motors, 210 volt, 1-phase, 50 cycles; will work on 230 volts; with auto reset thermal overload trip and silent sleeve bearings. In makers' cartons, £4 each carriage paid. Removed from carton and store soiled, £3 each carriage paid. A few at 110 and 130 volts. W. H. Collingsbourne & Co., Ltd., 1481, Stratford Road, Birmingham, 28.

ELECTRIC MOTORS, 24v. Heavy Duty, 7 x 3 1/2 in.; spindle 4 x 1/2 in., speed 2,000 r.p.m., weight 10lbs., manufactured for driving hydraulic pumps; good power output on 12v.; new; 20/-; 12v. Light Duty, 6 x 3 in.; spindle 1 x 5/16 in., 3,000 r.p.m., weight 3 1/2 lbs.; suitable for models, fans, etc., 15/-; Rotary Power Units, input 24v., output 250v.; in metal case, 12/6; all carriage paid. Wilton, 93, Toynebe Road, Wimbledon, S.W.20.

AIR CYLINDERS, 12 x 6 1/2 in., 1,000 lbs. sq. in., weight 15lb., screwed in, gas, 17/6; Air Lines 12ft. braided or 10ft. canvas inserted, 3/16in. bore, 5/- each; all carriage paid. Wilton, 93, Toynebe Road, Wimbledon, S.W.20.

NOW READY.—Complete building instructions for the "Discotape"—to convert your gramophone into a high fidelity Tape Recorder. Written in non-technical language with stage-by-stage diagrams. Price 3/6, refundable on purchase of Kit. Send for your copy now. Below.

THE DISCOTAPE KIT comprises all mechanical parts, ready for mounting on your gram. platform, converting it into the playing desk, plus all components for a small oscillator/preamplifier unit which plugs into your radio receiver, using it as the main amplifier. Does not preclude use of gram. or receiver for normal purpose. Below.

THE PERFECT KIT for the home constructor; simple to build, simple to operate. The Discotape enables you to have a Gram. and Tape Recorder in one unit! Price, complete kit, £12. N.E.A.L. Acoustics, Ltd., Court Street, Leamington Spa.

ELECTRIC MOTORS, B.I.H. 230/240v. 1 h.p., 1425 r.p.m.; new and unused; £5/5/- each. Miniature 12 or 24v. Motors, A.C./D.C.; ideal for models, etc.; size 2 1/2 in. long x 2 in. x 1 1/2 in. New Twin 40w. Ballast Units, no starter required; all voltages, 200/250 supplied; 25/-; requires holders and lamps only to complete. Single 40w. Units, S/H 17/6; Holders, 2/6 each. Starters, 2/6 each; 24v. Vent Axia Fans, new, 45/- each. Crompton, Parkinson, Chlorinator Pumps, 220v, 230v., A.C., 1 h.p.; little used; £10. Harrington Photographic and Electrical Supplies, Ltd., 423 Green Lanes, N.4. (Tel.: MOU. 2054.)

TRANSFORMERS DESIGNED and supplied for all requirements. Trains, Welders, Television, etc. Write or phone your requirements to F. W. Whitworth, A.M. Brit.I.R.E., Model Dept., Express Winding Co., 338, London Road, Mitcham. (MIT. 2128.)

METAL TOOL BOXES, 18in. x 5in. x 4in., hinged lids and fastener, 3/-; Red Rubber Tubing, 1/2 in. bore, 100ft. coils, 15/-; Air Tubing for high pressure, 1/2 in. bore, 10yds, 12/6; Perspex Domes, 20in. x 10in., 40/-; Rayon Twine, remarkably strong, 4 and 6lb. approx. balls, 20/- and 30/-; 28lbs. Caselene Cement Powder, 40/-; Batley & Co., Stockport.

AIR RECEIVERS, 54in. x 24in., £10; 24in. x 12in. x 150lbs., £7; 15in. x 12in., £2. Moisture Filters, 7/6; Safety Valves, 3/6. C. G. Nelson, 118, Anchorway Road, Coventry.

REJUVENATE your water softener; New Zeolite, 2/3 lb., 10lbs., post paid. C. G. Nelson, 118, Anchorway Road, Coventry.

ROTARY CONVERTER, 12v. or 24v. D.C. to 230v. A.C., 150w., £9; 230/40 D.C. to 230 A.C., 200w., £10; s.a.e. for bargains list. Lawrence, 134, Cranley Gardens, N.10.

"CONSTRUCT YOUR OWN REFRIGERATOR."—This book, written by a refrigeration engineer, is profusely illustrated with drawings and photographs and tells you, not only how to construct a cabinet or built-in refrigerator, but illustrates many that have been built by amateurs and are operating satisfactorily; 3/9, post free from: Robert C. Scott, Refrigeration Engineer, 52, Hadley Way, London, N.21.

LATEX FOAM UPHOLSTERY, 6ft. x 2ft. x 4in., covered, £5/15/-; carr. and pkg., 5/-; 2ft. x 1ft. 6in. x 4in., £1/10/-; c. and p., 2/-; 32in. x 16in. x 1 1/2 in., 14/-; c. and p., 1/-; s.a.e. complete list. B. & M. (Latex) Sales, 16, Hamm Moor Lane, Weybridge, Surrey. (Weybridge 3311.)

THE CLYDESDALE PATTERN CO. LTD., 125, West Regent Street, Glasgow, C.2. (CITY 7203-4.) For Sale: 1-9in. Bench Model Wood Band-saw, complete with 1 1/2 h.p. 220/250v. motor, 58in. vee belt and metal-cutting saw, £35 complete.

COMPRESSOR EQUIPMENT, Miscellaneous items; catalogue, 14d. Pryce, 157, Malden Road, Cheam.

COMPRESSORS for sale, 3 CFM, 180lbs. sq. in., on metal base, with driving wheel and receiver, price £3; 1 h.p. Heavy Duty Motors, price £3; carriage forward, Wheelhouse, The Grove, Isleworth (Phone: Hounslow 7558.)

AMAZING DEVICE, cuts perfect discs, wheels, etc., to 12in. diameter, with any circular saw, 10/6 p.p.d.; sample 6in. mahogany disc, photo, details, 1/6. Below:—

HOW TO REWIND and Service Electric Motors, Generators. Complete Practical Book only 3/-; p.p.d. Below:—

HOW TO MAKE IT BOOKS: Whittling in Wood; Inlay Pictures, Marquetry; American Action Toys; 21 Lovely Lamps; 3/- each; p.p.d. Below:—

BUILD YOUR OWN PHOTO Equipment, 12 designs in two books. Enlargers, printers, dryers, timers, etc., 6/-; p.p.d. Below:—

40 POWER TOOLS You Can Make from scrap, pipe fittings, etc. This amazing book of plans for circular saws, lathes, band-saws, jigsaws, planes, tapping attachment, jigs, etc., has sold 250,000 copies, and is a "must" for every home workshop, 12/6 only; p.p.d. Below:—

AMERICAN BOAT BUILDERS Annual; 28 boat plans, 8-22ft., and other helpful articles, 7/6; p.p.d. Below:—

CAR BODY REPAIRING. Complete A B C course; illustrated; 7/6; p.p.d.; lists free. A.P.S. (P), Sedgford, Norfolk.

SMALL DENTIST'S SYRINGES, beautifully made all metal instruments by leading makers. All parts heavily plated, and machined from solid. Smooth positive action. Lapped piston and cylinder. Piston rod calibrated 0-20. Ideal for precision lubrication without mess, and many other purposes. Complete with 6 strong hardened steel needles, in plated metal case with hinged lid and fastener. Ex-Ministry, new, unused. Worth £22s. Our price 9/6, post 6d. K. W. Logan, West-ale, Hitchin, Herts.

"PICADOR," ROTOSAW. Portable circular saw attachment for your electric drill fitted with 4in. circular saw blade, adjustable fence to cut up to 1in. in depth; ideal for wood, plastic, or soft metals; 33/- each, post paid. Lambs-wool polishing Bonnets, 5in., 4/3 each; Rubber Backing Discs, 5in., complete with key, 4/6 each; Abrasive Discs, 5in., 6 assorted grades, 2/-; Send 2d. for lists of Saw spindles, Vee Pulleys and Belts. Plummer Blocks, etc. Sawyers, Ltd., St. Sepulchre Gate, Doncaster.

TYLER Spiral Hacksaw Blades cut in any direction at conventional hacksaw speed without turning the work; 10in. Hacksaw Blades 4d. each from leading tool dealers. Write to Spiral Saws, Ltd., Trading Estate, Slough, for details.

"PERSPEX," clear, coloured, sizes cut, also Corrugated; Plastics, Aluminium, Asbestos, Mouldings Henry Moat & Son, Ltd., Atom Works, Newcastle, 1.

PERSPEX for all purposes, clear or coloured, dials, discs, engraving Denny, 15, Netherwood Road, W.14. (SHE. 1426. 5152.)

NUTS, BOLTS, SCREWS, Rivets, Washers and hundreds of other items for model engineers and handymen. Send now for free list. Whiston, New Mills, Stockport.

HOUSE SERVICE METERS, credit and prepayment; available from stock. Universal Electrical, 221, City Road, London, E.C.1.

2 INCH DIA. ASTRONOMICAL TELESCOPE KITS. For simple assembly; an efficient instrument prepared in 10 minutes; ready fitting parts. Comprising: selected 50 mm. dia. objective at 40ins., focus mounted in special aluminium cell with sensitivity and correcting stop (ensures achromatic stability with sharp image), lined eyepiece holder, turned brass eyepiece, 1in. focus, magnification 40 diameters (equivalent 1,600 x area, shows rings of Saturn, etc.) with large explanatory layout drawings; thoroughly tested; price 39/6; registered postage and packing free. Below.

CONVERSION OPTICAL PACK. Above unmounted objective with precision stop and eyepiece data sheet for converting small telescopes or microscopes into powerful 40ins. length instruments; price 12/6 pack. Astro Lay-out Drawings, 4/6 extra. Below.

POLARIZING KITS. Assorted Laboratory Grade Screens for simple adaptation to any size astronomical telescopes, microscopes, cameras, projectors, etc.; suitable for astro-daylight observation, microscopic analysis, colour and cloud photography, gem testing, 3-D. cinema viewing, etc., including experimental specimens showing chromatic and interference effects, with illustrated instructions detailing half and full wave experiments, application, etc.; price 12/6, all post free. J. K. M. Holmes, "Scientific Instruments," Dept. P.M.2, "Vizcaya," Wolvehill Terrace, Gosforth, Newcastle-on-Tyne, 3.

HOW TO METALIZE BABY SHOES, a permanent souvenir of childhood. Latest American process; wanted by every mother, complete instruction booklet, 3/-. How to make a 5/- Duplicator, 2/-; Send for our list of handy and money-making plans. Dept. S., 16, Newton Road, Southampton.

SYNCHRONOUS CLOCK MOTORS, 230v. A.C. S/Ph 50c., 12/6 each, plus 1/- postage. Universal Electrical, 217, City Road, London, E.C.1.

MODEL DEALERS

BUD MORGAN, The Model Specialist, 22, Castle Arcade, Cardiff. (Telephone: Cardiff 29065.) Model Aircraft, Trix Tri-ang, Graham Farish, Model Railways and Galleons; first-class mail order service. Send for my 1953 price list, price 3d.

HOBBIES LTD. have over 50 years' experience of catering for the needs of modellers, handymen and home craftsmen. Branches at 78a, New Oxford Street, London, and in Birmingham, Glasgow, Manchester, Leeds, Sheffield, Hull, Southampton and Bristol. Head Office, Dereham, Norfolk.

SHIPS IN BOTTLES.—The constructional kit that tells you how to make them; build for pleasure or for profits; kits 6/- ea. from Hobbies Ltd. and model shops, Cooper-Craft Ltd., The Bridewell, Norwich.

LONDON.—Robson's Hackney's L Model Shop, 149-151, Morning Lane, E.9. (Tel.: AMHerst 2988).

ATTENBOROUGH Model Railway. A Model railway specialists; finest in the Midlands; Agents for and stockists of many well-known firms. Why not ask for a copy of our A.M.R. Chronicle? The latest information regarding our stock, 1/- post free. 82, Arkwright Street, Nottingham, and 64, Narborough Road, Leicester.

HANDICRAFTS

MUSICAL MECHANISMS. Swiss made, for fitting in cigarette boxes, etc., 22/6 each. Send 6d. for complete list of handicraft materials. Metwood Accessories, 65, Churchil Street, Wolverton, Bucks.

HOBBIES

DOLLS HOUSE FITTINGS and Papers; Wooden and Metal Toy Wheels (trade supplied); illustrated brochure; s.a.e. Jasons, 135, Nags Head Road, Enfield, Middlesex.

MAKE MONEY MAKING TOYS. We supply all the parts in best quality plywood; also wheels, screws, pins, etc., holes bored to position; all ready to assemble and paint; complete with full instructions; impossible to go wrong. Send for free list. ELF Manufacturing Co. (Dept. F), Mitton Mill, Stourport-on-Severn.

RUBBER MOULDS for animals, figurines, etc., from 1/9; Religious Plaques, unpainted; Rock-hard Casting Compound, 15lbs., 10/-; Snow-white Plaster Sealer, 2/9; Supergloss transparent instant drying Varnish, 2/9. Stamp for full list. Burleigh Artware Supplies, 13, Burleigh Street, Hull.

TOY CASTING MOULDS, soldiers, sailors, airmen, animals, etc. Rubber Moulding Compound, 8/6 per lb. Moulds for Plasticwork, plaques, ornaments and Coronation souvenirs. Moulds from 3/6 each; catalogue 9d.; s.a.e. for list. F. W. Nuthall, 69, St. Marks Road, Hanwell, London, W.7.

1/6 EACH. Plans how to make the "Geomograph" and model Petrol Station. Hocerill Hobbies, Market Passage, Saffron Walden.

WOODWORKING

WOODWORKING MACHINES, Saw Benches, complete, 7in. £4/15/-; 8in. £5/10/-; Lathes, £7/10/-; Bowl Turning Heads, £7/10/-; Combination Lathes, £10/10/-; Planers, Saw Spindles, Motors, etc. 4d. stamp for illustrated booklet; h.p. available. James Inns (Engineers), Dept. F, Sherwood, Nottingham.

PLYWOOD, 3/16in. Finnish Birch, very clean sanded stock; 4 sheets, 30in. x 30in., 18/-; carriage paid. Stamps for lists of mouldings, plywood and complete woodworkers' supplies. Sawyers, Ltd., St. Sepulchre Gate, Doncaster.

MYBLO 6IN. SAWBENCHES, rise table and fall spindle, 12in. x 9in. table, ripp and mitre fences, V-drive, £6/15/-; from your tool dealers or direct from makers: F. Blood & Co., Arch Street, Rugeley, Staffs.

MAHOGANY PLYWOOD, new, any parcel, £1 delivered; c.w.o.: 5 at 66 x 1 1/2 x 1/2 in., 6 at 1 1/2 x 60 x 1/2 in., 7 at 42 x 1 1/2 x 1/2 in., 6 at 23 x 20 x 1/2 in., 14 at 14 x 23 x 1/2 in., 20 at 14 x 17 x 1/2 in., 14 at 12 x 27 x 1/2 in., 40 at 45 x 3 1/2 x 1/2 in., 20 at 42 x 5 1/2 x 1/2 in., 6 at 25 x 13 x 1/2 in., 12 at 40 x 6 x 1/2 in.; Birch, 30 at 5 1/2 x 7 x 4mm. Small mixed sizes, £1 1 cwt. Following, one side slightly glue stained; 7 at 23 x 23 x 3/16in., 10 at 20 x 20 x 3/16in. M. Leader (1920), Gosford Street, Middlesbrough.

MISCELLANEOUS

BUILD YOUR OWN REFRIGERATOR, all components available at reasonable prices. Frigidaire flowing cold units, £5; small units, Kelvinator, etc., £4; 1 h.p. heavy duty Motors, £3; Chrome Cabinet fittings, new, £1; money back guarantee; s.a.e. for list and schematic diagram. Wheelhouse, 1, The Grove, Isleworth, Middx. (Phone: Hounslow 7558.)

BOOKLETS "How to use Ex-Gov. Lenses and Prisms," Nos. 1 and 2 price 2/6 ea.; Ex-Gov. Optical lists free for s.a.e. H. English, Rayleigh Road, Hutton, Breatwood, Essex.

"FORTUNES IN FORMULAS," 900 pages containing 10,000 formulae, processes, etc., 25/-; American magazines, hobby, technical, etc.; stamp for lists. Herga, Ltd., Hastings.

50 MECHANICAL DEVICES, 10/-; Elgin, 12, Margravine Gardens, Barons Court, London, W.6.

MAKE YOUR OWN RANGEFINDER. Fully detailed instructions, 5/-; Elgin, 12, Margravine Gardens, Barons Court, London, W.6.

PHOTOGRAPHY

ENLARGER and Camera Bellows supplied; also fitted. Beers, St. Cuthbert's Road, Derby.

WATCHMAKERS

ALL FROM GOLD and Silver Cases: 25 antique Verge movements, take 2 1/2 the 5; 5 keywind Waltham Pocket Movements, 30/- the 5; 6 Swiss 15-Jewel Keyless Lever Movements, 30/- the 5; 5 beautiful 15-Jewel Wristlet Lever Movements, 40/- the 5; Merkels, Jewellers, Grey Street, Newcastle-upon-Tyne.

WATCH CASES, Movements, Dials, Wheels, Pinions; return post service. Gleave, Albemarle Way, E.C.1. Write for list No. 7/53.

HE CAN HELP YOU. Every member of our staff is a skilled watchmaker and as such he understands your difficulties and trials. Why not send for our latest material and tool lists gratis and post free? Interchangeable Balance Staffs, Winding Stems, Buttons, Hands, complete Balance Assemblies, Escape Wheels, Pallets, in fact, everything the watchmaker requires. No inquiry too trivial, we are here for your benefit. H. S. Walsh, 28, Anerley Station Road, London, S.E.20.

WATCHMAKERS' SREWDRIVERS, high tensile blades, swivel top; set of 5 graduated sizes, in fitted box, 5/- post paid. Sawyers, Ltd., St. Sepulchre Gate, Doncaster.

ASSORTED Jewelled Pocket Movements from gold cases, 10 for 25/-; Jewelled Pocket Watches, 10 for 40/-; Jewelled Wrist Movements, 10 for 40/-; Jewelled Wrist Watches, 10 for 60/-; Loader Bros., Dept. P.M. 38, Milestone Road, Carleton, Oxford.

HAVE YOU TAKEN ADVANTAGE of our Watch and Clock Repair Service; if not send it to us for estimate by reg. post; nothing too difficult. We also thank past clients for letters of satisfaction received. The Melnor Horological Dept., 32/2, Waterloo Road, Nottingham.

INTERCHANGEABLE Watch Parts: Staffs, 1/-; Stems, 8d.; Buttons, 5d.; other material quoted for; make and cal. no. or movement required. Every description repairs undertaken. J. H. Young & Son, Wholesalers, 133, London Road, Chippenham, Wilts.

GET YOUR TOOLS, Materials and Spare Parts from Western Watch Supplies Ltd., 17, Yorke St., Wrexham. Send 6d. for lists.

INSTITUTES

EVERY APPROVED CANDIDATE graded in the Technical Engineering and Allied Classes (administrative, executive, technical) is eligible for membership of the Institute of Executive Engineers and Officers; admission fees reasonable. Give age, industry and past held for full particulars of entry to the Secretary, Executive Chambers, 241, Bristol Road, Birmingham, 5.

RADIO

CAN YOU SOLDER? That's all you need to make a really good Radio or Tape-recorder from standard Osborn Components. Send 5d. (stamps) to-day for free circuits and lists. Dept. P.M.G. Osborn Radio Products, Ltd., Borough Hill, Croydon, Surrey. (Croydon 5148-9.)

EX-R.A.F. "Constant Speed Units." Assembly of medium-sized gears, ballraces etc., alum casing, weight 10lbs., 7/6 each, post 2/-. The Radio Services, Lt. Bullingham, Hereford.

ELECTRICAL

BROOKS 1/2 h.p. Motor, 230v., 50c., single-phase, 2,800 r.p.m., ball-bearing; ideal for driving wood-working machines; latest type, in maker's sealed box; brand new; £8/15/-; carr. paid. Blood, Arch Street, Rugeley, Staffs.

BARGAINS FOR ELECTRICIANS.—Brand new Cables in 25-50yd. lengths; T.R.S. twin, 1/044, 45/-; 3/029, 60/-; 7/029, 95/-; 3'029 with earth, 72/6; 7/029 with earth 117/6; P.V.C. twin, 1/044, 38/6; 3/029, 56/-; Transparent Flex, 14/36 twin, 17/6. All per 100yds. carriage paid. Fully wired Ballast Units, 38/6; c.w.o.; Request list, Jaylow Supplies, Ltd., 93, Fairholt Road, London, N.16. (Tel.: Stamford Hill 4384.)

TWIN RUBBER COVERED FLEX COTTON BRAIDED. Size 14/0076. Capacity 2 amps at 230 volts. Suitable for numerous uses including bells, telephones, automobile wiring, etc., etc. This wire is new and is electrically perfect. To-day's price 50/- per 100 yards. We are able to offer at amazingly low price of 20/- per drum containing approximately 100 yards (packing and carriage paid). Drum alone worth 5/-.

The 'Adept' Bench Hand Shaper. Length of stroke of ram 3 1/2 in. No. 2 B.H. Shaper, 6 1/2 in. stroke. Price £16 17s. 6d. Also Power Driven—Extra. Ask your dealer. Manufactured by F. W. PORTASS, MACHINE TOOLS, LTD. ADEPT WORKS, 55, MEADOW STREET, SHEFFIELD, 3.

CHEMISTRY APPARATUS. Send 2d. stamp for COMPLETE PRICE LIST. Booklets: "Experiments" 10d., "Formulas" 10d., "Home Chemistry" 2/3. Post Paid. BECK (Scientific Dept. A) 60 HIGH STREET, Stoke Newington, London, N.16.

BRITINOL Soldering Outfits Solve All Soldering Problems. (As reviewed in PRACTICAL MECHANICS May, 1953). The "Popular" Outfit, as illustrated. Britinol Spirit Blow-lamp, Telescopic Soldering Iron, Paste and Cored Wire Solder, 16s. The "Junior," as above, but without Soldering Iron, 9/6. All items sold separately. From Model Shops and Tool-Dealers. BI-METALS (BRITINOL) LTD., St. Mary's Works, Bridge Road, London, N.9. S.A.E. for illustrated list.

G.E.C. & B.T.H. GERMANIUM CRYSTAL DIODES. G.E.C. GLASS TYPE 5/16in. x 3/16in. B.T.H. LATEST TYPE MOULDED IN THERMO-SETTING PLASTIC. Both Wire Ends for Easy Fixing. 4/6 each, postage 2/6. B.T.H. SILICON CRYSTAL VALVE 3/6 each, postage 2/6. Fixing Brackets 3d. extra. Wiring instructions for a cheap, simple but high quality Crystal Set included with each Diode and Crystal Valve. COPPER INSTRUMENT WIRE ENAMELLED, TINNED, LITZ, COTTON AND SILK COVERED. All gauges available. B.A. SCREWS, NUTS, WASHERS, soldering tags, eyelets and rivets. EBONITE AND BAKELITE PANELS, TUFNOL ROD, PAXOLIN TYPE COIL FORMERS, AND TUBES. ALL DIAMETERS. Latest Radio Publications. SEND STAMP FOR LISTS. CRYSTAL SET INCORPORATING THE SILICON CRYSTAL VALVE Adjustable Iron Cored Coil. RECEPTION GUARANTEED. Polished wood cabinet, 15/-, post 1/- A REAL CRYSTAL SET NOT A TOY. POST RADIO SUPPLIES 33 Bourne Gardens, London, E.4.

You Can Become a HANDICRAFTS INSTRUCTOR. EXPERIENCE NOT ESSENTIAL. Men who enjoy making things in wood or metal can turn their hobby into a permanent and interesting Career! Short hours, long holidays, and security in a job you would really enjoy, can be yours if you become a Handicrafts Instructor. Let us send you details of the easiest and quickest way to get the necessary qualification. We definitely Guarantee "NO PASS—NO FEE". If you would like to know about our unique method of preparing you for one of these appointments, write today, and we will send you an informative 144-page Handbook—FREE and without obligation. Mark your letter "Handicrafts Instructor." British Institute of Engineering Technology 591, Shakespeare House, 17/19, Stratford Pl., London, W.1. BIET

WEBLEY AIR PISTOLS. Marvellously accurate for target practice. No licence required to purchase for use on enclosed premises. Write for Catalogue of AIR PISTOLS, AIR RIFLES and Accessories. WEBLEY & SCOTT LTD., 106, Weaman Street, Birmingham Eng.

CAN YOU PLAY THE PIANO? If you are a music lover, why have you not acquired this enjoyable accomplishment? Has the prospect of practical practice practical discouraged you? It is unnecessary. My pupils' roll grows daily. I state it in every advertisement. It is your assurance of success. My class is seldom less than 2,000 pupils. I have taught over 87,350 AND I CAN TEACH YOU (in 12 lessons) even if you do not know a note. Ordinary musical notation only used, no freakish methods. FREE Book and advice. Ray Beginner, Moderate, Advanced. (Block letters, please.) MR. H. BECKER (Dept. 868), The Hall, Centurion Rd., Brighton, Sussex.

COMPRESSORS. Twin Cylinder ex-W.D. Ready for use, 12 cubic feet. Guaranteed. £12.10. Weight 65 lbs. Additional details on request. Smaller Compressors, etc. 6-page List 1d. ROGERS, 2 Matlock Avenue, Southport.

IMPETUS Precision PLANERS. Circular safety type cutter-head High quality tempered steel knives. Tables mounted on machined inclined ways. Ground table-surfaces. Fences adjustable to 45 deg. 4 in. MODEL £9.10.0 Motorised, £18.10.0. 6 in. MODEL £28.10.0. Motorised £44.0.0. Send for Catalogues of other 'Impetus' Products. JOHN P. M. S. STEEL, Dept. 80, BINGLEY, YORKS. Phone: BINGLEY 3551 (4 lines).

When replying to advertisers' announcements please mention "Practical Mechanics"

Amateur Radio Enthusiasts THE INCOMPARABLE GLOBE-KING. SINGLE VALVE S.W. RECEIVER ● WORLD-WIDE RANGE 11-100 METRES ● CRYSTAL-CLEAR NOISE-FREE RECEPTION ● ELECTRICAL BAND-SPREAD TUNING ● EXTREMELY LOW RUNNING COSTS. Catalogue Free. Stamp for postage. JOHNSONS (RADIO) 48, FRIAR STREET, WORCESTER

REFILL YOUR OWN BALL PEN. KOLOID REFILL KIT. POST FREE 3/6 PER OUTFIT COMPLETE WITH ILLUSTRATED INSTRUCTIONS AND TOOL. Contains Ink for Blue, Violet, 12-15 Refills Red, Green. G. H. HOLMES (Dept. 5), 67, Brunswick Park Road, London, N.11.

Make Money SILK SCREENING AT HOME. This amazing equipment PRINTS anything, COLOURS anything, DECORATES anything, and DUPLICATES. 6 colours in bold design or small type. 16in. x 12in. BARGAIN OF THE YEAR OFFER of printer complete with all supplies, inks, etc. and FREE 10/- COURSE (7 days approval) post pd. 47/6 A.P.S., SEDGEFORD, NORFOLK

UNIC ELECTRIC DRY SHAVER. 200-250 v. and 100-150 v. A.C. & D.C. £8.6.1. tax paid. Swiss made by watchmakers; a perfect shave in 3 mins, without brush and soap. Price includes leather pouch. Send for illustrated leaflet giving address of nearest agent. REBUS ELECTRIC, LTD., Gladstone Place, Newton, Abbot, Devon.

Trade Notes

"Do it Yourself the Derwent Way" Booklet

THIS is a handbook which will be of immense value to all handymen and amateur woodworkers. It contains full details for constructing a TV cabinet, for making tables, fireside bookshelves, stool frames, table lamps, etc. There is an article on amateur french polishing, one on sea-grass stool weaving and one on renovating a car. A large part of the booklet is concerned with the display of proprietary goods in catalogue form, and in many cases comprehensive price lists are included. Among the well-known names which appear are Croid universal glue, Rawplug wall plugs, Hobbies fretwork outfits, Kaylee transfers, and many others. Price lists appear for hardboard, plywood and various types of timber, and there is a section illustrating many types of fittings, including hinges, locks, brackets, handles, etc. All of the goods displayed in the book are available from the Derwent Crafts Shop, 32, Bridge Gate, Derby, and the "Do it Yourself the Derwent Way" booklet is also obtained from this address. Its price is 6d., or 8d. by post, and in it every home handyman or woodworking enthusiast should find a great deal to interest him.

Johnson's Photographic Competition Results

THIS year there were two separate competitions; the annual spring competition was as usual, and in addition there was a competition especially for club members. In the first competition there were three classes, Class 1 being divided into three sections A, Country Life; section B, Town

Life; section C, Portraits or Figure Studies. In each section a first prize of £10 was awarded, two second prizes of £5 and three third prizes of £2. Class 2 was for novices, and the awards were first prize £5, second prize £2, and four third prizes of £1. The awards in Class 3, which was for those under eighteen, were the same as those in Class 2. Twenty-one consolation prizes were awarded.

In the club competition there were two classes, both of which were divided into two sections. Class 1, section A, was for a picture indicating power, and section B for a picture indicating peace. Class 2, section A, was for pictures of people, and section B for any other subject. Prizes in each section of both classes were:

first prize £10, two second prizes of £5, two third prizes of £2, and two fourth prizes of £1.

Entries were received from all over the world and prizes were awarded to competitors from Hong Kong, Bombay, Nigeria and Malta.

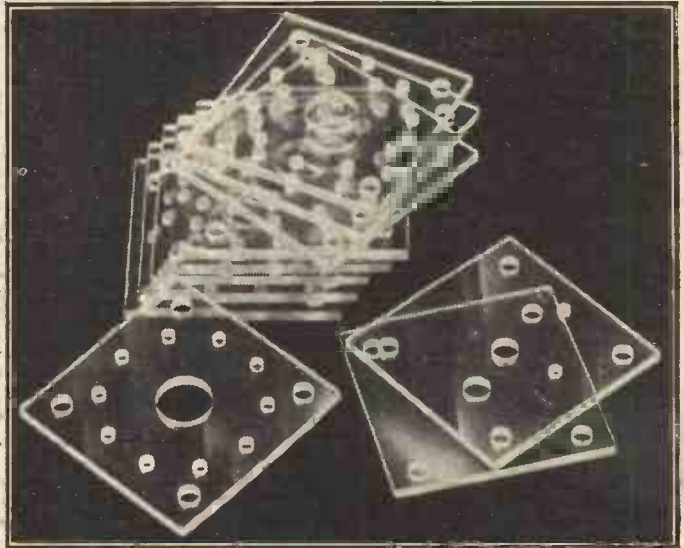

A batch of plastic switch wafers.

"Electronic Brain" Switch Wafers

AFTER reading our article in the June issue on the construction of an electronic brain, Messrs. Salendine Plastics, Ltd., have sent us a sample batch of switch wafers for the memory unit, made from plastic and drilled ready for assembly. They have constructed a drilling jig suitable for the mass production of these wafers. The end plates are made from 1/4 in. material which is quite rigid and should be thick enough to permit

a good cemented joint to the terminal strips, which could also be made from the same material. These units may be purchased ready made from Messrs. Salendine Plastics (Huddersfield), Ltd., Ing Works, New Hey Road, Salendine Nook, Huddersfield; the cost of the 11 wafers is 2/9, post paid.

LETTERS TO THE EDITOR

(Continued from page 478)

Solar System" Phil. Trans. A. 1903, also Ellerton on "Effects of Sun's Heat on Space Rocket" Journal of Am. Rocket Soc. No. 68, Dec. 1948, p.27. I am not a member of the British Interplanetary Society, but the excellent journal they produce will have examined this question in an erudite manner, I feel sure.

On the second point Mr. Land raises, viz. the sun's heat and how it crosses a vacuum, I can only refer him to an elementary book on physics. *Text Book of Physics*, Duncan & Starling, Chapter XXIX, p.367. No material substance is needed for the transmission of thermal radiation. Mr. Land should acquaint himself with electro-magnetic radiation then his hypothesis would be seen to be redundant.

Finally, the third point on meteorites. In spite of Mr. Land, I can assure readers that meteorites are heated by friction with the tenuous atmosphere through which they pass at between 15 and 50 miles per second.

Meteorites are almost invariably found to have a thin crust caused by intense heating of the material for a short time only. Its thinness shows the slight depth to which the heat has had time to penetrate. The temperature of a meteorite before it strikes the earth is usually very low. Fath, thinks it is not far above absolute zero. The intense heating is only in the outer layers and these are continuously stripped off. See *Encyclopaedia Britannica*: II Edition, "Meteorite" by L. Fletcher, M.A., F.R.S., Keeper of Minerals, British Museum, 1880-1909.

I cannot resist the opportunity of pointing out to Mr. Land and young readers, the importance of fully examining a subject before advancing what may be wild and foolish ideas based on false premises having an appearance of plausibility to the uninformed. In this country with our excellent library services, our museums and scientific institutions it is only mental indolence which prevents us from examining the material on records.—FRANK W. COUSINS, A.M.I.E.E., F.R.A.S. (Greenford).

Club Reports

Taunton and District Society of Model and Experimental Engineers

THE above society, together with other societies taking care of the average hobbies of people of our town, are making a joint exhibition in a large tent in Vivary Park from August 1st-8th.—W. J. GARDNER, Hon. Sec., 33, Charles Crescent, Taunton.

Torbay Society of Engineers and Model Makers

THE above society was formed in 1948 with workshops at Ellacombe, Torquay. We have recently moved from there to The Austy Manor Hotel, Asheldon Road, Torquay, where we are setting up our new workshop in a cellar under the hotel.

In the winter months we run a series of film shows once a month to which we invite all who are interested to come along and see them.

We extend a hearty welcome to all local and visiting model engineers who may be interested enough to come along. Hon. Sec., F. H. Beynon, 107, Ilsham Road, Torquay.

Cardiff and District Federation of Model Clubs and Societies

WITH reference to the formation of the above Federation the following five clubs are affiliated:

- Whitchurch and Dist. Model Eng. Soc.
- Cardiff Model Yacht Society.
- Cardiff & Dist. Ship Model Society.
- Cardiff Model Aeroplane Club.
- B.O.A.C. Model Club, Treforest, Glam.

It is hoped that all clubs in this area will soon become interested. Club secretaries may obtain further information from the Secretary, Mr. R. S. Page, 11, Twyn-y-fedwen Rd., Gabalfa, Cardiff.

The "Model Engineer" Exhibition

THE "Model Engineer" Exhibition is to be held at the New Royal Horticultural Hall, Westminster, from August 19th-29th.

Complementing the display of competition models will be a water-tank where radio-controlled model boats will be seen manoeuvring, a miniature Grand Prix track constructed by Rex Hays, the multi-gauge passenger-carrying live steam track run by the Society of Model and Experimental Engineers, and a demonstration area where all branches of model making will be shown.

QUERIES and ENQUIRIES

A stamped, addressed envelope, three penny stamps, and the query coupon from the current issue, which appears on the inside of back cover, must be enclosed with every letter containing a query. Every query and drawing which is sent must bear the name and address of the reader. Send your queries to the Editor, PRACTICAL MECHANICS, Geo. Newnes, Ltd., Tower House, Southampton Street, Strand, London, W.C.2.

Wood Dust Flooring Composition

I HAVE a quantity of "wood dust" (from sanding machine) which, I understand, can be mixed with other materials and made up into a very good flooring composition. Can you tell me what other materials are required, and where they are obtained? Can this composition be coloured or stained? What are approximate amounts of materials sufficient to cover a room 12ft. x 12ft.?—L. Gadd (Oldham).

A SUITABLE quantity of wood dust, say 40lbs. should be mixed with 40lb. caustic magnesite, obtainable from Messrs. Charles Page & Co. Ltd., 52, Grosvenor Gardens, S.W.1.; costing about 3d. per lb. This should be mixed with a solution containing 150lbs. of hydrated magnesium chloride crystals dissolved in about 10 gallons of water. These quantities are approximate and must be varied to your own idea of correct consistency; you should aim at getting it into a pasty mass.

This pasty mass should then be spread over the surface to be covered to a depth of $\frac{1}{2}$ in. to $\frac{3}{4}$ in. and allowed to set, which it will do in about six hours.

Colouring matter should be added to the caustic magnesite before mixing.

To cover the area you mention we should estimate that you need to double the quantities given above.

Mercury Vapour Lamp

I AM wishing to construct a quartz mercury vapour sun lamp. Could you say at what voltage these tubes work, whether A.C. or D.C. and if at a different voltage to mains, i.e. 240 volts, is this obtained by a transformer or dropping resistance?—H. A. Trimnell (Birmingham, 27).

THERE are various types of mercury vapour lamp. They may be designed to run from mains voltage but require a choke coil in series on A.C. mains in order to reduce the voltage across the lamps when operating. Some lamps can be run off D.C. mains in series with a resistor, whilst others may require a resistor and a choke coil in series on D.C. Thus the answer to your enquiry really depends on the particular type of lamp which you intend to use and no doubt full details could be obtained from the makers of the lamp.

You could probably obtain a suitable lamp from one of the following firms:

Perihel Ltd., 17, Edge Street, London, W.8.
Hanovia Ltd., 3, Victoria Street, London, S.W.1.

Watson & Sons (Electro-Medical) Ltd., East Lane, Wembley, Middx.

Polishing Granite

PLEASE tell me how to polish granite. I should like to know how it is done, the materials used and also how to achieve that final glaze.—R. H. Sparrow (Norwich).

TO polish an area of granite 1ft. x 6in. will take you about two days.

You will need:

- (1) Coarse carborundum.
- (2) Medium "
- (3) Fine "
- (4) Emery powder.
- (5) Putty powder.
- (6) Zinc oxide.
- (7) Thick hard felt.

The materials may be obtained from Harbro's Supply Ltd., 145, Albert Rd., Middlesbrough, and are used in the order shown.

The three carborundums are used with water. Then fine only with water and

Readers are asked to note that we have discontinued our electrical query service. Replies that appear in these pages from time to time are old ones and are published as being of general interest. Will readers requiring information on other subjects please be as brief as possible with their enquiries.

emery powder. Then, when it is as fine as you can get it, use putty powder on felt with water, then zinc oxide on felt with water, then felt dry. Take care that all traces of coarser abrasives are removed by swilling with sponges before proceeding to the next process.

If you want to save yourself a lot of trouble, we would advise you to take your

THE P.M. BLUE-PRINT SERVICE

12FT. ALL-WOOD CANOE. New Series. No. 1.
3s. 6d.*

10-WATT MOTOR. New Series. No. 2, 3s. 6d.*

COMPRESSED-AIR MODEL AERO ENGINE.
New Series. No. 3, 5s.*

AIR RESERVOIR FOR COMPRESSED-AIR
AERO ENGINE. New Series. No. 3a, 1s.

"SPORTS" PEDAL CAB. New Series. No. 4, 5s.*

F. J. CAMM'S FLASH STEAM PLANT. New
Series. No. 5, 5s.*

SYNCHRONOUS ELECTRIC CLOCK. New
Series. No. 6, 5s.*

ELECTRIC DOOR-CHIME. No. 7, 3s. 6d.*

ASTRONOMICAL TELESCOPE. New Series.
No. 8 (2 sheets), 7s.*

CANVAS CANOE. New Series. No. 9, 3s. 6d.*

DIASCOPE. New Series. No. 10, 3s. 6d.*

EPISCOPE. New Series. No. 11, 3s. 6d.*

PANTOGRAPH. New Series. No. 12, 1s. 6d.*

COMPRESSED-AIR PAINT SPRAYING
PLANT. New Series. No. 13, 7s. 6d.*

MASTER BATTERY CLOCK.*
Blue-prints (2 sheets), 3s. 6d.
Art board dial for above clock, 1s.

OUTBOARD SPEEDBOAT.
10s. 6d. per set of three sheets.

LIGHTWEIGHT MODEL MONOPLANE.
Full-size blue-print, 3s. 6d.

P.M. TRAILER CARAVAN.
Complete set, 10s. 6d.*

P.M. BATTERY SLAVE CLOCK. 2s.

"PRACTICAL TELEVISION" RECEIVER
(3 sheets), 10s. 6d.

P.M. CABIN HIGHWING MONOPLANE.
1s.*

The above blue-prints are obtainable, post free,
from Messrs. George Newnes, Ltd., Tower House,
Southampton Street, Strand, W.C.2.

An * denotes constructional details are available free
with the blue-prints.

piece to the nearest granite firm, or buy the necessary equipment—advice on these tools can be had from the Building Centre, Store Street, W.C.1. They will tell you where to get the gear and how much. As a guide, 6ft. x 3ft. slab takes two days to polish with machinery.

All the polishing machines are spinners water fed through the centre rather after the style of a dentist's drill, to which flat wheels, spinners, buffs and felt can be fixed, and many have flexible shafts, but we are sure tools for granite would have rigid shafts in order to apply maximum pressure.

Eyepiece for Telescope

I AM considering buying a telescope eyepiece of 1/5mm. focus for use with a 6in. x 50in. focus telescope mirror for observation of the moon and planets.

Could you therefore tell me which of the following types of eyepiece is most suitable?

- (1) Orthoscopic.
- (2) Huygenian.
- (3) Ramsden.
- (4) Kellner.

—A. Longton (Leyland).

IN the first place, on a 50in. focus mirror, a 1/5in. focus eyepiece would provide too high a power for all general purposes. Much depends upon the degree of excellence of the mirror, but in any case, if the 1/5in. is purchased you are recommended to buy another of $\frac{1}{2}$ in. focus which would give you a power of 100x.

Personally we prefer for all round work, the Huygenian eyepiece though a first quality achromatic orthoscopic is good, but much more expensive.

We would avoid the Ramsden and also the Kellner; both of these give an unpleasant ghost of bright objects which arises from light reflected from the inner surface of the field lens and back again by the front surface to a focus. This focus lies not far back from the field lens and is too near to the focus of the eye lens for comfort. It is probable that of all the eyepieces in use in the world, 90 per cent. of them are of the Huygenian type.

Picture-backed Mirrors

I HAVE seen a mirror with a picture on the reverse side, like a double-sided mirror. Please tell me how these are formed.—E. F. Tweed (Gt. Yarmouth).

THE picture-backed mirrors which you have seen are made up of two glasses, cemented together. On one glass, silver is deposited and polished on the back; the other glass is an ordinary photographic positive, i.e., a sensitised plate printed from a negative, developed and fixed as an ordinary photograph. The cement may be a gelatine solution or a solution of clear celluloid dissolved in amyl acetate. Whichever is used, the film on the positive should be hardened in an alum bath.

Cine-camera Speed Governor

I SHOULD be glad if you would give me details of the usual mechanism for the speed governor and variable speed control in cine-cameras for sub-standard films.—F. T. Jones (North Wales).

VARIABLE speed control with electrical camera motors is usually achieved by wiring a variable resistance in one lead. This should be a wirewound component of sufficient current-carrying capacity. A variety of governors are found in present-day motors of this type. In some types, governor weights

(Continued on page 484)

3 Valve Battery U.H.F. Receivers. 160 m/cs. Easily converted, 15/-.
New Oldham, 2 v. 16 A.H. Accumulators, 7 1/2 in. x 4 in. x 2 in., 8/6.
Powerful small Blower Motors, 24 v. A.C./D.C., 14/6. As used for the Hedge Trimmer.

12/24 v. Blower Motors, as used for Car Heater, 22/6. Ref. 10 KB/115.

Transformers. Input 200/240 v. Sec. tapped 3-4-5-6-8-9-10-12-15-18-20-24-30 volts at 2 amps., 21/6. 12 months' guarantee. This is ideal for use with Blower Motors.

Selenium Rectifiers F. W. 12-6 volt, 1 A., 8/6. 3 A., 14/6. 4 A., 23/6. 6 A., 30/-.
24 v. 2 A., 30/-.
250 v. 100 mA. HW., 9/-.
D.P.D.T. Relays. Operate at 200/300 volts D.C., 8/6. D.P. Make and Break, 8/6. Any combination or voltage can be supplied at varying prices.

0-5 amp. 2 1/2" Square M/C Ammeters, 11/-.
Multimeter Kits with 2 1/2 in. calibrated M/C meter, reads volts 3, 30, 150, 300 and 600. MA 0-60. Ohms 0-5,000. 25/6.

Compass Mountings each contains 4 Brass Pistons and Cylinders 1 1/2 in. x 3 in. Ex. Dia. 3 in. Bore, 4/6.

M/C Microphones with matched transformer, 14/6.
0-500 MICRO-AMMETERS, 2 in., 15/6.

1/2 h.p. Motors, 9/32 in. dia., spindle each end. 100/250 v. D.C. Very powerful. 5 1/2 in. x 3 1/2 in., 40/-.
A.C./D.C. 230 v. 1/20th h.p. Motors, 3 in. x 1 1/2 in. spindle, 4,000 r.p.m., 40/-.
4ft. Fishing Rod Aerials. 3 Sections, 6/- Base, 3/6.
G.E.C. 0-75 m/amp meter 1 1/2 x 1 1/2 in., 8/-.

New 6 v. Dynamometers, output 350 v. 125 mA. 6 v. Vibrator Units, output 200 v. 40 mA., 22/6.

All Carriage Paid in U.K.

THE RADIO & ELECTRICAL MART

253B, Portobello Road, London, W.11
Park 6026

UNREPEATABLE SUMMER BARGAIN OFFERS

PLESSEY A.C. MAINS shaded pole gram. motors, tapped 200/250 v. 50 cycles, shaft runs at 2,500 r.p.m., has 3 diameters, as used on the 3-speed gram. units, size 3 in. x 3 in. x 2 1/2 in., list price 36/-. our price brand new boxed, 12/6, post 1/2. 10 for 45 carriage paid. **PERMANOID** (p.v.c.) covered connecting wire, tinned copper 21 s.w.g., brand new 100 yd. coil 5/-, 12/-, four different colours, 18/-, post 2/-. **T.R.S. CABLE** (B.S. 5.7) single 1/04, brand new stock, 44 yd., 100 yds., 25/-, post 2/-. **REVERSING MOTORS**, ball-bearing, 4 in. long, 2 1/2 in. dia., 12 v. 1 amp. D.C. (shunt) or 110 v. A.C. (series), new boxed, worth 60/-, our price 7/6, post 1/4. **BROWN'S HEADPHONES**, L.R., ideal for crystal sets using the germanium crystal, fitted 6ft. leads, brand new boxed, 7/6, post 1/-. **GERMANIUM CRYSTALS**, the ideal crystal set detector, latest wire ended type, 2/6, post 3d. **WIRE STRIPPERS**, strips the insulation from flexes and cables up to 1/4 in. dia., usual toolshop price 15/-. our price brand new boxed, 5/6, post 6d. **SELENIUM RECTIFIERS**, full-wave bridge, 12 v. 4 amps., A.C. input 16 v., new boxed, 15/-, post 1/-. Transformers to suit, input 200/230/250 v., output 4-8-12-16-20 v. at 4 amps., brand new boxed, 20/-, post 1/6. **BUBBLE SEXANTAS MK. 9**. These fine instruments originally cost £40. Our price new unused in carrying cases, 25/-, post 2/-. **TELEPHONE SETS**, consists of 2 combined microphones and receivers, with 20ft. connecting flex, provides perfect 2-way communication, self-energised, no battery required, complete, new boxed, 8/6, post 1/-. **MULLIVANS MAGNETO-METERS**, an instrument for measuring the strength of permanent magnets, new in wood cases, 2/6, post 6d. **FEEDER COUNTERS**, 0-999 then repeating, nickel-plated cases, 1 in. actuating shaft, 2/6, post 4d. **THROAT MIKES**, U.S.A. pattern by Univ. Micro. Co., 1/6 pair, post 4d. **RADIATOR TEMPERATURE GAUGES**, quickly altered to a 2 mA. moving coil meter, new boxed, 2/6, post 6d. **MOTOR GENERATORS**, input 12 v., output 230 v. 30 mA., will run an A.C./D.C. mains electric razor from a car battery, 10/-, post 1/8. **ALTIMETERS**, have an aneroid movement identical to a weather barometer, new boxed, 3/6, post 1/-. **CELOPHANE BAGS**, size 8 in. x 6 in., ideal for sandwiches, packing, etc., etc., brand new cartons of 1,000, 15/-, post 2/-, sample free. **MAINS TRANSFORMERS**, input 230 v. 50-cycles, output 12 v. at 10 amps., enclosed in metal cases, 30/-, carriage 2/6. **PNEUMATIC DASH-POTS**, all brass, 3 in. long, 1 in. dia., plunger movement 2 in., new unused, 1/8, post 6d. **HOPMAN BALL RACES**, 1 in. dia., 3/16 in. bore, 5/32 in. wide, new unused, 2/6 pair, post 3d. **ARROW SWITCHES**, 250 v. 30 amp. panel mounting 4-way rotary, 3-heat and off series parallel, new boxed with knob, 2/6, post 1/-. **HAMOPIL T.R.S.** covered 19 s.w.g. tinned copper, brand new 500 yd. coils, 40/- carriage 2/6. **RELAYS P-3000 TYPE**, 100 ohms, 8-pole 4 m. 4 B., 2/6, post 6d. **ELECTROLYTIC CONDENSERS**, 32 mid. 450 v. new unused, 1/3, post 9d. **BALLOONS**, dingy type, natural latex, blow up to 3 1/2 in. dia., makes an ideal beach ball, etc., new boxed, 2/6, post 9d. **VARIABLE RHEOSTATS**, wire wound on ceramic, laminated wiper, 50 ohms at 1 amp. or 120 ohms at 2 amps., new boxed, 5/-, post 1/-. **AERIALS**, screw-in fishing rod type, 3 sections total 12ft. long, new boxed, 6/6, carriage 1/3. **TELEPHONE WIRE**, p.v.c. covered, 880 yd. (4 mile) coils, 20/-, post 2/-. **HECTOGRAPH CARBON PAPER** (for spirit duplicating), size 13 in. x 16 in., boxes of 100 sheets tissue interleaved, brand new, 5/-, post 4d. **UNICEL CABLE**, single 9/012 black braided, for car wiring, etc., 100 yd. coils, brand new, 15/-, post 1/4. ditto, Duocel, twin flat 9/012 black braided, brand new 200 yd. coils, 50/-, carriage 3/6. **CONCORDIA BELL TRANSFORMERS**, 200/250 v., output 3-5-8 v. at 1 amp., fused secondary, a superior bell transformer that retails at 15/-, our price brand new boxed, 8/6, post 1/-.
Many other items; send for our 30-page lists, price 6d.

MIDLAND INSTRUMENT CO.

MOORPOOL CIRCLE, BIRMINGHAM, 17

TEL: HAR. 1308.

MARBLE ARCH MOTOR SUPPLIES

286-302, Camberwell Rd., S.E.5. Rodney 2181. 113-133, Edgware Rd., W.2. Pad. 2435. 26 & 41 Goldhawk Rd., W.12. She. 3369. 1156, London Rd., Norbury, S.W.16. Pol. 4780. Lower High St., Watford, Watford 4493.

WOLF CUB DRILL. Compact, powerful 1 in. electric drill. Weighs only 3lb. Chuck spindle mounted in ball bearing. Complete with 6ft. of three core cable. State voltage when ordering. £5.19.6. Post & Packing 1/6.



BENCH VICES. As illustrated, light alloy bench vices. 3" jaws, 3" opening. Price 15/3. Now P. & P. 2/6.



BATTERY CHARGERS. Simple to operate. Will give long and reliable service. Charging 2 & 6 volt at 1 amp. Price Now 50/-
Charging 6 & 12 volt at 1/2 amp. Price Now 55/-
P. & P. 2/6.



BREAST DRILLS. 2-speed Breast Drill, capacity up to 3/4". A thoroughly reliable and sturdy tool with machine cut gears. Honestly worth 3/6. Our Price 25/-
P. & P. 2/-.



ENGINEERS 4" SQUARES. All Steel. Brand New in Makers Wooden Case. A precision tool at an incredibly low price. Only 4/6d. Post paid.
POSTAL ENQUIRIES TO CAMBERWELL

FOR ONE MONTH ONLY SUMMER CLEARANCE SALE

- AMPLIFIERS
- PICK-UPS
- TAPE-RECORDING & T.V. EQUIPMENT
- AUTOCHANGERS
- SPEAKERS

FOR ONE MONTH ONLY, ENDING 29TH AUGUST Here is the opportunity of a lifetime for home constructors. In order to make room for new stocks we are offering a limited number of brand new and reconditioned coil-to-new lines at real knock-out prices. All equipment guaranteed in perfect working order. Items include Decca and other well-known amplifiers, extension speakers of all types, tape-recorders, motors, changers, and pick-ups, demonstration T.V. sets, etc., etc. This is a genuine offer. Once sold, lines cannot be repeated. Send Coupon Now for Lists and Order Form

Post this Coupon for Sensational Bargain List. Send in 1/4d. unsealed envelope to:-

To CLASSIC ELECTRICAL CO., LTD., 352/354, Lwr. Addiscombe Rd., Croydon, Surrey.
Please send me by return your full 1953 Summer Bargains List.
NAME.....
ADDRESS.....
I am interested in (state type of equipment).....
8/53

CLASSIC ELECTRICAL CO. LTD.

352/354 LOWER ADDISCOMBE ROAD, CROYDON, SURREY. Telephone: ADDiscombe 6061/2

A. T. SALLIS
93, North Road, Brighton, Sussex.

Phone Brighton 25808

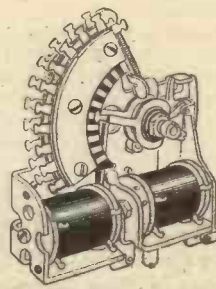

Uniselecto-r.—Minor Type. 2 tanks of 10 contacts, will operate from 4v. or 12v. with slight adjustment, has electro magnetic release when wipers reach end of the bank. Resistance of drive coil 50 ohms, release coil 70 ohms. Ideal for sequence switch in e.g. model radio control, tele-

phone exchanges, etc. Used, but new condition, 25/-. Post 1/6.

Gim Firing Switch.—Bakelite pistol grip handle with thumb switch. Ideal for drills, hair drivers, etc., 2/6, post 9d.

Mine Detectors.—Consisting of 2v. amplifier, complete with valves, search coils, headphones, etc. Ideal for locating metals, hidden treasure, etc., 39/6, carr. 8/6

Air Dryers and filter units for compressed air plants, 18 in. x 3 in. dia., with inlet and outlet taped 1/8 gas thread, 7/6, post 2/-.

Pumps.—Submersible type, 1/4 v., 120 g.p.h., 20 ft. lit. 50/-, post 2/6. Ideal for wells, boats, garden fountains, etc.

Remote Contactors.—12v. stepping mechanism, 120 impulses for 1 rev. of pointer, glass front, resetting control, on/off switch, flex, etc. Will make an ideal 0-120 magnetic counter for coil winding, etc. Brand new, 7/6, post 1/6. Have sound possibilities as electric pendulum clock. Will work in conjunction with master contactor.

Gearred Units dismantled from electric meters, containing 23 v. A.C. clock motor and about 30 brass and steel worm and spur gears. 15/6, post 1/-.

Rancee Vacuum Pumps.—Suitable as air compressors, size approx. (less shaft) 6 in. long 4 in. dia. Fitted 2 in. long 1 in. dia. splined shaft, rotary vane type giving a constant pressure or vacuum. Develop approx. 40/30 lbs. sq. in. New, unused, 37/6, post 2/-.

Large New List, No. 10 now available. Price 6d. inland, 1/6 overs, as Air Mail.

always keep 'Plasticine' handy on the bench

'Plasticine' is the world's most famous modelling material—one of those things for which there is always a new use especially in the field of practical mechanics. 'Plasticine' makes excellent mock-ups and prototypes; it is hygienic, long lasting and available in 16 attractive colours.

HARBUTT'S PLASTICINE LTD.
Bathampton, Bath, Somerset.

expand from centrifugal force as speed increases, this drawing along the rotating spindle a disc which moves a lever carrying a slider over a resistance element. Some models employ a carbon-pile resistance, pressure on this being reduced as the weights fly out. As speed increases, current is therefore reduced, and stable operation maintained. A method sometimes seen is that found in many gramophones, where the movement of the disc increases the friction between disc and an adjustable pad of leather, etc. It is suggested you examine the governors found in ready-made motors of this kind.

Steam Engine Queries

PLEASE give me the following information re a small vertical tandem, single crank, compound steam engine, Stephenson link motion, reverse, piston-rod common to both pistons, both valves on same valve spindle. High-pressure cylinder bore, 1 1/4 in.; low-pressure bore, 3/4 in.; common stroke, 2 1/2 in.

Information required : High-pressure cylinder : length of steam ports ; width of steam ports ; width of exhaust ports ; width of bars. Low-pressure cylinder, as above. Full travel of valves.—W. H. Parker (Blackpool).

FOR your small vertical tandem compound steam engine the ports and bridges may be as follow :

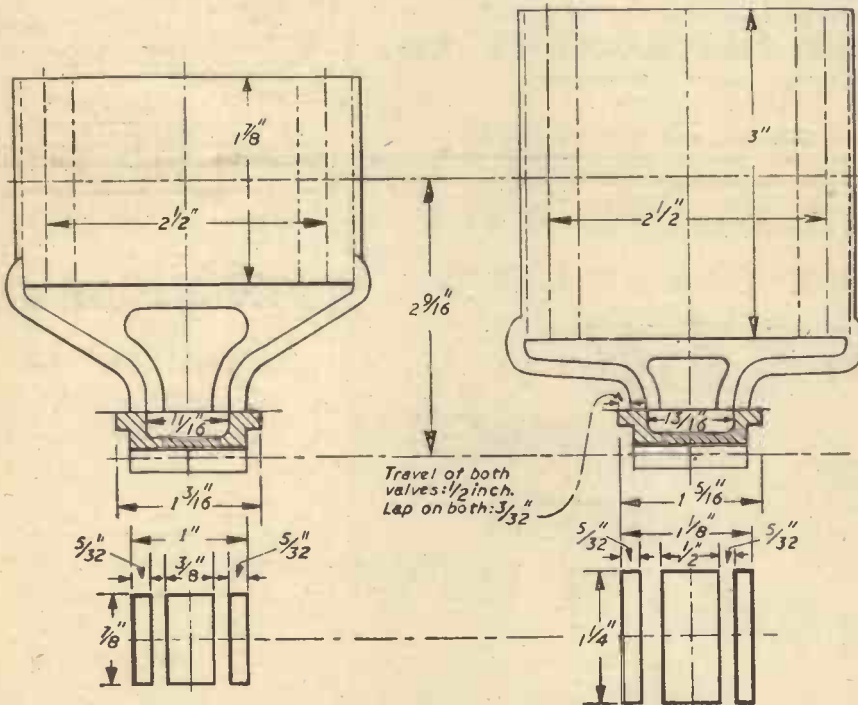

Cylinder and valve details for a small vertical tandem single-crank compound steam engine.

High-pressure cylinder :
 Steam ports, 7/8 in. x 5/32 in.
 Exhaust port, 7/8 in. x 1/4 in.
 Bridges, 5/32 in.

Low-pressure cylinder :
 Steam ports, 1 1/4 in. x 5/32 in.
 Exhaust port, 1 1/4 in. x 1/4 in.
 Bridges, 5/32 in.

The lap on both valves should be 3/32 in. so that the length of each valve will exceed the length over the ports by 3/16 in., the "length" being measured in the direction of travel.

The full travel of both valves will be the same—namely, 1/2 in.

The whole of the above details are embodied in the diagrams.

Electroplating Prevention

WHEN only one side of an article needs plating, e.g., a headlamp reflector, can one side be treated to avoid metal being deposited on it? If so, is it only necessary to calculate the surface area of the side being plated when reckoning the current required?—J. Simpson (St. Helens).

IT is certainly possible to treat a portion of an article to prevent metal being deposited on it, and in this case it is only the surface which is actually being plated which must be considered when calculating the required current.

For solutions which are not particularly corrosive, a lacquer made by dissolving scrap celluloid in equal parts of acetone and amyl-acetate can be used. This same lacquer can also be used to protect plated surfaces. For corrosive plating solutions, in particular chromic acid solutions, an acid-resisting paint is advisable. This can be made as follows: A small quantity of pitch is melted in a tin can, and to it is added an equal amount of coal-tar. Turpentine is then stirred in until it reaches a working consistency. In the case of cold solutions, a coating of candlegrease obtained by warming the article and rubbing with a candle is quite effective.

Scent Extraction

I WISH to extract the scent from a moorland plant (the flower part)

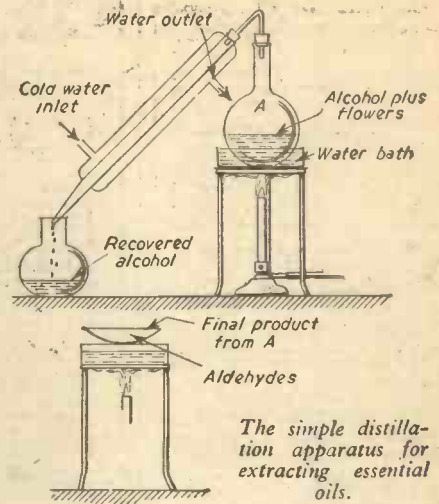

solvent and then distilling off the solvent leaving behind the essential oils.

Your solvent may be one of many, but we suggest you experiment with :

- (1) Absolute alcohol.
- (2) Ether.
- (3) Acetone.

You will need to set up a simple distillation plant and a sketch of the arrangement is given above. We suggest a Pyrex glass flask of about 500 cc. capacity, a water bath, and a receiving flask.

We must warn you that if you use ether it is most dangerously inflammable and no naked light must be within 20ft. of it. This means that distillation of the ether must be done by a steam-heated bath and your steam from a generator (flask or tin canister) must be led through to the water bath by a rubber tube or metal tube with rubber connections from another room.

Place your flowers in the flask and add your solvent, say, alcohol. Let this digest for some hours and then distil off the alcohol in the manner shown. The recovered alcohol can be used again. You do not need a licence for small-scale laboratory work of this nature. You only need it if you are actually making alcohol. The essential oils will become more and more concentrated as the volume of the original solution becomes less by distillation. When you reduce the bulk to a few ccs., tip out the contents into a shallow evaporating dish and finish the evaporation of solvent from the mixture or solution of essential oils and alcohol by evaporating over a water bath direct to the air.

Information Sought

Readers are invited to supply the required information to answer the following queries.

D. T. Dickinson writes : " Could you please inform me of a method for making a radiator blind to operate inside the radiator grill of an Austin A40 Devon saloon car ? "

S. L. Holmes writes : " A shop-window advertisement for a well-known liver-salt consists of a glass of water in a constant state of effervescence. I wish to make one of these for display purposes, and should be pleased if you could let me know, very broadly, the method of working. "

and I would be pleased if you could explain briefly how to do this. If distillation is necessary, is an excise licence required ? The apparatus would only be on a very small scale.—A. P. McAinsh (Glasgow).

WE are afraid you will meet with disappointment if you expect to capture the scent from a moorland plant by extraction of the essential oil that is the source of the perfume. These are mostly very complicated aldehydes that are easily dissociated.

However, you can obtain the essential oil and then build up again from that by blending other essences in an attempt to recapture the initial fragrance by extracting with a suitable