

A FOLDING OUTBOARD MOTOR BOAT

NEWNES

1/-

PRACTICAL MECHANICS

EDITOR : F.J.CAMM

JULY 1953

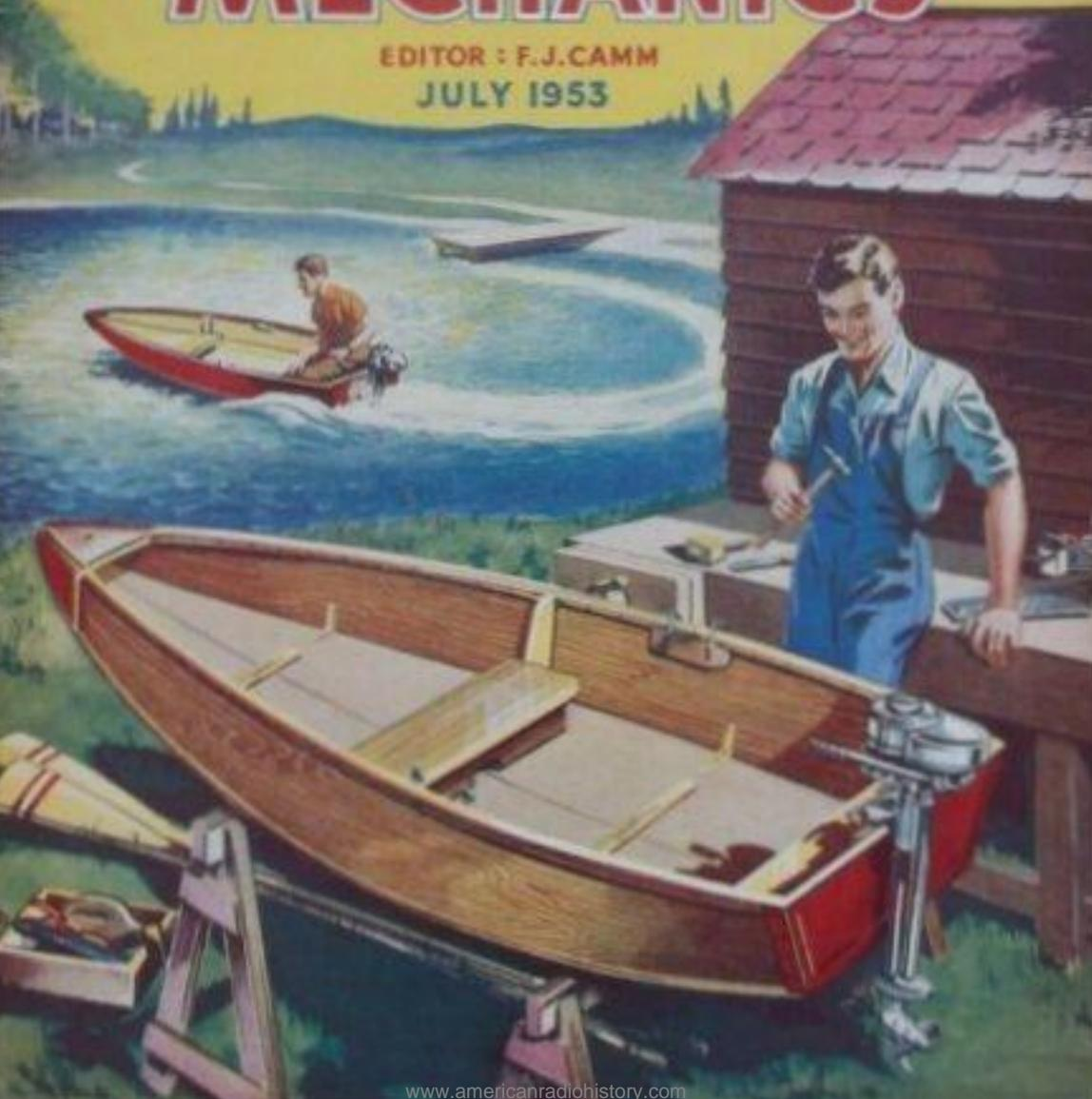

JULY,
1953
VOL. XX
No. 235

PRACTICAL MECHANICS

EDITOR
F. J. CAMM

The "Cyclist," "Practical Motorist," and "Home Movies" are temporarily incorporated.

By The Editor

Fair Comment

TELEVISION IN COLOUR

OVER twenty years ago the late J. L. Baird demonstrated that it was possible to transmit television pictures in colour. Since that time large sums of money have been spent in developing colour television and now it is reasonably certain that America will be transmitting pictures in colour as a standard part of their daily programmes next year. We are promised colour television in this country within the next five years.

It must not be concluded from this that America is more advanced in colour technique than we are; indeed, the reverse is the case. In this country the BBC is hampered by lack of the necessary money to install the special apparatus necessary, whilst individual radio firms are not able to devote very large sums of money for experimental work, although at least two firms have produced and demonstrated satisfactory systems.

Baird's method was elemental and not intended to represent the final system. He made use of two pictures of the same scene, superimposed one on the other, each in a different colour. Each picture was passed separately through a colour filter, and so passing through the appropriate colour. Unfortunately, two-colour pictures are inadequate and disappointing. So all colour systems to-day make use of the three primary colours of red, blue and yellow. All colour television systems make use of filters in front of the camera which break up the light into these three primary colours. The only difference in the various systems is in the method adopted for scanning the picture, also in the method adopted at the receiving end for reproducing the colour. The system of transmission is almost the same as for the present black and white pictures. In one of the popular methods which seems likely to be generally adopted, the colour pictures are transmitted as a series of waves which portray the degrees of light and shade of the three primary colours emanating from each part of the picture. This system cannot be so satisfactory as ordinary black and white pictures and so compromises have to be adopted.

In another method, which suffers from the same limitations, the picture

scanned according to its variations of brightness, hue and the degree of admixture with white. Although this is a more complicated system it possesses the undoubted advantage that by cutting out the hue signal by means of a switch at the receiving end the set, although designed for colour pictures, will then present good black and white pictures of a colour programme.

Colour television receivers are of two types. In one a standard black and white receiver is used which presents the picture to the vision in colour by means of a rotating disc containing red, blue and yellow windows. The speed of this disc is controlled from the transmitter and it acts in synchronism with a similar disc containing filters which spin in front of the camera. This system, however, is not very satisfactory and it is unlikely to be the ultimate solution to the problem of colour television. It was operated in America in 1951 for some experimental programmes, but was discontinued in view of the poor results.

The second and later system is based on the use of coloured phosphors on the screen of the receiving set. The end of the usual cathode-ray tube is coated with dots of phosphor arranged in between parallel lines coinciding with the transmitting system in use, that is to say between 400 and 800 according to the country. These emit white light when struck by an electron stream. Phosphors emitting red, yellow and blue light can equally be used. There are, of course, other systems, some electro-magnetic and some entirely electronic.

THE CONQUEST OF EVEREST

THE placing of the Union Jack on Everest's hitherto invulnerable peak, coinciding as it did with the Coronation, was not only a physical achievement on the part of an Englishman but also a victory for British scientists and scientific apparatus. Those who have attempted to climb Everest before had not the advantage of scientific equipment to the same extent as the present expedition. For example, oxygen breathing apparatus of a light type suitable for such an ascent was not available. This time an oxygen breathing set with light alloy cylinders, each stencilled with the Union Jack, charged to a pressure of 3,300lb./sq. in., complete with carrying frame, economiser and control gear and produced by an English firm, were available and contributed to the success of the expedition.

Earlier climbers, like the hero in Excelsior, ploughed the lonely furrow, and whilst all credit is due to the members of this expedition, we must not forget the work of those backroom boys at the Admiralty, the Ministry of Supply, the Medical Research Council, the Royal Aeronautical Establishment, and dozens of important firms whose combined experience was freely drawn upon.

A NATIONAL CAR MUSEUM

A NATIONAL Car Museum is advocated by a well-known motoring journal. The purpose of such a museum would be chiefly educational for there is no quicker way for designers and engineers to traverse the road trodden by pioneers than to study their work. Already the detailed specifications of some of the interesting cars of the past have been lost, and old vehicles themselves must some day crumble unless they are properly cared for. The Veteran Car Club makes the legitimate claim that its members have found the best method of preserving these old cars—by owning, cherishing and keeping them fit for the occasional outing organised by the club. No one disputes that, but no one can deny that access to V.C.C.-owned cars is hardly possible any time that inspection is desired. Selected examples of 60 years of automobile progress need housing under a roof that is of sufficiently large area to cover them all; it is in this respect that the Science Museum falls down.—F. J. C.

SUBSCRIPTION RATES

including postage for one year

Inland	- - - -	14s. per annum.
Abroad	- - - -	14s. per annum.
Canada	- - - -	13s. per annum.

Editorial and Advertisement Office: "Practical Mechanics," George Newnes, Ltd., Tower House, Southampton Street, Strand, W.C.2
Phone: Temple Bar 4363

Telegrams: Newnes, Rand, London.

Registered at the G.P.O. for transmission by Canadian Magazine Post.

Copyright in all drawings, photographs and articles published in "Practical Mechanics" is specially reserved throughout the countries signatory to the Berne Convention and the U.S.A. Reproductions or imitations of any of these are therefore expressly forbidden.



A FOLDING OUTBOARD MOTORBOAT

By "AQUA"

An Easy-to-build Portable Speedboat Which Can be Constructed at a Very Low Cost

THIS folding speedboat is probably about the simplest of its kind, and the term folding is employed to distinguish it from the collapsible variety, usually constructed of canvas, which gets torn, and numerous struts, which either break or are lost.

The boat has six principal parts, two sides, two halves to the bottom, a transom and a frame which keeps the boat spread open when it is erected.

The Construction

The bottom is made in two halves, the seam between the two running centrally fore and aft and is rendered watertight by covering with canvas. This also allows it to hinge so that one half can be folded over the other.

The sides are each hinged on either side of the bottom pieces in a similar manner, so that the boat, when in a folded position, resembles a folded screen. The bow of the boat is covered with a small canvas capping which serves to unite the extremities of the sides and bottom pieces, whilst the ends at the stern are united by a canvas back, which folds up when in the packed condition and spreads out to form a canvas transom when the boat is erected. The hinging of the sides is further assisted by three metal hinges on each side, a suitable one shown in Fig. 7.

A wooden transom is provided and slides into grooves on the sides and situated just inside the canvas transom, its purpose being to give the necessary rigidity to the stern and to accommodate the motor. The transom is, of course, rendered watertight by the canvas.

The sides and two bottom pieces are cut

from $\frac{3}{4}$ in. pine plywood and the transom from $\frac{3}{4}$ in. ply of similar material.

The edges of the canvas seams are battened with $\frac{3}{4}$ in. by $\frac{3}{4}$ in. battens of hardwood.

Obtaining Rigidity

The boat is rendered rigid amidships by a frame which slides into grooves on the sides and held there by small door bolts which engage with holes in the frame. Simple

if dipped in boiled oil before insertion. Since these may be purchased from any ironmonger as required they are not included in the materials list.

Rowing

For rowing, ordinary rowlocks are not used, but a simple piece of iron rod $\frac{3}{4}$ in. in diameter is secured to the side of the boat and so as to project a few inches above it.



Fig. 1.—Showing the motorboat travelling at speed.

folding seats are employed, one at the transom and one amidships, which are dropped into position after erection.

The fastenings used to secure the various parts may be either rivets or screws; to those with experience of rivets this is the cheaper way, but it is a tricky job for the inexperienced, who are advised to use screws ($\frac{1}{2}$ in. No. 6 is the most suitable size), brass for preference, but iron may be used for economy

The top of this rod is bent over in the form of a hook and the oars are provided with metal eyes which slide over the rods. Thin brass strip is used along the edges of the sides to prevent chafe, and the top edges of the side pieces are strengthened along their entire length by being battened on each side with $\frac{3}{4}$ in. by $\frac{3}{4}$ in. hardwood (Fig. 8). The midship frame is made from $\frac{3}{4}$ in. ply and sawn from the solid piece.

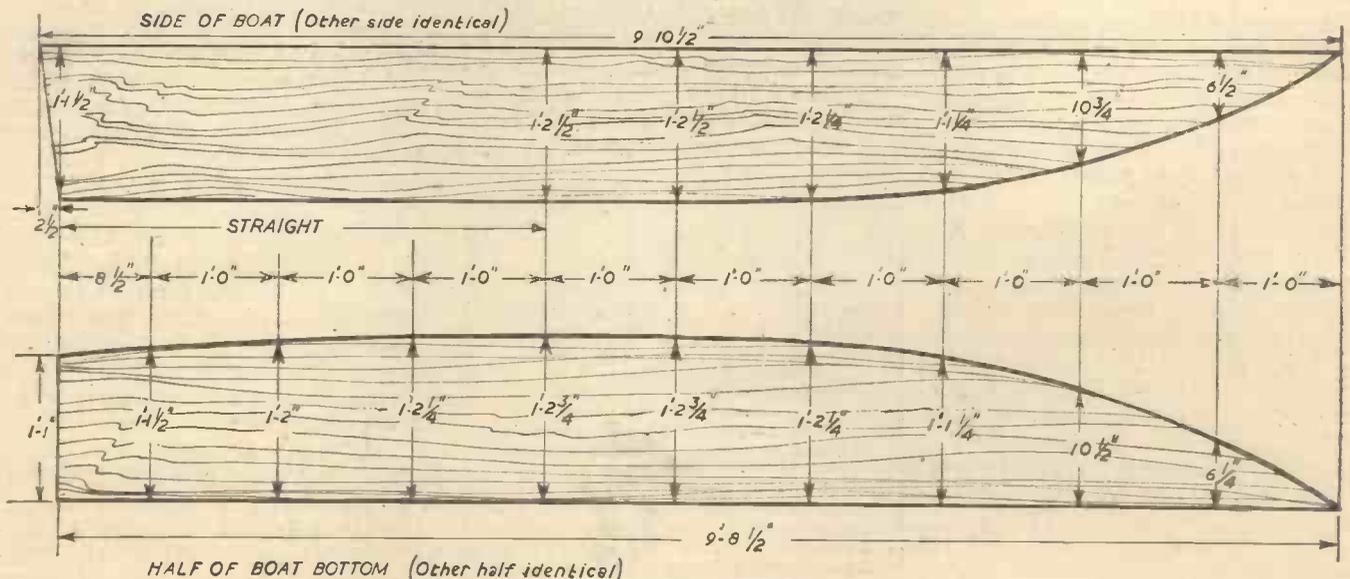

Fig. 2.—Dimensions of the sides and bottom of the boat.

It will be seen then, that the craft is entirely constructed from wood and rendered watertight with canvas, but since the canvas only covers the seams, there is no risk of perforation or splitting as in the case of a boat constructed wholly of canvas on a wooden frame. Thus, when assembled, the boat more nearly resembles one of the rigid variety than a collapsible.

The overall length is approximately 9½ ft., with a beam of 3½ ft. and a depth of 15 in. Folded, the dimensions are 9 ft. by 15 in., thus it can be easily carried on the roof of the car or stowed along a wall. The transom, frame and seats are, of course, packed on top of the folded hull.

Launching

From the folded position to complete erection ready for launching, a period of about four to five minutes at the most is required.

To erect, the folded boat is stood on edge and sides pulled outwards when the device will resemble the letter W; pressure is then brought to bear on the central bottom seam which corresponds with the apex of the central part of the W. This forces the sides out at the bottom and flattens the bottom of the boat so that the cross-section now resembles a flat-bottomed U.

An Expanding Device

The next stage is to insert the rigid transom, and to facilitate this an expanding device is used. This is composed of two pieces of wood about ¼ in. by 1 in. crossed and riveted together in the manner of a pair of scissors; and the ends of the longer arms are notched so that they can fit over the inner strengthening battens of the tops of the sides.

The device is placed in position and by pressing down on the junction of the two battens of which it is composed, leverage is obtained to force the sides outwards, when the wooden transom can be slipped home.

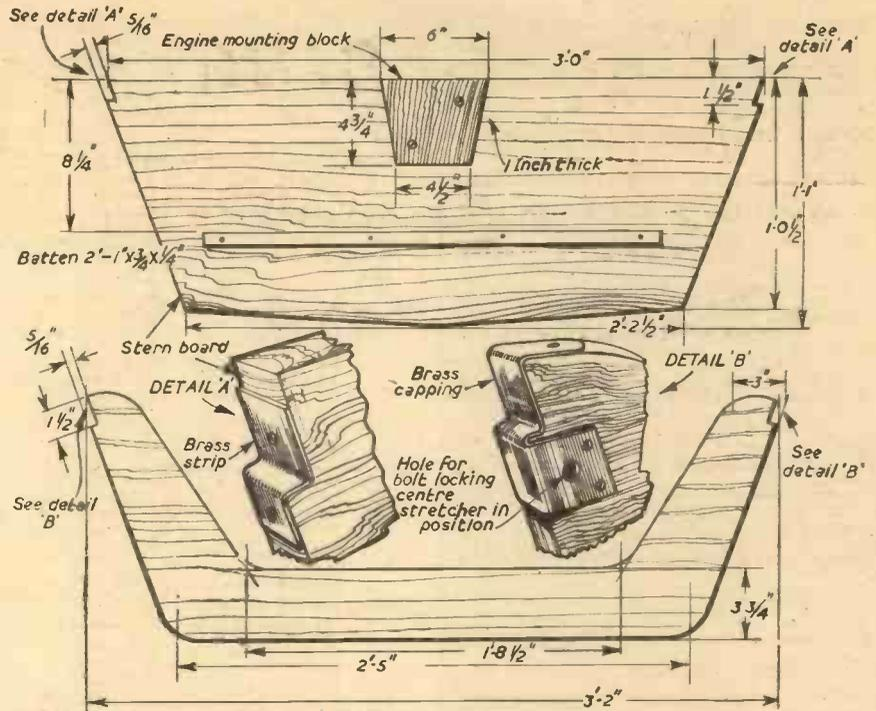

Fig. 3.—The stern board and centre stretcher.

The central frame is inserted in a similar manner with the use of the expander, and when in position the bolts are shot, thus securing it rigidly in place. The seats merely rest in place and are in no way secured.

For the finish, varnish is best, one good coat of half varnish and half linseed oil as a primer and two light coats of neat varnish being sufficient.

All canvas joints are treated with marine

glue as specified in the materials list. Tar or paint may be used but are messy and unsightly.

Materials

Plywood is the material suggested although masonite or similar material could be equally well employed. For the hardwood battens either American elm or oak could be used. If cheapness is a consideration,

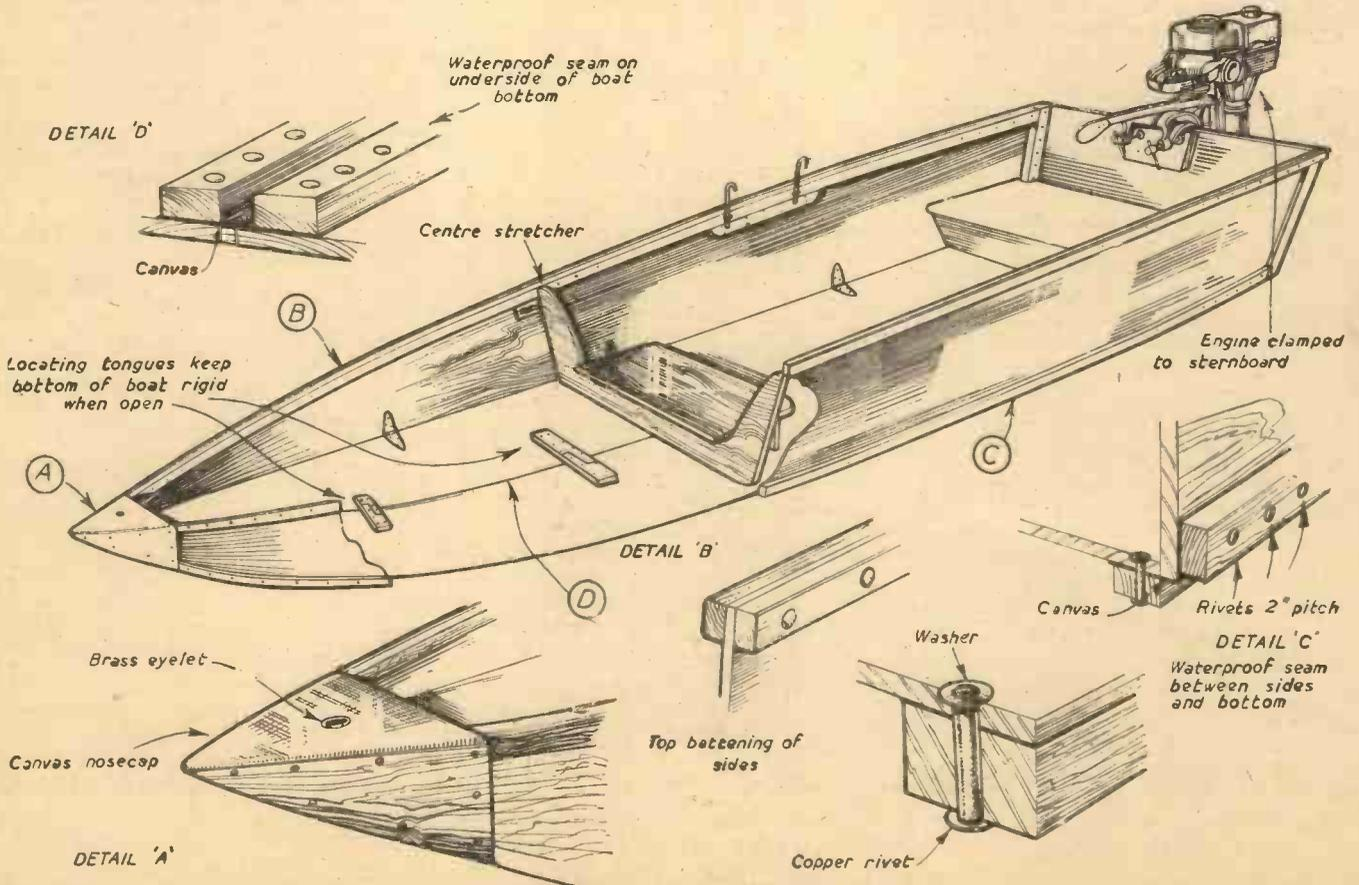

Fig. 5.—Perspective sketch of the finished boat, and details of the various joints.

ordinary English elm may be employed, but this twists badly in storage pending use.

The following materials list contains suggested materials and they are given in the sizes in which they should be bought. All wood should be planed.

MATERIALS

- For the Sides and Bottom :
4 pieces 3/4 in. pine plywood, each roft. long and 14 in. wide.
- For the Transom :
1 piece ply, 3 ft. x 14 in.
- For the Frame :
1 piece 3/4 in. ply, 3 ft. 2 in. x 14 in.
- For Seats :
1 piece 3/4 in. ply, 5 ft. x 12 in.
1 piece 3/4 in. ply, 5 ft. x 12 in.
- For Battens :
10 pieces American rock elm or oak, 3/4 in. x 1/2 in., each roft. long.
- For Miscellaneous Strengthening Pieces :
1 piece of mahogany 1/4 in. thick, 7 in. wide, 5 ft. long.
- Canvas (extra stout) :
1 strip 12 in. wide, roft. long.
1 piece 18 in. x 3 ft. 6 in.
1 piece 2 ft. x 8 in.
- Hinges, etc. :
4 zin. butts for seats.
6 long type gate hinges, 4 in. overall.
2 small door bolts about 2 1/2 in.
- Screws :
Order as required, mostly 1/4 in. No. 6.
- Marine Glue for Joints :
(1 quart tin.)

The first stage of the work in constructing the boat will be to cut out the two sides and the bottom pieces. These, of course, are cut from the large piece of 5/16 in. plywood shown in the materials list.

Referring to Fig. 2, the upper part shows one of the side pieces whilst the lower shows one half of the bottom. The parts should be marked out and shaped in accordance with these diagrams, and it will, of course, be seen that it is only necessary to mark out one of each in this way, for the finished parts can then be used as templates for the others.

Great care must be taken to see that the two sides and the two bottom halves are

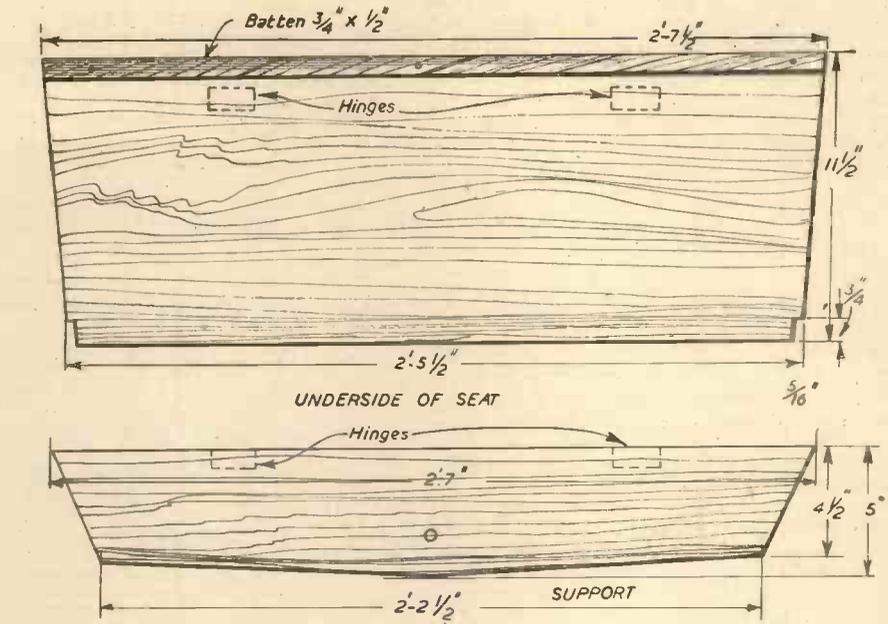

exactly the same shape and in every way identical, and to make certain of this, it is as well to clamp them together for the final finishing off. The work on sides and bottom completed, the back board or transom may be cut out according to Fig. 3 from 3/4 in. plywood. Cut the notches at the top corners very carefully, as shown in detail A, lining them with thin brass strips as shown. The notch, it will be seen, is 5/16 in. deep and 1 1/2 in. long. It is as well to finish the job outright, so that the engine mounting block and seat batten may be fitted right away.

The Seat Batten

The seat batten should really be of L section, so that the groove in the rear edge

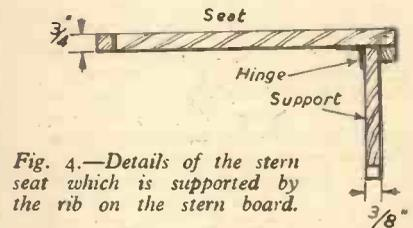
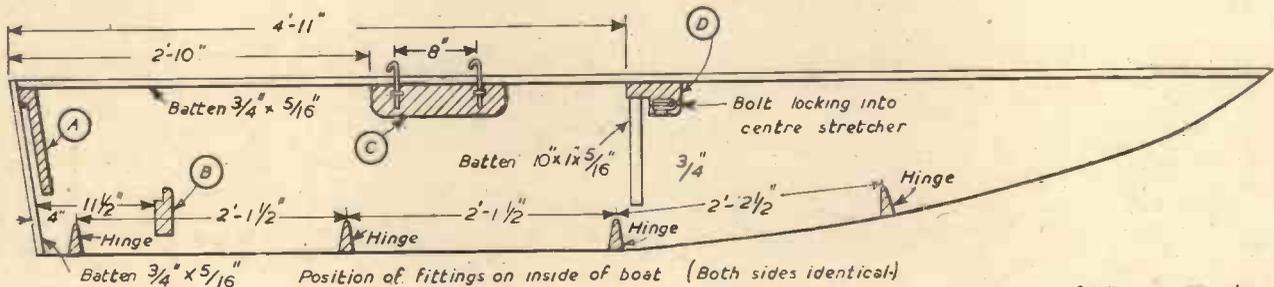

Fig. 4.—Details of the stern seat which is supported by the rib on the stern board.

of the seat can drop over it, thus preventing the seat from drifting forward. The centre stretcher or frame may now be made according to Fig. 3, from 3/4 in. plywood.

(To be concluded)



Position of fittings on inside of boat (Both sides identical)

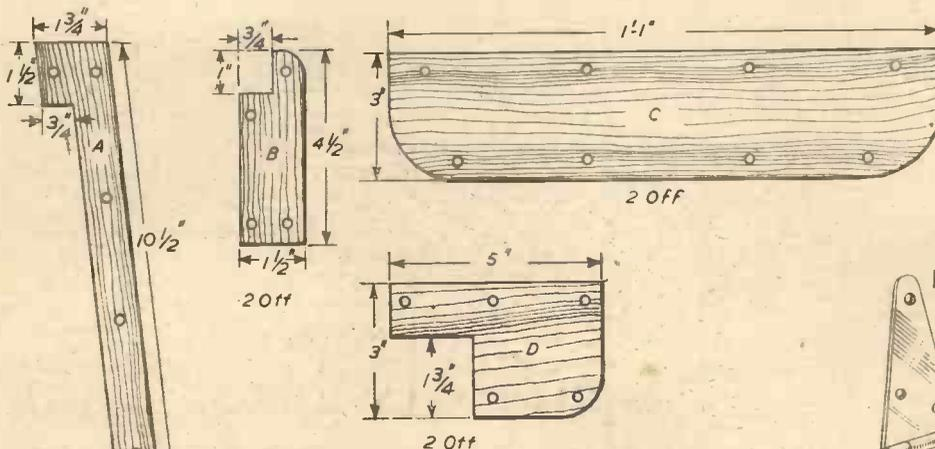

Fig. 6.—Showing the location of all the fittings on the side of the boat.

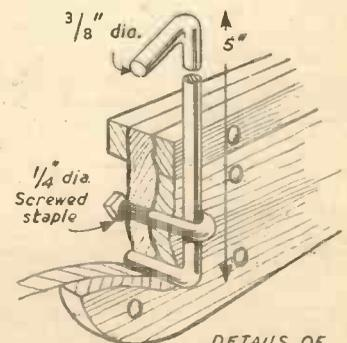

Fig. 7.—Details of the hinges.

DETAILS OF ROWLOCK
Fig. 8.—The rowlocks which are constructed from 3/4 in. round iron rod, should be bent to the shape shown. A suitable type of hinge (8 required)

About Circular Saws

With Particular Reference to the Pitch, etc., of the Saw-teeth

By N. CLIFFORD

THE efficient functioning of a circular saw depends to a very great extent on the quality of the blade coupled with the correct design and spacing of the saw-teeth, suitable running speed, and similar factors. Obviously, any tool made of poor quality steel will soon become blunted and there will be an excessive waste of time spent in re-sharpening, with the added possibility that the re-sharpening itself will result in an alteration of cutting bevels, etc., that will lead to poor quality sawing.

Here the remedy is obvious. A good quality blade from a reliable manufacturer will still be economical even if it costs twice as much as a less efficient tool.

The design of teeth requires some consideration, however, and the typical layout of these is shown in plan and elevation in Figs. 1 and 2 respectively.

The "Gauge"

The "gauge" of the saw (I) is the thickness of the actual plate. To allow the plate to run freely through the wood, the saw-teeth are bent to left and right alternately, the distance between the tips of two adjacent teeth across the blade being known as the "set" (S). The degree of set governs the width of saw-cut that is made. Too wide a set means waste in sawing, while too narrow a set causes friction between the saw and the wood, resulting in the overheating of the plate. Recommended formulae exist for determining the set to be used on each type of tooth, but the general figures of

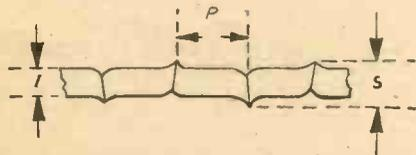

Fig. 1.—Edge-on view of saw-teeth.

from 0.010in. to 0.015in. may be taken as correct.

The "pitch" is the distance along the blade between the points of two adjacent teeth, and is, therefore, related to the number of teeth. A separate plate for each type of timber to be sawn (e.g. fibrous hardwoods, dense hardwoods, heavy softwoods, and so on) is the unattainable ideal for most mechanics, for individual plates would have from 40 to 80 teeth according to their intended purpose. An all-purpose plate for rip-sawing should preferably have 54 teeth (a pitch of 0.0582 times the plate diameter).

The "Hook" and Clearance Angle

Each individual saw-tooth has various angles, and one of the most important of these is the "hook" marked "A" in Fig. 2. Within limits the greater the angle of hook the faster the cutting, but for normal purposes the hook must not exceed 25 deg. The angle between the point of the tooth and the heel (B) is the "clearance angle," and this should be 20 deg. Between the heel and the base of the hook is the "sharpness angle" (C).

Other terms applied to particular parts of the saw-tooth may also be recognised by reference to Fig. 2. The "back" is the long slope (D), the base of the clearance angle is the "heel" (E), the "top" is the short sloping edge (F), which in length is

equal to one-quarter of the pitch, while the "point" is the extreme tip. The broad base of the tooth is the "foot" or "root" (R).

An extremely important part of the design of the saw-tooth is the "gullet" (G). The purpose of this gullet is to remove the saw-dust, hence it needs to be as large as possible, and of good, well-rounded shape.

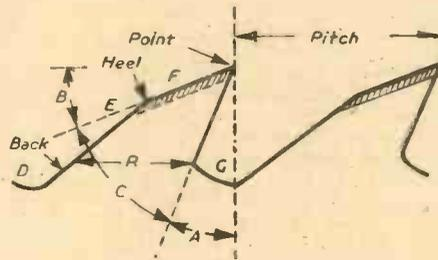

Fig. 2.—Profile of circular-saw teeth.

Obviously, there must be some limit to the depth of this, otherwise it will have a weakening effect on the actual tooth. A combination of too deep a gullet and too little set can easily result in a fracture of the saw-tooth. The size of the gullet is, therefore, determined by the pitch, and for an all-purpose rip-saw will be 0.45 times the pitch of the teeth. The rounded base of the gullet is 0.15 times the pitch.

Top Bevel

Fig. 3 gives a view of two saw-teeth set one behind the other, and from this it is easy to see how the set permits of the thinner plate passing through the wood without jamming. It is not clear from this, however, that the top edge of each tooth carries a bevel. This is known as the top bevel and is shown to a large scale in Fig. 4, where the angle of the top bevel is indicated by "H." The top bevel angle for a general purpose rip-saw should be from 10 deg. to 15 deg.

The speed at which a circular saw is run is measured by the distance travelled in feet per minute of any given point on the rim. If the speed is too great the teeth will have

a tendency to wobble and may cause the saw to wander off the desired line, whereas too low a speed makes the feeding of the wood to the saw more difficult. The recommended rim speed for an all-purpose rip-saw is 10,000 feet per minute. In this connection it is important to note that when starting up a saw it should be given time to work up to its correct rim speed before the actual sawing is started.

The rim speed is obviously controlled by the spindle speed, and as circular saws vary in diameter from 6in. to the same number of feet, there is an enormous variation of spindle speeds. These last are expressed in terms of revolutions per minute, and for a rim speed of 10,000 feet per minute there will be a spindle speed of less than 550 r.p.m. for a 6ft. saw, to more than 6,000 r.p.m. for a 6in. saw. Correct speeds can be assured only by the use of a suitable motor for the size, etc., of the saw to be driven. Overpowering of the saw is equally as dangerous as under-powering.

Spindle Collars and Bearings

Saw-sharpening is a job for the expert, but the home mechanic can satisfy himself that sharpening is done in accordance with the correct principles. Given proper design and spacing of teeth and rim speed, the greatest obstacles to sawing technique have

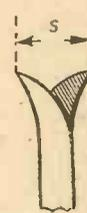

Fig. 3.—Showing the "set" of saw-teeth.

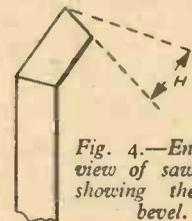

Fig. 4.—Enlarged view of saw-tooth showing the top bevel.

been overcome, but the spindle collars must be set square and the bearings in good condition, for any inaccuracy at the spindle will be increased out of all recognition at the rim. Other points that will assist in defect-free sawing include the packing, and the accuracy of the adjustable fence, table, and roller feed, if forming part of the equipment.



The patrol boat Bold Pioneer, the first operational warship powered by gas-turbine engines, seen during advanced trials in the Channei. She and her sister-ship, the Bold Pathfinder, also completed, are the first of a new class. The gas-turbines enable the boats to carry a heavy armament at high speeds.

Photometer Construction

General Details of Construction and Calibration of Photoelectric Exposure Meters

By F. G. RAYER

PHOTOELECTRIC exposure meters are relatively easy to build, making use of a selenium cell and meter movement. Such meters can be accurate and reliable, while the cost of construction is only a small fraction of the cost of a ready-made exposure meter of this type.

The type of cell used in the meters to be described is that known as selenium barrier layer cells, and may be obtained from Megatron Ltd., 115A, Fonthill Road, London, N.4. For normal purposes a very

by adding a series resistor, as shown in Fig. 2. This slightly reduces the maximum sensitivity. (E.g., the pointer movement is slightly reduced for dim light values.) The other end of the scale, however, is much modified, and can now extend to 1/500th or even 1/1000th of a second. This arises because the resistor reduces the current which can flow, so that the current is fairly small, even with a strong degree of illumination.

As the value of the resistor is increased the pointer deflection is reduced for a given light intensity. A scale of up to 1/500th second was obtained with a 7,000 ohm resistor with the cell and meter mentioned. The pointer deflection may also be reduced by shunting the meter. (E.g., rendering it less sensitive by adding a resistor in parallel with it.) Two-range meters may be made by adding a small push-switch so that the resistor may be brought in at will.

Cell Mounting

Ready-mounted cells may be purchased, or cells may be mounted as shown in Fig. 3. The cell is held against a strip of insulated material with small clips, these being fashioned so that they bear upon the metallic ring on the surface of the cell. These clips are wired together (to reduce possible contact resistance) and form the negative pole. A strip of foil or thin metal under the back of the cell forms the positive pole.

A sensitive meter should not be connected to a cell when the latter is strongly illuminated without a limiting resistor, or the meter movement may be deranged.

A method of reducing the light reaching the cell is shown in Fig. 4, where the cell is mounted in a recess. For use in dim light the cell may be directly exposed. When the light is strong, however, a grille can be folded over it. This may be made from metal, bakelite, or any other opaque material. The number and size of holes in it will determine the sensitivity obtained with the photometer when the grille is in position. The simplest method is to drill small holes one at a time until the required result is obtained.

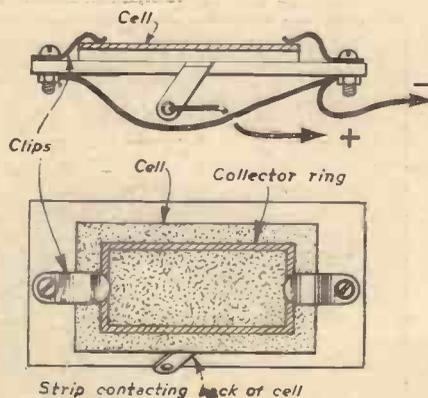

Fig. 3.—Mounting for the cell.

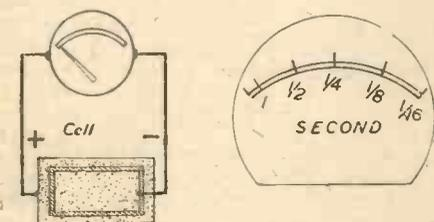

Fig. 1.—Selenium cell and meter.

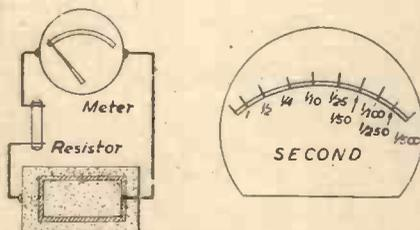

Fig. 2.—Series resistor to increase scale.

large cell is not required. An average size is the 22 mm. by 40 mm. type, and this only costs a few shillings. Circular cells are also available, and can be used in exactly the same way as the rectangular cells. Cells of this type generate an electrical current when light strikes them. The strength of the current depends upon the intensity of the light, and may be measured directly with a suitable meter. The intensity of the light striking the cell is therefore shown by the meter pointer. The scale of the meter may be calibrated in exposure times, or bear numbers which may be referred to a table, or calculator, to ascertain the exposure.

Fig. 1 shows the simplest type of circuit and the kind of scale obtained. (Methods of calibrating the finished photometer are given later.) The cell elements are deposited upon a metal plate, or back, and this forms the positive connection. On the surface of the cell a metallic ring is deposited, and this forms the negative terminal.

The meter movement itself requires to be of sensitive type, especially if weak light values are to be measured accurately. A cell of the size mentioned will give an output of approximately 300 microamperes, when exposed to a light of 100 foot-candles intensity. Various new and ex-service meters and meter movements are obtainable. That used in the circuits to be described was one having a full-scale deflection of 50 microamperes, since comparatively dim interiors were to be dealt with. Some glide-path and other equipment have movements of even greater sensitivity. There is no need that the exact full-scale deflection be known.

As Fig. 1 shows, the scale is not very extensive, covering from only 1 second to 1/16th second. The scale may be increased

A series resistor may still be retained, if desired. This depends upon the sensitivity of the meter. For normal use out-of-doors, and with bright interiors, there is no need

to provide a dual-range meter. However, if a meter of very sensitive type is made up for use in dim interiors, a grille or resistor must then be used if the meter is to serve out-of-doors. With a dual-range meter, each scale is individually calibrated. It is, of course, quite easy to add a second range to a single-range meter, either by altering the circuit as explained, or by providing a grille to cut down the light.

Some exposure meters are made so that

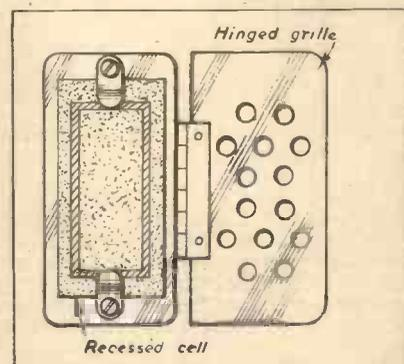

Fig. 4.—Grille to restrict light reaching cell.

light can only reach the cell over a comparatively small angle. This is achieved by having the selenium cell in a sunken recess, or by having a honeycomb type of grille in front of it. Comparatively small areas of brightness may then be measured. For ordinary purposes no special effort need be made in this direction. The cell itself is to some extent directive, and should always be faced directly at the object to be photographed. Out-of-doors, the cell may be turned slightly downwards, or shielded from the sky with a hand.

The actual manner in which cell, meter, and resistor are arranged is not important. In some instances the cell can be included in the meter case itself, an aperture being cut so that light may reach the cell. The meter movement should always be handled with care. If removed from its case, it should be kept free from dust or metal filings, etc., which may foul the moving coil gap. A new scale may be drawn upon stout paper or thin card. Alternatively, if the meter is already fitted with a scale, this can be retained, and the numbers referred to a table, or calculator, so that the exposure may be read.

Exposure Calculator

It will be seen that the scales in Figs. 1 and 2 are marked directly in fractions of a second. This is a method which is very convenient in practice, but such markings can only refer to one lens aperture and film speed. (F5.6, with a 30 deg. Sch. film, in the case mentioned.) With such markings, the experienced photographer can readily arrive at other figures for different apertures. For example, if it is necessary to stop down to F8, then the exposure must be doubled. Similarly, stopping down to F11 would require an increase of approximately four times in exposure.

A simple method of arriving at the aperture to be used with any particular shutter speed is shown in Fig. 5. Two discs are pivoted together, one bearing the apertures

or stops, and the second marked with the shutter speeds. Assuming that the correct exposure at $F_{5.6}$ is $1/50$ th second, then the shutter speed for other apertures is as shown. (E.g., $1/50$ th second at F_2 , $1/250$ th at $F_{2.8}$, and so on.)

If an exposure other than $1/50$ th second at $F_{5.6}$ is indicated, then one disc is rotated until the correct exposure comes opposite $F_{5.6}$. For example, $1/50$ th second at $F_{5.6}$ would give readings of $1/250$ th at F_8 , $1/100$ th at F_{11} , and so on. It will be seen that exposures of several seconds frequently become necessary when using apertures up to F_{22} , F_{32} , or F_{45} .

It should briefly be explained that the larger the "F" number the smaller is the aperture of the iris, or lens. Because of this the exposure time is increased so that sufficient light may still reach the film. Small, cheap cameras frequently have lenses of F_{11} . Those of slightly more expensive make have lenses of F_8 or so. The better class of camera usually has a lens which can be opened out to $F_{3.5}$ or $F_{4.5}$. High-class cameras have lenses as large as $F_{1.4}$ or F_2 . If the "F" number of a cheap camera is not marked, it may be found by measuring the diameter of the iris, or aperture, and dividing this into the distance between iris and film. It will, therefore, be seen that the larger in diameter the lens is the smaller will be the "F" number.

If a meter with ordinary scale is used, the numbers may be marked upon the vacant section of the larger disc in Fig 5. For example, with a 50 microampere meter the markings would be from 0 to 50. An arrow may then be marked on the inner disc. This arrow is turned to the same figure as the pointer reading. The exposure for various apertures will then be shown.

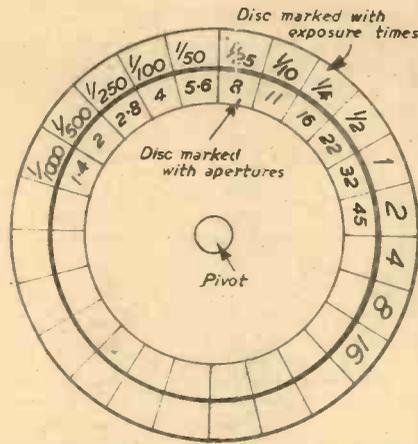

Fig. 5.—Calculator for apertures and speeds.

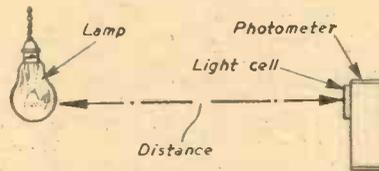

Fig. 6.—Method of calibrating meter.

Calibration

When the photometer has been made up it must be calibrated. The cell should be fitted in the position it will occupy, with any clips, cover, etc., in place.

If a ready-made exposure meter is available then the home-made instrument can be calibrated from it. The two meters should be directed at the same object or light and the reading noted.

If no such meter is available then other means can be employed. It will be realised that the readings obtained will vary slightly when calibration is effected in this way, but the standard of accuracy achieved can be high enough so that subsequent exposures will be successful.

For out-of-doors use it is possible to select a clear day. In midsummer, around the hour of noon, exposures for a medium-toned object will be as follows:—

Sun shining unobstructed: $1/250$ th second at F_8 , 30 deg. Sch. film.

Sun shining, slightly overcast: $1/100$ th second.

Bright, but no sunshine: $1/50$ th second. Moderately dull: $1/25$ th second.

In each case the meter is directed at the object, not the sun or sky, and the pointer reading or position is noted down. If the calibrations are to be for $F_{5.6}$, then they should be $1/50$ th, $1/250$ th, $1/100$ th and $1/50$ th second.

Dim light values may be found by using a lamp, as shown in Fig. 6. Any existing shade should be removed. In this case the meter is pointed directly at the lamp and the distance measured. The light actually emitted by various lamps of the same wattage varies lightly, but is sufficiently standard for calibration to be effected. The meter should be held at the distances given below and the pointer reading marked accordingly.

- 6ft. ... $\frac{1}{4}$ second at F_8 .
- 4ft. ... $1/8$ th second.
- 3ft. ... $1/16$ th second.
- 2ft. ... $1/32$ nd second.
- 1ft. ... $1/125$ th second.
- 6in. ... $1/50$ th second.

This is with a 100 watt lamp, and the calibrations are for a film of 30 deg. Sch. rating. Exposures for other apertures will be found on the calculator described.

A Household Ozoniser

Construational Details for Making Apparatus to Purify the Atmosphere of Rooms, etc.

OZONE is one of the most powerful disinfectants know and as a deodorant and a means of freshening up the atmosphere of rooms it is unexcelled. It has an extremely simple method of generation and at once diffuses into the air of a room or apartment, penetrating to every corner of the room.

Ozone is an invisible gas, possessing a characteristic odour. Every amateur experimenter who has worked with electrical apparatus in which sparks are produced must, at times, have noticed a peculiar smell in the vicinity, an odour which is not unpleasant, despite its unusual pungency. This odour is due to the formation of small amounts of ozone by the electrical apparatus.

In composition ozone is nothing more nor less than a condensed form of oxygen. This is, of course, its great virtue, for it readily oxidises all impurities in the atmosphere, reverting afterwards to ordinary oxygen.

Preparing Ozone

There are several methods of preparing ozone, but the most useful one and that utilised by the apparatus described in this article consists of subjecting a current of air to the silent electric discharge. Air consists mostly of oxygen and nitrogen and it is the oxygen of the air upon which the electric discharge operates, converting a proportion of it into ozone.

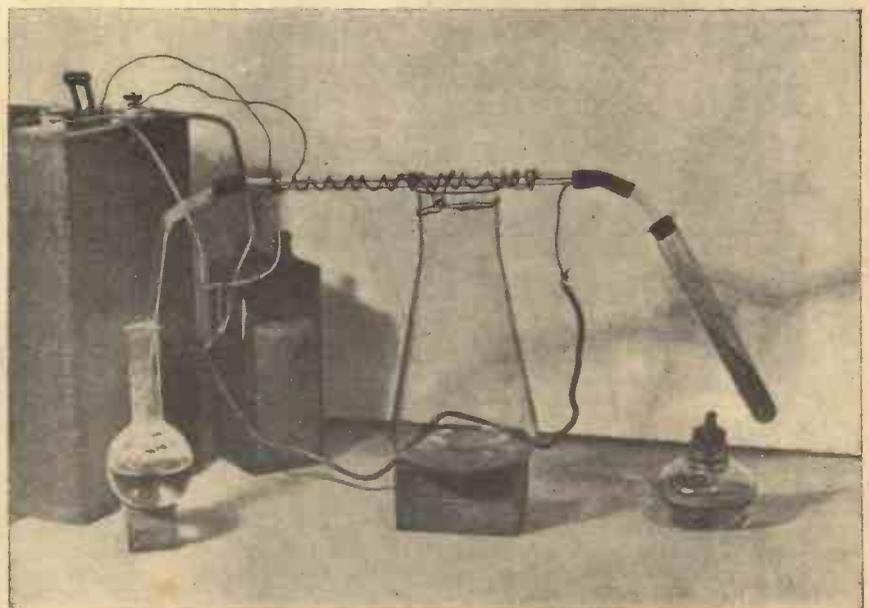

Ozonising pure oxygen. In this simple bench apparatus which employs the ozone tube shown in Fig. 1, oxygen is generated by heating a mixture of potassium chlorate and manganese dioxide in the test tube attached to the right of the ozone tube, the ozone generated by the passage of the oxygen through the tube being dissolved in water.

For the production of the necessary high-tension current, either a step-up transformer giving at least a 1,000 volt output when operated on an ordinary A.C. supply, or, alternatively, a small induction or spark coil operated by means of an accumulator or through a small step-down transformer working off the mains, may be used. An ordinary bell transformer is quite suitable for working a small induction coil, particularly if it is only used intermittently.

On the whole, it is better to employ H.T. current from a small induction coil than from a step-up transformer operated directly off the mains, since, in the latter instance, the transformer output circuit would require careful earthing for purposes of safety, whilst, at the worst, the H.T. current from a small induction or spark coil can only give one a sharp shock if contact is inadvertently made with its output circuit.

An "Ozone" Tube

To form the "ozoniser" we require what is termed an "ozone tube." In its simplest form it consists merely of a narrow piece of glass tubing about a foot or 18 in. in length. Down the tubing is pushed a straight length of bare copper wire, this wire being connected to one of the output or secondary terminals of the induction coil. On the outer side of the glass tube is wrapped a spiral of bare copper wire, this wire being connected with the other secondary terminal of the inductance coil, see Fig. 1. On passing a current of air or oxygen through the glass tube and operating the induction coil at the same time, the air issuing from the tube will contain three or four per cent. of ozone, a concentration which is amply sufficient to act as a disinfectant and deodoriser.

A better form of ozone tube consists of a narrow glass tube about a foot long containing within it a spiral of bare copper wire which runs along almost the entire length of the tube. This tube is supported concentrically within a wider

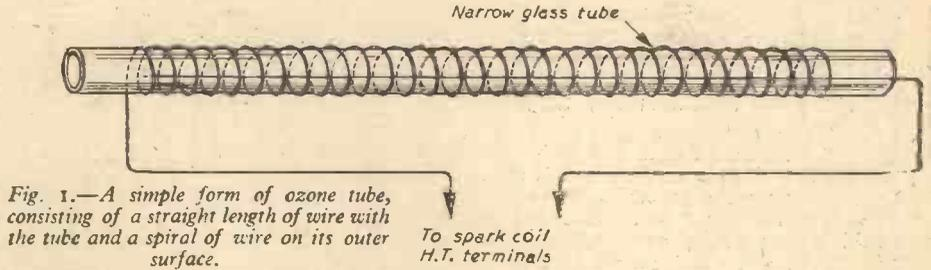

Fig. 1.—A simple form of ozone tube, consisting of a straight length of wire with the tube and a spiral of wire on its outer surface.

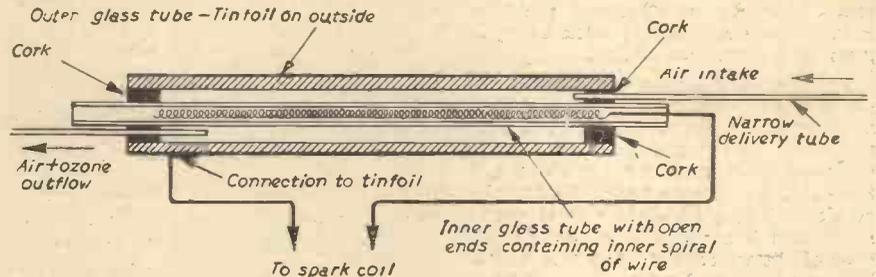

Fig. 2.—A more serviceable form of ozone tube. Air is passed between the two concentric tubes.

wall of a room. The apparatus could conveniently be mounted upon a substantial baseboard in order that it may be carried about from room to room. A suggested layout is given in Fig. 3.

Layout of Apparatus

The diagram accompanying this article shows clearly the disposition of the ozonising apparatus upon its baseboard or wall panel. Note particularly that the ozone tube and its H.T. leads must be well insulated, otherwise current-leakage will occur, with diminution of the ozoning efficiency of the apparatus.

In order to operate the apparatus efficiently, it is necessary to cause a current of air to flow through the ozonising tube. The air may be sucked through, pumped

deodorising it and freshening up its atmosphere.

Ozone, however, should not be liberated in rooms in which there are valuable oil paintings since the gas sometimes tends to attack the pigments of paintings, causing them to undergo slight colour changes. Apart from this precaution, however, the employment of ozone as a household disinfectant and deodorant and its generation by means of a simple ozonising apparatus such as the one described above, is a perfectly safe procedure and one which is invaluable for the purpose of freshening up sick rooms, food stores and other apartments in which bacterial contamination is likely to occur.

As much as eight per cent. of ozone can be generated by passing pure oxygen through the ozone tube instead of ordinary air.

Oxygen may readily be prepared by heating in a test tube a mixture of two parts of powdered potassium chlorate and one part of manganese dioxide.

As a means of testing for the presence of ozone in a room, there is nothing better than the simple "starch-iodide" test. Make a five per cent. solution of potassium iodide and add to it about half its volume of starch solution. Immerse pieces of white blotting paper in this mixed solution for a minute or two and then hang them up to dry.

Preserve these "starch-iodide" papers in a box provided with a well-fitting lid.

When it is desired to test for ozone, merely moisten one of the starch-iodide papers and wave it about in the air. The slightest trace of ozone in the atmosphere will manifest itself by the appearance of a pale blue coloration of the starch-iodide paper.

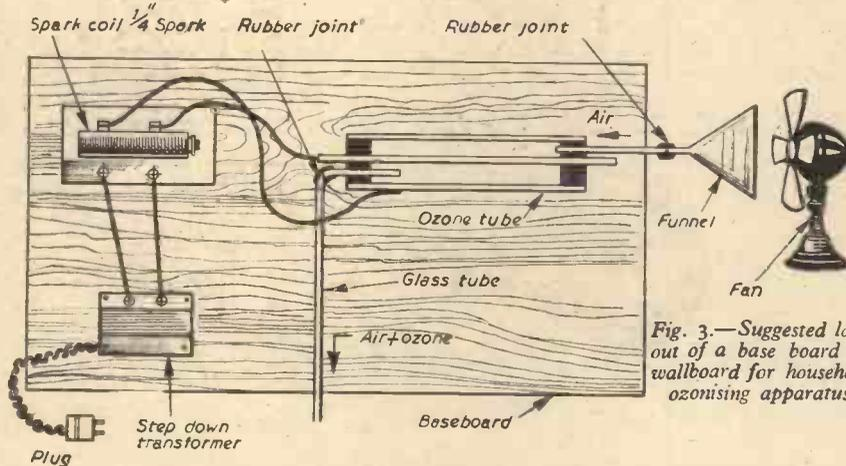

Fig. 3.—Suggested layout of a base board or wallboard for household ozonising apparatus.

glass tube approximately two-thirds or half an inch larger in diameter than the smaller tube. On the outside of the outer tube a layer of tinfoil is cemented with shellac varnish, flour paste or any other suitable adhesive. Contact from the secondary terminals of the induction coil is taken to the spiral wire running through the interior of the inner glass tube and to the tinfoil on the exterior of the outer tube, see Fig. 2.

If, under these conditions, the induction coil is operated and a current of air is passed between the two glass tubes, the air will issue from the tubes charged with ozone to the extent of from four to seven per cent.

For constant service in a household, it is, of course, necessary to have the ozonising apparatus mounted on an ebonite or wooden wall panel screwed firmly in position to the

through or blown through by means of a small electric fan placed near the air-intake tube of the apparatus. The current of air passing through the tube should not be a swift one, a moderately slow air stream producing the greatest proportion of ozone.

If any rubber tube connections are made to the ozone tube, they must be well varnished, for ozone attacks rubber in all its forms and quickly perishes it. The two corks supporting the inner glass tube within the outer one should be well impregnated with paraffin wax.

A Precaution

Operated for a period of 15 or 20 minutes, the household ozoniser described above will completely charge an ordinary sized room with ozone, disinfecting it thoroughly, fully

WORKSHOP CALCULATIONS
TABLES AND FORMULÆ
Tenth Edition
by **F. J. CAMM**

A handbook dealing with methods of calculation; solution to workshop problems, and the rules and formulæ necessary in various workshop processes. It contains all the information a mechanic normally requires.

From all booksellers, 6/- net,
by post 6/6 from the publisher,

GEORGE NEWNES, LTD. (Book Dept.),
Tower House, Southampton Street, W.C.2



Fig. 2.—The beacon with antenna erect, fitted to airman's "Mae West."

"SARAH"—Search and Rescue and Homing Equipment—was initially considered as being applicable primarily to the radio search and rescue of lost personnel. However, early field demonstrations of the equipment have revealed the fact that the system is equally applicable to other uses on the part of both the Fighting Services as well as civilian organisations where it is important to have a method for the location of remote personnel or equipment.

The problem of locating a crash survivor in an ocean or land area that may be hundreds of miles in any direction is so formidable as to be almost impossible without the use of radio communication. Various methods of improving the visibility of the wrecked personnel, such as dye markers, favourably coloured survival rafts and flags can do little to improve the situation in view of the tremendous distances involved. Slow flying aircraft at low altitudes must be called upon to traverse back and forth in precise patterns with overwhelming demands on the visual acuity of the search crews. Further, a large number of craft are required to cover the area in any kind of reasonable time. Operations are limited to daylight hours and conditions of good visibility. It is readily apparent that the survival probability of wrecked personnel under these search conditions is practically zero.

Radio communication offers several possible methods of improving these conditions so that, with proper design, the probability of survival is exceedingly good. The requirements of an ideal rescue system are:—

(a) It should facilitate rapid accurate search over wide areas under all conditions of visibility.

(b) It should provide positive, continuous directional information with constant or increasing accuracy as the searching aircraft approaches the wrecked personnel.

The system should be compatible with helicopter, shipborne or land transportable search and homing equipment, since pick-up of the survivor must finally be accomplished by one of these means at any time of the day or night or under any conditions of visibility. The wrecked personnel must be pin-pointed to within a few feet to meet these requirements.

General Considerations

There are a number of requirements which must be met by any rescue system and which must be considered carefully in selecting a suitable equipment design. The most important factors are:—

(a) Minimum weight of equipment carried by survivor (radio beacon).

(b) Minimum physical and mental effort for erection and operation of radio beacon equipment.

(c) Maximum range of search.

(d) Continuous, positive, directional homing signal with constant or increasing angular accuracy down to a range of a few feet.

(e) Full operation at all times and under all conditions of visibility.

(f) Operation longer than the probable survival time of the wrecked personnel.

(g) Two way voice communication for maintenance of morale and operational reasons.

(h) The presence of several persons in a small area must not confuse the searching forces; presentation of the various signals must provide each signal with a separate identity.

The successful manner in which the design of the "SARAH" equipment met the requirements of the ideal system were apparent in actual field tests under a wide variety of conditions.

Beacon Equipment

The beacon equipment (carried by the wrecked personnel) consists of (a) the radio beacon transmitter with antenna; (b) the speech unit; (c) battery; (d) interconnecting cables. The complete unit weighs 52oz. As used by flying personnel, it is proposed that this equipment be attached to the life jacket, since this will be on the wrecked person even when all else is lost. This requirement places strict limitations on size and weight which are met satisfactorily by the present design. A photograph of the beacon equipment is shown in Fig. 1. Two sets of equipment are shown, one with provision for two-way voice communication, the other without such provision.

In use, immediately after inflation of the life jacket, the wrecked person will remove the protective cover from the rolled antenna. The antenna is a self-erecting, 31in., flexible metal tape which stands in a vertical position when erect. The length of the antenna is 0.62λ which has been found to be optimum for land and sea operations. It is capable of functioning in a surface wind of 25 miles per hour and, because of its flexibility and resilience, will withstand considerable abuse without impairing its efficiency. Fig. 2 shows the beacon with antenna erect.

Tube complement consists of two tubes, one for beacon and one for voice transmit-receive. Maximum reliability against tube failure is thereby assured.

"SARAH"

(Search And Rescue And Homing)

A System for the Quick and Accurate Location of Wrecked Personnel

Radiation Pattern

The radiation from the beacon antenna is omnidirectional in the horizontal plane and provides an inverted cone pattern in the vertical plane.

Beacon Operation

In the beacon mode, the beacon equipment transmits a coded pulse generated in an optimised squegging oscillator with a repeating regime controlled to provide groups of pulses at a suitable low pulse repetition frequency.

The characterised pulse spacing in each pulse group provides a type of display in the rescue receiver which permits ready identification of different beacons in the same area.

The peak power output of approximately 16 watts in this mode provides a maximum range of 66 miles to a rescue aircraft at 10,000ft. altitude and six miles to a rescue ship, assuming the receiver antenna has a height of 30ft. to 40ft. These ranges are, of course, also determined by sensitivity of the rescue receiver. Battery capacity is adequate to maintain this signal for 20 hours continuous duty. Fixes from an altitude of 500ft. are accurate to within ± 100 ft. which is more than adequate information for subsequent pick-up by helicopter or surface vessels.



Fig. 1.—Two sets of beacon equipment, the one on the right with provision for two-way voice communication.

Speech Transmission

When the wrecked person is within visual or audible distance of the spotting or rescue aircraft or ship, he may depress a three position switch to "transmit" position and transmit speech. Modulation is by pulse repetition frequency variation of a 6,000 pulse per second (when unmodulated) signal.

Since the peak power in this condition is about quarter that of the beacon mode, the range is correspondingly reduced. However, speech transmission is only used when the ranges are very short so that greater power is unnecessary. Homing by the rescue aircraft or ship may continue during this mode. Battery capacity is adequate to maintain 19 hours beacon operation and one hour in the voice transmit-receive mode. Since the selector switch that determines the mode

of operation requires a definite effort to hold in any position but "beacon," to which it is returned by spring force, it is unlikely that it will be held depressed for long periods by confused or delirious, wrecked personnel.

It is important to note that beacons are non-compatible with one another, yet completely compatible with rescue craft. This prevents unnecessary and almost inevitable conversation which would occur between beacons if they were compatible.

Rescue Receiving Equipment

The rescue receiving equipment is all of the units carried by search aircraft, helicopters, search and pick-up surface vessels and consists of:

- (a) Receiver.
- (b) Power pack.
- (c) Aircraft search and homing antenna.
- (d) Shipboard search antenna.
- (e) Shipboard homing antenna.
- (f) Shipboard homing antenna control unit.
- (g) Voice transmitting antenna.
- (h) Interconnecting cable as required.

At present the receiver and power pack are separate units. A new subminiaturised design, currently in late engineering stages, will permit attachment of power unit to receiver, thus making a single unit. Size and appearance is shown in Fig. 3.

Search and Homing Receiver Operation

In use, the receiver presents a cathode ray indication of the search area during the search phase. Any beacons within the area covered by the receiving antenna appear as spikes on a vertical reference trace. By time sharing methods, a right and left antenna on the aircraft are arranged to display beacon spikes



Fig. 3.—The rescue receiving units, carried by searching aircraft, helicopters and surface vessels. Left, the receiver; centre, the power pack; and right, prototype of a new miniature combined power unit and receiver.

either to the right or left, respectively, of the vertical reference trace. Directional information is thereby obtained. The right and left antenna patterns being inclined forward, they overlap ahead and provide means for homing on the beacon, or beacons, one at a time. The characterised time spacing of the pulses in the beacon pulse group offers an excellent means of separating beacons in the search area.

During the early search phases, before any beacon signals have been received, an automatic feature may be used by which the receiver tuning is swept back and forth at a slow rate over a four megacycle range (± 2 megacycles from the nominal operating frequency). This permits frequency search over a band of

± 2 megacycles thus ensuring that signals are not missed due to any mistuning effect.

When a beacon is observed, the scanning may be stopped instantaneously to permit homing operations. In addition to the automatic sweep feature, the receiver may be manually adjusted to a nominal operating frequency over the range of ± 5 megacycles.

It is to be noted that as the aircraft flies over the beacon, the beacon signal suddenly vanishes, due to the vertical radiation pattern characteristic of the beacon antenna. By this method a fix is obtained. The width of the null will naturally vary with the altitude of the homing antenna.

This device was designed, developed and manufactured by Ultra Electric, Ltd.

Interlinking of Projectors for 3D

UNLESS film exhibitors have the room to accommodate a wide screen and are prepared to sacrifice some forward seating capacity for it, the showing of 3-dimensional films requires the interlinkage of two projectors so that they both run in synchronism instead of alternately as they do with non-stereoscopic film. Keeping the two projectors accurately in step from start to finish has presented the cinema industry with a major problem which cannot, as might at first appear, be solved properly by mechanical coupling. In practice, projectors subtend an angle of approximately 6 deg., making a rigid shaft out of the question, and flexible shafting introduces lost motion which is difficult to predetermine or control. The interlinking of projectors by electrical means is, however, made possible

by the development by The General Electric Co., Ltd., of a modified "Twin Torq" motor.

Projectors in nearly all cases are driven by a $\frac{1}{2}$ h.p. split-phase A.C. induction motor running at 1,440 r.p.m., and whilst this type of motor is generally regarded as a constant speed machine, it is, nevertheless, subject to small fluctuations of speed with varying loads. Consequently, if there is a difference between the load characteristics of two projectors, one motor will run at a speed slightly below that of the other. To correct this difference in speed for 3D operation, one G.E.C. Twin Torq motor (a 2-pole machine, having a 3-phase stator and a single-phase wound rotor fed from the mains through a pair of sliprings) is coupled to the driving motor of each projector, preferably by means of a direct chain drive from one motor shaft to the other. All four motors are then electrically connected as shown in the accompanying illustration.

Angular Displacement

Thus, if a split-phase motor loses speed due to an increased load on its projector, the Twin Torq motor directly coupled to it also loses speed. This tendency

to lag creates an angular displacement between the Twin Torq rotors on each projector, causing unbalanced voltages to be induced in both stator windings, with the result that current now flows from one stator to the other. This flow of current has the effect of producing equal and opposite torques on the Twin Torq rotors, causing both rotors to be pulled into step with each other.

The torque exerted by both Twin Torq motors is related to the mechanical difference between the two projectors. Where this difference in mechanical loading persists the Twin Torq rotors will not assume perfect alignment, but will be displaced from each other by a small angle, the value of which will depend upon the load and design of the motors.

Without practical experience over a prolonged period no accurate estimate can be given of the maximum out-of-balance forces likely to be met under all kinds of working conditions. One of the main causes of varying load can be attributed to the differing frictional losses in the bearings and other moving parts of the projector. Deposits of chemical emulsion from the film on the skids and guides of the projector, if not frequently removed, also increase friction and impose an added load on the motor. The G.E.C. have, therefore, developed the Twin Torq motor to exert a torque of 50oz.-in., with a full load rotor displacement of 30 deg., and this is considered upon authority to be ample for normal requirements.

The Twin Torq motors must take charge from the moment of starting up until the projectors finally come to rest.

In addition to the Twin Torq motor a composite motor incorporating the split-phase and Twin Torq motors in one frame is also offered by the G.E.C. to manufacturers of new projection equipment.

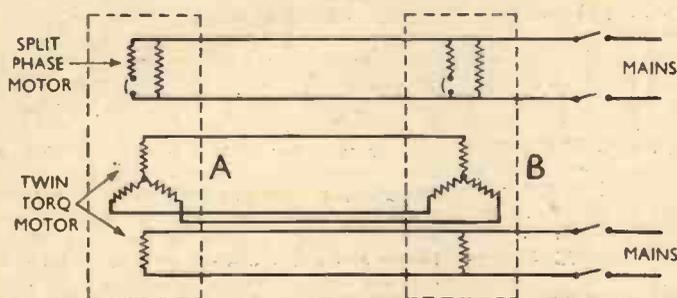

The manner in which G.E.C. Twin Torq motors are electrically connected to the driving motors of two projectors (A and B) so that they hold the two projectors in step.

AN ELECTRIC GAS LIGHTER

A Cheaply Constructed Appliance for the Kitchen

By P. W. TYRRELL

THE following notes explain fully the construction of a gas lighter which is quite easy and cheap to construct, and is a perfectly safe kitchen accessory.

The Lighting Rod

This is made from the plunger rod taken from an old cycle pump. The handle should preferably have no name on it, though this is immaterial. The leather washer and flanged disc should be removed, leaving only the 3/16 Whitworth screw which fits into the end of the rod. Next a miniature screw fitting lamp-holder to take a standard torch bulb is obtained, and from this is taken the threaded socket and the circular part with lug and terminal (parts B and A on the drawing). Also from the socket is taken the fibre washer which has to be drilled to take the 3/16 screw. Next, two holes are drilled diametrically opposite near the end of the rod through which to pass the wires which run up the inside of the rod and out of the top through a rubber grommet.

Assembly

A length of flex is obtained sufficient to allow easy reach to the gas stove, and this is threaded through the grommet and down the inside of the rod then out at the end through the holes provided. One wire is then secured under the terminal on part A. The other wire is soldered up into a loop about 1/4 in. dia. The small fibre washer is next slipped over the screw and over this the screw socket B and then part A, which

is the terminal lug. Next to this is another fibre washer and under it is the soldered loop of wire. The complete assembly is now fitted to the rod by the screw. In assembling, great care must be taken to prevent the socket B touching the screw and causing a short circuit. All this is shown diagrammatically on the drawing at the section X-X. After screwing up tightly the assembly can be tested with a meter, or, for those who do not possess a meter, testing may be effected by connecting up a battery and bulb and joining one wire to the socket and the other to the screw—if the bulb does *not* light everything is in order.

The Micro-switch Assembly

The micro-switch is of the 250 volt 5 amp. type. Through the switch run two parallel holes which are employed for fixing the operating arm bracket. This is a piece of metal about 3/4 in. wide by about 3/32 in. thick, which should be bent up to make a U-shape projection about 1/4 in. from the switch when fitted. This should now be suitably drilled to take the fixing bolts which pass through the switch. It should also have a hole in the end for screwing on the operating arm. This is of the same material as the bracket and is bent up to the shape shown in the side elevation. An adjusting screw should now be fitted to the arm in such a position as to engage the spring steel arm of the micro-switch. Two L-shaped

pieces are now fitted as shown for taking the tension spring and its adjuster. This done, the micro-switch assembly may now be adjusted for correct operation. The tension spring is slackened off and the adjuster screwed to such a position that the switch is "on" when the lighter rod is *not* in its clip. The spring must now be adjusted so that on replacing the lighter rod in its clip the switch clicks "off." The essential dimension is the length marked x on the drawing. This cannot be definitely specified as it depends on the weight of the complete lighting rod, the weight of the flex and the strength of the tension spring. It should be of such a length that when the rod is placed on the end of the arm it descends a sufficient distance to make the micro-switch click off. Other dimensions are made to suit the materials, etc., at hand.

The Transformer

This is a bell transformer having secondary windings at four, eight and 12 volts. The one the writer had was of cubical shape and, very conveniently, had a sliding metal cover, though this is not essential it is better for drilling purposes.

The base of the micro-switch should now be removed and two wires secured under the terminals. Two slightly longer screws should now be found to replace the ones which secured the base. Next drill two holes in the transformer cover to take the two screws, pass the screws through the cover and then through the switch base, and

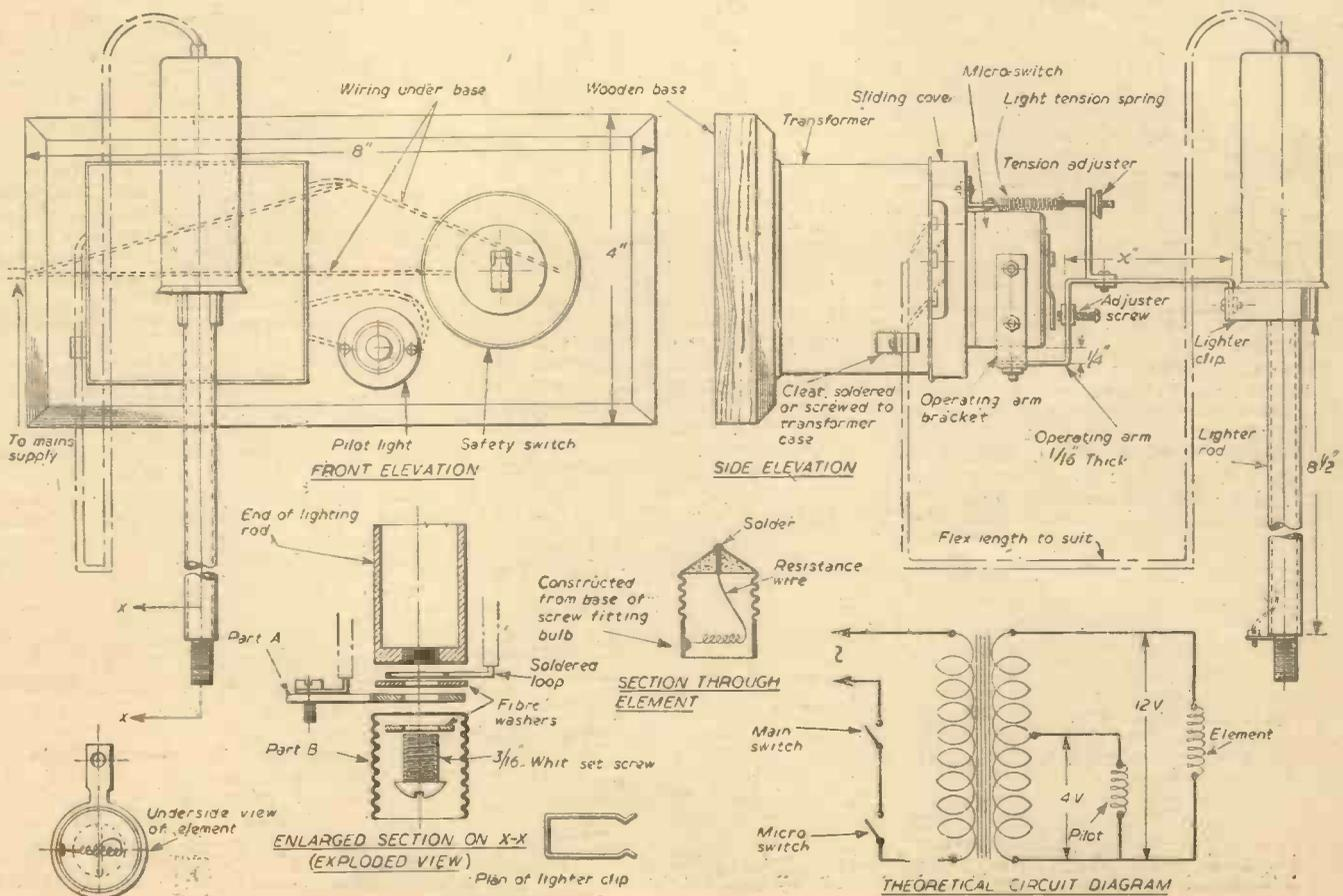

Front and side elevations of the lighter unit, details of construction, and circuit diagram.

finally screw into the actual switch and tighten down. Another hole should be drilled through which to pass the micro-switch wires.

The Element

This is the most delicate part of the whole gas lighter to make. It is made from an old torch bulb. All the glass is removed, and as small a hole as possible is drilled down the centre. A short length of resistance wire is obtained and passed down the hole to be secured under a blob of solder at the bottom. The wire is wound into a coil and the end secured under another solder blob on the side of the brass container. The length of wire cannot be specified as it depends on the specific resistance of wire and its diameter. It must, therefore, be found by experiment. This is easily done by applying

a potential of 12 volts to the ends of the wire and then reducing its effective length until it glows fairly brightly.

Assembling the Unit

A piece of wood, of a size to accommodate the transformer, a miniature bulb-holder, and a tumbler switch is prepared, and to it the above components are fixed. Two wires are led from the bulb-holder and connected across the four-volt terminals of the transformer. The ends of the flex from the lighting rod are connected across the 12-volt terminals. One lead from the house mains is connected to the transformer and the other to one side of the tumbler switch. The micro-switch is then connected between the remaining terminal on the transformer and that of the tumbler switch. This done,

with the element and pilot bulb inserted, the unit is ready for use, and can be connected to the mains. The purpose of the pilot light is threefold: 1. If it will not glow at all on removing the lighting rod, the tumbler switch being "on" either the adjusting screw needs screwing in, or the spring needs tightening, or there is a circuit fault.

2. If it continues to glow after replacing the rod, either the screw is too far in or the spring too tight.

3. If it glows brightly, this indicates failure of the element.

Finally, in connecting up the unit to the mains, it should be remembered that the red mains lead always goes to the switch and the black to the appliance, in this case, the transformer.

Tobacco Shredding Machine

A Machine for Shredding Home-grown Tobacco

By W. R. B. ORME

THIS tobacco shredder has proved quite efficient, provided the leaves are all well compressed. If made into a slab 1½ in. deep it should be cut with a sharp knife into sections slightly under 1½ in. wide and not more than 6 in. in length. Some growers roll the leaves and bind them tightly with string from end to end. So long as the roll is 1½ in. diameter and 6 in. in length, having squared ends, the shredder will operate satisfactorily, but the former method is the better.

Wooden Base

The casting is screwed to a wooden understructure (A, Figs. 1 and 2) made in ¾ in. plywood. This should be made quite strongly, as a fair amount of strain is put on it when cutting a hard cake of leaves 1½ in. x 1½ in. A slot (D, Fig. 2) is cut through the cutting end so that a joiner's cramp may be inserted to hold the machine firmly to a bench or table. Before constructing the machine, a pair of gear wheels of about 1½ in. outside diameter and about ¾ in. width of

the spring end. One pinion is bushed if necessary and bored ¾ in. and taper pinned when assembling. An engine valve spring is fitted to pull the cutter firmly on the face of the casting, adjustment being obtained by the two nuts at the end F, Fig. 1.

"Pusher" Shaft

The bottom "pusher" shaft, Fig. 3, is for forcing the cake of tobacco towards the cutter. This is threaded its full length—12 in. A length of ¾ in. BSF studding, provided it is perfectly straight, will do the job. A block of aluminium to slide easily along the channel, 1½ in. x 1½ in. by ¾ in. is drilled and tapped ¼ in. BSF. The rod is screwed into this block and locked with lock nut, Fig. 3. The second pinion is bushed if necessary and drilled and tapped ¼ in. BSF.

Cutter and Handle

The cutter is made in the form of a snail-shell, being cut from a piece of steel approximately ¼ in. thick, drilled and tapped ¼ in. BSF at A (Fig. 4). Screw this on the cutter shaft with the handle tightly up to it. Then mark the blade in the form of a convolute, the edge commencing at G, ½ in. from centre of hole A, finishing at H.

Whilst screwed together, drill and tap hole F in the handle (Fig. 5) ¼ in. BSF, and run point of drill into cutter at C, Fig. 4. Drill hole E, Fig. 5, ¼ in. clearance in handle and ¼ in. BSF tapping in cutter and tap ¼ in. BSF at B, Fig. 4. These two holes take hexagon set screws, which provide adjustment in or out of the blade and assist the drive from handle to blade. A ¾ in. lock nut is fitted outside handle on cutter shaft. Disassemble the cutter from handle and grind convolute to a keen edge. The operating handle is 10 in. long and is set to miss the tray, E, Fig. 1, which catches the shredded tobacco. When assembling, adjust blade and handle so that there is clearance at point H, Fig. 1, thus keeping blade in close contact with casting face at K.

Figs. 1 and 2.—Side and end views of the completed tobacco shredding machine.

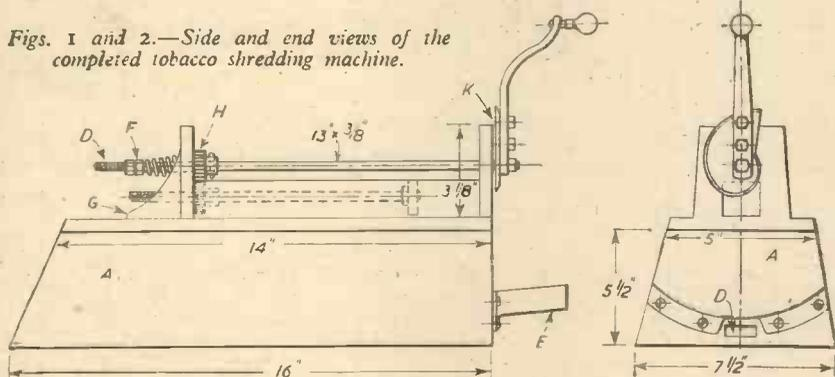

Construction

The machine consists of an aluminium casting, the pattern for this being the biggest job. The base is 14 in. x 5 in. x ½ in. An upright 3½ in. at base and 3 in. at top, 3½ in. high and ¾ in. thick is fixed at right-hand end. At 9 in. from this position a second upright 2½ in. wide at base, tapering slightly for ease of moulding, having a round top 3½ in. high and ¾ in. thick, buttressed as at G, Fig. 1.

Between these two uprights are fitted two sides 9½ in. x 1¼ in. x ¼ in. (tapered for moulding). These form the channel in which the cake is forced to the cutter. A square hole 1½ in. x 1½ in. is made in the first upright to correspond with the channel. The complete casting is shown in Fig. 2a. The cutter-end upright must be accurately machined on its outside face where the cutter impinges and this face must be absolutely at right angles to the cutter shaft. The shaft holes should be bored first and the cutter made and mounted with the operating handle, then the face may be machined perfectly true, using the cutter as the machining tool. Of course, it will have to be dismantled several times for sharpening.

teeth, having a boss on one side, should be obtained from an ex W.D. store. These sizes are only approximate, so long as they are identical. The size will decide the distance apart of the two shafts on which they operate, but the measurements on Figs. 1 and 2 are correct for 1½ in. diameter wheels.

The Shafts

The top shaft (D, Fig. 1) is threaded ¾ in. BSF for ¾ in. at the cutter end and 2 in. at

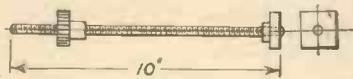

Fig. 3.—Pusher shaft.

Figs. 4 and 5.—Details of the cutter and handle.

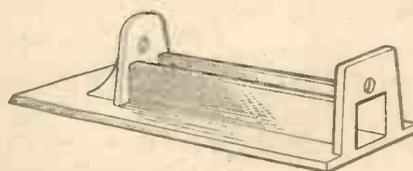
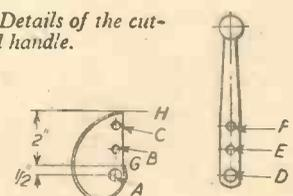
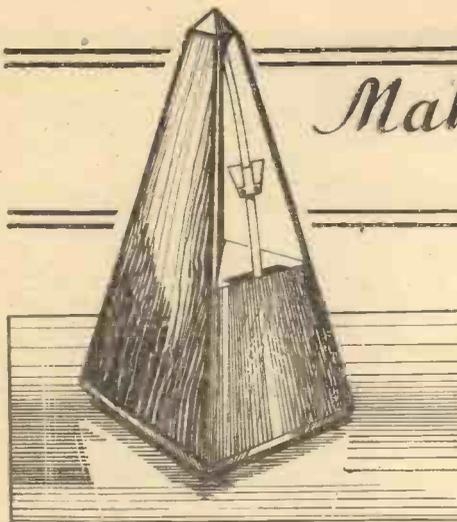

Fig. 2a.—(Left) The aluminium casting for the body of the machine.



Making a METRONOME

Constructional Details of an Instrument for Use in Practising Musical Scales and Exercises



THE metronome is a very simple piece of clockwork, but differs from a clock in the fact that its pendulum is weighted at a point above its point of suspension. Those who have used a harmonograph will know that the rate of a pendulum may be slowed down considerably by such means, which in the metronome make it possible to use a short pendulum and thus ensure that the instrument is not unduly cumbersome.

Fig. 1 shows a front view of the pendulum. A is a small flat leaden weight firmly attached to the flat steel stem B, the length of which may be 7 in. At C, the point of suspension, is a brass boss, which carries the arbor shown in Figs. 3 and 4. This arbor not only serves as suspension for the pendulum, but has attached to it two pallets by which the escapement wheel is allowed to progress

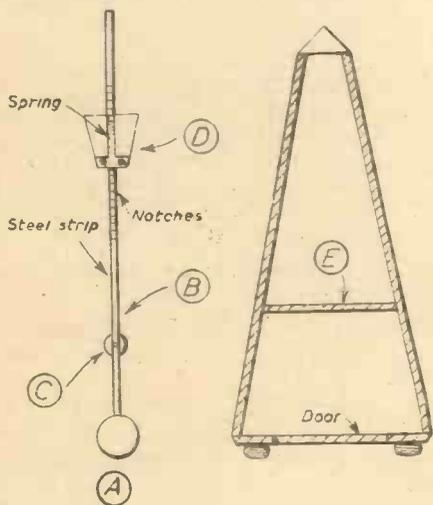

Figs. 1 and 2.—(Left) A front view of the pendulum. (Right) A sectional view of the case which is a steep pyramid of square section.

one tooth at a time at each beat of the pendulum.

The Pallets

These are shown in Fig. 3 and are small flat steel plates, set one in advance of the other, so that when one leaves a tooth in the escapement wheel, the other presents itself to the next tooth, which coming against it with some force makes an audible tick for the guidance of the player.

The escapement wheel is of the pin-wheel type—i.e., its teeth are brass pins set radially upon its periphery. The escapement wheel

arbor carries an 8-tooth pinion, seen in Fig. 4, which gears with the toothed wheel attached to the drum. This wheel has about 110 teeth.

The Mechanism

Fig. 3 is the side view of the mechanism and Fig. 4 a view looking from below, which shows the plate to which the parts are fixed, but for clearness the inside bearing of the pendulum pivot has been omitted. This plate is screwed to the underside of the floor marked E in Fig. 2. A slot is cut through this floor to allow the head of the

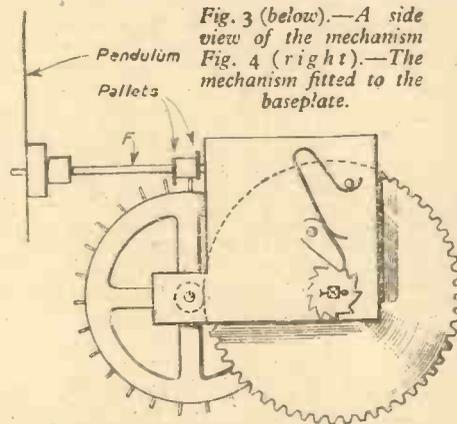

Fig. 3 (below).—A side view of the mechanism. Fig. 4 (right).—The mechanism fitted to the baseplate.

pendulum to vibrate freely in the space above.

The spring barrel is provided with the usual winding square and ratchet wheel and also with "stop-work" to prevent over winding. The latter is a small toothed wheel pivoted to the head of the drum (see Fig. 4), which gears with a single tooth upon the drum arbor. The teeth of this wheel are discontinued at one point, which when reached by this tooth prevents further winding.

The Lead Weight

Reverting to the pendulum, Fig. 1, D is a leaden weight that slides upon the stem, controlled by the light spring shown in the centre.

Fig. 2 shows the usual form of case in sectional view. It is a steep pyramid of square section. The floor E is a fixture. The bottom has a door clipped in place to give access to the mechanism for lubrication and adjustments.

The Head of the Pendulum

The front above the floor E also is removable so as to bring into view the head of the pendulum and to admit of adjusting its rate.

A scale of speeds is fixed behind the pendu-

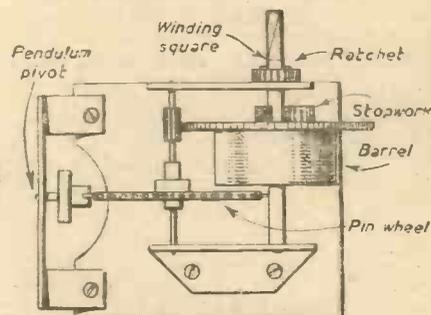

lum and it is usual to mark it "presto," "allegro," "andante," etc.

A small brass plate should be fixed at the top of the case behind which the head of the pendulum can be slipped to stop it, and for safety in transport, and the case should be mounted upon three ball feet.

There is a vacant space behind the board that carries the scale which acts as a resonator to emphasise the beats.

"Bristol" Sycamore Helicopter in Malaya

A BRISTOL SYCAMORE helicopter was recently flown by Bristol Freighter to Malaya for trials under humid tropical conditions, and for flight evaluation tests as a jungle ambulance aircraft in service with the R.A.F. The Sycamore will first be engaged on tropical trials extending over two to three weeks and will then be handed over to the R.A.F. Far East Casualty Evacuation Flight for about ten weeks.

The machine is the Mark 10 ambulance version of the Sycamore. It embodies two "Perspex" blisters which—without imposing aerodynamic penalty—increase the cabin width to allow two stretcher casualties to be carried athwartships behind the pilot. The new "Bristol"-designed lightweight stretchers are of tubular construction and, when not in use, can be compactly folded and stowed in the luggage compartment behind the engine bay. Both stretchers are secured by clamps. Beside the pilot's station is a

swivel seat which enables a medical orderly to attend casualties during flight, and the back of the pilot's seat is reduced in height to give the attendant complete freedom of movement. In addition to the standard V.H.F. set for normal air-to-air communications, the Sycamore has special radio equipment to enable the crew to keep in touch with ground forces. A rope ladder is carried to allow the medical orderly to descend and examine touch-down points before landing in jungle country.

In dense jungle growth it is often necessary for a helicopter to rise vertically at take-off to as much as 200ft. to clear surrounding trees before beginning forward flight. This condition, particularly in a humid tropical atmosphere, must impose a stringent test on any type of helicopter and the Sycamore's performance will be carefully analysed from comprehensive day-to-day reports sent back to "Bristol."

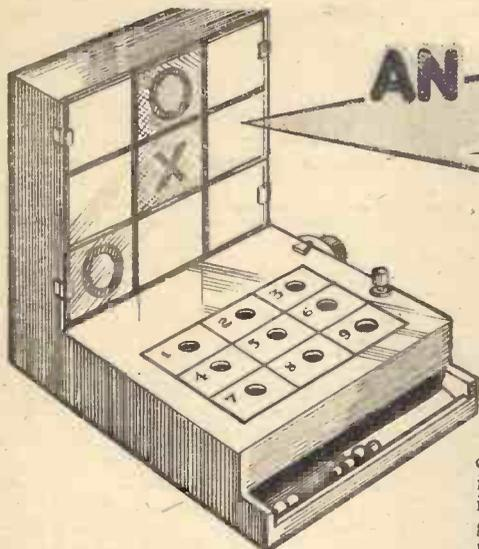

AN "Electronic" BRAIN

Constructional Details of a Novel and Fascinating Machine

By E. HARRIS MORGAN, B.Sc.

(Concluded from page 364, June issue)

THE switch is completed by fitting the switch position indicator, constructed as shown in Fig. 9. The drum (a suitable tin lid can be used) has a bush soldered to it at its centre and a hole cleared through the metal. It then has the word "OFF" and the numbers 1-9 painted around its edge at equal intervals. An indicator for the switch is cut from tinfoil and mounted on top of the perception unit as can be seen in Fig. 3. In the final setting up, the drum must be adjusted so that this index shows the correct setting of the switch.

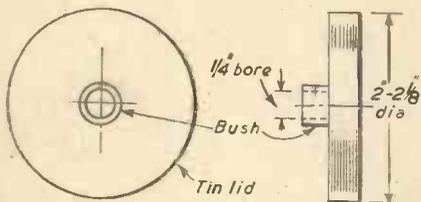

Fig. 9.—Memory switch position indicator.

The Indicating Unit

This unit is of quite straightforward construction. Fig. 10 shows the general appearance with measurements. As before, the measurements are by no means critical except where mentioned below. Eighteen m.e.s. lampholders are required and these are fitted to the spacers before assembly. The spacers fit together in the same way as the

divisions of an egg-box. Two pieces of glass 12 in. square with a sheet of tracing paper between them, are fixed to the front of the indicating unit. The method shown in Fig. 10 makes for simplicity, but if the necessary tools are available the glasses can be fixed by cutting grooves in the side-pieces and sliding the glasses in from the top. Some modification of the design will be necessary in this case. The back of the indicating unit should be secured with only a few screws so that it can be removed easily for replacement of bulbs. The "O" bulbs are wrapped with red cellophane and the "X" bulbs with green cellophane. To the face of the glass nearest the bulbs are fixed "Xs" cut from red cellophane, and "Os" cut from green cellophane. Some transparent cement should be

used for this purpose. The appearance of the glass, looked at from the back of the instrument, is as shown in Fig. 11.

When an "O" bulb is switched on, the glass is illuminated by red light. This passes through the red "X" casting only a slight shadow on the tracing paper, but the green "O" intercepts the light and thus throws a dark shadow on the tracing paper. The "X" bulb produces an "X" on the screen in the same way.

When purchasing the cellophane, a simple test will establish the suitability of the colours. Two overlapping pieces of different coloured cellophane are held up to the light and the area of overlap examined. This area should be dark brown in colour, the darker the better, provided that the individual colours are not too dense.

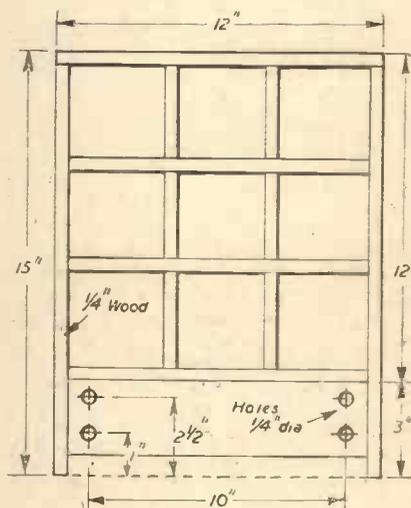
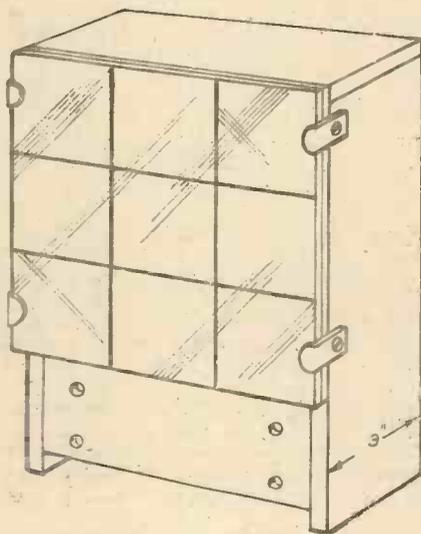

See note on Fig. 3

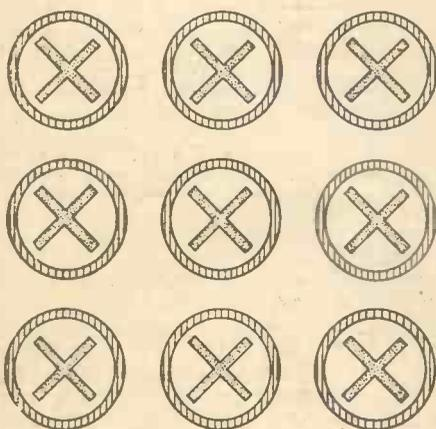

Red-cellophane Green cellophane

Fig. 11.—Appearance of glass viewed from back of instrument.

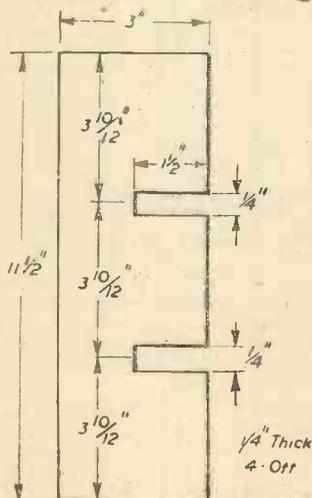
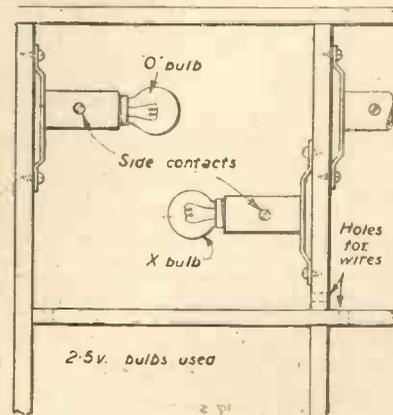

Fig. 10.—Details of the indicator unit.



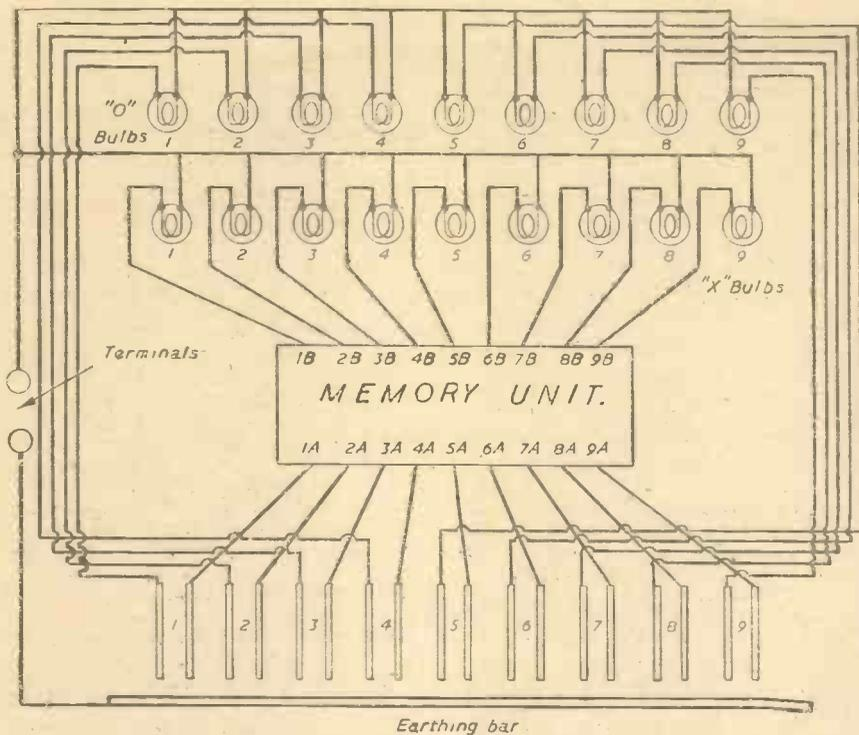

Fig. 12.—Circuit diagram of instrument. (Internal wiring of memory unit omitted.)

Assembling the Instrument

The memory switch is screwed into position in the perception unit by means of wood screws through the top of the unit into the hardwood endpieces of the memory unit. Terminal strip A should face the front of the instrument and terminal strip B the rear. The shaft of the memory unit passes through a 1/2 in. hole drilled in the right hand side of the perception unit. The indicating unit is then bolted to the perception unit by means of four O-BA bolts. The instrument is now wired up according to the instructions already given. These instructions are summarised here for convenience.

1. The left-hand rods of the ball railways are connected to the side-contacts of the correspondingly numbered "O" bulbs.
 2. The right-hand rods of the railways are connected to the corresponding numbers on terminal strip A of the memory unit.
 3. The positions on terminal strip B of the memory unit are connected to the side-contacts of the correspondingly numbered "X" bulbs.
 4. The base contacts of all bulbs are joined together and brought to a terminal on the left-hand side of the indicating unit.
 5. A wire is connected to the earthing bar and brought to a terminal on the left-hand side of the perception unit. (These last two terminals should be fairly close together.)
- Fig. 12 shows the connections in detail (excluding the internal connections of the memory unit).

The switch is now adjusted. The position

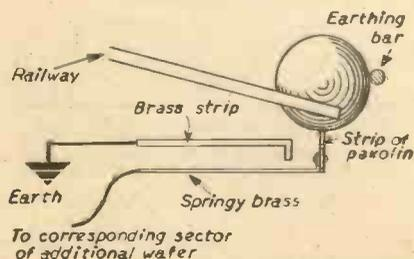
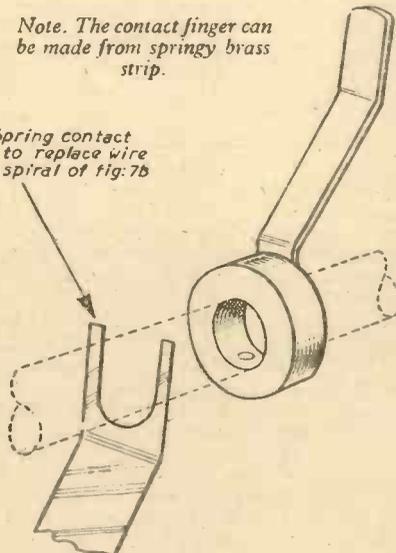

Fig. 14.—Suggested modifications for converting the instrument to fully automatic operation.

of the moving contacts is noted; the drum is slipped on to the shaft, and with the grub screw loose, rotated until the number corresponding to that position is opposite the index. The grub screw is tightened and the working of the switch checked, any necessary adjustments being made. The bottom and back of the instrument are now screwed into position.

Note. The contact finger can be made from springy brass strip.

Spring contact to replace wire spiral of fig. 7b



Switch held open by ball in position 4

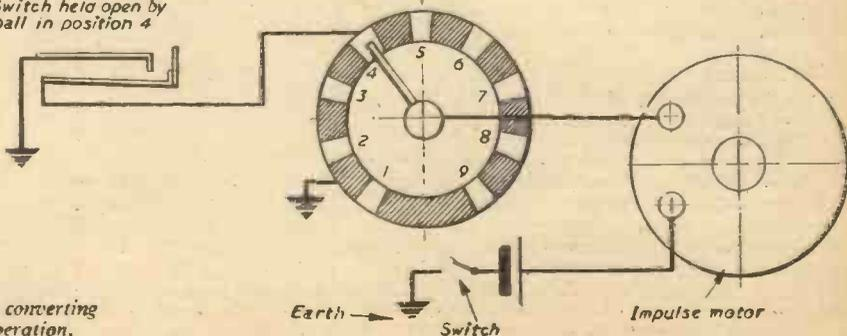

Testing the "Brain"

The instrument is now ready for testing, and the reader is advised to proceed as follows: A twin-cell cycle lamp battery is first connected to the terminals on the L.H.S. of the instrument (polarity is unimportant). The switch is placed in position 1 and a steel ball dropped through hole 1; an "O" should

Switch position

	1	2	3	4	5	6	7	8	9
1	5	3	2	7	-	2	4	4	4
2	3	5	1	3	8	1	6	4	4
3	2	1	5	2	7	9	2	6	6
4	7	7	8	5	6	8	1	1	2
5	-	-	-	-	1	-	-	-	-
6	8	9	9	2	4	5	2	3	3
7	4	4	8	1	3	8	5	9	8
8	6	6	4	9	2	7	9	5	7
9	6	6	6	8	3	3	8	7	5

Fig. 13.—Table to be used in testing the instrument.

appear in position 1 of the indicating unit and an "X" in position 5. The switch is now rotated to position 2, when an "X" should appear in position 3. The switch is then passed through positions 3-9 when "X"s should appear in the appropriate squares. The reset button is then pressed and the steel ball placed in another hole, the switch being operated as before. The whole process is repeated for each of the holes in the perception unit. In this way the instrument is given a thorough and methodical testing, and any wrong connection can quickly be traced and put right. Fig. 13

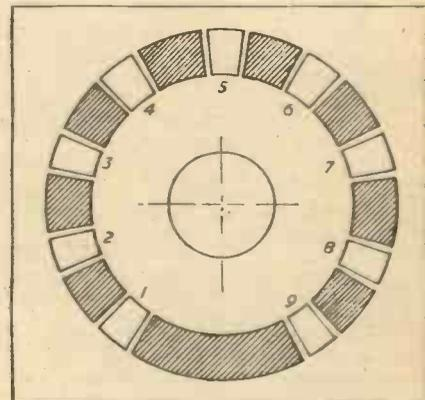

Additional wafer. Shaded portions earthed. Blank portions earthed via appropriate ball switch of perception unit.

shows in table form the positions in which an "X" should appear for various positions of the switch and steel ball.

Finishing the Instrument

The instrument can be finished in a number of ways, and this is a matter which must be left to the reader's preference. One thing however *must* be done; the holes in the perception unit must be numbered legibly in accordance with the system used throughout this article, since these numbers are required in the course of play.

Method of Using the Machine

In order to avoid undue complexity, the selector mechanism for the memory unit has been designed to be operated manually. This selection can be made fully automatic by

arranging for an impulse motor to drive the switch. The switch would then have to be modified so that it could turn continuously, and the action of dropping a steel ball through any hole could be made to cause the switch to stop in the desired position. An impulse motor is suggested for this operation because it stops instantaneously on cutting off the current, whereas an ordinary motor would tend to overrun. For readers interested in a fully automatic instrument a suggested circuit is shown in Fig. 14 together with the necessary modification to the switch. It should be borne in mind that these are merely suggestions to form the basis of experiments on the part of the reader.

The machine's opponent, on commencing

a game, must decide which position he is going to fill *initially*. The switch is moved to this position and *left there throughout the game*. Placing the switch in one position and inserting the first steel ball in another position should not be allowed as this is denying the machine essential information.

Beating the Machine!

The machine is not infallible (it can hardly be made so using this simple system), but the method of beating the machine is well hidden and will not be discovered easily by those not in the secret. It is left to the reader to discover its "Achilles' heel," which, however, is not to be found in "cheating" the machine by juggling with the selector switch.

Back to First Principles

6—Degradation of Energy

By W. J. WESTON

WE speak, and rightly, of friction as a force, a form of energy; but it is a force that impedes, not promotes, movement. The rubbing between the moving surfaces of a machine converts much of the energy employed into heat; and the heat is dissipated without useful effect; there has been a degradation, a transfer to a lower kind of energy. We can lessen friction by smoothing contacting surfaces, by oiling so that one surface floats over a film of oil; we cannot wholly eliminate it. Even when a steel ball is scudded over a sheet of ice some retardation of the speed there will be, though inappreciable to the eye. The resisting effect of friction transfers us from the smooth surface familiar in theory to the rough surfaces met in practice.

The Problem

A plane is inclined to the horizontal at an angle of 30 deg. On it is a load of 40lb. What force parallel to the plane will prevent the load from slipping down? The coefficient of friction is .25. What is the least force that will pull the load up the plane?

The Comment

The coefficient of friction is a multiplier that measures the friction, constant for the same surfaces, variable for different surfaces. Put a heavy book on your polished dining table; tie to it a weight hung over the side of the table. The weight being small, the book stands, the weight being made great enough the book begins to move. And the ratio between the weight of the book (its pressure on the table) and the moving force is always the same; add the second volume of the book, and you will need to double the moving force. It is this constant ratio that is the coefficient of friction. Thus, the coefficient of friction of wood on steel is .5, of steel on oiled steel only .1.

The Answer

By the inclination of the plane the vertical force of 40lb. is resolved into:—

Reaction to the Plane Surface :
 $40\text{lb.} \times \cos 30^\circ$
 Force Parallel to Plane : $40\text{lb.} \times \sin 30^\circ$
 $\cos 30^\circ = .866 \therefore$ reaction to plane = $40\text{lb.} \times .866$
 $\sin 30^\circ = .5 \therefore$ downward force parallel to plane is 20lb., and upward force parallel to the plane, also of 20lb., will keep the load at rest.

The resistance of friction is given by :

Reaction to Plane \times Coefficient of Friction.
 That is $40\text{lb.} \times .866 \times .25 = 8.66\text{lb.}$
 The total force needed is $\therefore 20 + 8.66$ or 28.66lb.

The Problem

A weight of 40lb. is placed on a rough plane inclined at 22 deg. to the horizontal. It is found that the least force, acting downwards,

Diagram illustrating the inclined plane problem.

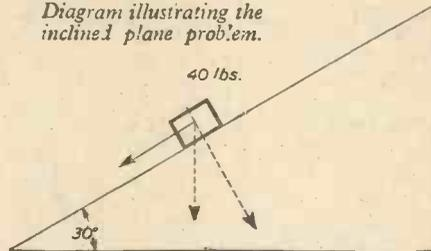

along the slope of the plane that will give movement is 4.9lb. weight. Find (i) the coefficient of friction, and (ii) the least force that, acting along the slope of the plane, will just cause the weight to move upwards. (The sine of 22 deg. is .3746; the cosine is .9272.)

The Comment

Before the application of the 4.9lb. force, there is already a tendency for the weight to move down the plane, a tendency measured by the component of 40lb. weight *parallel to the plane*. This tendency is resisted by friction that has not yet reached its maximum (its *limiting point*): the 4.9lb. needed to produce movement is the excess of this limiting friction over the force at the outset keeping the weight at rest. It is this *limiting friction* compared with the *reaction to the surface* that gives the coefficient of friction.

In the upward movement the effective force must equal this limiting friction plus the component of 40lb. down the plane.

The Answer

The component of 40lb. weight parallel to the plane is $40\text{lb.} \times \sin 22^\circ = 40\text{lb.} \times .3746 = 14.984\text{lb.}$

The maximum friction is $\therefore 14.984\text{lb.} + 4.9\text{lb.} = 19.884\text{lb.}$

The component of 40lb. weight perpendicular to the plane is $40\text{lb.} \times \cos 22^\circ = 40\text{lb.} \times .9272 = 37.088\text{lb.}$

The coefficient of friction is $\therefore 19.884 \div 37.088 = .536.$

And the upward force needed is $\therefore (19.884 + 14.984)\text{lb.} = 34.868\text{lb.}$

The Problem

A block of wood, weight 4lb., rests on a horizontal plane 6ft. long. When one end of the plane is raised 2ft. the block begins to slide down: what is the coefficient of friction? If the vertical height is increased to 3ft., what is the least force perpendicular to the plane that will maintain equilibrium?

The Comment

The raising of the plank calls for an ever-growing resistance of friction till it reaches its limit at 2ft. up. Pressure down the plane is then the weight \times sin of the angle of friction, i.e., $4\text{lb.} \times \frac{2}{6}$ or $1\frac{1}{3}\text{lb.}$ It is this pressure that is balanced by the other component of the weight, $4\text{lb.} \times$ cosine of the angle of friction, multiplied by the coefficient.

The force perpendicular to the plank in the second case is wholly spent in adding to the reaction of the weight to the plank.

The Answer

I. Suppose μ to be the coefficient of friction. $\cos \angle \times 4\text{lb.} \times \mu = \sin \angle \times 4\text{lb.}$

i.e., $\sqrt{\frac{32}{6}} \times 4\text{lb.} \times \mu = \frac{2}{6} \times 4\text{lb.}$

$\therefore \mu = \frac{\frac{2}{6} \times 4\text{lb.}}{\sqrt{\frac{32}{6}} \times 4\text{lb.}} = \frac{2}{\sqrt{32}} = \frac{2}{4\sqrt{2}}$

$= \frac{1}{2\sqrt{2}} = .3535$ (coefficient of friction)

II. $(F + 4\text{lb.} \times \frac{\sqrt{27}}{6}) \mu = 4\text{lb.} \times \frac{3}{6}$

$\therefore \mu F = 4\text{lb.} \times \frac{3}{6} - 4\text{lb.} \times \frac{\sqrt{27}}{6} \times .3535$

$\therefore F = \frac{4\text{lb.} \times \frac{3}{6}}{.3635} - 4\text{lb.} \times \frac{\sqrt{27}}{6}$

$= \frac{2\text{lb.}}{.3635} - 2\sqrt{3}\text{lb.}$
 $= 5.65\text{lb.} - 3.464\text{lb.}$
 $= 2.186\text{lb.}$

NEW AND FULLY REVISED EDITION (8th)

PRACTICAL MOTORIST'S ENCYCLOPAEDIA

17/6, or 18/- by post from
 George Newnes Ltd., Tower House,
 Southampton Street, Strand, W.C.2

GAS BLOWTORCH

A Useful and Easily-made Appliance for the Handy-man

By "ENGINEER"

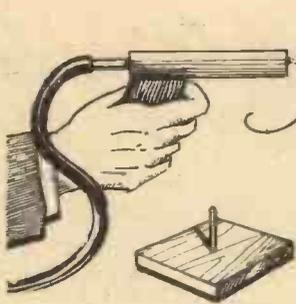

THE following article describes the construction of a self-blowing gas blowtorch which gives a large hot flame. A blowtorch of this type has many applications such as paint stripping, glassworking, soft and silver soldering and so on. It can be made quickly and cheaply; the time taken to make an actual model was less than half-an-hour and the cost only a few pence. If broken, it can be replaced rapidly.

The materials required are, 1ft. of soft glass tubing, 3/8in. outside diameter, a piece of wood, 1 1/2in. by 3/4in. by 6in., a second piece of wood, 5in. by 3in. by 1in., and a piece

tion of the blowtorch. The hole so formed should be between 1/12th and 1/10th of an inch in diameter. The exact size is best found by experiment, starting with a hole that is too small and enlarging it gradually, checking by lighting the blowtorch between each adjustment.

The Stock and Base

The piece of wood 1 1/2in. by 3/4in. by 6in. is next drilled as shown in Fig. 2 (a). The glass tube should be an easy fit in the 3/8in. hole. The wood between the 3/8in. hole and the 3/4in. hole is cut away so that a wedge may be inserted to hold the glass tube firmly in position. This arrangement allows for rapid replacement of the glass tube if it

On lighting the jet with the gas turned full on a large roaring flame of the type shown in Fig. 3 (a) or (b) should be obtained. Both are hot flames but if anything 3 (a) is the hotter.

Working Principle

The principle on which the instrument is based is quite simple. The jet is designed to produce a turbulent flow of gas; the turbulence commencing as near to the jet as possible. This condition causes air to be mixed with the gas, and a suitably sized jet gives the right proportion of gas/air. The size of the jet is not very critical since turbulence is far easier to produce than a smooth flow. However, if the jet is too small,

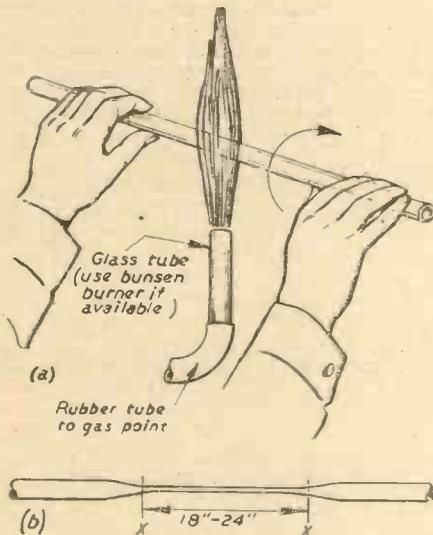

Fig. 1.—Method of heating the tube, and the appearance of the tube after heating and drawing.

of tinplate 3/8in. by 5in. If a bunsen burner is not available, a second piece of glass tubing about 2-3in. long and 3/8in. outside diameter should also be purchased.

Heating the Glass Tubing

The glass tubing is heated at its centre by means of a bunsen burner and, when quite soft, is removed from the flame and the hands pulled apart slowly but steadily. While heating the tubing in the flame, it should be rotated continuously so that it is evenly heated. This requires a little practice, for both ends of the tubing must be rotated at the same rate when the glass is soft. If a bunsen burner is not available, the short length of glass tubing is connected to a gas point by means of a length of rubber tubing, and the flame produced used in the same way. This flame will not be as hot as a bunsen flame and the tube will take longer to soften. Fig. 1 shows the arrangement using the short glass tube, and the appearance of the tube after heating and drawing.

The tube is now broken at the points XX by scratching with a file and tapping. The broken edges should not be too jagged, but a little jaggedness appears to help the opera-

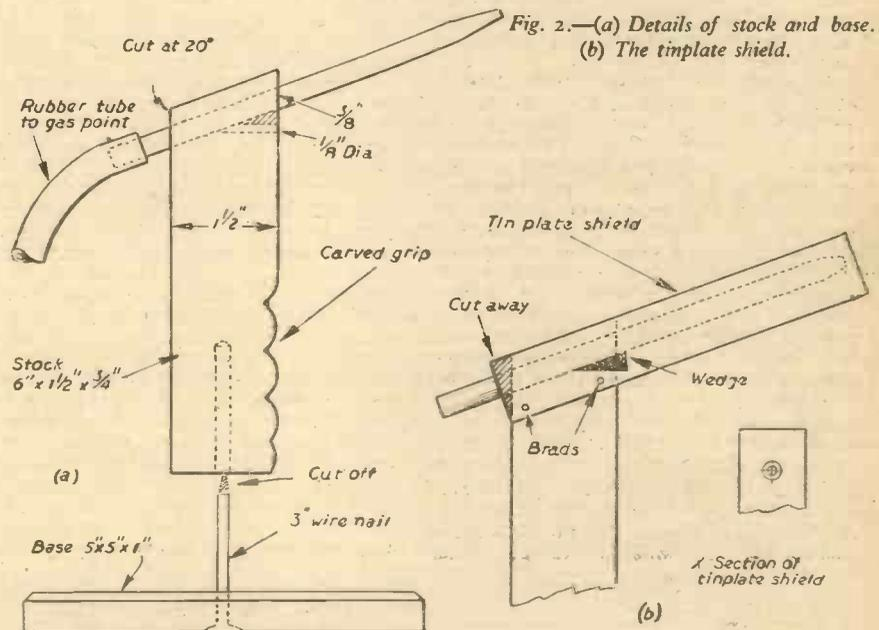

Fig. 2.—(a) Details of stock and base. (b) The tinplate shield.

should become broken. The tinplate is bent and fitted as shown in Fig. 2 (b), the shaded portion being cut away. If desired, the stock can be carved to give a comfortable "pistol grip."

To form the base of the blowtorch, a 3in. wire nail is driven through the centre of the 5in. by 3in. by 1in. block of wood and the tip cut off. The nail fits freely in a hole drilled in the stock (Fig. 2a). The torch may thus be used as either a bench or a hand instrument.

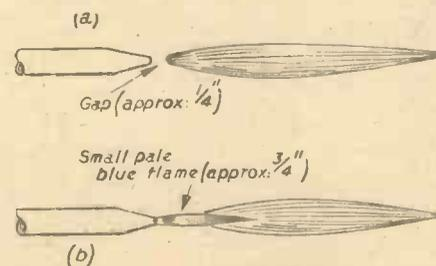

Fig. 3.—(a) and (b) The types of flame produced by the torch.

the velocity of the escaping gas will be too low to produce turbulence, while if the jet is too large, insufficient air will be mixed with the gas and a smoky flame will result.

The reader will find that the usefulness of this instrument quickly repays the few minutes and few pence spent on its construction.

PRACTICAL MECHANICS
HANDBOOK

By F. J. CAMM

12/6, or by post 13/-.

Obtainable from booksellers, or by post from George Newnes, Ltd. (Book Dept.), Tower House, Southampton Street, Strand, W.C.2.

THE general principle of the saw will be familiar to most readers, and care in the making and construction of the various parts will result in a machine that is rigid, yet remarkably flexible. Although primarily designed for coping saws; fret and junior hacksaw blades can be fitted enabling a wide variety of material to be rapidly cut in various shapes. The complete unit is portable and weighs little more than the average sewing machine, but it is capable of cutting in. plywood with ease. The design is readily adaptable to individual requirements, and most of the material needed can be found in the average home workshop.

In describing the various parts all the necessary details are given, but it is taken for granted that each part will be properly finished off and the whole enamelled in appropriate colours. All nut and screw sizes are referred to as Whitworth, but in practice B.A. sizes should be used where they are more suitable, and the fullest use made of spring washers.

Cradle

The cradle (Fig. 1) for the saw frame is made from three pieces, the stand, the horizontal pipe and the spacer, which are screwed together for welding or brazing, the screws afterwards being removed. Care must be taken to get the pieces set up square, as an error at this stage would be very difficult to rectify afterwards.

Make the main support from sheet iron about 1/4 in. thickness. Cut the rectangle 12 1/2 in. by 5 in. and bend to shape in a vice, using a piece of pipe or round wood as a former. If any difficulty is found in turning the flanges, these can be made separately and fixed in position with tap screws. Drill the holes for the holding down bolts, the lamp bracket and the temporary set up screws.

The horizontal piece is 16 in. long and is made from 1/2 in. gas tubing, cut to length and filed square at both ends. Drill and tap two 3/8 in. holes to correspond with the holes in the top of the main support and screw the two pieces together using short tap screws, so that the bore of the pipe is kept clear.

The upright spacer is made from a piece of flat iron bar 7 1/2 in. by 1 1/2 in. by 3/4 in. with a knife edge filed to an angle of 90 deg. at each end. Drill and tap the 1/4 in. and 3/8 in. holes and check each knife edge with a set square to make sure it is at right angles to the sides and parallel across the width of the bar. Screw

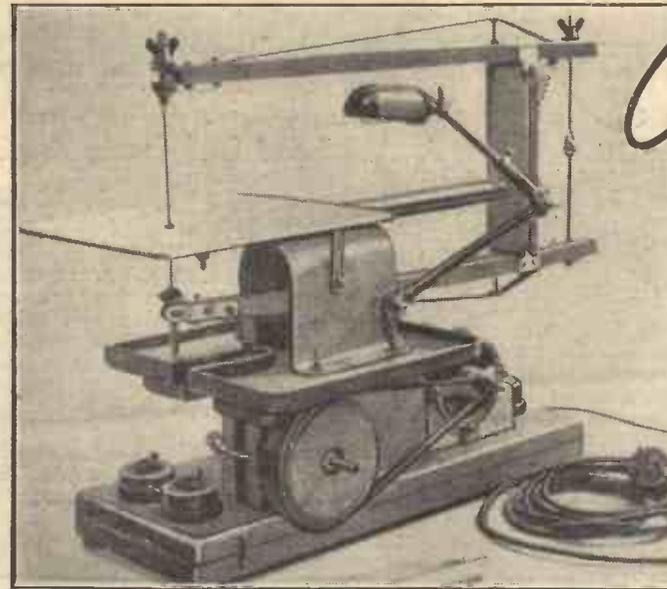

An Elec

Constructional Details

A slot 1/4 in. wide and 1 1/4 in. deep is cut in the centre of the front edge, to clear the saw blade, and four 3/16 in. holes are drilled in the corners of the plate to take the bolts holding the main cutting plate.

Saw Frame

Shape the arms (Fig. 2) from good

General view of the complete machine.

one end of a length of 1/4 in. stud iron into the lower tap hole and pass the other end through the horizontal pipe. Using a square of scrap iron with a 1/4 in. hole in it as a washer, draw the spacer tightly up against the end of the pipe. A double spring washer under the nut will counteract any expansion due to the heat during welding. Two or three small cylinders of wood or adhesive tape are fitted on the stud iron to keep it central in the pipe.

Weld the stand into one complete unit, then remove the stud iron and temporary screws and proceed with the main support for the cutting table. This consists of a 5 in. square of 1/4 in. sheet iron which is held in position on the end of the horizontal pipe by means of two 1 1/2 in. by 3/4 in. countersunk screws. File a flat surface 3 3/4 in. long on the top and bottom of the pipe and drill two 1/4 in. holes right through the plate and the pipe. Bolt the plate in position and check its alignment with the upright spacer. These two must be at dead right angles to each other, otherwise the saw will cut the material at the same angle as the plate. Continue to file the flat surface until the correct angle is obtained, and the plate is recessed flush with the pipe.

quality straight grained timber, preferably beech or sycamore, and sand paper them until a smooth surface has been obtained. Apply two or three coats of linseed oil, allow it to dry well into the wood and finish off with wax furniture polish.

Make the brackets, for the saw blade clamps, from 1/16 in. sheet iron and recess them into

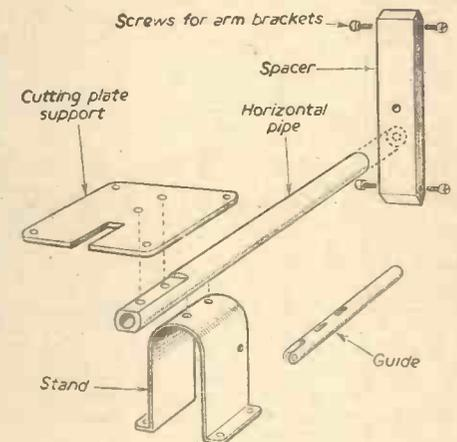

Fig. 1.—Component parts for the cradle.

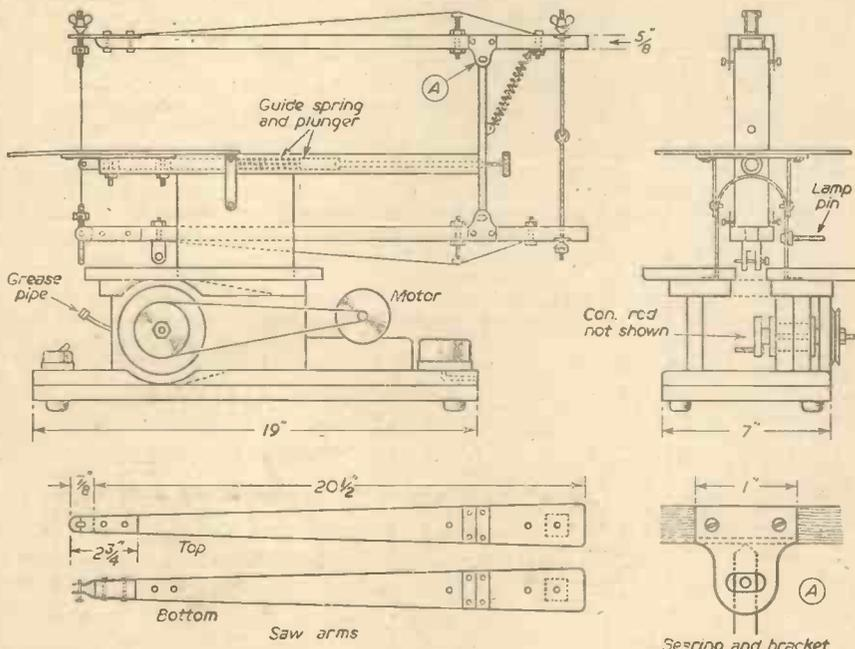

Fig. 2.—Side and front elevations, and details of saw arms and bearing bracket.

the wood. Fasten securely in position with 3/16 in. nuts and bolts (Fig. 3). The bottom brackets are fitted straight and closed together afterwards in a vice, using a piece of 3/8 in. metal as a gauge. Drill a 1/4 in. hole through the two pieces, 3/8 in. from the end, to take the retaining pin for the bottom clamp. In the top bracket drill a 1/4 in. hole and file it into a slot to fit the top clamp.

The main bearings consist of two brass plates let into the arms and fastened with four countersunk wood screws. A light saw cut, across the centre of each plate, fits on the knife edge of the spacer. Make sure the cut is at right angles to the centre-line on the arms, as a small error here will be much greater at the saw blade.

Small brackets are fixed to the sides of arms, at right angles to the bearings and these hold the arms loosely in position. A small tap screw passes through a slot in each bracket and is screwed into the side of the spacer (Fig. 2a). When the frame is in use the brackets clear the sides of the spacer and the 3/16 in. tap screws by about 3/32 in., and do not come into use unless a saw blade breaks.

The tension on the saw frame is maintained by a 3/16 in. round rod which couples together

Electric JIG SAW

a Handy Machine for the Home Workshop

By D. LYONS

the short ends of the arms 1 in. from the back. This rod is made from two pieces, having an overall length of 10 in., after being looped together in the middle and threaded for about 1 in. at each end to take the adjusting nuts. The top one of these is a 3/16 in. wing-nut, but the standard size is rather small for the job and when compared with the 5/16 in. wing-nut on the clamp on the other end of the arm it spoils the general appearance. To keep these nuts uniform, two 1/2 in. wing-nuts were used, one being tapped out 5/16 in. and the other 3/16 in. after being brazed up solid and redrilled.

End Bearings

The adjuster wing-nuts are seated on vee-shaped brass bearings similar in principle to the main bearings, and these add considerably to the flexibility of the frame. Three are

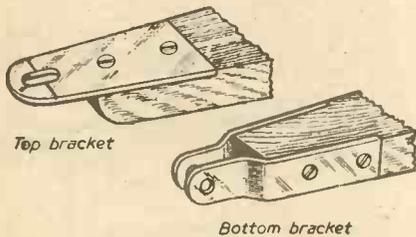

Fig. 3.—Saw clamp supports.

required, two for the back stretcher rod and one for the top saw clamp; they are made from a brass strip 1/2 in. by 1/2 in. cross section. Mark off three pieces 3/4 in. length by cutting with a hacksaw to a depth of 1/16 in. With a punch, mark the centre of each rectangle and drill the three holes. The first two holes are tapping and clearance sizes for the tension rod and the third is 1/2 in. File out the 1/2 in. hole to fit the top saw clamp and tap the clearance hole to fit the bottom of the tension rod. Shape the vee edge with a file, making sure it passes through the centre of the holes. Continue the saw cuts and separate the three pieces from each other. Small squares of 1/16 in. brass drilled and screwed to the arms complete the bearings, a shallow saw cut locating the vee edge and keeping it central. Make the holes in the brass plates about 1/16 in. larger than the diameter of the tension rod to allow for movement.

Saw Clamps

The clamps are 2 1/2 in. long and are made from 3/8 in. screwed iron rod or bolts with the heads sawn off, and large 5/8 in. brass nuts (Fig. 4).

File a flat surface on opposite sides of the rod and with a fine hacksaw cut down its length for about 1/2 in. parallel with the flats. Drill a 3/8 in. hole, 1/2 in. from the end and passing through the cut. Make a further cut in the side of the rod until it runs into the 3/8 in. hole. Clean the slots out with carborundum cloth and try the saw blade for fit. It should slip in easily and the cross pin lie in the remains of the 3/8 in. hole. Make two clamps and in the bottom one drill a series of 1/2 in. holes to allow for adjustment to various lengths of saw blade. This is done by simply withdrawing the pin from the bracket and moving the clamp up or down as required.

Drill through the brass nuts from side to side and tap to take 3/8 in. or other suitable tap screws. When the blade is in position the nuts are run down to cover the slots holding the pins of the saw. The tap screws are tightened against the flat sides of the rod, keeping the nut secure and gripping the blade.

When fitting the top clamp through the bracket, the flat sides should be an easy fit in the hole, but the back and front must be clear, allowing the clamp to swing back and forward on the vee-shaped bearing.

Strut Wires

Two bracing struts of 1/2 in. flat steel tape are fitted to the arms to counteract any excessive bending of the wood when the frame is under tension. The steel ribbon normally used to bind parcels was used for this, but 1/2 in. clock spring would be a good substitute. If this is used, heat the ends to remove the temper before drilling the fixing holes. Drill the holes the same distance apart as the holes in the arms, so that when the tape is fitted it lies flat against the wood. When finally adjusted the tape should rise about 1 in. at the tension bolt. If it is too tight to do this open the holes with a round file until enough slack is

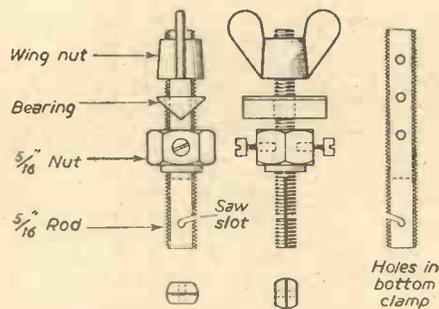

Fig. 4.—Details of saw clamps.

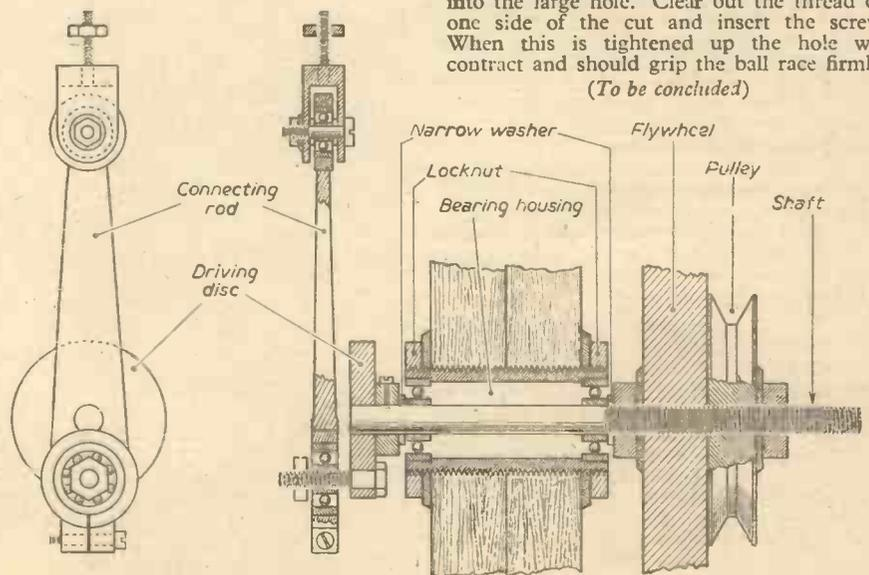
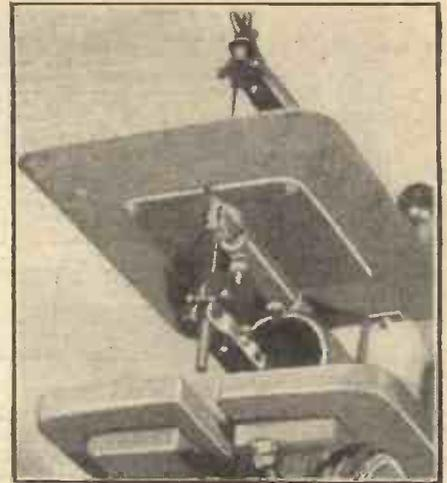

Fig. 5.—Main drive and connecting rod.



Enlarged view of part of the front end of the machine

obtained, but the amount of stretch in the tape is very deceptive so do not be tempted to file too much.

The tension bolts are 3/8 in. tap screws fitted with small brass tips, and inserted between the tape and the wooden arms. A nut and washer holds the screw against the pressure of the tape. To tension the arm, tighten the nut back until the strut is bow tight, and lock the screw in position with a second nut on the other side of the arm. The brass tips are slightly rounded on the top and are fitted to keep the tape central over the screw and spread the pressure evenly over the width.

Connecting Rod

This is made from 1/2 in. mild steel and is fitted with a 3/8 in. ball race at the top and a 1/2 in. ball race at the bottom (Fig. 5). When referring to the bearings these are the shaft sizes, the overall sizes being 1/2 in. and 1 in. respectively. Drill the two holes at 3/4 in. centres and try the ball races for a good fit. Slight looseness in the large hole will be taken up with the pinching screw, but a good firm fit must be obtained at the small bearing. Tinning the hole with solder will make up any slight discrepancy but, of course, this must not be overdone.

Mark out the shape of the connecting rod and cut away the surplus metal with a hacksaw, finishing off with a fine file. Drill and tap the hole for the pinching screw and make the cut into the large hole. Clear out the thread on one side of the cut and insert the screw. When this is tightened up the hole will contract and should grip the ball race firmly.

(To be concluded)

THE SHAPE OF WINGS TO COME

The Reasons for Sweptback Wings and the Problems Which They Introduce. Delta, V and Crescent Wings, and Possible Shapes for Supersonic Speeds

By DAVID KEITH-LUCAS, B.A., M.I.Mech.E., F.R.Ae.S.

(Concluded from page 376 of the June issue)

THE conclusion which can be drawn is that there is a strong case for the delta wing in the smaller sizes and especially when the sweepback is 60 deg. or more. On very large aircraft of, say 200,000lb. and upwards the delta becomes uneconomical and a V wing probably with strut mounted engines is then the obvious choice.

At intermediate sizes around 100,000lb. the choice is not so simple and the best solution may be a V wing, with engines buried in the wing roots, which can be enlarged if necessary, as on the Valiant.

thin because the wing will then be working in pure supersonic flow where the drag penalty for thickness is great. It seems that before long we shall be forced to use thickness : chord ratios as low as 3 per cent. and 4 per cent. and the wing will, therefore, have to be of small aspect ratio in order to be sufficiently stiff and strong. I imagine that it will be worthwhile to provide just sufficient sweepback to overcome any tendency to wing divergence.

We therefore arrive at the two alternative planforms shown in Fig. 18.

Of the two solutions the one using acute sweepback is theoretically preferable. There is always the possibility of wanting to fly at lower speeds when climbing, manoeuvring or if damaged in combat, and it is well not to have to worry about forbidden speeds at which the drag is high and there are uncomfortable trim changes.

The Landing Problem

One of the big problems will be to get such highly swept wings to give adequate lift at low speeds. There are also likely to be some difficulties with longitudinal and lateral stability.

It has been said that the hardest part of designing a supersonic aircraft will be to make it fly slowly, and it is probably true if the designer allows very little compromise with high-speed performance.

Take-off may present a problem, but the thrust necessary to fly at very high speeds is likely to be adequate for unassisted take-off unless the wing lift is very poor or the wing loading is very high.

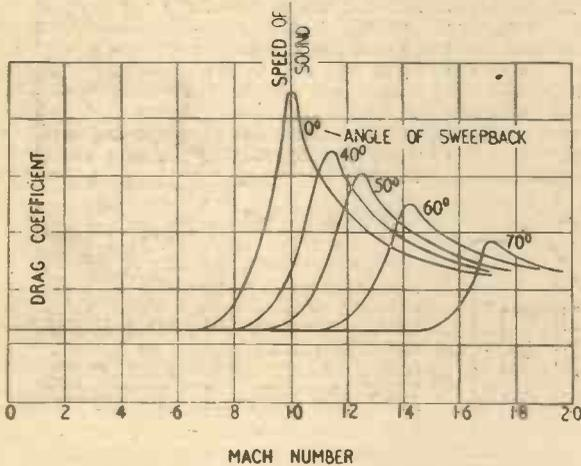

Fig. 17.—The general effect of sweepback on the drag of an aerofoil at high mach numbers.

Supersonic Shapes

The drag coefficient of an aircraft wing is almost constant at subsonic speeds, but peaks up to a very much higher value at transonic speeds and then settles down again to an intermediate value at supersonic speeds. The precise values are not easily obtained because the ordinary wind tunnel techniques break down at transonic speeds. The effect of sweepback as we have already seen is both to reduce the drag rise and to delay it to higher speeds. Fig. 17 shows the sort of pattern we get for wings of various angles of sweep.

As an example let us take a mach number of 1.6 and we see that the wing with the lowest drag is that with the greatest sweep, but the next lowest is a straight wing.

For very high speeds where the degree of sweep required would be impracticable it may, therefore, be better to have no sweep at all. Put another way, we must either have enough sweep to delay the compressibility troubles to speeds beyond the range in which we are operating or else we can hurry on the troubles by using no sweep at all so that all is well again at the operating speeds. What we must not do is to fly in the troubled region of mixed subsonic and supersonic flow. If we favour the straight wing we must make it very

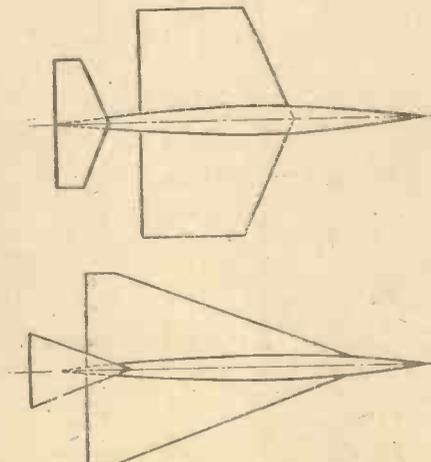

Fig. 18.—Possible planforms for supersonic aircraft.

If it is not good enough the take-off can always be assisted by catapulting or by quick burning rockets. If even these are not sufficient, we can return to the principle of air-launching from a parent aircraft in the manner that was pioneered by Short Brothers at Rochester and has subsequently been used for supersonic research aircraft in America.

The real problem is likely to be in landing where these aids cannot so readily be used.

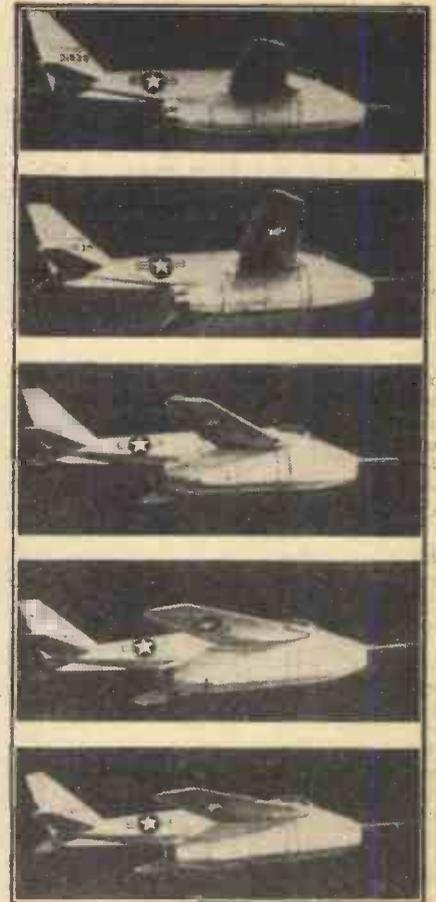

Fig. 19.—Bell X5 aircraft showing the process of sweeping the wings in flight.

Here then is a challenge—all sorts of mad ideas come to mind. Should we "unsweep" the wings for landing as on the experimental Bell X5 in which the wings are pivoted about a vertical hinge at the root so that the angle of sweep can be varied in flight? (See Fig. 19.) It may be the answer although it is bound to introduce a penalty in weight and possibly in drag, too, but it can be done as proved by the Bell X5 and by the Westland-Hill Pterodactyl MkIV which flew as long ago as 1931. Birds often use this technique, but nature can make moving joints with much less weight penalty than we can and without having to consider the maintenance aspect in quite the same way.

The engine thrust to achieve the supersonic speeds must be at least comparable to the weight of the aircraft so we might possibly swivel the engines round to give lift instead of propulsive thrust. It sounds a bit complicated and the control problems are sure to be very involved, but it might be worth trying.

Perhaps the best way out of this difficulty is to avoid it altogether which we could do if we arranged for the high-speed aircraft to link up with a parent aircraft in flight, using a technique similar to flight refuelling. This is not a very happy idea as we must be absolutely sure that the parent never

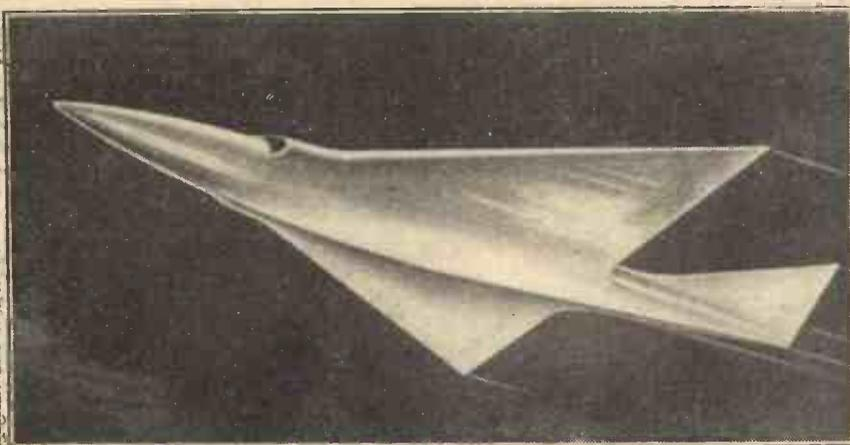

Fig. 20.—Proposal for a supersonic flying boat.

goes unserviceable while its chicks are on a mission and, moreover, that it never falls a victim to enemy attack.

We might even consider stopping the aircraft in flight by air brakes and forward-firing rockets and then letting it down on parachutes or by a retractable rotor as a helicopter. It is obviously impossible to do the helicopter scheme without fantastic complication and the parachute would be much too bulky to stow without severe drag penalty.

We may then be forced to put up with the high landing speeds by using arrester gear. This, at least, is a practical suggestion, but it would involve great cost in runways and arrester gear.

Alternatively, we might put up with the high landing speeds if we make the aircraft into a flying boat and land on water. Ernest Stout has suggested an aircraft of this type which appears to have very little more drag than an equivalent landplane and the water will certainly provide the necessary braking force smoothly and effectively. Fig. 20 shows how such an aircraft might look and we may be able to improve upon it still further by the use of hydro-skis instead of the planing bottom. It is one of my ideas of the shape of wings to come but, in spite of my faith in the future of water-based aircraft, I believe that there will always be a need for landplanes and an alternative solution applicable to landplanes will have to be found.

Atomic Power

Our discussion, so far, has been about the foreseeable development of fixed-wing aircraft using the types of propulsion which are already familiar to us. We have not even considered helicopters or guided missiles. Just around the corner are much more exciting things like space ships, artificial satellites and atomic-powered air liners. It is very tempting to plunge into speculation as to the shape of these future craft, but it is doubtful whether there is any value in doing so until our knowledge is on firm enough foundations to support the structure of a logical argument.

The atomic-powered air liner might be a possibility to-day, but it would have to be extremely large and would probably be uneconomical on account of the enormous weight of the screening necessary round the reactor unit. We could argue from that single premise that the aircraft ought to be a flying boat because of the high landing weight which, on a landplane, would mean a heavy undercarriage and the need for airfields with exceptionally long runways capable of taking very heavy loads. All of this is an expense which the tax-payer would be glad to dodge. The reactor unit and

engine would be in the hull of the boat and the passengers would have to be housed in the wing or in the wing tip floats.

We could now prepare a sketch of the

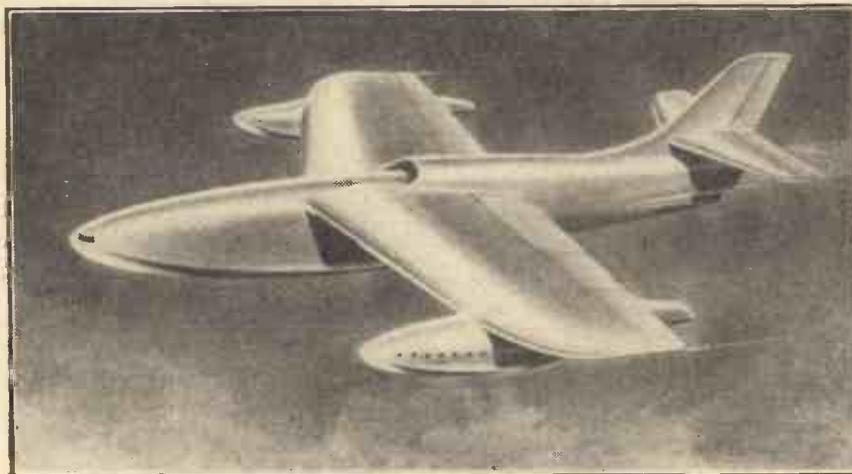

Fig. 21.—An atomic-powered flying boat—an impression of what it may look like.

atomic-powered flying boat, but it would not be altogether convincing because it would strike us as old-fashioned (see Fig. 21). We have, indeed, been applying the old arts of aircraft design to a new form of propulsion whereas a much more radical approach

is needed. The jet fighters of to-day are not the Spitfires or Hurricanes of yesterday with new engines in them, but are of new shapes to suit the new conditions. What shape the atomic-powered aircraft will be is a subject deserving much thought when we know enough about the characteristics of the engine. Will the engine really weigh so much or will we again find that what we thought was fundamental is no more than a passing phase? Somehow, it seems unlikely that the atomic-powered aircraft will look old-fashioned. It will come as a challenge and a stimulus to new research in structures and aerodynamics, but this time Britain must lead and not wait to pick up the threads from a narrowly defeated enemy. There must, therefore, be a close understanding between the atomic research establishments and the aircraft industry. Unnecessary secrecy will deprive the country of the chance to lead in the atomic age.

Acknowledgments

I should like to express my appreciation to Mr. C. H. R. Griggs, who is responsible for the artist's impressions of future types.

BOOKS FOR ENGINEERS

By F. J. GAMM

Screw Thread Tables, 5/-, by post 5/3.

Refresher Course in Mathematics, 8/6, by post 9/-.

Gears and Gear Cutting, 6/-, by post 6/6.

Workshop Calculations, Tables and Formulæ, 7/6, by post 7/10.

Dictionary of Metals and Alloys, 10/6, by post 11/-.

Wire and Wire Gauges (Vest Pocket Book), 3/6, by post 3/9.

Screw Thread Manual, 6/-, by post 6/6.

Practical Mechanics Handbook, 12/6, by post 13/-.

Newnes Metric and Decimal Tables, 3/6, by post 3/9.

Newnes Electrical Tables and Data, 10/6, by post 11/-.

Slide-rule Manual, 5/-, by post 5/3.

Mathematical Tables and Formulæ, 5/-, by post 5/3.

Newnes Plastics Manual, 17/6, by post 18/2.

Published by

GEORGE NEWNES LTD., TOWER HOUSE,
SOUTHAMPTON STREET, STRAND, W.C.2

Building a POLARISCOPE

An Efficient and Practical Instrument for Experimenting with Polarised Light

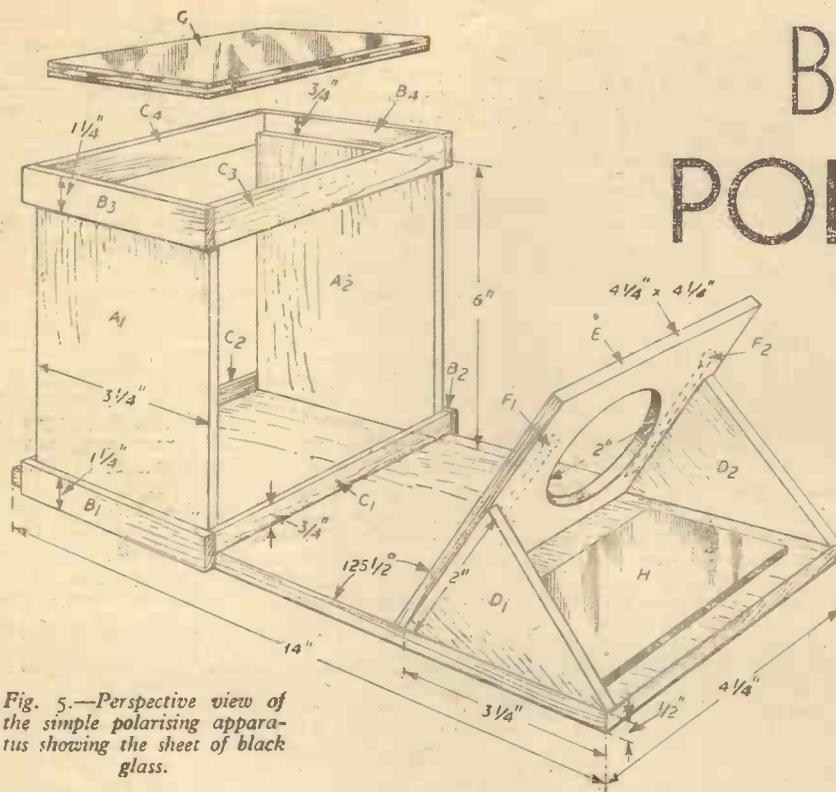

Fig. 5.—Perspective view of the simple polarising apparatus showing the sheet of black glass.

two halves as shown, and after polishing the faces of cleavage as well as the outer faces, rejoined them to form a prism as shown at ABCD. The joined faces at AD were cemented with Canada balsam, which formed, within the prism, a surface capable of reflecting the "ordinary" ray out through the side of the prism (see EFG), while the "extraordinary" ray was permitted to travel on through the whole prism emerging as depicted at EH, and now constituting a ray which could vibrate in one plane only, otherwise polarised light.

Now for a very remarkable effect. If two of these Nicol prisms are placed end to end and looked through in the direction of a source of light, they appear perfectly clear and transparent while their axes are in the same plane, but if one of them be rotated till its axis is at right angles to the other, we will find, on looking through them, that the light, however powerful, has totally disappeared, just as though it had been extinguished.

The Explanation

Fig. 4 gives an illustration of the reason for this seemingly magical phenomenon. If two grids of wire with very fine gaps between the bars are placed with both sets of wires running in the same direction and parallel, we can see through them, but if one is turned at right angles to the plane of the other, the part where they overlap seems solid. This is roughly what has happened in the case of the two prisms. The first one has stopped all light except that travelling in a horizontal plane; when we rotate the second it is in a position to pass only light in the vertical plane, but there is none to pass (having been screened out) so the result is no light at all!

When two prisms are used in this manner the first is termed the "polariser" and the second the "analyser." This combination, with certain additions and refinements, constitutes the instrument known as the "polarimeter," a device of great service in laboratories and particularly valuable in the sugar industry, for sugar has a peculiar pro-

AS nearly everyone knows, white, or "ordinary" light consists of a mixture of all the colours, violet, blue, green, yellow and red, as shown in Fig. 1, and when light falls on an object which absorbs or passes all waves except one, that particular one becomes visible to the eye and we say the object is blue, red, or whatever colour applies. So much for what is quite elementary knowledge. What is not so clearly understood, however, is that substances which we term "transparent," actually do offer a certain amount of resistance to the rays of light, so that the normal speed of light—which, in the open air is about 186,282 miles per second—is materially slowed down where it passes through glass, crystal, celluloid, water, or any other transparent substance. Everyone has, at one time or another, noticed that if a straight rod is put into clear water, it appears as though it were bent at the point where it breaks the surface. This "bending" applies also to a ray of light falling obliquely on a transparent object, but the short, or violet rays are bent more than the long, or red rays, and it is because of this peculiarity that light, passing through a prism or bevel glass, is seen spread out into the familiar rainbow spectrum. This progressive bending of light is known as refraction, and is the basis of all optical science.

Now, while all transparent substances refract light, there are some which do so in a most unusual manner, dividing the beam into two distinct rays, one of which is refracted in a much greater degree than the other. The ray which is refracted in the usual way is known as the "ordinary," while the second, whose degree of refraction is variable, is termed the "extraordinary" ray. The two most usual substances used to produce this effect are Iceland Spar (which is crystallised carbonate of lime) and Tourmaline, the former being far more commonly used.

If a crystal of this spar be placed over a figure, design, or other mark on paper, the image seen through the spar will distinctly

double, as shown in Fig. 2, where the effect is demonstrated utilising the first two letters H and O. If a dot be made in ink and viewed in this manner, two distinct dots are seen, and if the spar be rotated the second dot will appear to travel round the first, just as the moon appears to encircle the earth, while first one, then the other, of the dots will alternate in shade from dark to light.

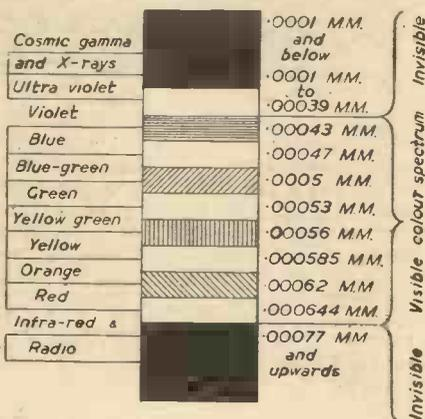

Fig. 1.—The visible and invisible spectrum with types of rays and approximate wavelengths in mm.

Polarising the Light

The phenomenon just described is the basis of the Polariscopes, and it is by adapting the principle in such a way that one type of ray is discarded, or thrown out during its passage through the prism, that we are able to project a light ray which is moving, or vibrating in one plane only. In other words, instead of the light radiating in all directions like the spines on a cactus, it is made to radiate in one plane like the ribs of a fan.

To produce this effect, a very eminent optician named Nicol evolved a special prism which is shown in diagrammatic form in Fig. 3. He cut a crystal of Iceland Spar into



Fig. 2.—Diagram to demonstrate the "double ray" of such crystals as Iceland Spar, Tourmaline, etc. At "A" the letters Ho are viewed through a piece of such spar and show a double image. At "B" the letters are seen through a piece of ordinary glass.

RADIOGRAM CHASSIS (WITH FREE GIFT OF AN 8in. P.M. SPEAKER AND/OR SPECIAL REDUCTION TO 12/6 FOR A 10in. P.M. SPEAKER).

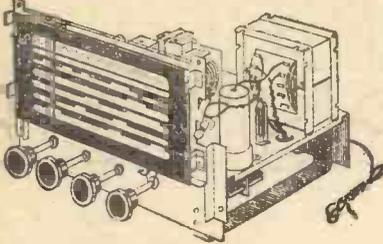

Absolutely brand new, and unmarked. Originally designed for the export market, and exactly as fitted in radiograms costing over £100. It has six wave-bands, and a six-position tone control. All knobs engraved, negative feed-back, and fly-wheel tuning. 11-115 metres in five ranges, and medium wave 188-550 metres. Our special PRICE, £15.15.0 and carriage FREE. Also the Home Market model with long, medium and short bands. Gram. switch position and pick-up sockets.

Our PRICE £10.17.6, carr. 4/5. Both chassis measure 11½in. x 7in. x 8½in., and with valve line-up 6BE6, 6BA6, 6AT6, 6BW6, 6X4. Modernise your set now.

RADIO TELEPHONES

Brand-new transmitter/receiver. 53-75 mc/s. Visual range. Complete in canvas carrying case and individually boxed in heavy transit case. Works off set of dry batteries or a vibrator from a 12-volt accumulator. Batteries or the vibrator stow inside the unit. Supplied less batteries and vibrator at Special Price of £9.17.6 or £18.17.6 a pair. Carriage 5/6 each. Vibrators 37/6 each.

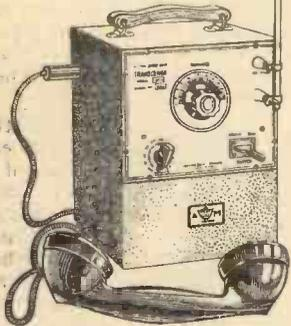

C.O.D.
or
C.W.O.

VALVES

SALE PRICE 8/9 EACH

- 35Z4, 10P13, 20D1, 20F2, X66, 1S4, 1S5, 1R5, 1T4, EF91, 10F1, 6F15, EL91, L63, UAF42, X113, X143, DN143, PZ30, EF39, 6K7, EAF42, ECC91, UM4, EF80, 6A8, 12K8, 3V4, 807, 50L6, 6F6, 3B34, 6Q7, EF36, 6SA7.

6 VALVE SUPERHET. V.H.F. RECEIVER FOR 7/6.

Ex W.D. brand-new condition. 6 channel switching. Receives T.V. and most British and Continental Stations including Police, Fire, Taxis and Amateurs: 30.5 to 40 mc/s. I.F. 7 mc/s. 6 Valves. H.T. 200 Volts at 50 mA, L.T. 13 volts. As the valves have been available ex-W.D. at low prices we are offering the chassis less valves. Complete with valves, 17/6. Post 2/9. As a Ba-gain break-up unit it contains the following: 30 ceramic trimmers, 6 ceramic v/holders, 3 Westector rects., 2 transformers, 1 double block condenser, 32 condensers (small), 36 resistances (½ to 1 Watt), 5-bank Yaxley 6-way switch, 3 coils, 3 I.F.'s, 6 v/cans and covers Ideal neat chassis, etc.

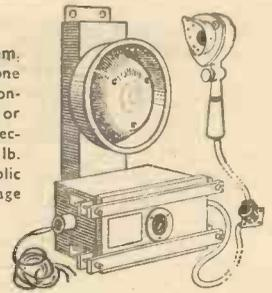

LOUD HAILER. Powerful P.A. system. Brand new, and consists of microphone and combined amplifier/speaker. Iron-clad and waterproof. Works off 12 or 24 volts, therefore independent of electricity failures. Total weight 20 lb. As used by Police and other Public Companies. Our Price £8.17.6, carriage 5/6.

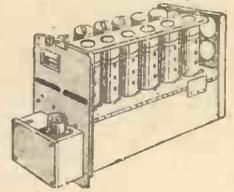

MAINS TRANSFORMERS. Unused. Primary auto-wound and tapped 0, 205, 225, 245 and 300 volts at 200 mA. Secondary 5 volts, 2 amps, and 6 volts, 7 amps. PRICE, 12/6. Post 2/-.

TELEPHONE HANDSETS. Standard inter-communication type. Complete with dial and bell. Works off A.C. or D.C., 27/6 each. Post 2/-.

LOCATING DEVICE. Made by Truvox. Still in maker's boxes. Ideal burglar alrms. Bell works off 4½ volts. Recommended for use with our nickel-chrome wire. 27/6. Post 2/6.

TELESCOPIC MASTS. Ex-W D., but brand-new condition. Dural. Extend to 7ft. 6in. Ideal aerials, etc. 7/9. Post 1/-.

WIRE. Nickel-chrome, .014in. (50 yards) and .032in. (25 yards) in sealed tins, with run-out mechanism. 4/6 per tin. Also spring steel wire (same sizes) at 1/- per reel.

ACCUMULATORS. New. Lead acid. 2 volts, 14 a/H. 1½in. x 1½in. x 6in. PRICE 4/6. Post 1/-.

MICRO SWITCHES. Brand new American midgets. 250 volt, 3 amps. 5/- each.

O. P. TRANSFORMERS. Store soiled. Match all normal O.P. valves to 2-5 ohm speech-coil. 1/9. Post 6d.

TUNING CONDENSERS. Store soiled. Two gang, .0005 mfd. Tested. 2/9. Post 6d. Special offer, 3 for 7/-.

STAMP FOR COMPLETE CATALOGUE

**DUKE & Co., 621, ROMFORD ROAD, LONDON, E.12
GRA. 6677**

**MONEY BACK
GUARANTEE**

TAKE MY TIP—insist on

and be sure of
Craftsmanship
and Quality

126. 'G' CRAMP

186. B.
MECHANICS' VICE

189.
WOODWORKERS' VICE

186. E
FITTERS' VICE

104. STEEL SASH CRAMP

No workshop or handyman's bench is complete without a quality vice. When seeing your dealer, ask for WODEN Tools by name. He will be pleased to sell you "WODEN" because, in his experience, he knows that they are second to none for accuracy and perfect finish.

**THE STEEL NUT & JOSEPH HAMPTON LIMITED
WODEN WORKS WEDNESBURY PHONE DARLSTON 331**

THIS PRECISION-BUILT POWER-PLANER
gives 12,000 cuts
per minute

**MYFORD
P11 BENCH PLANER**

Planes—rebates—bevels up to 4½in. wide. High-speed 3-blade rotor gives 12,000 cuts per minute. Entirely new, precision-built throughout. Produces rebates for door and window frames; square tapered cuts for furniture legs, lamps, etc. Only £17.10.0 and the finest 4½in. Bench Planer obtainable. Overall length 38in.

Send now for Publication 1100.

**MYFORD ENGINEERING COMPANY LIMITED
BEESTON · NOTTINGHAM · Phone: 54222 (3 lines)**

Build it yourself with these

CLASSIC EXAMPLES

OF TO-DAY'S OUTSTANDING HI-FI EQUIPMENT

Everything for the Quality Specialist

CASH OR EASY TERMS

ALL TAXED STOCK AT NEW REDUCED P.T. RATES

A Selection from our Stocks of TAPE RECORDING EQUIPMENT

Wearite Tape Deck	£35.0.0
Bradmatic Tape Desk	£42.0.0
Truvox Tape Desk	£23.2.0
Lane Tape Desk	£17.10.0
Simon 1A	£83.0.0
Scophony	£65.0.0
Vortexion	£84.0.0
C.J.R. Portable	£119.10.0
Quad Tape R.	£16.16.0
Bradmatic Circuits	5.0
Bradmatic 6 RP Heads	£3.15.0
Bradmatic 5 RP Heads	£3.5.0
Bradmatic 5E Erase Head	£3.5.0
Spare Spools, 600 ft.	...	4s. 6d.:	1,200 ft.	...	6.6
Tapes, G.E.C., Scotch Boy or E.M.I.	£1.15.0

GRUNDIG, VORTEXION, E.M.I., WIREK, etc. MICROPHONES, etc.

See them in our new Recorder Showrooms

FULL RANGE OF AMPLIFIERS, including

Rogers Baby de Luxe	£23.10.0
Decca P.A.6	£18.18.0
Goodsell Williamson	£33.5.0

Also DECCA, LEAK ROGERS, SOUND SALES, etc.

SPEAKERS, including

Goodmans 101 8 in.	£6.12.3
Tannoy Duo Concentric 15in.	£33.10.0
Wharfedale 10in. Golden	£7.14.0

MOTORS, PICK-UPS, including

Garrard RC75A	£15.13.0
Decca GU4	£9.5.0

Send for full lists. We also specialise in large-screen TV.

THE CLASSIC ELECTRICAL CO., LTD.

352/364, LOWER ADDISCOMBE ROAD, CROYDON, SURREY.

Telephone: ADDISCOMBE 6061-6062.

E.D. DIESELS FOR YOUR MODELS



E.D. 46 BABY

Specification: Bore 1/2 in. R.P.M. 9,000-12,000. Height 1 1/2 in. Stroke 3/8 in. cu. capacity 0.45 c.c. B.H.P. 0.04. Weight 1.4 oz. with tank. Length 2 1/2 in. Width 1 1/2 in. Fuel Control placed at 30 deg. for easy access.

Price £2.12.3

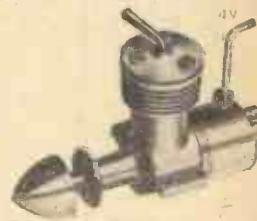

E.D. 1 c.c. (BEE)

A compact little motor with an overall height of 2 1/2 in. Weight 2 1/2 oz. Bore 0.437 in. static thrust 12 oz., stroke 0.400, r.p.m. 7,000 plus.

Price £2.14.7

E.D. 3.46 c.c. HUNTER

Developing 10,000 r.p.m. the three-forty-six is one of the finest engines for control-line and stunt flying. Stroke 0.625 in., height 3 in., width 1 1/2 in., length 4 1/2 in., weight 5 1/2 oz.

Price £3.18.5 (Watercooled, £5.9.3)



E.D. 2.46 RACING ENGINE

Specially designed for use as a diesel, glo-plug or spark ignition engine, the 2.46 develops over 1/2 h.p. at 14,000 r.p.m. plus. Total weight 5 oz. Price £3.18.6 (Watercooled, £5.9.3)

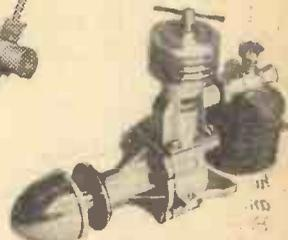

E.D. 2 c.c. COMPETITION SPECIAL

Gives 23 oz. static thrust and incorporates vernier compression adjustment. Height 3 in., width 1 1/2 in., length 4 in., weight 5 1/2 oz. Price £3.1.9 (Watercooled, £4.10.3)

ORDER THROUGH YOUR MODEL SHOP

E.D. ELECTRONIC DEVELOPMENTS (SURREY) LTD.

1223 18, VILLIERS ROAD, KINGSTON-ON-THAMES, SURREY, ENGLAND.



BENNETT COLLEGE can help you to

success through personal postal tuition

THOUSANDS OF MEN in important positions were once students of The Bennett College. They owe their success to Personal Postal Tuition—The Bennett College way. You have the same chance to qualify for a fine career, higher pay and social standing.

One of these courses will lead to your advancement

- | | | |
|-------------------------|-------------------|---------------------|
| Accountancy Exams | Shorthand | Mathematics |
| Auditing | English | Public Speaking |
| Book-keeping | General Education | Police Subjects |
| Commercial Arithmetic | Geography | Salesmanship |
| Costing | Journalism | Secretarial Exams |
| Modern Business Methods | Languages | Short Story Writing |



SEND TODAY for a free prospectus on your subject. Just choose your course, fill in the coupon and post it.

- | | | |
|------------------------|---------------------------|---------------------|
| Agriculture | Engineering Drawings | Road Making |
| Architecture | Forestry | Sanitation |
| Aircraft Maintenance | Locomotive Engineering | Sheet Metal Work |
| Building | Machine Design | Steam Engineering |
| Carpentry | Mechanical Engineering | Surveying |
| Chemistry | Mining | Telecommunications |
| Civil Engineering | Motor Engineering | Textiles |
| Commercial Art | Plumbing | Wireless Telegraphy |
| Diesel Engines | Power Station Engineering | Works Management |
| Draughtsmanship | Press Tool Work | Workshop Practice |
| Electrical Engineering | Quantity Surveying | and many others |
| Electric Wiring | Radio Engineering | |

To THE BENNETT COLLEGE (Dept. G. 76), SHEFFIELD

Please send me free your prospectus on:

SUBJECT.....

NAME.....

ADDRESS.....

.....AGE (if under 21).....

PLEASE WRITE IN BLOCK LETTERS

GENERAL CERTIFICATE OF EDUCATION : R.S.A. EXAMS.

perty of rotating or twisting the polarised ray, and this fact is turned to account in the testing of the various types of sugars.

Colour Displays of Amazing Beauty

The most commonplace objects, when viewed by polarised light, acquire a coruscating variety of dazzling prismatic colours

reproduce with the faintest approach to fidelity. Actual crystals, splinters of glass or pebble, thin slivers of ores of rock; in fact, almost any substance, will yield the most amazing results, while a small piece of mica or talc will be a positive revelation, changing as it does its entire colour scheme as the flexible material is bent or pressed.

the instrument are, to a very great extent, dependent on the angle of $54\frac{1}{2}$ deg. being as nearly exact as possible.

The bundle of old glass plates (which must be thoroughly clean) may be from six to nine in number, as thickness varies. These plates are simply dropped into the opening formed by B₃, B₄, C₃ and C₄, and rest on the upper edges of A₁ and A₂.

The rays of light (natural or artificial) fall on the square of black glass (H), and are reflected through the object under examination, this being clipped into place on the stage (E). The rays then pass to the glass-plate bundle, which here does duty for the more expensive Nicol prism, and the effect is viewed by looking down on the glass plate which is uppermost. The box-like carrier has been arranged to slide along the baseboard, so that the best position may be found before it is fixed, and also to allow for adjustment in case the all-important angles of the subject-carrying stage should not be quite exact. This instrument is, of course, a polariser only.

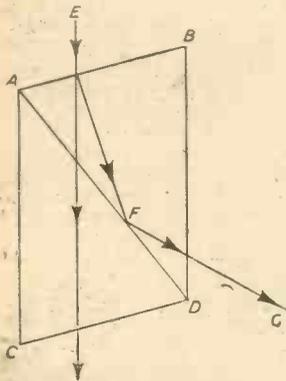

Fig. 3.—Diagrammatic sketch of Nicol's prism. A crystal of Iceland Spar is cut in two halves as shown at AD. The faces are polished and cemented together again with Canada Balsam. The paths of the ordinary and extraordinary rays are shown by the arrows. The pile of glass plates in Fig. 5 takes the place of this somewhat expensive prism.

which is almost beyond description, and which must be seen to be believed. A few drops of a solution of such common substances as salt, sugar, borax, soda copper sulphate, and a hundred other everyday compounds, will, if placed on a glass slide and viewed by this magic light, reveal a positive unearthly beauty of kaleidoscopic and ever varying colours which no photographic or colour-printing process could ever hope to

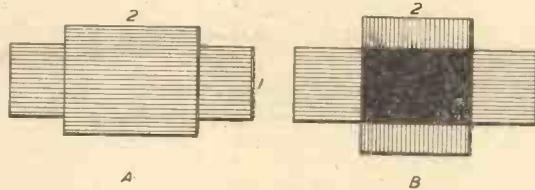

Fig. 4.—Two clear prisms, but light cannot pass! The polariser allows light to pass in one plane only. At "A" both prisms are in the same plane, so light passes through both without impediment. At "B" prism No. 2 has been rotated to the vertical plane and, as No. 1 prism has already stopped the passage of vertical rays, the overlapping prisms show total darkness, though each is quite transparent. The illustration shows the parallel case of two very fine wire grids.

Making a Polaroscope

The professional instrument is a luxury quite beyond the average pocket in these days, but there is no reason why readers should not share in the wealth of beauty and colour available.

Fig. 5 shows a very simple, yet quite efficient, apparatus which can be made from odds and ends found in most workshops. The only item which need be bought specially is the square of black glass, and this can be obtained quite cheaply from any good glazier. Ordinary "mirror" is not recommended. The construction is perfectly simple and straightforward, and the drawing is practically self-explanatory. The greatest care should be exercised in cutting the triangular pieces D₁ and D₂, for the optical properties of

List of Materials

- A₁, A₂.—2 pieces of $\frac{3}{8}$ in. wood, each $3\frac{1}{4}$ in. by 6in.
- B₁, B₂, B₃, B₄.—4 pieces of $\frac{1}{4}$ in. wood, each $3\frac{1}{4}$ in. by $1\frac{1}{4}$ in.
- C₁, C₂.—2 pieces of $\frac{1}{4}$ in. wood, each $4\frac{1}{2}$ in. by $\frac{3}{4}$ in.
- C₃, C₄.—2 pieces of $\frac{1}{4}$ in. wood, each $4\frac{1}{2}$ in. by $1\frac{1}{4}$ in.
- D₁, D₂.—2 pieces of $\frac{3}{8}$ in. wood, each 2in. by $3\frac{1}{4}$ in. with contained angle $52\frac{1}{2}$ deg.
- E.—1 piece of $\frac{3}{8}$ in. wood, each $4\frac{1}{2}$ in. by $4\frac{1}{2}$ in. with centre hole, diameter 2in.
- F₁, F₂.—2 spring strips screwed at one end (to grip slides).
- G.—1 pile of six cleaned photographic $\frac{1}{4}$ plates ($3\frac{1}{4}$ in. by $4\frac{1}{2}$ in.).
- H.—1 square of black glass about 3in. square.
- I.—1 baseboard of $\frac{1}{2}$ in. wood $4\frac{1}{2}$ in. by 14in.

A Calendar Clock

By W. H. SHEPPARD

How to Make a Mechanical Calendar

ALL readers know that the long hand of a clock revolves 12 times to one of the short hand and it occurred to the writer that as there are 12 months in the year a clock mechanism might be used to give simultaneous readings of days and months.

To make a calendar like that shown in the accompanying drawing, take any old clock in which the gear train between the two hands works satisfactorily, and measure the size of the dial. Then mark out a dial like that on the drawing. In this case the outer circles are on a 5.2in. pitch circle diameter, each small circle being $\frac{1}{2}$ in. dia. Other sizes would be in proportion. Now remove the clock mechanism from the case; remove the hands; paste the calendar dial over the old one; replace the hands and replace the mechanism in the case. When replacing the hands on their spindles, take care to register both in the 12 o'clock position. Now turn the hand adjusting knob until the hands point respectively to the day and month. Each day turn the large hand to the next day until the number of days in the month indicated is reached, and the following day advance to "1." The small hand will follow automatically and indicate the month.

Refinements

More ambitious readers may care to experiment with a ratchet and plunger on the adjusting knob or an electric solenoid to work from a press switch; alternatively, the calendar-clock may be made fully automatic by a 64:1 reduction gear (in 2 steps of 8:1) from a mains unit (i.e., for 50 c.p.s. — suitable adjustments for other frequencies). The simple calendar described has, however, served the writer satisfactorily for several years.

How to mark out the dial.

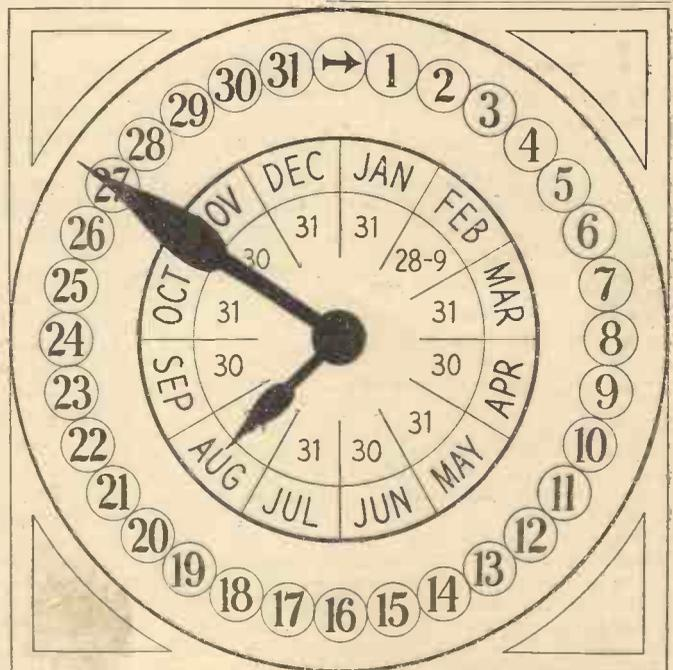

LETTERS TO THE EDITOR

The Editor does not necessarily agree with the views of his correspondents.

SIR,—Re Mr. W. J. Land's letter (PRACTICAL MECHANICS, April) concerning the heating of a space ship due to solar radiation, I feel there are one or two points that need answering.

As is well known, heat may be transmitted by three effects—convection, conduction and radiation. In a vacuum flask these are reduced to a minimum by its construction (see diagram) because:

(1) Glass is a poor conductor of heat (about $\frac{1}{1,000}$ as efficient as, say, brass), and so loss of heat from the flask by conduction through the walls is slow.

(2) Convection cannot occur since there is a vacuum between the walls, and thus no medium to carry the heat. A little can occur through the neck when open, but the loss is also very small.

(3) The walls are silvered on the vacuum sides to reduce losses by radiation, and this is the point where Mr. Land makes an error. Heat may be transferred across the vacuum by electro-magnetic radiation, similar to visible light in every way, except that it has much longer wavelengths. Now, Kirchoff's

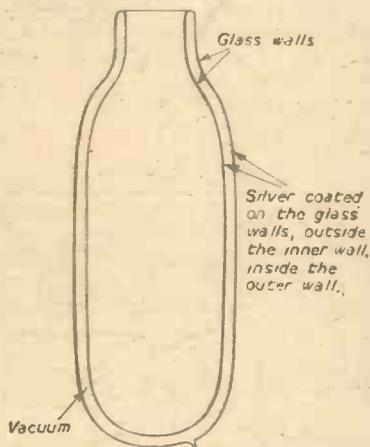

Diagram of a vacuum flask.

Law of Radiation says that, to put it loosely, the more light a body reflects the less heat it will radiate. Thus, a silvered surface, reflecting some 90 per cent. of the light incident upon it, will be a very poor radiating surface, and so the loss of heat across the space between the walls of a vacuum flask is very slow.

The sun, separated from us by a good vacuum, transfers heat to us purely by radiation. Now, a space ship out in this good vacuum, will radiate heat itself, almost as fast, if not faster, than it receives it; hence the rise in temperature of the interior of the ship would be very slow indeed. It must be remembered that at any time rather less than half the surface area of the ship would be exposed to solar radiation, whereas all the surface would be radiating heat away. However, the temperature of the ship might tend to rise, and I estimate that, for a reasonable size of space ship, it would take about

2-3 months to reach red heat when at the same distance from the sun as is the earth. The rise in temperature is so slow that modern refrigeration techniques would take care of it quite easily; designers would probably put the heat to some useful purpose.

With regard to meteorites, they do not "burn" in the earth's oxygen, but are raised to incandescence and vaporise from the heat of atmospheric friction due to speeds of some 70 miles per second. Under these circumstances it would not matter overmuch if they were red-hot or not before arrival.—M. GADSDEN.

Simple Electric Alarm

SIR,—The following simple electric alarm device may interest other readers. I converted an old clock which had no alarm spring in it by making the alarm trip lever make contact with an insulated piece of thin strip brass, when it would normally have set off the alarm which had originally been installed in the clock. This method has

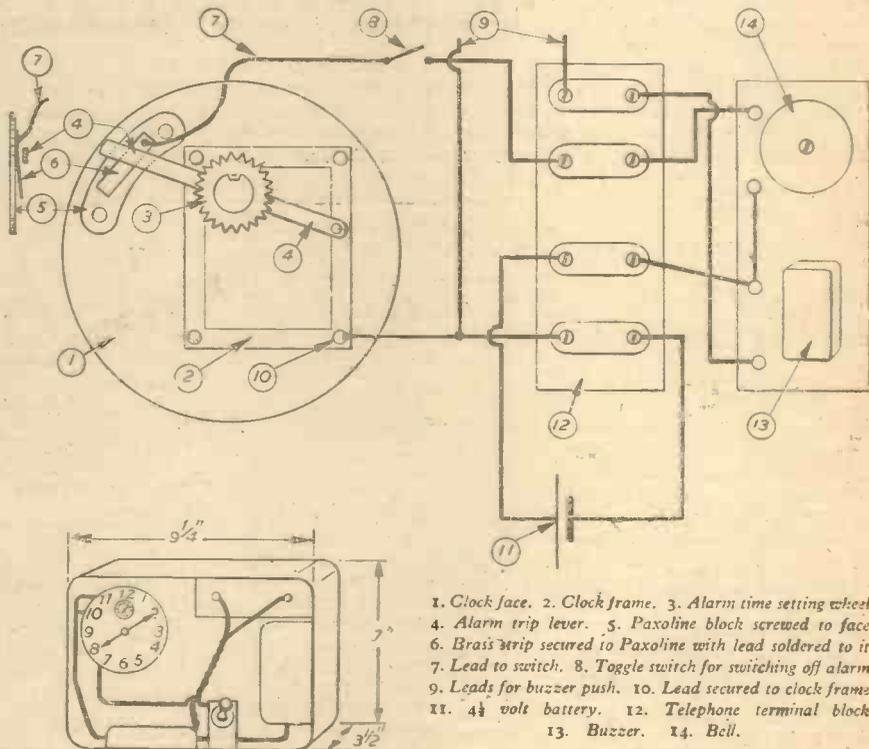

Diagram of connections and general layout of a simple electric alarm.

been working since 1946, and I have renewed the battery only once. It has never failed to work. I set the alarm at the required time by the small hand, as you would an ordinary alarm, wind up the clock, switch on a small switch, and the clock will go off at the setting.

The layout consists of a Goltone bell and buzzer A.C.-D.C. combined, in one case, bought from a cheap stores for about 4s.; 1 Telephone terminal board with four positions; 1 toggle switch (spring loaded);

1-4 1/2 volt dry battery and, of course, the clock with the insulated strip. These are connected as shown in the sketch.

The buzzer, by the way, is connected to my child's room in case he needs attention in the night. If universal it can be connected to the electric bell transformer of the door bell.—S. OTTER (Richmond).

Electroplating Details

SIR,—With reference to the article "Electroplating at Home" in the May issue of PRACTICAL MECHANICS, I feel I must disagree with the writer's statement on the current density to be used per sq. inch for silverplating. As a practical electroplater I would point out that the recommended current density of 0.2 per sq. inch of cathode surface area: some 28.8 amps per sq. foot, is far too high, and the silver deposit with such a current density will be of a powdery or "spongy" nature and will be absolutely non-adherent. The practical c.d. per sq. foot is about 2.5 amperes. It would therefore be about 0.02 amps per sq. in.

Also, I feel that the writer could at least have been more specific about the sulphate copperplating bath he recommends: this is, of course, not suitable for coppering the ferrous metals, as the copper deposits in the acid solution by immersion only and such a deposit on ferrous metals is non-adherent. The only really popular copperplating bath for the ferrous metals is the cyanide bath. The sulphate solution is of course suitable for copper alloys, brass, bronze, pewter and "white metals."

Also, I am not too sure that the diagram in Fig. 3 (a and b) is correct. Whilst I have

1. Clock face. 2. Clock frame. 3. Alarm time setting wheel.
4. Alarm trip lever. 5. Paxoline block screwed to face.
6. Brass strip secured to Paxoline with lead soldered to it.
7. Lead to switch. 8. Toggle switch for switching off alarm.
9. Leads for buzzer push. 10. Lead secured to clock frame.
11. 4 1/2 volt battery. 12. Telephone terminal block.
13. Buzzer. 14. Bell.

no pretensions towards theoretical electricity. I was always under the impression that electron flow left the source of generation from the positive pole and returned to its source via the negative pole, not as in the other direction as given.

Lastly, I cannot quite agree with the writer who is optimistic about the amateur's chances with chromium plating. The pro-

(Continued on page 433)

GALPIN'S

ELECTRICAL STORES
 408 HIGH ST., LEWISHAM, S.E.13
 Tel.: Lee Green 0309. Nr. Lewisham Hospital.
 TERMS: CASH WITH ORDER. NO C.O.D.
 All goods sent on 7 days' approval against cash.

EARLY CLOSING DAY THURSDAY

MAINS TRANSFORMERS (NEW), suitable for spot welding, input 200/250 volts, in steps of 10 volts, output suitably tapped for a combination of either 2 1/4/6/8/10 or 12 volts 50/70 amps, 95/- each, carr. 7/6.
MAINS TRANSFORMERS (NEW), 200/250 volts input in steps of 10 volts, output 0, 6, 12, 24 volts 6 amps, 42/6 each, post 1/6. Another as above but 10-12 amps, 55/- each, post 1/6; another, as above, but 25/30 amps, 75/- each, carriage 3/6; another, input as above, output 0/18/30/36 volts 6 amps, 47/6 each, post 1/6.

EX-RADAR MAINS TRANSFORMERS, 230 volts input 50 cycles 1 phase, output 4,500/5,000 volts approx. 80 m/amps, 6.3 volts 2 amps, 4 volts 1 1/2 amps, 2 volts 2 amps, these transformers are new immersed in oil, can be taken out of the oil and used as television transformers giving output of 10 m/amps, overall size of transformers separately 5 1/2 in. x 4 1/2 in. x 4 in. and 3 in. x 3 in. x 2 1/2 in., price 75/- each, carriage paid.

MAINS TRANSFORMERS (NEW), input 200/250 volts in steps of 10 volts, output 350/0/350 volts, 180 m/amps, 4 volts 4 amps; 5 volts 3 amps, 6.3 volts 4 amps, 45/- each, post 1/6; another 350/0/350 volts 180 m/amps, 6.3 volts 8 amps, 0/4/5 volts 4 amps, 45/- each, post 1/6; another 500/0/500 volts 150 amps, 4 volts 4 amps C.T., 6.3 volts 4 amps C.T., 5 volts 3 amps, 47/6 each, post 1/6; another 425/0/425 volts 160 m/amps, 6.3 volts 4 amps, C.T. twice 5 volts 3 amps, 47/6 each, post 1/6.

TRANSFORMERS SPECIALLY MADE TO ORDER, delivery 72 hours from date of order. Please let us quote you.

MAINS TRANSFORMERS, 200/250 volts input, output a combination of 6, 12, 18, 24, 30, and 36 volts at 6 amps, 45/- each, post 1/6.
METERS, Moving Coil, 0 to 14 amps., 18/6 each. Ditto, Moving Iron, suitable for A.C. 0 to 30 amps., 25/- each. Another moving coil, 100 to 250 amps. D.C., 35/- each, all 4in. scale. (Others in stock, please state your requirements.)

12/24 VOLT RECTIFIERS at 4 amps., with suitable Mains Transformer, 200/230 volts input, 55/- each, except 12/24 volts.

MAINS TRANSFORMERS, input 180/250 volts, output 435/0/435 volts, 250 m/amps, 6.3 volts 10 amps, 6.3 volts 8 amps, 6.3 volts 8 amps, 5 volts 6 amps, 65/- each; another, input as above, output 4,000 volts 2 1/2 m/amps, 4 volts 1 amp., 2 volts 2 amps, 45/- each.

SMOOTHING CHOKES, 4 henries, 250 m/amps, D.C. resistance 120 ohms, 12/6 each.

CONDENSERS, 0.1 mfd., 6,000 volts working, 6/6 each.

LARGE STUD TYPE DIMMER RESISTANCES, 10 ohms, 9/18 amps, 32 studs, 35/- each.

3 KILOWATTS DOUBLE-WOUND VOLTAGE CHANGER TRANSFORMERS, 110/230 volts or vice-versa, as new, weight approx. 100 lbs., £12/10/- each, carriage forward.

ELECTRIC LIGHT CHECK METERS, useful for subletting, garages, etc., all for 200/250 volts A.C. mains, 5 amp. load, 19/- each; 10 amps, 22/6; 20 amps, 27/-; 25 amps, 32/6; 40 amps, 38/6; 50 amps, 46/6; and 100 amps, 57/6 each, all carriage paid.

6 or 12 VOLT RECTIFIERS at 4 amps output, complete with suitable transformer, 200/230 volts input, 45/- each, post 1/6.

MAINS TRANSFORMERS, 200-250 volts input, output 400/0/400 volts, 280 m/amps, 6.3 v. 8 a., 2 v. 3 a., 5 v. 3 a., 4 v. 2 a., the last two heaters insulated at 8,000 volts, 85/- each; another, 200/230 volts input, output tapped 0, 9, 18 volts at 4 amps, 25/- each, post 1/-.

D.C. MOTORS, 230 volts, .3 h.p., 3,000 r.p.m., in good condition, £3/5/0 each; ditto Fan Motors, 230 volts D.C., 20/- each; 110 volts D.C., 17/6 each.

MAINS TRANSFORMERS, input 200/250 volts, output 45/50 volts, 70 amps., suitable for arc welding, £15/- each; another 70 volts, 50 amps, £15/- each.

EX-W.D. U.S.A. HAND GENERATORS, less winding handle, output 425 volts at 110 m/a., at 6.3 v., 2 1/2 amps., complete with smoothing, 30/- each, carriage 2/6.

ROTARY TYPE RESISTANCES, stud 5/arm type 10 ohms 3 amps., 17/6 each. (Other types in stock, please ask for quotation.)



The Improved MOLE Self-Grip WRENCH

for all HANDYMEN

The Mole Wrench is absolutely invaluable as a 'third hand' to the engineer, technician and handyman alike, for those frequent jobs where a really firm grip is necessary. The Mole Wrench locks on to the job with tremendous power or is instantly adjusted for a gentle grip—always leaving both hands free and immediately released, by touching the centre lever. Use it as a vice, super pliers, clamp, wrench and so on. This tool of 100 and 1 uses is obtainable from your local ironmonger, garage, motor or motor-cycle accessory dealer.

7" 12/6 10" 15/-

If in any difficulty, write for supplier's address.

M-MOLE & SON LTD BIRMINGHAM-3

THE INSTRUMENT THAT CAN SAVE AND MAKE YOU POUNDS

Would you not consider it a real boon if you could multiply your sight six-fold and ensure that everything you examine was revealed in a brilliant white light?

Yet this miracle can be worked by you, if you will avail yourself of the benefits of the **ULTRA LENS**. No instrument you can buy more quickly, justifiably and pay for itself and the **ULTRA LENS** is an internally illuminated magnifier revealing objects in a six-fold magnification and bringing out points of weakness or strength and enabling you to gauge accurately the most minute of measurements.



It reveals every detail with startling exactness, in natural colourings, and presents in many instances previously unsuspected data which can often be used to advantage.

Price £5.15.0 complete in cardboard case with spare bulb, battery and transparent measuring scale. Packed in luxury velvet lined case 10/- extra. Postage and Packing at cost.

Full particulars on request.
THE ULTRA LENS COMPANY
 17c, Oxendon Street, London, S.W.1.

EX-AIR MINISTRY WRAY PRISMATIC BINOCULARS.—6 x 30 eyepiece focusing. Guaranteed condition. Complete in web case. Price, £7/19/6. Leather case, if desired, 10/- extra.

EX-GOVT. BARR & STROUD RANGEFINDERS.—80 cm. base. Original cost approx. £100. Perfect condition. £12.

EX-R.A.F. MARCHING COMPASSES.—As new, £1/1/-.

OPTICAL KIT for simple Astronomical Telescope, 9/6.

EPISCOPAL LENS with constructional diagram, 12/6.

ACHROMATIC OBJECT GLASSES.—Diam. 50 mm., focal length 5 in. Perfect. 10/6 each.

New illustrated Catalogue on request. Satisfaction guaranteed on all purchases or full refund.

CHARLES FRANK,
 67-73, SALTMARKET, GLASGOW, C.I.
 Phone: BELL 2106-7

PHOTOGRAPHIC ENLARGER TIMER

A first-class clockwork timer, constructed from an ex-Govt. unit giving 1/2 to 16-second exposures with each winding. Complete with Foot Switch, Calibrated Dial, Focussing Switch. Ready for connection to the mains and enlarger.

50/- POST & PKG 2/6

ACFIL PUMPS.—These pumps enable you to fill all accumulators on the bench with the carboy at floor level. Brand new, only 30/-, post 2/-.

P.M. SPEAKERS.—In cases, ideal for extension speakers. 6in., 30/-; 5in., 17/6. Postage 2/-.

POWER AMPLIFIERS.—50 watt "Tanroy" rack mounting, less valves, only £9 10/- to clear. Carriage 7/6.

AMPLIFIERS.—45 watts, Marconi Type 6, using 2X23, 6ML4, rack mounting, complete with power pack, 200-250 volts 50 cycles, less valves, £6, carriage 7/6.

LAMP HOUSES with pair of 6in. condenser lenses and focusing mount, suitable for flood or spotlight, £4.

CINE PROJECTOR 16 mm.—"Ensign" silent, complete with Dallmeier 2in. Superlite lens, transformer and carrying case, £27 10/-.

GB MODEL L516.—Sound, complete with valves, lamps, lens, speaker, r/c stance, £25. B.T.H. MODEL S.R.B.—Sound, complete, £75.

METRO-VICK AUTO TRANSFORMERS, 230/110v., 500 watt, totally enclosed, £4/10/-.

PHOTOFLOOD LAMPS.—"Eko" 1,000 watt, 220/230 volt, 10/- each. Post 1/-.

PROJECTION LAMPS.—115v. 750 w. Profocus, Brand New, 25/-.

BROMIDE PAPER, 5in. x 5in., glossy, soft, 7/6 per gross packet. 6 Packets for 35/-.

RESISTANCE MATS.—Make ideal heating mats for Aquariums. Photographic solutions. Print driers, etc. Various voltages, 150 or 620 watts. Black heat, size 10in. x 6in., 2/6. Post free.

DIAND GENERATOR or Battery Charger. —6 volts D.C. at 4 amps, contained in a strong metal case with automatic cut-out, very useful where no mains are available, could be converted to a wind charger. Only 30/-, Carriage 5/-.

BLOWER MOTORS.—Dual voltage, 12/24 10 KB/15, recommended for car heaters, 2/-, post 2/-.

BALL RACES.—No. EE2, 1in. x 1in., 3/-, post free.

THRUST RACES.—13/16in. x 1in., 1/6, post free.

VOLTMETERS.—0-300 A.C. Moving Iron 3in. Flush or Surface Type, 25/-; 0-300 Flush D.C. Moving Coil, 10/6; 0-20, 2in. Flush Moving Coil, 7/6; 0-40, 2in. Flush M.C., 10/6; post 1/-.

ACCUMULATOR CHARGERS, 230 v. A.C. in black crackle case with fuses and meter, 6 and 12 volts at 4 amps. Bargain Price, £4/19/6 Pkg. and carr. 5/-.

RECTIFIER UNIT.—Input 230 volts. Output 12-0-12 volts 1 ampere, 50/-, packing and carriage, 5/-.

PORTABLE TEST METER.—Just the job for the home constructor. In neat case, 6in. x 5in. x 4in., reading 1.5, 3, 150 volts, 6 and 60 mA. D.C., 5 k and 25 k ohms, 25/- each to clear. Post 1/6.

AERIAL RODS.—22in. long, 1in. diameter. Every section can be fitted together, 2/6 dozen, 6/- for 3 dozen, 11/- half gross, 20/- gross, £6 per 1,000.

SLOW MOTION DIALS.—6in. Scaled 0-100, reduction 230 to 1 or direct, ideal for wavemeters, signal generators, etc. Our price, while they last, 5/6. Post 1/-.

FLASHING SWITCH UNIT with 6 contacts. Full rotation 60 seconds, operated by a Sangamo Synchronous Motor. 230 volts A.C., 2 watts. In metal case, 3in. x 2in. x 2in., 15/-, Post 1/-.

INTERESTED IN FISHING?—Then send for one of our tapered whip aerials and make yourself a fine rod worth pounds. Consists of three tubular steel, seamless copper plated sections, 4ft. long, which screw into each other and are well finished. 7/6 each. Carriage C.B., 2/-, Eire, 6/6.

STUART PUMPS.—230 volt A.C. motor, will lift 400 gals. per hour 15ft., £11/15/-; larger size, 1 h.p., £22/10/-, Carriage 7/6.

PUMPS FOR GARAGE FOUNTAINS, £10. Ex stock, send for further details.

SWITCHES.—A row of 5 in a flush mounting bakelite moulding, 5in. x 1 1/2 in. x 2in. Ideal for model railways, etc., 5/6. Post 9d.

24 VOLT MOTOR with reduction gear and cam-operated switches, 15/6, post 1/-.

Send 6d. in stamps for comprehensive list giving full details of Potentiometers, Condensers, Resistors, Telephone Key Switches, Rectifiers, etc.

WILCO ELECTRONICS

204, LOWER ADDISCOMBE ROAD, CROYDON.

**HERE'S VALUE!
ELECTRIC MOTORS**

NEW 1/4 H.P. Made by world-famous Manufacturer. 220/230 Volt. A.C. 50 cycles. 1,420 r.p.m. Single phase. Continuous rating. Capacity start. Drip-proof sleeve bearings. Solid base platform. Standard drive shaft. Similar to illustration. Complete with condenser. Usual Price, 55. **P & C PRICE 89/6**
Carr. 1 Packing 7/6

NEW SMITH'S 8-DAY CLOCKS
Ex-R.A.F. Complete with TRIP Hands. Made to Air Min. specification. Model B. 2 1/2 in. dial, in bakelite case. With 2 1/2 in. base. (Worth Double.)
Post & Packing, 1/6. **35/-**

NEW THERMOMETERS
Ex-Govt. 0-100 deg. C. 2 1/2 in. dash-fitting with approx. 20'40ft. tubing. Suitable for WATER or OIL.
Union 2/6 extra. **22/6**
Post and Packing 1/8.

PRESSURE STOVES
New British Army Paraffin Stove. Pressure pump flame adjuster. Folding metal arms give 10 in. diameter. Spares kit. Very strong construction. Fitted metal container 9 1/2 in. x 5 in. Takes up little room in pocket or kit. Ideal for all purposes. **25/-**
Post & Packing 1/8.

NEW ALTIMETERS
Ex-Govt. Single Arm. 0-20,000ft. IDEAL FOR CONVERSION TO BAROMETER. Special reduction. **6/6**
Post & Packing, 1/-.

Send for free new illustrated catalogue.
PRIDE & CLARKE Ltd.
(Dept. P.M.) STOCKWELL ROAD, LONDON, S.W.9. BRIXton 6251.

SPECIAL SUMMER CLEARANCE OFFERS:—

TAPE RECORDER HEADS by famous maker, record or playback, new unused, usual price £2/19/6, our price 12/6 each, post 3d. **COLLARO GRAM MOTORS**, complete with turntable, 100/130 or 200/250 v. A.C., new boxed, 45/-. **SPERRY BOMB COMPUTERS**, brand new in their steel transit cases, cost over £400, our price £5, carriage 10/-, also the bombsights, in steel cases, 50/-, carriage 10/-.

TELEPHONE WIRE, p.v.c. covered, 1/2-mile coils, 20/-, post 2/-.

T.R.S. CABLE, 250 v. single 1/044, 100 yd. coils, new wrapped, 30/-, post 2/-.

WIRE STRIPPERS, strips the insulation from cables up to 1/2 in. dia., new boxed, usual toolshop price 15/-, our price 5/6, post 6d.

DIMOND H ROTARY SWITCHES, 250 v. 30 amp., 4-position, 3-heat and off series parallel, new boxed, 2/6, post 1/-.

EVERSHED AND VIGNOLES OHMMETERS, twin scale, 0-1,000 and 100-200,000 ohms and inf., green bakelite cases, in leather cases, tested and perfect, 70/-, post 1/6.

SWITCHPLUGS, domestic type, 5-amp. 3-pin, complete with plug, 3/6, post 1/-.

VARIABLE RHEOSTATS, wire-wound on ceramic, laminated wiper, 50 ohms 1 amp. or 12.5 ohms at 2 amps. new boxed, 5/-, post 1/-.

AERIALS, screw-in fishing rod type, 3-section, total length 12ft., new boxed, 6/6, carriage 1/3.

MOTORS, 1/4 h.p., 230 v. single phase, 50 cycles, A.C. mains, 1,420 r.p.m. shaft 1 1/2 in. by 9/16 in. diam., resilient cradle mounted, new, unused, by reputable maker, 70/-, carriage 5/-.

SLYDLOK FUSES, 250 v. 15 amp. for back or side entry, 1/6 each, post 3d., 15/- doz., post 1/-, ditto 30 amp., 2/6 each, post 4d., 24/- doz., post 1/3.

TELEPHONE HAND GENERATORS, small popular type, new unused, 6/6 post 1/2, associated single dome A.C. bells, new, unused, 3/6, post 9d.

RING SPANNERS, double ended vanadium, by famous maker 3 types only, 1/2 in. and 7/16 in. Whit., 7/16 in. and 1/2 in. Whit., 1/2 in. and 3/4 in. A/F. all 2/6 each, post 9d.

BALLOONS, Dinghy type, blow up to 3 1/2 ft. dia., make ideal beach balls, etc., new boxed, 3/6, post 6d.

MOTORS, 12 v. shunt, reversing, take approx. 1 amp., fitted shaft, new boxed, 7/6, post 1/-.

CAR RELAY FLASHERS, 12 v. incorporates slugged relays with platinum points, full radio suppression, peak current only 15 mA, flasher frequency 120 per min., in dust and damp proof die-cast cases, size 4 1/2 in. x 3 1/2 in. x 3 1/2 in., new boxed, 30/-, post 1/3.

Many other items: 30-page list 6d. each. Trade List Free.

MIDLAND INSTRUMENT CO.

Moorpool Circle, Birmingham, 17.

Tel.: HAR-1308. Evening HAR-2664.

**ALPHA OFFERS
VALVES GUARANTEED NEW AND BOXED.**

JCSGT 8/-	6/6	9/-	25A6G 9/-
1R5 8/-	6/6	10/6	25Z4G 9/-
1R4 8/-	6/6	9/6	35L6GT 9/6
1S5 8/-	6/6	7/6	35Z4GT 9/6
1T4 8/-	6/6	8/6	ECH42 10/6
3Q4 9/-	6/6	10/-	ECL90 11/6
3S4 9/6	6/6	8/6	EF36 7/6
3V4 9/-	6/6	7/6	EF80 11/6
4D1 3/-	7/6	8/6	EY51 12/-
5U4G 8/6	7/6	8/6	HL23DD 8/-
5Y3GT 8/-	7/6	8/6	KT33C 11/-
6A7 6/6	7/4	8/6	MS/PEN 5/-
6AL5 8/-	8/0	8/9	PEN25 8/6
6AM6 9/-	8/0	8/9	VU39 8/6
6F6G 7/6	9D2 3/-	X24 7/6	
6J7G 6/6	12AT7 9/6	SP61 3/9	
6K7G/CT 6/6	12K7 9/-	SP41 3/6	
6K8G 9/6	12Q7 9/-	VR91 6/6	

Condensers:—
64 mfd. 350 v. ... 3s. 6d. ea.
32 x 16 mfd. 350 v. ... 3s. 3d. ea.
250 mfd. 12 v. ... 2s. 0d. ea.
8 x 8 mfd. 350 v. ... 2s. 0d. ea.
24 x 8 mfd. 350 v. ... 2s. 0d. ea.
32 x 4 x 4 mfd. 350 v. ... 2s. 0d. ea.

Colvren Wire Wound Volume Controls:—
50 ohm. 200 ohm. 5K ohm. 5K ohm. 15K ohm. 20K ohm. 25K ohm. 35K ohm. 50K ohm. all 2s. 0d. ea.
Welwyn 50K ohm pre-set carbon. 1s. 9d. ea.
Polar 500 ohm pre-set Wire Wound Control. 1s. 9d. ea.
Colvren CLR 902 1,000 ohm pre-set. 2s. 0d. ea.
B.I. Condensers Wax Tubular. 42 mfd. 1,000 v. 7s. 0d. doz.
Tape Recording Motors. Collaro AC48 1 Anticlock. 1 Clockwise. 5s. 0d. pair. P.V.C. Covered wire. bright colours, red, green, blue, yellow, etc. 5s. 0d. per 300ft. Rubber Grommets, various sizes, 6d. doz.

ROMAC TELEVISION RECEIVER
Model 189. Brand New in Makers' Cartons complete with 17 BVA Valves, etc. but less Tube. Valve types are: 6AM6, 6AL5, 12AT7, 2751, 185BT, EY51, 6V6GT. These sets were listed by the makers at over £80. Special Purchase enables us to offer at £25 0s. 0d. each, less tube.
A charge of 25/- is made to cover Carriage and Packing and Insurance. Brimar C12B Tubes are available at current price. Full scale Circuit Diagram. 4s. 6d. ea.

Rectifiers:—
RM1. 14s. 0d. ea. RM2. 4s. 9d. ea. RM3. 5s. 9d. ea. RM4. 16s. 0d. ea.
TERMS:—Cash with Order or C.O.D. Minimum C.O.D. Fee, 2/3.

MAIL ORDER ONLY
Full list available 6d. in stamps. Postage: 6d. to 10/-, 1/- to 20/-, 1/6 to 40/-.

ALPHA RADIO SUPPLY CO.
56 VINCES CHAMBERS, VICTORIA SQUARE, LEEDS, 1.

PRACTICAL BARGAINS

FIELD TELEPHONE SETS.—Each complete with buzzer call, hand telephone and Morse Key, for short or long distance 65/- each. Post 2/6.

MICROPHONES.—Air Pilot's Electro-magnetic, with switch lead and plug. New condition at 4/6 each. Post 6d.

MICROPHONES.—Air Pilot's ANB-MC1 for fitting in oxygen mask, with lead-in. New at 5/6 each. Post 6d.

MORSE KEYS.—Totally enclosed R.A.F. super quality, new at 4/6 each. Post 6d.

MAGSLIPS.—Hunters 3-inch at 8/6 each. Post 1/-.

R.A.F. AERIAL WINCHES.—A reeling device with very many different applications. 3-position spring-loaded control handle giving "Brake," "Free" and "Hatchet." High Electrical lead-in. New condition at 3/6 each. Post 1/-.

MAGNETIC RELAY UNIT.—5-contact in beautiful mounting with 2 coils. New condition at 5/6 each. Post 6d.

ENGINE-DRIVEN GENERATORS.—12v. 600 watt at 50/- each. Carriage 2/6. 12 v. 750 watt at 50/- each, carriage 2/6.

ALTERNATORS.—24 v. 1,200 watt at 35/- each. Carriage 2/6.

WALKIE-TALKIE.—Transmitter/Receiver 50 (Canadian), 6-9 Mc/s. New condition at £15 each.

TELEGRAPH EQUIPMENT.—Tape Perforators, Sound Transmitters, Tape Printers, Coding Units, etc.

V.F. SPEECH PLUS SIMPLEX.—Voice Channel provided with telegraph line.

TELEPHONE.—Carrier Units and Smoothing Units.

WIRING.—Standard new Electric Cable P.V.C. Single 1/044 at 18/6, 3/029 at 20/-, FLAT TWIN 1/044 at 37/6, 3/029 at 39/6. V.L.R. SINGLE 1/044 at 22/6, 3/029 at 29/6. FLAT TWIN 3/029 at 42/-, 7/029 at 57/6, all per 100 yds. Cables of all types T.R.S., V.L.R., P.V.C. Cellulose Lacquered over all, and Co-axial, in a wide range of sizes up to 37/103.

PLUGS AND SOCKETS.—A variety of types for Aircraft Radio including Amphenol Co-Axial in quantity.

R. GILFILLAN & CO. LTD.
52, SOUTH STREET, WORTHING, SUSSEX.
Telephone: WORTHING 8713.
Cables: "GIL WORTHING."

Tyler Spiral Blades

MARVEL 7" BAND SAW **WOOD METAL PLASTIC**

The round blade is revolutionary and essential.

Cut in any direction

The amazing blades with 360 deg. cutting edge are incorporated in the compact, sturdily-made Tyler Marvel equipped with built-in 1/4 h.p. single-phase Hoover motor. The entire weight is only 65lb. 8oz. Saw speeds, 200, 400 and 750ft. per minute. Complete, £33 (including spiral and flat blades and guides).

Spiral Saws Ltd · Trading Estate · Slough · Bucks

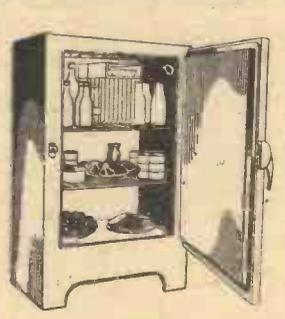

BUILD YOUR OWN REFRIGERATOR

It's as simple as A.B.C. No knowledge of Refrigeration or Engineering required. The equipment we supply has only to be fitted into an insulated cabinet of approximately 3 cu. ft., which any amateur constructor can make, then plugged into an electric point—as simple as plugging in an electric fire. This is genuine refrigeration equipment as used by leading manufacturers.

- Guaranteed for one year.
- No interference with radio or television.
- Completely silent.
- Very low electric consumption.
- Suitable for A.C. or D.C. current.

FOR AN APPROXIMATE COST OF **£30** SEND S.A.E. FOR FULL DETAILS TO:—
ESSEX REFRIGERATION CO. LTD. (DEPT. M.I.)
PARAMOUNT WORKS, QUEEN ST., ROMFORD, ESSEX. Tel. Romford 9671-3

FOR SUMMER SAILING

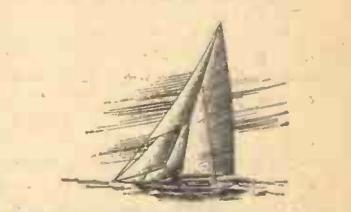

There is nothing which reflects the modeller's skill to better advantage than model boat building. Modelcraft offer a fine series of plans for yachts of all types, launches, etc. The following selection (from the Modelcraft List, 1/-, post free, with refund voucher) is typical.

- 'KESTREL' 24in. yacht. Plan includes treatise on building and sailing ... 5/6
- INTERNATIONAL 'M' CLASS Racing Yacht
- 'OSPREY' 50in. model ... 15/-
- 'MERLIN' 36in. M.Y.A. model ... 10/6
- 'DAYTONA' Motor Cruiser 33in. model ... 12/3



Postage 6d. per p/air
MODELRAFT
77, (L), GROSVENOR RD., LONDON, S.W.1

LETTERS TO THE EDITOR

(Continued from page 430)

cess is tricky at its best, even to those having experience of the process, as the shoddy chromium plate on the market will bear witness, and I would not be optimistic of the novice's chances of complete success. Taking the subject all round, I would say silver is undoubtedly the one which is most likely to prove successful to the beginner.—S. H. CANE (Hackney, E.9).

The Author's Reply

SIR,—I must express my thanks to Mr. Cane for pointing out an error in the current density quoted in my article on electroplating. The correct current density, as pointed out by Mr. Cane should be 0.02 amps sq. in. and not 0.2 amps sq. in.

With regard to the other points made by Mr. Cane, I have the following observations to make.

Admittedly, the most versatile plating bath for copper, is, as he suggests, the cyanide bath, but this bath is quite complex in composition and moreover is of an exceedingly poisonous nature. It was my intention, where possible, to avoid suggesting the use of a cyanide bath and to this end I included copper plating as merely an initial exercise. In order to make the record complete, I include below a formula which is admirably suited for plating ferrous metals, and which is comparatively innocuous.

Copper sulphate	2 oz.
Sodium potassium tartrate	5 oz.
Sodium hydroxide	2 oz.
Distilled water	2 pints.

I can assure Mr. Cane that the diagram in Fig. 3 (a and b) is perfectly correct as far as it goes. Of course it makes no attempt to explain the current flow in the electrolyte. This flow is quite complicated and involves the migration of positive ions to the cathode, and negative ions to the anode. That is not the whole story, for besides ions of the radicals concerned, hydrogen ions and hydroxyl ions are also present, and have to be taken into account in any complete theory. Any radio engineer will be able to confirm that the electron flow is from the negative pole to the positive pole and, of course, what is true of electron flow in a radio circuit is equally true of electron flow in any simple circuit.

Mr. Cane thinks I am optimistic about amateur's chances with chromium plating. In face of this I can only repeat what I have already said in the article, and that is, that if the instructions are followed carefully and exactly, there is no reason why an amateur should not obtain successful results. In mentioning shoddy chromium plate, Mr. Cane does not tell the whole story, and I am sure that he would be the first to admit that a good deal of shoddy plating has been due to shortages of material and the use of unsuitable substitutes, e.g., the shortage of nickel for use as an intermediate plating on ferrous metals. The only real difficulty that I have encountered with chromium plating, is getting the action to start, and this is easily overcome by momentarily passing a somewhat higher current density than that calculated from the formula.—E. HARRIS MORGAN (Winkleigh, N. Devon).

Stencil Cutting

SIR,—I wish to reproduce printing matter such as letterheads on a duplicator stencil. I have tried to cut stencils on a printing machine, but the type will not penetrate the wax coating.

The Gestetner people will prepare stencils for this type of work, but one has to order a complete ream and this is too expensive for small orders.

I have examined these commercial stencils and I am inclined to think that they are prepared as follows:—

1. An unwaxed stencil is printed upon

using a wax-resisting ink. 2. The stencil is then waxed. 3. The printing ink is now dissolved away leaving the stencil ready for the duplicator.

I have a photographic stencil outfit, but it is not much use for reproducing business headings because even when the paper is oiled to assist transparency a long exposure is necessary in order for the light to penetrate the paper; this long exposure, unfortunately, allows a certain amount of light to penetrate the printed matter, rendering the stencil useless. Gestetners will prepare a positive of printed matter on photographic film for about 10/-, but again the cost is too high for small runs.—M. G. LEES (Gloucester).
[Readers' suggestions are invited.—ED.]

RE INFORMATION SOUGHT

Revolving Lampshade

SIR,—If Mr. Ball is prepared to accept a reduction of lighting efficiency to produce a revolving motion in a lampshade, he may be interested in my "aquarium lamp," which forms a novel interior decoration and provides a subdued light suitable for television viewing, etc.

The lamp is in the form of a cylinder, mounted on a normal stand, and presenting a typical aquarium scene, devoid of fish. When the current is switched on the "tank" is illuminated, when fish appear and slowly begin to move and swim around.

The lamp comprises an outer cylinder, of green parchment or Crinoline, with aquarium scenery painted on. There is a chrome rim at the top, with a mesh infilling, and a rim at the bottom supported by a "Spider" on the lampholder of a plain chrome table lamp standard.

An inner revolving cylinder of clear cellulose acetate is provided, with opaque representations of exotic fish thereon. A fan, made of very thin balsa wood, with a laminated balsa rim, is fixed in the top. A similar rim only in the bottom maintains

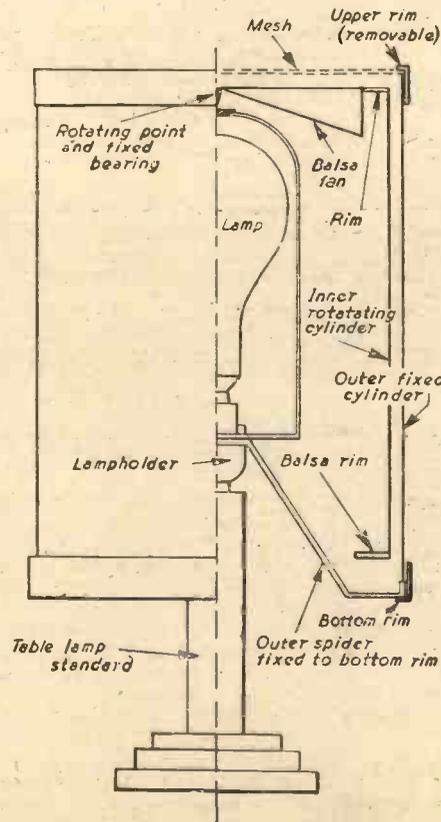

Sectional diagram of a revolving lampshade.

the cylinder symmetrical. This inner cylinder rotates on a steel point affixed to the underside of the fan, bearing in a centre pop in a brass disc located at the top of a second "spider."

The accompanying sketch illustrates the position of the main components, and the entire assembly can be produced from readily available materials on the inevitable kitchen table.—R. W. DIXON (Nottingham).

Shaded Pole Motor

SIR,—The shaded pole motor is a variety of the single-phase A.C. induction motor.

It is well known that a simple single-

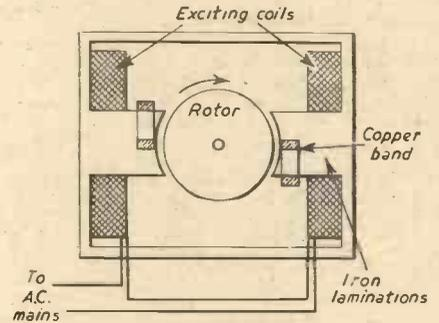

The copper bands in a shaded pole motor.

phase motor is not self-starting and special methods are needed to start it. The commonest method is the use of a starting winding which is connected in a special way to the single-phase mains which also feed the principal winding. In this way the current passing through the starter winding, and therefore the magnetic flux produced by it, is out of phase with the current and flux on the principal winding.

The effect of these magnetic fluxes waxing and waning at different times and at different places on the stator is to create the illusion of a rotating magnetic field around the motor, with the result that the motor is dragged round by the magnetic fields. (I hope some of your more technical readers will not quarrel with this description which is meant to be vivid rather than meticulously accurate.)

When a simple motor for light duty, such as driving a gramophone turntable is required, sufficient phase difference can be created on each pole face by "shading" the pole. A slot is cut longitudinally along each pole face near the middle and a copper band is passed through the slot and made to embrace half the pole face.

The effect of such a closed band is to retard the growth (and also decay) of the magnetism in the portions of the pole face it embraces, since every change of magnetism in that portion causes a current to flow in the copper band which in turn sets up a counter magnetism which resists the change of magnetism causing it. In this way the shaded portion carries magnetism which changes rather later than that on the unshaded portion. In this way a suggestion of magnetism passing along the pole face is created and the motor is self-starting.

It will be appreciated that a shaded pole is entirely dependent on varying magnetism. Therefore a permanent magnet will be unaffected.—G. E. BRIDDON (Chelsea).

Model Boat Building

By F. J. CAMM

5/-, By post 5/6

From **GEORGE NEWNES, LTD.**,

Tower House, Southampton St., Strand, W.C.2

Trade Notes

New 7in. Heavy Duty Saw

THE Wolf RS7 has been designed as an industrial heavy duty machine quite distinct from the portable saws which are being produced for the popular electric tool market.

Much care and close attention has been paid to the correct balance of the machine. This is so perfected that it can be used throughout the longest working period with practically no operator fatigue.

The motor is mounted transversely at a

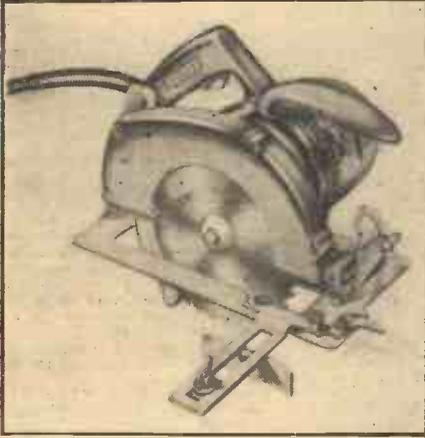

The new Wolf 7in. portable heavy duty saw.

right-angle to the blade; the drive being by means of heavy helical gears. Thus the saw rests in a perfectly balanced position on the main piece of the work which means extra safety, less effort and a clean cut.

Balanced running is assured by means of the dynamical balancing of all moving parts: Smooth operation, easy guiding and feeding ensures straight, dead-on-the-line cutting.

The cutting line is kept clean by the introduction of a volute on the inner surface of the guard which causes the sawdust to be ejected at the rear of the machine behind the operator.

The saw blade is completely guarded and safe to operate under all conditions. The

lower part is guarded by a pressed steel telescopic guard, the mechanism of which is completely sealed from sawdust, etc.

Depth of Cut

The depth of cut is adjustable to a maximum vertical cut of 2-5/16in. Bevel cuts are made up to an angle of 45 deg. and to a depth of 2in. Angle adjustments are quickly and easily made by a conveniently placed pointer. An adjustable ripping guide is provided as part of the standard equipment.

A wide selection of blades is available for sawing timber, wallboard, plywood, stonework, light sheet metal, corrugated asbestos sheets, etc.

A combined rip and cross-cut blade of the finest Sheffield crucible steel is supplied with each machine. For a smoother cut a cross-cut blade is recommended, and for a finer finish there is the planer blade. Other blades include a fine-toothed one for clean and fast cutting of wallboard and composition board. For cutting plain and corrugated sheet metal up to 20 gauge a friction blade is available. Cement, stonework, brickwork and asbestos sheet can be cut rapidly and easily by fitting an abrasive disc.

The double-pole switch is similar to that incorporated on the famous Wolf super-heavy duty drill, Type WD4c, and specially designed by Wolf for use in electric tools. With extreme current carrying capacity it combines dependability and simplicity.

The gears are cut in nickel chrome-molybdenum steel and high frequency hardened. The gear wheel and spindle on which the saw blade is mounted is a solid forging, complete in one piece, mounted on ball bearings in steel liners. All ball bearings are of the sealed type of ample capacity and mounted in steel liners.

For convenient and safe handling of the Wolf RS7 a strong steel carrying case with ample accommodation for extra cable and blades is available as an accessory.

These are a few only of the special features of this new machine and readers are invited to send for illustrated leaflet containing full technical details.

The more advanced enthusiast, as well as the beginner, will find much of interest in this practical and well-illustrated handbook.

Club Reports

Hitchin and District Model Engineering Club

MEMBERS and friends of the Club recently had an enjoyable trip to the Romney, Hythe and Dymchurch Railway, the party travelling by two special coaches from their headquarters. A special train was laid on by the R. H. and D. authorities, and visits made to the museum, model railway, and Duke of Sutherland's loco and coach. Tea was provided, and the weather was fine, this being appreciated by the photographic members.

The Club exhibition opens on October 1st in the Hitchin Town Hall, and anyone wishing to enter models for the Visitors' Cup should write to the Secretary early for entrance forms. Secretary: Mr. E. Keith, 25, Heathfield Road, Hitchin, Herts.

Johnsons' Stop Baths

JOHNSONS of Hendon, the well-known photographic chemicals and apparatus manufacturers have recently put on to the market two new stop bath "pactums." The print stop bath pactum is recommended for all types of printing papers; it arrests development immediately, prevents staining and helps to conserve the fixer. It is not suitable for use as a hardener stop bath for films.

The chrome alum negative stop bath is specially for use with films and plates and may be used for hardening negatives which have already been processed. Used as a



A strong steel carrying case is also available.

stop bath, it neutralises the developer and hardens the emulsion and is particularly useful when processing at high temperatures or when the temperature of the wash water differs from that of the other solutions. It prevents softening and reticulation of the emulsion. It is not suitable for use with printing papers.

In each case the pactums are dissolved in 20oz. of cold water and both solutions keep well in a stoppered bottle. Full instructions for their individual use are enclosed with each pactum, the price of which is 7½d. each.

International Radio Controlled Model Society

THE rules and entry forms are now available for the Fourth International Radio Controlled Models Contest to be held at Southend-on-Sea, Essex, on the 25th and 26th July this year.

The contest on July 25th is for model boats, and will be held at Southchurch Park, Southend-on-Sea. On July 26th the contest for model aircraft will be held at Southend Airport, Rochford, Nr. Southend.

The aircraft contest is being held in conjunction with the S.M.A.E., and with the sanction of the Federation Aeronautique Internationale and the Royal Aero Club.

A sincere welcome is extended to all radio control enthusiasts to attend the events.

I shall be pleased to supply any further information concerning these contests.—R. Ing, 36, Sunny Gardens Road, Hendon, London, N.W.4.

BOOKS Received

Amateur Photography. By Thomas Jamieson. Published by George Newnes, Ltd. 384 pages. Price 15s. net. (Eighth edition.)

THE amateur photographer will find in this book the necessary knowledge for ensuring the production of a first-class photograph at all times, and not depending on luck rather than judgment. To assist in reaching such proficiency, the book has been prepared by experts having an intimate knowledge of the many difficulties and disappointments that confront the beginner. In this new and extensively revised edition the chapter dealing with colour photography has been enlarged considerably and contains information covering "Ektachrome," "Kodachrome," "Dufaycolor," Ilford Colour Films, "Agfacolor" films, "Gevacolor" films, "Pakolor" films, and the Johnson Colour Screen Process. The section devoted to flash-light photography has been brought up to date, and includes information on flash bulbs, flash holders, and portable electronic outfits.

PRACTICAL ENGINEERING
6d. Every Friday

READERS' SALES AND WANTS

The pre-paid charge for small advertisements is 6d. per word, with box number 1/6 extra (minimum order 6/-). Advertisements, together with remittance, should be sent to the Advertisement Director, PRACTICAL MECHANICS, Tower House, Southampton Street, London, W.C.2, for insertion in the next available issue.

SITUATIONS VACANT

The engagement of persons answering these advertisements must be made through a Local Office of the Ministry of Labour or a scheduled Employment Agency if the applicant is a man aged 18-64 inclusive or a woman aged 18-59 inclusive unless he or she, or the employment, is exempted from the provisions of the Notification of Vacancies Order 1952.

B.B.C. requires Tracer for planning and installation department, central London. Wage £6/5/- with increments to £7/5/-; some training engineering drawing and tracing; knowledge electrical symbols and theory desirable. Apply: E.E.O., B.B.C., London, W.1.

FOR SALE

HOUSE SERVICE METERS, credit and prepayment; available from stock. Universal Electrical, 221, City Road, London, E.C.1.

COMPRESSOR EQUIPMENT, Miscellaneous Items; catalogue, 1/6d. Pryce, 157, Malden Road, Cheam.

COMPRESSORS for sale, 3 CFM, 180lbs. sq. in., on metal base, with driving wheel and receiver, price £3; 1/2 h.p. Heavy Duty Motors, price £3; carriage forward. Wheelhouse, 1, The Grove, Isleworth. (Phone: Hounslow 7558.)

TRANSFORMERS, for trains, welding, low voltage lighting, battery chargers, etc.; all transformers fitted with "earth protection" screen, "play safe." Write or phone your requirements to F. W. Whitworth, A.M. Brit. I.R.E., Model Dept., Express Winding Co., 333, London Road, Mitcham. (MIT. 2128.)

SYNCHRONOUS CLOCK MOTORS, 230v. A.C. S/Ph 50c., 12/6 each, plus 1/- postage. Universal Electrical, 217, City Road, London, E.C.1.

AMAZING DEVICE, cuts perfect discs, wheels, etc., to 12in. diameter, with any circular saw, 10/6; p.p.d.; sample 6in. mahogany disc, photo. details 1/6. Below:—

HOW TO REWIND and Service Electric Motors, Generators. Complete Practical Book only 3/-; p.p.d. Below:—

HOW TO MAKE IT BOOKS: Whittling in Wood; Inlay Pictures, Marquetry; American Action Toys; 21 Lovely Lamps; 3/- each; p.p.d. Below:—

BUILD YOUR OWN PHOTO Equipment, 12 designs in two books. Enlargers, printers, dryers, timers, etc., 6/-; p.p.d. Below:—

40 POWER TOOLS You Can Make from scrap, pipe fittings, etc. This amazing book of plans for circular saws, lathes, band-saws, jigsaws, planes, tapping attachment, figs, etc., has sold 250,000 copies, and is a "must" for every home workshop, 12/6 only; p.p.d. Below:—

AMERICAN BOAT BUILDERS Annual: 28 boat plans, 8-27ft., and other helpful articles, 7/6; p.p.d. Below:—

CAR BODY REPAIRING. Complete ABC course; illustrated; 7/6; p.p.d.; lists free. A.P.S. (P), Sedgford, Norfolk.

SMALL DENTIST'S SYRINGES. Beautifully made all metal instruments by leading makers. All parts heavily plated, and machined from solid. Smooth positive action. Lapped piston and cylinder. Piston rod calibrated 0-20. Ideal for precision lubrication without mess, and many other purposes. Complete with 6 strong hardened steel needles, in plated metal case with hinged lid and fastener. Ex-Ministry, new, unused. Worth £££s. Our price 9/6, post 6d. K. W. Logan, West-alley, Hitchin, Herts.

CONSTRUCT Your Own Refrigerator. This book, written by a refrigeration engineer, is profusely illustrated with drawings and photographs and tells you, not only how to construct a Cabinet or Built-in Refrigerator, but illustrates many that have been built by amateurs and are operating satisfactorily; 3/6, post free. Obtainable direct from author and publisher. Robert C. Scutt, Refrigeration Engineer, 52, Hattway Way, London, N.21.

"PERSPEX", clear, coloured, sizes Aluminium, Asbestos, Mouldings. Henry Moat & Son, Ltd., Atom Works, Newcastle, 1.

ELECTRIC MOTORS, B.T.H. 230/240, 1/2 h.p., 1,425 r.p.m.; new and unused; £5/5/- each. Miniature 12 or 24v. Motors, A.C./D.C.; ideal for models, etc.; size 2 1/2in. long x 2 1/2in. x 1 1/2in. New Twin 40w. Ballast Units, no starter required; all voltages, 200/250 supplied; 25/-; requires holders and lamps only to complete; Single 40w. Units, S/H 17/6; Holders, 2/6 each; Starters, 2/6 each; 24v. Vent Axia Fans, new, 45/- each; Crompton Parkinson Chlorinator Pumps, 220v., 230v., A.C., 1/2 h.p.; little used, £10. Harringay Photographic and Electrical Supplies, Ltd., 423, Green Lanes, N.4. (Tel.: MOU. 2054.)

NUTS, BOLTS, SCREWS, Rivets, Washers and hundreds of other items for model engineers and handymen. Send now for free list. Whiston, New Mills, Stockport.

"PICADOR" ROTOSAW. Portable circular saw attachment for your electric drill fitted with 4in. circular saw blade, adjustable fence to cut up to 1in. in depth, ideal for wood, plastic, or soft metals; 33/-, each, post paid. Lambs-wool polishing Bonnets, 5in., 4/3 each; Rubber Backing Discs, 5in., complete with key, 4/6 each; Abrasive Discs, 5in., 6 assorted grades, 2/-; Send 24d. for lists of Saw spindles, Vee Pulleys and Belts, Plummer Blocks, etc. Sawyers, Ltd., St. Sepulchre Gate, Doncaster.

ELECTRIC WELDING PLANT, used and unused, for sale; s.a.e. for lists. Hermsworth, Townley & Co., 1, Brook Road, Manchester, 14.

WIND GENERATORS, Plants, Propellers, Dynamos, etc. (s.a.e., brochure) Jamelite, Midtaphouse, Liskeard, Cornwall.

LENS WORKERS. Supplies of Lenses. Lists available. Mason & Gantlett Limited, 3, Orford Place, Norwich.

SAW BENCHES, 7in. £4/15/-, 8in. £5/10/-; Combination Lathes, £10; Planers, £9/10/-; Motors, Spindles. Send 4d. stamp for complete illustrated booklet. H.P. available. James Inks (Engineers), Marshall Street, Nottingham.

PERSPEX for all purposes, clear or coloured, dials, discs, engraving. Denny, 15, Netherwood Road, W.14. (SHE. 1426. 5152.)

SANGAMO CLOCK MOTORS, 200/250 volts, A.C., 200 r.p.m., 9/6 each, plus 6d. postage. Harry Martin, 217, Liverpool Road, Haydock, Lanes.

B.T.H. tor unit, £15, one-third cost; 8/1 Worm Reduction Gears with vee pulley, £1 each, posted. Bellangers, 306, Holloway Road, London, N.7.

TYLER Spiral Hack Saw Blades cut in any direction at conventional hacksaw speed without turning the work. 10in. Hack Saw Blades 4d. each from leading tool dealers. Write to Spiral Saws, Ltd., Trading Estate, Slough, for details.

MODEL DEALERS

SHIPS IN BOTTLES.—The constructional kit that tells you how to make them; build for pleasure or for profits; kits 6/- ea. from Hobbies Ltd., and model shops. Cooper-Craft Ltd., The Bridewell, Norwich.

HORNBY DUBLO CONVERSIONS, H. Duchess, Gressley 2-rail scale, 52/6, 3-rail scale, 42/6; Tankers 2-rail, 42/6, 3-rail, 32/6. Sheffield Electrical Model Engineers, Shalesmoor, Sheffield.

LONDON.—Robson's Hackney's Model Shop, 149-151, Morning Lane, E.9. (Tel.: AMHerst 2989.)

ATTENBOROUGH Model Railway. A Model railway specialists; finest in the Midlands; Agents for and stockists of many well-known firms. Why not ask for a copy of our A.M.R. Chronicle? The latest information regarding our stock 1/-, post free. 82, Arkwright Street, Nottingham, and 64, Narborough Road, Leicester.

MODEL RAILWAY FANS! Everything you could wish for in "The Complete Model Railway Catalogue," 136 pages, over 200 illustrations, contains, Lionel, Marklin, Hornby, Trix, Tri-ang, X-Acto, Peco, etc. etc.; all parts and spares. Your copy, 2/6, post free from Dept. M., Taylor & McKenna, 98, Craven Park Road, Harlesden, N.W.10.

BUD MORGAN, The Model Specialist, 1st, 22, Castle Arcade, Cardiff. (Telephone: Cardiff 29065.) Model Aircraft, Trix, Tri-ang, Graham Farish, Model Railways and Galleons; first-class mail order service. Send for my 1953 price list, price 3d.

HOBBIES LTD. have over 50 years' experience of catering for the needs of modellers, handymen and home craftsmen. Branches at 78a, New Oxford Street, London, and in Birmingham, Glasgow, Manchester, Leeds, Sheffield, Hull, Southampton and Bristol. Head Office, Dereham, Norfolk.

HOBBIES

IF YOU INTEND MAKING an Electric Table Lamp from that whisky or liqueur bottle, send bottle to us and we will drill hole in side near base for flex, and fit a lampholder neatly and securely to neck. Charge is 5/3, plus 1/3 postage. Smith Technicians, 59, Grove Road, Norwich.

HOBBYISTS, handicraft workers send 6d. stamps for our illustrated catalogue, "Perspex" Jewellery, Flowercraft, etc. Newing & Co., 96, Grove Vale, London, S.E.22.

TOY CASTING Moulds, soldiers, sailors, airmen, animals, etc., catalogue, 3d. Moulds for Plasticwork, plaques, ornaments and Coronation souvenirs. Moulds from 3/6 ea.; catalogue, 9d.; s.a.e. for list. F. W. Nuthall, 69, St. Marks Road, Hanwell, London, W.7.

DOLLS HOUSE FITTINGS, Papers; Wooden and Metal Toy Wheels (trade supplied); illustrated brochure; s.a.e. Jasons, 135, Nags Head Road, Enfield, Middlesex.

GROW wonderfully decorative miniatures of Real Trees by secret Japanese methods; fascinating hobby. Send s.a.e. for illustrated details. Miniature Trees, Dept. 90, Room Two, 3, Bloomsbury Street, London, W.C.1.

WOODWORKING

PLYWOOD, 3/16in. Finnish Birch, very clean, sanded stock; 4 sheets, 30in. x 30in., 18/-; carriage paid. Stamps for lists of mouldings, plywood and complete woodworkers' supplies. Sawyers, Ltd., St. Sepulchre Gate, Doncaster.

HANDYMEN—New Timber, sound, seasoned, selected, thicknessed, neatly bundled; Send for list. 1/2in. x 1 1/2in.; 1/2in. x 2in.; 1/2in. x 2 1/2in.; 1/2in. x 3in.; 1/2in. x 3 1/2in.; 1/2in. x 4in.; 1/2in. x 4 1/2in.; 1/2in. x 5in.; 1/2in. x 5 1/2in.; 1/2in. x 6in.; 1/2in. x 6 1/2in.; 1/2in. x 7in.; 1/2in. x 7 1/2in.; 1/2in. x 8in.; 1/2in. x 8 1/2in.; 1/2in. x 9in.; 1/2in. x 9 1/2in.; 1/2in. x 10in.; 1/2in. x 10 1/2in.; 1/2in. x 11in.; 1/2in. x 11 1/2in.; 1/2in. x 12in.; 1/2in. x 12 1/2in.; 1/2in. x 13in.; 1/2in. x 13 1/2in.; 1/2in. x 14in.; 1/2in. x 14 1/2in.; 1/2in. x 15in.; 1/2in. x 15 1/2in.; 1/2in. x 16in.; 1/2in. x 16 1/2in.; 1/2in. x 17in.; 1/2in. x 17 1/2in.; 1/2in. x 18in.; 1/2in. x 18 1/2in.; 1/2in. x 19in.; 1/2in. x 19 1/2in.; 1/2in. x 20in.; 1/2in. x 20 1/2in.; 1/2in. x 21in.; 1/2in. x 21 1/2in.; 1/2in. x 22in.; 1/2in. x 22 1/2in.; 1/2in. x 23in.; 1/2in. x 23 1/2in.; 1/2in. x 24in.; 1/2in. x 24 1/2in.; 1/2in. x 25in.; 1/2in. x 25 1/2in.; 1/2in. x 26in.; 1/2in. x 26 1/2in.; 1/2in. x 27in.; 1/2in. x 27 1/2in.; 1/2in. x 28in.; 1/2in. x 28 1/2in.; 1/2in. x 29in.; 1/2in. x 29 1/2in.; 1/2in. x 30in.; 1/2in. x 30 1/2in.; 1/2in. x 31in.; 1/2in. x 31 1/2in.; 1/2in. x 32in.; 1/2in. x 32 1/2in.; 1/2in. x 33in.; 1/2in. x 33 1/2in.; 1/2in. x 34in.; 1/2in. x 34 1/2in.; 1/2in. x 35in.; 1/2in. x 35 1/2in.; 1/2in. x 36in.; 1/2in. x 36 1/2in.; 1/2in. x 37in.; 1/2in. x 37 1/2in.; 1/2in. x 38in.; 1/2in. x 38 1/2in.; 1/2in. x 39in.; 1/2in. x 39 1/2in.; 1/2in. x 40in.; 1/2in. x 40 1/2in.; 1/2in. x 41in.; 1/2in. x 41 1/2in.; 1/2in. x 42in.; 1/2in. x 42 1/2in.; 1/2in. x 43in.; 1/2in. x 43 1/2in.; 1/2in. x 44in.; 1/2in. x 44 1/2in.; 1/2in. x 45in.; 1/2in. x 45 1/2in.; 1/2in. x 46in.; 1/2in. x 46 1/2in.; 1/2in. x 47in.; 1/2in. x 47 1/2in.; 1/2in. x 48in.; 1/2in. x 48 1/2in.; 1/2in. x 49in.; 1/2in. x 49 1/2in.; 1/2in. x 50in.; 1/2in. x 50 1/2in.; 1/2in. x 51in.; 1/2in. x 51 1/2in.; 1/2in. x 52in.; 1/2in. x 52 1/2in.; 1/2in. x 53in.; 1/2in. x 53 1/2in.; 1/2in. x 54in.; 1/2in. x 54 1/2in.; 1/2in. x 55in.; 1/2in. x 55 1/2in.; 1/2in. x 56in.; 1/2in. x 56 1/2in.; 1/2in. x 57in.; 1/2in. x 57 1/2in.; 1/2in. x 58in.; 1/2in. x 58 1/2in.; 1/2in. x 59in.; 1/2in. x 59 1/2in.; 1/2in. x 60in.; 1/2in. x 60 1/2in.; 1/2in. x 61in.; 1/2in. x 61 1/2in.; 1/2in. x 62in.; 1/2in. x 62 1/2in.; 1/2in. x 63in.; 1/2in. x 63 1/2in.; 1/2in. x 64in.; 1/2in. x 64 1/2in.; 1/2in. x 65in.; 1/2in. x 65 1/2in.; 1/2in. x 66in.; 1/2in. x 66 1/2in.; 1/2in. x 67in.; 1/2in. x 67 1/2in.; 1/2in. x 68in.; 1/2in. x 68 1/2in.; 1/2in. x 69in.; 1/2in. x 69 1/2in.; 1/2in. x 70in.; 1/2in. x 70 1/2in.; 1/2in. x 71in.; 1/2in. x 71 1/2in.; 1/2in. x 72in.; 1/2in. x 72 1/2in.; 1/2in. x 73in.; 1/2in. x 73 1/2in.; 1/2in. x 74in.; 1/2in. x 74 1/2in.; 1/2in. x 75in.; 1/2in. x 75 1/2in.; 1/2in. x 76in.; 1/2in. x 76 1/2in.; 1/2in. x 77in.; 1/2in. x 77 1/2in.; 1/2in. x 78in.; 1/2in. x 78 1/2in.; 1/2in. x 79in.; 1/2in. x 79 1/2in.; 1/2in. x 80in.; 1/2in. x 80 1/2in.; 1/2in. x 81in.; 1/2in. x 81 1/2in.; 1/2in. x 82in.; 1/2in. x 82 1/2in.; 1/2in. x 83in.; 1/2in. x 83 1/2in.; 1/2in. x 84in.; 1/2in. x 84 1/2in.; 1/2in. x 85in.; 1/2in. x 85 1/2in.; 1/2in. x 86in.; 1/2in. x 86 1/2in.; 1/2in. x 87in.; 1/2in. x 87 1/2in.; 1/2in. x 88in.; 1/2in. x 88 1/2in.; 1/2in. x 89in.; 1/2in. x 89 1/2in.; 1/2in. x 90in.; 1/2in. x 90 1/2in.; 1/2in. x 91in.; 1/2in. x 91 1/2in.; 1/2in. x 92in.; 1/2in. x 92 1/2in.; 1/2in. x 93in.; 1/2in. x 93 1/2in.; 1/2in. x 94in.; 1/2in. x 94 1/2in.; 1/2in. x 95in.; 1/2in. x 95 1/2in.; 1/2in. x 96in.; 1/2in. x 96 1/2in.; 1/2in. x 97in.; 1/2in. x 97 1/2in.; 1/2in. x 98in.; 1/2in. x 98 1/2in.; 1/2in. x 99in.; 1/2in. x 99 1/2in.; 1/2in. x 100in.; 1/2in. x 100 1/2in.; 1/2in. x 101in.; 1/2in. x 101 1/2in.; 1/2in. x 102in.; 1/2in. x 102 1/2in.; 1/2in. x 103in.; 1/2in. x 103 1/2in.; 1/2in. x 104in.; 1/2in. x 104 1/2in.; 1/2in. x 105in.; 1/2in. x 105 1/2in.; 1/2in. x 106in.; 1/2in. x 106 1/2in.; 1/2in. x 107in.; 1/2in. x 107 1/2in.; 1/2in. x 108in.; 1/2in. x 108 1/2in.; 1/2in. x 109in.; 1/2in. x 109 1/2in.; 1/2in. x 110in.; 1/2in. x 110 1/2in.; 1/2in. x 111in.; 1/2in. x 111 1/2in.; 1/2in. x 112in.; 1/2in. x 112 1/2in.; 1/2in. x 113in.; 1/2in. x 113 1/2in.; 1/2in. x 114in.; 1/2in. x 114 1/2in.; 1/2in. x 115in.; 1/2in. x 115 1/2in.; 1/2in. x 116in.; 1/2in. x 116 1/2in.; 1/2in. x 117in.; 1/2in. x 117 1/2in.; 1/2in. x 118in.; 1/2in. x 118 1/2in.; 1/2in. x 119in.; 1/2in. x 119 1/2in.; 1/2in. x 120in.; 1/2in. x 120 1/2in.; 1/2in. x 121in.; 1/2in. x 121 1/2in.; 1/2in. x 122in.; 1/2in. x 122 1/2in.; 1/2in. x 123in.; 1/2in. x 123 1/2in.; 1/2in. x 124in.; 1/2in. x 124 1/2in.; 1/2in. x 125in.; 1/2in. x 125 1/2in.; 1/2in. x 126in.; 1/2in. x 126 1/2in.; 1/2in. x 127in.; 1/2in. x 127 1/2in.; 1/2in. x 128in.; 1/2in. x 128 1/2in.; 1/2in. x 129in.; 1/2in. x 129 1/2in.; 1/2in. x 130in.; 1/2in. x 130 1/2in.; 1/2in. x 131in.; 1/2in. x 131 1/2in.; 1/2in. x 132in.; 1/2in. x 132 1/2in.; 1/2in. x 133in.; 1/2in. x 133 1/2in.; 1/2in. x 134in.; 1/2in. x 134 1/2in.; 1/2in. x 135in.; 1/2in. x 135 1/2in.; 1/2in. x 136in.; 1/2in. x 136 1/2in.; 1/2in. x 137in.; 1/2in. x 137 1/2in.; 1/2in. x 138in.; 1/2in. x 138 1/2in.; 1/2in. x 139in.; 1/2in. x 139 1/2in.; 1/2in. x 140in.; 1/2in. x 140 1/2in.; 1/2in. x 141in.; 1/2in. x 141 1/2in.; 1/2in. x 142in.; 1/2in. x 142 1/2in.; 1/2in. x 143in.; 1/2in. x 143 1/2in.; 1/2in. x 144in.; 1/2in. x 144 1/2in.; 1/2in. x 145in.; 1/2in. x 145 1/2in.; 1/2in. x 146in.; 1/2in. x 146 1/2in.; 1/2in. x 147in.; 1/2in. x 147 1/2in.; 1/2in. x 148in.; 1/2in. x 148 1/2in.; 1/2in. x 149in.; 1/2in. x 149 1/2in.; 1/2in. x 150in.; 1/2in. x 150 1/2in.; 1/2in. x 151in.; 1/2in. x 151 1/2in.; 1/2in. x 152in.; 1/2in. x 152 1/2in.; 1/2in. x 153in.; 1/2in. x 153 1/2in.; 1/2in. x 154in.; 1/2in. x 154 1/2in.; 1/2in. x 155in.; 1/2in. x 155 1/2in.; 1/2in. x 156in.; 1/2in. x 156 1/2in.; 1/2in. x 157in.; 1/2in. x 157 1/2in.; 1/2in. x 158in.; 1/2in. x 158 1/2in.; 1/2in. x 159in.; 1/2in. x 159 1/2in.; 1/2in. x 160in.; 1/2in. x 160 1/2in.; 1/2in. x 161in.; 1/2in. x 161 1/2in.; 1/2in. x 162in.; 1/2in. x 162 1/2in.; 1/2in. x 163in.; 1/2in. x 163 1/2in.; 1/2in. x 164in.; 1/2in. x 164 1/2in.; 1/2in. x 165in.; 1/2in. x 165 1/2in.; 1/2in. x 166in.; 1/2in. x 166 1/2in.; 1/2in. x 167in.; 1/2in. x 167 1/2in.; 1/2in. x 168in.; 1/2in. x 168 1/2in.; 1/2in. x 169in.; 1/2in. x 169 1/2in.; 1/2in. x 170in.; 1/2in. x 170 1/2in.; 1/2in. x 171in.; 1/2in. x 171 1/2in.; 1/2in. x 172in.; 1/2in. x 172 1/2in.; 1/2in. x 173in.; 1/2in. x 173 1/2in.; 1/2in. x 174in.; 1/2in. x 174 1/2in.; 1/2in. x 175in.; 1/2in. x 175 1/2in.; 1/2in. x 176in.; 1/2in. x 176 1/2in.; 1/2in. x 177in.; 1/2in. x 177 1/2in.; 1/2in. x 178in.; 1/2in. x 178 1/2in.; 1/2in. x 179in.; 1/2in. x 179 1/2in.; 1/2in. x 180in.; 1/2in. x 180 1/2in.; 1/2in. x 181in.; 1/2in. x 181 1/2in.; 1/2in. x 182in.; 1/2in. x 182 1/2in.; 1/2in. x 183in.; 1/2in. x 183 1/2in.; 1/2in. x 184in.; 1/2in. x 184 1/2in.; 1/2in. x 185in.; 1/2in. x 185 1/2in.; 1/2in. x 186in.; 1/2in. x 186 1/2in.; 1/2in. x 187in.; 1/2in. x 187 1/2in.; 1/2in. x 188in.; 1/2in. x 188 1/2in.; 1/2in. x 189in.; 1/2in. x 189 1/2in.; 1/2in. x 190in.; 1/2in. x 190 1/2in.; 1/2in. x 191in.; 1/2in. x 191 1/2in.; 1/2in. x 192in.; 1/2in. x 192 1/2in.; 1/2in. x 193in.; 1/2in. x 193 1/2in.; 1/2in. x 194in.; 1/2in. x 194 1/2in.; 1/2in. x 195in.; 1/2in. x 195 1/2in.; 1/2in. x 196in.; 1/2in. x 196 1/2in.; 1/2in. x 197in.; 1/2in. x 197 1/2in.; 1/2in. x 198in.; 1/2in. x 198 1/2in.; 1/2in. x 199in.; 1/2in. x 199 1/2in.; 1/2in. x 200in.; 1/2in. x 200 1/2in.; 1/2in. x 201in.; 1/2in. x 201 1/2in.; 1/2in. x 202in.; 1/2in. x 202 1/2in.; 1/2in. x 203in.; 1/2in. x 203 1/2in.; 1/2in. x 204in.; 1/2in. x 204 1/2in.; 1/2in. x 205in.; 1/2in. x 205 1/2in.; 1/2in. x 206in.; 1/2in. x 206 1/2in.; 1/2in. x 207in.; 1/2in. x 207 1/2in.; 1/2in. x 208in.; 1/2in. x 208 1/2in.; 1/2in. x 209in.; 1/2in. x 209 1/2in.; 1/2in. x 210in.; 1/2in. x 210 1/2in.; 1/2in. x 211in.; 1/2in. x 211 1/2in.; 1/2in. x 212in.; 1/2in. x 212 1/2in.; 1/2in. x 213in.; 1/2in. x 213 1/2in.; 1/2in. x 214in.; 1/2in. x 214 1/2in.; 1/2in. x 215in.; 1/2in. x 215 1/2in.; 1/2in. x 216in.; 1/2in. x 216 1/2in.; 1/2in. x 217in.; 1/2in. x 217 1/2in.; 1/2in. x 218in.; 1/2in. x 218 1/2in.; 1/2in. x 219in.; 1/2in. x 219 1/2in.; 1/2in. x 220in.; 1/2in. x 220 1/2in.; 1/2in. x 221in.; 1/2in. x 221 1/2in.; 1/2in. x 222in.; 1/2in. x 222 1/2in.; 1/2in. x 223in.; 1/2in. x 223 1/2in.; 1/2in. x 224in.; 1/2in. x 224 1/2in.; 1/2in. x 225in.; 1/2in. x 225 1/2in.; 1/2in. x 226in.; 1/2in. x 226 1/2in.; 1/2in. x 227in.; 1/2in. x 227 1/2in.; 1/2in. x 228in.; 1/2in. x 228 1/2in.; 1/2in. x 229in.; 1/2in. x 229 1/2in.; 1/2in. x 230in.; 1/2in. x 230 1/2in.; 1/2in. x 231in.; 1/2in. x 231 1/2in.; 1/2in. x 232in.; 1/2in. x 232 1/2in.; 1/2in. x 233in.; 1/2in. x 233 1/2in.; 1/2in. x 234in.; 1/2in. x 234 1/2in.; 1/2in. x 235in.; 1/2in. x 235 1/2in.; 1/2in. x 236in.; 1/2in. x 236 1/2in.; 1/2in. x 237in.; 1/2in. x 237 1/2in.; 1/2in. x 238in.; 1/2in. x 238 1/2in.; 1/2in. x 239in.; 1/2in. x 239 1/2in.; 1/2in. x 240in.; 1/2in. x 240 1/2in.; 1/2in. x 241in.; 1/2in. x 241 1/2in.; 1/2in. x 242in.; 1/2in. x 242 1/2in.; 1/2in. x 243in.; 1/2in. x 243 1/2in.; 1/2in. x 244in.; 1/2in. x 244 1/2in.; 1/2in. x 245in.; 1/2in. x 245 1/2in.; 1/2in. x 246in.; 1/2in. x 246 1/2in.; 1/2in. x 247in.; 1/2in. x 247 1/2in.; 1/2in. x 248in.; 1/2in. x 248 1/2in.; 1/2in. x 249in.; 1/2in. x 249 1/2in.; 1/2in. x 250in.; 1/2in. x 250 1/2in.; 1/2in. x 251in.; 1/2in. x 251 1/2in.; 1/2in. x 252in.; 1/2in. x 252 1/2in.; 1/2in. x 253in.; 1/2in. x 253 1/2in.; 1/2in. x 254in.; 1/2in. x 254 1/2in.; 1/2in. x 255in.; 1/2in. x 255 1/2in.; 1/2in. x

QUERIES and ENQUIRIES

A stamped, addressed envelope, three penny stamps, and the query coupon from the current issue, which appears on the inside of back cover, must be enclosed with every letter containing a query. Every query and drawing which is sent must bear the name and address of the reader. Send your queries to the Editor, PRACTICAL MECHANICS, Geo. Newnes, Ltd., Tower House, Southampton Street, Strand, London, W.C.2.

Casting in Type Metal

I WISH to cast some small human figures in metal (lead tin alloy), using a plaster of Paris mould. Unfortunately, the pattern I have is much too large. I wish to cast the figures at about two-thirds the size of the pattern (zin. high).

I have seen a method outlined, using gelatine. The figure is cast at its normal size in gelatine, with a small amount of a powdered inorganic substance added, to give the cast stability. The gelatine cast is reduced in size (by osmosis) in strong alcohol and the process continued until the desired size is obtained.

Can you suggest any modification of the above method or, better still, an alternative method?—A. W. Hamlin (London, W.13).

THE idea of using casts in gelatine and then reducing their size by shrinking in alcohol would, we think, be unworkable in your case with such tiny figures.

A quantity of such figures once had to be made to a scale of 1/2 in. to 1 ft. (about 1 1/2 in. high) and were done then by modelling in "Plasticene" on a piece of glass, one side, the front, of the figure on one side of the glass and the back of the figure on the other side. Glass was used so that the two halves could be seen through it and so made to correspond and be in alignment. Then a wooden box was made without bottom or top, just four sides. All four sides were then sawn through to make two shallower boxes. These were clamped on each side of the glass so that they too came into alignment and each enclosed its respective half of the figure. One at a time each box was filled with liquid Portland cement and when both were set and dry they were removed from the glass. The Plasticene came away with the cement and had to be dug out, leaving perfect impressions.

We should have mentioned that at the feet of each of the models a coned runner was formed in Plasticene which was reproduced in the cement. When the moulds so formed were removed from the glass they were baked to make them perfectly dry and the figures were cast in type metal. The modelling can be equally well done in wax, if preferred.

One objection to the gelatine idea is that shrinkage would not take place equally. You will be well advised to try your hand at modelling, but make careful sketches of each figure, back and front, to work from.

Polychromatic Enamel

I SHOULD like some information on the use of a polychromatic enamel on my motor-cycle frame, fork and mudguards. These have been stripped down to bare metal. How many coats of enamel should be given and what undercoat is used for this enamel? The

colour I have in mind is either a light blue or beige.—P. J. Owens (Treharris).

A POLYCHROMATIC enamel is merely an enamel or paint which can be procured in one of many colours. Hence, strictly speaking, the term is one which can be applied quite truthfully to almost any proprietary range of paints or enamels. The term does not, of itself, imply anything specially distinctive. You will be able to obtain a light blue or a beige-coloured paint or enamel from any ordinary paint shop or colour merchants, or from your nearest branch of the Halford Cycle Co., Ltd., Corporation Street, Birmingham.

These so-called polychromatic enamels may be of any nature, cellulose or otherwise. "Polychromatic" is not a distinctive title, nor is it in any respect a trade name. It forms no indication of the actual nature of the enamel. As we have remarked, it merely indicates that the enamel is one which may be obtained in many colours. These enamels for cycle and motor-cycle use do not usually require any undercoat. They may be applied either by brush or by spray. Two good

Readers are asked to note that we have discontinued our electrical query service. Replies that appear in these pages from time to time are old ones and are published as being of general interest. Will readers requiring information on other subjects please be as brief as possible with their enquiries.

coatings are usually sufficient for any enamel of this nature. It is of the utmost importance, however, that the metalwork should be well degreased previously in order that the enamel "takes" to the metal surface evenly. Apart from this essential requirement of adequate cleanliness and degreasing, there is no special point regarding the application of motor-cycle

enamels. Degreasing is best done by immersing the part in a solution of caustic soda in water, say, 10 parts of caustic soda in 90 parts of water.

Cleaning Old Prints

I HAVE a number of old engravings (prints) that are dirty and spotted with brown marks. Please tell me a method of removing these without damaging the subject.—H. H. Pacy (Aylesbury).

IT is difficult to advise on the cleaning of old prints without knowing exactly what is the nature of the marks. The brown marks can be due to iron, which may have been a contaminant in the paper and which "grow" from the surface in the form of a brown stain. A chlorine-containing substance is usually employed to generate dry chlorine which will remove stains of this kind, but it should be remembered that chlorine is a lung-irritant gas.

Indeterminate stains can be dealt with by carefully dabbing them with a solution of sodium chlorate, using a camel hair brush. For ink stains citric acid is put on to the stain and then moistened, being carefully removed after a short time, depending on the depth of stain. The use of citric acid in this way can follow the treatment with sodium chlorate.

Fly marks can be dealt with, oftentimes, with hydrogen peroxide, while "foxing" can be carefully treated with a chlorine-containing substance like Milton.

If you make a habit of cleaning old prints I would suggest your reading "Print Restoration and Picture Cleaning," by Maurice James Gunn (1922), originally published by "Bazaar Exchange and Mart," Breams Buildings, London, E.C.4.

Purifying Soot

PLEASE let me know if common chimney soot can be purified for medicinal use. I am experimenting and I think soot has a lot of virtues which could be used for ailments.—J. W. Bishop (Stockport).

WE do not advise you to experiment with common chimney soot as a medicinal agent, for you will find that it has more vices than virtues in this connection. Tar water is mentioned in the pharmacopœia and it has a few useful medicinal attributes, but this does not apply to soot water which is mainly of use as an insecticide. This is because common soot contains various toxic materials. If you attempt to purify the soot you would extract these toxic materials and you would be left with ordinary carbon which would be of no value either positively or negatively to you. Chimney soot may be looked upon as being a powder containing a high proportion of carbon mixed with various organic oils and other liquids.

If, however, for experimental purposes you wish to purify common chimney soot, the best and the easiest way of doing this is simply to take a quantity of the soot and to heat it to redness for about half an hour. This will result in the contained impurities and toxic materials being driven off, but at the same time much of the carbon will be oxidised away to form the gas carbon dioxide so that the purification process will be a wasteful one.

Plant Crystals

CAN you please describe the process used to produce crystals from plants for viewing under a microscope?—H. Haigh (Grays, Essex).

WE are not perfectly certain of what you mean by your mention of "producing crystals from plants for viewing under microscope," but we are assuming that you are referring to what are commonly called by botanists *Raphides*, which term is derived from the Greek *raphis*, a needle, these crystals being

THE P.M. BLUE-PRINT SERVICE

- 12FT. ALL-WOOD CANOE. New Series, No. 1, 3s. 6d.*
- 10-WATT MOTOR. New Series, No. 2, 3s. 6d.*
- COMPRESSED-AIR MODEL AERO ENGINE. New Series, No. 3, 5s.*
- AIR RESERVOIR FOR COMPRESSED-AIR AERO ENGINE. New Series, No. 3a, 1s.
- "SPORTS" PEDAL CAR. New Series, No. 4, 5s.*
- F. J. CAMM'S FLASH STEAM PLANT. New Series, No. 5, 5s.*
- SYNCHRONOUS ELECTRIC CLOCK. New Series, No. 6, 5s.*
- ELECTRIC DOOR-CHIME. No. 7, 3s. 6d.*
- ASTRONOMICAL TELESCOPE. New Series, No. 8 (2 sheets), 7s.*
- CANVAS CANOE. New Series, No. 9, 3s. 6d.*
- DIASCOPE. New Series, No. 10, 3s. 6d.*
- EPISCOPE. New Series, No. 11, 3s. 6d.*
- PANTOGRAPH. New Series, No. 12, 1s. 6d.*
- COMPRESSED-AIR PAINT SPRAYING PLANT. New Series, No. 13, 7s. 6d.*
- MASTER BATTERY CLOCK.*
Blue-prints (2 sheets), 3s. 6d.
Art board dial for above clock, 1s.
- OUTBOARD SPEEDBOAT
10s. 6d. per set of three sheets.
- LIGHTWEIGHT MODEL MONOPLANE.
Full-size blue-print, 3s. 6d.
- P.M. TRAILER CARAVAN.
Complete set, 10s. 6d.*
- P.M. BATTERY SLAVE CLOCK—2s.
- "PRACTICAL TELEVISION" RECEIVER
(3 sheets), 10s. 6d.
- P.M. CABIN HIGHWING MONOPLANE.
1s.*

The above blue-prints are obtainable, post free, from Messrs. George Newnes, Ltd., Tower House, Southampton Street, Strand, W.C.2.

An * denotes constructional details are available free with the blue-prints.

ones of calcium oxalate and phosphate which are needle-shaped and are frequently found embedded in the green material of leaves, in which position they can be seen under the medium powers of a microscope. Raphides, too, are also common in the bark of many trees, but we hardly suppose that you would call these plant crystals. Most of the higher plants contain raphides or plant crystals which are embedded in the middle of their cells. The leaves or stems of such plants do not require any special treatment for the crystals to be discerned. The leaves are sectionised, cleared, and mounted by the usual microscopical technique, after which processes they are permanently visible on the microscope slide. Not all raphides are needle-shaped. Some may be stellar or star-shaped and others may show an actual cubical formation. The majority, however, are needle-shaped and they are rendered, under the microscope, all the plainer by viewing under the usual polarising apparatus.

Stamp Query

HAVING read, with interest, an article in "Practical Mechanics" recently on stamps I venture to ask your assistance. I have a Norwegian pictorial stamp, portraying Arne Garborg, whose centenary was in 1951. The country-name is misspelled, being on the stamp NOREG, instead of NORGE, as it should be. Has this any value?—A. P. Sweby (St. Albans).

THE spelling "NOREG" instead of the usual "NORGE" is intentional. Arne Garborg associated himself with the movement to create a Norwegian literary language based on the peasant dialect derived from old Norsk, instead of the Dano-Norwegian literary medium.

In honour of his work the stamps are, therefore, inscribed "NOREG." As many thousands of these stamps were issued the present value is only a few pence.

Removing "Static" from Tissues

CAN you please tell me of any method to rid tissue paper of "static" produced when printing on the same?—F. A. Norton (Leicester).

THE manufacturers state: "The question of neutralising static electricity in tissues has always been a difficult problem, and unless the electricity is removed in the manufacture of the paper we do not know of any means of overcoming the difficulty after the paper has been packed and delivered. From our experience we find that when the paper is kept in stock the electricity gradually goes, provided the paper is not kept in a dry atmosphere."

"In our process of manufacture we have wires attached to various parts of the dry end of the machine, and these remedy the trouble to a certain extent. When the paper is being cut on the cutting machine we arrange to have a small cloud of steam through which the paper passes, and this reduces the trouble to a minimum."

We suggest you try maintaining a steam cloud when printing.

Magnesium Flash Firing Circuit

AT a school for partially sighted children we are putting on the play "Aladdin." Could you let me know a simple method of producing a flash and if possible a wisp of smoke as the Genie of the Lamp appears?

If magnesium powder is used, can you describe the circuit necessary to fire it electrically?—W. J. Wall (Coventry).

THE circuit to fire magnesium powder electrically is quite simple, a small battery of the flashlight type being used. The attached sketch will show you a simple

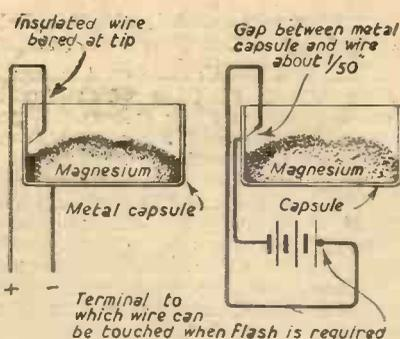

circuit. But a more safe method is to use a flashlight bulb.

Fixed Focus Enlarger

WE wish to construct a fixed focus enlarger, for photographic work, from 3½ in. x 2½ in. to postcard. Will you please outline a method, and also a specific reasonably priced lens? Would an unused box camera (f7.7) be of any use for the purpose?—J. T. Stock (Nottingham).

EITHER the f7.7 lens box camera or the folding camera with which the original pictures were taken may possibly be used; probably the first could be the more readily adapted. Obviously the lens is the most important item and means will have to be provided both for extending the focus and admitting light at the back where the negative will be placed. The lamp will need to be enclosed and well ventilated and the whole arrangement may be something like the enclosed sketch. Both the position of the negative and of the enlargement will have to be found by experiment, and when found the extension pieces can be made to the exact measurements found by the test.

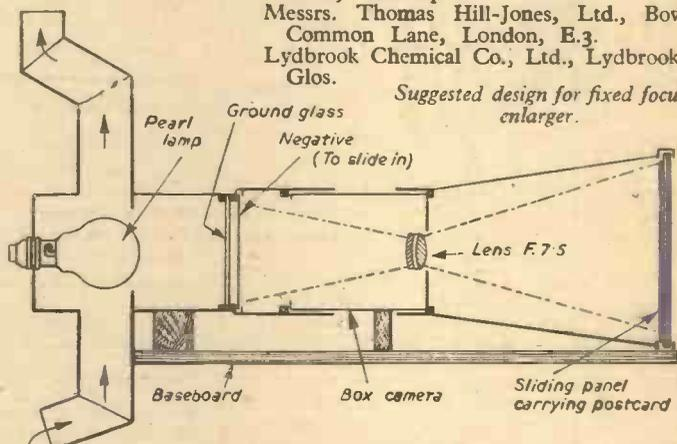

Wood Distillation, Ltd., Cannop, Coleford, Glos.

The charcoal or charcoal mixture is packed loosely in a non-metallic pipe, such as a 2ft. length of earthenware drainpipe. This is bunged firmly at the lower end and a trickle pipe is passed through this. Arrangements are made for the roof water to trickle through the charcoal column and to pass out via the exit pipe, a convenient tap being attached to the latter. The construction of these charcoal filter-columns is really very simple, and we do not think that you will experience much difficulty in getting first-class results with your experiments. Water which has been filtered through any of the above media is, of course, eminently suitable for drinking purposes.

Information Sought

Readers are invited to supply the required information to answer the following query.

J. R. Douthwaite writes: "I have made the hedge trimmer as described in PRACTICAL MECHANICS; this has passed its test successfully and I should now like to make a 'Master Hedge Cutter' of the reciprocational type. Can you supply details?"

Filling Holes in Vice Bed

I HAVE recently purchased a second-hand "Versa Vice" No. 3 machine vice which has several drill holes up to 5/16 in. in the bed, due to carelessness. I shall be pleased to hear if you have any suggestions to offer on filling these up.

I have had it suggested that iron or steel filings and a certain acid would effect the necessary repairs.—D. Wharton (Birkenhead).

IF these impressions are not too numerous, probably the simplest method for you to adopt is to drill slightly larger holes, tap them and fit plugs; afterwards filing or grinding them flush.

Alternatively, you can remove, say, ¼ in. from the floor of the vice which has these unsightly marks and fit a steel plate, perhaps casehardening the top face to overcome further damage. This method involves the risk of the base distorting, but actually this is not a serious factor, because when the vice is once more tightened on the machine table it automatically resumes the original position, thus any discrepancies are not transferred to the work.

We feel that either of the above methods

G.E.C. & B.T.H. GERMANIUM CRYSTAL DIODES

G.E.C. GLASS TYPE 1/16in. x 3/16in.
B.T.H. LATEST TYPE MOULDED IN THERMO-SETTING PLASTIC
Both Wire Ends for Easy Fixing.
4/6 each, postage 2/6.
B.T.H. SILICON CRYSTAL VALVE
3/6 each, postage 2/6.
Fixing Brackets 3d. extra.
Wiring instructions for a cheap, simple but high quality Crystal Set included with each Diode and Crystal Valve.

COPPER INSTRUMENT WIRE ENAMELLED, TINNED, LITZ, COTTON AND SILK COVERED.
All gauges available.
B.A. SCREWS, NUTS, WASHERS, soldering tags, eyelets and rivets.
EBONITE AND BAKELITE PANELS, TUFNOL ROD, PAXOLIN TYPE COIL FORMERS AND TUBES.
ALL DIAMETERS.

Latest Radio Publications.
SEND STAMP FOR LISTS.
CRYSTAL SET
INCORPORATING THE SILICON CRYSTAL VALVE
Adjustable Iron Cored Coil.
RECEPTION GUARANTEED
Polished wood cabinet, 15/-, post 1/-.
A REAL CRYSTAL SET NOT A TOY
POST RADIO SUPPLIES
33 Bourne Gardens, London, E.4

You Can Become a HANDICRAFTS INSTRUCTOR

EXPERIENCE NOT ESSENTIAL
Men who enjoy making things in wood or metal can turn their hobby into a permanent and interesting Career! Short hours, long holidays, and security in a job you would really enjoy, can be yours if you become a Handicrafts Instructor. Let us send you details of the easiest and quickest way to get the necessary qualification.

We definitely Guarantee "NO PASS—NO FEE"
If you would like to know about our unique method of preparing you for one of these appointments, write today, and we will send you an informative 144-page Handbook—FREE and without obligation. Mark your letter "Handicrafts Instructor."

British Institute of Engineering Technology
591, Shakespeare House, **BIET**
17/19, Stratford Pl., London, W.1

HIGH GRADE SURPLUS ELECTRONIC COMPONENTS
SPECIAL OFFER PARMERKO TRANSFORMERS—Prim. 100-250 v. Sec. 1,300-0-1,300 v. 250 m/a. Completely shrouded, £3/15/-, carr. 7/6. Prim. 100-250 v. Sec. 500-0-500 v. 400 m/a. 220-0-220 v. 30 m/a. 6.3 v. 7 amps. 4 v. 6 amps. completely shrouded, £3/15/-, carr. 7/6.
HEAVY DUTY POTENTIOMETERS BY BRITISH ELECTRIC—Type T. 6 inch Dia. Pots. 1,000 ohms 4/28 amps with 3 inch skirted knob, 22/6, p/p 2/-.
4 inch Dia. Pots. 2,000 ohms .22 amps with 3 inch skirted knob, 15/-, p/p 1/6.
ZENITH TRANSFORMERS—Prim. 190-270 v. Sec. 5 v. 150 amps and 8 v. 2 amps, £4/15/-, carr. 7/6.
CAUTERIZING TRANSFORMERS—Prim. 110 v. Sec. 0 v. 100 amps, £3/10/-, carr. 9/-.

J. HALLETT
19, Upper Richmond Road, London, S.W.15

CIRCULAR SAW SPINDLE ASSEMBLIES
Complete range for Saws from 4in. to 30in. from 24/9. Circular Saws, bearings, pulleys, belts, motors. Sawbenches complete, 8in., 72/11. 8in., 98/7. 12in., 124/5. 24in., £17/17/2. Quotations gladly for specials. Send 10d. for Handbook-Catalogue of Sawbench design data.
BEVERLY PRODUCTS
Ranskill, 22, Notts

PARKER'S SHEET METAL FOLDING MACHINE

Heavy Vice Model.
Capacity 18 gauge
M.S. x 2ft. wide.
Loose Attachments, if required, for Radio Chassis, Tray or Box making.
Weight 22 lbs. Price 42/6. Attachments 1/6 per ft. Carriage 4/-. With Attachments 5/6.

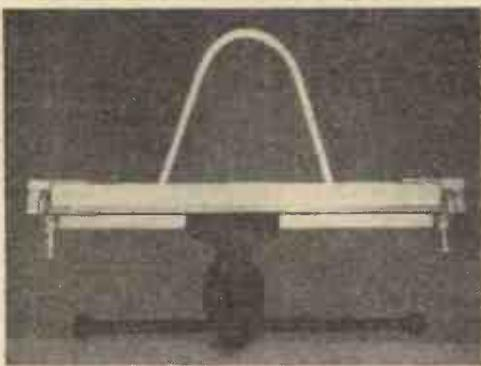

ALSO PARKER'S FOUR IN ONE REVOLVING DRILL VICE
Comprising:
Upright Vee.
Inclinable Vee.
Right Angle.
Flat Side. Admits stock of 3in. dia.
Weight 13 lbs.
Overall length 13in.
Price 42/6.
Carriage 2/6.
Send for details.

A. B. PARKER WHEATCROFT WORKS, WELLINGTON STREET, BATLEY, YORKS.
Telephone: BATLEY 426.

A PRECISION BALANCE
for your own RESEARCH work. The "COURIER" Balance outfit (Pat. appl. for) enables you to construct an instrument capable of a performance equal to Balances many times the price. Designed and prepared by experienced Balance Mfrs. the outfit incorporates steel knives, real Agate bearings. Alloy Beam, Brass pans and fittings.
Price for Complete Outfit, Instructions and Blueprint **47/6d.**
(U.K. Postage 1/-)
From your usual suppliers, or direct from Makers:
WILLIAM A. WEBB, LTD.
(Dept. C).
1/8, Perryman's Farm Road, Ilford, Essex.

BUYING NEW EQUIPMENT?
First, consult our new **1/0 BUYER'S GUIDE** Post Free (returnable)
T. GARNER & SON LTD.,
Hand and Machine Tool Division
Redbrook Works, Gawber,
Phone: BARNESLEY 2908

RATCHET & REVOLUTION COUNTERS
Ask for Leaflet No. 18/7
Speed up to 6,000 r.p.m.
B. & F. CARTER & Co., Ltd., Bolton 5

COMPRESSORS
Twin Cylinder ex-W.D. Ready for use. 12 cubic foot. Guaranteed. £12.10.
Weight 65 lbs. Smaller Models, etc. List.
ROGERS,
2 Matlock Avenue, Southport.

REFILL YOUR OWN BALL PEN
KOLOID REFILL KIT
POST FREE 3/6 PER OUTFIT
COMPLETE WITH ILLUSTRATED INSTRUCTIONS AND TOOL
Contains Ink for Blue, Violet, 12-15 Refills | Red, Green.
G. H. HOLMES
(Dept. 5) 67, Brunswick Park Road, London, N.11.

I'll Teach You to Play the Piano
Without Drudgery, Fatigue or Failure.
Original Lessons using ordinary music, no freakish methods, making failure impossible. My pupils roll grows daily. I state it in every advertisement. It is your assurance of success. My class is seldom less than 2,000 pupils. I have taught over 67,000 and **I CAN TEACH YOU** (in 12 lessons) even if you do not know a note. Free book and advice. Say **BEGINNER, MODERATE, ADVANCED.** (BLOCK LETTERS PLEASE)
MR. H. BECKER (Dept. 758), The Hall, Centurion Road, Brighton, Sussex.

MAKE IT A Jubilee Coronation Year
Famous in Four Reigns
L. ROBINSON & CO. (GILLINGHAM) LTD.
London Chambers, GILLINGHAM, KENT. Phone 5282

IMPETUS Precision PLANERS
Circular safety type cutter-head High quality tempered steel knives. Tables mounted on machined inclined ways. Ground table-surfaces. Fences adjustable to 45 deg. **£9.10.0**
4 in. MODEL £18.10.0. 6 in. MODEL £28.10.0. Motorised £44.0.0. Send for Catalogues of other 'Impetus' Products.
JOHN P. M. S. STEEL, Dept. 30, BINGLEY, YORKS.
Phone: BINGLEY 3551 (4 lines).

Amateur Radio Enthusiasts
THE INCOMPARABLE GLOBE-KING
SINGLE VALVE S.W. RECEIVER
● WORLD-WIDE RANGE 11-100 METRES
● CRYSTAL-CLEAR NOISE-FREE RECEPTION
● ELECTRICAL BAND-SPREAD TUNING
● EXTREMELY LOW RUNNING COSTS
Catalogue Free. Stamp for postage.
JOHNSONS (RADIO)
46, FRIAR STREET, WORCESTER

WEBLEY AIR PISTOLS
Marvellously accurate for target practice.
No licence required to purchase for use on enclosed premises.
Write for Catalogue of AIR PISTOLS, AIR RIFLES and Accessories.
WEBLEY & SCOTT LTD.,
106, Weaman Street, Birmingham Eng.

GENERAL CERTIFICATE OF EDUCATION EXAM.
THE KEY TO SUCCESS AND SECURITY
Essential to success in any walk of life. Whatever your age, you can now prepare at home for the important new General Cert. of Education Exam. (you choose your own subjects) on "NO PASS—NO FEE" terms.
SEND FOR FREE 136-PAGE BOOK
Full details of how you can obtain this valuable Certificate are given in our 136-page Guide—FREE and without obligation. Write to-day.
B.T.I., 160, AVON HOUSE, 356-366, OXFORD STREET, LONDON, W.1.
NO PASS—NO FEE

THIS MONTH'S BARGAINS!!!

SOCKET SPANNER SETS.—Large size from 1 1/16-1 1/2. A.F. sizes contains 12 sockets and 2 extension bars in a strong steel case. Normal list price for this kit would be £15. Our price, 30/-, plus 4/- carriage and packing.

RADIO RECEIVERS, TYPE R109.—This is an 8-valve superhet receiver covering the following wave bands: 1.8 Mc/s - 3.9 Mc/s, 3.9 Mc/s - 5.5 Mc/s. Complete with all valves and vibrator pack. Built-in speaker, works off 6-volt batteries. No mains required. Ready to use at £6 each. Carriage and packing, 10/-.

TRUVOX HAND MICROPHONES.—A very robust job suitable for use with loud hailer systems. Ideal for your garden parties this summer. Price, 7/6 each, packing and postage 1/8 extra.

VALVES.—Type VU.120A EHT. Television Rectifier. New and boxed. Price, 3/-, including postage and packing.

METERS.—0-100 m/a. 2 1/2 in. scale. Round. Flush panel mounting. This is a shunted meter, the basic movement being 2 1/2 m/a and with the shunt removed can be used as a voltmeter with a suitable resistance in series, of course. Calibrated 0-100. Details for conversion supplied if requested. Price, whilst stocks remain, 7/6 each, plus 1/8 postage and packing.

THROAT MICROPHONES.—Miniature American carbon type in moulded plastic/rubber. Slightly store soiled, but guaranteed in perfect working order. Price, 1/3 each, plus 6d. postage and packing, or 10/- per doz., post paid.

NAVIGATOR COMPASSES.—New, in strong wooden transit cases. Alcohol Fluxgate. This is a very fine instrument. Ideal for Cadets, etc. Limited quantity. Price, 50/- each, plus 3/6 postage and packing. Send S.A.B. for all enquiries please.

JEFFREY H. DAKIN
13 Church Road, Edgbaston, Birmingham, 15.
EDGbaston 2220

FOR HOME, OFFICE, WORKS AND LABORATORY USE
THE "DERMIC" OILER
Mark III
4/11 Post Free
As supplied to Official Departments and Undertakings, Engineering and Aviation firms, etc.
Use a "DERMIC" Oiler for clean and accurate lubrication of models, clocks, watches, sewing machines, typewriters, movie cameras and projectors and any delicate instruments or mechanism.
Can also be used for the clean and efficient application of soldering fluid. Packed in box with full instructions.
Manufactured by
S. & B. PRODUCTIONS,
Orton Buildings, Portland Road, South Norwood, London, S.E.25.
Phone: LIV 4943.

BUILD YOUR OWN BOAT FROM PREFABRICATED PARTS
Send 2/6d. for Illustrated Booklet containing details of all our kits and finished boats.

Home Boat Building
BELL WOODWORKING CO., LTD.,
Boat Builders, Aylestone Park, Leicester
Telephone 32480

NEW!

E.M.I. INSTITUTES EXPERIMENTAL KIT

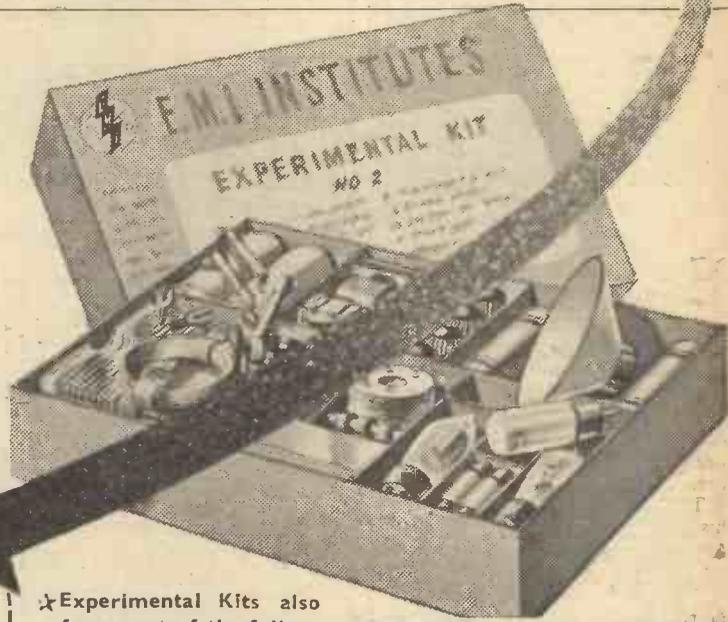

LEARN THE PRACTICAL WAY

A specially prepared set of radio parts from which we teach you, in your own home, the working of fundamental electronic circuits and bring you easily to the point when you can construct and service a radio set. Whether you are a student for an examination, starting a new hobby, intent upon a career in industry, or running your own business—this Course is intended for YOU—and may be yours at a very moderate cost. Available on Easy Terms. **WE TEACH YOU:** *Basic Electronic Circuits (Amplifiers, Oscillators, Power Units, etc.) Complete Radio Receiver Testing & Servicing.*

POST IMMEDIATELY FOR FREE DETAILS

TO: E.M.I. INSTITUTES, Dept. 144 X
Grove Park Road, Chiswick, London, W.4

Name

Address

Experimental Kits also form part of the following courses: Draughtsmanship, Carpentry, Chemistry, Photography, Commercial Art, Etc.

EMI INSTITUTES
Associated with
MARCONIPHONE & HMV
COLUMBIA & HMV
(His Master's Voice)

I.C.1

SURPLUS BARGAINS

FRACTIONAL H.P. EX-R.A.F.



1/4 H.P. BRAND NEW ELECTRIC MOTOR

Made by Hoover

EACH ONLY 37/6 Carr. 2/6

Not to be confused with smaller, cheaper types. Size 1 1/2 in. x 5 1/2 in. x 5 1/2 in., weight 18 lbs., volts 200-250. State A.C. or D.C. 2,000 r.p.m. Ideal for Polishing, Grinders, Washing Machines, etc. Existing spindle 1/2 in. diameter, 1 1/2 in. long. All-purpose extension spindles to screw on, 7/8 pair extra.

BATTERIES, unused ex-Army, Philco 6 v. 77 amp., 65/- Carr., 5/-; Thor 6 v. 90 amp., 70/- Carr., 5/-.

POCKET WATCHES, new foreign import (luminous), 17/6. Post and Ins., 1/-.

WATERPROOF BLOUSES, ex-Services, unused yellow lightweight material, elastic waist and cuffs, zip front, 10/- incl.

LEATHERETTE LUMBERS (new), state chest size. Cut price, 37/6. P/Post, 2/- (Ditto gabordine material, same price.)

WATERPROOF LEGGINGS, 5/- pair incl.

SHORTS, Nat. Service, unused khaki or white. State waist size, 12/6 incl.

TROUSERS, new, khaki or white drill, with waist belt. State meas., 15/- incl. (Ditto grey flannels, 22/6 incl.)

ARMY BOOTS, reconditioned Grade I. Sizes 6, 7, 8, 9, and 10, 18/6 incl.

SHOES, ex-Naval Recdtd., 13/6 incl.

BOILER SUITS, ex-Services, recdtd., navy blue (state chest and height), 13/6 incl.

THIGH BOOTS, rubber, reconditioned sound, 25/- incl. (Ditto Wellingtons, 14/-).

Send S.A.E. for Latest Lists (MONEY BACK GUARANTEE)

AUTO COLLECTIONS LTD.
15, LAWRENCE STREET,
NORTHAMPTON



Accurate mileage at a glance



Precision built with watch-like accuracy, neat, light and strong, records up to 10,000 miles and then repeats. Complete with striker and rust-proof hub spindle bracket. Chromium plated finish. Price 7/5

FOR 24", 26", 27" & 28" WHEELS

Universal Fork Fixing Bracket for cycles which cannot take normal hub spindle bracket. Price 1/-.
Price 1/5

"King of the Road" LUCAS CYCLOMETER

JOSEPH LUCAS (CYCLE ACCESSORIES) LTD • CHESTER ST • BIRMINGHAM 6

WATSON'S SPECIAL OFFERS

MOTOR GENERATORS.—Unused. Input 24v. Two outputs 240/280v. 40w. and 90/140v. 40w.; can be used as motor on 12v. or 24v. Less than the value of the ballraces. Price 9/6. Post 2/-.

EX-R.A.F. TOOL BOXES.—Size 14 1/2 in. x 8 in., dovetailed and metal bound. Price 9 9, carr. 2/6. Larger size 20 in. x 12 in. x 1 1/2 in. Price 13/6, carr. 3/6.

VIBRATION ABSORBING MOUNTINGS.—Steel frame, 18 in. x 8 in., with four rubberised feet. 3/6. Post 1/3.

BALLRACES.—Brand new, 1 1/2 in. x 7/32 in. 3/- each; 10 for 26/-, 1 1/2 in. x 7/32 in. 3/3 each; 10 for 28/-, Post 6d.

V-ROPE.—"B" Section, 2 1/2 in. x 7/16 in., 52 in. overall, 3/6 each, 5 for 15/-, Post 1/-.

BOMBIGHT COMPUTER.—The most complex instrument offered: 80 lbs of interesting parts, gear and worm wheels, motors, etc. In metal transit case. £300 worth for 67/6. Carr. 7/6.

LANDING LAMPS.—7 in. diam., easily converted to car spotlights, matt black finish. 8/6 each. Post 1/6.

SMALL TRANSFORMERS.—200/250 1 ph. 50 cycles to 12v. 100w. Extremely useful for domestic power purposes, model railways, and small low-voltage handlamps. Price 35/-, Post 2/-.

GEAR PUMPS.—By Rolls-Royce and similar makers, 1/2 in. suction and delivery beautifully made, and will deal with a large volume of liquid. Price 20/- each. Post 2/-.

ASTRO COMPASS.—Precision observation instruments. Optical sight, four scales, two spirit levels in transit case. 8/6. Post 1/3.

PRESSURE GAUGES.—0-150 lbs./sq. in., luminous remote reading, each gauge with 45/50 ft. copper tubing and banjo connection. Price 9/6. Post 1/10.

COILED SPRING ENDLESS BELTS.—Size 1/2 in. 12 in. long, extensible to 15-16 in. Fastened by screwing conical L.H. end inside coils. Any number can be joined together for length required. Twenty for 6/0. Post 9d.

MINE OR METAL DETECTORS.—A fine article with hundreds of uses for detecting concealed metal objects. £4/10/- Carr. 3/6.

FLEXIBLE LEADS.—20 ft. length, four conductors, T.R.S., 3/- each, four for 10/-.

COAXIAL CABLE, impedance 52 ohms, 1-yd. **BATTERY CHARGERS**.—Metal rectifiers, output 24v. (charges two 12v. batteries), built to a high service specification. £10/- Carr. 12/6.

MAP CASES.—Transparent perspex with hinged door, 8 1/2 in. x 9 in. Price 1/3. Post 9d. Hundreds of other Bargains available.

Send stamp for List.

EASTERN MOTORS,
ALDBURGH, SUFFOLK.

Telephone 51.