

MAKING TUBULAR FURNITURE

NEWNES

PRACTICAL MECHANICS

9^p

EDITOR: F. J. CAMM

MARCH 1948

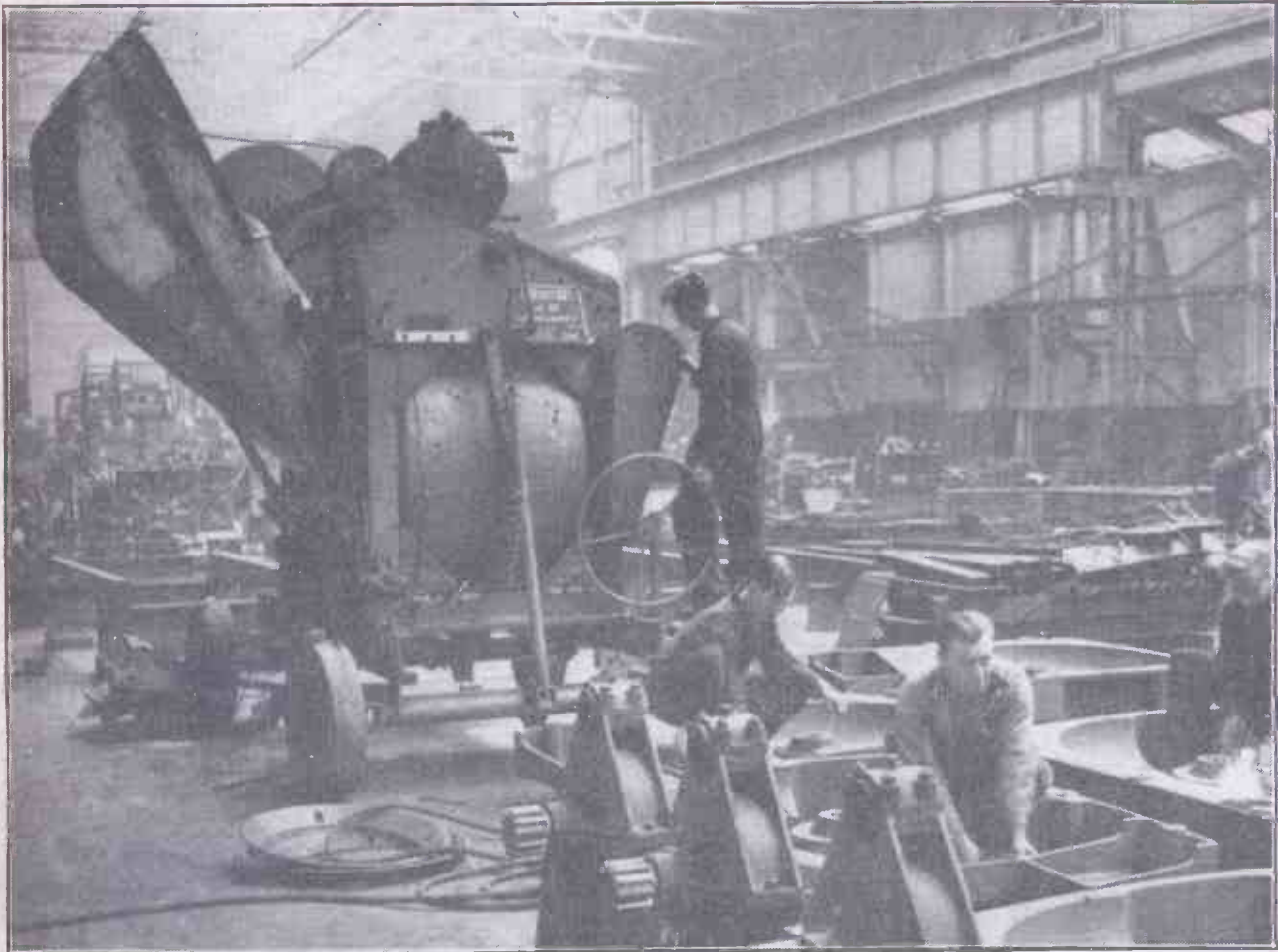

IN THE GENERAL FITTING SHOP OF A BRITISH ENGINEERING FIRM (SEE PAGE 210).

PRINCIPAL CONTENTS

Making a Telescope Reflector
The Conundrum of Coal
A Circular Saw Bench

Electric Water Heating Practice
Ballistics in Nuclear Physics
Printing Box and Safelight

World of Models
Trade Notes
Cyclist Section

"I never knew there
were so many kinds of..."

CLIPS

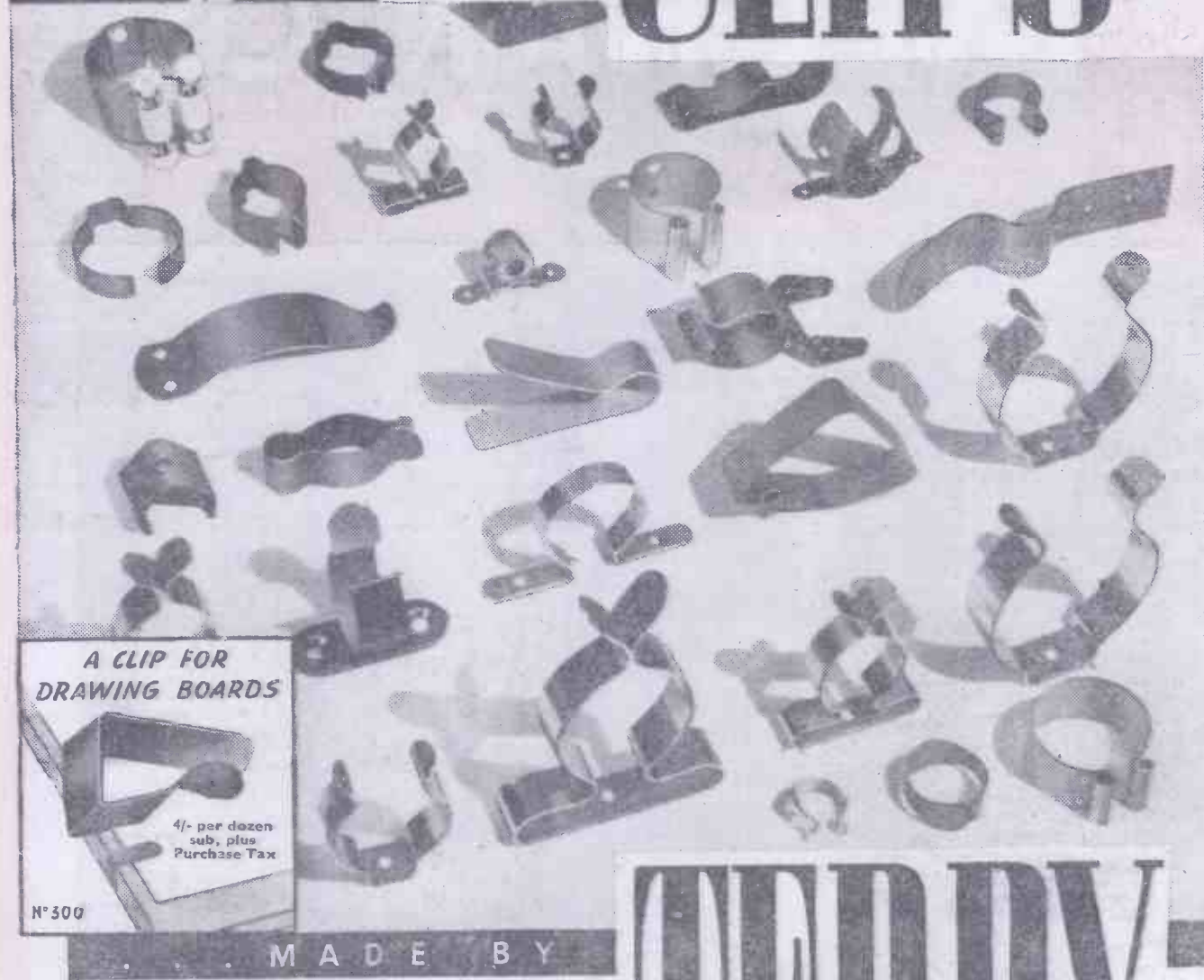

**A CLIP FOR
DRAWING BOARDS**

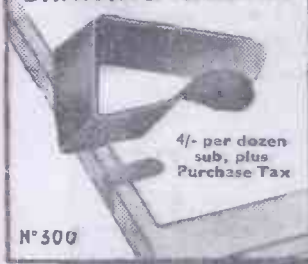

4/- per dozen
sub. plus
Purchase Tax

N° 300

MADE BY

TERRY

People are amazed when they learn of the variety of CLIPS we make—steel clips, bronze clips, stainless clips, big clips, small clips . . . clips in every conceivable shape and pattern . . . clips for every possible use.

We can make to print or specification or our Research Department can design a clip for that particular job of yours.

Over 92 years of clip-making is at your disposal.

HERBERT TERRY & SONS LTD., REDDITCH



London, Birmingham, Manchester

THE "ZYTÖ" TEN MOTORISED BALL BEARING SAW BENCH



For crosscutting, ripping, grooving, mitring, bevelling, etc. Takes 10in. saw. Spindle runs in heavy ball-bearings, parallel rise and fall Table with rackfeed and canting for bevelling, etc. Right and left hand mitre slides, approved saw-guards. Vee belt drive, built-in dust chute, swivel motor base.

Supplied A.C. 200-220., 230-250.
Three-phase 400-440.
Direct Current.

Price and illustrated leaflet free and post free on application.

THE "ZYTÖ" 3" CAPACITY PRECISION BENCH DRILLING MACHINE

3 jaw, self centring chuck, capacity 0-3" 3-speeds, drills to centre of 6". Maximum distance between chuck and base, 10". Size of table, 5" diam. This can be swung clear of work. Size of base machined, 5 1/2" x 5". Price Complete, £10/17/6 Ex Stock. With 3-jaw key type self-centring chuck, £11/18/6.

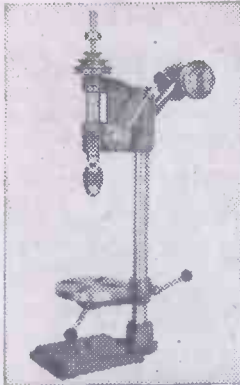

S. TYZACK & SON,
341-345 OLD STREET,
Telephone: Clerkenwell 4004 5-6

TOOL AND MACHINERY LTD. SPECIALISTS
LONDON, E.C.1
Telegrams: Tyzgar, Finsquare

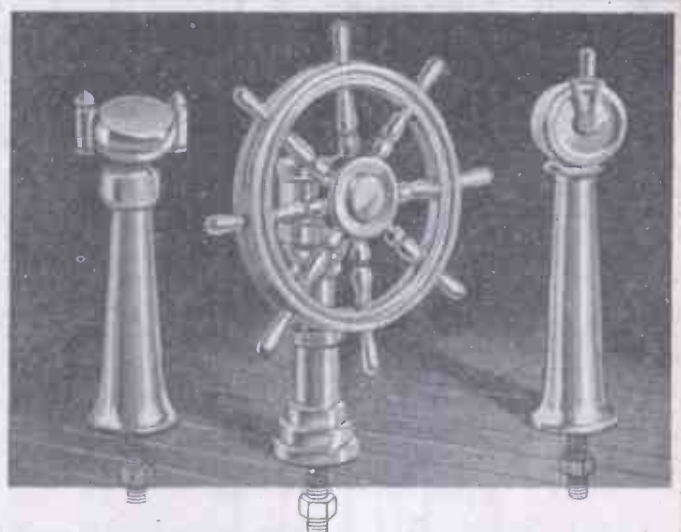

Three of-over FIFTY!

* We now offer from stock in Northampton, London and Manchester, a range of over Fifty SHIPS' FITTINGS, in two sizes (1/2 in. scale and 3/16 in. scale), beautifully finished and nickel plated and ready for easy assembly.
* THE MARINE MOTOR for motor boats up to 1 metre works on dry battery or accumulator, 6-8 volts, weight 15 ozs. Price 37/6.
* SCALE MODEL STANCHIONS in hard brass, unequalled for accuracy and strength—scale 1/4 in. to 1 foot.
* For particulars of these and other models now available, write now for List (SF/12), price 1/-.
Write also for (MY/12), price 6d. 'How to Sail your Model Yacht.'
(LI/2) price 6d. 'Stock List of Model Supplies.'
Please quote our reference for each booklet.

BASSETT-LOWKE LTD.

NORTHAMPTON

London Showrooms: 112, High Holborn, W.C.2.
Manchester: 28, Corporation Street.

You are invited to visit our London or Manchester branches, where our Staff is at your service.



NOTE THE LARGE LIP FOR EASY POURING



JOHNSON PLASTIC DEVELOPING DISHES

THESE deep dishes are easy to empty without splashing or dribbling. Embossed ridges raise prints and prevent accumulation of sediment. Light, strong and not liable to get chipped or broken. Hard, black plastic can be kept clean, bright and free from stains. Impervious to ordinary chemicals. They can be obtained from all photographic dealers and will be invaluable to amateur photographers who develop their own negatives and make their own prints.

4 1/2 x 3 1/2 (9 x 12 cm.), 1 1/8-in. deep
4 1/2 x 6 1/2 (13 x 18 cm.), 1 1/2-in. deep
6 1/2 x 8 1/2 (18 x 24 cm.), 2-in. deep

JOHNSONS OF HENDON
PHOTOGRAPHIC CHEMICALS AND APPARATUS



Whatever your soldering job, in your home or workshop, you will prefer to use Ersin Multicore Solder. No extra flux is required. Multicore is the simple and precision method of making sound soldered joints for all household purposes. Just apply it simultaneously with the soldering iron; the three cores automatically provide correct proportions of flux to solder.



Workshop Sizes 4/10 — 6/9 each

MULTICORE SOLDERS LTD.,
Mellier House, Albemarle Street, London, W.1.
Tel.: REGent 1411.

I.C.S. TRAINED MEN are in Greater Demand than Ever—Maximum production depends on high technical skill, such as that acquired by I.C.S. Students

**TENS OF THOUSANDS MORE
TRAINED MEN ARE URGENTLY
NEEDED NOW—BUT THERE IS
NO WORTH-WHILE PLACE FOR
THE UNTRAINED**

**Ambitious men everywhere have succeeded through
I.C.S. Home-Study Courses. So also can you.**

The man with an I.C.S. Training in any one of the subjects listed below knows it thoroughly, completely, practically. And he knows how to apply it in his everyday work.

Accountancy
Advertising
Aeronautical
Engineering
Air and Vacuum
Brakes
Air-Conditioning
Architecture
Architectural Drawing
Auditing
Boiler Engineering
Book-keeping
Building Construction
Building Specifications
Business Training
Business Management
Carpentry
Chemical Engineering
Chemistry, I. & O.
Civil Engineering
Clerk of Works
Coal Mining
Colliery Examiner's
Colliery Overman's
Commercial Art
Concrete Engineering
Cotton Manufacturing

Diesel Engines
Draughtsmanship
(State which branch)
Drawing Office Practice
Electrical Engineering
Electric Power, Light-
ing, Transmission,
Traction
Eng. Shop Practice
Fire Engineering
Free-Lance Journalism
Fuel Technology
Heating and Ventilation
Hydraulic Engineering
Hydro-Electric
Illumination Eng.
Industrial Management
Internal Comb. Eng.
Joinery
Lettering
Machine Designing
Machine-Tool Work
Marine Engineers
Mechanical Drawing
Mechanical Engineering
Mine Surveying
Mining Engineering

Motor Engineering
Motor Mechanic
Motor Vehicle Elec.
Municipal Eng.
Plastics
Plumbing
Quantity Surveying
Radio Engineering
Radio Service Eng.
Refrigeration
Sales Management
Salesmanship
Sanitary and Domestic
Engineering
Sheet-Metal Work
Short-Story Writing
Steam Engineering
Structural Steelwork
Surveying
(State which branch)
Telegraph Engineering
Textile Designing
Welding, Gas and Elec.
Woodworking
Woollen and Worsted
Manufacturing
Works Engineering

And most of the Technical, Professional, Commercial and Civil Service Exams.; also C.I.I. Elements of Nat. Insurance.

(I.C.S. students preparing for Examinations are coached till successful)

If you need technical training, our advice on any matter concerning your work and your career is yours for the asking—free and without obligation. Let us send you full information regarding the subject in which you are specially interested. **DON'T DELAY. Make ACTION your watchword.**

The successful man **DOES** to-day what the failure **INTENDS** doing to-morrow. Write to us **TO-DAY**

..... Use this Coupon

INTERNATIONAL CORRESPONDENCE SCHOOLS LTD.

Dept. 95, International Buildings, Kingsway, London, W.C.2

Please send me particulars of your Courses in.....

Name..... Age.....
(USE BLOCK LETTERS)

Address

Addresses for Overseas Readers
Australia: 140, Elizabeth Street, Sydney.
Egypt: 40, Sharia Malika Farida, Cairo.
India: Lakshmi Bldgs., Sir Pheroza Mehta R.4., Fort,
Bombay.
New Zealand: 182, Wakefield Street, Wellington.
South Africa: 45, Shortmarket Street, Cape Town.



Tools YOU Should have

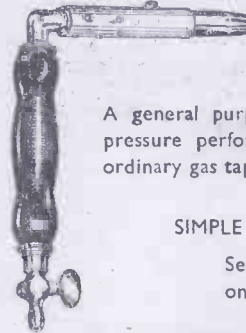

The "AEROMATIC" Soldering & Brazing Torch

A general purpose low pressure gas torch with high pressure performance. Only needs connecting to any ordinary gas tap. No maintenance, no adjustments, no lighting back.

SIMPLE — FOOLPROOF — EFFICIENT

Sent complete, as illustrated,
on receipt of 37/6d. with order.

The "CRYSTAL" Spray Gun

The ideal tool for all painting jobs from a model to a car. Also for house painting, distemping, etc. Connected to any standard vacuum cleaner it will produce professional results without mess, waste or effort.

The "Crystal" Spray Gun will be forwarded by return, post free, on receipt of 75/- with order. N.B. Please state make and type of cleaner when ordering. A special connector, desirable with all and essential with some cleaners, is available at 3/6 extra.

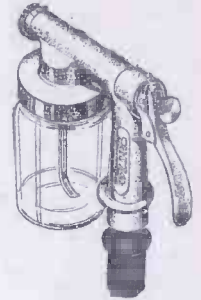

**TRADE
ENQUIRIES
INVITED**



Dept. P.M.

DOMESTIC SUPPLY COMPANY

341, REGENT'S PARK ROAD, LONDON, N.3

(Near Finchley Central Station)

Tel: FINchley 5190

A Wise Investment!



TYPE 'K'

S. G. BROWN, Type 'K'

Moving Coil Headphones, with the following outstanding characteristics, supply that High Fidelity Reproduction demanded for DX work, monitoring and laboratory purposes, etc.

NOTE THESE CHARACTERISTICS.

D.C. RESISTANCE, 47 Ohms.

IMPEDANCE, 52 Ohms at 1,000 c.p.s.

SENSITIVITY, 1.2 x 10⁻¹² Watts at 1'kc.=.0002 Dyne/cm².

PRICE £5.5.0 PER PAIR

Supplies now available.
Order from your Local Dealer.

For details of other
S. G. Brown Headphones
(prices from 25/- to 60/-)
ask for illustrated Brochure
"P.M."

Descriptive Literature on request.

HEADPHONES WHICH UPHOLD BRITISH PRESTIGE

*Phone: ACOrn 5021.

S.G. Brown, Ltd.

VICTORIA ROAD, NORTH ACTON, LONDON, W.3.

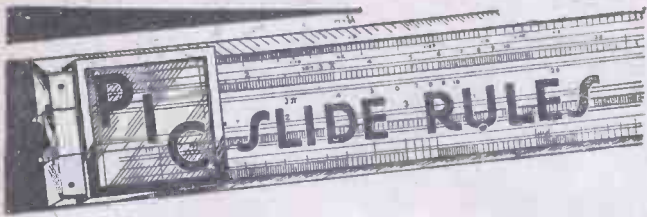

Manufacturers of
DRAWING and
SURVEYING
INSTRUMENTS

SLIDE RULES

DRAWING MATERIALS

DRAWING OFFICE
STATIONERY

A. G. THORNTON LTD
Drawing Instrument Specialists
41 GARTSIDE ST. MANCHESTER 3.

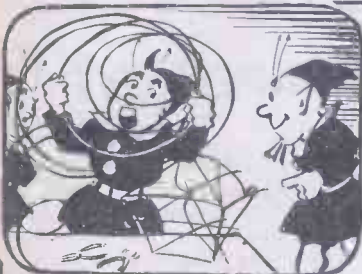

THE "FLUXITE QUINS"
AT WORK

"You're in a fine tangle,"
grinned EE.
"What on earth is that thing
s'posed to be?
A lampshade, by gum!
You need FLUXITE, old chum,
Or you'll be in a worse mess,
strikes me."

For all SOLDERING work—you need FLUXITE—the paste flux
—with which even dirty metals are soldered and "tinned." For
the jointing of lead—without solder; and the "running" of white
metal bearings—without "tinning" the bearing. It is suitable
for ALL METALS—excepting ALUMINIUM—and can be used
with safety on ELECTRICAL and other sensitive apparatus.

**With Fluxite joints can be "wiped"
successfully that are impossible
by any other method**

Used for over 40 years in Government works and by leading
engineers and manufacturers. Of all Ironmongers—in tins,
10d., 1/6 and 3/-.

● TO CYCLISTS! For stronger wheels that
will remain round and true, here's a time-
tested tip. Tie the spokes where they cross
with fine wire AND SOLDER. It's simple—
with FLUXITE—but IMPORTANT.

THE "FLUXITE"
GUN puts "FLUX-
ITE" where you
want it by a simple
pressure.

Price 1/6 or filled
2/6.

ALL MECHANICS WILL HAVE

FLUXITE

IT SIMPLIFIES ALL SOLDERING

Write for Book on the ART OF "SOFT" SOLDERING and for Leaflets on
CASE-HARDENING STEEL and TEMPERING TOOLS with FLUXITE.
Also on "WIPED JOINTS." Price 1d. Each.

FLUXITE LTD., Dept. P.M., Bermondsey Street, S.E.1

TWO MODELS NOW OF THE

Here's good news: the D.L.P. Eight-in-one
Tool is now available in two models—the D.L.P.
Major and the D.L.P. Minor (the D.L.P. Major
is larger). Eight different tools in one compact
unit that will handle scores of different jobs.



8 TOOLS IN ONE

- 1 Parallel vice with hardened jaws.
- 2 Pipe vice with hardened reversible grips.
- 3 Tube, rod and strip bender.
- 4 Cable, rod and pin cutter.
- 5 Flat and conical anvils.
- 6 Screwing machine.
- 7 Cable stripper.
- 8 Punching.

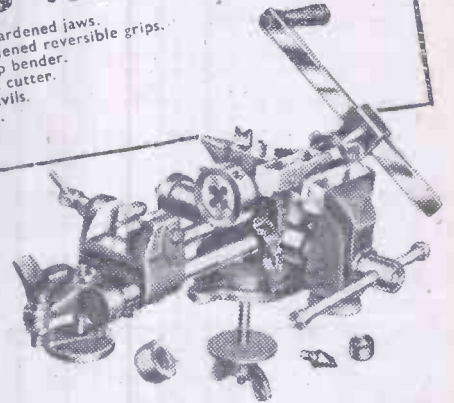

D.L.P. Major

Has a 5in. Parallel Jaw Vice.
Screw-cutting up to 2in.
diameter. Fitted with geared,
detachable handle.

D.L.P. Minor

3 1/2 in. Parallel Jaw Vice.
Screw-cutting up to 1 1/2 in.
Whit. Fin. gas, lin. conduit.

Both machines beautifully made and finished.
Write NOW for illustrated leaflet.

HAMILTON MOTORS, LTD.

466-490, Edgware Road, London, W.2
Tel: PADdington 0022.



fight
the
crisis
with

SAVINGS

SAVE THE BANK WAY

Your Bank will tell you about a new
simple way of buying National
Savings Certificates—either by single
purchase or regular investment,
operated free of charge to customers.

What's wrong with keen saving
anyway? It's good for us all and
good for our country, too. So let's
get cracking with every sixpence and
shilling we can muster. Ten shillings
buys a Savings Certificate that
becomes 13/- tax free in ten years—
no bad bargain! And the maximum
holding is a thousand certificates.
Buy through your Bank or from a
Post Office or Savings Group.

Issued by the National Savings Committee

Leytool

RATCHET SPANNERS

HUGE demand enables us to offer "Leytool" Ratchet Spanners at prices little above those paid for ordinary good quality spanners. They save time and money because they work faster, operate more easily, and get into those inaccessible places where ordinary spanners will not go.

They are a sound British engineering job, made of carbon chrome steel, hardened all over and negradised. Available in 8 standard sizes to fit 150 nut sizes in B.A., Whitworth, B.S.F., S.A.E., Metric and square. Special sizes made to order.

Also available, Mechanic's Set of 5 "Leytool" Ratchet Spanners in Canvas Wallet.

Write for Illustrated Leaflet giving sizes and prices.



'Look to Leytools' FOR THE MOST UP-TO-DATE AND EFFICIENT DESIGN

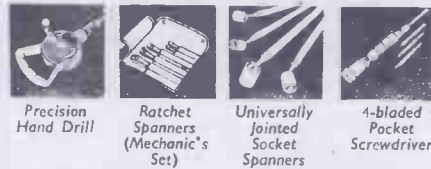

All Leytools are entirely original and patented designs. Write for illustrated leaflets.

Export Agents in all countries. Names and Addresses on application.
LEYTONSTONE JIG & TOOL CO., LTD., High Road, Leyton, London, E.10
 Telephone: LEYtonstone 5022-3-4

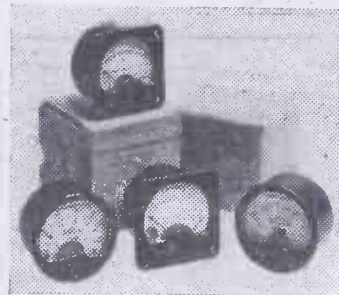

METERS

at a
'ONCE - IN - A - LIFETIME' PRICE

Brand new ex Admiralty and R.A.F. milliammeters, voltmeters, and ammeters, offered at a price far less than their manufacturing cost. Never to be repeated!

A very comprehensive range as follows:

0-1 mA. moving coil D.C.	2 1/2 in.	15/11
0-5	2 in.	10/-
0-30	2 1/2 in.	6/9
0-50	2 1/2 in.	7/-
0-40/120	2 in.	7/-
0-100	2 1/2 in.	12/6
(with shorting switch)		
0-150	2 in.	7/3
0-500	2 1/2 in.	7/3
0-1500	2 1/2 in.	7/6
0-10 amp.	2 1/2 in.	7/6
0-14	iron, ironclad 5 in.	37/6
50-0-50	coil D.C. 2 in.	7/6
150-0-3000 mA.	3 1/2 in.	15/-
0-5 amp. R.F. Thermo-couple	2 in.	7/3

0-2.5 amp. R.F. Thermo-couple	2 in.	7/3
0-4 amp. R.F. Thermo-couple	2 1/2 in.	10/-
(with shorting switch)		
0-10 amp. R.F. Hot Wire	5 in.	30/-
0-12 amp. R.F. Thermo-couple	3 in.	10/-
0-40v. Moving coil D.C.	2 in.	7/-
0-300v.	2 in.	7/-
0-15v.	iron A.C. 2 1/2 in.	10/-
0-20v.	2 1/2 in.	10/-
0-1500v. Electrostatic	3 1/2 in.	27/6
0-2000v.	3 in.	27/6
0-3000v.	3 in.	27/6

OR OUR SELECTION OF 6 ASSORTED METERS FOR 35/-

9-VOLT VIBRATOR PACKS. A miniature 2v. power supply to operate any normal set from any 2v. L.T. As designed for the Canadian "Walkie Talkies." Size of unit, 8 in. x 3 1/2 in. x 4 1/2 in. Output 90v. or 180v. 35 mA. 1.5v. L.T. As new. ONLY 52/6 (Carr. and pkg. 2/6). Alternatively supplied in carrying case at 55/- (Carr. and pkg. 3/6). Spare Vibrators. 2 v. 7 pin. 9/6. Spare Fuses (10 amp.), 6d. each. Two accumulators 15/-.

FOOT CONTROL SWITCHES. A very heavy duty foot switch able to carry up to 600 watts. Press for "ON." Precision machined of solid brass. A "Third hand" for only 22/6 (carr. pd.). Ideal for control of machinery, dark room, etc., etc.

REMOTE CONTROL UNITS. A Canadian made wireless remote control unit, used to send and receive messages over wireless equipment from either of 2 distant locations. Complete with microphone and headphones in transit case, and fitted with hand generator and bell set, Morse key, etc. ONLY 39/6 (Carriage pd.).

HAND MICROPHONES. Brand new moulded bakelite hand microphones, with switch incorporated. Complete with lead, etc. ONLY 3/6 (Post 9d.).

MINIATURE SPIRIT LEVELS. Brand new brass cased spirit level, with 2 fixing holes on base, 1 ins. between fixing centres. ONLY 1/11 (Post 5d.), OR 3 for 5/-.

Watch next month's announcement of the Burgoyne Solder Gun.



MAIL ORDER SUPPLY CO.,
 Dept. P.M.,
 24, New Road, London, E.1.
 Stepney Green 2760-3906

Start work on it now and be ready for the spring

The "Merlin"

36" M.Y.A. restricted class

MODEL YACHT

plans and instructions

8/6
 POST 6d.

THESE plans consist of three large sheets of drawings fully annotated and two sheets of instructions. Set out with all the thoroughness and attention to detail for which Modelcraft are renowned they give you all you need to create a potential cup winner. Two alternative methods of hull construction are described.

Magazine & List No. 5
 At press now. Gives details of over 450 plans, plan books, kits and accessories as well as articles, notes and hints. We are doing our level best to keep up to the demand for the magazine, but the only way to be sure of your copy is to be put on the subscriber list or to get your modelshop to reserve your copy every quarter.

Modelcraft Ltd.
 77(L) Grosvenor Road
 London, S.W.1

MYFORD

TYPE ML7

3 1/2" HEAVY DUTY LATHE

The finest Lathe in its class.

Extensive range of accessories.

MYFORD ENGINEERING COMPANY LIMITED
 BEESTON NOTTINGHAM Phone: 54222 (3 lines)
 07.148B

I.C.I.

"PERSPEX" & "CRINOTHENE"

We are OFFICIAL STOCKISTS of I.C.I. "PERSPEX" and "CRINOTHENE," carrying large stocks for immediate delivery at CONTROLLED PRICES.

"PERSPEX" in Clear and Coloured, in flat sheet from 1/16 in to 1/2 in. thickness.

Small Consumers, Hobbyists and prototype Plastic Engineers, come to us with your enquiries.

★ Send for Price List.

Shows the way to TECHNOLOGICAL SUCCESS IN ENGINEERING BRANCHES AND PROFESSIONS

Throughout industry in every country, but particularly in Great Britain, technological success has become the basis required for personal success. Write now for this great guide to careers in Engineering covering Mechanical, Electrical, Chemical, Production, Aeronautical, Automobile, etc., and which shows how to become A.M.I.Mech.E., A.M.I.E.E., A.M.Inst.C.E., A.M.I.Chem.E., etc., in which and other engineering institution examinations T.I.G.B. home-study students have gained OVER FIFTY FIRST PLACES, to—

The Professional Engineering Tutors,
THE TECHNOLOGICAL INSTITUTE OF GREAT BRITAIN,
 218, Temple Bar House, London, E.C.4.

PLASTICS (MCR.) LIMITED.

11, WHITWORTH ST., MANCHESTER. 1.

Phones: Central 0272 and 1725

PELMANISM

For Courage and Confidence

PELMANISM is useful in all the affairs of life. That is its outstanding recommendation to those who wish to make the best of themselves in their occupations, in all their recreations, and in their social and cultural relations.

Every line written in the Pelman Course is directly applicable to some aspect of human life and conduct. The intention of every word in the Course is to make clear to men and women the means by which they can develop their powers to the fullest extent so that they can live more happily and be more successful—so that, on the one hand, they will make and use occasions for profit and advantage and, on the other hand, be at ease in any company. Both conditions are necessary to complete self-respect and a full life.

Remember—Everything you do is preceded by your attitude of mind.

Pelmanists are not left to make the applications themselves. An experienced and sympathetic instructional staff shows them, in exact detail, how to apply the principles of Pelmanism to their own circumstances and aspirations. Thus every Pelman Course is an individual Course. Over and over again our correspondents say in effect, "I feel that this Course was prepared for me, and me only." Substantially this is so, for the instructional notes and letters of advice are entirely personal to the individual; they are for him or her only.

Half fees for serving and ex-Service members of His Majesty's Forces (Apply for Services Enrolment Form)

It may be that frustration, or anxiety may come your way; if, unfortunately, it does, then with a mind trained to meet the vagaries and turmoil of everyday life, you will be in a position speedily to overcome these hindrances and set-backs; and eventually be free to devote all your mental energies to attain a fuller, richer and happier life.

The dominant aim for every man and woman must be to show a courageous, confident, well-equipped mental front. The general effect of the training is to induce an attitude of mind and a personal efficiency favourable to the happy management of life.

Take Up Pelmanism Now

The Pelman Course is fully explained in "The Science of Success." The Course is simple and interesting and takes up very little time. You can enrol on the most convenient terms. The book will be sent to you, gratis and post free, on application to-day to:

PELMAN INSTITUTE

(Established over 50 years)

130, Norfolk Mansions,
Wigmore Street, London, W.1.
Callers welcomed.

PELMAN (OVERSEAS) INSTITUTES: PARIS, 176, Boulevard Haussmann. AMSTERDAM, Damrak, 68. NEW YORK, 211, North Avenue, New Rochelle. MELBOURNE, 396, Flinders Lane. DURBAN, Natal Bank Chambers (P.O. Box 1485). JOHANNESBURG, P.O. Box 4928. CALCUTTA, 102, Clive Street. DELHI, 10, Allpore Road.

Baker's



ONLY HEAT REQUIRED TO COMPLETE THE JOB

OBTAINABLE FROM ALL IRONMONGERS

Established 1834

SIR Wm. BURNETT & CO., (Chemicals) LTD.
GREAT WEST ROAD, ISLEWORTH, MIDDLESEX

BELFAST TORONTO MELBOURNE
JOHANNESBURG WELLINGTON N.Z.

Smee's

MAKE THESE YOURSELF AND MAKE MONEY!



Toy Soldiers,
Cowboys & Indians,
Wild & Farmyard
Animals,
Aeroplanes,
Ships, Cars, etc.

With our toy-casting moulds and fast-drying enamels, making these and other models becomes a really profitable pastime, or fascinating hobby. Full instructions with every first order. Send s.a.e. for full details. Write to-day!

PROGRESS TOY CO. LTD.
Dept. P.M., KIRBY ROAD, BLACKPOOL, S.S.

Telephone: BLACKPOOL 750

YOU

can become a first-class RADIO ENGINEER

We are specialists in Home-Study Courses in Radio Engineering, Servicing, Transmission, Television, Mathematics and Radio Calculations.

Post coupon now for free booklet and learn how you can qualify for well-paid employment or profitable spare-time work.

(Post coupon in unsealed envelope—1d. stamp.)

T. & C. RADIO COLLEGE,
NORTH ROAD, PARKSTONE, DORSET.

Please send me free details of your Home-Study Courses in Mathematics, Radio and Television.

Name _____
Address _____
M.25 _____

HIGHSTONE UTILITIES

CRYSTAL SETS

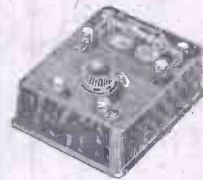

Our latest Model is a REAL RADIO RECEIVER, which is fitted with a PERMANENT CRYSTAL DETECTOR. WHY NOT HAVE A SET IN YOUR OWN ROOM OR AS A STAND-BY? —9/6, post 6d.
DE LUXE RECEIVER in polished oak cabinet. 18/6, post 1/-.

Spare Permanent Detectors, 2/- each. When ordered separately, 2/6. Postage, 3d.
.0003 Pre-set Condensers, 2/-, post 3d. Headphones, brand new, S. G. Brown, G.E.C., etc., 15/-, 28/-, and super-sensitive, 30/- a pair, postage 6d.

MICROPHONES

Just the thing for impromptu concerts, room to room communication, etc. Bakelite table model, 6/9; Suspension type, 5/6. Post 6d. Super Model on stand, 12/8. Fitting instructions included. Mike Buttons, 2/6. Transformers, 5/-.
Public Address Transverse current Mike, 37/6, post 1/-.
All microphones have transformer incorporated.

MORSE KEYS AND BUZZERS

Standard size keys wired to work Buzzer or Lamp, 3/-, post 6d. No. 3 Heavy Duty Double Coil, 4/8, post 3d. Plugs (for Jacks) with short length of twin flex, 1/6, post 4d.

BELL TRANSFORMERS



These guaranteed transformers work from any A.C. Mains, giving 3, 5, or 8 volts output at 1 amp., operate bulb, buzzer or bell. Will supply light in bedroom or larder, etc. PRICE 7/-, Post 6d.
BELLS for use with either the above or batteries, 6/-, Post 6d.

SOLDERING IRONS

Adjustable Bit, all parts replaceable and fully guaranteed. 200/250 v., 60 watts, 9/6; 150 watts, 12/6, post 6d. Small Soldering Irons for use on gas, 1/4. Post 4d. Resin-cored solder for easy soldering, 6d. packets, or 1lb. reels, 6/-, Postage extra.

Sparkling Plug Neon Testers with vest pocket clip, 2/9, or with gauge 3/3, post 3d.

Ex-R.A.F. 2-valve (2-volt) Microphone Amplifiers as used in plane inter-com., in self-contained metal case, which in turn is housed in a useful wooden box, 10/- each (less valves), post 1/-.

Field Intercommunication Sets, ready for use, complete with ringing hand generator, bell, signal lamp, morse key, relay and all necessary jacks and switches. Contained in a strong metal case with circuit diagram. 25/- each, carr. 2/6; 47/8 pair, carr. 2/6. New handcom sets, for use with above, 7/6d, post 6d. Ex-G.P.O. Telephone Bells and Box, 5/-, post 7d. Telephone hand generator, with handle, 9/6, post 1/6. Bell, 4/6, post 6d.

Hand Microphones, with switch in handle, and lead, 4/-, Similar instrument moving coil, 8/-, post 6d.

Headphones, reconditioned and in good order, 5/6 a pair, post 6d. (better quality, 7/6 pair.)

New Headphones, 10/- a pair, post 6d. Balanced armature type (very sensitive, and very suitable for use with crystal sets), 12/6 a pair, post 6d. New Single Ear-pieces, 3/6. Bal. armature type, 5/-, post 4d. Headphones with moving coil mike, 15/-, Similar phones with throat mikes, 12/6, post 8d. Headphone cords, 1/- a pair, post 3d. (£4 per 100). Replacement bands for headphones, 1/-, post 4d. (£4 per 100). Wire bands, 6d. per pair (£2 per 100).

Rotary Transformers, 12 v. D.C. input, in sound-proof cabinet, for Car Radio, etc., will also light two 25 w. lamps in series, 22/6 each, carr. 2/6.

Goodmans 10in. P.M. Loudspeaker in cabinet with volume control and transformer, 35/-, carr. 2/6.

METERS, 600 m.a., 3in., m/c., 15/-; Double reading 40/120 m/a., 2in., m/c., 8/-; 20 amp., 2 1/2in., m/i., 7/6; 15 volt 2 1/2in., m/c., 9/6; 30 amp., 6in., m/l Switch-board mounting, 35/-; 6,000 v. 3 1/2in., m/c., £3/10. All postage extra.

SEND 1d. S.A.E. FOR ILLUSTRATED LIST B.P. OF USEFUL ELECTRICAL ACCESSORIES. Money refunded if not completely satisfied. Letters only. Please include postage; any excess will be refunded.

HIGHSTONE UTILITIES
58, New Wanstead, London,
E.11

"ENGINEERING

OPPORTUNITIES"

PREPARE FOR COMPETITION—NOW!

As the Engineering Industry swings into its normal stride, the inevitable competition for the secure and well-paid posts will return. It is the man who stands out from the rest because he is *technically trained* who will be in the happy position of taking over the more responsible, more secure, and better paid positions. "**ENGINEERING OPPORTUNITIES**" will show you how to get this all-important technical training quickly and easily in your spare time. This 100-page book is full of valuable information and explains the simplest way of preparing for recognised Examinations. Among the courses described are :

MECHANICAL ENGINEERING GROUP

A.M.I.Mech.E.
A.M.L.E.D.
City & Guilds
General Mechanical Eng.
Diesel Engines
*Draughtsmanship & Tracing
Works Management
Press Tool Work
Pattern Making
Foundry Practice

Mining Practice
Estimating
Foremanship
Jig & Tool Design
Viewing & Inspection
Welding
Sheet Metal Work
Maintenance Eng.
Metallurgy
Refrigeration

COMMERCIAL ENGINEERING GROUP

A.M.I.P.E.
Commercial Eng.

Cost Accounts
Languages

CIVIL ENGINEERING GROUP

A.M.I.C.E.
Inst. Mun. Engineer
A.M.I.Struct.E.
M.R. Sanl.
City & Guilds
Sanitary Inspector
Specification
Structural Design

Mining Surveying
Road Eng.
Hydraulics
Municipal Eng.
General Civil Eng.
Structural Eng.
Reinforced Concrete
Railway Eng.

SURVEYING AND BUILDING GROUP

A.R.I.B.A.
F.R.I.C.S.
A.M.I.H. & V.E.
L.I.O.B.
F.A.I.

Costing & Valuations
Heating & Ventilating
Clerk of Works
Surveying & Levelling
Building (all branches)

ELECTRICAL ENGINEERING GROUP

A.M.I.E.E.
City & Guilds
General Electrical Eng.
Alternating Currents
Power House Design
Traction
Mains Eng.
Mining Electrical Engineering

Electricity Supply
Electrical Meters
Electrical Design
Illumination
Installations
Telegraphy
Telephony

WIRELESS GROUP

A.M.Brit.I.R.E.
C. & G. Telecommunications
General Wireless
Short-wave Wireless

Advanced Wireless
Radio Servicing
Television
Sound-film Projection Eng.

AUTOMOBILE ENGINEERING GROUP

A.M.I.M.I.
City & Guilds
Automobile Repairman
Course

General Automobile Eng.
Garage Management
Electrical Equipment
High Speed Diesels

AERONAUTICAL ENGINEERING GROUP

A.F.R.Ae.S.
R.A.F. (Maths.)
Pilots' Licences
A.R.B. Licences

Aero Engines
Navigators' Licences
Aeroplane Design
Meteorology

UNIVERSITY DEGREES

London Matriculation
School Certificate

University Entrance
Intermediate B.Sc.

* Our Diploma is accepted for Graduateship of the Inst. of Engineering Draughtsmen and Designers.

**WE DEFINITELY GUARANTEE
"NO PASS—NO FEE"**

If you are earning less than £10 a week you cannot afford to miss reading "**ENGINEERING OPPORTUNITIES**"; it tells you everything you want to know to *make your future secure*, and describes many chances you are now missing. In your own interest we advise you to write for your copy of this enlightening guide to well-paid posts NOW—FREE and without obligation.

BRITISH INSTITUTE OF ENGINEERING TECHNOLOGY

410A, SHAKESPEARE HOUSE, 17, STRATFORD PLACE, LONDON, W.1

THE B.I.E.T. IS THE LEADING INSTITUTE OF ITS KIND IN THE WORLD

PRACTICAL MECHANICS

Owing to the paper shortage "The Cyclist," "Practical Motorist," and "Home Movies" are temporarily incorporated.

Editor: F. J. CAMM

VOL. XV MARCH, 1948 No. 173

SUBSCRIPTION RATES	
(including postage)	
Inland	- - - 10s. 6d. per annum.
Abroad	- - - 10s. per annum.
Canada	- - - 10s. per annum.
Editorial and Advertisement Office: "Practical Mechanics," George Newnes, Ltd.	
Tower House, Southampton Street, Strand, W.C.2	
'Phone: Temple Bar 4363	
Telegrams: Newnes, Rand, London.	
Registered at the G.P.O. for transmission by Canadian Magazine Post.	
Copyright in all drawings, photographs and articles published in "Practical Mechanics" is specially reserved throughout the countries signatory to the Berne Convention and the U.S.A. Reproductions or imitations of any of these are therefore expressly forbidden.	

FAIR COMMENT

BY THE EDITOR

What is Craftsmanship?

THE Hallmark of workmanship and manufacturing excellence is epitomised in the words "British Made." Goods made in this country are eagerly sought all over the world. Those goods are the silent ambassadors which can make or break the reputation of this country as a nation of craftsmen. No one planned the British Empire, and in these days of planning where interest is centred on the reward and an increase of the reward, rather than on commanding that increase by improved skill and craftsmanship, it must not be forgotten that more than ever it is necessary for British goods to be made in accordance with the tenets laid down by the early English craftsmen. Their lives were wrapped up in their work. They toiled for the love of it. No effort was too great in order to improve the quality of their goods, nor were they greatly concerned about shorter working weeks.

In those old days when a master took apprentices who were initiated into the mysteries of a particular craft, men toiled from six o'clock in the morning to six or later in the evening. They had only 1½ days per week off, and Bank Holidays. There was no summer holiday. Incidentally, the word mystery is a corruption of the word mastery, so that apprentices were initiated into the mastery of their craft.

The apprentice was bound by his indentures for seven years, and promised to absent himself from his master neither night nor day nor to suffer damage to his goods or property during that time.

His parents had to pay £100 or more to have him indentured, a solemn proceeding taking place in a solicitor's office. The solicitor read the articles over to him and, at the end, the apprentice placed his finger on the seal and signed his fate for seven years with the words, "This is my act and deed."

His salary was 2s. a week for the first year, proceeding by annual rises of 2s. to 14s. a week. At the end of the seventh year he could remain on as an improver at a salary of £1 a week, which was paid in the form of a golden sovereign (good old days!), or the apprentice was "hammered out" by the other apprentices beating noisily with hammers on vices, clanging spanners, and generally creating an unholy din. The apprentice leaving in this way became a journeyman. He went from firm to firm, improving his skill, gaining further experience up to the age of about 25, when he could consider himself a craftsman or a master man.

Workman's Amenities

THIS state of affairs does not exist to-day. The working week has shrunk, and wages have expanded. Men do not start so early in the morning, nor work so late at night. It is a five-day week instead of a five-and-a-half-day week. There are holidays with pay; the conditions under which men work have greatly improved. The social life of the workers in the factory is the concern of special personnel. There is Music While You Work, wage incentives, and other rewards to coax the worker to do what he is really paid to do. His health is also guarded by clinics within the factories.

In spite of all these improved amenities there is still dissatisfaction, and I think it can be traced to the fact that the desire for the reward has become greater, in fact, has overpowered the desire to become qualified for the reward. For it cannot be denied that craftsmanship, in these days of specialisation, is declining. It is an overworked word, and is falsely used by many to describe their crude work. To-day it is most difficult, however much you pay, to get a really good job of work done. The higher prices do not carry higher skill.

Craftsmanship has been replaced by vanity in the use of the word. An unskilled workman loves to call himself a craftsman, which is precisely what he is not. I still feel that to-day with all the opportunities provided for the advancement of skill and technical education that some means should be found of classifying workmen. A man has not the right to call himself a craftsman because he happens to be employed in a particular trade.

It was not easy in the early days of industry to become a member of one of the Old Craftsmen Guilds. You had to satisfy the masters of the Guild that you had served your time, and that you had become skilled at your trade. It was necessary to produce references from your master, and later your employers. Even then you were not admitted to full membership until you became a master man.

Vanity does not replace skill. A great deal of shoddy work is being turned out from our factories to-day. This state of affairs cannot be allowed to go on. We must improve the quality of the British products in view of the fierce competition we are suffering from other countries who can produce under more favourable conditions than we do.

A New Recording Development

THE great importance of recording and reproducing what are known as transient pulses for the attainment of the highest

standard of fidelity was stressed by Sir Ernest Fisk, Managing Director, Electric and Musical Industries, Ltd., in an address before the Royal Society of Arts in London recently.

Explaining how the frequency distribution of these irregular non-repeating wave-forms determine the tonal character of a particular sound, Sir Ernest Fisk, who was lecturing on the development of sound recording and reproduction, revealed that these transient pulses were known to extend well up to the top limit of human hearing and even beyond it into the supersonic range.

Sir Ernest Fisk then disclosed that for the first time in the history of Sound Science, frequencies of up to 20,000 cycles per second were now being recorded on gramophone records produced by his organisation.

In terms of electrical reproduction, this major development in the science of sound recording and reproduction means that every note and every tonal characteristic detectable by the human ear in an original performance can now be heard with equal fidelity indirectly off a gramophone record.

While the upper frequency response limit of the human ear is a factor that varies enormously not only with the individual but according to age, very few people indeed can detect notes with frequencies higher than about 15,000 or 16,000 cycles per second. The main significance of the achievement of recording and reproduction of frequencies as high as 20,000 cycles per second is the safety margin that it provides beyond the top limit of human hearing for supersonic transients affecting the character of sounds within the audibility range.

In striking contrast to Sir Ernest Fisk's description and demonstration of this latest recording achievement was his comprehensive historical survey and demonstration of very early acoustic machines. These included one of the very first hand-driven disc-type gramophones produced by Emile Berliner towards the end of the nineteenth century (the origin of gramophone record technique as we know it to-day) and the slightly later horn model made world famous by its incorporation in the "His Master's Voice" Trade Mark, which was painted by Francis Barraud in 1899.

In his concluding remarks, Sir Ernest Fisk made reference to the accusations sometimes made that the gramophone industry is holding back development of sound recording methods on film and on tape, etc., in order to protect their supposedly large investments in the disc manufacturing business.—F.J.C.

Making a 6-in. Astronomical Telescope Reflector

The Methods, Tests and Techniques Employed in the Production of an Astronomical Telescope Mirror

By T. J. MULLIGAN

THE production of an accurate reflector for an astronomical telescope is a task which falls well within the capabilities of the amateur handyman; an efficient mirror can be made at home, the only equipment required being two glass discs and the abrasives, polishing materials and silvering chemicals.

When suitably mounted the reflector will provide its constructor with hours of interest and pleasure in the observation of the moon, planets, stars and nebulae.

The Telescope

Fig. 1 shows the arrangement of the optical components of a reflecting telescope; it will be seen that the concave reflector is situated at the rear end of the tube, and the eyepiece fixed at the side, near the front end of the tube. For the purposes of simplification the eyepiece is depicted as a single lens, although in practice a Huygenian type of eyepiece would be employed, which is composed of two plano-convex lenses.

In this sketch the mirror is shown reflecting light from a star or very distant terrestrial object; this light can be considered as being parallel, and would normally be converged to the mirror's prime focus " f_1 ," there forming an image of the star or object.

In this position the image could not be conveniently observed, so a prism "p" is interposed which diverts the focus to a point outside the tube where it can conveniently be inspected by means of the eyepiece "e."

It will be appreciated that since the prism lies directly in the path of the oncoming light a shadow will be cast upon the mirror of an area equal to that of the prism (since the incident light is parallel, ignoring diffraction effects). This represents a loss of light, but the loss is negligible when the area of the mirror is large in comparison to the area of the shadow. In the author's telescope the silhouette of the prism was 0.525 sq. in., which is less than 2 per cent. of the area of the 6-in. reflector—a negligible amount.

The magnification depends upon the distance of the principal focus from the surface of the mirror and the magnification factor of the eyepiece. The size of the telescope is determined by the diameter and focal length of the reflector—in other words, by its aperture. There are obvious limits to the size of a home-constructed telescope: The focal length should be such that the eyepiece is comfortably placed for the observer's eye when the tube is in a vertical position. A focal length greater than this would make impossible the study of the heavens directly above, unless a much more ambitious mounting were constructed, of a type rather beyond the capabilities of the average

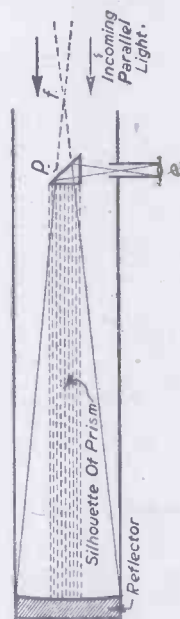

Fig. 1.—Diagram showing the optical components of a reflecting telescope.

amateur. In addition, as the size and weight of the telescope increases, the strength and mechanical efficiency of the mounting increases in importance.

The aperture decided upon by the author was $f/10$, using a reflector of 6-in. diameter and the tube-length a little over five feet.

Materials

Two glass discs are required of equal diameter, one for the mirror disc and the other to be used as a grinding tool; these discs should be of a thickness not less than one-eighth of the diameter. A smaller thickness to diameter ratio would be liable to flexure or deformation of the reflecting surface under its own weight, thus causing serious deterioration of image quality. Blanks suitable for mirror discs can be obtained from Chance Bros., Ltd., of Smethwick, either with edges roughly ground to diameter but not guaranteed circular,

or with edges machined and square with the main surfaces; blanks suitable for use as grinding tools are also supplied. These blanks are obtainable with a thickness of one-sixth of the diameter.

The abrasive used is carborundum powder, a good selection of grits being Nos. 70, 90, 120, F, FFF, 400 and 600. These grits are not at all expensive, and can be obtained either from the local engineers' stores or from the Carborundum Co., Trafford Park, Manchester.

Rouge is required for polishing; two to three ounces should suffice with care. Jewellers' rouge can be obtained from watch-makers' suppliers and is quite often stocked by chemists.

A small quantity of pitch is required for securing the mirror disc to its holder. The polishing tools are made from pitch with the addition of beeswax.

Preparations

Since the grinding operation will be a lengthy process, it is advisable to take extra pains with the preliminaries.

The grinding post is the first and most important item; in this case the indispensable

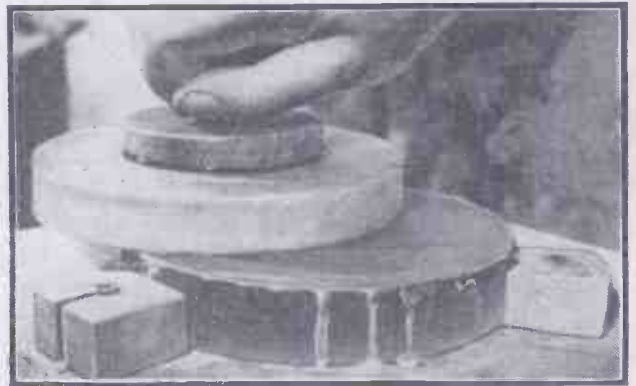

The grinding process.

requirement is rigidity—it must be either very heavy or securely anchored. The author's post was a tree trunk which had seen service as a chopping block; this was screwed to the floor and made a stout grinding post. A heavy barrel, or even a stone bird-bath might be suggested as possible grinding posts. The height should be from three to four feet; the width of the top and base should not exceed eighteen inches, to permit of a comfortable grinding action whilst walking round the post.

The top board, which carries the glass tool disc, should fit on dowels so as to be removable for washing when changing over to finer grades of carborundum; this fitting is shown in Fig. 2.

A shelf or table should be situated conveniently close to the post. This should be cleared and covered with a sheet of newspaper; on it are placed a dish of clean water and the tin containing the first grade of carborundum grits. A place should also be provided in which to stand the mirror disc in the intervals between grindings.

Next a position must be found in which to

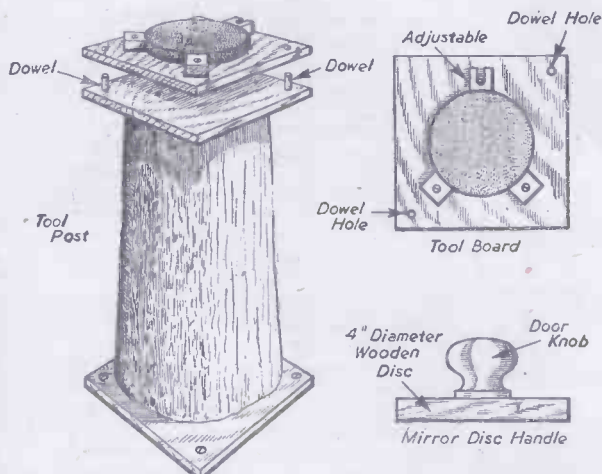

Fig. 2.—Grinding post and details of tool-board, mirror disc and handle.

stand the mirror disc upright when testing for radius of curvature; there will need to be a clear space of at least twelve feet in front of the mirror; the necessity for this will be explained when the procedure of testing for radius of curvature is described.

Grinding powders should be kept in tins and clearly labelled; one grade only should be kept on the shelf near the post at a time.

Grinding

The tool-board (Fig. 2) is placed on its dowels on the tool post; the dowels should be a snug fit—no movement of the tool can be tolerated when grinding.

The disc selected for use as the tool is placed in position on the tool-board and secured by means of the adjustable edge piece; a piece of felt placed beneath the tool disc will help to prevent rocking which might be caused by any unevenness in the tool-board.

The whole assembly—tool, tool-board and tool-post—should be quite rigid, and incapable of independent movement.

A handle is required for the mirror disc, as shown in Fig. 2. The underside of the 4in. wooden disc, which should be quite dry, is smeared with turpentine, and a little melted pitch poured over it; the holder is then stood aside for a few minutes in an inverted position to allow some of the heat to dissipate. When ready for applying to the glass the pitch should be warm and sticky, but not too hot.

The mirror disc, which should be gently warmed, is smeared with turpentine, and the pitch coated holder pressed against it, taking extra care to set it as centrally as possible.

When these preliminaries have been com-

or the mirror disc will rock at the end of each stroke, resulting in chipped tool edges and consequent scratches on the surface of the mirror. (Fig. 3.)

The tool should be kept moist enough to allow of easy passage of the mirror over the tool; too much water on the other hand will result in much of the carborundum escaping over the edge of the tool. The correct proportions of carborundum and water are best found by experiment.

Grinding is continued until the harsh "gritty" sound has softened, and the mixture of grits and water has become white with powdered glass. More carborundum and water are then applied to the tool, and grinding continued.

The rate at which the mirror grinds concave depends upon the pressure applied and the number of strokes, but it is unwise to attempt to speed up the operation by applying undue pressure or increasing the number of strokes per minute. Intimate contact of the mirror and tool should be maintained whilst grinding, and this is not practicable at a high speed which would result in the mirror rocking slightly upon its edge at the end of each stroke; this would result in a turned-up edge, which would be very difficult to remove. Too much pressure upon the mirror handle would produce a similar effect.

Two or three hours grinding will probably be required before the mirror exhibits any appreciable concavity; it will be understood, however, that since the radius of curvature aimed at is 10ft., the amount of depression visible will be quite small.

A straight-edge laid across the disc will provide a rough check upon the progress being made; after an hour's grinding a small gap will be visible in the centre of the disc. Grinding is continued with 70 carborundum until the gap appears to be a little less than one thirty-second of an inch. The mirror can then be rinsed clean in preparation for the test to determine the radius of curvature.

Completed, the grinding operation can commence. The tool surface is wetted with a medicine dropper full of water, and about a teaspoonful of No. 70 carborundum powder applied. The mirror disc is similarly wetted, and laid on to the tool.

The grinding operation is carried out as follows: the mirror disc is stroked backwards and forwards across the centre of the tool in a direction directly away from the operator; on the completion of each stroke the mirror is rotated about 20 deg. As the strokes are made, the operator walks slowly round the post, so that no two strokes follow exactly the same diameter. (See Fig. 3.)

A rhythmic action should be aimed at, walking round the post at the rate of one step for each complete stroke; after a few journeys round the post this action, including the little spin at the end of each stroke, will become quite automatic, and the number of steps taken to complete the circuit of the post will become constant.

The "throw" of the stroke should ideally be equal to the diameter of the tool; care, however, should be taken not to exceed this

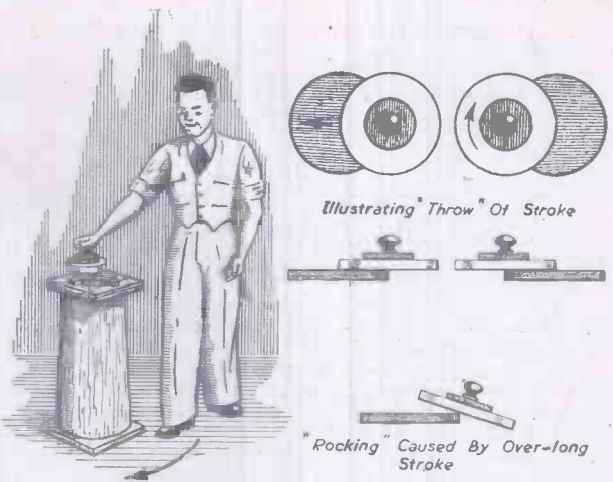

Fig. 3.—Illustrating the actions during the grinding operation.

flame to appear upon the surface of the wetted disc. The observer now retreats slowly, moving the candle from side to side, and raising or lowering it when necessary to keep the image visible.

At first the image of the flame will follow the movement of the candle; that is to say, as the candle moves from left to right, the image will move from left to right also, and vice versa.

As the distance from the disc is increased, the image will increase in size, and eventually a point will be reached where the image, instead of moving to and fro, will appear and disappear; beyond this point the movement will be reversed, that is to say, as the candle moves from left to right, the image will move from right to left.

The point at which no lateral movement can be seen can be taken as being the centre of curvature, and is equivalent to double the principal focus. The distance from this point to the disc is measured.

The focus aimed at is five feet, so the radius of curvature will require to be ten feet.

First tests should show the radius of curvature to be well over this figure; so grinding should be recommenced and continued with occasional intervals for testing until the desired curvature is very nearly attained.

If the test shows that the radius of curvature is too small, the concavity can be reduced by reversing the grinding positions of the mirror and tool discs, the mirror being placed upon the tool post and the tool disc stroked across it.

When the radius is found to be not more than six inches more than ten feet, a change-over is made to a finer grade of carborundum.

The mirror disc and its holder are first thoroughly scrubbed so that not a speck of the original 70 grit remains; the tool disc and its base are removed from the post and similarly scrubbed.



Using the pitch polishing tool during the polishing process.

Test to Find Radius of Curvature

The radius of the concave surface could be obtained by means of a spherometer, but the optical method combines simplicity with a standard of accuracy which is adequate for this stage of the operation.

The rinsed mirror disc is dipped in water in order to provide a partially reflecting surface; it is then stood upright against a wall or on a shelf at one end of the twelve feet space mentioned earlier, as shown in Fig. 4.

Standing a few feet away from the mirror, a lighted candle is held in such a manner as to cause an image of the



Fig. 4.—Test for determining the radius of curvature.

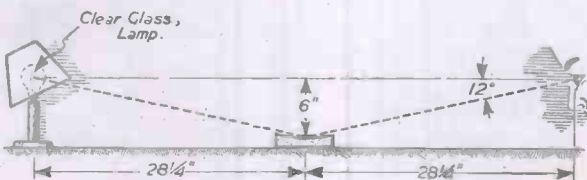

Fig. 5.—The reflection test.

The shelf upon which the tin of 70 carborundum and the dish of water stood is now cleared and the sheet of newspaper replaced with a clean sheet; this is to minimise the risk of coarse grits fouling the finer grinding operations.

The tool on its base is replaced upon the post, and a tin of finer grit and a dish of clean water placed on the shelf. Grinding is now continued with the finer grit.

The coarsely ground surface will require to be worked with the 90 carborundum until all the large grinding pits due to the 70 grit have been smoothed away; a good check can be obtained by occasionally inspecting the surface with a magnifying glass.

Successive grindings with the finer grades of carborundum will produce a surface with a fine, silky texture. Both discs and holders should be thoroughly washed when changing grits, and the water and newspaper changed. Scratches caused by the introduction of foreign grits at this stage can mean hours of back-breaking work to remove.

Care should be taken to maintain intimate contact of the ground surfaces when using the finest grades of carborundum; a little soap or glycerine added to the water, or good quality talcum powder added to the carborundum powder will lessen the tendency of the surfaces to adhere.

The finer grades of powder will produce an excellent surface with a soft, silky feel; this surface will not be transparent, of course—this condition can only be attained by polishing.

A further simple test is available to prove the readiness of the surface for polishing. The set-up for this test is depicted in Fig. 5. A distinct white image of the filament should be seen on the surface of the mirror at the 12 deg. angle indicated. If the image is red, the surface is not yet ready for polishing, and fine grinding must be continued until the reflected image is white.

An extra half hour spent at this stage in obtaining a perfect surface will save hours of rouge polishing.

Polishing

Polishing of the finely-ground surface is effected by means of a pitch tool charged with rouge. This tool can be made either by running melted pitch over the glass tool *in situ*, or by making a hardwood disc the same size as the mirror for use as a base for the pitch. The former method makes a good solid polishing tool, free from the risk of deformation of the base; there is, however, a danger of cracking an expensive glass disc by pouring on the pitch too hot. A hardwood based tool requires to have its pitch surface re-formed before each spell of polishing; that is to say, when it is left overnight the mirror is allowed to rest on it, thus preserving the surface contour and counteracting the effects of warpage.

Polishing and Figuring

For the purposes of polishing and figuring, two pitch tools should be used for optimum results—a hard pitch for polishing and preliminary figuring, and a softer pitch for final smoothing.

The relative properties of these two types of pitch are of the greatest importance. Theoretically, it might appear possible to polish and figure a good reflector simultaneously on one tool, but this would require an impossibly perfect combination of correct hand pressure, carefully calculated staggered strokes, and perfectly tempered pitch.

The practical method is to obtain a preliminary polish with a hard pitch tool, using staggered strokes in order to avoid as far as possible tool edge zones; then figuring on a hard tool with facets modified to alter the mirror surface from spheroid to paraboloid, and to correct polishing defects; this would

be followed by "smoothing" on a softer pitch tool.

The advantages and disadvantages of hard and soft pitch tools might be summarised as follows: hard pitch polishes comparatively rapidly and resists deformation due to hand pressure; on the other hand the hard outer facets tend to produce marked "ring" zones when regular strokes are employed. These zones will be explained more fully in the chapter devoted to figuring.

Soft Tools

Soft tools possess the advantage of being easier to mould to the shape of the mirror, and also they do not produce edge zones. There are two very serious defects: the outer facets are rapidly deformed by hand pressure, which causes the mirror to polish more rapidly towards the centre, thus causing a central depressed zone which is exceedingly difficult to correct; in addition, soft tools polish very slowly.

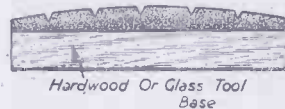
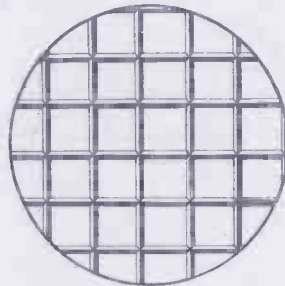

Fig. 6.—Plan and section of the pitch tool used for polishing.

be capable of taking a thumbprint, yet not soft enough to be depressed by the thumb.

If the pitch obtained is too soft it can be hardened by boiling, thus evaporating some of its more volatile constituents. If too hard it can be softened by adding a little turpentine.

Sufficient of the prepared pitch to cover the glass tool or hardwood base to a depth of about a quarter of an inch is melted in an old pan together with one ounce of beeswax. It is then strained through muslin.

If the glass tool is being used for a base, it should be dried and carefully warmed; it is then wiped over with turps.

The pitch is poured over the tool; a band of cardboard or stiff paper wrapped around the disc and secured with string will prevent

the pitch from being lost over the edge. Immediately the pitch has set, but whilst it is still quite warm, the cardboard band is removed and the edge of the pitch roughly bevelled with a sharp knife lubricated with a paste of rouge and water.

The mirror disc is smeared with rouge and water and pressed hard on the warm pitch at the same time moving it slowly backwards and forwards and rotating it in a similar manner to that employed in grinding. This is to form the surface of the pitch convex so that it is a perfect fit for the mirror. When all-over contact has been obtained between the mirror and the pitch the mirror is removed and facets cut in the pitch.

The pitch tool is shown in Fig. 6 and it will be seen that it is divided into squares which form a pattern which is slightly off centre; if a square or the corner of a square is exactly in the centre of the disc the remaining squares would form a pattern symmetrically disposed about the centre, and such a tool would tend to produce polishing zones.

Cutting the Facets

The facets are best cut with a sharp knife lubricated with rouge and water; a paraffin-soaked rag should be kept handy for keeping the knife clear of adherent pitch. The channels should be cut about one eighth to one quarter inch deep.

When the faceting has been completed, the pitch tool should be allowed to stand overnight with the mirror disc, coated with rouge, resting upon it; this is to "iron out" the edges of the facets, which would be raised when cutting the channels.

The mirror disc has its handle removed, and the pitch scraped off and cleaned up with paraffin. Greater control of the polishing and figuring operations is possible with the handle removed, and the heat of the hands is equalised over the whole disc—an important consideration to be borne in mind during the figuring operation.

A small quantity of rouge is placed upon the surface of the mirror and a little water added; the mixture, which should be of a creamy consistency, is spread over the surface with the finger tip. The mirror is then placed on the tool and polishing commenced.

The action is similar to that used for grinding, but the strokes are much shorter and should be slightly oval instead of straight backwards and forwards; the strokes should be constantly varied in length, to avoid tool edge zones. More weight is applied, using both hands, and the disc rotated about 20 deg. every two or three strokes.

Polishing must be continued, occasionally renewing the rouge, until the greyish ground surface entirely disappears and becomes transparent. The mirror is then ready for testing and figuring.

(To be continued)

BOOKS FOR ENGINEERS

Screw Thread Tables, 5/-, by post 5/3.

Refresher Course in Mathematics, 8/6, by post 9/-.

Gears and Gear Cutting, 6/-, by post 6/6.

Workshop Calculations, Tables and Formulæ, 6/-, by post 6/6.

Engineer's Manual, 10/6, by post 11/-.

Plant Engineer's Pocket Book, 6/-, by post 6/6.

Newnes' Metric and Decimal Tables, 3/6, by post 3/9.

Wire and Wire Gauges (Vest Pocket Book), 3/6, by post 3/9.

Screw Thread Manual, 6/-, by post 6/6.

Newnes' Engineer's Reference Book, 42/-, by post 43/-.

Practical Mechanics' Handbook, 12/6, by post 13/-.

Published by

GEORGE NEWNES, LTD., TOWER HOUSE, SOUTHAMPTON STREET, STRAND, W.C.2

A Combined Printing Box and Safelight

A Handy Appliance for Amateur Photographers

By L. C. MASON

THE pursuit of photography does not call for any large quantity of bulky apparatus, but nevertheless an accumulation of accessories can soon create a storage problem. When two pieces of apparatus can conveniently be combined in the one unit, thereby saving valuable space, such a combination is worth considering.

The printing box here described also does duty as a safelight for enlarging. In addition to these two functions it has a number of features not generally found in the normal printing box. If the reader does not at present do his own enlarging, the safelight feature can be used to provide a measure of control when using the box for contact printing.

Constructional Details

As can be seen from the photograph, it consists of a light plywood box carrying a conventional printing frame at the top and having an electric lamp mounted in the bottom. The box itself is by no means a "cabinet maker's" job, being made of such odd pieces of wood as were to hand. The sides are of 3/16 in. three-ply (Fig. 1). Admittedly this is still unobtainable in any quantity, but small pieces—"offcuts"—up to 6 in. wide are available if search is made for them. Indeed, there is no reason why "hard-

board," or some similar material, such as was used for blackout screens, should not be used. The sides are merely screwed or pinned to small square posts in the corners, this being about the easiest joint to make. It will be seen from the photograph that a small door is provided in one side, through which a safelight or screen can be inserted. The corner posts end just below this slot, and strips of wood, run along inside from corner to corner to form runners to carry the safelight. The corner pieces extend up to the under side of the runners. Similar runners are fitted above the safelight as well, to cut out any light leaks past the edges of the safelight. Above the upper set of runners a further set of short corner pieces are fitted, which in turn end off just below the edge of the box.

The lid (Fig. 2) which carries the printing frame rests on the top of these corner pieces, which should be of such a length as to bring the top of the lid flush with the top of the sides. The lid in this case is a piece of the same three-ply from which the sides were made, and has a rectangular hole cut in it slightly larger than the aperture in the printing frame. The edges of this hole are bevelled off with a file and sandpaper and then blacked to prevent risk of reflections causing a dark band near the edge of the print. The lid is fixed to the face of the printing frame by small screws; one into each side of the frame is sufficient.

It is desirable to make the lid a snug fit in the top of the box, so that although it is easily removed and replaced it does not slide about while the clamping springs are being manipulated.

It will be noticed that the door covering the safelight slot is double thickness. The inner piece of wood just fits into the slot so as to eliminate light leaks from this point when the door is closed. One hinge in the middle of the door is quite sufficient, as it is very light. The moulding round the bottom edge serves no useful purpose, but an odd length was available, so was added for the sake of appearance.

Lamp-holders and Connections

The lamp is mounted in a batten holder which is screwed to the three-ply bottom. A



The completed printing box with the safelight partly inserted.

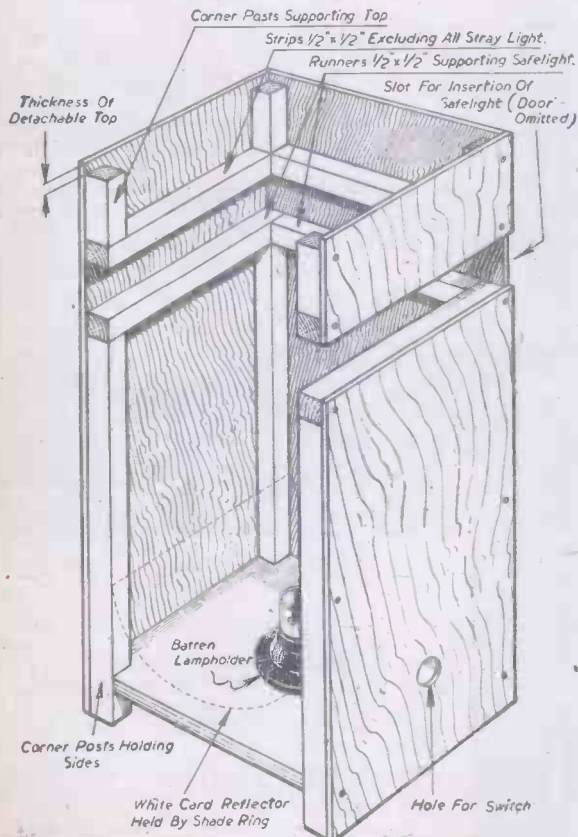

Fig. 1.—The printing box with one side removed to show interior construction.

piece of white card covers the bottom and is held in place by the shade ring of the lamp-holder. This serves to cover up the wiring and back of the switch and also to provide some gentle light reflection. The switch is of the "one-hole fixing" type (Fig. 3), such as most wireless junk boxes can provide. Check to see that it is marked as suitable for mains voltages. The lead is merely a few feet of ordinary lighting flex led through a hole at any convenient point near the bottom of the box. A hole in the side opposite to that carrying the door and switch would probably be most suitable. Tie a knot in the flex just inside the box, so that an accidental pull will be taken by the side of the box and not by the connections, which might part and blow the fuses. The connections to the switch will probably have to be soldered to small lugs on the back of the switch. Watch that these are not bridged by a strand of flex or blob of solder.

No dimensions have been given so far, as these depend on the size of printing frame normally used. However, in the box illustrated (Fig. 1) the frame is the 3 1/4 in. by 2 1/2 in. size and the box is 6 in. by 5 in. by 9 1/2 in. high. The safelight is not a commercially produced size, and consists of a sheet of amber gelatine bound with passe-partout between two pieces of glass. It might be

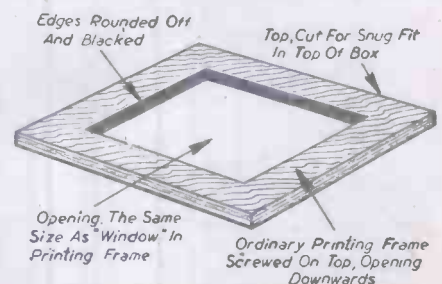

Fig. 2.—Detachable top for the printing box.

worth while to make the box big enough to take the standard 7in. by 5in. safelight.

Using the Printing Box

When used as a simple printer the safelight is completely removed. If desired, it can be replaced by a piece of ground glass of the same size to give some diffusion of the light or to cut down its intensity when printing from a thin negative. The ground glass can also serve another purpose, and that is in the event of it being necessary to screen or hold back part of the negative being printed. In this case it serves as the support for a paper mask shaped to cover the area to be held back. This is laid on the glass and, of course, blocks out the light where required. Part of the exposure only may be given, using such a mask, and then glass and mask removed to give the remainder, in the knowledge that neither lamp, negative nor paper has moved since the start of the exposure.

It will be found that with such factors as light strength and lamp-to-negative distance constant, very little experience will

enable exposure times to be estimated near enough four times out of five. Doubtful cases can easily be test-stripped with an opaque card in place of the screen. I find that a 25-watt pearl bulb is suitable for 99 per cent. of negatives, which is also about right for a safelight. For an unusually dense

negative a 40-watt bulb can be substituted, which will cut the exposure time by nearly half.

When used as a safelight the lid is completely removed. My darkroom is the bathroom, and as the walls are glazed with white tiles for some 5ft. up I find that if the box is inclined towards the wall there is ample soft, reflected light available for comfortable working. As the safelight glass is below the top edge of the box the light is somewhat directional and can thus be easily kept away from such undesirable anyspot, as the enlarger baseboard.

Finish is a matter of choice; a coat of varnish might be useful, as in the event of the box getting splashed the varnished surface is easily wiped clean and dry.

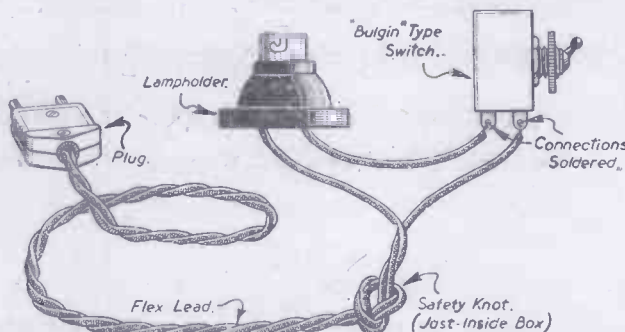

Fig. 3.—Details of plug, lamp-holder, switch, and connecting lead.

Aviation Notes

Hercules Engines for South African Airways

NEWS that South African Airways have put the first six of their fleet of eight Vickers' Vikings into service reveals that the "Bristol" Hercules engine has established yet another sphere of operations in its already impressive record of activities.

Entailing an approximate monthly mileage of 65,000 miles, South African Airways are operating three return services per week between Johannesburg and Cape Town via Bloemfontein.

Enthusiastic reports of the performance of the engines in these aircraft have already been received by the Bristol Aeroplane Company. One aircraft is due for check after a very successful 100 hours' flying. During most of that time it has been used for training crews, development flights round the Union, and has operated in the Rhodesia-South African service.

Mr. J. A. Danes, "Bristol" engineer stationed at Transvaal, reports that "the Hercules engine is establishing a very good name

for itself in this part of the world. The crews have complete confidence in the engine and waste no time in telling their rival brothers, who fly Skymasters and Lodestars, all about its finer points and high performance."

The Hercules, which enjoys the distinction of having powered nearly thirty different types of military and civil aircraft, has, since its inception, achieved a continuity of increase in maximum power output unequalled by any other type of aero engine. From 1325 b.h.p. in 1937, the power has risen to

2270 b.h.p. in 1947—an increase of over 71 per cent. in ten years.

The Hercules 634, as fitted to the Viking, has, with standard 100/130 grade fuel, a take-off power of 1690 b.h.p.; a maximum emergency power of 1795 b.h.p.; a maximum continuous power of 1550 b.h.p. and a maximum continuous power of 1330 b.h.p. on lean mixture.

Britain's New "Flying Wing"

THE Armstrong Whitworth jet-propelled "Flying Wing" was recently demonstrated on the ground and in the air at Bitteswell Aerodrome by test pilot Squadron Leader Eric Franklin, D.F.C., A.F.C. Pow-



Two views of the Armstrong Whitworth "Flying Wing."



ered by two Rolls-Royce "Nene" engines, and produced at a cost of nearly £200,000, the Flying Wing represents the most advanced type of research machine in the world. With a wing span of 90 feet the machine can climb at 4,800ft. per minute, and cruise at 36,000ft. for 1,500 miles, at 330 m.p.h.

This all-metal tailless aircraft is of revolutionary design, and is the prototype of the air liner of the future. Fins and rudders are at the wing tips.

Electric Water Heating Practice-2

Calculating Optimum Loading : Tank Capacities : Various Types of Water Heaters

Heat and Electricity

BRITISH Thermal Unit (B.Th.U.) is the heat required to raise 1lb. of water through 1 deg. F. This is equal to 0.293 watt hours, which is a little under $\frac{1}{3}$ of 1 watt hour.

1 watt = 3.415 B.Th.U. per hour.
1 kilowatt hour (kWh) or 1 unit is equal to 3,415 B.Th.U.s.

Assuming temperature of the incoming cold water is 54 deg. F., and it is required to raise 1 gallon to 180 deg. F. or through 126 deg. F. at 100 per cent. efficiency, electricity consumed would be 0.37 kWh, or $0.37 \times 20 = 7.4$ kWh for 20 gallons.

At 80 per cent. efficiency, consumption would be 0.46 kWh and 4.6 kW. for 1 and 10 gallons respectively.

To ascertain the electricity consumed for any set of conditions, the formula used is:

$$\text{Units consumed} = \frac{\text{Galls. of water} \times \text{temp. rise in deg. F.} \times 10 \times 100}{3415 \times \text{efficiency per cent.}}$$

With 20 gallons of water, 126 deg. F. temperature rise and an efficiency of 80 per cent., we get

$$\frac{20 \times 126 \times 10 \times 100}{3415 \times 80} = 9.2, \text{ or } 9 \text{ units approx.}$$

To estimate the loading of an immersion heater, in kW., to heat water in a given time, the formula used is:

$$\text{Temp. rise deg. F.} \times \text{galls. capacity} \times 10 \times 100 = \frac{3415 \times \text{hours} \times \text{efficiency per cent.}}$$

Assuming temperature rise is 126 deg. F., tank capacity 20 gallons, heater efficiency 80 per cent., and the given time or recovery period is to be 4 hours, we get:

$$\frac{20 \times 126 \times 10 \times 100}{3415 \times 4 \times 80} = 2.3 \text{ kW.}$$

This 2.3 kW. switched on for 4 hours consumes 9.2 kWh.

As no 2.3 kW. heater is made the choice lies between 2 kW. and 3 kW. If hand controlled, the larger size should be adopted. In fact, manufacturers install a 2 kW. heater in self-contained lagged automatic storage heaters of 20 gallon capacity.

Where it is necessary to ascertain the time it would take to heat a quantity of water with

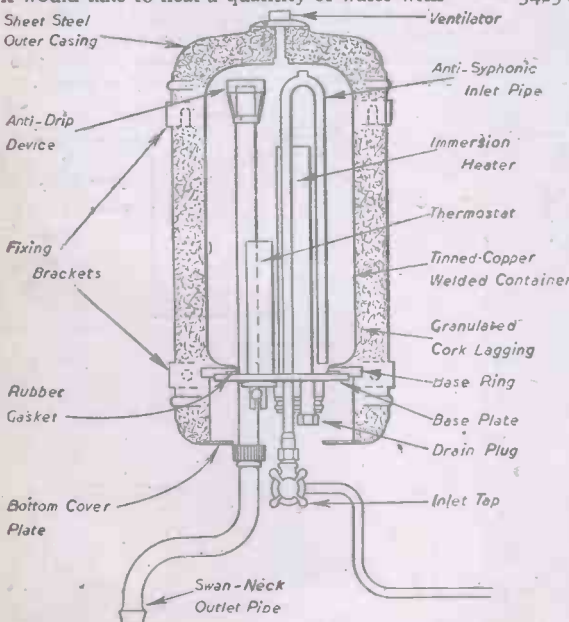

Fig. 10.—A displacement type, single-point, 1 1/2 gallon water heater, and method of connecting it to cold water mains. Compression fittings of the Kontite type are used, which require no plumbing or soldering. Alternatively, a piece of rubber hose will make a satisfactory connection.

By G. A. T. BURDETT, A.M.I.A.

(Continued from page 170, February issue)

a given loading, the following formula is used:

$$\text{Temp. rise in deg. F.} \times 10 \times 100$$

$$= \frac{3415 \text{ loading in kW.} \times \text{efficiency}}$$

Assuming a temperature rise of 126 deg. F.,



Fig. 9.—Pyrex container removed from outer casing shows the operation of the displacement type water heater. The mushroom head of the anti-drip device can be clearly seen.

capacity of tank 25 gallons, immersion heater of 3.0 kW. loading and an overall efficiency of 80 per cent.

$$\text{Time taken in hours} = \frac{126 \times 25 \times 10 \times 100}{3415 \times 3 \times 80} = 4 \text{ hours approx.}$$

If the temperature rise is known, the heater loading, overall efficiency and the time taken to raise the water to that temperature, gallons heated can be ascertained with the formula:

$$\text{kW.} \times 3415 \times \text{hours} \times \text{efficiency per cent.} = \text{Temp. rise in deg. F.} \times 10 \times 100$$

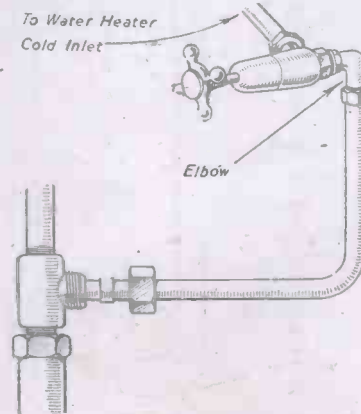

Using the figures 3 kW., 4 hours, 80 per cent. efficiency, 126 deg. rise in temperature, we get:

$$\frac{3 \times 3415 \times 4 \times 80}{126 \times 10 \times 100} = 25 \text{ gallons.}$$

Overall efficiency of heater is obtained thus:

$$\text{Efficiency} = \frac{\text{Temp. rise in deg. F.} \times \text{galls.} \times 10 \times 100}{3415 \times \text{loading in kW.} \times \text{time in hours.}}$$

If temperature rise is 100 deg. F., capacity 20 gallons of water, loading is 3 kW. and time taken 2 1/2 hours:

$$\text{Efficiency} = \frac{100 \times 20 \times 10 \times 100}{3415 \times 3 \times 2.5} = 78 \text{ per cent.}$$

These figures are representative of normal operating conditions and therefore an adequately heat-insulated tank has an approxi-

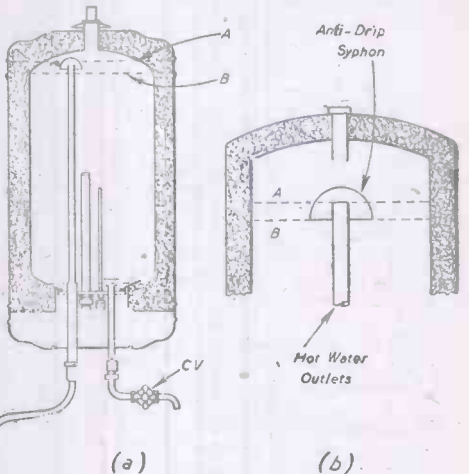
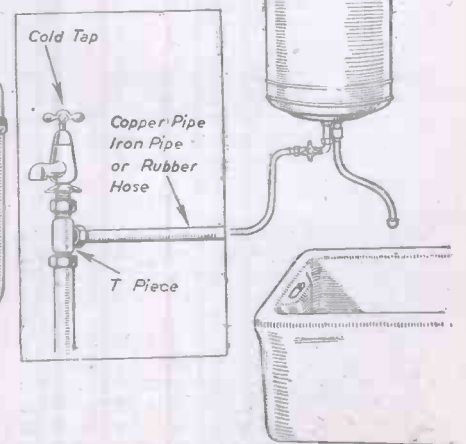

Fig. 11.—Anti-drip device on displacement type water heater. Upon the closing of the control valve CV, water level is at "A." Water still runs up outlet by syphonic action and the level is reduced to "B." Water, upon being heated again, can expand to "A" before dripping occurs, but this rarely happens.

mate efficiency of 90 to 95 per cent. and the approximate efficiency of a non-insulated tank 80 to 85 per cent.

Where only rough calculations are needed the following will give approximate requirements within a reasonable degree of accuracy.



Electricity Consumption

One unit of electricity (kWh) will raise: 2 gallons of water at average cold mains temperature (52 deg. F.) to boiling point (212 deg. F.); 3 gallons to 150 deg. F. and 5½ gallons to 100 deg. F.

Approximate Capacity of Tank

Approximate capacity, in gallons, of rectangular and cylindrical tank can be found from the formulæ:

Rectangular:

$$\frac{\text{Length} \times \text{breadth} \times \text{height}}{280} = \text{gallons}$$

All dimensions in inches.

$$\frac{18\text{in.} \times 18\text{in.} \times 20\text{in.}}{280} = 23 \text{ gallons approx.}$$

Cylindrical:

$$\frac{\text{Diameter} \times \text{diameter} \times \text{height}}{350} = \text{gallons}$$

$$\frac{1\frac{1}{2}\text{in.} \times 15\text{in.} \times 36\text{in.}}{350} = 23 \text{ gallons approx.}$$

Water is normally stored in the tank at a higher temperature than at which it is used. By mixing with cold water, the right quantity at the right temperature is obtained. For

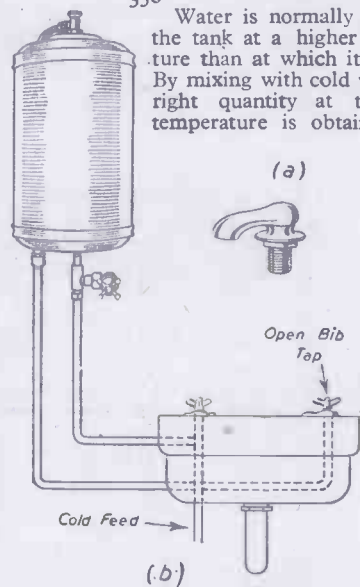

Fig. 12.—Open bib tap (a) which can be fitted to open outlet of displacement type water heater. This is shown in a wash basin (b), while in (c) the tap has been modified to provide ease of plumbing.

instance, temperature of water for washing up should not be more than scalding temperature, which is 120 deg. F. and for a bath the average temperature is 105 deg. The amount of water required for a medium-sized bath is about 22 gallons; 10 gallons at 180 deg. mixed with 12 gallons at 50 deg. F.

The formula for ascertaining the resultant temperature is:

$$\frac{\text{Gals. hot} \times \text{temp. hot} + \text{galls. cold} \times \text{temp. cold}}{\text{Total gallons}} = \text{Resultant temperature}$$

$$= \frac{10 \times 180 + 12 \times 50}{22} = 109^\circ \text{ F.}$$

Assuming that the temperature of the hot water is 160 deg. F., and this figure should not be exceeded in hard water districts or scale will form and the elements' and heater's effective storage reduced,

$$\frac{160 \times 10 + 12 \times 50}{22} = 100^\circ \text{ F. resultant temp.}$$

Where in the former case two good baths can be obtained in quick succession from a 20-gallon water heater, in the latter less cold water must be used to obtain the required temperature. Alternatively, some little time must elapse between the two baths. In practice, where the loading of the heater is 3 kW. or higher, sufficient recovery is made by the time the first bath has been taken. In effect, therefore, two consecutive baths are possible from a 20-gallon water heater.

Self-contained Water Heaters

These consist of water containers, usually

made of sheet copper, with lapped or welded joints and tinned inside. Smallest sizes, 1½ gallons, sometimes have heat-resisting glass containers of the Pyrex type (Fig. 9), and are suitable for culinary purposes where the water supply is taken direct from the mains. Monel, a special non-corroding alloy, is also used for containers.

The container is surrounded by heat-insulating material, such as granulated cork, and covered by an outer metal case, stove enamelled white. With the exception of special models, heaters are cylindrical in shape, to give the lowest surface area for a given capacity, and, therefore, lower heat losses. They are also designed to withstand a water pressure of 50lb. per sq. inch, which is equivalent to a 115ft. head of water, rarely met, of course, in domestic premises.

Inlet pipe is in the base of the container and has a baffle, usually of mushroom shape, fitted over the open end to prevent incoming cold water mixing with the hot, and enables from 75 to 85 per cent of the heater contents to be drawn off without any noticeable fall in temperature.

The outlet pipe is also at the bottom of the heater, though in some heaters, as will be seen later, a second outlet is provided at the top. This arrangement of two outlets simplifies plumbing where outlet taps are to be fed above and below the heater.

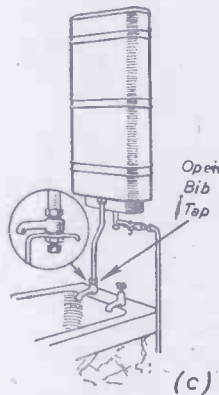

Loadings

Electrical loadings of self-contained water heaters are standardised and have been fixed as a result of long experience by manufacturers and supply authorities, and range from 500 watts for the 1½ gallon and 6.0 kW. or more for the 100 gallon size. These give a recuperation, or recovery period of about four hours (except for the smallest sizes, where it is less), but as they are thermo-

statically controlled and are well-lagged, there is little advantage gained in switching them off except when not in use for long periods of about four days or more. Therefore, recovery, or the time taken to heat up the total contents is not very important provided the correct size of heater is installed.

Non-pressure Type of Water Heater

This type, also termed displacement water heater because the supply of hot water is controlled by a tap in the cold water inlet, is made in the smaller sizes only. When the inlet tap is opened the cold water displaces the hot by an overflow leading to an open spout, Fig. 10.

The three most popular displacement types are 1½, 3 and 5 gallon sizes; the smallest being most extensively used for domestic purposes and ideal for fixing over the kitchen sink, over the wash basin, or any position where small quantities of hot water are required at frequent intervals.

One outlet only can be supplied from the displacement type, it being essential that the outlet is always open or pressure would build up in the heater and damage would result.

Installation is simple. Existing cold tap is removed and a tee-piece inserted and the tap replaced. A few feet of piping is then installed between heater and tee-piece and no other plumbing is necessary.

Special fittings may also be used which consist of two compression pieces. One, an elbow, is fixed near the inlet, and the other, a tee, in the cold water supply. A short piece of copper piping is installed and the unions are tightened (Fig. 10). These, known as the Kontite fittings, require no plumbing or soldering. Alternatively, a piece of rubber hose pipe may be used, but the copper pipe is more satisfactory.

Average use of hot water from a 1½ gallon heater in the kitchen is 6 gallons per day at 180 deg. F., which gives the user 10 gallons of really hot water for a daily consumption of 2.5 kWh. or units per day. This heater need never be switched off, and the standby losses are only 4 units per week. In view of the convenience of constant hot water, it is worthwhile, therefore, leaving the water heater constantly in circuit for such a small weekly loss.

Displacement, or non-pressure type water heaters, are made in capacities up to 30 gallons. The 12 and 15 gallon heaters are suitable where two baths are not taken in quick succession, and the 20 and 30 gallon heaters for larger premises or where two consecutive baths are frequently required.

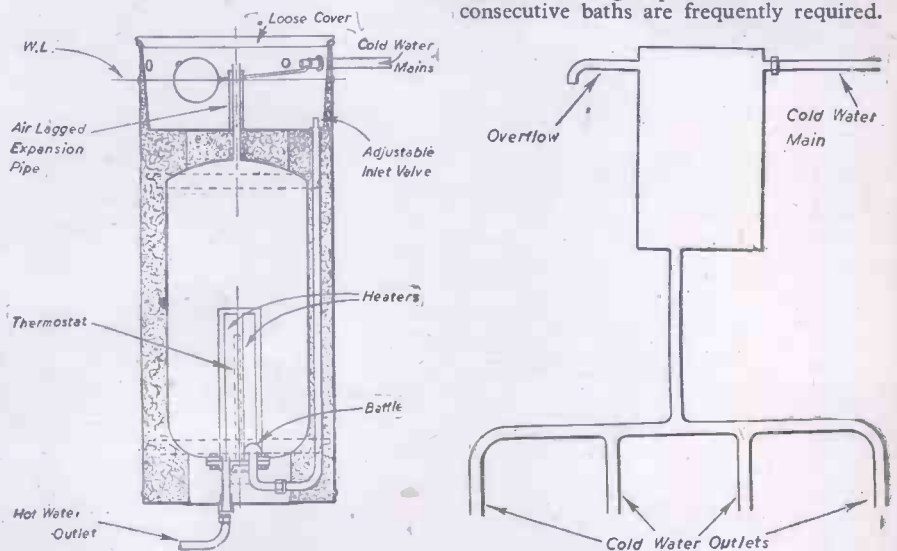

Fig. 13.—Cistern type water heater, which is a self-contained water heating system. Usually the cold water mains may be connected direct to inlet. Closed (tap) outlets may be run from the outlet and therefore minimum plumbing is required.

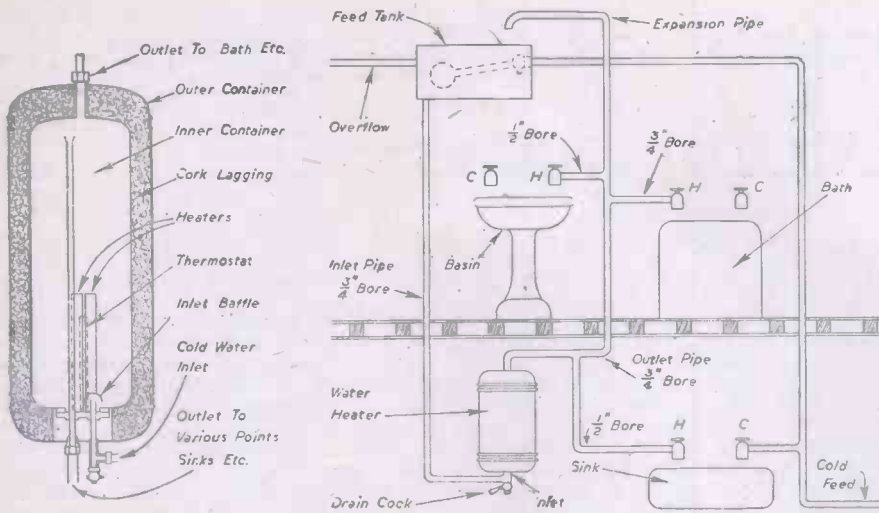

Fig. 14.—Pressure type water heater for wall fixing. Outlets may be taken either from the top or bottom. This heater must be fed from a ball-valve type of cold water cistern. Outlets are of the closed (tap) type. Floor standing models operate similarly, but the immersion heater is installed horizontally to allow for inspection. Piping arrangements are shown in the diagram on the right.

Although only one outlet is allowed to be taken from displacement heaters, two points such as bath and wash-basin can be served by one heater by fixing it on the wall between the bath and basin and arranging the swivel spout accordingly.

Anti-drip Arrangement

Water expands approximately 4 per cent. in volume when heated through a temperature rise of 150 deg., i.e., from 40 deg. F.—190 deg. F., which is approximately the rise in temperature in the normal installation.

As the displacement type water heater has an open outlet, dripping, due to expansion of the water on heating, would occur. Self-contained storage heaters, therefore, are fitted with an anti-drip device, the most common being in the form of a syphonic trap formed at the top end of the outlet pipe. When the cold water inlet valve is shut off, water continues to run for a few seconds as the level of water in the container drops slightly to allow for this expansion. When the tap is turned on again there is a delay of a few seconds before the hot water flows. The user soon becomes used to this characteristic, and operates the tap accordingly (Fig. 11).

Where it is not convenient to install the water heater over the sink or bath, a length of pipe may be run to the tap position and, as it must have an open outlet, this tap can be replaced by an open bib tap (Fig. 12).

Cistern-type Water Heaters

These are complete, compact electric water heating systems in themselves, and comprise: storage water container, immersion heater and thermostat and ball valve system contained in one outer casing. Provision is made for cold water inlet and overflow, and hot water outlet (Fig. 13).

Standard capacities (hot water storage) range from 5 gallons up to 100 gallons with standard loadings. These can be connected direct to the cold water mains supply, and any number of hot water outlet points may be supplied, but since they are gravity fed, no outlet must be situated at a higher level than the storage tank.

Cistern-type water heaters operate on either of two forms, (a) constant volume and variable temperature where the cold water is drawn off and the storage container is always full of water, and (b) the constant temperature variable volume system, where hot water can be drawn off at a greater rate than the cold water enters the chamber.

Advantage of method (b) is that all the hot water can be drawn off without drop in temperature since incoming cold water is so slow that it does not mix and cause cooling. This is achieved by the incorporation of a restricted cold water feed between ball-valve cistern and hot water container. This adjustable water feed valve is shown in Fig. 13.

Where water supply authorities do not allow this type of water heater to be connected direct to the main supply, it should be connected to a downward feed from the house cistern.

In the heater illustrated in Fig. 13 it will be seen that the immersion heater and thermostat are enclosed in a cylinder. This is always full of water and is a precaution against burning out the heater when the water container is drained, either through failure of water supplies or when the constant temperature variable volume system is used. The thermostat then operates when the small quantity of water reaches the pre-determined temperature.

Pressure-type Water Heaters

This type of storage water heater is fundamentally the same as the hot water storage tank in the normal domestic hot water system after conversion to electric, but it is factory produced. Capacities range from three gallons with an electrical loading of 1 kW. up to 100 gallons with a loading of 6 kW. or more. Special models are also made for industrial and commercial application with higher loadings and capacities. Smaller sizes, 3-30 gallons, are arranged for wall mounting, and above this capacity are floor standing.

Pressure-type water heaters are made and designed to operate in a similar manner to the displacement types but, instead of having an open outlet, the system operates under a pressure, with the control points on the hot water outlets instead of the cold water inlets.

Heaters of this type should not be connected to the mains water supply, but from a low pressure tank supply. Pressure of the

hot water system will therefore depend upon the height of the cold water feed cistern above the storage heater, as in the normal solid fuel system. The cold water inlet is situated at the base of the heater, and the hot water outlet at the top, to which is connected the system expansion pipe from which the hot water outlets are run (Fig. 14). Any number of hot water outlets may be run from below this heater, as indicated.

Pressure-type water heaters may be used either as the sole source of hot water supply, or in conjunction with the solid fuel system (Fig. 15). When the latter method is adopted, not only does it act as a booster heater when the solid fuel boiler is in operation, but serves as additional storage capacity, which greatly adds to the utility of the existing system.

Hot water outlets may be situated above or below the heater but not, of course, above the cold water cistern, which is usually situated in the loft.

The expansion pipe, which extends to a position above the cold water storage tank,

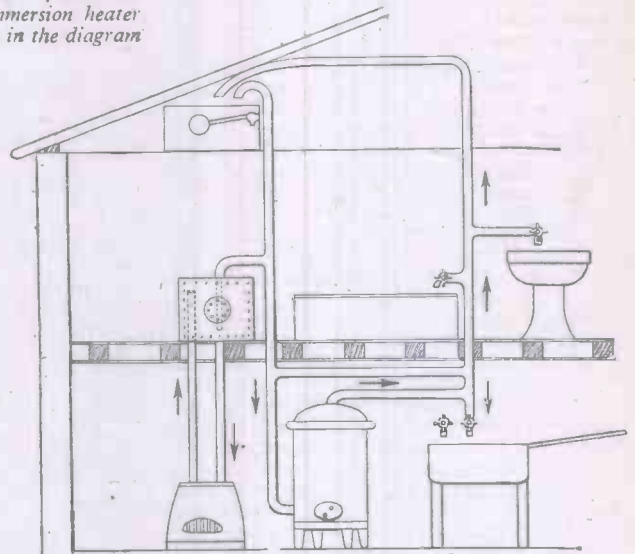

Fig. 15.—Utilising a pressure type self-contained water heater in conjunction with a solid fuel "boiler" system. Since the electric heater is fed from the outlet of the hot water storage tank, when the fire is lighted the electric heater may be used as a booster heater. Total storage is therefore increased.

must always have an open end or undue pressure will build up in the water container as the volume of the water expands. Also, this pipe should rise vertically without bends to provide an outlet with minimum resistance. From this pipe the horizontal hot water service pipes are run. Therefore, the size of the expansion pipe should be large enough to provide maximum flow to all positions.

(To be continued.)

MASTERING MORSE

By the Editor of
PRACTICAL MECHANICS

3rd EDITION

This handbook, written with special regard for service requirements, will enable even the beginner rapidly to become proficient in sending and receiving.

1/- net Of all Booksellers, or by post 1/2 from GEORGE NEWNES, LTD. (Book Dept.), 1/- net Tower House, Southampton Street, London, W.C.2

The Elements of Mechanics and Mechanisms—5

By F. J. CAMM
(All Rights Reserved)

Opposing Forces—Third Law of Motion

WE have dealt with the case of a body moving with a certain force which has produced a given velocity in one direction, while another acts on it from another direction. The rule for finding the resultant of velocities acting in opposite directions is: Subtract the smaller velocity from the greater. The motion will, of course, take place in the direction of the greater with the velocity of the difference between the two.

Assume that two balls of iron of the same mass are rolling towards each other, one with a velocity of 10ft. a second, and the other with a velocity of 40ft. a second. When they meet the velocity of the first will negative 10ft. per second of the velocity of the other ball, which will be left with a velocity of 30ft. per second. This will be divided equally between the two balls, which will roll away each with a velocity of 15ft. per second, in the direction in which the faster ball was moving when they met.

Bodies thrown upwards provide a further instance of a force acting on a body in motion in a direction contrary to that in which the body is moving.

We can cause a ball to rise in the air by muscular force, but whilst it is rising the force of gravity is acting on it, tending to pull it down. The force of gravity is a constant, never-ceasing force, and it continues to act on the ball all the time it is rising. That is the reason why the ball attains a certain altitude and then returns to earth.

All our movements on the earth illustrate the second law of motion because in addition to the movement of our bodies caused by our own muscular efforts we also partake of the motion of the earth. When we jump we fall again on the same spot of ground.

The Third Law of Motion

Newton's Third Law of Motion states that "to every action there is an equal and contrary reaction," in other words action and reaction are equal and opposite. A spring balance provides an example of it. If we place a weight on the hook of the balance, gravity acting on the weight causes the spring to stretch and the weight to move downwards. When the weight has moved a certain distance it comes to rest. The opposing action of the spring against the force of gravity is responsible for this, and the two forces are said to be in *equilibrium*. It is the *reaction* of the spring against the *action* of gravity which causes the weight to be in *equilibrium*.

This law holds good in all cases. If you push against the wall with a pressure of 10 lbs. the wall pushes back with a pressure of 10 lbs. If a piece of iron is suspended on a string and a magnet is brought near to it, the iron will be attracted towards the magnet. If the magnet is suspended the iron will be found also to attract it. Thus the action of the magnet on the iron and the reaction of the iron on the magnet are equal. If the iron be placed in the pan of a pair of scales and balanced by a 1 lb. weight it will require perhaps a second pound weight to balance it when the magnet is brought underneath the scale pan containing the iron.

If the position of the magnet and the piece of iron is transposed, exactly the same extra

weight will be found necessary to restore equilibrium when the iron is brought below the scale pan containing the magnet.

In the example of a person pressing against the wall, he may exert such great pressure that he himself is forced back. To break a piece of string two persons could hold the ends and pull in opposite directions. Exactly the same results would be obtained if one end of the string were tied to a hook in the wall.

Another Example

When a ball is held in the hand the force of gravity tends to draw it downwards. Equally, the ball tends to pull the earth upwards but, of course, to an immeasurably fine extent. When the ball is set free it tends to draw the earth upwards just as much as the force of gravity tends to pull the ball downwards.

Now how is this motion measured? It is measured by the momentum, that is to say, the quantity of motion of the two bodies. When they meet, their *momenta* will be equal. But as the mass of the earth greatly exceeds the mass of the ball, the velocity of the earth will be proportionally less than the velocity of the ball. Thus, if the ball had been falling for 1 second at the moment it meets the earth, it will have a velocity of 32 ft. per second. The upward velocity of the earth, however, because of its greater mass, will be too small to measure.

From this it is concluded that one body cannot attract another without itself being attracted by that other body. Again, we cannot have action without reaction, and they are always equal and opposite.

The attraction of the earth and the moon is mutual; they both attract one another. But as the earth is larger and heavier than the moon, the motion of the moon is affected far more than the motion of the earth, and because of the earth's greater mass the moon is caused to circle round the earth. The reacting force of the moon draws towards it the waters of the ocean, and produces the phenomenon known as the tides.

When a gun is fired there is the action of the powder enforcing the bullet or shell from the muzzle, and there is also an equal and contrary reaction in the recoil or ricochet of the gun against the shoulder of the person firing the gun, or of the gun against its mountings. If the mass of the gun is 500 times that of the bullet, then the velocity with which the gun is forced back will only be one-fifth-hundredth of that imparted to the bullet.

When a rocket is fired it obtains its motion from the reaction of the force with which the exploding gas escapes. It does not obtain it, as so often has been thought, by the gas pushing against the air. A rocket is more efficient in a vacuum when there is no air to push against.

Work

Work is defined as the *production of motion against resistance*. If a 10 lb. weight is lifted from the floor on to a table, work has been done. Because of its inertia the weight would remain on the floor until some force acts upon it, as we have seen earlier. Similarly, work would be done if we removed the weight from

the table and placed it on the floor. Muscular force is used in this case, but it would be ineffective unless it could overcome the resistance of the weight, due to gravity. In lifting the weight we have performed mechanical work.

When the weight has been placed on the table it might at first sight appear as though the table were doing work in keeping it in place against the force of gravity. Since, however, there is no motion and the weight retains its position, no work is being done; a man who stands still with a weight in his arms is doing no work. If a rope is attached to the weight and it is dragged along the floor or the surface of the table a certain amount of resistance will be felt. This is caused not by the attraction of gravity, because that is balanced by the reaction of the table or the floor, but by the friction of the weight upon its supporting surfaces. If the weight has a polished surface the resistance will be less, and if the top of the table, for example, is covered with glass it will be even less. We should thus be doing less work, because there would be less resistance.

If the weight and the table top were perfectly smooth there would be no resistance at all, and however much we move the weight about we should do no work, since there would be no resistance to overcome. When a cart is drawn along the road only friction has to be overcome, friction in this case being the sum of the resistance in the hubs of the wheel and the *tractive* resistance of the tyres in contact with the road.

When a hill is encountered, the horse has, in addition, the force of gravity to overcome, and he is therefore performing a greater amount of work.

Now when we have to measure work we must first decide upon a unit as with measurements of length, area, capacity and weight. To fix upon a measure of work it is necessary to consider the motion of the body, on which the work is performed and the resistance that has to be overcome in order to remove it.

Motion can be defined by recording how many feet the body has moved, and resistance is best expressed by comparing it with the resistance to be overcome when a body is raised from the earth. This resistance is usually expressed in pounds, and it is due to the force of gravity. Because this force is constant and always in action, it is the best means of measuring work.

Unit of Work

The unit or standard of work usually adopted is that which is done in raising a weight of 1 lb. through a vertical height of 1ft.

This unit is known as the *foot pound*.

If a weight of 10 lb. be raised 1ft., 10 times as much work will be done as when 1 lb. was raised 1ft.

Again, if a weight of 2 lb. be raised 4ft. it will take twice as much power as is required to raise 2 lb. 2ft. Thus to raise a weight of 10 lb. 1ft. we shall require 10 lb. of force.

This may be reduced to a rule: The amount of work required to be done is equal to the weight in pounds of the body multiplied by the vertical distance in feet through which it is raised.

(To be continued.)

Ballistics in Nuclear Physics

Notes on This Important Science

By FRANK W. COUSINS, Grad.I.E.E.

IT was the dream of Hermes Trismegistus and his followers, the alchemists, that they should discover the philosopher's stone, reputed to turn or effect the transmutation of base metal into gold, and to find the elixir of life. The cult was very strong between the 12th and 17th century, and many were the great names coupled with its teachings and researches. To-day, the elixir of life would appear to be most remote, but Hermes Trismegistus has been absolved before his progeny.

The nitrogen atom was bombarded by fast-moving helium nuclei (alpha particles) giving unstable fluorine which gave an isotope of oxygen (O₁₇) and hydrogen. The experiment consisted of placing radium in a container with nitrogen, and arranging for the end of the container to be covered by a foil sheet and a zinc-sulphide screen; scintillations immediately appeared. This suggested that the alpha particles from the radium had expelled a proton from the nitrogen nucleus, and this would mean the automatic formation of another element (see Fig. 1).

Rutherford and Chadwick showed that other light elements were transformed by alpha particle capture, and it was soon realised that to carry investigations to a more successful stage powerful sources of atomic projectiles were desirable, and pioneer work upon atomic ballistics was begun, to assail the armour of the nucleus.

In 1932, at the Cavendish Laboratory, Cockcroft and Walton performed the first transmutation, using a machine or device which generated the ballistic forces and produced a high energy particle capable of entering the nucleus. Their apparatus consisted of a voltage multiplying rectifier to obtain high voltage at a constant potential. The simplified circuit appeared in their report(1); it was an ingenious adaptation of the impulse generator overcoming the main

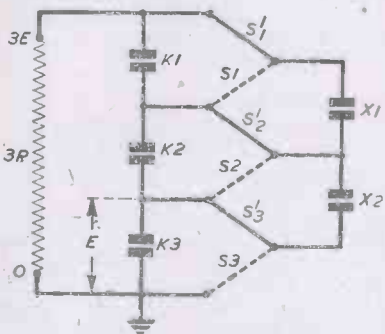

Fig. 2.—Cockcroft and Walton's voltage multiplying circuit.

The Pioneers

In the late 19th century Becquerel discovered radio-activity, in that certain uranium salts were found to produce energy spontaneously and apparently continuously.

Professor Pierre Curie and Madame Marie Curie showed that this was due to radium, a substance which they managed to isolate. Further clever researches showed that radium was one of a series of elements from uranium to lead, which change spontaneously over a definite time period from one to the other; the alchemists had not been so far wide of the truth when they hoped for the philosopher's stone.

That any real detailed light was thrown upon the sub-microscopic subject of radio-activity was owing to the persistent genius and the classic researches of Ernest Rutherford, later Lord Rutherford of Nelson, who, working at the Cavendish Laboratory from 1919, showed that the energy-changes associated with radio-activity were of a high order in comparison with the normal energy associated with chemical changes. Rutherford and Niels Bohr had expounded their conception of the model of the atom, showing that it comprised a centre sun or nucleus of positive charge surrounded by electronic shells, the electrons of which were constrained to move in fixed orbits. It followed that whereas normal chemical changes were made in the orbital electron zone of the atom, the radio-active energy changes were owing to changes in the structure of the nucleus.

Transmutation

In 1919 Rutherford and his colleagues performed an actual transmutation of the element nitrogen, obtaining an isotope of oxygen. The equation being:

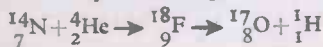

drawbacks of that type of circuit, viz., a momentary discharge, and providing an uninterrupted current flow (Fig. 2). The three parallel condensers K₁, K₂ and K₃, each of the same capacity, are connected in series to the supply E. A further pair of condensers, X₁ and X₂, are connected to K₁, K₂, K₃, as shown. The switches (dotted), S₁, S₂ and S₃, are originally connected, and these connect X₁ and X₂ to K₂ and K₃; when the switches are moved to the upper positions S'₁, S'₂, S'₃; X₂ shares, its charge with K₂ and both will be charged to E/2, the next reversal and K₂ and X₁ will be connected and take up potential E/4 while X₂ will be recharged to potential E. Charge will gradually be transferred to all condensers until in the absence of loss a potential 3E will develop across the condensers K₁, K₂, K₃ in series.

Cockcroft and Walton were able to draw continuous current at voltages as high as 700,000, this being utilised to accelerate protons (hydrogen ions) for the bombardment of a lithium target (Fig. 3). It was found

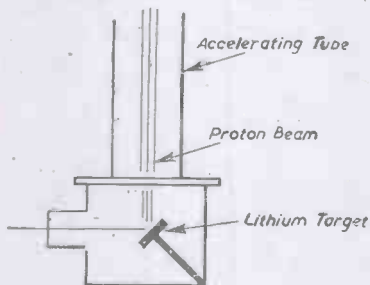

Fig. 3.—Diagram illustrating the bombardment of a lithium target.

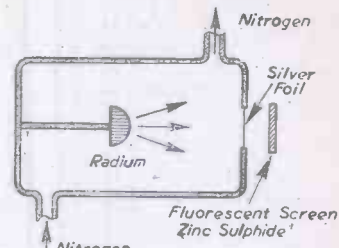
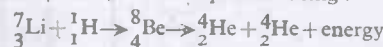

Fig. 1.—Rutherford's transmutation of nitrogen.

that the lithium nucleus (mass 7) absorbed a proton (mass 1) to form a nucleus (mass 8) which disintegrated to form two helium nuclei (mass 4 each). The equation being:



In 1934, at the University of Rome, Prof. Fermi proceeded to bombard most of the known elements in the periodic table with neutron projectiles. He found that in many cases the neutron was captured, and an electron emitted from the unstable nucleus; this raised the positive charge of the nucleus by one and thus transmuted the "old" nucleus to the nucleus of the next element in the periodic table.

Hahn, by chemical methods, investigated the unsatisfactory conclusions of Fermi's assault upon the uranium nucleus, and he was able to show that the uranium nucleus upon the absorption of a neutron underwent a splitting into two lighter elements, of nearly equal mass, barium and krypton, the phenomenon of nuclear fission. Great energy is produced when fission occurs since the products of the fission possess a total mass less than the original nucleus invaded by the neutron and the little piece of lost mass, Δm, is transformed into energy in accordance with Einstein's classic equation: E = Δm c² where c is the velocity of light.

With these facts before the scientific world it became increasingly clear that it was important to manufacture devices capable of generating projectiles for nuclear research, so that the nuclear physicist could direct nuclear bullets at any chosen target to investigate the possible nuclear reaction.

The particles used in this nuclear ballistic art usually fall under one of the following headings:

- (a) alpha particles .. helium nuclei.
- (b) Beta rays .. electrons (fast).
- (c) protons .. hydrogen nuclei.
- (d) deuterons .. heavy hydrogen nuclei.
- (e) neutron .. electron and proton closely bound. No electric charge.

(a), (b), (c) and (d) may be accelerated by a cyclotron or electrical machines termed generically magnetic induction accelerators, the betatron, or synchrotron, or by an electrostatic generator such as the Van de Graaff generator, (e) the neutron having no electric charge is produced as a secondary projectile from the bombardment of a suitable element;

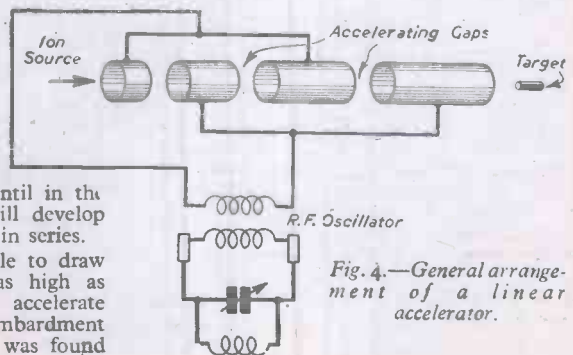

Fig. 4.—General arrangement of a linear accelerator.

for example, they may be given off when beryllium is bombarded with alpha particles. We will now consider these machines in detail in that they are the essential tools of the nuclear physics laboratories from which future developments will come.

The Cyclotron

The cyclotron was invented by Dr. E. O. Lawrence (2), and for his work in this connection he was awarded the Nobel prize. The principle of the cyclotron came to Lawrence after his great experience with linear accelerators, wherein the particles were accelerated across a number of gaps between a number of metal tubes in series, the alternate tubes being connected to the opposite poles of an oscillatory circuit (Fig. 4).

The cyclotron overcame the difficulties experienced with linear accelerators by causing the particles to move in a substantially archimedean spiral, and it introduced a new principle into the nuclear ballistic art, in that the acceleration force was provided in a series of pushes applied to the particle as it passed a specially constructed gap. The fundamental principle is based upon the phenomenon that a charged particle moving in a plane perpendicular to a uniform magnetic field describes a circular orbit at a constant angular velocity regardless of its speed.

In its simplest form the cyclotron consists of two D-shaped electrodes (Fig. 5), having a shallow box-like form, within an evacuated chamber situate between the poles of an electromagnet of great power. The D-shaped electrodes are connected to a high frequency oscillator and so spaced apart as to delimit an air-gap of finite dimensions. It has been shown that an ion of charge "e" and mass "m" may be liberated from within the evacuated chamber and accelerated by the high voltage across the D-shaped electrodes. The magnetic field "H" bends the ion's

path with an angular velocity $\omega = \frac{eH}{m}$; if the high frequency voltage is of a suitable order the ion may be in a resonant condition and it will then be accelerated continuously so that its orbital movement increases in radius of curvature. At a suitable predetermined radius the ion's path is influenced by a directive electric field of force, and the ion is withdrawn from the confines of the D-shaped electrodes through an aperture in the wall of the D, where it is caused to impinge upon a suitable target.

The type of particle under the ballistic forces is decided by the residual gas within the chamber, e.g., heavy hydrogen would cause deuterons to be formed, or helium would provide a supply of alpha particles. The cyclotron has been applied most successfully to the acceleration of positive particles (protons and deuterons). Due to relativistic changes predicted by the mass-energy equation particles increase in mass as their velocities approach the speed of light, and an

increase in energy does not give, entirely, an increase in velocity, this phenomenon causes the particle in the cyclotron to fall out of step with the high frequency voltage across the D-shaped electrodes and sets a limitation to the usefulness of the device. For similar reasons coupled with the low mass of the electron, the cyclotron has not been used to produce high energy electrons (beta rays).

The Betatron

The betatron was first described by a physicist of Siemens-Schucertwerke Aktiengesellschaft(3) of Berlin-Siemensstadt, in 1937, but it was developed and perfected by D. W. Kerst (4, 5, 6) of the University of Illinois. It possesses a *modus operandi* quite distinct from that of the devices described so far. The fundamental components are

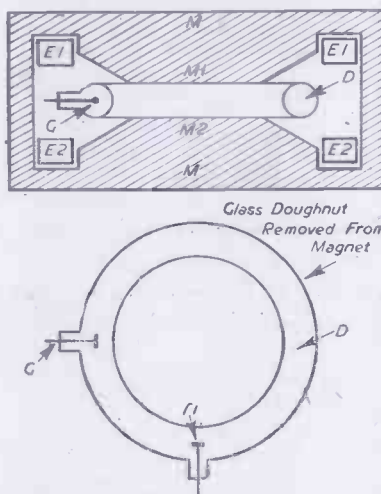

Fig. 6.—The fundamental components of the betatron, shown diagrammatically.

shown diagrammatically in Fig. 6, where M represents an A.C. magnetic circuit and M₁, M₂ are cylindrical pole faces between which is disposed a vacuum chamber D (universally called the glass "doughnut"), having an electron gun G, and a tungsten target T; the entire vacuum chamber being surrounded by exciting coils E₁, E₂.

The operation is analogous to a power transformer with a single bar secondary; the coils E₁, E₂ being not dissimilar to the primary winding, and the electrons within the vacuum chamber to the secondary current. At the start of the operational cycle electrons are injected into the chamber from the electron gun and accelerated by induction forces dependent upon the changing magnetic field within the orbit supplied from the A.C. magnet. The electrons whirling in the orbit are made to undergo many revolutions of the chamber as the voltage increases with time; but since the voltage is alternating in form the electrons need be removed after 1/2 cycle

(i.e. voltage maximum) by shift coils which destroy the stability of the orbit and cause the electrons in the electron beam to spiral inward and bombard a tungsten target, thus generating high energy X-rays. It has been shown by Westendorp and Stobley that this acceleration period of the electrons may be increased by the use of bias coils, which in effect lower the voltage zero line, giving an increased acceleration period, as shown in Fig. 7.

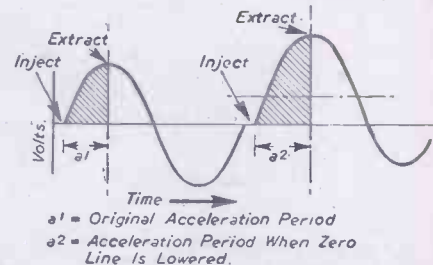

Fig. 7.—Westendorp's improvement in the acceleration period.

It is of interest to record that the General Electric Company of America have made a betatron which is capable of generating 10⁸ electron volts; difficulties are experienced, however, at these very high energies; since the electron of relatively low mass soon approaches a velocity close to the velocity of light (c) since this sets a limit to its movement any additional energy intake results in an increase in the mass of the electron itself; at even greater energy levels radiation of the energy appears in the form of electro-magnetic waves and the dissipation of energy in this form may become substantially equal to the acquisition of energy.

The Synchrotron

The synchrotron is a modified betatron, the essential modification being arranged to overcome the drawbacks referred to in the preceding chapter.

The modification consists of the inclusion within the vacuum chamber ("the doughnut") of a high-frequency resonant cavity forming a gap across which the electrons pass once each cycle. The cavity is connected electrically to an oscillator and the electrons are given extra energy as they pass this gap which is similar in principle to the gap between the Ds of the cyclotron.

The principle of phase stability operates here, in that if the energy given to the electron is too small the orbital radius is reduced and the electron arrives at the cavity earlier than it would have done, and it receives in consequence an extra amount of energy from the voltage wave impressed upon the cavity (Fig. 8). Conversely, if the energy given to the electron is too large the orbital radius increases and the electron is late in its arrival at the cavity; it receives, in consequence, a reduced amount of energy from the voltage across the cavity (Fig. 8).

A schematic view of the synchrotron is shown in Fig. 9, and the resonant cavity R_c is shown, the inner and outer surfaces of the cavity are coated with a conducting layer suitably designed to reduce eddy currents to a minimum and the inner layer has a gap in a plane normal to the electron orbit, across which the bunched electrons under the synchrotron action are attracted.

The Van De Graaff Electrostatic Generator (7, 8, 9, 10)

Most of the very early machines for generating high voltages were "static" machines, that is to say, they produced voltage owing to the phenomena of static electricity. The most famous of these early machines is the Wimshurst machine; it comprises two co-axial insulating discs, revolving in opposite directions with suitable collecting brushes, and is to be seen in most college laboratories. The electrostatic generators of to-day are very similar in their general operation but much different in appearance. Otto Von Guericke, of Magdeburg, is credited with the invention of such generators, but the real development has been due to the researches of R. J. Van de Graaff, who has decided the design of the powerful generator which carries his name.

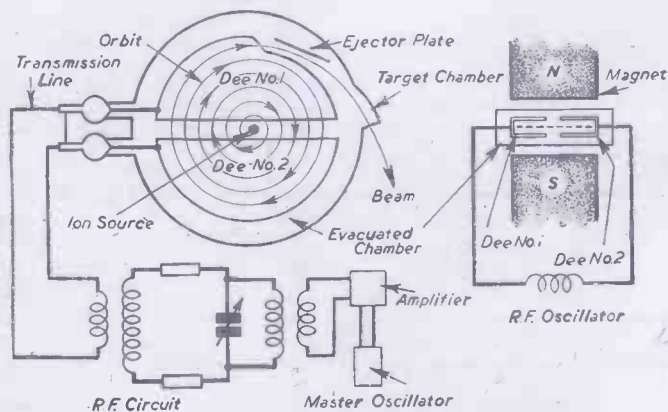

Fig. 5.—A simple form of cyclotron.

The chief advantage of the electrostatic generator, as compared with cascade transformers and rectifiers, is the low cost per kv., and the only real disadvantage is the low current capacity obtainable.

A small type of generator is shown in Fig. 10; it comprises fundamentally a conducting shell in the form of a spherical cap, the high voltage terminal, this is termed the "corona cap" and it is mounted upon an insulating column specifically designed to relieve any high stresses. The insulating column is mounted upon an earthed frame containing a half-wave rectifier transformer combination which sprays, by corona effect, a charge of electricity upon a belt formed from an insulating material (paper or silk), the ascending side of the belt carries the charge to the upper pulley of the belt drive, and gives its charge to the corona cap which acts as a Faraday cage and retains the charge by induction upon its outermost surfaces. To increase the efficiency of the generator the descending part of the belt is sprayed with an electric charge opposite in sign to that on the portion of the belt ascending.

The very large generators in high voltage laboratories of modern design, have Van de Graaff electrostatic generators, incorporating the accelerating tube, down which the nuclear bullets are fired under the potential existing between the corona cap and earth. It is usual, also, to surround the corona cap with gas under pressure, as in the generators at Wisconsin University and Westinghouse Electric Manufacturing Co. The gas must

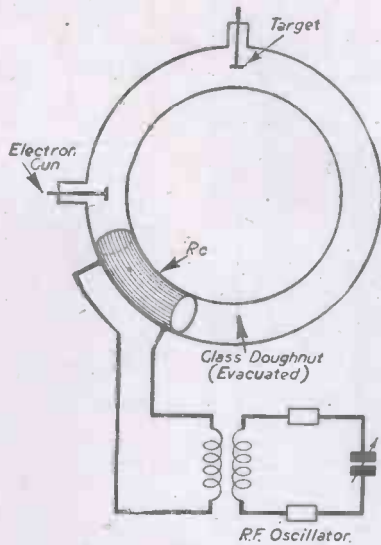

Fig. 9.—The synchrotron.

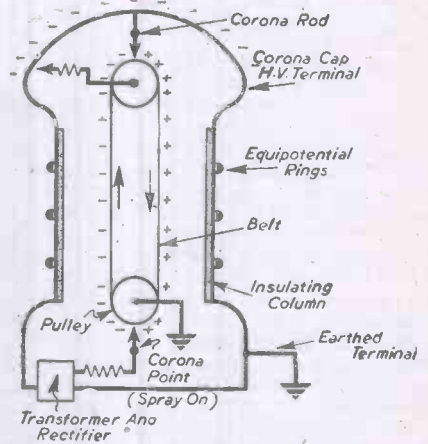

Fig. 10.—Van de Graaff electrostatic generator.

If one generator is positively charged to, say, $+10^6$ volts and the other to -10^6 volts, the voltage obtainable across them is 2×10^6 volts, a decided advantage.

The electrostatic generator may be used to accelerate both positively charged particles and negatively charged ones, provided the sign of the voltage is altered. Electrons have been successfully accelerated to energies of over 10^6 electron volts and they have provided X-rays of high intensity for the treatment of diseases.

Work is now proceeding upon the possible use of a Van de Graaff generator in combination with resonant cavity linear accelerators to produce energies as high as 280,000,000 electron volts and even higher.

Uranium Fission Piles (II)

The uranium fission pile is a development of work undertaken during the war, at high secrecy. Within a calculated lattice of graphite, uranium rods are disposed, the system being arranged to be above a critical size and fission neutrons which escape from one of the rods pass into the graphite and lose energy rapidly by collision. When

the neutrons diffuse to a uranium rod again they are readily captured by ^{235}U and further fissions are initiated. The very great concentration of free neutrons within the pile may be utilised to bombard any element placed inside the pile and this is now done to obtain radio-active isotopes, which normally could not be obtained, and to-day radio-active phosphorus and cobalt are produced

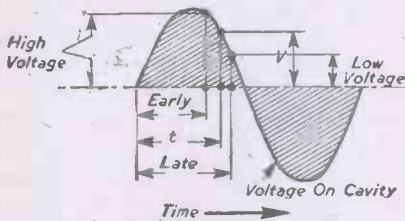

Fig. 8.—Diagram illustrating the principle of phase stability.

be of an insulating nature or may be Freon (CCl_2F_2) an organic vapour of high dielectric strength. The use of pressurised gas in this way prevents leakage from the corona cap to the atmosphere and facilitates the use of the generator under humid conditions.

It is not unusual to find two Van de Graaff generators operating in tandem, one having its corona cap positively charged and the other having its cap negatively charged, the potential difference between the two caps being used for the accelerating voltage. (Fig. 11.)

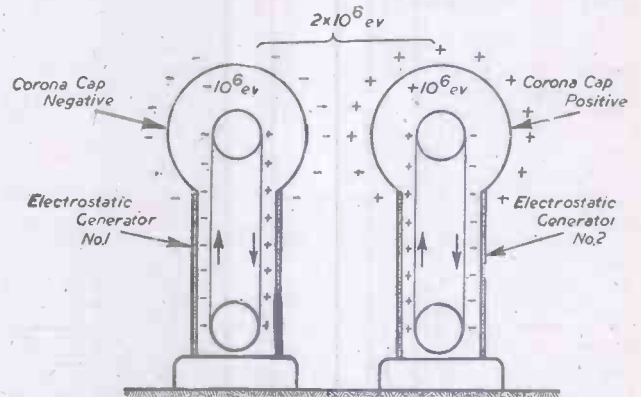

Fig. 11.—Van de Graaff generators operating in tandem.

in this fashion for medical research. Other valuable isotopes are also formed, some of which are not to be found naturally upon the earth, the best known being plutonium.

BIBLIOGRAPHY

1. Proc. Royal Society, 136, p. 619, 1932.
2. E. O. Lawrence and Livingston, M.S. Phys. Rev. 40, p. 19, 1932.
3. Br. Pat. No. 466,836.
4. D. W. Kerst, Phys. Rev. 58, p. 841 (1940).
5. D. W. Kerst, Phys. Rev. 60, p. 47 (1941).
6. D. W. Kerst, Rev. Sci. Inst., 13, p. 387 (1942).
7. R. J. Van de Graaff, K. T. Compton, L. U. Van Atta, Phys. Rev. 43, 149, 1933.
8. E. U. Condon, Elektrotechnische Zeitschrift, 59, Jahrg. Heft. 39, 1039, Sept. 1938.
9. F. H. Merrill, Students' Journal I.E.E., Vol. 9, 124, 1939.
10. R. C. Brown, School Science Review, June, 1947, p. 369. (Small type for laboratory use.)
11. Oliphant, J.I.E.E., Vol. 94, Part I, No. 79, July, 1947, p. 304. See also—
 - a. Betatron, by W. Bosley, B.S.C. Journal of Sci. Inst., Vol. 23, No. 12, Dec., 1946.
 - b. Atomic Artillery, G. E. Review, June, 1947.
 - c. Why Smash Atoms? (Pelican Book), A. K. Solomon.
 - d. Atomics, Power Plant Eng., Sept. 1945-March, 1946.
 - e. Smyth's Report, 1940-45. A general account of the development of methods of using atomic energy for military purposes under the auspices of U.S. Gov. (H.M. Stationery Office, London.)

Bristol Freighter Carries Home Damaged 'Plane

A "BRISTOL" Freighter landed at Langley, near London, recently and opened its nose doors to reveal another aircraft neatly stowed inside the hold. It was an Airspeed Consul, severely damaged in a night landing accident at Valencia and brought back to England for rebuilding.

The Freighter, on charter from Airwork Ltd. to Air Transport (Paris), was flown by Mr. P. R. Hornidge, former B.A.C. Test Pilot. Mr. Hornidge, interviewed on his return, described how he found the Consul on its back at Valencia airport, where it had overshot the landing strip and turned a somersault. Nose and cockpit were badly smashed, but the fuselage and wings were reasonably intact.

"We loaded the entire job inside the

Freighter," said Mr. Hornidge, "without any mechanical help whatever. We got together a labour gang of about twenty Spaniards and manhandled the Consul aboard. The centre-plane went first, with the fuselage on top, and the wings and engines at the sides. When the Consul was in, it was impossible to reach the flight deck by walking through the fuselage and climbing the ladder in the normal way. We had to get in by means of the emergency entrance hatch in the port nose door."

The Freighter was chartered, added Mr. Hornidge, "because it was the only aircraft capable of doing the job." Loading took three hours; unloading, three-quarters of an hour.

A Circular-saw Bench

Constructional Details of a Folding Saw Bench for the Amateur's Workshop

By W. BADDELEY

IT sometimes happens that the home handyman goes to his workshop desiring to start making some piece of furniture or other structure built of wood, only to have his enthusiasm damped considerably when he finds the timber has to be cut out by hand saw.

The remedy is fairly simple if he is willing to utilise a few evenings and to lay out a comparatively small sum to construct the small power saw described in this article.

The small outlay will repay him many times over in labour and time saved.

My own workshop, like most amateurs', is very limited in space, and the main objection to installing a circular-saw bench lay in the amount of floor-space it would occupy. This was overcome by making the table fold under the workbench when not in use.

Fig. 1 shows the two positions.

The materials required should be fairly easy to acquire, and include the following:

- One electric motor ($\frac{1}{2}$ or $\frac{3}{4}$ h.p.).
- One circular saw (6in. dia.).
- Enough timber for the folding supports and table.
- Four aluminium castings.
- Two pieces of round bright mild steel ($\frac{1}{2}$ in. and $\frac{3}{4}$ in. dia.) and some wood screws.
- One piece of bar brass ($\frac{3}{16}$ in. dia.).

cut to 31 $\frac{1}{2}$ in. long by 3in. or 4in. broad. The leg and support (A) can then be fixed in position as in Fig. 1.

The length of the leg should be such that when in the erected position it should press the horizontal support against the underside of the bench. This pressure, coupled with the wing nut fixing (C), helps to keep down vibration during operation and counteracts the strain of a belt drive.

The Saw Table

This is shown in detail in Fig. 2 and, as will be observed, $\frac{5}{8}$ in. timber is used. The type of wood is not important but if a hard wood is used a much longer life can be expected and the chance of warping reduced.

The table bars shown in Fig. 2 are screwed and glued to the under-side of

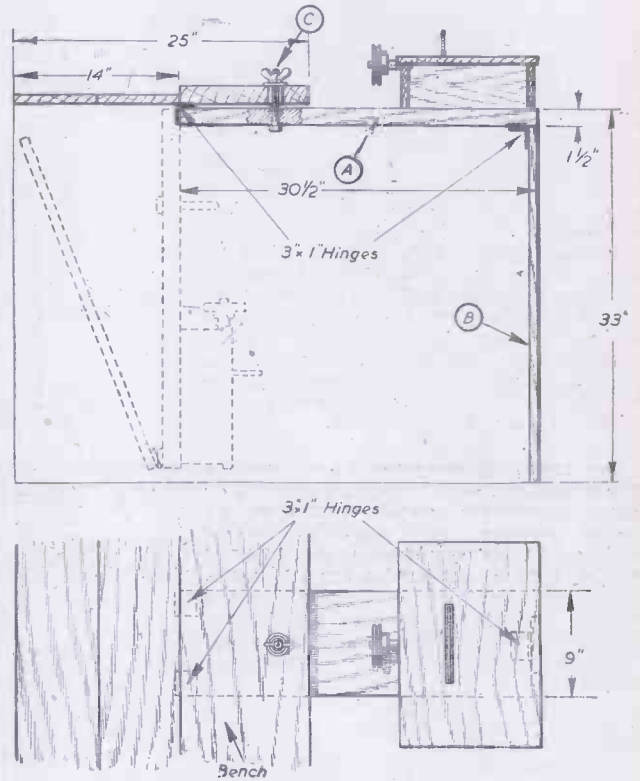

Fig. 1.—Side view and plan of the folding saw bench.

The table, when built up, should be planed flat and smooth on the top, and the slot for the saw cut out.

The whole assembly can now be given a coat of shellac varnish. This is much better than paint, as the surface is not so sticky.

The Saw Spindle and Bearing

These parts are the most difficult to make, as they have to be finished fairly accurately to function properly. A lathe will be necessary to turn the spindle and bore out the bearing.

The Bearing (D)

As shown in the exploded view in Fig. 3, this consists of a piece of $\frac{3}{4}$ in. diameter bar brass 4 $\frac{1}{2}$ in. long. Mount this in the self-centring chuck, face the end and drill out $\frac{15}{32}$ in. diameter, afterwards reaming out to $\frac{3}{4}$ in. diameter. Reverse it in the chuck and face off the other end to 4in. long.

The Spindle (E)

This is made from a piece of mild steel 7 $\frac{1}{2}$ in. long by $\frac{3}{4}$ in. diameter. It is turned

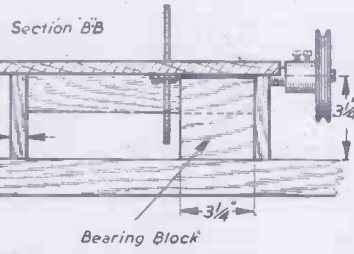
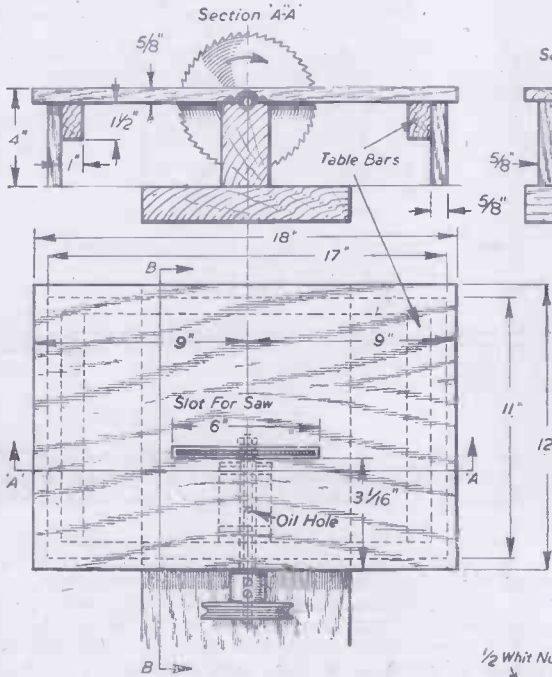

Fig. 2.—Section, side view and plan of saw table assembly.

the top and so placed to register the top's position in relation to the table frame.

The top of course is only screwed to the frame, not glued, as it has to be removed from time to time to remove the saw.

The dimensions given in the drawings have been taken from my own saw table, but obviously the dimensions of the supports will have to be altered to suit the reader's requirements.

Construction

The main support (A) should be made from wood 1 $\frac{1}{2}$ in. thick cut to 30 $\frac{1}{2}$ in. long by about 9in. broad.

The Leg (B)

The leg (B) is made from wood 1in. thick

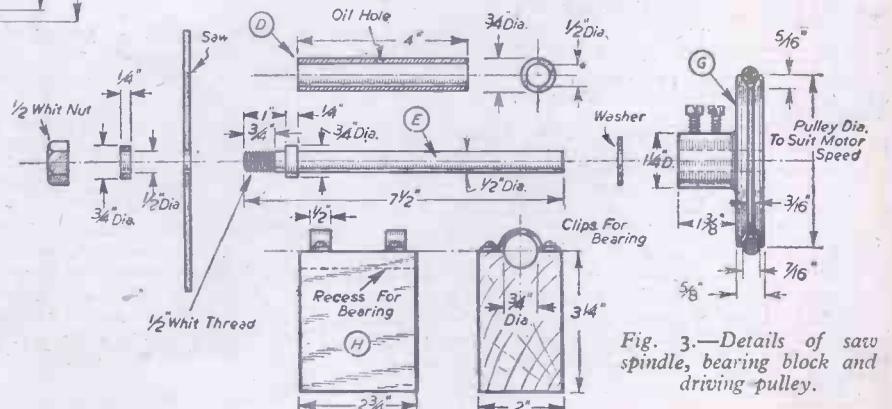

Fig. 3.—Details of saw spindle, bearing block and driving pulley.

between centres to the sizes shown, care being taken to ensure a good running fit in the bearing.

The Pulley (G)

This component is intended to be made in aluminium and can either be machined from the solid or from a casting.

The diameter of this pulley is determined by the speed and diameter of the driving pulley, but the saw speed to aim at is 1,500 r.p.m.

The following formula will give the correct diameter of pulley :

Diameter of saw pulley equals :

$$\frac{\text{Dia. of driving pulley} \times \text{r.p.m. of driving pulley}}{\text{r.p.m. of saw pulley}}$$

For the drive, 3/4 in. round leather belting is used.

If shafting is not already installed in the workshop it would be advantageous to do it now, as a variety of tools can then be driven from the same motor.

The Bearing Block (H)

Hard wood should be used for this block which has a cradle cut in the top to hold the spindle bearing, while the small clips made of strip steel 1/8 in. thick are used to anchor it.

The block is then screwed and glued to the main support in the position shown in Fig. 2.

This completes the saw table except for

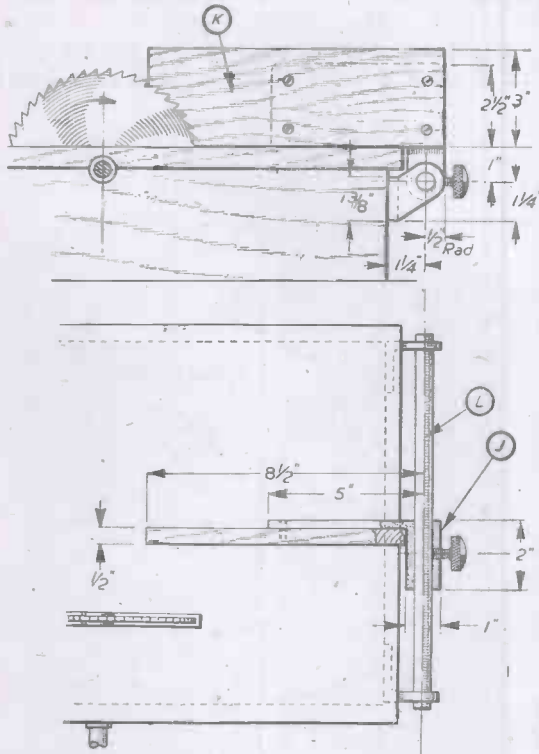

Fig. 4.—Details of the sliding guide.

the adjustable guide shown in Fig. 4.

It is a simple arrangement and can be built up in the most convenient way for the constructor.

My own arrangement consists of a 12 in. length of 1/4 in. diameter mild steel (part (L)) fixed rigidly with grub screws in the two brackets which are screwed to the table. The brackets are aluminium castings.

The Sliding Guide (J)

This is also an aluminium casting, which is drilled 1/4 in. diameter to allow it to slide along the 1/4 in. bar. It is locked in any desired position by the milled-head screw.

Part (K) is a piece of hard wood finished to size and screwed to the slide. This part is made in wood for ease in fixing angle cutting attachments, etc.

The idea of a circular-saw folding under the work bench is not new, but I have endeavoured to give the reader something concrete with which to build his own machine.

Various gadgets will suggest themselves to the constructor for making unusual cuts as he becomes familiar with the saw.

Trade Notes

"Electro-Lake" Toy

A NOVEL and instructive toy, recently placed on the market by Quin Med Research Products, 2, Portland Road, Holland Park, London, W.11, takes the form of a miniature circular lake, complete with lighthouse and rock foundation. By an ingenious arrangement of hidden coils, which are energised by an ordinary 3-volt dry battery, a tiny ship placed on the water can be navigated in different directions by pressing buttons on the switch box, as shown in the accompanying illustration. Two model ships are provided with the outfit, one having a tiny permanent magnet, while the other gives an added interest, and can be moved by means of the controlled boat. (This second boat is not shown in the illustration.)

The lighthouse is provided with a bulb and will flash when the switch buttons are pressed. As an alternative to the dry battery mentioned, the toy can also be

worked from a 2-volt accumulator, which, of course, will supply the necessary current for a longer time. Additional magnetic boats are obtainable.

We understand that the retail price of the "Electro-Lake," complete with battery and including purchase tax, is £4.

Peco-Way "OO" Gauge Track

A unique and realistic form of "OO" gauge track has been designed by Messrs. Pritchard Patent Products. The new track, which is true to scale with a correct sleeper and chair spacing, has a very pleasing appearance and is extremely easy to construct. It is not expensive, and no soldering is required for straight and curved rails, and only a minimum of soldered joints are used in the point construction. Full particulars and instructions for building this new "OO" gauge permanent way are given in an illustrated booklet entitled Peco-Way, which can be obtained for sixpence from Messrs. Bassett-Lowke Ltd., 112, High Holborn, London, W.C.1, where supplies of all the accessories are available, and a demonstration section of the track is on view.

Portable Electric Tools Refresher Course

Messrs. S. Wolf & Co., Ltd., manufacturers of "Wolf" Portable Electric Tools, have instituted a series of 3-day courses for salesmen engaged in the tool and equipment trades.

The course is proving of particular interest to those sales-

men recently demobilised from the Services; since it is helping them to regain touch with the portable electric tool industry, and to catch up with developments in the design and production of "Wolf" electric tools.

The first day is given over to consideration of the basic principles of salesmanship applied to portable electric tools and visits to the works. The second day is devoted to the uses for portable electric tools, followed by demonstrations, and the third day to after-sales service, packing and presentation.

Club Report

Eccles and District Model Engineering Society

PROGRAMME of talks, etc., up to the end of March, 1948 :

February 29th: Internal Combustion Engines, by R. O. Harper: This talk should be particularly interesting. Mr. Harper has unrivalled experience with these engines of all sorts, shapes and sizes. His motor experience goes back to the days when each trip was an adventure and the engines did live up to their name of "infernal" combustion engines still given to them by some of the steam fans.

March 14th: Plans for this day are rather vague at the moment. It is hoped to arrange a visit to some place of interest such as a colliery or a power station. Details will be issued later.

March 28th: Pattern Making. No lecturer has yet been arranged for this talk. It is, however, hoped to get Mr. Meadows, of Manchester, who was by trade a master pattern maker.

All the above talks will take place in the Clubrooms, Eldon Place, at 11 a.m.

Hon. Sec., W. J. Thompson, 16, Prestwood Road, Salford, 6.



Tubular Furniture

How to Design and Construct Your Own Without Welding

By GORDON HOWL

FURNITURE to-day is at a premium, both new and second-hand, therefore exacting planning is needed to provide a tasteful and well-equipped home.

A house with the bare necessity of a table to eat from and a chair to sit upon will forever remain just a house. To make a home a home the personal touch is required, and to provide non-essential but desirable furnishings, the householder often constructs them himself.

Wood being so scarce, other materials have to be sought to provide the accessories to the home, and metal tube, hard asbestos board and canvas have been found to be good substitutes, requiring little or no timber when constructing. Such substitutes are easy to obtain and moderately inexpensive.

One of the benefits of making one's own furniture is that it can be designed to personal tastes and requirements, and with this in mind, specific dimensions for the furniture illustrated have been omitted, so as to enable the reader to adapt the design to his own particular requirements or circumstances.

In Fig. 5 a variety of designs is depicted to show the adaptability of this type of construction.

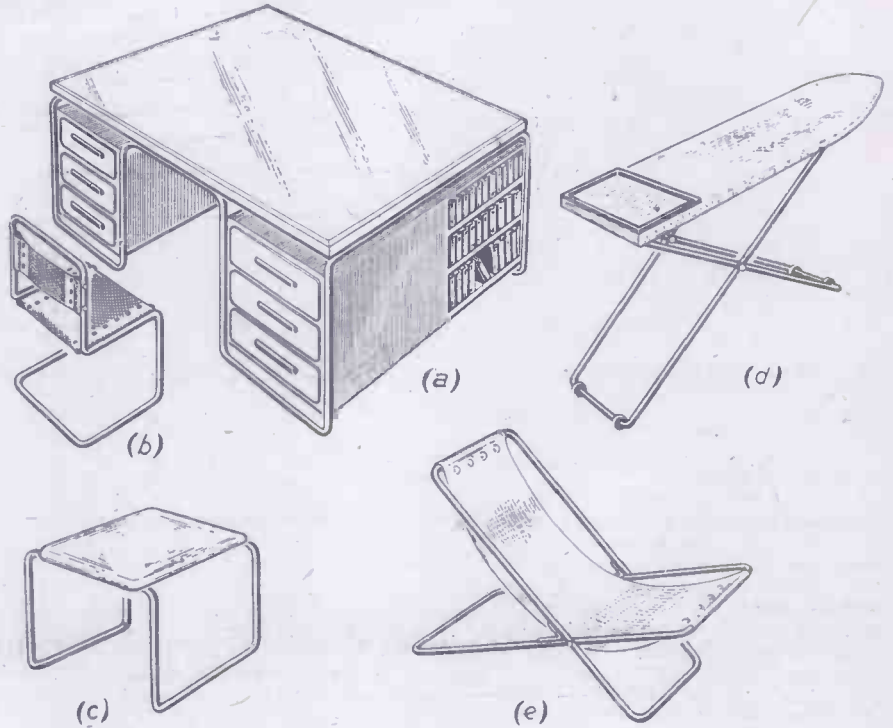

Fig. 5.—Some typical examples of tubular furniture.

The Bending Fixture

Smooth, clean lines are the keynote of tubular furniture, and to make the bends consistent a fixture, simple to construct without forfeiting its efficiency, is required for bending the tube cold.

The fixture shown in Fig. 1 is economically constructed and adequately suitable for making the 2in. radius bends. It will be noted that this is the mean radius, and allowance for this fact has been made in the fixture.

The bending rolls are mounted on a hardwood base (A) 8in. square by 1in. thick. The

former wheel (B) is retained by three wood screws 2in. long spaced at intervals of 120 degrees on a 2½in. P.C.D.

Lines are scribed on the wheel with an inclusive angle of 90 degrees as shown in Fig. 2.

To avoid the follower wheel (C) binding on either the handle or the base board a 1/16in. clearance is given at the bottom face and a 1/16in. by 1in. diameter shoulder at the top face. The wheels themselves will not touch but will be in connection only through the medium reason the centre of

the "vee" of part B and against the peg (G). The follower wheel is held in position against the tube and the pin (E) is dropped in. Immediately pressure is applied the tube will be found to be locked in position between the former wheel and the peg (G).

The actual bending of the tube is explained in more detail in the paragraph on "Bending the Tube."

After the tube is bent, the removal is simply effected by extracting the pin (E) when the wheel (C) will drop away. All other necessary details and dimensions for constructing the fixture will be found in Figs. 1 and 2.

Design and Bending

It is desirable, as far as possible, to make the furniture from one continuous length of tube with only one joint. Naturally, with the larger constructions this will not be possible, and one will have to resort to secondary joints. In such a case it is advisable to place the joints where they incur the minimum of strain and are least conspicuous.

The article under consideration should first be drawn to scale and dimensioned, particularly the straight portions, for these are the setting dimensions. If the workshop is large enough it is a great asset to lay the plan and elevation out to full scale in chalk

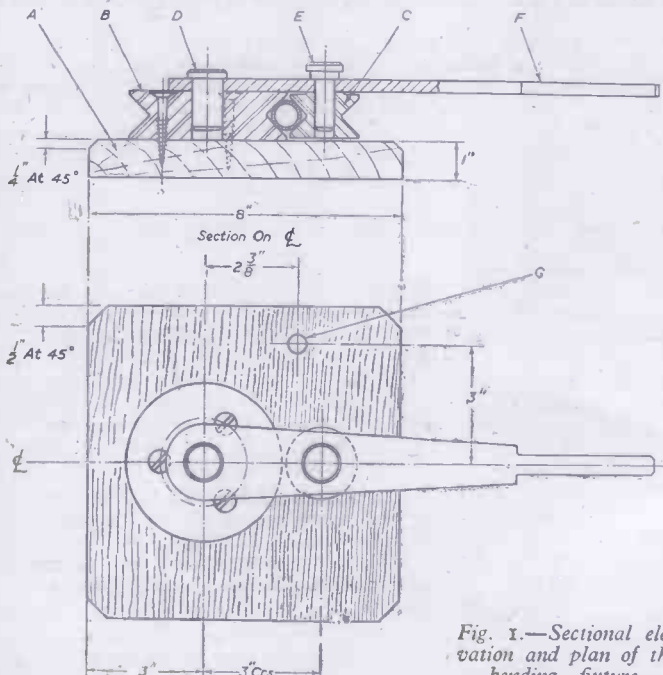

Fig. 1.—Sectional elevation and plan of the bending fixture.

The two wheels are connected by the pins (D and E) passing through the handle (F). The grip of this handle is made ½in. wide to fit the inside diameter of the tube and to facilitate extra leverage, if necessary, by fixing a length of tube on the end.

To operate the fixture, insert the tubes in

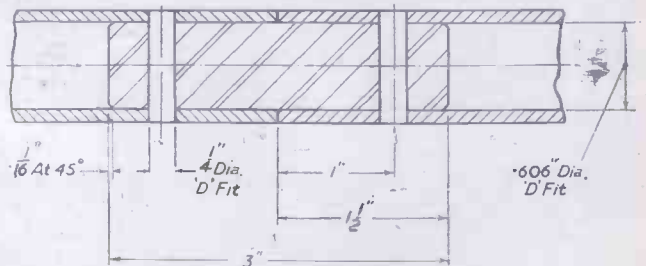

Fig. 3.—Sectional view showing the construction of the joints.

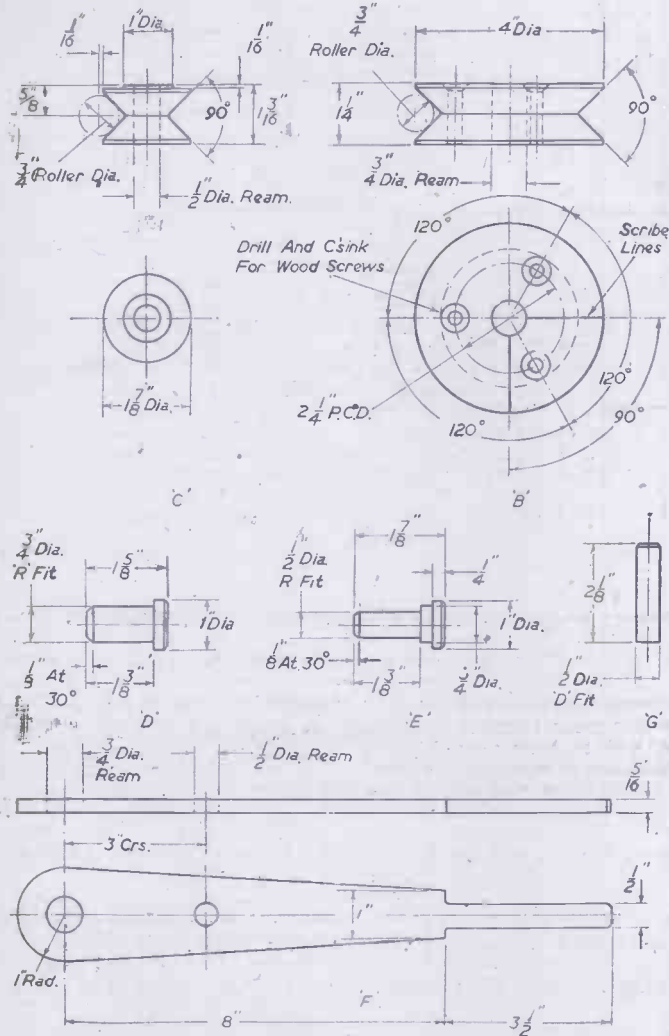

Fig. 2.—Component parts for making the bending fixture shown in Fig. 1.

upon the workshop floor. The views will be quite legible if superimposed upon each other, for certain lines will coincide.

The tube chosen is $\frac{3}{4}$ in. outside diameter electrical conduit, and should always be bent with the seam inside the radius to minimise the risk of splitting.

To commence the bending, mark the straight portion from the joint to the first bend and insert in the bending fixture, matching the mark with the first scribed line and square up with the stop peg. Bend at 90 degrees with a firm, even pull. Do not bend too fast or jerkily as this is liable to lose the location. Still keeping the tube under pressure by hand, clear the handle and mark the tube in line with the second scribed line on the former wheel. This fixes the point from which to mark the second straight portion. From this mark, place on the drawing, mark the next straight portion and bend as before. It will, in all probability, be found that after this bend the straight portions do not line up, but these can easily be set in the vice. This must be

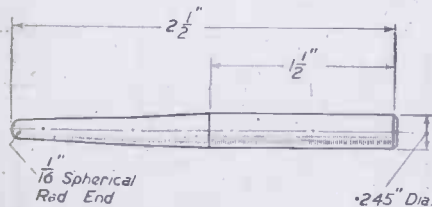

Fig. 4.—Drift for lining up the holes for jointing.

done after every bend, or the job will not be square at the finish, and jointing will be difficult.

Jointing

The joint shown in Fig. 3, although very simple, must be accurately made to give a good finish to the construction.

After the bending is completed it is advisable to try the job on the drawing and mark off the joints, cutting away any surplus tube.

The ends of the tube are then squared up in the vice and a $\frac{1}{4}$ in. diameter hole drilled at one side of the joint only. $\frac{11}{16}$ in. from the end. The jointing peg, $\frac{3}{8}$ in. long (Fig. 3), is turned to be a good drive fit in the tube.

The B.S.I. give the inside diameter of the tube at .606 in., but it will be found to be very rough indeed; therefore, in this case, to fit by trial is a safer method than working to a micrometer. The peg is drilled with a $\frac{1}{4}$ in. diameter hole at one end only, and carefully driven into the tube to match up with the existing hole.

If the holes do not quite match up a tool, as shown in Fig. 4, will be found very useful for passing through the holes and pulling the jointing peg into line. When the holes are in line, secure the jointing peg to the tube by driving a $\frac{1}{4}$ in. diameter silver steel dowel through, leaving it protruding either side until the joint is complete. To finish off the joint, grip the other end of the tube in the vice, drive the free end of the peg in, and drill both tube and peg on assembly, making secure with another $\frac{1}{4}$ in. diameter silver steel dowel. To finish, saw off the protruding ends of dowels and file flush with the surface of the tube.

When the holes are in line, secure the jointing peg to the tube by driving a $\frac{1}{4}$ in. diameter silver steel dowel through, leaving it protruding either side until the joint is complete. To finish off the joint, grip the other end of the tube in the vice, drive the free end of the peg in, and drill both tube and peg on assembly, making secure with another $\frac{1}{4}$ in. diameter silver steel dowel. To finish, saw off the protruding ends of dowels and file flush with the surface of the tube.

Finishing

The finishing, whether paint or electroplate, depends upon the material of the tube and individual taste, but if the tube previously mentioned is used, all the original covering such as paint, lacquer, etc., should be stripped off and the tube carefully polished with fine emery cloth. The undercoat of lead paint should now be applied and left to dry. A further undercoat can be given if necessary. The finishing coat should be of a good, hard gloss enamel paint.

Typical Examples of Construction

The furniture shown in Fig. 5 suggests the variety of articles which can easily be made,

using the above method of construction.

From the sketches it will be observed that the general tubular construction follows the lines previously explained, therefore a brief outline of the not-so-obvious points need only be noted, such as the fixing of the canvas, etc.

The general dimensions of any object it is desired to construct can readily be obtained from any standard work on furniture construction. In a number of cases the dimensions may be limited by the material to hand, and the design would then be controlled by virtue of the necessity to comply with existing fixtures.

Desk

The top consists of $\frac{1}{2}$ in. thick unplanned boards battened together by positioning the battens directly over the middle of the drawers where there is room to spare. Cover these with a sheet of $\frac{3}{16}$ in. or $\frac{1}{4}$ in. hard asbestos board secured by counter-sunk head screws. The screws will be sunk deep enough to allow a facing of plastic wood over each one. The whole should then be surrounded by plain bevelled beading, which can easily be fixed by panel pins. When this top is painted it will form an ideal surface for writing upon. If a more expensive job is required it can be effected by covering the top with American cloth or leatherette prior to beading, and the beading finally stained.

The construction of the drawers can be obtained from any woodworkers' manual or a set of drawers may be available from which the basis of a design can be obtained. The drawers are set at the tangent of the bend in the tube, thus giving a space between the set of drawers and the desk top, which is very useful for letters, writing paper, magazines, etc.

If the desk is made to normal proportions, the back of the drawer case can be adapted to accommodate books of reference and other works, as the actual drawer will only occupy part of the full length of the desk.

To fix the drawers and top the frame is drilled and countersunk in the most inconspicuous positions to take stout wood screws.

Chair

The tubular construction of the chair deviates slightly from the other furniture. The top of the back is bent at an angle of 20 degrees to 30 degrees so that the sitter's back takes its support from the canvas and not from the tube.

The canvas seat and back rest are identical in construction and differ only in size. The details of the seat as now given will apply similarly to the back.

Fig. 6 shows a section through the anchor bolts.

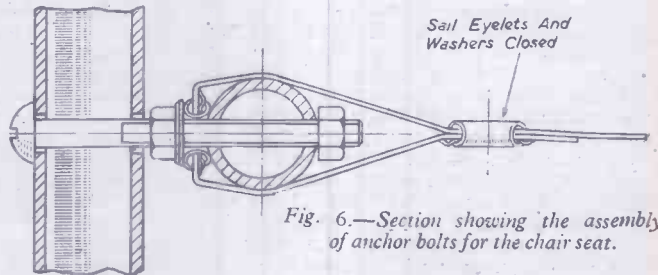

Fig. 6.—Section showing the assembly of anchor bolts for the chair seat.

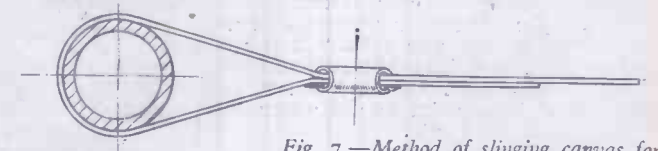

Fig. 7.—Method of slinging canvas for the deck chair.

Two lengths of straight tube are cut from the same stock as the chair, and are made about 3 in. shorter than the length of the chair. The ends are plugged with turned wood or metal buttons after the tube has been drilled. The tubes should then be set in position with the chair, and markings made for the two anchor bolts to be drilled.

The holes in the chair should be about $\frac{3}{8}$ in. diameter and those in the seat tube $\frac{5}{16}$ in. clearance diameter. The length of canvas should be such as to allow for lapping round the tube, and to eliminate fraying the two outer edges should be bound.

Mark off the positions of the four eyelets, two of which will coincide with the anchor bolts. Tucker sail eyelets and washers will be found most suitable for the job, and can be obtained at most ironmongers. Cut the holes for the eyelets through which the anchor bolts pass and fix in position. Complete the seat by screwing in the $\frac{5}{16}$ in. Whit. round head bolt and close up the lap with four more eyelets. Sew up any loose

ends with strong cord to finish a durable seat.

The back is treated in a similar manner.

Deck Chair

The deck chair canvas, ready for fitting, can be bought from any of the leading stores and fixing should be made either by sail eyelets or by sewing; the former method being the stronger job. When folding over the tube make sure of a long angle as shown in Fig. 7 to prevent the canvas ripping on the top edge.

To lock the deck chair angle plates should be made and set on the chair to the desired angle, and fixed by screwing in to the tapped tube. It will be understood that the chair folds opposite to the usual standard practice.

Ironing Board

The top of the ironing board is standard. The back leg is allowed to swivel by running in two conduit clips and the folding and standing positions may be secured by Terry spring clips.

To prevent the ironing board creeping when in use, it is advisable to fit rubber to

the base of the legs. This can easily be achieved by cutting a piece of garden hose into four 1 in. lengths and splitting them to clip round the tube, making fast with a good cement.

Dressing Table Seat

This is merely the basic construction fitted with a padded seat secured by wood screws from underneath. With a wooden top it becomes a stool, or by making the construction larger, with an appropriate top, a pleasing coffee table is the result.

Conclusion

Finish is very important for it is imperative that the completed article be pleasing to the eye. Pastel shades of hard gloss enamel are very effective, contrasting with the non-metallic parts of the furniture.

If the frame of the desk is bent from polished copper tube with a sheet aluminium top, it will be found to be very effective.

Naturally the finish will depend, for the most part, on the other furniture in the room.

Letters from Readers

Hot-water System

SIR,—The article in the January issue by Mr. Burdett on "Electric Water Heating Practice," is very interesting. There is one point, however, which I think would improve the converted installation shown in Fig. 2b.

Instead of removing the pipe XY a plug cock should be inserted, and the new pipe (dotted lines) installed as shown. This plug cock is kept shut when the immersion heater is in service and if desired can be opened when solid fuel is used. Its chief advantage is that it can be opened up whenever it is necessary to drain the tank, and it saves a deal of mess draining from a cock on the tank.

In my house the hot-water storage tank is only 3 in. above the bathroom floor, and the drain cock on the tank is of little use. I therefore arranged with the borough council to insert the plug cock (whilst installing the immersion heater) and the extra cost was very small.

They have now adopted this method as general practice. Great care should always be taken when drilling, etc., for the heaters that no swarf or filings are left in the tank, as this causes much of the pitting and rusting, and a new tank is required well before its time.—K. T. MULLOCK, M.I.E.C. (Thornton Heath).

Trisecting an Angle

SIR,—There are many ways of trisecting an angle, but none by Euclidean methods. As Derbian has pointed out, Euclidean geometry allows only the use of an ungraduated straight-edge and a pair of compasses of unlimited length and radius respectively. I cannot agree with Derbian that it is not "permissible to transfer any dimensions." It is not on this score that R. Rhodes's method falls down, but on the more fundamental fact that it does not trisect angles! Mr. Rhodes did not set out his "proof," but one surmises he believes that in any triangle the angles are proportionate to the opposite sides, whereas, of course, it is their sines which are.

R. E. Brett's method in the December issue is invalid for the same reason—it does not trisect angles. He says that, "It is well known that if we divide the base of an isosceles triangle into a given ratio, say $m:n$, and join the dividing point to the vertex, the vertical angle will also be divided in the ratio $m:n$." If it is well known it is indeed popular fallacy; certainly it is untrue.

I missed the May-June issue, but K. R. Saillard's construction, reproduced and proved by R. E. Brett in the December issue, is familiar. Unfortunately, whilst angles may be trisected by this method, the construction cannot be effected by Euclidean geometry. W. W. R. Ball says of it in his "Mathematical Recreations and Essays," "The ancients determined the position of the point B by the aid of the conchoid; it could also be found by the use of the conic sections."

Trisection can be effected within Euclidean restrictions to within any required degree of accuracy by repeated bisection. Bisect the angle AOB by OC; the angle COB by OD; AOD by OE; EOB by OF; and then and thereafter the larger of the two angles into which the original angle AOB has been divided by the previous bisection. The 1st, 3rd, 5th, 7th bisection gives the sum to $1, 2, 3, 4$ terms of the series $\frac{1}{2} - \frac{1}{8} - \frac{1}{32} - \frac{1}{128}$, etc., and the 2nd, 4th, 6th, 8th bisection the sum to $1, 2, 3, 4$ terms of the series $\frac{1}{4} + \frac{1}{16} + \frac{1}{64} + \frac{1}{256}$, etc., where the original angle AOB is taken as 1. Both series are rapidly divergent, and in both cases the limit is $\frac{1}{3}$. By this method any angle may be trisected

to within the maximum accuracy of one's skill and one's instruments. In practice, though not in theory, this solves the problem.—ARTHUR B. THOMAS (Manchester).

[This correspondence is now closed.—ED.]

Crystallisation Experiment

SIR,—With reference to the query on page 139 of the January issue of PRACTICAL MECHANICS, regarding the growing of crystals on coal, your correspondent may be interested in the following description of what, I believe, is the original method of producing these growths.

The ingredients are: Household (washing) blue, 10z.; ammonia, 20z.; water, 20z.; red or green ink (liquid), 20z.; common salt, 1½oz.

When mixed together the resulting solution is poured over some pieces of coal in a glass dish. The best results are obtained with pieces of coal about 1 in. to 1½ in. cube, in a dish about 7 in. to 8 in. diameter and about 3 in. deep.

Growth should be started in a warm room, and after a few days and subsequently, say, once a week, a little fresh solution should be gently poured over the coal.

Some very fascinating effects may be produced from these interesting growths and they may be kept "alive" for many months.—A. ANDERSON (Stoke Newington).

Ground Controlled Approach for Civil Aircraft

THE Ministry of Civil Aviation, in making provision for post-war commercial flying, took account of the many advances in radio and radar that had been made under the impetus of war. One of the most fruitful advances that appeared to have been made was in the radar system known as Ground Controlled Approach. Accordingly it was decided that G.C.A. would be installed at key airports in the United Kingdom and used for civil aviation.

To this end "Federal" G.C.A. radar units were obtained for civil use, and arrangements were made for the Royal Air Force to train a number of civil crews. The first civil crew started training on January 6th, 1947; since that date the R.A.F. have trained eight complete crews. There are a further six crews under training. The Ministry of Civil Aviation started its own G.C.A. Deployed Training School at Aldermaston Airport on October 27th, and the first three crews to be trained by this unit completed their course on December 14th.

To enable London Airport to have the benefit of a G.C.A. unit during the bad weather of last winter, and so gain the necessary experience as soon as possible, an R.A.F. crew and "Bendix" G.C.A. equipment from Prestwick Airport was loaned to the Ministry of Civil Aviation by the R.A.F. on February 7th, 1947. This R.A.F. crew was supplemented by the first civil G.C.A. operational crew on May 7th, the Ministry of Civil Aviation taking over completely on July 1st.

The operational crew consists essentially of a "talkdown" controller, a supervisor and two directors. The last-named bring the aircraft around the circuit of the aerodrome on the radar search tubes, line it up on the approach path, and then hand over control to the "talkdown" controller, while two girl trackers have the important responsibility of relaying the position of the aircraft on the approach path to the "talkdown" controller from radar precision tubes.

The Conundrum of Coal

The Modern Attack on the Problem of its Chemical Composition

FROM being one of the commonest of all commodities, coal seems nowadays to be fast rising to the position of one of our scarcest articles of mineral wealth. The "black diamonds" of the past are nearly literally establishing themselves as such.

Yet coal itself, even in Britain, is not a scarce commodity. There is plenty of it under the earth. The same applies also in many other countries, whilst in China the coal deposits are considered to be almost inexhaustible.

There is no doubt, so far as this country is concerned, that in coal we have our one large source of home-produced power. True it is that small oil wells have been opened up in Britain and that these have contributed useful quantities of natural oil to aid our resources. Nevertheless, putting the question of atomic energy apart as a matter which has not yet reached the stage of industrialisation, without coal we in this country would be bereft of the major portion of our civilisation's power, to say nothing of our lighting and our heat. That, in a nutshell, is the reason why the coal question has attained such overwhelming importance in these modern times and why, in one way or another, a general solution to the many problems and perplexities of its getting must ultimately be arrived at.

From a technical and scientific standpoint it is a curious thing that the chemical composition or make-up of coal is still a matter

anywhere in our attempts to discover the real chemical nature of coal. Nor, for that matter, does the familiar experiment of heating coal and observing the nature of the gaseous and other products which result from its thermal breaking-up in this manner.

Unsolved Problems

The problem of the chemical composition of coal is a real one. It is a conundrum which still perplexes chemists and other scientists. But because the solving of such a problem is not considered to be bound up with any consequences of practical importance, the question of coal's composition has more or less been side-tracked, only a few scientists having worked on the problem now and again.

Ordinary chemical analysis can readily show that the element most abundant in coal is carbon, and that, in addition, it contains hydrogen, some oxygen, nitrogen, sulphur, phosphorus and several other elements.

is a very curious metal. It melts at 30 deg. C. and it remains molten when held in the hand. A silvery-white metal, something like aluminium, gallium, if it were commoner, would have many useful applications both in its pure state and in the form of its alloys.



Gallium, a rare metal which melts in the hand. Its oxide is present in some coal ashes.

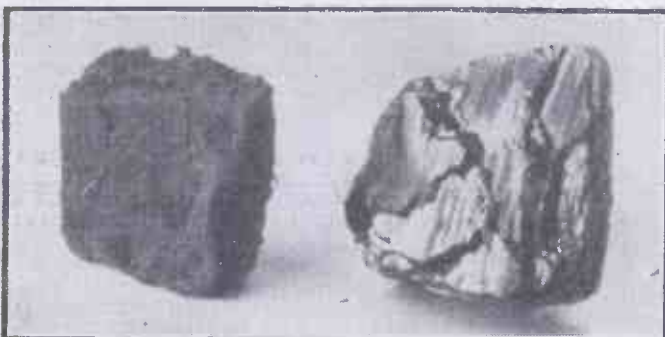

A lump of peat and one of coal seen side by side. Note the fibrous nature of the peat compared with the hard, shiny nature of the coal. Both substances have a common origin.

Coal ash contains more than 95 per cent. of a mixture of four oxides—silicon oxide, aluminium oxide, calcium oxide and iron oxide—but, strangely enough, there are some coals, particularly the Northumbrian coals, the ashes of which contain at least two rare metals in the form of their oxides. One of the metals is germanium, a rare substance which is in some respects only half a metal because in many properties it resembles silicon, a

typical non-metal and the element of sand. In some Northumbrian coal ashes, germanium oxide has been found to the extent of nearly 1 per cent.

The other rare-metal oxide found in some coal ashes is gallium oxide. Now, gallium

Just how gallium and germanium originally found their way into certain varieties of coal is, of course, quite a mystery. They must have been present as constituents of the original plants and vegetation from which the coal has been derived since these elements are present in the actual coal substance, but their actual significance in this connection has never been determined.

Coals have been roughly classified into two main varieties, the hard and the soft coals. The best known of the hard coals is anthracite. Like all the hard coals, it contains a maximum amount of carbon (from 90 to 95 per cent. of this element). Consequently, it gives out a maximum degree of heat when it burns, and usually with such coals there is a minimum of smoke and flame. Hence, the hard coals are reserved mostly for steam-raising purposes.

The soft coals contain from 50 to 80 per cent. of carbon. Such are the bituminous coals (so called, for they contain no actual bitumen). Because they burn brightly they are employed for domestic purposes and for gas manufacture, these coals producing a maximum amount of inflammable gas.

Products of Coal

The behaviour of coal and its thermal decomposition on heating has been very carefully studied for more than a century.

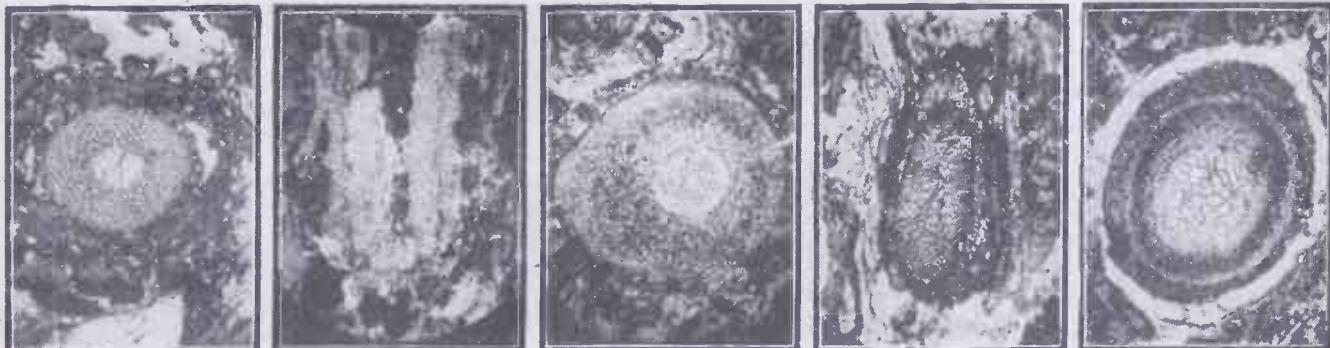

These five actual photographs prove conclusively the vegetable nature of coal. Each photograph was made from a thin section of coal in which cross-sections of the stems and leaves of the original coal-forming vegetation are clearly revealed.

When an average grade of soft coal is heated in iron retorts to about 1,800 deg. F. (982 deg. C.) it produces gas, a watery ammoniacal liquor and a black tar, a residue of coke remaining behind in the retort.

It is from the black tar ("coal tar") that so many of the raw materials of the modern chemical industry in Britain are obtained. One ton of coal tar supplies, on an average, 5 gallons ammonia liquor, 6 gallons crude naphtha, 26 gallons light oils, 17 gallons creosote oil and 38 gallons of heavy anthracene oils. The residue comprises about 12 cwt. of a black, brittle pitch which is left in the retort.

It might be imagined that the above detailed information would give us some idea of the original composition of coal. Unfortunately, however, such is not the case. You can no more tell the chemical composition of coal from a survey of its distillation products than you can picture the exact design of a building from an examination of its bombed remains. The black, rocky material which is coal is essentially such a very complex mixture of carbon, sulphur and nitrogen compounds (all derived from the slow decomposition of vegetable matters under great pressure) that only the most elaborate and refined of chemical analytical processes can ever hope to sort out and identify the mixture.

Turf or peat is usually said to be coal in the making. Both coal and peat are derived from vegetable matters, but in peat the coalification process has hardly had time to get under way. You can readily see and separate the fibrous portions of the turf, despite the fact that they have become naturally matted. But it is a curious fact that if turf is treated with a dilute solution of caustic soda, the individual fibres swell up and largely lose their identity, so that the turf becomes blacker and less fibred than it was originally. This fact definitely seems to show that turf is "coal in the making," yet all efforts to speed on the process by artificial means and to convert turf or peat into coal have failed. Within the limits of our present-day knowledge the natural

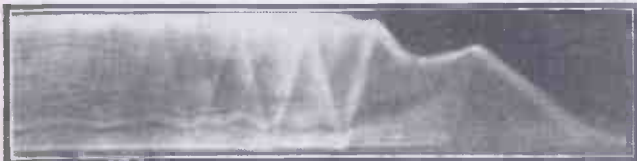

A split-second photograph of an explosion and pressure wave travelling through a coal dust-air mixture.

coalification process cannot be accelerated. Hence, from the detailed study of turf and its reactions we are not very greatly carried on the road towards the elucidation of the chemical composition of coal.

It is not possible to analyse coal by subjecting it to any process of heating, because by so doing the coal is destroyed. You cannot treat coal with acids, alkalis or other chemicals, for they, too, tend to alter its original nature.

Some light has been thrown on to the inner structure of coal by making thin, microscope sections of the material and by subjecting these to close examination. By this means, it is possible to differentiate between the coal which has been derived from the woody structures of the original vegetation and those which have come from the more resinous parts of the vegetation.

Selective Solvents

The most promising attack on the problem of coal's composition has been effected by the use of selective solvents.

There are a number of chemical liquids

which, without actually destroying or changing the nature of coal, are capable of dissolving certain portions of the coal material and leaving others undissolved.

For instance, extraction of coal with hot benzene under pressure results in the selective solution of some parts of the coal. Other selective solvents are pyridine and aniline. Chloroform and boiling carbolic acid (phenol) have also been made use of for the same purpose. All these liquids (or mixtures of them) have been found to be capable of removing definite portions of the coal substance and of so effecting a rough separation without

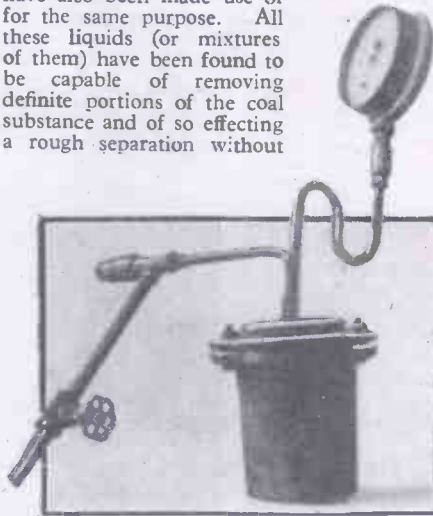

Pressure pot, for the solvent extraction of coal.

actually changing the coal substance in any way.

In this manner, modern science has recognised some four very definite constituents of coal, these being present in all types of coal no matter whether they are hard or soft varieties. The constituents are: Fusain, Durain, Vitrain and Clarain. Each of these constituents is undoubtedly complex in itself and is made up of a large number of different chemical compounds. Yet, for each individual coal constituent the separate components must all be related, since they have apparently similar properties.

Coal Constituents

Fusain is the main constituent of the hard, anthracite-type coals. It is hard and sub-hydrous, that is to say, poor in hydrogen content. Fusain appears to have a pronounced influence on the coking qualities of coal, its presence very much

reducing these qualities. Scientific opinion, although not as yet very positive, is that the fusain in a coal is derived from the woody structures of the original coal-forming vegetation. In very thin sections faint indications of the original woody structure can be seen in this component.

Next comes Durain. This is the granular, hard, "earthy" constituent of coal which gives it a dull matt surface. It seems to decrease the burning properties of the coal. In contrast to this is Vitrain, the coal material which gives the bright, glistening surface to the mineral. This has a fairly high hydrogen content, for which reason it burns well and has good gas-producing qualities.

Finally, there is Clarain, another bright constituent of coal somewhat related to vitrain. This constituent shows its presence best as the bright, glossy surface which is manifested when a lump of coal is broken at right angles to its bedding planes, that is to say, to the planes in which the coal material was originally formed in the earth.

In addition to the above components of all average coals there is a very interesting one to which the name of "Resinite" has

been given tentatively. Now, this resinite material is, as its name implies, of a resinous nature, and it consists apparently of the original vegetable and woody resins of the prehistoric coal forests and swamps. An interesting feature of these "coal resins" is that they are seemingly very little altered in composition from the original resins present in the material of the coal age. They are all per-hydrous or rich in hydrogen, and of all the original coal-forming materials they are the ones which have undergone the least degree of change with the passing of the countless centuries.

"Humic Acid"

By the extraction of coal powder with an aqueous solution of caustic potash a substance known as "humic acid" has been obtained. Without any doubt, this material is not a single acid but a complex mixture of compounds having related properties. But the interesting point about this "humic acid" (whatever it may ultimately be found to consist of) is that if it is present in greater amounts than 2 or 3 per cent. the coal will not coke well and the gas which is derived from it will have a high percentage of carbon dioxide. All coals which are essentially capable of good carbonisation invariably contain less than the above "humic acid" content. Hence humic acid decreases the fuel value of coal. These "humic" substances all contain nitrogen and they are usually associated with small amounts of a neutral, wax-like substance of low oxygen content which can be extracted from the coal.

The bright coals—those containing maximum amounts of clairain, are considered to have been deposited *in situ* in the areas of the original coal forests, whereas the dull coals (those containing maximum amounts of durain) are nowadays regarded as being "drift" materials, the decayed vegetable and other plant material having originally grown somewhere else and subsequently having drifted and been deposited at distant areas. There is plenty of evidence of this contention, but it is all of a botanical and geological nature, and rather too complex to be brought in here.

When coal is very finely powdered and mixed with air or oxygen it acts as a very powerful explosive. Many studies of the rate of flame propagation through coal dust-air mixtures have been made, this subject having received a large amount of attention in consequence of its important and, indeed, vital bearing on measures involving safety in mines.

Coal can also take fire spontaneously under certain as yet not very clearly understood conditions. However, the explosive nature of coal dust combined with the material's proneness to spontaneous combustion, points to the presence in the coal of a very highly reactive constituent or group of constituents, the nature of which is as yet unknown. If strides could be made in this department of chemical science, much might be done to reduce mine explosion risks, which, after all, present chemical problems to the investigator as well as purely physical ones.

"Liquid Coal"

The essential chemical reactivity of coal is shown when powdered coal is suspended in a hydrocarbon liquid, such as paraffin, and is treated with hydrogen gas under a pressure of 230 atmospheres (1 atmosphere equals a pressure of 15lb. per sq. in.) and at a temperature of approximately 425 deg. C. Under these conditions the coal is partly transformed into a liquid fuel, up to 60 per cent. of the weight of the coal undergoing this rather startling chemical change. The

composition of the "liquid coal" is as yet imperfectly known, but it is mainly of a hydrocarbon nature and, as such, it is, after simple distillation and refining, perfectly suitable for use as a fuel for oil and petrol engines of all types.

The mass production of "coal oil" from powdered coal is, therefore, an accomplished fact. Its extended application on an enlarged industrial scale only awaits further technical development, the coming of cheaper hydrogen gas and, of course, the requisite commercial and industrial demand for this type of oil fuel.

Here must end our article on the compo-

sition of coal. The one fact which will strike the reader who has perused so far is our very great ignorance of the exact nature and the precise chemical composition of coal. Such, however, is a very definite fact, regrettable though it may be.

We know what coal will do, what heat it will give, what power it will produce and exactly what materials we may, under given conditions, obtain from it, yet we lack an exact knowledge of what coal is.

To say that coal is a carbon compound implies extremely little. What we want to know is how the various constituents of coal are related to its observed properties. Which

coal ingredient is, for instance, most responsible for its gas production, which for its tar generation, which for its burning, its heat of combustion, the ammonia of the "gas liquor," and so on.

Admittedly, at present, such knowledge would be more theoretical than practical, yet, ultimately, the practical and utilitarian bearing of this information would be very great indeed. For not only would it enable us to utilise coal more efficiently and, as it were, to get more out of it, but also by means of suitable admixtures we might thereby be enabled to effect coal economies which are at present hardly dreamed of.

Mathematics as a Pastime

The Third Power : A Cycloid Toy.

By W. J. WESTON

A CUBE is a solid figure contained by six equal squares; and, since a side of the square is at once the length and the breadth and the thickness of the cube, the cubical contents equal the third power of this side. The third power is often called the cube.

This cube is interesting. Examine it a little: the examination may have a bearing upon your filling-up of football forms. Look at the accompanying table.

Perhaps you would like to continue it until you reach 10 along the top and down the left-hand side. You see how the table is built: 2 has two numbers down and across rising by 2; 3 has three numbers rising by 3; 4 has four numbers rising by 4—and so on. You have now in each corner the square of a number: 1, 4, 9, 16, 25. You have also in each compartment the cube of a number: (2+4+2), (3+6+9+6+3)—and so on.

		1 ³	2 ³	3 ³	4 ³	5 ³
1	2	3	4	5		
2	4	6	8	10		
3	6	9	12	15		
4	8	12	16	20		
5	10	15	20	25		

Table for working out the third power problem.

Now consider this: four football matches are to be played; how many forms must you fill so as to ensure one form with the actual results?

Three results are possible in each match; and we assume—what the home-team supporters will deny—that a draw is just as likely as a win or a loss for each team. Many jump impetuously to the conclusion that the number of forms needed is the number of matches cubed: for four matches it would be 4³ or 64.

A little thought shows the error. Suppose two matches. Then the three possible results of one match must be combined with—multiplied by, that is—the three results of the second match. The number of forms needed is not 2³ or 8, but 3² or 9.

There is, you see, a deal of difference between 10 raised to the third power and

3 raised to the tenth power. The first is 1,000; and, assuming that you take five minutes to fill in ten results on a form, you might be able to accomplish these. It would mean, though, more than three days and nights of continuous writing. The second, however, 3¹⁰ is 59,049; and 200 days would not suffice for that.

A Cycloid Toy

You have some ingenuity in manipulating material—wood, or steel, or plastics. You are able, therefore, to make a mathematical toy that will win many a wager. The toy depends upon a peculiar property of the cycloid.

As a wheel rolls along a level surface, each point on the outside rim touches that surface, rises to the top of the wheel, then sinks to the surface again. And, while the point is rising and sinking, it is being carried at an equal rate along the surface. The distance travelled, therefore, between two contacts of the point with the surface must be four times the height (or diameter) of the wheel. That is to say, the path of the point in space is a curve, the base of which is four times the height. Moreover, the curve comes to a point (or cusp) at each end, as in Fig. 1.

The curve differs in its having a pointed (or cusped) beginning and ending from the curve traced by a point on the flange of a wheel. This latter point traces an ampler curve and, since the flange keeps pace with the rest of the wheel, the ampler curve is bound to be shortened. It is shortened by its having a loop at each end. As you see from this loop, a point on the flange will have—no matter how speedily a wheel rolls forward—during an imperceptible time a backward movement. The path of a point on the flange is as shown in Fig. 2.

The curve traced by the point on the rim of the wheel differs, too, from the curve traced by a point within the circle: this latter curve needs bends (or inflexions) to prolong it. The path is indicated in Fig. 3.

The word appropriated to the path traced in space by a point in the circumference of a circle as the circle rolls along a straight line is *cycloid*. The Greek ending *-oid*, you remember, means "being like": you speak, for instance, of the anthropoid apes, those having the form of man. The cycloid is not a circle, nor part of a circle; it is a curve like a section of the circumference. The cycloid with loops is a curtate (shortened) cycloid; the cycloid with inflexions is a prolate (extended) cycloid.

Now, the cycloid—the common cycloid with cusps—has one property that distin-

guishes it from all other curves. The property is that the cycloid, being inverted, gives you the path of quickest descent from a higher point to a lower in the same vertical plane. The property seems to have been found out by accident, not calculation. However, make an arch having its base exactly four times its height (or depth) and test the matter. (Fig. 4.)

One of two similar spheres—two ball-bearings or two similar marbles—travels from A to B along the plane surface. The second

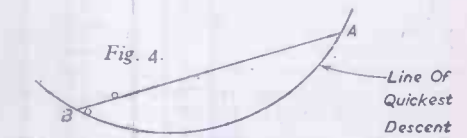
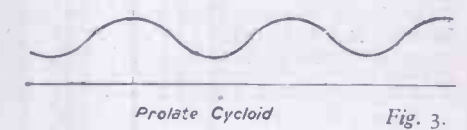
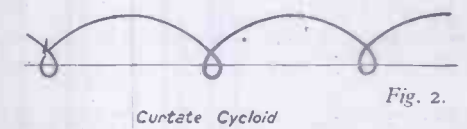
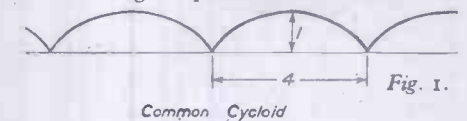

Diagrams illustrating different forms of cycloid.

sphere, released at the same time, travels from A to B along the inside of the cycloid. The second, though it has farther to go, and though it reaches the end of its journey by climbing upwards, gets to B when the first is an appreciable distance away. And, if you replace the plane surface with a curved surface, other than a cycloid, you get the same result. The sphere rolling along the arc of the cycloid reaches B first.

GEARS AND GEAR CUTTING

Edited by F. J. Camm.

Price 6s. from all Booksellers or 6s. 6d. by post from George Newnes, Ltd., (Book Dept.), Tower House, Southampton Street, London, W.C.2.

THE WORLD OF MODELS

Luton Model Engineering Exhibition : New Type of Exhibition Model : Railway Museums

By "MOTILUS"

THE town of Luton, in Bedfordshire, is well known as the manufacturing centre for the popular Vauxhall motor cars and other engineering works, and during the past ten years its importance has increased as a centre for engineering work where high skill and accuracy is needed. I have previously referred to the model work done by the Model Engineering Section of the Vauxhall Motors Recreation Club, and that done by the Geo. Kent Model Engineering Society: also to the more recently formed Percival Aircraft Model Engineering Society.

In December last, a Model Engineering Exhibition was held in Luton at the Waller Street Assembly Hall. This was a combined effort, sponsored by the Vauxhall Motors Recreation Club and supported by the two other societies mentioned above, together with the Aylesbury and District Society of Model Engineers, the Watford Model Engineering Society, the Luton and District Society of Model Engineers, the Luton and District Model Aeronautical Society, the South Beds

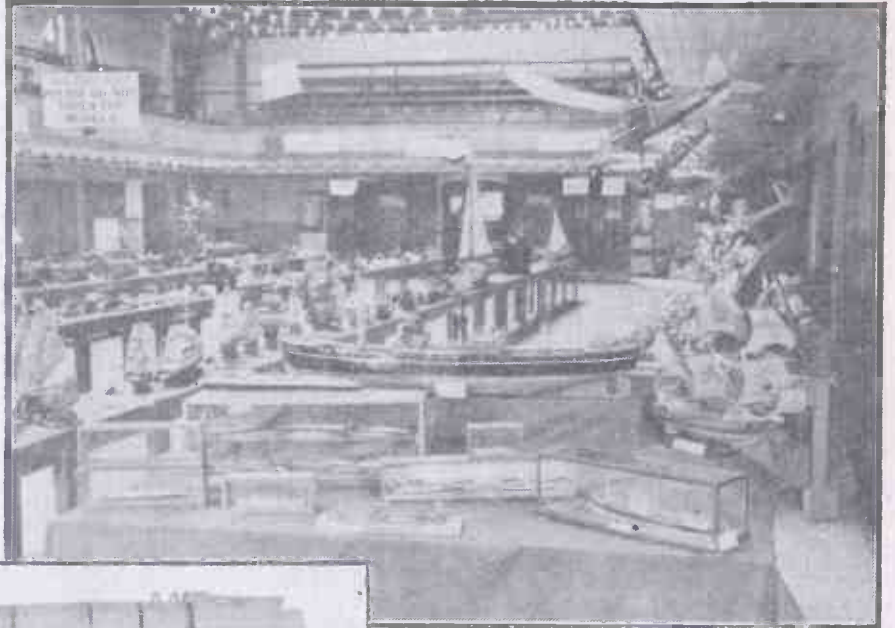

Fig. 1.—A general view of the Luton Model Engineering Exhibition, showing the ship section in the foreground.

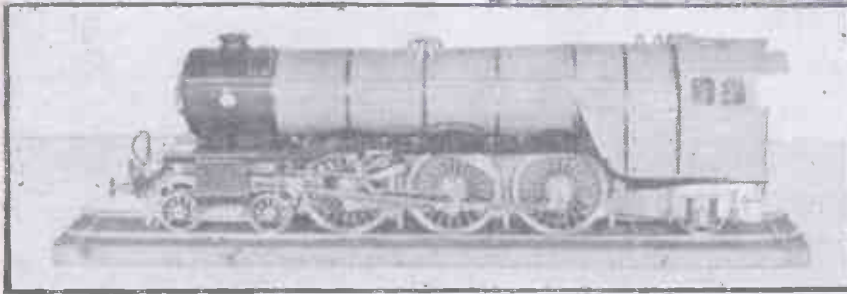

Fig. 2.—A $\frac{3}{4}$ in. working scale model L.N.E.R. "Pacific," built by Mr. A. Woodward of the Luton Model Engineering Society.

Ship Model Society, and also the Society of Model and Experimental Engineers, London.

At this exhibition, there were over two hundred and fifty models on show, including locomotives, traction engines, ships, aeroplanes, etc., and in general they were all of a very high standard. This must give great satisfaction to anyone who appreciates the value of modelmaking as a hobby, and also as an incentive of interest in accurate and well-finished light engineering production. The highlight of the show was considered to be a really marvellous beam pumping engine, the work of Mr. A. Woodward, of the Luton Model Engineering Society. This was an exquisite piece of work, and an example of superb craftsmanship. Nor was this the only work of Mr. Woodward that was shown: he also included in his contribution to the exhibition an excellently finished and well-constructed $\frac{3}{4}$ in. scale model of an L.N.E.R. "Pacific" locomotive (Fig. 2).

Passenger-carrying Track

The passenger-carrying railway track was as popular as usual, and although Mr. E. G. Ebon's "Hatton Five" was not up to its usual form, it did some useful work. Mr. Dawson Bond's $\frac{3}{4}$ in. scale "Stanier" L.M.S. mixed traffic locomotive lived up to the high expectations of those who had seen it running on a track before, and Mr. F. Lane's $\frac{3}{4}$ in. scale "Bantam Cock" performed splendidly. Everyone was pleased, also, with the excellent trial run of Mr. E. W. Fraser's beautiful Great Western Single, "Lorna

Doone." Mr. George Archer contributed the largest locomotive at this exhibition, a 1 in. scale, rebuilt L.M.S. "Royal Scot" and tender (unfinished), which is being built from the official L.M.S. drawings. This model will be up to Mr. Archer's usual good standard, and it is interesting to note that there are to be over three thousand rivets in the tender alone! Mr. Stokes, of the Luton Society, had on view a $\frac{3}{4}$ in. scale chassis of an L.N.E.R. "Atlantic," which, if the finished model comes up to the standard of the

present work, will be a first-class job. Another model that was very much admired was a fine $\frac{1}{4}$ in. scale "Flying Scotsman," built by Mr. Forest of the Aylesbury Society. This had been made from castings and drawings supplied by Messrs. Bassett-Lowke, Ltd., of Northampton. Owing to the very comprehensive set of drawings, castings and finished parts that can be supplied by this company, this "Flying Scotsman" is one of the most popular engines for the enthusiast who wants to make a start on building a real $\frac{1}{4}$ in. scale model locomotive. I would also mention a $\frac{2}{3}$ in. gauge "Green Arrow" built by Mr. O. Tiefenbock, of the Vauxhall Motors Society; when one appreciates the difficulties under which this model was built, one realises it is a very fine effort.

Model Ships Section

Regretfully leaving many interesting locomotive models still unmentioned, we must

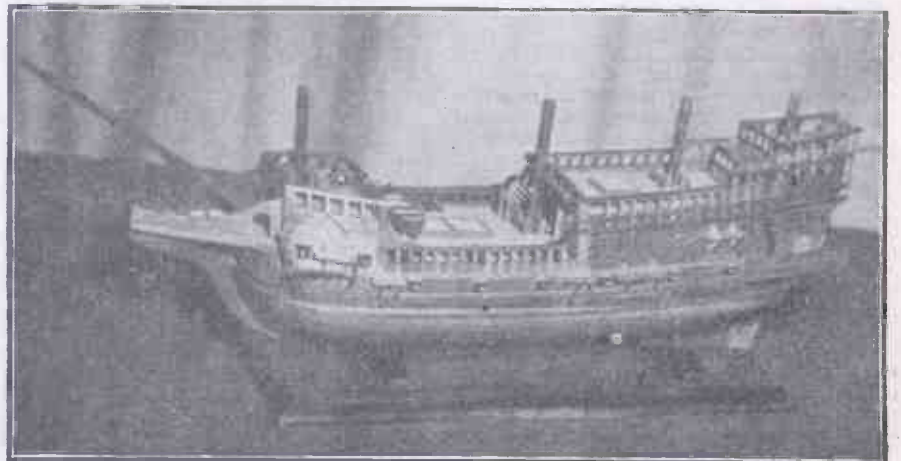

Fig. 3.—A very commendable piece of craftsmanship in wood. An old-time warship made by Mr. Soddy.

pass on to have a look at the shiplovers' section. Here again, the standard of work was high and this has no doubt been helped by the fact that the secretary of the New Luton Ship Society, The South Beds, Mr. T. Willots, is an outstanding modeller in the building of waterline ship models. Mr. Willots had on show many beautiful examples of his skill, neatly displayed in small, glass cases. Also in the ship section were some good models of ships by Mr. S. Shelton, of the Percival Aircraft Society. Mr. Shelton has a keen eye for detail and his artistry is evident in his model work. Another ship modeller whose work was worth noting was Mr. J. Gurteen, of the George Kent Society, who showed a unique and fine model ship, 54in. long and made entirely of postcards, obtaining, even in this seemingly awkward medium, some beautiful detail. Old-time ships were well represented, and special mention must be made of the old-time warship model by Mr. Soddy (Fig. 3), and also Mr. Bratcher's excellent model of the paddle steamer, *Balmoral*.

Near the ship section was a special stand

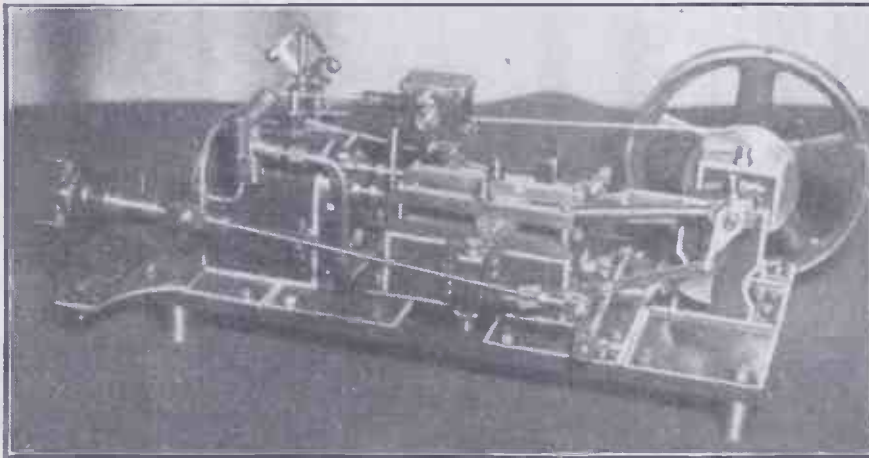

Fig. 4.—A remarkable piece of work by twelve-year-old Master Donald Crisp. This working model horizontal steam engine was made entirely by Master Crisp, with the exception of the boring of the cylinder and the making of the reversing screw, which was done by his father.

of general engineering models. Among these were tools such as drilling machines, grinding attachments, etc., and also horizontal steam engines, vertical engines, petrol engines and traction engines. As an encouragement to young engineers, some examples of tools made by Percival Aircraft apprentices were shown on this stand.

The aero section was in the capable hands of the Luton and District Model Aeronautical Society. The detail and high standard of work on the aircraft of Mr. Miller, a member of the society, is truly remarkable. The large number of trophies this society had on show also displayed the high average standard of their work. One must also congratulate the makers of the fine small compression ignition engines. The secretary of the society, Mr. Clark, is a very helpful and genial personality, and the model aircraft men generally appear to have made enormous strides in both design and workmanship.

Mr. J. Hellewell, of the Vauxhall Motors Club, in addition to a very good model traction engine of 1in. scale, on which the gear cutting had been done in his own workshop, and an equally fine Gauge O locomotive, also contributed items not often seen in a model exhibition: they were three optical instruments which, to function properly, must incorporate accurate craftsmanship. The three

instruments Mr. Hellewell had made were a 9.5mm. cine projector, a microscope, and an optical projector.

The juveniles should always be encouraged in these model exhibitions: they may be the prizewinners of the future. Full credit should be given to the twelve-year-old boy, Master Donald Crisp, who had made a model horizontal engine: an outstanding piece of work for a young person of this age (Fig. 4).

There were several trade exhibits and special mention must be made of the excellent display by Messrs. Gibbs and Dandy and Lushington Tool Company. This included small machine tools, hand tools, and many useful accessories that are so sought after by the amateur model enthusiast. Modelmakers are specially favoured by the managing director of this company, Mr. R. Dandy, who is a modelmaker himself and appreciates their requirements.

My general impression of the exhibition was of the extraordinary high standard of work shown; you could have counted on the fingers of one hand the few poor models that

thing for his young son, after seeing how the little fellow was intrigued with a model lorry his father repaired for a friend. Being connected with road transport, Mr. Short naturally turned to a vehicle with which he was familiar, and the illustration (Fig. 5) shows the Leyland tipper in its elevated position, displaying to advantage the nice proportions and details of the prototype. The model is approximately one-tenth full size and has an overall length of just over 2ft. 6ins. Made of sheet copper and steel, it is driven by a gramophone motor which propels the lorry at about walking pace and also operates the gear pump to elevate the tipper. The wheels are 4½in. diameter and are fitted with real scale model rubber tyres, supplied by the India Tyre Company. The radiator is constructed of small brass tubing, to scale, and the head and rear lights all operate from a dry battery. The cab windows are fitted with glass and the doors can be opened and shut. Owing to the limited amount of spare time Mr. Short has for his favourite hobby, the construction of the lorry took him ten years to complete. This is not the only model he has made: one of his first attempts was a 2½in. gauge L.N.E.R. "Flying Scot," built from drawings, castings and fittings purchased from Messrs. Bassett-Lowke, Ltd., of Northampton. Mr. Short told me that this locomotive has done 4½ hours continuous working, the boiler being fired by methylated spirit, a constant water supply being kept up by an axle-driven feed pump.

New Type Exhibition Model

When sea travel became popular with the public generally, shipping offices and travel agencies in towns began to use models to attract prospective passengers to their



Fig. 5.—A large model of a Leyland hydraulic tipper, over 2ft. 6in. long, built by Mr. G. W. Short, of Kettering. (Photo by Speight of Kettering.)

were displayed. The only complaint I have is that this exhibition cannot be held at closer intervals than two years! However, when we consider the spare time it takes to produce models really worthy of an exhibition of this calibre, we realise that a bi-annual plan is perhaps sound policy.

Model Hydraulic Tipper

On show at a model exhibition in Kettering, Northamptonshire, last November, was a model Leyland hydraulic tipper, made by Mr. G. W. Short, of Kettering. I had the pleasure of meeting Mr. Short some time after the exhibition and was interested in the story he had to tell regarding this first-class piece of model work. Mr. Short originally had the idea of making a play-

liners. Such models were generally made in a special department for that purpose at the shipbuilders' and were often included in the contract for the ship. Originally they were full hull models and showed, not only the enormous amount of detail on the decks in those early days, but also the accurate shape of the hull, rudder, propellers and all "under-sea" features. In later years publicity experts considered that the waterline ship model was more realistic for the would-be traveller and had them made, usually by specialist firms, showing only that part of the ship which appears above the waterline, for which purpose the model was displayed on an artificial sea—a calm one, needless to say! Later still, it was felt that a more intimate and personal approach would be better

and models were made of the interior of the ship and also of individual cabins. I mention this only as an introduction to a model I saw recently in the London offices of the Blue Star Line, in Lower Regent Street. This was a large-scale reproduction of one of the cabins on their new ship, the *Argentina Star*. She is the first of four 12,000-ton passenger-cargo vessels of entirely new design and sailed on her maiden voyage in June last year. This vessel was built in the yards of Cammell Laird at Birkenhead, and has many new features in the planning and equipment of the ship, with accommodation for sixty first-class passengers, all in single or double cabins. The model I saw exhibited was to a scale of 3in. to the foot, or one-quarter full size, and it incorporated some new ideas in the presentation of a ship's cabin (Fig. 6). Instead of one of the blank walls being removed and the portholes being represented on the far side, the wall abutting the promenade deck was chosen for removal and its place taken by a sheet of glass, with the position of the rectangular ports just indicated to show their height and size. The passenger can thus have a better idea of the position of the cabin, as this method emphasises the fact that the ports do overlook the open sea. The cabin selected in this instance was a two-berth one, with private bathroom: every minute detail of furniture and modern fittings was shown, even down to soap in the bathroom and miniature books on the shelf! Indeed, it was one of the most attractive and fascinating ship cabin models I have yet seen, and my congratulations go to Messrs. Bassett-Lowke, Ltd., the makers, who were responsible for this novel display. I can imagine would-be passengers, after seeing this preview of the cabin in which they might rest and sleep during the sea voyage, hurrying into the Blue Star offices and booking this very accommodation: but there is no need for this, as all the cabins are equally well fitted and planned, although some are necessarily without private bathrooms.

Railway Museums

I have noticed that the daily press recently has been advocating the establishment of a railway museum in this country. I wonder, now the railways are nationalised, whether the Government will look after this important duty and endeavour to maintain, for future generations, a record of the progress that has been made in rail travel, in view of the fact that we were the pioneering country in railways. The Germans had a magnificent museum at Nuremberg in pre-war days, with models of every description of locomotive and rail equipment, including sections of track, examples of bridges and everything connected with German railways. As far as I am aware, there is no museum devoted exclusively to railways in this country, except the one at York. This museum is mostly concerned with L.N.E.R. examples, but is a brave effort and well worth a visit. It includes actual, historic locomotives, such as the Great Northern Railway single wheel engine No. 1, built at the G.N.R. works in Doncaster in 1870, and designed by P. Sterling: also the 4-4-2 "Henry Oakley," No. 990, built at the G.N.R. works in 1848, to the design of H. A. Ivatt. Another is the L.B. and S.C. Railway locomotive, "Gladstone," built at the Brighton works of that company in 1882, to the design of Wm. Stroudley. Last, but by no means least important, the famous G.W.R. "City of Truro," built at the G.W.R. local works at Swindon: in the year 1904 this engine achieved the highest authentic speed recorded up to that date for a railway train, 102.3 m.p.h., during part of the run from Plymouth to Bristol, with the ocean mails for London. In speaking of railway museums, I am not,

of course, forgetting the excellent collection of models in the railway section of the Science Museum, South Kensington. My reference, however, is only to museums devoted entirely to the railway world.

Modelmakers' Rule

I am pleased to see that Messrs. Bassett-Lowke, Ltd., have re-issued their pre-war modelmakers' ivory rule. This is a repro-

6in. long, you can measure up to 2ft. in Gauge 0 and 37ft. in Gauge 00. On the reverse side are inches in 1/16ths and 1/12ths, and also the metric scale for comparison. These rules can be obtained at the London and Manchester branches of Messrs. Bassett-Lowke, Ltd., or direct from Northampton by post, price 9d.

ERRATA.—The model bridge made by Mr. B. Timmins, described in the January

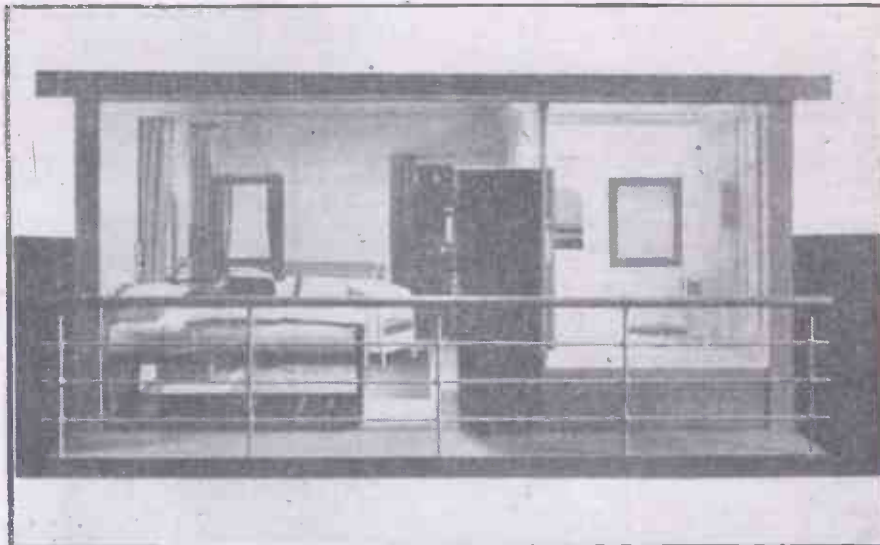

Fig. 6.—A new type of exhibition model by Bassett-Lowke, Ltd., of Northampton, showing the interior, as viewed from the deck, of a two-berth cabin, with private bath. The model is of one of the cabins on the new Blue Star liner, "Argentina Star," engaged on the South American service.

duction of the previous well-known friend of the modelmaker and model railway fan, except that, instead of measurements being given for Gauges 0 and 1, they are for Gauges 00 and 0. This is a sure indication that 00 Gauge is now more in use than 1 1/2 inch Gauge. Although the rule is only

issue, was built at the instruction of the managing director of Messrs. Painter Bros., Ltd., of Hereford. It was loaned by that company to British Insulated Callender Cables, Ltd., for inclusion in their exhibit at the Engineering and Marine Exhibition at Olympia last year.

Books Received

Electric Wiring (Domestic). Edited by E. Molloy. Published by George Newnes, Ltd. 240 pages. Price 7s. 6d. net.

THIS book is intended for persons engaged in electric wiring and electrical contracting work, and for plant and maintenance engineers in works and factories. Young men employed in the service or maintenance departments of electricity supply companies will also find in this work a valuable supplement to the ordinary text books, as used for the theoretical study of electrical work. It explains in a clear and concise manner the most up-to-date methods of electrical installation work. A chapter is devoted to the various systems available, and in separate chapters the more important systems, such as the conduit system, are dealt with. The various systems of surface wiring are also fully described. Other chapters deal with the wiring of a small house during erection; the fitting of additional points; and efficient earthing. The book is well illustrated with line drawings and half-tones.

A History of Highland Locomotives. By M. C. V. Alichin. Published by Railway Hobbies, Ltd., 86, Essex Road, Southsea, Hants. 72 pages. Price 10s. 6d. post free.

THIS book contains a complete summary of Highland locomotives and includes detailed information of every locomotive which

came into the possession of the Highland Railway from its incorporation until its final absorption. Locomotives are listed in the class and type of their original construction, and are identified by their original running numbers. There are over one hundred illustrations, with representative locomotives from almost every class. Numerous line drawings are included for the benefit of model railway enthusiasts.

Our Cover Subject

DEMANDS from all the world markets are being received by British manufacturers for mobile cranes, excavators, machine shovels, etc. With a tremendous amount of engineering and reconstruction work in progress in all parts of the world, there is a boom in these mechanical labour-saving devices. One of the biggest British manufacturers is the Ipswich firm of Ransomes and Rapier, Ltd., and they have just received an order for the world's largest "Walking Dragline"—an excavator—which will weigh 1,500 tons, and have a boom head higher than Nelson's Column. The illustration gives a view of one of the general engineering fitting shops, showing preparatory work being carried out on the heavy machinery bedplate castings prior to mounting the machinery. The finished machine is a Rapier concrete mixer of 1/2 cub. yd. capacity.

QUERIES and ENQUIRIES

A stamped addressed envelope, three penny stamps, and the query coupon from the current issue, which appears on page 48 (THE CYCLIST), must be enclosed with every letter containing a query. Every query and drawing which is sent must bear the name and address of the reader. Send your queries to the Editor, PRACTICAL MECHANICS, Geo. Newnes, Ltd., Tower House, Southampton Street, Strand, London, W.C.2.

Emulsified Wax : Peroxide Dentifrice

I HAVE a recipe for making a hairdressing preparation and one of the ingredients is emulsified wax. I would be obliged if you would inform me how to make this emulsified wax. I assume that the wax to be emulsified is paraffin wax.

Also, could you inform me how I can make a tooth-cleaning peroxide dentifrice?—R. W. Hall (Cheshington).

WE are inclined to think that the wax which you mention should be "white wax," which is not paraffin wax. However, an emulsion of any of these waxes is produced in the following manner:

Nine parts of stearic acid and 300 parts of water, together with 3.5 parts of triethanolamine are mixed together and heated to boiling point (100 deg. C.). The mixture is allowed to simmer very gently. Eighty-eight parts of the wax are melted separately and the molten wax is slowly added to the simmering solution, the latter being well stirred continuously (preferably mechanically) until all the wax has been added. At this stage a creamy emulsion will have been formed. Stirring is continued until the liquid has cooled down to normal temperatures.

The emulsion thus formed is stable, and it can be diluted to some extent by the very cautious and slow addition of water.

You can make a "peroxide" dentifrice by adding to the ordinary dentifrice ingredients (chalk, magnesium carbonate, soap, etc.) about 10 per cent. of either sodium percarbonate or sodium perborate, preferably the former, which may be obtained from Messrs. B. Laporte, Ltd., Luton, Beds., or Messrs. Vicsons and Co., 148, Pinner Road, Harrow, Middx. The percarbonate should constitute about 10 per cent. of the total weight of the dry dentifrice.

Removing Scale from a Geyser

I HAVE an electric geyser which scales up badly, due to the hardness of our water. Can you tell me of any compound or chemical which can be used to dissolve the scale?

The geyser has three coil elements immersed in the water, and the lime forms a solid core, which seems to expand, causing the wires to break.—E. G. Ingleby (Bristol).

IF you place, at intervals of a week, about a saltspoonful of sodium metaphosphate in the water-supply tank of your geyser the scaling trouble will gradually be lessened, the sodium metaphosphate gradually dissolving away existing scale and preventing the formation of additional scale.

Perhaps, however, you would be better advised to consult Messrs. Albright and Wilson, Ltd., Water Treatment Department, 49, Park Lane, London, W.1, who manufacture a special and slowly-soluble form of sodium metaphosphate to which they give the name "Micromet." This has been specially introduced for small-scale water treatment such as yours, and we think you will find it very well adapted for your purpose. It is, of course, understood that the phosphate-treated water will not be used for drinking purposes.

Soap Substitute

I WOULD be much obliged if you could give me a formula for a soap substitute, liquid or hard.—H. Haunch (Liverpool).

IT would be quite impossible for you to make a soap substitute for yourself since a long and complex chemical process would be involved.

There is an excellent soap substitute on the market called "Teepol." This can be had in liquid or in solid form from Shell Chemicals, Ltd., 112, Strand, London, W.C.2. If you can procure some of this material (which is made from petrol residues) you can dilute it with water or mix the solid material with soda or make it into a paste with water and china clay, etc. In fact, you can use it in numerous ways, according to your exact requirements. But it would be quite impossible to make this or any similar "soap substitute" from any "formula."

Sound-insulated Walls

WILL you please inform me if it is possible to insulate the party walls of a house so as to make them practically sound-proof?

I had in mind the fixing of plastic or aluminium sheet with a backing of, say, 1 in. thickness of

glass wool or other suitable material. Can you suggest an alternative?—D. Wurd (Derby).

YOUR scheme for sound-insulating your wall is quite good. You may use a sheet of asbestos composition or one of plasterboard, but, preferably, not one of metal. The sheet should sound "dead" when struck with the knuckles. Allow an inch or an inch and a half space between the sheet and the wall. This should be loosely packed with any clean, fibrous material, such as hair, fibre, kapok, dried seaweed or fibreglass.

Fibreglass is excellent stuff for the purpose. It may be obtained from Fibreglass, Ltd., Ravenhead, St. Helens, Lancs.

Sterilised hair is also very effective. This is supplied by Messrs. Edward Wenn and Sons (Worcester), Ltd., Worcester; Messrs. Angus Brothers, Ltd., 73, Robertson Street, Glasgow, C.2.

Whatever material you may use do not pack it too tightly. The whole idea is to break up the air existing between the wall and the outer sheet into individual "air cells" across which the transmission of sound becomes very difficult.

Hand Printing on Silk

WILL you please give me the formula and process for fast dyeing patterns on silk by hand—the result to be washable?

Can you also state where the materials (apart from the silk) are obtainable?—M. Bishop (Kenton).

WE are afraid that to comply with your request for formulae and methods for the hand printing of silk would necessitate the writing of a small treatise on the subject! This we cannot do, and we can only, in this connection, refer you to your adequate information to any textbook on fabric printing, of which you should find many in your nearest reference library.

Silk is usually dyed with aniline dyes of the "basic" or "acid" class, such as fast acid scarlet, acid yellow, primuline, orange II, brilliant green, naphthalene black, methylene blue, methyl violet, etc. The fundamental method of printing comprises the making of very strong solutions of these dyes and in thickening them up by the incorporation of a soluble gum such as dextrine or British gum. In this way, a smooth dye paste is obtained. This is rubbed evenly on the hand block which is then applied to the silken fabric. The fabric is then heated in an atmosphere of steam for about an hour in order that the dye may penetrate the fibres of the material and fix itself therein.

The process of silk printing is not easy. It needs much skill and experiment.

Materials mentioned above may be obtained from any laboratory supply firm, such as Messrs. Vicsons and Co., 148, Pinner Road, Harrow, Middx., or Messrs. Griffen and Tadlock, Ltd., Kemble Street, Kingsway, London, W.C.2, but before you obtain them we would advise a thorough study of a textbook on the subject of silk dyeing and/or printing, since this is a subject which cannot be worked merely from a "formula."

Probably a suitable book for your needs would be: A. Ganswindt (trans. by C. Salter): "Dyeing Silk, Mixed Silk Fabrics and Artificial Silks" (pre-war net price, 12s. 6d.).

Plaster Moulding

I AM interested in making small toys and simple table decorations in animal shapes, cast in plaster of Paris, or a similar material. Would the moulds have to be carved in wood, each half separately, and then the plaster paste be squeezed into the mould, or could a pattern be made from which to make the moulds? Also, can you refer me to a book on the subject? Would the finished cast have to be treated with varnish before painting?—R. C. Evans (Hove).

YOUR best plan to facilitate your proposed decorative moulding and casting work is to procure several books on the subject from your local library and to read these up carefully. Interesting books for you are:—

S. W. Anthonias: "Pottery and Modelling"; Catherine Peach: "Modelling and Casting for Children (Dryad leaflet)"; "Modelling with Self-setting Clay" (Dryad leaflet); G. J. Cox: "Pottery for Artists, Craftsmen and Teachers"; H. and D. K. Wren: "Pottery: Finger-built Methods."

One or two similar volumes are also published to-day

by Sir Isaac Pitman and Sons, Ltd., Parker Street Kingsway, London, W.C.

Having read through some books such as the above, you will be in a better position to appreciate and assess the problems of simple plaster moulding.

It is, of course, quite impossible for us, within the space of a short reply, to give you detailed instructions as to how to go about the task of casting for toy-making, but, in brief, you should use ordinary plaster of Paris and cast it in smooth wooden moulds. Gelatine moulds can also be used, but these are apt to be messy and difficult to work. The interior of the moulds should be lubricated with a paste of soap, water and glycerine in order to prevent the cast from sticking.

You may add a little natural chalk (finely ground) to the plaster composition, but too much of it will upset the hardening of the plaster. Also, you may add dry mineral colours in order to tint the casts. It is a good plan to incorporate with a plaster a little very finely ground asbestos powder with the plaster material, since this, being fibrous, gives strength to the casts. Asbestos powder may be obtained fairly cheaply from Turner Brothers Asbestos Co., Ltd., Rochdale, Lancs.

The hardened casts may be painted directly. It is better, however, to brush them over with a solution of gelatine in warm water (say, 7 parts of gelatine in 93 parts of water). This sizes the material, imparts a little extra strength to it and keeps the paint on the surface so that it is not absorbed by the cast.

"De-frosting" in Refrigerator : Water Hammer

I SHALL be glad of your advice on the following points:

(1) Is it practicable to employ a hygroscopic chemical in a gas-operated refrigerator with a view to diminishing the need for "de-frosting"? If so, what chemical could safely be employed?

(2) Is it possible to abolish a persistent "water hammer" effect (evidenced by a loud ticking noise) occurring in the main hard-water feed pipe to a mains-type water softener? The softener is installed at the top of the house, and the outflow is directly into the cold-water cistern.—V. T. Baxter (Bristol).

(1) It is definitely not practicable to use a hygroscopic substance in order to diminish the need for de-frosting a gas-operated refrigerator, the reasons being (a) that all such chemicals are relatively expensive, and (b) that the water-holding powers are strictly limited and that, in consequence, they would need constant and frequent renewal.

(2) The hammer effect which you mention may be due to the presence of one or more air-locks, but it seems more likely to be associated with a silt-upping of the main feed pipe, the water thus having to force its way into the softener system against some undue pressure. In this instance, a personal examination of the apparatus is more or less necessary before an accurate opinion can be given, although we think that if you examine the main feed pipe at or about its junction with the softener system you will find the trouble to lie in some encrustation or blockage of the circuit at this point.

Disinfectant Solution

COULD you please give me some formulae for disinfectant, of which cresosote is an ingredient, and which can be produced cheaply? Also, could you tell me how to make a liquid with a strong pine odour for use in disinfectants? Where can materials for the above solutions be obtained?—G. D. Pauline (Rotherham).

ORDINARY cresosote itself is quite an effective disinfectant when mixed with water, and in this form alone it is useful for "rough" disinfectant purposes, such as the flushing of drains. Cresosote is never a constituent of the "finer" disinfectants. For the better disinfectants of the Lysol type, the following is a good formula:—

Cresylic acid	100 parts (by weight)
Linseed oil (raw)	56 "
Potassium hydroxide (caustic potash)	8 1/2 "
Water	200 "

Dissolve the caustic potash in a little of the water and keep it separate from the rest of the ingredients, which are all mixed together and heated over a water-

THE P.M. LIST OF BLUEPRINTS

- "PRACTICAL MECHANICS" 12 FT. ALL-WOOD CANOE.* New Series. No. 1. 3s. 6d.
- "PRACTICAL MECHANICS" 10-WATT MOTOR. New Series.* No. 2. 3s. 6d.
- "PRACTICAL MECHANICS" COMPRESSED-AIR MODEL AERO ENGINE.* New Series. No. 3. 5s.
- "PRACTICAL MECHANICS" SPORTS PEDAL CAR.* New Series. No. 4. 5s.
- F. J. CAMM'S FLASH STEAM PLANT. New Series. No. 5. 5s.
- "PRACTICAL MECHANICS" £20 CAR (Designed by F. J. CAMM). 10s. 6d. per set of four sheets.
- "PRACTICAL MECHANICS" MASTER BATTERY CLOCK* Blueprints (2 sheets), 3s. 6d.
- "PRACTICAL MECHANICS" OUTBOARD SPEEDBOAT 10s. 6d. per set of three sheets.
- A MODEL AUTOGRIO* Full-size blueprint, 2s.
- SUPER-DURATION BIPLANE* Full-size blueprint, 2s.
- The I-c.c. TWO-STROKE PETROL ENGINE* Complete set, 7s. 6d.
- STREAMLINED WAKEFIELD MONOPLANE—3s. 6d.
- LIGHTWEIGHT MODEL MONOPLANE Full-size blueprint, 3s. 6d.
- P.M. TRAILER CARAVAN* Complete set, 10s. 6d.
- P.M. BATTERY SLAVE CLOCK* 2s.

The above blueprints are obtainable, post free, from Messrs. George Newnes, Ltd., Tower House, Southampton Street, Strand, W.C.2.

An * denotes that constructional details are available, free, with the blueprint.

bath. The caustic potash solution is then gradually stirred in and the heating continued for about an hour. An amber-coloured liquid will result. This is the finished disinfectant. For use it is mixed with a large volume of water in the manner of Lysol.

In the above formula the cheaper caustic soda can be substituted for caustic potash, but its saponifying action on the linseed oil is not so potent.

The liquids having a strong pine odour which you desire is pine oil or pine essence, both of which are very scarce, owing to the reduction of imports. You will probably be able to obtain pine essence from Messrs. John Beard and Son, Ltd., Great Ancoats Street, Manchester, price about 5s. per lb. The other materials above mentioned can be obtained from the same firm, or from any firm of painters' suppliers.

Methylamine Hydrochloride

I SHALL be glad if you will please inform me how to prepare methylamine hydrochloride (CH₃NH₃Cl) from ammonia or its salts, and hydrochloric acid.—A. Healey (Hemsworth).

METHYLAMINE is not readily made directly from ammonia, although it is obtained in small quantity by heating methol alcohol with ammoniacal zinc chloride.

It is best made on the laboratory scale from acetamide, which latter compound is made by slowly distilling solid ammonium acetate (see any text-book of practical organic chemistry for details of this acetamide preparation).

The acetamide is treated at ordinary temperatures with bromine. It thereby forms colourless crystals of acetobromamide. A cold dilute solution of caustic potash is added to the acetobromamide. A yellow solution results. This is gently warmed. It evolves a mixture of carbon dioxide gas and methylamine, which latter is a fishy-smelling gas, extremely soluble in water. The methylamine gas is led into dilute hydrochloric acid (one in four). The resulting solution of methylamine hydrochloride is subsequently concentrated for the recovery of the solid hydrochloride.

Tattooing "Inks"

COULD you please state the constituents of tattooing inks, and where they may be obtained?—P. D. Malloch (Perth).

TATTOOING inks are not really inks at all. They are merely insoluble pigments ground up with a little water or water and glycerine, the resulting fine colour-paste being inserted in the tiny punctures made by the tattooing needle.

Any pigment may be used provided that it is non-poisonous. Pigments which have been employed are: lampblack, indigo, red iron oxides and even green chromium oxide. We understand that such "inks" are not now commercially manufactured. Your best plan, therefore, is to purchase a few tubes of good water-colour paints from a reputable firm, such as Messrs. Winsor and Newton, Ltd., of London, and to use these for your experiments.

Animals, of course, may be tattooed by means of a silver or magenta marking ink, but the employment of such inks on a human being is unsafe.

Dye for Celluloid

I AM interested in making one or two sheets of clear transparent celluloid, which I require in order to carry out some experiments in the field of cartoon cine projection.

The size of sheets required would be about 12in. by 20in. Could you please give me a list of the ingredients to be used in making the sheets?

Could you also tell me if any special paints or dyes are needed in order to paint on celluloid? If so, could you supply me with the formula for making these? The colours I should need are red, black and yellow.—G. Sawyer (Bury St. Edmunds).

IT is impossible for any unskilled individual to make celluloid sheets for himself of the size you mention, or, indeed, for that matter, to make celluloid at all in a satisfactory condition. Celluloid is essentially a plasticised compound of gun-cotton and camphor. The details of its manufacture are maintained more or less secret. The best you can do in the present circumstances is to obtain a good book dealing with celluloid and to study it carefully. You will then be in a position to appreciate the intricacies of the process. A book which we can recommend is F. Bockmann (translated by Stocks): "Celluloid; Its Raw Material, Manufacture, Properties and Uses." This was published (pre-war) at 8s. 6d. net.

To make a stain or dye for celluloid, dissolve clear scrap celluloid in a mixture of about equal parts of acetone and amyl acetate. Then make up a strong solution of a dye in methylated spirit. Add a little of this to the celluloid solution, but not too much of it. A good stain will result.

Expansion of Mercury: Thermo-couple

I WOULD be obliged if you could supply the answers to the following:

- (1) Over what range of temperatures does mercury continue to expand, i.e. when does it stop rising? Would it be possible to use mercury to measure temperatures up to, say, 2,000 deg. C.?
- (2) How is the output of a thermo-couple affected by the amount of dissimilar metals in contact; i.e. how would the output of a couple welded together at the tips compare to the output of a couple welded together for, say, 2in.?

Also, what is the effect of using different gauges of wire for the couple?—W. H. Beran (Brighton).

(1) MERCURY expands progressively until it reaches a temperature near its boiling point. At this temperature (a few degrees below its boiling point)

mercury increases its regular rate of expansion. Since mercury boils at 357 deg. C., it obviously cannot be used for measuring temperatures up to 2,000 deg. C. Some chemical thermometers contain mercury and nitrogen. This gas makes it possible to use the mercury expansion up to a temperature of 360 deg. C.

Mercury freezes at minus 38.8 deg. C. From a few degrees above this temperature to a few degrees below its boiling point the expansion of mercury is regular, this constituting its thermometric range.

(2) So long as the elements of a thermo-couple are united in firm contact at one end so as not to set up undue resistance the actual expanse of the contacting area does not affect the current. The current is mainly influenced by the dissimilarity of the metals and by the temperature difference between the heated and unheated ends of the couple.

The thickness of the wire from the couple does not influence the current generated.

View-finder for Folding Camera

I HAVE a "Zeiss-Ikon" folding camera, for which I wish to make a direct-vision view-finder, folding type, to be fitted on the side of the body.

The camera takes size 27 film (eight exposures, 2 1/2 in. x 2 1/2 in.), and is fitted with a Trinastigmat lens, f6.8. The principal dimensions, with bellows extended, are given in the accompanying sketch.

It is intended that the view-finder shall be fitted in the area A, and take the form shown in the smaller diagram.

Can you please inform me of the size of viewing orifices required and their dimensional relationship with each other? Also any practical hints to assist in the execution of the job?—G. G. Fowler (Luqa, Malta).

YOUR proposed direct view-finder is quite sound in design, and it will be satisfactory in practice, always provided that it is accurately made and carefully fixed and aligned to the side of the camera. This type of view-finder can be purchased from a good

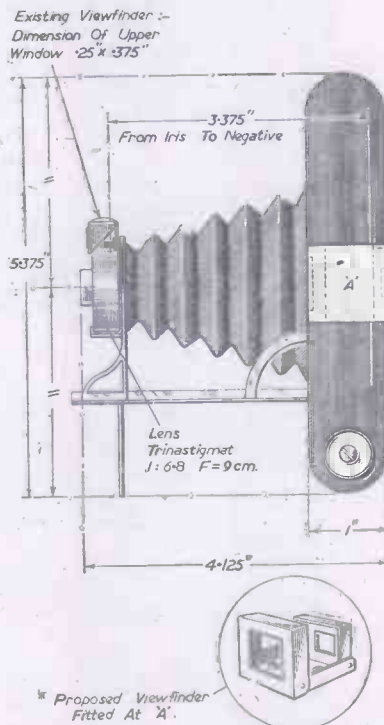

Side view of a folding camera and detail of collapsible view-finder.

photographic dealer, such as Messrs. Jonathan Fallowfield, Ltd., Newman Street, London, W., or Messrs. Wallace Heaton, Ltd., Bond Street, London, W.1.

If you wish to make one for yourself the rear aperture should measure 1in. x 1/4in. and the front aperture 1 1/2in. x 1 1/4in., the apertures being 1 1/4in. apart. These figures are approximate only, and are correct only when the camera is used for distances greater than about 6ft. You should make a "hook-up" of the finder first of all, and then test it out photographically on a well-defined object before finally finishing-off the device. Alternatively, you could have in place of the rear aperture a small rectangular reducing lens. A front aperture would not then be needed, its place being taken by a small metal upright carrying a small disc, the centre of which is exactly coincident with the centre of the reducing mirror and fixed 1in. or 1 1/4in. distant from it. This type of finder can also be purchased.

The device is simply cut out in light metal (aluminium), which is afterwards blackened. Both aperture frames should be made so as to fold inwards, the larger one over the smaller one, so as to give compactness to the device. Cross wires or lines should be provided with either design.

Freezing Mixtures

I HAVE recently purchased an ice box, and wish to know if there is a composition of chemicals that could be used for cooling purposes in place of ice.—L. Clee (Southend).

THERE is no chemical or chemical composition which is economically practical as a replacement for ice in a cooling box. Solidified carbon dioxide gas may be used, but this is expensive and difficult to obtain at the present time. The various chemical freezing mixtures may be tried. They are quite efficient on a small scale, but they are hopelessly expensive and short-lasting on the larger scale.

Formulae of some of these freezing mixtures are given below:

Potassium nitrate	2lb.
Ammonium chloride (sal ammoniac)	2lb.
Water	5 pints
Potassium nitrate	2 1/2 lb.
Ammonium chloride	2 1/2 lb.
Sodium sulphate	4 lb.
Water	9 pints
Sodium sulphate	8 parts (by weight)
Dilute hydrochloric acid (1 in 4)	5 parts

Ammonium nitrate 4lb.
Water 4 pints
Strong cooling by any of these mixtures would last five or six hours at the most.

All the above materials can usually be obtained from any drug store. Some paint dealers supply them, also, as well as horticultural merchants.

Illuminated Signs

CAN you please help me with the following problems?

Prior to the war certain shops had showcards in the window which were "illuminated" by a violet bulb, causing the lettering on the cards to appear luminous.

What is the scientific principle underlying this idea?

What is the type of bulb used and source of supply?

What are the substances with which the pigment is impregnated?—J. Williams (Denton).

CERTAIN materials which are more or less white under ordinary illumination fluoresce vividly under ultra-violet rays. Salicylic acid, quinine sulphate, zinc silicate, cadmium tungstate, calcium tungstate, potassium bichromate, zinc sulphide and various organic compounds all give fluorescent responses under U.V. illumination. Hence, when a design is prepared with an ink or paint containing one or other of the materials and is illuminated with U.V. rays, the design becomes seemingly self-luminous. These materials may be ground to a powder, and mixed to paint consistency with a clear cellulose or oil varnish.

You should be able to obtain the necessary varnish medium fairly locally from Messrs. James Beard, Ltd., 16, Great Ancoats Street, Manchester, and the fluorescent materials from Messrs. J. W. Towers and Co., Ltd., 44, Chapel Street, Salford, 3.

The electric bulb necessary is one emitting some type of U.V. illumination. We understand that all small and portable bulbs of this type are no longer manufactured, for which reason we can only refer you to a large firm of electrical wholesalers, such as the Wholesale Fittings Co., Ltd., Shudehill, Manchester, or, perhaps better still, to the General Electric Company, Ltd., Wembley, Middlesex, or to one of their agents.

It should also be noted that uranium glass gives a greenish-yellow fluorescence under U.V. illumination. Signs may be made out of this material which you might possibly be able to obtain from Messrs. Chance Brothers, Ltd., Oldbury, Birmingham.

Episcope Lenses

COULD you please advise me on the arrangement of the lenses in an episcope?

At present I have one double convex lens, 2 1/4in. diameter, 1 1/2in. focal length, in the instrument I am building, but it does not project a fully clear image on the screen. When the centre of the image is in focus the remainder is blurred.

I should be very pleased if you would prescribe a suitable lens construction about 3 1/2in. diameter, giving the type of lenses used and the order, also where I could buy them.—G. W. Johnson (Stapleford).

THE actual diameter of a projection lens or objective has nothing to do with its suitability for the purpose.

In the case which you mention the trouble is due to your using an insufficiently corrected lens, the lens in question not being capable of focusing the whole of the image at the one time.

What you require is not a single lens, but a combination of two lenses fixed at about equal distances from a central aperture or "stop." This, the so-called "doublet" lens, forms the basis of all projection lenses, and also of photographic portrait lenses. Either of these lens types will suffice for your purpose, but the orthodox projection lens will be the more satisfactory of the two, and it will give you a perfectly focused picture. You should apply for secondhand lists to Messrs. Broadhurst, Clarkson and Co., Ltd., Farringdon Road, London, E.C.4, or to any well-established photographic dealer, as, for example, Messrs. Wallace Heaton, Ltd., New Bond Street, London, W.1.

You should note that a 1 1/2in. focal length lens is not necessary. A lens of 8in. focal length (or thereabouts) will be quite sufficient.

RIGHT IN THEORY



... means *RIGHT* in Practice

Theoretical Knowledge and Practical Knowledge you must have if you are to "make the grade" as a qualified technician. Through the medium of special postal courses, the Pitman College of Technology can provide you with the right theoretical training which will not only materially assist your progress on the practical side, but will enable you to qualify more easily for a well-paid technical post when your apprenticeship is completed.

- Elementary Engineering Course — Workshop Calculations Workshop Training Engineering Science (Mechanical & Electrical) Engineering Drawing Mechanics General Science Electricity & Magnetism Heat, Light & Sound
- Single Subject Courses include:— Wireless Engineering Motor Engineering Diesel Engines Plastics Radio Communication Elements of Structural Engineering Elements of Quantity Surveying

Write at once for free prospectus to:

PITMAN COLLEGE OF TECHNOLOGY

177 SOUTHAMPTON ROW, W.C.1
Principal: H. R. Light, B.Sc. (Lond.), F.C.I.S.

ELECTRIC MOTORS

24 v. D.C. for driving models of all descriptions, and cameras. Can be adapted for many useful experimental purposes. All brand new. Price 15/- each.

FUL-VUE SAFETY SPECTACLE
American-type steel frame, plastic nose bridge, unbreakable lenses, natural vision. Ideal for people whose work involves danger to the eyes through dust, heat and flying particles. The frame is of a quality and design unobtainable in this country; it can be worn to great advantage in comfort and appearance. 10/-

POCKET SAW
Of high speed steel. When extended 42ins. long. Complete with sharpening file and tooth bender. Price 10/- each.

ORDNANCE MAP CASE
Celluloid window 20ins. x 18ins. Zip-fastening, laminated cloth roll. 20/-

SPRING BALANCE WEIGHER
Pocket type, weighs up to 12 lbs. Marked off in 1 lb. sections. Overall size 3 1/2ins. 7/6 each.

No C.O.D. Delivery 8 to 10 days: Full money back guarantee.

M. LAWTON (Dept. P.M.),
121-123, Bury New Road, Manchester, 8.

THE WORLD'S GREATEST BOOKSHOP

FOYLES
FOR BOOKS
New and secondhand Books on every subject WE BUY BOOKS, TOO
119-125, CHARING CROSS ROAD, LONDON, W.C.2.
Gerrard 5660 (16 lines). Open 9-6 (Inc. Sat.)

RATCHET & REVOLUTION COUNTERS

Ask for Leaflet No. 18/5
Speed up to 6,000 r.p.m.
B. & F. CARTER
& Co. Ltd., Bolton 5



MODEL ENGINEERS

FOR THE TURNER:

Lathes, 3 1/2 and 4 1/2 S.S. Bench Millers. Drilling Machines. Hand Bench Shaping Machines.

FOR THE WOODWORKER:

Wood Turning Lathes, 2 1/4 and 5 1/2 centres. 4in. Planers. Saw Benches. Sanders. Spindle Moulders.

Pedestal Jig and Fret Saws.

Perspex—All sizes and colours in stock.

NUTTALL'S (LATHES) LIMITED, MANSFIELD, NOTTS.

Remote Contactor. New, with many useful items including luminous dial and pointer, 3 amp. toggle switch, two relay bobbins wound 3 ozs. clean enamelled copper x 36z. wire, two Platinum contacts, cable leads, etc. 3/6 each. 3 different Multi-point Switches, silver contacts, 3 for 2 1/4, 7/6 doz. 10-way Terminal block and connector, 30 screws, 1/- each, 6 for 5/-.

Hamofil heat-resisting rubber covered copper connecting wire. 12 yds. 2/-.

Peribraid sleeving, finest quality, high voltage, various colours. 1 m.m., 1.5 m.m. 4d. yard.

Bakelite bobbin wound 11 ozs. clean usable 36 s.w.g. enamelled copper wire. 1/- each, 10/6 dozen.

Used ex-R.A.F. low resistance earphone with switch. 2/6.

New S.G.R. Brown ex-Army high resistance headphones, complete with headband and leads. 12/6 per pair. New U.S.A. single small earphone, 1,000 ohms resistance. 5/6.

New U.S.A. high resistance headphones, complete with headband and lead. 12/6 per pair.

As above, but special lightweight with detachable rubber ear guards. Complete. 15/- per pair.

All above postage extra.

Send S.A.E. for list of insulated copper wires, screws, nuts, tags, Ebonite and laminated Bakelite panels, coil formers, etc., etc.

POST RADIO SUPPLIES
33 Bourne Gardens, London, E.4

ELECTRIC ENGRAVERS.—Powerful instruments in cylindrical case, on stand with spring attachment and switch. Suitable for dog collars, tool marking, etc. 4-6 volt model, price 50/-; A.C. mains model, 200-240 volts, 60/-; A.C. Engraver only 50/-.

TELEPHONE SETS, comprising 2 G.P.O. hand phones, 2 bells, 2 pushes and 80ft. twin wire. Price 65/-, post free. Single instrument, 25/6.

6 inch Brass Brackets 1in. thread, 1/9.

S.B.C. Fancy glass shades 1/9. Circular resistances on china base 10 ohm. 2/-.

Screwplates for threading 0.24 B.A. 4/6.

MOTOR.—4-6v. dry battery driven, well made, powerful, 11/6. Illustrated list, 6d.

Carbon Diaphragm 1/- each and carbon granules 6d. packet.

BATTERY CHARGERS FOR A.C. MAINS. FOR CHARGING 2-volt accumulators at 1 amp. Parts with diagram. 12/6. Complete 21/6. Postage 10d.

FOR TRICKLE CHARGING CAR CELLS, parts with diagram. Output 1 1/2 amps. for 6v. cells, 30-s.t. For 12v. cells, 35/- set.

Large sizes quoted for.

MINIATURE HEADPHONE. Reproduces equal to best 'phones. Fits into ear, does not require headband. Two nipples large and small 10 ohm or 1,000 ohm. Black or flesh enameled. 4ft. cord. Price 30/-.

ECONOMIC ELECTRIC CO.,
64, London Road, Twickenham, Middlesex. Tel.: POPesgrove 1318



EXTRA CASH IN SPARE TIME

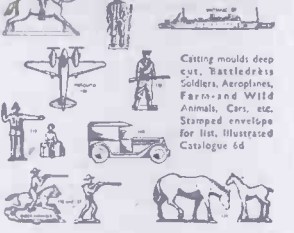

Casting moulds deep cut. Includes: Soldiers, Aeroplanes, Farms and Wild Animals, Cars, etc. Stamped envelope for list. Illustrated Catalogue 6d

TOY-CASTING MOULDS — DEEP CUT

Soldiers, sailors, airmen, ships, 'planes, tanks, cars, farm animals, wild animals and keepers. Sample mould 3/6. Plastercraft Metal Moulds.—Wall plaques, galleons, brooches, dog ornaments, etc. Sample mould of brooch 3/6. German flat moulds from 3/6. S.A.E. for list. 6d. for illustrated Catalogue.

NUTHALL, 69, ST. MARK'S RD., HANWELL, LONDON, W.7

MAKE MONEY IN YOUR WORKSHOP

SETS OF CLEAR CONSTRUCTIONAL DIAGRAMS and instructions for BUILDING YOUR OWN

- (1) TOY, MODEL or WOODWORKER'S LATHE, 3/6.
- (2) Power or foot treadle drive FRET JIG SAW MACHINE, 3/6.
- (3) Ball bearing Table Model CIRCULAR SAW, 3/6.

(or 9/- for the three.)

ALL these well tested; simple machines can be built EASILY from READILY OBTAINABLE PARTS AND MATERIALS ONLY and will turn out 10! Sellable articles for the shops and market. Prompt posting.

P. M. BARHAM, Bridge Avenue, St. Sampsons, Guernsey, C.1.

NICKEL PLATING

Complete Equipment, including Nickel Anode, Plating Salt, etc. Full instructions for Plating Ornaments, Car Fittings, and all Metal Parts. Flashlamp battery only required.

Price 15/-, post free.
HOLBOROW & CO.,
71, Weymouth Bay Avenue, Weymouth.

THE HANDYMAN'S "Odds and Ends" MIXTURE

Here's a useful assortment of about 2lb. components for mechanics, model makers, etc. Screws, nuts, washers, grub screws, taper pins pivots, nipples, studs and innumerable small machined parts. All high quality surplus from production runs. No rejects and no two lots alike. 7s. 6d., post free.

SPENCER COMPONENTS
22 CAROLINE STREET BIRMINGHAM 3

ADANA PRINTING MACHINES

Print in the odd hours with an Adana—still the most absorbing of crafts. No. 1 H/S Machine £24.10.0. No. 2 H/S Machine £9.15.0. Will pay for itself in a month or two. Send for illustrated folder to Dept. P.M.30.

Adana (Printing) Machines, Ltd.,
15/18, Church St., Twickenham, Middx.

Same Interesting Offers by ELECTRADIX

DYNAMOS. 12 volt 10 amp. D.C. shunt wound 1,400 r.p.m., C.A.V. in new condition, £4/10/0. 30 v. 5 amp. 1,500 r.p.m., £5/10/0. 50/70 volt 10 amp. 1,000 r.p.m., £4/10/0. 24 volt 10 amp 800/1,000 r.p.m., £10/10/0.

METERS. 11C Voltmeters, 4in., G.E.C. 0-60 volts, 45/-; Ammeters to match, 0-40 amps., 45/-; Electrostatic voltmeters, panel type, 3,500 volts, £3/10/0.

SMALL MOTOR GENERATORS, by E.D.C. 6 v. input 230 v. D.C. 40 m.a. output, take the place of H.T. batteries; in new condition, 55/-.

INDUCTOR ALTERNATORS. 230 volts 2 amps., totally enclosed, single or 3-phase ball bearings, 2,800 r.p.m., 4-pole type, £8/10/0, need separate excitation, 6/8 volts 6/8 amps.

METAL RECTIFIERS. Large plate type, 75 volts 6 amps, £4/10/0. 12 volts 15 amp. 3 parallel bridges, 50/-.

TRANSFORMERS. B.T.H. 200/230/250 v. input 2 volts 20 amps. and 75 volts 6 amps. with 15 taps, 70/-.

SWITCHES. Dewar key panel type, 8-pole C.O. flush fitting, 5/-.

Yaxley 3-pole 3-way, 3/6; 8-pole 1-way, 3/6. D.P.C.O. toggle switch 250 v. 1 amp., flush panel, 3/-.

S.P.C.O., 2l-8-way Lucas switchbox, 3/6; 6-way, 3/-.



RESISTANCES. Var. slide vit, enamelled tube with laminated brush and slides, 14 ohms 5 amps., suitable with 5070 volt dynamo for charging circuits at 5 amps., 25/- each. As new.

TELEPHONES for House or Office. Constructors' Parts for your own set-up. Ex G.P.O. stocks, wall type, comprising Bracket Mike, Transformer and Condenser, Magneto Bell in walnut cabinet, 8in. x 6in. x 3in., fitted terminals and connections, Switch Hook and Contacts, Hand Magneto Generator and G.P.O. Receiver, 35/- per pair, with wiring diagram.

G.P.O. Sound Powered hand combination Telephone. In moulded bakelite case, switch in hand, cord and plug, new, 21/- each.

CRYSTAL SETS. The new Lesdix Boudoir Set, bakelite case, condenser tuning, semi-perm detector, 17/6. H.R. Headphones with headband and cord, 15/-.



MICROPHONES. Hand mikes in moulded bakelite case fitted latest pattern G.P.O. inset, 4/6, post 6d. Tannoy hand mike (as illustration). Multi-cell carbon type, metal case with neat switch in handle for sports meetings and announcers, 12/6. Specia Transformer, 8/6. G.P.O. mike button, 1in. dia., filled carbon granules and fitted mica diaphragm, 3/6 each. S.G. Brown midge microphone button, 10/- each. High Ratio mike transformer, 4/6. G.P.O. Mike Insets, 2/6 each.

METAL BOXES 9in. x 9in. x 8in., with lid and front fasteners; loops for carrying strap and plinth for panel, 12/6.

SPEEDMETERS, by A. T. Speedometer Co. 1,500 r.p.m., 4in. blade, dial with white scale and figures, 20/-.

SEND-RECEIVE Hand Coms. All-metal Field Hand Coms. for portable or fixed stations. The famous No. 16 Govt. type, used in field telephones; mike and earpiece with damaged finger switch easily repaired, 5/- (No. cords supplied).

MULTIPLE CONNECTION STRIPS of soldering tags; telephone type, moulded mounting, 60-way, 3/6. R.A.F. 10-way telephone terminal strips, 2/9.

POLE STRAY STRAINERS for aerial masts, transmitting and television, 1/6 each. Swan-neck Insulators for gutter fixing, 1/6.

PARCELS. 7lb. useful oddments for the junk box. All clean, dismantled from Government and other surplus apparatus. 7/6 post free. (Not for Overseas buyers.)

Please include postage for mail orders.
ELECTRADIX RADIO
214, Queenstown Road, London, S.W.8
(Late Queens Road)
Telephone: MACaulay 2159

GALPINS

ELECTRICAL STORES

408, HIGH STREET, LEWISHAM, LONDON, S.E.13

Phone: LEE GREEN 0309

TERMS: CASH WITH ORDER (NO. C.O.D.)

EX-GOVT. (GEC) ELECTRIC FANS, 12 volts AC/DC laminated field, complete with 5in. impeller. New boxed, 25/- each, 11/- post. Transformer to suit 230 volts input 10/16 volts at 4 amps. output, 32/6 each.

MAINS VARIABLE RESISTANCES. Ex-Govt. (new) slider type, 450 ohms to carry 0.7 amps., 30/- each; 4,000 ohms, .25 amps., 35/- each. Worm wheel control slider type, 60 to carry 1 1/2 amps., 27/6 each; 5.7 ohms 8 amps., 32/6 each. Dimmer resistances stud switch arm type 2,700 ohms to carry .27 amps., 30/- each.

EX-GOVT. (NEW) MAINS TRANSFORMERS, 200/250 volts 50 cys. 1 ph. input 525/0/525 volts 150 Mlamps. 6.3 v 5 a., 5 v. 3 a. output standard rating, 35/-, post 2/-. Mains Smoothing Chokes, 10 Hy. 150 Mlamps. 180 ohms D.C. Resistance, 8/6 each. Ditto, 100 Mlamps, 5/6 each, post 9d. Smoothing Condensers (oil filled), 4 M.F. 1,000 volt working, 3/6 each. (All the above can be offered in large quantities.) Please write for special quotation.

EX-R.A.F. MICROPHONE TESTERS (new). These consist of a FERRANTI 0 to 450 Microamp 2 1/2 in. scale meter shunted to I.M.A. incorporated Westinghouse Rectifier, the whole encased in polished teak case calibrated at present 0 to 10 volts, 32/6 each.

EX-R.A.F. POWER UNITS, TYPE 225 (new). Containing the following components: 3-V.U.1.11 Rectifier Valves, 1-5U4G 2-EB 34s, 3-Multi Contact Relays, High Voltage Condensers, Chokes, Transformers, etc. To clear, 65/- each.

EX-R.A.F. ROTARY CONVERTORS, D.C. to A.C., 12 volts D.C. to 220 volts 50 cys. 1 ph. A.C. at 100 watts, 85/- each. Ditto, Admiralty Pattern, 110 volts D.C., Input 230 volts A.C. output at 200 watts, £12/10/0 each. C.I.F. Ditto, 220 volts D.C. Input, same output, £15, C.I.F. Another, 24 volts D.C. Input, 50 or 100 volts 50 cys. 1 ph. at 300 watts, £3/15/- each, C.I.F.

EX-R.A.F. CRYSTAL CALIBRATORS UNITS, Type 18 R.A.F. serial No. 104115237 These units contain 100 Kc/s xstal 2-EF 50 valves and numerous other items all new and unused, 35/- each.

SPECIAL OFFER METERS, ALL NEW BOXED. Moving Coil First-grade Instruments, 0 to 20 volts, 10/- each, or 3 for 25/-; 0 to 40 volts, 12/6 each; 0 to 10 amps., 15/- each; all 2in. scale. 0 to 25 volts A.C. calibrated 50 cys., 25/- each; 0 to 4 amps. Thermo Coupled, 25/- each; 0 to 3,500 volts Electrostatic, 35/- each, all 2 1/2 in. scale.

MAINS TRANSFORMERS (AUTO WOUND). Voltage Changers tapped 10, 20, 25, 90, 130, 150, 190, 210 and 230 volts, all at 1,000 watts, a combination of 34 voltages can be obtained from this Transformer, new ex-Govt. stock, £5/10/- each, carriage 5/-. Mains Booster Transformer, tapped 0, 6, 10, 19, 175, 200, 220, 225, 240, and 250 volts at 1,500 watts (new ex-Govt.), £5/5/- each, carriage 5/-. Another, 200 volts input 240 volts output at 2,500 watts, £7/10/-, carriage 7/6. Another, 2 to 1 ratio, 110 volts input 220 volts output or vice versa at 4,000 watts, £12/10/-, carriage 10/-.

Another, 230 volts input tapped output 40, 41, 42, 44, 46, 47, 49, and 52 volts at 100 amps., £15 each, carriage 10/-; the latter two are double wound. Another auto. wound, tapped 0, 110, 150, 190, 210 and 230 volts at 1,500 watts, £6/10/- each, carriage 5/-. Ditto, 2,000 watts, £7/5/-, carriage 5/-.

EX-NAVAL CATHODE RAY RECTIFIER UNITS. These units are new and weigh 90 lbs. Consisting of high voltage condensers, 15 volume controls, chokes, approx. 100 resistances and condensers all coloured, coded or marked, valve and tube holders (no valves), transformers are included but are for 500 cys., price £2 clear, 42/6 each, carriage paid.

MAINS TRANSFORMERS, EX-GOVT. All 50 cys. input 230 volts input 500/0/500 volt at 250 Mlamps. L.T. 5 v. 3 a., 37/6, carriage 3/6. Another 50 volts at 30 amps. output, 75/- each, carriage 6/-. Another two L.T. windings, 6 1/2 volts at 10 amps., 27/6 each. Another 230 volts input 700 volts at 150 Mlamps., 4 v. 2 a., 4 v. 1 a. output, 27/6 each, carriage 3/6. Another 700/0/700 volts 80 m.a., 12 v. 1 a., 4 v. 2 a. output, 30/- each.

EX-R.A.F. IFF UNITS. As new, these units contain 10 valve S.P. 41s, Ef 50s, EA 50s, etc., also approx. 100 resistances and condensers, also complete with motor generator, 12 or 24 volts input 450 volts at 50 Mlamps. output. To clear, 24-volt type, 35/-; 12-volt type, 42/6, carriage 3/6.

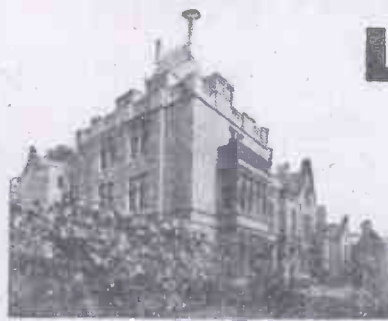

LEARN TO EARN

Leave the overcrowded ranks of the poorly paid—let The Bennett College help you to the top where there is always plenty of room for the well-trained. Just choose your career or let us advise you. The Bennett College with its proud tradition of friendly personal tuition and its long record of triumphs, is the most progressive, most successful Correspondence College in the World. We teach nearly all the Trades and Professions by post all over the Globe. DISTANCE MAKES NO DIFFERENCE.

★ CHOOSE YOUR CAREER AND WE WILL SEE YOU THROUGH

- Accountancy Examination
- Advertising and Sales Management
- Agriculture
- A.M.I. Fire E. Examination
- Applied Mechanics
- Auctioneers and Estate Agents
- Aviation (Engineering and Wireless)
- Banking
- Blue Prints
- Boilers
- Book-keeping, Accountancy and Modern Business Methods
- B.Sc. (Eng.)
- Builders' Quantities
- Building, Architecture and Clerks of Works
- Cambridge Senior School Certificate
- Carpentry and Joinery
- Chemistry
- Civil Engineering
- Civil Service
- All Commercial Subjects
- Commercial Art
- Common Prelim. E.J.E.B.
- Concrete and Structural Engineering
- Draughtsmanship, all Branches
- Engineering, all Branches, Subjects and Examinations
- General Education
- G.P.O. Eng. Dept.
- Heating and Ventilating
- Institute of Housing
- Journalism
- Languages
- Mathematics
- Matriculation
- Metallurgy
- Mining, All Subjects

- Mining, Electrical Engineering
- Motor Engineering
- Municipal and County Engineers
- Naval Architecture
- Novel Writing
- Plastics
- Play Writing
- Plumbing
- Police, Special Course
- Preceptors, College of Press Tool Work
- Production Engineering
- Pumps and Pumping Machinery
- Quantity Surveying—Inst. of Quantity Surveyors Exams.
- Radio Service Engineering
- Radio (Short Wave)
- Road Making and Maintenance
- Salesmanship I.S.M.A.
- Sanitation
- School Attendance Officer
- Secretarial Examinations
- Sheet Metal Work
- Shipbuilding
- Shorthand (Pitman's)
- Short Story Writing
- Social Welfare
- Speaking in Public
- Structural Engineering
- Surveying
- Teachers of Handicrafts
- Telecommunications (City and Guilds)
- Television
- Transport Inst. Examinations
- Viewers, Gaugers, Inspectors
- Weights and Measures Inspectors
- Welding
- Wireless Telegraphy and Telephony
- Works Managers

If you do not see your own requirements above, write to us on any subject. Full particulars free.

COUPON. CUT THIS OUT



IF YOU AT-TEND TO THIS NOW IT MAY MAKE A WONDERFUL DIFFERENCE TO YOUR FUTURE.

To Dept. 76, THE BENNETT COLLEGE LTD., SHEFFIELD

Please send me (free of charge)

Particulars of

Your private advice about

(Cross out line which does not apply)

PLEASE WRITE IN BLOCK LETTERS

Name

Address

The College with a  as well as brains

BARGAINS in Ex-Government Stocks

TRIPODS, 3ft. high when erected. Fitted brass thread and cap, web sling for carrying. In wood or metal. Suitable for Surveyors, projectors, cameras, display purposes, etc. 14/6

The famous "WALKIE TALKIE" Aerial. Spring Brass. Extends 8'3" from 15". 14/6



PRESSURE GAUGE reads 0-150 lbs. Fitted with good length of copper tubing. 7/6

PYROMETER TYPE THERMOMETER reads 0-100° Centigrade 8/6

4-VALVE SUPERJET Recover for short waves complete. Needs only batteries & phones. 29/6

Matched phones, pr. 9/-; H.T. Battery 9/-. Packing & Insurance 2/6.



PORTABLE ELECTRIC HEATER, ideal for lofts. 500 watts 37/6

MULTIMETER, 17 ranges, AC/DC volts, m/amps & ohms. New and perfect. £7

ELECTRIC PANEL HEATERS. Can be placed or fixed anywhere. 900 watts 52/6



Carriage Paid (Dept. K)

INSTRUMENT CO., 244 Harrow Rd., London, W.2

LABORATORIES

of all branches of industry are equipped with the finest apparatus and chemicals obtainable. We suggest you consult us for your requirements.

Send 2d. for Latest Student Price Lists and Order Form.

"Easy Home Chemistry for Boys" 2/- (post 4d.)

Electrotors (Electric Motor)
No. 240 ... 8/6 (post 4d.)
No. 242 ... 10/6 (post 4d.)
(All supplied with Pulley.)

Lists 1d. S.A.E. Trade enquiries invited.

VICSONS & CO., Dept. "P. M."

148, PINNER ROAD, HARROW, MIDDLESEX

JUBILEE WORM DRIVE HOSE CLIPS

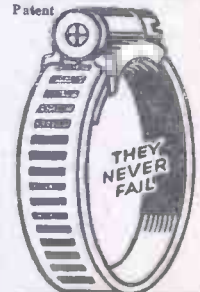

The long-life clip with the ever-tight grip

The Best Known For Radiator Joints, Air, Oil and Water Hose Joints. We guarantee a Tight Joint

L. ROBINSON & Co. 25, London Chambers, GILLINGHAM, KENT

For the "far-seeing" cyclist

The **NEW PHILIDYNE**

REGD. TRADE MARK

CYCLE DYNAMO LIGHTING SET (TYPE 'L')



Demand is heavy,
so place an
order **NOW**

**GOOD,
USEFUL
LIGHT**



even at walking speed

The **NEW 8-Pole Dynamo** (Type 7422) weighs only 9½ ounces yet is rated at 6 volts, .5 amps and provides good bright light even at walking pace. Particularly smooth action, free from pulley drag or "snatch". Self-lubricating. Polished aluminium finish.

The **NEW Headlamp** is smart, streamlined and is designed to take flat battery for parking and traffic halts. Switch for either battery or dynamo connection to both lamps is sited on top of lamp. Finished in black lacquer with chrome-plated rim and polished reflector.

The **NEW Rearlamp** is a component part of the dynamo. Lens is of heavy plastic, unbreakable in normal use, prisms internally with smooth convex exterior. Polished aluminium finish.

(Obtainable from the trade only).

PRICE complete with twin-flex cable and clips 43/6.

Made in Great Britain, a product of

PHILIPS ELECTRICAL LIMITED

CENTURY HOUSE, SHAFTESBURY AVENUE, LONDON, W.C.2

BRANCHES AND SALES DEPOTS AT BIRMINGHAM, BLACKBURN, BRISTOL, CARDIFF, EDINBURGH, GLASGOW, LEEDS, LIVERPOOL, MANCHESTER, NEWCASTLE, NOTTINGHAM, SHEFFIELD. (F.H.314P)

A light grasp here

FERODO lined shoes ensure an instant velvet-smooth response to your hub brakes.

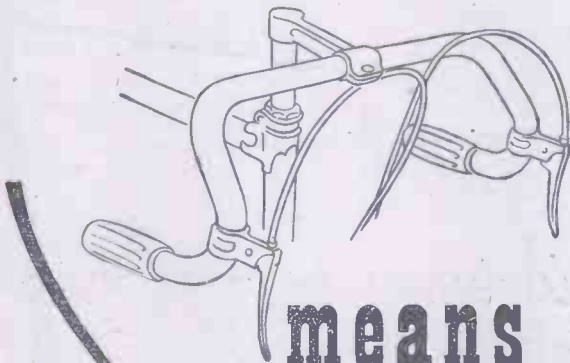

means a
sure grip
here

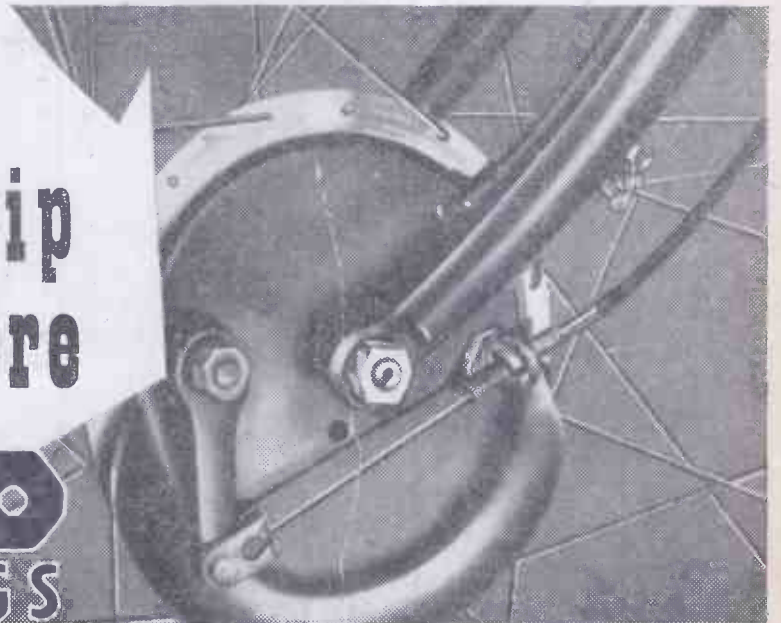

FERODO
BRAKE LININGS

FERODO LIMITED • CHAPEL-EN-LE-FRITH
A Member of the Turner & Newall Organization

REGD TRADE MARK
FERODO



DUNLOP

DIAMOND JUBILEE

1888-1948

Sixty Years of Continuous Leadership

8H/315.

 An advertisement for Phillips Bicycles. It features two bicycles, one on the left and one on the right, facing each other. Above them is a banner with the slogan "Just the job!" written in a cursive font. The entire scene is framed by a double-line border. At the bottom, the brand name "PHILLIPS BICYCLES" is written in a stylized, bold font.

Just the job!

**PHILLIPS
BICYCLES**

J. A. PHILLIPS & CO. LTD.

SMETHWICK • BIRMINGHAM



VOL. XVI

MARCH, 1948

No. 312

Comments of the Month

By F. J. C.

B.L.R.C. Policy

THE B.L.R.C. is on the threshold of becoming the accepted authority for control of cycle racing in England, notwithstanding the fierce attacks from the paid advocates of existing organisations, and the oblique attacks from individual critics who each would like to be considered the one tailor of Tooley Street speaking for the rest of the cycling movement.

It is well known that they speak for themselves, but because of their long association with the cycling movement, have assumed proprietary rights in it. The triumvirate of Tooley Street, namely the R.T.T.C., the C.T.C. and last but not least, the N.U.C., do not represent the cycling movement. The R.T.T.C. speaks with the best authority for those interested in racing on the roads, and they are the most concerned with any action that may be taken by the authorities in connection with road sport.

The R.R.A. can be ignored, since it is a small body and road records are very much in abeyance.

We are not concerned with the views of those who, as paid advocates, have remained in the cycling movement to earn their livings. We have no doubt that they have performed the jobs for which they are paid well and to the best of their ability. They would be signally lacking in duty if they did not oppose any form of racing which tends to put out of existence the organisations they represent.

This is a vital time in the history of the British League of Racing Cyclists, and it is time that its parts realised that they cannot be the whole. The membership is rapidly increasing and their international links as with France, for instance, are now a reality.

The B.L.R.C. has been founded and guided by men who by age or other circumstances have no wish or hope of reaping financial reward for their labours, unlike the critics from other camps. At this period the bid for control by self interested place seekers is an expected development. Such moves have taken place in all other associations and the B.L.R.C. would be wise to purge the Augean stable now, and not to leave it like other bodies have done until the cancer on the corporate body has become too deep-rooted.

The League has the great advantage that it is not interested in anything but the sport. At the present time riders have fought for and temporarily gained the right to be the judges of their own appeal. If this is carried to logical conclusions they will next be selecting themselves for international cycling contests. That position is quite fantastic. We appeal to the members to think of the League and to cut out personalities.

It has done a great job of work in revivifying interest in cycling sport, and it has done more than any other cycling bodies within the whole history of the cycling movement to make cycling sport news.

Other bodies want hole and corner methods of running time trials as if they are doing

something illegal, or of which they are ashamed. Little wonder that the public knows practically nothing about cycle sport, and that newspapers ignore it, and only comment upon cycling at all when something happens to provide an item of attack.

Not so long ago the C.T.C. invited its members to keep up a barrage of letters to the Press, attacking any adverse comment. They overlook the fact that this campaign, fomented through its own house journal, was known to the Press, for many of them are members of the C.T.C.

The Press do not like inspired letters, and it is not surprising that most of them went into the waste-paper basket. The spontaneous and uninspired letter cannot be mistaken and if space is available it sees the light of print. Letters from cycling organisations are similarly easily recognised. They are mostly couched in bitter terms, contain many familiar phrases and outworn arguments, all of which can be found in the columns of the house journal referred to, and have been spouted from small public platforms at unimportant club dinners by the proprietors of the cycling movement, or by one of the tailors of Tooley Street.

The League has the golden opportunity of putting cycling back on the map, and of confounding its critics. Let it not play into the hands of the latter by internal dissension and internecine conflict. These can only destroy what it is hoped to build up.

Headlight Dazzle

THE Ministry of Transport makes a strong appeal to drivers to co-operate in anti-dazzle measures along lines disclosed in the Interim Report (attached) of the Road Research Board as to the extent to which faulty adjustment of motor headlights is responsible for dazzle.

Recommendations in the report include suggestions that headlamps should be set so that driving beams do not rise above the horizontal and that passlamps should be adjusted so that the maximum intensity of the beam is dipped at least 3 deg. below the horizontal, i.e., a 1ft. dip at 19ft. from the lamp. Neither headlamps nor passlamps should, it is urged, point to the right.

The Ministry asks drivers to see that their lamps are adjusted accordingly, paying attention also to the following points:

Adjust low-mounted passlamps and foglamps so that they point to the left, and dip foglamps in the same way as passlamps.

If lamps have front glasses with flutings intended to be vertical, make sure that the flutings do not appear as tilted from the bottom left to top right when viewed from the front.

Follow the maker's instructions.

Drivers are often tempted to tilt headlamps slightly upwards so as to give a better light, or fail to correct a tilt which has come about accidentally. Faulty adjustments of this kind, whether deliberate or not, cause dis-

All letters should be addressed to the Editor, "THE CYCLIST," George Newnes, Ltd., Tower House, Southampton Street, Strand, London, W.C.2.

Phone: Temple Bar 4363

Telegrams: Newnes, Rand, London

comfort to other road users and seriously increase the risk of road accidents.

The report also recommends that headlamps and passlamps should be mounted not higher than 3ft. 6in. and preferably not lower than 2ft. 6in. from the ground. The Ministry of Transport agrees that such limits are desirable and has consulted the Society of Motor Manufacturers and Traders on the question of making regulations accordingly. It seems probable, however, that such regulations can apply fully to new vehicles only and even here there may be practical difficulties in the way of altering designs already in production.

Low-mounted lamps are a serious source of trouble because they cannot be aligned to throw the beam far enough ahead and at the same time avoid dazzling oncoming drivers. The report recommends total prohibition of the use of lamps with centres less than 2ft. from the ground except in fog or snow.

The Ministry of Transport is giving further consideration to this problem, having regard to the fact that where a low-mounted lamp is the only device available to comply with the existing anti-dazzle regulations, such a prohibition might make the lighting system on some vehicles illegal. It is pointed out, however, that the majority of such lamps are provided as foglamps, and drivers are urged to use them only as such, and ensure that the beam is depressed and points to the left.

Inspection of Cycles

THE police have renewed their campaign of inspecting schoolchildren's bicycles, and of putting them through tests in the Highway Code and in riding. We have no doubt that this is done in the interests of road safety, for it cannot be denied that many of these juvenile cycles are in a bad state of repair, and that parents are not always too careful in seeing that the brakes are properly adjusted, the tyres correctly inflated, and that the bearings are lubricated and in a correct state of adjustment.

At the same time, it must be borne in mind that the police have not a statutory right to insist upon these examinations, nor have they the right to insist upon riding tests and "failing" those who do not pass them.

The Neutral R.S.P.A.

WE do not like the attitude of the Royal Society for Prevention of Accidents in deciding to remain neutral on the question of the increased speed limit for heavy vehicles. The drivers have already protested against the increase of 20 miles an hour to 30 miles an hour, and they say that the increase is bound to lead to an increase in the number of accidents in which vehicles are involved. Time alone will prove whether they are right in this respect. But surely the Royal Society for the Prevention of Accidents should have a viewpoint on the matter. It has decided to sit on the fence, being apparently afraid of upsetting the owners of such vehicles.

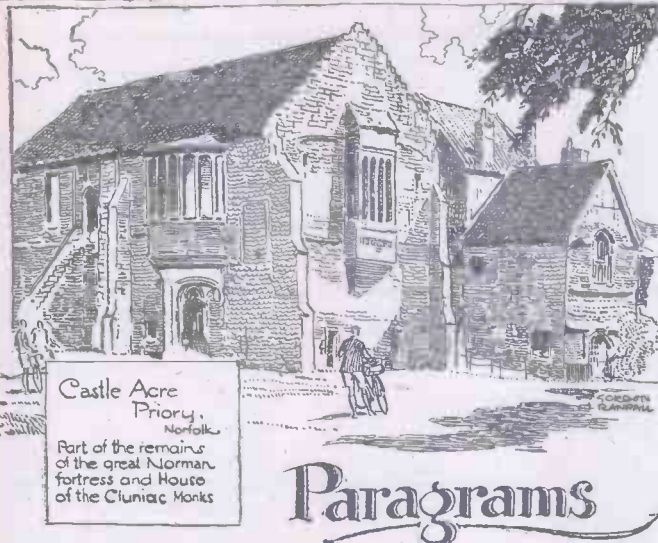

Castle Acre Priory, Norfolk
Part of the remains of the great Norman fortress and House of the Cluniac Monks

Paragrams

Cycle Firm's Founder Dies

THE death has occurred at the age of 51 of Mr Brook Hardcastle, of Tickhill Road, Doncaster, founder of the cycle and radio business of Brook Hardcastle, Ltd. He started work in a Yorkshire colliery, but after a few years he started his own tiny cycle repair shop at Goldthorpe. Business prospered and gradually he opened additional shops, and within 20 years after he had opened his first shop there were 45 branches. The business was turned into a limited company in 1928. Mr. Hardcastle, as a hobby, took over and modernised the old-fashioned village of Thixendale, which he bought in 1945, but the war years and their shortages considerably affected his business, and to-day the company has three main branches.

Still Going Strong!

MR. CYRIL MUNDTY, a cycle dealer and member of Peterborough Cycling Club, gave his fellow clubmen a surprise by turning up for a run on a Dursley-Pedersen cycle which he had acquired in the course of his business. It is in perfect condition and was not outmatched on the run by any of the modern machines. The younger generation in the club were greatly amused at the appearance of the cycle but Mr. Mundy can stand all the laughs anyone cares to hand out and he hopes to ride it for many years to come. Another of the Club's unusual mounts is a tandem tricycle, built by a member out of the frame of an old tandem, which also performs perfectly. This tandem took part in the same run, as also did several tricycles.

Which Way?

A NEW type of rear light brought out by an American firm consists of twin lenses, each with an arrow pointing either to the left or to the right. From a control switch on the handlebars the rider of the cycle can light up either arrow at will and indicate to following traffic which way he is about to turn.

Helping Themselves

BOYS at Rossington Modern School, Yorkshire, are being taught to stand on their own feet and not to expect to be spoon-fed by the State. Police checks of cycles are all very well, but they take up the time of policemen who could very well find more important work to do, so the boys at Rossington, under the supervision of their science master, Mr. J. Webster, now carry out all normal repairs to their bicycles. Since the scheme started not a single scholar has been involved in a road accident due to a faulty machine.

Rousing the Worst Instincts

WHEN it was suggested at a meeting of Grimsby Road Safety Committee that the town should have a squad of "courtesy cops" to go on duty at rush periods a member suggested: "I am beginning to think loudspeakers are a curse, and that they do no good in persuasion. In fact, I am beginning to think they fail in their purpose. They rouse the worst instincts in people." The Chief Inspector of Police pointed out that there was no actual law to prevent cyclists doing such things as riding three abreast if they wished, and he thought people would resent being told not to do something that was not forbidden by law.

Sir Walter Helps Exports

A STATUE of Sir Walter Raleigh, measuring 8ft. 6in. high and standing on a 4ft. 6in. plinth, was a prominent feature of a private exhibition of advertising models held in London for foreign buyers. Sir Walter's mission in life will be to assist in the ever expanding export drive of the Raleigh Cycle Company, whose Nottingham works are playing a very considerable part in restoring Britain's economy. The figure, which is most realistic, is one of the products of the Loughborough firm of Models (Leicester), Ltd.

Inviting Death on the Road

WHEN Grimsby Highways Committee agreed that four "Slow-Major Road Ahead" signs should be erected at dangerous crossings in the town, several members suggested that "Halt" signs might be found more use to be the others were apt to be disregarded. The Borough Engineer, however, explained that the Ministry of Transport did not usually permit the erection of "Halt" signs until there had been enough accidents at the spot to prove that such signs were needed. "And so we have to wait until there have been a number of accidents before we can do anything about it," commented one councillor.

Nightwork!

A HORNCastle cyclist, seen the other night to be footslogging along the road and pushing his cycle, which was loaded with a spade, fork, rake and other gardening tools and a large hurricane lamp, was asked what new sport he was going to indulge in on such a dark night. He explained that he was just going along to meet a friend and carry out some work on his favourite bowling green by the light of the lantern as, he was busy during the daytime.

Not for Speedsters!

AN Italian cyclist, whose idea of cycling is to ride without getting the wind and rain on his face, has invented a weather protection for cyclists in the shape of a combination umbrella and windscreens. It is made of stiffened material and reaches almost from the ground on either side of the front wheel to well above the rider's head, being fastened to the handlebars and supported by a strut from the crossbar. Six transparent plastic portholes are provided so that the rider can see where he is going, that is, if he ever moves at all with this cumbersome contraption to absorb his energy.

Old Landmark Back Again

THE sign of the Bell at Stilton, a familiar sight to thousands of cyclists along the Great North Road through Huntingdonshire, is once again back in its old position after an absence of some three years. The ironwork bracket holding the sign of the Bell was found to have become very fragile through age, and a new bracket, an exact replica of the old one, has been produced by one of the few remaining craftsmen in ironwork left in the country, Mr. John Bunning, of Stamford, Lincs, and now supports the newly painted sign. The Bell is considered to be one of the oldest inns in England, being over 450 years old, and its old walls can remember the days when beer was thicker than water.

Club's New Trophy

A TROPHY is being presented to Doncaster Wheelers by the family of the late Mr. J. A. Bates, a keen rider with the club for 21 years, and will be presented each year to the winner of a specified time trial, it was stated at the club's December general meeting. Reference was also made at the meeting to next year's plans for the club, which include the promotion of an open 25-mile T.T. race for men in April and a similar event for women riders later in the year. The club's "25," held each Whitsun for several successive years for "middle-markers," is being discontinued.

Rintaku!

THAT is what the Japanese shout for these days when they want a taxi—and up comes a pedal tricycle. Owing to the shortage of petrol and motor vehicles, these tricycles have been developed to fill the gap. The passenger sits in a small enclosed cab over the two rear wheels while the "driver" pedals away in front. Only one passenger can be carried in each rintaku, so if a Japanese takes his girl friend out for an evening's entertainment he has to hire two "taxis." Duralumin forms the greater part of the framework of these vehicles in order to lighten the driver's load, but even so he earns his money.

Another Mill Vanishes

A PICTURESQUE spot on the main road from Derby to Loughborough, the ancient Dishley watermill, is being demolished by the Leicestershire War Agricultural Committee. The waterwheel and the mill are being removed and the millrace and pond drained in order to prevent flood water from the Willowbrook backing up in very wet weather and overflowing the surrounding land. Records show that the mill was in existence in the 17th century, when it belonged to the Abbey of Garendon. With the demolition of this mill there will be only one working mill left in the Loughborough district, that in the village of Cotes.

Cycling Memories

MR. EDWARD A. FULLER, of Wymeswold, Leics, who has just celebrated his diamond wedding anniversary, at the age of 82, has been a cyclist

since the early days. In 1903, for a wager, he cycled from Loughborough to Leicester and back, riding one of the heavy machines of the period, with cushion tyres, over poor roads. He broke the existing record for the journey by completing the trip in two hours and when he got back to Loughborough he finished up by riding round the yard of the Lonsdale Hotel in between several dozen beer bottles set up to form an obstacle race course. Mr. Fuller was to have been paced on his trip by a car, but this ran into a ditch soon after the start and several dozen other cyclists who were to have kept him company also dropped out, and Mr. Fuller met most of them on the outward journey as he was on his way back.

Training Them Young

HUNTINGDONSHIRE Education Committee have approved in principle a scheme for the testing of young cyclists to see if they have sufficient road sense to enable them to be on the road in safety. The committee have also approved plans for the formation in local schools of units of the Cycling Safety League.

The Indispensable Cycle Pump

AN ordinary bicycle pump is part of the equipment at the North Lincolnshire railway station of Normanby Park, a station which deals with a good deal of ironstone and steel traffic for the nearby steelworks. It is one man's full-time job to attend to the 15 or so pressure paraffin lamps on the station, and to be continually going round from one lamp to another when they are alight, pumping them up with his cycle pump. Only a short distance away there is a private railway track owned by a steel company with electric cables running along it.

Sweet Reward

THE prize for attendance, presented at the annual dinner and prize-giving of St. Ives Wheelers, held at the Golden Lion Hotel, St. Ives, Hunts, was a box of chocolates sent from Canada by a former club member, Mr. A. Causton. There was a good gathering of members and friends. The Mayor of St. Ives, who proposed the toast of The Club, referred to the fact that one of the local residents was one of the oldest racing cyclists in the country, Mr. George Dennis Day. Mr. Day was a racing cyclist at Cambridge University in the old penny-farthing days, and he received his Blue for the sport. The Mayor also suggested that the abolition of the basic petrol ration was a blessing in disguise for cyclists.

Freak Accident

AMONG several unusual accidents mentioned in the road safety bulletin issued by the Chief Constable of Lincolnshire is one in which a lorry driver by his presence of mind, was able to save a cyclist from serious injury or death. The cyclist was approaching the lorry when he suddenly became giddy and swerved. The lorry driver saw what was happening so he shot out his arm and held the cyclist up until he could bring the lorry to a stop. The Chief Constable's bulletin also emphasises the fact that a cyclist who wishes to reach home all in one piece should resist the temptation to carry large parcels on his handlebars.

Take it Easy, Legs!

AMERICAN cyclists, who prefer their cycles to look like motorcycles, would also sooner rig up some mechanical attachment rather than pedal, and their prayers have been answered by the marketing of a lightweight bicycle power-plant. This comprises a small engine, complete with petrol tank and all the other gadgets, mounted above a single balloon-tyred wheel which is half the size of the normal cycle wheel. When the cyclist feels he wants to rest his legs, he simply removes his rear wheel and chain and attaches the power unit and connects up handlebar controls. They away! he goes in a cloud of blue smoke, with lots of smell and noise, to enjoy the beauties of the countryside.

Change of Speed

MEMBERS of the Loughborough and District Motorcycle Club have turned to cycling now that their basic petrol ration has vanished. Their first cross-country trial on cycles proved most popular, in spite of the mud baths, water-splashes and other inconveniences so beloved to motor cyclists. Several members said they had never enjoyed themselves so much before and even the rider who kidded and fell headfirst into a water-filled ditch that did not smell of violets, was in favour of many more similar events. One woman rider made a crash landing in a thorn bush but she, too, remained undaunted, so perhaps by the time the basic ration is restored we shall have made quite a few new converts to cycling.

Yorkshire Section of B.L.R.C.

AT the annual general meeting of the Yorkshire Section of the British League of Racing Cyclists, held on Sunday, January 11th, at the Black Bull Hotel, Otley, there was a record attendance of delegates despite the atrocious weather conditions. One service delegate had ridden from Louth in Lincolnshire and had to ride back the same evening.

G. Whittaker, of Bradford R.C.C., was elected chairman; W. Woods, of Vegetarian R.C., general secretary and press secretary; D. Padgett, of Bradford R.C.C., event organiser; and K. Farrar, of the Bradford Co-op Velo club, was elected treasurer.

The secretary reported that there were now 16 clubs in the section, three more having joined during 1947.

Around the Wheelworld

By ICARUS

More Light on Massed Racing

LAST month I dealt with the criticisms by G. H. S., in a contemporary, of massed start racing and methods of running it as disclosed in a talk by the general secretary of the B.L.R.C. before a cycling club.

Those criticisms reminded me of the lines:

"I do not love thee, Doctor Fell,
The reason why I cannot tell;
But this alone I know full well,
I do not love thee, Doctor Fell."

In other words, G. H. S. does not like massed start racing.

Now, G. H. S., ex-secretary of the C.T.C., in 1943 issued a statement to the Press on massed start racing, and this statement included a reference to those running massed start racing as a number of hot-headed youths. These remarks were taken as representing the views of the C.T.C., of which he was then Secretary. Finally, after representations, he had to admit that the views were his own, and I believe he withdrew his statement about "hot-headed youths."

Nothing daunted, after his attack to which I referred last month, he devotes another full page in a contemporary to a further attack entitled "More Light on Massed Racing," and the vehicle for his attack are two letters of disagreement with his views which, he admits, are "reasonably restrained except for a slight sting in the tail of one of them."

G. H. S. expressed the hope that his article will "remove and sterilise" that sting. In my view it does not. His article is merely another attack. His remarks call to mind the words of George Herbert (1593-1633):

"... striking, sometimes a friend, sometimes the engineer."

Now, it is unfortunate for G. H. S. that he refers to the "Three Tailors of Tooley Street," which was the title of a leading article in this journal dated January, 1944, in which the N.C.U., the R.T.T.C., and the C.T.C. were likened to those three tailors who, in addressing a petition to the House of Commons, began: "We, the people of England demand..." The distinction here is that on the matter of massed start racing G. H. S. gives the impression that he is the one tailor of Tooley St.

One of his correspondents in dealing with Government opposition to M. S., says: "This is an unfortunate, but it would seem an inevitable consequence of the violent anti-massed-start and anti-League propaganda campaign directed by the N.C.U., the R.T.T.C., and a cycling journal. The popular opinion is that the damage done to the cause of cycling by the B.L.R.C. is negligible, but the damage done by your persistently biased articles is regrettably enormous, and who knows where it will end!" G. H. S. in his reply to this says that the apologists for the League have said that if and when the crash comes the fault will lie with those who said the B.L.R.C. was making a mistake.

What they have said is: "If and when the crash comes," time-trials will go down with massed start, and those responsible for the crash will be those, including G. H. S., the N.C.U., and the R.T.T.C., who, between them, have fomented opposition to M. S. on the flimsy pretext which we now know to have been based on false premises.

Mr. A. P. Chamberlain, at a meeting of the club where Kain was the guest speaker, publicly admitted that he had conducted correspondence with the Home Office and the Ministry of Transport opposing massed-start racing.

The R.T.T.C., that uneasy bed partner of the N.C.U., supports their policy. G. H. S., having taken up an attitude which cannot be supported by the facts, should withdraw from the fray, in which all victories have gone to the B.L.R.C.

When G. H. S. was the secretary of the C.T.C. I conducted correspondence with them on this matter. I asked them whether a postal vote of its membership had been taken on the subject in view of statements in the Press, to which the name of the C.T.C. had been coupled. The answer was that C.T.C. policy is determined by its Council, and no postal vote has been taken or is needed on massed-start racing.

This is another democratic [sic] body like the N.C.U.! They did admit that they conducted more massed cycling than any other cycling club, but apparently they had not sufficient unity of purpose with the other bodies to have written to the Home Office and the M. of T. on the matter. They were willing to wound yet afraid to strike.

Although our contemporary has devoted two pages to the subject, there is not a scintilla of sound argument against massed start.

"Is the N.C.U. an Illegal Body?"

IN view of the sorry position in which the N.C.U. now finds itself, I was somewhat amused to read the following in a cycling journal published in 1898:

"It is not a little extraordinary that for years the National Cyclists' Union has been carrying on a very praiseworthy but wholly illegal existence. Every good cyclist wishes well to the Union in its proper work, which is that of regulating race meetings and kindred matters. When, however, it steps outside the limits wisely prescribed by its founders, and attempts to copy the methods of its greater sister club, and, whether from envy or malice, tries to supplant in the public mind the credit due to the Cyclists' Touring Club by interfering with matters of touring and similar questions, it is surely time to raise some protest. Take one example: the action of the Union against a railway company on the question of passengers' luggage seems to be absolutely without justification. The Union has no right to spend one penny of the members' money without personal consent of each member, and the writer knows of many members of the National Cyclists' Union who are convinced of the futility of contending that cycles are passengers' luggage, and would never sanction the expenditure of money in such an undertaking.

The Union undoubtedly makes a profit in many ways; the application of that profit is immaterial. The fact that it makes a profit is sufficient to bring it under the Company Acts, and to render its registration as a company necessary. Any association of a large number of persons carrying on business at a profit is absolutely illegal unless properly registered. The result is that the National Cyclists' Union is only a gigantic partnership, and that each member is absolutely entitled to be personally consulted before anything is done. The liability of each member is wholly unlimited and, unlike membership of the Cyclists' Touring Club, may involve the surrender of all one's property. Any contracts or agreements made by the National Cyclists' Union are really worthless to the Union, and are only valid as far as concerns individuals who sign such agreements. Or, to put it plainly, the loss arising from an hotel agreement, or the costs of an action

at law, fall solely on the secretary or councillors responsible for such proceedings, and there is no right of indemnity against anybody."

Cycle Makers' President

FOR the fourth year, Mr. George Wilson, C.B.E., managing director of Raleigh Industries, Ltd., Nottingham, has been elected President of the British Cycle and Motor Cycle Manufacturers' and Traders Union, Ltd. Mr. C. Douglas Terry, of Herbert Terry and Sons, Ltd., Redditch, and Mr. J. Y. Sangster, of the Triumph Engineering Company, Ltd., Coventry, have been elected vice-presidents for the third time.

R.R.A. Triennial Dinner Cancelled

THE Minister of Food has refused a licence to the R.R.A. for more than 100 guests at their proposed Triennial Dinner, or rather, the revival of the Triennial Dinner, since for understandable reasons the function was not held during the war. The possibility of running a buffet, instead of a dinner, was not found to be practicable. The idea, therefore, is cancelled. This is a pity, because the members of the R.R.A. are not afforded an opportunity on many occasions for getting together, and it is now over nine years since the last function. There is very little interest at the present time in road records.

Tribute to Nevill Whall

THE National Committee on Cycling have sent the following resolution to Mr. Nevill Whall, who has resigned as a C.T.C. representative on leaving the C.T.C.: "The National Committee on Cycling have received with real regret the news that they are no longer to have the benefit of Mr. Nevill Whall's ripe experience. They wish to put on record their appreciation of all that he has done to maintain the rights of British cyclists and their own sense of the loss to them of his quick mind, tact and judgment."

Special tributes to Mr. Whall were paid by Mr. A. P. Chamberlain, as secretary of the N.C.U., and by Mr. H. R. Watling, National Committee chairman, who said that they had always found him active in debate and courteous and able in controversy. He added that they had the very special pleasure of welcoming Mr. R. C. Shaw as Mr. Whall's successor.

The Demon Cycling Club

AT the annual general meeting of the Demon C.C. it was reported that the club membership had increased by 100 per cent. The motion to inaugurate a club championship for this season was passed unanimously. The principal officials elected were: president, J. Beddow; chairman, J. W. Page; secretary, A. G. A. Wilkes; press secretary, R. A. V. Page.

Annual Dinner of B.L.R.C. (London Section)

THE third annual dinner and dance of the London Section of the B.L.R.C. was as successful as the two previous. It was held at the Victoria Hall, W.C.2, with the new president, F. S. Durman, in the chair. The speeches were all limited to not more than four minutes. I hope that the dissension existing will disappear. Disagreement may be healthy, but dissension devastating, as Mr. F. J. Camm, in responding to the toast of the Press, said, the part can never be greater than the whole.

Wayside Thoughts

By F. J. URRY



Buckland-in-the-Moor
Devon.
One of Britain's prettiest villages.

The Marvel

BEFORE the news reached the press of this country I had a letter from an Australian friend telling me of the remarkable endurance feats of a 73-year-old cyclist, one Ernest Old, a native of Blackpool, and an old soldier of the Boer War. I did not believe them, and I wrote and said so, for the stories savoured too much of those tyre testimonials: "It has been ridden 26,000 miles without a puncture and is still good for many more centuries." I have never seen the tyre with so long and virtuous a mileage, and I didn't believe a man beyond the "allotted span" could successfully undertake a journey of a thousand miles in a trifle under 10 days. But the reports inform me that this veteran has won the cycling marathon from Melbourne to Darwin and back, 5,200 miles, in a couple of months. You will agree that it needs an extraordinary man to make such a journey, and when you reflect that the individual in this case was 73, you cannot fail to be astonished. I am; for I know what cycling endurance is, and at least I know something of the limitations imposed on activity by the passage of time. I do not recommend you to emulate such a feat, but quite seriously I do suggest there is a value in cycling which as a health preserver and an agent for activity is still a long way from realisation by the elderly. Recently I walked some seven miles over plough and stubble and through roots in search of game, with an old friend who found the vigour too much for his comfort and rested on many beats while I tramped on. We are of a similar age, and when later in the day we were enjoying the refreshment of tea he told me the kind of fool he has been ever to give up his cycling. "That is the reason you can stick it and enjoy the long day when I wilt half-way through and shall be stiff and sore for a week." And probably he is right.

Keep to Quality

IT is the way of the world after having bought something cheap to brag about it, not that there are many cheap things to buy at present, or, to put it a more truthful way, the "cheap" things are dear. I hope I am not given to bragging, for it is an unfortunate characteristic in anyone, but if I were to fail in this matter I think I would rather brag of my purchases in the sense of how good they were rather than how cheap, and this specially applies to bicycles and everything connected with them, from the actual article to the raiment you wear. The word cheap generally carries a second-grade meaning, and never more so than when it is used in connection with bicycles. Of course, many people do not believe this, for bicycles look very much alike and one cannot peer under the enamel or the plating, or test the bearings for perfect finish, hardness or alignment, which is a pity, for if the difference between the goods was manifest to the uninitiated, I am sure the quality machine would more easily become the common choice of riders. My energy is the driving asset of my cycling; how it is used or conserved, expended pleasurably or painfully, is largely due to the type of bicycle I ride, its gearing and its equipment. So when I buy I have this fundamental fact in mind; I am the motive power, and my enjoyment of that exercise is mainly dependent on my choice. In this matter I am not greatly concerned with looks; that is a secondary consideration, but with reasonable lightness, good tyres, moderate gearing, easy, effortless steering and comfortable seating—yes, these are important, and if such advice could be quickly and easily demonstrated the quality of cycling would at once increase. But it cannot, and would-be riders must depend on the advice of experience, their own

pocket and their inclinations, and far too often the lure of cheapness wins. It is the easiest thing in the world to be critical, but one of the most difficult to take the advice of experience. We listen to it, yes, but too often with the thought we can do better. Perhaps I was fortunate in discovering the truth of this business of choice in the very early days of cycling.

Eavesdropping

THE incomprehensive nerve of some people to say cycling is hard work when they know so very little about real riding goes on and, if anything, increases. I overheard a pre-arranged conversation the other day which was illuminating. A certain friend of mine did the job, simple enough, by putting me in a room next to that of the director of the concern, and then opening a conversation on this subject of cycling. And it ran something like this: "Well, James, I don't care what you say, you will never convince me that fellow

Urry enjoys riding to work in the rain." That is sufficient to give you a basis to the arguments that followed. The fact is that the speaker had never tried this manner of transport for a single day, never mind about a wet one, and his opinion as evidence against cycling was worthless. He will apply for petrol for business purposes and get it, being head of a big firm whose main business is to equip cyclists. It is a trifle Gilbertian to think along these lines, to imagine people who owe everything to cycling sitting smugly in an office and more or less denouncing the folk who ride because they like riding and are free from the costs and burden of motoring. In a perfect world one would imagine such folk would be the first to applaud the bicycle and all it has meant and still means to emancipation and health; but then, the perfect world seems as far off as ever, and those among us who have discovered their little perfection of living and moving find it most difficult to rouse a tiny desire in other people, and especially it seems to me, people who, possessing money, imagine that which it purchases at high prices must be better for them and their well-being. Ah! but they have forgotten the simplicities; the individual freedom that marries so happily with exercise and bodily well-being, and lives joyfully ever after. I am not so poor that I do not count these things beyond price and look to them to fulfil for me the comely comfort of happiness.

Still Waiting

THE buying of good bicycles is not going to be easy, I am told, and equipment and replacements

will be equally difficult. The news is not encouraging, and we had hoped for better things two and a half years after the end of the war. So I have been looking into the condition of my little stock of bicycles, and one or two of them have gone into dock for expert attention, so that they will be fit and ready to meet my needs, and possibly those of my friends, when touring time comes round again. One of these machines needed a new pair of rims, for the rear one, of hiduminium, had worn completely through on its brake track, and the front one was not much better. On the other hand, a thirteen-year-old bicycle, also fitted with alloy rims, was in perfect trim and only needed re-spoking to make the wheels firm and reliable. This alloy was of Italian origin, and the rims have stood up to some 25,000 miles of regular wear without wilting under the braking strain; so it would seem that our British product needs the addition of a hardening element in its make-up. I must, too, have several saddle tops re-blocked to restore them to a reasonable shape, for I do not like using the adjusting bolt for tensioning purposes: it pulls the saddle out of shape and reduces its comfort. Chains are going to be difficult to obtain, I hear, and some of the wise lads, discovering supplies in small country depots during their week-end peregrinations, are buying them up against the certain need of service. I have, fortunately, one new bicycle, and I'm saving that for the long journeys and the touring, using those models with doubtful tyres for daily riding, and the intermediate samples for the leisurely week-ends when the repair of a puncture merely adds the opportunity of a smoke to the journey. My waterproofs are growing old and not too reliable, but I find that by turning the cape back to front it will still do its job reasonably well on the seven miles out and home journey, while the better one and a decent pair of leggings hang in a dark corner awaiting the time when they may be called upon to defy the spring and summer storms along the ways I hope to go.

Planning in Advance

WHICH reminds me of a little meeting where four of us tentatively discussed the possibility of a 1948 holiday in the Highlands. The subject arose out of a report that the remote spots of fair Britain would not be overcrowded during the petrol-less days of early summer, and the four members of this holiday syndicate, the youngest of whom was sixty-four, could risk the straight tour from place to place and renew the adventures of their youth, a little more steadily perhaps, without discomforting their years. A Scots friend of mine tells me that June is usually the best month for weather north of the Great Glen, and as that date falls before the Scottish holidays begin, it should be an ideal one for our purpose. So the project is taking shape. We have "begged off" for a fortnight from the domestic hearth, we have settled on a train journey to Inverness, we have agreed to "drum-up" in true Scots fashion for lunch and tea, to cut the miles according to the weather, the wind and the mood of the moment, and to telephone from bed to bed, as it were, to secure our comfort. Yet, even so, when the itinerary was examined it was found to provide just over 500 miles of riding and some of it was pretty tough for ancient pedalers. What a pleasure it is to pore over the maps and anticipate a summer to come and all the quiet joys of care-free wandering over the lonely road 'twixt Inverness and the Ultima Thule of Groats and Cape Wrath. It may be a tiny adventure in embryo compared with the great expeditions, but it is all your own, and the thought of it gilds the waiting time of winter and preserves in you the desire to keep reasonably fit and active for that moment when joyous activity will earn the dividend of great happiness.



Before the pupils of the Putney County School for Girls could ride their cycles to school, it was necessary for them to pass certain road tests. Cycle tests were held in the playground. In the illustration some of the girls are seen doing their road tests under the vigilant eye of a local policeman who came along to help.



Now is the
time to order
your new "C.B."

DISCUSS YOUR NEEDS
AND SPECIFICATION
WITH "C.B." SALES
AND SERVICE DEPOT
MANAGERS AT:

WANDSWORTH
101, East Hill, S.W.18.
Manager: George Brooks
Tel.—BAttersea 1381

LEWISHAM
34, Leg High Road, S.E.13
Manager: Wally Fluke
Tel.—LEe Green 2072

HARRINGAY
71, Grand Parade, N.4
Manager: Dave Davey
Tel.—STAmford Hill 4363

EALING
16, Bond Street, W.5
Manager: Ernie Bundock
Tel.—EALing 3557

OR WRITE

CLAUD BUTLER

"C.B." WORKS, CLAPHAM MANOR ST., S.W.4

"THE CHAMPION'S CHOICE"

Claud Butler invites your enquiries for any type of machine, road, track, touring, club, to your own angles and dimensions or to C.B. recommended design. Get these details settled and your order in hand for the new 1948 season now. C.B. frames are built throughout with "531" double butted tubing and, as an example, the C.B. low-temperature-process welded frame, complete with fork, head and bottom bracket bearings and seat pin, costs only £11-4-2, including C.B. metallic finish, continental lining, and chromium fork crown.

"No other tyre
will really satisfy
me now"



APEX
'SUPERLITE'
CELLULOID PUMP
15 x 7/8" BLACK

Thick Celluloid
Beautifully Polished

Light of Weight
but of
robust construction

'SUPERLITE' 15in.
CELLULOID (with
solid drawn brass
plunger tube) each **5/-**

'LASTWEL' CELLULOID
(with steel split
plunger tube) 15in. **4/6**
each

The World Famous
BAILEY'S
'SUPER'
PUMP
15 x 7/8" BLACK
Steel Lined
Celluloid Covered

Lining is Solid drawn
cartridge fashion, the ends
being solid with the barrel

Cannot warp nor leak.
BAILEY'S 'SUPER' (Steel
lined and Celluloid
covered) 15in. each **5/6**

BRASS PUMP, Nickel
Plated or Black enamelled
(with steel split
plunger tube) each **4/-**



APEX PRODUCTS

Are in use in every Country in the world.

They are known and appreciated for their reliability, long service and efficiency in their job of inflating tyres.

Labour and materials are still very much restricted; consequently supplies of pumps are scarce! If you are lucky in owning an Apex Pump, treasure it.

MADE BY

APEX INFLATOR Co. Ltd.
ALDRIDGE ROAD, PERRY BARR,
BIRMINGHAM 22B

Rubber dipped insulated cord body with deep tread for long life and safe riding. Tubes are circular-moulded—tailor made to fit without wrinkling—rubber-base valve prevents air leaks.

Firestone

BEST TODAY ★ STILL BETTER TOMORROW

A
PRECISION-BUILT MASTERPIECE

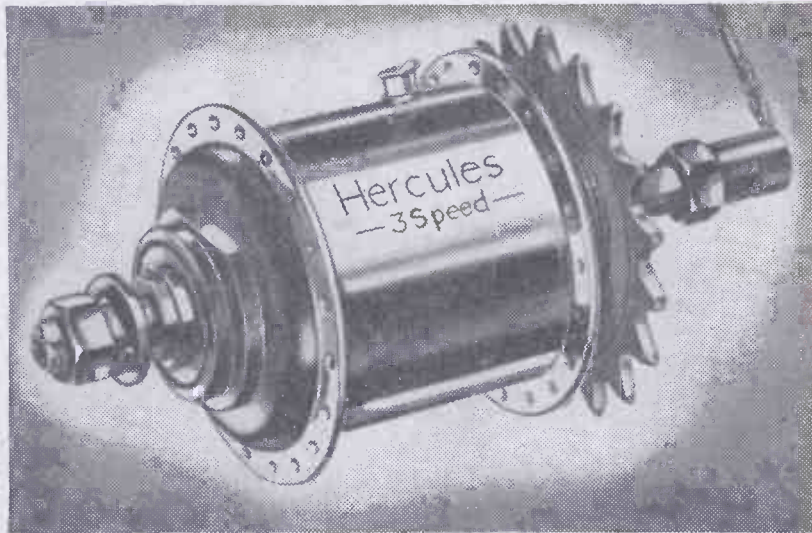

★ **Hercules** ★
3-SPEED HUB

This modern 3-Speed Hub, precision-built throughout in the famous Hercules cycle factories, has already been fitted as original equipment to many thousands of Hercules cycles and is unexcelled in performance. Now it is also available in reasonable quantities for servicing any make of cycle. See your local Dealer or write to us for name of nearest Dealer.



Manufactured solely by

THE HERCULES CYCLE & MOTOR CO. LTD., ASTON, BIRMINGHAM

CYCLORAMA

By
H. W. ELEY



Cley
Norfolk

The picturesque windmill
Now a private dwelling house
but retaining all its original
charm.

Bicycles for Christmas

ON Christmas morning, and since, what a lot of gleaming new bikes around the roads . . . many of them juvenile types, gifts from "Santa." And what joy they must have brought to the hearts of kiddies, and "big kiddies"! I cannot think of a better gift than a bike, and we should be glad that the British cycle manufacturer, by dint of hard work, good planning, and an appreciation of the home as well as the export market, managed to provide the retailers with such good quantities of cycles. I believe that the industry has a great record in these difficult post-war days, and we do well to applaud the work of its leaders, and of the men and women at the benches.

Looking Forward

YES!—forward to Easter, for it is not so very far away! And, on these March nights when the wind is chill, and I feel like an hour or two by the fireside, it is good to take down some old maps and note-books and conjure up memories of past tours and travels. Pipe we'll alight . . . the fire burning brightly . . . the old spaniel dreaming good doggy dreams on the hearth-rug . . . how good to ride, in memory, down the old roads again and recapture some of the happiness of former years. That ride to Devon, with memories of old Wiltshire and Somerset towns and villages; that good tour in the Lake district, when we entered into the magic land of mountains and tarns, of noble sheets of water, tree-fringed and unsurpassed in loveliness; that year when the call of the road took us to the homely little towns and hamlets of East Anglia . . . to the land of Constable and Gainsborough, to quiet lanes, down which good Suffolk punch horses ambled with great waggons which reminded us of "The Hay Wain." And then there was the memorable year when we cycled, a goodly little party of us, into Central Wales, to the beauties of Radnor and Montgomery—and we recall how we loved the hillsides, dotted with Welsh sheep, and the rowan trees, with the berries like rubies, glistening in the morning sun. Yes! not at all a bad plan to have a "touring evening" by the fireside . . . and make plans for Easter!

Salute to Spring

WHATEVER the weather may be in the mad month of March, my calendar tells me that, officially, spring commences on March 21st . . . so I salute the new season and vow that I will at an early date sojourn out into the countryside and search for the virginal snowdrop in some grassy dell, and find joy again in the golden gorse which spangles the common—that hardy bloom which is with us almost all the year round, however bleak may be the wind on the heath and however the snow may fall. And soon it will be catkin time, and we may rejoice again in the purplish buds of the alders down by the stream and in the yellowish catkins of the willow which hangs so gracefully over the water's edge. Yes, salute to spring!

The Benevolent Fund

FOLLOWING the big propaganda drive to secure new members, my good friend Heysom, the general fund organiser, tells me that good results have been achieved, and that there is a new and lively interest being displayed in the fund and its operation. At the moment, as is fairly well known, the membership is not open to non-manual workers in the cycle and motor trades, but this phase of the matter has, I know, received very careful thought, and possibly some day the scope of the fund will be extended. In any case, it is a fund worthy of loyal and good support, and I am proud to have served on the committee which aimed at making its good work more widely known. And in Heysom, working with my old friend A. H. Dawson, the fund has a great stalwart.

Proud Moment

IT was at the recent benevolent fund ball, held at the Lyceum—and it was a proud moment for me, because I met Mrs. A. J. Wilson, the widow of the founder of the fund. My friendship with her goes back over many, many years, when her late husband was the chief of the famous Wilson Agency, which handled so many motor and allied accounts in the advertising world. Mrs. A. J. W. looked well . . . and how delighted she was to renew contacts with

some of the associates of her late husband! "Faed" will never be forgotten in the business . . . and long may his widow survive as a link with grand old days!

Does Cycling Get a Fair Deal?

I HAVE written on this question before, and recently, at a club dinner, I was talking to my neighbour at the table and it cropped up again. Do the newspapers tend to ignore cycling as a national movement? My good dinner neighbour was emphatic that they do, and mentioned how much space, even in these difficult days, they manage to give to other pastimes and hobbies and interests; well, it is a point of view, but I must not enter into any controversy on the matter; I could wish, very strongly, that more space could be devoted to cycling and cyclists . . . and I do not forget that we number some 10 to 12 millions! Let us leave it at that.



Camber Castle
Surrey

On the edge of the wild Romney Marshes this now ruined Castle once quelled Rye from sea attacks by the French. Note the marks of the original sea level can be plainly seen on the outer stone work.

My Point of View

By "WAYFARER"

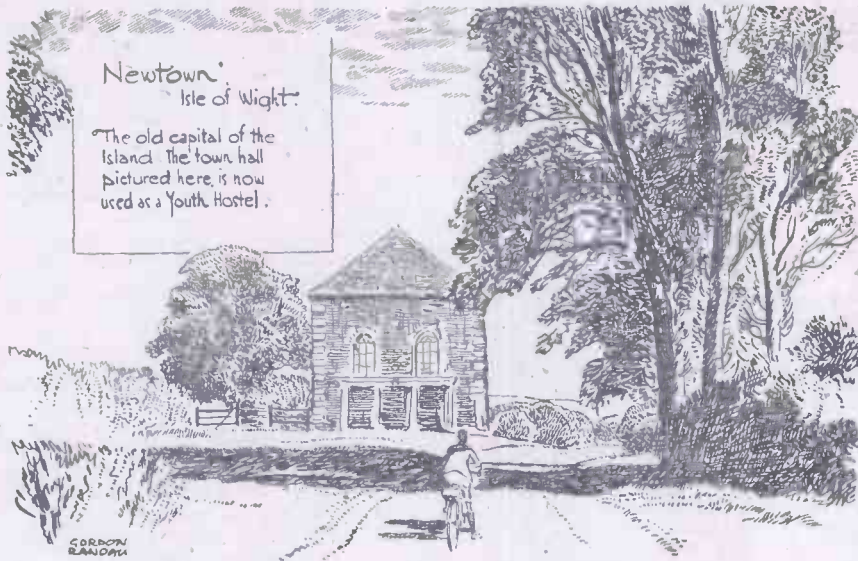

Desperate Remedy

THERE was a transport strike in the great city which I ornament with my presence, and enrich through the medium of taxation, and the circumstances constrained a bright lad to write to the local newspapers to express his thanks to the strikers, because, through the absence of buses, he "discovered a long-lost joy—a sharp walk in the crisp morning air." This unwonted (if compulsory) spot of exercise caused him to find greater pleasure in eating, and, when he went to bed, he slept the sleep of the just. I am not sure whether this is not all very pitiable. There is no law against taking exercise, and how much better thousands of people would be, men and women alike, if they made a point of walking or cycling to and from their work or, if the distance is too great, walking or cycling part of the way. I write as a practical exponent of the gospel I preach, and I know from years of experience how much I owe to the bicycle and to my two legs, in the way of health, convenience, money-saving and comfort—and, in the cold weather, of blood-circulation—and, as regards cycling, the time saved.

Medicine

BECAUSE of a late start, I went by almost the direct route to my destination, intent on having a farmhouse tea. It was a bleak day, which stung bare knees, bit gloved fingers, and had a watery effect on eyes and nose. Nevertheless, I enjoyed the outing, and rode fast, wherever possible, in order to maintain circulation. The route chosen was a hilly one—the hilliest leading out of the city containing my dwelling-place—so that plenty of foot-stamping was available. The sun went off duty in a wonderful blaze of colour, and my farmhouse was reached in the greyness of the gloaming. The front door, "made-up" (as they say in this part of the country) for the night, was quickly opened, and the lack of fire in the dining-room was atoned for by the introduction of two paraffin lamps, which provided both light and heat. Nevertheless, the temptation to linger for very long after an excellent tea was absent.

... And Jam

FOR a moment or two, I found that the night was extremely dark, but my eyes gradually became used to the conditions, and it was quite easy to see. Sitting secure behind my gas lamp I made good progress, and, when the murk which was strewn across the sky moved away and revealed a marvellous display of stars, the sable night was toned down. I had earned the tail wind which was now my portion, and the bleakness that had characterised the afternoon was thereby mitigated. Over deserted roads and lanes I forged steadily ahead, meeting next to nothing, and thoroughly enjoying the seclusion. I climbed up through the hooded valley which so often falls to my portion, and topped the high hills forming a rampart between the farmhouse and my home. Then, instead of going straight ahead towards the myriad of twinkling lights which, at night-time, mark the great city of my dwelling-place, I made an extension to my route, using lanes even more tortuous

than those I had already traversed. It was an easy ride—"jam" after the "medicine" of the afternoon—and I felt well content on docking, with an exact half-century of miles (17 and 33) to my credit.

The Lonely Inn

CONSCIOUS of a great urge to spend a night at the Lonely Inn, which stands in an elevated position in the Welsh Marches (and which, last August Bank Holiday, provided me with an excellent lunch), I wrote and obtained accommodation. Incidentally, the expedition would enable me, who am always frivolous in these matters, to celebrate the advent of November and the arrival of the occasion for putting back the clock. Actually, too, I had a business call to make on my way to the Lonely Inn, and it was difficult to discern any other method of achieving this visit except at considerable expense.

I am at present living in such a hectic whirl that there was no time to go into the question of distance, though a glance at the map suggested that the ride was well within my compass. For one deplorable moment I dallied with the prospect of accepting railway aid, but side-tracked the idea. Railway aid without speed is, in my view, useless, and no speed was available. The journey ultimately proved how foolish it would have been to cram my "dollars" into the maw of a rapacious train, the direct distance being a trifle over 60 miles. I fought the wind to Bridgnorth and through Corvedale; I went off the normal route to make my call, and was there given a nice tea, which was some consolation for missing the man I wanted to see, and then, in the darkness of the night, with a promise of rain, I completed my journey, climbing steadily to the Lonely Inn.

A grand wood fire, and a company of six young people grouped about it, provided a satisfactory welcome, and it was not long before I was "doing my stuff" with an excellent array of food—very hot soup, roast goose and the usual etceteras fruit tart and custard, and biscuits, butter, and cheese, with coffee to follow. The Lonely Inn I found to be a curious old place, built below the road, which is on a level with the upper floor. Actually, at the end of a long passage, from which the bedrooms open, is a door straight on to the road. There are odd corners and bends, and I took home with me evidence that one of these had "got in my way"! The machine which normally makes the electric light was on strike, and small paraffin lamps abounded. The Lonely Inn contains two bathrooms, each with "h. and c." Before retiring for the night I walked abroad in the pouring rain, and was struck by the intense silence and the loneliness—two things I sought. Then, in this dead but consoling quietude, I climbed into bed, blew out the paraffin lamp, and went to sleep, being disturbed only by what I took to be the scurrying of mice in the rafters above me.

Sunday was what people would call a "bad" day. It rained and it blew, and, as the day grew older, the conditions worsened. As I had to call again on the man I had missed, my homeward route was dictated for me—in part, at any rate. Otherwise, I would have "made a ride of it," despite the unpleasant weather conditions.

I called to see the man, and was given lunch. Then, with marked generosity, my friend (an old cyclist) offered to give me a lift over the long hill facing his house, which he told me would take me 20 minutes' walking time. I accepted this offer. My bicycle was put on the luggage-rack of his car, and in less than five minutes I was on the ridge. With the wind helping me I flew down the other side, and went steadily onwards, changing my plans from minute to minute. Ultimately I had tea in Bridgnorth, and then commenced a three-hour ride in the dark, with the hope of being home by 9 p.m., as usual. It was a very black night, and the rain was sousing down with energy worthy of a better cause. But in less than half an hour a change came over the scene. The wetness ceased, the clouds rolled off, and millions of stars came out, causing the blackness of the night to melt away. So, with 60 miles on the tally (plus 66 miles for the previous day) I arrived home on the dot of nine, well content with my expedition to (and from) the Lonely Inn.

Suicide Pact!

A FEW years ago there was a movement, which I considered rather unreasonable, to interfere with cyclists who carried things (thus to some extent hampering their movements) on their machines. The gardener was going to be forbidden to carry a scythe when riding a bicycle; the roadman was going to be told that he must not carry a shovel as he rode to his work, and so on. I viewed these efforts at interfering with the convenience of what we call the working-classes (and others) with some concern and annoyance, it seeming to me that the powers-that-be were tackling an aspect of the road problem in the wrong way—as usual. The whole thing ultimately fell to the ground, or perhaps it was that the coming of the war put it into cold storage, where it will remain until the interferers decide to trifle with the idea again.

The matter was revived in my mind a few days ago, when I was in the pleasant Warwickshire town of Nuneaton. There I saw—and it must be admitted that I was rather horrified at the sight—two men on bicycles carrying a ladder between them. There is not much in that perhaps, but it was the method which appalled me, for the head of each man was thrust between the rungs, one at either end of the ladder, and thus they progressed along a main suburban road bearing a fair amount of mixed traffic. For a moment I wondered whether I was in the presence of a suicide pact, it appearing to me that, if anything untoward happened, one of the men (both, perhaps) might easily break his neck. The two men pedalled gently out of my life, and I can only hope that they both survived a practice which *did* appear to me to be really risky. Possibly, however, they had had years of practice at the job and knew exactly what to do if danger threatened.

We Oddities

ON the whole, I am prepared to believe that we cyclists are, in a way, oddities. We—some of us, anyhow—go out in very hot weather, and pretend to enjoy the conditions. We go out in very cold weather, when the fireside possesses such allurements, and we come back and talk about the grand day it has been. We go out on wet days and windy days, and thus flaunt our "queer idea of pleasure." We are strange creatures who actually cycle in the dark, when, as is well known, "you can't see anything." We spurn the comfort and convenience of bus and tram for our workaday journeys, preferring to splash through the (sometimes) filthy conditions of the winter—preferring to get wet and dirty—preferring to mix ourselves up with congested traffic. We do all these things—and survive. And not only do we survive, we are actually all the better in health for our method of living. Yes, we are confessed oddities.

There are a few greater oddities among us. One of these, in my view, is the cyclist who believes in carrying a mirror on his handlebar and thinks we should all do the same. He asserts that the mirror is indispensable, although he carefully refrains from saying what happens when—or if—he is riding in the rain, and the mirror is concealed under his cape. Moreover, does the mirror possess any real value in the dark? Then there is the oddity who loads up his bicycle with all the latest gadgets, including bits of leather round the hubs, a motor horn, a speedometer, and a "Stop" sign. There is the oddity who thinks that the use of the bell by cyclists should be forbidden—who thinks that to ring your bell savours of dictatorship, meaning "Get out of the way!" It may be suggested here that the wise cyclist always carries a bell, but uses it as little as possible. There are occasions when a bell is indispensable. It means anything but dictatorship; it means nothing more than "I'm here. Sorry to disturb you, but may I come along?" And there is the oddity who seriously suggests that the problem of road accidents at night-time would be solved if all our roads—the whole 170,000-odd miles of them—were flood-lit. That suggestion has actually been made in print. Obviously, it was made without the slightest thought, and it always seems to me that a moment's consideration of the proposal from the expense point of view—ignoring all other aspects of the matter—would be sufficient to condemn it. Were it desirable to flood-light all our roads—and I, personally, consider it highly undesirable and deplorable—the expense would stand in the way.

"Practical Mechanics" Advice Bureau COUPON

This coupon is available until March 31st, 1948, and must be attached to all letters containing queries, together with 3 penny stamps. A stamped, addressed envelope must also be enclosed.

Practical Mechanics March, 1948

Published about the 31st of each month by GEORGE NEWNES, LIMITED, Tower House, Southampton Street, Strand, London, W.C.2 and Printed in England by W. Spearlight & Sons, Ltd., Exmoor Street, London, W.1. Sole Agents for Australia and New Zealand—Gordon & Gotch (A/sia), Ltd. Sole Agents for South Africa—Central News Agency, Ltd. Subscription Rates (including postage): Inland, 10s. 6d. per annum. Abroad, 10s. per annum. Canada, 10s. per annum. Registered at the G.P.O. for transmission by Canadian Magazine Post.

CONDITIONS OF SALE AND SUPPLY: This periodical is sold subject to the following conditions, namely, that it shall not, without the written consent of the publishers first given, be lent, re-sold, hired out or otherwise disposed of by way of Trade except at the full retail price of 6d.; and that it shall not be lent, re-sold, hired out or otherwise disposed of in a mutilated condition or in any unauthorised cover by way of Trade; or affixed to or as part of any publication or advertising, literary or pictorial matter whatsoever.

A Fine Set

The verdict of many satisfied constructors using the famous **DORSET** Circuits.

NOVICE or **EXPERT**. These circuits are **TOPS**. Each manuscript contains very detailed instructions, easy to read black and white drawings, point to point wiring, every step and stage described. **NO RADIO EXPERIENCE** necessary.

DORSET 2/6 CIRCUITS

A.C. or A.C./D.C. 5-valve three-wave superhet. with pick-up.
ALL DRY BATTERY PORTABLE.
 4-valve, med. and long.
BATTERY FOUR. Three-wave superhet. 14 or 20 volt valves. (A real humdinger on short).
 A.C./D.C. 6-valve **AMPLIFIER** for mike and pick-up, inc. pre-amp.

DORSET COMPONENTS

specially designed for above.
 Chassis, Coil packs, Group Boards, I.F. Transformers, Chokes, Mains Transformers, Speakers, etc.
 "Hot Spot" battery soldering outfits.
 Send 1d. for list. Theoretical circuits, 2d. each.

WELDONA

RADIO ACCESSORIES LTD.
 38, Gloucester Road, BRIGHTON.

CHEMISTRY APPARATUS

Send Stamp for
COMPLETE PRICE LIST



Special Offer
 Bunsen Burner
 Tripod and Useful Glassware
 12/6
 Post Paid.

(Scientific Dept. A)

BECK 60 HIGH STREET,
 Stoke Newington, London, N.16

NO MAN CAN KNOW TOO MUCH OF HIS PRODUCT

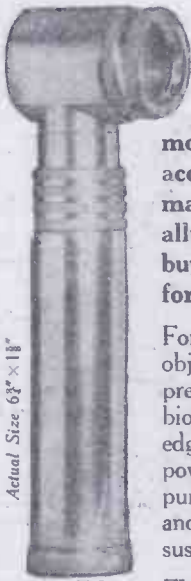

Actual Size 3 1/2" x 1 1/2"

BRITISH MADE

The Ultra Lens is a revealing eye of six actual diametrical—36 area magnifications, which brings out points of strength or weakness, and enables the most minute measurements to be gauged accurately. Whether you are engaged in manufacturing, buying or selling, it is an ally of real value. No instrument you can buy will more quickly justify and pay for itself.

For the close scrutiny of every conceivable object, metals, tools, fabrics, fibres, minerals, precious stones, paint, print, manuscripts, biological and botanical specimens, cutting edges, fractured surfaces, raw materials, powders, granules, and innumerable other purposes, the **ULTRA LENS** is invaluable, and presents in many instances hitherto unsuspected data which can be used to advantage.

FULL PARTICULARS ON REQUEST.

The Ultra Lens Company,
 75, Finsbury Court, Finsbury Pavement,
 London, E.C.2.

MATRIC.

WHY needlessly handicap yourself and watch other people winning success and security? Whatever your age, you can now prepare for the all important Matriculation Examination at home on "NO PASS—NO FEE" terms. Write now for our valuable "GUIDE TO MATRICULATION" which explains the easiest and quickest way to matriculate—FREE and without obligation.

BRITISH TUTORIAL INSTITUTE.
 (Dept. 160), 356, Oxford Street,
 LONDON, W.1.

"NO PASS—NO FEE"

The Hallam
 "Super" Aero Petrol Engine

EASILY MADE FROM OUR CASTINGS.
J. HALLAM & SON
 UPTON, POOLE, DORSET.
 MINIATURE PETROL ENGINES for
 Aeroplanes, Boats and Race Cars.
 Send 3d. for list.

DURALUMIN AND ALUMINIUM SHEETS

Duralumin 36 in. x 24 in., 7/-
 24 S.W.G. 48 in. x 36 in., 12/-
 72 in. x 36 in., 15/-
 Aluminium 3 ft. x 2 ft., 12/-
 20 S.W.G.
 On all above add 2d. per sq. ft. carriage.
 Inquiries invited for various sections.
COMPETITION CARS, LTD. The
 Old Millers, Nayland, Nr. Colchester,
 Essex. Tel.: Nayland 394.

BOOKS:
 L.N.E.R. Nameplates ... 2/-
 L.M.S. Loco Ref. Book ... 3/-
 "Planning & Layout" ... 3/-
 "Two Rail Electrification" ... 3/6
 L.B. & S.C.R. Locomotives ... 3/6
 "Miniature Building Construction" 8/6

LINESIDE BUILDING KITS:

Footbridge	00	0
Signal Cabin	2/9	-
Loco Shed	4/-	-
Shops and Flats	7/6	-
Country Station	8/6	-
Public House	10/-	-
Public House	11/6	-

Postage extra. "00" or "0" Parts List
 3d. per post.

TYLDESLEY & HOLBROOK (L.E.A.)
 109, DEANSGATE, MANCHESTER, 3

PERSPEX WORKERS!
 "Eliminate irksome filing and turn out improved work on your own JOINTER and SHAPER. In one operation it will make an edge dead straight and square. EASILY CONSTRUCTED. No hard-to-get materials needed. Outlay should not exceed 1/-. Clear Drawing and Instructions—2/6, post free. Satisfaction Guaranteed."
T. SINCLAIR
 2, PAXTON TERRACE, EYEMOUTH
 BERKSHIRE.

1 pint Spray Guns	£3 10 0
4 pint Spray Guns	£8 0 0
3 C.P. Compressors	£9 10 0
6 C.P. Twin Compressors	£22 10 0
Air Chambers with Gauges	£3 10 0
6in. Saw Benches	£10 0 0
Heavy Duty Jig Saws	£20 0 0
Air Hose, V. Belts, Pulleys, Gauges, Valves, etc.	

Illustrated Lists.
H. HALL, 2, Glamis Way, Greenford, Middlesex.

The WINCH

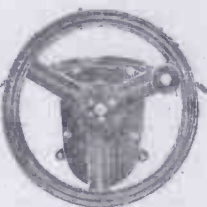

Geared hand wheel, with positive drive to jin. Flexible Steel Cable. Suitable for adapting to: Wire Strainers, Light Winches, Clothes Line Strainers, Street Lamp Winches, Children's Car Steering Wheels, Boat Steering Wheels, Centre Board Winches, Sail Winches, and many other uses.

Inquiries welcomed from Manufacturers and Wholesalers interested in large quantities. Send 7/- p.o. for sample, with wire.

JOHN DOWNTON & CO., 89 HIGH STREET, EPPING, ESSEX

Sets of **CLEAR DIAGRAMMS** and **INSTRUCTIONS** for making **EASILY WORKSHOP BENCH, SAW BENCH, LADDERS, STEPS, LATHE STANDS, WIND CHARGER MASTS** from "L" section **METAL** (obtainable at Zero Cost). Price 4/6. Posted promptly. As advertised.—P. Robert, Les Buittes, Torteval, Guernsey, C.I.

The Institute of Practical Radio Engineers have available Home Study Courses covering elementary, theoretical, mathematical, practical and laboratory tuition in radio and television engineering; the text is suitable coaching matter for I.P.R.E. Service entry and progressive exams; tuition fees at pre-war rates—moderate. The Syllabus of Instructional Text may be obtained, post free, from the Secretary, 20, Fairfield Road, Crouch End, N.8.

SAILOR SAM'S SECRET

How to make

SHIPS IN BOTTLES

COMPLETE KITS, 5/6 and 6/-. from all good-class Model, Sports and Toy Stores
GOOPER - CRAFT, LTD.
NORWICH ENGLAND

WANTED. Loose copies. Good condition. "Practical Mechanics," Volume 9. Any reasonable offer accepted.—Roberts, 10, Queen Street, Shephed, Loughborough.

SPARKS' DATA SHEETS

Provide detailed descriptive matter and Full-size Constructional Print of Designs Tested and Guaranteed by
L. ORMOND SPARKS

NEW DESIGNS:

THE "OLD FOLK'S TWO."
 An A.C./D.C. 2-Valve Plus Rect. for those who cannot be bothered with tuning. 3 Station Selection by Switch. L/M Waves. 31 Watts O/Put. Pre-set Tuning and Reaction ... 2/9
THE "CUB." A Fine Little A.C./D.C. 2-Valve, Plus Rect. M/L Wave receiver. Powerful, Inexpensive and Simple to Build. 31 Watts. Good response... 2/6
THE "CADET" A.C./D.C. **AMPLIFIER.** The youngest addition to my famous range of Amplifiers. A full 31 Watts Output. Vol. and Tone Controls. Good Quality. Ideal for P.U. ... 2/6

The above form another example of why Sparks' Data Sheets lead the way. They provide the designs commended by critical constructors and the Trade.

A SELECTION of my 37 Designs available in Data Sheet form. Send Stamp for Full List. Components and Speakers in Stock.

THE "CHALLENGER" PORTABLE. An Amazing A.C./D.C. Portable. 3-Valve plus Rect. M/L Waves. Fine Power and Quality. No A. or E. needed ... 2/9
A.C. TWO-VALVE (Plus Rect.) M/L Waves. 31 Watts Output ... 2/6
A.C. THREE-VALVE (Plus Rect.) T.R.F. Circuit. M/L Waves... 2/9
A.C. SUPERHET. 3 Valves plus Rect. All-wave. 4 Watts Output... 2/6
A.C. 3 WATT QUALITY RADIO-GRAM. A.C. M/waves only. Quality rather than range. P.P. Neg. F/Bk. 3.6
BATTERY ALL-DRY PORTABLES. Tiny Two. Med. waves. Local station on 2in. Speaker ... 2/6
THREE-VALVE PORTABLE. M/L Waves. A very popular Set ... 2/6
THE PORTABLE FOUR. Med. waves only. T.R.F. Circuit... 2/6

MANY OTHER DESIGNS for Sets and Amplifiers available. Please include stamp with order. Prompt Service.

L. ORMOND SPARKS (M).
 9, Phoebeth Road, Brockley, S.E.4
 (Nearest Station: Ladywell, S.R.)
 (Phone: Lee Green 0220.)



PERFECT PASTIMES FOR PLEASURE AND PROFIT

Crinoline—Cellulose Acetate—Parchment—Plastics—Lampshade Frames and Patterns—Raffia—Plastic Leather—Toys Models—Materials, tools and fittings for Crafts that are different.

Send 1/- for copy of the Magazine **CRAFTWORKER** (includes full price lists)

HOME CRAFTS (Dept. 2), Albion Street, Broadstairs, Kent.

TARGET LATHE TOOL GRINDING JIG

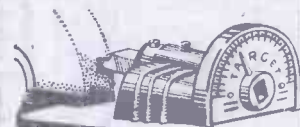

The Target Tool Grinding Jig gives correct Lathe Tool Grinding Angles, with clean-cut sharp edges impossible to obtain by free-hand grinding.

10/6 (S.A.E. for illustrated Leaflet) FROM YOUR RETAILER

OR POST FREE FROM—
TARGET Manufacturing Co., Dept. P.M., Wollaston, Wellingborough.

"PERIMET" ELECTRODE SOLDERING AND BRAZING TOOL

Operates from 4 or 6 Volt Accumulator or Transformer.

Price 15/-, post free.
MAINS TRANSFORMER, 3 Heats. 35/- delivered.
HOLBOROW & CO., 71, Weymouth Bay Avenue, Weymouth.

Free Guide - "Success in Engineering"

One of the following Courses taken at home in your spare time can definitely be the means of securing substantial promotion in your present calling, or entry into a more congenial career with better prospects.

ENGINEERING, AERO, ETC.

Plastic—Radio—Aero Engines—Aircraft Design—Welding—Aerodynamics—Electrical Engineering—Television—Electric Wiring—Talking Picture Work—Generation and Supply—Works Management—Metallurgy—Refrigeration—Planning. Estimating. Rate-fixing—Time and Motion Study—Aero Inspection—Automobile Engineering—Sheet-metal Work—Engineering Draughtsmanship—Aero Draughtsmanship—Jig and Tool Draughtsmanship—Press Tool and Die Draughtsmanship—Structural or R/F Concrete Draughtsmanship—Sanitary Engineering

GENERAL

Matriculation—College of Preceptors—Chartered Institute of Secretaries—Aircraft Apprentice.

MUNICIPAL SERVICE

School Attendance Officer—Handicraft Teacher—Registrar—Housing Manager—Sanitary Inspector—Weights and Measures Inspector—Inst. of Mun. and Cy. Engineers—A.R.I.C.S.

THE BUILDING BOOM— SECURE YOUR SHARE!

The Free Guide also gives particulars of our extensive range of modern Building and Structural Courses, Building Draughtsmanship, etc. The great post-war Building programme offers unlimited prospects to technically trained men.

BECOME A DRAUGHTSMAN QUALIFY AT HOME AND EARN BIG MONEY

Men and Youths urgently wanted for well paid positions as Draughtsmen, Inspectors, etc., in Aero, Jig and Tool, Press Tool, Electrical, Mechanical and other Branches of Engineering. Practical experience is unnecessary for those who are willing to learn—our Guaranteed "Home Study" courses will get you in. Those already engaged in the General Drawing Office should study some specialised Branch such as Jig and Tool or Press Tool Work and so considerably increase their scope and earning capacity.

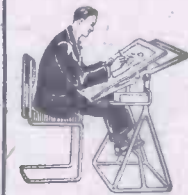

NATIONAL INSTITUTE OF ENGINEERING

(Dept. 29)

148, HOLBORN, LONDON, E.C.1

OVER SIXTY YEARS OF
CONTINUOUS SUCCESS

SOUTH AFRICAN BRANCH: E.C.S.A. P.O. BOX 8417 JOHANNESBURG.

FOUNDED 1885—FOREMOST TODAY—OVER 100,000 SUCCESSES

"PRACTICAL ENGINEERING" said—

We recommend all readers interested in improving their position to apply for a copy of this valuable book. "Success in Engineering" is not a pamphlet. It is a 132-page book, containing valuable and vital information on all branches of engineering. . . . There are many engaged in engineering who owe their success to The National Institute of Engineering.

The FREE GUIDE explains:

- Openings, prospects, salaries, etc., in Draughtsmanship, Inspection, and opportunities in all other branches of Engineering and Building.
- How to obtain money-making technical qualifications through special RAPID FULLY-GUARANTEED COURSES.

Write now for your copy of this remarkable publication.

A.M.I.E.E., A.M.I.Mech.E.,
A.M.Brit.I.R.E., A.M.I.P.E.,
A.M.I.C.E., A.M.I.Struct.E.,
A.M.I.Mun.E. M.R.San.I.,
A.M.I.S.E., A.F.R.Ae.S.,
London B.Sc., Degrees.

Fully guaranteed postal courses for all the above and many other examinations. Fully described in the Free Guide.

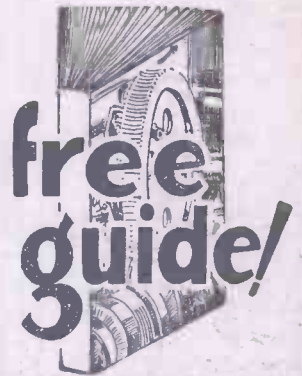

THE ACID TEST OF TUTORIAL EFFICIENCY SUCCESS—OR NO FEE

We definitely guarantee that if you fail to pass the examination for which you are preparing under our guidance, or if you are not satisfied in every way with our tutorial service—then your Tuition Fee will be returned in full and without question. This is surely the acid test of tutorial efficiency.

If you have ambition you must investigate the Tutorial and Employment services we are able to offer. Founded in 1885, our success record is unapproachable.

Why not fill in and post the attached Coupon NOW for further details and Free Authoritative Guide to openings in Engineering and Building? This book contains a mine of valuable and exclusive information and may well prove to be the turning point in your career.

PROMPT TUTORIAL SERVICE GUARANTEED

FREE COUPON

To NATIONAL INSTITUTE OF ENGINEERING
(Dept. 29), 148, Holborn, London, E.C.1.

Please Forward your Free Guide to

NAME

ADDRESS

My general interest is in: (x) ENGINEERING
(2) AERO (3) RADIO (4) BUILDING (Place a cross against
(5) MUNICIPAL WORK the branches in which
you are interested.)

The subject or examination in which I am especially interested is

To be filled in where you already have a special preference.
(i.e. stamp only required if unsealed envelope used.)