

*Palin*

THE MODEL ENGINEER EXHIBITION

NEWNES

9<sup>D</sup>

# PRACTICAL MECHANICS

EDITOR: F. J. CAMM

OCTOBER 1946

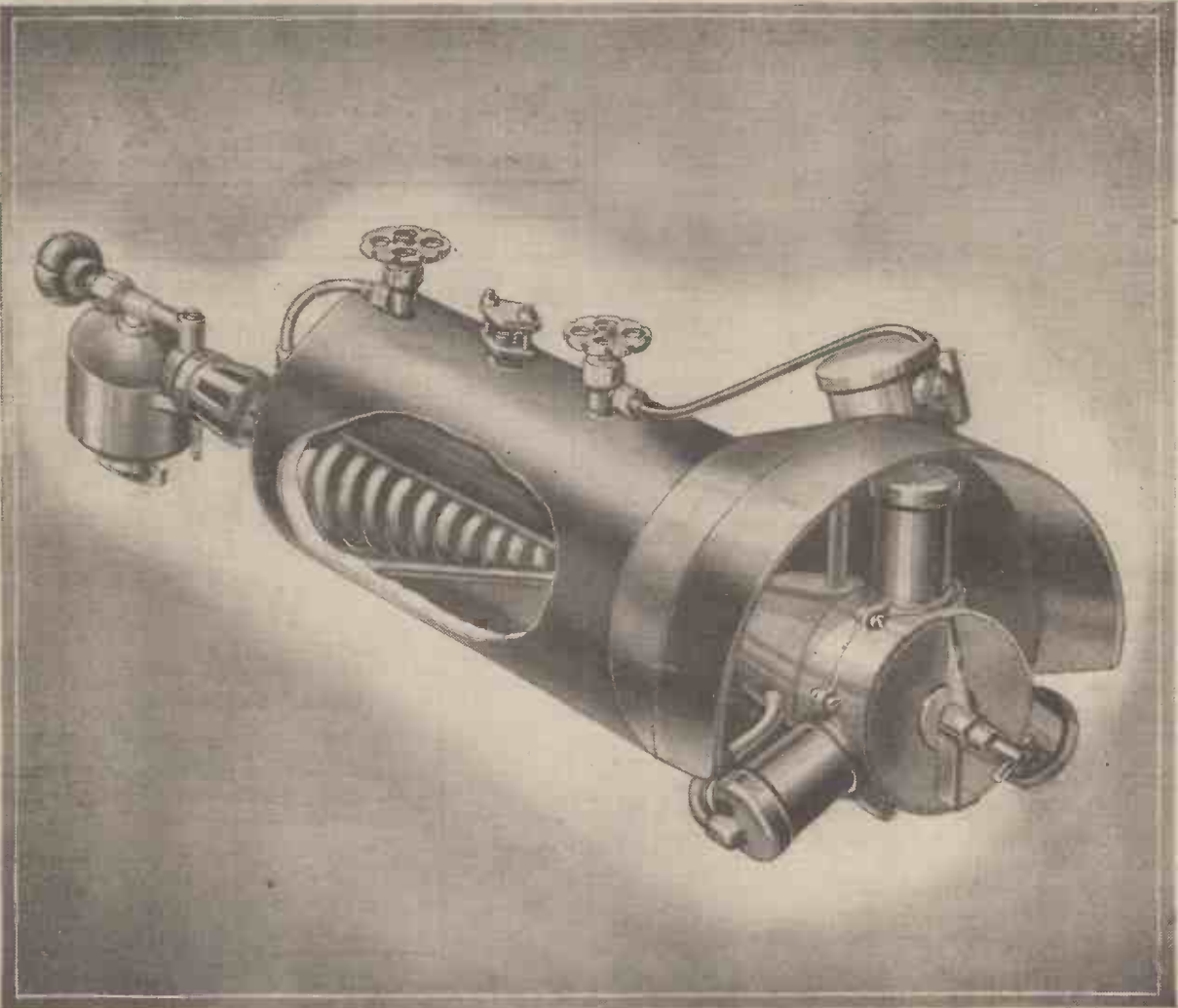

A GENERAL VIEW OF F. J. CAMM'S FLASH STEAM PLANT (See page 6)

# Join the Well-paid Ranks of the I.C.S. TRAINED MEN

THERE IS ALWAYS A GOOD POSITION FOR THE MAN WITH A SPECIALIZED TRAINING, BUT THERE'S NO WORTH-WHILE PLACE FOR THE UNTRAINED

Ambitious men everywhere have succeeded through I.C.S. Home Study Courses. So also can you. We offer you the benefit of our 55 years' matchless experience as the creative pioneers of postal instruction. Since our establishment in 1891, more than 1,000,000 British men and women have enrolled for I.C.S. Courses.



The man with an I.C.S. Training in any one of the subjects listed below knows it thoroughly, completely, practically. And he knows how to apply it in his everyday work.

- |                                  |                           |                          |
|----------------------------------|---------------------------|--------------------------|
| Accountancy                      | Cotton Manufacturing      | Motor Mechanic           |
| Advertising                      | Diesel Engines            | Motor Vehicle Elec.      |
| Aeronautical Engineering         | Draughtsmanship           | Municipal Eng.           |
| Aero Engine Fitting              | (State which branch)      | Plastics                 |
| Aero Fitting and Rigging         | Drawing Office Practice   | Plumbing                 |
| Aeroplane Designing              | Electrical Engineering    | Quantity Surveying       |
| Air-Conditioning                 | Electric Power, Lighting, | Radio Engineering        |
| Aircraft Eng. Licence            | Transmission, Traction    | Radio Service Eng.       |
| Architecture                     | Eng. Shop Practice        | Ry. Equip. & Running     |
| Architectural Drawing            | Fire Engineering          | Refrigeration            |
| Boilermaking                     | Free-Lance Journalism     | Salesmanship             |
| Book-keeping                     | Fuel Technology           | Sanitary & Domestic Eng. |
| Building Construction            | Garage Management         | Scientific Management    |
| Building Specifications          | Gas-Power Engineering     | Sheet-Metal Work         |
| Business Training                | Heating and Ventilation   | Steam Engineering        |
| Business Management              | Hydraulic Engineering     | Structural Steelwork     |
| Carpentry                        | Hydro-Electric            | Surveying                |
| Chemical Engineering             | Joinery                   | (State which branch)     |
| Chemistry, Inorganic and Organic | Machine Designing         | Telegraph Engineering    |
| Civil Engineering                | Machine-Tool Work         | Telephone Engineering    |
| Clerk of Works                   | Marine Engineers          | Textile Designing        |
| Colliery Examiner's              | Mechanical Drawing        | Welding, Gas & Elec.     |
| Colliery Overman's               | Mechanical Engineering    | Woodworking Drawing      |
| Commercial Art                   | Mine Surveying            | Works Engineering        |
| Concrete Engineering             | Mining Electrical         | Works Management         |
|                                  | Motor Engineering         |                          |

And most of the Technical, Professional, and Matric Exams.

If you need technical training, our advice on any matter concerning your work and your career is yours for the asking—free and without obligation. Let us send you full information regarding the subject in which you are specially interested. DON'T DELAY. Make ACTION your watchword.

The successful man DOES to-day what the failure INTENDS doing to-morrow. Write to us TO-DAY

Use this Coupon

**INTERNATIONAL CORRESPONDENCE SCHOOLS LTD.**  
Dept. 95, International Buildings, Kingsway, London, W.G.2.

(Use penny stamp on unsealed envelope)

Please send me particulars of your courses in.....

Name..... Age.....  
(USE BLOCK LETTERS)

Address.....

Addresses for Overseas Readers

- Australia: 140, Elizabeth Street, Sydney.  
Egypt: 40, Sharia Malika Farida, Cairo.  
India: Lakshmi Bldgs., Sir Pheozsha Mehta Rd., Fort, Bombay.  
New Zealand: 182, Wakefield Street, Wellington.  
South Africa: 45, Shortmarket Street, Cape Town.  
Palestine: 33, Mamillah Rd., Jerusalem.



THE "FLUXITE GUINS" AT WORK  
"Hurry! Oh, hurry! Please do, Our clock's got the jitters," cried OO,  
Yelled OI "It's all right—Hand me in the FLUXITE and stop making that hulla-balloo!"

For all SOLDERING work—you need FLUXITE—the paste flux—with which even dirty metals are soldered and "tinned." For the jointing of lead—without solder; and the "running" of white metal bearings—without "tinning" the bearing. It is suitable for ALL METALS—excepting ALUMINIUM—and can be used with safety on ELECTRICAL and other sensitive apparatus.

With Fluxite joints can be "wiped" successfully that are impossible by any other method.

Used for over 30 years in Government works and by leading engineers and manufacturers. Of all Ironmongers—in tins, 10d., 1/6d. and 3/-. Ask to see the FLUXITE POCKET BLOW LAMP, price 2/6d.

TO CYCLISTS: Your wheels will NOT keep round and true unless the spokes are tied with fine wire at the crossings AND SOLDERED. This makes a much stronger wheel. It's simple—with FLUXITE—but IMPORTANT.



THE "FLUXITE" GUN puts "FLUXITE" where you want it by a simple pressure.  
Price 1/6 or filled 2/6.

ALL MECHANICS WILL HAVE

## FLUXITE

IT SIMPLIFIES ALL SOLDERING

Write for Book on the ART OF "SOFT" SOLDERING and for Leaflets on CASE-HARDENING STEEL and TEMPERING TOOLS with FLUXITE. Also on "WIPE JOINTS." Price 1d. Each.

FLUXITE LTD., Dept. P.M., Bermondsey Street, S.E.1

## A Welder for Every Home!!!!

THE MOST USEFUL ELECTRIC ARC WELDER IN EXISTENCE. A HUNDRED USES.

WELDS!! BRAZES!! SOLDERS!!

Efficient!!!

Light Weight!!!

Portable!!!

Durable!!!

Practical!!!

Sturdily Constructed!!!

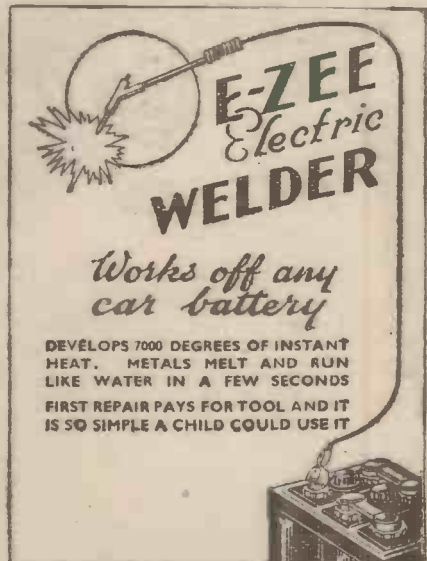

DEVELOPS 7000 DEGREES OF INSTANT HEAT. METALS MELT AND RUN LIKE WATER IN A FEW SECONDS  
FIRST REPAIR PAYS FOR TOOL AND IT IS SO SIMPLE A CHILD COULD USE IT

RETAIL 32/6 PRICE

Two Carbons and Welding Wire included. With Full Instruction Leaflet. SEND CASH OR CHEQUE TO

**DACO LTD. (Dept. P.M.1.),**  
4, BUCHANAN BUILDINGS, HOLBORN, LONDON, E.C.1.

Sole Mail Order Distributors. Registered Collector of Purchase Tax.  
BANKERS: MARTINS.

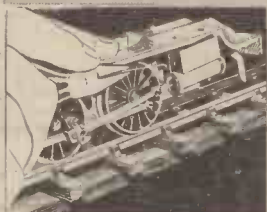

DETERMINING POSITION & SIZE OF VALVE CHEST PORTS

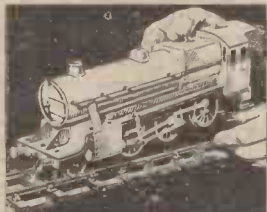

SLIDING THE SPIRIT LAMP INTO POSITION

**BUILD THIS REAL  
'LIVE' STEAM LOCO  
NOW!**

In 30 hours it is possible to build from a set of finished parts, the famous Bassett-Lowke, Gauge "O" Steam Mogul. Price £10 7s. plus £2 5s. Purchase Tax, including a fully illustrated book on how to build it.

**WRITE FOR**

"Laying Model Permanent Way," price 3d. "How to Build a Traction Engine," price 6d. "Abridged Catalogue Gauge "O" Model Railways (G/I2), price 6d.

**BASSETT-LOWKE LTD.  
NORTHAMPTON**

LONDON: 112, High Holborn, W.C.1. MANCHESTER: 28, Corporation St.

**NEW UNIVERSAL  
SPRAY GUN**



**75/-**

**complete**

Special Hoover connector 3/6 extra.

- Portable, Powerful, Light-weight Highest Efficiency.
- Operates Off Any Standard Vacuum Cleaner.
- Precision Built Throughout of First-class Materials.
- Any One Can Operate It.
- Handles Anything From Paint to Insecticide.
- An Investment For Long Trouble-free Service.

Send remittance with order—The "Crystal" Spray Gun, complete with instructions, will be forwarded by return, post free.

**THE DOMESTIC SUPPLY CO.  
341, REGENT'S PARK ROAD,  
LONDON, N.3.**

*The* **NEW  
MEDIUM FOR  
MODELLERS**

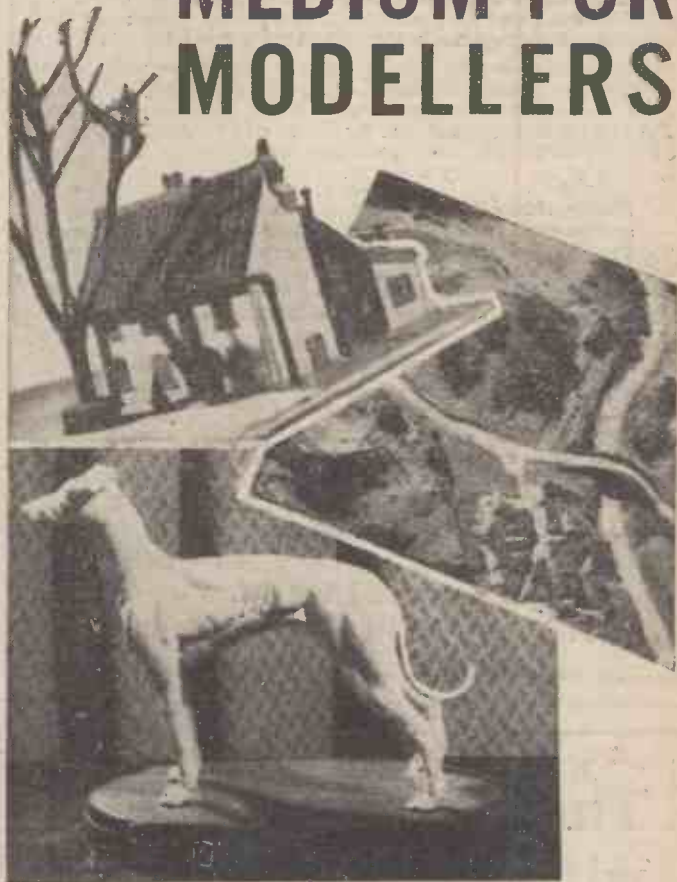

Above are three widely different models made from one material — PYRUMA.

This plastic, ready-to-use medium becomes stone hard on air-drying or baking. It can then be sized and painted with poster colour or enamels.

PYRUMA is inexpensive and obtainable in tins from ironmongers, hardwaremen, artists' and handicraft shops.

Send 1d. stamp to the address below for illustrated instruction sheet on PYRUMA modelling methods.



Write :  
Dept. 4,

**J.H. SANKEY & SON, LTD.**

ILFORD

EST. 1857

ESSEX

# OPPORTUNITIES IN PLASTICS

A most Informative handbook entitled "OPPORTUNITIES IN PLASTICS" is now available for distribution. This guide discusses in considerable detail the prospect of careers in all branches of the Plastics Industry—knowledge required, salaries, possibilities of promotion, and so on—and explains how you may prepare for these opportunities through our modern, home-study courses.

We specialise In Plastics training and our courses are authoritative, up to date and comprehensive. The range of our tuition is wide, covering **Elementary Instruction in Basic Subjects, PLASTICS TECHNOLOGY, coaching for the CITY AND GUILDS EXAMINATIONS,** and specialised instruction in such specific branches of the industry as:

Plastics Mould Design, Plastics in the Paint, Varnish and Lacquer Industries, Plastics Costing and Estimating, Plastics for the Aircraft Industry, Plastics for the Electrical Industry, Plastics for the Building Industry, Plastics in Sales Promotion, Plastics in Textiles, Designing in Plastics, Synthetic Rubber Technology, etc.

All courses are conducted under a guarantee of

## "SATISFACTION OR REFUND OF FEE"

"OPPORTUNITIES IN PLASTICS" will be sent on request, free and without obligation. The book contains so much useful information and guidance that whatever your interest in Plastics may be, you should make a point of writing for your copy at once.

**BRITISH INSTITUTE OF PLASTICS TECHNOLOGY**  
4, SHAKESPEARE HOUSE,  
17, STRATFORD PLACE, LONDON, W.1

## The way to success with snapshots

Use only those chemicals upon which you can rely. Follow the instructions given by the makers and, if your exposures are correct, you will get perfect results.

### AZOL for the negatives

A concentrated one-solution developer. All you have to do is to add water. With each bottle comes a simple set of Time and Temperature tables for developing plates or films in tanks by daylight, or in dishes in a dark room.

### UNIVERSAL for the prints

Universal is a concentrated M-Q developer which only needs the addition of water. Used for Gaslight or Bromide prints it will give you sparkling results. It contains the two new chemicals—142, for brightening prints, and 326, for even flowing.

## FOR THE FIXING

USE JOHNSON LIQUID ACID-HARDENING FIXING  
ENSURES COMPLETE FIXATION. PREVENTS FRILLING

Ask your dealer for Scales Brand Chemicals

JOHNSON & SONS MANUFACTURING CHEMISTS LTD.  
HENDON, N.W.4 ESTABLISHED 1743



*Leytool*  
PRECISION  
HAND  
DRILL

Price  
**23/6**

Prov. Patent No.  
20987/44

Write for interesting pamphlet giving details of 42 sizes of "Leytool" Ratchet Spanners —another "Leytool" superior job.

If any difficulty in obtaining from your local Ironmonger or Tool Store, send your order direct, or write for fully descriptive leaflet.

**LEYTONSTONE JIG & TOOL CO., LTD.,**  
LEYTOOL WORKS, HIGH ROAD, LEYTON, LONDON, E.10

Telephone: Leytonstone 5022-3

It's really  
**A PLEASURE  
TO USE**  
this

## NEW DRILL

Away with your old, awkward out-of-date hand drill brace! Get your hand on this new "Leytool" drill and feel the difference in the perfect balance, the comfortable hand grip and the smooth, easy action. Turn the handle and note the steady power produced by the precision-cut gears, and the ease with which it does its job without the need for the slightest body pressure. Here is a noteworthy improvement in design on all previous hand drills... a precision-made tool without compare.

Solid one-piece die-cast body.

All gears accurately cut and totally enclosed, requiring absolute minimum of exertion. (Maximum power is obtained by rotating slowly.)

Accurate self-centring chuck.

Takes drills up to 1/2-inch diameter.

Chuck spindle and jaws are hardened and tempered to resist wear.

Self-lubricating bearings, obviating necessity for oiling.

Ball thrust race takes the drilling pressure.

If you use solder it will  
cost you no more to use

## ERSIN MULTICORE

The **FINEST** Cored Solder  
in the World

Contains 3 cores of extra active non-corrosive Ersin Flux. No extra Flux required.

The solder that was used for making high precision soldered joints in radar and other vital equipment. Nominal 1 lb. reels and 6d. cartons available from most electrical shops and ironmongers.



### SIZE 2 MULTICORE CARTONS 6d.

Each carton contains sufficient Ersin Multicore Solder to make over 200 average joints on radio and electrical equipment.

NOMINAL 1 LB REELS HIGH TIN CONTENT PRE-WAR QUALITY				
Catalogue Reference No.	Alloy Tin/Lead	S.W.G.	Approx. length Nominal 1-lb. reel	Price per nominal 1-lb. reel
16014	60/40	14	64 feet	6/-
16018	60/40	18	178 feet	6/9

Samples free of charge upon request.

## MULTICORE SOLDERS LTD.

MELLIER HOUSE, ALBEMARLE ST., LONDON, W.1

Tel.: REGENT 1411 (P.B.X. 4 lines)

**"COMPTON" SPRAY-PAINT EQUIPMENT**  
FOR CELLULOSE, SYNTHETIC OR LEAD PAINTS



MARK II H, With Hermetic Sealing Arrangement. Price for 30-45lbs. Supply, **£2 1s. 6d.**



MARK IV, Round or Flat Spray. Fast and Economical. This Gun and Mark II H available for High or Low Pressure Air Supply.



Price, **£8 1s. 6d.** complete

Mill Hand-Operated Outfit, Approx. Height of Pump is 2ft., Approx. Weight of outfit is 22lbs.

FROM YOUR TOOLSHOP OR DIRECT LEAFLETS AND DETAILS ON APPLICATION

**DAWSON, McDONALD & DAWSON**  
COMPTON WORKS, ASHBOURNE, DERBYSHIRE

**MYFORD**

**Post-War Lathes**

Type ML7, first of the new Series of MYFORD Lathes to go into production, is a 3 1/2" heavy duty, screw-cutting Lathe, built to close limits and representing outstanding value.

All Myford Products are distributed through recognised Tool Merchants.

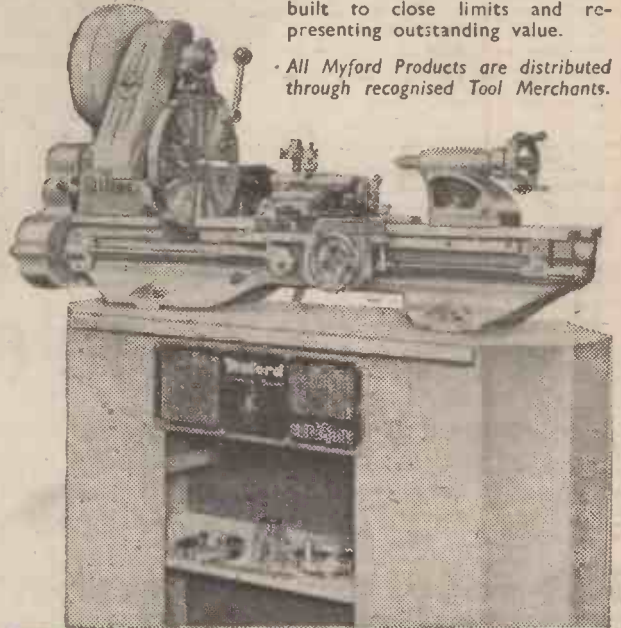

**MYFORD ENGINEERING COMPANY LIMITED**  
BEESTON · NOTTINGHAM · Phone: 54222 (3 lines)

78-105

**A World-wide Reputation!**

IN 1903 Mr. S. G. Brown invented the rightly famous S. G. BROWN Type "A" Headphone. This type is still acclaimed as the finest and most sensitive headphone procurable.



Type "A"

Radio Amateurs desiring maximum reception results over all wavebands, coupled with quality reproduction and highest possible efficiency should ask their dealers for a pair of S. G. Brown Type "A" Headphones.

**TYPE "A" Adjustable Reed Movement** .. .. . 5/6

For a less expensive pair of headphones, which will also give excellent results, ask for the S. G. Brown Type "F" Featherweight Price .. .. . 23/-

**S.G. Brown, Ltd.**

Telephone : ACOrr 5021  
VICTORIA ROAD, NORTH ACTON, LONDON, W.3

**IT'S THE MOVEMENT THAT COUNTS**

No. Three

*Talk on Torque*



The Smith electric clock movement has a coil encircling a magnetic rotor. This gives the rotor torque of considerable power and constancy. That is why Smith 'Sectric' Clocks are so eminently dependable. Jewellers, Electricians and Stores will soon be able to supply you from a variety of models.



**SMITH SECTRIC**  
CLOCKS

PLUG IN TO  
GREENWICH TIME

Scientific S.C.M. 46 G

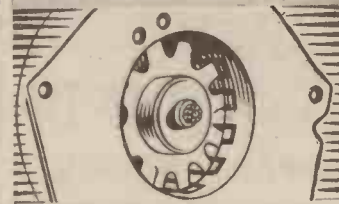

# "ENGINEERING



# OPPORTUNITIES"

## PREPARE FOR COMPETITION—NOW!

As the Engineering Industry swings into its peace-time stride, the inevitable competition for the secure and well-paid posts will return. It is the man who stands out from the rest because he is *technically trained* who will be in the happy position of taking over the more responsible, more secure, and better paid positions. "**ENGINEERING OPPORTUNITIES**" will show you how to get this all-important technical training quickly and easily in your spare time. This 100-page book is full of valuable information and explains the simplest way of preparing for recognised Examinations. Among the courses described are :

### MECHANICAL ENGINEERING GROUP

A.M.I.Mech.E. City & Guilds General Mechanical Eng. Diesel Engines Draughtsmanship & Tracing Works Management Press Tool Work Pattern Making Foundry Practice	Estimating Foremanship Jig & Tool Design Viewing & Inspection Welding Sheet Metal Work Maintenance Eng. Metallurgy Refrigeration
---	--

### COMMERCIAL ENGINEERING GROUP

A.M.I.P.E. Commercial Eng.	Cost Accounts Languages
-------------------------------	----------------------------

### CIVIL ENGINEERING GROUP

A.M.I.C.E. Inst. Mun. & Cy. Engineer A.M.I.Struct.E. M.R.San.I. Sanitary Inspector Specifications Structural Design	Road Eng. Hydraulics Municipal Eng. General Civil Eng. Structural Eng. Reinforced Concrete Railway Eng.
---	---

### SURVEYING AND BUILDING GROUP

A.R.I.B.A. F.S.I. A.M.I.H. & V.E. L.I.O.B. F.A.I.	Costing & Valuations Heating & Ventilating Clerk of Works Surveying & Levelling Building (all branches)
---	---

### ELECTRICAL ENGINEERING GROUP

A.M.I.E.E. City & Guilds General Electrical Eng. Alternating Currents Power House Design Traction Mains Eng.	Electricity Supply Electrical Meters Electrical Design Illumination Installations Telegraphy Telephony
--	--

### WIRELESS GROUP

A.M.Brit.I.R.E. City & Guilds General Wireless Short-Wave Wireless	Advanced Wireless Radio Servicing Television Talking-Picture Eng.
---	--

### AUTOMOBILE ENGINEERING GROUP

A.M.I.A.E. M.I.M.T. City & Guilds I.A.E. Repair Certificates	General Automobile Eng. Garage Management Electrical Equipment High Speed Diesels
---	--

### AERONAUTICAL ENGINEERING GROUP

A.F.R.Ae.S. R.A.F. (Maths.) Pilots' Licences Ground Licence	Aero Engines Navigators' Licence Aeroplane Design Meteorology
--	--

### UNIVERSITY DEGREES

London Matriculation School Certificate	University Entrance Intermediate B.Sc.
--	---

**WE DEFINITELY GUARANTEE**

**"NO PASS—NO FEE"**

If you are earning less than £10 a week you cannot afford to miss reading "**ENGINEERING OPPORTUNITIES**"; it tells you everything you want to know to *make your future secure*, and describes many chances you are now missing. In your own interest we advise you to write for your copy of this enlightening guide to well-paid posts **NOW—FREE** and without obligation.

## BRITISH INSTITUTE OF ENGINEERING TECHNOLOGY

410A, SHAKESPEARE HOUSE, 17, STRATFORD PLACE, LONDON, W.1

**THE B.I.E.T. IS THE LEADING INSTITUTE OF ITS KIND IN THE WORLD**

## SUBSCRIPTION RATES

(including postage)

Inland	- - -	10s. 6d. per annum.
Abroad	- - -	10s. per annum.
Canada	- - -	10s per annum.

Editorial and Advertisement Office: "Practical Mechanics," George Newnes, Ltd.

Tower House, Southampton Street, Strand, W.C.2  
Phone: Temple Bar 4363

Telegrams: Newnes, Rand, London.

Registered at the G.P.O. for transmission by Canadian Magazine Post.

Copyright in all drawings, photographs and articles published in "Practical Mechanics" is specially reserved throughout the countries signatory to the Berne Convention and the U.S.A. Reproductions or imitations of any of these are therefore expressly forbidden.

# PRACTICAL MECHANICS

Owing to the paper shortage "The Cyclist," "Practical Motorist," and "Home Movies" are temporarily incorporated.

Editor: F. J. C. AMM

VOL. XIV OCTOBER, 1946 No. 157

FAIR COMMENT—

—BY THE EDITOR

## Craftsmanship

THE recent exhibition of models and small tools at the Horticultural Hall, organised by Percival Marshall, should reassure those who feel that craftsmanship in this country is dying out. The remarkable models exhibited there, most of them hand-work, indicated the versatility of those exhibitors who had in their home workshop produced these excellently finished and ingenious replicas of full-sized prototypes, as well as models of their own design. The craftsmanship is there. The desire to make things is innate; it merely needs encouragement of a sort which this exhibition gives.

Whether people in this country will ever revert to the old apprenticeship system is a matter of conjecture and concern. Many of those who exhibited models were engineers who had left the craft for one reason or another. Most of those with whom I chatted told me that they liked it as a hobby, but it did not pay as a profession and that they had found a more profitable livelihood in other industries. Most of them had done useful work during the war in munition factories. The ingenuity displayed shows that this race is abreast of all others in mechanical skill and inventiveness. If the State can give the same encouragement to inventors as it is endeavouring to give to craftsmen, our home trade and our export trade would be permanently assured. I inspected some of the ingenious inventions at this exhibition shown to the public for their delectation, but also with a sort of forlorn hope that some interested parties might take up the idea. We do not encourage inventors in this country. The machinery of the patent office, in the first place, is too slow and too costly. Only a few firms take the trouble to watch patent office specifications for inventions in their own fields. Too often an invention is purchased so that it may be killed, at least for 16 years. But there, in the comparatively small floor space of the Horticultural Hall, were the results of billions of hours of careful thought and work, new ideas, inventions, new tools, examples of that high form of intelligence which it should have been the duty of every Member of Parliament to inspect. Many did so, and I noticed not a few peers of the realm evincing great interest. If I might make one small criticism it was that far too much was exhibited in too small a space. Public interest is demonstrated by the fact that the exhibition was packed throughout its duration, and in many cases there were queues of people awaiting the removal of the "House full" notice. This was really the first public exhibition (the Gauge and Toolmakers' Exhibition was really a trade show) since 1939. There were the usual reunions of old model-makers who

had returned from the war. Club men gathered on the stand of the Society of Model and Experimental Engineers. Percival Marshall, the great-grandfather of all modelists and one who has done so much to promote good craftsmanship in this country, was there during the run of the show to advise and to encourage.

Let us hope that it presages a gradual return to those pre-war days which seem so distant now, but which have become mellowed and sanctified in our memories of those good days eviscerated by the recent holocaust.

### The Driving Tests

THE Minister of Transport proposes to reintroduce the driving tests in the autumn. These tests were first instituted by Mr. Hore-Belisha when he was Minister of Transport. The present Minister has appointed Mr. J. H. Rolt as chief driving examiner and he is also appointing supervising driving examiners in the 11 traffic areas throughout the country, together with additional supervising driving examiners in the London traffic area. The chief examiner will advise on the training of the examiners, which seems to suggest that successful candidates will be inexperienced. Surely it should not be necessary to examine an examiner? Before the war there were about 300 driving examiners who conducted about 350,000 driving tests each year. Unfortunately, the driving tests did not, as expected, materially reduce road accidents. Some of the tests amounted to mere tricks, and good drivers were failed because they did not suspect tricks.

### The Automatic Cycle Pump

SO many letters have been received asking for further details of the automatic cycle pump, exhibited on our stand at the recent Model Engineer Exhibition, that an illustrated article has been prepared and appears on page 21 of this issue; this will answer the various questions which have been raised. Although the pump has also been designed for use on motor-cars, it is unlikely that this particular adaptation will be ready for some time to come.

### The Britain Can Make It Exhibition

ALL readers should make a point of visiting the Britain Can Make It Exhibition at the Victoria and Albert Museum, as it will indicate how speedily this country has changed over from war to peace production. There are more than 20,000 separate exhibits, representative of over 50 British industries. There are not only examples of current productions but also prototypes of articles which will be in production in the

near future. There has always been a great demand abroad for British goods, and this exhibition displays the fact that in spite of the gargantuan efforts we made in the war our powers of recovery are by no means impaired. The exhibition is well laid out and the various exhibits may be inspected in orderly sequence. One fact is self-evident. We not only know how to make the goods. It shows that we know how to display them.

### Our Query Service

WILL readers please note that we have discontinued our electrical and chemical query services owing to staff shortage. Will they also please note that we cannot undertake private design work under this service. Many readers are entering business on their own account and are expecting us to design apparatus for them. This of course takes far more time than is possible under present conditions. May we ask correspondents also to be brief? In other words, to come to the point straight away?

### H. G. Wells

WITH the passing of H. G. Wells the world of science and literature loses one of the greatest men of modern times. As a writer he was no mere showman like Wilde, now dead, and one or two others now living. He was a scientist who predicted the course of events with uncanny exactitude. His *War in the Air* written towards the end of the last century, correctly forecast the military use of the aeroplane and the development of atomic power and atomic bombs. Some months before his death I drove him from his house in Hanover Terrace to a Roadfarers' Club luncheon, and during the course of that journey I learned something of the great efforts he made to ensure extreme accuracy in his books. One of his earliest was *Wheels of Chance* which was serialised in our companion journal *The Cyclist* some years ago. It is still the only cycling novel worth reading. It deals with real roads and real inns, and many a cyclist has followed in the wake of Mr. Hoopdriver and taken part in the chase of the Lady in Grey. He was one of the earliest cyclists, and it was during his fortnight's holiday on a bicycle, during the period when he was draper's assistant in Windsor, that he conceived the idea of weaving his tour into an entertaining novel, which has been through dozens of editions and has been filmed and broadcast. Although the doctors in his twenties told him that with care he might live to the age of thirty he proved them wrong by living a further fifty years. There is not a single living novelist who can take his place.

F. J. C.

# F. J. Camm's Flash Steam Plant

## Constructional Details of a Novel Power Unit for Model Aircraft

By E. W. TWINING

THE general scheme of this plant was suggested by the writer many years ago, but was never put into practical form or worked out in detail and proportion until the original flat rotary valve had been abandoned and Mr. Camm's conical D valve adopted. For reasons which will be explained later, Mr. Camm's design for the valve, which was intended for compressed air, has had to be considerably modified to meet the needs of steam conditions in the engine.

At the outset it should be stated that the whole outfit, as shown in the drawings, is fairly large, the cylinders—of which there are three—measuring 1 in. in the bore, with a stroke of 1½ in. This will involve the construction of a large model plane or boat to carry it. Now the reason why such size was adopted is that the larger such a plant is made the lower is the weight per unit of horse-power developed. Suppose, for instance, the size of the cylinders were halved, i.e., suppose the engine were made to the same dimensions as the compressed-air motor, driven at the same revolution speed at the same steam pressure, the horse-power developed would be a mere fraction of that of the larger engine, whilst in an endeavour to meet this condition of lbs. per horse-power, the weight of the steam generator, the blow-lamp, the engine and casing would have to be reduced as the cube of the scale.

### Weight and Horse-power

Let the reader make a careful scrutiny of the drawing, Fig. 1, which shows the whole layout of the plant, and having obtained a clear conception of the scheme, we will see what are the actual facts. First let us take the engine as shown; with three cylinders each of the bore and stroke mentioned. The generator is to supply steam at a pressure not lower than 150 lb. per sq. in. This should drive the engine, with a propellor of reasonable diameter and pitch, at about 1,500 revolutions per minute. At this speed and pressure the engine will develop about two horse-power and have a total weight with fuel, water and oil, of approximately 7 lb., which is 3½ lb. per horse-power.

Suppose now we make the same calculations for a steam engine of the size of the compressed air plant, namely, ½ in. bore by ½ in. stroke, we find that the power works out—on the same pressure and revolution speed—at 0.2 horse-power, i.e., one-tenth only of the larger engine. If the plant were made exactly half the size of the larger one, in every respect—thickness of boiler shell, tubing, lamp and

everything—the weight would be reduced as the cube of 2, that is to say:

$$\frac{7 \text{ lb.}}{2^3} = 0.875 \text{ lb.}$$

$$\text{Now } \frac{0.875 \text{ lb.}}{0.2 \text{ h.p.}} = 4.375 \text{ lb. per h.p.}$$

So we see that as we reduce the size of the plant, the weight per h.p. increases considerably. There is another important fact which makes matters worse, this is that there are certain parts throughout the plant from the engine to the lamp which cannot be reduced to scale, for if they were they would have insufficient strength, and so for practical reasons the complete weight would have to be about 1½ lb., which works out at 7.5 lb. per horse-power.

It is hoped that these arguments and calculations will not be found tedious, but it has been thought advisable to introduce them by way of a warning to the reader not to be led into the somewhat obvious temptation to build the steam outfit to a smaller size in order to fit it to a more handy plane.

### The Working Principle

Before dealing with the details of construction of each part it will be advisable to outline the principle on which the plant works.

Commencing with the furnace; this consists of a fuel container, which fuel is ordinary petrol, a needle valve for regulating the supply, three nipples or nozzles of the size which is standard for small blow-lamps, a three-ported shutter covering the nipples, the object of which shutter will be explained later, and a perforated mixing tube.

The steam generator consists of two parts: (1) A shell boiler fitted with two water tubes and a safety valve, and (2) a flash coil of steel tubing. Now the shell boiler does not supply steam to the engine, but is utilised only to generate pressure and deliver the water contained in the shell, at the said pressure, to the flash coil, where it is converted into steam which passes to the engine. In all steam plants previously made the water to

the flash coil was supplied from a tank under air pressure. Not only was the water cold, but the delivery pressure varied from perhaps 100 lb. at the start to practically nil before the water had gone. In the present case, as the pressure in the shell boiler will be 150 lb. per sq. in., the water will pass to the flash coil at a temperature of about 350 deg. F. and, so long as any water remains in the shell, the pressure will be constant. A wheel valve is provided for regulating the water supply to the coil.

It will be seen from Fig. 1 that a second wheel valve is fitted on the top of the boiler shell. A pipe from this leads to a small tank containing lubricating oil, which oil is delivered in minute quantities to the cylinders of the engine. Although the lubricant is more or less injected into the ports from the valve face, it has not to be forced in against steam pressure from the flash coil, but as there will be some exhaust steam to contend with, it will be necessary to have pressure at the back of the oil, hence the arrangement shown.

At the present stage the engine does not call for description, the principle being much the same as that of the compressed-air model. But there is one feature in the plant which must be referred to. It will be obvious that as the control of the fire and water will pass out of the hands of the operator as soon as the machine begins to fly, some means must be provided to guard against the possibility of burning the flash coil through evaporation of all the water before the fuel is consumed.

### Synchronising Water and Fuel

It would be possible by actual test to so time these two, by putting a definite quantity of fuel into the tank, that the petrol is all consumed just before complete evaporation of the water, but as the same fuel is required to first raise steam, perhaps from the cold, in the shell boiler, one cannot be always sure that the two will be emptied at the same time, so the shutter or extinguishing valve has been devised, shown in Fig. 1, which when suitably operated will cover, all together, the three nozzles of the burners. The method operating this shutter is simple; the propellor spindle is so designed that it withdraws from

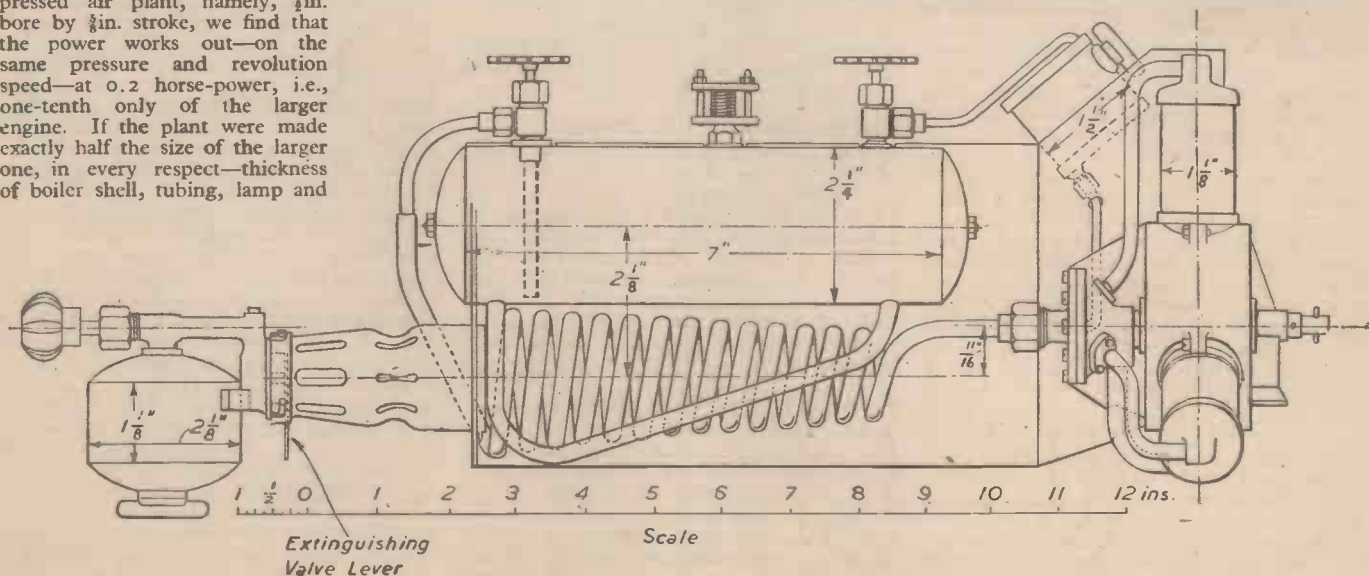

Fig. 1.—The complete layout of the plant.



the tubular propellor shaft in order to allow the airscrew to free-wheel. The spindle will carry a revolving disc, and when the propellor and discs are being driven by the engine there will be a small roller, carried on the end of a spring-loaded lever, running on the periphery of the disc. The lever is attached to a light shaft which will run along to the burners. At the burner end there will be another lever engaging with the arm on the extinguishing valve.

So long as steam is passing to the engine it will drive the propellor, but as soon as the engine stops, from lack of water in the flash coils, the air drag of the propellor will cause the spindle to slide in its bearings, the roller will pass off the disc and the spring referred to will cause the levers at both ends of the shaft to move; the one at the fire end will operate the extinguishing valve, so shutting off the petrol gas, and thus save the destruction of the dry flash coil.

**Heat Insulation**

In order to protect the machine from the heat of the furnace, the whole of the steam generator is to be encased in thin sheet metal and this is to be well lined with asbestos cardboard. The end of the mixing tube of the blow-lamp will be introduced through a hole at the end of the casing opposite to the centre-line of the coil. At the other, the engine end, the casing is divided to form three openings, each of which will come opposite to the three cylinders. Thus, the cylinders will have circulating around them the hot gases as they leave the furnace or firebox, and so the losses from condensation until the steam has done its expansive working will be reduced to a minimum.

It will be seen, therefore, that throughout the plant the thermal efficiency should be high, and the only trouble likely to be experienced is the possible carbonisation of the lubricating oil. Nothing of this sort is anticipated if a good high-temperature oil is used.

**The Engine**

Coming now to practical details we will commence with the engine. This is shown by

two sectional drawings in Fig. 2, that on the left-hand side being through the centre line of the crankshaft, and that on the right a cross section through the centre of the crankcase and two of the cylinders; the third cylinder being shown entire.

In this engine no soft soldering will be permissible, everything which is not to be detachable must be silver-soldered. So, as provision must be made for assembling in an orthodox manner, the crankcase is to be made in two halves, the parting being on the circumferential centre-line, and the joint

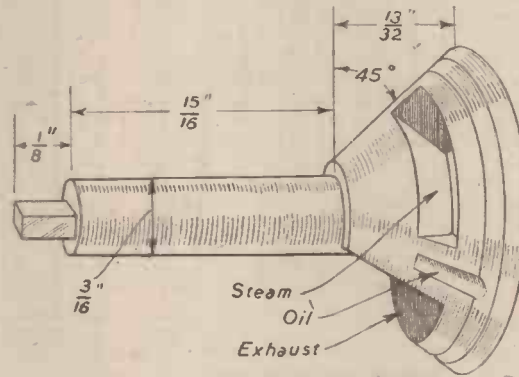

Fig. 3.—The rotary valve.

secured with six cheese-headed screws passing through lugs as shown. This arrangement provides a means of fixing the cylinders and makes it possible to assemble all the working parts—crank, connecting rods and pistons—without difficulty. Then each cylinder is passed over its piston, and the halves of the crankcase screwed together, clamping all three cylinders in place.

This end is achieved by having in each half-crankcase three cylindrical rings between the three pairs of lugs. To receive these, each cylinder has two rings silver-soldered to them, the space between the rings being a perfect fit over the half rings on the crankcase halves.

**The Cylinders**

The cylinders are made from steel tubing bored and lapped out, and the pistons, of gunmetal, are lapped into them. The pistons have no packing rings, so they must be a very perfect fit in their cylinders. To render them still less liable to leakage each has four grooves turned in them of square section. This method of packing—if packing it can be called—was adopted in the Williams and Robinson vertical tandem compound engines where, the cylinders being all in line, the piston rods passed from one cylinder into the next, without any stuffing boxes and glands, and simply had such grooves turned in the piston rods. The theory is that such small quantities of steam which may pass have to fill the first groove, then be "wire-drawn" and fill the next, then wire-drawn into the third, and so on. By the time the last groove is completed and so the steam loss is infinitesimal.

**The Valve**

As already stated, this is rotary and conical, and of much the same type as Mr. Camm's original design. A drawing showing it in perspective forms the subject of Fig. 3, which shows clearly the form of both the steam port and the oil port with its circular supply groove. This groove is kept filled with oil by a corresponding groove in the valve face, and this is supplied by a pipe taken in on one side of the valve chest, and leading from the tank, shown in Fig. 1.

The approximate position of the pipe is as indicated, but the point of entry is really immaterial so long as it clears the seatings for the flanges on the steam pipes, between the ports and the cylinders. Neither does it matter on which side of the engine the pipe enters.

In Fig. 3 the steam port, which was a cavity similar to the exhaust in the compressed air engine, is seen as a port, passing through the valve. This arrangement is rendered necessary by the oil groove which requires a completely annular outside to the valve.

(To be continued.)

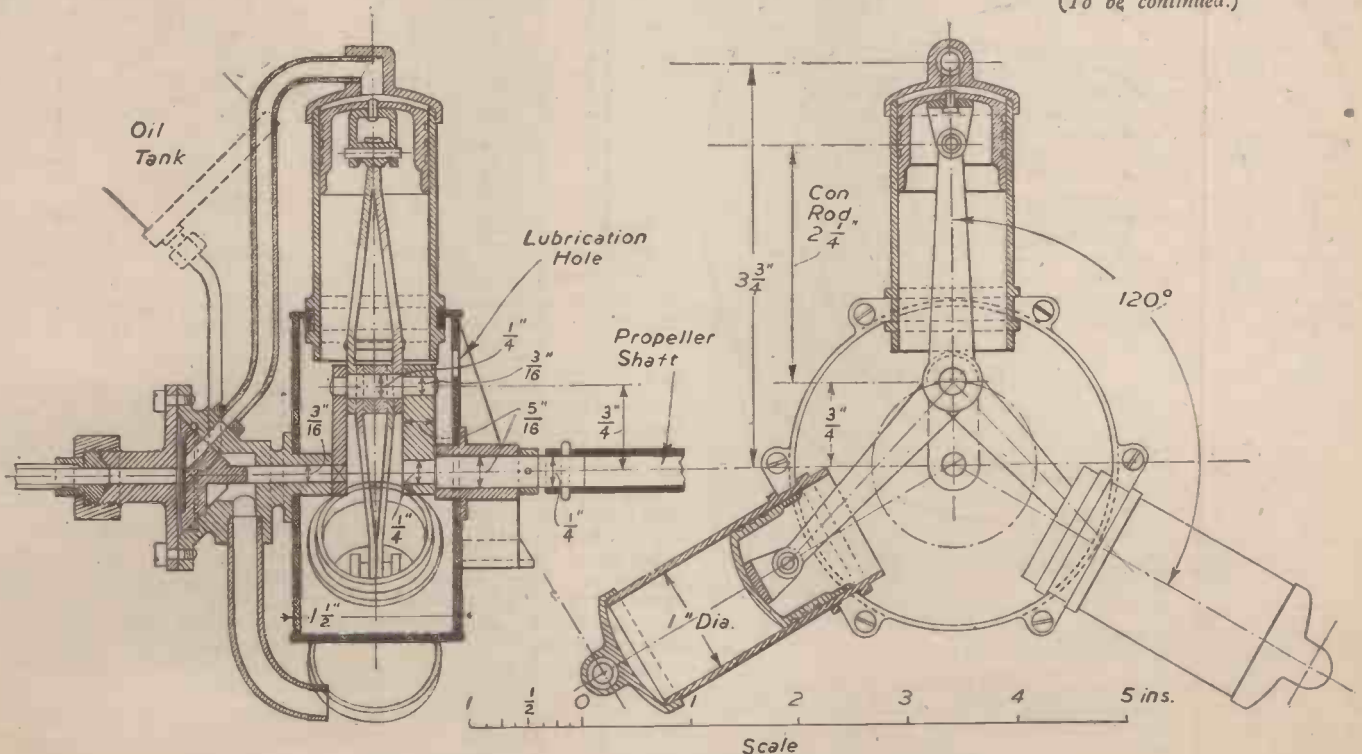

Fig. 2.—Sectional views of the engine of the flash steam plant.

# The Orffyreus Wheel

## A Suggested Solution

**A**MONGST the many "perpetual motion" devices which have been produced by harmless but well-meaning "cranks" in the past is the wheel made and exhibited by Councillor Orffyreus in 1717. Previous to this Orffyreus had constructed three other wheels of smaller diameter, but his last and largest wheel was 12ft. in diameter. This strange machine, which is illustrated in Fig. 1, is a hollow drum of very light construction, about 14in. thick and covered with canvas. Through the centre of this wheel or drum runs an axle of about 6in. diameter, terminating at both ends in iron axles of about 3in. diameter upon which the machine turns. It is on record that this wheel revolved freely at 26 revolutions per minute, and by means of a cord tied to an axle was capable of turning an Archimedeian screw for raising water. It is also stated that an official test of the machine took place from November, 1717 to January, 1718, when the room containing the revolving wheel was securely locked and the windows sealed. At the end of the test the seals were broken and the room opened, when it was found that the wheel was revolving with its accustomed regularity. Some time after this test Orffyreus, in a fit of rage, destroyed the machine, the working of which remained a mystery.

The subject of this remarkable wheel has just been revived by an interested reader, Mr. H. A. Joseph, of Epsom, who has submitted a suggested solution to the working of the Orffyreus wheel, as shown in the accompanying drawings, Figs. 2 and 3.

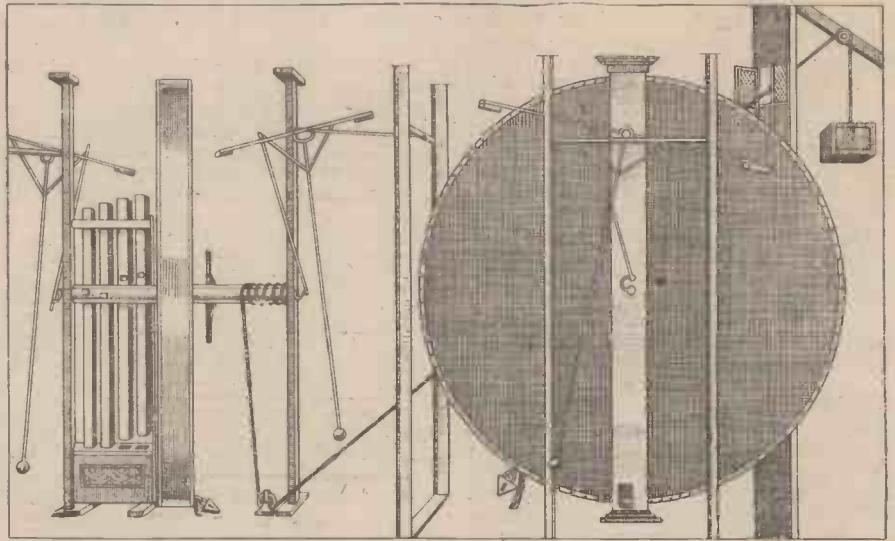

Fig. 1.—The original Orffyreus wheel (from an old print).

### Constructional Details

An axle is provided having a diameter of 2ft. and tapered so as to revolve between two centres. Fixed to this axle, and revolving with it, is a disc having a diameter of 12ft., the centre being cut out to a diameter of 2ft.

A glass tube about 1in. diameter is now bent to form a flat spiral emanating from a circle having a 2ft. diameter and extending in one revolution to 4ft. from the edge of the 2ft. circle. A second glass tube is bent to form a circle of 2ft. diameter and then to form

Sever the joint at the outer edge of the loop and insert six separate pounds of mercury so that 1lb. is in each loop and 1lb. riding in the circle of the loop round the axle. Remove air to form a vacuum and rejoin.

### Questions

Owing to the action of the spiral it would appear that the wheel starts unbalanced and remains unbalanced, and in reference to the suggested solution Mr. Joseph formulates the following questions:

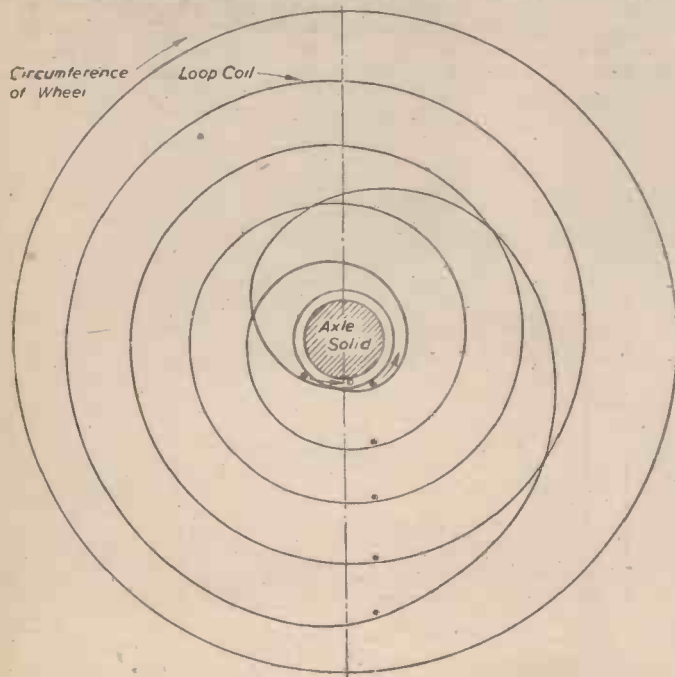

Outer Circle = Wheel  
 Inner Lines = Loop Coil - Vacuum Tube or Channel  
 Dots ..... = Liquid Weights Such As Mercury Of Equal Value  
 Wheel and Coil Without Weights = Balance  
 Wheel and Coil = Solid Unit Revolving With Axle

Fig. 2.—The suggested solution. The wheel with the coil without weights is balanced. When weights are added, and the wheel begins to rotate, the weights begin to fall, and have a velocity. Four weights are continuously descending and one weight is continuously rising. One weight is riding under the axle continuously.

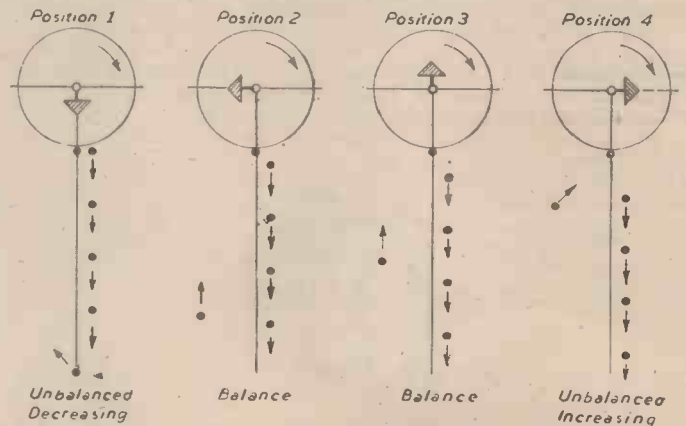

Fig. 3.—Diagram indicating the position of weights at each 90 degrees of turn of axle. (Note) When wheel is unbalanced the bias is always on the right-hand side.

a flat spiral making four revolutions, finishing at a point 4ft. from the edge of the circle.

The two spirals are now joined together, forming a continuous loop—flat except for distortion necessary to connect. The loop is now mounted and fixed to the disc.

By means of adding compensating weight the axle, disc and looped spirals are now balanced (a balanced wheel).

1. Where is the opposite or counter action when the wheel is unbalanced, as the bias appears to be always on the right-hand side of the wheel when turning?

2. What would be the altered position of the weights if the wheel is rotating at 60 r.p.m. and subject to centrifugal force?

3. With the wheel revolving at 60 r.p.m., does the lower weight ever reach the lowest point of a vertical line drawn through the centre of the wheel having regard to centrifugal force, and the fact that it reaches the edge some distance before it crosses the vertical line?

As Mr. Joseph remarks, the interest lies not so much in the solution itself—right or wrong—as in the amount of knowledge gained in trying to prove it.

# A Band-spread Short-wave Three

Constructional Details of a Simple Receiver which Brings in Many Stations at Good Loudspeaker Volume

By F. G. RAYER



Fig. 1. — Three-quarter front view of the Band-spread Short-wave Three.

THE circuit of this receiver is shown in Fig. 5, and it will be seen that it is a 1-V-1 arrangement. The R.F. stage is untuned, and although this does not give quite so much gain as a tuned stage would, it is nevertheless worth while. Its use removed aerial damping and obviates the necessity of ganging two circuits—a particularly difficult matter with band-spreading—as would be necessary if it were tuned. Plug-in coils are used, so that any wavelength can be tuned, and to remove resonant peaks and loss of reaction upon the limits of the tuning ranges a resistor is used in place of the normal reaction choke. V.M. volume control is used, and a parafeed A.F. transformer for maximum gain and stability.

It will be found that the receiver is simple to operate and that many stations can be received at really good loudspeaker volume if a fair aerial is used. For DX listening, 'phones will be used. The band-spreading capacitor has a reduction drive and enables stations with little frequency separation to be individually logged against dial readings.

### Constructing the Receiver

The top of chassis layout is shown in Fig. 2. This is very straightforward, and there is very little wiring—only the two leads from the band-spread capacitor and the anode and pre-set leads. The lead from the pre-set goes to the grid of the R.F. valve. The anode lead goes to tag 1 of the coil holder, and the bandspread capacitor is connected in parallel with the .00015 mfd. component below the chassis.

The chassis used in the original receiver was 10in. by 8in. by 2½in. deep. It was made from three-ply, except for the two side runners, which are of thicker wood to permit of the top, back and front runners being screwed to it. Before screwing the top sheet of ply in position, a sheet of copper foil is placed upon it so that the runners hold it in position. The 6 B.A. screws holding the valve holders, etc., will also help to retain the foil in position. This foil is earthed via the mounting bracket of the band-spreader.

### Component Layout

Fig. 4 illustrates the wiring and component layout below the chassis. The reaction capacitor has a small internal reduction drive to facilitate operation, although this refinement is not absolutely necessary and an ordinary component can be used. The 50,000 ohm potentiometer has an internal 3-point switch and is wired so that when switching on volume is at a minimum, further

movement increasing volume. If the reverse proves to be the case, the two connections to the outside ends of the potentiometer element should be changed round.

For accurate logging the band-set capacitor should have a very exact type of pointer, close to a dial, so that it may be accurately set. If this is not done, the readings of the band-spreader will be modified, and the very accurate logging possible will not be achieved. Because of this, it is best to contrive a catch which engages with notches filed in the surface of the control knob adjacent to the chassis, or to use one of the special band-set capacitors if this can be obtained.

The earth terminal on the rear runner may be in direct contact with the wood, but the speaker terminals should for preference be insulated with paxolin washers. The small stand-off insulator forms the aerial connection.

### Wiring Details

Wiring should be with a fairly stout gauge of tinned copper wire, insulated sleeving being added where necessary. Wiring con-

nections should be run approximately as shown, and particular attention given to those in the tuned circuit. Long connections here will reduce the minimum wavelength tunable, and connections from the band-setter should be direct to the coil holder, not via other connections.

All the battery leads are made from flex and are taken out through a hole in the rear

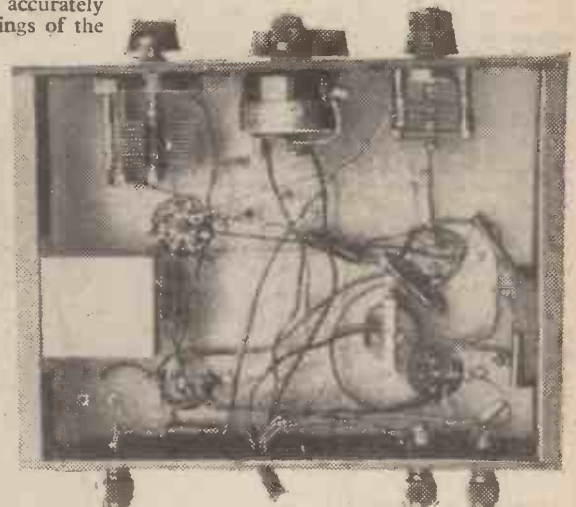

Fig. 3.—Sub-chassis view of the Band-spread S.W. Three.

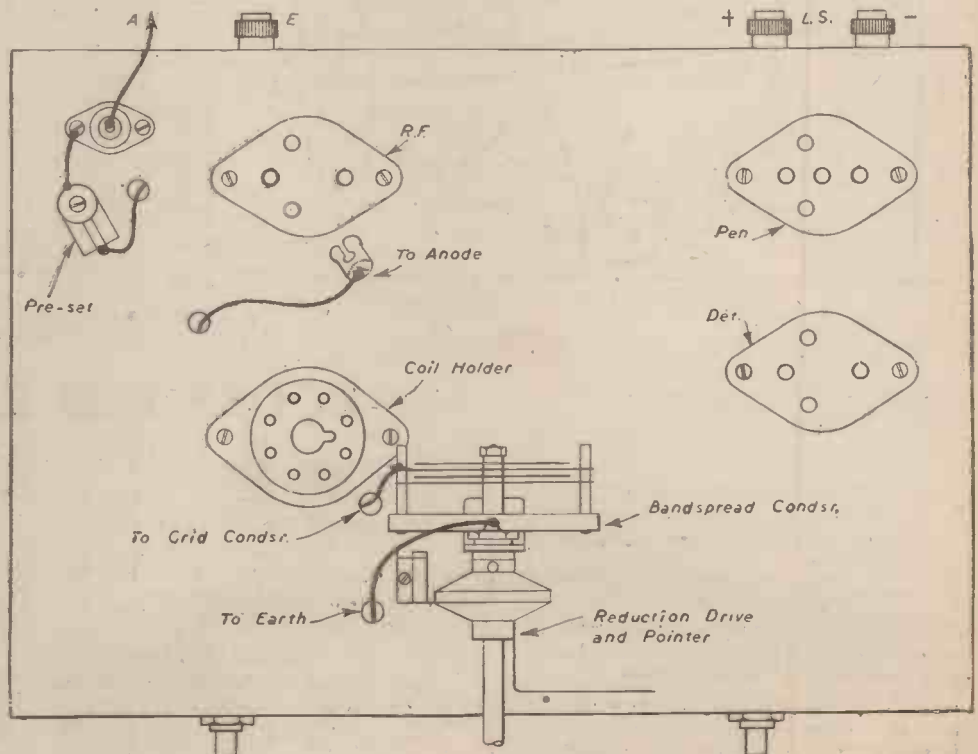

Fig. 2.—Top view of chassis, showing layout of components.

runner. They may then be fitted with identifying connectors and twisted together.

**Coupling Condenser**

The .05 mfd. coupling capacitor should for preference be of mica insulation, and is screwed to the side runner. The 1 mfd. component is screwed to the other runner, and all other small parts are suspended in the wiring. A knot should be made in the G.B. 4½-volt lead, so that the thin connection from the parafeed transformer will not be pulled adrift. Connections for the transformer are not shown, as they vary with different makes and are usually marked on the component.

**Using the Receiver**

Batteries should be connected as shown for the initial trial, and the coil for 22-47 metres will probably be best for the first test. Actually, the layout enables this coil to tune down to 19.2 metres, when efficiency will be high. All tuning is done with the band-spreader, and it should, of course, have a dial upon the front of the cabinet in which the receiver is housed, although this cannot be shown by the illustrations.

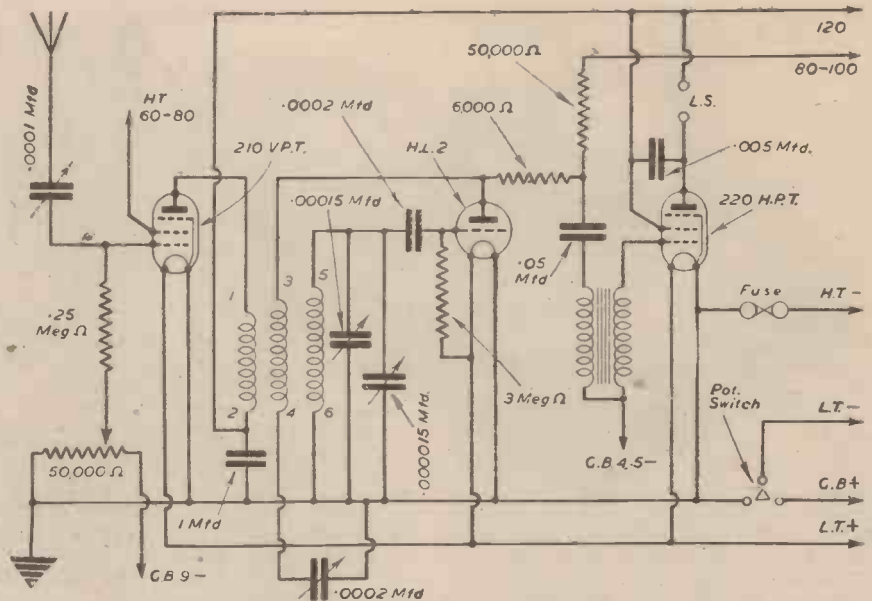

Fig. 5.—Theoretical circuit diagram.

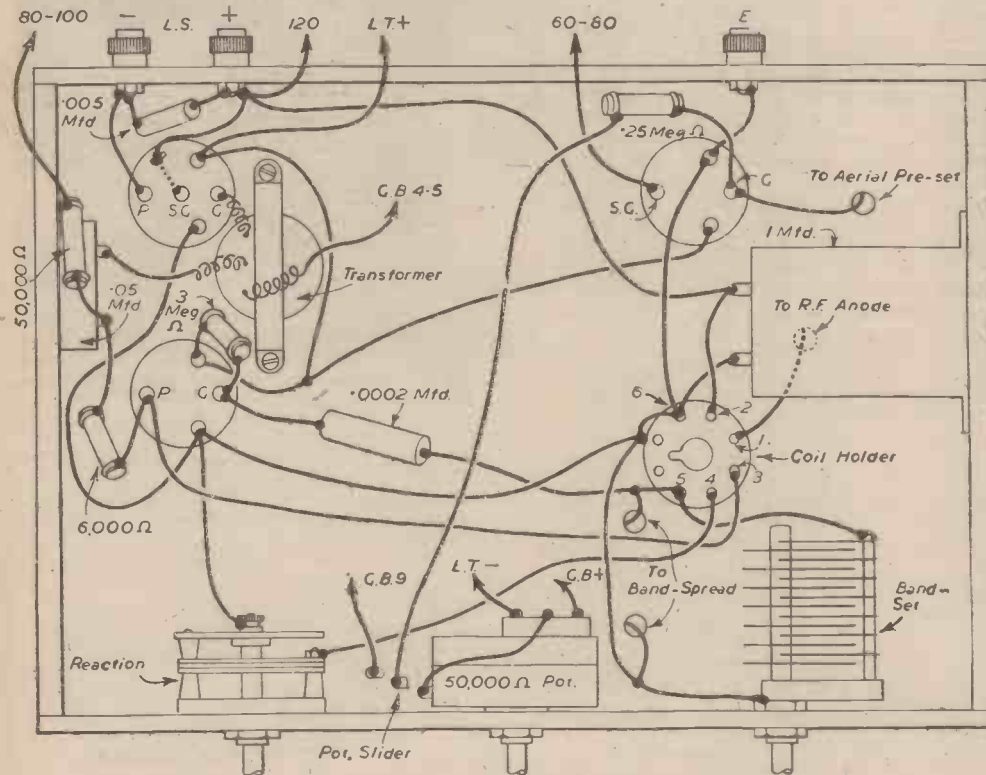

Fig. 4.—The wiring and component layout below the chassis.

In all probability the aerial pre-set will need to be adjusted to a fairly low capacitance, and the effect of altering it should be noted

**LIST OF COMPONENTS**

- 50,000 ohm potentiometer.
- 3 and .25 megohm and 6,000, 50,000 ohm resistors.
- .00015, .00015 and .0002 mfd. variable capacitors.
- .0001 mfd. pre-set.
- .0002, .005, .05 and 1 mfd. fixed capacitors.
- 3 valve holders and coil holder.
- Parafeed transformer (ratio 1 : 4).
- Fuse-plug.
- Knobs.
- Coils for 9-50 metres or as desired.
- Valves: Cossor 210VPT, Osram HL2K, Cossor 220HPT, or similar types.

upon various frequencies. H.T. 80-100 should be adjusted to obtain smooth reaction, and H.T. 60-80 should also be tried in various tappings, as the voltage here influences the gain of the R.F. stage. If some slight decrease of amplification can be tolerated, G.B. 4½ should be increased to 6, as this will result in quite a large decrease in anode current. If phones are used for DX listening, 6 volts bias may be used permanently.

**Valve Alternatives**

If to hand, a S.G. valve may be used instead of the R.F. pentode, although gain will be slightly less. A triode can also be used in the output stage, and if it is not intended to use a speaker at all with the set this modification is worth considering, as a reduction in background noise will result.

**Blueprints**

Readers interested in the construction of radio receivers should consult the list of blueprints published each month in our companion journal PRACTICAL WIRELESS. There are blueprints available of crystal sets, battery-operated one-valve to four-valve receivers, mains-operated receivers and superhets. Short-wave sets and portables are also included. With each blueprint, which is obtainable from our publishing department, constructional details are given.

**BOOKS FOR ENGINEERS**

By F. J. CANN

- Screw Thread Tables, 5/-, by post 5/3.
- Refresher Course in Mathematics, 8/6, by post 9/-.
- Gears and Gear Cutting, 6/-, by post 6/6.
- Workshop Calculations, Tables and Formulae, 6/-, by post 6/6.
- Engineer's Manual, 10/6, by post 11/-.
- Practical Mechanics' Handbook, 12/6, by post 13/-.
- Engineer's Pocket Book, 10/6, by post 11/-.
- Wire and Wire Gauges (Vest Pocket Book), 3/6, by post 3/9.
- Screw Thread Manual, 6/-, by post 6/6.
- Newnes Engineer's Reference Book, 42/-, by post 43/-.

Published by

GEORGE NEWNES, LTD., TOWER HOUSE, SOUTHAMPTON STREET, STRAND, W.C.2

# Rocket Propulsion

The Ba. 349 "Natter"

By K. W. GATLAND

(Continued from page 422, September issue.)

**H**IGH in priority during the desperate months leading to Germany's final overthrow was another rocket-powered interceptor, the Bachem Ba. 349 "Natter" (Viper).

This machine resulted from a specification issued by the German Air Ministry towards the close of 1944 for a rocket propelled aircraft to defend specific targets. Four firms competed in the design, each producing a prototype: Heinkel, a type known as "Julia"; Junkers, the "Walli"; Messerschmitt, the Me 1104; and Bachem, a machine provisionally known as the BP. 20. The latter project was eventually accepted for development and given the designation Ba. 349, while the rest were dropped.

As closely akin to a guided missile as to a fighter aircraft, the tender for this design was submitted by Dr. Eric Bachem, founder of the Bachem Werke G.m.b.H., at Waldsee-Württemberg.

Bachem based his design on a vertical take-off and an exceptionally high rate of climb.

To satisfy these requirements, it was decided to concentrate on the speed factor and to effect no compromise such as maintaining a reasonable wing loading for usual flight manœuvres and landing. The design, in fact, was such that landing by normal means was impossible, and it was at first planned to sacrifice the complete aircraft.

The latter problem was overcome quite simply. It was arranged that the pilot abandoned the machine immediately after

pressing home his attack and descended by parachute, the after section of the fuselage (containing the motor and accessories) following him down in a similar fashion, to be collected and later re-built into another "Natter." At least, that was the intended operation, but on the one occasion that the Germans carried out a manned test, the cockpit hood blew up when the machine was only 300ft. from the ground, causing it instantly to turn over and plunge to earth, the rockets still firing at full power. Needless to say, the pilot was instantly killed.

All other ascents were made under the control of auto-pilots.

### The Ba. 349A

Powered by an HWK 109-509A1 Walter engine, the first production version of the "Natter" flew at a maximum speed of 540 miles per hour, climbing at the rate of 35,800ft. per minute to reach its ceiling at 49,000ft.

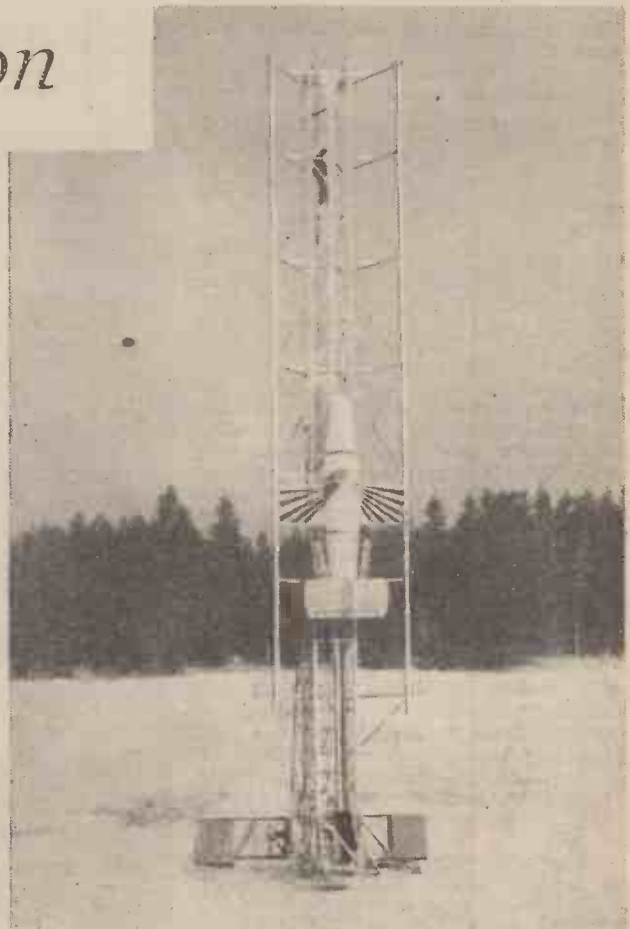

This picture gives a good idea of the small amount of space required to operate the "Natter." Intended to be launched from bombed sites, parks, or any convenient space near the factory it was assigned to defend, the Ba. 349B climbed at the phenomenal rate of 37,000 feet per minute.

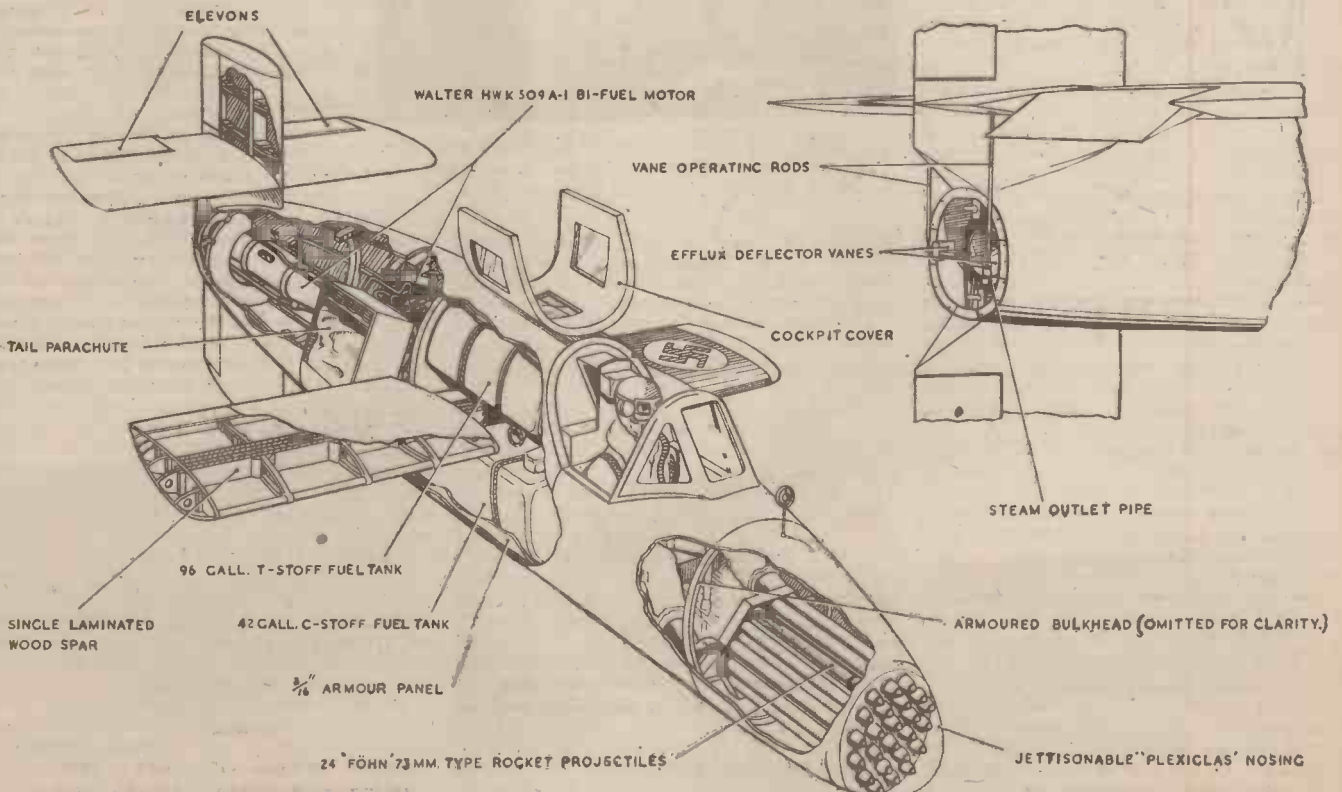

A part-sectional drawing of the Ba. 349A "Natter," showing the simple construction of the airframe and the layout of the main components.

The construction of the fuselage was entirely of wood, being of semi-monocoque design, with a laminated wood skin, stringers and formers. It was built in two main sections and the pilot was installed inside a heavily armoured cockpit immediately behind his main armament of explosive rockets in the nose. These were mounted in a quadrangular or hexagonal frame (according to the calibre of the rockets used), the heads being faired by a "Plexiglas" domed nosing during flight, which was blown preparatory to firing by explosive bolts. In addition to the rocket armament, which could be either thirty-three R4M R.P., or twenty-four of the larger Föhn 73 mm. type, some production versions mounted two Mk. 108 30 mm. cannon.

For protection, there was the bullet-proof windscreen, and two armoured bulkheads at front and rear of the pilot, while the sides of the cockpit and fuselage local to the propellant tanks were also screened by 3/16in. armour panels. This heavy armouring, coupled with the small frontal area and high speed of the "Natter" made it almost invulnerable to harm from bombers' defensive guns.

The main controls were a control column, rudder pedals, auto-pilot and throttle box, whilst mounted on the front cockpit bulkhead were two buttons, one for firing the R.P., the other causing ejection. Levers for jettisoning sections of the aircraft were also fitted close at hand.

At the rear of the cockpit were two propellant tanks—96 gallons of T-stoff above and 42 gallons of C-stoff below—and farther aft still, the fuselage parachute, turbine pumps, accessories and, finally, the rocket motor.

The short-span wings, which did not detach from the fuselage, embodied a continuous laminated wood spar passing between the tanks, with wooden ribs, and metal-sheathed tips. There were no ailerons.

The tail-assembly, which was built in a similar manner to the wings, comprised fin and rudder area both above and below the fuselage, with the tail-plane itself mounted well above the centre-line on the topmost fin. The elevons, fitted on the tail-plane, were, of course, functioned by the control column, serving the dual purpose of elevator and aileron.

An interesting point about the control system is that the elevons were linked to corresponding vanes which worked in the exhaust stream at the rocket nozzle. Thus, not only were longitudinal and lateral movements made more sensitive by the offset reaction which resulted when the vanes were deflected, but flight with "hands-off" was excellent under the control of the automatic pilot.

This method was yet another having its origin in the V-2 research at Peenemünde, and its application in the "Natter" certainly contributed greatly toward its well-stabilised climb. It will be noted in this regard also that no attempt was made at wing sweepback, despite the high speeds involved.

By the close of hostilities, the Germans were masters of high speed aerodynamics and had the very best of equipment for such research, having regard for both "tunnel" testing and actual free-flight experiments with aircraft they had specially built.

The Messerschmitt 163—Germany's first rocket interceptor—was not, however, a particularly good example of their work. One problem not easily overcome was the large degree of washout required at the wing tips which, though necessary as part of the general stability, did not contribute to the performance when the machine was throttled beyond the 500 m.p.h. mark. The incorporation of washout made for excellent handling qualities at low speeds, but although the wings were swept back to improve stability and to delay compressibility effects

nearing the sound velocity, this factor was the one largely responsible for the machine becoming uncontrollable at  $M=0.82$ .

The German technicians, however, took no chances with the "Natter." They took the urgency of its development, and consequently did not embody features that might break down in trials and cause delays in production.

Despite the fact that elevons displaced the more normal wing ailerons and tail elevators, the control system was really not that much

continue our flight programme through the use of radio-control, a device we have brought to a high state of perfection in co-operation with the Army Air Force. We are prepared to substitute robot control for our pilot at any time it may be desirable."

Precise details of this machine have not yet been made known, but there can be little doubt that the best features of German research have been incorporated, and it may well be that the control system has been adapted from the "Natter."

The overall length of the Ba. 349A was 21ft. 3in., the span 13ft. 1in., and the wing area, 51.6 sq. ft. From tip to tip, the vertical stabiliser measured 7ft. 3in.

### Operation

Launched almost vertically, the machine rose from its 80ft. ramp under power from dry-fuel A.T.O. rockets mounted on the fuselage at the tail-end. Although it was usual to use four units each developing 1,100lb. thrust and operating for 6 seconds (probably the Walter 109-505 di-glycol powder type), the Schmedding 553 producing 2,200lb. thrust for 12 seconds was the alternative. In the latter instance, only two charges were employed, and these were the units originally developed in the final research of the BP-20 prototype. The initial acceleration was slightly greater than 2g., and the rocket assisters were jettisoned at a height of about 5,000ft., by which time the main bi-fuel engine was developing full power.

The take-off ramp was pivoted near its base so that it could be brought horizontal to enable the "Natter" to be conveniently loaded from its transport; the tips of its wings and lower fin having been strengthened to run in the three guide rails.

Upon receiving the usual warning of raiders approaching, the pilot climbed into his cockpit and was elevated by his crew into the launching position. The course of the bombers was to be checked by a standard radar predictor, and the setting passed direct to the auto-pilot in the interceptor through an electrical link broken at the instant of take-off. Thereafter, the machine was steered automatically on the pre-set course until the pilot took over to make corrections to his flight path caused by the movement of the bombers since the time of launching. The course of the raiding aircraft was, of course, radioed from the ground to assist the pilot in his manoeuvres.

Closing in on the bombers, the pilot jettisoned the plastic nose fairing exposing his rockets. His machine drew rapidly to firing range and levelling up with the aid of a simple ring and bead sight, the nose racks were suddenly empty, with flame and blast encompassing the target.

Evasive action by the bombers would have been difficult because breaking formation would have meant lone bombers fighting off conventional patrol fighters without the covering fire that would otherwise have been afforded by supporting machines. Thus, had it been found possible to guide the fast

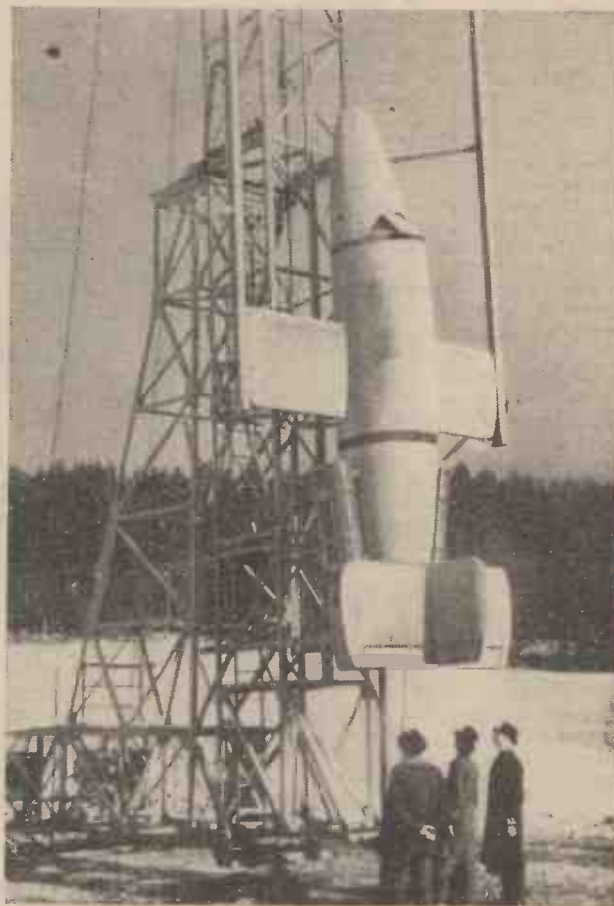

All set for take-off. The tips of the wings and lower fin of the "Natter" were strengthened to run in the three guide rails of the 80-foot launching ramp.

untried. It had, in fact, proved highly effective in the Messerschmitt design, and coupled with the exhaust-vane stabilisers the results were very satisfactory.

The exhaust-vane system, incidentally, is likely to play a large part in maintaining control at trans-sonic and super-sonic speeds, and it will be interesting to watch developments.

The Bell Aircraft Corporation has, in fact, already produced an aircraft with which it is hoped soon to penetrate the sound barrier. This is the XS-1, fitted with a ram-jet "athodyd" and rocket booster, but the technicians in charge of its testing programme are first making certain of the plane's behaviour with "power-off." The machine has already accumulated several hours' flight time, having been taken up to height beneath a large bomber and released to obtain first-hand knowledge of its stability and general handling qualities at low speeds. Only when complete data has been obtained in glide flight will the machine be tried under power: "Controllability is the big unknown," said Lawrence D. Bell, president and general manager of the company; "Should our pilot discover dangerous flight characteristics in the speed-of-sound range, it will be possible for us to

climbing "Natter" with a reasonable degree of accuracy, there can be little doubt that its development would have been most beneficial to Germany's air defence.

Having expended his armament, the pilot was no longer able to control his aircraft because of the displaced C.G.

The remainder of the story suggests little more than a fight for survival. The pilot's first action was to operate a lever, which detached the complete nose section of the machine. When the air pressure had carried it clear, the pilot, still sitting in his seat, was exposed in the open. By this time he had snapped open the buckle of his harness and the operation of the second lever then caused the ejection of the tail parachute. This applied a violent braking effect on the aircraft, pitching the pilot forward out of his seat, whereupon—after perhaps being in the air for barely two minutes—his parachute opened automatically, and he was wafted back to the ground. At the same time, the remaining section of the interceptor divided and the more valuable portion, containing the engine and accessories, also descended beneath its separate parachute for re-use.

It is clear that the job of a Luftwaffe pilot towards the close of hostilities was no basis for planning a future.

#### Production of the "Natter"

The "Natter" was produced in two type series, the original production version, Ba. 349A, and a development, Ba. 349B.

There was little difference between the prototype (BP. 20) and the early production models, and all that was noticeable to the observer was a modified lower fin. This was short and brought forward in Bachem's original design, but in production the vertical stabiliser was square-cut and almost equal in length above and below the fuselage. The only other alteration was that, on some machines of the "A" series, an austerity engine had been substituted, the HWK 109-559.

Originally projected at the time when recovery of the power plant had not been considered, this unit embodied an uncooled combustion chamber, a simplified pumping arrangement and was without electric starting. Its development was obviously no mean achievement, despite the fact that it was only called upon to operate for two minutes. The motor, which probably embodied a ceramic liner in place of the cooling jacket, delivered a maximum thrust of 3,750lb. and was equally as controllable as the more durable types.

The Ba. 349B, of which there were only a few produced by the time of the defeat, was propelled by an HWK 109-509D Walter engine. This unit was not vastly different to the "C" version, having an additional "cruising" chamber which, operating with the main chamber, gave the machine a maximum speed of 621 miles per hour at 16,400ft. and boosted the climb to 37,300ft. per minute. The all-up weight was 4,920lb., only 120lb. greater than the earlier model, and the wing loading at take-off 95.5lb. per sq. ft., reducing to 37.6lb. per sq. ft. when expended of propellant. Flying at an average of 495 miles per hour, and by careful use of the two chambers, the machine could be operated under power for four and a half minutes.

The overall length of the "B" sub-type was 20ft. 7in., all other leading dimensions remaining as in the Ba. 349A. Thus, the wing area, too, was unchanged. The all-up weight at take-off, including four dry-fuel assisted take-off units totalling 1,000lb., was 4,925lb., reducing to 1,940lb. at the time of break-up for landing. The parachute for landing the tail fuselage and motor weighed 88lb. At take-off the wing loading was 95.5lb. per sq. ft., diminishing to 37.6lb. per sq. ft. with tanks dry.

Designed from the mass-production view-point and using only semi-skilled labour in its construction, the machine was not sufficiently advanced in production to see service during the war. Its development had apparently been greatly hampered by Allied air assaults, and eventually, in view of the highly satisfactory results achieved in tests of the rocket-boosted Messerschmitt 262 jet-fighter, production orders were cancelled.

#### The Heinkel "Julia"

Of the three designs for rocket interceptors rejected in favour of Bachem's "Natter," the Heinkel "Julia" would seem to have been the most promising.

The general layout was really quite orthodox despite a prone piloting position, and although launching was vertical the plane was able to glide and land in the normal manner. Again, sweepback and all unconventionalities were avoided, the obvious intent being to produce a simple and easily produced structure. It did not, however, incorporate the degree of simplicity that Bachem's team had embodied in the "Natter." It is true that the airframe of the "Julia" was more to the form of a normal fighter, but the fact that the plane could be operated repeatedly did not carry much weight with the German Air Ministry. It was obvious that the loss of an easily replaced interceptor did not



A "Natter" streaks skywards under the control of its auto-pilot. The climb was assisted in the initial stages by four dry-fuel rockets which contributed 4,400lb. thrust. These fired for six seconds and were jettisoned at about 5,000 feet, leaving the internal bi-fuel Walter engine to operate for the remainder of the flight at a maximum thrust of 3,520lb.

matter so long as Allied bombers were knocked out before they had a chance to reach their objectives. In any case, the pilots of local defence interceptors were fortunate to find a suitable landing field within gliding range and forced landings would invariably "write-off" a returning machine as surely as if it had been abandoned in mid-air.

(To be continued.)

## Technical and Scientific Register

A RECENT meeting of the Electrical Engineering Committee was attended by Sir Arthur Fleming, Col. Sir Stanley Angwin, Mr. J. R. Beard, Mr. W. K. Brasher (secretary, Institution of Electrical Engineers), Mr. E. S. Byng, Mr. C. W. Marshall, Mr. E. A. Mills, Mr. H. J. Nunn, Dr. C. C. Paterson and Mr. C. Rodgers (B.R.A.M.A.).

Amongst the various questions considered by the committee were proposals for securing employment for men who joined the technical branches of the Forces immediately on graduation and are now being demobilised. They have not previously had industrial experience, but many have had the advantage of commissioned service in technical corps and have shown qualities of leadership and initiative which should be of great value to industry. Suggestions made by the committee are likely to lead to experimental schemes of training in industrial concerns with a view to preparing these ex-Service personnel for responsible posts after training. The committee realise that adequate pay arrangements will be required in order to make training schemes of this kind economically practicable.

The committee stressed the importance of

developing still further the close co-operation which already exists between the Ministry's Technical and Scientific Register and the Professional Engineers Appointments Bureau, and expressed the hope that industry generally would make use to the fullest possible extent of the facilities offered by the register.

The Technical and Scientific Register of the Ministry of Labour's Appointments Department, which is operating from York House, Kingsway, London, W.C.2, has the benefit of the guidance of advisory committees, composed of leading representatives of the various professions catered for by the register, to ensure that it is providing the greatest possible service to employers seeking professionally qualified technical and scientific staff, and to those seeking appointments.

The chairmen are Sir Arthur Fleming (electrical engineering), Sir William Stanier (mechanical engineering), Sir Peirson Frank (civil engineering), Sir Robert Pickard (chemistry), Sir Lawrence Bragg (scientific research) and Mr. T. E. Scott, F.R.I.B.A. (Architectural and Public Utilities Advisory Committee, including surveying, town planning and valuation).

# Induction Instruments

## General Principles and Applications

By J. POWELL

THE principle of the ammeter and voltmeter such as met with in everyday practice is generally known by anyone who has to make measurements of an electrical nature, these being either Moving Coil, Hot Wire, Moving Iron or Electrostatic. The Moving Iron is probably the most common, owing to its adaptation to either alternating or direct current circuits. It is therefore proposed to deal with the principle of operation and construction of the lesser well-known class of ammeters and voltmeters that rely for their operation on inductive principles, finally leading to the instrument that finds itself in almost every household, and uses the principles of induction as will be discussed in connection with ammeters and voltmeters, namely, the watt-hour meter.

It is proposed first of all to establish the general principle of operation for all induction instruments, and then consider the different applications of these principles separately.

### Theory of Induction Instruments

These instruments are essentially alternating current ones and depend for their action upon the torque produced by a reaction between a flux, the value of which is dependent upon the voltage or current to be measured, and eddy currents induced in a metal disc or drum through the action of another flux, with a value again dependent on the voltage or current to be measured; thus two fluxes have to be created differing in phase by a given angle.

To illustrate this point more fully let us consider two fluxes  $\phi_a$  and  $\phi_b$  differing by an angle  $\beta$  (see Fig. 1).

$\phi_a$  will induce an E.M.F.  $E_a$  in the disc or drum lagging  $\phi_a$  by 90 deg.  $E_a$  in turn will produce an eddy current  $I_a$  in the disc lagging  $E_a$  by an angle  $\alpha$ . The flux  $\phi_b$  will produce a similar state of affairs, and this can easily be followed from the vector diagram, Fig. 1. Thus, we have the interaction of two fluxes, and since torque at any instant is proportional to the product of  $\phi$  and  $i$ , an interaction between two torques is similarly set up.

Now, the phase angle between  $\phi_b$  and  $I_a$  is equal to  $[90 + (\beta - \alpha)]$

Similarly, the phase angle between  $\phi_a$  and  $I_b$  is equal to  $[90 + (\beta + \alpha)]$ .

Therefore, calling the torque due to  $\phi_b$  and  $I_a = T_1$  and the torque due to  $\phi_a$  and  $I_b = T_2$  we have for the final torque  $T$ .

$T$  proportional to  $T_1 - T_2$

$T \propto \phi_b I_a \cos(90 + (\beta - \alpha)) - \phi_a I_b \cos(90 + (\beta + \alpha))$

And  $\cos(90 + (\beta - \alpha)) = -\sin(\beta - \alpha)$

And  $\cos(90 + (\beta + \alpha)) = -\sin(\beta + \alpha)$

But  $I_a$  and  $I_b$  are proportional to  $\phi_a$  and  $\phi_b$  respectively,

$T \propto -\phi_b \phi_a \sin(\beta - \alpha) + \phi_a \phi_b \sin(\beta + \alpha)$

$T \propto \phi_b \phi_a [\sin(\beta + \alpha) - \sin(\beta - \alpha)]$

$T \propto \phi_b \phi_a [\cos \alpha \times \sin \beta]$

Now  $\alpha$  is dependent upon the resistance and reactance of the eddy current path, and thus for any one instrument there will remain constant

$$T \propto \phi_b \phi_a \sin \beta$$

From this it is observed that if the two fluxes are in phase and hence  $\sin \beta$  equal to zero, the torque  $T$  will be zero; thus, from this it is easy to see, as was stated earlier, that the operation of these instruments is dependent upon the phase difference between two fluxes, brought about by the values to be measured. From what has already been said, it is obvious that the frequency of supply will have a critical effect on these instruments, a change

in frequency bringing about a change in reactance and hence impedance of the circuit. Wave form, too, affects the reading of the instrument, and for this reason it is desirable to use the instruments on constant frequency and wave form supplies, in order to obtain accurate readings. Owing to the scale readings covering a full 360 degrees, errors are more susceptible from the spring control than with other forms of instruments. However, we shall see how these errors may be overcome when dealing with each type separately.

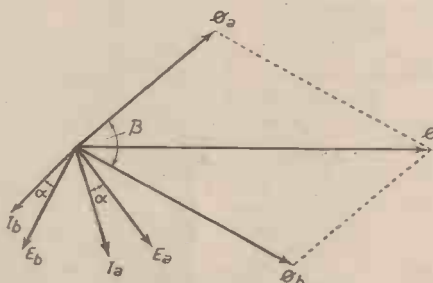

Fig. 1.—Vector diagram for the general case.

The conditions to be fulfilled then are to produce two fluxes differing in phase by some angle  $\beta$ . This is accomplished in practice by two methods, either by splitting the winding of the electromagnet in which the flux exists into two portions, one being inductive and the other being non-inductive, or by splitting the phase of the working flux by a copper band placed round a portion of the poles of the electromagnet, the latter method being more commonly known as the "shaded pole" type.

### The "Shaded Pole" Instrument

Fig. 2 shows the principle of the "Shaded Pole" instrument—consists in the main of the electromagnet, rotating disc and damping magnet.

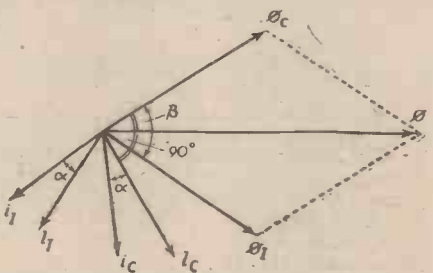

Fig. 2.—Vector diagram for the shaded-pole instrument.

The disc is of light construction, being made of aluminium, it being supported by the spindle, which rotates in two jewelled bearings. To this spindle is attached the pointer of the instrument, the degree of rotation being governed by the control spring which is also attached to this spindle, thus returning the pointer back to its zero position as soon as the current ceases to flow. From the figure it is seen that the disc rotates between a laminated field magnet and a permanent magnet; the permanent magnet provides the damping for the instrument, thus the aluminium disc serves a dual purpose, it being used both for operational and damping purposes. It is the laminated magnet from which the instrument

actually derives its name. At a closer inspection it will be seen that besides carrying an exciting coil, a copper band is let into one of the poles of the field system, it being through the operational functions of this band that the name is derived.

The coil of the electromagnet is energised either by the current to be measured or by a current proportional to the voltage to be measured; thus it is now proposed to consider such a set of conditions.

On applying an energising current to the electromagnet of an alternating nature, a magnetic flux of a similar nature is induced in the copper shading bands, and the iron surrounding these bands, the magnetic fields set up by the induced currents in the shading bands causing the flux in the portions of the iron surrounded by the bands, to lag in phase in the order of 40 to 50 deg. behind the flux in the unshaded portions of the poles, thus giving the fundamental principle of the instrument, required for operation as was derived earlier, that of two fluxes differing in phase by a given angle. Referring once again to Fig. 2 and the vector diagram, it may be seen how the shaded pole instrument uses the conditions of torque brought about by two fluxes out of phase.

By comparing the vector diagram in Fig. 2 with that of Fig. 1 it is seen that they are similar in construction, which is as would be expected if the instrument is to operate on the principle derived for the case of Fig. 1.  $\phi$  is the main flux in the iron, being the vector sum of  $\phi_c$  and  $\phi_1$ , which are the fluxes in the shaded and unshaded portions respectively,  $\phi_c$  lagging by an angle  $\beta$  behind  $\phi_1$ .

Considering the disc, the two fluxes  $\phi_c$  and  $\phi_1$  will induce in it two E.M.F.  $E_c$  and  $E_1$  these E.M.F. being 90 deg. behind their respective fluxes, these voltages in turn cause eddy currents to flow in the disc, their values being  $i_c$  and  $i_1$ , each lagging its respective voltage by a small angle  $\alpha$ , brought about by the inductive path set up in the disc.

Again from the illustration it is seen that the component of  $\phi_c$ ,  $i_1$  and  $\phi_1$ ,  $i_c$  are reacting against each other, thus the resulting torques will be in opposition and as for the general case  $T = T_1 - T_2$ .

From the general case it may be established that

$$T \propto \phi_c i_1 \sin(\beta - \alpha) + \phi_1 i_c \sin(\beta + \alpha).$$

And if  $K$  is a constant

$$T = K \phi_c i_1 \sin(\beta - \alpha) + \phi_1 i_c \sin(\beta + \alpha).$$

Now bringing in the impedance of the eddy current paths we have:  $i = \frac{e}{Z}$

and as the induced voltage is proportional to the flux  $\times$  frequency we may say:

$$e_c \propto \phi_c \times f \text{ and } e_1 \propto \phi_1 \times f$$

$$i_c \propto \frac{\phi_c f}{Z} \text{ and } i_1 \propto \frac{\phi_1 f}{Z}$$

$$T = \frac{K_1 \phi_c \phi_1 f}{Z} [\sin(\beta - \alpha) + \sin(\beta + \alpha)] \\ = \frac{2 K_1 \phi_c \phi_1 f \cos \alpha \sin \beta}{Z}$$

Where  $K_1$  is another constant.

Thus from the latter it is seen that the functioning of the instrument is dependent upon the reaction of two separate torques on the disc brought about through the product a flux and current in one case and the flux and current in another case, the conditions of the two cases being governed by a phase angle.



Having now considered the operational requirements for the instrument, it is desirable to see how the instrument varies in actual operation from the theoretical case developed above. The first error that will present itself is, obvious from the final equation, that of frequency of supply on which it is to be used. This can produce a serious error in the reading when the instrument is in use unless precautions are taken to prevent it, even so the induction instrument is essentially dependent upon constant frequency of supply.

The method adopted to overcome this source of error is rather dependent upon whether the instrument to be considered is an ammeter or voltmeter, the case not being so serious with the latter; however, by the use of a non-inductive shunt this problem may to some extent be overcome. For the normal case an increase in frequency would result in an increase in torque, but by the use of this shunt an increase in frequency also brings about an increase in the impedance of the circuit, resulting in the current being taken by the non-inductive shunt, its impedance being independent of frequency. The voltmeter, on the other hand, owing to its construction, has the advantage that an increase in frequency brings about a corresponding increase in impedance of the inductive winding, resulting in a reduced operational current which to some extent compensates for the increase in torque.

Temperature is yet another source of error, although not quite so serious as the one of frequency. It is already known that a variation in temperature brings about a corresponding variation in resistance and as the eddy current paths in the disc are influenced by their resistance, a change in temperature in the disc will affect the eddy current values, hence some method must be adopted by which the temperature may be kept constant. In the case of the ammeter a shunt is used consisting of a material whose temperature coefficient is of a higher value than that of the disc, thus with an increase of temperature in the disc, bringing about a reduced eddy current value due to the increase in resistance and a corresponding loss of torque, the current passing through the instrument is increased, resulting to some extent on a compensation for the loss of torque.

Having now considered the aspect of errors due to electrical and temperature phenomena it now remains to see what error is likely to be brought about by the spring control. This may be contributed mostly to the fact of the pointer moving through nearly 360 deg., thus causing the spring to have a large amount of pull at the extreme end of the scale, so bringing about the tendency for a shifting zero to result, after a period of operation, owing to a certain amount of permanent stretching developing in the spring, hence adjustment has to be allowed for in connection with this when the instrument is being calibrated.

**The Ferraris Instrument**

Fig. 3 shows the operational principle of this instrument, it depending as in the last case on the reaction between two fluxes differing in phase by a given angle. In place of the electromagnet carrying the copper band, we have, for creating the field systems, a small yoke carrying a four-pole field system, the yoke and poles being of a laminated construction. Upon these four poles are wound the coils that are necessary to produce the rotating magnetic field. A drum made of aluminium replaces the metal disc, although the currents induced in the drum are of the same nature as that in the disc, rotation being caused through a similar set of conditions. It is interesting to note that the action of this instrument is analogous to the working of the induction motor, the magnet system forming

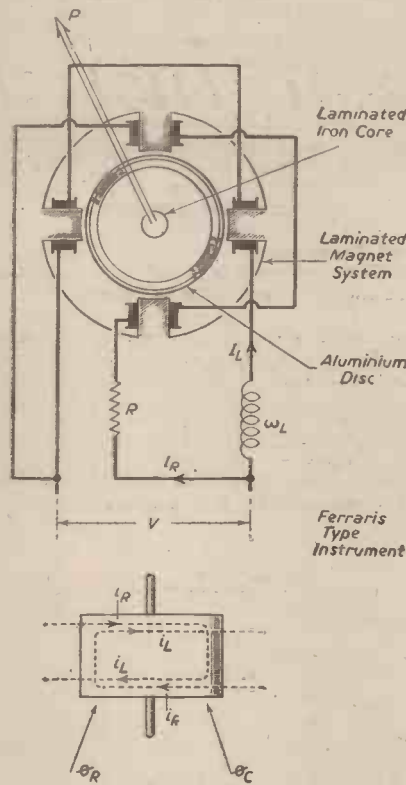

Fig. 3.—Diagram of the Ferraris type instrument and view of the drum indicating the forces acting on it.

the stator winding, the drum fulfilling the same conditions as those of the rotor of an A.C. machine; in fact, if it was not for the control spring the drum would rotate continuously at some speed slightly less than that of synchronism, i.e., the speed of the rotating field. As we have already mentioned, the angle of rotation is governed by a spring attached to the drum, the pointer coming to rest when the operating torque is equal and opposite to the controlling torque. Referring to Fig. 3, it is seen that the drum is acted upon by a resistive and inductive flux, these being created by inserting a non-inductive resistance in series with one pair of coils, and an inductance in series with the other pair, the combination as a whole forming two sets of coils in parallel, each set consisting of two coils in series, one set containing the resistive portion, the other set the inductive portion, thus providing the out of phase fluxes as in the shaded pole field system.

The theory of operation, as may be observed from the vector diagram, is exactly the same as for the latter instrument, the two fluxes  $\phi_C$  and  $\phi_R$  inducing in the drum the E.M.F.s  $e_L$  and  $e_R$  each lagging the flux by 90 deg. respectively, these E.M.F.s in turn bringing about the eddy currents  $i_L$  and  $i_R$  in the drum lagging the E.M.F.s by a small

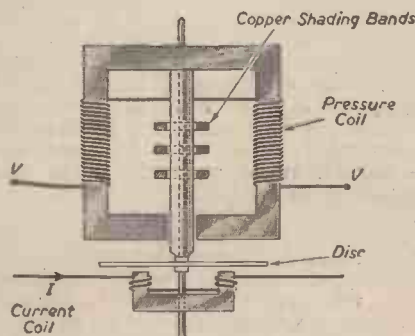

Fig. 4.—Diagram of an induction wattmeter.

angle  $\alpha$ . Therefore, once again we have two torques in opposition brought about, e.g.,  $\phi_L i_R$  and  $\phi_R i_L$ , the resultant torque being given by the difference of the two separate torques.

$$T = T_1 - T_2$$

And from what has been said

$$T \propto \phi_L i_R \cos(90 + \alpha - \beta) - \phi_R i_L \cos(90 + \alpha + \beta)$$

Which in the final equation reduces to

$$T = \frac{2 K_1 \phi_L \phi_R f}{Z} \cos \alpha \sin \beta$$

This equation may be taken a stage further if it is assumed, as in the general case, that  $\phi_L$  and  $\phi_R$  are proportional to the currents  $I_L$  and  $I_R$  respectively, so giving

$$T = \frac{K_2 I_L I_R}{Z} f \cos \alpha \sin \beta$$

And since the currents  $I_L$  and  $I_R$  are proportional to the current to be measured, which is  $I$ ,

The equation may be written

$$T = \frac{K_3 I^2 f}{Z} \cos \alpha \sin \beta$$

The torque referred to in both the "shaded pole" and the last consideration is the Mean Torque. The same reasoning as in the "shaded pole" instrument may be put forward to account for frequency and temperature errors; thus it is not proposed to deal with factors again. Damping is provided by means of two permanent magnets, between which rotates a thin aluminium disc, the magnets producing eddy currents in the disc, so providing the necessary damping. It is, however, necessary in this case to provide a separate disc which is attached to the same spindle as the drum, and acts in exactly the same way as the disc of the shaded pole instrument.

**Induction Wattmeter**

These instruments are very similar in operational principles to the ammeters and voltmeters just described, employing the rotating disc arrangement as found in the shaded pole type. Fig. 4 shows the diagrammatic arrangement of one form of instrument. The disc rotates between an upper and lower laminated field system, the upper one carrying the pressure or voltage coil and has a large number of turns of fine wire: it is also seen that the two poles of this magnet carry copper shading bands, in order to give the resultant flux in the magnet a lag of 90 deg. behind the applied voltage. The lower magnet carries the current coil and consists of a few turns of heavy gauge wire. Owing to the copper bands on the core of the pressure coil a lagging phase angle of nearly 90 deg. is created between the current and applied voltage of this coil. The current coil being connected in series with the line will produce a flux which will be in phase with the line current; thus if the line current lags by an angle  $\theta$  with respect to the voltage, the phase difference between the two fluxes produced by the voltage and current coils will be  $(90^\circ - \theta)$ . It has already been proved for induction instruments that the torque exerted on the drum or disc is proportional  $\phi_b \phi_a \sin \beta$ ; therefore applying this deduction to the induction wattmeter, we have

$$T \propto \phi_b \phi_a \sin(90^\circ - \theta)$$

$$\text{i.e., } T \propto \phi_b \phi_a \cos \theta$$

And as we have already seen  $\phi_b$  is proportional to  $I_b$  and  $\phi_a$  is proportional to  $I_a$ , although it should be pointed out that in this case the currents  $I_b$  and  $I_a$  are the existing currents and not the eddy currents produced in the disc by the fluxes

$$T \propto I_b I_a \cos \theta$$

$$\text{And } I_b = \frac{E}{(WL)_b}$$

i.e.,  $E = \text{Line Voltage}$  and  $(WL)$  is the reactance of the pressure coil.

$$I_a = I_1 \text{ the line current}$$

$$T \propto VI \cos \theta$$

Damping may be provided as in the previous cases by means of a metal disc and permanent magnet, the disc again serving both purposes. It is the intention to study this form of damping in greater detail when considering the watt-hour meter, as it forms one of the essentials of induction instruments, and thus merits special consideration. As in the previous cases spring control is used for controlling the pointer, a scale of 300 deg. being adopted.

**The Measurement of Energy**

Although there are many types of watt and ampere-hour meters in use to-day, specific attention will be given here to the motor type of meter that makes use of the principle of the induction wattmeter, the disc rotating continuously and operating a counting mechanism, so recording the required amount

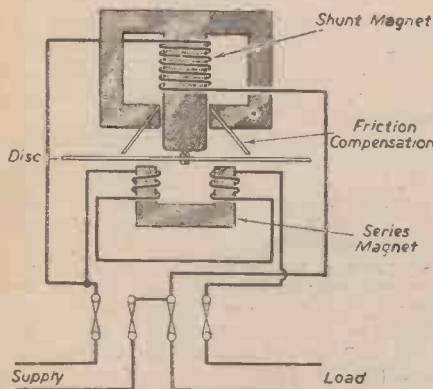

Fig. 5.—Watt-hour meter using the induction principle.

of power or energy expended over a period of time. In the case of the ampere-hour meter the speed of rotation is proportional to the amount flowing, whilst with the watt-hour meter it is a measure of the power consumed.

As the theory of operation of these instruments is identical to that of the induction wattmeter, and hence to all induction instruments, it is not necessary to go into the development of principle again, except to add any slight modifications that result from the alterations of design. The two most important parts of the instrument that receive alteration are the pointer and spring control, these being replaced by a brake magnet which induces eddy currents in the disc, which now revolves continuously instead of only round 300 deg.

In considering the single-phase watt-hour meter as found in nearly all households to-day, it is interesting to note that the instrument now carries only one pressure coil upon a central limb of the shunt magnet, whilst on the other two limbs are placed two extra copper shading bands for the purpose of friction compensation. As in this case the disc is continuously rotating, and thus cutting the lines of force, an E.M.F. will be induced in the disc in addition to the statically induced E.M.F.s in the magnets due to the alternating currents. The frequency of supply, however, is generally in the order of 50 cycles/sec. and seldom less, whilst the full load speed of the disc is only in the order of 45 r.p.m. Thus the dynamically induced eddy currents are small compared to those induced statically, and hence the operating torque will be large in comparison with the torque exerted dynamically. Now, as we have already seen, the flux of the pressure magnet lags 90 deg. behind applied voltage (considering an ideal case), so once again it may be said that the operating torque will be

proportional to  $E.I \cos \phi$  considering virtual values of current and voltage, the angle  $\phi$  being the phase difference between them.

With the previous instruments, the spring control produced the retarding torque, steady deflection occurring when the driving and retarding torques were equal; with the watt-hour meter, however, the braking magnet provides the necessary retarding torque in place of the spring control, a steady speed being obtained when the driving and braking torques are equal and opposite. This can easily be shown as follows:

$$T \propto \phi_1$$

If this flux  $\phi$  is due to the braking magnet and  $i$  is the induced eddy current value in the metal disc, then this torque will be a braking torque opposing the motion of the disc; thus calling it  $T_B$  we may say

$$T_b \propto \phi_1$$

The voltage  $e$  induced in the disc will be proportional to the flux  $\alpha$  speed of rotation, i.e.,  $e \propto \phi n$ .

$$\text{And } i = \frac{e}{R}$$

$$i = \frac{\phi n}{R} \text{ Where } R = \text{resistance of eddy current path.}$$

$$\therefore T \propto \phi \times \frac{\phi n}{R}$$

$$\propto \frac{\phi^2 n}{R}$$

If  $\phi$  and  $R$  are constant for any instrument  $T_b \propto n$ .

But for a steady speed value to be obtained the driving torque must equal the retarding torque.

$$T_D = T_{B_1}$$

And calling the steady speed  $N$  we have

$$T_D = T_{B_1} \frac{\phi^2 N}{R}$$

$$T_{B_1} \propto N$$

$$\text{or } T_D \propto N.$$

Hence a steady speed of revolution is obtained when the driving torque  $T_D$  is equal to the braking torque  $T_b$ .

$$\text{Further, if } T_D = E I \cos \phi$$

$$T_b = E I \cos \phi$$

the braking torque and driving torque are equal to the speed of the disc

$$N \propto E I \cos \phi$$

$N \propto$  Power of the circuit, so showing that the power may be assessed by the number of revolutions made by the disc over a given period of time.

A consideration must now be given to the errors that are likely to occur in this type of instrument, the chief of these being friction, phase and temperature, the latter being in the order of second degree of importance compared with the other two.

Friction errors cannot be avoided where rotation takes place, and in the case of the watt-hour meter this occurs at the bearings where the disc is pivoted, and is dependent upon the weight of the moving system. In order to ensure accurate recordings, some form of compensation must be made to overcome the friction forces, and this is accomplished by providing an extra driving torque that is proportional to the friction torque, the extra torque being provided by means of the two extra shading bands on the shunt magnet. These cause eddy currents to be induced in the two outer limbs, thus bringing about a phase displacement between the enclosed and main gap-flux which induces a small driving torque in the disc, the force of this torque being controlled by adjustment of the positions of the two shading bands. This adjustment must be undertaken with care so as to ensure that the torque produced is not sufficient to cause the disc to revolve under no load conditions and adjustments

should be made using a light load, after which the disc should operate at a speed proportional to all load conditions.

The phase error is brought about through incorrect phase displacement between the voltage and flux of the shunt magnet when the meter is on load, the power factor being less than unity. As we saw earlier, the object of the copper shading ring was to give a phase displacement of exactly 90 deg. between the flux and voltage of the shunt magnet, this being obtained by adjustment of the shading ring, and in order to eliminate the error due to load conditions, the instrument tending to read "fast," the ring has to be moved farther down the pole, that is, nearer to the disc.

Temperature errors in the disc again cause increased resistance of the eddy current paths, so bringing about a reduction in the driving and braking torques, but due to the decrease of flux of the pressure coil, brought about by a decrease in current resulting from increased temperature of the coil, the driving torque is reduced. At the same time, the flux of the permanent magnet is reduced, and hence a reduction in braking torque results, and it is found in practice that these two effects tend to neutralize each other, and thus will have little effect on the actual working of the instrument.

It will be sufficient to leave the subject at this stage, all other forms of induction instruments working on the principles that have been evolved and, in conclusion, the principle of eddy current damping will be discussed, as it plays so large a part in the successful operation of these instruments.

**Eddy Current Damping**

When a sheet of conducting material moves in a magnetic field, so as to cut through lines of force, eddy currents are set up in it, and a force exists between these currents and the magnetic field, which is always in the direction opposing the motion. This force is proportional to the velocity of movement of the conductor, and thus, if the

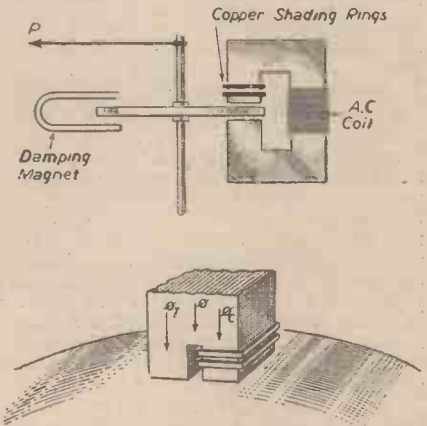

Fig. 6.—Diagram illustrating the principle of the shaded pole instrument, and enlarged view of the shaded pole.

magnetic field is constant, the damping force is proportional to the velocity of the moving system, and is zero when there is no movement of the system.

**Theory of Operation**

$B =$  Flux density in lines/nqcm cut by the disc.

$b =$  length or breadth of pole.

$w =$  Velocity of disc in ras/sec.

$v =$  radius from the centre of the disc to the centre of the pole face.

$$i = \frac{c}{R} \text{ Where } R = \text{instance of eddy current path.}$$

$$\text{And } e = \frac{Blvw}{10^8} \text{ volts}$$

$$i = \frac{Blwr}{10^9 R} = \frac{Bbwr}{R \times 10^9} \text{ amps.}$$

R the resistance of the eddy current path is dependent upon the area of the magnet pole and the thickness of the disc  $t$  and is proportional to  $\frac{bS}{dt}$   $S$  being the specific resistance of the metal of the disc in ohms/cm. cube.

$$i = \frac{Bbwrtd}{10^9 K.b.S.} \text{ amps.}$$

$K$  being a constant for any given radial portion of the poles.

And the damping force is given by

$$F_D = \frac{Bil}{10} \text{ Dynes}$$

$$F = \frac{B^2 wrdtb}{10^9 k.b.S} = \frac{B^2 wrdtl}{10^9 K.S.}$$

But  $b=1$  for a given instrument.

$$F_D = \frac{B^2 wrdtb}{10^9 K.S.}$$

And Torque = Force  $\times$  Radius.

$$T = \text{Damping Torque} = \frac{B^2 wrdtb}{10^9 K.S.} \times r \text{ dyne cms.}$$

This shows how use may be made of a metal disc and permanent magnet to produce the necessary damping for the induction instrument, it being particularly advantageous from the point of view that the disc serves a two-fold purpose.

To the average user of electrical instruments, the induction type is not met with as frequently as the moving-iron and coil instruments, their chief place of operation being the switchboard, which makes it more essential that one should be equally familiar with their method of operation as with any other type of instrument, especially as the most used instrument of all, the watt-hour meter, uses the same principle of operation.

## Open-cast Coalmining

### Refitting Excavator Machines with Petter Engines

**I**N view of the national importance of coal at the present day, the interest attached to the open-cast coal sites which the Ministry of Fuel and Power are exploiting to the utmost is a vital one.

A number of various types of excavator machines were shipped from America under Lease-Lend and, owing to difficulty in obtaining spares, it was decided to re-power with British engines as replacement became necessary. The first two machines to require new engines were of the Bucyrus Monighan, type 4W, and for this work four-cylinder Petter Superscavenge engines were selected.

#### Eight Hundred Tons per Day

The site where one Monighan is operating is on the Town Moor, outside Newcastle, and the machine is excavating approximately 800 tons of coal per 17-hour day, with the total employment of some 30 workers.

The original engines were Fairbanks Morse, 240 b.h.p. at 257 r.p.m. Power was transmitted by flat belts from main driving shaft to intermediate shafting, which in turn operated hoist and drag winches and also the walking mechanism. In the space originally occupied by the Fairbanks engine, a countershaft was installed carrying an eight-groove vee-belt pulley, and, at one end, the original main driving pulley. This countershaft is driven through 1½ in. vee belts by the Petter engine which runs at the reduced speed of 400 r.p.m. to give 240 b.h.p. In order to avoid damage to the engine by distortion of the excavator frame under the very arduous working conditions, the power unit is mounted on a three-point trunnion suspension, one at the forward end of the engine and two at the pulley end. A fabricated steel baseplate supports the engine and outer bearings, with the spherical portions and the trunnion bearings bolted to it. Dry sump lubrication is employed, the oil being stored in a tank located behind the engine on the frame.

Compressed air starting is utilised, a receiver of 5 cubic feet capacity being provided, which is charged by a petrol-engine-driven compressor. A Burgess snubber type silencer is included in the exhaust system. The original radiators fitted to the excavator were retained for the cooling water system, with engine-driven pump circulation.

#### "Walking" Type of Excavator

The Monighan excavator is of the "walking" type and has a 4 cubic yard dragline bucket with 110ft. jib which it is proposed to extend in the near future. The total weight of the machine is over 240 tons.

A particular point of interest is that the residents in nearby flats are no longer disturbed by engine noises which were



A rear view showing the Bucyrus Monighan machine about to "walk."

experienced when the Monighan was operating in its original form.

The Superscavenge engine has given high satisfaction. A similar engine has been installed in a second Monighan on the north-eastern open-cast coalfields. Seven

further engines are now on order for the Ministry of Fuel and Power for converting Monighan excavators in the Midlands, North-eastern Wales and Scottish areas, some of which will be operating buckets up to 6 cubic yard capacity.

## Intensive Courses in Chemical Engineering

**A**S one method of meeting the demand for Chemical Engineers which modern industrial development is creating and increasing, the Ministry of Education are arranging for full-time intensive training courses in a number of Technical Colleges. The courses, which will last for approximately 12 months, will be open to men who have graduated in engineering, physics or chemistry or have secured the Higher National Certificate in engineering or chemistry, or who have obtained a general science degree in mathematics, chemistry and physics. Men who have obtained wartime degrees in the specified subjects will be eligible for the courses, and they may be able to qualify for an award under the Further Education and Training Scheme in respect of the course. No candidate can be accepted who has not fulfilled his military obligations or who has not done a sufficient period of civilian war work to enable him to resume his studies.

The courses will be recognised by and operated in co-operation with the Institution of Chemical Engineers, who, with the Industrial Associations of those branches of industry concerned with the employment of chemical engineers, will co-operate with the Ministry of Labour and National Service in the selection of candidates for training. The fee for the entire course will be of the order of £60-£80. The course will qualify for allowances under the Further Education and Training Scheme to candidates who are eligible under the general conditions applying to that scheme.

Applications for further information (ask for leaflet P.L.126) should be addressed to the Ministry of Labour and National Service, Technical and Scientific Register, York House, Kingsway, London, W.C.2. (Telephone No. : Temple Bar 8020.)

# The Annals of Electricity—11

Georg Simon Ohm and his Famous Law

**M**OST readers already know all about the famous Law of Electrical Resistance which bears ineradicably the name of that celebrated yet little-known electrical pioneer, Ohm.

For Ohm was, indeed, little known during his lifetime, and his life career has received little notice ever since. The truth of the matter is that Georg Ohm lived a very retiring sort of life. He shunned publicity and self advertisement. He seldom realised his ambitions, and fame never came to him. Indeed, it is a fact that his first announcement of his now famous "Law" cost him his job, for his reasonings set up so much derision against him that, for his own peace of mind, he had to give up his teaching post and, for five or six years at least, to live a life of something like abject penury. There was no honour for prophet Ohm at that time among his own countrymen.

The first body of scientific men to recognise publicly Ohm's claims to scientific eminence was our own Royal Society in London. After the "Copley" medal had been conferred upon Ohm by that Society in 1841 his fortunes began to turn for the better. The hour of his triumph and of his scientific vindication had arrived. His theories and demonstrations became universally recognised. "Ohm's Law" gradually became an electrical byword in every scientific laboratory the world over.

Georg Simon Ohm came of an old Bavarian family which had been established in the little town of Erlangen for a century or more. He was born in the aforesaid town on March 16th, 1789, the eldest son of a master locksmith who was in business there. His mother died when he was quite young, and the two Ohm sons, Georg and Martin, had, in some ways, to learn how to fend for themselves at an unusually early age.

## The Two Ohms

It happened some years afterwards that a student of a local college was given lodgings by locksmith Ohm, and that, in part-payment of his rent, he undertook to tutor the two sons in arithmetic, geometry and elementary science. This he did with so much gusto and enthusiasm that the two lads became infected with his love for

science. Those early lessons formed the beginning of their careers. Georg, as we know, became, in after life, the pioneer electrician, whilst Martin, his younger



Georg Simon Ohm.

brother, grew to be a distinguished mathematician in Berlin.

Even locksmith Ohm, the father of the boys, joined in the family studies, stealing time from his work in order to do so.

It was eventually arranged that Georg should attend the local university to study mathematics, physics and philosophy. This he did, but only for three terms, after which Martin took his place, Georg then obtaining a situation as a private tutor in Berne and later in Zurich, Switzerland. Later, however (in 1811) he returned to the University of Erlangen as a student, took his degree there and passed the examination for a position as *privat-Dozent* (private tutor) in the university.

Continued want of means compelled him to leave the university and to become a school teacher, specialising in mathematics and physics first in a school at Bamberg and afterwards in the "Gymnasium" at Cologne.

During his period at Bamberg he was

very badly paid. Often, to make ends meet, he had to go over to Erlangen to assist his father and to work as a locksmith. About this time he wrote an "Essay on Geometry." The book was entirely a product of his spare time, and it is said that he wrote it during the cold winter months and in a room without a fire. It would seem, however, that the "Essay" attracted some attention, because it is almost certain that he was subsequently selected for the post at Cologne in consequence of it.

## Origin of Ohm's Law

Ohm had a decided gift for teaching, and he was a success at Cologne. But he had higher aspirations than the mere mechanical imparting of knowledge. He began to undertake original investigations, particularly in the realm of electricity. During the ten active years which he had at Cologne he carried out the electrical investigations on resistance which subsequently made his name famous. But it was all work undertaken against great difficulties. No one was at all interested in his researches. A lone hand, with very little time at his disposal, having, perhaps, even less money to expend on his work and having very little apparatus to work with, the persevering and painstaking Ohm plodded away at his experiments week in, week out, during his spare time at an old work bench in a disused laboratory in the Cologne "Gymnasium."

His fundamental work was given to the world in a series of short papers which were published in obscure German technical journals between the years 1825 and 1827. In the latter year, a formal presentation of his investigations was published in the shape of a pamphlet entitled *Die Galvanische Kette mathematisch bearbeitet* (The Galvanic Circuit Mathematically Considered).

Thus was born the nowadays ubiquitous "Ohm's Law," that deservedly famous electrical generalisation which states that the current flowing through a circuit is equal to the voltage divided by the resistance of the circuit and which therefore renders it possible to connect the amperage, voltage and resistance of an electrical system by means of a single mathematical expression.

So far as we can gather, Ohm's work on his "Law" was not an entirely new



Standard resistance boxes for use in connection with galvanometer working.



A typical laboratory variable resistance used in experiments concerning Ohm's law.

départure solely initiated by himself. We can go back to the days of the Hon. Henry Cavendish (1731-1810), that strange and eccentric London chemist and electrician who, in his laboratory near Clapham Common, partially anticipated Ohm's great law by showing that the resistance of an electrical conductor is independent of the intensity of an electrical discharge from a condenser. Indeed, Cavendish went so far as to enunciate laws according to which an electrical discharge divides itself up among a number of conductors.

**The "Flux of Heat"**

Very possibly Ohm was quite ignorant of Cavendish's investigations. He seems to have derived his idea from the work of a French physicist named Fourier, who had shown that what he styled the "flux of heat" in a metal bar or rod is directly proportional to the difference in temperature between its ends.

By way of analogy, Ohm, taking Fourier's cue, experimented with the crudest of apparatus and was able to demonstrate the fact that an electrical current behaves in very much the same way as the "flux of heat," and that, for a given conductor, the "electrical flux" (in other words, the current-flow) is directly proportional to the difference of electrical potential between the ends of the conductor.

Subsequently Ohm showed that, employing exactly the same potential-difference, the current when passed through different conductors is always inversely proportional to the internal resistance of the conductor.

During his early experiments Ohm worked with "galvanic" or chemical batteries. All such articles, however, had the intensely annoying and exasperating property of not maintaining a constant current flow, a fact which Ohm found to render exact work quite impossible.

**Thermo-electric Couple**

Fortunately for Ohm, Professor Seebeck, of Berlin, had, in 1821, discovered another source of electrical current when he showed that a current could be generated by heating the junction of two dissimilar metals. Seebeck's device, the thermo-electric couple, proved to be Ohm's salvation in regard to his researches on resistance, for he had in the thermo-battery a current source which was extraordinarily constant so long as the degree of heating was maintained constant. Ohm used a thermo-battery comprising a bar of pure bismuth which was introduced into a circuit of pure copper wire, one of

the two points of contact between the bismuth and the copper being kept below melting ice, the other junction between the metals being immersed in gently boiling water. A simple form of galvanometer was included in the circuit, and it showed readings of the utmost steadiness.

Ohm showed that the resistance of any given conductor to the electric current is directly proportional to its length, and inversely proportional to its cross-section and to its inherent conductivity. Thus Ohm demonstrated the fact that, unlike the static form of electricity which only resides on the surface of conductors, the ordinary "flowing" electricity which constitutes the current passes equally through the interior of the conductor, for if this were not the case the resistance of a conductor would not be inversely proportional to its cross-section.

**Ohm's Enemies**

Ohm's publication, *The Galvanic Circuit Mathematically Considered*, which appeared in 1827, did not fall entirely on deaf ears. Rather it had to contend with hostile ears.

It is almost incredible that this epoch-making announcement brought its originator misery, distress and actual poverty. The theories embodied in the pamphlet were vigorously criticised, and even derided. They were dealt with in contempt by people who ought to have known better. But the cruellest action of Fate came when the German Minister of Education (who must, obviously, have been influenced by some antagonistic party) gave very pointed hints to the effect that a man who would put forward such theories as were contained in *The Galvanic Circuit* was not fit to be a physicist or to teach science.

In these circumstances Ohm could do little other than resign his teaching post at Cologne. The bitterest disappointment seems to have militated against his endeavouring to defend himself in a positive manner against the assertions of his enemies. His reaction was to throw everything up and to go back to his home town, Erlangen, there to seek refuge from the onslaughts of the scientific world in the high places.

**Wasted Years**

Six good years of Ohm's life were thus wasted at Erlangen. What he did with himself during those years we hardly know. It seems that he continued in some small way his electrical experiments, because a number of papers of minor note written by him were printed in some of the German journals of that period.

His circumstances, which had always been more or less straitened, now degenerated into those of actual poverty. Stung into positive action by the injustice of his circumstances, and ir-



*A modern laboratory resistance box for "introducing" ohms into a circuit. By a number of combined tappings it enables any number of ohms from 1 to 5,000 to be added to the resistance of an electrical circuit.*

elled also by a condition of life almost approaching that of actual distress, he several times presented his case to the Bavarian king and petitioned a royal review of it. In the end his petitions were heard. He was, in 1833, given a physics teaching post in the Polytechnic School of Nuremberg, a post which led to a professorship and which retained him at Nuremberg for the ensuing 16 years.

**Ohm's Law Recognised**

It was during these years that Ohm slowly climbed his way into recognition in the scientific world. The Royal Society of London, as we have seen, took the first step in paying tribute to his investigations. This accomplished, other learned bodies and schools followed suit. After a lapse of more than ten whole years, "Ohm's Law" at last came into general recognition as an electrical generalisation having the most extended theoretical and practical possibilities.

By a sort of general concensus of opinion technical people gradually began to refer to the electrical unit of resistance by the title of "Ohm," so that when this term was officially adopted internationally by a congress of electricians which met in Paris in 1884, the "Ohm," as an electrical unit, needed little introduction.

The tragic circumstances of Ohm's earlier creative life seem, in a way, to have sapped his originality, so far as electrical researches were concerned. He never again repeated his earlier electrical triumph. Rather, he seems to have gone in more for literary work, as, for example, the writing of a great treatise on molecular physics, a work, however, which was never finished. He wrote a textbook of physics and various other papers dealing with the theory of sirens, musical sounds, interference of light by crystals, various optical matters and other subjects. But never again did original electrical work seem to be uppermost in his mind. The tremendous disappointment and the cruel injustice which he had suffered in connection with his earlier investigations never seemed to forsake him.

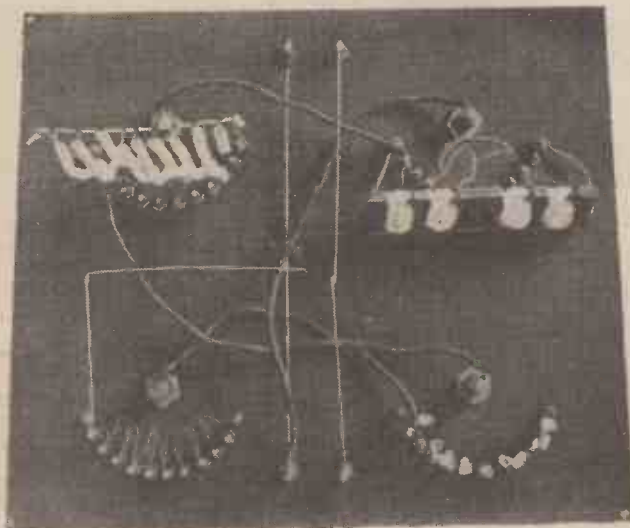

*Back view of the resistance box panel showing the series of resistance coils and tappings.*

Yet Ohm was now able to improve his life's circumstances. After a successful spell at Nuremberg he was, in 1849, called to Munich as curator of the great Physical Museum in that city. He became a "Councillor" of the German telegraphic administration, and in 1852 he was made professor of experimental physics in the University of Munich.

#### Ambition Attained

This was the fulfilment of a long-cherished ambition, for a professorship at

Munich carried with it European recognition of ability, achievement and status.

At Munich, official duties piled themselves rapidly on Ohm's shoulders. They appear to have depressed him greatly. His health failed, and early in 1854 he suffered an apoplectic stroke from which he recovered with sufficient strength of mind and body to continue his lecture work. But on July 6th in the same year, late in the evening, just before he was due to retire to bed, another stroke came on. This time he never recovered, dying shortly after the attack.

So ended Ohm, apostle of electrical resistance.

Georg Simon Ohm was a curious man, and even in the scientific world he was something of a recluse. He was known personally only to a few friends and to a select inner circle of students.

Ohm's career is now almost forgotten. The memory of the man has long faded. Only the international unit of electrical resistance, the "Ohm," nowadays serves to remind us that he once lived.

## Scientific Facts

By Prof. A. M. LOW

#### Atomic Common Sense

IF I fail to mention atom bombs it will be thought that I am rather peculiar or very foolish. My personal view is that atomic power may eventually prove the greatest blessing the world has known. Cheap power—when we discover how to turn matter into energy in such a fashion that electricity results direct—could give us motor-cars run by induction from cables below the ground, clothes heated by broadcast energy, radio to which we could listen without irritating our friends in the same room, and a host of other important things. Even the bomb might enable us to change the weather by altering the course of rivers or moving mountains. And these results are far more interesting than the mere blowing up of cities which have taken centuries to complete. From the aspect of war, some bombs in a rowing boat could destroy half a navy while a few schoolboys with peashooters might decimate a country. For I believe that we shall discover far better atom bombs and, even more important, how to use them. Atom bombs which explode themselves automatically without a vast amount of auxiliary apparatus or heavy water. What is more, I think that secrecy is fantastically impossible, for any good science students, given the money, could produce the bomb. Nor do I think the suggestion of outlawing atom bombs is even mildly sensible. War happens when law fails. Why not outlaw murder, theft, drunkenness or rotten apples? It is impractical to say to a nation "you may play with bows and arrows and we promise not to use a weapon which, at the touch of a button, makes the whole of your armed forces look like children." Perhaps that is worth thinking over. So I would prefer to leave it to you.

#### Science Helps Burglars

THE other day I saw an interesting burglar-proof invention for motor-cars which was more sensational than the usual petrol lock or the ignition switch-off of which one loses the key during the first few weeks.

In principle, this device consisted of a very delicately poised contact, so arranged that the slightest movement of an unattended car caused a little trembler to move or, in fact, to tremble! Connected in series with the reed was a switch which would make contact only if the trembler oscillated for two or three seconds on end. Directly the would-be thief tried to touch the car or to remove a rug, a strong vibration was set up in the machine and a contact made which was connected to the horn. The resulting yelps could not be stopped except by the owner, and everyone, with the exception of the thief, was happy.

Future burglars will no doubt be so scientifically minded that they will shake cars so hard that any delicate mechanism of such devices will be put out of order. They

will use ultra-violet lamps to put selenium cells out of action, or else they will play tunes to cars which are fitted with switches which only respond to a definite pitch of whistle kept by the owner.

Really, a burglar's life has such interesting possibilities that I am seriously thinking . . . well, perhaps after all I had better think it over!

#### Cheap Light

LIGHT is probably the most important commodity of civilisation. Its efficiency seldom exceeds about 2 per cent. What will engineers think of us in the future? They will say we are savages and they will be right.

The latest plans are interesting, for it is cheaper to produce light outside the wave-

lengths of the visible spectrum. Naturally this would be little use for it would show objects in the queerest of colours, quite different from those to which we have become accustomed by centuries of sun.

This does not daunt the lighting expert who now produces cheap invisible light and causes it to make substances glow or fluoresce. That is how a great deal of this tubular light is accomplished, although it still is less efficient than the friendly glow-worm.

I am sorry, but glow-worms are really beetles. I do not think anybody yet quite knows if the beetle switches on his lights to please himself or for what modern novelists call "sexual emulation." But he can control it, and often the tap of your foot upon the ground causes a blackout. Fortunately for me, no one knows why this is so, and indeed no one knows much about anything. Glow-worms are far more efficient than any man-made light.

#### Make Your Ghosts

I DARE express no opinion about ghosts, although I think myself that these are commonly due to an overwrought mind or to the effects of our stomachs.

You can make an awfully exciting ghost yourself. Obtain, or make, the cheapest of magic lanterns, with a black light ultra-violet bulb shining through a silhouette of the traditional shrouded form. Blow into the room some very fine dust which glows in ultra-violet light and you are all set.

Stage your seance and at the right moment switch on. Give your permission to the sitters to take the very unusual step of turning on the main lighting whenever they like in order to prove how genuine you are. As they do so, the ghost disappears and nothing at all can be seen.

Much the same effect can be secured by painting a face in thin vaseline rubbed into the back of an old coat. But always tell your audience, for tricks are no good unless they have an interesting purpose, and please, as I do, avoid saying that all ghost people are liars. In my opinion no one yet knows.



An impressive study of a giant mushroom cloud that soared into the sky after the dropping of the Atom Test Bomb at Bikini, on the guinea-pig fleet. The photograph was taken from a B-29 Fortress at a safe distance. The blast damaged more than half of the 73 ships of the fleet.

# The Automatic Tyre Pump

The Editor's New Invention (the Campump) for Inflating Tyres whilst the Vehicle is in Motion

By F. J. CAMM

**T**HOSE readers who visited the Model Engineer Exhibition at the Horticultural Hall will have seen on our stand a bicycle equipped with two pumps which automatically inflate the tyres whilst the vehicle is in motion. It attracted a great deal of attention, and the B.B.C. thought it an outstanding exhibit of the show and illustrated it on the television screen in their Picture Page feature on Thursday, August 22nd, 1946. It was also shown on the newsreels throughout the country. I have received so much correspondence on this pump that I hope this article and illustration will provide fuller details than is possible from an external examination.

## Correct Tyre Pressures

The invention is intended to provide the missing link in pneumatic tyres. The manufacturers of tyres quite rightly stress in their advertisements the importance of correct tyre pressures. Tyres should not be under-inflated nor over-inflated; both have deleterious effects, especially on synthetic rubber.

Tyres to-day are of extremely high quality, but no one has yet made a rubber or a valve which is completely air-tight. In other words, although a tyre may not be punctured it will gradually lose pressure, and thus need to be inflated from time to time. The inflation of even a bicycle tyre is not easy work, and hand pumping is somewhat awkward and exhausting, especially for ladies. With my automatic pump in action the tyre can be inflated whilst you are riding the machine, and the operation is almost effortless; certainly you do not notice that you are pumping, as many found when they tested the pump at the exhibition. Moreover, it will keep the tyre correctly inflated even if there is a slow puncture in it.

A pressure release valve is fitted which may be adjusted to blow-off at any pre-determined pressure up to 100lb. per square inch. As manufactured, this valve is set according to the tyres to which it is to be fitted.

The barrel of the pump is of duralumin, and in it is a short stroke piston with a rubber washer of special design which injects the air via a small metal pipe through the standard tyre valve. When the pump is not required it may be locked out of action by means of a bayonet catch. At the end of the plunger is a grooved roller which runs round the periphery of a duralumin eccentric pushed on to the spindle. The pump itself is clamped to the spokes by means of two screws which secure it quite rigidly. It may be fitted in a few seconds, and it does not call for any structural alteration to the forks or the wheels. In other words, it can be fitted to any bicycle. It is likely to be on the market early in the New Year. It can also be fitted to hub-gear bicycles. It inflates a dead flat tyre to full pressure in approximately 200 yards, although I do not suggest that a bicycle should be ridden with flat tyres. A few spins of the wheel will put air into the tyre, whilst if the bicycle is inverted and the cranks rotated, the back tyre may be inflated very rapidly indeed, far more rapidly than if the bicycle were ridden.

## For Motor-cars

The pump is, of course, also applicable to motor-cars. It has always seemed to me wrong that the motorist should be expected to use physical energy to inflate the large

tyres fitted to cars. It is indeed hard work. A motorist switches off his powerful engine and uses his own energy when the car itself could do the work. Others, of course, have had the same idea, and there have been many devices, engine operated, for inflating a tyre. This means, however, that the car has to be stopped, and also the pump has to be frequently disconnected to check the pressure. With my pump the pressures are automatically checked whilst the car is in motion. The makers of the car do not leave the lubrication of the engine in the hands of the driver, nor the cooling of it. All the driver need do is to see that an adequate supply of water is in

the radiator and oil in the sump. Why, therefore, should the driver not be similarly relieved of the trouble of ensuring that his tyres have an adequate supply of air? At the present time, however, manufacturers are not particularly anxious to fit any device to their cars which is likely to increase the cost. The Purchase Tax on cars is making them dear enough, and motorists may have to wait a little time before the benefits of the automatic tyre pump are brought to them.

But whether manufacturers of cars adopt my invention or not, it is inevitable that in the ordinary march of progress the pneumatic tyre must in the near future become a self-contained unit incorporating its own pump.

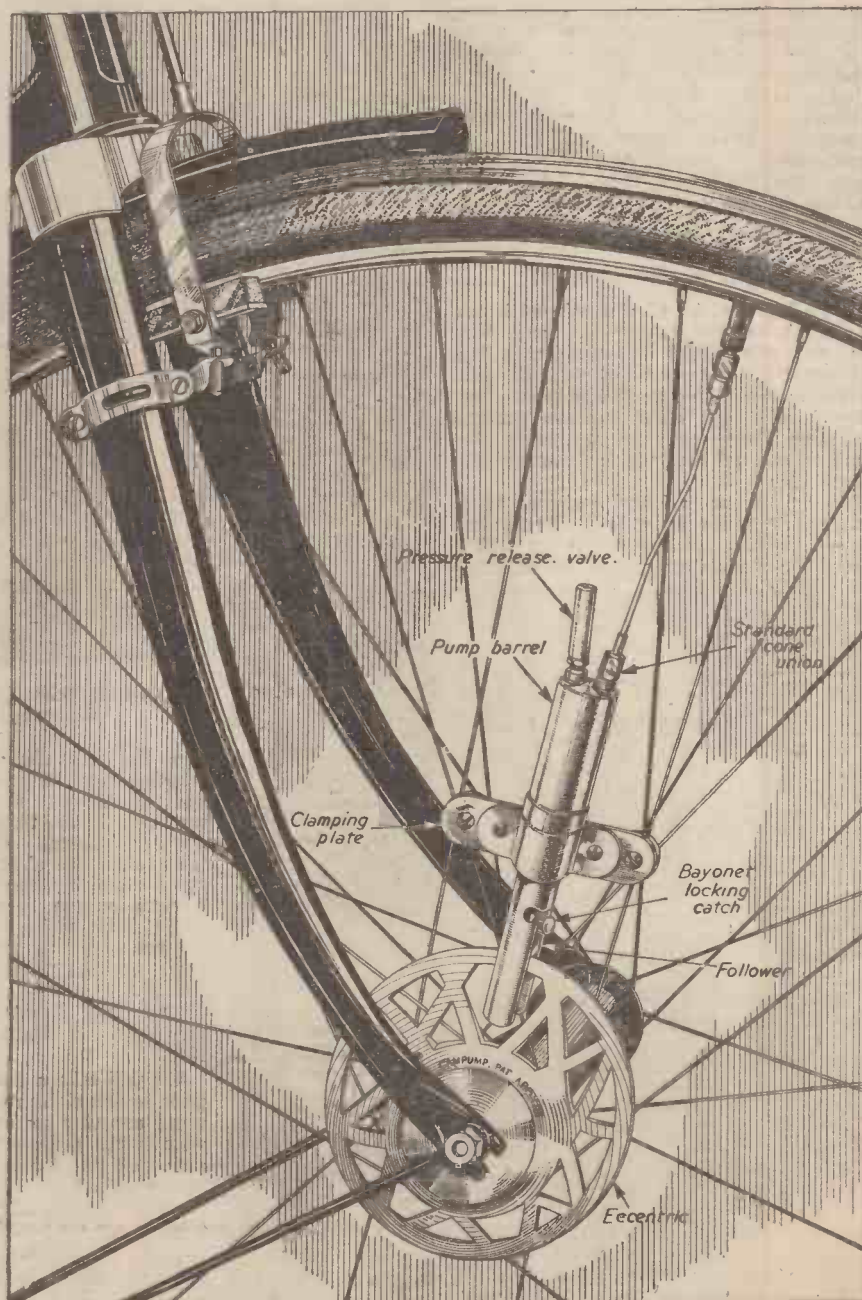

A close-up view of the automatic tyre pump fitted to the front wheel of a cycle.

# The Model Engineer Exhibition

A Glimpse at Some of the Remarkable Exhibits

By the MARQUIS of DONEGALL



*A corner of the exhibition.*

**A**FTER two visits of a couple of hours each to the twenty-first and first post-war Model Engineer Exhibition I have still not absorbed a quarter of such exhibits as even I am capable of appreciating.

But I will first attempt some general description from the time we enter the New Horticultural Hall which the exhibition entirely fills.

First we go up a broad staircase of a few steps into the main hall. Facing us down the centre are the stands on which most of the models are entered in competi-



*A miniature replica (about 8in. long) of H.M.S. "Morpeth Castle" Corvette, modelled by R. L. Miller, of Brighouse.*

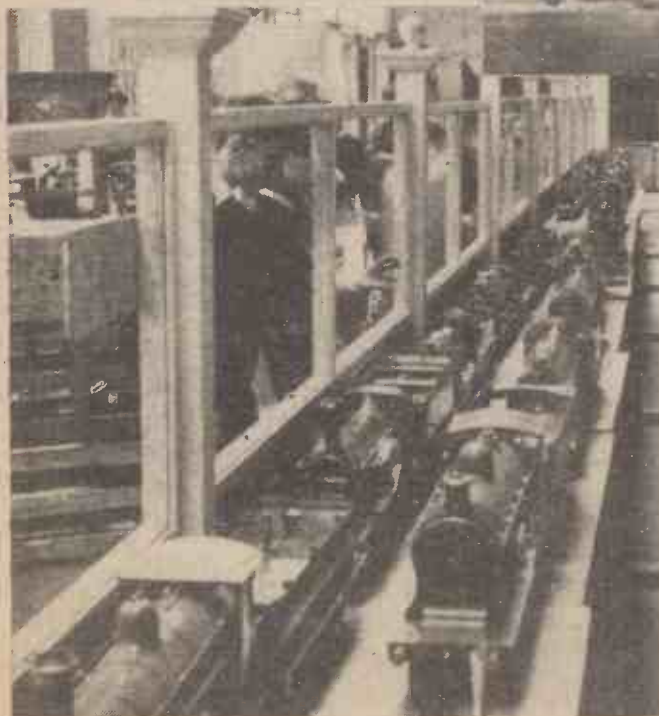

*A fine array of model locomotives seen at the exhibition.*

tion for the championship cups, medals and diplomas. But we will leave these exciting items, of which there are about 270 entered by competitors whose ages range from eight to 73, not forgetting the lady model-makers, for whom a cup is offered by Admiral Sir Reginald Bacon, K.C.B.

We will take a few steps to the right and wend our way up an alley with stalls on each side as opposed to the open tables on which the competitive exhibits are displayed. Against the right-hand wall of this alley are some club stands. The clubs include the Society of Model

and Experimental Engineers, with Lord Forres as president; the Society of Model Aeronautical Engineers (in the centre of the hall); Vauxhall Motors Club; the Model Railway Club; the Kodak Club, and many others.

We notice the considerable increase in clubs formed by commercial firms, such as Murphy Radio, George Kent, Ltd., and some already mentioned. Going down this section we notice that the oo gauge is increasing in popularity. The Croydon Society, the North London Society and others have a complete lay-out running continuously. Hamblings display the new two-rail electric propulsion, and the complete model club scenic layout of the Malden Society is a glimpse into the future of model engineering clubs.

#### R.A.F. Stall

On the other side of our alley the stalls, except for the Royal Air Force stall, are commercial, showing construction outfits

for embryo model-makers, home printing presses, constructable model aeroplanes, kites and gliders, model aero-engines, and at the end of the side is the R.A.F. display showing a Derwent 1 Rolls-Royce jet engine, which giant is a real Gulliver in Lilliput, and a Battle of Britain Merlin III.

At the end of the alley we have the Royal Navy stand, giving out particulars of crafts to be learned in the Navy.

We pursue our way along the top of the hall to the alley down the opposite side. Here we find drawing-office equipment, more constructional engineering sets, dynamos and motors for model-makers, castings for scale locomotives, and a complete range of petrol engines for model aeroplanes, speed-boats and racing cars.

Plumb in the middle we find a stall (of which a rival firm has one on the left of the main entrance) devoted to our old childhood friend, the gyroscopic top. Naturally I had to buy one, and it has amused my Alsatian ever since.

Just before we come to the opposite side alley there is a large stand displaying for sale all kinds of tools and light machinery.



**Passenger-carrying Railway**

Now we turn down the alley towards the front entrance. The entire length of the wall of the main hall is occupied by the passenger-carrying railway track. This is, of course, the most popular item of the exhibition among the smaller visitors.

This year there is 90ft. of track as opposed to 60ft. in the past, and the fare is 3d. a ride. The multi-gauged track belongs to the S.M.E.E., the locomotives being supplied by them and other societies.

We are rather lucky in that just as we are admitted to the "engine shed," Mr. Reid, of the B.B.C., is about to drive a train for the purpose of describing it in "On the Spot" in the Light Programme. Mr. Reid took his seat behind "Uncle Jim" Crebbin, grasping a hand microphone firmly in his right hand and leaning round Mr. Crebbin to pull and push miniature levers as instructed.

Frankly, I didn't realise that these versatile and ubiquitous young gentlemen of the B.B.C. were capable of performing so many simultaneous operations. The only thing that Mr. Reid did not do was to feed out the cable from the recording van, which operation was performed by an assistant running alongside, whose puffing no doubt



The "Practical Mechanics" stand, showing Mr. F. J. Camm's automatic cycle-tyre pump.

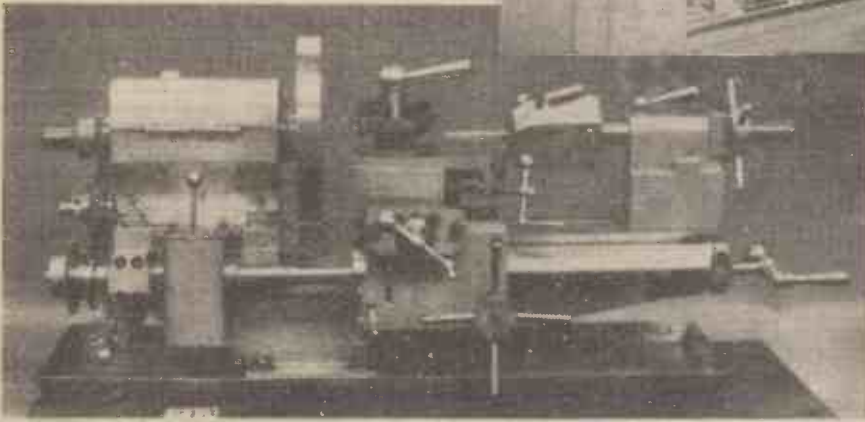

A miniature lathe, made by R. Bradley of Sheffield, while a P.o.W. in a Japanese camp in Singapore.

added appropriate noises off. "Uncle Jim" Crebbin, I learned, was an official of the Bank of England and has a track in his garden at Finchley. The 5in. gauge locomotive "Old Bill," immortalised by the B.B.C., was, of course, of his own construction, and he informs us that it will go 15 miles an hour on an endless track.

Next we are introduced to "1188," a locomotive of somewhat ancient pattern, by Mr. A. J. Maxwell, who appears in G.W.R. driver's overalls and peaked cap. Mr. Maxwell was with the G.W.R., man and boy, for many years, and "1188" is the engine that he was first put to clean as a lad. He had retired from the G.W.R. before the war, but went back on war service.

**George Newnes' Stand**

So we leave the "engine shed" and, starting down the alley, we look at the stalls opposite the railway track. These again are commercial stands embodying more model building kits, George Newnes, Ltd., books and periodicals, including F. J. Camm's PRACTICAL MECHANICS. There is also on this stand Mr. Camm's scale model Burrell road tractor, all chromium plated. He tells us that scaling down the pressure gauge, which shows up to 80lb. pressure to the square inch, was the most difficult part of the job. The model, which includes Stephenson reversing gear, is probably one of the smallest in the world, and took him three months of evenings to make. It ranks

with Dr. Winter's solid silver model of Stephenson's "Rocket."

More mechanisms and units, miniature engines, watchmakers' tools, rubber products for aero modellers, and workshop supplies.

**The Hydrofin**

Now we are back at the main entrance and turn up again to visit the stalls, backing the ones that we have just visited, that front on the competition models in the centre of the hall. Here we have precision tools, model aircraft and assembly, jig-saw puzzles, model-makers' plans and plan books, and the hydrofin—a most remarkable contraption, half-way between a seaplane and a motor-boat, which carries scores of passengers and does 70 miles an hour.

A model of the *Queen Mary*, to put in a tray of water on the dining-room table, propels itself on a drop of methylated spirit. More machine tools and we are back at the top, to go down the stalls facing the other side of the competition models. More model aircraft, aero-

motors, gauge 00 and 0 model railway equipment, locomotive castings, literature, lamps, and Bassett-Lowke.

Coming down the centre we get the exhibits of the Society of Model and Experimental Engineers, founded in 1898, and the Society of Model Aeronautical Engineers, evolving from an original association founded in 1907.

In this section there are so many remarkable exhibits that we are forced to be invidious and pick out a few. You cannot very well miss Mr. E. Harding's M.G. racing car, which would, I think, almost fit in a box for a pair of men's shoes, and is stated to hold the British record at 74 miles an hour. Similar models have done over 100 m.p.h. in America and are known as "spin-dizzies" over there. Nor, because

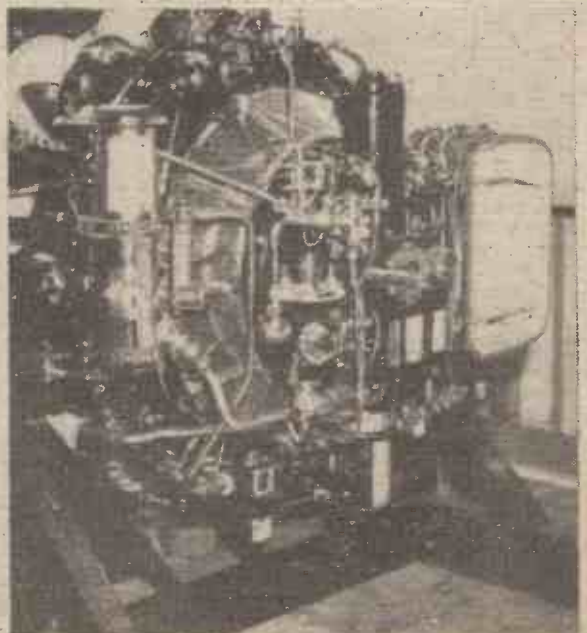

The new Derwent I Rolls-Royce jet engine, seen on the R.A.F. stand.

of its size, can you very well miss the N.F.S. fire unit, and if I tell you that the escape goes up about 10ft. you can work out the scale for yourselves.

#### Tiny Electric Engine

Because you can hardly see it, we almost miss the smallest electric engine in the world. It has a chained magnifying glass attached, but even so we have to take it on trust.

Before we go up to the gallery over the front hall there are some beautiful models of ships, including Mr. Richard F. Bell's model of the Danish cadet training ship, *Kobenhavn*, which disappeared with all hands after leaving Buenos Aires on a training cruise.

In the gallery are all the professionally made models of Messrs. Rootes' war vehicles, with the exception of Field-Marshal Lord Montgomery's "Old Faithful" open Humber. I know it exists, because it was on the table at a luncheon the firm gave some months back. Probably the Field-Marshal has had



*Both young and old were interested in the many realistic models seen at the exhibition.*



*H. A. Cox putting the finishing touches to his model of a ship-rigged yacht at the exhibition.*

it. Also their aircraft, Halifax and Beaufighter.

The model of the future House of Commons can only be distinguished from the old House if you know the arrangement of the galleries intimately. All the super-structure of Gothic carving that obscured the galleries behind the Speaker's Chair is to be eliminated, and—I was pleased to note—peers are to have more space. Criticism: having become a model maniac in the last week, I suggest that H.M. Office of Works might have provided this lovely model with a proper miniature clock.

#### Working Model Cinema

As we wander round we come to the model super-cinema loaned by the Malden Society. The cinema organist plays continuously to a miniature packed audience with the usual blending of changing soft lights. The model also shows a 16mm. film by back-projection, but unfortunately this was found to be impracticable in the exhibition.

Next we come to the Croydon Society's 00 gauge lay-out and the model tube-escalator complete with dynamo room, lent by the London Transport Board. It is complete even to the miniature advertisements.

On to some beautiful models of trams

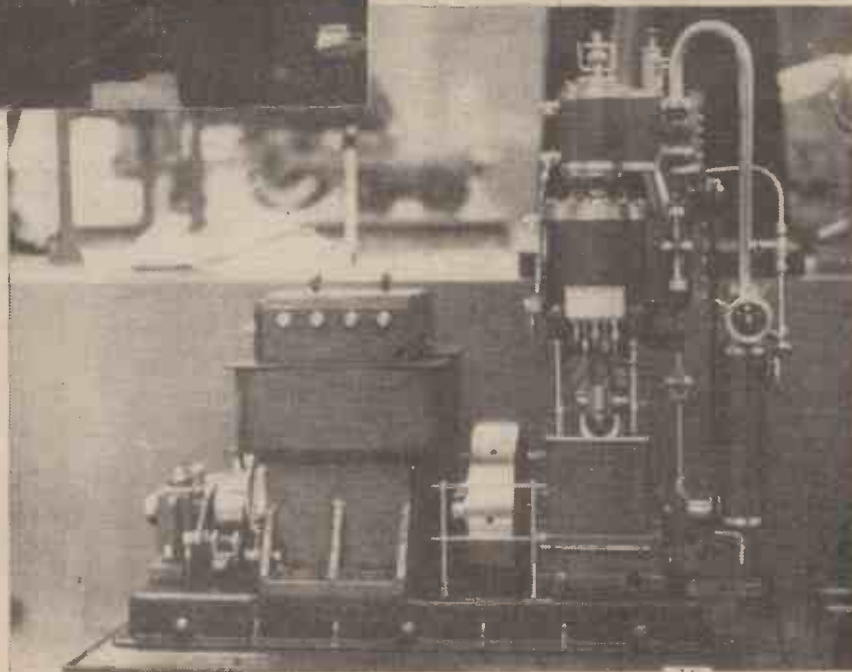

*Another fine exhibit—a vertical steam-driven dynamo set made by W. T. W. Rolls, of Nottingham.*

by the Tramway and Light Railway Society. In the centre of the gallery we are particularly impressed by the models of State and other coaches, and on the corner of this stand Mr. Frost, a one-armed veteran of the 1914-18 war, has loaned a caseful of

remarkable exhibits varying from a bound book to a carved doll's house armchair, products of his left hand.

Our tour of the exhibition would not be complete without talking to Mr. Percival Marshall, the father of British model engineering. Mr. Marshall trained and worked as an engineer for 10 years. But he had publishing in his blood from his father, who founded Horace Marshall and Son.

Furthermore, he realised some 40 years ago that model engineers in Britain were badly in need of integration at that time, and founded *The Model Engineer*. He also

founded the Society of Model and Experimental Engineers, and is the Big White Godfather of this first post-war Model Engineer Exhibition. Finally, I hope you have enjoyed taking this cursory glimpse at it as much as I have.

# The "Bristol" Twin-engined Multi-purpose Aircraft

## General Description and Operating Data of the "Bristol" Type 170 Civil Transport Aircraft

THE "Bristol" type 170 aircraft is designed to meet two of the most important requirements of air transport, viz., the air carriage of all classes of cargo, and the provision of cheap, comfortable and reliable passenger carriage. The machine has an exceptionally spacious interior which makes it adaptable to a wide variety of uses.

### General Particulars

The new aircraft is of essentially utilitarian design and of "Bristol" standard all-metal construction—fully proved in Bristol aircraft during six years of war—and having disposable loads of 11,950lb. in its Freighter version, and 9,700lb. in the Passenger, or "Wayfarer" version. It is a high wing monoplane with fixed undercarriage to render it especially suitable for air transport in remote areas where prepared runways may not be available. Ease of maintenance, low operating costs and sturdiness of construction are features of the design.

It has a low wing loading—26lb./sq.ft. at 36,500lb.—and is able, therefore, to operate on small airfields. Power is provided by two "Bristol" Hercules 14-cylinder radial air-cooled sleeve-valve engines of 1,675 b.h.p. each.

### Operating Characteristics

**Cruising speed.** A range of cruising speeds from 140 m.p.h. to 180 m.p.h. is available on a power output of from 40 per cent. to 55 per cent. of take-off power.

**Take-off and landing.** At fully laden weight the aircraft clears a 50ft. barrier in under 700 yards. The ground run is about 350 yards. Landing distance over a 50ft. barrier is 650 yards.

**Climb.** The rate of climb is 1,100ft./min. at sea-level, 750ft./min. at 10,000ft.

**Payload and range.** Still air range cruising



The "Bristol" Type 170 aircraft in flight.

at 180 m.p.h. with payload of 4-tons of cargo is 700 miles; 600 miles with 32 passengers and their baggage.

**Single-engine performance.** The ample reserve of power ensures adequate single-engine performance, the rate of climb on one engine being 280ft./min. at sea level.

Operating costs, estimated on a conservative basis and on annual utilisation of 2,000 hours; 300 mile still air range with 60 per cent. reserve of fuel, are: capacity load, 7.8 pence per ton-mile and 1.1 pence per passenger-seat mile, equivalent to 12.0 pence per ton-mile and 1.7 pence per passenger mile with a 65 per cent. load factor.

Span, 98ft. Overall length, 68ft. 4in. Height

over fin, 21ft. 8in. Main hold, 215 sq. ft., 2,020 cu. ft. Main cabin, 31ft. 8in. long by 6ft. 9in. wide (8ft. 0in.) 24in. above floor. Wing loading, 26lb./sq. ft. Power loading at take-off, 10.9lb./b.h.p.

In the "Wayfarer" there is accommodation for 32 passengers, ample stowage space for luggage, and individually controlled heating and ventilation.

On May 9th, the occasion of the celebrations marking the first anniversary of the liberation of the Channel Islands, the first of a fleet of 32-seater Bristol Wayfarers, prior to going into regular service with the Channel Islands Airways, Ltd., made a proving flight to both Guernsey and Jersey. The round trip of nearly 500 miles—made in 3½ hours' flying time—was from the Bristol Aeroplane Co.'s airfield at Filton via Southampton, Guernsey, Jersey and Croydon.

While at Guernsey and Jersey Airports, the "Wayfarer" was open to inspection by the public, thousands of whom had not previously seen an aircraft of such size at close quarters.

Especially interested in the "Wayfarer" at Guernsey was the Governor of the Island, Sir Phillip P. Neame, V.C., C.B., D.S.O., who recalled that he flew in the Bristol Box Kite at the Army Manœuvres on Salisbury Plain in 1910.

Guernsey Airport, which is probably the smallest airfield in the British Isles—the entire length of the landing field is less than 1,000 yards—gave Mr. A. J. Pegg, the Bristol Aeroplane Company's test pilot in charge of the flight, no trouble at all; there was a handsome margin at both landing and take-off.

Wing Commander Swoffer, Controller of the States Airport—who is most closely concerned with the performance of the "Wayfarer"—remarked, "The performance was excellent in both landing and take-off. It is very obvious that the time has come when suitable aircraft must be built to meet the size of small airfields, and it would appear that the Bristol Aeroplane Company has successfully solved the problem with the 'Wayfarer.'"

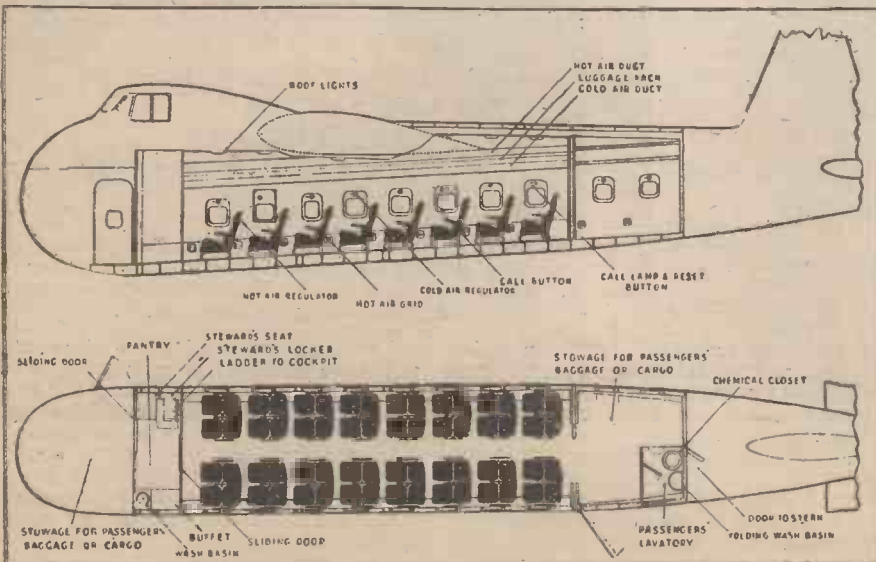

General arrangement drawing of the Bristol "Wayfarer" showing the layout for accommodating 32 passengers.

# Inventions of Interest

## Bicycle Shock-absorber

FOR the comfort of the cyclist there has appeared a spring suspension arrangement to prevent road shocks from being transmitted through the frame of the bicycle to the handlebars.

The device consists of one or more springs coiled at one end round the handlebar and fixed at the other end to the pillar which is adjustable in the steering column.

The pillar is connected to the handlebar by one or more arms rigidly secured to the handlebar and free to turn in relation to the pillar.

This arrangement is such that vibratory up-and-down movements of the steering column pillar are to a great extent absorbed, while perfect rigidity is maintained for steering.

## To Release Aircraft Dinghies

THE collapsible dinghy acts as the life-boat of aircraft. An improvement of this inflatable life-saver is the subject of an application for a patent in this country. It concerns the release of the dinghy from aircraft housings such as are in the hollow wings.

The device has reference to known arrangements in which a cylinder of gas is pocketed in the dinghy and connected so as to inflate the latter in times of emergency. And the dinghy is stored in its collapsed condition with the cylinder located and supported in a cradle in the housing. There are means enabling the pilot to open the cylinder cock from a remote point and thus to inflate the dinghy. The expansion forces open a housing cover permitting the dinghy to release itself and to float away from the aircraft.

The aim of the improved invention is to ensure that the inflated dinghy will freely release and discharge itself from the housing without entanglement or fouling of the gas cylinder with the housing.

According to the invention, there are provided stowing and ejecting means for a dinghy stowed in a collapsed condition in an aeroplane housing, in which a cradle supporting the inflating gas cylinder pocketed in the collapsed dinghy is subjected to an elevating force. This tends to urge the loaded cradle upwards to a dinghy-ejecting position, but is normally restrained by locking means which are automatically released by the expansion of the dinghy during its inflation.

## Shaving Brush and Hone

A SUBJECT of Switzerland has applied for a patent in this country for a combined shaving brush and razor sharpener.

To the handle of the brush there is fitted at least one abrasive surface for sharpening the blade.

The handle has a longitudinal groove in which is inserted a piece suitable for sharpening blades. This piece can be made of glass, porcelain or plastic material containing a quantity of a finely distributed abrasive surface.

It is preferable to design the piece with two opposite surfaces of different grain, so that it can be slid into the groove in the handle with either surface in working position, as desired.

## Blotting Paper

THE British Patent Office has received an application concerning the manufacture of highly absorbent rag papers adapted for use as blotters.

The information on this page is specially supplied to "Practical Mechanics" by Messrs. Hughes & Young, Patent Agents, of 7, Stone Buildings, Lincoln's Inn, London, W.C.2, who will be pleased to send free to readers mentioning this paper a copy of their handbook, "How to Patent an Invention."

In the making of such paper it appears that previously it has been customary to rot the rags for long periods, so that they would be soft enough to break up readily in the breaker machine without wetting up and thus reducing the absorbency of the paper.

This method, it is stated, is extremely slow and costly, in view of the considerable time required for rotting and the need for extensive rotting stores.

In the case of the improved process, the rags of natural cellulose fibres to be employed in the manufacture are boiled for a while in water containing small additions of formaldehyde and ordinary papermaker's alum or some other mildly acid substance before being subjected to the mechanical action of a papermaker's breaker or beater.

This short and simple treatment has the effect of altering the nature of the cellulose. Thereby it loses its tendency to wet up under the mechanical action of the breaker or beater. And it is thus possible to break down the rag pieces into fibres suitable for the manufacture of blotting or other absorbent papers and to secure promptly a final product having a high degree of absorbency.

## Aerial Bombs

THE bomb which played such a deadly role in the Great War which closed last year is not yet entirely excluded from the specifications published by the British Patent Office.

A subject of Czechoslovakia has conceived two inventions relating to these weapons of modern warfare. One concerns bombs with a parachute attachment enabling them to be suspended in space as a protection against enemy aircraft and having means responsive to tension on the bomb whereby, when brought into suspension, the bomb explodes upon impact.

An improved bomb of this type is characterised in that a safety device rendering its firing member operative after the bomb has been launched into the air locks the firing member permanently in the inoperative position, after the pull on the suspension has once been relaxed.

The arrangement is such that, when the

tension on the cable is eliminated or reduced, the fuse is automatically made safe even when the tension has been restored after once being relaxed.

The percussion mechanism may be of any suitable kind, such as the pendulum type or of the sort dependent upon inertia forces. Or it may be subject to the action of a spring or other source of power.

## Bus Ticket Punch

THERE has been accepted an application for a patent in this country concerning a bus ticket-punching apparatus. This device supplies a permanent facsimile record of the punching in such a manner that the total amount of the money taken can be rapidly ascertained and checked.

Another feature enables the tickets to be punched in different positions, according to fare stages, and makes an indication of such fare stages in the ticket-issue record.



Mr. R. Barton, of Bolton, has invented a pit-cage safety device, designed to arrest the descent of a colliery cage in the event of the winding rope breaking. The illustration shows Mr. Barton with a pit-head model for demonstrating his safety device.

The apparatus is of the kind in which tickets are punched and severed from a continuous paper strip wound into a coil or roll carried by a spool rotatably mounted upon the frame or the body of the apparatus.

In this new device the punch anvil or plate, and the punch mechanism, are movable as a unit to different positions. The result is that the punching is effective at a position on the ticket corresponding to the fare stage within which the ticket is issued. The fare stages are indicated both on the ticket strip and on the record strip.

# Penicillin Production

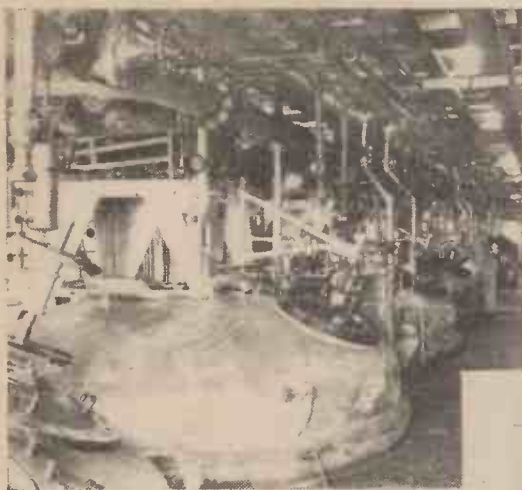

Penicillin has been called the wonder drug by physicians and patients alike. Where other drugs have failed, penicillin has succeeded. At Speke, on the outskirts of Liverpool, is one of the world's wonders—the sterile area in which penicillin is prepared. In the United States more than 20 drug-making companies are producing penicillin.

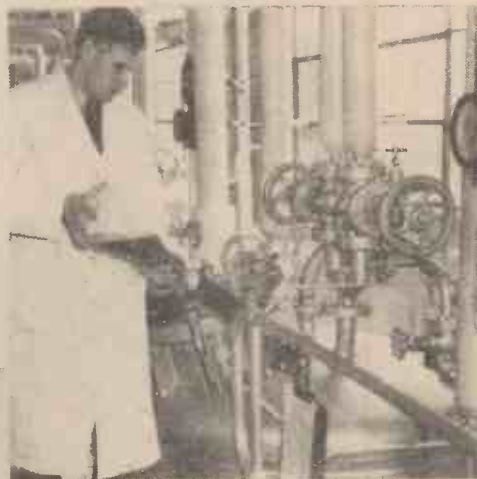

In one of the laboratories of E. R. Squibb and Sons, at New Brunswick, New Jersey, showing the tops of the 15,000 gallon germinator tanks for the growth of the mould. These tanks extend two and a half stories below the floor shown in the illustration. Samples are taken from the tank from time to time to check the progress of the growth.

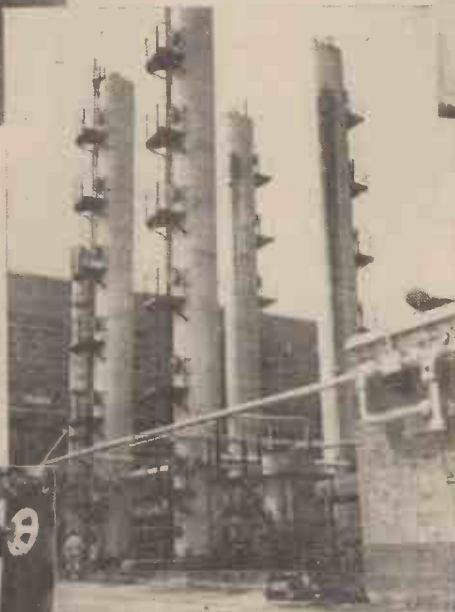

In the laboratory at Speke, a "seed tank" is being inoculated with a laboratory culture. All the assistants here have to submit to all the precautions used in an operating theatre. The penicillin, after having been reduced to a concentrated form, is brought for bottling on trays that have a cover of stainless steel.

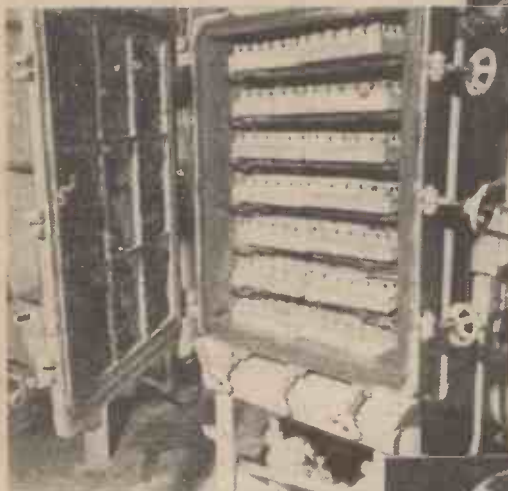

The air-scrubbing towers, at Speke, for purifying the air used in the process of fermenting. Each batch of penicillin is tested on rabbits, or mice, specially kept for the purpose. After the tests the penicillin is ready to be released for human use.

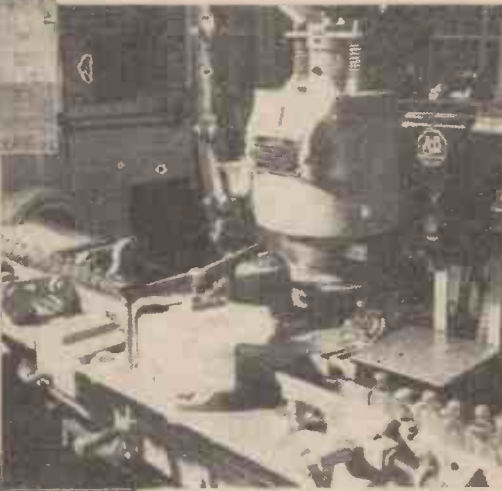

(Above) From the freezing chambers the phials are next placed in these drying ovens which dry the penicillin by removing water as a vapour directly from its frozen solid state by means of a high vacuum in low temperature vacuum dehydrators.

(Right) The raw products which go to make up penicillin. They are: corn steep liquor, foam control liquor, penicillin mould, brown sugar and four different types of inorganic salts.



A modern capping machine for the penicillin phials. A rubber diaphragm cap is inserted in each phial; an aluminium band holds the cap immovably in place and an aluminium seal minimises moisture absorption. It is the hope of the entire penicillin industry to make this effective therapeutic substance in very high quality available to everyone.

# THE WORLD OF MODELS

By "MOTILUS"

## Model-making in Switzerland

people. There are no restrictions whatever on purchases, and luxuries which most of us have not seen for years are in ample supply. Perfumes from France, wines from all European countries and overseas, liqueurs from Holland and France, tropical and local fruits, clothing of all types, and all the "under the counter" goods are obtainable in abundance.

However, the purpose of this article is not to tell of the amenities and pleasures of the country, but to give some impressions of the splendid work which has been done by the modelmakers of that country during the war period. I consider that I can say, generally speaking, that for its size Switzerland contains more modelmakers per head of population than any other country in Europe. There

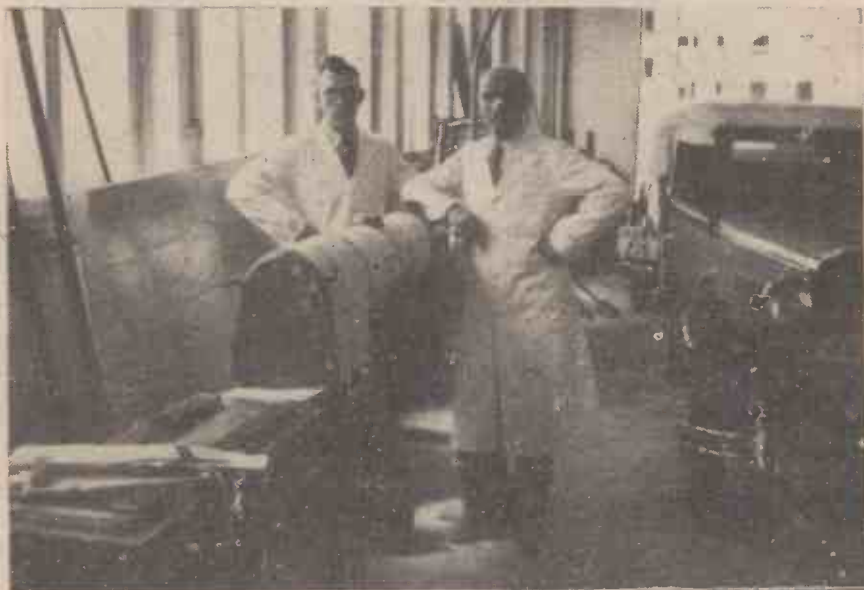

Fig. 1.—Messrs. Brast Brothers, the model locomotive builders, in their garage at Lucerne.

THE last time I saw my modelmaker friends in Switzerland was before the war, when the Swiss International Exhibition was held in 1939 at Zurich, and along part of the shore of that famous lake the "Zurich See." It was a great pleasure to again visit that beautiful and hospitable country in July, after six war-weary years in England, especially after an air flight taking under three hours from London. Switzerland in her general appearance looks even better than she did in pre-war days. She has always been considered the cleanest, neatest and best organised country in Europe, and still maintains that reputation.

Zurich, my first "port of call," is overflowing with prosperity, the shops, restaurants and cafés are full of bright, well-dressed



Fig. 3.—A scene near the railway station of the 7½in. gauge railway of Messrs. Brast Brothers. The L.M.S. "Royal Scot" leaving the station with its load.

are many modelmakers' clubs, full of enthusiastic members, a large proportion of whom are highly-skilled workers mostly connected with the watch factories and light engineering works for which Switzerland is so famous.

### 1½in. Scale Locomotives

My first call was to see Messrs. Brast Brothers, of Lucerne, who are garage proprietors. These brothers, Hans and Walter, are well known for their keen interest in the hobby of building garden railway locomotives of 1½in. scale, 7½in. gauge. They made their first effort in this direction some years before the war when they built their first steam locomotive, a 4-4-0 L.M.S. *George V.* Just before the war, they completed a model of the *Royal Scot* from castings, parts, drawings and fittings supplied by Messrs. Bassett-Lowke, Ltd., of Northampton. Recently they have completed a model of one of the early Swiss steam locomotives, of the year 1870, to the same scale. At present their spare time is being spent on



Fig. 2.—Mr. Karl Von Speyr, of Hergistwil, driving an L.M.S. 4-4-0 locomotive (built from drawings and castings supplied by Bassett-Lowke, Ltd.) over the small bridge on the public line at the village of Haow.

a Pacific type L.N.E.R. locomotive. Owing to the difficulties of obtaining drawings, castings, etc., from England, they were obliged to obtain official Railway drawings of this locomotive, and they have made their own design, their own patterns and castings, and, as will be seen from Fig. 1, the boiler is now mounted on the chassis; they hope to have the model on the track before the end of this summer.

Now that the full-sized steam locomotives have entirely disappeared from Switzerland and have all been replaced by electrically-driven ones, the models of steam-propelled locomotives which carry passengers are regarded as real novelties, especially by the younger generation, some of whom have never seen a full-sized steam locomotive in actual use. The Brast Brothers have been enterprising enough to have secured a site at the village of Haow, a few miles from Lucerne, on a frequent bus route, and on high days and holidays they and their friends, amongst whom they number Mr. Karl von Speyr, run a 7½ in. gauge railway round this site, carrying loads of passengers of all ages. (Figs. 2 and 3). The track used is Vignoles section, which is laid on wooden sleepers. The railway is complete with a modified signalling system and real "railway" tickets are issued.



Fig. 6.—The gauge "O" electric railway in the attic of Mr. A. Graf, who is employed by the Swiss State Railways.

Zollikerberg, Zurich (Figs. 4 and 5), which is on one of the main electric tram routes to the outskirts of the city. The railway is very outstanding in its physical features which include waterfalls, gradients, bridges, etc.,

all faithfully reproduced to scale. The mountain scenery is built up of solid rocks and soil and at one end is a special viewpoint from which the railway is operated. From this elevated platform, practically the whole of the line can be seen, and the 365 poles which carry the overhead wires, the 12,000 sleepers which carry the rails, the 700 trees, and the electric locomotives and rolling stock which make up the 450 sq. metres of layout can really be appreciated. This line is also open on Sundays and other holidays and parties of schoolchildren are taken there from time to time as an educational outing—one which I am sure most schoolchildren of our country would not fail to enjoy.

**Narrow Gauge Mountain Railway**

Mr. Karl von Speyr, previously mentioned in connection with the steam locomotives of the Brast Brothers, is also a very keen model railway builder himself, and in a specially prepared basement of his home at Hergiswil he has a most excellent electric gauge "O" model railway. From one of the stations of his track he operates a small narrow gauge "mountain railway" to the same scale. He also runs a Bassett-Lowke gauge "O" L.M.S. *Mogul*, in which he has attached a device for controlling same from the track.

Another interesting electrically driven railway, although not so well displayed as that of Mr. Karl von Speyr, is one built by Mr. A Graf, Neustadtstrasse 16, Lucerne,

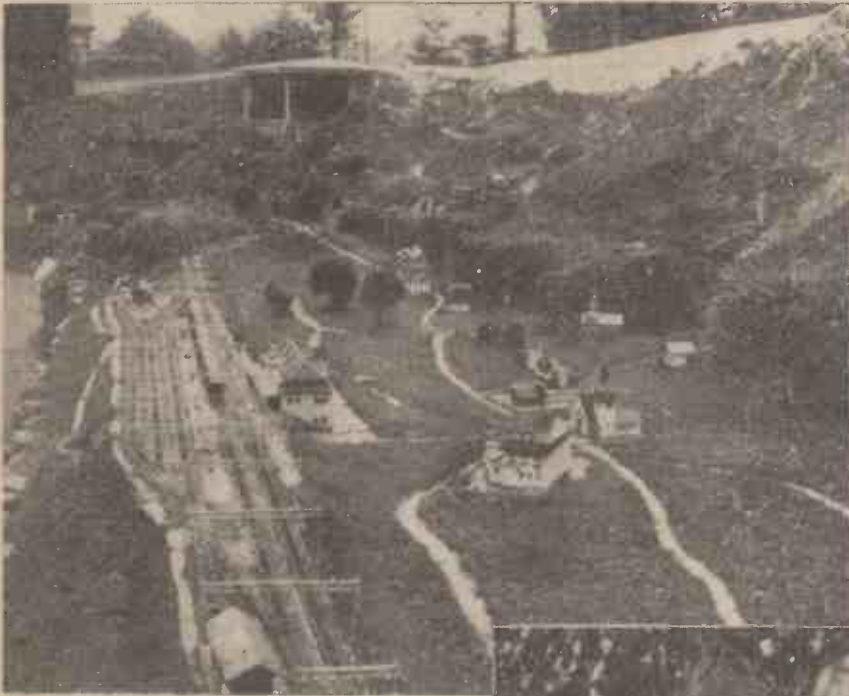

Fig. 4.—A general view of the gauge "O" electrically-operated Lotschberg Model Railway at Zurich.

**Electric Model Railways**

Considering that in Switzerland steam railways are a thing of the past, it is not strange to find that most of the amateur model-makers in that country are very "electrically minded," and turn to the making of electric locomotives and equipment. Electric railways for them, although they do not have the novelty value of the steam railway, possess a greater appeal in other directions. Readers will, perhaps, remember that at the Zurich Exhibition in 1939 there was a marvellous outdoor railway in gauge "O," which represented the famous Lotschberg Line. This was originally built to the order of the Lotschberg Railway Company by Messrs. W. Seiler, Senior and Junior. At the close of the exhibition this was purchased by the makers, and was rebuilt and transferred to the garden of their home at Reitholzstrasse 4,



Fig. 5.—Close up of a section of the Lotschberg Model Railway with two youthful Swiss admirers.

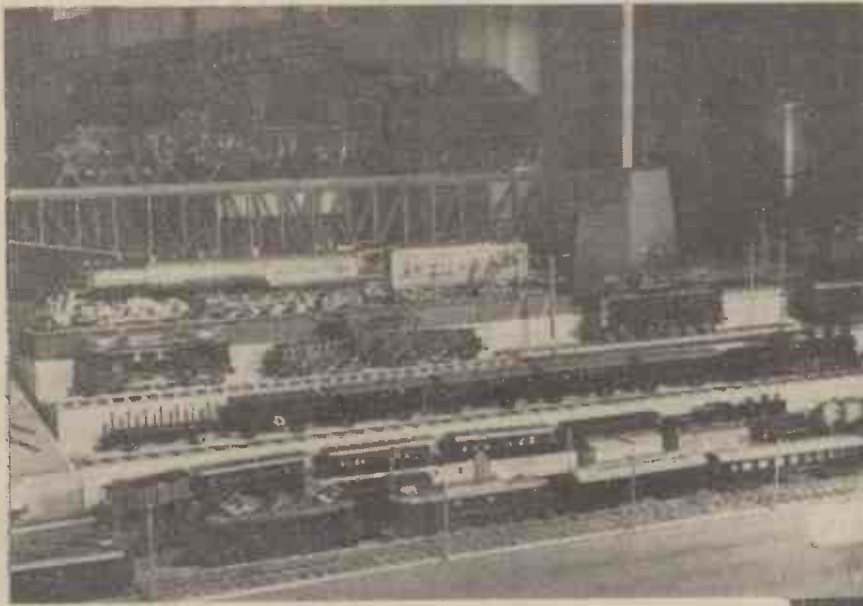

in his attic. (Fig. 6.) This very keen model maker is an electrical engineer on the State Railways, and his great interest is in accurate and detailed operation of the electric portion of his line. His rolling stock is carefully made with minute interior fittings, and his railway is operated on the standard 20 v. A.C. current. My only regret is that he has not more space in which to display this very comprehensive and interesting layout.

**An Active Club**

To give some idea of the extent of the interest in models, I might mention that the chief club has over 200 active members. The moving genius behind the Swiss Model Railway Club is Mr. W. Siegwart, the president. He is most enthusiastic about the work of the Club and the loyalty of its members. Any model-makers going over to Switzerland, now that travel conditions are easier, should make an effort to contact Mr. Siegwart at Rebergstrasse 53, Wettingen, because I am sure that if time permits he will be only too pleased to show them some of the wonderful Swiss craftsmanship in this favourite hobby.

**Annual Exhibition**

Annually they hold an exhibition, and in Fig. 7 is seen one portion of the models displayed. These include the following: The large locomotive on the girder bridge is a 7 1/2 in.

Fig. 7.—(Above) Some of the work of the Swiss Model Railway Club displayed at the 1941 Exhibition (see text).

Fig. 10.—(Right) Two water-line models, the P. and O. "Straithaird," and the R.M. "Andes," now the "Atlantis," from the collection of Mr. Philip Keller.

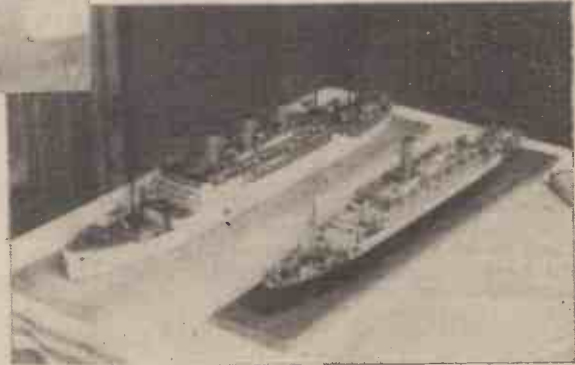

Royal Scot, built by the Brast Brothers. The large locomotive below the Royal Scot is a 2-8-8-4 Mallet type locomotive and tender for 2 1/2 in. gauge, built by W. Gassman, of Zurich. The large electric locomotive underneath the Mallet is a 2-6-6-2 model of the Standard Swiss State Railway locomotives, built by Mr. W. Kleinhans, of Zurich. In the near foreground are the two

Mr. Willy Gassman has completed a model of H.M.S. *Renown*, from the drawings of the ship before it was altered. (Fig. 8.) It has quadruple screws, is geared and is driven by double-action steam engines (Fig. 9), the steam being supplied by a marine type oil-fired boiler. There are many electrically-worked gadgets on this ship, but I regret that they are too elaborate to describe in these pages.

**Fine Collection of Models**

Before leaving this wonderful country, I must make a reference to Mr. Philip Keller, of Kraemerstein, St. Niklausen, Switzerland. I have no hesitation in saying that Mr. Keller has the finest private collection of scale model boats in the world. They number over 200, and Mr. Keller is constantly adding new specimens. Before the war they were exhibited in a portion of his flat in Paris,

but with the exception of a few which are in England, they have now been moved to his home at St. Niklausen, on the shores of Lake Geneva. Mr. Keller is only too pleased, by appointment, to show any ship lovers his fine collection of models. Not all his models are waterlines, many of them are full hull models, all built to an approximate scale of 33ft. to the inch. They have been collected from many countries of Europe, and show some excellent detail work. The illustration, Fig. 10, shows two of them, the P. & O. liner *Straithaird*, and the old Royal Mail liner *Andes* before she was converted to a pleasure-cruising liner and renamed the *Atlantis*.

Certainly Switzerland is a true paradise for those who love models and model-making—nowhere else in my travels have I found such enthusiasm for the hobby, or such wonderful craftsmanship—the two qualities which must be found in the "perfect" model-maker.

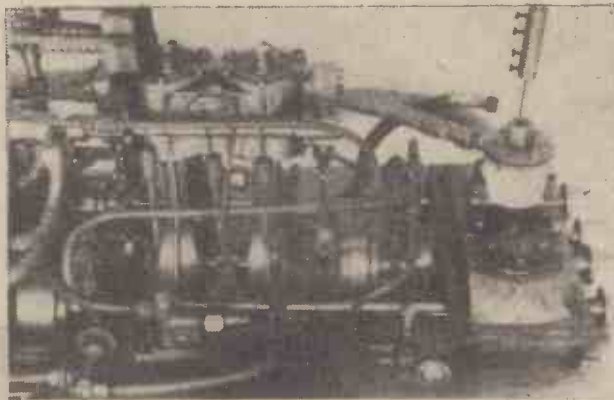

Fig. 9.—The engines of the model of H.M.S. "Renown."

electric locomotives of the Model Lotschberg Railway, together with the coaches as previously described.

Not all the model enthusiasts are interested in railways alone, and despite the fact that they are a long way from the sea in the centre of Europe, some of the enthusiasts are keen model boat builders.



Fig. 8.—A stern view of H.M.S. "Renown," built by Mr. Willy Gassman.

**MASTERING MORSE**

By the Editor of PRACTICAL WIRELESS

3rd EDITION

This handbook, written with special regard for service requirements, will enable even the beginner rapidly to become proficient in sending and receiving.

1/- net Of all Booksellers, or by post 1/2 from GEORGE NEWNES, LTD. (Book Dept.), Tower House, Southampton Street, London, W.C.2. 1/- net



# Notes and News

## Light Your Pipe at the Radiator

THE connection between hot water radiators in a house and hydrogen seems queer, but you will find quite often that if you release the air after a long period of standing and apply a match to it the "air" burns. It is, in fact, hydrogen, or possibly marsh gas.

It was marsh gas which used to produce the will-o'-the-wisp light bubbles. Ignited by phosphorous compounds as the result of decomposition they produce witch lights, a principle now employed to make gas in quantities.

The radiator may also produce hydrogen from a little acidity in the water acting upon impurities in the iron, and it is quite easy to light a cigarette from the flame that ensues.

It is just as well to put a little piece of copper gauze over the orifice before applying the match. Copper conducts heat so quickly that the heat cannot pass from the match to the radiator and thus you secure safety.

It was, in fact, this principle which led Sir Humphrey Davy to invent the miner's safety lamp. As long as the gauze remains cool, gas from the mine can burn inside the flame chamber but cannot pass through to the dangerous atmosphere by which it is surrounded.

## Books Received

"Home Photography." By David Charles, F.R.P.S. Published by Johnson and Sons, Hendon.

MANY readers will be interested in this newly-published 40-page booklet, which is a revised version of a booklet published by Messrs. Johnson and Sons, some years ago under the same title. This new edition has been completely re-written and contains a great number of useful hints and tips, while intended primarily for amateurs who are just starting to do their own developing and printing, will, undoubtedly, prove very interesting to more experienced workers. Over the past few years Messrs. Johnson and Sons have compiled a list of enthusiastic amateurs all over the country to whom they regularly send any new leaflets and booklets published by the firm. Any reader sending for "Home Photography" will be given the opportunity of having his name added to the

list. Copies can be obtained from Johnson and Sons, Manufacturing Chemists, Ltd., Hendon, N.W.4, by sending 3d. in stamps to cover postage.

"Duplicate Locomotives of the London and South-Western Railway." Published by Railway Hobbies, Ltd., 86, Essex Road, Southsea, Hants. 16 pages. Price 2s. 1d. post free.

THIS booklet is an inventory of duplicate locomotives running immediately prior to the amalgamation. Classes, types, building dates and numbers are included, and a representative selection of photographs, from the collection of a well-known photographer, provides the illustrations.

and this can be done by completing the circuit through the receiver hooks.

To make a call the procedure is as follows:

- (1) Remove own receiver.
- (2) Press bell-push.
- (3) Release and wait.
- (4) Operator at other end removes his receiver and answers.

It will be understood that when both receivers are removed the bells are disconnected and do not interfere with the speech circuit. The method of making connection through a receiver and hook is shown in Fig. 2.

J. H. ALFORD (Sutton Coldfield).

## Club Note

Mansfield and District Model Engineering and Handicrafts Society

OWING to the high cost of laying an electric power cable and the continued extensions of time by the Power Co. for completing

## Home-workshop Telephone

SIR,—With reference to the article on a Home-workshop Telephone, in the August issue of PRACTICAL MECHANICS, one

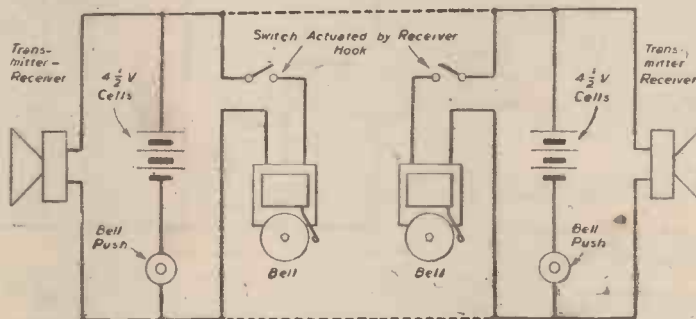

Fig. 1.—Modified circuit diagram for a home-workshop telephone.

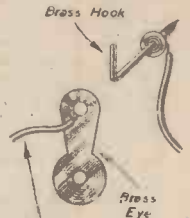
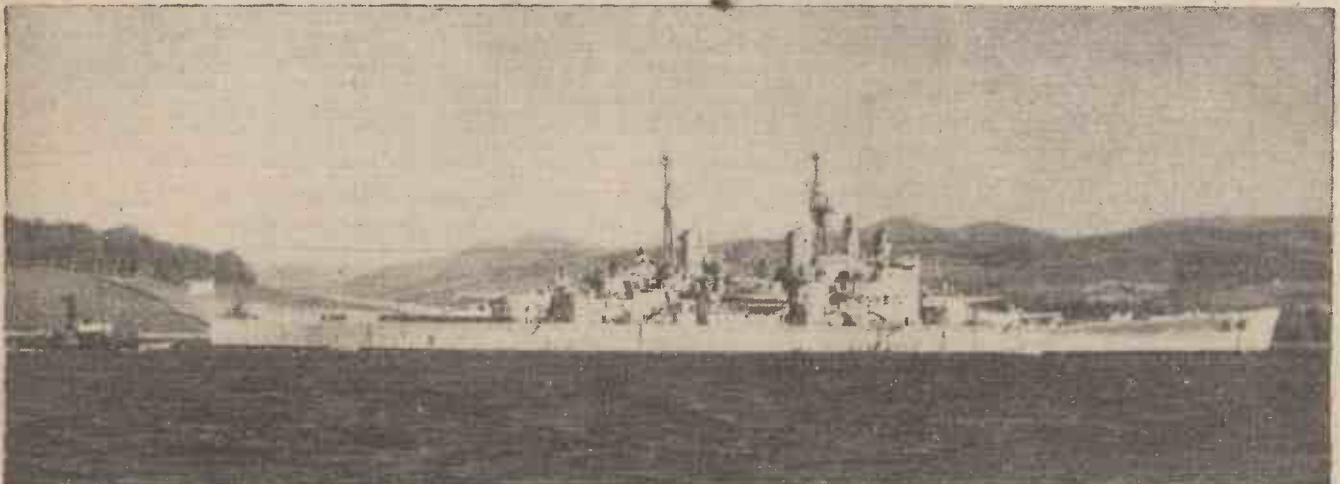

Fig. 2.—Method of making connection between receiver and hook.

disadvantage of the system described is that it is only possible to call from one end. Also, there are three wires for connecting the stations, and it has a limited range.

I enclose a modified circuit diagram (Fig. 1) which, I think, is an improvement on "Hobbyist's" arrangement. The circuit uses the same transmitter-receiver idea, but there are only two wires for connecting the stations. Also, there is the advantage that a call can be made from both ends. When the circuit is in use the bells are disconnected,

this work, it has been decided at a special meeting of the above Society to move their workshop to new premises situate at 82, New Lane, Stanton Hill, where there is a supply of current already laid on. In addition, there is also room for an outdoor locomotive running and testing track. Will all old members and new ones kindly note the change. The weekly meeting night will still be Thursday, at 7.30 p.m. Hon. Sec.: J. Corbett (Lathes), Stanton Hill, nr. Mansfield, Tel. 583 Sutton-in-Ashfield.



H.M.S. "Vanguard," the last capital ship of her type which will be built for the Royal Navy, recently underwent her trials in Meikleros Bay, Firth of Clyde. It is stated that the "Vanguard" is the most powerful battleship in the world to-day.

# QUERIES and ENQUIRIES

A stamped addressed envelope, three penny stamps, and the query coupon from the current issue, which appears on back of cover, must be enclosed with every letter containing a query. Every query and drawing which is sent must bear the name and address of the reader. Send your queries to the Editor, PRACTICAL MECHANICS, Geo. Newnes, Ltd., Tower House, Southampton Street, Strand, London, W.C.2.

## Photo Enlargement on Glass

I WISH to make an enlargement from a negative on to glass. Is it possible to sensitise the glass by using a bichromate solution? Failing this, will you suggest an alternative for sensitising the glass?—A. G. Smith (New Milton).

PHOTOGRAPHIC emulsions are exceedingly difficult to make on a small scale and, in nearly every case, they lead to great disappointment. Fortunately, it is now possible to purchase ready-made sensitive emulsions which may be coated on to any clean, smooth surface. We would, therefore, strongly advise you to take this line of action and to purchase a bottle of "Emulsol," a specially-made photographic emulsion which may be obtained from any good photographic dealer, such as Messrs. Wallace Heaton, Ltd., New Bond Street, London, W.1.

For making an enlargement it is not possible to use any ordinary bichromate-gelatin mixture.

As an alternative to using a ready-made sensitiser you could, of course, purchase a packet of slow "lantern" plates in a large size. These could be obtained to order through any photographic dealer and you could make an enlargement direct on to one of these, the plate developing up as a positive.

In these large sizes the minimum quantity of plates which you can buy is half a dozen.

## Nickel Plating

PLEASE inform me if it is possible to obtain nickel salts and pure nickel anodes, for plating, without a permit?

For a small bath, are salts and quantity of water required in the same proportions?

What is the correct material for stopping off the areas which do not require nickel plating, and what is the best amperage to use? Also, what is the time required for nickel plating a specified thickness, say .0002in., on steel?

Is it possible to plate large surfaces if the plating bath is not large enough to accommodate the article to be nickel plated?—J. T. Bowman (Basingstoke).

NICKEL salts and pure nickel anodes can be obtained without a permit from Messrs. Wm. Canning and Co., Ltd., Great Hampton Street, Birmingham, a firm which specialises in plating supplies and requisites.

There are, in general, many different formulae for any given type of plating work, and when determining on the use of any given formula various considerations have to be taken into account if the maximum plating efficiency is to be obtained. It is for this reason that the various plating formulae which we have given in the past have varied considerably. Generally speaking, however, the proportions of the ingredients of a small plating bath should be the same as those of a large plating bath, although, in some special cases, there may be a difference between the two.

Shellac varnish, bituminous paint, wax solutions, synthetic resin solutions, rubber solution—all these may be used for stopping-off areas which are not required to be plated. The stopping-off compound is subsequently dissolved away with a suitable solvent after the plating is over.

Nickel-plating emperages vary a good deal with the composition of the bath. Taking an average bath, consisting of 40z. nickel ammonium sulphate and 80z. nickel sulphate dissolved in a gallon of water, an average current density is about 5 amps. per square foot of surface to be plated, the E.M.F. being about 4 volts. You can obtain this current from a suitable accumulator battery. It is difficult to estimate the time required for a given depth of plating under conditions which are not specified, but an average of 15 minutes should give the plating thickness which you specify.

No. You cannot plate large surfaces satisfactorily unless the whole of the surface is immersed in the electrolyte. Processes have been suggested in which the surface is plated by means of a cloth-covered electrode saturated with the electrolyte, but all such processes are anything but satisfactory in the case of nickel plating and similar work.

## Cement for Concrete Blocks: Glass Bricks

I SHALL be grateful for your advice on the following:

I am shortly putting up a building to be made of concrete blocks (sizes of blocks 18in. x 9in. x 4 1/2in.). What mixture of cement, etc., would you recommend for joining the blocks together? The walls will be loaded.

Also, would glass bricks be a good substitute for a glass window? What material is used to join glass bricks together, and for cementing them?—R. Allen (Newmarket).

A GOOD cement can be made by intimately mixing 1 part of Portland Cement with 3 parts of "filler," the latter to consist of fine grit or sand and ashes. Alternatively, you can use sand alone as a filler, but it is better to incorporate some inert material having a finer particle size than sand alone. Such material could be ground stone, limestone, crushed rock, etc.

A glass brick does not pass as much light as an ordinary sheet of glass. The light-loss caused by the use of such a brick is usually very considerable. Hence, a room lighted by glass bricks will not be as bright as one lighted by ordinary window glass.

Glass bricks or blocks are usually held in an iron frame, being luted thereto by a red or white lead cement to render the joints waterproof. Pitch or bitumen compound may also be used for the same purpose.

## Small Electric Light Plant

I AM installing a motor generator set for providing electric light on a houseboat, and enclose a diagram of the proposed connections. Particulars of the set are as follows: Generator—12 v., 12 a., 1,425 r.p.m. Petrol motor—Johnson Iron Horse. Batteries—Two 12 v., 60 a.h. connected in parallel. Maximum number of lights burning at one time—Eight 12 v. 12 w. Maximum length of cable between battery and lamps—60 ft.

I should be obliged if you would criticise this arrangement, and also answer the following questions:

(1) What size of wiring should be used to avoid undue voltage drop?

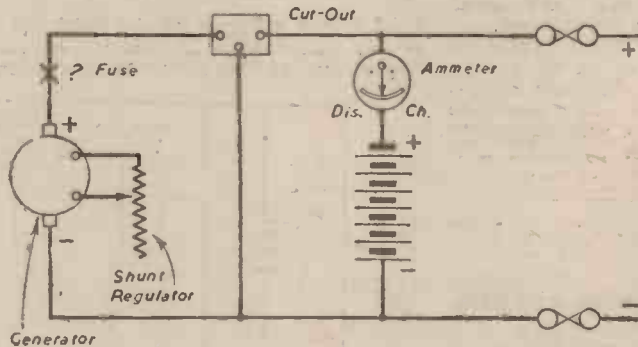

Circuit diagram for a small electric light plant (A. Stephenson).

(2) What rating for fuses, and what gauge of wire to use?

(3) Should a fuse be fitted on the dynamo, if so what size?—A. Stephenson (Sunbury).

THE proposed arrangement appears satisfactory, and we have only two comments to make. The first is that if there are occasions when you wish to feed the lights direct from the dynamo a switch should be included in the battery circuit. A switch should also be connected in the dynamo circuit near the fuse. Secondly, there may be times when you wish to be able to control the battery charging current whilst using the lamps at normal voltage. To do this you could connect a variable resistance in the battery circuit.

We should advise 7/0.029 or, preferably, 7/0.036 wiring to avoid excessive volt drop to the lamps.

The main fuses should be rated at 8 amps. and should blow at about 16 amps. A single strand of 31 s.w.g. copper wire would satisfy these conditions. A fuse rated at 12 amps. and melting at 24 amps. should be connected in the dynamo circuit. A strand of 28 s.w.g. copper wire is suggested for this fuse.

## Electrically Heated Photographic Press

I HAVE a large press which has a pressing surface of about 11in. by 9in. I wish to convert it into a dry-mounting photographic press. My idea is to make a shallow, heavy brass-plate, box, 11in. by 9in. by 1in. approximately. Inside this I thought of fixing an electric-heating element, completely insulated from the brass by either

sheet asbestos or if this is not suitable, sheet mica. I propose to use brass plate 3/32in. thick, and shall be obliged if you will inform me what type of element would be suitable for such a task on a 240 volt supply?—J. O. Yates (Romford).

IT would be an advantage to use thicker metal than 3/32in. for the plate; about 1/4in. or even thicker would be preferable, if obtainable. The element could consist of 50ft. of 0.03125in. by 0.008in. Brightray resistance tape, as supplied by Messrs. Henry Wiggin and Co., Ltd., of Grosvenor House, Park Lane, London, W.1. The tape could be wound on mica strips to cover almost the full area of plate. The elements should be firmly clamped between the top plate and another plate, a thin strip of mica being placed between each plate and the element. It is rather important that the element with its outer mica insulation should be firmly pressed against the top plate in order to ensure good conduction of the heat.

## Colouring Wax

FOR some time I have been trying to make wax dolls for the purpose of creating miniature historical tableaux. I have been using ordinary candle wax and colouring it, when in melted form, by mixing with it ordinary artists' oil colours. So far, however, I have not been able to obtain good results. My chief troubles are: The wax is too transparent, and is apt to change colour (from pale pink to a deep orange), especially when re-melted.

In view of this I shall be much obliged to you if you would kindly supply me with the following information:

What materials (chemical or otherwise) should I mix with the wax in order to give it body?

What colouring material should I use in order to obtain a perfect and stable flesh tint?

Where can I obtain materials, including waxes?

Are there any (preferably technical) books on the subject?—J. Cassar (Malta).

ARTISTS' oil colours are not suitable for admixing with wax materials. What you require for this purpose are oil-soluble or wax-soluble dyes, such as those of the "Waxoline" series, which are manufactured by Imperial Chemical Industries, Ltd., S.W.1. Similar dyes are also manufactured by Messrs. A. Boake, Roberts and Co., Ltd., Stratford, London, E.15, and such dyes are also obtainable in small quantities from most of the laboratory supply firms, such as Messrs. A. Gallenkamp and Co., Ltd., 17-29, Sun Street, London, E.C.2, or Messrs. W. and J. George and Becker, Ltd., 17-29, Hatton Wall, London, E.C.1.

You could give the candle wax a greater "body" by incorporating with it about 20 per cent. of white stearine wax, and the hardness of the wax could be raised by mixing it with about 10 per cent. of prime yellow carnauba wax, which is the hardest of all the waxes. Here again, small amounts of these waxes can be obtained from the laboratory supply firms above mentioned. In larger quantities wax material is obtainable from either Messrs. Chas. E. Windischguell, Ltd., 1, Leadenhall Street, London, E.C.3, or Messrs. Wilkins, Campbell and Co., Ltd., Britannia Works, West Drayton, Middlesex.

By a judicious admixture of ordinary white wax, stearine and carnauba wax, together with the use of a wax-soluble dye, as above suggested, you should be able to obtain any effect which you may desire.

There are many books available on the chemical and physical nature of waxes, but, so far as we have been able to trace, there are no books dealing with the making of wax dolls and figures. It is possible, however, that Messrs. W. and G. Foyle, Ltd., booksellers, Charing Cross Road, London, W.C.2, might be able to trace some secondhand and out-of-print book on this subject if you would write to them, giving exact particulars of your requirements.

## THE P.M. LIST OF BLUEPRINTS

- |  |  |
|--|--|
| The "PRACTICAL MECHANICS" £20 CAR (Designed by F. J. CAMM), 10s. 6d. per set of four sheets. | SUPER-DURATION BIPLANE* Full-size blueprint, 1s.       |
| "PRACTICAL MECHANICS" MASTER BATTERY CLOCK* Blueprints (2 sheets), 2s.                       | The 1-c.c. TWO-STROKE PETROL ENGINE* Complete set, 5s. |
| The "PRACTICAL MECHANICS" OUT-BOARD SPEEDBOAT 7s. 6d. per set of three sheets.               | STREAMLINED WAKEFIELD MONOPLANE—2s.                    |
| A MODEL AUTOGIRO* Full-size blueprint, 1s.   | LIGHTWEIGHT MODEL MONOPLANE Full-size blueprint, 2s.   |
|  | P.M. TRAILER CARAVAN* Complete set, 10s. 6d.           |
|  | P.M. BATTERY SLAVE CLOCK* 1s.                          |

The above blueprints are obtainable, post free from Messrs. George Newnes, Ltd., Tower House, Southampton Street, Strand, W.C.2.

An \* denotes that constructional details are available, free, with the blueprint.

**Colouring Concrete Floor!**

**I** WISH to use my garage as a workshop and want to colour the concrete floor a "tile red." Can you please tell me how to do it?  
The garage has never housed a car, and the floor—laid about 1924—is free from oil and petrol stains.  
Can you also tell me what to use on another concrete space (my side area, open to weather) to prevent the surface being continually dusty?  
—H. J. W. Yardley (London, S.W.).

**T**HERE is no satisfactory process of "dyeing" or colouring an existing concrete floor. Without actually replacing your concrete floor with another floor or coloured concrete, your only means of effecting the result you desire is to put a "skim" coat of coloured concrete over your present floor, a process which, in our opinion, is not to be recommended, although, no doubt, any contractor would do the job for you.

To prevent dusting of a concrete floor, the surface particles of concrete must be firmly bound down. This can be effected to a certain extent by repeatedly applying to the concrete surface a wax emulsion floor-dressing, such as "Autogloss" manufactured by British Asphalt and Bitumen, Ltd., The Docks, Preston, or better still, by treating it with a silicon ester, which soaks into the surface and deposits silica therein, thus firmly binding all the loose and dusty particles together. Such a preparation is "Kexacrete," manufactured by Kautic Plastics, Ltd., Elstree, Herts.

**Transfer Inks**

**W**ILL you please inform me what mixture is used for embroidery and needlework patterns, so that when ironed with a hot iron the pattern comes off on to the cloth? Also, can the mixture be bought or made, and is it necessary to use a special pen or other instrument?  
—A. Hopwood (Hyde).

**S**O far as we are aware, transfer inks of the type you mention are not marketed at the present time, although, no doubt, any local printer might be able to procure a little of such ink for your own use. Essentially, these inks comprise a soft wax solution, in which a suitable colour or pigment is incorporated. The following is a typical formula, but it will be difficult for you to make it up owing to the great scarcity of gum mastic:

Ultramarine (or other pigment)	50 parts (by weight)
Gum Mastic	30 " " "
Benzene	15 " " "
Vaseline	10 " " "
Beeswax	10 " " "

The wax, gum and Vaseline are gently melted and the pigment is then stirred in. Finally, the benzene is added. More or less benzene can be used according to the precise consistency of ink which is desired.

**Bleaching Black Cloth**

**C**OULD you please tell me the best method of bleaching black cloth with bleaching powder? How much bleaching powder would be needed to bleach 14 square yards and where could I obtain it?  
—K. Lawrence (Hertford).

**T**HE mode of bleaching black velvet cloth depends entirely upon the nature of the black dye which has been used on the cloth. If the material has been dyed with Aniline Black (one of the fastest of all known dyes), then it will be quite unbleachable. On the other hand, if an ordinary "basic" black dye, such as Naphthol Black, has been used, the bleaching will be carried out without much difficulty.

The procedure is to grind up about 1lb. bleaching powder with sufficient water to form a thin cream. This cream is then stirred into two or three gallons of water, and the black material is immersed in this liquid for about five or 10 minutes, being kept constantly on the move. It is then removed from this bath, lightly wrung out, and afterwards immersed in a liquor made up by adding two parts of hydrochloric acid to 98 parts of water. Bleaching takes place after immersion in this "souring" or acid bath, and after two or three minutes' immersion the material should be withdrawn, lightly wrung out and laid out in the sun. If there is no sun, or if the bleaching action is insufficient, it may again be returned to the bleaching powder bath and the process repeated.

After the full degree of bleaching has been effected it is of the utmost importance that the material should be thoroughly well washed in plenty of water in order that every trace of the bleaching and acid liquors is eliminated. If this requirement is not faithfully carried out the material will slowly deteriorate.

Bleaching powder can now be obtained from any large retail chemist's shop. The quantity of bleaching powder required to treat 14 square yards of material will depend entirely on the fastness of the dye. A couple of pounds might be sufficient.

**Focal Length: Refraction**

**W**ILL you please answer the following queries:  
What is the difference between the terms "focus point" and "focal length"?  
Why does light twist when entering the small hole in a pinhole camera, or a lens? I have tried unsuccessfully to prove whether the rays cross at a given distance between lens and film. Is there a way to find this out?  
—E. A. Divers (Worthing).

**T**HE focal length of a lens is the distance between the centre of the lens and the screen, plate, film, paper or other plane surface upon which the image of a distant object is most sharply focused.  
Focus point is the point at which light rays, after

passing through a lens, converge to form the image of a distant object. It is often known as the "focus" of the lens.

When a light-ray passes between two media of different densities (such as air and glass) it undergoes, among other things, a certain amount of bending or "refraction." Hence light-rays passing through a lens from all angles are bent (usually inwardly) so that they converge together from their normal straight-line paths, the point of maximum convergence being the focus of the lens.

In the case of a lens, this convergence of light-rays after passing through the lens is best actually "seen." This can be effected by darkening a small room by completely obscuring its window and by mounting a suitable lens in an aperture made in the window-obscuring screen. On bringing a sheet of white paper into the path of the rays proceeding from the lens, a rough area of light (more or less ill-defined) will be seen. By moving the paper backwards and forwards, a point will be arrived at where a well-defined image of the object outside the window will be obtained. Also, by blowing tobacco-smoke into the path of the rays of light, their "track" will be well-defined and their point of "twisting" will be seen.

Light rays always travel in perfectly straight lines. Now, in the case of a pinhole, rays travelling through the pinhole from low levels will proceed in an upwards direction through it, whilst, conversely, rays travelling through the pinhole from upper levels will proceed in a downwards direction through it, so that the upwards and the downwards proceeding light rays will cross one another at the pinhole, and these rays will form an inverted image of the object from whence they proceeded. The smaller the aperture of the pinhole, the sharper will be the image of the object.

**Windings for a Small A.C. Motor**

**I** AM in possession of a stator and rotor built up to a length of zin. laminations as shown in the accompanying sketch. I would be obliged if you could give me particulars of windings

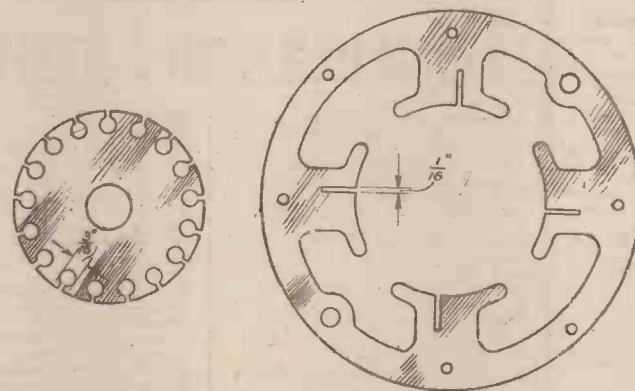

Stator and rotor stampings for a small A.C. motor (W. Stone).

suitable for speeds of 1,440 and/or 1,880 revs. approximately for 200/230 volt mains? The stampings have been designed for shaded-pole starting, and I have been informed that this motor will run hot. Will you confirm if this is correct?  
—W. Stone (Christchurch).

**T**HE stampings could be wound as a self-starting split-phase motor to run at about 2,800 r.p.m. or as a non self-starting motor running at about 1,400 r.p.m., assuming the supply is at 50 cycles. A speed of 1,440/1,880 r.p.m. is very low for a series type of motor of this size; this type of motor would require a commutator, of course, and its speed would vary considerably on a varying load. The rotor slots are not very suitable for a series type of motor. The question as to whether the motor would run hot or not depends on the windings employed, and also on the radial air gap clearance between the rotor and field poles.

**Paintings on Glass**

**I** WISH to paint some colour pictures on ordinary glass for use as lantern-slides. Could you please tell me how water-colour paints can be employed effectively? If gum-water is used with the colour, can you enlighten me on the following points:

Which is the best gum to use for this purpose?  
What proportions of gum and water require mixing, and which is the best varnish to use for a final coating, to render the colours more transparent?  
—Wm. De'ath (Bristol).

**D**ISSOLVE 5 parts of ordinary cooking gelatine in 95 parts of water. Use this solution to mix with tube water-colours, and paint the medium on to the glass in the normal way. The gelatine solution will not keep for more than a week, unless it contains a few drops of carbolic-acid to act as a preservative and to prevent mould growths.

In the place of gelatine in the above method, you can use gum arabic, but of the two we think that gelatine is rather the more preferable since it does not tend to crystallise and to become opaque.

The colours produced in this way will not be transparent. Transparent colours are best produced by using aniline dyes and celluloid solution as a base. The method is as follows:  
Dissolve by shaking scrap clear celluloid in a mixture

of equal parts of acetone and amyl-acetate. The resulting solution should be water-white and of paint consistency.

Take a small quantity of it, and add to this a few drops of a strong solution of an aniline dye in methylated spirit. You will now have a clear, coloured liquid which can be painted on to glass to give a perfectly transparent coloured film. Any aniline dye which is soluble in spirit can be used for the purpose.

All the above materials may be obtained from any firm of chemical wholesalers and laboratory furnishers, as, for instance, Messrs. A. Gallenkamp & Co., Ltd., 17-29, Sun Street, London, E.C.2. Or, perhaps your local pharmacist and druggist would assist you in obtaining such materials.

No final varnishing is needed with the dyed celluloid stains; whilst, in the case of the water-colours, no varnish would increase the transparency of the colours which, being insoluble pigments, are necessarily non-transparent.

**Cleaning Piano Keys**

**I** SHALL be obliged if you can inform me whether it is possible to clean piano keys which appear to be of "Erinoid" or some similar substance, and which have become discoloured with ordinary playing use?

The instrument is a very fine "Bechstein," but the original ivory keys have been replaced.—C. Massey (Birkenhead).

**I**T seems to us very extraordinary that such a fine instrument as the one you name should have had its original ivory keys replaced by ones of substitute material.

There is very little one can do for the discoloration of celluloid or "erinoid" material, since if any drastic bleaching material is used, the key surface is bound to suffer. The best thing which you can do under the circumstances is to treat the keys a few at a time, removing, say, half a dozen from the instrument and giving them a good rub down with a paste made of

whiting and methylated-spirit. This might remove some of the discoloration. The next process is to sponge the keys down with hydrogen-peroxide and then place them in the sunshine. An alternative bleaching solution is "Milton," which is a stabilised sodium hypochlorite solution. This may be rubbed over the keys with subsequent exposure to sunlight. If, however, these two treatments do not work then the only other alternative is to have the key surfaces planed or ground away, this being a job for a piano-repairing firm, such as Rushworth & Drapers, of Liverpool.

A good deal can be done to prevent the discoloration of pianoforte keys by always keeping the "fall" or lid of the keyboard open so that the keys are continually exposed to light. Plenty of light, combined with a dry

atmosphere is the best specific against pianoforte key discoloration.

**Coefficients of Thermal Expansion**

**W**OULD you please let me know the temperature coefficient per inch for degree of temperature rise (Fahrenheit) of the following metals: copper, brass, iron, steel, nickel, and aluminium (drawn)?

I would also like to know the two metals with the largest and smallest rate of expansion, and what two metals are used in the bi-metallic strip as used for a flasher in an electrical circuit.  
—A. G. Marshall (Nuneaton).

**T**HE following are the coefficients of thermal expansion which you require, the coefficient of expansion of a solid being defined as the increase in length of a bar of the solid metal, 1 centimetre in length, when heated through 1 deg. C.

Metal	Coefficient of Expansion
Copper	0.000167
Brass	0.00051
Iron (Cast)	0.00010
Iron (Wrought)	0.00012
Steel	0.000105-116
Aluminium	0.00025
Nickel	0.00013

Mercury, gallium and the alkali metals (rubidium, sodium, potassium, caesium) have the largest expansion of all metallic substances. Invar, which is a nickel-steel alloy, containing 36 per cent. of nickel, has the smallest expansion rate (over a limited temperature range). Indeed, some types of invar have been produced which do not expand at all. But in this matter of metallic expansion and contraction rates, we have to remember that metals do not expand at regular rates over wide ranges of temperature. "The invars, for example, will expand quite considerably when heated to high temperatures. Hence, unless one particular temperature range is stipulated, it is impossible to state strictly which is the most and which is the least expansible metal or alloy.

The commonest bi-metallic couples are:  
Copper-Brass  
Nickel-Brass  
Invar-Brass  
Invar-21 per cent. Nickel-Iron alloy  
Silver-Brass  
Silver-Copper  
Mild Steel-Brass  
Monel-Brass

# GALPINS

GOV'T. SURPLUS ELECTRICAL STORES  
408 High St., Lewisham,  
London, S.E.13

Telephone: Lee Green 0309. Near Lewisham Hospital

TERMS: CASH WITH ORDER, NO C.O.D.

EX. - G.P.O. MAGNETO GENERATORS, hand-driven approx. output 75 volts 20 m/amps. A.C., useful to the experimenter, small pattern, 7/6 each.

ROTARY CONVERTERS, condition as new. 24 volts D.C. input at 2½ amps 75 volts A.C. 1 phase output, 55/- each, post 2/6.

USEFUL PANELS, comprising of Smoothing Chokes, Mod. Transformers, Condensers marked in decibels and various other components useful to the Amateur, all components as new, 20/- each, carriage 2/6.

VOLTAGE CHANGER TRANSFORMERS. Auto-wound, fully guaranteed, immediate delivery. 350 watts, 55/-; 500 watts, 70/-; 1,000 watts, £5 15s.; 2,000 watts, £8 15s. All tapped 0, 110, 200, 220 and 240 volts.

TRANSFORMERS BY WELL-KNOWN MAKERS, input 200/250 volts 50 cy. 1 phase output 1,500 volts at 3 Kilowatts twice, £12 10s. each. Voltage Regulation Transformer oil type 200/250 volts 50 cy. 1 phase, £15 each, new condition.

RECTIFIERS (SELENIUM), 24 volts 6 amps. output, 55/- each. 150 volts 300 m/amps output, 25/- each. New and unused.

BALLAST LAMPS (GOOD MAKERS), new 125 volt 30 watts E.S. fitting, 6/- per dozen.

METERS ALL BY WELL-KNOWN MAKERS, edge type 1st grade moving coil 2½ in., 0 to .3 amps., 35/-; 0 to 2 amps., 35/- . Both the above read 2 m/a without shunt. Ditto, 0 to 1 volt 1,000 ohm per volt 1 m/a, 45/- . Another ¾ Decibel Meter reading zero - 10+3 F.S.D. 50 microamps, 85/- each. Another ¼ in. round face meter 0 to 25 and 100 volts A.C. fitted rectifier, 55/- each. All fully guaranteed and condition as new.

LARGE POWER UNITS BY WELL-KNOWN MAKERS, input 100 to 200 volts 1 ph., 50 cycles output 24 volts 11 amps and 130 volts 600 m/amps., smoothed all fitted in metal cabinet size, 57½ in. x 19½ in. x 12½ in., fitted cutout, fuses, relays and switches, new condition, £12 10s. each, carriage forward.

MAINS TRANSFORMERS, all by well-known makers and fully guaranteed; input 200/250 volts, 50 cy. 1 phase; output 2,000/0/2,000 volts at 250 m/amps with 2 L.T. tappings, 75/- . Ditto, 475/0/475 volts at 150 m/amps, with 3 L.T. tappings, 4v. and 6v., price 42/6. Ditto, 80, 100, 120, 140, 200, 220, 240 volts at 3,000 watts, £12 10s. Ditto, 6, 16 volts at 14/90 amps. output, £15. Transformer cores, suitable for winding 2,000 watts, 27/6; 100 watts, 7/6 each.

EX-R.A.F. 10-VALVE CHASSIS (sold for components only). Consisting of: 2, 150 ohm Mult. Contact Relays, 9 British type Octal Base Valve Holders, 30 Tubular Condensers, ranging from 10 P.F.F. to 1 M.F. 25/30 Resistances ½, 1 and 2 watts all mounted on chassis, size 12½ in. x 8½ in. x 2½ in. Components all in good condition. "A real bargain" at 12/6 each, postage 1/6.

EX-GOVT. ROTARY CONVERTERS, input 12 to 18 volts D.C. at 3½ amps. output 450 volts 60 m/amps. fitted with automatic switching and smoothing, 32/6 each, 2/6 carriage.

ELECTRIC LIGHT CHECK METERS, guaranteed electrically, 200/250 volts 50 cy., 1 phase, input 5 amp. type, 12/6; 10 amp. type, 15/- each. Carriage 1/-.

D.C. MOTORS, approx. ¼ h.p. series wound, all guaranteed electrically for 110 or 250 volts mains. Price 15/- each. Carriage 1/-.

HIGH-GRADE SWITCHBOARD TYPE AMP. METERS, 5½ in. dial for A.C. or D.C. calibrated 50 cycles, 0 to 30 amps., 32/6 each. Ammeters moving coil, 3½ in. dial 0 to 10 amps., 20/- each.

LARGE TYPE RECTIFIERS, 12 volts, 4 amps., 45/-; 12 volts 0/8 amps., 55/-; 6 volts 1 amp., 12/6; 50 volts at 2 amps., 42/6. All fully guaranteed.

MAINS TRANSFORMERS, to suit the above 12 volt rectifiers, with tapped output of 6, 12 and 24 volts at 6 to 8 amps., 40/- . Carriage 2/-.

## "LET ME BE YOUR FATHER"

Thus is expressed the friendly personal bond existing between Bennett College and each student. It is this close individual tuition which leads to quick success.



We teach nearly all the Trades and Professions by Post in all parts of the world. The most progressive and most successful Correspondence College in the world.

If you know what you want to study, write for prospectus. If you are undecided, write for our fatherly advice, it is free. Distance makes no difference.

## DO ANY OF THESE SUBJECTS INTEREST YOU?

- Accountancy Examinations
- Advertising & Sales Management
- Agriculture
- A.M.I. Fire E. Examination
- Applied Mechanics
- Army Certificates
- Auctioneers and Estate Agents
- Aviation Engineering
- Aviation Wireless
- Banking
- Blue Prints
- Boilers
- Book-keeping, Accountancy and Modern Business Methods
- B.Sc. (Eng.)
- Builders' Quantities
- Building, Architecture and Clerks of Works
- Cambridge Senior School Certificate
- Civil Engineering
- Civil Service
- All Commercial Subjects
- Commercial Art
- Common Prelim. E.J.E.B.
- Concrete and Structural Engineering.
- Draughtsmanship, all Branches
- Engineering, all Branches, Subjects and Examinations
- General Education
- G.P.O. Eng. Dept.
- Heating and Ventilating
- Industrial Chemistry
- Institute of Housing
- Insurance
- Journalism
- Languages
- Mathematics
- Matriculation
- Metallurgy
- Mining, All Subjects
- Mining, Electrical Engineering
- Motor Engineering
- Motor Trade
- Municipal and County Engineers
- Naval Architecture
- Novel Writing
- Pattern Making
- Play Writing
- Police, Special Course
- Preceptors, College of
- Press Tool Work
- Production Engineering
- Pumps and Pumping Machinery
- Radio Communication
- Radio Service Engineering
- R.A.F. Special Courses
- Road Making and Maintenance
- Salesmanship I.S.M.A.
- Sanitation
- School Attendance Officer
- Secretarial Examinations
- Sheet Metal Work
- Shipbuilding
- Shorthand (Pitman's)
- Short Story Writing
- Speaking in Public
- Structural Engineering
- Surveying
- Teachers of Handicrafts
- Telephony and Telegraphy
- Television
- Transport Inst. Examinations
- Viewers, Gaugers, Inspectors
- Weights and Measures Inspectors
- Welding
- Wireless Telegraphy and Telephony
- Works Managers

If you do not see your own requirements above, write to us on any subject. Full particulars free.

### COUPON. CUT THIS OUT

IF YOU ATTEND TO THIS NOW IT MAY MAKE A WONDERFUL DIFFERENCE TO YOUR FUTURE.

To Dept. 76, THE BENNETT COLLEGE LTD., SHEFFIELD

Please send me (free of charge) Particulars of..... Your private advice about.....

(Cross out line which does not apply)

PLEASE WRITE IN BLOCK LETTERS

Name ..... Address .....

**SANGAMO SYNCHRONOUS MOTORS.**—Self-starting, exceptionally good torque; rotor speed 200 r.p.m., 200-250 v. A.C., 50 c. Consumption 2½ watts. Size 2½x2. Geared 1 rev. 60 min., can be reset to zero by friction drive from front or back. Shaft ½ in. x 1/10 to run clockwise; ideal movements for making electric clocks, time switches, etc. Nickel-plated finish. Price 22/6 each. 12 to 1 Dial Trains to fit above spindle; per set, 2/6.

**SANGAMO SYNCHRONOUS MOTORS (as above).**—Geared 1 rev. 60 sec. Ideal movements for making electric dark room clocks, time switches, etc. Nickel-plated finish. Price 22/6 each.

**CHAMBERLAIN and HOOKHAM SYNCHRONOUS MOTORS (Enclosed Type).**—Self-starting, exceptionally good torque; rotor speed 200 r.p.m., 200-250 v. A.C., 50 c. Consumption 3 watts. Size 2½ x 2. Geared 1 rev. 60 min., can be reset to zero by friction drive from front or back. Shaft ½ in. x 1/10 to run clockwise; ideal movements for making electric clocks, time-switches, etc. Nickel-plated finish. Price 25/- each. 12 to 1 Dial Trains to fit above spindle, per set, 2/6.

**15 AMP. MERCURY SWITCHES,** enclosed bakelite tubular cases, 2½ in. x ½ in., fitted swivel saddle, connector block, etc., 5/6 each.

**WIRE-WOUND NON-INDUCTIVE RESISTANCES,** 2 watt, ideal for Meter Shunts, Resistance Boxes, etc., 2½ per cent. accuracy, wound on bakelite bobbins, ½ in. x 1 in. One of each of the following ratings, 25, 50, 100, 200, 400, 600, 1,000 and 2,000 ohms. 5/6 per lot, postage paid, quantities available.

**THROAT MICROPHONES,** fitted with elastic bands, phone plug, 15 ohms speech coils, etc., 7/6 each.

**CASH WITH ORDER, POST PAID ON ALL ABOVE GOODS.**

**TO CALLERS ONLY.**—A comprehensive stock of scientific instruments, meters, gears, relays, etc.

**H. FRANKS,**  
Scientific Stores, 58, New Oxford Street, W.C.1. Phone: Mus. 9594.

There is no substitute for **Plasticine**

THE WORLD'S FOREMOST MODELLING MATERIAL

WITH A 101 USES IN HOME, SCHOOL, STUDIO AND WORKSHOP



Beware of imitations. Genuine "Plasticine" is made only by **HARBUTTS**

**ELECTRADIX**

**DYNAMOS** for Battery or Windmill Charging, car type, enclosed machines, circular body, 1,000/1,500 r.p.m., 6 volts 10 amps., \$4; 12 volts 10 amp., \$4 10s.; 24 volt 40 amp., \$10. Special Control Box with cut-out Field Regulator for this machine, 60/-; 30 volts 5 amps., \$6; 80 volts 12 amps., \$10.

**FANS**, D.C. Desk Fans, 110 volts, by leading makers, Robust Models, silent running, with strong metal base, 12in. Blade and Guard, 45/- Oscillating type, 55/-.

**FAN MOTOR** only; 110 or 220 volts D.C., for workshop and experimental purposes, 35/-.

**MOTOR BLOWERS**, 32 volt D.C. Motor Blowers with 1/4 h.p. Motor, output 500 cu. ft. per minute, \$8/10/0. Small Valve cooling or Lab. work, for 12 volts D.C., \$3/10/0.



**HEADPHONES**. Double High Resistance Headphones, sensitive to Crystal Reception, lightweight, bakelite case and cap, long Cord and Double Headband, Best British make, 22/6. Single low Resistance Headphones, with Headband and Cord, special bargain for experimental purposes, 8/6.

**SWITCHES**.—The famous Dewar Key Switch, 8-pole C.O., new, flush fitting, 5/-. Ex W.D. D.P.C.O. Switches on Ebonite base, 3/6. D.P.C.O. Toggle Switches, flush panel type, 3/9. Yaxley 1-pole 8-way, 3/6; 3-pole 3 way, 3/6. Lucas 8-way Switch Boxes, 3/6; 6-way, 3/-.

**CRYSTAL SETS**. The Lesdix Bijou Crystal Set in bakelite case, semi-perm. detector, condenser tuning, 15/-. Headphones, 22/6 pair, with Cords.  
**MAKE YOUR OWN CRYSTAL SET** with our Crystal Set assembly, comprising .0005 mfd. variable Condenser, paxolin Coil, 2 1/2 x 3 1/4in., Coil wire for winding, Crystal Detector, .001 fixed Condenser and 4 Terminals, 10/6.

**CRYSTAL DETECTORS**.—Semi-perm. detector, 2/6. Spare crystals, 1/6. Catswhisker Detector, 2/6. Spare crystal, 1/- Multiple detector arm, choice of 6 Catswhiskers, 1/6.

**AERIALS**.—7/22 copper aerial wire, 50ft., 2/-; 100ft., 5/6; 30ft. indoor aerial wire, on reel, 1/-; 30ft. single spiral copper indoor aerial, 1/9; twin with bakelite endpiece and loop, 2/6; Egg and Shell insulators, 3d. each. Lead-in wire, rubber covered, 3/- dozen yards. Earth Clips for water pipe fixing, 9d. each.

**TELEPHONES**.—Hand Combination Telephones, new surplus G.P.O. Stock, bakelite handle with Microphone and Receiver, Battery Switch, fitted, 15/- each. All metal Field Handcoms as used in Field Telephones, Mike and earpiece with damaged finger Switch, easily repaired, 7/6.

**SPARK COILS**, ex G.P.O., with short-wave helix for Model

Control, 55/-. Spark Transmitters with Coil, Gap, Condenser in canvas covered Mahogany Case with folding key, 55/- Spark Coil only for lin. to lin. spark from 6 to 12 volt Accumulator, 25/-. Spark Gap, 3/6.

**HAND MAGNETO GENERATORS**.—Output approx. 70 volts, 25 m.a. A.C., perm. Steel Magnet wound Armature driven by gearing in handle, for A.C. experiments, bell circuits, shocking coils, etc., 10/- each, postage 1/-.

**G.P.O. CONNECTION STRIPS**.—Soldering Tags, Telephone type, moulded base, 60 way, 3/6. Telephone Plugs and Jacks, 3/6 pair.

**POLE STAY STRAINERS** for aerial masts, transmitting and television, 1/6 each; postage 6d. extra.  
**INSULATORS**. Swan-neck insulators for gutter fixing, 1/6 each.  
**MAGNETS**. Midget ALNI perm. steel disc magnets, 3/4in. centre-holes 3/16in. dia., of tremendous magnetic force; unlimited uses, 3/6 each. Horse-shoe permanent steel magnets, various sizes, from 3/6 each.

Send for our Special leaflet on Relays, Chargers, Dynamos, Microphones. Please let us have your enquiries for Instruments and Apparatus you are wanting.

Please include postage for mail orders.  
**ELECTRADIX RADIOS**  
214, Queenstown Road, London, S.W.8. (Late Queen's Road)  
Telephone: MAcAulay 2155

*Fit*  
**Fibrax**

and get there safely!

In any emergency Fibrax Brake Blocks will always pull you up. They are made of material specially processed to give the maximum braking efficiency. Highly resistant to wear. Production limited in these days, but you can depend on your dealer to do his best to supply you.

FIBRAX LTD.,  
2 TUDOR STREET,  
LONDON, E.C.4.



**HOYT'S LUTEX**

Non-melting, non-hardening Lute for packing or stopping off Leaks in white metalling jigs etc....

**ELIMINATES POROUS CASTINGS**

LUTEX contains NO moisture and cannot cause porosity in contact with molten metal.

**ECONOMICAL**

LUTEX retains oven consistency, will not dry or harden and can be used many times without losing its efficiency.

**PRICES.**

4 lb. .. 6/3 24 lb. .. 20/-  
7 lb. .. 10/- 56 lb. .. 55/-  
14 lb. .. 17/6  
Nett: Carriage Paid in U.K. and Else.

Depend on it - it's a HOYT Product  
THE HOYT METAL COMPANY OF GREAT BRITAIN, LTD.  
DEODAR ROAD, BUTNEY, LONDON, S.W.15

Laminated Bakelite panels, 1/4in. thick, 6in. x 4in., 1/3; 6in. x 6in., 1/9; 8in. x 6in., 2/3; 10in. x 6in., 2/9; 10in. x 8in., 3/6; 12in. x 8in., 4/- Ditto, 1/16in. thick same sizes, 10d., 1/2, 1/6, 1/10, 2/4, 2/8. Polished Ebonite panels, 3/16in. thick, sizes as above, 1/9, 2/9, 3/6, 4/6, 6/-, 7/-, respectively. B.A. screws, gross useful sizes, 2/6; do. nuts, 2/6 gr.; assorted gross screws and nuts, 2/6; brass washers, 1/6 gr.; fibre washers, 1/8 gr.; assorted soldering tags, 2/- gr.; assorted small eyelets and rivets, 1/3 gr. Cotton-covered copper wire, 1lb. reels, 18, 20, 22, 24 g., 1/6; 28, 28 g., 1/9; 30, 32 g., 2/-; 34 g., 2/3. Enamelled do., same prices including 36 g., 2/3; 38, 40 g., 2/6; 43 and 44 g. available. Silk-covered do., 2oz. reels, 24, 28, 28 g., 1/6; 30, 32, 34, 36 g., 1/9; 40, 42 g., 2/-; 22 g. D.S.C., 2/6 1/2; 44 g., 45 g., 1oz., 2/-; 16 g. D.S.C., 1lb., 5/-; 18 g. D.S.C., 1lb., 7/- Heavy insulated aerial wire, 50ft., 1/6; 75ft., 2/3; 100ft., 3/-. Lead-in tubes, 4in. 9d.; 6in., 1/-; 9in., 1/4. Rubber-covered stranded copper wire, 13d., 21d., 3d. Tinned copper connecting wire, 20ft., 6d.; do. rubber-covered, 10ft., 6d.; finest quality stranded and single push-back wire, 12yds. 2/3; resin-cored solder, 1lb., 3/6; twin bell wire, 12yds. 2/3. New "Lucerne" permanent crystal detectors, 2/-; "Lucerne" crystal set coil with wiring instructions, 3/6; glass tube crystal detectors, complete, 2/-; guaranteed crystal with cats-whisker, 6d. Reconditioned headphones, complete, 4/00 ohms, 12/6. All postage extra. Trade supplied.  
**POST RADIO SUPPLIES**  
33, Bourne Gardens, London, E.4.



HE used the wrong material. YOU need not!

We can supply the right material for your specific needs.

- GUNMETAL. STEEL.
- BRONZE.
- DURALUMIN. FIBRE.
- EBONITE, ETC.

Complete List "P.M."; 2d. post free.  
SHOP NOW OPEN. VISITORS WELCOMED.  
**RETAIL MATERIAL SUPPLIES**  
377, Milkwood Rd., HERNE HILL, LONDON, S.E.24. (Close to Station)

**PELMANISM**

For All Times and Circumstances

PELMANISM has stood the test of time. During the last half-century, in peace and war, in times of prosperity and of depression, it has helped and encouraged men and women in all the affairs of life. Now in this time of reconstruction and planning for the future two facts stand out against a background of evidence—the large number of serving and ex-service members of H.M. Forces enrolling for the Pelman Course and the continued support of those in civilian occupations.

Half-fees for serving and ex-service members of His Majesty's Forces (Apply for Services Enrolment Form)

This increasing demand proves the creative and re-creative value of Pelmanism. Minds under stress and strain are sorely in need of restful recreation and soothing stimulus. Pelmanism gives all this and more. It is the way to clear thinking and calm but determined action under all circumstances. You cannot be harassed by anxieties, fears and worries, or feel helpless, mute and fearful in times of sudden emergency when imbued and buoyed up by the friendly personal guidance of Pelmanism. Take the Course to-day and possess those self-reliant attributes permanently enjoyed by over half a million grateful Pelmanists.

**A True Philosophy**

Pelmanism is a true philosophy of living for ordinary sensible people who wish to make the best of themselves at all times and under all circumstances. The Pelman Institute has won and held its unique position through all wars and worries, trials and tribulations, during the last half-century. To-day Pelmanism is appreciated as much as ever. The test of time has proved the Power of Pelmanism and in these exceptional and ever-changing times it is playing its part in reconstruction.

Remember—Everything you do is preceded by your attitude of mind.

The Pelman Course is fully described in a book entitled "The Science of Success." The Course is simple and interesting, and takes up very little time; you can enrol on the most convenient terms. The book will be sent you, gratis and post free, on application to:—

**Pelman Institute**,  
(Established over 40 years)  
130, Norfolk Mansions,  
Wigmore Street, London, W.1.  
Readers who can call at the Institute will be welcomed.

PELMAN (OVERSEAS) INSTITUTES: NEW YORK: 271 North Avenue, New Rochelle. MELBOURNE: 396 Flinders Lane. JOHANNESBURG: P.O. Box 4928, DURBAN: Natal Bank Chambers (P.O. Box 1489). DELHI: 10 Alivore Road. CALCUTTA: 102 Clive Street.

**CHEMISTRY ARE YOU INTERESTED?**



Whether you dabble in experiments or pursue a course of serious study you will need our **LABORATORY EQUIPMENT**.  
Send 1d. stamped envelope for **PRICE LIST**.

**BECK**  
(SCIENTIFIC DEPT. A), 60, HIGH STREET, STOKE NEWINGTON, LONDON, N.16.  
Booklet: "Experiments in Chemistry," 7d. P.O.

**JUBILEE WORM DRIVE HOSE CLIPS**



The long-life clip with the ever-tight grip.  
**THEY NEVER FAIL**

The Best Known For Radiator Joints, Air, Oil and Water Hose Joints. We guarantee a Tight Joint.  
**L. ROBINSON & Co.**  
25, London Chambers, GILLINGHAM, KENT

"See Britain by Cycle..."



**6 POLPERRO...**  
 Rich in its history of smugglers and their hoards, recounted at length by weather-beaten seamen, the rugged Cornish coast has no equal in its appeal—that's if you like your scenery comparatively untouched. Abounding in small coves filled with pellucid blue water, the coast boasts no quainter spot than Polperro, lying in its valley, and more like a Breton than an English village.

# DUNLOP

6H/311

**Modelcraft's**  
 NEW  
**MAGAZINE**  
 AND LIST  
**August, 1946**

Colour card cover,  
 30 pages of articles,  
 news items and  
 historical notes.

Over 300 plans,  
 plan books and  
 other items listed.

PRICE **6d.** POST FREE  
**MODEL CRAFT**  
 LTD.  
 77 (PM), Grosvenor Rd.  
 LONDON - - - S.W.1



**APEX**  
**'SUPERLITE'**  
**CELLULOID PUMP**  
 15 x 7/8" BLACK

Thick Celluloid  
 Beautifully Polished  
 Light of Weight  
 but of  
 robust construction

'SUPERLITE' 15in.  
 CELLULOID (with  
 solid drawn brass  
 plunger tube) each **4/3**

'LASTWEL' CELLULOID  
 (with steel split  
 plunger tube) 15in. **4/-**  
 each

The World Famous  
**BAILEY'S**  
**'SUPER'**  
**PUMP**

15 x 7/8" BLACK  
 Steel Lined  
 Celluloid Covered

Lining is Solid drawn  
 cartridge fashion, the ends  
 being solid with the barrel.

Cannot warp nor leak.  
**BAILEY'S 'SUPER'** (Steel  
 lined and Celluloid  
 covered) 15in. each **5/-**

**BRASS PUMP**, Nickel  
 Plated or Black enamelled  
 (with steel split  
 plunger tube) each **3/3**



## APEX PRODUCTS

Are in use in every Country in the world.

They are known and appreciated for their reliability; long service and efficiency in their job of inflating tyres.

Labour and materials are still very much restricted; consequently supplies of pumps are scarce! If you are lucky in owning an Apex Pump, treasure it.

MADE BY  
**APEX INFLATOR Co. Ltd.**  
 ALDRIDGE ROAD, PERRY BARR,  
 BIRMINGHAM 22B



All Standard Works  
 for the  
 Mechanical Engineer.  
 English and American.

**THE SPON BOOKSHOP**  
 (LATE OF HAYMARKET.)  
 ESTD 1850  
 129 VICTORIA STREET  
 LONDON, S.W.1

## MATRICULATION

*brings Success & Security*

Whatever your age, you can now study for the all-important Matriculation Examination at home on "NO PASS—NO FEE" terms. "MATRIC" is the accepted passport to all careers, and opens up opportunities which would otherwise be completely closed to you. Ensure the success and security of you and yours through post-war difficulties by writing for our valuable "Guide to Matriculation" immediately—FREE and without obligation. B.T.I. (Dept. 160), 356, Oxford Street, London, W.1.



Editor: F. J. CAMM

VOL. XV

OCTOBER, 1946

No. 296

All letters should be addressed to the Editor, "THE CYCLIST," George Newnes, Ltd., Tower House, Southampton Street, Strand, London, W.C.2.

Phone: Temple Bar 4363

Telegrams: Newnes, Rand, London

Comments of the Month.

By F. J. C.

## Street Lighting

THE Ministry of Transport, which some years ago took over the trunk roads of this country and became responsible for them, has now become the central authority responsible for street lighting, and has taken over from the Home Secretary the allocation of iron and steel and timber necessary for street-lighting equipment. This move is long overdue, for the lighting of our streets as at present practised is nothing short of a national scandal. Jacks in office and local big-wigs on borough councils, rural councils, and urban district councils, have for years exercised their local rights to light their streets as they think fit. When crossing the boundary from one district to another one runs into either a totally different system of lighting or else there are no lights at all.

The Ministry has now indicated to lighting authorities the procedure to be followed in the future and has drawn attention to a number of points of special importance. The Minister "asks" (he has assumed power, but is not giving orders!) that special consideration should be given in the future to securing reasonable uniformity in lighting standards, and draws attention to the fact that the diversity of lighting standards adopted by lighting authorities on adjoining lengths of road has in the past been a source of danger and inconvenience to road users. These pious hopes will be ignored by the beggars on horseback who are clothed in an authority which is anything but brief. It will be the mixture as before until the Minister peremptorily orders local authorities to comply with a predetermined standard of lamp height, light-intensity, and light spacing.

The Minister "expresses the hope" that "as soon as practicable" lighting authorities will "do their best" to adopt the appropriate recommendations of the Reports of the Departmental Committee on Street Lighting, which was issued as long ago as 1937.

As from the date of the circular now issued to local authorities, the Minister will issue any necessary authorisation for street-lighting schemes except in so far as streets on new housing sites or streets other than public highways are concerned. These come within the province of the Minister of Health.

Attention is drawn in the circular to the fact that owing to the serious coal situation there is still need for the utmost economy in the consumption of fuel for street lighting. We suggest this economy can be practised during the hours of daylight! Street lamps are lit sometimes as much as an hour before darkness. During the summer in some districts in London they were lit as much as three hours in advance of darkness. There should be no economy in lighting during darkness. That is the danger period. Adequate street lighting will help to eliminate the dazzle problem, for motorists at present on some stretches of road in populous areas are compelled to use their headlights.

The Minister suggests that fuel could be saved by turning out street lights at midnight. We do not agree. A vast amount of commercial

traffic is done at night, and the drivers of these heavy vehicles are entitled to travel along a lighted way. Attention is drawn to the fact that there is still a considerable shortage of gas mantles, but that is a shortage artificially created by the Treasury and by our export policy. Human life must come first, and lighting saves life. Why use gas? Electricity is available through the Grid scheme to illuminate all of our streets. The Minister has arranged with other departments concerned that even when a number of departments have to take action in a specific case, one application on the part of the lighting authority will be sufficient.

### Driving Tests

DRIVING tests are to be resumed in the autumn, and Mr. J. H. Rolt has been appointed as chief driving examiner. His duties will be to advise the appropriate administrative officers of the Ministry of the practical steps which are necessary to carry out such tests as may be determined, to advise on the training of the examiners, and the organisation and arrangement for the tests. The suggestion that examiners should be trained is quaint—rather like appointing a man to examine scholars and then teaching him the three r's. Surely, there are sufficient numbers of really capable motorists who can act as examiners and who are already trained. We hope the tests will be free from the tricks and the trickiness which was practised by many of the pre-war examiners. Supervising driving examiners are to be appointed in the 11 traffic areas throughout the country, together with additional supervising driving examiners in the London traffic area.

The candidates themselves must pass driving tests, and they will then go through a course at a police driving school.

Before the war 200-250 driving examiners carried out about 360,000 driving tests each year.

Of course, these tests will not eliminate the accident-prone but they may do much to improve the standard of driving ability in view of the large numbers of new motorists now coming on to the road, after a hiatus of six years of war. Even those who used their cars during the war may have grown careless as a result of the comparative road freedom they enjoyed during the war. They must learn to readjust their methods to the new conditions. It must, however, be remembered that the driving tests which were originally introduced by Mr. Hore Belisha did not appreciably reduce the number of accidents.

### Obstruction

THE Roadfarers' Club have prepared a memorandum of obstruction and submitted it to the Ministry of Transport and to Scotland Yard. Some of the points in this memorandum are of interest. It points out that obstruction on the highway is not a problem introduced by the motor-car alone, for the Highway Act of 1835 made provision for such. Everyone is agreed that in cities

and busy towns there is severe congestion of the highway. The memorandum thinks that it is the duty of the State to recognise that the motor-car is no longer the toy of the rich, and that many hundreds of thousands now use cars in connection with their business. It is unreasonable to expect them to place their cars in garages every time they stop. The London parks could be used for the parking of tens of thousands of vehicles and unilateral parking on the nose-in principle could be permitted in the streets of many towns and cities. At present the police are endeavouring to solve the problem by prosecution. That never has and never will solve the problem. The motorist is fined for leaving his car an "unreasonable" time and there is really no defence to such a charge for the policeman is left to decide what is an unreasonable time. He thus has a discretion in the matter which is often unfairly exercised. The police sought and obtained power to remove from the highway any car causing obstruction, yet they will often wait two hours to prosecute a motorist. Is this not aiding and abetting the obstruction in view of the police powers?

It is suggested that discrimination should be made between those who are using their cars for pleasure purposes and those who are using them in connection with their work. The memorandum suggests that the payment of overtime pay to the police whilst they are in court is wrong in principle and is likely to cause a few to "make a case." The garage space of this country is totally inadequate.

The memorandum thinks that there are far too many traffic lights which cause the roads to become obstructed. They are insensitive to the needs of the moment, needlessly hold up traffic at crossings when other traffic does not wish to proceed at right-angles to it. Many of these, it is thought, could be abolished without introducing the need for police control. Some of these lights are so badly timed that they render ineffectual traffic lights hundreds of yards to the rear. Secondly, where the police do control traffic they will quite often hold up a file of fifty or more vehicles in order to allow one vehicle to cross. The police should be instructed that the needs of the many must not be sacrificed to the needs of the few. It is also thought that when the police do bring cases of obstruction before the court they should give evidence of the obstruction. Also they should prove that they have had the car under continuous observation during the whole period of the alleged offence. To our certain knowledge, the police do not give such evidence, nor do they always keep the car under continuous observation. How, therefore, can they give reliable evidence as to time?

The fixing of stopping places for public service vehicles is another cause of obstruction and congestion. It is not so much a maximum speed limit which is required in London and other towns and cities as a minimum.



**Road Courtesy**

A LEICESTER motorist, who took it upon himself to enter a discussion about the habit which many motorists have of flinging open their car doors into the traffic stream, suggests that everyone knows that a driver alights on his offside, and that if some "dreamy cyclist or pedestrian" is caught by the impact, this motorist suggests that the person who collides with the door should be made to pay the cost of repairs. Any motorist who talks like this, and behaves on the road as he talks, would benefit from a course on road courtesy.

**Still Not Satisfied**

A MAN who at St. Ives (Hunts) Police Court was sentenced to four months' hard labour for stealing a cycle, was stated to have told a policeman who went to arrest him: "If you want me, you—fetch me!" The policeman did fetch him, and handcuffed him, as requested. Then the man complained to the magistrates that when he was arrested he was "pushed about and smacked on the chin."

**Car Better Than Cycle!**

FOR once the car has proved better than the cycle. A Cheshire woman motorist gave a lift the other day to a hitch hiker, and he repaid her by giving her a pair of nylon stockings, one of two dozen pairs which he had just brought back from America. The lucky woman trembles when she thinks what she would have missed had she been cycling.

**"Trader Handbook" (Motor, Motor-cycle and Cycle Trades)**

IN a recent announcement the price of the 1946 "Trader Handbook" was wrongly given as 7s. 6d. This should read 10s. 6d., post free.

**Mobile Crime**

A MAN who appeared before Marsh (Cambs) magistrates charged with bidding for articles at local auction sales and taking them away without paying, was stated to have used a perambulator hitched behind a bicycle to carry away his plunder. After the coup which proved to be his last he was chased by the irate auctioneer and nearly made his getaway, but the perambulator loaded with loot seized up and he was caught.

**Cycle Sheds for Pre-fabs.**

MARKET HARBOROUGH (Leics) Urban District Council have taken up with the Ministry of Health the question of providing cycle sheds for prefabricated houses.

**Quietly Does It**

MRS. K. WOOD, chairman of Eynsford (Kent) Parish Council, is strongly against the village policeman using a motor-cycle, and the Council want the Chief Constable to take away the motor-cycle and give the policeman a bicycle instead. She says that any burglar can hear the policeman coming on his motor-cycle and lies low until the danger is over, but on a bicycle the policeman can creep up quietly and catch the burglar in the act.

**Lighter Lightweight**

A SPECIALLY compact cycle, with a small front wheel and larger rear wheel and a weight less than half that of a normal lightweight machine, has been built by a Norwich cyclist. When the cycle is not being ridden the front wheel can be turned under

the frame so that the machine can be stowed away in a small space. The cycle carries a rider of normal size and weight.

**One of the Pioneers**

MRS. L. P. BLANCHARD, of Sleaford Road, Boston, Lincs, who has just died at the age of 84, was one of the first women in the district to ride a bicycle. She had lived in Boston since she was 13 years old.

**Better than Sherlock Holmes**

A POLICE constable, giving evidence at St. Ives, Hunts, against an R.A.F. officer charged with cycling without a light, said he saw a cyclist without a light and signalled to him to stop. The man rode straight on, but as he rode by his clothes touched the policeman's hand and he knew by the feel that the clothes were those of an R.A.F. officer. The constable eventually caught the offender after chasing him on a borrowed cycle.

**Living Traffic Signal**

THE Chief Constable of Peterborough has just carried out a test of a human traffic signal

in one of the city's busiest streets. A war reserve constable went on duty after dark wearing a long white coat and a helmet with an illuminated glass panel bearing the word "Police." The constable signalled the traffic with two lamps, one red and one green, and quickly sorted out the after-theatre traffic. An American Army officer, on leave from Germany, who saw the test, plans to equip some of the men he uses for traffic control work in the American Zone in a similar way.

**Fewer Missing Cycles**

ACCORDING to the report of the Chief Constable of Lincolnshire for the past quarter, the most significant feature of the period is the great decrease in the number of cycle thefts. This decrease coincides with a considerable closing down of Army camps and R.A.F. stations, so it would appear that the "crime wave" during the war was mostly due to soldiers and airmen who were anxious to get back to camp, and did not mind how they got there.

**A Troublesome Itch**

A SOLDIER who appeared at Leicester Quarter Sessions charged with stealing cycles, which he afterwards sold, told the Court that if he got drunk and saw a bicycle he had an "itch" to take it. The Court decided that this "itch" needed a little investigation, so the man was remanded for a medical report to be made.

**We Only Won the War**

WHILE German prisoners ride to their work in special buses, British miners have to cycle miles to work in all weathers, complained a member of Thorne (Yorks) Rural District Council. He said it was time the Council did something for the miners in their district, but a previous application for buses to be arranged has already been turned down by the Ministry of Transport.

**Still Going Strong**

MR. CHARLES WILSON, of Ramsey Heights, Hunts, has been a keen cyclist for many years and even now, at 83, he does a daily newspaper delivery round on his tricycle. His cycling helps to keep him fit for his other duties as sexton and gravedigger at the parish church.

**Asking for Trouble**

OUT of 78 bicycles belonging to children at Ramsey, Hunts, which were inspected, 75 were found to be defective and likely to

cause accidents. Because of the frequency of accidents in the district, a Safety First Council has been formed at Ramsey to take all steps to reduce road accidents.

**Service**

A GIRL cyclist who left her machine in a street in St. Neots, Hunts, returned later to find it was missing. She notified the police and had little hope of seeing her cycle again, but a few hours later it was found back in the place from which it had been taken—complete with a fresh coat of black enamel, even on the plated parts.

**Navigation Rather Shaky!**

KETTERING Friendly Cycling Club decided, during a recent Sunday run, to visit Northamptonshire's dying and almost forgotten village—Faxton—which now has less than a dozen inhabitants, and only one child. Three of the club members had been to the village previously and acted as navigators for the party, but something went wrong. They doubled backwards and forwards, one rider fell into a stream and finally, when they thought they could see Faxton church, they found they were back in the village from which they had started their search.

**Cycle Tracks at Stretford (Lancs)**

CYCLE tracks are being mooted again by Stretford (Lancashire) Highways Committee. The committee proposes to provide such tracks along a stretch of the main Manchester-Chester road—claimed to be the busiest weekend cycle road in Britain—between the Old Cock Hotel and the Sale boundary. The committee's proposals have yet to be considered by the two adjacent County Councils—Lancashire and Cheshire—which will ascertain whether the scheme will fit in with their plans for new trunk roads.

**Bituminous Surfaced Roads**

TO get away from treacherous surface presented by granite setts in wet weather, Stretford (Lancs) Corporation is to experiment with bituminous surface carpeting as part of a £20,800 scheme for improving certain roads in the borough.

**Lighted Pedestrian Crossings**

TO make pedestrian crossings more easily seen, all Belisha beacons are to be lit up in Prestwich (Lancs) in the near future.



British champion, Reg. Harris, unbeatable all this year, met his match in the Quarter-Finals of the World's Cycling Championships at the Oerlikon Velodrome, Zurich, last month, losing to Bijster, of Holland, whom he has conquered four times on the selfsame track. Bijster, in turn, was beaten in the semi-final by the eventual winner, Oscar Plattner, of Switzerland. Our illustration shows Reg. Harris with his manager, Mr. McDonald, before the start of the Quarter-Finals at Zurich.



# Around the Wheelworld

By ICARUS

## The Camm Automatic Tyre Pump

THE automatic tyre pump, invented by Mr. F. J. Camm, and which may be attached to any bicycle without structural alteration, was exhibited at the recent Model Engineer Exhibition at the Horticultural Hall, where it attracted a vast amount of attention. It was shown on the newsreels and on the television screen and thousands of cyclists who visited the exhibition wanted to buy a pair. The position is this. World patents have been taken out for the pump, and it is now being manufactured. It is expected that it will be on the market early in the New Year. For those who did not visit the exhibition, and therefore did not see the pump in action, may I say that it can be fixed by anyone to a standard bicycle in about a minute. An eccentric camplate is pushed over the spindle of each wheel and this operates the push-rod of the pump, which is of small bore and of small stroke, thus injecting air into the tyre, to which the top of the pump is rigidly connected to the standard valve by means of a short length of small bore brass tubing. In the head of the pump is an adjustable safety valve which can be set to blow-off between 10 lb./sq. in. and 100 lb./sq. in. It has been found that with the pump in action it will keep the tyre fully inflated at the correct pressure even though the tyre is punctured. It is, of course, possible to cut the pump out of action by means of a bayonet slot, which locks the plunger out of contact with the camplate. The pump may be fitted even to three-speed hubs.

Other automatic pumps which have been produced have called for special hubs being built into the wheel (somewhat costly) or structural alterations to the bicycle itself. The Camm pump is extraordinarily efficient and pumps at a very low speed. It is almost impossible to detect whether the pump is in action or not. Mr. F. J. Camm is, of course, the Editor of *The Cyclist*, PRACTICAL MECHANICS, *Practical Engineering* and *Practical Wireless*. An article elsewhere in this issue illustrates and describes the pump in detail. It is to be shown at the Glasgow Exhibition at the Kelvin Hall on November, 15th-27th, 1946, inclusive.

## Local Cycling News

THIRTY-SEVEN daily and seventy-one weekly newspapers have written to the National Committee on Cycling agreeing to publish local news on cycling. The "National" bodies have been so informed and it is hoped that through their branches an acceptable local news service will be established. A list of these newspapers is available from Robert Williamson, Hastings House, Norfolk St., London, W.C.2.

For the guidance of club scribes, may I be allowed to give some advice as to the sort of material they should and should not send to editors. Do not, for example, send news that Miss Bessie Flip-Flop has become engaged to Frank Freewheel. That item of news is of interest only to the two parties concerned and no editor is going to waste a line on it. The fact that Percy Pilbeam happened to win the Club Handicap with an entry of three is similarly unworthy of space. The club may have held its annual general meeting and shown a profit over the year's trading of 5s. 11½d. No one wants to know that either. It is purely a domestic matter for the club. Only send to editors matter which will be of interest to those

outside the club. Do not endeavour to use your local newspaper as a means of circulating matter of interest only to members of the club. In a well-organised club the members will be kept well informed of what is going on and there is no need to have it printed in the local newspaper.

Remember also that under the archaic rules of the R.T.T.C. prior publicity must not be given to cycle races (beg pardon, time trials). One or two clubs have offended in this respect, although my sympathies are with them. I do not know whether this move to secure cycling publicity has been inspired by the extraordinarily successful press campaign conducted by the B.L.R.C., who have certainly hit the headlines, but it would seem so.

## News Required

DO send to the editor of your local paper details of any successful open events in which club members figure. Do send them protests about the actions of the local police or statements by local magistrates when such call for criticism. Do not send them the usual cycling tripe breathing fire and hate against motorists, rear lights and cycle tracks, and remember that we are living in 1946, not 1886. Avoid sending circular letters promoted by national bodies. Editors are well aware of the claque. Also avoid sending letters promoted by national bodies which are merely intended to procure publicity for those bodies. The fact that Mr. Bill Brown, a member of the A.B.C. Cycling Club, was awarded £18 6s. 4½d. for the loss of a leg due entirely, of course, to the intercession of the A.B.C. Cycling Club is of no interest to anyone except Mr. Bill Brown and the insurance companies concerned. Such paragraphs are merely intended to gain publicity for the A.B.C. Cycling Club and they regularly find their way into the W.P.B. I throw such notices into the waste-paper basket at once.

Don't write to editors representing cyclists as an oppressed class, threatening to use the vote at the next general election if they cannot have their way. This sort of effete tactics is out of date, out of joint.

Do not forget to invite the local Press to your annual dinners and dances. It is at the annual general meetings that the Press will be able to gain its information as to the activities of the club during the past year.

## Adviser for Cyclists

CYCLING club secretaries and members of clubs in Southern England are to have an expert adviser on tyre and rim

equipment at their service. He is Mr. F. A. Borton, whose double qualifications are that for 20 years he has been a keen cyclist (before the war he was secretary of the Harrow Cycling Club) and that for 18 years he has been a member of Dunlop's staff.

Now, after six years in the Army Ordnance Corps, he is back with Dunlop and has been given his present duties. He will also be in touch with lightweight bicycle builders and assemblers.

## Roadside Rests

AN illustrated brochure has been issued by the Royal Automobile Club, describing an idea in road travel, entirely new to this country, which is likely to prove extremely popular amongst walkers, cyclists and motorists alike.

It consists in providing Roadside Rests—small open reserves to which all may have free access on quitting the road nearby. There is a growing consciousness and desire that the noble heritage of natural beauty which these islands provide should be seen and more widely enjoyed by road travellers—hikers, cyclists and motorists—by foreign tourists and local folk. Roadside Rests would provide the opportunity for indulging this inclination in places where people could take their ease in the shade and shelter of trees or on the grass by the side of a stream, in simple comfort among the gracious sights, sounds and smells that belong to the countryside.

The brochure describes in detail a typical Roadside Rest, its situation, development and control, the directions leading to it and the facilities provided for shelter and parking. It contains a section on the use of Roadside Rests as Memorials in connection with the War or other local commemorations. It is illustrated with photographs of the types of countryside in which Rests could suitably be sited, and with plans and drawings of their various aspects.

It is being circulated by the R.A.C. to local authorities and others who would be interested in providing these Rests, and it is hoped that the idea will be adopted and developed in this country to the advantage of every class of road user.

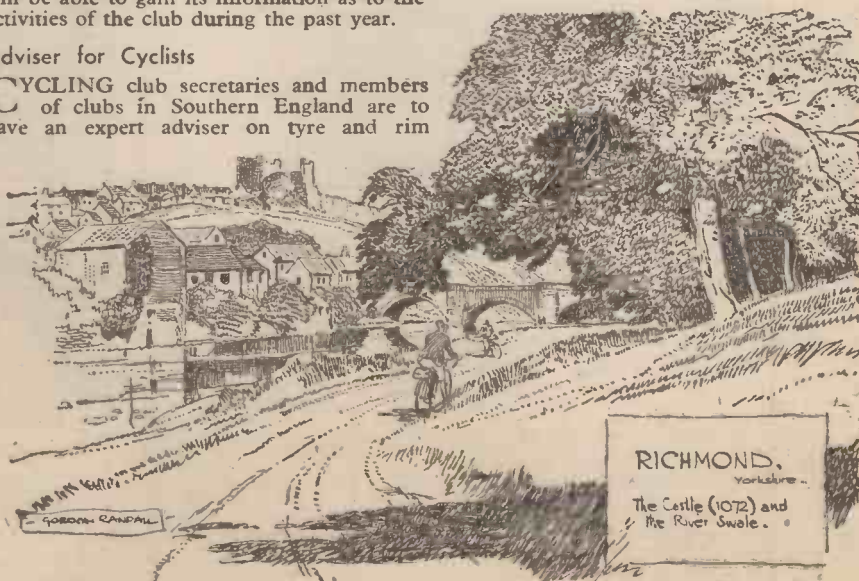

# Wayside Thoughts

By  
F. J. URRY

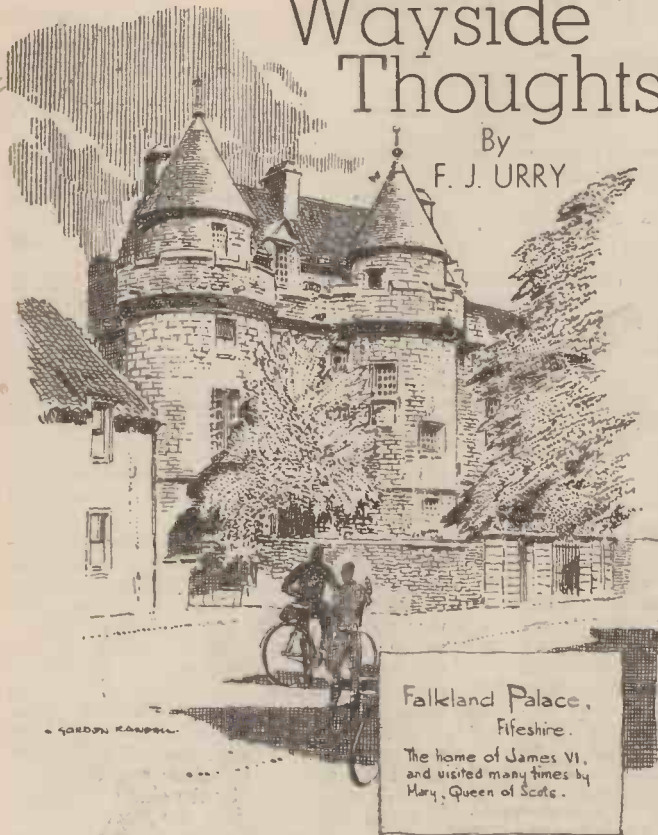

## The Important Thing

I WAS travelling to work one morning and overtook another rider free-wheeling down a long slope. He caught me a furlong farther on and asked why it was my machine ran away from his when obviously his rider was the heavier person. And, of course, my reply was that mine must be the better bicycle; there is no other explanation unless the answer is lubrication, which did not appear to be obvious. My casual friend was not just a utility cyclist using his vehicle as the hack to be forgotten and neglected immediately its daily job was done, so I explained to him the value of reasonable lightness in construction, quality in bearings and the resilience and liveliness of open-sided tyres. It isn't often one meets an individual seeking information on the differences between the best and the not quite so good, and the exchange of opinion was certainly interesting and, I hope, informative. The fact that my machine would coast farther than his despite his greater avoidupois was evidence of its better quality, but, as I explained to him, that obvious fact was of secondary consideration and did not count for much. The gain in the possession of quality was far more important to the rider when the machine was under muscular drive—and the evidence of the ease was a hidden virtue—than ever it was when the bicycle and rider travelled by gravitation or the aid of the wind. That, I think, is something many people miss in the account of quality, and often haggle at the price demanded for its possession without counting the cost imposed on their own energies. For a bicycle is personal in the highest sense of the term, for unless it fits comfortably and runs as the best machinery should, then it cannot give its owner the highest pleasures of the pastime, and anything less to me is unthinkable. We are still a long way from that desideratum, I agree, but we are creeping a little nearer to it year by year.

## Many Visits

DURING the rather slimy weather of late May and nearly all June, I had the joy of several little holidays. When I was in Scotland with the Centenary Club at the Macmillan function, we enjoyed five lovely days with but an hour's rain, and although the elders of the trade do not ride far or fast in the reckoning of the younger generation, they did some two-hundred miles of Galloway and were amazed at the beauty of that S.W. corner of Scotland. There were twenty-three of us, and it is rather remarkable to report that only one puncture occurred, a glass dagger through the cover of a new Sprite. I mention this because most of the company were using the lightest tyres procurable, and as open-sided covers have not been made since about 1940, this near immunity from perforation says something for the quality of the pre-war type of light tyre. After that happy interlude was over, four of the party went for three days to the Isle of Arran, and explored that lovely island in cool windy weather, and the three companions who had not previously visited this gem of the Firth of Clyde agreed it embodied every phase of Scottish scenery. To finish up a historic week we visited some of the lochs and glens of Southern Argyle, and in all made a

gentle round of some four hundred miles of happy roaming. Since then I have seen mid-Wales again under the fury and the sudden sorrow of the late Whitsuntide, and while the weather was a disappointment it had its compensations, for Pystal Rhyader was finer than ever I have seen that fall, and all the hills that score the mountains were riotously drunk on their way down to the mother streams. I went over the Hirnant Pass from the Bala side during a break in the dampness; it was a fine passage, and my companions and I seemed to be the only humans left in the world, but I warn you that from the summit to Lake Vyrnwy the road is unrideable—scarcely jackassable—owing to continuing lumbering operations.

## Other People's Troubles

I HAVE a letter from the biggest maker of bicycles in the U.S.A. deploring the difficulties of meeting the present demand for bicycles, and the price to which they have soared due to wage increases. In this communication I am told that the works project of output was 2,400 machines a day. Like makers here, output is restricted, owing to lack of small parts and my friend tells me he has cabled all over the world for supplies of half-inch pitch chain! We cyclists are apt to grumble when we cannot buy the goods we desire, but judging from this report the position in America seems worse. I mention

this communication here because I get so many letters asking why certain makers do not market the type of goods they made, and readily sold, before the war. I do not want to pose as an apologia for cycle manufacturers; they have the faults common to all of us, but today they are surely having a rough time, what with labour and shortages, and material failures, and the worries endeavouring to dam the floods of overflowing order books. Another letter comes from Canada. Can I suggest a maker who will supply the writer with a first-class British-built frame? Canadian makers, according to my correspondent, have no hope of filling such an order for many months ahead. Returning traveller friends tell me that bicycles in Switzerland are £20 each, just the ordinary roadster models with no trimmings; and there is no Purchase Tax. I am beginning to feel we riders in this country are fortunate in comparison to cyclists in other parts of the world; yet I suppose I shall still go on pressing for a return of the very best we can make in bicycles and equipment, for the simple reason that I know the discerning cyclist realises it is the only way if one desires to obtain from the pastime that meed of joy and happiness which is the very spirit of cycling.

## It Takes More Than That

SOME of my friends whom I persuade to try cycling far too often delude themselves, and nearly always that means disappointment. I lend them a bicycle, they feel fine for ten miles or so, and when I suggest rest or a drink they pooh-pooh the idea. They want to tour long before they can ride. What a mistake it is to imagine anyone can ride—in the time sense of the term—just because they can steer a bicycle and pedal it a few miles along a main road without hurt. I think the people who say cycling is merely a matter of balance do the pastime no service. You must be reasonably fit for the game, not athletically fit in the strenuous sense, but as fit as you desire to be for, say, golf or walking. You need to sit comfortably on a saddle for a distance of twenty miles or more, and when you can do that and remain happy, you are fit enough for touring. But I have seen strong men wilt on a summer's day when they have made the mistake of thinking muscular power and the art of balance were the only things needed to make a cyclist. In a degree they are both necessary, but their proper application is the art of cycling, and that art is not going to be gained in an hour's travel. The casual five miles does not matter, the rider can "stick" it for such a distance even though it may leave with him or her the firm impression that cycling is "hard work"; indeed, that is just how the untrue tag came into the mouths of men—they use the vehicle for transport, caring nothing for the pastime. But if you want to tour—and I am unaware of any more desirable form of leisure or holiday-making—for goodness sake give yourself a chance to be a cyclist, to pass over the countryside almost unaware of the means of your travel, but highly alive to its exercise, its rhythm, and the beauty of the ever-changing scene. Anybody can ride a bicycle, and anybody can ride it with a full sense of delight in the going, if they will but get fit and keep fit, using their muscular energy rightly to create happiness.

## The Eating Question

NO one has recently solved the problem of eating satisfactorily when on tour, and I don't think they will while controls last. Normally, you get a pretty poor meal for a very high price and climb the next hill on route feeling a trifle empty at the top of it. If there are but a couple of us touring I try to take as much from the home larder as I can spare, and so does my friend, and so we eke out with what we can buy along the road, which, I may add, frequently amounts to no more than an eye-full. Country people are very kind and often sympathetic, and the presence of fowls always suggests eggs—a choice delicacy these days. If we are four then we usually adopt the Scots custom of drumming up. Four can carry the appurtenances without adding undue weight to the pack. The brewing of tea at any time of the day is then a simple matter, and given a good cup of tea and the plainest of plain meals, I for one can go sailing merrily along. Yet I admit I am not over fond of plain meals; I like things that sizzle in a frypan; for say what you will the art of eating is part of the enjoyment of life as well as being a sheer necessity. Perhaps because I've been on the road a long while, I know quite a lot of people in the touring centres, and most of them are kind to me, so that in the long run our touring and week-end picnics have had a flavour about them. And to be candid I have not noticed any diminution of the touring fraternity because of the food difficulties, and so suspect that such adventurers have their own means of persuasion. We are frequently apt to say it is a hard world, but within the borders of this delightful land I have found a fund of friendliness during the passage of these difficult years, unsuspected in those times when one "ordered" rather than "persuaded." It isn't the food problems that has kept me off the road, or accommodation, it is just the lack of enough holiday to use up all the projected tours I have in mind.

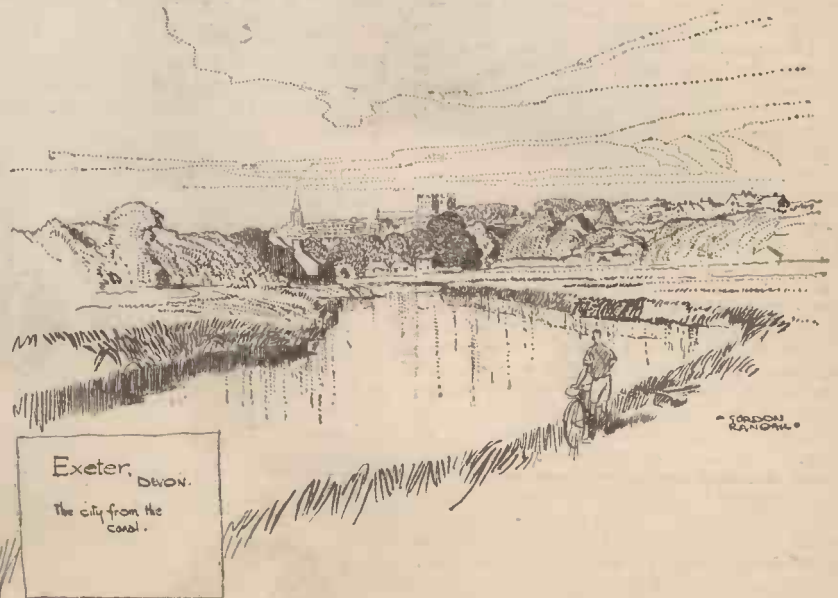

*"No other tyre will really satisfy me now"*

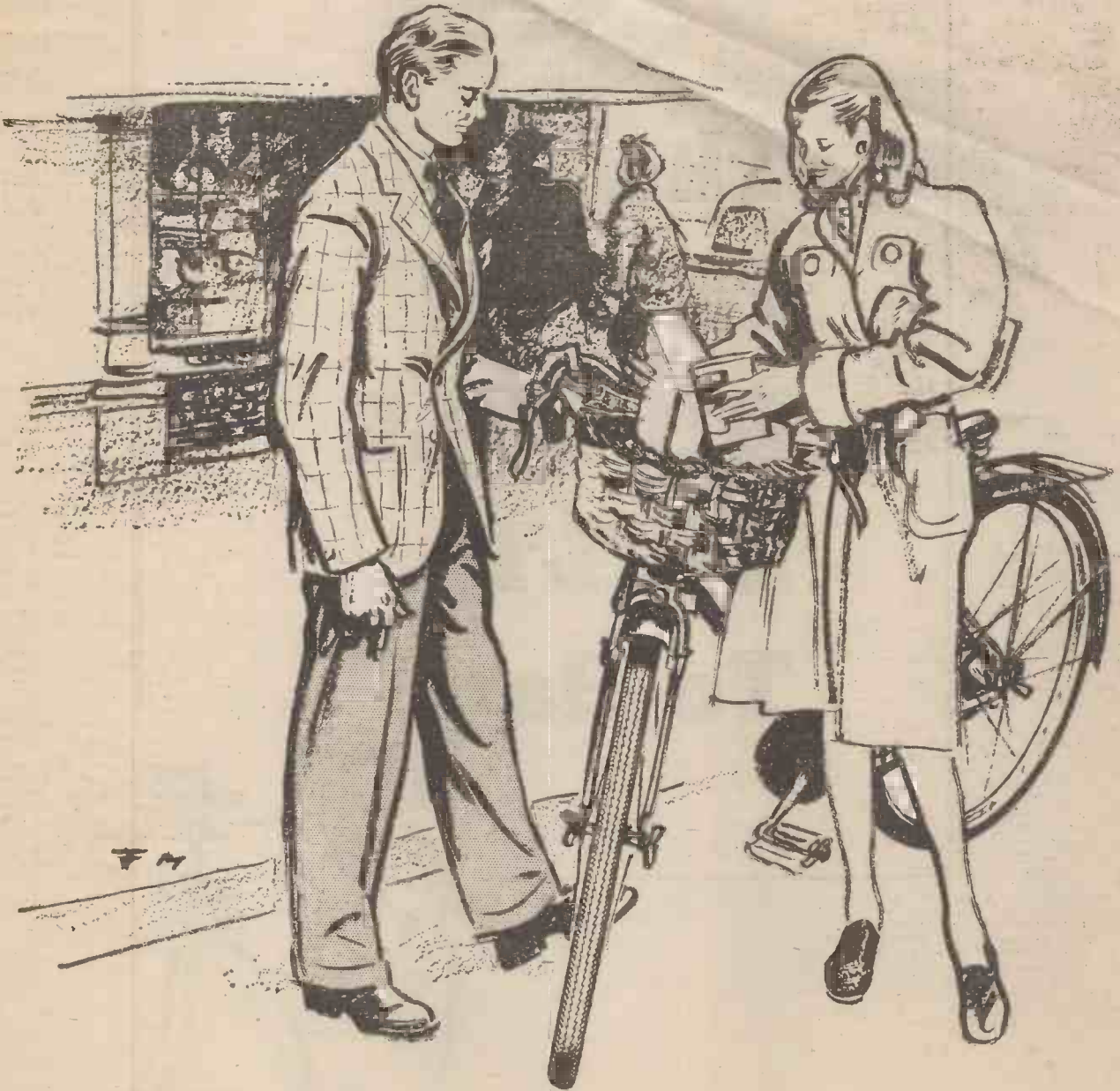

**Firestone**  
BEST TODAY ★ STILL BETTER TOMORROW



**The  
FINEST  
BICYCLE  
BUILT  
To-day**



**Hercules**

THE HERCULES CYCLE & MOTOR CO . LTD . ASTON . BIRMINGHAM

# CYCLORAMA

By  
H. W. ELEY



## DEVIZES.

WILTS.  
The beautiful parish church  
dating from 1110 A.D.

### Suffolk Scene

A GOOD cycling county, this homely Suffolk, where the cattle fatten on the marshes, and the coast towns are full of age-old romance—some of them mere shadows of what they were, but full of interest nevertheless. I rode around ancient Dunwich, once the capital of East Anglia, and heard again of the churches—I believe there are eight of them—now buried 'neath the sea, due to coast erosion. I rode into Southwold, and talked again with hardy old fishermen, who still go out after sole, and plaice, and skate. And I ate pints of shrimps at tea-times, and saw, with sorrow, that the old ferry across the Blyth to fair Walberswick had gone . . . and one now has to cross in a rowing boat. But Walberswick is there, damaged it is true, but still the mecca of artists. And on the way to Beccles I saw a team of those great chestnut Suffolk "punches"—so strong, and so typical of this county of the soft dialect, the Holland-like dykes, and the pleasant towns like Bury St. Edmunds, and Clare, and Long Melford. To the cyclist who yearns for fresh ground, and who knows not Suffolk, I commend it to him. And a good book to read before embarking on the trip is Julian Tennyson's *Suffolk Scene*.

### "Wheels of Fortune"

MANY readers may have read this book by Sir Arthur du Cros, once chairman of Dunlop. It recalls all the exciting, and even romantic, days of the invention of the pneumatic tyre by John Boyd Dunlop, and is a fascinating volume for any cyclist. There is, of course, much ignorance about the earliest

days of the pneumatic tyre, and I suppose that everyone now knows that a Scot named Thomson invented a "pneumatic" about the year 1840 . . . but it was never commercially developed. But having recently re-read du Cros's book, I was much intrigued with the story of that epic cycle race at the Queen's College Sports, in Belfast, in 1889 . . . when the superiority of the pneumatic tyre was first, and forcibly, demonstrated. Good, sometimes, to look back, and reflect on the "birth pangs" of things now familiar and accepted as commonplace!

### Those "Dreadful Cyclists"

ONE so often hears, from the lips of motorists who never were cyclists, general and forceful condemnation of riders of the bike. They "wobble all over the road"; they "shoot out of side roads without warning"; and they "want all the road." Well, in my holiday travels, I observed motorists and cyclists . . . carefully, and of set purpose. I had heard, for instance, that with the increase of cars on the roads, the standard of driving was rather lamentable. And I wanted, too, to see some of these dreadful cyclists. So . . . I rode with eyes open, and mind alert. I did not see *any* dreadful cyclists! True, I saw some pretty poor riding, and I saw some strange tricks by motorists (I will be charitable, and assume that they were novices). But I thought that the general standard was good. The truth is that when a motorist is "anti-cycle" minded, he will indulge in all sorts of wild charges and thoughtless invective. We still need more kindly tolerance on the roads.

### Some Dealers are Smiling

A NEWLY-PAINTED cycle shop . . . a smiling dealer standing at the door . . . a fair stock of new machines in the window! It was a goodly and cheery sight, and made me think that at long last the drear days of austerity are passing. There was even a bright and colourful window-bill exhibited, and I felt that "the Trade" was now getting back to pre-war standards. How one grieved at those empty shops, those windows shorn of all display matter, and those inadequate stocks of tyres and accessories! I suppose that, slowly but surely, we are getting back to days of plenty . . . and the gods be praised.

### Recipe for a Happy Sunday

DESPITE all you have read about flattened fields of corn, and poor harvests, and the woes of the farmers (and in some parts of the country they are very real!), there will still be Harvest Thanksgiving Services . . .

and many a village church will be gay with sheaves of corn, and the kindly fruits of the earth. If it is not too late when you read this article, I advise you to ride out, some Sunday, to a village church . . . when the annual Harvest Festival is held. You will find it good to join in with the men of field and farm, and give thanks for the good things of the land. Farmer Hodge's big field of wheat may not be up to his high hopes, and old Jake Brown's oats may have been a bit damaged by the heavy storms, but "all is safely gathered in" and it is right and logical to give thanks. And to ride out to a village on such an occasion is always good. I did it in Essex last year, and found a new-born realisation of what we owe to the land and its tillers.

### Those Inn Signs

When I wrote recently about curious and uncommon inn signs, I think I requested readers to send me the names of any they discovered on their cycle rides. The other day someone kindly advised me of an inn, the name of which is to me unique . . . "The Pretty Pigs," near Tamworth . . . at Amington, I think. I joyfully add this to my collection, and hope some day to see this inn, and have a pint of ale in its tap-room. But I could do with more names for my collection, and perhaps some readers, when cycling this autumn, will keep eyes open for the unusual and curious sign? England abounds in them, and it is to be hoped that our brewers will never succumb to the drear doctrine of standardisation, and sweep them away. I dread to think that in some village, hard by the green, "The Farmer's Boy" may disappear, to be replaced by a sign stating "Inn No. 167, Area 44."

### The Romantic Bath Road

Of all our great and historic roads, I suppose that the Bath Road holds pride of place in the hearts of most cyclists. It has been the scene of so many epic rides. It is associated with so many famous riders' names and exploits. And it has romance still . . . right from its start. One has only to ride as far as Brentford, or Hounslow, to enter a world of past glory and ancient history. At Brentford, Julius Caesar—in 54 B.C.—crossed the Thames ford, and defeated the forces of the Britons. On Hounslow Heath, such immortal highwaymen as Dick Turpin and Claude Duval played their games with mask and pistol, and relieved coach-travellers of their purses! So near to London, yet so full of romance and the glamour of the past! I always like to think of these things when I set out on this old highway . . . begun by the Romans, and on its long journey to fair Bath, passing through such good old towns and hamlets.

### Lure of October

I like this mellow month of October, when the trees in wood and plantation are all brown, and russet and yellow; when Mother Nature uses autumnal tints on her magic canvas . . . and when the air is crisp, and one may go a-nutting in the coppice where the squirrel lurks, and then skips along the trunk of the great beech tree. And in the inn there is "October Brew" to be had . . . and it was always a belief in my boyhood days that ale brewed in October was the best ale of all! A grand riding month, so . . . out in October, before King Winter takes his throne, and the foliage is gone. . . .



**Bullington Church**  
Sussex.

One of England's smallest churches. A lonely little building surrounded by trees off the main road from West Dean to Alfriston. Only the chancel remains of the original building which was destroyed centuries ago, by fire.

## My Point of View

By "WAYFARER"

### History Re-written

NOW the motor-car has brought the road into its own again. I extract that fragment of re-written history from a very interesting book called "Narrow Boat," by L. T. C. Rolt (1944). I was always told that the bicycle, which preceded the motor-car by many years, did something of the same sort.

### Significant

NOTICE at the municipal boundary of a Black Country place:

**MOTORISTS:  
ROWLEY REGIS.  
THIS IS A SAFETY TOWN.**

Wolverhampton has the same idea in operation, with an added request for careful driving. Evidently, somebody in the Midlands knows something as to the cause of "accidents."

### Seen in Passing

(1) "COFFEE and Cordials, ad." And a very pleasant mixture, too! (2) "Taxi for Hire. Lemonade." The connection is not easy to discover! Or is it?

### The Only Intimation

DURING an early September week-end I paid a courtesy call on a well-known caterer who gave up "feeding the brute" some ten years or so ago. I have not seen her since then. The grown-up daughter announced my approach, whereupon the mother said: "No! It can't be 'Wayfarer.' I remember seeing the announcement of his death in the papers a few months ago." Will friends kindly accept this, the only intimation? Nevertheless, I am bound to say that the announcement in question, if it ever appeared, was grossly exaggerated, like that relating to a much more famous writer. Actually, I am very much alive—and kicking!

### The Co-operative Method

IT must be counted unto cyclists for righteousness that we do believe in co-operation as between ourselves. We seldom, if ever, pass a brother cyclist in distress ("distress," of course, is a relative term) without proffering our aid. Usually, this is not required, but now and again we can help materially by lending a pump or by providing a patch, a spot of rubber solution, a bit of valve tubing, or a chain link. We assist one another in other ways, too—particularly with our knowledge of roads and lanes. Personally, I am very conscious of the way in which I have been aided, especially when moving to Birmingham about 25 years ago. Friends and acquaintances took me in hand and showed me nice lane routes to various places—routes which I use to this day—thus adding very much to my enjoyment of cycling. To say that, of course, is not to suggest that there is no fun in finding your own way about the countryside, but sometimes it is an advantage to be told where and how to go. Yes—we cyclists do display a fine spirit of co-operation, which is all to the good. And most of us are glad to pay back, with interest, the benefits we have received.

The foregoing paragraph, complete in itself, was drafted out just a year ago. It can now be added to. A week or two back, at my usual Sunday rendezvous for tea, I found a mixed party of cyclists whose leader was cogitating over the question of the route home. After a time he came to me and asked whether I would detail to him the quiet way by which I travelled. My reply was: "No! Quite frankly, I can't. It is

too intricate to describe—and you'd never remember the details. But I'll tell you what I'll do, if you like: I'll conduct your party home for you." That proposition suited his book very well, and, after tea, the party "fell in" and moved off—with the usual delays (my most parties display! My route, which has been previously mentioned in these columns, touches main roads only to cross them, and consists of a series of rather tortuous (and lonely) lanes, which are chiefly of good surface. The whole party seemed to enjoy the experience, though I do not think it was long before they were "guessing." When we neared the dispersal point one of the girls told me that she hadn't the faintest idea where she was, although she was quite near her home! From my point of view the journey was a very pleasant one, and it was nice to be able to "do unto others as I have been done by"—if one may slightly corrupt a quotation.

### There's a Trailer . . .

A CONTINUING problem in connection with road usage exists in the use of the elongated type of "Queen Mary" vehicle, and in that of trailers. When I am on a busy highway and hear something heavy about to do the overtaking act, I say to myself: "There's a trailer behind." Sometimes the prophecy is Right or wrong, however, it is a reminder to me to be very strictly on the qui vive, and not to diverge from my course until I am sure that the complete overtaking unit has gone by. Moreover, experience suggests that a further precaution should be taken, in order to provide against the possibility—a very real danger—of the driver pulling in too quickly after he thinks he has passed me. Very few of these drivers seem to realise that it takes a little time for a long outfit whether "Queen Mary" or trailer, to get well clear of a cyclist, and it is therefore no bad plan for the cyclist to slow down, thus making sure that he will not be bowled over by the tail-end of the overtaking vehicle or vehicles. It is no part of a cyclist's duty to take such a precaution, but this little "extra" may make all the difference in the world to the wheelman. Personally, I am devoid of any ambition for a sticky end at the hands of a driver who does not know his business in the matter of careful conduct.

### Colour Craze

WHEN talking to a well-known cycle builder the other day—one of the best (if not the best) of the "small" men—I commented on the absence of black-enamelled bicycles in his shop-window, and I gathered that there is now little demand for sable hues, all the craze being for bright colours. Certainly these bicycles, with their modern finish, look very attractive. They also give an impression, which is sometimes borne out (certainly it is in the case of the "small" man above referred to) of lightness. I have always been strongly in favour of black enamel, but, upon my word, if ever I obtain a new bicycle (not very likely at my time of life), or when I have one of my existing bicycles redecorated, I shall feel tempted to indulge in the colour craze. There may be a mental effect, and it is possible that a brightly-coloured bicycle would make me much less sluggish on hills. You never know! It seems worth trying.

### Just a Word

ONE day recently, when I was passing through suburbia towards a most delectable countryside, where I was intent on spending a few hours a wheel, my eye, ever watchful for anything of interest, caught a house-name on a garden gate. It was just a word: no more. To the non-cyclist it meant nothing: to the travelled cyclist it was full of significance, and it conjured up pictures of distant islands and tumbled seas. The name was "Dunstaffnage," a tiny place near Oban, where once, in the course of a cycle tour, I stayed for the night, obtaining satisfactory accommodation at a small hotel which, if I remember aright, lives right on the sea shore. Anyhow, I recall the delight of lingering there (prior to paying through the nose for using Connel Ferry Bridge!), looking over the Firth of Lorne to Lismore and Mull, revelling in "the sight of salt water unbounded," in the scanty shipping which passed to and fro, and in the sublime pictures of "the everlasting hills." I felt inclined to knock at the door of the house concerned and enquire of the inhabitants how they came by the name, and what measure of romance lay behind it, but I realised that, if I carried this plan to its logical conclusion, I would spend quite a lot of time posing these inquisitive—and apparently idle—questions, always facing the danger of being viewed as a professional stealer of door-mats! Another name which I see regularly on the gate of a nice house in a pleasant country lane, and which I find thought-provoking, is "Falcarragh." It is just a word, but it transports me very quickly to the north-west corner of County Donegal, and I am able to enjoy a mental

panorama of Mulroy Bay, Sheephaven, Horn Head, the Bloody Foreland, Tory Island, and The Rosses. To you, good reader, each of these names may be just a word, as they all were to me before I became a most intensive cycle tourist. Now such names, and a thousand-and-one others, leap into life whenever I come across them. That is the effect they will have on all who "spread their wings" and ride forth, with energy and intelligence, to see something of the glory contained within these islands of ours. And how interesting they help to make life afterwards!

So, with the aid of house-names and that of (say) the obituary column of *The Times* (what an unexpected source of inspiration!), we may obtain reminders of the places we have visited as cycle-tourists, and be instantly transported to Thaxted, or Arrochar, or Wensleydale, or Berwyn, or Ranworth, or Hilbre, or Glencoe. Just words! But what words!

### "Never at War"

A FRIENDLY inn-keeper told me the other day that one of his customers had said that he likes staying at that particular inn because it had never been at war, the food and general conditions being in the pre-war class. I suppose that we could all mention places which passed the war over—save, perhaps, in respect of a not-too-carefully observed black-out, when black-outs were in the fashion! I know such places, anyhow, though they are not for mention in a public print—places where the food supplies were (and are) as good, and as plentiful, as before the war.

### The Way of Instinct

A MAN who came to see me the other evening, and who knew me to be—shall we say?—well-disposed towards the bicycle and all that the bicycle connotes, turned the conversation into cycling channels. After a while he asked: "And what about the ticker?" and he placed his hand where he thought his heart was, or ought to be. "As to that," I replied, "I cycle by instinct. I never ride to anywhere in the neighbourhood of exhaustion. I avoid straining myself, especially in the climbing of hills. My eating and sleeping apparatus are in perfect condition. I ride with my mouth shut. I am never tired. You, I imagine," I added, "are only about half my age. Go and do likewise, and thus get the best out of a pastime which is suitable for most people, of both sexes, and of every age."

### What a Price!

IT is to be presumed that a recent road "accident" in which eight lives were lost will create a new demand for the abolition of all level-crossings. Will somebody tell me how much the process would cost, and who would have to foot the bill? Further, is it not possible that the remedy for accidents at level-crossings, caused by (say) a motor-coach crashing through the closed gates in broad daylight and then having an argument with a train, should not be sought elsewhere—and cured by some different and less expensive method? Certainly these crossings are a nuisance, especially in an impatient age, but it seems to me that the price of saving a few minutes, especially in the case of people who have no use for them, may be inordinately high.

### Don't

IF this should catch the eye of any motorist, may I ask that he, or they, and others of his class, should refrain from pitying the "poor" cyclist encountered along the road. We do not seek sympathy or commiseration from our big brothers of the wheel. We indulge in cycling because we believe it to be, in very truth, the best-ever pastime. We know that we obtain through cycling gifts and benefits which can be secured in no other way—"glittering prizes" whose value is beyond computation. We go into the game with our eyes wide open, being well aware that, occasionally, we have to "chew acid" and "take a basinful," but the bicycle bestows upon us tremendous advantages which are quite out of proportion to the price we pay in discomfort arising from heavy rain or the hurt resulting from head-winds. We would not be cyclists if we did not enjoy the game, with all its high lights and vicissitudes.

### Resurgence

IT is an encouraging sign of the times that new "tea" (and occasionally "lunch") notices are making their appearance in country places. In the course of the last two months, during which I have cycled more vigorously, in all probability, than ever before, I have come across quite a number of these welcome announcements. Let 'em all come! The war, of course, knocked the catering business sideways, and we have a very long way to go before the number of rest and guest houses approximates to the 1939 total. It is to be hoped, however, that all the good ones will return as soon as circumstances are favourable.

### Whom to Blame?

THE ingenuity displayed by certain motorists in finding a scapegoat for the accidents in which they are involved is amazing. It was well exemplified recently by an anonymous letter-writer, who strained our credulity by suggesting that he was so busy avoiding pot-holes that it was difficult for him to miss hitting pedestrians! Of course, the statement is entirely untrue, though it seems worth while to remember it in conjunction with the equally specious excuses of "rain on the windscreen" and "a dark night." The search for scapegoats will doubtless continue. Personally, I cannot help thinking that a policy of wise and courteous conduct, on the part of everybody, without any exceptions, and a readiness to accept responsibility for accidents, should they happen (and they are not an essential part of the scheme of things), is the one to be preferred.

## Which Professional Qualification for You!

Government and Industry urge you and others like you to train for the highest post-war technical posts within your capacity. Write to-day for "The Engineers' Guide to Success"—free—and use the FIRST PLACE COURSES of the T.I.G.B. to attain the engineering knowledge and qualifications necessary to success.

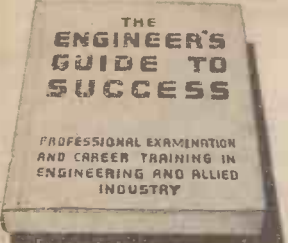

The Technological Institute of Great Britain,  
213, Temple Bar House, London, E.C.4

## FOR THE MUSIC LOVER AND HOME CONSTRUCTOR

Superbly realistic reproduction of RADIO and RECORDS can now be obtained from home constructed Amplifiers and Radio Tuning Unit. The Thrilling Realism of the Concert Hall is achieved by the latest up-to-the-minute developments including CATHODE FOLLOWER OUTPUT STAGES and a unique non-distorting Tone Control Network with separate control of Bass and Treble. Full circuit details of 7 watt and 3 watt Amplifiers and a High Fidelity Radio Tuning Unit including full size point to point wiring diagram are now available. All components including ready drilled chassis are in stock and for a few hours work you can have a reproducer which for Fidelity of Reproduction excels anything previously available. The full drawings are 2/6 each or 5/- the set of three. Stamp for details and price lists of many interesting items.

**CHARLES AMPLIFIERS,**  
14 LAFITONE GARDENS, KENTON, BARROW, MIDDLESEX.

Toy, Model and Pattern Makers,  
Sign, Letter and Cabinet Makers.

## BUILD YOUR OWN MONEY MAKING MACHINES

easily from readily obtainable parts and Materials ONLY at remarkably low cost.

Set of clear diagrams and instructions for building:

- (1) Power-driven FRET-JIG SAW (Table Model). Uses Coping Saw. Will cut Wood, Leather, Plastics, etc., etc. Price 3/6 a set.
- (2) Toy or Model Maker's LATHE. Alternative types of easily made Headstock, chuck, etc., included. Price 3/6 a set.

Posted promptly.  
**P. M. Barham, Les Bultes, Torteval, Guernsey, C.I.**  
(Parts stocked)

**ELECTRIC ENGRAVERS.**—Powerful instruments in cylindrical case, on stand with spring attachment and switch. Suitable for dog collars, tool marking, etc. 4-6 volt model, price 55/-; A.C. Mains model, 200-240 volts, 75/-, postage 1/-.

**TELEPHONE SETS,** comprising 2 G.P.O. hand phones, 2 bells, 2 pushers and 80ft. twin wire. Price 65/-, post free. Single instrument, 25/6.

**WIRELESS HEADPHONES,** 12/6 pr. **BATTERY CHARGERS FOR A.C. MAINS.** FOR CHARGING 2-volt accumulators at 1 amp. Parts with diagram. 12/6. Complete, 21/6. Postage 10d.

**FOR TRICKLE CHARGING CAR CELLS,** parts with diagram. Output 11 amps. for 6v. cells, 30/- set. For 12v. cells 32/6 set. 6v. 6-3 amp. set, 55/10.

**SWITCHBOARD METERS, A.C.-D.C.** N.P. cases, 11" dial. Any readings up to 0-25 volts, 0-25 amps. Price 15/6 each.

**HOAT MOTORS,** low centre, wound field, high-speed, weight 18oz. Size 5in. x 1 1/2in. x 2in. Well made—No Rubbish. Price 26/-, post paid.

**ECONOMIC ELECTRIC CO.,**  
64, London Road, Twickenham, Middlesex. Tel.: POPesgrove 1318.

# Varley

40 YEARS RELIABLE SERVICE TO THE INDUSTRY

**POWER CHOKES TRANSFORMERS WIRE WOUND RESISTANCES DELAY SWITCHES**

MADE BY **OLIVER PELL CONTROL LTD**  
CAMBRIDGE ROW, WOOLWICH, S.E. 18  
TELEPHONE: WOOLWICH 1422

## SMALL TOOLS

DRILLS, REAMERS, LATHE TOOLS, MICROMETERS, ETC. **EVERYTHING for the ENGINEER-MECHANIC** BENCH MILLERS, LATHES, BENCH DRILLS, ELECTRIC MOTORS A.C. and D.C. (Send 4½d. for Lists)

**SPECIAL LINE:** 6-way Leather Punches 7s. 0d. each. Plus 1s. 0d. postage and packing.

**NUTTALL'S (LATHES) LIMITED, MANSFIELD, NOTTS.**



**EASILY MADE FROM OUR CASTINGS. J. HALLAM & SON UPTON, POOLE, DORSET. MINIATURE PETROL ENGINES for Aeroplanes and Speed Boats.**  
Send 3d. for new list.

**BOOKS.** Postage 1d. extra.  
A.B.C., L.M.S. or L.N.E.R., each ... 2/-  
A.B.C., G.W.R. or S.R., each ... 1/6  
G.W.R., L.N.E.R., S.R., Titans, each ... 1/6  
"TILED TRAINS OF GREAT BRITAIN" ... 6/-  
By Post, 6d. extra.

**ROLLING STOCK.** Gauge 0. True Scale. **BLACK BAKELITE WITH DISC WHEELS:** 3 LINK COUPLINGS, LETTERED L.M.S., L.N.E.R., G.W.R., S.R. ... 12/6  
12 Ton Goods Van ... 15/9  
Postage, 4d. extra.

**TYLDESLEY & HOLBROOK**  
109, DEANSGATE, MANCHESTER, 3.

## SHORTHAND

**DUTTON'S ONE-WEEK SHORTHAND** is used by over 60,000 men and women. Accepted by Services and examining bodies. Test Lesson 3d. Write Dept. P.M., 93 Great Russell St., London, W.C.1.

## IN ONE WEEK

You'll be glad you kept on saving when you can again buy an

# ADANA

Adana Printing Machines, Ltd., TWICKENHAM, MIDDLESEX

## I WILL MAKE YOU A BRILLIANT PIANIST



**THE WORLD'S GREATEST BOOKSHOP**

**FOYLES**  
FOR BOOKS  
New and secondhand Books on every subject  
—BOOKS BOUGHT—  
119-125, CHARING CROSS ROAD, LONDON, W.C.1  
Gerrard 5660 (16 lines). Open 9-6 (inc. Sat.)

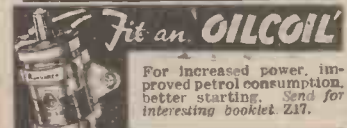

**RUNBAKEN, MANCHESTER 1**  
COMMUNICATION BY RADIO (Licence Permitting)  
Supplies are now available of the famous Walkie Talkie Transmitter/Receiver Stations as used by H.M. Forces. This gear originally cost over £100 to manufacture, we can supply the complete station at the amazingly low price of £15 15s., plus 10/- carriage. Note: The sets and accessories are absolutely brand new and actually in the same carton as they left the manufacturer.

- 1. Transmitter/Receiver Set.
  - 2. Vibratory Power Pack for same.
  - 3. Headphones and Microphone (2 sets).
  - 4. Telescope and Rod Aerials.
  - 5. Accumulators and connecting leads, etc.
  - 6. Complete set of spare valves, etc.
- VALVE SUPPLY CO.**  
25, Oldfield Circus, Whitton Avenue, Greenford, Middx.

## SPARKS' DATA SHEETS

Provide full constructional details, theoretical diagram, component list, and full-size black and white prints of Tested and Guaranteed Designs. **LATEST RELEASE**

**ALL-DRY PORTABLE No. LO/8.** M/L Waves. 3 Valves. Self-contained frame aerial. Speaker and Batteries. This design supersedes the famous LO/8 the most popular Portable design ever published. Complete Data Sheet ... 2/6

**A.C. 3-WAVE 3-VALVE SUPERHET (No. L.O./11).** S., M. and Long-waves. Simple to construct. ... 2/6

**COMPACT TWO-VALVER (Batt.) No. L.O./12.** Medium and Long-waves. Powerful sigs. - Coll available. ... 2/6

**A.C./D.C. MIDGET PORTABLE (No. L/U.M.).** Self-contained Medium and Long-wave aerial and Speaker. Three valves plus Rect. ... 2/6

**THREE-VALVE S.W. RECEIVER (Batt.) No. L.O./7.** H.F. Stago. Band-spreading. H.P. and L.F. volume-controls. A.D.X. set. ... 2/6

**MIDGET 3-VALVE PORTABLE.** All-dry batt. M/L waves. By H.T. ... 2/6

**MIDGET TWO-VALVER.** All-dry batt. Med. wave. 9v. H.T. ... 2/6

**COMPACT STRAIGHT 3 SET (Batt.).** Med. waves. Good vol. ... 2/6

**THREE-VALVE T.R.F. SET.** Batt. M/L waves (No. L.O./4). A fine set ... 2/6

**A.C. THREE-VALVER (No. L.O./9).** M/L waves. 31 watts output. Quality 2/6

**FOUR-VALVE T.R.F. SET (No. L.O./8).** M/L waves. P.P. output. Power and quality. Batt. operation. P.U. ... 2/6

**A.C. 8 WATT AMPLIFIER.** Neg. feedback. P.P. output ... 2/6

**A.C./D.C. PORTABLE AMPLIFIER.** 6 to 8 watts output ... 3/6

**A.C. QUALITY RADIOGRAM.** Designed for quality rather than range. Med. waves. 8 watts. P.P. output ... 3/6

**RADIO UNIT.** Two valves for use with A.C. or A.C./D.C. amplifiers ... 2/6

**A.C. QUALITY 2-VALVER.** M/L waves. A most popular set ... 2/6

**3 WATT AMPLIFIER.** ... 2/6

**TWO-VALVE AMPLIFIER (Batt.).** Pentode output. Fine vol. ... 2/6

**THREE-VALVE ditto with push-pull output.** Ideal for P.U. ... 2/6

**SUPER S.W. TWO-VALVER (Batt.).** A popular well tested Rx ... 2/6

Many other Data Sheet designs available.

**COILS.**—Matched Pairs of my High Efficiency Dual-Range T.R.F. Coils, with diagram, 9/9 per pair.  
Please send stamp with order and for List.  
**L. ORMOND SPARKS (M),**  
9, Phoebe Road, Brockley, S.E.4 (Ladywell S.R. Station) (Lee Green 0220)

## RATCHET & REVOLUTION COUNTERS

Ask for Leaflet No. 18/4  
Speed up to 6,000 r.p.m.  
**B. & F. CARTER**  
& Co. Ltd., Bolton 5

## LEARN LEATHERCRAFT

(Complete Beginners Outfit. 40/-)  
Rotary Six-Way Punch—Leather Pieces for Purse—Cig. Cases—Wallets, etc., Press Studs and Press Stud Fixing Tools. Thonging—Spec. Leather Knife, Fixative—Fancy Fittings, etc.

Cash Refunded if not completely Satisfied.

## "CLAYTON LEATHERCRAFTS"

(DEPT. 146 P.M.),  
**SUTTON-IN-ASHFIELD, NOTTS.**

Six-Way Rotary Punches, 10/- Post Free.

**BUILD AN A.C./D.C. Superhet.** Radio giving exceptionally good performance and tone, £10 (inc. very attractive figured walnut cabinet). Extensive drawings, photographs and detailed instructions to enable veriest novice to build a professional set. Postal help with greatest pleasure. Money back written guarantee if you fail.—J. Morgan, 184, Whyteleafe Road, Caterham, Surrey.

**NEW 4-valve radio sets** in very smart highly french polished cabinets. A.C. 8½ gns. A.C.-D.C. 9 gns.—Dumville, 66, Parkhill Road, London, N.W.3. Tel.: GUL 1453.  
**12in. POWER BENCH BANDSAWS.** Make your own. Send 10/6 for working prints and photograph. Sound, simple design.—Rawlinson (PM), 34, Cაცყwa Road, Whitechurch, Cardiff.  
**NEW MACHINERY.** Electric Motors, Band Saws, Drilling Machines, Pumps, Grinders, Welders, etc.—John P. Steel, Bingley.

# Free Guide - "Success in Engineering"

One of the following Courses taken at home in your spare time can definitely be the means of securing substantial promotion in your present calling, or entry into a more congenial career with better prospects.

## ENGINEERING, AERO, ETC.

Plastics—Radio—Aero Engines—Aircraft Design—Welding—Aerodynamics—Electrical Engineering—Television—Electric Wiring—Talking Picture Work—Generation and Supply—Works Management—Metallurgy—Refrigeration—Planning, Estimating, Rate-fixing—Time and Motion Study—Aero Inspection—Automobile Engineering—Sheet-metal Work—Engineering Draughtsmanship—Aero Draughtsmanship—Jig and Tool Draughtsmanship—Press Tool and Die Draughtsmanship—Structural or R/F Concrete Draughtsmanship—Sanitary Engineering.

## GENERAL

Matriculation—College of Preceptors—Chartered Institute of Secretaries—Aircraft Apprentice.

## MUNICIPAL SERVICE

School Attendance Officer—Handicraft Teacher—Registrar—Housing Manager—Sanitary Inspector—Weights and Measures Inspector—Inst. of Mun. and Cy. Engineers—P.A.S.I.

## "PRACTICAL ENGINEERING" said—

We recommend all readers interested in improving their position to apply for a copy of this valuable Book. "Success in Engineering" is not a pamphlet. It is a 132-page book, containing valuable and vital information on all branches of engineering. . . . There are many engaged in engineering who owe their success to The National Institute of Engineering.

The FREE GUIDE explains:

- Openings, prospects, salaries, etc., in Draughtsmanship, Inspection, and opportunities in all other branches of Engineering and Building.
- How to obtain money-making technical qualifications through special RAPID FULLY-GUARANTEED COURSES.

Write now for your copy of this remarkable publication.

A.M.I.E.E., A.M.I.Mech.E.,  
A.M.Brit.I.R.E., A.M.I.P.E.,  
A.M.I.C.E., A.M.I.Struct.E.,  
A.M.I.A.E., A.F.R.Ae.S.,  
A.M.I.S.E., M.R.San.I.,  
London B.Sc., Degrees.

Fully guaranteed postal courses for all the above and many other examinations. Fully described in the Free Guide.



## THE BUILDING BOOM— SECURE YOUR SHARE!

The Free Guide also gives particulars of our extensive range of modern Building and Structural Courses, Building Draughtsmanship, etc. The great post-war Building programme offers unlimited prospects to technically trained men.

## BECOME A DRAUGHTSMAN QUALIFY AT HOME AND EARN BIG MONEY

Men and Youths urgently wanted for well paid positions as Draughtsmen, Inspectors, etc., in Aero, Jig and Tool, Press Tool, Electrical, Mechanical and other Branches of Engineering. Practical experience is unnecessary for those who are willing to learn—our Guaranteed "Home Study" courses will get you in. Those already engaged in the General Drawing Office should study some specialised Branch such as Jig and Tool or Press Tool Work and so considerably increase their scope and earning capacity.



## THE ACID TEST OF TUTORIAL EFFICIENCY SUCCESS—OR NO FEE

We definitely guarantee that if you fail to pass the examination for which you are preparing under our guidance, or if you are not satisfied in every way with our tutorial service—then your Tuition Fee will be returned in full and without question. This is surely the acid test of tutorial efficiency.

If you have ambition you must investigate the Tutorial and Employment services we are able to offer. Founded in 1885, our success record is unapproachable.

Why not fill in and post the attached coupon NOW for further details and Free Authoritative Guide to openings in Engineering and Building? This book contains a mine of valuable and exclusive information and may well prove to be the turning point in your career.

PROMPT TUTORIAL SERVICE GUARANTEED.

## FREE COUPON

To NATIONAL INSTITUTE OF ENGINEERING  
(Dept. 29), 148, Holborn, London, E.C.1.

Please forward your FREE Guide to

NAME .....

ADDRESS .....

My general interest is in: (1) ENGINEERING (Place a cross against the branches in which you are interested.)  
(2) AERO (3) RADIO (4) BUILDING  
(5) MUNICIPAL WORK

The subject or examination in which I am especially interested is

To be filled in where you already have a special preference.  
(rd. stamp only required if unsealed envelope used)

## NATIONAL INSTITUTE OF ENGINEERING

(Dept. 29)

148, HOLBORN, LONDON, E.C.1

OVER SIXTY YEARS OF  
CONTINUOUS SUCCESS

SOUTH AFRICAN BRANCH: E.C.S.A., P.O. BOX 8417 JOHANNESBURG.

FOUNDED 1885—FOREMOST TODAY—OVER 100,000 SUCCESSES

## "Practical Mechanics" Advice Bureau. COUPON

This coupon is available until October 31st, 1946, and must be attached to all letters containing queries, together with 3 penny stamps. A stamped, addressed envelope must also be enclosed.

Practical Mechanics

October, 1946.

Published about the 30th of each month by GEORGE NEWNES, LIMITED, Tower House, Southampton Street, Strand, London, W.C.2, and Printed in England by W. Spearight & Sons, Ltd., Exmoor Street, London, W.10. Sole Agents for Australia and New Zealand—Gordon & Gotch (Asia), Ltd. Sole Agents for South Africa—Central News Agency, Ltd. Subscription Rates (including postage): Inland, 10s. 6d. per annum. Abroad, 10s. per annum. Canada, 10s. per annum. Registered at the G.P.O. for transmission by Canadian Magazine Post.

CONDITIONS OF SALE AND SUPPLY: This periodical is sold subject to the following conditions, namely, that it shall not, without the written consent of the publishers first given, be lent, re-sold, hired out or otherwise disposed of by way of Trade except at the full retail price of 9d.; and that it shall not be lent, re-sold, hired out or otherwise disposed of in a mutilated condition or in any unauthorised cover by way of Trade; or affixed to or as part of any publication or advertising, literary or pictorial matter whatsoever.