

# HOW THE TOTE WORKS

NEWNES

# PRACTICAL MECHANICS

MAY 1939

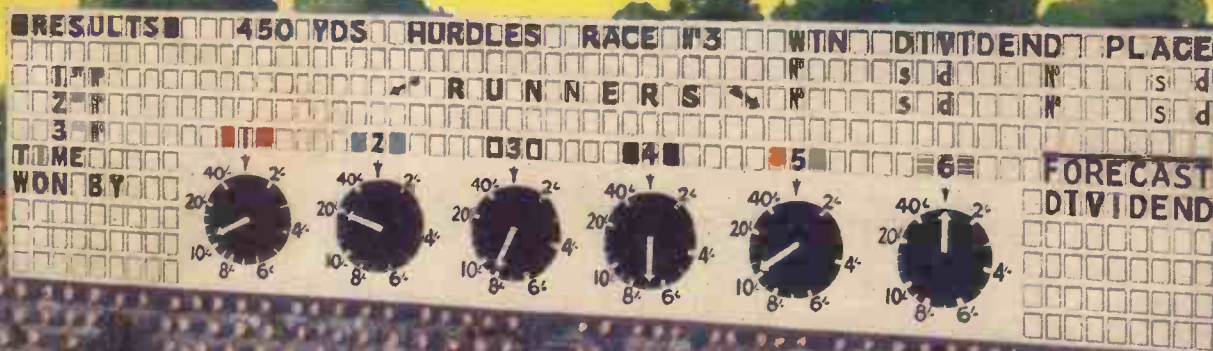

6!





LET ME HELP  
YOU  
INTO A KEY  
POSITION

DO ANY OF THESE SUBJECTS INTEREST YOU?



Accountancy Examinations  
Advertising and Sales Management  
Agriculture  
A.M.I. Fire E. Examinations  
Applied Mechanics  
Army Certificates  
Auctioneers and Estate Agents  
Aviation Engineering  
Banking  
Boilers  
Book-keeping, Accountancy and Modern Business Methods  
B.Sc. (Eng.)  
Building, Architecture, and Clerk of Works  
Builders' Quantities  
Cambridge Senior School Certificate  
Civil Engineering  
Civil Service  
All Commercial Subjects  
Commercial Art  
Concrete and Structural Engineering  
Draughtsmanship. All branches

Engineering. All branches, subjects and examinations  
General Education  
G.P.O. Enk. Dept.  
Heating and Ventilating  
Industrial Chemistry  
Institute of Housing  
Insurance  
Journalism  
Mathematics  
Matriculation  
Metallurgy  
Mining. All subjects  
Mining, Electrical Engineering  
Motor Engineering  
Motor Trade  
Municipal and County Engineer  
Naval Architecture  
Novel Writing  
Pattern Making  
Play Writing  
Police, Special Course  
Preceptors, College of

Press Tool Work  
Pumps and Pumping Machinery  
Radio Communication  
Radio Service Engineering  
Road Making and Maintenance  
Salesmanship, I.S.M.A.  
Sanitation  
School Attendance Officer  
Secretarial Exams.  
Sheet Metal Work  
Shipbuilding  
Shorthand (Pitman's)  
Short Story Writing  
Speaking in Public  
Structural Engineering  
Surveying  
Teachers of Handicrafts  
Telephony and Telegraphy  
Transport Inst. Exams.  
Weights and Measures Inspector  
Welding  
Wireless Telegraphy and Telephony  
Works Managers



If you do not see your own requirements above, write to us on any subject. Full particulars free.

STUDY AT HOME IN  
YOUR SPARE TIME

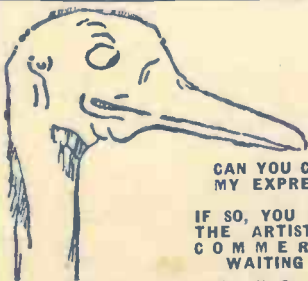

CAN YOU CHANGE  
MY EXPRESSION?

IF SO, YOU MAY BE  
THE ARTIST THAT  
COMMERCE IS  
WAITING FOR

*Jim Duck*

Just try it for yourself.  
Trace or draw the outline  
and then put in the features.

There are hundreds of openings in connection with Humorous Papers, Advertisement Drawing, Posters, Calendars, Catalogues, Textile, Designs, Book Illustrations, etc.

60 per cent. of Commercial Art Work is done by "Free Lance Artists" who do their work at home and sell it to the highest bidders. Many Commercial Artists draw "retaining fees" from various sources, others prefer to work full-time employment or partnership arrangement. We teach you not only how to draw what is wanted, but how to make buyers want what you draw. Many of our students who originally took up Commercial Art as a hobby have since turned it into a full-time paying profession with studio and staff of assistant artists; there is no limit to the possibilities. Let us send full particulars for a FREE TRIAL and details of our course for your inspection. You will be under no obligation whatever.

*Jim Duck* ART DEPT. 76.

YOU CANNOT MAKE MONEY  
BY SAVING

If you save 10s. per week for 10 years you have only got £260, but if you spend 2s. 6d. per week for 12 or 18 months on a correspondence course, you give your brains a chance to earn thousands of pounds; then there is no need to save.

Savings are likely to vanish, but earning capacity is a permanent investment.

I HAVE HELPED THOUSANDS  
OF OTHERS

And when I say thousands, I do not exaggerate, as I can produce well over 10,000 unsolicited testimonials from grateful students who, through our Postal Training, have achieved their life's ambition.

*J. Bennett*



Dept. 76, THE BENNETT COLLEGE, SHEFFIELD

EVERY DEPARTMENT IS A  
COMPLETE COLLEGE: EVERY  
STUDENT IS A CLASS TO  
HIMSELF

JOURNALISM  
Short Story, Novel and Play  
Writing

There is money and pleasure in Journalism and in Story Writing. No apprenticeship, no pupillage, no examinations, no outfit necessary. Writing for newspapers, novels or pictures is not a gift; it is a science that can be acquired by diligent application and proper guidance. It is the most fascinating way of making part-time profitable. Trained ability only is required; we do the training by post. Let us tell you all about it.

DEPARTMENT OF LITERATURE 76

If you attend to this now, it may make a wonderful difference to your future.

COUPON—

CUT THIS OUT



To Dept. 76, THE BENNETT COLLEGE LTD., SHEFFIELD  
Please send me (free of charge)

Particulars of.....  
Your private advice about  
(Cross out line which does not apply)

.....  
.....  
.....

PLEASE WRITE IN BLOCK LETTERS

Name.....

Address.....

.....  
.....



During spring-cleaning young Mrs. Wings "Dumped" a pile of old pots, pans and things; But her husband cried, "Here! With some FLUXITE, my dear, They'd be good for a dozen more Springs!"

See that FLUXITE is always by you—in the house—garage—workshop—wherever speedy soldering is needed. Used for 30 years in government

works and by leading engineers and manufacturers. Of ironmongers—in tins, 4d., 8d., 1/4 and 2/6. Ask to see the FLUXITE SMALL-SPACE SOLDERING SET—compact but substantial—complete with full instructions, 7/6. Write for Free Book on the ART OF "SOFT" SOLDERING and ask for Leaflet on CASE-HARDENING STEEL and TEMPERING TOOLS with FLUXITE.

TO CYCLISTS! Your wheels will NOT keep round and true unless the spokes are tied with fine wire at the crossings and SOLDERED. This makes a much stronger wheel. It's simple—with FLUXITE—but IMPORTANT.

### THE FLUXITE GUN

is always ready to put Fluxite on the soldering job instantly. A little pressure places the right quantity on the right spot and one charging lasts for ages. Price 1/6, or filled 2/6.



ALL MECHANICS WILL HAVE

# FLUXITE

IT SIMPLIFIES ALL SOLDERING

FLUXITE Ltd., Dept. P.M., Dragon Works, Bermondsey St., S.E.1

## There's Room on your Bench for

- ★ 3½" Parallel Vice.
- ★ ¼" to 2" Pipe Vice.
- ★ Tube, Rod and Strip Bender.
- ★ Screwing Machine (up to ¾" Whit., ½" Gas or 1" Conduit.)
- ★ Cable, Rod and Pin Cutter.
- ★ Cable Stripper.
- ★ Flat and Conical Anvils.
- ★ Punching Machine.

The D.L.P. Vice-Screwing Machine combines the functions of all the above, and gives results at least as good as the separate tools. Space required is only 12" x 18".

PRICE  
£5.17.6



Patent No. 418,829

May be obtained through your local Tool Merchant

Sole Distributors for the British Isles:—

BUCK & HICKMAN LTD., 2, Whitechapel Road, E.1.  
Overseas Enquiries to DeLaPre Components Ltd., Northampton.

52-17A

## These Trade Books

Compiled by Experts for Home Study in the Winter Evenings  
Will Increase Your Trade Value in the Market

### ELECTRICITY

**THE ELECTRICAL EDUCATOR**, edited by SIR AMBROSE FLEMING, M.A., D.Sc., F.R.S.: with Contributions from the greatest Living Authorities. Comprises complete Courses of Study on Electrical development, Magnetism, Electrical Instruments, Drawing for Electrical Engineers, Photo-Telegraphy, Electrical Calculations, Electrical Salesmanship, Telegraphy, Telephony, Television, Wireless Telegraphy, etc. This work is of priceless value to the mechanic who cannot study in class, enabling him to educate himself in any special branch of electrical work, without leaving his fireside, during the winter evenings. In addition, this "Educator" includes all information up-to-date as to examinations for certificates in the various branches of the electrical trades. Thus it has an added usefulness for all students preparing to sit for examinations. *The man who succeeds is the man who has the best information.* The mechanic who has any interest in electricity and who sets himself to master one or more of these educative Sections increases his value in the wages market.

### ENGINEERING

**THE ENGINEERING EDUCATOR**, New Edition, Enlarged and Revised Up-to-date, edited by W. J. KEARTON, N.Eng., A.M.I.Mech.E., A.M.Inst., M.A., and written with Authority in Every Department. **THE ENGINEERING EDUCATOR**, written by men accustomed to teach this difficult technical knowledge, supplies that sound theoretical information which the practical man knows must *foundation* his practical working experience. Here are complete Courses of Study on Mathematics, Mechanics, Metallurgy, etc., for men entering into any branch of the engineering or allied trades. Here, also, are the outlines of Automobile and of Locomotive Engineering; and all about Steam Plants, Pattern Making and Moulding, Power, Lubrication, Specifications, Drawing Office Practice, Patents and the training of mechanical engineers—the thousand and one subjects linked up with the engineering trades up-to-date. There is nothing scrappy or incomplete about these valuable treatises.

### OUR FREE PAMPHLETS

Send for One or Both of These To-day

For the Electrical Educator

THE NEW ERA PUBLISHING CO., LTD., 12-14 Newton Street, High Holborn, LONDON, W.C.2.

Send me, free of charge or obligation to order anything, pamphlet on THE ELECTRICAL EDUCATOR, with terms of easy payments while I am using the Work.

NAME.....  
ADDRESS.....  
Date..... P.M.120

For the Engineering Educator

THE NEW ERA PUBLISHING CO., LTD., 12-14 Newton Street, High Holborn, LONDON, W.C.2.

Send me, free of cost or obligation, descriptive booklet on THE ENGINEERING EDUCATOR, with your offer to send the Work for a small first Payment if I decide to order it.

NAME.....  
ADDRESS.....  
Date..... P.M.120

GREAT NEW PRACTICAL PART WORK

# MOTOR REPAIR *and* OVERHAULING

**FIRST PARTS**  
*Now on Sale*

**T**HIS authoritative new part work is absolutely essential to Garage Proprietors and Mechanics, to service men and motor engineers—and all who have a practical interest in mechanical transport. Providing in convenient form all the time-saving repair methods applicable to the leading makes of cars and motor vehicles, it ensures that every job taken in will be carried out expeditiously and to the satisfaction of the customer! It is no exaggeration to say that MOTOR REPAIR AND OVERHAULING will quickly prove itself worth its weight in gold as a garage standard reference work.

**1/2 WEEKLY PARTS**

TO BE COMPLETED IN ABOUT 36 WEEKLY PARTS

## MOTOR REPAIR *and* OVERHAULING

WRITTEN BY EXPERTS  
INDISPENSABLE TO MOTOR ENGINEERS, MOTOR MECHANICS  
AND OWNERS OF GARAGES AND SERVICE STATIONS

**PRICE 1/-**

**PART 1**

A COMPREHENSIVE AND PRACTICAL GUIDE FOR REPAIR MEN AND GARAGE PROPRIETORS

DEALING WITH UP-TO-DATE REPAIR METHODS AND EQUIPMENT FOR ALL THE CHIEF MAKES OF CARS AND COMMERCIAL VEHICLES

(INCLUDING COMPRESSION-IGNITION TYPE ENGINES)

**Turns GARAGE MAN into MANAGER**

GEORGE NEWNES LIMITED

Men in the motor industry value efficiency above all else, and this great new work assures expert maintenance knowledge for no fewer than 200 models.

To be completed in 4 Volumes:

- Vol. 1. Standard Motor Components and Repair Methods.
- Vol. 2. Engine, Clutch and Gear Box Units.
- Vol. 3. Body, Chassis and Frame Repair.
- Vol. 4. Electrical and Accessory Equipment.

Written by highly skilled engineers and mechanics. Illustrated by clear photographs of actual service operations, with many useful charts and tables.

OVER 1,500 ILLUSTRATIONS

**GET YOUR COPIES TO-DAY**

OF ALL NEWSAGENTS AND BOOKSTALLS

2

*Invaluable Charts Presented With*  
**PART 1**

**DAIMLER 15 h.p. QUICK CHECK-OVER DATA SHEET**

Make	Model	Year	Engine	Transmission	Drive	Weight	Capacity	Speed	Range	Consumption	Notes
Daimler	15 h.p.										

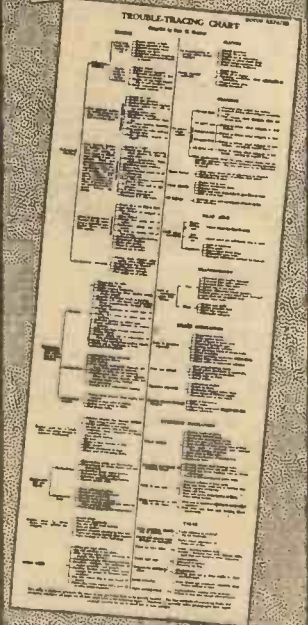

These are a QUICK CHECK-OVER DATA SHEET and a TROUBLE-TRACING CHART for car and components. Every part throughout the work will include a Quick Check-Over Data Sheet. In this way over 200 models will be dealt with.

# Wizard

TRADE MARK

## Power Tools

### Combination Belt and Disc Sander

This useful tool should be a part of the equipment of every workshop. It will save many hours of hard work in producing beautiful, smooth and straight surfaces.

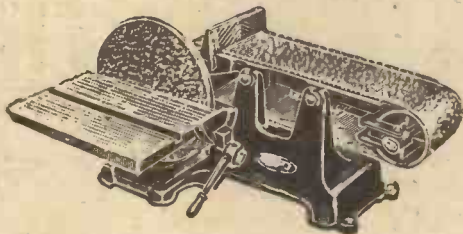

Price £5 3 6

Write for illustrated priced Catalogue No. 137C.

**WIZARD MACHINERY CO.**  
13 VICTORIA STREET, LONDON, S.W.1

Telephone  
ABBEY 3018

PRO PAT.

## MAKE IT WITH UNIT 'X'

*in Wood or Metal*

Turns, Drills, Moulds & Grooves, Surface Grinds, Sands, Jigsaws, Rivets, Circular Saws, Polishes, Mills, Punches, Spins, Dovetails, Grinds Tools.



95%

COMPLETE or 15/- cash and nine payments of 10/-

Equipment includes: Circular Saw, Grinding Stone, Buff, Jigsaw and Blades, Sanding Drum, One Tilting Table, 3/4 in. Chuck, Punch, Tool Post and Cutting Tool, Spanner, Oil-Can.

THERE IS NO LIMIT TO THE NUMBER OF OPERATIONS POSSIBLE ON THIS MARVELLOUS MACHINE. ACCURATE WORK TO FINE LIMITS. IN WOOD OR METAL.

TRIANGLE PRODUCTS LTD., BLAKE STREET, MANCHESTER, 15

## FOR ACCURATE WORK AND PERFECT FINISH A "MILNES" LATHE is Essential

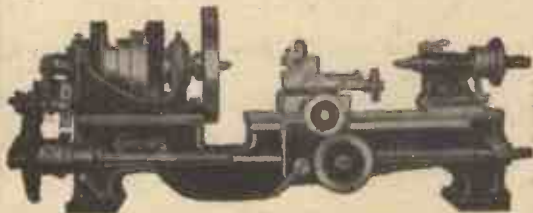

7 in. diameter Centre Lathes

SELF-CONTAINED ELECTRIC OR COUNTERSHAFT DRIVE  
Robust construction in every detail with easy means of adjustment ensure a lifetime's efficient service from "MILNES" MACHINES

Send for full lists to: HENRY MILNES, LIMITED, INGLEBY LATHE WORKS, BRADFORD, YORKSHIRE, ENGLAND.

## Ohlsson Petrol Engines

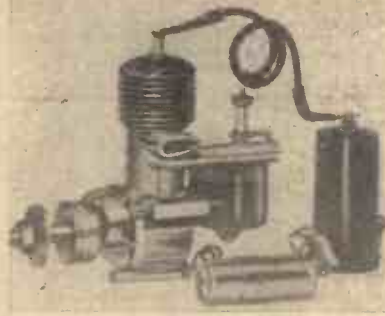

The Perfect Aeroplane engine for planes up to 8 lbs. weight. Bore 2 in. Stroke 1 5/16. Power 1/5 h.p. Weight complete as illustrated 13 ozs. The finish of these engines is as near perfect as it can be made. The crankshaft is hardened and ground. The piston is a perfect compression fit in the cylinder which gives these engines a far greater running life than most engines of this size. Price complete with plug, coil, condenser, carburetter and tank, ready to run.

£4 12 6 Postage 6d.

## The Ohlsson "23" Engine

A smaller engine for 'planes up to 3 lbs. weight. The bore and stroke is 5 8 in. and develops 1/7 h.p. Price complete as above £4 5 0 Postage 6d.

## A.C. Split-Phase Motors

220-240 volts 50 cycles.

These motors are suitable for workshop use or any other purpose where continuous full load output is required from the motor. They are practically dead silent when working and are fitted with large oil sleeve reservoir bearings.

PRICES: 1/4 h.p., 1,425 r.p.m. 55/-  
1/2 h.p. " " 55/-  
3/4 h.p. " " 65/-

Built-in Switch, 3/9 extra. Car. Forward



SEND FOR BOND'S 1939 GENERAL CATALOGUE PRICE 6d.; THIS WILL INTEREST YOU AS ITS 208 PAGES CONTAIN EVERYTHING THAT THE MODEL MAKER MAY REQUIRE.

**BOND'S O' EUSTON ROAD LTD.**  
357, EUSTON ROAD, N.W.1

'Phone EUSton 5441-2

Established 1887



"00" Gauge  
'Princess Royal'  
L.M.S.  
Locomotive.

We are specialists in the popular "00" gauge and can supply you with anything from Permanent Way parts to a complete railway.

Watch out for some of our new productions to be announced in next month's issue.

**MULTI-MODELS LTD.**

10-11 NEW BURLINGTON ST.  
REGENT ST. LONDON W.1.

Telephone: Regent 5676

## "SOLDO"

THE SELF-HEATING SOLDERING IRON

Can be used anytime and anywhere...

SIMPLE AND SAFE

With the "SOLDO" IRON you are not dependent on Gas or Electric heating; just place a Mox tablet in the special container in the iron and ignite with fusee supplied.  
READY FOR USE IN 30 SECONDS.  
Descriptive Leaflet "P." Free on Request.



PRICE of complete outfit. "Soldo" Iron. 10 Mox tablets. Box of fusees. **10/-** Past Free.

FREE with each order. A sample of "Soldo" Tinning Compound.

NOTE.—The "Soldo" Iron can also be heated by gas, if desired.

SOLDO CO., LTD., 5, SICILIAN AVENUE, LONDON, W.C.1.

# AMBITIOUS ENGINEERS

THIS IMPORTANT HANDBOOK  
ON  
SUCCESSFUL ENGINEERING CAREERS

## FREE ON REQUEST



After months of intensive effort and research, we are pleased to announce that the New edition of our Handbook, "ENGINEERING OPPORTUNITIES," is now out of the publishers' hands and ready for free distribution. Containing 268 pages of practical guidance, this book is, beyond argument, the finest and most complete handbook on Successful Engineering Careers ever compiled. It is a book that should be on the bookshelf of every person interested in engineering, whatever his age, position or experience.

The Handbook contains, among other intensely interesting matter, details of B.Sc., A.M.I.C.E., A.M.I.Mech.E., A.M.I.E.E., A.M.I.A.E., A.M.I.W.T., A.M.I.R.E., CIVIL SERVICE, and other important Engineering Examinations: outlines courses in all branches of CIVIL, MECHANICAL, ELECTRICAL, AUTOMOBILE, RADIO, TELEVISION and AERONAUTICAL ENGINEERING, BUILDING, GOVERNMENT EMPLOYMENT, etc., and explains the unique advantages of our Employment Department.

WE DEFINITELY GUARANTEE  
**"NO PASS-NO FEE"**

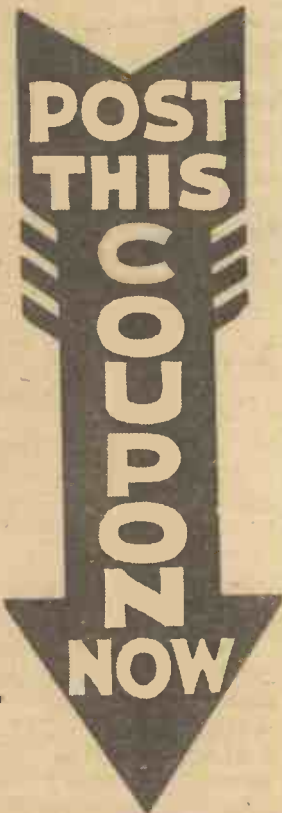

If you are earning less than £10 per week you cannot afford to miss reading "ENGINEERING OPPORTUNITIES." In your own interests, we advise you to write (or forward the coupon) for your copy of this enlightening guide to well-paid posts—NOW. *There is no cost or obligation of any kind.*

### BRITISH INSTITUTE OF ENGINEERING TECHNOLOGY

410a, SHAKESPEARE HOUSE,  
17, 18 & 19, STRATFORD PLACE, LONDON, W.1

-----TEAR OFF HERE-----  
**FREE COUPON**

BRITISH INSTITUTE OF  
ENGINEERING TECHNOLOGY,  
410a, Shakespeare House,  
17-19, Stratford Place, W.1.

Please forward, Free of cost or obligation of any kind,  
your 268-page Handbook, "ENGINEERING OPPORTUNITIES"

NAME .....

ADDRESS.....

.....

.....

## SUBSCRIPTION RATES

Inland and Abroad 7s. 6d. per annum  
Canada - - 7s. per annum

Editorial and Advertisement Offices: "Practical  
Mechanics," George Newnes Ltd.  
Tower House, Southampton Street, Strand, W.C.2.  
Phone: Temple Bar 4363.  
Telegrams: Newnes, Rand, London.

Registered at the G.P.O. for transmission by  
Canadian Magazine Post.

Copyright in all drawings, photographs, and  
articles published in "Practical Mechanics"  
is specifically reserved throughout the  
countries signatory to the Berne Convention  
and the U.S.A. Reproductions or imitations  
of any of these are therefore expressly  
forbidden.

# PRACTICAL MECHANICS

Editor: F. J. CANN

VOL. VI. MAY, 1939. No. 68.

## FAIR COMMENT

### LEISURE AND PROFIT

THE comments I have made in the past three issues concerning the need for training if you desire to improve your position in life, have brought me a number of somewhat pathetic letters from readers who have awakened to a belated realisation of the fact that they are now in their late twenties, and there seems little prospect of their position improving. I do not believe it, for if the will to do is there it is never too late. The defeatist attitude alone defeats, and it is certainly not too late at the age of 20 or 30 to 40 to start again. It may be a little more difficult at those ages, but it is by no means impossible, for means now exist which were unavailable even 20 years ago. A man between the ages I have mentioned is occupied earning his living during the daytime; only his leisure is available for private study or for attendance at evening classes.

#### Excellent Courses

THE technical Correspondence Colleges have produced so many excellent courses, covering almost every field of endeavour, that the plea of lack of opportunity for the acquisition of knowledge does not exist. Everything worth while is attained only by personal effort. Results undeserved, like merit undeserved, are like so much dross. Technical books are now so cheap that it is possible to acquire knowledge formerly only taught in colleges.

I am a firm believer in the power for advancement which Correspondence Courses and Evening Classes, plus home study can exert. I have personally inspected many of the courses of the Correspondence Colleges, and in every case I have found them to be most thorough. Moreover, the service given in connection with the courses is meticulous and attentive. Each student is permitted to ask as many questions as he likes, and the tutors send most useful and easily understood answers. These courses cost but a small proportion of

their real value, and it is interesting to note that they have been responsible for placing in important positions many thousands of people who would otherwise be occupied in blind alley jobs.

Those readers who have written to me expressing doubt as to whether it is possible for them to start now should take comfort from this thought.

#### Financial Position

THERE are other means of improving one's financial position than by study, for we must not omit the possibility that some individuals, however much they try, are incapable of absorbing knowledge. Yet, such individuals are capable of exercising considerable practical skill: These readers usually have practical hobbies, such as model making, wood working, wireless, and so on. It is possible by means of those hobbies to develop a profitable sideline indeed, and some of my readers have developed such sidelines to an extent where they have now become full time occupations.

It is the manner in which you spend your leisure which counts. Time is, indeed, money to-day. Lathework, watch-repairing, wireless, model locomotive building, and many other of the practical crafts which have formed the subject of a series of articles in this journal can be profitable means of employing your spare time. Those who follow practical occupations are often faced with unemployment when a slump or a national crisis cuts across their industry. It is then that the individual who has not allowed all of his eggs to repose in one basket reaps the reward. There is the story of the two schoolboys of 15 who both started work on the same bench as apprentices. They met ten years later; one was still employed in the shop where he was apprenticed, whilst the other had become a works manager. The boy who had remained as a sort of superior apprentice congratulated the other on his luck, whilst

the works manager congratulated the other upon remaining a fixture. I am not a believer in luck, for whatever good luck you may have is cancelled out at some time by a corresponding amount of bad luck.

#### Carving out a Future

THE man who employs his leisure in his early years with the idea of carving out a future is entitled to and usually gets his reward. Leisure spent entirely on pleasure is costly and destroys prospects, for pleasure has to be paid for. It must be placed on the debit side of progress. Whilst I cannot reply individually to all of the letters I have received on this subject, I hope my correspondents will examine themselves anew and not accept their present circumstances as the inevitable and the inexorable.

#### Our New Handbooks

THE two latest handbooks to be issued from the offices of this journal—namely the "Practical Mechanics Handbook" at 6s. (400 pages and 379 illustrations), and "Workshop Calculations, Tables and Formulae," at 3s. 6d. (144 pages and 120 illustrations)—have been well received, and reviewers have made many complimentary remarks concerning both. These two books were produced to fill a gap in technical literature, for their contents comprise subjects which have previously necessitated reference to several books.

Another book which we have recently published entitled "Practical Leatherwork," has been adopted by many of the classes teaching practical crafts. It has special chapters on appliqué, gesso, raffia, batik beadwork, stencilling and rug-making. It is excellent value at 1s., and contains 96 pages and no less than 179 illustrations.

A special catalogue of our technical books will be sent to any reader who sends a postcard giving his name and address. Mark postcards "Catalogue."

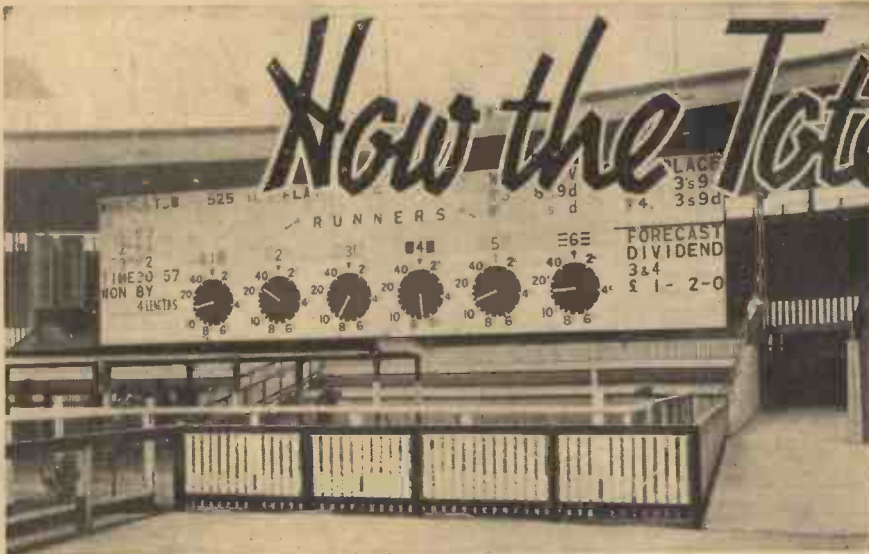

# How the Tote Works

The Totalisator is an Electro-mechanical Adding Device which Retains a Complete Record of all Bets made on Ticket Issuers Situated in Remote Parts of the Racecourse

THE "Julius" totalisator is an electro-mechanical adding device designed with the object of recording instantaneously bets made on numerous Ticket Issuers situated in remote parts of the Racecourse, and capable of being operated simultaneously. The Adding Equipment takes the form of an elaborate mechanical counter electrically-controlled, so that, if through an accident or mishap of any kind the supply of electrical energy is interrupted, the "Julius" machine retains a complete record of all betting transactions completed up to the moment of such severance of the supply. The importance of this when the machine is counting money, cannot be over-estimated, since a loss of records of how the money invested has been allocated between the competing horses or greyhounds, as the case may be, entails a vast amount of work in repaying every penny to investors and asking them to re-invest the same all over again when the totalisator has again commenced to function.

## The Ticket Machine Operator

Let us see what happens throughout the machine when a customer purchases a totalisator ticket at a selling window. First of all, the ticket machine operator, usually known as the "seller," depresses a movable handle on her machine into the appropriate index hole representing the horse or greyhound, usually known as the "runner," asked for by the customer. At the same time the seller takes the stake money. The ticket machine, which prints its tickets as required from a blank roll of paper, cannot commence to print the customer's ticket until an electrical circuit is established between itself, the adding machine counting the bets on the particular runner upon which the investment is being made, and the Grand Total Adding Machine counting all bets made in the particular pool. The ticket machine handle locks itself into the index hole, and at the same time closes a switch setting up a circuit to the Adding Equipment mentioned above. A self-tripping magnetic switch breaks the circuit again as soon as an impulse has passed through the runner Adding Unit and the Grand Total Machine. In tripping this circuit, known as the betting circuit, this magnetic switch energises the printing mechanism of the ticket-issuing machine and production of the ticket commences. As soon as the actual printing operation is completed, and while the ticket is being cut off and thrown out of the machine,

the movable handle is unlatched and may be moved to any other index hole for the purpose of producing another ticket. The complete operation of selection, registration and production of the ticket to the customer, is accomplished at a speed of 90 tickets per minute from every ticket-issuing machine.

Every ticket-issuing machine can issue tickets on any runner Win and/or Place, or, in the case of Forecast Ticket Machines, on any combination of two runners.

## A "Unit Bet"

Since totalisator betting is purely a mathematical process, it is necessary to

have some standard minimum stake usually called a "unit bet." The recognised unit bet in Great Britain is two shillings. In India it varies from R's2 (two rupees) on some racecourses to R's5 on others. The fixing of the unit is left to the discretion of the proprietors of the racecourse concerned.

Certain selling windows on the majority of racecourses are reserved for the sale of tote tickets of higher stake value, always multiples of the unit. For example, in Great Britain it is possible to stake 2s., 10s., £1 or £5 on a runner and take one ticket for the bet instead of a large number of 2s. tickets.

The Adding Equipment to which an electrical impulse is transmitted from each Ticket Issuing Machine every time a ticket is issued, consists of a number of separate adding units which are grouped as follows:

Win Pool—dealing with all bets on the chance of any runner winning a race.

Place Pool—dealing with all bets on the chance of any runner



(Left) A ticket issuing machine.  
(Below) The control room showing control panel, results telewriter, dividend telewriter and telephones.





coming first or second in a race. Forecast Pool—dealing with all bets on the chance of any two runners coming first and second respectively.

In both the win and place pools there are separate adding units for each of the runners and also two main adding units called respectively the Win Grand Total and the Place Grand Total. These latter machines total, in units, all the bets made in their respective pools, regardless of the runner selected.

In the Forecast Pool there are separate adding machines for each of the possible combinations of any two runners and, of course, a Forecast Grand Total.

handle such a rush of registrations with ease. This is accomplished by the provision of a storage device consisting of a screw and nut, arranged as shown in the accompanying drawing. When bets are received the screw is wound into the nut one tenth of a revolution for every unit received. As soon as the first bet is received, the stop catch is withdrawn from engagement with the stop on a friction clutch which is geared one to ten to the nut. The clutch revolves one revolution and in doing so, unless further bets have been received meanwhile, the screw is drawn forward to its former position, carrying with it the stop catch which again engages the stop of the clutch and prevents

the T.I.M.s are passed through electro-magnets, some of which are clearly visible in the accompanying photographs. Any one of these electro-magnets, when energised momentarily, operates the rocker of an escapement and permits one tooth of the associated escapement wheel to pass.

The escapement wheels move under the influence of a spring which imparts its torque to all wheels simultaneously by means of a train of epicyclic bevel gears. Thus, any or all of the escapement wheels may move at any moment depending upon the impulses received by the electro-magnets controlling them.

The spring is mounted on an extension of the escapement shaft and is attached thereto. The end of the shaft extension is splined and fits into and causes to rotate the screw of the screw-and-nut storage assembly previously mentioned. The other end of the spring is attached to the nut of this assembly so that the sequence of events in the adding machine when betting is taking place is as follows :

- (a) Electro-magnet energised momentarily.
- (b) Armature with rocker attached is attracted and then released.
- (c) Escapement wheel moves forward one tooth as result of rocker movement.
- (d) Shaft of escapement assembly rotates and carries screw with it.
- (e) Screw moves into nut.
- (f) Stop catch releases clutch.
- (g) Clutch takes up drive and turns nut in same direction as that in which screw has just turned. Nut also turns the counter.
- (h) Screw is drawn forward carrying with it stop catch.
- (i) Stop catch interrupts rotation of clutch and prevents further turning of nut once *status quo* has been established.
- (j) Counter shows total of units corresponding to impulses received.

further rotation until another bet is received.

Also geared to the nut and driven by it is a counter which totals progressively in units the bets received by the particular adding machine.

**Electrical Impulses**

The electrical impulses received from

(Left) A close-up view of a place main adding machine, showing the terminal panel and auto cut-out relay.

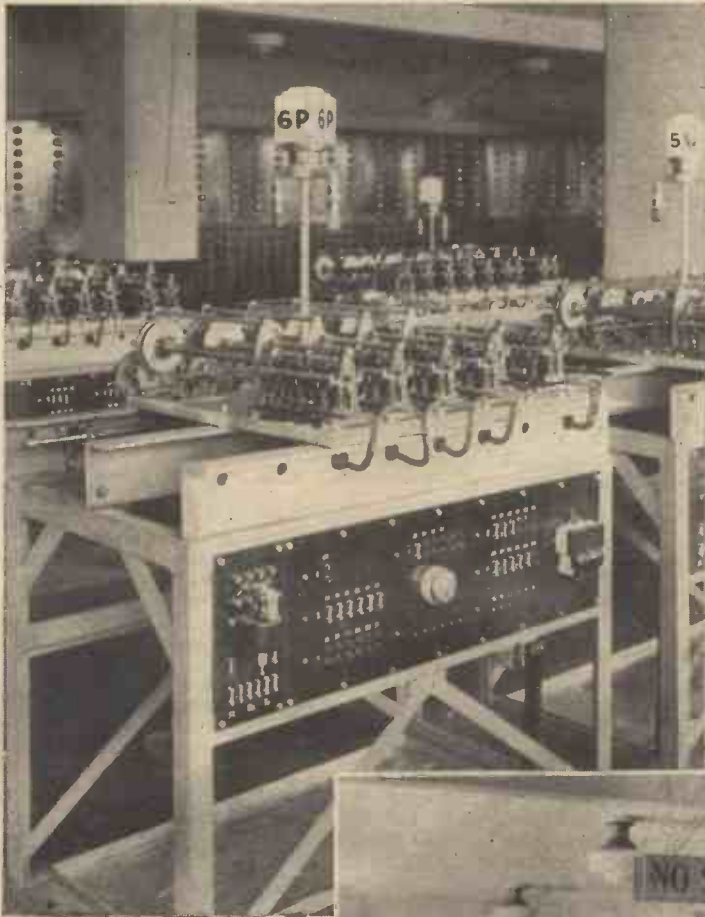

(Right) General view of main adding machine. Each adding unit is complete with its own motor drive.



**Ticket Issuing Machines**

Each and every one of these adding machines is capable of receiving and totalling instantly large numbers of bets sent from the Ticket Issuing Machines in the course of their operations.

As mentioned earlier in this article, the Ticket Issuing Machines can and do operate simultaneously, if necessary. Every T.I.M. functions as an independent feeder to the central adding equipment, and it happens that on occasions where there is an outstanding runner in a race, the bulk of the betting is on that particular runner. Every adding machine is so designed that it can

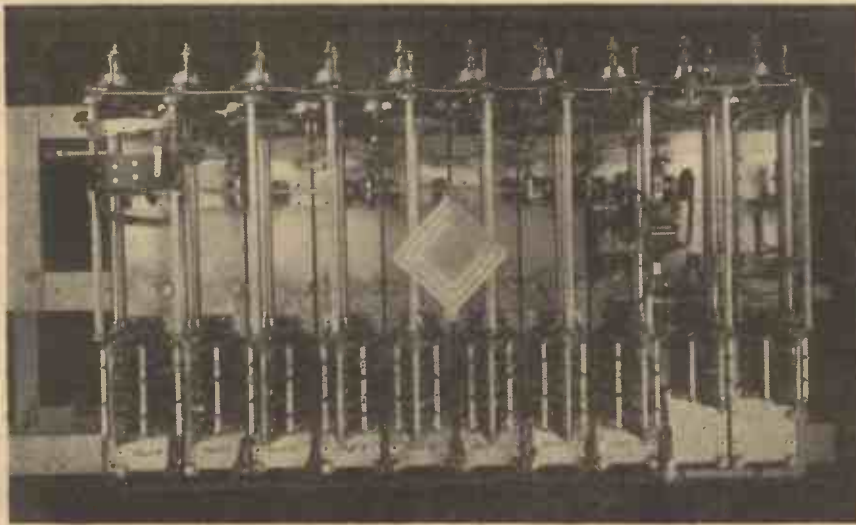

Plan view of the forecast grand total, showing how the escapements are arranged. Each shaft of escapements has its own storage gear and clutch drive, but the movements of each shaft are totalled on one counter to be seen in the top right-hand corner of the machine.

is only momentary, the power drive will continue to turn the nut after betting has eased down or stopped and until the storage screw has reached its normal position. In doing this, the nut turns exactly the same number of revolutions and/or parts of a revolution as the screw made in the first place under the influence of the escapement and, since the meter is counting the movements of the nut at the rate of input to the screw, viz. 10 unit bets per revolution it will show the total number of unit bets received by the machine in the first place.

The driving speed of all adding machines is arranged so that with the maximum possible speed of issue of tickets from all ticket issuing machines operating simultaneously, the total of such bets is recorded on the adding machine meter within a few seconds.

Should a rush of betting on any one runner persist beyond the storage capacity referred to above, an auto cut-out is arranged so that betting from all ticket issuing machines on that runner is stopped just as the limit of the storage capacity is reached. The auto cut-out is closed again when the power drive has wound the storage screws out to their normal positions and betting is allowed to proceed on that runner again. Meanwhile it should be noted that no interference has taken place with the betting on all other runners. This safety device acts as a guard against inaccuracy through betting exceeding the storage capacity of the machines owing to a failure of the main drive.

The usual alarm signals are shown in the control room when anything of an abnormal nature takes place.

**Units Invested**

The majority of "Julius" Totalisator Adding Machines are so designed and situated that they function also as indicators to the public of the numbers of units invested on each runner and of the totals of the various pools. This is done by controlling the movement of comparatively large diameter drums from the delicate adding equipment of the totalisator.

In the case of large installations, such as that at the White City Stadium, London, it is impracticable to combine the adding equipment with the public indicators and the control of the latter by the former is effected by means of impulses transmitted progressively from the adding equipment to the indicators as betting proceeds. Where exceedingly high rates of registration have to be dealt with, it would be useless to attempt to display to the public progress-

ively the unit figure of the totals of bets on each runner, and the Grand Total, since such unit figures would be changing so rapidly that they would merely be a series of blurred white marks on the Indicator until the cessation of betting. An ingenious system has been incorporated in the machine, therefore, whereby all unit figures remain at zero during the betting period, and upon the cutting off of the machine at the start of the race, the exact final unit, as recorded on the Main Adding Equipment is set up on each Public Indicator.

During the betting period at the White City Stadium, tens of units are transmitted from the main adding equipment to the public indicators, thus affording the public a perfectly satisfactory guide as to the investments being made on the totalisator.

**The "Win" Pool**

Additional information with respect to the "Win" pool is given to the public by the "Julius" machine by means of dial indicators showing the actual dividend to be expected should any particular dog win the race. The possible dividends so displayed are computed automatically by the "Win" adding units and the prices indicated from moment to moment represent the return to be expected should betting stop at that particular moment. Naturally, as betting proceeds, and more money is invested on some runners than others, the prices of all fluctuate in proportion to the varying amounts invested. The prices indicated on each runner at the cessation of betting are the tote starting prices of all runners. It has been found that the public ignore the displayed totals of units wherever the alternative dial indicators are installed, since

the tiresome mental calculation, necessary in order to arrive at the dividend from totals of units invested, is entire-

This diagram illustrates the storage mechanism of the Julius totalisator.

ly eliminated by the dial indicators. What is more, while an investor is calculating possible dividends from the totals of units displayed such totals are changing and increasing, so that when he has completed his little sum, the investor finds that he is several minutes behind the market, while the dial indicators display the actual prices based upon all the investments actually completed at any given moment. In other words, there is no time lag whatsoever, in the prices displayed by the dials.

**Odds Computing Device**

The odds computing device which controls the dials may best be described as being a mechanical adaptation of the well-known trigonometrical method of finding the ratio between two numbers by means of the right angled triangle.

In a win totalisator for say twenty runners, the registration of all bets on the Win Grand Total produces a proportionate movement of twenty sliders along 20 vertical guide bars. Horizontal guide bars are fixed at the lower ends of each of the vertical bars. These horizontal guide bars each carry a slider controlled by, and moving in proportion to, the units registered on one of the "runner" adding units. Thus two sides of a right angled triangle are formed in respect of each runner. Every triangle has a vertical side of the same length and representing the divisible pool. The horizontal sides vary in accordance with the number of betting units staked on the runner with which it is associated.

The hypotenuse of each of these triangles is formed by steel straight edges pivoted on and carried by the grand total sliders. These straight edges are caused to take up the angular position produced by the relative movement of the respective pairs of sliders, and the angles so formed by each hypotenuse to each of the sides of its own triangle are measured continuously, and this measurement is indicated by a dial and pointer. The pointer is geared to the straight edge in such a manner that all the possible ratios between the two sides of the right angled triangles lie within one revolution, i.e., 360 deg. movement of the pointer.

The scale on the dials may be marked in cash, as shewn in the accompanying photograph, or in "odds" if preferred.

Sets of repeater dial indicators are usually set up at various vantage points on the

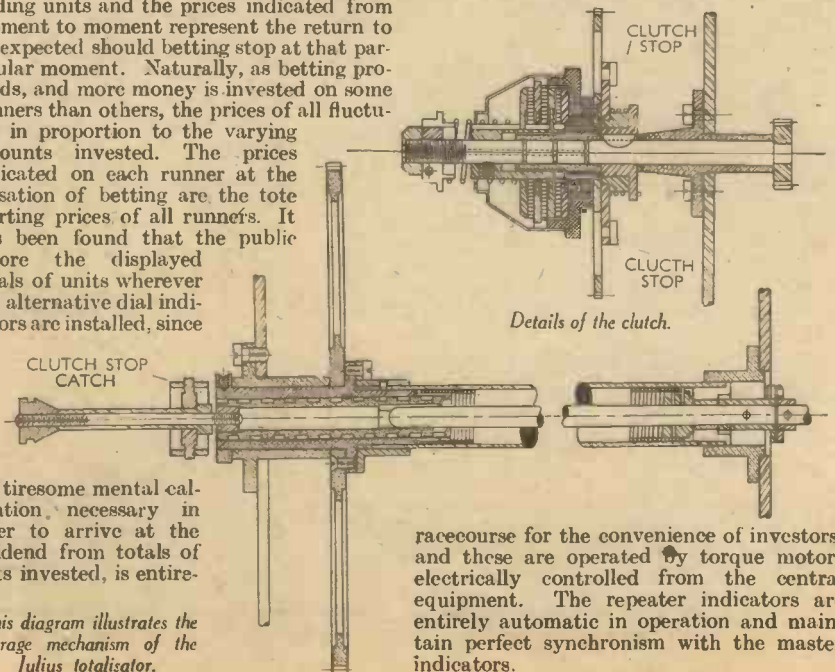

racecourse for the convenience of investors, and these are operated by torque motors electrically controlled from the central equipment. The repeater indicators are entirely automatic in operation and maintain perfect synchronism with the master indicators.



## No. 2—Acids and Alkalies. How to Make Chemical Salts. The Art of Crystal Growing.

**M**ANY of us are apt to define an acid as a substance which is sour and corrosive. Only to a limited extent, however, is such a definition true. For, although sulphuric, nitric, and hydrochloric acids are corrosive and sour liquids, no one could possibly consider citric acid, which constitutes the sour principle of the lemon, or tartaric acid, which is found in grapes, to be in any way corrosive. Moreover, there are some acids known which are almost sweet to the taste!

In reality, an acid may, for our purpose, be defined as a substance which contains hydrogen, all or a portion of which latter element may be replaced by a metal, an alkali, or, as chemists say, a "base."

An alkali is, as we all know, exactly the opposite of an acid. Ammonia is our best-known alkali. But there are others, such as caustic soda, caustic potash, and lime, which are also strongly alkaline and which possess the property of uniting with acids to form salts.

### "Bases"

Chemists frequently refer to alkaline substances as "bases." Thus, caustic soda may be termed a base, since it may be acted upon by an acid to form a salt.

Now, all these salt-forming alkalies contain within themselves a group of two atoms—an oxygen and a hydrogen atom—by means of which they are able to enter into union with an acid to form a salt.

Suppose we dissolve a few grams of caustic soda (sodium hydroxide) in a little warm water and

add to it, drop by drop, dilute hydrochloric acid until the liquid just shows an excess of

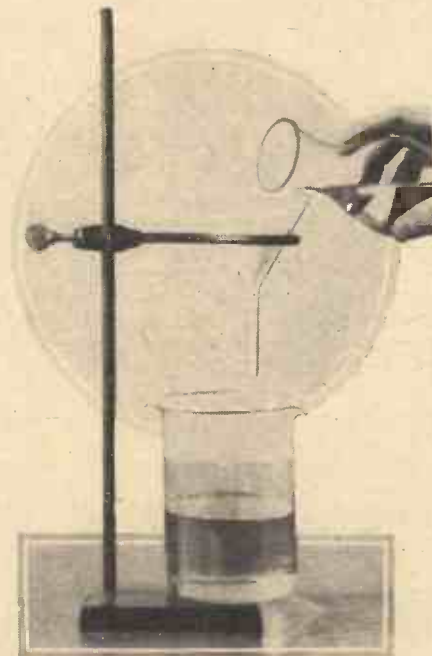

Filtering a chemical solution before allowing it to crystallise.

acid and begins to turn blue litmus paper red. If after concentrating the resulting liquid a

little by boiling, we allow it to cool, we shall obtain a crop of white crystals which are definitely different from the caustic soda which we originally dissolved in the water. Moreover, the liquid will have lost the slimy feel due to the presence of caustic soda, and the crystals themselves will be found to be neither acid nor alkaline.

### Crystals

They are, in fact, crystals of sodium chloride, of common table salt, and their mode of formation is made plain by recourse to the following chemical symbols:—

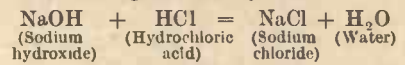

Here it will be observed that, as in all chemical equations, the elements in the reacting substances are denoted by symbols. Thus, in the above equation, H stands for hydrogen, Cl for chlorine, O for oxygen, and Na (from the Latin *natrium*, meaning soda) for sodium.

By bringing together an acid (HCl) and a base (NaOH) a portion of the acid has combined with a part of the base, forming an entirely new compound and also producing water.

Chemical reactions of this type whereby an acid is "neutralised" by an alkali or a base to form a salt are very common. In fact, we can lay down a general law with regard to them, the law being thus stated:—

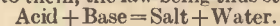

Sometimes a metal will liberate free hydrogen from an acid. If, for instance, a few pieces of scrap zinc are dropped into a little dilute hydrochloric acid contained in

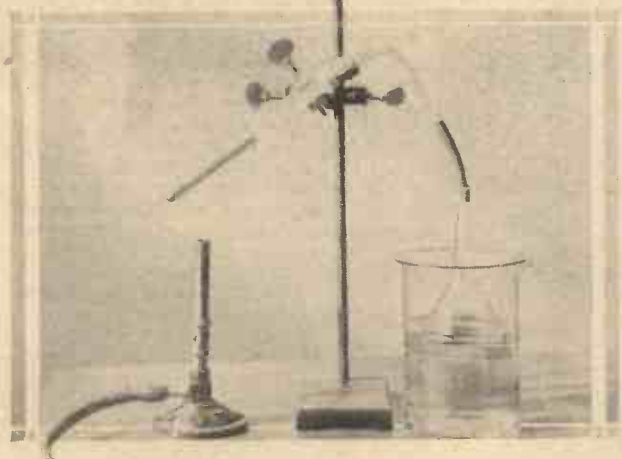

(Left) Apparatus for the home preparation of ammonia. Mixture of slaked lime and sal ammoniac heated in a tube. Note the funnel delivery tube dipping just below the surface of the water in the beaker. (Right) Crystals of zinc sulphate set aside to dry in glass trays.



a test tube, hydrogen gas will be evolved vigorously and a salt—zinc chloride—will be formed in solution, the chemical reaction being as follows:—

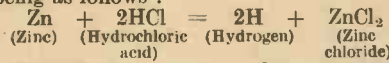

It is of great interest and use to prepare a number of chemical salts by the action of a metal or an alkali on an acid.

#### An Example

Suppose, for example, we wish to make the salt, zinc sulphate, all we have to do is to take a quantity of dilute sulphuric acid (i.e. the strong acid diluted with four times its volume of water, the acid being added to the water and *not vice versa*) and to drop into it some scrap zinc. After the vigorous action has subsided and no further zinc will dissolve in the liquid, the latter should be filtered, poured into an evaporating basin and gently simmered in order to concentrate the liquid. After the bulk of the liquid has been reduced by about a third, it should be put away overnight to cool and, in the morning, a crop of prism-like crystals will be found at the bottom of the liquid. These are crystals of zinc sulphate,  $\text{ZnSO}_4$ , and a further crop of them may be obtained by concentrating the liquid to a still smaller bulk.

By dissolving zinc in hydrochloric or nitric acids, and by concentrating the resulting liquids, we cannot satisfactorily obtain crystals of zinc chloride and zinc nitrate respectively, for these salts are very "hygroscopic" or water-absorbent, and they generally refuse to crystallise unless very special care is taken with the process.

At the present stage of our chemical career, it will not be advisable for us to begin the preparation of strong acids. Rather, let us turn our attention to making one of the most important alkalies known—ammonia.

Ammonia is a gas, colourless and invisible, but possessing an extremely strong and pungent odour which is well known. Now, ammonia is a compound containing three atoms of hydrogen and one atom of nitrogen, so that we write its chemical formula  $\text{NH}_3$ .

#### An Ammonia Experiment

When ammonia is dissolved in water (in which liquid it is extremely soluble), some of it is generally considered to form a compound with the water and to become ammonium hydroxide, or  $\text{NH}_4\text{OH}$ . Note the  $-\text{OH}$  or "hydroxyl" group of atoms in this compound, for it is a very important one, and we find the same group of two atoms occurring in a multitude of metallic and other compounds, all of which are usually attacked by acids to form salts. Thus, we have sodium hydroxide (caustic soda),  $\text{NaOH}$ , potassium hydroxide (caustic potash),  $\text{KOH}$ , calcium hydroxide (slaked lime),  $\text{Ca(OH)}_2$ , copper hydroxide,  $\text{Cu(OH)}_2$ , magnesium hydroxide,  $\text{Mg(OH)}_2$ , any of which will interact with an acid to form the metallic salt of the acid. Hence if we dissolve copper hydroxide or copper oxide in dilute sulphuric acid we shall obtain a blue solution of copper sulphate which may be concentrated by boiling and then allowed to crystallise out.

It is not a difficult matter to make many alkalies. For example, a solution of sodium hydroxide (caustic soda) may be prepared by flinging small fragments of metallic sodium into a bowl of water. Immediately each sodium fragment touches the water, it melts, assumes a globular form, and swims about violently on the surface of the water, emitting a stream of hydrogen which, just before the sodium globule disappears com-

pletely, bursts into flame with a tiny explosion.

This spectacular experiment is quite a safe one to perform, provided that the sodium fragments employed are no bigger than a pea in size.

Sodium is a very soft metal, which can be cut with a knife, like cheese. So great is its affinity for the oxygen of the air, that it tarnishes immediately on exposure to the atmosphere becoming covered with a white layer of sodium oxide. For this reason, sodium is always stored below the surface of an oil, such as solvent naphtha, and in well-stoppered bottles.

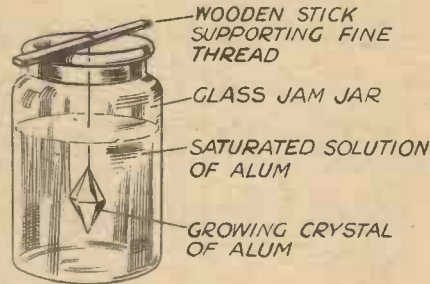

Growing giant crystals of common alum.

#### Metallic Sodium

When metallic sodium comes in contact with water, its avidity for the oxygen of the water is so great, that it attaches to itself some of the atoms of the water, releasing hydrogen, which escapes as a gas from the water. Thus:—

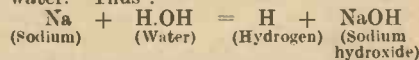

Water in which metallic sodium has been "dissolved" always has a slimy feel and will be found to be strongly alkaline, turning red litmus paper blue. This is due to



A solution of zinc sulphate which has crystallised out.

the presence of sodium hydroxide (caustic soda), and the latter substance can be recovered from the water simply by evaporating it to dryness.

Potassium hydroxide (caustic potash),  $\text{KOH}$ , can be made in exactly the same manner by "dissolving" metallic potassium in water. Here, however, the action of the potassium on the water is so extremely energetic, that the fragment of metal takes fire immediately it comes in contact with the water.

Another simple, instructive, and useful

experiment consists of the preparation of ammonia gas and its solution in water to make the ordinary "liquid ammonia."

To make ammonia gas, we require a mixture of 1 part of sal ammoniac (ammonium chloride) and 2 parts of slightly moist slaked lime. This mixture is placed loosely into a large test tube, which is provided with a cork through which passes a bent delivery tube, the lower end of which is attached to a glass funnel, which just dips below the surface of water contained in a beaker or bowl. On gently warming the mixture in the test tube, ammonia gas will be driven off and will dissolve in the water.

So soluble is ammonia gas in water (1 part of water dissolving nearly 1,000 parts of the gas) that the water in the beaker will tend to be sucked up the funnel. In order to avoid this, the rim of the funnel should only just dip below the surface of the water.

#### Liquid Ammonia

By means of the above experiment, quite a strong solution of "liquid ammonia" may be obtained. It will smell strongly of ammonia and may be neutralised by acids to form salts. Thus, if we neutralise some of our home-produced ammonia liquid with dilute acetic acid, we shall obtain a solution of ammonium acetate.

Quite an interesting chemical pursuit is the growing of oversized or "giant" crystals. Most of the crystals obtained by ordinary crystallisation processes, it will be noted, are only small ones, seldom measuring more than a quarter of an inch in length or breadth.

Take, for example, common alum, which, incidentally, is what is known as a double sulphate of aluminium and potassium, possessing the formula,  $\text{Al}_2(\text{SO}_4)_3\text{K}_2\text{SO}_4$ . When this substance is dissolved in water so as to make a strong solution, and the solution is afterwards concentrated a little by boiling and then set aside to cool, small crystals of the alum will separate out.

We now take a quantity of strong alum solution which is almost at crystallising strength and place it in a glass jam jar so that the latter is at least half filled with the solution. After this we search among our crop of small alum crystals and select one of the most perfect we can find. This is tied to the end of a long hair or a fine piece of silk or cotton, the other end of the thread being tied to a stick which rests across the top of the jar. By this means the small alum crystal is suspended halfway down in the alum solution and it is allowed to remain there *absolutely undisturbed* for several days. Care should also be taken during this time to see that the temperature of the solution does not change appreciably.

If these necessary precautions are taken, the small "seed" crystal, as it is usually called, will be seen to grow day by day until, after five or six days, it will have attained a size of an inch and a half or more, being perfectly formed on all its faces. Such a crystal should then be removed, wiped dry, and then given a coating of clear varnish in order to preserve it.

Other substances which can be grown into "giant" crystals in the same way are common salt, photographic hypo (sodium thiosulphate), chrome alum, copper sulphate, potassium dichromate, Rochelle salt, nickel ammonium sulphate, and magnesium sulphate (Epsom salts).

There are a few materials which seem to be absolutely devoid of crystalline formation. Such materials are known as "amorphous," meaning "formless." Ordinary glass is usually amorphous. So, too, are materials like lampblack and soot.

# MODERN MAPS

## —HOW THEY ARE MADE

By The Editor of W. & A. K. Johnston Ltd.

Aerial photography is a great help to the map maker.

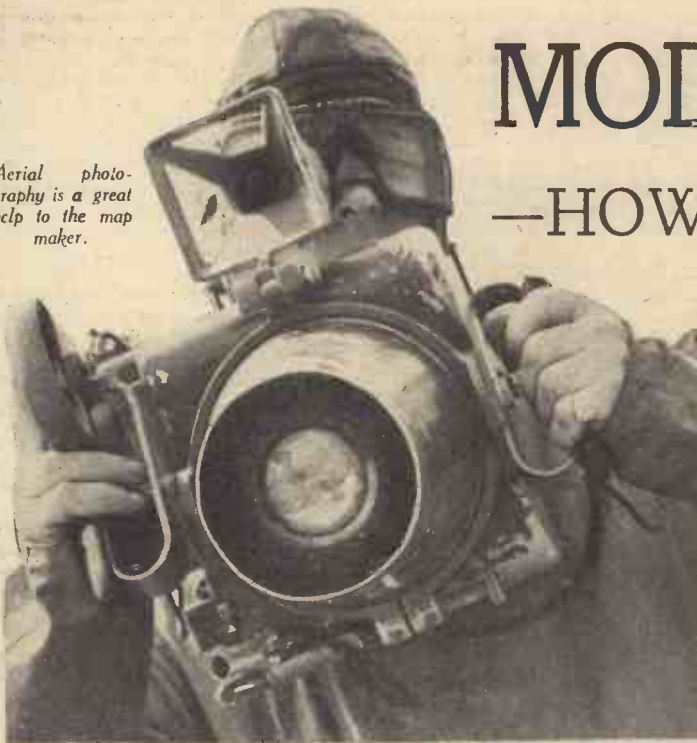

**M**AP publishers have to busy themselves nowadays with the revision of their maps, and they are fortunate if they do not find that a map of Europe in particular is out of date before its printing is completed. It is therefore of special interest at this time to inquire how it has come about that we are able to obtain maps of such beauty and accuracy as are to-day available at most moderate prices.

Every civilised country has a National Survey Department, controlled by the Government, which is engaged primarily on the production of maps of that country. It is clear that some such Survey Departments are faced with a much more formidable task than are others. In South America, for instance, while thousands of miles have been traversed by surveyors working on more or less accurate methods, there are still vast areas which are un-surveyed, notably in Patagonia, Paraguay, the Northern Andes, and Brazil.

great exactness and with minutely accurate instruments, and often in conditions of great natural difficulty. In the Gold Coast in West Africa, for instance, the surveyors have to work in dense tropical forest, where torrential rain falls from June to October.

task of combining all his material in a finished drawing upon a scale chosen to suit the purpose of the map. Information must be selected, to avoid overcrowding the map with details; differences between the authorities in use must be reconciled; and appropriate conventional signs must be employed to convey clear and definite information to all readers of the map.

The printing of maps began in the second half of the fifteenth century, the maps being engraved either on wood or on copper plates and impressions from these plates being pulled in a hand-press. Wood engraving was eventually entirely replaced by the use of copper, on which maps remarkable for clearness of detail and beauty of lettering were produced by a combination of the graver's tool and etching with acid. When corrections were required owing to increased geographical knowledge, errors were scraped from the surface of the copper, and the depression thus produced was made level again by tapping with a hammer on the reverse side of the plate. New work could then be cut on the levelled surface.

### The History of Map Making and How the Map Maker Produces the Accurate and Beautiful Maps of Today.

#### Oldest in the World

In our own country the National Department responsible for this work is the Ordnance Survey of Great Britain, with headquarters at Southampton. This is the oldest organised survey in the world, having begun its work in 1791. It derives its title from the fact that when first formed and for many years afterwards it was controlled by the Master General and Board of Ordnance, since the mapping of the Kingdom was undertaken originally for military requirements. The first sheet of a map of the United Kingdom on the scale of 1 inch to 1 mile was published in 1801, but this work was not completed until 1890. Mapping by accurate survey is, of course, required to-day for many other than military purposes.

For the most part survey is carried out on the ground. It is always performed with

Insect pests which plague them at their task are mosquitoes, the jigger flea, the guinea-worm, and others. Elsewhere work has to be carried on in waterless deserts or amid pathless mountains. The accuracy of the results obtained by survey from the air, a process developed to meet military requirements in the Great War, does, however, make it possible in many cases to substitute this method for ground survey.

#### Help From Explorers

The results of such surveys, the routes recorded by explorers in their travels, and all other available sources of information are placed at the disposal of the geographical draughtsman. In the spelling of foreign place-names he obtains valuable assistance from the authoritative lists prepared by the Permanent Committee on Geographical Names, and published by the Royal Geographical Society. He has the

#### Lithography

In 1796, lithography, that is, the art of printing from a design on a specially prepared stone, was invented in Germany by Senefelder. Senefelder used for this purpose a closely grained limestone discovered by him at the village of Solenhofen in Bavaria which was of unrivalled quality for use in

lithography, even in its stratification, and of a suitable thickness of from three to five inches. While stone continued in use for lithography, the best material was always obtained from this district of Bavaria. The copper plate on which a map was engraved was inked up in lithographic ink with a hand roller and an impression pulled in a hand-press on transfer paper. From this paper the design was transferred to the stone, on which it was etched with acid. After use the design could be planed off the stone, and the stone, when it had been resurfaced by polishing, could be used for a fresh transfer. Alternatively, a design could be drawn by pen or chalk directly upon the stone.

In the early days of lithography, which was introduced in this country about 1850, map designs in outline only were printed, colours being added by hand. About ten years later, however, a really satisfactory type of lithographic machine, with a cylinder to give pressure, was introduced from France. Colours were then added to the design by lithography, with the result that the cost of production was lowered and maps became much cheaper.

#### Colouring

The method by which the colours were obtained was, and still is, as follows: An impression from the stone carrying the design or outline of the map was transferred to the stone on which it was desired to reproduce any one colour, say, yellow. The whole of the printing surface which was *not* to carry a yellow tint was then covered with a thin coating of gum, tinted pink to show its presence. To the remainder of the surface which was not protected in this way there was transferred an impression pulled from a copper plate which either was covered with a series of very fine parallel lines, closely ruled, or else was covered with a great number of small dots, called "stipple." When the gum was sponged off the stone, all those parts which it was desired to print in yellow were shown to be covered with either the lines or the dots.

If more than one strength of yellow colouring was required, this was obtained by repeating the gumming-out process, covering in this case those parts of the printing surface of the stone which were to reproduce a pale yellow tint as well as those which were not to be printed at all in yellow. A second impression from the ruled plate was then transferred to the stone, the lines on this occasion being laid to cross the first lines at right angles. Details which were intended to appear in solid yellow were inked in by hand. When run in the lithographic printing-press with a yellow ink, this stone thus conveyed to each sheet of paper three strengths of yellow—pale from the single ruling or stipple, dark from the cross-ruling or a double stipple, and solid.

#### The "Copy"

The "copy" which the copper-plate engravers followed had necessarily to be supplied to them by draughtsmen. These geographical draughtsmen selected the information which was to be shown on the map, indicated the relative importance of various place-names to be expressed by larger or smaller lettering, and so placed all details on the map that each item stood out as clearly as possible. The draughtsman's work was thus essential to the engraver. If a method could be devised whereby the engraver's work could be eliminated, the production of maps could be expected to become considerably less costly.

This method was found in the introduc-

tion of a photographic process. The copy which the draughtsman had hitherto prepared for the hand-engraver was now completed in a finished style of lettering, and photographed on a glass negative. From this negative it was printed on to a specially copper surfaced plate and the impression etched into the plate by acid. The hand-engraver required to make some half-dozen cuts with his graver to complete each letter. The draughtsman could obtain a similar result much more quickly, although from the artistic point of view his work did not perhaps give quite the same beauty of lettering.

The next step was the substitution of metal plates for lithographic stones, zinc being employed in this country, while aluminium was used in America. This medium made possible further changes. In the first place it was found practicable to sensitise the zinc plate and print direct to it from the photographic negative. Thus the necessity of photo-engraving on copper and pulling transfers from the copper was eliminated. Secondly, the flat-bed litho-

to a rubber blanket on a second cylinder. From this rubber blanket the paper sheet, on a third cylinder, receives its impression of the design. The advantage of using the rubber blanket is that the rubber is able to print a design on any paper, whether smooth or rough in surface. So long as the paper had to come in contact with the unyielding surface of a stone or a metal plate, only smooth-surfaced, specially prepared paper could be used in lithography. Paper is now generally fed into a rotary offset press not by hand but by an automatic feeder, which lifts each sheet in turn by suction at a much faster rate than a girl could possibly do by hand.

#### Zinc Plates

Zinc lithographic plates, like lithographic stones, can be used many times over. They are given a fresh grained surface by the shaking action of a machine in which they are laid under a quantity of marbles. A grained surface is necessary in order that the interstices between the grains on the plate may retain water. For, in fact, the



*A typical example of modern map making. A set of 31 of these maps in a grained moroquette case forms the subject of a presentation offer by our companion paper "Practical Motorist."*

graphic printing press could now be replaced by the rotary offset process.

#### Flat Bed Machine

In the flat-bed machine the lithographic stone (or, when zinc plates were used, the plate raised to the necessary height on a special mounting) travelled backwards and forwards along the bed of the machine. The sheets of paper were fed by hand into grippers on the top of a cylinder revolving over the bed. At the moment when the stone was passing beneath the cylinder the sheet of paper was brought into contact with the stone, the design on which was inked up by rollers at the end of each run, and thus an impression of the design was given to each sheet of paper. The paper sheet was then automatically released by the grippers on the cylinder, and delivered in a pile at the end of the machine opposite to the inking rollers.

In the offset process the zinc plate and the sheet of paper do not come in contact with each other. The plate encircles a printing cylinder, and transfers its design

antipathy between grease and water is the foundation of lithography. One set of rollers in a lithographic press applies ink to the plate, as has already been noted. Another set of rollers applies water. Lithographic ink is greasy, and thus, when inked up, the design on the plate is greasy. But if the remainder of the plate, on which there is no design, were not kept moist by water, the greasy ink on the design would tend to spread beyond the design over the paper.

In the preparation of colour-plates there has been no change such as has marked the general process of printing. To the plate, as to the stone, ruled lines or stipples are still applied after a gumming-out process. It is not, however, always necessary to use a separate colour-plate for each colour on a map. Blue can be printed over yellow to give green as well as the two primary colours. Blue and pink combined give purple; pink and yellow give brown. Varying tints of green, purple and brown can also be obtained by combining the primary colours in different strengths.

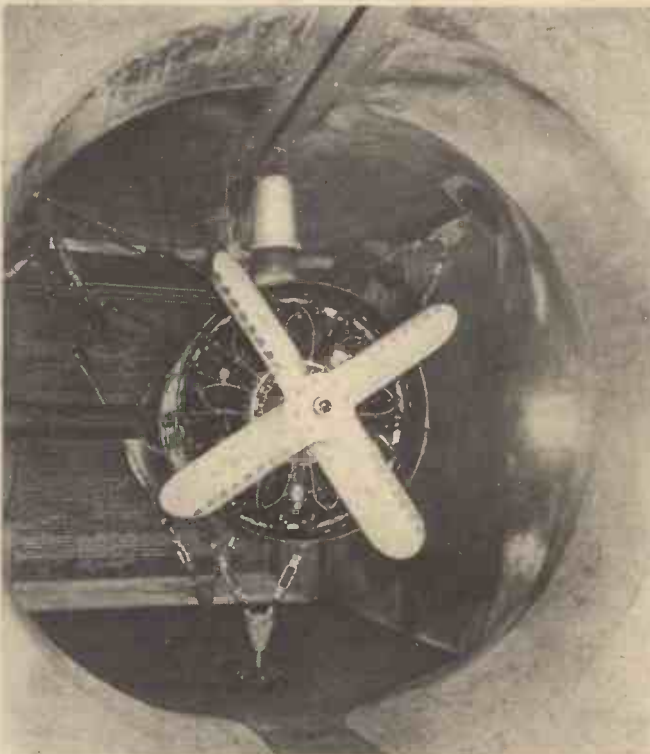

A front and rear view of one of the test cells which will accommodate engines up to 3,000 h.p. Sound-proofed, the cells can be operated on a 24-hours-a-day basis without disturbing residents in the vicinity of the plant. Every aircraft engine built by the Wright Company is subjected to a 10-hour test, operating under its own power, before being delivered. The engine mounted on the test stand shown above is a Wright Cyclone of 1,100 h.p.

## TESTING AEROPLANE ENGINES

ONE of the most significant indications of the progress anticipated in the development of aircraft engines within the next few years was the announcement recently made by Guy W. Vaughan, president of the Curtiss-Wright Corporation, that the Wright Aeronautical Corporation is preparing for the production testing of power plants of twice the output of the Wright Double-Row Cyclone, whose rating of 1,500 h.p. is the highest ever accorded an aircraft engine of any type by the U.S. Civil Aeronautics Authority.

These preparations for the future quantity production of high powered aircraft engines, Mr. Vaughan disclosed, consist of the building of a battery of 14 test cells in which engines up to 3,000 h.p. may be mounted for the 10 hours of operation, under their own power, which all Wright engines must complete before delivery to the aircraft manufacturer or military service. Four of the new test cells are already in use, while others will be placed in operation as rapidly as they are built.

### Final Tests

Mr. Vaughan pointed out that the new equipment will be used solely for the purpose of carrying out the final tests on engines being built on a production basis, and not for experimental development.

"The trend in aircraft engines is unswervingly toward single units of higher power to meet the demands created by the larger aircraft projected," Mr. Vaughan said. "Aircraft manufacturers already have designs of ships whose size would dwarf any aircraft now in operation or actually being built. While there are many other problems to be solved before these planes become a reality, one of the principal deterrents to the execu-

tion of the designs is the lack of single engines of sufficiently high output to enable the plane manufacturer to obtain the total power required without resorting to the use of a larger number of power plants than is deemed practical.

"During the past 10 years we have doubled the output of the nine cylinder radial air cooled engine, and by building similar engines with 14 cylinders arranged in two rows, have produced power plants three times as powerful as those of a decade ago.

### A New Type of Testing Equipment which is Capable of Accommodating Aircraft Engines up to 3,000 h.p.

#### The Future

"Exactly what the future will bring in the line of higher powers, I am not now in a position to state. However, last year the Wright Company completed a \$250,000 experimental testing laboratory which will provide for the endurance proof testing of engines of 3,000 h.p., swinging flight propellers up to 20 feet in diameter. That we are preparing to-day for the testing of production engines of similar capacity should be significant at least of our confidence that more powerful engines will be built."

The fact that they are stressed for 3,000 h.p. engines is only one of the features of the new production testing equipment which Mr. Vaughan described as the most modern in existence. Of particular interest are the provisions made in the new test cells for the reproduction of conditions which are encountered in flight. A blower connected to the carburetter air intake by a duct enables test engineers to simulate the "ramming"

effect of air entering the carburetter at 200 miles an hour as in a modern airliner. This blower is also equipped with controls, by means of which the air fed to the carburetter may be "thinned" out to simulate flight at high altitudes and heated or cooled to reproduce changes in temperature.

#### Test Cells

The test cells are built in pairs separated by a control room on each side of which are tables and panels on which are mounted the throttles and the various instruments with which the engines are checked for power out-

put, fuel and oil consumption, cooling, and other functions during the test runs. A clear glass window above the instrument board gives the test observer an unobstructed view of the test cell and the engine. The control rooms are kept free from exhaust gases and other fumes by special air conditioning equipment.

#### Mounting the Engine

Sound proofed to a greater extent than most modern airliners, the new cells could be operated on a 24-hours-a-day basis without disturbing residents in the vicinity of the Wright factory. Even with an engine operating at full throttle, the noise level outside of the testing building is no greater than from a mill or ordinary manufacturing plant. In the control rooms, a telephone conversation may be carried on in normal tones without difficulty.

A new method employed in mounting the engine on the test stand closely approxi-

(Continued on page 454)

## First in France

STATED to be the first of its kind in France, a swing bridge has been constructed at Le Havre, complete with foot-paths and capable of turning on its own axis.

The more usual type of swing bridge splits in the centre in order to enable boats to pass, but this one turns sideways flat against the bank. The bridge spans one of the locks used by trans-Atlantic liners.

## Suits Made from Coal

A NON-INFLAMMABLE material made its appearance at the recent Leipzig Fair made of coal and chalk. If you have a suit made from this material, however, it will be inadvisable to press the trousers with a hot iron, as the material melts!

## A Motor Torpedo Boat

MESSRS. John Thornycroft have recently built a new type of motor torpedo boat for the patrol service of the defence department of the Philippines. It has been agreed by naval experts that this type of boat is the best protection possible for a small nation

# THE MONTH IN SCIENCE AND

records what it "sees" on paper. It tells how the brain is working and a wink of the eye is indicated by hundreds of little ink waves. It can write at the high speed of 70 little waves a minute.

Every tiny electrical wave from the brain is scribbled in ink and the reactions can be recorded without the patient suffering any pain by putting electrodes on the scalp. It enables surgeons to diagnose mental diseases.

## Testing the Upper Atmosphere

THE first sea-air tests preparatory to the establishment of an ocean-wide chain of floating weather stations, were recently carried out on the U.S. coast-guard cutter *Chelan*. These stations will be established

passed its flying trials and has a landing speed of 30 m.p.h., weighs 600 lb., and its petrol consumption is 35 miles to the gallon.

The *Luton Major* is a high-wing, two-seater cabin monoplane fitted with folding wings and is powered by a 55 h.p. Walter "Micron" engine. It is capable of carrying a load of 430 lb., has a cruising range of 320 miles, a top speed of 101 m.p.h., and cruises at 85 m.p.h.

## The "America"

A NEW United States Lines flagship *America* is being built at a cost of £3,687,500 by the Newport News Shipbuilding and Dry Dock Co., at Newport News, Virginia. It will serve as companion ship to the S.S. *Washington* and S.S. *Manhattan* in the North Atlantic service and will replace the historic *Leviathan*.

The *America* will have a load-draft displacement of about 34,000 tons, and accommodation for 1,219 passengers and 639 crew. She will be 723 ft. in length.

## Remarkable X-ray Apparatus

WHEN the Duchess of Gloucester recently opened the new building of the Charterhouse Rheumatism Clinic at Weymouth Street, London, she saw a demonstration of an X-ray apparatus which has the world's greatest coverage. Although used never more than 20 in. away from a patient, it can cover the entire trunk of an adult and can penetrate clothing, none of which is removed during treatment.

This apparatus was invented by the



The new Thornycroft motor torpedo boat which reached a speed of 41 knots in her trials

which is unable to maintain a navy of major power.

The vessel has three 12-cylinder petrol marine engines developing 1,800 h.p., carries two torpedo tubes, depth charges and light anti-aircraft guns. The guaranteed speed is 39 knots, but the boat has attained a speed of 41.1 knots (47 m.p.h.) in her trials.

## More Streamlined Locomotives

THE L.M.S. are going to construct 20 more streamlined locomotives, of the type which is accompanying the Coronation Scot train on its exhibition tour of the United States.

## An Electro-encephalograph

THE above astounding name has been given to an instrument which was recently demonstrated at the National Hospital in Queen Square, London. It is capable of "seeing" inside the brain, and

for the opening of regular transatlantic passenger flights starting in mid-June. Two coast-guard boats will be used, the *Chelan* and the *Champlain*.

A radio meteorograph will be attached to a balloon, and sent skyward from each of the two ships daily. They will soar higher than an aeroplane can fly, recording pressure, humidity and temperature, which will be sent back to the ship by radio. A theodolite used on board ship will record the direction and velocity of the wind. All weather data will be computed immediately on the ship and relayed to weather stations and transatlantic planes. A parachute is attached to the meteorograph to carry it to earth after the balloon explodes in the upper atmosphere.

## New Baby Plane

MOST readers will remember the *Luton Minor Light Aeroplane*, the construction of which was given in our issues dated October 1937 to March 1938. The firm who designed this plane, *Luton Aircraft, Ltd.*, have now produced a new baby training plane which they have called the *Luton Major*. This new machine has



Demonstrating the unique apparatus for administering the "deadly" X-rays as a tonic at the Charterhouse Rheumatism Clinic.



# THE WORLD OF INVENTION

director of the Rheumatism Clinic so that he could use the "deadly X-ray" as a tonic and healing ray in the same way as sun rays. Hitherto, without this special equipment, the X-rays were considered extremely dangerous and elaborate precautions were taken to prevent operators from coming into continual contact with the rays and to prevent the patient from receiving an overdose.

## Robot Trains

EACH hour, beneath the streets of London, forty trains without a human being aboard rumble along underground tunnels carrying nothing but letters. It is London's robot post office railway. These trains run through 6½ miles of tunnels, 90 ft. below ground level. There is no other railway like it in the world, and besides speeding up the delivery of mail, it helps to reduce the vehicular traffic on London streets. The trains, which are electrically controlled from switch cabins, usually consist of two cars, each containing four mail-bag containers, with average capacities of 15 bags of letter mail and 6 bags of parcel mail. They run at an average speed of 35 m.p.h. and stop automatically.

## Insulating Against Noise

THE National Physical Laboratory are carrying out large-scale experiments in an endeavour to perfect a building structure which will provide adequate insulation against both air-borne and impact sounds. Floors on the "floating" principle are used, together with a special type of double walls which are separated from each other, the inner walls resting, not on the "floating floor," but on the structural floor beneath it. The doors and windows are also double.

## New Diesel Engine Train

AN L.M.S. streamlined engine train recently began regular passenger service between London (St. Pancras) and Nottingham and intermediate stations. It has replaced steam trains which used to operate on this route and provides London with its first diesel-engine train passenger service.

The new train consists of three cars linked together on the articulated principle, weighs 73 tons and seats 24 first-class and 138 third-class passengers. Powered by six Leyland engines, each developing 125 h.p. at 2,200 r.p.m., it is capable of a speed of 75 m.p.h.

## New Biblical Link

PROFESSOR MONTET, of Strasbourg University, M. Drioton, the Director-general of the Service of Antiquities, and M. Fougerousse, the French architect, have made some sensational discoveries in Egypt, which are considered the most important since the finding of the tomb of

Pharaoh Tutankhamen. About 400 sq. yards have been excavated to a depth of 40 ft. on the site of the ancient city of Tanis, which many hold was the point from which the Israelites started their exodus to the Promised Land. It was the capital of the Pharaohs in the Delta between the 18th and 13th centuries B.C. Professor Montet said that he had found two chambers which had been pillaged, except for small figures, a large marble statue, and two presumably royal coffins of basalt and granite.

Further investigations led him to the chamber of Pharaoh Psusennes, which, however, now proves to contain the mummy of Pharaoh Shishak and not that of the king. It was Shishak who plundered the Temple of Jerusalem in the reign of King Rehoboam.

The walls of the chamber, which are about 15 ft. by 8 ft., are richly adorned with coloured reliefs and inscriptions, including the cartouche of Pharaoh Psusennes. The latter find was the cause of the mistake in the identity of the kings.



A new type of diving suit which has been tested to withstand external water pressure at 2,000 feet.

## New Diving Suit

CYRIL VON BAUMANN, a lecturer and writer, recently made a 60-ft. test dive at Toms River, New Jersey, U.S.A., in a new type of diving suit that requires no outside help. A cylinder containing a mixture of oxygen and helium is fitted inside the suit and this is operated by the diver whilst under water. The diving outfit has been tested to withstand external water pressure at 2,000 ft.

Von Baumann's experimental activity may determine the possibility of exploring the depths of the ocean in greater comfort and safety. Dr. Beebe has previously ex-



Major Muir holding an air-mine attached to a meteorological balloon. The balloon in the picture has only been inflated to a quarter of its size.

plored the bed of the ocean in a device shaped like a diving bell. It was called the bathysphere and was capable of reaching a distance of 3,000 feet below sea level.

## An "Air Mine"

MAJOR H. J. Muir, of Southampton, has invented the newest form of defence against air attack in the form of an "air mine." Major Muir has been working on his invention for two years. The device consists of a high-explosive bomb, which has four detonators. It is suspended by a 40-ft. wire from a small balloon.

## A True Vacuum

THE word vacuum has been applied to a number of devices such as brakes, lamps, cleaners, etc., but actually no one has produced what is considered a true vacuum.

It was calculated that the nearest approach to a vacuum contained 1,640,000,000 molecules or separate particles of gas per cubic inch, but they are so minute that they are invisible even under the most powerful microscope.

## World's Largest Battleships

IF the necessary funds can be raised, there is a likelihood of America building what may prove to be the world's largest and most powerful battleships.

## A "Mystery" Engine

FROM America comes the news that they have produced a new 500 h.p. super-light aeroplane engine, which is declared capable of driving a light bomber 12,000 miles non-stop.

Less than one-third the weight per horse power of present aeronautical engines, it scales at 412 lb. It is able to operate at cruising speed for an hour on eight gallons of third-structure petrol, it is four times as economical as the performance of current plane motors with 100-octane fuel.

The mystery engine contains only 30 moving parts, is full and rotary in principle, runs on five ball bearings and needs no pistons, connecting rods or cylinders. An all-metal two-seater attack bomber is being built for the engine.

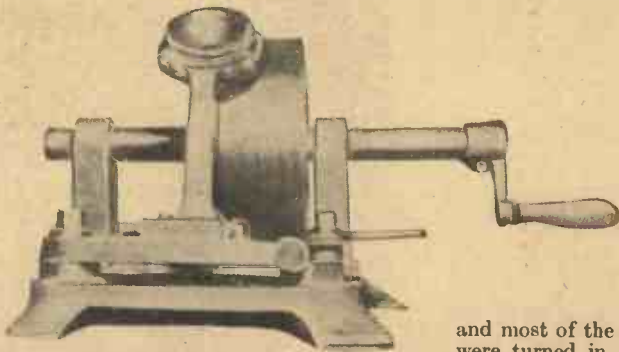

Fig. 1.—The first hand-operated model of the "gramophone" as completed in 1881 by Mr. Tainter and his associates. It was the forerunner of commercial sound recording.

**T**HE system of recording sound on a wax cylinder, which made the phonograph, the gramophone and the dictating machine practical propositions, dates back over fifty years.

It was in 1881 that Charles Sumner Tainter and the famous Bell, the inventor of the telephone, evolved in collaboration what they called, to use their own words, "the first practical phonograph."

Their original model was placed in a hermetically sealed container and deposited in the Smithsonian Institute at Washington. There it remained until 1937, when the case was opened in the presence of representatives of Tainter and of the descendants of Graham Bell. Mr. Tainter, who is still living in California, was unable through feeble health to be present at the opening ceremony.

The machine found in the container had a "hill and dale" track, that is to say the record was cut vertically on the surface of the wax cylinder. There was also an electro-plated metal "master" of a laterally cut groove on a wax disc, the forerunner of the modern gramophone (see Fig. 1).

It is a remarkable and little known fact that the inventors at first visualised the new machine as a means of dealing with business dictation. That was how it appealed to Edward D. Easton, who, after seeing the machine demonstrated at an exhibition, became so enthusiastic about its possibilities that he formed the famous Columbia Gramophone Company to market it. Easton was at the time a New York reporter, and he subsequently became the president of the Columbia Company.

For a time the early machines were sold for business purposes. Later the phonograph entered upon its remarkable development as a means of musical entertainment,

and most of the energies of the proprietors were turned in this direction, though the dictation machine side of the business was never wholly neglected.

Until 1907 the dictating machine was known as the "office Graphophone," and as such was marketed by the Columbia Company. In that year the new name "Dictaphone" was coined—by an Englishman, curiously enough. The new name proved attractive and the real advance of the Dictaphone system dates from that time.

So far as the British Isles are concerned the progress of the dictating machine in business (see Fig. 2) has been due entirely to the efforts of three brothers, Messrs.

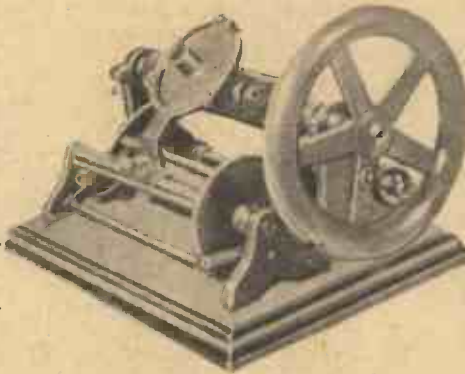

Fig. 2.—The first commercial dictating machine. It was hand driven.

Thomas, William and James H. Dixon. Mr. Thomas Dixon formed the Dictaphone Company Limited in 1909, and was the first managing director, with his brothers as fellow-directors. The company in 1911 moved from Oxford Street to its present headquarters at Kingsway House, London, and branch offices were soon established at Manchester, Birmingham, Glasgow, Liverpool, Leeds, Bristol, Newcastle-on-Tyne, Dublin and Belfast.

# How The

## Until 1907 The Dictating Machine Graphophone," But In The Same Year An Word "Dictaphone" And The Real System Dates From That

### How Speech is Recorded

The actual recording of speech on the wax cylinder of the dictating machine, though a natural marvel, is really very simple.

Air vibrations set up by the voice travel along the speaking tube (Fig. 3), and impinge upon the upper surface of a flexible diaphragm of mica. To the lower surface of the diaphragm, and resting on the surface of the revolving cylinder, is a tiny cutting tool of sapphire, the recorder point, which is ground into cup form with a very keen edge.

The air waves, striking the diaphragm, set it in vibration in the vertical plane. The vibrations are thus conveyed to the recorder sapphire, which cuts in the surface of the cylinder "hill and dale"—that is vertical—indentations corresponding in depth to the vibrations set up in the diaphragm of the air waves.

As the cylinder revolves, the "carriage" which bears the recording mechanism is drawn forward by a feed screw, with the result that the recorder point cuts a spiral groove from one end of the cylinder to the other. The depth of the cut is very shallow—little more than the thickness of a cigarette paper—but even so the indentations follow with extreme fidelity the vibrations of the diaphragm.

This is exactly the process followed in making a gramophone record, except that a flat wax disc is used and the diaphragm is set vertically so as to impart a lateral movement to the recorder. The great advantage of the disc record is that an electro-plated metal "master" can be used to press records, while cylinders have to be moulded, a far slower and less satisfactory process.

### Speech Improved

To make the voice of the dictator audible and enable the typist to transcribe the dictation, the recording process is simply reversed.



Fig. 3.—(Left) The dictating Dictaphone for desk use. Fig. 4.—(Right) The recorder reproducer on the dictating machine.

# Dictaphone Works

Was Called The "Office Englishman Coined The Advance Of the Dictaphone Time

For the cutting point of the recorder is substituted a tiny sapphire reproducer jewel, ground to a ball point and, like the recorder, fixed to the under surface of a similar diaphragm. When this is brought into contact with the revolving cylinder the ball point faithfully follows the indentations made by the recorder in the wax, and transfers exactly similar vibrations to the diaphragm and through it to the air. They then become audible as sound and the voice of the person dictating is clearly reproduced.

That, in simple form, is the actual process of recording and reproducing speech by means of the Dictaphone (Fig. 4). Various refinements are necessary, however, to enable the machine to be used for commercial purposes.

Of these, the most important is the clutch mechanism for starting and stopping the cylinder, so that it shall revolve only when the dictator is actually speaking, and shall "wait for him" when he pauses to consider what to say next. If the machine ran on unchecked it is obvious there would be blank spaces on the cylinder which would lead to waste of material and delay in transcribing.

The machine is driven by a small electric motor of the "universal" type, operating on any circuit, direct or alternating, from 32 volts to 250 volts, an easily adaptable resistance being set according to the voltage of the current. Where no electric supply is available, a 30 v. accumulator is used. The motor, once started, runs continuously, but the mandrel on which the cylinder is carried remains stationary until the clutch mechanism puts it "in gear," exactly as in the case of a motor car "idling."

When the dictator is ready to speak he presses the clutch control button placed on the speaking tube and operated by a finger (see Fig. 5). This, by means of a Bowden wire connection, sets the cylinder in motion. As long as he is actually speaking the dictator keeps the control button

depressed; when he pauses, he releases it and the cylinder stops. Since the cylinder only revolves when the dictator is actually speaking, the spiral groove is filled from end to end with dictated matter. The recorder point travels along the entire length of the cylinder in about twelve minutes, so that each cylinder will take about 1,200 words at average dictation speed.



Fig. 5.—The control button which operates the clutch mechanism.



Fig. 7.—The transcribing Dictaphone.

three positions. Pulling the lever forward sets the recorder in place for dictation. Set in the centre the recorder mechanism is out of gear and the carriage can be moved forward or back as desired. When the lever is pushed back the recorder point is lifted clear of the cylinder and the reproducer point comes into play.

When the dictator wishes to hear what he has dictated he pushes the recorder control lever from front to back. This automatically "back spaces" the carriage, and by putting the mouthpiece of the speaking tube to his ear he can listen to the last ten or twelve words. If he wants to hear more than this he sets the recorder lever to "neutral," slides the carriage back and then pushes the lever to the reproducing position. Having listened to the end of the dictation he simply pulls the lever forward and proceeds with his dictation.

Corrections are sometimes necessary after matter has been dictated. These are simply spoken to the machine but are signalled to the transcribing typist by a device known as the automatic indicator (see Fig. 6). This is a small key which, when depressed, marks a line on a strip of sensitised paper known as the dictation slip. This slip, placed on the front of the machine, is divided up by a numbered scale corresponding to a similar scale on the typist's machine. When the dictator wishes to make a correction he depresses the key and dictates the change desired.

The filled cylinder is sent to the typist with the dictation slip. She sees the mark indicating a correction, finds the place on

Occasionally, especially if interrupted during dictation, the dictator will desire to hear what he has said.

On the dictating Dictaphone the diaphragm bears both recorder and reproducer points, only one of which can touch the cylinder at a time. This recording-reproducing mechanism is controlled by a small lever set at the top of the machine and has

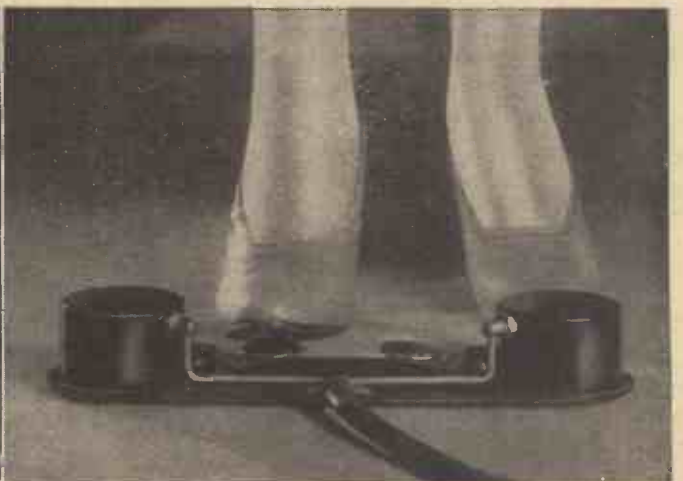

Figs. 6 and 8.—(Left) The automatic indicator. (Right) The Duplex foot control.

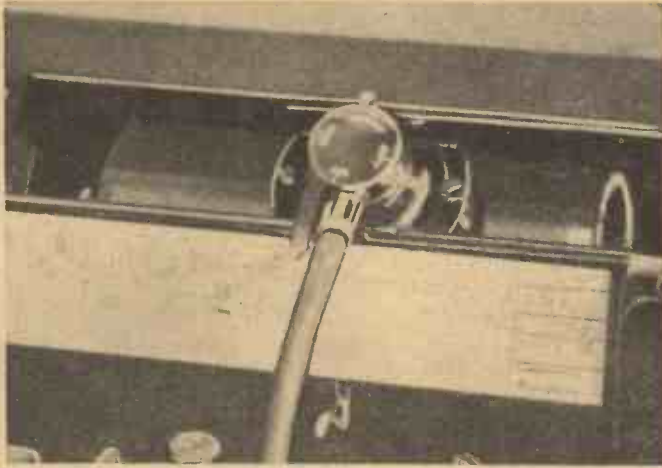

Fig. 9.—The automatic indicator and volume control on the transmitter Dictaphone.

the cylinder by means of the scale and listens before she begins to type. She is then aware exactly what change has to be made in the dictated matter.

#### Transcribing the Cylinder

When a cylinder has been filled with dictation, or at any time if the matter is urgent, it is sent with the dictation slip and any necessary papers to the typist for transcription.

She places the cylinder on the mandrel of the "Transcribing Dictaphone," which is similar in general construction to the Dictating Dictaphone but is fitted with a reproducer only, not a recorder (see Fig. 7).

This machine "talks back" the dictated matter and the typist, listening through a suitable head-piece or hearing tubes, listens to the message and types direct from the actual spoken words.

No typist, of course, could type at the speed of dictation, so provision is made for her to start and stop the machine at will.

Beneath her foot is the Duplex Foot Control, a device fitted with two plunger discs set side by side. The first of these, when depressed by the foot, starts the cylinder and the typist listens. Having heard a few words the typist raises her foot, the machine stops and she types what she has heard. Then she starts the machine again and the process is repeated, the machine alternately starting and stopping, until the whole of the dictation has been transcribed. A proficient operator rarely stops typing to listen because, as she finishes the last word or two she has heard, she is also listening to what is coming next and so typing is virtually continuous

Thanks to the control the fastest dictation causes no more difficulty than the slowest, since the typist can always control the speed of reproduction to suit her own typing ability. She can also increase or reduce the volume of sound and change the pitch of the voice until it is most agreeable to her ears.

Should the typist fail to hear a word she taps the second disc on the Duplex

Fig. 10.—The shaving machine head showing the "gate" open.

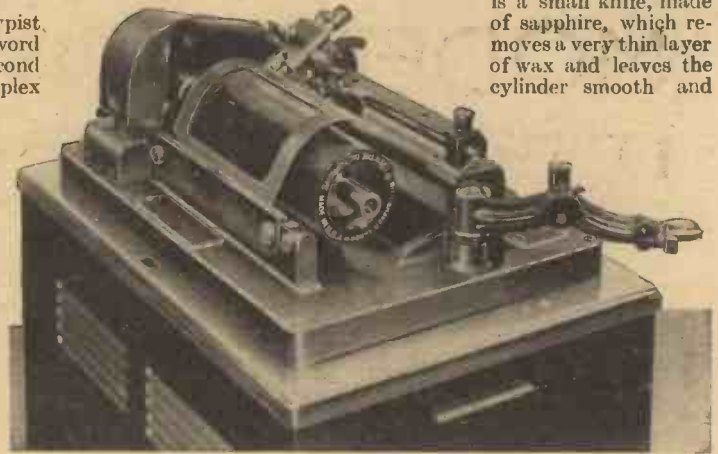

Foot Control (see Fig. 8). This automatically "back-spaces" to the extent of a dozen words or so, which are then heard again as often as may be necessary. When the typist has finished a letter she can move the reproducer back to the beginning, and listen to the entire message again while reading her transcript to make sure of its positive accuracy.

There can be no doubt that the abolition of shorthand writing through the use of the

dictating machine (Fig. 9) is a great relief to the typist. Shorthand writing at speed is strenuous work. Moreover, it occupies a great deal of time which, with the dictating machine in use, can be devoted either to typing or to some other office work. There are, also, far fewer mistakes when the typist has no shorthand to decipher, and can repeat the dictation words as often as may be necessary to secure absolute accuracy. It has been ascertained by repeated test that the Dictaphone operator can produce from 1,000 to 1,100 lines of typing daily without undue strain, whereas with shorthand from 500 to 600 lines is a good day's work. In a speed and accuracy contest staged by the Dictaphone Company, the winning typist transcribed for twenty minutes from Dictaphone dictation at a speed of 280 ten-word lines an hour.

#### "Shaving" the Cylinders

When the dictated cylinder has been transcribed it may, if of sufficient importance, be kept as a matter of record, but in ordinary practice it is "shaved" for use again (see Fig. 10). The shaving machine is virtually a small, electrically driven lathe. In the holder, which moves from right to left along the length of the rotating cylinder, is a small knife, made of sapphire, which removes a very thin layer of wax and leaves the cylinder smooth and

polished, ready for use again. The shaving of the cylinder takes only about 30 seconds.

When the knife is in the normal position at the left of the machine the "gate" at the other end is opened and, the cylinder having been placed on the mandrel, is closed and latched (see Fig. 11). The knife is now just clear of the left-hand end of the cylinder. At the side of the knife is the set gauge rod which is fitted with a broad, flat end, with the knife projecting very slightly in front of it.

The set gauge rod is pressed down till it just touches the surface of the cylinder, locked into position and then withdrawn automatically by a light spring. This leaves the knife sufficiently advanced for what is known as the primary cut.

When the carriage is raised and moved to the right-hand end of the cylinder for the shaving operation to begin, the current is automatically turned on and the knife travels along the whole length of the cylinder, taking off a layer of wax to a depth, automatically determined, of .00075 inch. As soon as the knife reaches the end of the cylinder the current is automatically turned off and the machine stops.

Usually one shaving is sufficient but, should a second be necessary, moving the knife again to the right-hand side of the machine automatically advances the knife .005 inch. Each cylinder can be shaved approximately 100 times before it becomes too thin for further use.



Fig. 11.—Setting the shaver blade.



The 18ft. Rytecraft "Folcanu" on the Thames equipped with an Evinrude Motor. The Rytecraft canoe motor bracket is shown in operation together with one of the larger motors available. For 1939 there is a wide range of outboards, both Elto and Evinrude, for canoes ranging from 9 lbs. in weight and £9 in price.

## MODERN CANOE DESIGN

**D**URING the last few years there has been some small measure of advance in canoe construction, but not until the coming of the "Folcanu" have scientific principles of construction combined to develop and immeasurably add to the merits of the early types of canoe.

In place of a hard brittle skin 5-ply, rubberised canvas is used. This is tough, water and rot-proof, whilst the stem and the stern are of soft rubber vulcanised to the skin. There is fabric decking at each end and at the side, whilst the open portion, in which two people can sit, with plenty of space to spare for camping requisites and other odds and ends, is surrounded by a coaming which forms a breakwater at the forward end, so that flying spray or rain literally runs off "like water on a duck's back."

Hitherto canoes have been kept small partly to obtain reasonably light weight and portability, but the desirable length of 18 ft. is now feasible because the ash framework, which is manufactured by men skilled in cabinet making, is designed to be taken apart and fitted together again with amazing facility. Deterioration is indefinitely postponed, for all metal fittings are non-corrosive and no aluminium is used.

### Stability

The stability of any boat of a given length depends largely upon the proportions of beam to draught. In the case of the "Folcanu" these are ideal, the width being 34 in. and the draught 4 in., whilst the distance between the cockpit coamings is 23 in.

Although the weight is only 75 lbs., the transport of even an 18ft. craft can be something of a problem, but all difficulties in this connection have been solved definitely by designing the "Folcanu" so that it can be packed in two waterproof canvas carrying bags enabling it to be handled with no more trouble than would be occasioned by a couple of small suit cases.

The opportunities for using craft of this kind are almost unlimited, and no effort of the imagination is needed to realise that a "Folcanu" is not only ideal for those who

take canoeing as a serious sport and require the best craft that science can devise, but it is equally well suited for those who enjoy camping, or wish to have a serviceable boat with them when they are touring in a motor-car, so that they can explore any section of sea coast which may take their fancy, or investigate the delights of some remote river, loch, lake or canal.

In slifort, ownership of a "Folcanu" carries with it the freedom of the water.

### Motor or Sailing Boat

The British Motor Boat Manufacturing Co., Ampton Street, London, W.C.1, is

---

### A CANOE THAT CAN BE CONVERTED INTO A SPEEDY MOTOR BOAT OR A SAILING BOAT

---



The Elto "Cub" outboard motor which can be fitted to a canoe.

responsible for the remarkably successful design of the "Folcanu."

They also realise that although paddling is a delightful and healthful exercise, there are many owners who prefer to take their pleasures afloat with still less exertion and for this reason the "Folcanu" has been developed in other directions. For example it makes a delightful sailing boat and the sail complete with mast, boom, gaff and halyard costs only 37s. 6d., whilst lee-boards can be fitted easily.

Another attractive possibility is the conversion of the "Folcanu" into a speedy motor boat. This can be accomplished in under two minutes by the use of an outboard motor bracket, upon one end of which the power unit is carried. An ideal outfit for this job is the well-known Elto "Cub." This unit is entirely self contained and remarkable as it may seem it weighs only 14 lbs. ready to run, whilst the price is £9.

Steering is carried out by the outboard tiller supplied with the engine, or alternatively a rudder can be fitted and here again great ingenuity enters into the design of even such a simple fitment as this, for not only is it arranged for use with hand lines, but foot control is also provided. In the event of beaching the "Folcanu" the rudder is arranged to tilt, so that it cannot be damaged even if it is handled carelessly.

Every item of this canoe speaks of the vast amount of care and attention which has been given to every detail, not only in the matter of design, but in regard to workmanship which should make every owner proud to possess such a craft.

### Performance

In really rough water there is never cause for anxiety, for the stability of the "Folcanu" is remarkable. The speed which can be obtained with little effort is another cause for surprise to those who have never handled a craft of this type before, whilst the seats and back rests are fitted at just the right angle to combine the maximum amount of support and comfort. Last, but not least, are the attractive colours in which these canoes can be obtained.

# HEAT TREATMENT OF TOOL

## High Carbon-High Chromium Die Steels

WHILST on the subject of steels, which are essentially die steels, it would be most opportune to discuss a highly alloyed quality. A very popular steel is the high carbon-high chromium type, containing 2.0%-2.25% carbon and 12%-14% chromium. Given proper attention during heat treatment, this steel does not show any appreciable movement or distortion, but rapid heating and under soaking result in very serious distortion. Because of the high proportion of chromium carbide in the steel, the soaking times must be carefully controlled as the solution of this constituent is rather sluggish. It has been found that at least 1 hour per inch of thickness is necessary, but excessive soaking results in alarming grain growth. The temperature range (950° C.-980° C.) should be strictly adhered to and must not exceed the upper limit, otherwise the grain size will be seriously affected. The steel is generally quenched in oil, taking all the usual precautions to prevent distortion. However, in certain cases where design or size makes quenching inconvenient, or difficult, and where intense hardness is not required, cooling in a strong air blast is sufficient to give a Rockwell hardness of 55-58 "C" Scale, as against 66 "C" Scale with oil quenching. Care must be taken in cooling with air blast that the rate of cooling is the same in all parts of the tool. Tempering again depends upon the ultimate purpose of the tool. Temperatures of 150° C.-200° C. will be found to be sufficient to relieve stresses without reducing the hardness, but where the hardness must be reduced, tempering can be carried out at temperatures up to 550° C. depending upon the hardness required. Whilst this steel has not at any time a high toughness value as interpreted by Izod figures, it will be found that tempering for short periods at the higher temperatures will give better results in this direction than long periods at very low temperatures.

### Highly Polished Surface

Since this steel is very susceptible to grinding cracks when in the hardened and tempered condition, some die manufacturers finish their products with a mirror-like polished surface, and as any hardener who has been faced with such dies knows, these jobs are veritable nightmares, since the manufacturer expects the tools back just as he sent them. The most satisfactory method found in the works to which the writer is attached is to pack the articles in a small carburising box or welded box of heat-resisting material, using spent charcoal as the packing medium. The soaking period is then greatly increased, and as the sizes of boxes and tools vary, there can be no hard and fast rules, but experienced hardeners will soon become familiar with the method. When the boxes are brought from the furnace they are opened, and the articles gripped with suitable tongs and quickly quenched. Thus they are exposed to the air for a minimum amount of time. When there are a number of articles in the same box, it is advisable to have the help of assistants. This method will be found to give astonishing results, and all that will be necessary, after suitable tempering with similar precautions, will be a light polish of the tool faces.

## STEELS—No. 2

With Special Reference to Highly Alloyed Types  
By L. Price

### Finishing Steels

The next steel to be discussed is a "finishing steel," so called because of its use



× 450 High-speed steel correctly hardened.



× 450 High-speed steel correctly hardened and tempered.



× 450 High-speed steel grossly overheated. Note presence of eutectics due to incipient fusion.

in trimming tools, to impart a "high finish" to the product. The carbon content is about 1.5%, tungsten about 4%, and chromium about 5%. This steel is a water-hardening quality, requiring a hardening temperature of 830° C.-850° C. For good results, it is absolutely essential with this steel that heating, soaking, and quenching be carried out with extreme care, otherwise broken tools will easily outnumber the good ones. Drawing dies, etc., which have holes through them must be treated with special precaution. This steel hardens intensely (67 "C" Rockwell), but it does not always harden throughout. This depends, of course, on the section. In other words, there is developed after heat treatment, a hardened case with a soft, tough centre. The depth and uniformity of the case depend entirely upon the observance of the above points. A light tempering at 200° C. is essential immediately after, or just before the tool reaches room temperature, in order to relieve the stresses.

An extremely useful property of this alloy is its expansion hardening. This is particularly useful with drawing dies. When a die has worn to its limits, it can be normalised and re-hardened. It will then be found that the hole has shrunk, so that it can be polished to size, or some required size again. This process may, with care in heat treatment and judicious use of the die, be repeated as many as six times before the die finally breaks or before the bore becomes too large. When carrying out this process, attention should be paid to normalising. It must be remembered that this steel hardens intensely and not throughout, and consequently is very highly stressed. Sudden changes in temperature, and resulting expansion, are liable to cause bursting. Hence the heating for normalising, which is, of course, to remove the stresses, should begin at a fairly low heat.

### Hot-Forging Die Steels

There are quite a number of members in this class, but the heat treatment is essentially the same for all, there being only a slight variation in the hardening temperatures. The differences in analysis are not great, but they do impart certain special features which in turn depend upon the heat treatment for good results.

The carbon content is about 0.30%, tungsten 8-9%, although some of the steels have a much lower tungsten content, and chromium varies between 2% and 4%. Some of these alloys have small additions of vanadium and molybdenum and about 4% of nickel. These latter elements are present either singly or in various combinations depending upon the ultimate purpose of the steel.

Preheating at 800° C. is advisable, since the hardening range is 1100° C.-1200° C. The steel is usually oil quenched, although air-hardening gives a very satisfactory hardness. The hardness after quenching should be about 470-500 Brinell. Tempering is necessary to reduce stresses, but where the hardness has to be lowered, it will be found that no appreciable change is effected until a temperature of 650° C. is reached. It has been noted that in the majority of cases a Brinell hardness of about 350 gives very satisfactory results, but the user of the steel would be well advised to consult the manufacturer when in doubt.

A reasonable tolerance for finishing  
(Continued on page 422)

# Commutator Building

By A. H. Avery, A.M.I.E.E.

## When Building A Dynamo The Construction Of The Commutator Presents The Most Difficulty To Those Unaccustomed To This Type Of Work

Of the various items connected with the mechanical work in small dynamo and motor construction, commutator building is perhaps the one presenting most difficulty to those unaccustomed to handling this special work. The commutator is a composite structure made up partly of different metals and partly of insulating material,

follow these irregularities of surface sufficiently rapidly to maintain the necessary pressure on the commutator needed to collect the current sparklessly.

### A "Spongy" Commutator

These may seem very insignificant details to those whose chief interest lies in

each segment being held by short screws or even brass pins. Such weak mechanical construction nearly always results in the commutator flying to pieces at high speeds, while neither wood nor ebonite make a suitable mounting for the segments as the one is liable to split and the other to soften with heat. A far simpler and better construction for 2-part and 3-part commutators is to drive the metal tube on to a centre bush of "horn fibre," and make shallow sawcuts across the ends into which thin strips of brass can be driven and soldered (Fig. 3).

### Brush Contact

Disc-type commutators can be likewise built up of brass or copper rings held to a horn fibre disc at the back by countersunk screws, and afterwards divided into the required number of segments by a narrow slotting saw. Insulation between the segments is unnecessary in such small commutators as long as the sawcuts are narrow, in fact it is often detrimental, as it is likely to become displaced at high speeds and prevent the brushes from making proper contact.

Commutators having a larger number of segments, and especially those intended for use on higher voltages, do not lend themselves to this method of construction. The need for a large number of segments is not present when working on low voltages, but on commercial voltages such as 200 to 250 good commutation can only be secured by sub-dividing the armature winding into a large number of coils, and as each coil needs one bar in the commutator, multi-section commutators from 24 to 48 bars or more are found on all machines running at normal speeds and of fractional horsepower sizes. Between the main brushes on any commutator it is usual to allow not more than 15 or 20 volts between adjacent segments; more than this leads to pronounced sparking tendencies, especially at abnormally high speeds. To secure a perfectly rigid construction employing such a large number of bars, each one adequately insulated from all its neighbours as well as from the hub or sleeve upon which it is mounted, is no easy task. Especially is this the case when one realises that no distortion or loosening of the segments, due to centrifugal effects at high speeds or expansion due to high temperatures, must arise. There is

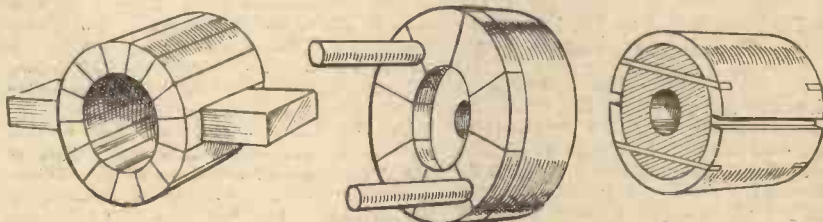

Figs. 1 to 3.—(Left) The barrel type of commutator. (Centre) The disc type, and (right) a simple method of making 2-part and 3-part commutators.

the tooling speeds and cutting angles suitable for the one not always suiting the other, in fact, both in the selection of material and in the machining operations a compromise is often essential.

The function served by the commutator in a dynamo or motor is, of course, to enable the currents flowing round the coils connected to its bars to be picked up by stationary contacts, namely the brushes. At the high speeds with which commutators mostly rotate this contact between the sliding and the fixed member must be as intimate as possible, and the intervals of time between first and last contact of each bar with the brush as unvarying as possible. Irregular contact periods with the bars must inevitably give rise to sparking tendencies at the brush tips, and if sparking is present to any pronounced extent, the edges of the bars become burnt and roughened, aggravating the trouble.

### The Segments

One of the first essentials, therefore, in building a commutator, is to ensure that all the bars or segments of which it is composed, and also the insulation separating them, are identical in thickness. The second and equally important point is to see that the commutator surface is truly cylindrical, and also truly concentric with the bearings. The latter point is not always appreciated. A commutator may be turned up to run perfectly true on its own armature shaft when running between centres, or even on a separate mandrel, but it sometimes happens that the shaft centres are not true with the bearing journals, either from the shaft being slightly bent, or the lathe centres not being formed to a standard angle; a transference from one to the other in the latter case often puts a shaft decidedly out of true, as well as the commutator which is mounted upon it. A commutator which is mounted eccentrically on the shaft will cause the brushes to rise and fall slightly in their holders when it is running, and as the brushes themselves possess a certain amount of inertia they may not be able to

toys and the very small machines used with low-voltage batteries, but their importance is real and needs no stressing if the best possible performance is aimed at, and the machine is intended for long trouble-free service. Not only is a true running surface essential, but complete rigidity of construction as well. A loosely built or "spongy" commutator will most certainly become

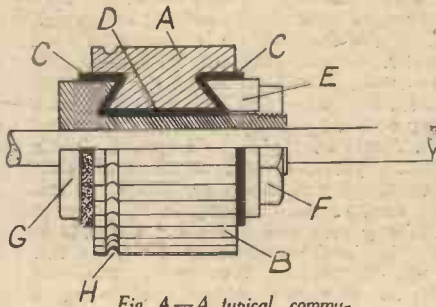

Fig. 4.—A typical commutator assembly shown in part section.

distorted in shape when running at high speed and at full temperature, however true it appears to be when cold. It then becomes a hopeless proposition in actual service.

Owing to the multiplicity of parts and their varying nature it is not too easy to build a satisfactory commutator without considerable experience, and the following hints are for the guidance of less experienced workers in this direction. Beginning with the simplest example, such as those used with electrical toys, there are two distinctive forms: the barrel type (Fig. 1), and the disc type (Fig. 2). In the former the brushes bear on the outside diameter either radially or tangentially, while in the latter they press on the end face. In earlier times it was the custom to make up barrel-type commutators by driving a piece of brass tube on to a hard wood or ebonite centre, and afterwards slotting it with radial cuts into as many segments as were required,

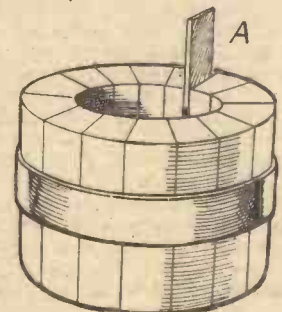

Fig. 5.—Copper bars held together by a rubber band to facilitate assembly.

only one way to secure satisfactory results, and that is to select the right materials and build them up in the right manner. These materials, which are the only ones that can be relied upon for commutator construction, are: (1) Hard drawn copper for the segments; (2) Soft amber mica for the insulation; (3) Steel clamping rings and nuts to hold the assembly together, and (4) a steel sleeve or hub for mounting the whole on the shaft.

#### Commutator Assembly

A typical commutator assembly is shown in part section in Fig. 4. The hard drawn copper bars, A, are first cut to length and arranged upright on a level bench, being held together by a stout rubber band round the middle, (Fig. 5). The taper of the segments is such that when the correct number is assembled they fit together accurately without any appreciable gaps either on the inside or the outside diameters. Pieces of mica, equal in number and of the same radial width as the bars, are next cut and gauged to a definite thickness of 0.030 in. and inserted between segments one by one as at A in Fig. 5, spreading the bars momentarily for that purpose. The assembly is next compressed to the utmost extent by forcing it into a stout steel ring, having a slightly tapered centre hole, under a press, (Fig. 6). It is better to press the steel ring on while hot, as its natural contraction when cold will then further aid compression.

#### Avoid Short Circuits

The ring is then mounted in the lathe and the interior of the segments bored and the end recesses formed to an angle of 45

degrees for the clamping rings, every care being taken to avoid burring the copper over from one segment to the next, or short circuits will be set up, which are very difficult to get rid of. Having prepared the steel sleeve G, with its head undercut to a similar taper, and the loose clamp ring E and nut F, the whole structure is ready to

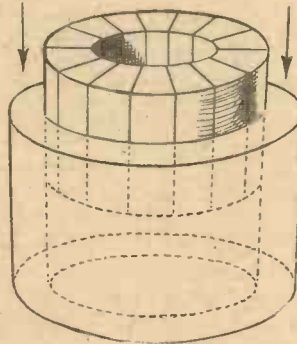

Fig. 6.—The bar assembly being forced into a stout steel ring.

build up on its sleeve. Moulded mica or micanite cones CC, 0.060 in. thick are inserted at each end of the commutator recesses, and a mica sleeve D of similar thickness slipped over the sleeve G, to fill the space between the segments and the hub. Then place the loose clamp ring E in position and tighten up the nut F as hard as possible while the commutator is quite hot. Press the outer ring off and the rest of the work can be done on a mandrel between centres, skimming the outer surface

and ends perfectly true. A U-shaped recess is generally formed at H to separate the brush face from the soldered armature connections, a diagonal sawcut being made in the centre of each segment to receive the armature connections. Finish the surfaces with a dead-smooth file, followed by finest glass-paper. Emery paper must on no account be used as the grains may become embedded in the copper and play havoc with the brush faces when working. If a "Megger" is available all the bars should be tested for insulation resistance, and show a resistance of at least one megohm from bar to bar, and from all bars to sleeve. Commutators used on commercial voltages are usually flash-tested as well with a high-voltage transformer, the standard test being 1,000 volts plus twice the working voltage applied for a period of one minute.

#### Low-Voltage Machines

On low-voltage machines employing copper-carbon brushes, and especially on high-speed machines, it is good practice to undercut the mica insulation between the copper bars to a depth of 1/32 in. on the brush track. This requires considerable care not to leave any fins of copper short-circuiting segments together, or any loose flakes of mica at the sides to trip the brushes. When carefully done, however, it improves the performance to a marked degree, avoiding many troubles likely to arise from uneven wear between copper and mica insulation leading to the fault known as "high mica," which prevents the intimate contact between the brushes and the commutator face, so necessary to secure sparkless commutation.

## HEAT TREATMENT OF TOOL STEELS

(Continued from page 420)

should be left on the dies and punches, etc., since this steel is somewhat prone to scaling. A useful method of minimising this trouble is to "paint" the article with a paste (made with water) of china clay and powdered charcoal in equal parts. The hardness is not affected by the paint, and should it adhere it can be easily removed by a strong wire brush. Provided the steel is tempered back to a suitable hardness, it is one of the most trouble-free.

#### High-Speed Steels

Finally, we must deal with high-speed steels, and although the treatment may seem straightforward, the number of questions that might be raised are far too many to consider here. There are several types of high-speed steel, but the precautions to be taken are essentially the same and are necessary to each quality. The consideration of temperatures is fairly simple. Preheating for all the steels should not be excessive either in time or temperature. Steels containing 14% tungsten should be transferred then to a furnace at 1200°C.-1250°C., and after soaking carefully and thoroughly, the time depending upon the size of the tools, they should be withdrawn and cooled in an air blast. Oil quenching of this particular alloy often results in the tool splitting. The 18% tungsten high-speed steels are oil quenched from 1250°C.-1300°C., although in certain cases air blast may be an advantage, especially where intricate designs are involved. The super high-speed steels containing 5% or 10% Cobalt have gained much favour recently because of their extremely good performances at high speeds. They require a little higher temperature to obtain the best

results, viz.:—1300°C.-1350°C. Correct soaking at super heat ensuring a complete solution of the carbides is the key to good results. Should the tool be insufficiently preheated, it will be found that the prolonged soaking of the tool, in order that it may obtain correct quenching temperature, will result in rapid grain growth in the thinner portions, and in all probability "burning" will take place which will ruin the tool, or at the very least, lower its efficiency and life. Excess gas should be used in the furnace, unless a modern controlled-atmosphere furnace is available. The use of excess gas will tend to reduce scaling and decarburisation.

#### Secondary Treatment

So much for the first part of the treatment but as most users know, a secondary treatment is necessary. The temperature range employed for this purpose is 560°C.-580°C. The time, however, varies with the size of the tools, but in general three quarters of an hour suffices. Cobalt high-speed steels require another treatment at this temperature, preferably after an interval of about 24 hours, in order that the secondary hardness property may be fully developed.

High-speed steels are usually required to conform to certain hardness specifications. If these figures are not obtained, on no account must the tool or tools be re-treated without an intermediate annealing or normalising. Should this precaution be omitted, the steel will tend to be brittle. An almost infallible indication of this treatment is the "fish-scale"-looking fracture which is obtained when the tool breaks, and if this were subjected to

preparation and examination under the microscope, an enormous grain size would be revealed.

#### Butt-Welded Tools

Butt-welded tools are given essentially the same treatment as ordinary tools, but cooling in an air blast should be used to avoid cracking at or near the weld. Another branch in high-speed steel tools is that of carbon steel shanks tipped with a small piece of high-speed steel. The preparation of the shank and tips is, of course, the work of the toolroom, but the tipping and heat treatment falls to the heat-treatment department. The prepared tip bed in the shank should be covered with a layer of some well-known brand of welding compound, such as tip-weld, and the tip then placed on top in its correct position. A little more compound should be placed at the vertical junctions. The shank and tip are then preheated as usual in high-speed steel hardening, and then transferred to the high-temperature muffle (keeping an excess of gas to minimise oxidation). When the tip and end of shank have attained the correct hardening temperature, and after proper soaking, the tool should be removed and a firm steady pressure applied to the tip. The tool should then be cooled in an air blast until it reaches black heat, at which temperature it must be transferred to the tempering furnace (at 560°C.-580°C.) for the secondary treatment.

In conclusion, the reader is asked to be tolerant if some detail he should be particularly anxious about has not been discussed. The scope of the steels and types of steels referred to is far greater than this article allows. An endeavour has been made to keep simplicity the key-note, so that the user of the steel might pick up any information that would assist him in his own particular plant.



# Photo-Electric Cells

By R. L. Maughan, M.Sc., A.Inst.P.

*Photo-Electric Cells have been used Extensively in Recent Years for Automatic Control of Street Lighting, in Sound Films and Television, Burglar Alarms. etc., etc.*

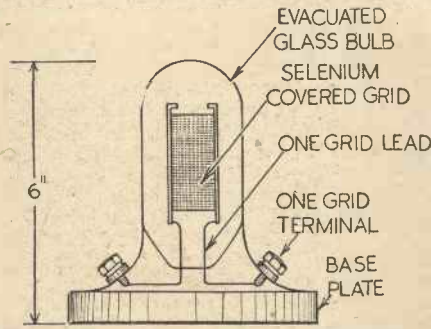

Fig. 1.—Section through a selenium conductive photo-electric cell.

THE photo-electric cell has been familiarly described as a "mechanical eye," and the wide use made in recent years of the photo-electric phenomenon in the automatic control of street lighting, of machines for weighing, counting and measuring, in sound films and television, and in devices for raising alarm against fire, burglary, paper breakages in printing presses and so forth, makes this an apt title.

In structure a photo-electric cell presents a fairly simple appearance. One type closely resembles, at first inspection, a wireless valve of the earlier kind, the diode or triode; another type consists of a thin metallic disc mounted in an ebonite or bakelite frame, its diameter being roughly that of the top of a tea-cup. The function of any photo-electric cell is to deliver an electric current when light falls upon it, and by suitably employing this current almost any form of mechanism may be operated as a consequence. The photo-electric effect, upon which the working of

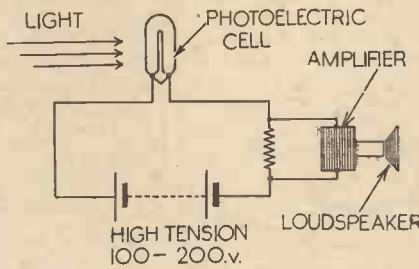

Fig. 2.—The photo-electric cell incorporated in this circuit is made to operate a loudspeaker.

the cell depends, is concerned with the production of electricity by the irradiation of matter, and is one of a series of grouped phenomena in physics, involving energy transformations. A physical phenomenon may be described as the effect observed when energy in one form passes into energy in another form. Thermodynamics deals with the mutual conversions of heat and mechanical work, thermo-electricity with heat and electricity, piezo-electricity with mechanical work and electricity, and photo-electricity with electricity and light.

### Minor Discoveries

The discovery of the photo-electric effect can hardly be accredited to any one person, any more than the date of its discovery can be assigned to any one particular year. It emerged rather from the mists of obscurity into the realm of scientific knowledge as a result of a series of comparatively minor discoveries made by various scientists, during the past one hundred years.

In 1839, Alexandre Becquerel (whose son, Henri Becquerel, made the discovery of radio-activity in 1896), recorded his observations of the first phenomenon, which may be truly classified as a photo-electric one. In the course of an experiment with a simple voltaic cell (two metal plates immersed in acid), he noticed that a slight extra voltage was developed in the cell by directing a beam of light upon it. Little significance seems to have been attached

to this discovery at the time, and it was not until 1873 that the photo-electric phenomenon received investigation from another point of view. In that year W. Smith made the all-important discovery that the electrical resistance of the semi-metal selenium varies considerably when bathed in light, and three years later Adams and Day made a full investigation of the generation of electric currents in a circuit containing illuminated selenium. At this period the attention of many other scientists appears to have been drawn towards this line of research, and the laws underlying the interchangeability of light and electricity began to receive a great deal of study, stimulated very possibly by the publication at this time of James Clerk-Maxwell's electro-magnetic theory of light. In 1887 Hallwachs, prompted by an observation made by Hertz in the same year, demonstrated that a negatively charged metal plate loses its charge when illuminated. This experiment is often regarded as the foundation from which the modern study of photo-electricity has proceeded and the description "Hallwach's effect" is commonly used as an alternative to "photo-electric effect", for although the experiments of Becquerel and Smith were truly photo-electric in character they were not recognised as such at the time of their performance. Towards the close of the nineteenth century, after Sir J. J.

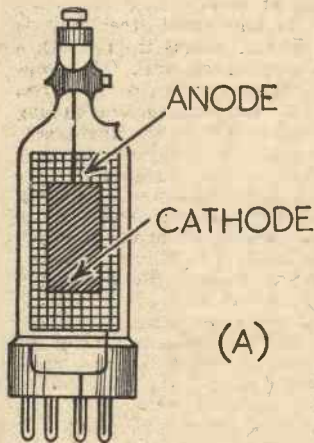
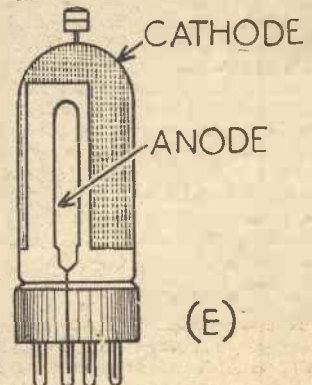
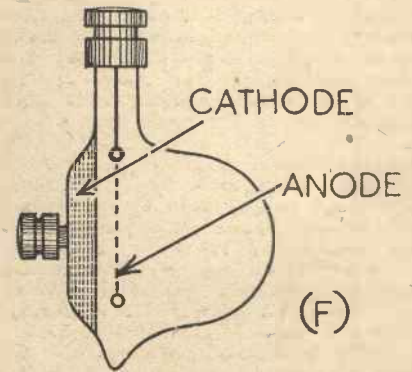
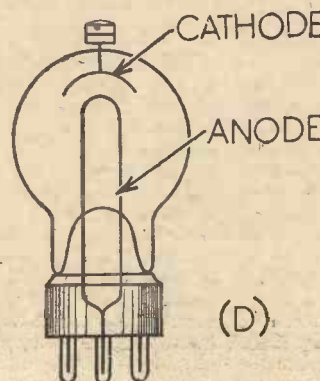
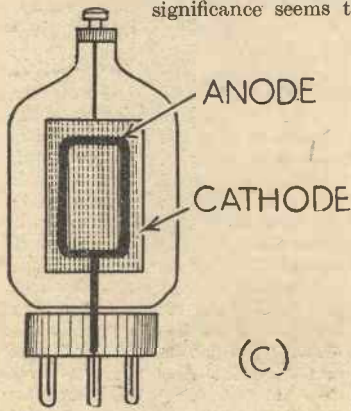
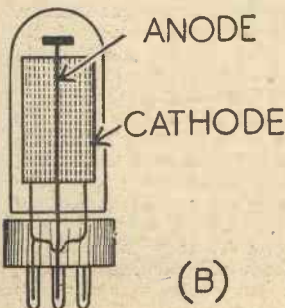

Fig. 3.—Types of alkali metal cell.



Thomson had shown that the unit of negative electric charge and the electron were identical, Lenard and Thomson explained the Hallwachs or photo-electric effect in the terms which in principle are still accepted to-day, namely that when light is projected upon a body electrons are ejected from that body.

#### Two Main Classes

Photo-electric phenomena fall into two main classes, the "internal effects" and the "external effects," each of which gives rise to its own particular type of photo-electric cell. The variation of the resistance of selenium with the intensity of the light incident upon it is an example of the internal photo-electric effect. The element selenium being semi-metallic, has a property characteristic of all metals in that it contains a certain percentage of free electrons furnished from the outer orbits of the selenium atoms, and being outside the range of the attractive forces of their parent atoms these electrons are highly mobile within the body of the metal. The number and degree of mobility of these electrons governs the electrical resistance of the metal. The stream of quanta which constitutes the beam of radiation incident upon the metal carries energy into the metal to a marked degree in that fraction of the beam which is absorbed, and to a smaller degree in that fraction which is reflected. This absorption of quanta alters the number and mobility of free electrons and consequently changes the resistance of the metal. Thus a circuit containing selenium to which a steady voltage is applied carries a current whose magnitude will respond to the changes in the intensity and wavelength of the light flooding the selenium.

#### Hallwachs's Experiment

The original experiment of Hallwachs's was a demonstration of the external photo-electric effect. A metal plate bathed in ultra-violet light becomes the source of electrons which stream away from its surface, and if the plate is given an excess of free electrons in the form of a negative charge of electricity, the electron stream is much denser and can be detected and measured more easily. This electron stream constitutes the external photo-electric current, and in order to facilitate its manipulation and measurement it is "beam directed" by placing in the neighbourhood of the cathode which supplies the electrons a positively charged electrode which gathers in the photo-electric current. This arrangement of electrodes closely resembles the system adopted to direct and control the thermionic current in the wireless valve, and accounts for the valve-like appearance of a certain class of photo-electric cells.

It is to be remarked, however, that this similarity does not extend much beyond structural features, as the currents in the two cases depend upon totally different phenomena for their generation. The thermionic electron stream in the wireless valve is purely a case of hot emission controlled by the temperature of the electrically heated valve filament, whereas the photo-electric current is a cold emitted electron stream governed by the chemical nature of the cathode and the characteristics of intensity, wavelength and polarisation of the incident light.

#### Four Main Categories

Broadly speaking the various kinds of photo-electric cells fall into four main categories. The first type is the conductive cell, which includes the selenium, tellurium

and thalofide varieties, depending for their action on the internal photo-electric effect. The second type is the alkali metal cell, an "external effect" cell, which may be evacuated or gas-filled, and resembles the thermionic valve in appearance. The third is the electrolytic cell, whose action is not thoroughly understood but which seems to involve both internal and external effects. The fourth is the dry-plate rectifier cell whose action may be described as a localised external photo-electric effect.

The conductive cell (see Fig. 1), consists of an evacuated glass tube which contains a plane metal grid coated by a thin layer of the semi-metal selenium. Two leads pass from the grid to a pair of high tension terminals or plug pins mounted in the base of the cell, and under a potential difference of one or two hundred volts an electric current flows through the selenium. Under

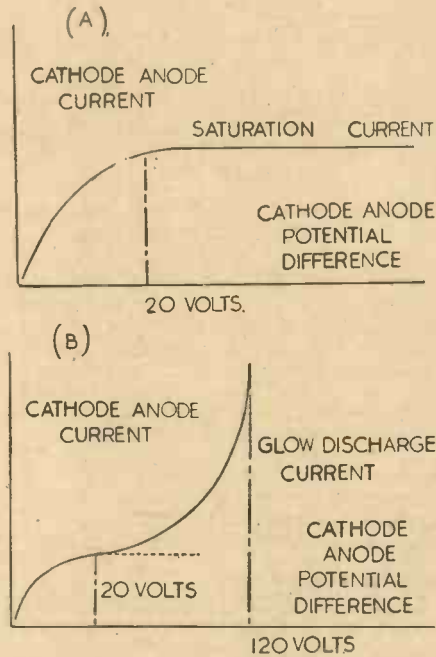

Fig. 4.—Anode current, anode potential curves for vacuum and gas-filled alkali metal cells.

normal circumstances this current is very small since the ohmic resistance of selenium is very high, but when the selenium is illuminated its resistance is reduced to an extent depending largely upon the intensity of the light which floods it, and a proportionally larger current flows in response to the increased lighting. This fact may be usefully employed in such a circuit as that illustrated in Fig. 2, in which variations in the intensity of the light received by the cell produce responsive current variations which may be made to operate some mechanism, a loudspeaker for example, through an amplifier.

#### The Thalofide Cell

This property of selenium is shared by all the semi-metal conductors and various of their compounds. The thalofide cell is a conductive cell in which a coating of thalious oxysulphide covers the grid instead of selenium, and in the tellurium cell the grid coating of selenium is partly or wholly replaced by tellurium. But the practical use of the conductive cell is narrowly limited since it possesses the outstanding defect of photo-electric hysteresis, or the lagging behind of the current response to the variation in the light intensity, a property which renders it useless in all but the slowest of light variations.

In the alkali metal cell the defect of

hysteresis is absent, the photo-electric effect follows light fluctuations without measurable delay even for fluctuations of the order of one hundred millionth of a second's duration, which makes this type of cell particularly suitable for the production of sound from talking films where the response of current to light variation must be practically instantaneous. In appearance it resembles the simple diode wireless valve, containing an anode and cathode in a glass tube which may be gas-filled or evacuated (see Fig. 3). The cathode takes the form of a broad sheet of an alkali metal, usually potassium or caesium, whose surface has been further sensitised by a deposit of silver oxide or caesium oxide. In the manufacture of these cells the chemical nature of these sensitising deposits and the process of laying them are very often well-guarded commercial secrets. The alkali metals are always chosen for cathode manufacture on account of their copious output of electrons when irradiated by light.

The anode of the alkali cell is designed as a wire mesh or wire loop mounted in the immediate neighbourhood of the cathode so as to attract and absorb the electrons as they are supplied by the cathode. A potential difference of 10 or 20 volts established between cathode and anode ensures the rapid conduction of the electrons across the gap between the two electrodes, just as in the case of the wireless valve. The anode is most generally situated close to and in front of the cathode directly in the path of the beam of light in the form of a thin wire mesh or loop so as to offer the least possible obstruction to the light which passes on to strike the cathode.

#### Alkali Metal Cells

Fig. 3 illustrates a variety of designs of the alkali metal cell. *Type A* has a rectangular plate cathode of oxidised copper or silver on which is deposited a very thin layer of caesium or potassium. The cathode terminal is attached to the top of the tube, whose elongated neck is given a thin deposit of silver which acts as a guard-ring round the cathode lead. The anode is a wire mesh which cages the cathode and is wired to one of the plug-pins in the base of the cell. The other three pins are merely added to give the cell additional stability when plugged into a panel, and have no electrical connections.

*Types B and C* have a composite caesium-silver-oxygen cathode arranged as a semi-cylindrical sheet about a single straight filament (in *type B*), and a rectangular wire loop (in *type C*), which act as anode. In *type D* the wire loop anode projects well up the tube interior and is surmounted by a caesium cap cathode fitted into the tube top. *Types E and F* have their cathodes (potassium or caesium on copper or silver) spread over the inner wall of the glass tube, with wire loop or wire mesh anodes supported in front of them.

#### The Cathode

There are two general features in the design of these cells which are noteworthy. The cathode is mounted symmetrically with respect to the anode in order to avoid the disturbing effect which an electrostatic charge on the wall of the glass tube would create, and the cathode anode leads are taken out of the tube at opposite ends in order to reduce the chance of leakage of charge direct from the anode lead to the cathode lead through the insulation material of the base of the cell.

The alkali metal cell may be evacuated or gas-filled, the usual gas being argon, although the other inert gases and also

(Continued on page 454)

# A POWERFUL HAND PRESS

*This Tool Can Be Used For Small Punch And Die Work And Is A Powerful Hand Press For Its Size.*

**T**HERE are many jobs in the small engineer's workshop where a powerful press is required both for driving and pressing out parts which are press fits. The usual punch and hammer method cannot be employed usefully and without damage on good fitting work. The hand-press described and illustrated here can be used also for small punch and die work in the small shop and is a very powerful tool for its size. A more powerful tool can be made by increasing each dimension by one half. It would then stand 12 in. high and have a 1 in. stroke.

It has the advantage, so far as concerns the maker, that it has no double-start square thread screw and nut to make, the power being applied by a cam which can be designed to give great power with a small stroke, or a long stroke with less power. Figs. 1 and 2 show the tool in side and front view and in part section. The ram A, of the punch is turned out of cast steel round bar and has two diameters—a lower small diameter and an upper large diameter. This arrangement is designed to reduce height and yet allow of the intervention of a helical compression spring B, the function of which is to return the press ram. This spring lies between the under shoulder of the upper big diameter of the ram and the upper ledge of the bottom bore of the main casting D, which takes the smaller diameter of the ram.

### The Ram Operating Cam

The ram is prevented from turning round in the bores in the casting D, by a  $\frac{3}{8}$  in. hardened steel pin E, which fits a vertical slot F, in the casting; shown clearly in the front view, Fig. 2. The ram is operated by a cam carried in trunnion bearings in the head of the main casting. The cam is in contact with a hardened steel roller, which is carried on a steel pin tightly fitting a transverse hole in the top end of the ram, the ram being slotted as shown in the front view, to take the roller and the steel pin being a tight, pressure fit in the ram and a close turning fit in the roller.

The cam is shown in end view and section in Fig. 3. It is of mild steel and has a central hole to take the trunnion J (Fig. 2) and it is a driving fit on the trunnion. A

longitudinal hole is drilled to take the reduced end of the operating lever, which is a push fit in the hole and has a  $\frac{3}{8}$  in. screw thread at the end by means of which it can be locked in by a nut and spring washer. It is important that the shoulder on the lever at X, Figs. 1 and 3 should not be square, but radiused, and that the hole in the cam should have, at its end, a similar

curve relatively to the centre of its trunnion and the line of the axis of the hole which takes the lever.

### Cam Arrangement

An arrangement of cam, using the same trunnion, is shown in Fig. 4, which allows of an adjustment of the cam-operating curve relatively to the handle. This is sometimes very convenient when the cam and trunnion are similar to that shown in Figs. 1, 2 and 3 except that there is no hole for the lever and the cam is pinned to the trunnion by a large diameter pin in a hole which is slightly flared each end so that there is no chance of the pin shearing. This is seen in the sectional view Fig. 4, and the cam shape is, as shown, a circle.

The lever is bifurcated and formed in three pieces. Two are cranked to pass round the head of the press and are bolted, one each side, to the long lever as shown in Fig. 4. The ends of the cranked arms are bent round and drilled through both bends to fit the trunnion ends and are slotted as shown at X. The nut and bolt draws the ends tightly round the trunnion. By undoing these two nuts and bolts the bifurcated lever can be adjusted to any position around the circumference of the trunnion ends, and therefore any position

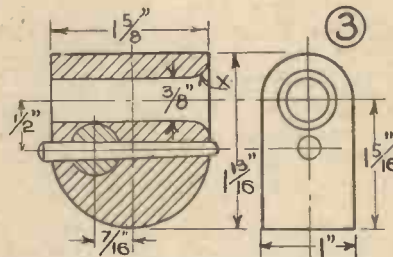
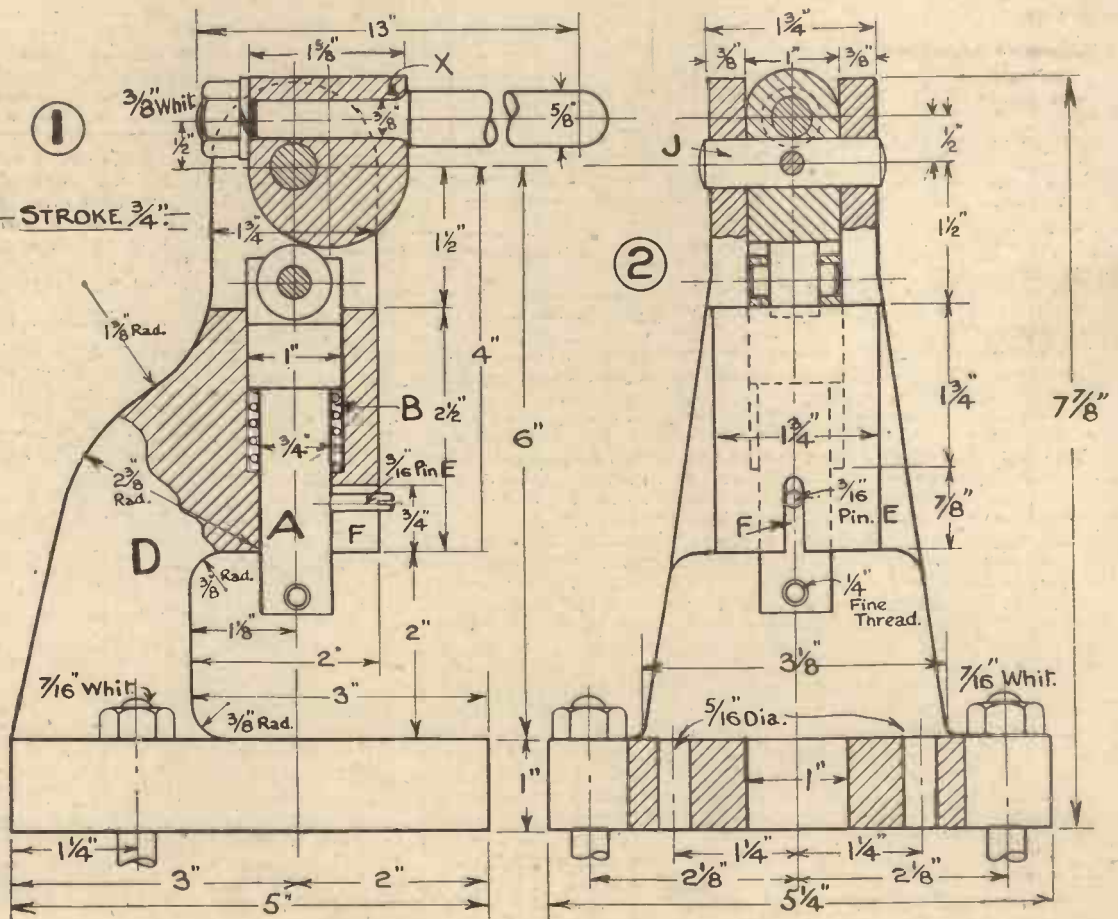

Fig. 3.—A sectional and end view of the cam.

radius as shown. It is intended to prevent the bending and breaking which might occur in the case of a square shoulder on the lever, and is important. The shape of the cam should be as to the drawing which shows the position of the radius of the cam



Figs. 1 and 2.—The hand press shown in side and front view and in part section.

of cam lever can be easily arranged by this simple adjustment.

**Main Casting**

The pattern Fig 5, for the main casting, which will be cast in iron is made of pine-wood, the main part being cut out of three pieces of timber glued together and the base screwed on. It is cast sideways and core prints are fitted at the top and bottom of the head. They will be  $\frac{1}{8}$  in. smaller than the smallest diameter of the bore for the ram A, Fig. 1. The two standing shoulders for the trunnion are not separated on the pattern but are solid. They are afterwards drilled and slotted and filed to shape. This saves an elaborate core box. The core for the prints on the pattern will be a plain cylinder and will be made by the foundry to fit the recesses in the sand left by the prints when the pattern is being rammed. Three views of the wooden pattern are shown in Fig. 5, which shows the prints for the core. The dimensions will be found in Figs. 1 and 2.

**Holes for Bolts**

In machining the main casting the bottom of the base is filed smooth and the holes for the holding down bolts are drilled.

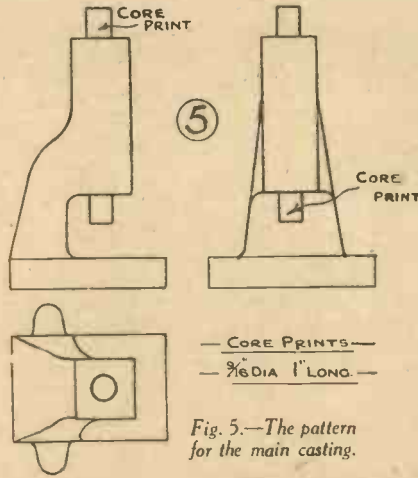

Fig. 5.—The pattern for the main casting.

is drilled very carefully and reamed to dimensions as on the drawing.

**The Ram**

The ram is of cast steel turned to the dimensions shown in Fig. 6. The bottom hole is drilled  $\frac{7}{16}$  in. in diameter to take the

just projecting from the front of slot F (Figs. 1 and 2).

The spring is then threaded round the ram up to the shoulder (the roller and its pin being in position), and the ram is pushed into its guide hole and the hardened pin screwed in. This pin prevents the ram rotating.

**The Top Cam**

The top cam is made of mild steel bar of a diameter  $\frac{1}{4}$  in. above the finished diameter of the cam and is turned on the outside. Then the centre for the trunnion is set off from the cam centre by the amount shown on the drawings, and a hole is drilled and reamed to size. The trunnion is then turned a tight fit in the hole in the cam and a close moving fit in the holes in the two upstanding lugs.

Cam and trunnion are then assembled in the head with the ends of the trunnions projecting equally each side as shown in Fig. 4—a plan view, and a hole is drilled through the cam and spindle  $\frac{1}{4}$  in. diameter at the big end when reamed with a standard taper reamer. A cast steel taper pin is then turned to fit the hole and is case hardened. Cam and spindle are then dis-assembled and case hardened and again assembled.

**The Lever Ends**

The lever ends are made as shown in the detail drawing at Fig. 4  $\frac{5}{16}$  in. Whitworth bolts and nuts being used to draw the ends tight down on the trunnion ends. These and the central lever are all bolted together by the two  $\frac{1}{4}$  in. Whitworth bolts in holes at the positions and distances apart shown. The holes should be drilled undersize for the bolts and afterwards reamed so that the bolts have to be driven in each hole. Reamer one hole through the three pieces first. Then drive in the bolt and fasten with the nut and then reamer the other hole.

It is important that there should be no slackness here, hence this procedure. Fit spring washers under both nuts.

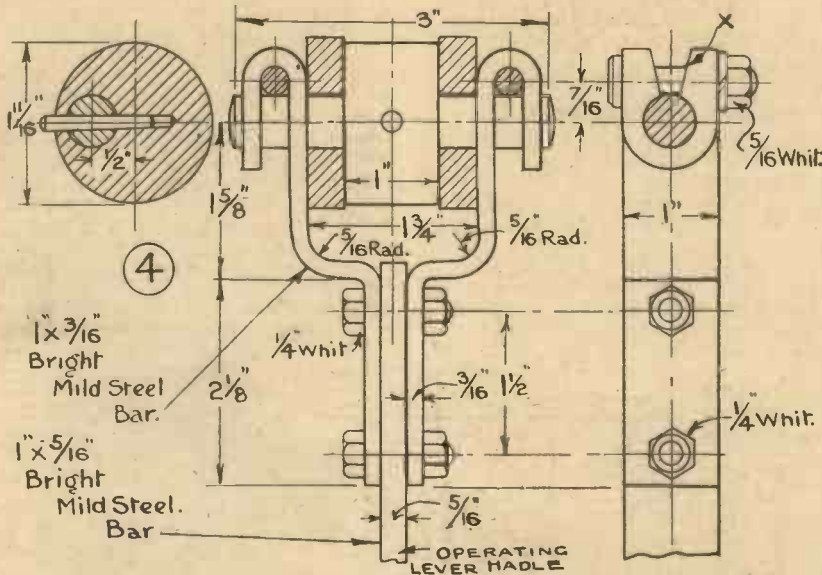

Fig. 4.—An arrangement of cam using the same trunnion, which allows of an adjustment of the cam-operating curve relatively to the handle.

The casting is then bolted by these holes to the face plate with the centre line of the bore for the ram lining up with the lathe centres. The bore is then bored out with an inside tool to the dimensions shown on the drawings as regards depth of counter bore (for the spring) and ram bore diameters. Then a transverse hole is drilled through the head of a diameter equal to the width between the upstanding lugs and the saw slots are cut down to the hole—one each side. The bottom of the slot thus formed is then squared.

The casting is then bolted on the drilling machine table and a hole is bored through the base using the turned hole or the ram as a guide. The casting is then chucked by the bore on a mandrel held in the three-jaw chuck and the hole in the base bored out by an inside tool to the dimensions shown. Next the slot F is cut in the front  $\frac{3}{8}$  in. wide. To do this bore a series of holes from the top centre shown to the bottom and drill  $\frac{3}{32}$  in. holes along their slot cut with a chisel and file. Next the hole for the trunnion through each upstanding pillar

tool being used in the press. The transverse hole is drilled and reamed to size  $\frac{3}{8}$  in. and a hardened steel pin is made to exactly fit it tightly. Then a cast steel roller to the dimension given in the detail drawing is turned and bored to a running fit on the hardened steel pin and outside to the dimensions shown. The ram, pin and roller details are shown in Fig. 6.

A spring is wound of  $\frac{1}{8}$  in. round spring steel wire with convolutions  $\frac{3}{4}$  in. apart when inert. When compressed it should be  $\frac{3}{8}$  in. long and a bare 1 in. outside diameter.

The ram is assembled in the bore of the press with the roller and its pin in position and the roller fore and aft of the casting. A hole is then drilled, for  $\frac{1}{4}$  in. in the ram when at top position using the extreme top of the slot F (Fig. 2) as a guide and a  $\frac{1}{4}$  in. drill. The tapered bottom of this hole acts as a guide for drilling a hole tapping size for  $\frac{3}{8}$  in. Whitworth through the ram or for at least  $\frac{3}{8}$  in. and a  $\frac{3}{16}$  in. steel pin is screwed to fit the hole and is screwed in with its slotted end (for screwdrivers use)

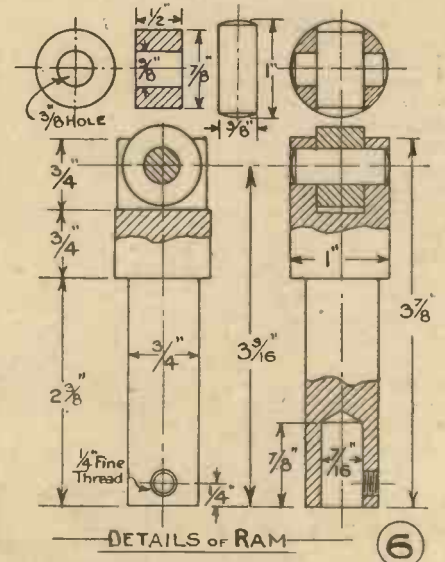

Fig. 6.—The ram is made of cast steel and should be turned to the dimensions shown.

**LATHE WORK FOR AMATEURS**

By F. J. CAMM  
96 Pages

1/- or 1/2 by post from Geo. Newnes Ltd., Tower House, Southampton Street, W.C.2.

The following information is specially supplied to "Practical Mechanics," by Messrs. Hughes & Young (Est. 1829), Patent Agents, of 9 Warwick Court, High Holborn, London, W.C.1, who will be pleased to send readers, mentioning this paper, free of charge, a copy of their handbook, "How to Patent an Invention."

# Our Busy Inventors

By "Dynamo"



This tiny typewriter has been specially designed for people who have to type on their travels. It weighs only 3 lb.

## Trash Receptacle

IN the United States there has recently been patented what is neatly styled a "trash receptacle." This is akin to the litter cage which one sees in this country. It is also a relative of that editorial dustbin—the waste-paper basket. The receptacle has an equilateral triangular frame supporting a bag. Each angle of the frame has a socket, into which are inserted the upper ends of the legs of the contrivance. The bag is detachable, having a mouth with eyes which engage over pins.

Let us hope that this invention will help Uncle Jonathan to form the habit of tidiness.

## Triple Parachute

THE incorporation of one balloon within another was, I believe, first suggested in one of the thrilling romances of that ingenious story-teller, Jules Verne. The idea has, I understand, been employed by explorers of the stratosphere, and now a triple parachute apparatus has emanated from the brain of a German, who has patented it in the United States. This aerial lifeboat comprises a large parachute with a set of main shroud lines and ropes suspending the load. There is a first small auxiliary parachute with a separate set of shroud cords arranged below the lower mutual connection point of the main shroud lines and joined to the load. And there is a second additional small parachute having a separate set of shroud cords arranged over the top of the main parachute.

Provided that this complicated contraption does not get in its own way, it should successfully counteract the disastrous effects of the law of gravitation. In one of the sacred books of the Hebrews there is this apposite saying: "A threefold chord is not quickly broken."

## Rubber Soles for Horses

THE universality of the motor-car has substantially reduced the demand for horses. But the blacksmith is not yet as extinct as the dodo. I do not suppose that he himself makes his horseshoes, as he did in

the days of yore. He probably buys them manufactured, and simply adjusts and fits them to the hooves. The muscular hammerman of the smithy will be interested in a device for which the United States Patent Office has granted a patent. This consists of means for securing "Wear-protectors of Rubber for Horseshoes," which is the title of the invention. I cannot say whether this rubber sole will deaden the clatter of the milkman's horse in the early morning. But, if so, it will be a boon to sleepers who are awakened by the preliminary canter of the dairyman's steed.

## Smooth Sailing

NOW that prospective holidaymakers are booking their cruises, the subject of that *bête noir* of the bad sailor—seasickness—is eminently appropriate. The history of attempts to prevent this distressing, though not serious, malady records the invention of an English lady, which she patented about a quarter of a century ago. Her idea was a berth which, whatever the angle of the ship, invariably maintained its horizontal position. This obviated rolling and ministered materially to the comfort of the occupant of the berth. However, it did not preclude pitching—the rise and fall of the berth—which I am disposed to think is at least one cause of the disturbance in the internal economy.

## The Problem of Seasickness

THE cause of seasickness is still somewhat problematical. In this connection, it is interesting to note that a German doctor, residing in America, believes he has found a solution. His observation has led him to conclude that the low content of carbon dioxide in ocean air is largely responsible for seasickness. This, he considers, especially produces the first phase of general discomfort experienced even when the sea is calm; in which case the movements of the boat cannot be the cause of the unpleasant sensation. He has noticed that heavy movements of boats have a different effect on people on the ocean than is the case when the boat is on an inland sea, such as Lake Ontario. In the latter instance, although the movements are identical, no sickness results. He concludes that the air over an inland sea, with its normal carbon dioxide content, makes for the comfort of the traveller. On the other hand, the lack of carbon dioxide in ocean air is an unfavourable factor occasioning seasickness.

## Air-Conditioned Cabins

THE aforementioned doctor points out that, in the case of inhaled anaesthetics, it has been found that the breathing of the unconscious patient is greatly improved if the inhaled gas mixture contains a small percentage of carbon dioxide. He, therefore, contends that the difference in



The first penny-in-the-slot ice cream machine which recently made its appearance in Shoreditch.

the composition of ocean air and that over a Continent, as far as their content of carbon dioxide is concerned, is the cause of sea-sickness.

Upon this conclusion he has based an invention for which he has applied for a patent in this country.

This invention may be classified as a method of air-conditioning ships. By means of plant designed for the purpose the air fed to rooms, cabins, etc., is mixed with controlled proportions of carbon dioxide. This method can be employed on airships as well as on ocean-going vessels.

### Butter Softener

THE influence of Jack Frost upon butter makes it very obdurate, so that it does not spread with the facility of the famous chestnut tree. To counteract this hardness, an inventor has devised an appliance for softening and spreading butter. Of a suitable shape for spreading purposes, it comprises a hollow receptacle with a filling aperture at the back to admit hot water and a cork to prevent its exit. The rear part of the receptacle is rectangular, while the front is wedge-shaped, and a handle is attached. This appliance will befriend the busy housewife on a cold and frosty morning.

### Automatic Roller Scraper

THE advent of spring brings the garden into the limelight or rather the genial rays of the sun. Undoubtedly horticulture is a hobby which tranquilly refreshes both mind and body. There is significance in the old myth of Antaeus who, when wrestling with Hercules, was invincible as long as his feet touched the earth. And it is said that there is virtue in the soil, so that it is healthful for man to remain in close touch with Mother Earth. But what is a garden without a roller? And the roller must be efficiently scraped. Now, it has been a practise to mount on the yoke of the roller a scraper in the form of a flat metal plate or strip extending across the periphery. But I am informed that difficulty has been experienced in arranging the scraper in a simple manner, so that it is equally effective in either direction of rotation of the roller.

The object of a recent invention is to enable a scraper to be mounted at one side of the yoke without involving the above-mentioned difficulty. As a consequence, the noble army of amateur gardeners should make a good impression upon their lawns and paths.

### Non-Spectacular Spectacles

NOT every man has the courage of the faith-healer, who, declaring that he did not need eye-crutches, removed his glasses, placed them on the ground and screwed the lenses with his heel. The average member of the human family resorts to the optician. Since, however, the wearing of glasses implies a defect in vision, there is no reason why one should advertise the fact by donning spectacles with conspicuous frames. The adoption of rimless glasses was a definite step in the direction of imperceptibility; but some time ago a fashion from the other side of the Atlantic emphasised the defect with thick horn rims.

The British Patent Office has received an application for the patenting of an invention whose object is an improved construction of spectacle frame, which shall be less obtrusive and particularly suitable for ladies. In the case of this frame, the lenses are encircled by lower glass-clear parts and the upper parts are formed or coated with a coloured translucent or opaque material.

The shape of the upper parts follows very closely the lines of the eyebrows and the colour selected may correspond with that of the eyebrows.

### Light on the Human Target

A FIREARM for night shooting equipped with a miniature searchlight to enable one to see the enemy, is by no means an



A combined alarm clock and lamp. When the alarm goes off the lamp lights up.

entirely novel weapon. When the foe suddenly finds himself in the limelight, he may possibly be dazzled and he will certainly present a more definite target. In known weapons of this description, the light projector is switched on and off by means of a spring contact or push button, which has usually been fixed on the right-hand side of the butt. This is designed to permit the switch to be operated with the thumb of the hand grasping the butt.



A device for straightening bent nails. The nail is placed in the slot, the lever is pressed down, and the nail is straight.

A current invention is an improvement upon the above-mentioned weapon. In the new device the spring contact member is of elongated form and is arranged on the left side of the butt. It is so placed that two or more fingers rest on it when the butt is held. However, the strength of the spring is such that an electrical contact is established only when the hand closes round the

butt with increased pressure.

A firearm of this kind can be handled just like an ordinary gun, but it is necessary intentionally to depress the spring contact in order to light up the projector. There is no need to change the grip or even to lift a thumb or finger to depress the contact, as is the case when the contact is positioned on the right-hand side of the butt.

This illuminating gun will enable the sharpshooter to throw light on the subject or rather the object.

### Uniform Explosions

AS the bomb is destined to play a leading part in the tragedy of the next war, naturally inventors have been concentrating with a view to making that deadly missile as devastating as possible. One lately designed air bomb has a shell moulded by a centrifugal concrete condensing method involving action and vibration, in combination, such as is used for making concrete pipes. It is claimed for this bomb that it is very efficient in its bursting effect, inasmuch as the lumps of metal are scattered more uniformly than heretofore. The explosion gases are prevented from escaping prematurely through the wall of the shell, whilst the concrete is of such considerable strength that it bursts only under relatively high-explosion pressures.

### Gun Turrets for Aeroplanes

IN order that a machine gun may be effectively used on board an aeroplane, the gun should be capable of easily performing rotary and lifting and lowering movements. It is stated that the high speed of displacement of aeroplanes and the action of the wind make efforts to overcome these resistances difficult, especially at high altitudes.

A patent has been applied for in this country by a Belgian who has invented an improved gun turret for aeroplanes. In this turret the rotary and elevating and depressing movements are effected by means of motors, under pressure. These movements are automatically started by the action of the gunner or the gun.

### Portable Raft

IN the brave days of old, the shipwrecked mariner was forced to improvise a raft à la Robinson Crusoe. But since the good old times, many accommodating appliances have been contrived to ensure the safety of those in peril on the sea. . . or one of the latest of these, hailing from Japan, an application for a patent has been received by the British Patent Office. The device includes a number of collapsible, buoyant bodies, each comprising one or more inflatable tubes or cylinders of flexible material. A rod is connected to the lower side, and the bodies are furnished with an arrangement enabling them, side by side, to form a raft. A detachable seat and hinged rowlocks are also provided. However, the float may be used with the seat alone as a hand-propelled raft.

It would be an exaggeration to describe this contrivance as a pocket raft. But, for the purpose of transporting the appliance, the cylinders can be separated from the tubular rod, the air may be exhausted and the "whole caboodle" can be easily packed.

Apart from serving as a life-saving device, this handy raft could be utilised in a variety of ways. For example, the explorer, when negotiating an undiscovered country, would find it useful for crossing or navigating rivers. And, from the point of view of a pastime, it would afford interesting recreation.

# EXTRACTING NATURE'S CHEMICALS

**S**IDE by side with the development of chemical synthesis, or the building up of complex chemical substances from simpler materials by artificial means alone, have evolved the many present-day processes by means of which important chemicals are extracted from purely natural materials.

Most of these modern chemical extraction methods, highly efficient though they may be, are extremely elaborate in their details and, as such, cannot be translated very successfully to the laboratory scale. Nevertheless, there are not a few common naturally produced materials which easily lend themselves to chemical extraction on even the smallest scale and it is from these cheap and, for the most part, common materials that the chemical experimenter and student may derive a very considerable amount of practical interest and instruction.

## Vinegar

Take, for instance, vinegar. The best grades of this naturally produced liquid are fermented from wines. Vinegar contains anything from 4 to 10 per cent. of acetic acid, and the pure acid may readily be extracted from it by warming the vinegar with a quantity of carbonate or bicarbonate of soda until the acid contained in it is completely neutralised. The resulting solution of sodium acetate is then evaporated to dryness and the solid residue strongly heated until all its water-of-crystallisation has been expelled.

Now collect the resulting fused sodium acetate, powder it up, and place it in a



(Left) A few ounces of human hair and (right) a quarter-teaspoonful of cystine crystals which may be extracted from it.

Put the vessel containing the mixture away in a warm place for about a week and then add to it 2 ounces of zinc carbonate. Leave it for another few days, stirring it frequently, and then boil the product. Finally, filter the now semi-solid mass and concentrate

thin cream made by mixing slaked lime with a little water). Boil for another five minutes and then filter the liquid through cloth and evaporate the filtered liquid to dryness. Powder up the dried residue and shake it up with small amounts of chloroform in which the extracted caffeine is very soluble. Filter off the chloroform extract, evaporate or distil off the chloroform, and purify the resulting caffeine by crystallisation from hot water.

Working on a small scale, a quarter of a pound of tea will be necessary for the extraction of approximately one gram of pure caffeine, the active principle of tea and the substance which, in great measure, imparts to that beverage its refreshing qualities.

Cystine, a very complex organic substance containing nitrogen and sulphur, is present in wool and in animal and human hair, from which latter materials it can be extracted in the pure form without much difficulty.

## Crystals from Hair

Make a visit to your hairdresser and procure from him about half a pound of the hair sweepings from his floor. Place these in a large round flask and pour on to them 500 c.c. of concentrated hydrochloric acid. Now fit above the flask a reflux or upright condenser so that any vapours passing off from the liquid are condensed and fall back into the flask. Using this apparatus, boil the hair-acid mixture for about six or seven hours. Then partly neutralise the acid by adding to it very cautiously caustic soda

## How to Extract a Number of Chemical Products from their Natural Sources. An Essentially Practical Article which will especially appeal to the more advanced Home Chemical Experimenter.

small retort, just covering it with concentrated sulphuric acid. Gently distil the mixture, and pure acetic acid will pass over into the receiver of the retort. The acid boils at 118 degrees C. and freezes to a mass of ice-like crystals when cooled strongly. With careful working, the experimenter should be able to obtain from ordinary vinegar an amount of acetic acid approximately equaling 5 per cent. of the volume of the vinegar used.

## Formic Acid

Formic acid is closely related to acetic acid. It occurs in nettle leaves and stems. A dilute solution of it may readily be prepared by chopping up nettle plants in a small amount of water and by subsequently distilling the mixture.

Another natural acid is lactic acid, which is interesting if only in consequence of the fact that it is formed in the human muscles after exertion. Lactic acid also occurs in sour milk, and it is from that liquid that it is best prepared on the small scale.

Dissolve 4 ounces of loaf sugar in 500 c.c. of water and add to the solution a pinch of tartaric acid. Add to the liquid 150 c.c. of sour milk and  $\frac{1}{2}$  ounce of rancid cheese.

by heat the filtered liquor. Crystals of zinc lactate will separate out from it.

To obtain the free acid from the zinc salt, the latter is suspended in a small quantity of water and a stream of sulphurated hydrogen is passed through it for a few minutes. The liquid is now shaken up with ether, in which the free lactic acid is soluble, and is run off. By allowing the ether solution to evaporate spontaneously, fairly pure lactic acid is obtained as a thick, sour, yellowish liquid.

From acetic, formic and lactic acids it is, of course, quite easy to make any number of salts by dissolving the oxides or hydroxides of metals in the respective acid. Thus, for instance, copper acetate may be obtained by dissolving copper hydroxide in dilute acetic acid.

## A Vegetable Product

A purely vegetable product of such importance is caffeine, which occurs in tea to the extent of about 2 per cent and which can be extracted experimentally from that commodity on a small scale.

Gently simmer 1 part of tea with 4 or 5 parts of water for a quarter of an hour and then add to it 1 part of milk of lime (i.e. a

solution and finally add an excess of sodium acetate in order to eliminate the remaining free hydrochloric acid. After a few hours, a brown precipitate will form. This consists of impure cystine. It is filtered off, boiled with a little dilute hydrochloric acid, and again filtered. The filtered liquor is then boiled with a little animal charcoal to decolorise it and, after again filtering, mixed with an equal quantity of a strong solution of sodium acetate. From this liquid, crystals of pure cystine will slowly separate. The yield of cystine from half a pound of hair should be about half an ounce.

## Uric Acid

Uric acid is a significant material, for it is this acid and its salts which, accumulating in the human body, set up various rheumatic and other complaints. Uric acid is easily extracted from human urine, or from the excrement of certain birds which, under the name of *guano*, is commonly used as a horticultural fertiliser.

From the latter it is obtained merely by treating with dilute hydrochloric acid in order to remove calcium phosphate, the uric acid subsequently being dissolved out

from the product by treatment with hot caustic soda solution. On the addition of hydrochloric acid to this solution, the uric acid is precipitated.

From normal urine, uric acid is obtained by evaporating it to small bulk, saturating it with ammonium chloride, and making it alkaline by the addition of a few drops of ammonia. After standing for half an hour, the liquid is filtered and the solid matter on the filter is dissolved in a small quantity of boiling caustic soda solution. This liquid, on being acidified with hydrochloric acid, slowly deposits pure acid uric.

#### Creatine

Creatine, a nitrogen-containing substance, is present in human and animal muscles to the extent of about 0.3 per cent., and is a very important substance in the animal economy. It has been calculated that the average adult human body contains about a quarter of a pound of this vital chemical. It is best obtained from raw beef. Chop up finely about half a pound of beef, taking care to free it from all fat, and warm it up with about five times its weight of water for an hour or two, not allowing the temperature of the water to exceed 60 degrees C. Carefully collect the resulting beef extract and again extract the beef with a smaller quantity of water, finally adding the second extract to the first. The meat may now be thrown away. Now heat the liquid extract to boiling point and add to the liquid a quantity of basic lead acetate solution until no further precipitate is formed. (Basic lead acetate solution is prepared by boiling ordinary lead acetate solution with litharge and then filtering.) The liquid is filtered and afterwards freed from its lead content by passing a stream of sulphuretted hydrogen gas through it. This precipitates the lead in the form of black lead sulphide. Again the liquid is filtered, and it is subsequently very gently heated and evaporated until it attains the consistency of a thin syrup. From this syrup prismatic crystals of creatine will slowly separate out. The yield is, of course, small, only about half a gram of the crystals being obtained from half a pound of beef.

#### An Interesting Substance

One of the most interesting substances in the whole range of natural chemistry is chlorophyll, the green colouring matter of leaves, which is essential to the existence of the plant.

Chlorophyll may readily be extracted from grass or green moss simply by boiling the clean material with alcohol or rectified spirit. Absolute alcohol is, of course, too costly to be used for this purpose, but if only a green solution of chlorophyll is required, the commercial "surgical spirit" will serve the purpose just as well.

Chlorophyll is of unknown composition. It has never been made artificially. Curiously enough, it contains magnesium, that element seeming to exercise as important a function in the green leaf as iron does in our blood. Chlorophyll extracts should be stored in amber bottles, since they are easily bleached by light. Such extracts are very useful for colouring medicinal tinctures, flavouring essences, and various toilet and cosmetic preparations, chlorophyll being an entirely non-poisonous substance.

#### A Crab Shell

An ordinary crab shell forms an interesting subject for chemical experiment, since it is possible to extract from it an animal sugar called glucosamine, which has the formula,  $C_6H_{11}O_5.NH_2$ .

First of all, remove all soft tissue from the discarded crab shell. Then soak the

clean shell in dilute hydrochloric acid for a day or two. This will make it soft so that it can readily be cut into small pieces with a knife or a pair of scissors.

Cut the crab shell up into shreds, place the shredded material into a flask and boil it up with concentrated hydrochloric acid until the shell practically all dissolves, giving a brown solution. Now add to the solution one quarter of its bulk of water and filter it, subsequently evaporating it until crystals form on the surface of the liquid. Cool the solution and then filter it. The brown crystals of impure glucosamine which will collect on the filter paper are subsequently boiled up with a little water and animal charcoal and again filtered. After a final evaporation of the filtrate, colourless crystals of pure glucosamine will be obtained.

#### Colouring Material From Flowers

Attempts are often made by amateur

for a quarter of an hour. The animal charcoal will absorb a good deal of the colouring matter and, after filtration of the liquid, fairly pure tannic acid should be obtained.

#### Acid from Amber

Finally, if one can obtain a small quantity of amber chips, it is interesting to prepare succinic acid from this material. Place the chips into a large test tube fitted with a cork through which a bent glass tube passes and dips into a smaller test tube cooled in water. Heat the amber chips strongly. A dark-brown oil will collect in the water-cooled test tube. This should then be dissolved in hot dilute nitric acid and filtered. The filtered liquid is evaporated to half its bulk and then allowed to cool. Colourless, or slightly yellow crystals of succinic acid will separate out. They should be filtered off, washed with cold water (in which succinic acid is only very

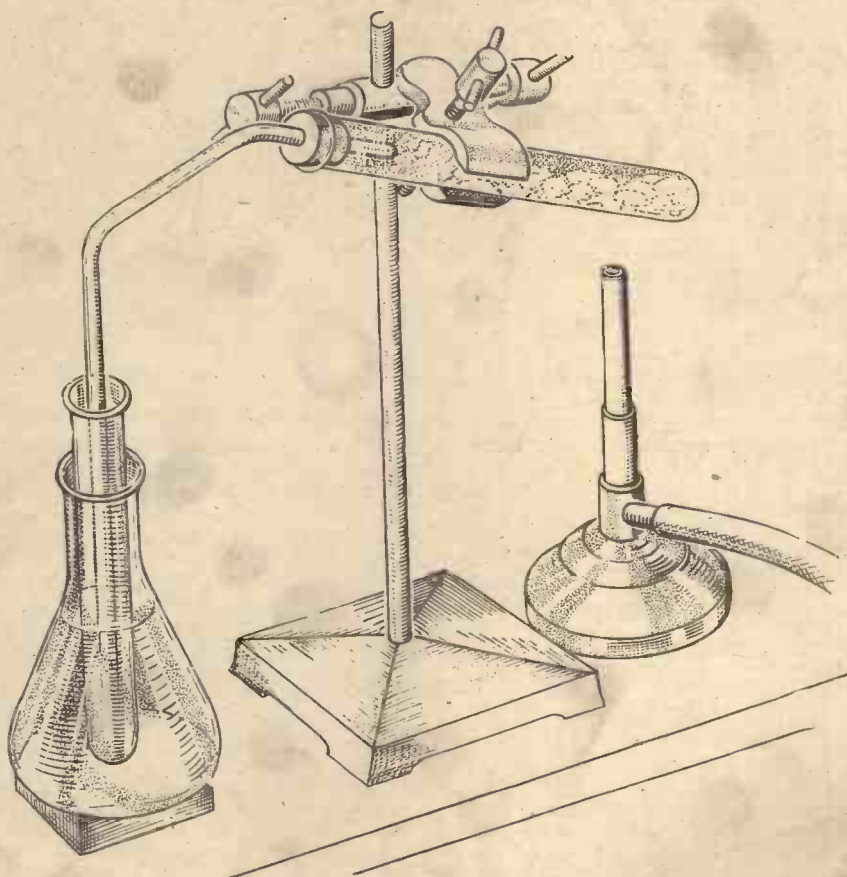

"Dry" distilling fragments of amber in the preparation of succinic acid.

chemical experimenters to extract the beautiful colouring matters from flowers. By boiling flower petals in alcohol or in a mixture of alcohol and water, coloured solutions may often be obtained, but the colours are highly fugitive and are of little use for dyeing purposes.

The oak galls which are found abundantly on oak trees in some parts of the countryside towards the end of the summer contain appreciable amounts of tannic acid which can be extracted from them simply by powdering up the dried oak galls and boiling them with water for an hour or two. The brown liquid extract is filtered off, evaporated to small bulk and the tannic acid allowed to crystallise out. If it refuses to crystallise or if the resulting crystals are brownish in colour, add animal charcoal to the liquid and boil it up again

slightly soluble) and then air dried.

By dissolving the acid in hot water and by adding various metallic salts to the hot solution, a large series of metallic succinates can be obtained, most of which are either insoluble or very sparingly soluble in water.

#### WORKSHOP CALCULATIONS, TABLES AND FORMULÆ

by F. J. CAMM

A handbook dealing with methods of calculation, solution to workshop problems, and the rules and formulæ necessary in various workshop processes. It contains all the information a mechanic normally requires.

From all booksellers 3/6 net,

by post 3/9 from the publisher:

GEORGE NEWNES LTD. (Book Dept.),  
Tower House, Southampton St., London, W.C.2



# MASTERS OF MECHANICS

## No. 44—An Architect Who Turned Engineer, Solomon de Caus, the Apostle of Steam Pressure



Solomon de Caus

**T**HERE is a story to the effect that Solomon de Caus died in a madhouse near Paris, exclaiming, just before his end, "I am not mad. I have made a discovery which will enrich handsomely the country which puts it into operation."

De Caus, this persistent legend has it, fell foul of the notorious Cardinal Richelieu by explaining to that ecclesiastical dignitary the fact that he discovered a mechanical agency which would be capable of working various machines and even of propelling carriages without horses. Whereupon, the story continues, the Cardinal condemned de Caus as a lunatic and had him confined in the State prison at Bicetre, in France, in which place of incarceration the inventor ultimately died, broken in mind, in spirit and in body.

### Book on Sundials

Almost certainly, the above story, beloved of scientific "romance" writers, is quite an unfounded one. Although it is true that de Caus was at one time imprisoned at Bicetre, such detention seems to have been for some now obscure political offence only, for it is believed that he died a natural death in or near Paris about the year 1626, a few years after he had published a book on Sundials, which, incidentally, he dedicated to the place-seeking Cardinal.

Whatever may be the whole truth of the matter, there is no doubting the fact that de Caus has many well-founded claims to be regarded as one of the first steam engineers of comparatively modern history. For although de Caus, so far as we nowadays can possibly tell, never hit upon the idea of the piston and the cylinder, that fundamental device which made steam motive power possible, his was certainly the brain which first worked out the details of a steam pump in which water could be raised from low levels to high ones.

Possibly de Caus, like many another ill-fated inventor, was born somewhat before his time. His schemes generally remained unappreciated, although it would appear that Edward Somerset, 2nd Marquis of Worcester who, in his stronghold at Raglan Castle, in Monmouthshire, had also worked out several steam pressure devices, heard of him and visited him during his period of imprisonment at Bicetre. The Marquis of Worcester's acquaintance with de Caus, however, must have been only a very trivial one, for, after brushing up against him in this manner, the Marquis referred to him no more.

### Weh Educated

Solomon de Caus was a native of Dieppe, France, in which town he was born in the year 1576. He grew up to be a man unusually educated for his time, not only in the classics but, also, in the few fragments of natural science which were available at that period.

From his childhood days, de Caus evinced

great artistic gifts, too. He painted like a master and he became an adept at the art of sketching from life. Mathematics interested him, also. Indeed, he appears to have absorbed all the available knowledge of his day with as much avidity as a dry sponge absorbs water.

In order to extend his sphere and range of knowledge and experience, de Caus travelled a good deal during his earlier days. It is on record that he visited England and that he actually studied in London for the profession of an architect. Whether he was actually apprenticed in any way, we have no means of knowing, but it is certain that this brilliant young fellow found his way into the employment of the Crown in England and that, giving his artistic bent full play, he designed and supervised the laying-out of decorative gardens for the Royal Palace at Richmond.

### Architect to a Duke

In 1613, de Caus finally left England to become architect to the Duke of Bavaria, who had recently married an English princess. For some time previously, he had been resident both in this country and in France,

alternating, it would seem, from one employment to another and accepting "commissions" not only for architectural work but, also, for what we should now term "landscape gardening and design."

At the Duke of Bavaria's gorgeous palace at Heidelberg, Solomon de Caus excelled himself. He completely transformed the Duke's extensive gardens, so much so that visitors came from far and near to see them and to admire not only the essential beauty of their design but, also, the man who had first planned them.

In these days, Solomon de Caus, then a man of some thirty-seven years of age, was leading a more or less successful life. Yet the round of his court duties did not take up all his available energies, for it was during his employment at Heidelberg that he published his first book on mechanics, a work which dealt with mechanical principles and the forces by means of which certain mechanisms could be operated. This book, which is now exceedingly rare, has done much to place its author in the front rank of pioneer engineers, for in it de Caus shows that he had a clear understanding of the effect of steam pressure and of the many applications which may be made of it.

De Caus had, of course, been interested in mechanical appliances—such as they were in those days—from his earliest youth. Exactly how he came to be acquainted with and to experiment in the application of steam power will never be known.

### A Legend

There is a legend, somewhat akin to the fatuous story connected with the life of James Watt, that de Caus first noted the power of expanding steam by the rattling of a pan lid under the influence of steam escaping from the heated vessel, and that he experimented by placing weights on the lid in order to hold it down, but noted in each case that the expanding steam had sufficient power to lift the weighted lid of the pan.

Another story has it that de Caus sealed water into copper vessels which he then strongly heated in a brazier fire, observing that the steam generated within the sealed containers invariably burst asunder the walls of the container. Experiments such as these, however, had been performed time and time again for ages. Hence, even if de Caus did repeat such drastic experiments for his own information, he is not entitled to any merit of priority on their account.

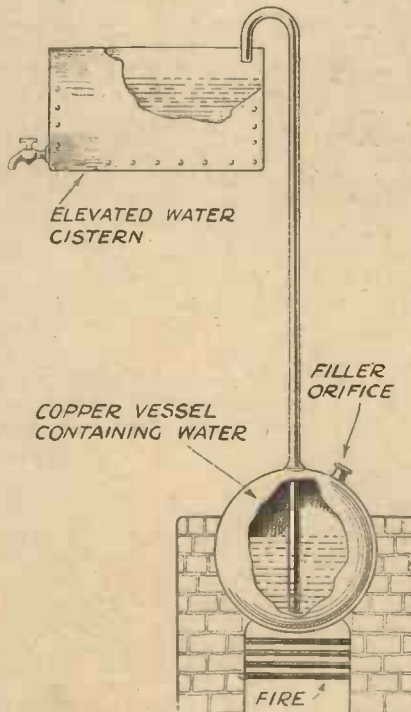

De Caus' "steam pump," one of the first devices utilising steam pressure

In connection with his architectural work, de Caus seems to have had much to do with the design of pumps and with the many practical problems then associated with the supply of water to castles, palaces and other similar large buildings.

Mechanisms were then in existence whereby water was raised from wells to elevated tanks on the roofs of buildings by means of an endless chain of light buckets which was operated by hand. The ordinary suction pump was, of course, unknown, for it makes use of the principle of the piston, a device which de Caus did not hit upon.

Probably de Caus observed water issuing from the spout of a vessel in which it was being boiled. If he did this and thought about the matter at all, it would not have been difficult for him to form instantly the conception of his "steam pump," a device by means of which water is forced by steam pressure from low to high levels.

### "Steam Pump"

This "steam pump," which de Caus described in his book, and examples of which he seems actually to have constructed and used for serviceable purposes, has an operating principle which, judged by present-day standards, is crude in the extreme.

All that de Caus' "engine" consists of is a spherical or hemispherical copper vessel into which an upright tube or pipe is thrust, the pipe reaching nearly to the bottom of the vessel.

The vessel is provided, also, with a filling cock through which supplies of water may be added periodically.

Finally, the vessel, three-quarters full of water, was placed over a fire and strongly heated.

Now, it is perfectly obvious what happens in this case. The steam generated by the heated water collects in the closed space at the top of the vessel and, by its continual pressure, powerfully forces the water out of the vessel up the vertical tube and into an elevated tank or receptacle.

Hence, in the words of de Caus, "By

this agency, water hath been smoothly and silently raised from a low-lying position to one of great height."

We may be permitted to exercise some doubts upon the "smooth and silent" operation of de Caus's "engine." For one thing, the copper boiler sometimes exploded owing to it being incapable of resisting the often considerable steam-pressure raised within it. And, as regard the "engine" being "silent" in operation, well, the convulsive expulsion of boiling water from a vertical pipe is generally, to say the least, not exactly a noiseless procedure.

However, de Caus's steam pump—for we may legitimately call it by that name—worked, and, perhaps, at times, worked really well, so much so that it is very probable that its inventor installed models of his engine in various localities.

### Harnessing the Sun's Rays

De Caus suggested, also, that, in hot countries, it might be possible to focus the sun's rays on the boiler of his steam pump and thus to increase the internal pressure of the steam which had been raised by ordinary fire-heating of the boiler. In this respect he stands out as one of the first attackers of a problem which has not yet been fully solved, to wit, that of utilising the heat of the solar rays for steam-raising and energy-providing purposes.

It is at this stage of de Caus's life that the Cardinal Richelieu story comes in, a narration which seems to be so obviously false that it has hardly merited the trouble of disproving.

The fact is that de Caus was politically minded, in addition to being an ardent inventor, experimentalist and embryo engineer, and it was for his political offences, and perhaps also for religious ones, that he got into trouble with the ruling authorities of his day. De Caus, as we have already seen, did certainly find himself for a time in the dreaded jail of Bicetre, but in no way can he be regarded as a martyr of science.

Indeed, after being freed from Bicetre, de Caus wrote a book on Sundials, dedicated

as previously mentioned, to the romantic and sinister Cardinal Richelieu. At this time, he was acting as architect and civil engineer to the King of France, a post which he retained to the end of his life.

Solomon de Caus died about the year 1626 and at the comparatively early age of 50. But engineering in those days was a somewhat dangerous and furtive occupation, engendering active suspicion upon its followers and bringing little good to them. Perhaps, therefore, de Caus ended his days like many an unrecognised pioneer has done—worn out, if not by poverty, at least by neglect, scorn and bitter disappointment.

### His Book on Mechanics

Had de Caus lived in a less perilous age, he might have made more of his steam-pressure "engine" than he actually did. For in his book on mechanics there is dimly to be discerned implied prophecies regarding the propulsion of mechanisms and even of road carriages by steam, and in this remarkable volume the now almost forgotten author views with delight the possibilities of unending mechanical power held out by this "great servant" of his—expanding steam.

Before any man had risen up in Britain to investigate the power of steam, Solomon de Caus had been active with his steam pump. For this reason, he has been claimed by the French writers as being the inventor of the steam engine and the discoverer of steam power. Such claims are, of course, inadmissible, for de Caus never actually derived motive power by the employment of steam, while as regards the latter of the above claims, even Hero of Alexandria, who flourished nearly a century B.C., obtained motive power from steam by means of his well-known "æolipile" or rotary steam engine.

None the less, Solomon de Caus occupies a pioneer and an honoured place in the long history of steam power, for he and he alone first endeavoured to apply steam power to useful ends and to bring into existence for serviceable purposes a now commonplace source of energy.

## MOTOR REPAIR & OVERHAULING

A NEW work that will prove invaluable to garage mechanics and to all those engaged in the maintenance and repair of cars and commercial vehicles is now appearing under the title of "Motor Repair and Overhauling." The work is being published in about 32 weekly parts at 1s. per part; and is, therefore, obtainable at a very moderate weekly cost from local newsagents and bookstalls.

All the practical points and special repair methods applicable to the leading makes of cars are provided in a convenient and easily readable form, compiled under the direct supervision of the Service Managers or Service Distributors of the particular cars dealt with, and are, therefore, absolutely authoritative.

Each part of "Motor Repair and Overhauling" is divided into four sections, dealing respectively with:

Standard Motor Components and Repair Work; Engine, Clutch and Gear Box Units; Body, Chassis and Frame Repairs (Including axles, steering gear, etc.); Electrical and Accessory Equipment.

Each part contains a "Quick Check-Over Data Sheet" providing in a handy form for reference all the data which are required by the repair man when a particular make of car is brought in for tuning or

general overhaul. The total number of different models dealt with in these sheets is close on 200 and the period covered extends from the year 1936 to 1939.

We recommend interested readers to obtain the parts and see for themselves.

## FRACTIONAL H.P. MOTORS

L. WILKINSON, "Electra House," 204 L. Lower Addiscombe Road, Croydon, is now marketing fractional h.p. motors at prices ranging from 55s. to 94s., according to type. The three types are split phase, capacitor start and three phase. They are dependable and efficient in working and are ideal for use in the workshop. Features of the motors are their exceptionally high torque, continuous heavy duty ratings, large oil reservoir, sleeve bearings and silent operation. They are free from radio interference and their direction of rota-



A useful little motor suitable for workshop use.

tion is easily reversed.

An integral mounted switch, as illustrated, forms a very convenient and economical method of controlling the motor and this can be supplied at 3s. 6d. extra. The motors are priced—split phase  $\frac{1}{4}$  h.p., 55s.;  $\frac{1}{2}$  h.p., 65s., capacitor start  $\frac{1}{4}$  h.p., 84s.;  $\frac{1}{2}$  h.p., 94s., and three phase  $\frac{1}{4}$  h.p., 60s.;  $\frac{1}{2}$  h.p., 70s.

### THE P.M. LIST OF BLUEPRINTS

F. J. CAMM'S  
PETROL-DRIVEN MODEL MONOPLANE  
7s. 6d. per set of four sheets, full-size.

The "PRACTICAL MECHANICS" £20 CAR  
(Designed by F. J. CAMM.)  
10s. 6d. per set of four sheets.

"PRACTICAL MECHANICS" MASTER  
BATTERY CLOCK  
Blueprint 1s.

The "PRACTICAL MECHANICS"  
OUTBOARD SPEEDBOAT  
7s. 6d. per set of three sheets.

A MODEL AUTOGYRO  
Full-size blueprint, 1s.

SUPER-DURATION BIPLANE  
Full-size blueprint, 1s.

The P.M. "PETREL" MODEL MONOPLANE  
Complete set, 5s.

The 1-c.c. TWO-STROKE PETROL ENGINE  
Complete set, 5s.

STREAMLINED WAKEFIELD  
MONOPLANE—2s.

The above blueprints are obtainable post free from Messrs. G. Newnes Ltd., Tower House, Strand, WC2

# MODEL AERO TOPICS

Current News from the  
World of Model Aviation

By F. J. C.

## Decentralised Competitions

WILL officials and organisers of S.M.A.E. decentralised competitions note that competitors' S.M.A.E. registration numbers must be quoted on the entry forms. Competitors are requested to forward to the Competition Secretary, Mr. J. C. Smith, the receipt for the renewal of their policies. This will ensure that they are not disqualified owing to the insurance lapsing.

## Indoor Helicopter Record

AN indoor R.O.G. Helicopter Record of 39.5 secs. made by J. Morris, of the Edgware Club, was passed.

## Pilcher Cup Results

THE following is the result of the Pilcher Cup:—1, N. Lees (Halifax); total points, 354.5. 2, R. H. Warring (W. Sussex); total points, 335.4. 3, R. Hincks (Luton); total points, 316.75. 4, L. Stott (Halifax); total points, 297.5. 5, H. Hirst (Halifax); total points, 269.5. 6, I. Hall (Northern Heights); total points, 253.

## The C.S.S.A. Power Cup

MESSRS. COXALL, CRABBE & NORMAN secured 102.4, 76.4 and 69.0 points respectively in the above.

## Skybird League Prizewinners

THE prizewinners' list in the Skybird League Sixth Annual Rally, which was held on March 15 at Messrs. Hamleys, Ltd., 200-202, Regent Street, London, W.1, is as follows:—Club Challenge Cup, won by Club 287; Replica Cup, won by Club 302; Henry Channon Cup, Replica and Premier Craftsman Medal, won by Mr. R. B. Borra; Mairi Stewart Cup, won by Miss J. R. Hooper; Air League Shield, won by Mr. P. J. Howes; the Aero Modeller Shield, won by Mr. D. Jones; Section "A," under 16 years, won by Master E. T. Land; Section "B," over 16 years, won by Mr. J. L. Cox; Sections "C" and "D," no restrictions, won by R. Cuerrier; Section "D," over 16 years, won by Mr. R. B. Borra; Serving Member, won by Clarkson.



A model of a Westland Lysander made from a kit supplied by Hamley Bros.

## New Club at Farnborough

A NEW club has been formed at Farnborough, with headquarters at Bon Marche, Lynchford Road, Farnborough, Hants. There are 27 members. The hon. secretary is Mr. H. McGinness.

## Forthcoming Competitions

THE elimination trials for the Wakefield International Cup will take place at Fairey's Great West Aerodrome shortly. From the entrants will be selected a team of six to represent Great Britain in the Wakefield Cup Competition to be held on August 6th in the U.S.A. Entries for the elimination trials must be received by the competition secretary on or before May 20th, which date also applies for entries to the King Peter Cup Trials, to be held on July 22nd and 23rd. Other forthcoming competitions are the Model Engineer Cup on May 7th; and the Short Cup, on May 21st.

## A Model Aircraft Log

MESSRS. CATON, of 1, Mermaid Court, Borough, London, S.E.1, rang me up the other day to tell me that my recent suggestion regarding a model aircraft log interested them, because they publish at 1s. 6d. a most interesting and well-produced book of 80 pages, entitled "The Heart of Your Model." This useful little book is not only a text book on the use of elastic, but contains many ruled-off pages in which you may enter details of your models. The book also deals with turns and power; running-in your motor; lubrication; storage; table of turns; hysteresis loss; a calendar; competition fixtures; monthly notes, etc.

I have recently been testing some elastic supplied by Catons, Ltd., and shall publish my results in due course. It has been lubricated with the lubricant supplied by the same firm.

## The Skybird Album

I HAVE received a copy of the splendidly produced Skybird Album which contains four pages of introductory matter, the news bulletin, and an illustrated list, as well as the complete results of the sixth annual rally of the Skybird League, referred to in a previous note. Readers should send for a copy of this album to the Skybird League Headquarters, 3, Aldermanbury Avenue, London, E.C.2.

## The New S.M.A.E. Handbook

THE new 48-page S.M.A.E. handbook is now ready and copies can be obtained from the hon. secretary, E. F. H. Cosh, 35, Maple Crescent, Sidcup, Kent. This contains a list of the officers, affiliated clubs, general competition rules, rules for timing duration flights and record attempts, rules governing petrol-driven models, list of 1939 competitions, with details of the rules governing them, and entry forms. A list of the current records is also given. The book is illustrated by half-tones of the trophies and cups to be won. A copy of the handbook should be possessed by every aero-modeller. It costs 5d. by post, from the address given.

(Continued on page 454)



A petrol model just taking off.

# LEVITATION MYSTERIES



*By Norman Hunter*  
 (The Well-known Conjurer of  
 "Maskelyne's Mysteries" Fame).  
 Further Articles on the Secrets of  
 Conjuring will appear Regularly  
 and Exclusively in this Journal

Secrets of Making  
 People and Objects  
 Float in the Air and  
 of Making Inanimate  
 Articles Move of  
 their Own Accord

**T**HE simplest form of levitation trick is accomplished by means of a length of fine cotton. There are a number of ways of arranging the cotton which enable the conjurer to convince his audience that no means of suspension at all can be employed. Fig. 1 shows a handkerchief being made to float about in the air and dance along the floor. The cotton in this instance is comparatively short. One end is attached to one of the conjurer's waistcoat buttons, the other end is tied to a little hook made by cutting the guard off a safety pin and bending the point. The cotton is then tied through the loop of the pin as shown in Fig. 2. The hook is attached temporarily to some part of the clothing where it can be easily reached when wanted.

### A Simple Illusion

The handkerchief having been shown or one borrowed, the hook is secured and secretly inserted in the centre of it. The handkerchief is then dropped on the floor. The performer has only to walk away from it and the handkerchief will follow him. He slips his hand under the cotton so that it runs over the back of his hand and down between the fingers. By raising the hand,



Fig. 2.—A hook made from a safety pin.

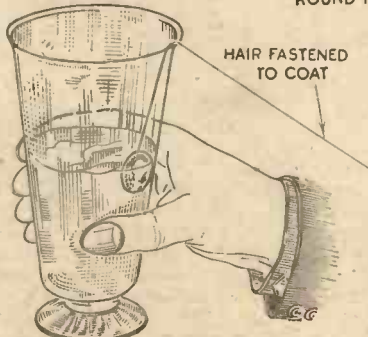
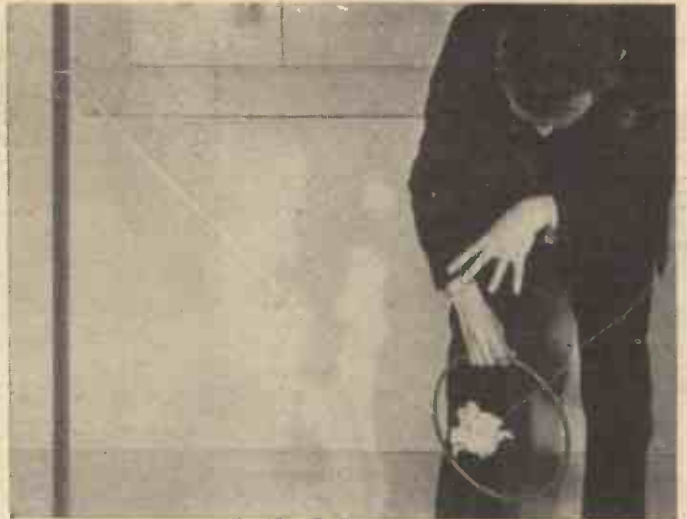

Fig. 6.—A simple levitation of a coin.

Fig. 1 (left).—The Dancing Handkerchief. — Black cotton, here shown as white string for clearness, is the secret motive power.

Fig. 5 (right).—Passing a Hoop Over a Ball of Paper Floating in the Air. The white string shows the method of utilising cotton for this levitation.



or moving it forward, or conversely by drawing the body back, the handkerchief can be made to float up to the finger tips. The cotton is represented in the photograph by white string to make the method clear.

While the various movements are being performed with the aid of one hand, the other hand may wave a stick under and over the handkerchief to prove the absence of connections. A hoop may be held under the handkerchief which may then be allowed to drop through it. A number of amusing antics may be performed by the handkerchief as will quickly be discovered by experiment.

### A "Floating" Ball

Fig. 3 shows another way of arranging the

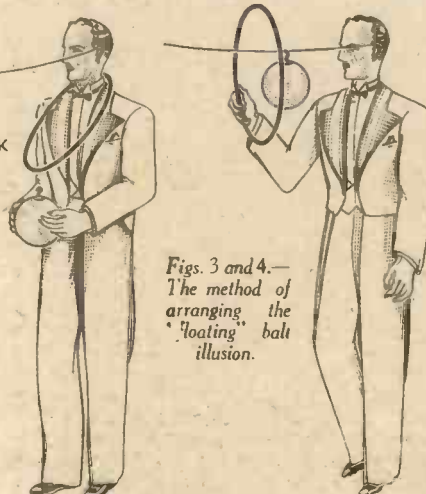

cotton, this time for causing a large ball to float about the stage. One end of the cotton is attached to a short piece of wire bent like the ear piece of a pair of spectacles. The other end is led across the stage and tied at some convenient point about five to six feet above the floor. Just before coming on for the trick the conjurer hangs a wooden hoop over his head and then attaches the ear piece to his ear. The ball is either a hollow one of thin aluminium with a tiny hook attached or else an ordinary football bladder inflated, suitably decorated and the nozzle cut short and fastened down with adhesive tape. A tiny hook is attached at the same point.

The performer enters with the hoop round his neck and carrying the ball in his hand. He has complete freedom of movement about the stage but must take care not to get the cotton tangled and for this reason it is wise to exclude any but essential articles from the platform during the trick.

Having shown the ball and thrown it up a few times to prove it to be a separate article and not attached to anything, the conjurer secretly hooks it on to the thread, stepping back until the thread is just taut enough to support it. He removes his hands, making passes and the ball remains suspended. By moving to and fro he can then cause the ball to rise and fall. At any time during the trick he can take the hoop off his neck and pass it freely over the ball because the thread already runs through the hoop, as shown in Fig. 4.

### Offstage Assistance

By having the opposite end of the cotton in the hands of an assistant mounted on a pair of steps off stage, the ball can be made to float about in various directions, the assistant raising and lowering his end,

moving forwards and backwards in co-operation with the performer. When the assistant's end of the cotton is raised the ball will slide along the thread towards the performer, while if the assistant lowers his end below the height of the performer and the thread is tautened, the ball will glide away from him.

With a little rehearsal between performer and assistant it is possible to make the ball float gracefully about with such apparent freedom that it seems impossible that it can be supported by anything. During the levitation the performer can not only pass the hoop over the ball but also wave a stick under and over it. It should be noted that the method of arranging the thread avoids having any support directly over the levitated object, this being the position in which an audience always suspects the connection.

**Another Arrangement**

Fig. 5 shows a similar arrangement for levitating a ball of tissue paper. In this case one end of the thread is tied to a standard lamp or to some heavy object on a table, or to the back of a chair and the other end is in the hands of an assistant. The hoop is hung over the chair or laid at the foot of the standard lamp with the thread lying slack along the floor out of the way. To perform the trick the conjurer picks up the hoop and a sheet of tissue paper while his assistant raises the thread. The performer crumples the paper round the thread and drops it on the floor. Within certain limits the assistant can now make the paper ball float up and down and, as the thread runs through the hoop this can be passed freely over the suspended ball. The hand or a stick can also be waved above and below the ball. With this or the method previously described, the trick is brought to a conclusion by the performer gripping the ball while the assistant jerks the thread, snapping it and drawing it clear so that the conjurer can walk straight down to the audience and show the ball freely.

**Levitation of a Penny**

Fig. 6 shows a simple levitation of a penny which is made to climb up the inside of a glass. The glass can be full of liquid. In this case the motive power is a human hair, one end of which is attached to the coat while the other end has a dab of wax attached. The wax is secretly attached to the coin which is then dropped openly into the glass. By moving the body back or edging



Fig. 7.—The Walking Chair. Lengths of black cotton looped over drawing pins and attached to the legs of the chair enable it to be made to crawl about the stage in a spooky manner.

the glass forward, making passes with the free hand to disguise the movement, the penny can be drawn up the side of the glass. When it reaches the top it is taken and dried on a handkerchief, the waxed hair being removed in the process and the coin returned to its owner.

The same method, using a hair, can be employed to make small light articles such as a spoon or a playing card walk along the table towards the performer. If the hair is long enough he can, while arranging the trick, get the hair

should be either dimmed or extinguished to avoid causing shine on the thread. With these precautions observed the thread will be quite invisible, and all the more so because the ordinary member of the public will not know where to look for it.

Before leaving the subject of levitations with thread I should like to describe a very spooky effect quite easily produced on a platform or even in a large room by its aid. The performer presents a trick in which he pretends to be assisted by some invisible person. "Draw your chair up to the table," he says. The chair obediently glides in the most mysterious manner up to the table and turns in exactly as if some unseen occupier were moving it. Various other uncanny effects can be performed on the same principle.

The essence of the secret is shown in Fig. 7. Two lengths of thread are required. A loop is made in one end of each; these loops are placed over the points of two large drawing pins and the pins placed upward under each of the front legs of the chair. The free end of each thread is then tied to the ends of a stick about eighteen inches long.

**Mysterious Chair**

The chair is placed to one side of the stage near the back and the threads led under the

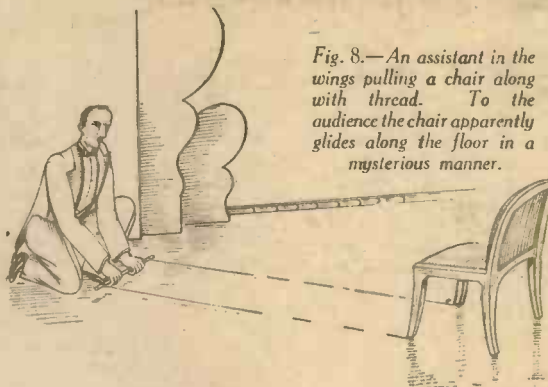

Fig. 8.—An assistant in the wings pulling a chair along with thread. To the audience the chair apparently glides along the floor in a mysterious manner.

table and off stage where an assistant holds the rod. When the chair is to walk the assistant, keeping the rod on the floor, draws it slowly along, pulling the chair along the stage by the threads (Fig. 8). As the chair reaches the table he swings the end of the rod round while continuing the pull and so makes the chair turn in to the table. The threads are flat on the floor the whole time so do not interfere with people walking about the stage and as long as dark thread and dark carpet or other floor covering are used there is no risk of detection.

Now we come to levitations of human beings. The illusion that was probably the original floating lady effect consisted of having the lady lie on a sort of couch made rather like a shallow box, where she had a

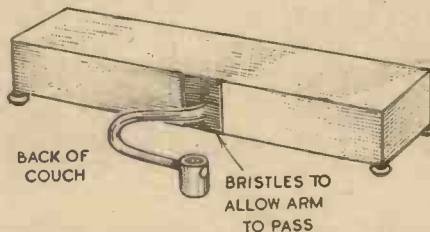

Fig. 10.—Showing the metal arm projecting from the back of the couch.

round some heavy article on the table and using this as a guide for the hair, cause it to draw the object away from him instead of towards him. Under artificial light in a normally lighted room the hair, as long as it is a dark one, is completely invisible even to people who may be looking for it. A similar series of tricks can, of course, be presented on a platform or at a little greater distance than that between people sitting at a table, by the use of fine cotton.

**Dark Background Essential**

In all tricks where a thread is used the important thing is to see that no light background comes behind any part of the thread. It is not necessary to use a black background, in fact a patterned curtain or wallpaper will conceal the thread more effectively. Glossy thread should be avoided and on a platform the footlights

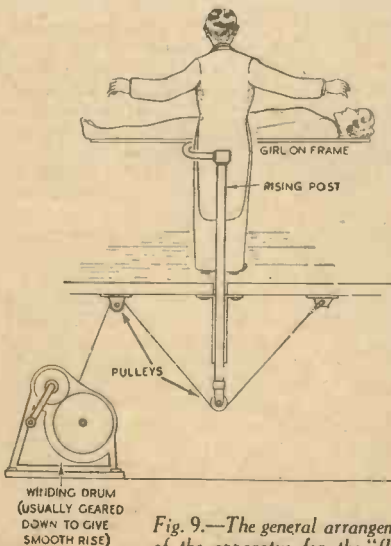

Fig. 9.—The general arrangement of the apparatus for the "floating" girl illusion.

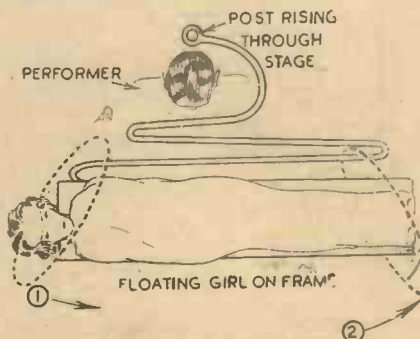

Fig. 11.—A plan view of the "floating" girl illusion showing the shape of the metal arm.

shawl draped round her. The magician then made passes, standing behind her and the lady slowly rose out of the box until she was suspended about three feet above the stage. To prove absence of support a large steel ring was passed several times over the floating form, after which the lady descended to her couch once more.

**A "Floating" Girl**

The illusion was performed by placing the lady on a metal frame hidden in the box. This metal frame had an arm projecting from the rear of the box where it was connected to a vertical rod passing below the stage. This rod was raised by a winch under the stage and so the lady was made to rise. The performer, standing behind the lady, concealed the vertical rod which rose behind his back, the connecting iron curving round him, hidden by the body of the floating girl.

Figs 9 and 10 show the general arrangement but the details vary with individual performer's own ideas. The passing of the hoop over the floating girl is made possible by the introduction of a specially bent metal arm which connects the frame on which the girl reclines with the rising rod. Fig. 11 shows the shape of this rod and gives a skeleton plan of the illusion. The passing of the steel ring is shown by stages in Figs. 11 and 12. It will be seen that when the girl has risen to the full height allowed, usually about the height of the performer's waist, he takes the ring and passes it over her head, taking it along as far as the bent arm permits. When he reaches the limit of the arm he turns the ring and so swings it round and off the girl's feet. At this point the ring is still on the bent arm. The performer now passes the ring from his left hand to his right, the ring going back behind the girl and passing along the rod. It is then passed over her head once more as shown in Fig. 12, along to her feet and off when it comes away free. To the audience the effect is that the ring is passed twice over the girl's body and apparently proves that she has no means of support.

The frame on which the girl rests is hidden by the shawl placed under it in the box like couch. This shawl being wrapped over the girl before the levitation starts effectively conceals the frame from view.

**Doll Illusion**

A very effective illusion on this principle could easily be constructed to operate with a large doll. In this case there would be no need for the powerful lifting gear and metal rod through the stage as the lifting could be done with threads. The frame and bent arm would be made of stout wire and small counter weights would be attached as shown in Fig. 13 to equal the weight of the doll, the threads being tied to either end

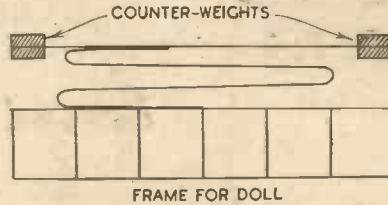

Fig. 13.—Plan of the apparatus for the levitation of a doll.

of the frame between the weights and the frame. See Fig. 14.

The threads should run straight up, over porcelain insulators or through insulated screw eyes as the porcelain gives a very smooth bearing for the thread. From the overhead position the threads are carried to the side of the stage, over two more insulators and down to a short stick in the

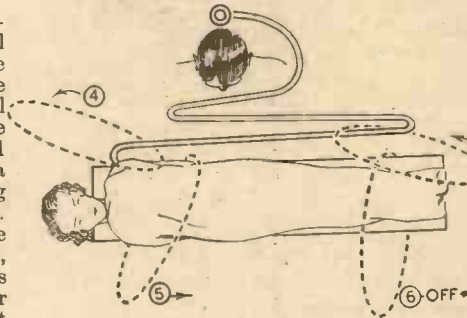

Fig. 12.—How the hoop is passed over the floating girl.

hands of an assistant. Raising and lowering the doll can be managed quite smoothly and, by tilting the stick the floating doll may even be made to rock backwards and forwards while in the air. The passing of a hoop over the doll is managed in exactly the same way as in the full size illusion, the threads being attached behind the bent arm.

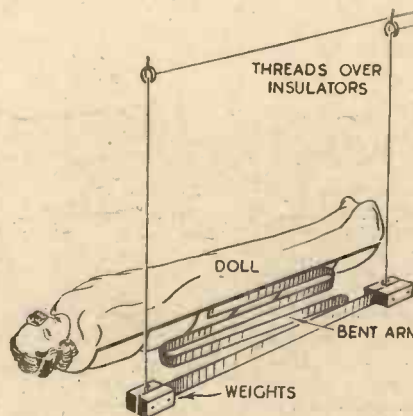

Fig. 14.—The suspending threads are tied to either end of the frame, between the weights and the frame.

**The Vanishing Lady**

Finally here is a sensational illusion which is both a levitation and a disappearance. A girl lies on a table and is covered with a white sheet. At the command of the performer the covered figure slowly rises into the air well above his head. The table is pushed away and the conjurer passes a hoop over the floating figure. Finally he snatches away the sheet and rolls it into a ball. The girl has entirely vanished and the stage is quite bare of any possible place of concealment.

Strangely enough this illusion is a very inexpensive one and, although it calls for careful rehearsal, is not difficult to present.

The table on which the girl lies has a portion cut out just large enough for her to pass through. This opening is closed by covering the table top with oilcloth. The cloth is slit down the centre of the opening and wide pieces of elastic sewn to either side of the cut so that they overlap. The sides of the table are just deep enough to conceal the girl and the under side of the table is boxed in.

When the girl lies on the table she supports her weight on her heels and elbows. As soon as the sheet conceals her she allows herself to slip through the trap which closes after her. Concealed behind the table is a frame made of thin blackened wire. This frame is shaped to represent a human figure when covered with a cloth and it is fitted with a fine wire bent arm in the same way as the doll illusion just described while small counterweights adjusted to equal the weight of frame and covering sheet enable it to be suspended by threads in the way described for the doll.

**Through the Trap**

The performer and his assistant first stretch the sheet between them and bring it over vertically in front of the girl as shown in Fig. 15. While she is thus concealed the girl slips through the trap, first swinging the fake over so that it rests on the table as she goes through the trap. The performer and his assistant then lower the sheet over the frame, arranging the back so that it does not foul the threads or cover the bent arm. At a signal from the performer an assistant in the wings causes the covered frame to rise by pulling on the threads, as in the doll levitation.

The table is now pushed off the stage and the girl can get out of the table and into any other piece of magical furniture in which it may be desired to produce her again. The hoop passing-over the floating form is now carried out in the usual way. Fig. 16.

To effect the vanish the performer takes hold of the hanging edge of the sheet. At a pre-arranged signal the assistant suddenly slackens the threads, allowing the frame to drop to the stage. At the same moment the conjurer whips the sheet off and runs forward rolling it into a ball.

The sudden dropping of the frame helps

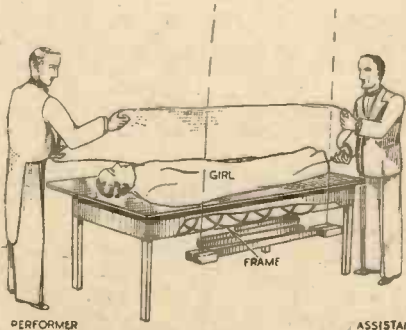

Fig. 15.—The performer and his assistant first stretch the sheet before them and bring it over vertically in front of the girl.

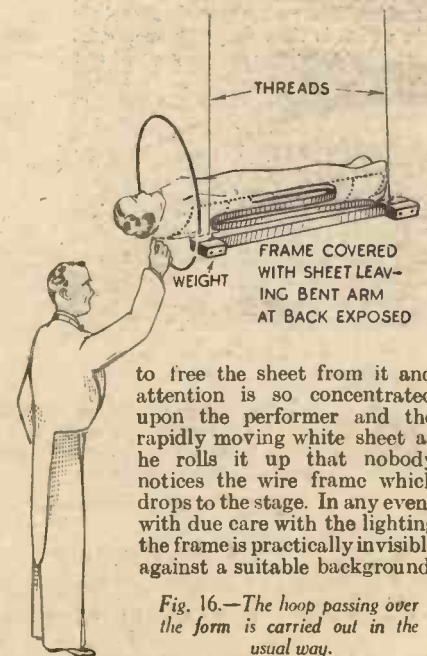

Fig. 16.—The hoop passing over the form is carried out in the usual way.

# MOVIE CAMERAS

**FOR A FEW PENCE A DAY!**

Any Cine Camera over 50/- on easy terms—start movie-making as soon as you have paid the first instalment.



**24 MONTHLY PAYMENTS OF 9/-.**

Cine-Kodak "8." A neat compact Instrument with view-finder incorporated in the carrying-handle. Halves running costs. Takes 25 ft. of 16-mm. film, half of the width being exposed at a time to make perfect 8 mm. movies. With f/3.5 lens. Cash price £10.



**15 MONTHLY PAYMENTS OF 10/-.**

Pathe "H," for interchangeable lenses. The finest 9.5-mm. cine camera on the market at such a low price. Fitted with f/2.5 lens.

Cash price £7 0 0.  
Good allowance on your used still or cine-camera in part exchange.

Send at once for easy payment form.

Free literature on any cine apparatus in which you are interested will be sent post free.

**CITY SALE & EXCHANGE (1929) LTD.**  
59/60 CHEAPSIDE, LONDON, E.C.2

## AT LAST! A Small Engine at a Reasonable Price

**"SYNCR0 BEE"**

### BRIEF SPECIFICATION

½ h.p., 3½ oz. weight, ½ in. bore, ½ in. stroke, 1,000/8,000 r.p.m. Machined steel cylinder. Piston special aluminium alloy with two rings. Connecting rod special aluminium alloy. Crankshaft precision machined from specially treated steel stock. Timer steel and fibre construction placed conveniently above oil and grime interference, as used on the famous Syncro Ace. Ignition Coil, Syncro's new "Super-Lite," weighs 1½ oz., specially developed for the Syncro Bee. Vertical or inverted without any dismantling.

All Parts Interchangeable.

New Champion Spark Plugs (V.2) ½ in. 5/6 each, post free.

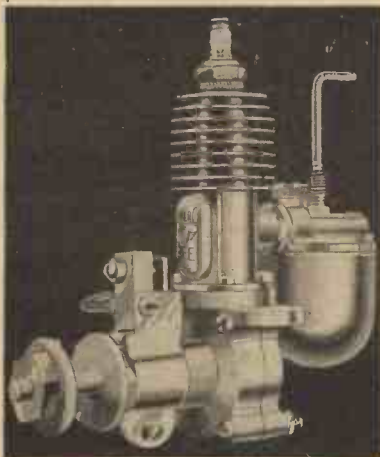

**PRICE: £3-15-6** Post Free.  
Fully tested and unconditionally guaranteed

**FREE**

As an introductory offer we will give free a specially carved propeller with each engine ordered from this Magazine. This offer is limited and early application is desirable.

THE LATEST "SYNCR0 SPECIAL" 8 c.c. can now be supplied by return. Price £3-7-6 (Post free).

# THE MODEL SHOP

6 COLLEGE RD., BARRAS BRIDGE, Newcastle-upon-Tyne

Please send 3d. for fully illustrated Catalogue.



## The Latest & Greatest

Here is a really safe and seaworthy folding canoe built of the finest materials by a British Boatbuilder. Sturdy and rigid when erected, the canoes are yet remarkably light and compact when in carrying bags. All metal fittings non-corrosive—no aluminium used. Large model accommodates two persons and camping equipment up to 10 cwt.

PRICES	
Single Seater Sports Model	12 gns.
Two Seater, 14 ft.	£12 0 0
Two Seater, 18 ft.	£18 0 0

## Turn her into a power boat

That you can enjoy the sport of motor-boating for next to nothing is no idle boast nowadays. An outboard to drive your canoe or a hired boat costs as little as £9.

Let us send you full particulars of our large range of Elto Evinrude and Britannia Outboard Motors.

**free**

Write and ask for Free Copy of "Pleasures Ahoj" — the magazine of Water Sport.

**THE BRITISH MOTOR BOAT MANUFACTURING COMPANY LTD.**  
12 Britannia House, Ampton Street, (Nr. King's Cross), London, W.C.1  
Telephone: Terminus 6361 (5 lines)

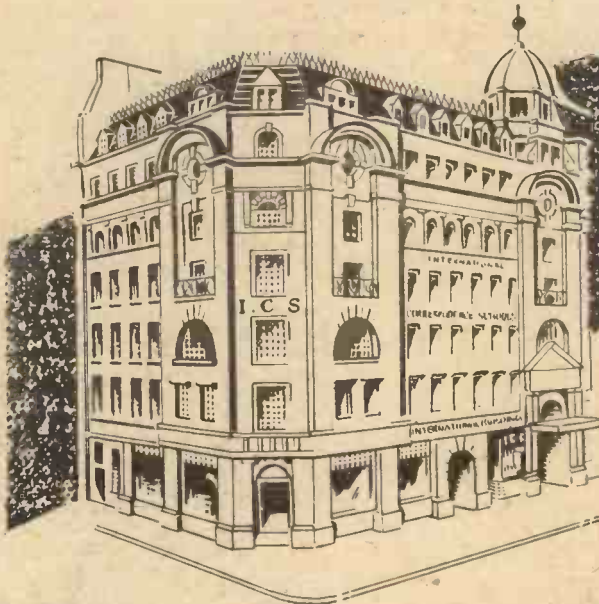

*Your Work -  
AND Your Pay*

This is  
**INTERNATIONAL BUILDINGS  
KINGSWAY, LONDON**

Head Offices of the

**INTERNATIONAL  
CORRESPONDENCE SCHOOLS**

It is the centre from which radiates technical, commercial, and professional instruction that has been of great benefit to tens of thousands of ambitious people.

The I.C.S. is the greatest as well as the largest institution in the Empire devoted to spare-time training. Its prestige is unequalled. Several State Departments have entered into working arrangements with the I.C.S. for the training of men.

More than 1,500 I.C.S. text-books, prepared at International Buildings, are marvels of clearness, accuracy, and practical helpfulness.

There are 80 Instructors at Kingsway, many of them Associates, Members, or Fellows of their respective technical or professional bodies. All are specialists, and expert in giving the student individual attention throughout his Course of Study.

Among the 400 I.C.S. Courses there is one that can qualify YOU for Promotion and better Pay.

The size of your salary is more or less in accordance with the measure of what you know and therefore can do. The more you know, the greater your pay.

Success—progress won by merit—depends on trained ability. Unless you have studied IN YOUR SPARE TIME, you have little chance of promotion, for knowledge that comes through everyday work is not enough.

You must know the principles underlying your work and be familiar with the many processes closely related to that work. *The one and only means of obtaining such knowledge is specialized study.*

No man need be without that extra efficiency which adds so much to his income, security, and happiness. He can acquire it on easy terms, by the simple I.C.S. method of teaching by post.

If you are in the early stages of your career and have not yet had a specialized training, you should start to get one without delay. Or perhaps you feel that your knowledge is a little out of date and ought to be modernized. In either case

**The International Correspondence Schools can help you.**

*Our expert advice on any matter concerning your work and your career is yours for the asking—free and without obligation. Let us send you a booklet dealing with the subject in which you are especially interested. It is packed with valuable information.*

The I.C.S. offer instruction in the subjects given below.

Write for Special Booklet to-day or use the Coupon.

**COUPON FOR FREE BOOKLET**

**INTERNATIONAL CORRESPONDENCE SCHOOLS, LTD. (Dept. 95), International Buildings, Kingsway, London, W.C.2**

Please send me your booklet containing full particulars of the Course of Correspondence Training before which I have marked X. I assume no obligation.

- Accountancy
- Advertising
- Aeronautical Engineering
- Air Conditioning
- Architecture
- Boiler Engineering
- Book-keeping
- Building
- Chemical Engineering
- Civil Engineering

- Diesel Engineering
- Draughtsmanship
- Electrical Engineering
- Engineering Shop Practice
- Fire Engineering
- Garage Management
- Gas-Power Engineering
- Heating and Ventilation
- Hydro Electric
- Journalism

- Lettering
- Mechanical Drawing
- Mechanical Engineering
- Mining Engineering
- Motor Engineering
- Pattern-making
- Plumbing
- Radio Engineering and Servicing
- Salesmanship
- Sanitary Engineering

- Scientific Management
- Short-Story Writing
- Steam Engineering
- Surveying
- Telephone and Telegraph Eng.
- Textiles
- Welding, Gas and Electric
- Wireless Engineering
- Woodworking
- Works Management

**EXAMINATIONS**

Technical, Professional, Matriculation, and Civil Service. State the one you wish to pass .....

NOTE.—If your subject is not on the above list, write it here .....

NAME..... AGE.....

ADDRESS.....





# THE SPEED OF THE WIND

By E. Hardy, F.Z.S.

How Clouds and Birds Show the Speed and Direction of the Wind

**A**VIATORS no less than travellers on the ground welcome information about the wind in the air, but if they do not happen to be near an aerodrome there may be some difficulty in assessing the speed of the wind, although its direction will be apparent enough. Clouds will always show the direction and speed of the wind at various levels in the air, at some height, while any strong currents at low level will be noticed by the manner in which certain birds, particularly seagulls, are able to glide with speed with the current, or turning into it with fixed wings, rise rapidly against it. Even on a cloudless day, the direction of the wind at a height of fifty to one hundred feet is shown by any kestrel or hoverhawk, the commonest falcon in our own countryside, which has the common habit of hovering frequently in its search for field-mice and it always hovers head to wind. Flocks of wildfowl on a lake, and in winter flocks of field fares (big greyish thrushes from Scandinavia) face the wind rather than let it ruffle their plumage.

## Limited Guides

Those, however, are only limited guides to wind speeds and we may need some more extensive guides without the inconvenience of instruments. So there is the following series of useful observations for assessing most air speeds at 40 feet. In calm air the smoke from a chimney rises vertically, and although in light air of only 2 m.p.h. this smoke is affected it does not affect the clouds or the weather vane. A light breeze of 5 m.p.h. causes leaves to rustle and is felt on the face but not until a gentle breeze of 10 m.p.h. blows is a flag extended from its mast, or small twigs as well as leaves brought into constant motion. At 15 m.p.h. (a moderate breeze) dust and loose paper are blown about and small branches moved on the trees. At 21 m.p.h. (a fresh breeze) you will see small trees begin to sway and crested wavelets are formed on lake or inland water. A strong breeze of 27 m.p.h. moves the larger branches of a tree and makes the telegraph wires "whistle." A large tree sways before a moderate gale of 35 m.p.h. and people exert extra effort to walk against it. It is noticeable difficult to walk against a fresh gale of 42 m.p.h. when dead twigs are broken off the trees. At 50 m.p.h. (a strong gale) chimney pots and slates may be blown off houses.

A whole gale of 59 m.p.h. is only occasionally experienced inland in Britain, but when such speed does occur whole trees are uprooted and buildings are damaged. A 68 m.p.h. gale is rarely experienced.

When the wind changes to the north in winter we expect snow if the barometer stays high and the thermometer drops to just above freezing. An east wind in winter is unreliable, for a depression may be deflected over the North Sea towards the

British Isles and snow may fall while the depression is stationary or moving away, making barometric reading useless, or it may move quickly to the south and give light snow, sleet or rain. The prevailing

*This generator relies on the speed of the wind for supplying its power.*



direction of the wind in any district is usually shown by the growth of exposed trees which tend to lean away from the wind, or the planting of clumps of trees as windbreaks by isolated farm houses, churches, etc.

## Wind Velocity

The wind is never entirely steady at a low level but is always made up of a series of gusts and lulls whose variation may be large (in gusty weather) or small (in steady wind) and these gusts are caused by trees, houses or hills, or other obstructions to the flow of air. Cliffs or mountains may even deflect the wind from its true direction as well as reduce its speed; that is why meteorological stations are built on high or exposed positions. Weathercocks are sometimes misleading, for they may have been set by a compass with their four points according to the magnetic North Pole, whereas the meteorologist and the Air Ministry always work from the geographical North Pole, and the difference between the magnetic and geographic North Poles is not constant over the British Isles or from one year to another, and may be anything up to 20 degrees. Many old weather cocks refuse to move on their bearings until an extra strong gust turns them, and thus they are useless for light or moderate winds. Hence the observations on smoke, flags, trees are really much more reliable than the average weather-vane although more precise measurements of the speed of the wind can be obtained with an anemometer, as used at the meteorological stations. This consists of wind wheel on the top of a post, like a rural water pump, worked by wind, and when rotated registers the speed on an indicator below, much like a speedometer.

The velocity of the wind obviously varies with the height above ground and at 60 feet it is considerably stronger than at 20 feet, and in the Beaufort Scale of smoke, tree, etc., guides already given, the height is at 40 feet. The rotation of the earth also has an influence on wind. The air does not

flow rapidly from high pressure areas to low pressure areas as might be expected; because of this rotation of the earth which deflects it, the wind tends to flow round the region of low pressure rather than towards the centre. Cold air from the Arctic moves southwards to replace warm air that has risen because of its increasing lightness, but as there is little rotation speed of the earth's surface in the polar regions, this air movement is so slow that the quickly rotating earth away from the poles moves faster than the air currents, and overtakes them, thus we get the cold east winds which seem to be moving against the direction of the earth's rotation whereas our prevailing westerly winds from the Atlantic are moving with the earth's rotation as well as their own speed.

## How Wind Circulates

If you have your back to the wind in the Northern Hemisphere, air pressure is lower on your left than on your right, but in the Southern Hemisphere the opposite is the case. This is because the wind circulates round a low pressure area in an anti-clockwise direction (right to left) in the Northern Hemisphere but in a clockwise direction in the Southern Hemisphere. Thus Southern weather maps are very confusing to those who have only studied Northern ones.

It is clear, too, from the meteorological observations that the winds are much stronger over Ireland and South-West England, where the isobars are closer together on the weather map, than over the North of England where the isobars, calculated from observations, are more widely spaced when they come to be plotted on the weather map. This is generally true of any weather map, that the wind is strongest where the isobars are closest together, the isobars being the lines on the map joining up areas of equal barometric pressure on a given date. In other words, this means that wind is strongest over areas showing the greatest range of air pressure and calmest over those with a fairly regular air pressure.

MODEL AERO TOPICS

# Folding Airscrews and

## Although Most Model Aero and the Undercarriage are Two

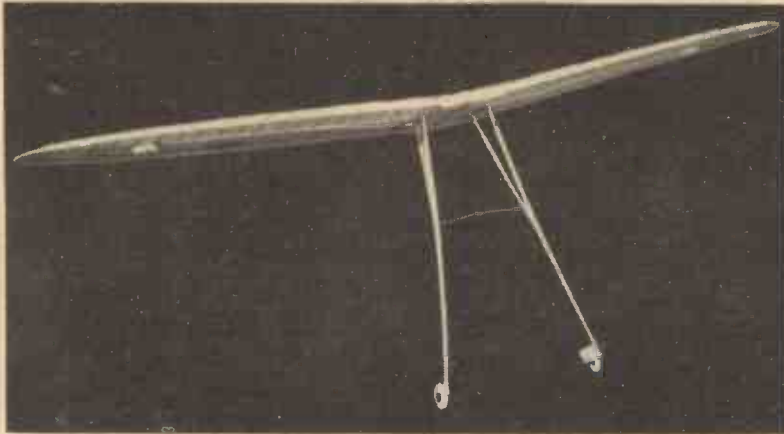

Two views showing the open and closed positions of the retractable undercarriage housed in the wings.

lining is negligible at the low speed of models (even the Wakefield class averages no more than 12 to 15 m.p.h.), and that any elaboration upon the slab-sided fuselage type of model, which is easily, cheaply and rapidly built, and replaced with equal facility if lost during elimination trials, is a waste of time, material and energy.

### Benefits from Streamlining

One suggests that this argument, like many another, is based on a half-truth. Doubtless, the full benefits to be derived from streamlining will not be felt in the case of a model. But it should be remembered that aerofoils are not at their best at such low speeds, and that an undue proportion of the modicum of power available is absorbed in overcoming inertia. As long as duration continues to be the keynote of competitive flying, surely any factor which causes waste of power is fit subject for elimination! One would suggest, therefore, that the reduction in drag obtainable from streamlining is worth while in the case of a

**M**ODEL aviation, in keeping with its full-scale counterpart, has been responsible for many controversies. Biplane or monoplane, high-wing or low-wing, gearing or plain drive, have all been debated vigorously—and inconclusively—and will doubtless continue to preoccupy us at intervals. Meanwhile, two seasons' experience with the "8/200" formula for Wakefield Cup models (minimum weight of 8 oz. and 200 sq. in. of wing-area, with a plus and minus tolerance of 10 sq. in.) has divided the aero-modelling community into two camps over the question "To streamline or not to streamline."

The anti-streamline party argue that the decrease in drag to be obtained from stream-

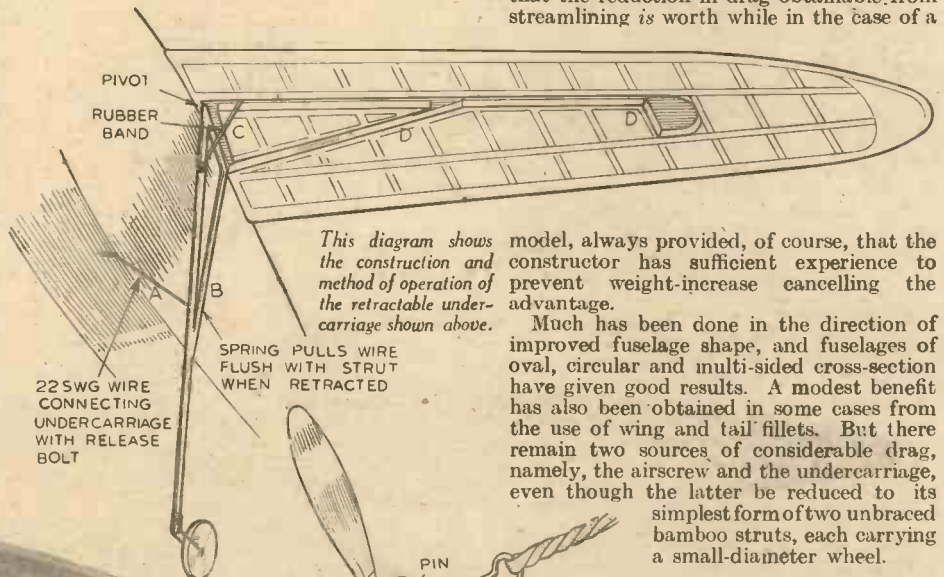

model, always provided, of course, that the constructor has sufficient experience to prevent weight-increase cancelling the advantage.

Much has been done in the direction of improved fuselage shape, and fuselages of oval, circular and multi-sided cross-section have given good results. A modest benefit has also been obtained in some cases from the use of wing and tail fillets. But there remain two sources of considerable drag, namely, the airscrew and the undercarriage, even though the latter be reduced to its simplest form of two unbraced bamboo struts, each carrying a small-diameter wheel.

### Retractable Undercarriage

Most full-scale aeroplanes are now fitted with hydraulic and manual devices, whereby the pilot can retract the undercarriage into the fuselage or wings after taking off. Providing the pilotless model with an undercarriage which retracts automatically and is really satisfactory is not an easy task. Perhaps that is why so many modellers persuade themselves that retraction is impractical. Several types of "one-way" retractile landing-gears have been produced, but the problem of lowering the wheels before landing has scarcely been tackled. It is hardly a pressing problem, since a properly-constructed model will sit down quite happily on the bottom of its fuselage. This might be expected to be very unhealthy for the airscrew, but in practice has not given much trouble, possibly owing to the free-wheeling device.

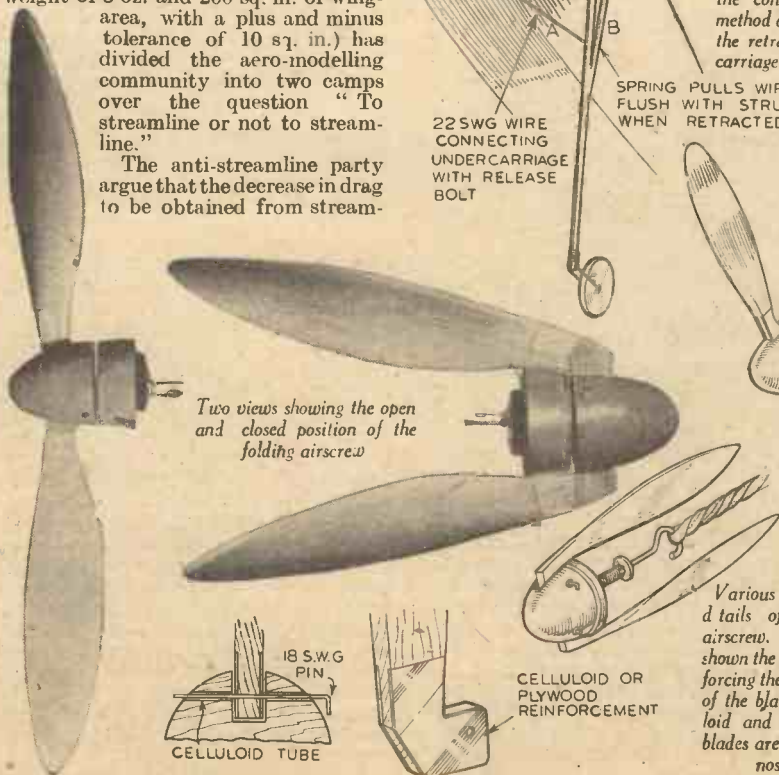

Two views showing the open and closed position of the folding airscrew

Various construction details of the folding airscrew. On the left is shown the method of reinforcing the swivelling end of the blades with celluloid and also how the blades are secured in the nose-piece.

# Retractable Undercarriages

Enthusiasts Endeavour to Streamline their Models as Much as Possible, the Airscrew Sources of Drag which are Seldom Obviated. The Suggestions put Forward Below will Help to Overcome these Obstacles

However, the airscrew itself has been an object of drag-reduction experiments, and a type which folds its blades when the power ceases has been in use for some time.

To the best of my belief, the first modeller habitually to make use of a folding airscrew was Mr. W. L. Henery, of The Model Aircraft Club, London. Though its use is usually the outcome of fitting a retractile undercarriage, in his case the order was reversed. At the time, the free-wheeling airscrew was coming into favour as a means of reducing drag during the glide, and, in keeping with aeronautical tradition, considerable controversy raged as to whether a free-wheeling airscrew really did or did not offer less resistance than the fixed variety! Mr. Henery swept all uncertainties aside,

mechanical sense). Mr. Henery's version avoids this fault. When in the extended position the blades bear no indication of being any different from the conventional fixed type. The clean outline is achieved by locating the pivots within a balsa spinner. The blade roots are tapered, and reinforced with thick celluloid, and fit snugly in tapered and reinforced recesses

used. As soon as rotation ceases, the air-flow folds the blades, so that they lie alongside the fuselage. This constructional system, in addition to achieving aerodynamic cleanliness, secures rigidity, and facilitates the rapid interchange of blades. Often, too, damage will only involve replacement of one blade instead of the entire airscrew.

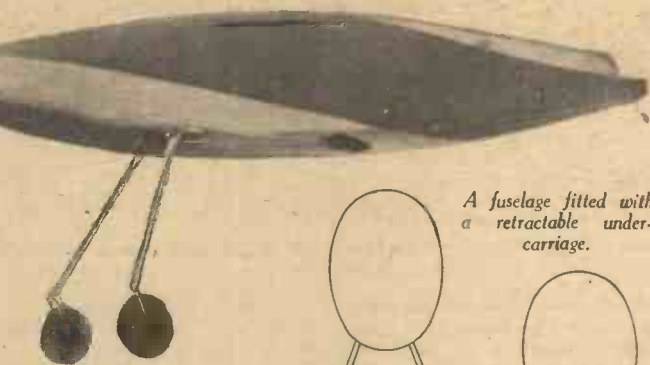
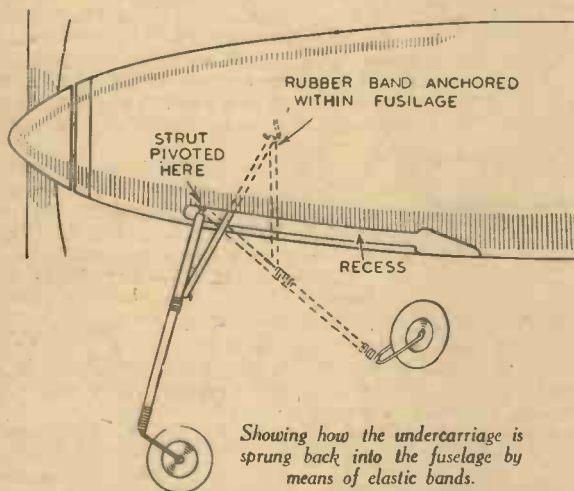

A fuselage fitted with a retractable undercarriage.

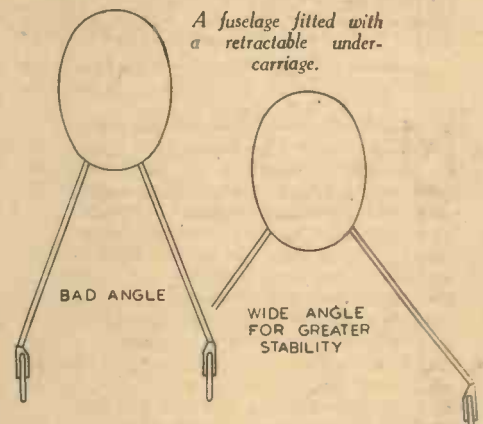
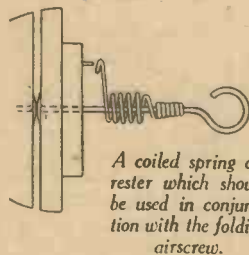

Showing the correct and incorrect angle for the undercarriage.



so to speak, and arranged for the airscrew blades of his 1936 Wakefield model to fold. The following year, he fitted the same machine, strengthened to bring it up to the new weight rule, with a simple form of retractile undercarriage. His 1938 machine had a folding airscrew and a highly ingenious mechanical device for retracting the undercarriage into the wings. Neither model secured a place in the Wakefield team, despite their aerodynamic refinements, but this was due to causes quite unconnected with airscrews or under-carriages.

### Folding Airscrew Construction

So much by way of preamble, and we can now turn to a more detailed consideration of our dual subject. The American model which won the Wakefield Cup in 1938 made use of a folding airscrew, since when several designs of such airscrews have been published. Many of these have been of very simple nature, and have in consequence suffered from sloppiness (in the

in the spinner. The accompanying sketches should make these points clear.

While the airscrew is revolving under power the blades are held hard forward against the front walls of the recesses by their own thrust. The centrifugal force is still sufficiently powerful to keep the blades outstretched when the power ceases, and it is therefore necessary to stop the rotation mechanically. This is done by means of a wire trip on the airscrew-shaft, which the lessening of the tension of the rubber-skein allows to engage with a small wire stop connected with the airscrew. This arrangement differs from the conventional "hang-up" normally used to bring the free-wheeling device into operation in that it has to be spring-loaded so that the airscrew is brought progressively to a standstill, instead of with a sudden jerk, this being essential if the airscrew-shaft and its accompanying "gadgets" are to remain intact. Some system of coiled spring arrester, as depicted herewith should be

One is not disposed to quote figures—which rarely prove anything more than the mathematical dexterity of the compiler—in support of the folding airscrew, but one has only to see the extraordinarily flat glide of a model so fitted to appreciate the very real reduction in drag which is achieved. If full benefit is to be derived, however, the model must be designed for such an airscrew. Merely fitting a "folder" to a model formerly sporting a fixed airscrew certainly reduces drag, but this results in an increase of speed, a doubtful advantage in a duration model. It is better to utilise the gain in efficiency to increase the lift, and this may call for a change in wing-section, or line-up, or both.

### Effects on Line-up

One has also to take account of the changed weight-distribution of the model. The folding airscrew is heavier than the fixed type. But the real problem is connected with the movement of the centre of gravity. With a Wakefield model there may be a blade movement of 8 to 9 inches, which may easily cause half an inch variation in the position of the c. g. Obviously, this must be allowed for in the line-up if trouble-free flight is to be achieved.

As to the best method, one suggests

that nothing should be done which would affect the glide, and that therefore the wing and tail settings should remain unaltered. This leaves us with the alternative of dealing with the thrust factor, and, since it is this factor which is responsible for the problem, it is fitting that it should be utilised for its solution.

Let us, by way of example, take as our datum-line the line of thrust, with the tail-plane chord coincident or parallel with it. The appropriate modification, when using the folding airscrew, would appear to be either a lowering of the thrust-line, or the use of "up-thrust" in relation to the tail-plane, or possibly a combination of both. A greater variation would be necessary in the case of a low-wing model, which normally has its thrust-line passing through the centre of resistance, than with the shoulder-wing or high-wing type with the wing resting on the fuselage, which often has a nosing-up tendency owing to the thrust-line having to be lowered for the rubber motor to clear the fuselage structure. A parasol, or a high-wing with the wing mounted on a deeply-humped fuselage would probably require no modification at all. In fact, these types would lend themselves particularly well, since their lateral stability tends to be of a very high order, while the low position of the thrust-line in relation to the centre of resistance, so far from being a difficult factor, is exactly what we require.

The folding airscrew renders the use of a retractile undercarriage of the one-way type an entirely practical proposition.

#### Undercarriage Retraction Simplified

Whether or not undercarriage retraction be considered worth while in connection with the present Wakefield formula, its development certainly lies along the course of scientific design progress. The undercarriage is a parasite for all but a few seconds of the model's flight, and in return for that very limited period of service, it extorts a heavy toll in the form of drag, and therefore impaired efficiency. No truly scientific designer can rest content with such a state of affairs. The dropping of the undercarriage in flight is barred by the contest rules of the Federation Aeronautique Internationale, and retraction is the obvious alternative.

The simplest and lightest method of retraction is that employed by Mr. Henery in his 1937 Wakefield model. The weight of the model holds the undercarriage in the extended position, against the pull of rubber bands, which retract it into the fuselage, immediately the wheels lift from the ground. As will be seen from the diagram the wheel-carrying struts must be pulled forward out of the vertical, and the wheels mounted to the rear of the struts, so that they pass right into the fuselage while the struts lie in the grooves provided for them. The

wheels should be kept as small as is consistent with satisfactory take-off (about  $1\frac{1}{2}$  inches diameter in the case of a Wakefield type), in order that they may not foul the rubber motor. Care must also be taken that the struts are pivoted at such an angle as will secure a wheel-track wide enough to ensure adequate ground-stability. This is very important now that the Wakefield contest rules stipulate that at the take-off the model be held only by the airscrew and one wing-tip. This conveniently simple undercarriage suffers from the disadvantage that it may retract before the model is fully air-borne owing to bouncing on a rough patch of ground, or being momentarily lifted by a gust.

The logical development is a mechanically

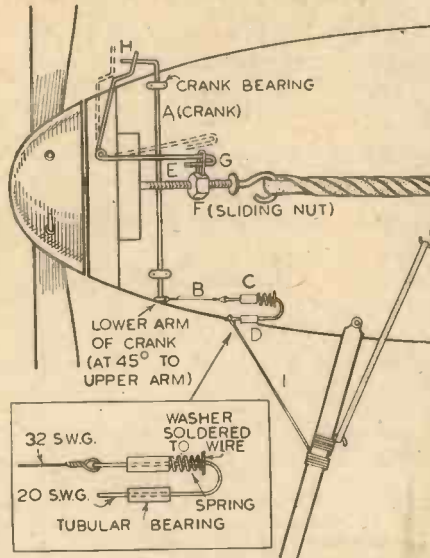

The actuating mechanism for the delayed retraction of the undercarriage.

operated gear which will delay retraction until the model is well clear of the ground. This method was adopted by Mr. Henery on his 1938 Wakefield effort, in conjunction, as already mentioned, with an undercarriage folding outwards into the wings. The latter feature, despite the mechanical ingenuity, proved unsatisfactory, the nearness of the wheels to the c. g. imparting a tendency to nose-over at the take-off. The operating mechanism, however, proved entirely successful, no mechanical failures having been experienced.

#### Delayed Retraction

Such a device applied to an undercarriage retracting rearwards into the fuselage should prove ideal. The actuating mechanism, shown above, functions in the following manner. A 20-gauge wire crank, marked "A," which can turn

through a right angle, is bent at the bottom to form a small loop at right angles to the upper horizontal arm. From this loop a 32-gauge wire, "B," runs rearwards, and is tensioned by being anchored to a spring-loaded 20-gauge wire, "C." The wire bends round and forms the bolt, "D," which locks and releases the undercarriage.

A portion of the airscrew-shaft is threaded, "E," and along it travels a nut with a 20-gauge wire loop, "F," which can be slipped over a 20-gauge wire trigger, "G" projecting from the rear of the nose-piece. This trigger represents the lower end of a right-angled 20-gauge wire pivoted at the bend, and the upper end of which forms another trigger projecting from the top of the nose-piece, "H."

To bring the device into operation the loop on the sliding nut is slipped over the lower trigger, thus holding it in the down position. The pivoting of the right-angled wire of which it forms part causes the upper trigger to move rearwards. Now the crank arm is moved through a right angle so that it lies approximately along the line of flight, and is engaged with the upper trigger. In this position it holds the bolt forward against the spring-tensioner. The undercarriage is held in the extended position by slipping over the bolt the looped end of a 22-gauge wire, "I," anchored to each strut.

#### How It Operates

As the airscrew turns, the nut travels along the threaded shaft until it slips off the lower trigger, which rises and thus causes the upper trigger to move forward and release the crank arm. This moves back to its original position at right angles to the line of flight, through the rearward pull of the tensioned wire, which takes with it the bolt. The undercarriage is then free to spring back into the fuselage. There are 50 threads on the airscrew-shaft, permitting a small variation in the positioning of the sliding nut, and therefore an equivalent variation in retraction delay.

As to the effects on trim of the retracting undercarriage, the movement of the c. g. can be kept down to a negligible figure by using light struts and wheels. Assuming the model to be lined up for best performance with the undercarriage up, any slight nose-heaviness prior to retraction tends to be overcome by the increased upward pull occasioned by the first burst of power from the rubber motor. The increased resistance with the undercarriage down causes a fast, nose-down take off, and a good take off board is therefore desirable, particularly, when there is little wind to assist matters.

Here the subject had perhaps better be left, since at this stage of development one is scarcely justified in attempting more than to provide pointers for further experimentation. One trusts that the foregoing remarks will prove helpful in this direction.

## A NEW ANTI-CORROSION PROCESS

### Details of the Roval Process

IT is known that the more porous a metal surface may be, the quicker it will corrode, for it is the interstices in the surface which hold the attacking fluids or gases to enable a favourable start, whereupon further porosity is formed and so proceeds the vicious circle. If incipient attack can be repelled, the strength of the defence is apparent. For example, metallic surfaces which have been polished or otherwise mechanically treated whereby the pores are to some degree closed, will be more resistant to corrosion than untreated surfaces

of the same material.

On such principle is based the Roval process. By electrolytic means whereby a special bath and entirely novel and complex electrodes are introduced, it is claimed that a mixture of metals—in effect an alloy—is caused to be deposited on the base metal. By the use of so-called accelerators which are thought actually to increase the speed of impinging particles, such deposition is found to penetrate the metal pores so that they are completely closed. The result in general being that when this has been

effected by the use of a mixture of metals which are themselves resistant, a surface is presented which withstands to a remarkable degree the formation of oxides or other salts which result as a product of decomposition.

As this process depends for its result on the closing of pores rather than a protective layer, it is not necessary or desirable to build up any appreciable metallic depth. This feature is said to offer a great advantage over ordinary plating or spraying processes inasmuch as the dimensions of the article treated are virtually unaltered, so that no adjustments or machining are necessary even in the case of precision work. For instance, screw threads may be treated without in any way impairing their fit.

**MORE FINE BARGAINS**



**5/- Powerful New Steel Moving - Coil SPEAKER-MAGNETS.**

Four-claw 4 1/2 lbs. 10 watt M.C. Speaker Permanent Magnets at manufacturer's price. A great opportunity for 5/-

**CONDENSERS.** Fixed electrolytic 12-4 mfd.—10 mfd. 275 volts 1/6; 6-4-6=12 mfd. 250 volts, 1/6; 8-4-8=11 mfd. 350 volts, 1/6; 24+8=32 mfd. 400 volts, 2/6; 8 mfd. 500 volts, 1/8; Mansbridge Paper and Mica, 4 mfd., 3/6; 8 mfd., 5/6; 10 mfd., 7/-; Dubilier .01 for 1,000 volts, 1/8; 005 Mica Trans. 5,000 volts, 2/6; 10,000 volts, 5/-; 25 mfd. mica, 4,000 volts, 6/-. Oil Condensers, 1 mfd. 3,000 volts, 5/6. Special Condenser Bargain to clear surplus. Western Electric 1 mfd. & 2 mfd., 2d. each, 1/6 doz.; 12-gross, carriage forward. Ideal for makers of smoothing and filter circuits. Offer open till cleared.

**BLUE BOTTLES.** Glass enclosed 1/2 and 1 watt Resistors .01, .025, .05, .1, 1/2 and 1 meg., List 1/- per doz., any of these sizes, 9/- per gross.

**COIL WINDERS.** Hand drive, bevel friction, 8" high, 2/6.  
**COILS.** B.W. plug-in, 1/6. Ribbed formers, 9d. Long-wave and B.C. 2-pin, 1/-; Reaction tuners, 9d. H.F. twin chokes, mals, 9d. Rugby and other coils in stock. All wavelengths in 2-pin, 1/3. 8/W. Formers ribbed and slotted, 4d.

**PANELS.** Aluminium 16- and 18-gauge one side enamelled, Paxolin and Ebonite, any size, from 24in. x 24in. at low prices.  
**VARIABLE CONDENSERS.** .005 mfd. Tekade, 1/3; .00075 Polar Compax, 1/-; 8/W. Formo 2/-; J.B. Midget, .0001, 1/8; 2-gang variable, .0005, 2/6; 3-gang, 3/6.

**PROJECTION LANTERNS,** on Stand, with 250-watt focus bulb, 25/-; Arc lamps, Slide lanterns, Film projectors, and Sound heads, cheap.

**MAGNETIC SOUND RECORDING.** Stille Steel Tape, 9d. yard.  
**EARTH SPIKES.** Massive R.A.P. earth spikes, with terminal for Aerials and Telephone lines, 1/- or 9/- doz.

**MOTOR BARGAINS** in Midget H.P. Motors for A.C. or D.C. 200/250 volts, 110th H.P. D.O.T. type, totally enclosed KB Cover, 2,000 revs., at a price never before offered, 7/6 only. Next larger GM No. 2 type, high speed 1/60 H.P., 4,000 revs., 9/6. Larger still, 1/45th H.P., Model G.E. No. 1, 12/6. All as new and first rate for model drive or light duty.



**MORSE RECORDING OF WIRELESS SIGNALS.** These well-known service paper tape makers record messages on any wave-length at speed. Records add enormously to interest. Magnificent British work, mahogany drawer containing tape reel. Such apparatus cost £40. £2 to £6 10s. each.

**ELECTRIC SOLDERING IRONS.** Heavy workshop type, 125 watts, 220/250 volts, 6/6. Big 220v. Alarm Bells, 10" gong, 39/-.

**220 VOLT FOOTWARMER.** Electric Mats, covered felt, 7/6. Bed-warmer Blanket Pads, 25/-; 12x6, 110 volts, 10/6.

**3-VALVE (part finished) BATTERY SETS** with cak cabinet ready wired and fitted 2 condensers and engraved panel, 13 x 7 x 6 in., 15/-.

**PUSH BUTTON TUNING.** 6-way Gang Push, metal cover, 1/6. Multiple Cord, 6d.

**STATIC CONVERTERS.** A.C. mains to D.C. 40 watts output, steel cased. Output 40 volts, 60/100 m.a. D.C. with valves, 45/-. A.C. mains to D.C. 120 watts at 1 amp. for 220 v. D.C. sets, steel-cased, valves, 50/-.

**SOUND RECORDING AT HOME** at a reasonable cost. No fancy prices for elaborate gear. No fine Feigh records on any disc.

**THE FEIGH RECORDER** fits any Gramo, has positive drive by ball-bearing worn gear and rack. The Recording Stylus is tracked across blank at the exact grooving spiral. Price, complete, as illus. with Tone Arm and cutter with real diamond, 37/6. All-Metal discs, 3/3 doz.

Latest Bargain List "P.M." Free on Request.

**ELECTRADIX RADIOS**  
218, UPPER THAMES STREET, LONDON, E.C.4  
Telephone Central 4611

**FOR ALL "00" TRACKWORK**

We Stock Curves and Points in every Radius from one foot three inches to four feet.

A feature of all Points is that they are constructed with pivoted blades, thus making them easy to connect to lever frames, etc., even over long distances.

PRICES: Points, any radius, each 3/3  
Track, any radius, per yd. 2/6  
All nickel rail brass sleepers.

For further particulars please send for—  
FREE ILLUSTRATED PRICE LIST

**Gresham Model Railways Limited**  
79, GRESHAM STREET, LONDON, E.C.2.  
Telephone: METropolitan 8201.

**SPLIT PHASE A.C. MOTORS**

1425 R.P.M. All Voltages. Ideal for workshop and industrial uses. Heavy duty rating. No radio interference. Silent running. 1/2 H.P. 55/-; 1 H.P. 65/-; Bull-in switch 3/6 extra. CARR. 1/6. Leaflet free on request or send 4d. for new Electrical Catalogue.  
L. WILKINSON, 204 LOWER ADDISCOMBE RD., CROYDON.

**BE A MAN!**

**STRENGTHEN YOUR VITAL FORCES!**

Are you a victim of Inferiority Complex, Self-Consciousness, Unreasonable Fears, Bad Concentration and Memory, Timidity, Lack of Self-Control, Weak Will, Bad Habits, Thinness, Flabbiness, Nervous Disorganisation, etc.

To trace the cause, write for my free book—  
"DO YOU DESIRE HEALTH?"

Sent POST FREE in plain envelope.  
Also write to me fully in confidence for a FREE and considered opinion of your case.

Over 30 years' experience in the drugless Treatment of Nervous disorders and ill-health arising from weakening and health-destroying habits and a lack of many self-control.

All replies and books sent in plain sealed envelopes.  
I. W. STANDWELL, Curative Physical Culture Consultant  
Dept. P.M., 329, High Holborn, London, W.C.1



**MINIATURE PETROL ENGINES** for Aeroplanes and Speed Boats. 1 to 15 c.c.  
Send 3d. for particulars

Easily made from our castings 12/6 per set.  
Complete Engines ready to run from £3 15s.

**J. HALLAM & SON**  
Upton, Poole, Dorset

**MAKE MORE MONEY**

£3 to £6 weekly can be earned at home in a wonderful business of your own. No matter where you live you can commence to make money in your spare or whole time. No risk, canvassing or experience required. A wonderful opportunity for anyone wishing to add pounds to their income. Particulars, stamp.  
**BALLARD, York House, 12 Hambrook Road, LONDON, S.E.25.**

**BECK'S CHEMISTRY**

FOR YOUR HOME LABORATORY

**SPECIAL 2/6 OFFER**  
**BLOWPIPE SET**  
(Carriage paid)

CRUCIBLE, TONGS, PIPECLAY TRIANGLE, BLOWPIPE, CHARCOAL BLOCK, BLUE GLASS

Many other sets at prices from 2/6 to 105/-.  
Write for FREE CATALOGUE.

"EXPERIMENTS IN CHEMISTRY," 6d. P.O.

**BECK** (Scientific Dept. A), 60, High St., Stoke Newington, London, N.16.

**3/6 MYFORD 3/6**

**BEST VALUE—INEXPENSIVE**



SUPPLIED TO NUMEROUS LARGE WORKS AND INSTRUCTIONAL CENTRES, ETC.

Bench - Treadle - Motorised Lathes & Accessories

Send P.C. for free illustrated list (your tool merchants' address would be appreciated)

**MYFORD ENG. Co., Ltd., Beeston, Nottm.**

**ENGINEERS**

The size of your pay packet depends almost entirely on your knowledge, and the ability to apply that knowledge. The successful engineer can easily earn £500 and upwards per annum. Will you let us show you how? We offer you the means of qualifying for entry and advancement in the engineering industry in the simplest and most efficient manner, viz., by home-study—undertaken in your spare time.

Our 120-page Engineering Guide (1939 edition) describes numerous Examination and Diploma Courses in Engineering, including:—

- ENGINEERING**
  - Inst. of Electrical Engineers, A.M.I.E.E.
  - Inst. of Wireless Technology, A.M.I.W.T.
  - Inst. of Civil Engineers, A.M.I.C.E.
  - Inst. of Structural Engineers, A.M.I.Struct.E.
  - Inst. of Builders, L.I.O.B.
  - Inst. of Sanitary Engineers, A.M.I.S.E.
  - Royal Sanitary Institute, M.R.S.I.
  - Inst. of Mechanical Engineers, A.M.I.Mech.E.
  - Inst. of Automobile Engineers, A.M.I.A.E.
  - Royal Aeronautical Society, A.F.R.Ac.S.
  - London B.Sc. Degrees
  - Wireless—Telegraphy—Telephony
  - Electrical Engineering
- Television—Electric Wiring
- Talking Picture Work
- Works Management
- Building Construction
- Sanitary Engineering
- Sheet Metal Work
- Refrigeration
- Motor Engineering
- Engineering Draughtsmanship
- Electrical Draughtsmanship
- Jig and Tool Draughtsmanship
- Die and Press Tool Draughtsmanship
- Aeronautical Draughtsmanship
- Structural Draughtsmanship
- Building Draughtsmanship
- Clerk of Works
- Building Inspection
- MUNICIPAL SERVICE**
  - School Attendance Officer
  - Handicraft Teacher
- Registrar—Relieving Officer
- Sanitary Inspector
- Weights and Measures Inspector
- M. & Cy. Engineers
- GENERAL**
  - Matriculation—Book-keeping
  - College of Preceptors
  - Chartered Institute of Secretaries
  - Massage—Institute of Hygiene
  - CIVIL SERVICE**
    - Clerical (age 16-17)
    - Executive (age 18-19)
    - Tax Inspector (age 21-24)
    - Patent Office (age 20-25)
    - G.P.O. Engineering (age 18-23)
    - Typist (age 16-25)
    - Customs (age 19-21)
    - Board of Trade (age 20-25)
    - Police College (age 20-26)
    - Police Force (under 27)

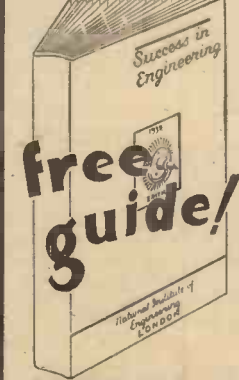

If you do not see your requirements above just explain what they are. We are able to advise on all branches of Engineering, Civil Service, Municipal Work, etc.

**THE ACID TEST OF TUTORIAL EFFICIENCY: Success—or No Fee**

We definitely guarantee that if you fail to pass the examination for which you are preparing under our guidance or if you are not satisfied in every way with our tutorial service—then your tuition fee will be returned in full and without question. This is surely the acid test of tutorial efficiency.

If you have ambition you must investigate the service we are able to offer. Founded in 1885, our Success Record is unapproachable.

**COUPON**  
NATIONAL INSTITUTE OF ENGINEERING  
(Dept. 29) STAPLE INN BUILDINGS, W.C.1.  
Please forward your 1939 Engineering Guide to:—  
NAME.....  
ADDRESS.....  
Exam. or subject in which interested.....  
(4d. stamp only required if unsealed.)

**NATIONAL INSTITUTE OF ENGINEERING (DEPT. 29),**  
Staple Inn Buildings, High Holborn, London, W.C.1  
(South Africa Branch: E.C.S.A. P.O. Box 8417 Johannesburg)  
(Founded 1885) Over 80,000 Successes

# ENGINES OF ALL TYPES FROM THE TINY TWIN TRAIN TO THE PERFECT SCALE MODEL

The Gauge "O O" Twin Trains are the realisation of the dreams of Model Engineers. They are controlled absolutely from any distance, starting, stopping and reversing, entirely independently and moving in opposite directions if required on the same rails. The system is constantly being added to, and there are already stations, signals, various types of rolling stock, and six different layouts to choose from. Get T.T. 12 Bassett-Lowke's latest book on the TWIN TRAINS. Price 2d. A.12. Complete Model Railway Catalogue, Gauge "O O" to 9 1/2 in. Price 6d.



A powerful "live steamer" in gauge "O." The 4-4-0 type "ENTERPRISE" of free lance design and available in black with red lines, ditto red and yellow, ditto green and white. Price, steam. **£2.10.0**



**NEW EDITION SHIPS LIST S.12. 6d. post free**

The "DUCHESS OF MONTROSE"—latest development in non-streamlined locomotives, constructed at Crewe last summer. Here is our Gauge "O" model—20 1/2 in. long. Wheel Base 17 1/2 in. Weight 4 lb. 9 oz.—priced in clockwork, or **£8.8.0** electric, a.c. or d.c. at

**BASSETT-LOWKE LTD., NORTHAMPTON** LONDON: 112 HIGH HOLBORN W.C.1  
MANCHESTER: 28 CORPORATION STREET



Build this FLYING scale model Westland "LYSANDER"

Scale 1/2" = 1 ft., 25" wing span. You can easily build one just as fine from our super kit. This model is a perfect flying job, too, and takes off ground. Send P.O. to-day!  
Kit Price only 10/6d., post free U.K. Send 4d. stamp for NEW Catalogue.

NORTHERN MODEL AIRCRAFT Co., 25 Lower Mosley St., MANCHESTER, 2

## VALUE KITS!

FLYING SCALE TYPES	Post Paid
Hawker Hurricane Span 12"	2/3
Heston Phoenix " 12"	1/9
Gloster Gladiator " 21"	3/-
Hawk Pursuit " 20"	3/-
Caudron Renault Racer	3/-
"Aeromodel" Series in stock, also Frog "Penguin" Kits.	

DURATION TYPES	Post Paid
Condor "Curlew" Span 20"	5/3
Condor "Clipper" " 30"	8/6

"NORMAG" Super Thrust PROPELLERS  
We hold the finest range in the country.  
Once used—always preferred.

## THE GRAYSON

3 1/2 INCH. BACK GEARED SCREW CUTTING

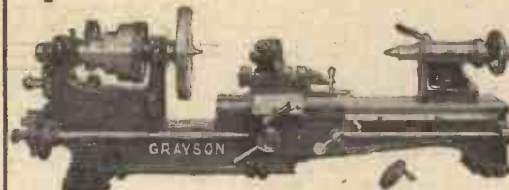

**LATHE**  
**£11**  
WRITE FOR LEAFLETS

Back-Gear, Screw Cutting, Fully compound Slide Rest, Machined Tees in Cross Slide and in Top Slide. Set-over Head-stock and Tail-stock, Double Clasp Nut and Quick Traverse Action in Steel Rack and Pinion. Full set of Change Wheels for cutting English and Metric Threads, Face Plate, Catch Plate, Screw Cutting Tables and Two Centres.  
Height of centre, 3 1/2"; Distance between centre, 18"; Swing in gap, 10"; Swing over saddle, 4 1/2"; Diameter of mandrel nose, 1 1/2".  
Centres No. 2 Morse taper—Mandrel and tailstock barrel bored, 1/2"; Lead screw, 1/2" x 8 t.p.i.; Face plate, 7"; Belt, 1 1/2"; Length of head, 8 1/2" (Phosphor bronze split bearings).

**E. GRAY & SON, LTD** 18-20 CLERKENWELL ROAD, LONDON, E.C.1. (Est. 1822)

# Practical Handbooks for the Modern Handyman

## The HOME MECHANIC SERIES

EACH **1/-** NET  
(By Post 1/2)

1. Power-driven Model Aircraft.
2. Model Aeroplanes and Airships.
3. Accumulators.
4. The Home Woodworker.
5. Twenty-five Simple Working Models.
6. The Handyman's Inquire Within.
7. Simple Electrical Apparatus and Experiments.
8. Model Boat Building.
9. Toy Making for Amateurs.
10. Lathe Work for Amateurs.
11. House Decoration and Painting.
12. The Home Electrician.
13. Motor-car Upkeep and Overhaul.

ASK YOUR BOOKSELLER to get you the book or books you require, thus saving postage. Alternatively, send the form to the Publishers, with Postal Order (plus postage) and the book or books will be sent direct to you.

These practical handbooks are designed specifically to help the amateur mechanic or craftsman. Each volume is simply written by an expert and profusely illustrated with photographs and diagrams.

To the Publisher, **GEORGE NEWNES, LTD.**  
(Book Dept.), Tower House, Southampton Street, Strand, W.C.2.

Please send me by return the book or books encircled below.

I enclose Postal Order value.....  
which includes postage.

1, 2, 3, 4, 5, 6, 7, 8, 9, 10, 11, 12, 13

Name.....

Address.....

P.M. 5.39

“PRACTICAL MECHANICS” WIRELESS EXPERIMENTER

# H.T. BATTERY ELIMINATORS

## A Few Alternative Circuits For Units Suitable For Use With D.C. And A.C. Mains Supplies

**A**LTHOUGH it has become customary for those who have a mains electricity supply to use a normal type of mains-fed receiver, it is clear from the correspondence we receive that there are still many battery-set users who wish to obtain their H.T. current from the mains supply. Some of them explain that they consider that a battery set gives better reproduction; others apparently feel more confident to build a battery set than one of the all-mains type. It is not for us to dictate, for everyone is entitled to his own opinions, but we are in favour of the mains set every time. In spite of that, however, it is often cheaper to build a battery set, whilst the constant experimenter who

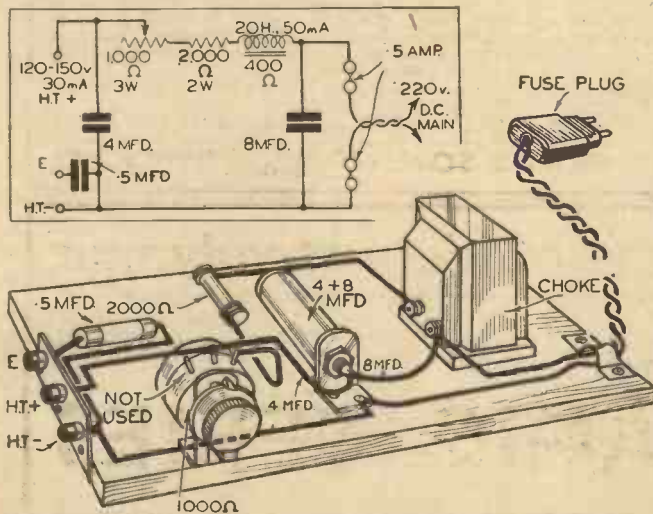

Fig. 1.—A simple form of D.C. eliminator in theoretical and practical form.

frequently re-builds his set can certainly effect a saving by making battery sets, and keeping a power-supply unit that can be used with practically any type of set that he might construct.

### The D.C. Unit

The simplest type of eliminator, is, of course, that intended for use with D.C. mains. All that is normally required is a smoothing choke, a couple of smoothing condensers, a fixed and variable resistor and a few connectors and small items. A circuit and pictorial illustration of a unit of this type are given in Fig. 1. It will be seen that there is only one H.T. positive lead, and that the voltage supplied can be varied to suit any type of battery set. Extra tappings could easily be arranged if desired, but they are seldom necessary with a fairly modern type of receiver. This is because voltage-dropping resistors and potentiometers for screening-grid supply and the like are usually included in the circuit of the set itself.

In case any reader wishes to provide

eliminator, for it is in many ways better to include the necessary voltage-dropping resistors in the set, placing them and their corresponding by-pass condensers as near to the points they feed as possible. The fixed resistors shown can each be rated at one watt, the potentiometer should, for preference, be of the wire-wound type and the variable resistor should be rated at not less than three watts.

### Components

Note the inclusion of a fused connector for the mains

supply, and also observe that the smoothing choke is rated at 20 henries, 50 mA and has a resistance of 400 ohms. Actually, these values are not critical, but it would be unwise to employ a choke with a lower inductance than 20 henries or with a lower maximum current-carrying capacity than 50 mA. Nearly all chokes of this type and of medium price have a D.C. resistance of between 300 and 500 ohms; any value between these two limits will provide the approximate outputs indicated.

The smoothing condensers can be either electrolytics or of the paper type, rated at not less than 250 volts working. A very convenient system is to employ a twin tubular electrolytic condenser mounted on a small metal bracket, as shown, from which the negative lead can be taken. Alternatively, a twin block condenser can be used, in which case a mounting bracket is not required.

The components are shown mounted on a wooden baseboard, but it is a good plan to make a cover from perforated metal or

additional tappings, however, we show how this can be done in Fig. 2. The three positive output terminals are marked with the voltage and current which they will provide when the mains voltage is about 220. Of the three outputs shown the first would be suitable for a leaky-grid detector, the second for the screening grid of the H.F. or I.F. valves and the third for the L.F. and output valves. We might as well make it clear that we are not strongly in favour of providing

tappings on the

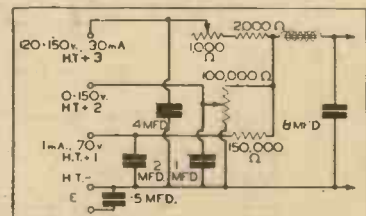
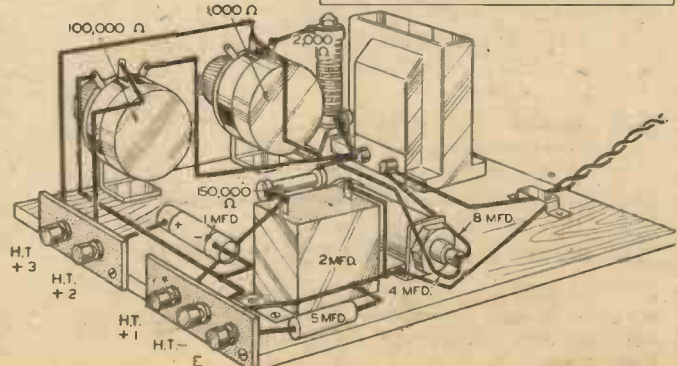

Fig. 2.—How additional resistors can be added when voltage-dropping arrangements are not included in the set.



tinplate with ventilation holes drilled in it. This must be clear of all connections, but should be earthed to the common H.T. negative-earth terminal.

**Negative or Positive Earth**

When the eliminator is used on a D.C. supply with negative earth it is necessary only to connect it in place of the H.T. battery, although it is generally desirable to take a second earth lead direct to the appropriate terminal on the unit. This can consist of a short wire from the earth terminal on the set. If the positive side of the mains is earthed, greater care must be taken, and the earth lead to the set must be taken through a fixed condenser with a capacity between .1 and 1 mfd. That is, the earth lead is joined to one terminal of this condenser and the other condenser terminal is joined to the earth terminals of the set and of the eliminator. It is also important that a condenser be included between the set and the aerial lead-in. Even if there is a small condenser in this position inside the set it is wise to fit an external one of not less than 250 volts working. The omission of the condenser might result in shocks being received should the aerial be touched.

**Simple A.C. Unit**

An A.C. eliminator is slightly more complicated, due to the fact that a rectifier and transformer are needed in addition to the parts used in the circuit already explained. When an H.T. current of not more than 30 mA is required—and this is sufficient for most types of battery set—a very satisfactory arrangement is to use a Westinghouse style H.T.15 metal rectifier in a half-wave circuit as shown in Fig. 3. When this is fed from a mains transformer giving a secondary output of 250 volts, 30 mA the maximum, unsmoothed, output from the rectifier is 230 at 30 mA. This is, of course, approximately the same voltage as that of the D.C. mains used for the circuit first described. Consequently, any additional voltage tappings can be provided in the same manner as shown in Fig. 2.

The general form of construction can be the same as that mentioned in connection with the D.C. unit, and the eliminator can be used in the same manner, except that an earth connection is not required unless there is a long lead between the unit and the set.

In those rare cases where a current in excess of 30 mA is required, a larger metal rectifier could be used, preferably in a voltage-doubler circuit as shown in Fig. 4. For a maximum output of 330 volts, 60 mA a suitable rectifier is the H.T. 16, and it should be fed from a transformer providing a secondary output of 240 volts, 200 mA. For either of these A.C. units it is best to use smoothing condensers with a maximum working voltage of 500, to ensure a reasonable factor of safety.

**Valve Rectification**

A very satisfactory method of obtaining a D.C. output, before smoothing, of 230

volts, 60 mA is by employing a full-wave valve rectifier such as the Cosmor 506 BU. Connections for this are given in Fig. 5, where both theoretical and pictorial arrangements are illustrated. Here again, the few simple parts may be mounted on a base-board, with or without a metal shield. The

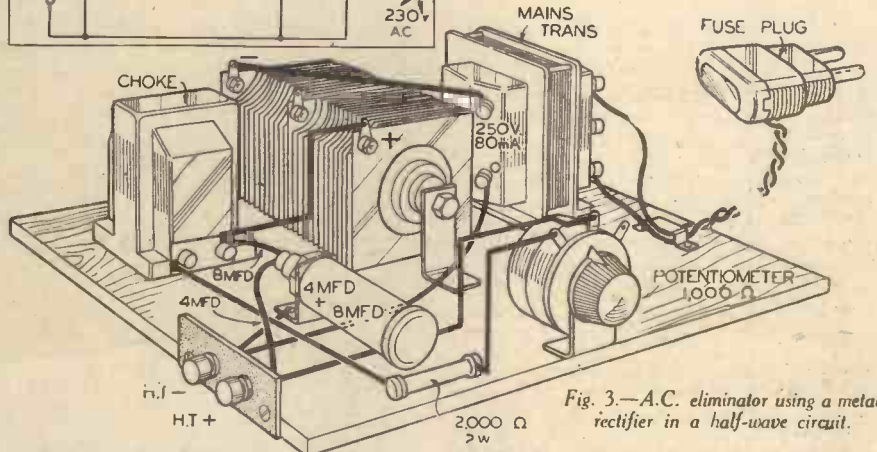
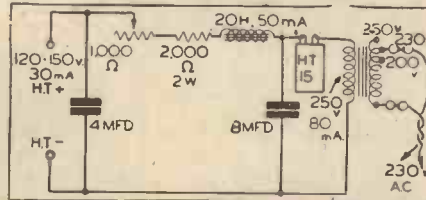

Fig. 3.—A.C. eliminator using a metal rectifier in a half-wave circuit.

shield, made of iron or tinplate, is always desirable since it helps to prevent mains interference and also prevents the constructor from accidentally touching any "live" parts when the mains are connected. For the screen to be fully effective it should always be earthed.

**Grid Bias**

When using any type of eliminator it is a convenience to employ automatic grid biasing, although a G.B. battery is perfectly satisfactory and will last for at least six months. An alternative system when using an A.C. eliminator is to use a transformer with an additional secondary winding in conjunction with a low-voltage rectifier, but that is rather an expensive method, and not one that most readers would favour.

As we are dealing only with the simpler

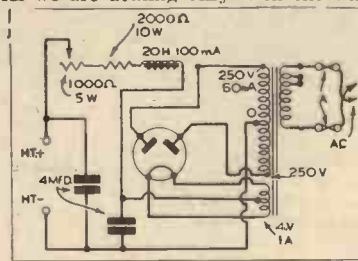
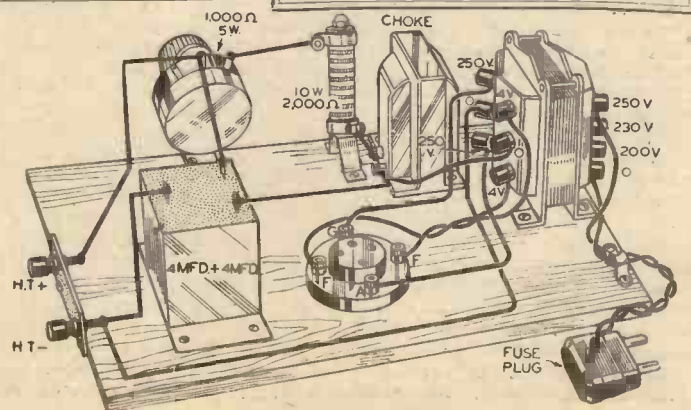

Fig. 5.—This A.C. eliminator uses a full-wave rectifier.

(Left) Fig. 4.—Circuit of an A.C. unit with voltage-doubler rectification.



types of mains unit we are not going to describe an eliminator with trickle charger built integral with it. As small trickle chargers suitable for two-volt accumulators of average capacity are so extremely inexpensive, we are inclined to favour the use of two separate units. If two small accumulators are obtained one of them can be charged while the other is in use, or a single accumulator can be used, a change-over switch being fitted to bring the charger into circuit when the set is switched off. Connections for this are given in Fig. 6.

**Switching**

There are two simple rules which should be borne in mind when using eliminators: The filaments should be switched on before the eliminator, and; The eliminator should be switched off before the filaments.

If these rules are reversed additional strain is thrown on the valve filaments and also on the various fixed condensers in the set. It is just permissible to switch on both eliminator and L.T. at the same time, but this is not very good practice when using a metal rectifier because a fraction of a second elapses between the time that the rectifier supplies the H.T. and the time that the filaments reach their working temperature.

**BUILDING A CARAVAN**

Many correspondents have asked for constructional details of a light trailer caravan. These and other readers will therefore be interested in the articles on this subject in the issues of our companion journal, PRACTICAL MOTORIST dated April 1st, 8th, and 15th.

Back numbers can be obtained for 4d., post paid, each from: The Publishing Dept., Geo. Newnes Ltd., Tower House, Southampton Street, Strand, London, W.C.2.

Two blueprint sheets, to a large scale, are also available at 10s. 6d. the set from the same address.



# A Vice-Operated Punching Press

This Device is Suitable for Punching Out a Number of Identical Parts from Strip Plate of Fairly Thin Gauge

IN connection with the making of a number of small parts, all exactly alike and capable of being punched out of strip plate of fairly thin gauge, there is a great saving in time and a surety of all being alike if they are produced by the punch and die method. Indeed, no other method is practical in many cases. But few small workshops are equipped with a fly press and they are expensive machine tools not capable of being so continually used in a small shop as to warrant their initial expense in purchase.

For small pieces, a press tool can be made which can be used in the vice and can be fitted with punches and dies to suit any job in the way of small multiple parts which may come along. Such a tool is the one illustrated here. It can be made with the ordinary small shop equipment of lathe and drilling machine. It is suitable for use with a parallel vice having jaws 3 in. or more wide.

The bigger and more powerful the vice, the better, since the size of the vice screw is the measure of its capacity in pressing or punching different thicknesses of blank material and different metals. Generally the tool will be used for strip brass.

Fig. 1 is a sectional plan view, Fig. 2 a front view, Fig. 3 a transverse horizontal section, and Fig. 4 a vertical section. The two plates A and B are of cast iron cast from a simple pattern and both alike in shape and dimensions. The plates are held in the vice and prevented from falling down by the ledge X in Fig. 4, one screwed to each plate.

The two plates are arranged to slide toward and away from each other in dead alignment by the two guide bars of cast steel C and D. It will be noticed these are shown in the same plane as each other in Fig. 1, for clarity. But actually they are arranged one near the top of the plates and the other near the bottom of the plates. Their positions are shown in true relation in the front view in Fig. 2.

## The Punch Hole

The central hole is the hole for the punch. The holes for the guide bars are at oppositely diagonal corners, one above the centre line and the other below, the punch being on the centre line. The castings for the plate are filed up on the adjacent faces and clamped together. It is a good plan to sweat them together after tinning their surfaces with solder. The three holes are then marked off. A centre line Y-Z, Fig. 2, is drawn and two lines parallel with it at the distance apart shown in the drawing from a vertical line through the centre of the central hole, the two holes for the steel guide bars are marked off equally to left and right of the central line, one in the top right-hand corner and the other in the bottom left-hand corner, and 1/2 inch from the edge of the plate.

The two plates are then drilled through each of the three centres marked with a 3/16 in. drill, taking care that the drilling machine table is dead square with the drill.

This should be carefully done. The two holes for the steel guide bars and the central hole are then opened out by drilling with successive-sized drills until we get these holes 1/2 in. in diameter right through both plates.

Cast steel guide bars are now turned to a driving fit in the corner holes and are driven in plate B and 1/8 in. transverse holes are drilled in the ends of the plates and through the bars to hold the bars secure by means of the 1/8 in. pins. The holes in the other plate are then reamed so that this plate fits down a sliding fit, with no end shake on the bars. Since the hole will be slightly larger than 1/2 in. if drilled with 1/2 in. drill, a 1/2 in. reamer will not open the clearance guide holes out but

screw head. The recess or counter bore is bored out with a cutter having a pilot of the screw diameter and to cut the diameter of the cheese head of the screw.

The other plate, A, is similarly chucked dead true to the hole already in it and the hole opened to 1 in. diameter and then, by an inside boring tool, to 1 1/4 in. diameter for 3/8 in. deep. This is to take a circular die of the same size. It is then reversed and opened out to 1 1/2 in. for 3/8 in. deep and a slot 1 1/2 in. is cut down the back of the plate which allows the piece cut out to drop down. This is shown, dotted in Fig. 2 and in section in Fig. 4.

To return the punch after each stroke as the vice handle is unscrewed, the compression coil springs shown round the guide bars are fitted. They are of round spring steel 1/8 in. in diameter and just encircle the guide bars.

## The Stripper Plate

To clear the strip from the punch which would draw it back after each stroke and prevent the strip being moved on for the next cut, a stripper plate, E in Figs. 1 and 4 is made in 1/8 thick cast steel plate. It has holes registering with the guide bars on which it is threaded. A washer, Fig. 4, very slightly thicker than the strip being fed is placed between plate A and the stripper plate, the latter has a hole to correspond with the punch through which

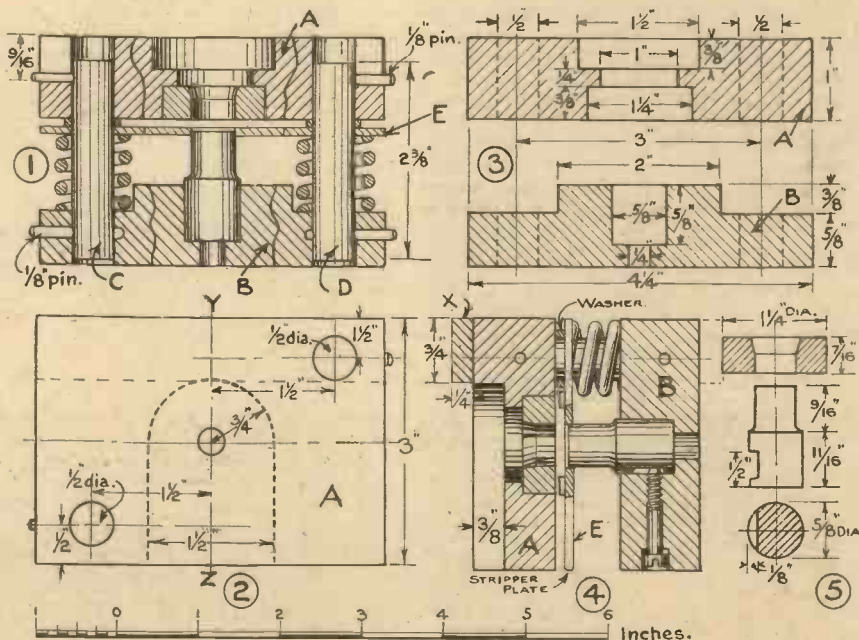

Fig. 1.—A sectional plan of the press. Fig. 2.—A front view. Fig. 3.—A transverse horizontal section. Fig. 4.—A vertical section. Fig. 5.—Details of the punch and die.

this can be managed by putting a piece of very thin brass foil down one side of the reamer, which will then reamer the hole to a close sliding fit on the steel bar which has been turned a drive fit in the unreamered holes in the other plate.

The hole for the punch is 5/8 in. and does not go right through, leaving a ledge in the 1/2 in. hole on which the punch beds. This is recessed by chucking the plate on the face plate, centring it truly by the 1/2 in. hole and boring out the 5/8 in. diameter recess for the punch diameter. The punch has a flat at one side and a long 3/16 in. screw (shown dotted in Fig. 4) is screwed through the plate to enter the central hole and grip the flat on punch. The cheese head of this screw is in a recess deeper than the

punch passes easily. Altering the thickness of the packing washers, adjust the stripper plate for different thicknesses of strip fed through. The stripper plate has guides screwed along its rear face which are set for each job a width apart equal to just over the width of the strip being fed in. This ensures the strip passing centrally across the die. The stripper plate is slotted and 1/8 in. cheese headed screws hold the guides at the correct distance apart for feeding in the strip stock. These as well as the punch and die are arranged for each job.

Punch and die, shown dimensioned in Fig. 5, are made of cast steel and hardened dead hard and then tempered to a golden yellow colour and quenched.

# "MOTILUS" PEEPS INTO THE MODEL WORLD



Fig. 9.—  
A model of the  
"Mayflower."

I HAVE escaped a little of the English winter by voyaging to the West Indies, and even in these "islands of the blest" I found enthusiasts in the craft of model-making. I think I cannot do better than devote most of my space this month to models out of England.

At Port of Spain, Trinidad, I found Mr. Beeby Thompson, who is in charge of the electrical department of Messrs. Alson and Co. This gentleman brought his railway with him from England, when he went out to take up his appointment some years ago. Fig. 1 shows his layout. He has constructed a central building, which forms a store for the railway and equipment, also has the track and central station now in the course of construction. His railway is "0" gauge, laid in brass "Lowko" track, and his equipment consists of a 4-4-2 standard tank, two 4-4-0 tender locomotives, one 4-4-0 "Enterprise" steam locomotive, and one 2-6-0 electric locomotive. He has a good selection of passenger and goods rolling stock and he is at present engaged in realistically ballasting his track. His young son is as keen as his father, and looks forward to his return from business for the evening demonstration of the railway.

## Turtle Crawls

The Cayman Islands are famous for two things—turtle crawls—where turtles caught off the coast of the mainland of Nicaragua are brought in boats to be fattened and prepared for the market, and over two hundred are exported per week. In this connection the boats used for this purpose are designed and built by the natives of the islands, and very fine craft they are. Native mahogany is used on these boats, and the trees are shaped during their growth to the correct form of the boat rib.

This craft of ship building also shows itself in model form, many of the shipwrights also being model makers. Fig. 2 shows a model of the famous Cayman type of boat, used in bringing the turtles to island, which is an excellent example of good craftsmanship.

The juveniles of the island also have great enthusiasm for model sailing boats. Two examples are shown in Fig. 3—one of the Cut-boat, peculiar to the Cayman Islands, and the other is built more on the lines of the Turtle boat. Each model is fitted with an outrigger, to prevent the boat capsizing in a strong gust of wind.

## Model Maker of Merit

Making a call at Madeira on the homeward journey, I was introduced by my friend and shipmate, Mr. J. C. Crebbin, to Mr. George P. Gordon, who is a model maker of great merit. I visited his home and was amazed to see the variety and quality of his work. He is an Englishman, born on the island, and has never left it, nor has he ever seen a locomotive, despite the fact he has built an excellent  $\frac{1}{4}$ -inch scale 2 $\frac{1}{4}$ -inch gauge "Lafayette" model designed by L.B.S.C. Mr. Crebbin cast his critical eye around the model and passed it as A.1. Among other of his pieces of work completed are a model gun and gun carriage (Fig. 4), a model weaving machine (Fig. 5), an old time gun and a kaleidoscope. He is now engaged on an inch to the foot scale model steam travelling crane from casting and drawings supplied by W. J. Evey, of Brighton (Fig. 6). His most fascinating and unique piece of work is a set of model maker's tools in miniature (Fig. 7), any one of which could actually have been used by a Lilliputian workman, did he exist. Here is a group of them compared with a Bryant and May's match box and a cigarette.



Fig. 8.—A model of Southampton Docks.

Our Model Man (With His Camera!) Has Been Abroad, But He Has Not Been Able To Escape From Model Makers, And Model Making. Here Are A Few Of His Experiences

## Southampton Docks

Looking in at Waterloo Station on my return, I was pleased to see the marvellous model of Southampton Docks that the S.R. are sending to the New York World's Fair (see Fig. 8). The slogan on the top was "Southampton Docks—America's link with Europe," and it will certainly give our American cousins an excellent idea of both the old Southampton Docks, and the new extension recently completed. The scale of the model is 100 feet to 1 inch, and most of the liners who visit the docks are shown in their different berths, and also the town of Southampton in the background. A really attractive and educational exhibit, which is a shining example of the Southern Railway's enterprise. The model by this time has been dismantled and despatched to America, but those who have not already seen it will have an opportunity of so doing at the close of the world's Fair.

## Model of the Mayflower

Here's an attractive little set of parts I have just come across. In fact, they are only just out, for they were first on show at the B.I.F. This little ship (Fig. 9) is the *Mayflower*—(1620) model of the ship of the Pilgrim Fathers—ancestors of our New England cousins, but there are also other models available—the *Santa Maria* and the *Golden Hind*. Their makers claim for them that an entirely inexperienced person can build them, for all the parts are completely finished and decorated, ready for assembling and they are not expensive.

# A NUMBER OF INTERESTING MODELS SNAPPED BY "MOTILUS" DURING HIS RECENT TRIP TO THE WEST INDIES



Fig. 5.—(Above) Mr. J. C. Crebbin with Mr. Gordon and some of the latter's models including a weaving machine.

Fig. 3.—(Left) The Cut-boat, peculiar to the Cayman Islands and a model built more on the lines of the Turtle boat.

Fig. 1.—(Below) Mr. Beeby Thompson's model railway at Port of Spain, Trinidad.



Fig. 2.—A model of a Turtle boat.

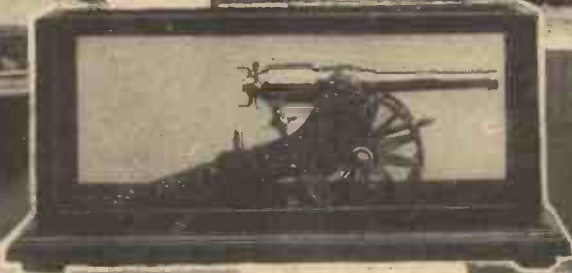

Fig. 7.—(Left) A set of model makers' tools in miniature. Fig 4.—(Above) A close-up of an all-metal scale model gun and gun carriage made by Mr. Gordon, of Madeira. Fig. 6.—(Right) Mr. Gordon with his 1 m. scale working model steam travelling crane, based on the well-known type of Stoddard and Pitt.



# TELEVISION IN CINEMAS

Rapid Progress has been made in the Design of Equipment Suitable for receiving and reproducing Television Pictures on Large Screens, and this Article deals Briefly with one Form of Apparatus now in use



Fig. 1.—The projector unit which houses the C.R. tube, time-base and amplifier equipment.

SHOWING large-size television pictures to an audience of a few hundred people falls into an entirely different category to the better-known television reception in the home. Many factors contribute to this, not the least of which is the skill of the person responsible for operating the set. From time to time different forms of large screen television pictures have been shown, among which can be mentioned the multiple lamp system, direct modulation of an arc lamp, Kerr cell modulation of an arc lamp beam, intermediate film recording and projection, and so on. One of the latest forms, however, is the use of the Baird projection type cathode-ray tube, this being the one employed for the Derby race demonstration. Whereas one of the principal difficulties encountered with the majority of the earlier big-screen television attempts was that of obtaining adequate light which could be modulated efficiently over the range of picture frequencies required, this seems to have been overcome with modern apparatus.

### The Important Section

There is no doubt that the most important item of the whole equipment is the cathode-ray tube itself, and this has actually been developed from the standard forms used now in every commercial television receiver available for home use. The tube employed has the familiar cylindrical glass neck, in which is accommodated the electrode system, and about which is mounted externally the line and frame deflecting coils, together with the solenoidal focusing coil. The neck then diverges in a funnel form to terminate in a flat optically ground glass face approximately six inches in diameter. On this is sprayed internally the screen material, which naturally has to be of a special composition to secure the additional light intensity, and also stand up to the increase in electronic bombardment which occurs in these tubes.

The degree of vacuum must be the best possible, to prevent the possibility of ionisa-

tion, while the insulation has to be capable of withstanding the increased anode voltages employed, when compared with that necessary for a home receiver. The intrinsic brightness of the small, but detailed, picture built up on the fluorescent screen of a tube of this character is such that it can be focused on to a remote viewing screen with the aid of a first-class projection lens. As far as the Baird apparatus, which has been exhibited and demonstrated, is concerned it is completely electro-optical in operation, the absence of moving parts preventing the possibility of mechanical breakdown risks. Furthermore, it gives a perfectly steady synchro-

nised picture, and is both portable and compact.

### Three Main Units

The actual apparatus is split up into three main units, namely, the projector, receiver and power supply rack, and the



Fig. 2.—The specially developed E.H.T. unit which furnishes the anode volts essential for the proper operation of the C.R. tube.

extra high-tension rectifier unit. The projector unit itself is seen in Fig. 1: a double-shelved four-legged stand accommodating the two parts. In the top section is the projection cathode-ray tube, lens, deflecting coils and time base generator, focusing chassis, and final stage vision amplifier, the output signal from which passes directly to the tube's modulator electrode. Inspection ports and covers are provided, while at the back are three controls for picture brightness, picture contrast, and filament current.

The metal box beneath the projector contains an intermediate vision frequency amplifier, together with both the vision gain control and the main sound control. In the case of the sound, the output is fed to amplifiers accommodated at the base of each loud-speaker. These in turn operate their respective speakers, and in this way it is possible for the projectionist to have full control of both the picture and sound. Furthermore, immediately behind the operator is a unit through which there is control of the anode voltage to the tube, via a tapped transformer. In the case of the Tatler Theatre installation, this represents the equipment accommodated in the centre of the first half dozen rows of the stalls, and the associated apparatus is housed in a room away from the audience, cable connections linking the sections together.

The standard form of rack supplies the projector unit with vision, synchronising and sound signals, together with power supplies, except for the anode voltage. From top to bottom the rack comprises:—

- (a) Sound radio receiver.
- (b) Vision radio receiver.
- (c) Power supply unit.
- (d) Power supply unit.
- (e) Power supply unit.
- (f) Main contactor panel.

Signals from a dipole television aerial erected on the theatre roof are fed to both the sound and vision receivers, and, after amplification, are fed to the main distribution panel contained in the vision rack, and finally to the main vision and sound controls shown below the projector head in Fig. 1.

Apart from having different output ratings, the power supply units are almost identical in design. The first of these furnishes the H.T. and heater current to the vision and sound receiver chassis; the next supplies H.T. to the vision amplifier of the projector unit; while the last supplies H.T. to the time base generator and the necessary current to the electro-magnetic focusing coil of the tube.

For large screen television projection work it is absolutely essential to have sufficient high-tension voltage to give a really bright picture on the tube screen. To meet this condition, therefore, a special high-tension rectifier unit embodying a voltage doubling circuit, employing two valves, has been designed, and this is shown clearly in Fig. 2.



# QUERIES and ENQUIRIES

A stamped addressed envelope, three penny stamps, and the query coupon from the current issue, which appears on page 456, must be enclosed with every letter containing a query. Every query and drawing which is sent must bear the name and address of the sender. Send your queries to the Editor, PRACTICAL MECHANICS, Geo. Newnes, Ltd., Tower House, Southampton Street, Strand, London, W.C.2.

**U.S.A. PATENT**

"I HAVE invented a new type of reflector for a torch, details of which are enclosed and wondered if it is worth patenting.

"Would it be possible to patent it in U.S.A.?" J. H. (East Lothian).

THE improved reflector for lamps is thought to be novel and forms fit subject matter for protection by letters patent. Provided the invention is novel and more useful than known reflectors, it should have a commercial value. You are advised to file an application for patent with a provisional specification which will give you protection at the least expense for about 12 months, during which time it should be possible to ascertain the commercial value of the invention.

An application for a U. S. patent, if an application for patent for the same invention has been previously applied for here, must be filed within twelve months from the date of application for patent in this country.

**IMPROVED MOUSE TRAP**

"I HAVE invented an improved form of mouse trap and would like your advice as to its novelty and whether it forms fit subject matter for protection by patent." J. G. S. (Auldgirth, By Dumfries).

THE improved mouse trap, provided it is novel, forms fit subject for protection by letters patent. It would, however, be advisable to make a search amongst prior patent specifications before protecting the invention, as it is thought that a very similar idea was marketed some years ago. Should the search not disclose any similar patents, it would be advisable to file an

application for patent with a provisional specification, which will give protection for about 12 months at the least expense. During the period of protection, before it becomes necessary to incur a relatively greater expense to obtain a full patent, it should be possible to ascertain the probability of the invention proving a commercial success by putting it before manufacturers likely to be interested in such inventions.

**A VARIABLE PITCH AIRSCREW**

"I HAVE recently filed a provisional specification for a variable pitch airscrew, details of which I enclose. I would like your opinion as to whether this is likely to prove practicable and whether it offers any features which are attractive or unattractive to manufacturers.

"If it is worth while how could I bring this invention to the notice of manufacturers?" W. D. (Warrington).

THE improved hydraulic mechanism for operating variable-pitch airscrews appears to be a practicable construction, and if novel and possessing greater utility than mechanisms at present employed, it might prove attractive to aircraft constructors. In order to ascertain if the invention is novel, the inventor is advised to make a search amongst patents for similar mechanisms, a considerable number of which have been patented in recent years.

Probably the most likely people to take an interest in the invention would be Aviation Developments, Ltd., of Argyle House, 29-31 Euston Road, London, N.W.1, and it is suggested that the inventor should put his invention before them.

**PROOFING ASBESTOS**

"COULD you tell me how to make a preparation to proof asbestos against sulphuric acid." K. H. R. (Boston).

PURE asbestos should not be attacked by sulphuric acid, although, of course, asbestos sheet will get into a sodden condition if acid drippings are allowed to accumulate upon its surface. Much of the present-day asbestos sheeting, however, is adulterated with non-asbestos material which is woven or otherwise incorporated into it, and it is this latter material which is attackable by acids.

In order to make your asbestos material thoroughly acid-proof, we suggest that you wash it and dry it thoroughly and then immerse the sheet in a bath of molten paraffin (or candle) wax for ten minutes so that the wax thoroughly impregnates the material. If, owing to the size of the sheets, you cannot undertake this method, the best alternative is to dissolve the wax in petrol or benzole and to paint the

## THE CHEERFUL MIND WHICH WINS SUCCESS Triumph of Pelmanism

IT is the cheerful mind which triumphs. It is the man or woman who gets up in the morning full of zest for the adventure of the coming day who conquers those doubts and difficulties which depress other people, and "carries through" his or her work cleanly, gaily and successfully.

This is one of the secrets of the immense popularity of Pelmanism. People in every part of the country are taking up Pelmanism to-day, not merely because it increases Mental Efficiency and Income-Earning Capacity, but because it thoroughly braces the mind, banishes Depression and Morbid Thoughts, develops a spirit of sane and healthy optimism, and thus enables those who have adopted it to live a fuller, a richer, and a more enjoyable life.

Over half a million satisfied people have taken the Pelman Course. To-day, the sons and daughters of men and women who took the Pelman Course long ago are taking the new revised Course.

A big and unique asset of the Pelman Institute is its large staff of trained Instructors and Examiners, long experienced and with sympathetic understanding.

The Pelman Institute is known the world over and has old-established and flourishing branches on each of the five Continents.

**Will Power and Personality**

You can read something about the wonderful work Pelmanism is doing in an interesting book, entitled "The Science of Success," a free copy of which will be sent to every reader who applies for it to-day. In this book you will read how Pelmanism trains the senses and brings increased power and energy to your mind; how it strengthens your Will Power and develops your Personality; how it cultivates those factors which make for Courage, Initiative, and Determination; how it banishes Timidity and Nervousness, and drives away dark, gloomy, morbid, and "defeatist" thoughts; how it helps you to take up a more cheerful and optimistic attitude towards life; how it enables you to cultivate an appreciation of the finer and more beautiful aspects of existence.

Pelmanism is quite easy and simple to follow. It takes up only a short time daily. The books are printed in a handy "pocket size," so that you can study them when travelling or in odd moments during the day. Even the busiest man or woman can spare a few moments daily for Pelmanism.

Write (or call) to-day to:

**PELMAN INSTITUTE**

(Established over 40 years),  
130, Pelman House, Bloomsbury Street,  
London, W.C.1.

and by return you will receive a free copy of "The Science of Success" and particulars enabling you to enrol for the Pelman Course on specially convenient terms.

PELMAN (OVERSEAS) INSTITUTES: PARIS, 178 Boulevard Haussmann. NEW YORK, 271 North Avenue, New Rochelle. MELBOURNE, 396 Flinders Lane. DURBAN, Natal Bank Chambers (P.O. Box 1480). JOHANNESBURG, P.O. Box 4928. CALCUTTA, 102 Clive Street. DELHI, 10 Alipore Road. AMSTERDAM, Danrak 68. JAVA, Malabarweg, Malang.

### THE HOME MECHANIC ENCYCLOPAEDIA

By F. J. CAMM

(Editor of "Practical and Amateur Wireless" etc.)

An up-to-date and comprehensive guide to the Mechanical, Scientific and Technical Interests of the day—with expert articles on Aircraft, Television, Models, Astronomy, Electricity, Photography, Chemistry, Woodwork, Motor Cars, Wireless, Home Cinema, with over 600 illustrations.

Only 3/6 Net

4/- post free from the Publishers—Book Dept., George Newnes, Ltd., Tower House, Southampton Street, Strand, London, W.C.2

NEWNES : LONDON



## ENGINEER'S Guide to Success

This Great Guide shows how to study at home with The T.I.G.B. for a well-paid post. Contains the widest choice of engineering courses in the world—over 200—including MECHANICAL, CIVIL, ELECTRICAL, AUTOMOBILE, AERONAUTICAL, RADIO, TELEVISION, CHEMICAL, etc.—alone gives the Regulations for Qualifications such as A.M.I.Mech.E., A.M.Inst.C.E., A.M.I.E.E., C. & G., G.P.O., etc.—contains remarkable tributes from Engineering Institutions and eminent technical men to the successful tuition methods of The T.I.G.B.—and details latest successes of T.I.G.B. students in all fields. Training until successful guaranteed for the one fee. Write for Free copy TO-DAY.

**THE TECHNOLOGICAL INSTITUTE  
OF GREAT BRITAIN,**  
218 Temple Bar House, London, E.C.4  
Founded 1917. 20,000 Successes.

## CASTINGS MATERIALS & MACHINES for Model Makers & Engineers

- Get our 72-page illustrated Catalogue, 6d., post free, showing a wide range of useful machines and attachments, etc., supplied in either rough sets, part machined or complete machined sets or finished complete.

**TOM SENIOR**  
"Atlas Works", Hightown  
Liversedge, Yorks.



### A GOOD-LOOKING NOSE

Best scientific device in world for correcting badly-shaped noses. Results like machine while you sleep, painlessly, permanently. Over 20,000 successes. Write for full explanatory booklet with testimonials. PROMINENT EARS permanently corrected at night by comfortable Lees Ray Ear Caps, 7/6 post free. Success guaranteed or money refunded.

**LEES RAY CO.,**

Feature Specialists, Agincourt Square, Monmouth.

solution on to the asbestos sheets. You can do nothing to the portions of the asbestos which have been attacked by the acid, apart from thoroughly cleansing them previous to the wax treatment.

Actually, however, a well-waxed wooden bench is almost as acid-proof as any asbestos sheeting, whilst a surface composed of good glass sheets placed over a waxed wooden bench forms the best of all non-acid surfaces. There is, in our opinion, little point in going to the considerable expense of procuring asbestos as an acid-proofing material.

### FIXING ABRASIVE GRIT

**H**OW can I fix abrasive grit to a wooden disc? The fixing must be strong enough to withstand a flint rubbing on the edge of the disc without loosening the grit. J. T. (Northampton).

**O**UR tests show that the abrasive grit on the sample of sandpaper submitted is secured to the surface of the paper by means of glue. Probably the grit has been glued on under pressure. No doubt, however, a specially "hard" glue is used for the purpose and if you will write to British Glues and Chemicals, Ltd., Imperial House, Kingsway, London, W.C.2, or to Messrs. Oury, Millar & Co., Ltd., 4 Queen Street Place, London, E.C.4, stating your wants, we think that you will have no difficulty in obtaining small supplies of the best grade of adhesive for the purpose.

It might be advantageous, however, if you were to devise some method of lining the edges of your wooden wheels with ordinary sandpaper. Might not this procedure simplify your task somewhat? It will be exceedingly difficult, however, for you to construct a gritted disc which will stand up to the continual rubbing of a hard flint without loosening of the grit particles on the edge of the disc.

### A LABORATORY BURNER

**I**S there a practical substitute which could be used in the absence of gas facilities and the bunsen burner? Would small paraffin or petrol blow-lamps serve the purpose, and if so, would these represent a greater element of danger than the familiar bunsen burner. The sole object of using these appliances is to be able to get a smokeless hot flame. The use of a methylated spirit lamp is taken for granted in some cases." F. F. (Wanstead).

**T**HERE are many laboratory burners available which consume either methylated spirit or petrol and which give a perfectly non-luminous flame which is easily controlled. Particulars of these burners can be obtained from any firm of laboratory suppliers, as for example, Messrs. Philip Harris & Co., Ltd., Birmingham.

Ordinary petrol or paraffin blow-lamps are not very suitable for the purpose you require, since their flames are not only too hot for average uses, but they are also not under good control.

### REPRODUCING PHOTOGRAPHS ON PAPER

**I** WOULD like to know if it is possible for an amateur to reproduce photographs on paper, such as the sheet that this letter is typed on. I have heard of a preparation for transferring photographs to wood, aluminium, etc., but not to paper. The preparation transfers the photograph so that the grain of the wood can be seen through it, which is what I do not want. I shall require a number of sheets of paper with the photograph reproduced on them. Could I not reproduce the photograph by using an aluminium plate, such as in "Rotaprint"

duplicating machines? If so, how are the prints transferred to the plate? Can you tell me the exact quantities of chemicals used, and the different kinds used?"—R. P. (Ayrshire).

**W**E are afraid that it is not possible to transfer photographs to paper in the sense which we presume you mean. We take it that you wish to transfer illustrations in books, newspapers, magazines, etc., to paper. In some measure, this is possible, simply by rubbing a lump of wax over the illustration, placing a sheet of paper over it and pressing the two together, whereupon a little of the greasy matter of the ink comprising the printed photograph is transferred to the clean sheet of paper, giving a more or less faithful representation of the image.

It is not, however, possible to transfer actual photographs in this manner, nor is it possible to transfer more than a very few printed illustrations by the above-mentioned wax method. Duplicating machines do not deal with "half tone" illustrations, i.e. with the delicate lights and shades which are present in photographs. They only handle the black-and-white matter of ordinary writing or printed characters.

### CASTING ELECTRON ALLOY

**W**HAT heat is required and what flux is used in the casting of electron alloy, also the ratio of flux to metal? A.M. (Newcastle-on-Tyne).

**T**O melt Electron alloy (magnesium, 95 per cent.; zinc, 4.5 per cent.; copper, 0.5 per cent.), you will find it necessary to heat a mass of metal to approximately 630 degrees C., that is to a good red heat. The melting should be done in a non-metallic container, the metal being kept out of contact with air as much as possible and stirred a minimum amount. It will only be necessary to cover the surface of the metal with a small amount of flux. You will find a mixture of equal parts of borax and of magnesium chloride quite satisfactory for this purpose. Borax alone may also be employed, but sal-ammoniac fluxes should be avoided, since magnesium tends to react with sal-ammoniac and other ammonium salts.

### HUMIDITY OF THE AIR

**I** WISH to test the humidity of the air, and I have been informed that the following method is quite reliable:—

"Two thermometers placed side by side, one having the bulb covered with muslin kept wet by a thread dipping into water, and, owing to evaporation, registering a lower temperature than the dry thermometer.

"Is this method reliable?—and if so, how is the correct reading arrived at?" D. R. (Leicester).

**T**HE arrangement of two thermometers side by side in the manner you describe, one of the thermometers having its bulb covered with muslin retained continually in a moist condition, forms an instrument which is known, technically, as the "Wet and Dry Bulb Hygrometer." When water (or any other liquid, for that matter) evaporates, it abstracts heat from its surroundings. Consequently, the thermometer whose bulb is continually in contact with the evaporating water registers a lower temperature than does the thermometer whose bulb is kept dry.

In order to ascertain the amount of moisture in the air by reading the temperatures of the wet and dry bulbs, it is necessary to refer to a series of "wet and dry bulb hygrometer tables." These tables are obtainable from makers of such instruments, as, for instance, Messrs. Negretti and Zambra, Ltd., Holborn Viaduct, London, E.C.1.

You will find a detailed explanation of the working of the wet and dry bulb hygrometer—which is quite a reliable instrument—in any practical textbook on heat.

**METHYLCYCLOHEXANE**

(1) **H**OW is carbon combined with hydrogen to form methylcyclohexane (C<sub>7</sub>H<sub>14</sub>)? Can it be done by heat? Is the procedure the same when forming other hydrocarbons (say, pentane, C<sub>5</sub>H<sub>12</sub>)?

(2) Is hydrogen liberated from sea water when the latter is electrolysed? What kind of electrode is used, and what voltage?"

(1) **M**ETHYLCYCLOHEXANE, C<sub>6</sub>H<sub>11</sub>. CH<sub>3</sub>, better known as hexahydro-toluene, cannot be obtained by direct combination of hydrogen and carbon. It is a liquid which boils at 97°C. It is best prepared by passing dry hydrogen gas saturated with toluene vapour through a glass tube containing freshly-reduced finely-divided nickel heated to a temperature of 180 to 200°C.

Since, however, toluene can be prepared indirectly from benzene and the latter can be prepared from acetylene which may be produced by the direct union of carbon and hydrogen, it is, theoretically, possible to obtain methylcyclohexane starting from carbon and hydrogen alone. Most of the other hydrocarbons of the paraffin series (i.e., Pentane, etc.) are not prepared by direct union of carbon and hydrogen.

(2) Impure hydrogen is liberated from sea water when the latter is electrolysed, the hydrogen being evolved at the negative pole. Carbon or nickel electrodes will suffice and the voltage passed should be between 4 and 8.

**TAKING PLASTER CASTS**

**I** WOULD like to know of a process whereby plaster casts could be taken of the human face. I have seen it done, but have been unable to get the names of the material used. The base was a liquid which was painted on the face, after which a plaster was put on. It was left on for 15 minutes and came away perfectly without any trouble. It seems that the secret is the base liquid, which was even painted on the hair." R. F. G. (South Africa).

**P**LASTER casts of the type you mention are usually taken in plaster of Paris, the latter having some material such as glycerine incorporated with it in order to delay its setting.

Several "base liquids" have been brought out for ensuring the easy withdrawal of the cast from the face or limb, but the composition of these liquids has not been made public. Most of them, however, contain oil or wax in some suitable solvent. You would find a solution of paraffin wax or vaseline in petrol or some other solvent quite suitable for the purpose. Solutions of celluloid in acetone have also been used for the purpose.

An article on making lifelike masks appeared in our issue dated July, 1938.

**COATING PLASTER OF PARIS CASTS**

**W**HAT kind of wax, and method is used, for coating plaster of Paris casts? Is there any book I could obtain on plaster of Paris work?" R. M. (Wellingborough).

**F**OR the work you mention, a solution of vaseline in petrol or benzole will be found most effective. This can be painted all over the plaster of Paris work. It is quick-drying and will leave a thin and even coating of lubricant behind.

There are a number of books published on plaster of Paris work. Among the best are: S. Jagger, "Modelling and Sculpture"

(7s. 6d.); A. Toft, "Modelling and Sculpture" (15s.).

An inquiry to Messrs. W. & G. Foyle, Ltd., Charing Cross Road, London, will doubtless bring you particulars of all secondhand volumes dealing with the subject which they may have available.

**MAKING PAPER COLLARS**

**H**OW were the paper collars made of "H" about sixty years ago?

"What was the material composed of, and was the machinery used in their manufacture very elaborate and expensive?" W. D. (Sussex).

**P**APER collars were cut from highly glazed and calendered paper, which was made by incorporating with good quality paper "stuff" heavy filling materials, such as barytes and gum arabic. The paper was then passed between heated rollers, which induced a high gloss on its surface. Subsequently, collars were cut in quantities from this paper material by hand-operated knives, each batch of collars being cut from a stock "pattern." Some collars, indeed, were cut individually from patterns by hand.

We think you would be able to procure highly glazed white or cream paper "stuff" for collar making, but we are of the opinion that you would find it necessary to perform the actual making up of the paper into collars by hand methods, since no mass-production processes for such collar making were ever extant.

**MAKING A BOW**

**I**N making an archery bow from ash or hickory, should the wood be seasoned or "green?"—S. T. (Cardiff).

**Y**OU would do best to use well-seasoned wood for your archery bow. If you use green wood, the wood will quickly "set," become devoid of springiness and become altogether useless for the purpose required.

**A RECORDING THERMOMETER**

**C**AN you give me any information on how to make a recording thermometer? It is particularly desired to know what medium is used to indicate the rise or fall in temperature." (W.B., Angus.)

**Y**OUR requiring to know how to make a recording thermometer is somewhat akin to requesting us to tell you how to make a motor-car! There are, you see, so many widely-varying types of recording thermometers that it is impossible for us to accede to your request in any specific manner.

In many such thermometers, mercury is used as the indicating liquid, also pure alcohol and various alcohol mixtures. Sometimes, also, the liquid is made to expand against a volume of gas, thereby setting up a slight pressure, which is indicated by mechanical means.

The literature on the subject of thermometers is exceedingly scanty, and there are no books (apart from text-books of heat and physics) which deal with thermometers and their "mechanism."

We would advise you to get in touch with Messrs. Negretti & Zambra, Ltd., 38 Holborn Viaduct, London, E.C.1, who are thermometer specialists and who issue descriptive literature relating to many branches of thermometer construction. State your requirements to them and you will receive the relative literature.

Messrs. Black & Son, 1 Green Terrace, Rosebery Avenue, London, E.C.1, are also similar makers of thermometers for all purposes and would doubtless also make suitable response to any enquiry submitted to them.



- It is easy to apply.
- It leaves no brushmarks.
- It gives a brilliant hard gloss finish.
- It does not readily chip or scratch.
- It's such value for money.



Obtainable at Handicraft Stores, Ironmongers, Oilmen, Grocers, etc. In Dark Oak, Walnut, Mahogany, Light Oak, Ebony and Clear (Colourless) Varnish.

Tins 6d., 1/- & 1/6

**VARNENE THE FINER OIL VARNISH STAIN**

Chiswick Products Ltd., London, W.4. V.F.U.157

*An Absorbing Hobby*

BUILDING A STUART MODEL IS AN ENGROSSING PASTIME, AND THE RESULT A CONTINUOUS PLEASURE



We Illustrate:

STUART NO. 10. High Speed Steam Engine. Bore 3/4". Stroke 3/4".

Each set is quite complete—drawings and instructions are included.

If you have a lathe—	
The rough castings	8 6
If not—	
Fully machined set	18 6
Ditto, with all holes drilled and tapped	25 -

This and many other Stuart engines are fully described in the 72-page CATALOGUE No. 3, 6d. post free.

**STUART TURNER LTD. HENLEY - ON - THAMES**

use  
**Baker's**  
SOLDERING  
FLUID

"Easily the Best Soldering Fluid Obtainable." This statement by a regular user of "BAKER'S" expresses the general opinion of the Motor and Engineering Trades. Sold in 6d., 1/- and 1/6 tins, also in bulk.

*"For a quick clean job!"*

SIR Wm. BURNETT & Co. (CHEMICALS) LIMITED  
GREAT WEST ROAD, ISLEWORTH, MIDDLESEX

## BE TALLER

Your Height increased in 14 days or money back. 3-5 inches gained, health improved. Guaranteed harmless. Remarkable testimony. Complete course 5/-, or particulars sent free under plain cover:—  
L. Stebbing System, 28 (M.P.60), Dean Road, London, N.W.2.

You NEED this  
**"IMPETUS" MOTOR TOOL**  
an Electric High Speed hand grinder, file router, etc., that SAVES TIME, EFFORT & EXPENSE. Faster, easier and more accurate. Nothing on the market to touch it at 63/- nett. Send for detailed specification NOW and be up to the minute. Super model, £55.  
JOHN P. S. STEEL  
Clyde Street Mills, Bingley.



## FREE SERVICE FOR READERS

**R**EADERS requiring information concerning goods or services advertised in PRACTICAL MECHANICS should give names of Advertisers from whom particulars are desired. Any number of names may be included and we will obtain for you catalogues, lists, and any other information you may be wanting. **THERE IS NO CHARGE FOR THIS SERVICE.**

Readers desiring particulars from a number of Advertisers will, by this method, save time and postage. If any Advertiser stipulates that stamps or postal orders are necessary before samples or catalogues are sent, please enclose the necessary amount with your instructions. You are cordially invited to make full use of this Service.

**ADVERT. SERVICE DEPT.,**  
PRACTICAL MECHANICS,  
TOWER HOUSE, SOUTHAMPTON  
STREET, STRAND, W.C.2

*Please obtain and send to me particulars from the Advertisers in your May issue whose names I give on list attached.*

Advertiser	Page No.	Information Required
------------	----------	----------------------

*Attach sheet of paper, with particulars, and your name and address (written in BLOCK letters), with date, to this announcement.*

## MODEL AERO TOPICS

(Continued from page 433)

### New Catalogues

I HAVE received a copy of the new catalogue issued by the Model Aircraft Stores (Bournemouth), Ltd. This catalogue has been very neatly arranged in alphabetical order and contains details of all model aircraft accessories, kits, blueprints, books, wire, wood, dope, fabric, wheels, etc., etc. It also contains details of three new engines, the Super Spitfire, the Hornet, and the Wasp. The catalogue costs 3d. from the company, 127b, Hankinson Road, Bournemouth.

### The Wakefield Fund

LORD WAKEFIELD has generously donated £100 towards the fund which will be used to send a team abroad to regain for England the Wakefield Cup. The fund now approaches the £300 mark, and Lord Wakefield has promised to make good the deficiency.

Lord Wakefield has promised, if political situations permit, to donate a further £100 if the fund does not reach the required level.

### Some Fine Kits

WE have received the new catalogue produced by Aeromodels, Ltd., 48, Park Road, Liverpool, 17, copies of which may be obtained by any reader for 2d. This details a number of flying scale kits, which are of all-British design and production, including the 22-inch wing-span Hawker Hurricane at 5s.; the 15-inch Hawker Fury Mark II at 4s.; the D.H. Tiger Moth; the Miles Magister; the Hawker Hind; the Wicko; the D.H. Leopard Moth; and the Aero Lark Flying Model. The illustrations reveal that the models assembled from the kits are remarkably realistic.

### Model Aircraft Trade Association

SOME time ago we made the suggestion that the aircraft industry was developing to such an extent that a trade association was necessary. We are glad to see that this has now been formed, under the title of the Model Aircraft Trade Association. A chairman and secretary-treasurer have been appointed and a committee formed. The aims of the Association are to raise the status of the industry by supplying quality materials at an economic price, to encourage business relationship between members of the Association, and in other ways to ensure an economic standard of trading. The committee consists of:—Mr. F. R. Barnard (Premier Aero Model Supplies), chairman; Mr. H. York (Model Aircraft Supplies), secretary-treasurer; Mr. D. G. Brown (The Model Shop); Mr. B. Coulthurst (Northern Model Aircraft Co.); Mr. E. H. Keil (K. Keil & Co.); Mr. J. N. Mansour (International Model Aircraft, Ltd.); Mr. R. J. O'Neil (Cloud Model Aircraft); Mr. S. Norman (Model Supply Stores); and Mr. R. Wood (Elite Model Aeroplane Supplies). Most of the leading firms have already joined the Association.

### Some Fine Models

THE Authentic Model Co., 44, Legh Street, Warrington, Lancs., have sent us details of the Miles Kestrel Trainer, and the Percival "Mew Gull" models which they are marketing in kit form at 3s. 6d. and 5s. respectively. They have been designed from the actual plans of the real plane to a scale of 1/24th full size—that is, 1/4 inch to the foot. The wings are correctly cambered, and by a novel and ingenious method of construction incorporating a tube running the entire length of the fuselage, great strength and

lightness are assured, and damage to the model from the breakage of the rubber eliminated. This tube also enables various bulkheads to be accurately placed, and ensures correct fuselage contour. The kits contain all the necessary wooden parts, wheels, covering tissue, dope, cement, glue, wire, rubber, and drawings. The kits are obtainable from shops and stores throughout the country.

## TESTING AEROPLANE ENGINES

(Continued from page 413)

mates the actual installation in the airplane. In place of the conventional framework of structural steel bolted to the floor, a steel tube is used. This tube is suspended from the ceiling by four cables and anchored to the floor by two more. Cradled in rubber, these cables provide a flexibility in the engine mount which could not be obtained with a rigid test stand.

### Two Air Towers

Two towers, one at each end of the test cell, provide for a free circulation of air. Drawn in through the forward tower by the propeller, the air passes over the engine and is discharged to the atmosphere at the rear. In these towers, which extend over 30 feet above the ground, is concentrated most of the sound-proofing material which dampens out the engine's roar. A monorail track extending from the front of the test cell, which opens on to a corridor leading from the assembly department, enables mechanics to lift engines from their assembly stands by means of a sling and guide them to the engine mount. This facilitates attachment and removal of the engine from the stand.

## PHOTO-ELECTRIC CELLS

(Continued from page 424)

hydrogen are now being used as well. The effect of gas filling is to increase the efficiency of the cell by intensifying the photo-electric current. The number of electrons released from the cathode by its reception of a beam of light of given intensity increases as the voltage between anode and cathode rises, but soon attains a maximum saturation value (which depends on the quality and intensity of the light beam), if the cell is evacuated (see Fig. 4a). On the other hand, in a gas-filled cell the electrons released from the cathode by the light produce still more electrons in the space between anode and cathode by the simple process of colliding with gas molecules and expelling electrons from them. In a cell of good efficiency a single electron arising from the cathode (photo-electron) will produce on an average 20 electrons in the gas by collision (ionisation electrons). Consequently there is a rapid increase in the photo-electric current as the anode voltage rises since there is always a plentiful supply of electrons in the gas, and eventually a visible glow discharge arcs through the gas (see Fig. 4b).

**ORDER NEXT  
MONTH'S COPY  
NOW!**



# BUY, EXCHANGE OR SELL

Advertisements are accepted for these columns at 3d. per word (minimum 12 words at 3s.—advertisements of less than 12 words are charged at the minimum rate of 3s.) subject to a discount of 2½% for 6 consecutive monthly insertions or 5% for 12 consecutive monthly insertions. TERMS:—Cash with order. Cheques, Postal Orders, etc., should be made payable to George Newnes, Ltd. The Proprietors reserve the right to refuse or withdraw advertisements at their discretion. All advertisements must be received on or before the 5th of the month preceding date of publication and should be addressed to the Advertisement Manager, "Practical Mechanics," George Newnes Ltd., Tower House, Southampton Street, Strand, W.C.2.

## CANOES

**BOAT AND CANOE.** Kits from 27/6. All types completed craft. List stamp. Trade.—Metacraft (P), Christchurch, Hants.

## CINEMATOGRAPHY

**ART CINE FILMS.** Exclusive 9.5 and 10-mm Free Films to Cine Camera or Projector buyers. All makes. State wants.—P. M. Dane, 64 Stanley Street Liverpool 1.

**CINEMATOGRAPH FILMS.** Standard Size from 6d. 100 feet. Machines, Accessories, Sample Films 1/- and 2/6 post free. Catalogues free.—"Filmieries," 57 Lancaster Road, Leytonstone, E.11

**WANTED FOR PROMPT CASH,** Miniature Cameras, Enlargers and Accessories, Cine Cameras, Projectors and Films, Microscopes, Telescopes, and Binoculars; small Lathes and Precision Tools.—Frank 67 Saltmarket, Glasgow.

## CLOCK MOVEMENTS

**CLOCK MOVEMENTS** of every description ready for cases. Lists post free.—Needham, 25 Stratton Road, Manchester 16.

## DUPLICATING

**THE ILLUSTRATED DUPLICATING SERVICE,** 11 Friars Street, Ipswich, for all duplicating requiring illustrations.

## ELECTRICAL

**A.C., D.C. MOTORS,** Grinders, Fans, Drills, Chargers. 1939 interesting lines. List free. Easco Electrical Services, 18pm, Brixton Road, S.W.9.

## ADDED INCHES

are Important To-day



and they are easily attained with one box of Challoner's Famous Formula.

**H.T.N. TABLETS** and easy system; well tried and safe. No strenuous exercises or old-fashioned appliances. If one box is insufficient we guarantee to supply another FREE. A. L. (Wilts.) writes: "Since I started your treatment I have gained 3 inches in height." Full particulars 1/4d. Sample 7/4d. Book on height improvement 3d., stamps or P.O. only. Sent under plain sealed cover.

**THE CHALLONER CO.** (late Bond Street), Dept. W 15, Laboratory & Works, Hyde Heath, Amersham, Bucks.

## JUBILEE WORM DRIVE HOSE CLIPS



The long-life clip with the ever-tight grip.

The Best Known

For Radiator Joints, Air, Oil, and Water Hose Joints.

We guarantee a Tight Joint.

Stocked by all Garages and Accessory Dealers.

**L. ROBINSON & CO.,** 25 London Chambers, GILLINGHAM, KENT.

## ELECTRICAL—Continued

**SUPER A.C. MOTORS.** Brand New, 1/10 h.p., 30/-; ¼ h.p., 38/6; ½ h.p., 38/6; ¾ h.p., 55/-; larger sizes. Electric Tools, Machines, Pumps, Compressors, etc.—John P. Steel, Clyde Street Mills, Bingley.

**AC/DC MOTORS,** 1/12th to 1/8th h.p., from 10/- Stamp particulars.—Brookes, Banners Street, Cradley, Staffs.

## ENGINEERING

**MINIATURE BALL RACES** from 1½ mm. o/d Send 2d. stamp for particulars of 1939 REDUCED PRICES. Sample, 1s. 6d. post free. Dept. P, MINIATURE BEARINGS, LTD. 3 Duke Street, St. James's, S.W.1.

## ENGRAVING EQUIPMENT

**ELECTRIC ENGRAVING EQUIPMENT SPECIALISTS.** Send for details of equipment for engraving nameplates, tools, dog collars, etc.—RUNBAKEN ELECTRICAL PRODUCTS, MANCHESTER 3.

## LITERATURE

**NEW DIFFERENT** imported American books, magazines. Science, inventions, mechanics, models. 12 different 4/- catalogue included, post free. G. A. Final, 15, Nashleigh Hill, Chesham.

## METAL WORK

**MAKE METAL TOYS.** Easy, profitable with "Success" Moulds. List Free. Complete trial mould, 1s. 6d.—Lee's, 1 Birkin Avenue, Nottingham.

## MICROSCOPY

**"THE MICROSCOPE AND ENTOMOLOGICAL MONTHLY."** The premier journal for all students of nature. 1s. from newspapers, or 1s. 1d. from Microscope, 20/21 Took's Court, London, E.C.4.

## MISCELLANEOUS

**TELESCOPES, MICROSCOPES,** Scientific Instruments, etc. Send for lists. Sale or Exchange.—C. V. Bolton, F.S.M.C., 49a Leigh Road, Leigh, Lanes.



**THE 'ADEPT' LATHE** 15/8 in. centres, 6lb. between centres. With compound slide-rest 22", or with hand-rest only, 13"0. Screw Tall Stock, 5/6 extra Post 1/-.

**THE SUPER 'ADEPT,'** 33/-  
**F. W. PORTASS, SHEFFIELD.**

## NERVOUSNESS

Every nerve sufferer should send for my interesting book, which describes a simple, inexpensive home treatment for Self-consciousness, Blushing, Depression, Worry, Insomnia, Weak Nerves, Morbid Fears, and similar nervous disorders. This wonderful book will be sent in a plain sealed envelope to any sufferer without charge or obligation. Write NOW and learn how to conquer your nervousness before it conquers you!

**HENRY J. RIVERS (Dept.)** 116 HIGH HOLBORN LONDON, W.C.1

## BLUSHING

**FREE** to all sufferers, particulars of a proved home treatment that quickly removes all embarrassment, and permanently cures blushing and flushing of the face and neck. Enclose stamp to pay postage to Mr. M. Temple (Specialist), "Commerce House," 72 Oxford Street, W.1. (Est. 38 years.)

## MISCELLANEOUS—Continued

**"PHOTO-ENGRAVING."**—A practical Handbook with complete set of materials for engraving printing blocks, 4/6.—Industries, 2 Waldegrave Park, Twickenham.

**HEADPHONES, CRYSTALS, CRYSTAL SETS,** microphones, model aeroplanes; tricks, jokes, etc. Lists with diagrams, FREE, or send 3d. for 40-page ILLUSTRATED CATALOGUE.—POST RADIO, 2 COPENHAGEN STREET, London, N.1.

## MUSICAL INSTRUMENTS

**BAND GUIDE.** Hints on the Bugle, Drum, Flute, Staff Parade formation, etc. Free, post paid.—Potter's (Manufacturers), West Street, London, W.C.2

## MODELS

**EVERYTHING FOR** electrical rewinds and repairs. Screws, nuts, and washers for model engineers. Lists free.—Lumen Electric Co., Litherland, Liverpool, 21.

**FOR TRIX TWIN RAILWAYS.** Some special 4-4-0 tank locomotives and coaches, including G.W.R. Particulars 1½d. Georges', 11 Friars Street, Ipswich.

## MONEY-MAKING OPPORTUNITIES

**SALES REPRESENTATIVE** wanted, spare time; 35s. weekly easily made.—Richfords, Ltd., 8a, Snow Hill, London.

## SCALE "00" MODELS

Have you seen our New all-metal coaches?

These are most realistic and are fitted with our new N/Silver spring buffers that really do work, also the floor is removable so that interior fittings such as seats, tables, etc., can be fitted. Call and see these models, price 17/6 each, or write for leaflet PM39 to

**THE ORIGINAL "00" PIONEERS**  
**HAMBLINGS** 10, Cecil Court, Charing Cross Road, W.C.

## INVENTORS

### VALUABLE GUIDE

General Advice Free. POST FREE 6d.  
**CHATWIN & CO.** Est. 1880  
Regd. Patent, Design and Trade Mark Agents for all countries.  
253 (D) Gray's Inn Road, London, W.C.1.

## THE WEBLEY SERVICE AIR RIFLE Mk II

NO LICENSE REQUIRED TO PURCHASE  
Or Use at Home  
WRITE FOR DESCRIPTIVE FOLDER  
Rooks, Rabbits, Rats, Sparrows and similar vermin can be destroyed by this extremely accurate and powerful Air Rifle. Ideal for Target Practice.  
CALIBRE 22 or 177 With Leaf-sight and Peepsight  
WEBLEY & SCOTT Ltd. 100, WEAVER STREET, BIRMINGHAM, 5

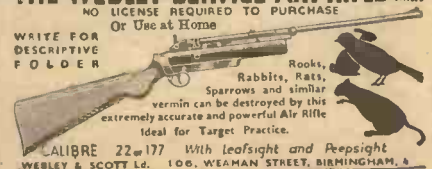

# BUY, EXCHANGE OR SELL

## TOOLS

1" Round Dies, Screwing  $\frac{1}{8}$ ";  $\frac{3}{16}$ ";  $\frac{1}{4}$ ";  $\frac{5}{16}$ " Whit., B.S.F.; or Brass 26 Threads; or American Fine. S.A.E. for Yankee Cars, Set of Five Dies 2/9; Four Sets 10/-; Best Quality 1" Die-Stocks, all Steel unbreakable with Hardened adjusting Screws, 1/9 each.—Below.

4,000 Taps, same sizes and threads as Dies, 2/9 set, four sets 10/-.—Below.

3 Tons Files, assorted parcels for General shop use, 8 doz. 8" to 12", 10/-; 2 doz. 12" to 16", 10/- Car. for Paid with £2 order.—Below.

Bright Mild Steel, round, approx. 50 ft. assorted  $\frac{1}{2}$ " to  $\frac{1}{4}$ " diam., 5/6; ditto 50 ft. Squares, Flats, Small Hexagon, 8/6.—Below.

Superfine Files, 6", for Gauge making or fine tool work, 4/- doz.—Below.

Vee Blocks and Clamps, Starret pattern, accurate, first-class finish, 2/6 each; 4/6 pair.—Below.

Fine Emery Wheels,  $\frac{1}{16}$ " to  $\frac{3}{16}$ " thick,  $\frac{1}{8}$ " hole;  $2\frac{1}{2}$ " to 4" diam., extremely useful for Grinding Drills, Small Tools. Special selection, 2/6 per doz.—Below.

Genuine Carborundum Wheels, 9" diam., 1" wide; 1" hole; suitable general tool use, 6/- each. Ditto  $1\frac{1}{2}$ " wide, 2";  $1\frac{1}{2}$ ", 10/-; ditto 14" diam,  $1\frac{1}{2}$ " and  $1\frac{1}{4}$ " wide, 5" hole, 12/- each. Smaller wheels, 4" diam,  $\frac{1}{2}$ " wide, 2" hole, 1/9;  $3\frac{1}{2}$ " ditto, 1/6; 3" ditto, 1/3; also Rough Wheels 8" diam.,  $1\frac{1}{2}$ " wide, 1" hole, 3/9 each; 7", 2/6; 6", 2/- each.—Below.

250 Gross Genuine Tungsten Hack-Saw Blades, 8", 9", 10", 12", 14" to 32" teeth;  $\frac{1}{16}$ " wide; a few gross 12",  $\frac{5}{16}$ " wide. These are very slightly stock soled but guaranteed serviceable, 8/6 gross. Three gross lots, 22/6. Power Blades, 12" by 1", 2/6; 14", 3/6 doz., subject unsold.—Below.

600 Large Gas Thread Taps, Taper, 2nds, Plugs,  $1\frac{1}{2}$ " 2/6;  $1\frac{1}{4}$ ", 3/-;  $1\frac{1}{8}$ ", 3/6; 2", 4/-;  $2\frac{1}{2}$ ", 4/6;  $2\frac{3}{4}$ ", 5/- each.—Below.

1,000 Taps in Electric Conduit and Brass 26 threads.  $\frac{1}{8}$ ",  $\frac{1}{4}$ ";  $\frac{1}{2}$ ", 1/3;  $\frac{3}{4}$ ", 1/6; 1", 1/9 each.—Below.

Morse Taper Sleeves, best quality, ground finish, 1-2, 1/6; 2-3, 1/10; 3-4, 2/6.—Below.

Mild Steel Blanks, any thickness to 1", sawn from bar to your exact requirements,  $1\frac{1}{2}$ " diam., 6d.;  $1\frac{1}{4}$ ", 8d.;  $1\frac{1}{2}$ ", 10d.; 2", 1/-;  $2\frac{1}{4}$ ", 1/6; 3", 2/-;  $3\frac{1}{2}$ ", 2/3; 4", 2/6; also  $1\frac{1}{2}$ " thick plus 10%; 2" thick plus 15%.—Below.

Special Clearance guaranteed quality Small Taps and Dies,  $\frac{1}{16}$ " Circular Split Dies, British and American make only. Usual price 10d. to 1/3 each. Sizes:  $\frac{1}{16}$ ", 5/32";  $\frac{1}{8}$ ", 7/32";  $\frac{1}{4}$ ", 9/32";  $\frac{3}{8}$ ", Whitworth, B.S.F. also Model Engineer 40 Threads in all above sizes; also 0, 1, 2, 3, 4, 5, 6 B.A. Clear 6d. each, 5/6 doz.—Below.

Small Taps in all above sizes. Taper; Second or Plugs,  $\frac{1}{4}$ " to  $1\frac{1}{2}$ ". Whit., B.S.F. Also 0 to 6 B.A. 4d. each; 3/- doz.; 9/32" and  $\frac{1}{4}$ " 6d. each. Please note we have no stock of M.E. 40 Thread Taps.—Below.

Die-Stocks for above Dies, steel throughout, hardened adjusting screws, 9d. each; Tap Wrenches, 0 to  $\frac{1}{2}$ " Adjustable, all steel, 9d. each.

Three tons ground bright Tool Steel Pieces,  $\frac{1}{2}$ " to  $\frac{1}{4}$ " diam., various lengths up to 6", easily hardened in water or oil. Guaranteed the very best quality material actually costing from 1/9 to 3/- per lb. A stock is essential for making Cutters, End Mills, Pin Drills, Punches, High Speed Shafts, etc., etc. 5 lbs. assorted, 3/-; 14 lbs. 7/-; also larger sizes,  $\frac{1}{2}$ " to  $1\frac{1}{2}$ ", 10 lbs., 4/-; 28 lbs., 10/-; also larger sizes  $1\frac{1}{2}$ " to 3" diam., in blanks and short pieces, not bright, 28 lbs., 6/6; 1 cwt. assorted,  $\frac{1}{2}$ " to 3", 30/-;  $\frac{1}{4}$ " cwt., 16/6;  $\frac{1}{2}$ " cwt., 9/- We guarantee you a good assortment for general use.—Below.

700 Cutting Off Grinding Wheels, approx. 7 $\frac{1}{2}$ " diam.  $\frac{1}{8}$ " thick,  $\frac{1}{8}$ " hole, 2/6 each; ditto, approx. 6" diam. 1/9 each.—Below.

Hexagon Die-Nuts, invaluable to all repair shops. Genuine clearance prices: Whit., B.S.F., S.A.E., U.S.S.; also brass 26 thread, sizes  $\frac{1}{16}$ ",  $\frac{1}{8}$ ",  $\frac{1}{4}$ ",  $\frac{3}{8}$ ",  $\frac{1}{2}$ ",  $\frac{3}{4}$ ". Usual price, 7/6 set; outstanding value, 2/9 set. Also  $\frac{1}{8}$ ",  $\frac{1}{4}$ ",  $\frac{1}{2}$ ", 1", in same threads, 4/- set of four. Any four sets  $\frac{1}{2}$ " to 1", 24/-, for thirty-six die-nuts.—Below.

700 Large Split Dies, best quality. Dies  $1\frac{1}{8}$ " diam.  $\frac{1}{16}$ " thick, cutting  $\frac{1}{16}$ ",  $\frac{1}{8}$ ",  $\frac{3}{16}$ ",  $\frac{1}{4}$ ". Whit. and B.S.F. Gas,  $\frac{1}{16}$ " by 24 threads, 1/3 each. Also  $1\frac{1}{2}$ " diam. Dies,  $\frac{1}{16}$ " Whit. only, 2/- each. Also 2" diam. Dies,  $\frac{1}{16}$ " Whit.,  $\frac{1}{4}$ " B.S.F.,  $\frac{1}{2}$ " Gas, 1" by 26,  $\frac{1}{16}$ " by 20,  $\frac{3}{16}$ " by 30 threads, 2/9 each, Worth double. Also  $2\frac{1}{2}$ " diam. Dies,  $\frac{1}{16}$ ",  $\frac{1}{8}$ ",  $\frac{1}{4}$ " Whit.,  $\frac{1}{2}$ " B.S.F.,  $\frac{1}{2}$ " Gas,  $\frac{1}{16}$ " Electric Conduit,  $\frac{1}{8}$ ", Gas, 3/6 each.

J. BURKE, 30 TRIPPET LANE, SHEFFIELD, T

## TOOLS—Continued

1,200 Best Quality Taps, Tapers, 2nds, Plugs.  $\frac{1}{8}$ ", 9d.;  $\frac{1}{4}$ ", 1/-;  $\frac{1}{2}$ ", 1/3; 1", 1/6. Whit., B.S.F. Also in gas thread,  $\frac{1}{8}$ ", 6d.;  $\frac{1}{4}$ ", 9d.;  $\frac{1}{2}$ ", 10d.;  $\frac{1}{2}$ ", 1/-;  $\frac{3}{4}$ ", 1/3;  $\frac{1}{2}$ ", 1/6;  $\frac{3}{4}$ ", 1/9; 1", 2/-.—Below.

12 Only Ball-bearing Double-ended Grinding Heads, to take  $\frac{1}{2}$ " bore wheels. Practically new, 15/- each. Six only Stands for same, fitted with rise and fall slide independent each side. Make very good tool and cutter grinders or surface or special grinders. Stands 10/- each, if purchased with grinder.

2/9 any lot. Eight lots £1.—Below.

$\frac{1}{2}$ " Toolholder with four H.S. Tools.

$\frac{1}{2}$ " Adj. Boring Tool with H.S. Tool.

$\frac{1}{2}$ " Drill Chuck, taper or straight shaft

$\frac{1}{8}$ " to  $\frac{1}{16}$ " Silver Steel, 13 pieces.

$\frac{3}{8}$ " to  $\frac{1}{2}$ " Silver Steel, 4 lb., 2" to 4" long.

500 Ass. Brass and Steel Screws, etc.

100 Steel Hex. Bolts and Nuts,  $\frac{1}{2}$ " to  $\frac{1}{4}$ ".

16 H.S. Drills, 1/32" to 5/32".

12 Drills,  $\frac{1}{16}$ " to  $\frac{1}{8}$ ". Carbon.

Set 1" Dies,  $\frac{1}{8}$ ",  $\frac{3}{16}$ ",  $\frac{1}{4}$ ",  $\frac{5}{16}$ ",  $\frac{3}{8}$ ", Whit.

Ditto, B.S.F. 26 threads or S.A.E.

Set  $\frac{1}{2}$ " to  $\frac{1}{4}$ " Taps, same as Dies. T.S. or P.

Slitting Saws, five 1/32" to  $\frac{1}{4}$ " thick, 1" hole.

Two dozen Fine and Odd Thread Taps to  $\frac{1}{2}$ ".

Three dozen Tungsten Hack-saws to 12".

18 Grinding Wheels,  $\frac{1}{2}$ " to 1" diam.

Three H.S. Tap Fluting Cutters,  $\frac{1}{4}$ " diam.

One dozen Ass. Files, 4" to 12".

Six Files, 12" to 16". Note postage terms.

Dozen Toolmaker's Needle Files, indispensable.

Best Carborundum Wheel, 7" by  $\frac{1}{2}$ " by  $\frac{1}{2}$ " hole.

200 Springs to approx. 6" long.

Small Taps, 7, 8, 9, 10, 12, B.A.,  $\frac{1}{16}$ ", 3/32" Whit. 6d. each, 5/9 dozen. No dies in these sizes.

High-Speed End Mills,  $\frac{1}{8}$ ", 2/9; Straight Shank,  $\frac{3}{8}$ " carbon ditto, 1/9.

£1 Orders Carriage Paid, except abroad. Money refunded if not satisfied with any of the above bargains.

J. BURKE, 30 TRIPPET LANE, SHEFFIELD, 1

BRAND NEW POWER TOOLS or quantity. 10 in. Bandsaws, 54/-. Jigsaws, 22/6. Wood Planing Machines, 80/-. Bench Drills, 11/-. Circular Saws from 25/-. 3 in. S.C. Toolroom Lathes, from £4 16s. New 1 in. Chromium Plated Micrometers, 12/6. Electric Drills, 32/6. Grinders, Spray Plants, Guns, Air Compressors, etc.—John P. Steel, Clyde St. Mills, Bingley.

Complete Ball-bearing Saw Benches from £4 18s. 6d. Easy terms. Lists Free.—Hartop Engineers, Bedford.

GRAYSON'S Glass-boring Outfits and Tube. Cutters avoid risk.—Below.

DRILLS, Taps, Dies, Files, Chisels and Punches. Best quality at keenest prices.—Grayson & Company, 300 Campo Lane, Sheffield.



**OUTSTANDING EARS CORRECTED**  
ORO, The Universal Ear Shaper, Treatment, produces amazing, immediate and permanent results. CONSPICUOUS EARS assume their normal position within a few minutes. No mechanical contrivance. Oro is ideal in that each application is INVISIBLE, comfortable and harmless. Praised by Doctors. Hundreds of satisfied users. Write for free booklet and testimonials.  
M. TRILETTI (R146)  
45, Hatton Garden, London, E.C.1.

**OUR ADVICE BUREAU COUPON**  
This coupon is available until May 31st, 1939, and must be attached to all letters containing queries, together with 3 pennystamps. A stamped addressed envelope must also be enclosed.  
PRACTICAL MECHANICS, MAY, 1939.

## TOOLS—Continued

MYFORD LATHE SPECIALISTS. Cash or no deposit terms from 10/- monthly. Immediate deliveries anywhere.—Nuttalls, 20 Albert Street, Mansfield.

SPECIAL OFFER, brand new Precision Chucks, low prices. Backplates rough or fitted.—P. Blood Wolsley Bridge, Stafford.

## WANTED

SET BACK NUMBERS "PRACTICAL MECHANICS." State price, plus carriage.—Box No. 132, c/o PRACTICAL MECHANICS.

WANTED. Flying Flea partly constructed, also blue prints or drawings. State terms.—Kirk, Townfoot, Drymen, Glasgow.

## WATCHMAKING

WATCH & CLOCK REPAIRERS. Send 3d. for complete list of material and tools.—Blakiston & Co., Ainsdale, Southport.

## WIRELESS

AMERICAN WIRELESS VALVES, 5s. each. State type.—Walton, Ainsworth Road, Radcliffe, Manchester.

CRYSTAL SET KITS, complete, 3/11, post free.—W. J. Buckle, 63 Avenue Approach, Bury St. Edmunds.

## WOODWORK

CABINET HARDWOODS, Oak, Mahogany, Ash, Whitewood, Plywoods. Lowest Prices. Send Cutting Lists.—Wilfred Parr & Co., March Works, Lancaster Road, Leytonstone, E.11.

## PATENTS

REGINALD W. BARKER & CO. (Established 1886), 56 Ludgate Hill, London, E.C.4.—Patent and Trade Mark Booklets Gratis.

## PATENTS AND INVENTIONS

AMERICA. Sell your patents through "INVENTION," leading U.S.A. monthly. Specimen copy 2/8, annually 25/- from British Agents, INTERNATIONAL ENGINEERING CONCESSIONAIRES, LTD, 3 Duke Street, St. James's, S.W.1.

HAVE YOU a sound, practical invention for sale, patented or unpatented? If so, write Chartered Institute of American Inventors, Dept. 16-C, Washington, D.C., U.S.A.

## PHOTOGRAPHY

PHOTOGRAPHIC MATERIALS. Plates, Films, Mounts, Chemicals, etc. Interesting money-saving lists and samples free.—"Kimber's," 105 Queens Road, Brighton.

£500 worth, good, cheap Photo Materials, Films Plates, Cards, Papers, Chemicals, Catalogue and 4 Samples free.—Hackett's Works, July Road, Liverpool 6.

DON'T TAKE RISKS. Good developers mean good results. Our reliable stock developers keep twelve months after mixing. Satisfaction certain to amateurs and professionals. Best developers ever put on the market. Make two pints strong developer. 6d. each, 6 for 2/3, 12 for 4/-. Post free.—Hackett's Works, July Road, Liverpool 6.

## SITUATIONS VACANT

G.P.O. ENGINEERING DEPT. (no experience required). Commencing £3/13/0 per week. Age 18-23. Excellent prospects. Free details of Entrance Exam from B.I.E.T. (Dept. 570), 17-19 Stratford Place London, W.1.

DRAUGHTSMEN. Numerous vacancies available in Electrical, Mechanical, Aeronautical and other Branches of Engineering, Building, G.P.O., etc., for men age 17-40. Exp. unnecessary if willing to learn. Details of openings, salaries, prospects, etc. FREE from N.I.E. (Dept. 372), Staple Inn Buildings, W.C.1.

**It's Startlingly Different!**

AT last Man has a magazine to himself—PEARSON'S MAGAZINE, which in an attractive new form presents everything that Man is thinking and talking about . . . Personalities in which he is interested, stories that do not pander to sentiment, candid opinions on current events, virile humour and entertaining features and striking photographic sections. . . . A magazine, in fact, that reflects in every way the masculine point of view. It is out TO-DAY!



Contents that prove that PEARSON'S is YOUR Magazine.

**HOW OTHER PEOPLE LIVE**

A Series that takes you all over the world. First you go to America and see in amazing photographs Man's methods of eating and travelling, his law and order, and the odd people with whom he daily brushes shoulders.

**WARRIORS IN WIGS**

Man's point of view on a man's job. Read of the criminal cases that established the name of Sir Patrick Hastings, K.C.

**MAN'S POINT OF VIEW IN PICTURES**

See a man fighting bulls with bare hands. See how your garden seeds are tested. Watch what happens in an African village full of dusky maidens when an airman makes a forced landing.

**EIGHT SHORT STORIES IN WHICH MEN PLAY THE LEADING ROLES**

**MAN'S HUMOUR**

By Hynes, Frank Ford, Edgar Norfield, Peter Probyn, and other artists men appreciate.

No wonder it's going round that PEARSON'S MAGAZINE is startlingly different.

**PEARSON'S MAGAZINE**

May number now on sale at all Newsagents and Bookstalls **1/-**

C. Arthur Pearson, Ltd.

**"One Week from To-night You'll See PROOF that I can make You a New Man!"**

*—Charles Atlas*

Holder of the Title: "The World's Most Perfectly Developed Man."

I GIVE MORE than "promises." I give PROOF! If you're sick and tired of half-baked ideas—if you really want a build like mine—then one week, just 7 days, is all that I need to prove I can give it to you!

You've got a body, man. Why not make it a real handsome man's body? There's NO good reason why you shouldn't have rippling cords of mighty muscle across your neck and shoulders. No reason at all why your chest shouldn't be strapping, big and husky like mine—your arms and legs powerful—your wind lasting—your vigour and pep 100 per cent.

I used to be a sickly scarecrow weighing only 7 stones—a laughing-stock wherever I went. No fun. No friends. Right then I almost "fell" for some of those freak contraptions to make me "strong." But THEN—by the luckiest break of my life—I discovered Dynamic Tension.

**I've No Use For Apparatus**

Look at me now. You don't see any flabby, no-account bag of bones here, do you? This is what my remarkable secret has done for my body. Twice—against all corners—I have won the title "The World's Most Perfectly Developed Man." No wonder I've got no use for tricky apparatus that may strain your heart or other vital organs. I've found the natural way to build the husky, solid, fighting muscles that Nature means you to have. And I've shown thousands of other fellows, many of them probably much worse off than you, how to develop themselves into champions my way.

I'll give you clean-cut health inside, too, show you exactly how to get rid of constipation, poor digestion, bad breath, pimples, and other weaknesses that are robbing you of the good times and things of life that can be yours.

Now make me PROVE I can do it. Let me send you the FREE book that opens the door to he-man living. Just tell me where to send it. Use the coupon. There's no obligation. But—be MAN enough to send the coupon NOW!

**48-Page Book FREE**

My big book, "Everlasting Health and Strength"—packed with actual photographs and vital facts every fellow must know to face life—tells the whole remarkable story of Dynamic Tension. Privately printed for me, it's FREE if you act AT ONCE.

Are you ready to learn my secret—ready to learn how I can give YOU the kind of body that will make you a masterful leader? Then tell me where to send your copy of my book. Fill in the coupon and post to-day to me personally.

CHARLES ATLAS (Dept. 10/S), 2 Dean Street, London, W.1.

**CHARLES ATLAS** (Dept. 10/S), 2, Dean Street, London, W.1.

I want the proof that your system of Dynamic Tension will make a New Man of me. Send me your book, "Everlasting Health and Strength," FREE and details of your amazing 7-DAY TRIAL OFFER.

NAME.....  
(Please write or print plainly)

ADDRESS.....



**NOTE:**  
No other man in the World has ever DARED make such an offer!



# GAMAGES

Send for copies of Gamages' Tool Bargain Leaflets for Metalworkers and Woodworkers

## ELECTRIC MOTOR-DRIVEN JIGSAW

**Big, Powerful and Speedy**



Will cut up to 3/4 inch plywood and to the centre of a 24 inches circle. Cutting table 8 inches square. Combined belt pulley and 8 inches diameter sanding disc. Overall length 18 inches. Height to top of frame, 12 1/2 inches. Maximum width, 8 inches. Powerful Universal motor. For A.C. or D.C. mains. 200/250 volts. Carriage 1/6. England or Wales.

**57/6**

## DELCO-REMY ELECTRIC MOTORS

at a Substantial Reduction

As is well known, Delco-Remy Electric Motors are of extremely robust construction. Designed for heavy continuous use, they are equally satisfactory for repeated intermittent work such as in refrigeration. No special switch is needed for starting, and the motor can be operated by means of an ordinary tumbler electric light switch. All brand new. 1/5 h.p. A.C. Capacitor start. 200/250 volts. 50 cycles. Originally listed at 74/-. Carriage 1/6. England or Wales.

**55/4**

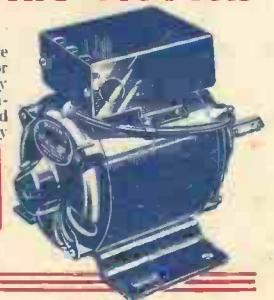

## 5,000 VOLT TRANSFORMERS

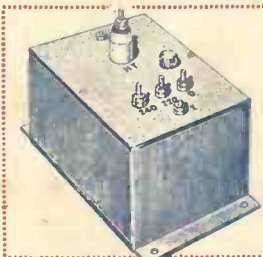

Work off ordinary A.C. mains (200/250 volts). Consumption only 10 watts. Ideal for experiments, and suitable for a wide variety of purposes including Ozone or Neon work, vermin traps, etc. Carriage 1/6. England and Wales.

**19/6**



## The GAMAGE 3 in. BACK GEARED, SCREW CUTTING, SLIDING, MILLING and SURFACING LATHE

Headstock and Bed are of ample proportions; with large-diameter mandrel in long adjustable bearings. Quick Traverse Handle for Saddle Return. Saddle has machine-cut slots. All gears are machine-cut. Dimensions: Swing in gap, 8 in.; Swing over saddle 3 1/2 in.; Mandrel nose 1/2 in. Whitworth; Mandrel and tailstock barrel bored 1/2 in. clear; Centres, standard No. 1 Morse taper; Lead-screw, 1/2 in. diameter by 8 T.P.1; Cone Pulley, 3 1/2 in., 3 1/2 in., 2 1/2 in. by 1/2 in. width; Back-gear ratio, 6 to 1; Approximate weight 60 lb. With compound Slide Rest and Back Gear, 20 in. between Centres, including 6 in. Face Plate, 2 1/2 in. Driver Plate, Machined Chuck Plate, 10 Change Wheels and Double Clasp Nut.

**£6.7.6**

OR DELIVERED ON FIRST OF 12 MONTHLY PAYMENTS OF **11/6**

Also with single clasp nut £5/19/6, or 12 Monthly Payments of 10/9. Carriage Outside Our Extensive Delivery Area, England or Wales, 3/6.



## WATERPROOF TOOLBAGS

An exceptionally well made bag. Very strong and absolutely oil and waterproof. Unbeatable value. Size: 14 in. long.

16 in., 6/-; 18 in., 6/6. All bags are 8 in. high and 6 in. deep. Post 6d. on each.

**5/6**

## SUPER-CHROME RATCHET SOCKET SPANNER SET

A first class set comprising 14 ins. brace, 9 in. sweep, 10 1/2 ins., heavy ratchet, 12 ins. sliding tee bar, 10 ins. extension piece and eight sockets. Sizes: 3/8, 1/2, 5/8, 3/4, 7/8, 1, 1 1/8, 1 1/4, 1 1/2, 1 3/4, 2, 2 1/4, 2 1/2, 3, 3 1/2, 4, 4 1/2, 5, 5 1/2, 6, 7, 8, 9, 10, 11, 12, 13, 14, 15, 16, 17, 18, 19, 20, 21, 22, 23, 24, 25, 26, 27, 28, 29, 30, 31, 32, 33, 34, 35, 36, 37, 38, 39, 40, 41, 42, 43, 44, 45, 46, 47, 48, 49, 50, 51, 52, 53, 54, 55, 56, 57, 58, 59, 60, 61, 62, 63, 64, 65, 66, 67, 68, 69, 70, 71, 72, 73, 74, 75, 76, 77, 78, 79, 80, 81, 82, 83, 84, 85, 86, 87, 88, 89, 90, 91, 92, 93, 94, 95, 96, 97, 98, 99, 100.

**37/6**

Carriage 1/- England or Wales. Also available in 1/2, 3/4, 1, 1 1/2, 2, 3, 4, 5, 6, 7, 8, 9, 10, 11, 12, 13, 14, 15, 16, 17, 18, 19, 20, 21, 22, 23, 24, 25, 26, 27, 28, 29, 30, 31, 32, 33, 34, 35, 36, 37, 38, 39, 40, 41, 42, 43, 44, 45, 46, 47, 48, 49, 50, 51, 52, 53, 54, 55, 56, 57, 58, 59, 60, 61, 62, 63, 64, 65, 66, 67, 68, 69, 70, 71, 72, 73, 74, 75, 76, 77, 78, 79, 80, 81, 82, 83, 84, 85, 86, 87, 88, 89, 90, 91, 92, 93, 94, 95, 96, 97, 98, 99, 100. S.A.E. at same price.

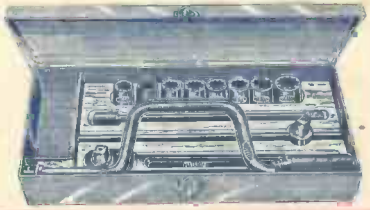

## BENCH GRINDERS



Hand driven, fitted 4 by 1/2 in. wheel, and with tool rest. Strongly made throughout, will give years of service. Splendid value. Post 7d. **3/6**

## ELECTRIC BURGLAR ALARMS

Really ingenious. Fits to the top of any door and rings a powerful electric bell immediately door is opened, and continues until door is closed. Easily put in or out of action by pulling cord at side. Takes ordinary 4 1/2 volt refile battery. Post 6d. **5/-**



## CHEST OF 61 SHEFFIELD MADE TOOLS for only **7/3** DOWN



Contains an extremely comprehensive range of fine quality tools—suitable for the construction of furniture, and, of course, all home joinery jobs. Chest stained and polished Walnut colour. Size: 27 in. by 11 in. by 7 1/2 in. Fitted with fixed compartments for small articles, and movable tray with 24 spring clips to hold chisels, bits, etc. Contents: 1 Skew-back Handsaw, 22 in.; 1 Tenon Saw, 12 in.; 1 Set 3 Blade Compass Saws; 1 Pad Saw and Handle; 1 Smoothing Plane, 2 in. double iron; 1 Joiner's Hammer, No. 2; 1 Claw Hammer, No. 1; Joiner's Mallet, 5 in.; 1 All-Steel Hatchet, No. 1; 1 Casé Oilstone, 8 in.; 1 Joiner's Square, 6 in.; 1 Sliding Bevel; 1 Spirit Level, 6 in.; 1 Spoke-shave, 2 1/2 in.; 1 Marking Gauge; 1 Cabinet Turn-screw, each 4 in., 6 in.; 1 pair Pincers, 6 in.; 1 Handled Chisel, each 1/2 in., 3/4 in., 1 in., 1 1/4 in.; 1 Handled Gouge, 1/2 in.; 1 Joiner's Plain Brace, 9 in.; 1 Centre Bit, each 1/2 in., 3/4 in., 1 in.; 1 Special Auger Bit, each 1/2 in., 3/4 in., 1 in.; 1 Mitre Block, 9 in.; 2 Gimlets; 2 Bradwails; 1 Glue Pot; 1 Cold Chisel, 6 in. by 1/2 in.; 1 Tack Hammer; 1 6 in. Half-round File and Handle; 1 4 in. Saw File and Handle; 1 Centre Punch; 1 Nail Punch; 1 Packet of 12 Sheffield Twist Drills; 1 Pencil.

PRICE CASH **79/6**

DELIVERED ON FIRST OF 12 MONTHLY PAYMENTS OF **7/3**

Carriage Outside Our Extensive Delivery Area 3/-, England or Wales.

GAMAGES, HOLBORN, LONDON, E.C.1

Telephone: HOLBORN 8481.

City Branch, 107 Cheapside E.C.2

Published about the 30th of each month by GEORGE NEWNES, LIMITED, Tower House, Southampton Street, Strand, London, W.C.2, and Printed in England by THE SUN ENGRAVING CO., LTD., London and Watford. Sole Agents for Australia and New Zealand—Gordon & Gotch, Ltd. Sole Agents for South Africa—Central News Agency, Ltd. Subscription Rates: Inland and Abroad, 7s. 6d. per annum; Canada, 7s. per annum. Registered at the G.P.O. for transmission by Canadian Magazine Post.