

**AUTOMATIC TRAFFIC SIGNALS** - *How they work*

**NEWNES**

# **PRACTICAL MECHANICS**

**JANUARY 1939**

**6<sup>D</sup>**





LET ME HELP  
YOU  
 INTO A KEY  
 POSITION

**DO ANY OF THESE SUBJECTS INTEREST YOU?**

Accountancy Examinations  
 Advertising and Sales Management  
 A. M. I. Fire E. Examination  
 Applied Mechanics  
 Army Certificates  
 Auctioneers and Estate Agents  
 Aviation Engineering  
 Banking  
 Boilers  
 Book-keeping, Accountancy and  
 Modern Business Methods  
 B.Sc. (Eng.)  
 B.Sc. (Estate Management)  
 Building, Architecture, and Clerk of  
 Works  
 Builders' Quantities  
 Cambridge Senior School Certificate  
 Civil Engineering  
 Civil Service  
 All Commercial Subjects  
 Commercial Art  
 Concrete and Structural Engineering

Draughtsmanship. All branches  
 Engineering. All branches, subjects  
 and examinations  
 General Education  
 G.P.O. Eng. Dept.  
 Heating and Ventilating  
 Industrial Chemistry  
 Insurance  
 Journalism  
 Mathematics  
 Matriculation  
 Metallurgy  
 Mining. All subjects  
 Mining, Electrical Engineering  
 Motor Trade  
 Municipal and County Engineer  
 Naval Architecture  
 Novel Writing  
 Pattern Making  
 Play Writing  
 Police, Special Course

Preceptors, College of  
 Press Tool Work  
 Pumps and Pumping Machinery  
 Radio Communication  
 Radio Service Engineering  
 Road Making and Maintenance  
 Salesmanship, I.S.M.A.  
 Sanitation  
 Secretarial Exams.  
 Sheet Metal Work  
 Shipbuilding  
 Shorthand (Pitman's)  
 Short Story Writing  
 Structural Engineering  
 Surveying  
 Teachers of Handicrafts  
 Telephony and Telegraphy  
 Transport Inst. Exams.  
 Weights and Measures Inspector  
 Welding  
 Wireless Telegraphy and Telegraphy  
 Works Managers

If you do not see your own requirements above, write to us on any subject. Full particulars free.

**STUDY AT HOME IN  
 YOUR SPARE TIME**

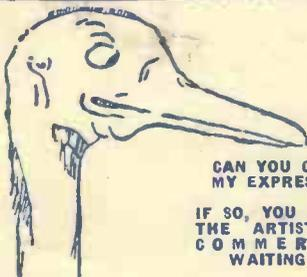

**CAN YOU CHANGE  
 MY EXPRESSION ?  
 IF SO, YOU MAY BE  
 THE ARTIST THAT  
 COMMERCE IS  
 WAITING FOR**

*Jim Duck* Just try it for yourself. Trace or draw the outline and then put in the features.

There are hundreds of openings in connection with Humorous Papers, Advertisement Drawing, Posters, Calendars, Catalogues, Textile Designs, Book Illustrations, etc.

60 per cent. of Commercial Art Work is done by "Free Lance Artists" who do their work at home and sell it to the highest bidders. Many Commercial Artists draw "retaining fees" from various sources, others prefer to work full-time employment or partnership arrangement. We teach you not only how to draw what is wanted, but how to make buyers want what you draw. Many of our students who originally took up Commercial Art as a hobby have since turned it into a full-time paying profession with studio and staff of assistant artists; there is no limit to the possibilities. Let us send full particulars for a FREE TRIAL and details of our course for your inspection. You will be under no obligation whatever.

*Jim Duck* ART DEPT. 76.

**YOU CANNOT MAKE MONEY  
 BY SAVING**

If you save 10s. per week for 10 years you have only got £260, but if you spend 2s. 6d. per week for 12 or 18 months on a correspondence course, you give your brains a chance to earn thousands of pounds; then there is no need to save.

Savings are likely to vanish, but earning capacity is a permanent investment.

**I HAVE HELPED THOUSANDS  
 OF OTHERS**

And when I say thousands, I do not exaggerate, as I can produce well over 10,000 unsolicited testimonials from grateful students who, through our Postal Training, have achieved their life's ambition.

*J. Bennett*



Dept. 76, THE BENNETT COLLEGE, SHEFFIELD

**EVERY DEPARTMENT IS A  
 COMPLETE COLLEGE: EVERY  
 STUDENT IS A CLASS TO  
 HIMSELF**

**JOURNALISM  
 Short Story, Novel and Play  
 Writing**

There is money and pleasure in Journalism and in Story Writing. No apprenticeship, no pupillage, no examinations, no outfit necessary. Writing for newspapers, novels or pictures is not a gift; it is a science that can be acquired by diligent application and proper guidance. It is the most fascinating way of making pastime profitable. Trained ability only is required; we do the training by post. Let us tell you all about it. DEPARTMENT OF LITERATURE 76

If you attend to this now, it may make a wonderful difference to your future.

**COUPON—**

CUT THIS OUT



To Dept. 76, THE BENNETT COLLEGE LTD, SHEFFIELD Please send me (free of charge)

Particulars of.....  
 Your private advice about  
 (Cross out line which does not apply)

.....  
 .....

PLEASE WRITE IN BLOCK LETTERS

Name.....

Address.....

.....  
 .....

PRO PAT.

## MAKE IT WITH UNIT 'X'

in Wood or Metal

URNS, DRILLS, MOULDS & GROOVES, SURFACE GRINDS, SANDS, JIGSAWS, RIVETS, CIRCULAR SAWS, POLISHES, MILLS, PUNCHES, SPINS, DOVETAILES, GRINDS TOOLS.



**95/-**

COMPLETE or 15/- cash and nine payments of 10/-

Equipment includes: Circular Saw, Grinding Stone, Buff, Jigsaw and Blades, Sanding Drum, One Tilting Table, 3 in. Chuck, Punch, Tool Post and Cutting Tool, Spanner, Oil-Can.

THERE IS NO LIMIT TO THE NUMBER OF OPERATIONS POSSIBLE ON THIS MARVELLOUS MACHINE. ACCURATE WORK TO FINE LIMITS. IN WOOD OR METAL.

TRIANGLE PRODUCTS LTD., BLAKE STREET, MANCHESTER, 15

## FOR ACCURATE WORK AND PERFECT FINISH A "MILNES" LATHE is Essential

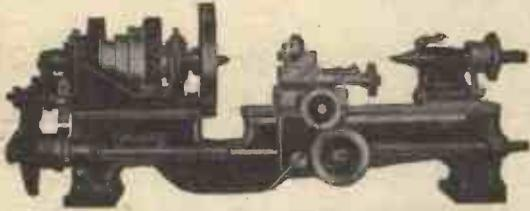

7 in. diameter Centre Lathe

SELF-CONTAINED ELECTRIC OR COUNTERSHAFT DRIVE Robust construction in every detail with easy means of adjustment ensure a lifetime's efficient service from "MILNES" MACHINES

Send for full lists to: HENRY MILNES, LIMITED, INGLEBY LATHE WORKS, BRADFORD, YORKSHIRE, ENGLAND.

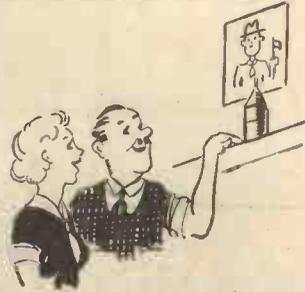

"Since I bought my new house," remarked Baird, "It's a long time since I've repaired, Still I'm keeping FLUXITE Always well in my sight, Like a good stout, I'm being prepared!"

See that FLUXITE is always by you — in the house — garage — workshop — wherever speedy soldering is needed. Used for 30 years in government works and by leading engineers and manufacturers. Of Ironmongers—in tins,

4d., 8d., 1/4 and 2/8. Ask to see the FLUXITE SMALL-SPACE SOLDERING SET—compact but substantial—complete with full instructions, 7/6.

Write for Free Book on the ART OF "SOFT" SOLDERING and ask for Leaflet on CASE-HARDENING STEEL and TEMPERING TOOLS with FLUXITE.

TO CYCLISTS! Your wheels will NOT keep round and true unless the spokes are tied with fine wire at the crossings and SOLDERED. This makes a much stronger wheel. It's simple—with FLUXITE—but IMPORTANT.

## THE FLUXITE GUN

is always ready to put Fluxite on the soldering job instantly. A little pressure places the right quantity on the right spot and one charging lasts for ages. Price 1/6.



ALL MECHANICS WILL HAVE

# FLUXITE

IT SIMPLIFIES ALL SOLDERING

FLUXITE Ltd., Dept. P.M., Dragon Works, Bermondsey St., S.E.1

## SKYBIRDS

World-Famous Aeronautical Models FIRST and BEST SOLID NON-FLYING 1/72nd scale model Aircraft Construction with every accessory to make the complete Hobby.

THE WORLD'S 3 FASTEST FIGHTERS

"Hurricane" "Spitfire" and "Curtiss" Constructive Sets, price 2/6 each



Photograph of Bristol "Blenheim" built from Skybird Kit, price 6/6

LATEST ADDITIONS:

The BLACKBURN "SKUA" Constructive Set 4/6

The GLOSTER "GLADIATOR" Constructive Set 3/-

If you are interested write for Skybirds free list:—

"SKYBIRDS" (Desk P.M.) 3, Aldermanbury Avenue, London, E.C.2

# Free!

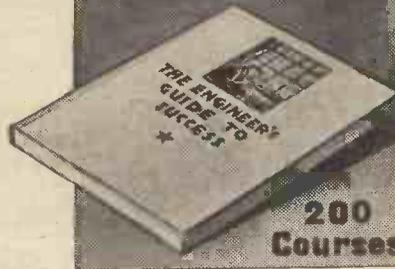

200 Courses

## ENGINEER'S Guide to Success

This Great Guide shows how to study at home with The T.I.G.B. for a well-paid post. Contains the widest choice of engineering courses in the world—over 200—including MECHANICAL, CIVIL, ELECTRICAL, AUTOMOBILE, AERONAUTICAL, RADIO, TELEVISION, CHEMICAL, etc.—alone gives the Regulations for Qualifications such as A.M.I.Mech.E., A.M.Inst.C.E., A.M.I.E.E., C. & G., G.P.O., etc.—contains remarkable tributes from Engineering Institutions and eminent technical men to the successful tuition methods of The T.I.G.B.—and details latest successes of T.I.G.B. students in all fields. Training until successful guaranteed for the one fee. Write for Free copy TO-DAY.

THE TECHNOLOGICAL INSTITUTE OF GREAT BRITAIN,

218 Temple Bar House, London, E.C.4 Founded 1917. 20,000 Successes.

'CASCO' for permanent glue jointing

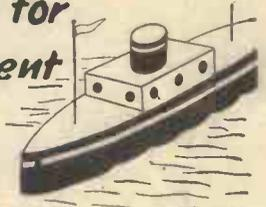

Use 'CASCO' for making model boats, trains, toys, etc.



'CASCO' is a new type of glue that sets by chemical action like cement. Being waterproof and heatproof, it will withstand any amount of rough usage.

'CASCO' is simple to use—only requires mixing in cold water. Obtainable from ironmongers, woodworkers' supply stores, oil and paint shops, in handy tins from 6d.

# 'CASCO'

COLD WATER GLUE

FREE Send coupon (1d. stamp unsealed) to Dept. P.M.3, LEICESTER LOVELL & Co., Ltd., 14-18, Nile Street, London, N.1, for generous sample of 'CASCO' and copy of 24 page 'CASCO' Gluing Guide.

Name .....

Street .....

Town.....

# AMBITIOUS ENGINEERS

## THIS IMPORTANT HANDBOOK ON SUCCESSFUL ENGINEERING CAREERS

# FREE ON REQUEST



After months of intensive effort and research, we are pleased to announce that the New edition of our Handbook, "ENGINEERING OPPORTUNITIES," is now out of the publishers' hands and ready for *free distribution*. Containing 268 pages of practical guidance, this book is, beyond argument, the finest and most complete handbook on Successful Engineering Careers ever compiled. It is a book that should be on the bookshelf of every person interested in engineering, whatever his age, position or experience.

The Handbook contains, among other intensely interesting matter, details of B.Sc., A.M.I.C.E., A.M.I.Mech.E., A.M.I.E.E., A.M.I.A.E., A.M.I.W.T., A.M.I.R.E., CIVIL SERVICE, and other important Engineering Examinations: outlines courses in all branches of CIVIL, MECHANICAL, ELECTRICAL, AUTOMOBILE, RADIO, TELEVISION and AERONAUTICAL ENGINEERING, BUILDING, GOVERNMENT EMPLOYMENT, etc., and explains the unique advantages of our Employment Department.

WE DEFINITELY GUARANTEE  
**"NO PASS-NO FEE"**



If you are earning less than £10 per week you cannot *afford* to miss reading "ENGINEERING OPPORTUNITIES." In your own interests, we advise you to **write** (or forward the coupon) for your copy of this enlightening guide to well-paid posts—NOW. *There is no cost or obligation of any kind.*

## BRITISH INSTITUTE OF ENGINEERING TECHNOLOGY

410a, SHAKESPEARE HOUSE,  
17, 18 & 19, STRATFORD PLACE, LONDON, W.1

-----TEAR OFF HERE-----  
**FREE COUPON**

BRITISH INSTITUTE OF  
ENGINEERING TECHNOLOGY,

410a, Shakespeare House,  
17-19, Stratford Place, W.1.

Please forward, **Free of cost or obligation of any kind,**  
your 268-page Handbook "ENGINEERING OPPORTUNITIES"

NAME .....

ADDRESS.....

.....

.....

## SUBSCRIPTION RATES

Inland and Abroad 7s. 6d. per annum  
Canada - - 7s. per annum

Editorial and Advertisement Offices: "Practical  
Mechanics," George Newnes Ltd.,  
Tower House, Southampton Street, Strand, W.C.2.

Phone: Temple Bar 4363.  
Telegrams: Newnes, Rand, London.

Registered at the G.P.O. for transmission by  
Canadian Magazine Post.

Copyright in all drawings, photographs, and  
articles published in "Practical Mechanics"  
is specifically reserved throughout the  
countries signatory to the Berne Convention  
and the U.S.A. Reproductions or imitations  
of any of these are therefore expressly  
forbidden.

# PRACTICAL MECHANICS

Editor: F. J. CANN

VOL. VI. JANUARY, 1939. No. 64

## What is a Master Clock?

**M**ANY hundreds of readers have built the Master Battery Clock (correctly so described), the blueprint for which we gave in our October issue. Many readers also installed the slave clock system which works in conjunction with it, and they all report that once the master clock has been accurately adjusted, the slaves (as, of course, they must do) keep accurate time with the master. Whatever time the master clock keeps the slaves must follow.

This is a fact which should be obvious even to those without the slightest knowledge of electricity, and I was most surprised, therefore, to receive a letter from a Birmingham reader, who stated, as if the matter was not open to contradiction, that the slave clocks can only keep time with each other, but not with the master clocks. He supported this argument, if such it can be called (and quite obviously without having built the clock, otherwise he would not have written), by stating that the applied electro-motive force and the construction of the master clock is such that an impulse is given to the pendulum at exactly minute intervals, and he wonders what will happen when the battery loses some of its E. M. F. In the course of a somewhat lengthy letter, in which he recounts what appears to be a distorted version of the elementary principles of free-swinging pendulums, he states that if the slave clocks are wired in series the winding of the coils should be heavier in order to take a less voltage than they would otherwise do. Having satisfied himself that his arguments are right he thinks that some readjustment of our instructions are necessary.

I shall, of course, do nothing of the sort, for our instructions are correct. The period of swing of a pendulum is dependent on its length, and although an impulse may be given at every swing this period will not differ from the case where an impulse is only given every two minutes. With regard to the slave clocks it does not matter whether these

## Fair Comment By The Editor

receive .5 amps or 5 amps, as the only requirement is the energising of the magnets. A master clock is a master clock no matter whether or not the slaves are attached to it. I welcome criticism, but such should not be couched in a didactic tone which presumes that the writer knows everything of the subject and that everyone else must necessarily be wrong. It is an old adage which says that if you have no knowledge of a subject it is wise not to rush in and exhibit the fact.

### Binding "Practical Mechanics"

**W**E receive, at the end of each volume, a number of letters from readers asking where they may have their copies bound in the binding cases which we supply for 3s. 6d., which price includes also the title page and index. Readers should send the binding case and index to A. W. Bain & Co., Ltd., 17/19, Bishop's Way, Cambridge Heath, London, E.2. They charge 5s. 3d. for binding the issues. Whether you have your copies bound or not, however, I recommend every reader to obtain one of the indexes (7½d. each) so that they can survey the contents of past issues without having to go through each one.

### "It's A Small World"

**T**HE articles under the above heading which are now appearing in "Practical Mechanics" deal with those ultra-small models, and particularly working models, which are made by enthusiasts interested in railways, ships, aeroplanes, and other mechanisms. In one issue we illustrated a miniature ship, and one of my readers, Mr. Phillip-Scott Martin, reminds me that he has made a small steam tug 9½ ins. long, equipped with a small working

engine of only ¼ in. bore and stroke. I made the particular engine for this boat which was exhibited at one of the Model Exhibitions and awarded a certificate. I hope to reproduce a photograph of this fine miniature model in an early issue.

### Queries About Explosives

**M**ANY readers interested in chemistry address queries to us relating to explosives. Where we are permitted to give the information we issue at the same time a warning as to the danger of conducting such experiments. In many cases we are not permitted to give the information, under the Official Secrets Act, and in others, owing to the provision of the Explosives Act, it would be illegal for the readers to experiment. One reader has written to me complaining that we ought to give this information, and I hope this explanation will make it clear to him that whilst we are anxious to help every reader we cannot aid them to break the law, nor to embark on experiments likely to have dangerous results.

### Customs Difficulties

**S**OME of our readers resident in Ireland and abroad experience difficulty in purchasing materials for the various devices described in this journal. They therefore appeal to me to assist them, and send me the money to make the purchases for them. I should be very glad indeed to do so were it not for the fact that these readers seem to overlook the import duties necessary, and also the troublesome business of customs declaration. I have therefore been compelled to return the remittances and ask the readers to deal direct with the firms concerned.

### Two New Books

Every reader interested in practical engineering subjects, particularly if engaged in that industry, should obtain copies of our new handbooks, "Practical Mechanics Handbook" at 6s. (by post, 6s. 6d.), and "Workshop Calculations, Tables and Formulae", 3s. 6d. (by post, 3s. 10d.).

# AUTOMATIC TRAFFIC SIGNALS



*A Brief and Simple Explanation of The Method of Operation of Electro-matic Vehicle-Actuated Signals. Not Only Do Detectors Regulate the Operation of The Light Signals, But "Count" The Number of Vehicles and Act According to Their Speed.*

**D**URING the few years since traffic lights—originally described as robots—were first introduced their development has been as rapid as that of the motor car. The first automatic light signals were simply controlled by a rotary switch or its equivalent, which caused the lights facing in one direction to change from red to amber and green while those facing in the opposite direction changed from green to amber and red. The serious objection to traffic lights of that type was that their operation was inflexible; whether traffic was light or dense, whether or not there was any traffic on one of the "controlled" roads, the lights changed at the same rate. Manual adjustments could, of course, be made to vary the speed with which the sequence of coloured lights was varied, but traffic was often slowed down considerably by the robot-like periodic light changes.

## Traffic Lights With "Brains"

The light controls used now are vastly different in behaviour and operation despite their outward similarity. If the older type referred to deserved the name of "robot" the present type should be called "living robots," "robots that think," "robots with a memory," or something like that. They do far more than change lights to show which line of traffic may proceed, and which must be stopped. They are able to govern the speed of light changes according to the traffic density, traffic speed and the requirements of pedestrians. All these things they do automatically, although

there are a few manual controls by means of which the signals can be modified at any time to make them more suitable for general changes in traffic conditions.

Naturally, a multiplicity of electrical circuits is required to ensure absolutely fool-proof operation in all conditions, but each one of the circuits is comparatively simple, and each comprises so few moving parts that failure is practically impossible. To ensure their automatic operation there must, of course, be a device for detecting the presence of vehicles on the various intersecting roads. It is the detector or mat, which is sunk into the road surface, which is the starting point for these operations. Generally, the pad consists of nothing more than two spring-steel contact plates in a suitable casing covered on top with a thick strip of very tough rubber. A section through one of the widely-used EVA (Electro-matic Vehicle Actuated signal system, supplied by Automatic Telephone and Electric Co., Ltd.) is shown in Fig. 1.

## Charging a Condenser

But, you will ask, how can a simple make-and-break such as this produce such astounding results? That brings us to a semi-technical explanation, which centres round the action of a fixed condenser of similar type to those used in radio receivers. As many readers are aware, if you apply

an electric potential to the two terminals of a condenser the condenser is charged with electricity; this can easily be proved by removing the two electrical leads and connecting a meter or other electrically-operated device in their place. The condenser is discharged, causing the meter to give a reading, or the device to operate in the same manner as it would if two leads from a battery were momentarily connected to it.

It will also be remembered that if a resistor is connected in series with the condenser and a potential applied to the circuit, as shown in Fig. 2, the condenser will be charged more slowly. The speed of charging is reduced as the value of the resistor is increased. Referring again to Fig. 2, it will be seen that a neon lamp and a relay are connected in series across the condenser.

Now let us see what happens when a potential is applied to the resistor-condenser circuit. At first the potential across the condenser will be zero. But this will gradually increase as charging takes place. When the voltage reaches a value equal to the striking voltage of the neon (say about 260 volts) the condenser will discharge through the neon lamp and the electromagnetic relay. Thus the relay will be energised so that its magnet will attract an armature and close a pair of contacts.

## —HOW THEY WORK

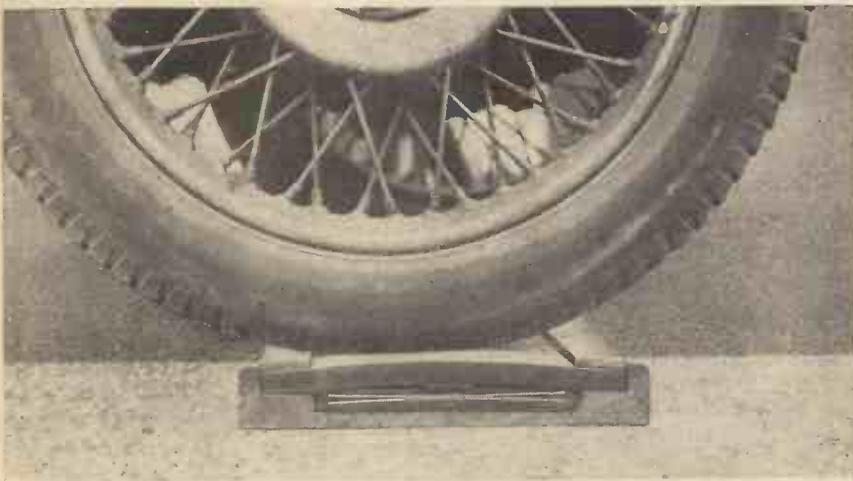

**A Neon Lamp and a Relay**

We must now go a step further. The contacts closed by the relay are in circuit with a supply voltage and the solenoid or electro-magnet shown in Fig. 3. Thus, closing of the contacts causes the solenoid to be energised. This, in turn, causes the armature plunger to be drawn into the solenoid winding by magnetic attraction. This pulls down the pivoted arm against

Fig. 1 (above).—Section through a road detector, showing the two spring-steel contact plates, which are pressed into contact.

the action of the spring, but does not operate the toothed wheel because of the provision of a ratchet device. As soon as the current supply is withdrawn from the solenoid (that is, as soon as the condenser in Fig. 2 has discharged) the spring pulls back the pivoted arm and the ratchet turns the toothed wheel.

It can be seen from Fig. 4 that the toothed wheel and solenoid are mounted at the end of a camshaft, the cams of which open and close a number of contact points; it is these which control the signal lamps themselves.

**Timing Circuits**

That is a brief outline of the principles of the condenser, so we can now see how some of the other secondary effects are produced. In what is shown as the A timing circuit there are two pairs of contacts, X and Y, these corresponding to the contacts in the detectors in the road. When contacts X are closed the neon-relay circuit is closed, so that the relay can operate as soon as the condenser is fully

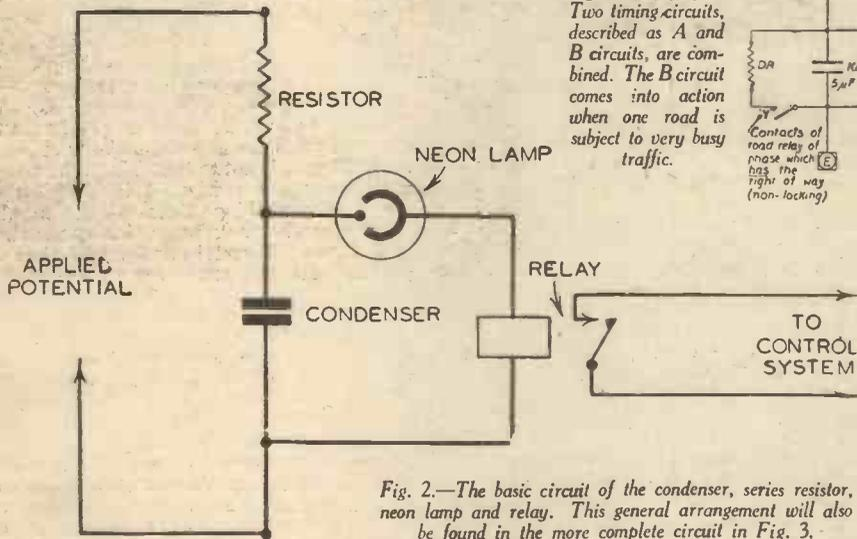

Fig. 2.—The basic circuit of the condenser, series resistor, neon lamp and relay. This general arrangement will also be found in the more complete circuit in Fig. 3.

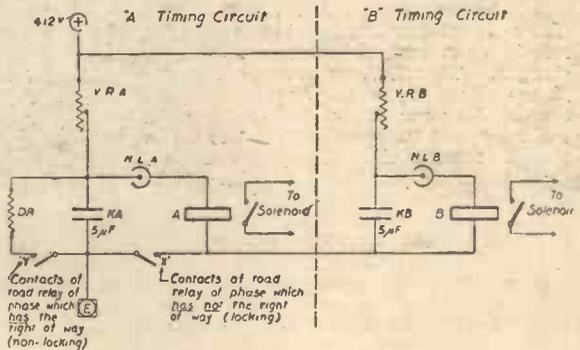

Fig. 3 (right).—Two timing circuits, described as A and B circuits, are combined. The B circuit comes into action when one road is subject to very busy traffic.

charged. When contacts Y are closed the condenser is discharged through the low-value shorting resistor marked D.R. As long as those contacts are closed the condenser cannot be charged because the feed potential (412 volts D.C. is used in practice) by-passes the condenser.

Suppose now that the contacts Y are controlled by the detector mats on the road which has right of way (green lights illuminated). As long as traffic continues along this road the contacts will be continually operated, the condenser kept discharged or in a low state of charge, and the solenoid prevented from operating. In consequence,

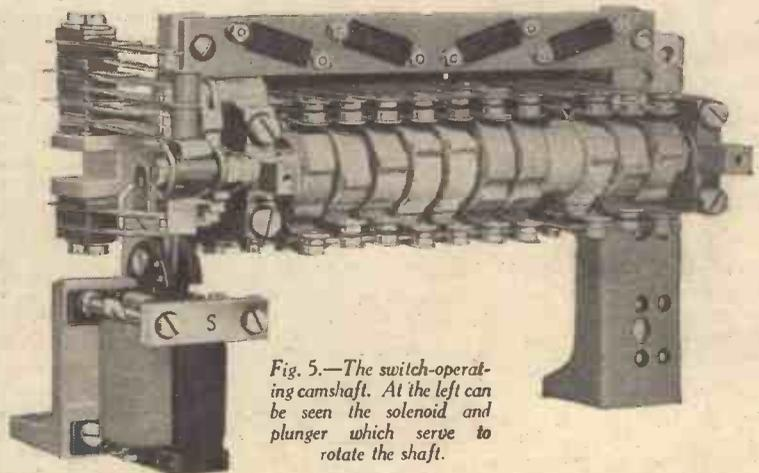
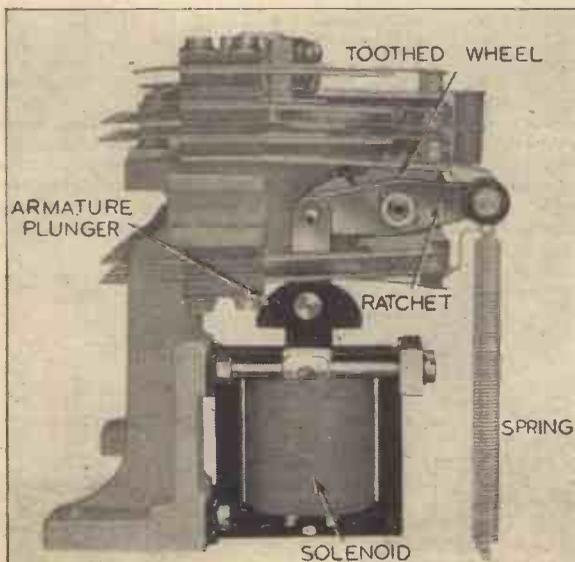

Fig. 5.—The switch-operating camshaft. At the left can be seen the solenoid and plunger which serve to rotate the shaft.

Fig. 4 (left).—This is the solenoid and plunger which work the ratchet at the end of the camshaft. This, as well as the complete camshaft assembly shown in Fig. 5, is from the EVA equipment.

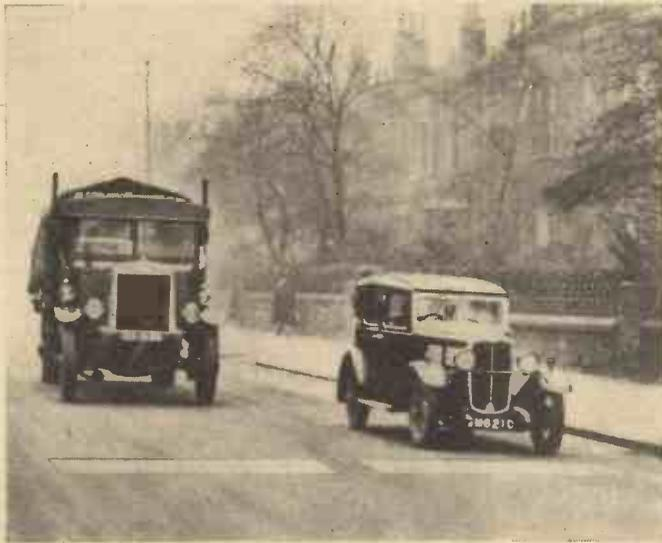
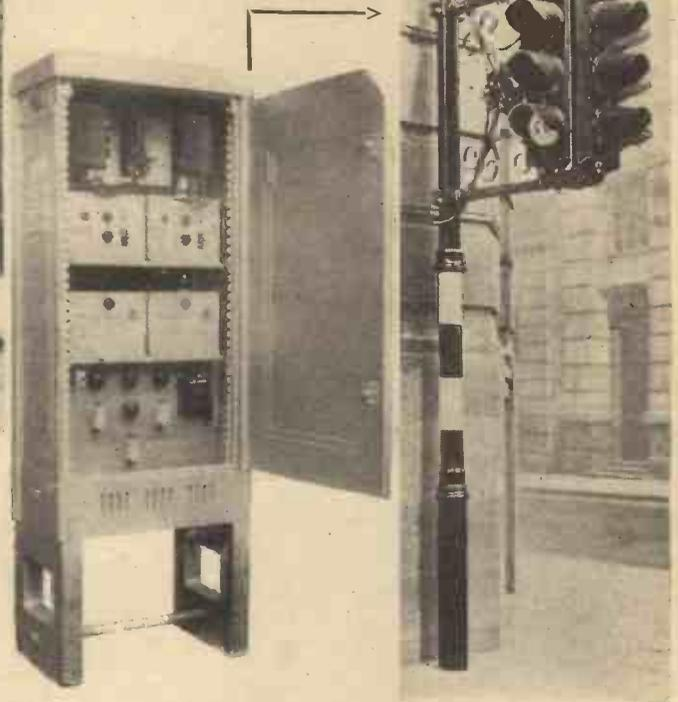

Fig. 6.—Sequence of events: car crosses detector; this is "noted" by the control; the lights are changed to green.



the lights will continue to give right of way to traffic on this road. But if the line of traffic is discontinued contacts Y will remain open and the condenser will be charged. Therefore, as soon as contacts X are closed by a car approaching the signals along one of the intersecting roads the relay will be operated and the lights changed to allow right of way on this road. By this means the lights are changed in accordance with traffic requirements.

If this were all, however, there might be times when it would be impossible to cross a busy main road, with the result that all traffic on roads intersecting it would be held up for an indefinite period. This brings us to the subsidiary resistor-condenser-neon-relay circuit described in Fig. 3 as the B timing circuit. The condenser marked KB in this circuit begins to charge as soon as contacts X are closed. As soon as KA or KB is charged to the flash-over potential of neon NLA or NLB the camshaft solenoid is energised and the lights are changed, thus breaking the main traffic stream and allowing traffic on the intersecting road to cross.

This action is repeated continuously, because the relay system is transferred from one phase, or one road, to the other by the operation of the cam-operated switches. One point which should be noted in Fig. 3 is that resistors VRA and VRB are variable manually. Thus, they can be set to give any speed of light-change that might be found desirable at any particular intersection. The lower the effective value of these resistors the more quickly do the lights change, and *vice versa*.

It would be utterly impossible in the space available to describe the many possible complete systems of circuits, but it is necessary to point out a few of the special and interesting features of the EVA system. Incidentally, it is the master timer unit shown in Fig. 6 which is often referred to as "Little Eva," and in which the many intricate change-over switching takes place.

**Automatic Speed Measurement**

One of these is the method by which the speed of traffic is measured. It is evident that, if traffic is not to be held up, the lights must change far more quickly when a car is approaching them at 40 m.p.h. than when a horse-drawn vehicle approaches at 5 m.p.h. A certain amount of time is required for the condenser to charge or discharge, and this can be varied by suitable choice of value for the series resistor. And a vehicle travelling at 5 m.p.h. keeps the contacts closed for 70 thousandths of a second, whilst one travelling at 25 m.p.h. closes them for only 14 thousandths of a second. With what might be described as an average setting of the controls a vehicle passing over the detector at 25 m.p.h. would reduce the condenser charge to 95 volts, and it can be seen from the charge-discharge-time graph in Fig. 7 that 3.7 secs. is required to charge the condenser from 95 volts to the neon striking voltage of about 260. There is therefore 3.7 secs. left before the striking voltage can be reached, and before the lights can be changed. When a vehicle travelling at 5 m.p.h. crosses the detector, the contacts being closed for 70 thousandths of a second, the condenser is almost completely discharged, so that fully 5 seconds will be required to re-charge the condenser.

(Continued on page 231)

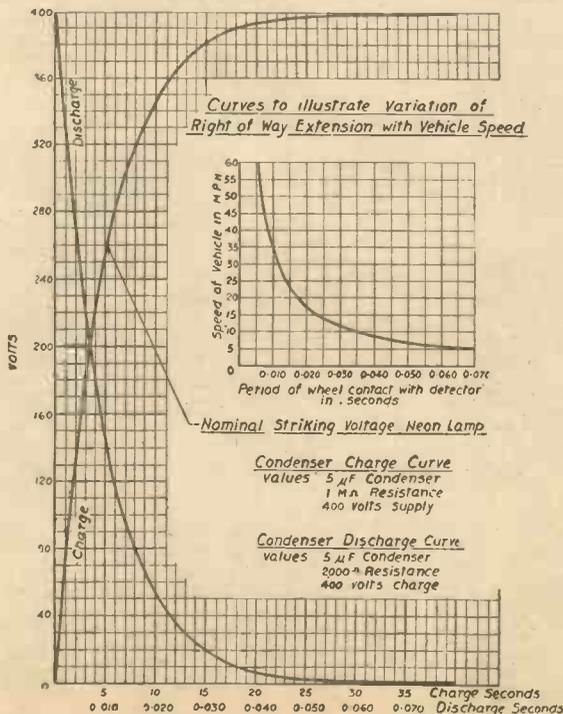

Fig. 7 (left).—This graph shows the time required to charge and discharge the control condenser with particular values of series resistors.

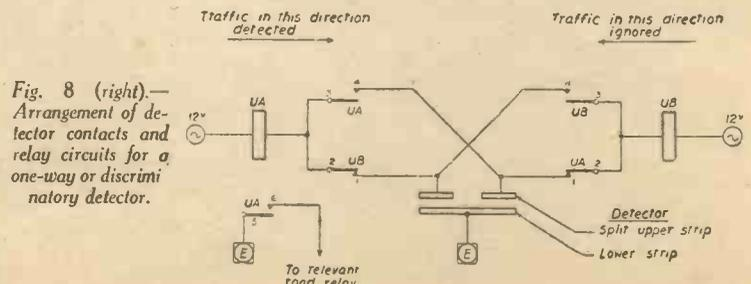

Fig. 8 (right).—Arrangement of detector contacts and relay circuits for a one-way or discriminatory detector.



# TRAVELLING IN TIME

## WILL IT EVER BE POSSIBLE?

**T**HE world around us embodies three well-known dimensions—length, breadth and thickness (or height). Mankind, almost from the very beginning of things, has been able, by one means or another, to travel over the earth's surface pretty freely in two dimensions, that is to say, in the dimensions of length and breadth, but is within only about the last hundred years or so that man has begun to master the art of journeying in the third dimension—the dimension of height.

The technique of mechanical flight by means of which man essays successfully, although, as yet, to a limited extent, to travel upwards from the earth's surface, is a relatively new one, capable, of course, of enormous development, but, nevertheless, severely restricted in extent.

*Illustrating that somewhere out in space a record of all past events in the form of light-waves or some other emanation persists.*

some means of travelling in Time, of journeying backwards and forwards into the Past and into the Future almost at the will of the individual Time-traveller.

Advocates of this entrancing possibility point out the undoubted fact that it took the human mind many thousands of years to master even the most elementary principles of travel in the third dimension, that is to say in height. Why, therefore, should it be doubted that at some future period the advancing ingenuity of the human brain will bring into being some at present unthought-of means of controlling, in some

Actually, of course, what happens is that all things travel continuously and uncontrollably along the Time dimension of their existence. We have, however, utterly no conception of *why* they should thus travel to their ultimate destiny. All we know is that they do journey on imperturbably in this manner, and that, in some strange way, their Time-motion is closely associated with their relative position in Space.

The problem of travelling in Time can now be stated fairly clearly.

We are all travelling in Time at a constant and steady rate. What the would-be Time-travellers would really like to do, however, is to control for themselves their own motion along the Time dimension and to journey not only in the seemingly inevitable "forwards" direction, but, also, to proceed along the Time dimension in a "backwards" manner. In other words, to travel freely at will both into the future and into the past.

### Into the Past and Future

Man's mind being, in some manner, independent of the strict laws of Space and Matter, is able, in a limited degree, to travel backwards and forwards along the Time dimension. We can all revisit in what we term our "mind's eye" the scenes of our former activities, and there are many people, too, who believe themselves to be possessed of the ability, limited though it may be, of perceiving the events of the future.

Ordinarily, however, memory is the vehicle upon which we travel mentally backwards along the Time dimension, Imagination being usually the coach in which our minds sally forth into the Future.

Strictly speaking, of course, the above mental processes do not constitute actual Time travelling. The true Time-traveller would be an individual who, like his name-

## A Subject Of Absorbing Interest Discussed From A Practical Standpoint

In addition to the three linear dimensions of the material world, there is another one along which all objects and, indeed, all material things proceed. That dimension is Time—the common enemy, the common friend of all humans.

### The "Fourth" Dimension

Time, really, is as much an attribute or a property of a material object as is the visible length, breadth or thickness of the latter. The page, for instance, on which these words are printed has length and breadth, together with a certain degree of thickness. But, in addition to these, it has, also, Time, the "Fourth Dimension," for if it were devoid of Time, it could not occupy a position in our world of Space, a timeless object being impossible.

Since, therefore, Time is a sort of extra dimension possessed by all material things, it has, upon occasion, been suggested that, ultimately, the brain of man may conceive

degree, the present-day resistfulness and implacability of old Father Time.

### Significance of Time

We cannot pretend here to discuss the many theories which aim at explaining the nature of Time. None of them, however, is satisfactory. We know as little concerning the meaning and the inner significance of Time as we do of the essential and ultimate nature of Space, Time's great and inseparable companion. All we can say for certain is that you cannot have Space without Time and that, conversely, Time is, in some entirely mysterious manner, intimately connected with Space.

How often, indeed, do people refer to the "passage of Time"? Such a phrase is quite an erroneous one, for it infers that individuals or material objects stand stationary whilst Time itself flows past them as a sort of ever-running stream of some intangible entity.

sake in Mr. H. G. Wells' immortal romance of *The Time Machine*, sits on or in some contrivance and, by manipulating certain controls, betakes himself into the Past or into the Future as he so desires.

Mr. Wells' famous *Time Machine* was, the reader may recollect, a thing of glistening nickel and ivory, parts of which, also, were composed of the purest rock crystal. It carried its rider thirty million years into the Future and then conveniently returned him, somewhat the worse for his adventure, to the "Present" from which he had started.

Actually, ideas have occasionally been put forward for Time-travelling in this manner. Some, for instance, have thought that if gravity could be insulated, the solution of the Time-travelling problem would be at hand.

It is certain that if one could travel with the enormous speed of an electron, some apparent modification of Time would result. The whole subject of human travel at this rate, however, is an entirely fantastical and impossible one, so much so that little benefit can be derived from pursuing it further.

#### A Fallacy

The notion of Time travel in a physical sense is really based upon a fallacy. For even if some demi-genius actually did construct a type of apparatus capable of carrying a person in both directions along the Time dimension, it is obvious that the adventurer betaking himself into the Past would very rapidly vanish into the oblivion from whence he came, whilst the traveller into the Future would meet with an even more mystifying Fate, since the Future (according to all but the most Determinist philosophies) is not a mapped-out track along which we all move, but is, to a certain extent, governed in detail and character by our actions in the Present.

Whilst, however, we can never hope to travel in Time in a physical sense, it is quite within the bounds of possibility that mankind may sometime be able to capture some reflection or record of the Past and to bring it into line with the Present.

Naturally, the problem is an involved one, even in its barest principle. Let us, however, regard it in the following manner.

#### Record In Light Waves

Many scientists believe that somewhere in this universe of ours there exists a record in light waves, or in some other form of electro-magnetic energy, of everything which has ever happened. The notion is quite a possible one. It goes counter to no known physical law. Indeed, it agrees fundamentally with the great Law of the Conservation of Energy, which states that although energy may undergo many varied changes it is never lost or annihilated.

Consider, now, a tree standing in the middle of a field, or better, perhaps, a more imposing object, St. Paul's Cathedral, say, or Westminster Abbey. Light waves and, maybe, some much more subtle form of emanation, speed outwards from the object with a velocity of approximately 186,000 miles per second—the speed of light.

Assuming that these waves are able to penetrate the earth's atmosphere successfully—and there is no reason why at least some counterpart of them should not do so—they must speed outwards into space at this constant velocity of 186,000 miles per second.

So far as we can ascertain, these light waves or electro-magnetic emanations picturing the tree in the field, St. Paul's Cathedral or Westminster Abbey will twenty thousand, fifty thousand, even a

hundred thousand years later, still be speeding outwards upon their apparently never-ceasing journey.

Could any intelligent being out in those illimitable depths of space capture the ever-travelling waves and translate them into visual or some other suitable impulses, he might then reasonably expect to be able to obtain a picture or some other type of record of the earthly tree or of the more imposing ecclesiastical edifices, as the case might be.

#### Reach Out into Space

Granted this possibility, it must now become evident that at the present time some type of electro-magnetic record of the landing of Julius Caesar in Britain or of, shall we say, the building of the Egyptian pyramids is hurrying through space at the

order to overtake a wave journeying through Space at the rate of 186,000 miles per second, it is obviously necessary to send after it another wave which will travel at a still greater speed.

It is just here that we come bang up against the immovable wall of mathematical theory. For mathematical theory states that this 186,000 miles per second (or, as the scientists have it, 299,796 kilometres per second) is the ultimate speed in the universe. No material or semi-material particle, no light wave, no other form of radiated energy, say the mathematicians, can ever hope to exceed this velocity. 186,000 miles per second is, as it were, the speed limit of the universe, a limit which is rigidly enforced quite automatically throughout Space by the very design and plan of the universe.

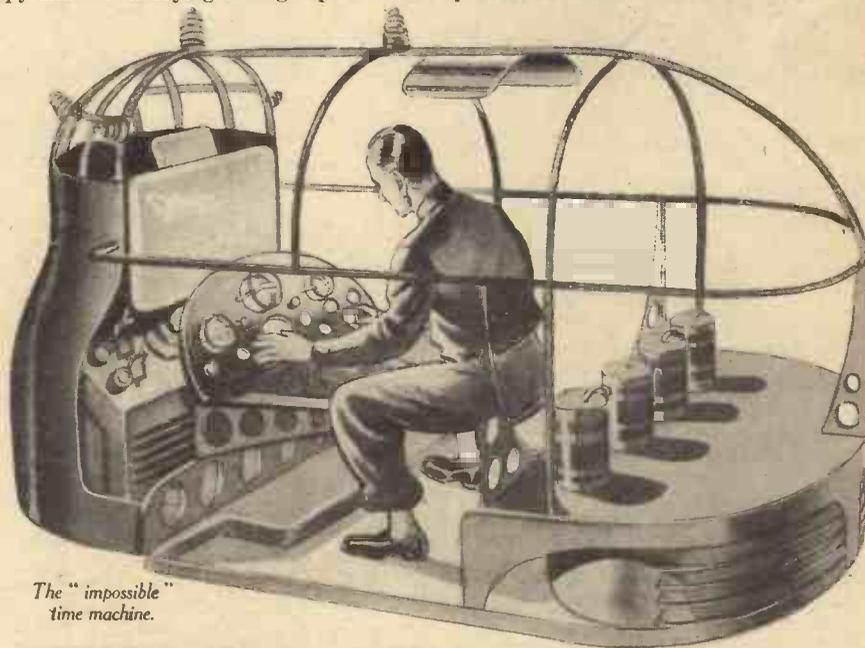

The "impossible" time machine.

velocity of 186,000 miles per second. If, by any means, it were possible for us (say, for instance, by some super electro-magnetic influence) to reach out and overtake those far-distant scurrying waves and to cause them to return to the Earth, then we should, by means of suitable receiving instruments of comparatively simple construction, be able to witness a presentation of Caesar's landing in Britain or of the original construction of the enigmatical pyramids.

And that is about as far as mankind can ever hope to go in the way of practical Time-travelling. Yet even this notion is, so far as we can see in the light of our present-day knowledge, an enormously difficult and complicated one. For, in

#### Space Travel

It seems, therefore, that, so far as we are concerned, the light waves or other forms of radiated energy proceeding from, say, the scene of the Battle of Bannockburn can never be made to return to the Earth. For all that, however, there may be just a chance that, with the eventual coming of interplanetary and Space travel, new discoveries will be made which will, in some manner, diminish the enormous and profound difficulties inherent in the problem of Time travel. It may, for instance, become possible to travel outwards into Space and to project electro-magnetic waves which will, by some as yet unthought-of electrical inductive influence, divert what we may now call the "historical" light waves from their paths and allow of their electrical reflection earthwards.

But all this is speculation, of course, as, no doubt, the reader emphatically agrees. Yet such principles seem to constitute the only ones by which it might conceivably become possible to bring the Past, or at least some record of it, up to the Present.

But as for capturing the Future in any such way, that is obviously impossible. For—materially, at any rate—the Future has no actual existence. Hence it cannot give rise to ether-wave records.

Which is, perhaps, after all, a most merciful dispensation. For although many of us would be overjoyed to experience a private "pre-view" of a future Derby race, few of us would view with equanimity a "future" picture of personal misfortune or calamity.

### A NEW BOOK WORKSHOP CALCULATIONS, TABLES AND FORMULÆ

BY F. J. CAMM.

An invaluable handbook for the Fitter, Turner, Mechanic and Draughtsman. 3/6, by post 3/10, from the Publisher, Geo. Newnes, Ltd., Tower House, Southampton Street, Strand, W.C.2

# NEW HUB DYNAMOS



A close-up of the new Philidyne hub dynamo, showing the milled nut which cuts out magnetic pull in daylight.

Last Year the Sensation of the Cycle Show was the Raleigh Dynohub. This Year other Firms have Produced Hub Dynamos and Below we give a Brief Review of those Exhibited at this Year's Show.

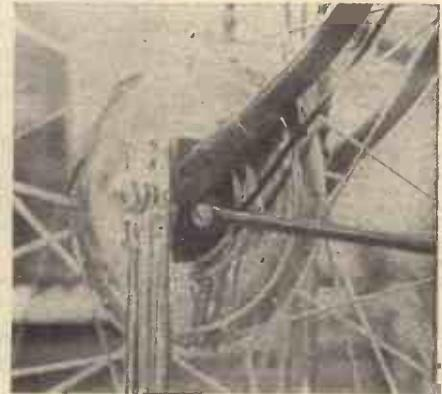

The Lucas hub dynamo.

LAST year in our review of what was new at the 1937 Cycle Show, we described the Patent Dynohub as a big advance in the cycling industry. This year other firms have produced dynamo hubs, and we illustrate them on this page.

The Enfield Cycle Co. are responsible for one of the new hub dynamos, and as it is a separate unit it follows that there will be some interesting arrangements of hub layout in which the dynamo is included. One of the Enfield bicycles on show was equipped with the dynamo. The dynamo being a separate fitting and bearing, it formed no part of the wheel, which was built and spoked in the orthodox way, but the spoke-flange on the dynamo side was naturally nearer to the other than is normal on non-dynamo hubs.

The arrangement has the feature, however, of permitting the wheel to be entirely disconnected from the dynamo in daylight. A simple spring clip or quick-release is to be fitted; and no doubt in time other ideas will develop so that the touch of a trigger on the handlebar will be sufficient to throw the dynamo into or out of engagement.

This dynamo is 6 volt, and costs 25s. extra to the price of a standard bicycle.

The Enfield hub dynamo is a distinctive pattern and was quite different from any of the others at the Show. H. Millers & Co. were another firm who showed a hub dynamo on their own stand. It had the orthodox method of spoking to its own flange. The output is 3 watts at 6 volts, and the price 25s.

Now as to the Lucas hub dynamo, which was showing on a B.S.A. machine, and for the present will be available to the public only through certain large manufacturers of bicycles, such as the B.S.A.

### Lucas Hub Dynamo on B.S.A.

The Lucas hub dynamo is rather larger than the others, and in appearance resembles a tandem hub brake. It is designed with 20 poles, and runs with great freedom, giving an output of 3 watts at 6-7 volts. Its weight has been given as representing a difference of 2 lb. over an ordinary wheel, but this, it must be remembered, refers to the model in its experimental stage. It invariably happens that weights are reduced even further after a model has gone into production.

Coming to the Philidyne dynamo hub shown on the James stand, it had many features of great interest. It was exhibited

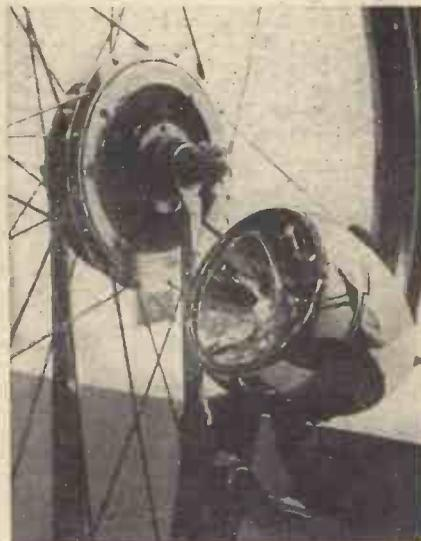

The new hub dynamo exhibited by H. Miller and Co., Ltd.

in two models, one of which was combined with a hub brake. The combined model appeared rather like a very large variable-speed gear, but this again is in experimental form and the marketed production will be much narrower. The dynamo-brake combined will be no larger than the dynamo alone which has been on exhibit at the Show.

### The Philidyne

Electrically the Philidyne is particularly interesting. Although its output is the same as that of the other new dynamo-hubs, namely 3 watts at 6-7 volts, it runs with amazing smoothness, and the A.C. flicker inseparable from all such dynamos generally is not perceptible to the human eye—at any rate. The sponsors state that there is positively a light without flicker at one mile per hour.

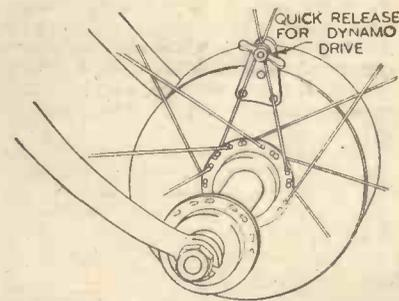

How the Royal Enfield dynamo is disconnected from the wheel, when desired.

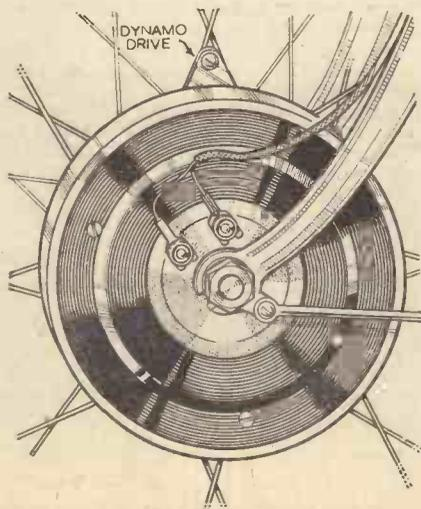

The novel Royal Enfield hub dynamo built as a separate unit.

### Magnetising at Will

The most novel feature, however, is that a large milled screw is fitted in the side which, when turned, moves the magnetic plate 3/16in. farther from the fields, and thus stops the normal pull or resistances. These are difficult enough to discern even when the dynamo is generating, but when the plate is moved by the operation of the screw the whole affair runs like a plain hub. The dynamo, by the way, has 24 poles, and the weight of the whole affair is given as only 1 1/2 lb.

Readers may think that the constant alteration of the magnetic plate in relation to the fields may affect the magnetism, but the makers are prepared to guarantee the dynamo against loss of magnetism for ever.

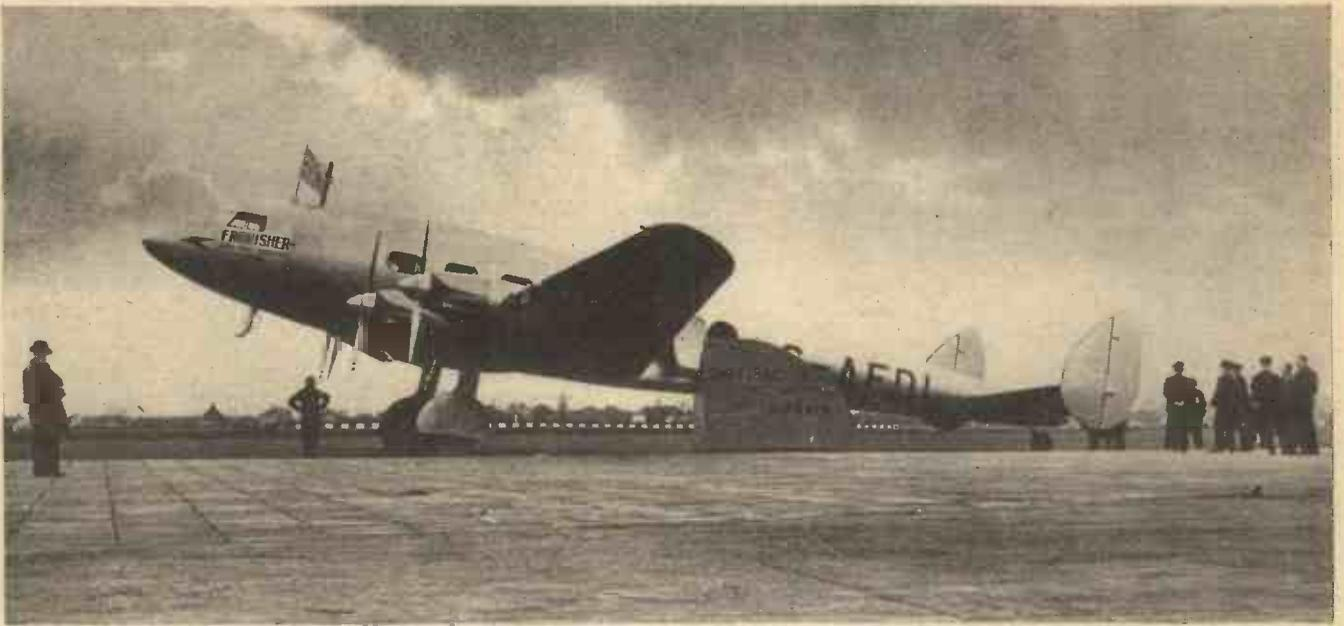

An impressive view of the "Frobisher" at Croydon Airport. It is Britain's latest transport aircraft and is regarded as one of the most efficient air-liners in the world.

## A "Pack" of Tunes

EXHIBITED at the recent Exhibition of Playing Cards at Bayswater, was a pack of cards containing 1,001 waltz tunes. Two bars of music are on each card, and by changing the order of the cards a different waltz tune can be played. A Continental composer has invented the pack.

## An Indian Braille System

THE Chatrapati Blind Institution in Bombay have decided that the blind people of India will soon have a Braille system of their own.

The institute are busily collecting funds for the scheme, and the first book, a Braille Primer, will soon be available in three different Indian languages.

Hitherto one of the difficulties of teaching the blind has been the diversity in the Braille alphabet necessitated by the large number of Indian languages.

## Own Traffic Sign

A CALIFORNIAN motorist, Mr. D. O. Wilson, has invented his own reply to the motorist who pulls up behind him at traffic lights and sounds his horn before green is signalled.

The device consists of a combination of horn, light and mask which is fitted to the rear of the car and worked from the dashboard. The features of the mask are illuminated by the light, and the mouth opens and a tongue protrudes. A suitable accompaniment is blown on the horn.

## World Exhibition

SIR CECIL WEIR, chairman of the recent Empire Exhibition at Glasgow, has outlined a plan for a great international exhibition in London in six or seven years' time. He says: "It would be useless to do this on any but the grandest scale, or far from the centre of London. Wembley is too far away, and the natural site for an international exhibition such as I have envisaged is Hyde Park."

The great exhibition of 1851 was the last

exhibition to be held in Hyde Park, and the buildings, which were transferred to the Crystal Palace, were burned down in 1936.

mounting, running in ball bearings and standing on a knee-shaped column. The automatic movement is achieved

# THE MONTH IN SCIENCE AND

## An Astronomical Camera

AN astronomical camera, said to be the strongest in Europe, has just been put into the service at the Sonneberg Observatory, Thuringia, Germany. Made at the Zeiss works, this new instrument is a marvel of the German optical industry, and with it it is possible to photograph stars so far only achieved in U.S.A. The instrument has a focal distance of 1.6 m. and takes a 30 by 30 cm. photographic plate. For convenience in operation and in following the daily movements of the stars, the tube of the camera is set up on a specially designed

with the aid of an electric motor controlled by an astronomical clock. Dr. August Sonnefeld, of Jena, is the inventor of this giant new camera.

## A Stall-Warning Device

A STALL WARNING device, designed to give an aeroplane pilot definite notice of the dangerous "stall" not now shown by the ordinary air-speed meter, is shown on next page after it was installed on the wing of a test plane. The new indicator has been developed by the laboratories of the National Advisory Committee for

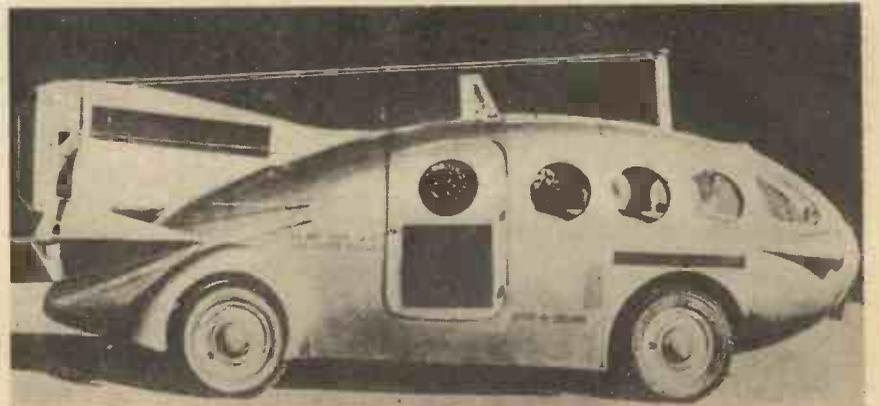

"The Mars Express" is the sensational name of this streamlined American-car constructed by Peter Vacca at a cost of 16,000 dollars. Built of aluminium the car is powered by a V8-compressor engine with a device built in the rear which gives the machine a rocket drive enabling very high speeds to be obtained.

Aeronautics at Langley Field, Va., where is has been given careful flight tests.

The stall indicator can be used to warn the pilot in any of a number of ways—by blowing a horn, lighting a warning light, or shaking the control stick or rudder pedal. The new instrument, working on the same principle as an air-speed meter, is located on the upper surface of the wing a short distance behind a special sharp-edge portion built on the leading edge of the wing.

This sharp edge can be so adjusted that when the main part of the wing approaches the stalling angle, a local stall over the small sharp leading edge is produced. The stall indicator detects the resulting flow separation in this small region sufficiently before the wing as a whole stalls, so that the pilot is warned to nose the plane down and recover safe flying speed before general loss of lift takes place.

### New Style of Fencing

AT a recent fencing demonstration at the Polytechnic Institute, London, electric foils were used which rang a bell when a hit was made.

To the wrist of each fencer was fixed a thin wire which ran down the hollow part of the épée to its point. From the wrist, the wire led to a bobbin, which, in turn, led to a battery box. In the box was a bell, together with two lamps of different colours, one for each swordsman. A lamp lights and a bell rings every time a hit is

The inventor reports cases of 12 cats whose hearts and lungs were short circuited through his apparatus (that is, the apparatus substituted for the animal's own heart and lungs) for periods of from ten to twenty minutes and who survived after the apparatus was disconnected, using their own hearts and lungs again.

The apparatus may be of great use in human surgery, especially in pulmonary embolism, where there is a very high death rate. Briefly, the apparatus consists of two pumps and a whirling cylinder where the blood is treated with oxygen.

### New Air Liner

THE fastest system of cross-Channel air services yet seen will be operated by Imperial Airways within the next few weeks when the "Frobisher," first of their three new 13-ton, air liners, will be commissioned for passenger operation. The "Frobisher" is now at Croydon Airport, London, being prepared for service on Imperial Airways

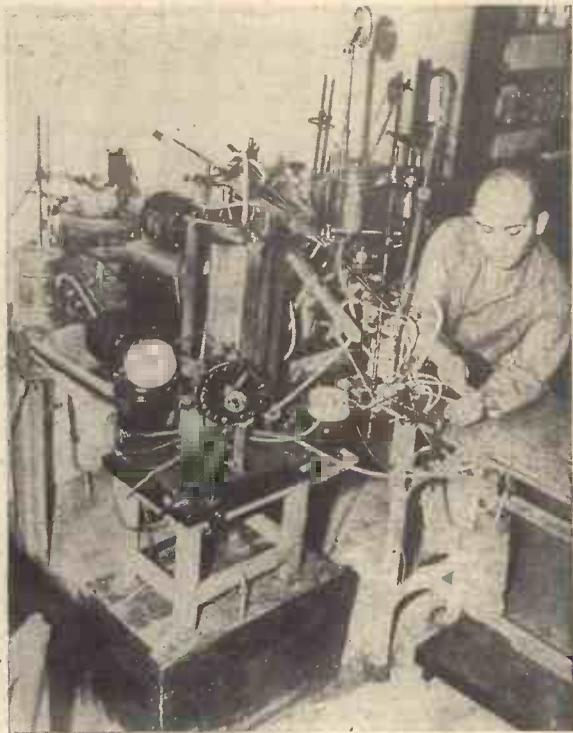

The mechanical heart and lungs perfected by Dr. J. Gibbon, Junior.

# THE WORLD OF INGENUOUS BRIEF-CASE

made, but does not register when the point of the sword hits the floor or an opponent's guard.

This method does away with judges, as, being perfectly accurate, its judgment is considered final.

### Mechanical Heart and Lungs

DR. J. H. GIBBON, jun., of the University of Pennsylvania Medical School, Philadelphia, U.S.A. has just perfected the first mechanical heart and lungs apparatus to sustain life in animals over periods of time. Other mechanical or artificial hearts only sustain life in tissues.

European routes and will soon be joined by the "Falcon" and "Fortuna," the other two aircraft of the same class.

The "Frobisher" and her sister-ships will be among the fastest air-liners in Europe. It is Britain's latest transport aircraft and is regarded as one of the most efficient air-liners in the world.

### Into the Depths

MR. E. WYMANN, of Lausanne, has constructed a new type of bathysphere. With it, the inventor hopes—by means of tubes—to plunge to a depth of 150 metres, to explore the bed of Lake Lemán, Lausanne.

Professor Piccard, after his successes in

the stratosphere, also intends shortly to experiment in this direction.

### Ingenious Brief-Case

THE brief-case is coming to be regarded more and more as a sort of "good companion" by men—particularly business men—who travel a good deal. In recent years brief-cases have been greatly improved: that is to say, their uses have been considerably increased both in number and degree. With their numerous divisions and first-class safety-locks, they are really almost like safes. And now information reaches us from Offenbach that the newest brief-cases will be even more useful than the old, for the latest development is a combined brief and writing-case.

A world-famous Offenbach firm is incorporating a zipp-fastened writing-case in the back of its brief-cases, which, incidentally, are also equipped with every modern device.

When opened, one side serves as a pad, whilst the other side is fitted with numerous divisions, both large and small, for note-paper, writing-materials, etc. A detachable blotter completes this useful innovation.

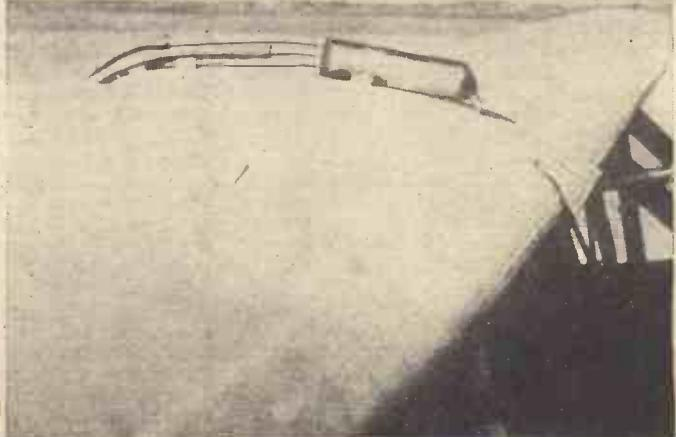
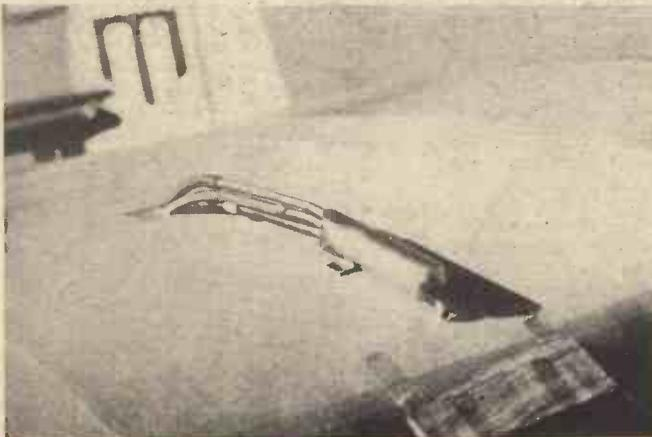

Two views of a stall-warning device designed to give an aeroplane pilot warning of the dangerous stall, fitted on the wing of a test plane.

# Repairing Domestic Apparatus

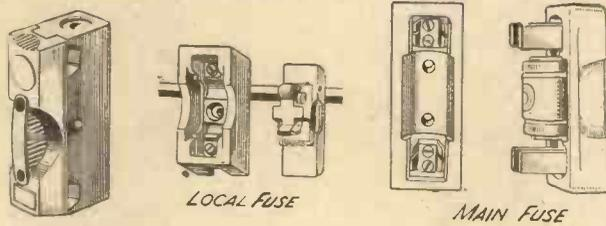

Fig. 1. Fuses and fuse carriers.

## LOCAL FUSE

IN these notes it is intended to deal with more than the mere replacing of a fuse or a burnt-out lamp. But first we must deal with some "Don'ts."

In this country, very soon, all supply will be A.C. at about 230 volts. Now the peak voltage on A.C. is 230 multiplied by the square root of two, i.e.  $230 \times 1.414$ , or something over 300. If you keep this point in your mind's eye you will be more careful about taking shocks from the mains. When making an examination of any apparatus, always disconnect from the supply, either by removing the plug or switching off at the mains. If you are doing any work on an installation, such as changing a fitting or plug, or anything connected with the permanent wiring, then switch off at the mains and pull the fuses. This is the only way to make certain that someone will not come along and switch on again.

## The Main Fuse

We will start with the point of entrance of the cable and follow it to the various points dealing with each fault as it arises. If a main fuse blows, you cannot replace it, but must phone the supply company, who will send a man out to do it. The main fuse box is sealed and it is an offence to break this. If a main goes, there must be some serious fault in the circuit.

## Replacing Local Fuse

If a local fuse blows, first find the reason why. There is always a reason, and a very good one. Generally, it is an overload on the circuit, or some accidental short, worn flexes, or cut wires, and so on. Remedy this and then replace the fuse with the correct size. It is usual to employ 5-amp. wire for lighting circuits, and 10 or 15 for power. Switch off the mains, remove the fuse carrier, clean off all carbon and fused wires, put in the new wire, and replace. Switch on. Remember to remove all the old wire. Make certain of good connections at the fuse clips. (See Fig. 1.)

## Replacing Switch

A switch may often need replacing, especially in such places as garages and workrooms, etc. First get a good switch of the same type and pattern, i.e. 5- or 10-amp. sunk or surface mounting, etc. (See Fig. 2.) Switch off at the main, pull the fuses. Now slacken the connecting screws on the switch, remove the fixing screws, pull out the switch, and then put in the new one. Take care to mount this the right way up and to put the wires on the same sides as before. It is quite possible to put the switch in so that the knob is down and the light off. Don't throw away the old switch, it may be kept as a useful spare in case of repairs. The cover and terminals and the action spring can be removed and put into broken switches. You may not think this worth while, but the repairing of a switch is quite intricate and interesting work. To

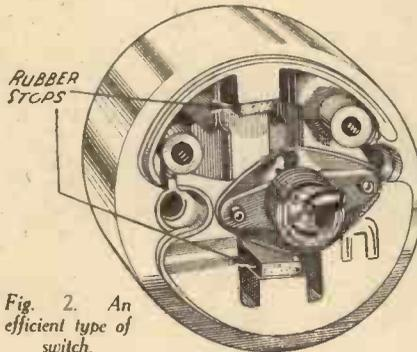
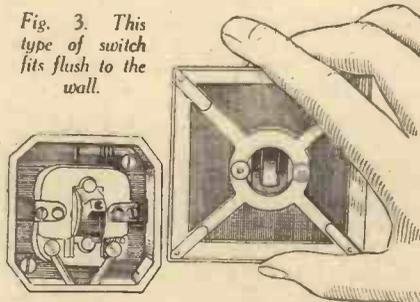

Fig. 2. An efficient type of switch.

"open up," remove the sealing wax from the heads of the screws at the back, undo these, and the dolly will pull out. It may leave the movable contacts behind. If not, a slight pull will remove them, exposing the action spring. You now have the switch in pieces and it is easy, if you have a spare, to replace a broken part. Contacts may be tightened up by judicious pressure with the blade of a screw-driver. Always use good

Fig. 3. This type of switch fits flush to the wall.



switches. It should not be possible to hold the contacts either just in or just out so that arcing occurs. The switch should open and close quickly with a snap, except in the case of the new silent switches for hospital work. Here the action is barely audible. (See Fig. 3.)

## The Distribution Point

Now we come to the distribution point. First the lamp-holder and flex. Flexes often get worn and frayed when the lamp swings in a draught or when a portable appliance is used at that point. If you are doubtful of a flex, replace it—the cost is negligible. In the case of large and powerful lamps, the heat will cause the insulation to perish, and finally the rubber cracks away, causing a short or the holder to become live. Never remove or replace a lamp with the switch on. In replacing a flex, switch off at the mains and remove the fuses. Unscrew the cover of the ceiling rose, disconnect the flex. Now, in a more comfortable position, examine the holder. If the springs in the contacts are quite good, it

may be replaced on a new length of flex. Slip the rose cover on the flex, climb the ladder, and connect up. Make sure that the weight of the flex and fitting is taken by the little hooks or projections on the rose base, and screw back the cover. (See Fig. 4.)

A word on using portable appliances from light points and two-pin distribution points. The flex and holder are rated at 3 amps. You should not use anything taking more

## By "Home Mechanic"

than 500 watts from a holder. All portable apparatus should be earthed. It cannot be earthed if used from the ordinary holder. Yet, you may say, why are irons, fires, and vacuum cleaners all sold with adaptors for use on the light. This, of course, is to give them a universal appeal, but the day is not far off when all apparatus will be sold with a special plug of probably the three-pin type. The sketches show how easy it is to get a shock from a two-pin point of, say, a fire or iron. In our opinion, the iron is almost a lethal weapon when used from the lamp-holder. The housewife is there with damp hands in the kitchen ironing, in easy reach of gas and water taps and earthed ironwork. A fault develops in the iron. With one hand she touches the stove, and a very bad shock results. The same can happen with open fires of the bowl type. Also, with two-pin plugs and fires with switches incorporated, it is possible for the switches to be off and the plug in and yet the element alive. If you wish to test all these statements, get a lamp, holder, and flex with crocodile clips as leads and use this as your subject or patient. Connect one lead to earth and the other to the iron or fire, as above, and observe that the lamp will light. Wherever possible, use only lamps at the lamp-holders and the proper apparatus at the two-pin point. These are designed for use with reading lamps and wireless sets which, theoretically, may not require earthing. (See Fig. 5.)

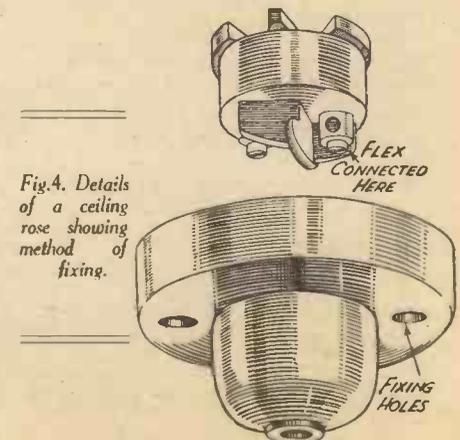

Fig. 4. Details of a ceiling rose showing method of fixing.

# Electrical

Useful Hints On The Upkeep And Repair Of Domestic Electrical Appliances, And How To Avoid The Many Pitfalls That May Be Encountered By The Home Electrician

## The Power Point

This has an earth pin which must be used. You may feel tempted to connect up the iron to the plug with the original twin flex. Don't, it is safer to get a good quality triple cable. If the iron is used a lot, then we advise a tough rubber-covered cable. The extra safety will well repay the outlay. Braided cable has a nasty habit of fraying at the adaptor and then shorting. The

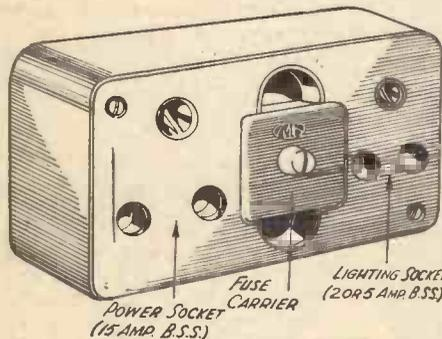

Fig. 6. A safe socket for all appliances.

wires in the cable each have their own colour, so that it is an easy matter to earth the correct one. The latest iron adaptor has a small spring tongue that touches the metal case of the iron. This is the earth contact. Bend it out so that it makes good contact. The same general remarks apply here as regards frayed cables, etc., but one must use the cable of the correct size for the appliance. If you are using a 3-kilowatt fire from a plug, don't wire up with lighting flex. Use the correct cable (this is generally supplied with the appliance). On the other hand, if you are using a 750-watt fire from a 15-amp. point, thinner flex can be used, but to protect the circuit the 15-amp. fuse must be replaced with a 5-amp. one. This is very important, because the earth might burn before the fuse blows if a fault develops in the fire. Fig. 6 shows a socket from which any apparatus may be used with safety.

## Two Types

All domestic appliances can be divided into two types, heating and motor-driven. Special notes will be given for the various

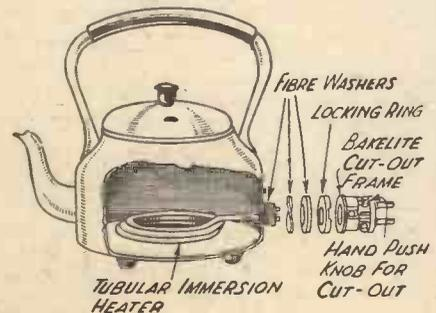

Fig. 7. A group of "heater" appliances



types, but first a general survey of the heating type. Here we include irons, fires, toasters, hair dryers, kettles, hot plates, stoves, and cookers, because in each case the element is a length of wire that gets hot when in use. A group of appliances is shown in Fig. 7. A combination of the two types is found in modern fires and hair dryers, etc. Nowadays all heating elements

as a black dot. Don't attempt to repair an element, but put in a new one, lay flat on the plate, put on the iron weight, tighten up the nuts. Put on the cover, make sure that the springs touch the element correctly, and warm up the iron. When hot, dismantle and put another half turn on the clamping nuts.

## Repairing an Electric Kettle

A kettle element is very similar to that of an iron, but is generally in two halves. The replacing of the element is carried out in the same way. First invert the kettle, then remove the cover plate exposing the elements. These are clamped under a thick copper disc by one screw passing through the centre. Remove this and the elements. Connections are made through copper flexibles insulated with porcelain beads. Preserve these, as they must be put back on the new element. Observe the position of the old element and replace the new in exactly the same way. Connect up as before. Most kettles, sterilizers, and similar appliances are fitted with a cut-out of some sort that opens the circuit when the vessel boils dry. Some have a small fusible capsule, which has to be replaced each time it boils dry. The commonest method, and found on all good-class apparatus, is the bimetal thermostat. The actual design varies with the maker, but the principle is the same. A bimetal strip forms part of the circuit and when this is overheated it bends outwards and opens the circuit. Any repairs here consist in cleaning the contacts and perhaps bending the strip slightly so that a good contact is made. The contacts can be reset by a knob on the base of the kettle and need not be touched in the ordinary way.

(To be concluded next month)

Fig. 5. Showing how a housewife may obtain a shock from an unearthed iron.



are standard, i.e. if your iron burns out a new element can be bought from the makers. The sketch (Fig. 8) shows a dismantled iron; we will deal with fitting a new element here first. Remove the cable connector. The shell is fixed to the base by two fancy nuts, A and B. Unscrew these and gently lift the cover off. In some types connection is made by two springs from the adaptor to the element; in others it is a strip of metal. If by springs, the cover comes straight off; if by strips, unscrew these at the connector. The element is clamped to the base between a heavy iron stop. Remove the two nuts and lift off the iron; the element may now be removed. The element is wound of strip on a mica former and is completely insulated from the frame. When removed, take it to your testing bench and connect in series with a lamp. If it lights, then the element is O.K. and the connector must be to blame. A faulty element can generally be spotted by holding to the light; the burnt spot shows

Fig. 8. An exploded view of an electric iron and below—



—the complete iron, mica filament and the various components.

# TOOLMAKING AND TOOL DESIGN—3.

The Principles and Methods of Making Press Tools, Jigs, Gauges and Fixtures

By W. H. DELLER

### Cast Box Jigs

As stated previously the bodies of box jigs are mainly made from iron castings. It is necessary for this form of construction to have a pattern prepared from which to produce the casting. A typical casting for an open-sided box jig is illustrated in Fig. 9. This represents but one form of this class of jig and for its completion needs surface machining and boring correctly to receive the guiding bushes and provided with suitable work holding arrangements. Other forms of work may need a complete box-shape when the lid of the box may be hinged to permit the loading and unloading of the jig. Large jigs of this de-

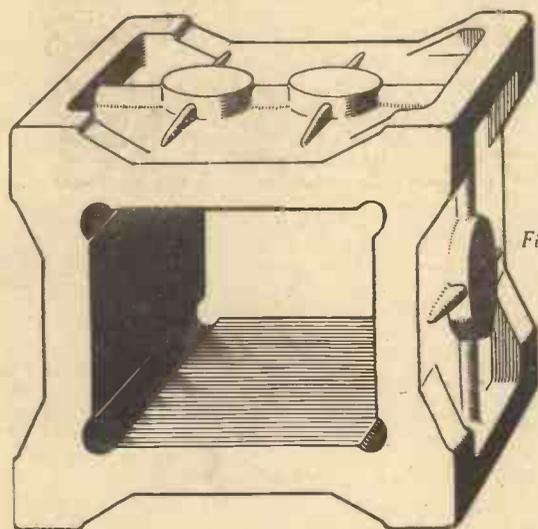

Fig. 9.—A typical casting for an open-sided box jig.



Fig. 13.—A simple form of plate clamp.

scription may require to be built up from cast sections, or the same principle may have to be adopted where the internal machining of the jig would otherwise be rendered difficult or impossible.

It will, of course, be understood that the jig casting requires to be designed in accordance with the shape of the job to be handled, when bosses for bushes, pads for supporting the work and seatings for locating pieces can be correctly disposed on the pattern for incorporation in the casting.

It is intended at a later stage to give suggestions for "jigging" several concrete examples of work with a view to covering briefly the problems likely to be encountered. This particular type of jig can then be more fully dealt with in its completed form.

### Methods of Clamping

While it is true that certain work may be held in a jig without being clamped in the ordinary sense—as for instance, where a large, bored cross-hole laying parallel with

a machined surface requiring to be drilled can be held in position by means of a cross-pin or mandrel passing through the jig and the work—in the majority of cases the holding has to be accomplished by some form of clamp or clamps.

The point of application of each clamp needs to be considered from the viewpoint of its liability to cause distortion of the work upon being tightened, and at the same time the clamping arrangement must provide adequate support where the machining is being performed against it.

Generally speaking the operation of any jig is retarded where it is necessary to remove nuts from studs before the jig can be

shown in Fig. 10. Here a central stud tapped into the bushed surface of the jig is provided with a substantial slotted washer, of sufficiently large diameter to encompass the hole in the work, which is tightened down by means of a flanged nut. It will be apparent that by slackening the nut slightly the washer may be slid out and the work removed over the stud without taking the nut off the stud.

Where circumstances permit, the nut shown may be modified to dispense with the necessity of employing a separate spanner or key for tightening and loosening.

This form of clamping is satisfactory for work of substantial proportions or where the holes to be drilled are disposed reasonably close to the point of support, otherwise for similar work of a lighter nature the clamping arrangement illustrated in Fig. 12 may be employed. This consists of a spider, having legs of a suitable length to engage the surface of the work, the central hole being large enough to clear the clamping nut as in Fig. 11. Where the surface against which the legs bear is irregular in relation to the machined surface of the work opposing the locating face of the jig—as for instance a rough cast or stamped surface—the ends of the legs should be domed and the surface about the centre hole in the spider machined concave. The under surface of the washer will then need to be machined convex to correspond, thus forming a compensating clamp which will take care of any unevenness in the surface of the work.

### Plate Clamps

A simple form of plate clamp is seen in Fig. 13. This may consist of a plain slotted plate as shown when the heel piece of suitable height to correspond with the thickness of the work is attached to the jig. The clamping stud should be arranged in such a position as to permit the front of the clamp being slid clear of the work without entirely removing it from the stud.

Where this type of clamp is used the front of the clamp is retained at its normal height when the work is removed by means of a light compression spring passed over the stud. Where it becomes necessary to remove the clamp entirely, to facilitate loading and unloading, the slot may be run out to the front of the clamp or the front end of the slot may terminate in a hole large enough in diameter to clear the clamping nut. A certain degree of compensation for taking care of variations in thickness of the work may be obtained by providing a lip on the underside of the clamp bearing against the work. Where this is done the surface clamping nut requires to be convex and the top of the clamp machined concave to suit in the appropriate position. The surface of the heel will

*Continued on page 230*

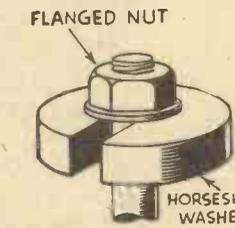

Fig. 10.—A simple form of clamping.

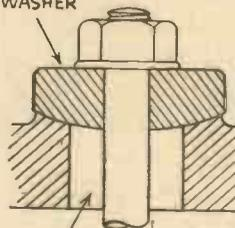

Fig. 11.—The central hole should be large enough to clear the clamping nut.

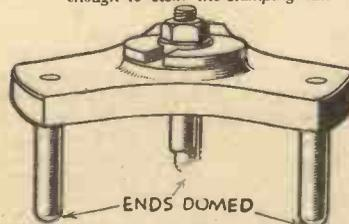
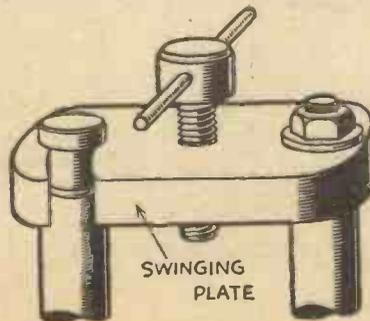
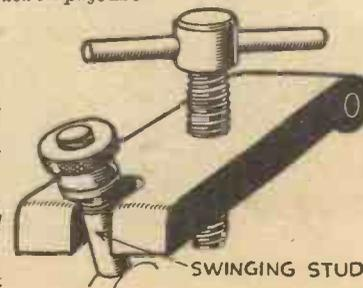

Fig. 12.—This clamping arrangement is of the spider type.

loaded and unloaded. In fact it is better wherever possible to avoid loose pieces of any description. This is not, however, always possible without the addition of unnecessary complications. A particularly simple form of clamping that is effective for work having a central hole that has been machined at a previous operation is that



Figs. 14 and 15 (Left).—A swing type of clamp. The plate of this clamp swings about a pin set in the bossed end of the plate.





# MODEL AERO TOPICS

By F.J.C.

Current News from the World of Model Aviation

## Aerial Photographs by Model Aeroplane

**M**R. W. A. SMALLCOMBE B.Sc., who is curator of the Reading Museum and Art Gallery, has sent me details of his petrol-driven model aeroplane which is equipped with mechanism for taking photographs whilst the model is in flight. I illustrate the model on this page. The 'plane is a high-wing monoplane with all parts detachable and weighing complete with engine, camera, battery, coil and condenser, 3 lbs. 2 ozs. The span is just under 6 ft., but when carrying the camera a wing having a larger surface and under-camber is used. The engine is a 2.5 c.c. single-cylinder "Gnome" driving a 10 in. airscrew. Mr. Smallcombe says that the machine flies well carrying all the necessary weight. The camera shutter is actuated by the clock mechanism after the engine ignition has been cut-off—that is when the machine starts to glide. The camera takes a film pack of twelve films, but at present he can only get one photo at a time before resetting. He thinks that on open sites there is no reason why successful photographs should not be taken of fields, encampments, villa sites, etc. The release device will permit the dropping of parachutes. It is believed that this is the first power model to fly in Reading. Mr. Smallcombe has been experimenting with models since 1908.

*Will She Take Off?  
One of the Competitors  
Launching A Wakefield  
Model.*

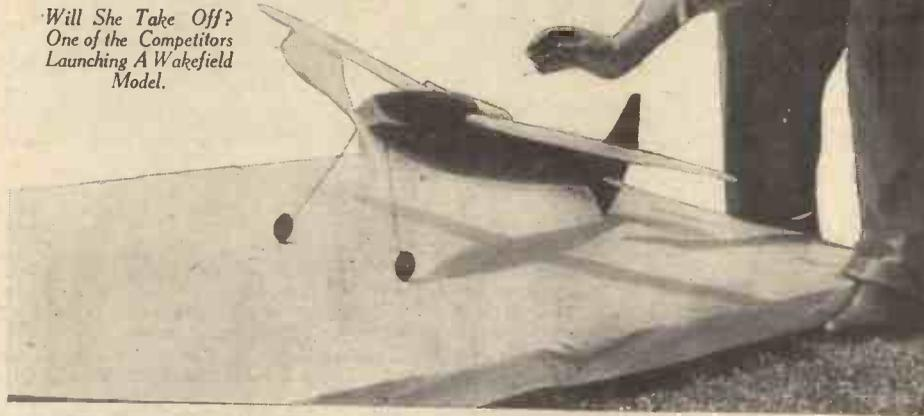

## Indoor Flying Meetings at the Albert Hall

**M**R. J. C. SMITH, Hon. Competition Secretary of the S.M.A.E. has undertaken to arrange indoor flying meetings at the Albert Hall. It is also intended to arrange competitions so that provincial club members can take part.

## Abridge Model Flying Meetings

**T**HE Woodford M.A.C. have been granted permission by the S.M.A.E. to use the Abridge Aerodrome for flying petrol models.

## Change of Name

**T**HE Heaton Moor Club states that they have changed their title to the Stockport & District F.M.C.

## More Affiliations

**T**HE following clubs have become affiliated to the S.M.A.E.; Ulster M.A.C.; Hayes & District M.A.C.; Batley & District M.A.C.

## Wakefield Rules for 1939

**I**T has been decided by the S.M.A.E. that the rule relating to wing area should be modified. The rule as amended states that the area shall be actual plan area of the cambered surface, measured irrespective of dihedral or polyhedral.

## Records

**T**HE following records have been passed: Mr. Pettican R.O.G., Indoor fuselage, 1 m. 46.25s.; Mr. Mawby H.L., indoor rotorplane 45s.; Mr. Mann R.O.G., O.2.P.1. 30s.

## 1939 Competition Dates

**T**HE following dates, in 1939, were fixed for S.M.A.E. competitions:—

- March 19th. Pilcher Cup for gliding Competition to be run under F.A.I. rules. Decentralised.
- March 19th. Decentralised Petrol competition for the C.S.S.A. Cup.
- April 2nd. Gamage Cup. Decentralised.
- April 16th. Weston Cup for Wakefield models. Decentralised.
- May 7th. M.E. Cup for Gliders under F.A.I. rules. Decentralised.
- May 7th. F.R.O.G. Elimination Trials.
- May 21st. Short Cup for Seaplanes. Decentralised.
- May 28th. Wakefield Trials. Centralised.
- May 29th. King Peter Cup Trials.
- June 11th. Flight Cup for petrol models. Centralised. (Cranwell Aerodrome.)
- June 25th. Lady Shelley Cup for Seaplanes. White Cup for Flying boats (R.O.W. Tank). Centralised. (Faireys Aerodrome.)
- July 17th to 23rd. King Peter Cup.
- August 6th. National Cup. Woman's Cup. F.R.O.G. Finals. Centralised. (Faireys Aerodrome.)
- August 7th. Sir John Shelley Cup. Bowden Trophy for petrol models (Faireys Aerodrome.)
- September 3rd. K. & M.A.A. Cup for Biplanes. Decentralised.



*Mr. Smallcombe with his Camera-equipped Petrol Model*

September 17th. Farrow Shield. De-centralised.  
 September 24th. M.E. Cup No. 2 for Speed. Centralised. Ground to be announced later. The usual Photographic Competition will be run.  
 The following competitions will be counted in the Plugge Cup Competition: Pilcher Cup, Gamage Cup, Weston Cup, M.E. No. 1, Short Cup, K. & M.A.A., Farrow Shield.

**Technical Data**

THE S.M.A.E. propose to produce a booklet containing technical information on wing sections, etc. It will be compiled by Mr. Houlberg.

**Sheffield Society of Aero-modellers**

IT has been decided to disband the Sheffield Model Aircraft Society and form a new society under the title of the Middlewood (Sheffield), Model Aero Club. Local readers are invited to get into touch with the Secretary, Mr. R. S. Hemingway, 8 Charles Ashmore Road, Meadowhead, Sheffield, 8.

**Release Mechanism for Composite Model Aircraft**

THE extent to which full-sized aircraft is influencing model design can be seen at any model aircraft meeting. Composite model aircraft have received the attention of one of our readers, Mr. Mainwaring, who has forwarded me details (reproduced herewith), and a photograph of his successful efforts in that direction.

During recent months, several attempts have been made to make a pair of models emulate the example set by Mercury and Mzia when they successfully parted company in mid-air. Some of these attempts have apparently met with considerable success and appear to have used a variety of means of affecting the actual release. More than one person has used the usual rubber tensioner and freewheel mechanism to do the job, but it seemed to the writer, that to make the carrier lift the smaller model (the latter with stationery propeller) and then to release it when its own power was spent, was falling short of what was aimed at—a reproduction of the Mayo Composite. In this all engines are going for the take-off and release takes place with both sections under power.

With these thoughts in mind, the release gear here to be described was evolved and has been used on two different carriers (a Kinglet and a J.B. 3.) with considerable success.

The heart of the mechanism is an old

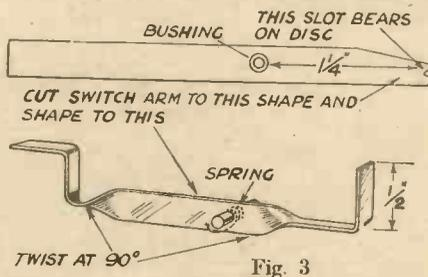

Fig. 3



Photograph of Mr. Mainwaring's Composite Model.

wheel will fall off and should be put aside.

Next the balance-wheel (the one with the hair-spring affixed) should be removed. In ninety-nine cases out of a hundred this necessitates the removal of one screw. Probably the escapement arm will drop out too; if so, so much the better; if not, it must be taken out. If the watch is now wound, the remaining wheels should revolve with a "whizzing" sound far more quickly than they have ever done before!

A circular disc 1 inch in diameter is cut out of tin (a piece from a tobacco or toffee tin will do) and shaped according to Fig. 1. The hole is now drilled in its centre the same size as the hole in the hour hand of the watch as it has to fit on the same place—that is, on the collar of the cog-wheel which was carefully preserved when the watch dial was removed. If a suitable drill is not to hand, simply use a needle and then reamer out the hole until large enough. The centre of the disc and the collar on to which it fits should now be cleaned and tinned with a soldering-iron. They are then soldered together as shown in Fig. 2. If the wheel is now replaced on the centre shaft of the watch, and the latter wound a few times, the disc will revolve. It will take about 15-20 seconds to complete one revolution.

Next cut out of the same piece of tin as was used for the disc, a piece 3 inches long and 1/4 inch wide. This should be shaped as shown in Fig. 3, and should have a small piece of bushing soldered in 1 1/4 inches from the end as shown.

The assembly can now be started. The watch should be fixed to a piece of 2 m.m. ply by any convenient means—binding on with thread is as good as any—and the spindle for the switch lever screwed into the same relative position as shown in Fig. 4.

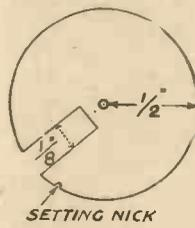

Fig. 1



Fig. 2

Release Mechanism for Mr. Mainwaring's Composite Model.

This spindle is made by screwing a 4 B.A. brass bolt up through a suitable hole in the ply. The nut is then screwed down tight and all the thread above it stripped off with a small file so that the switch lever will slide on and move easily. A small spring made from fine steel wire and mounted on the same spindle serves to make one end of the lever bear against the disc.

If the lever is now set in the smaller nick in the disc and the watch given ten or twelve winds the mechanism is set. To release give the lever a light touch sufficient to make it disengage from the nick. The disc will start to revolve and when the deep recess comes round to the lever, the latter will click into position.

The movement at the other end of the lever will be about three-quarters of an inch.

Reference to Fig. 4, will show how this time switch is used for releasing our "Mercury." The base is made from 1/4 inch sheet balsa and its maximum width is just sufficient to allow the smaller 'plane's wheels to stand on it. Two blocks A are cemented in position so that the wheels will be one on either side. Small holes in the blocks take the release pins—ordinary household pins—as shown. These, when "Mercury" is in position, project through holes in the wheels and hold the smaller model firm on the carrier's back.

The "watch" part of the mechanism must be fixed to the 1/4 inch balsa at a distance from the blocks A equal to the horizontal distance of the wheels of the smaller 'plane' from its centre of gravity. This means that the centre of gravity of the smaller 'plane' will then be exactly over the switch gear, which in turn will be over the centre of gravity of the carrier 'plane. Hence after release there will be no change in position of the centre of gravity which, of course, would throw the carrier out of trim.

The threads which transfer the switch movement to the releasing pins need no comment. Ordinary household pins cemented into the 1/4 inch balsa are used to position the threads, and the actual positions of these pins will depend on the individual dimensions.

At the extreme rear of the 1/4 inch sheet, a piece of 26 S.W.G. steel wire is cemented as shown. This supports the weight of the smaller 'plane' behind its centre of gravity and the kinks in it allow it to be adjusted in length so that the lines of flight of the two 'planes are approximately parallel.

The entire release gear is fixed on to the

(Continued on page 194)

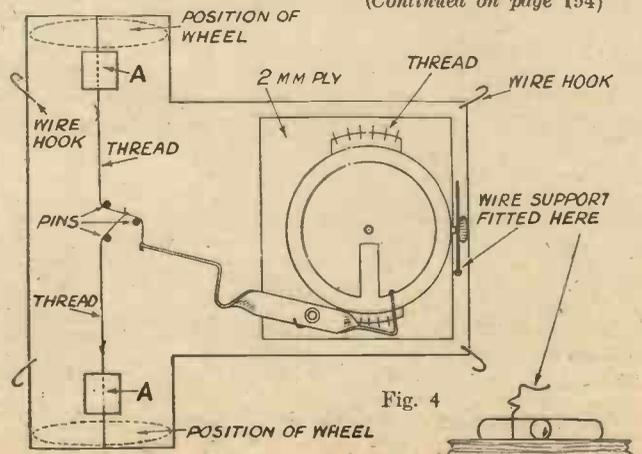

Fig. 4

wrist-watch which most people, in these days of very cheap watches, would not have much difficulty in acquiring even if they had not already got one. The movement is taken out and the hands and dial removed. This should not present any difficulty; when the dial is off care should be taken not to loose the small wheel beneath it to whose collar the hour hand is usually fixed. This

# Watch Repairing and Adjusting—4

## Methods of Correcting a Balance and Repairing a Damaged Spring

**T**HE balance and hair-spring are handled by some repairers with the minimum rather than the maximum of care, but they should always be treated with respect for the timekeeping properties of a watch are governed by the action of these two important parts. No attempt can be made with regulation unless the balance is in perfect poise. This means that the balance should have no heavy point but remain stationary when placed in any position. Faults in timekeeping are often traced to the variation of the balance vibrations when the watch is in different positions. "Positional errors" as they are called are due to a balance with an uneven distribution of weight.

### Correcting a Balance

To correct such a balance the usual method is to employ a poising tool as shown in Fig. 1 which consists of two adjustable knife edges. The hair-spring is removed, but the roller is left in its correct position. The knife edges are operated by means of the adjusting screw until each pivot rests on a knife edge. A slight turning will be sufficient to discover the heavy point if the balance is out of poise. Several methods can be used for removing excess weight. One or more sinks can be made in the underside of the balance run (at the lowest point) with a small chamfering tool.

Another method is to reduce the head of a screw with a file and re-polish it—be sure never to touch either of the four quarters timing screws. An easier method, and one which can be applied to high-class balances is to make the slit in the offending screw a little deeper with a screw-head file. In this way the weight will be reduced, but the balance will not be defaced. Of course it may be necessary to treat several screws before the balance is equilibrium. When a watch is in a horizontal position an out of poise balance has no effect, but should the watch be placed in a hanging position, a gain or loss will be noticeable according to the position of the error. Some inferior watches which are tested in only two positions—"dial" up and pendant down (in the case of wrist watches)—have their balances actually left out of poise to counteract the going slow in the pendant-down position—an effective but somewhat crude form of compensation.

### Over-Compensated Watches

Occasionally a watch is found to be over-compensated, which means that it goes fast in hot weather. To correct this, weight must be removed from the free ends of the balance rim towards the balance arms. This is done by taking a screw from each of the free ends of the rim, and screwing it in a hole nearer the arms. An insufficiently compensated watch is one which goes slow in hot weather, and to overcome this difficulty all the weight must be concentrated at the free ends of the rim

by removing one or more screws to the extreme ends of the rim.

The original flat type of hair-spring has been succeeded by the Breguet or overcoil hair-spring for precision timekeeping and the majority of good-class watches are now so fitted. The considerable expansion and contraction of the coils of a flat hair-spring are continually moving the centre of gravity from one side to the other. This movement of the centre of gravity has the same effect upon timekeeping as a balance out of poise. In a Breguet hair-spring the last coil is bent upwards, and across the

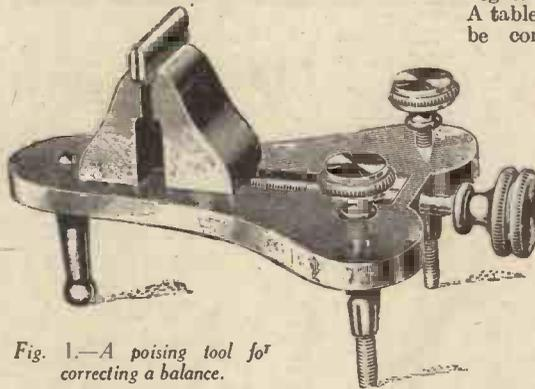

Fig. 1.—A poising tool for correcting a balance.

other coils to the hair-spring stud. The shape of the overcoil follows a definite theoretical curve (the Breguet curve) and is of such a shape that during the expansion and contraction of the coils the position of the centre of gravity remains unaltered. Fig. 2 shows a typical overcoil curve.

### A Damaged Spring

Should it be necessary to replace a damaged Breguet spring two methods can be adopted. The first method consists of making alterations in the curve until the spring has a perfectly concentric movement—a method which takes time, and not one to be recommended, for a spring which has had considerable bending is of little use. The second method, which is easier and better, is to obtain a series of pattern drawings, and lay the spring on the particular drawing which corresponds in size, and shape the curve as depicted.



Figs. 3 and 4.—(Above) Replacing a damaged Breguet spring. (Right) The spring should be fixed to the collet so that, in the pendant-up position, the collet and outer pinning points are located as indicated by the cross.

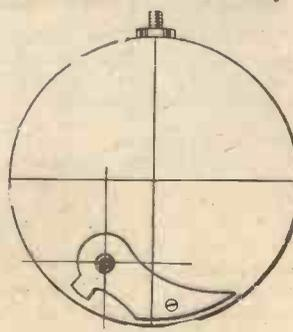

Select a new spring that is approximately half the diameter of the balance and pin it to the collet. Break away sufficient of the centre of the spring to free the collet, and bend the end of the spring inwards almost at right angles, make the end straight and a little longer than the hole in the collet. File a long pin to fit the collet hole, and file a flat upon it. Place a small piece of the spring in the hole and push in the pin. Make a mark on the pin at each end of the hole as shown in Fig. 3. Withdraw the pin, cut off the small end, partly sever the other end, and remove any burrs. Place the collet upon a broach or similar tapered tool, place the spring in the hole, push in the pin—not too tight—and break it off. Be certain that the spring is perfectly flat before pushing the pin tight, for any movement here will have a disastrous effect upon timekeeping.

The spring should not be finally fixed to the collet until the position of attachment of the inner coil has been determined. The spring usually comes away from the collet at one of four points on a cross whose centre is the centre of the collet, and whose arms are parallel to two lines drawn at right angles to each other through the centre of the movement as in Fig. 4. The various positions have a gaining, losing or negative effect upon the rate of the watch. A table showing the different effects should be consulted in conjunction with the

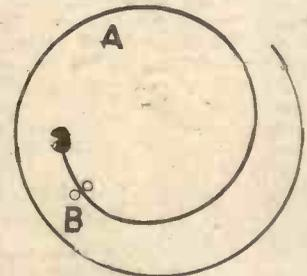

Fig. 2.—A typical Overcoil curve (The Phillips).

particular type of watch under repair. In a watch in which the "pendant-up" position is the most used the spring usually comes away at right angles to a line drawn parallel to the "pendant-up" position. In the case of precision watches the inner curve, too, is theoretically designed; in any case the spring should have no angular bends for such bends are against the natural form of the spring.

### Hair-spring

The hair-spring (now colleted) should be placed upon the balance staff in order to ascertain the "count." The "count" refers to the number of vibrations the balance will make in an hour. Although there are rates above and below, the majority of watches (both pocket and wrist) have balances which vibrate 18,000 times an hour. The most satisfactory way of counting the new spring is to use one of the many balance counting tools. A

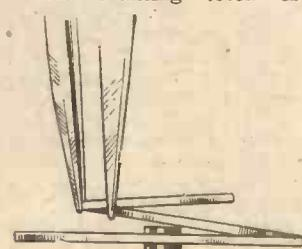

Fig. 5.—Using two pairs of tweezers to adjust the coil of the spring.

special piece of apparatus often supplied with three standard balances of different rates. The balance being tested is held above the standard balance, and the two vibrated together until each has the same rate.

A new spring can be counted with the aid of a pocket chronograph or stop-watch. Hold the outer coil with a pair of tweezers, and let the broken balance pivot rest on the glass of the stop-watch. Start the balance vibrating before the seconds hand reaches the zero mark. An 18,000 balance will give 150 alternate vibrations in a minute. If the balance vibrates slower grasp the spring nearer the centre and vice-versa; when the balance is vibrating correctly make a scratch on the spring. As this point represents the part that will be between the regulator pins, leave sufficient spring to reach the stud and break off any waste.

#### Springs

No hard and fast rule can be laid down with regard to the upward bend. Some favour a gradual bend, others a sharp bracket bend. Each springer has his own favourite idea and special tools are made for the purpose. A pattern should be selected which corresponds as nearly as possible to the diameter of the spring, and

which has the same measurement from centre to stud as the distance between the jewel hole and hair-spring stud on the balance bridge. Remove the spring from the balance and lay it upon the corresponding pattern. The "count" mark is placed upon the line drawn on the pattern. The outer coil is gripped at about three-quarters of a turn from the end with a stout pair of tweezers, and pulled upwards with another pair of tweezers. The curve is next formed according to the pattern. That part of the spring from the "count" mark to the end will be concentric. Using the two pairs of tweezers hold the spring at the end of the incline and lever up the terminal curve until it is parallel with the other coils of the spring as shown in Fig. 5. The shape of the curve is also governed by the distance the regulator pins are from the centre of the jewel hole. When the pins are almost in a line with the circumference of the spring, the curve will have a straight section. This straight section is reduced to an even curve the nearer the pins come to the centre. The completed hair-spring should now be replaced on the balance, the balance put in the watch and the bridge screwed down. The "count" mark should be placed between the regulator pins, the end of the spring, if the

curve has been made properly, should now be in line with the pinhole in the stud, and should only need the slightest touch to put it in the hole. Make a small pin in the same way as described for pinning the spring to the collet, and secure the spring to the stud, not tight, however, until the regulator moves freely without altering the shape of the spring.

#### Temperature Tests

Temperature tests are made in an ice-box at about 30° Far. and in an oven at about 90° Far. and last for 24 hours, any adjustment is made by moving the temperature screws to or from the free ends of the balance rim, as previously described. A test in a middle temperature is advisable to restore the balance to its original position. There are a number of positional tests, the usual being pendant up, pendant down, pendant right, pendant left, dial up and dial down. The time of the vibration should be the same both in the long and short arcs. In other words, it should be isochronous. The vertical positions lessen the arc of vibration. If there are no errors due to faulty escapement, pallets out of poise, bad jewel holes, or ruby pin too tight in the fork, the quarter screws can be screwed in or out as required.



Fig. 1.—How the blade should be held against the grinding wheel.

THE cutting action of a pair of scissors is what is termed "shearing," and in order that this action should be effective the edges of the two blades must pass each other in close contact from end to end of the cutting. To ensure this the blades are slightly hollowed and curved towards each other, so that when nearly half open they appear in side view as in Fig. 2. The pivot at the base of the blade should hold them together closely.

of the blade. (See white dotted line.)

Separate the blades by removing the pivot and treat each one similarly. Fig. 1 shows how the blade should be held in the right hand and pressed against the wheel with two fingers of the left hand.

Unless the scissors have been badly treated so as to become notched on the arris A, Fig. 3, there is no need to grind that edge.

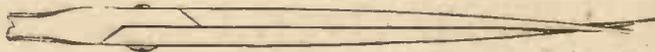

Fig. 3.—An enlarged section of a worn blade.

Scissors become blunt usually owing to the pivot becoming loose, in consequence of which the blades wear each other away at the cutting edges, so that in time the two extreme edges fail to meet closely.

Fig. 3 shows an enlarged section of a blade that has become worn in this way, the black dotted lines indicating the original section.

#### Restoring the Cutting Edge

To sharpen, therefore, the curved faces of the blades must be ground until the cutting edge is restored to its original

## Sharpening a Pair of Scissors

### Hints on Grinding and Adjusting Scissors

condition. This is best done with an emery wheel (or carborundum), and must be done with a clean run from end to end

emery cloth glued on its face mounted in the lathe will serve for the grinding, in which case it is well to work with two grades, a coarse one first and a finer one for the finishing.

(Continued from page 192)

carrier 'plane by rubber bands round the fuselage hooked on the hooks shown. Make sure that it is firm and see that the centre of gravity of the 'plane is in the same position with it as without it. Now try gliding the 'plane and then flying it. When trimmed to your satisfaction the whole is ready for a try-out. The watch is given about a dozen winds—enough to make the disc revolve once—and the switch set. The smaller model is then wound and its prop held by a rubber band looped over one blade and one under-cart leg or other suitable place. It is then put in position and the pins put through the holes in the wheels. Now the carrier is wound and all is ready for launching. The time switch is started and the models launched in the usual way. They will separate after about ten or fifteen seconds.

Using a high powered model like the J.B.3, as carrier, it is quite easy to make the models R.O.G. from a smooth surface. It is, in fact, easier than hand-launching as it is easier to deal with the switch and two props when the models are standing on the ground.

#### The S.M.A.E. Diary

I AM glad to know that the S.M.A.E. have adopted the suggestions I made last month, and are including in their diary a list of affiliated clubs, dates of competitions, and technical information. I do, however, suggest that for a diary to be really useful it should be produced not later than December of each year, and perhaps next year this can be done. This will mean, of course, that the annual date fixing conference will need to take place not later than September, and there is really no valid reason why next year's competitions should not be fixed in that month. They are in most other sports

# THE 'CARDIOPHONOSCOPE'—2

By F. Britton, D.Sc.

An Automatic Counter Recorder for Use With a Cardiometer or any Impulse Generator

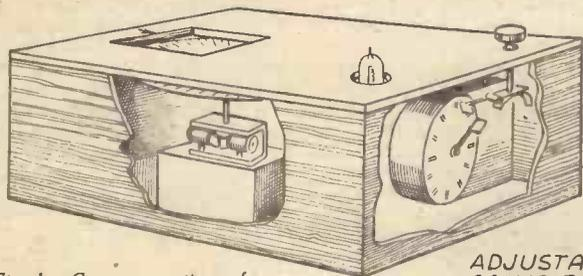

Fig. 1.—Cutaway section of Cabinet showing phonic-wheel with calibrated disc in position under the panel.

CONTINUING the details of the instrument described in the September issue of PRACTICAL MECHANICS, there are one or two practical applications regarding the cardiophonoscope. It was mentioned that a further development lay in the projection of an impression on to a screen with the aid of a projection lantern. We will deal with that scheme first. It is illustrated in Fig. 3. Now this represents the visual recording of the heart-beat to an audience and should be very useful for class demonstration. It will be noticed that the leads from the relay and battery are shown on the right; these pass to the horizontal solenoid, the core of which actuates a rod attached to the movable slide (shown shaded) illustrated in detail in Fig. 5. The shaded slide in Fig. 5 is the fixed one, on which a careful diagram of the heart is drawn in one of the inks used for writing on glass—preferably black. The two lower halves of the heart diagram are shaded in red and blue; these represent the left and right ventricles. On the moving-

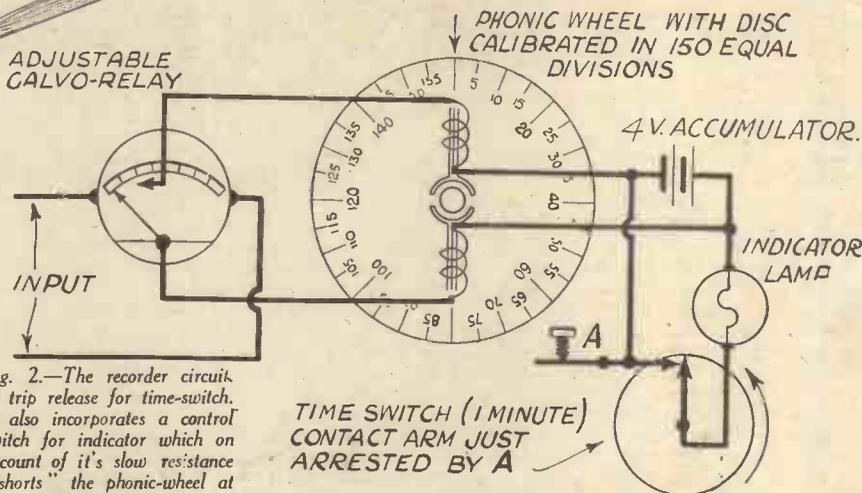

Fig. 2.—The recorder circuit. A trip release for time-switch. It also incorporates a control switch for indicator which on account of its slow resistance "shorts" the phonic-wheel at a corresponding division.

**The Recording Counter**

Reference to Fig. 2 will give an idea of the circuit employed. It will be obvious that a fairly sensitive galvanometer will be required. Actually only the movement itself is necessary—these may be procured for about five shillings. The contact arm should be made adjustable, so that the instrument contacts are closed at a pre-set current value. I would advise a moving-coil

movement owing to its freedom from interference from magnetic fields external to the apparatus. The leads from the relay-galvanometer are attached to the adjustable contact and also the needle—this may be effected by soldering a fine wire on to the screw holding the hair-spring of the moving-coil. These two leads are connected to the phonic-wheel, which consists of a lightly pivoted wooden spindle having two thin iron pole pieces fixed on it balanced between the pole-pieces of two small electro-magnets in series with a four-volt battery. The spindle of the phonic-wheel has attached to it a large cardboard disc on which is drawn a number of figures from nought to 150 at equal divisions apart. These represent (if the instrument is to be used for the cardiophone apparatus) the rhythmic contractions of the heart.

It will be seen that this phonic-wheel is controlled by the time-switch, which cuts out the wheel at the end of one minute.

**The Time Switch**

The design of this switch is very simple and will need very little description. It

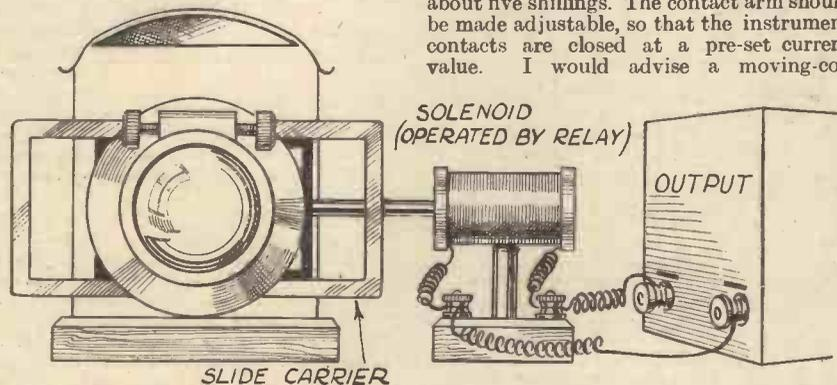

Fig. 3.—Projection lantern arrangement with moving slide (shown shaded). The fixed slide with heart in simple outline is behind the moving slide.

slide diagram the lower quarters are shaded blue and red, respectively, so that when this slide covers the fixed one it appears on the screen as though the left and right auricles are relaxing while the left and right ventricles are contracting (the blood being squeezed out of them), so that they appear both the same colour, the blue and red being superimposed.

So much then for the development of the cardiophonoscope for screen work and demonstration. The two diagrams, Fig. 3 and Fig. 5, should make the working of the attachment quite clear. I now deal with a simple recording device which may be applied to many types of amplifying instruments used for the reception of minute impulses—whether they be biological or purely physical.

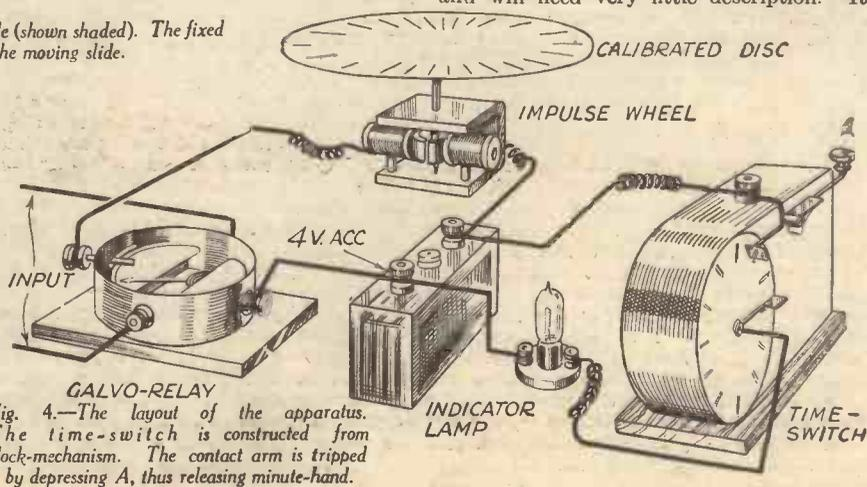

Fig. 4.—The layout of the apparatus. The time-switch is constructed from clock-mechanism. The contact arm is tripped by depressing A, thus releasing minute-hand.

is made from an ordinary clock-mechanism, the seconds hand being the one used for closing the circuit shown. A light piece of copper foil is soldered on to the hand and makes contact with a similar copper stop arranged to intercept it when it has rotated exactly once round the dial (one minute). This contact is pivoted so that on depressing the release knob shown at A Fig. 2 the seconds-hand is permitted once more to move on. The circuit from the time-switch incorporates an indicator-lamp; both switch and lamp being shunted across the same battery that operates the phonic-wheel. The lamp used must be a low-resistance one so that it virtually "shorts" the phonic-wheel. Thus, after one minute the seconds hand is arrested and closes the contacts, completing a by-pass circuit through an indicator lamp which immediately gives warning that a record of a minute's duration is completed. At the same time, the device automatically cuts out the phonic-wheel and so brings the disc to a stop at the appropriate figure which indicates the number of impulses which have passed through the galvo-relay.

If the contact arm on the time-switch is made adjustable the switch may be arranged to operate at any particular interval of time; the indicator lamp coming into action at precisely the point required while a direct reading will be furnished by the graduated disc. Naturally the number of divisions on the disc is purely arbitrary; the experimenter may have any number that he desires. In the present case the number—150—was for the purpose of registering the heart pulsations. As regards the winding of the electro-magnets of the phonic-wheel, quite a small number of turns will be found sufficient—about ten—but the experimenter should test this so that the most positive movement can be given by the armature. This movement should not be sluggish but immediate and sharp. A sluggish movement on the part of the armature is more often due to poor contact at the relay end of the apparatus and not

to the bearings of the armature, although this must be attended to. Should the investigator prefer it he may purchase these phonic-wheels from any of the well-known scientific instrument manufacturers. Messrs. Beckers of Hatton Wall, London, supply them listed at 12/6 each. In their construction it must be borne in mind that they are liable to move too freely immediately the relay circuit is closed and so may require only a very small battery to operate them. The home constructor

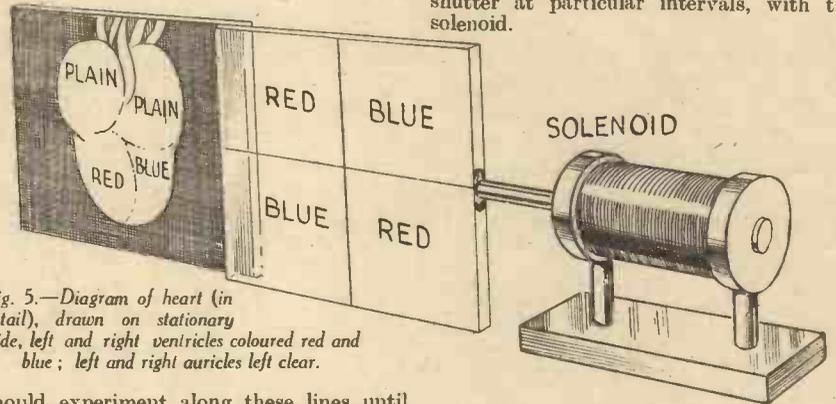

Fig. 5.—Diagram of heart (in detail), drawn on stationary slide, left and right ventricles coloured red and blue; left and right auricles left clear.

should experiment along these lines until he had perfected the movement.

#### Applications of the Recorder

The uses to which the counter may be put are many, and no doubt, the experimenter will naturally apply the instrument to his own particular work. In some experiments it is necessary to measure the accumulated charge generated by certain reacting substances and to condense the total charge with the aid of a condenser of suitable capacity, discharging the latter through the counter. In order to record rapid variations of potential it is necessary to use an oscillograph—at least for direct visual effect. Nevertheless even in these cases it is quite possible to store up a charge

of energy in a condenser and to discharge it through the recorder; but it must be remembered that the time-factor in the case of a condenser discharge is out of all proportion to the registration of current by means of the present instrument.

Another development of the instrument might be on the lines of a shutter mechanism operated by the relay after the style of the diagram Fig. 3. but operating a camera loaded with a roll film, or at least a moving film—exposure taking place by opening the shutter at particular intervals, with the solenoid.

It might be advisable to add that while experimenting with the lantern attachment, trial should be made with lamps of different colours to obtain the most striking effect on the screen. My own lantern gives quite a good and clear definition of the image 4 feet square at a distance of 12 feet using 150 c.p. ordinary metal-filament lamp. The lantern attachment may be used in conjunction with a loudspeaker to impart an actual visual and sound impression as mentioned in the former article; while for the operator's own use he may make his own observations and remarks to his audience by reference to the counter-recorder.

#### Side Exits for Sound

THE motor horn, though condemned to nocturnal silence, during the day still adds its quota to the Dutch concert of the streets. As its warning toot is a necessary evil, it is important that its vocal chords should be kept effective. Usually the outer end of the horn is fitted with a wire gauze screen to prevent obstruction of the horn by insects or dust. In wintry weather, the screen may be covered with snow.

An inventor has applied in this country for a patent for a motor horn, which he maintains will operate satisfactorily even when the screen is completely blocked with snow or other matter. This horn has perforations behind the screen so that in case of a block in the traffic of sound, the music comes out by a side turning.

#### Toy Armoured Cars

SOME good people, who deplore the spirit of militarism, may think it is instilled in the minds of the young when they play at soldiers. But it is difficult to wean the juvenile from this particular form of make-believe. As a consequence, there is likely to be a continual supply of toys which meet this demand on the part of the youngster. A toy armoured vehicle, invented by a German, is the subject of an application to the British Patent Office. This device has clockwork mechanism for the simultaneous production of reports and corresponding sparks to imitate gunfire. In addition, a rotating control member

## OUR BUSY INVENTORS

(See also page 227)

causes the mechanism periodically not to operate. This ensures successions of reports, and sparks with intervals of non-firing. Thus the toy is made exactly to resemble, on a small scale, a full-sized armoured car.

#### Packing by Machinery

IT is the usual practice in the mechanical wrapping of tablets or sweets to eject the wrapped articles in a container. From this they are removed and packed by hand. There has been submitted to the British Patent Office an apparatus which collects and banks sweets and other small articles. The machine then places them in boxes or cartons upside down. After these receptacles have been filled, they are turned the right side up. So mechanism yet further encroaches upon the manual. But, though the ingenuity of the inventor decreases the number of hands required, the resultant cheaper production benefits the general community. The ideal of political economy as Jeremy Bentham taught, is "the greatest happiness of the greatest number."

#### Not New, But Improved

THE origin of many inventions is lost in the obscurity of the far past. The Chinese are said to claim to have been the devisers of certain common objects. For example, it is on record that the idea of a wheel was first suggested to the mind of a Chinese emperor, when he saw a leaf rotated on the ground by the wind. It is possible, however, that many inventions were thought of independently in different parts of the world. The old saying that there is no new thing under the sun is largely borne out by the specifications of the British Patent Office, in the headings of which the word "improvement" so frequently occurs. But inventions more or less old, but characterised by some new feature, appear to be inexhaustible.

According to tradition, the father of invention was Vulcan, the god of the ancients, who presided over fire and was the patron of all artists who worked in iron and metals. There is an amusing story told of this deity. It is said that his first work was a throne of gold with secret springs. This he presented to his mother, Juno, the Queen of Heaven, to avenge himself for her want of affection towards him. Juno was no sooner seated on the throne than she found herself unable to move. Many ambitious people have desired to occupy a throne. But a throne which sticks to one like a limpet to a rock is too much of a good thing.

DYNAMO.

# SUCCESS IN ENGINEERING

One of the following Courses taken at home in your spare time can definitely be the means of securing substantial promotion in your present calling, or entry into a new and more congenial career with far better prospects. We have helped thousands of others to success. Why not let us do the same for you—you should at least investigate the opportunities we can place within your reach—it will cost you nothing to enquire.

## ENGINEERING

- Inst. of Electrical Engineers, A.M.I.E.E.
- Inst. of Wireless Technology, A.M.I.W.T.
- Inst. of Civil Engineers, A.M.I.C.E.
- Inst. of Structural Engineers, A.M.I.Struct.E.
- Inst. of Builders, L.I.O.B.
- Inst. of Sanitary Engineers, A.M.I.S.E.
- Royal Sanitary Institute, M.R.S.I.
- Inst. of Mechanical Engineers, A.M.I.Mech.E.
- Inst. of Automobile Engineers, A.M.I.A.E.
- Royal Aeronautical Society, A.F.R.Ae.S.
- London B.Sc. Degrees
- Wireless — Telegraphy — Telephony
- Electrical Engineering
- Television — Electric Wiring
- Talking Picture Work

- Works Management
- Building Construction
- Sanitary Engineering
- Sheet Metal Work — Refrigeration
- Motor Engineering
- Engineering Draughtsmanship
- Electrical Draughtsmanship
- Jig and Tool Draughtsmanship
- Die and Press Tool Draughtsmanship
- Structural Draughtsmanship
- Aeronautical Draughtsmanship
- Building Draughtsmanship
- Clerk of Works
- Building Inspection

- Weights and Measures Inspector
- M. & Cy. Engineers

## GENERAL

- Matriculation — Bookkeeping
- College of Preceptors
- Chartered Institute of Secretaries
- Massage — Institute of Hygiene

## CIVIL SERVICE

- Clerical (age 16-17)
- Executive (age 18-19)
- Tax Inspector (age 21-24)
- Patent Office (age 20-25)
- G.P.O. Engineering (age 18-23)
- Typist (age 16½-25)
- Customs (age 19-21)
- Board of Trade (age 20-25)
- Police College (age 20-26)
- Police Force (under 27)

## MUNICIPAL SERVICE

- School Attendance Officer
- Handicraft Teacher
- Registrar — Relieving Officer
- Sanitary Inspector

If you do not see your requirements above just explain what they are. We are able to advise on all branches of Engineering, Civil Service, Municipal Work, etc.

### Become a Draughtsman AND EARN BIG MONEY



Numerous vacancies are now available in Electrical, Mechanical, Structural and other Branches of Engineering, Building, Civil Service and G.P.O., etc., for men age 17-40. Practical experience is unnecessary for those who are willing to learn—our Guaranteed "Home Study" courses will get you in. Those already engaged in the General Drawing Office should study some specialised Branch such as Jig and Tool or Die and Press Tool Work and so considerably increase their scope and earning capacity.

### THE ACID TEST OF TUTORIAL EFFICIENCY: SUCCESS — OR NO FEE

We definitely guarantee that if you fail to pass the examination for which you are preparing under our guidance, or if you are not satisfied in every way with our tutorial service—then your Tuition Fee will be returned in full and without question. This is surely the acid test of tutorial efficiency.

If you have ambition you must investigate the service we are able to offer. Founded in 1885, our success record is unapproachable.

Why not fill in and post the attached coupon for further details and free authoritative guide to openings in Engineering, Civil Service or Municipal Work? These books contain a mine of valuable and exclusive information and may well prove to be the turning point in your career.

## NATIONAL INSTITUTE OF ENGINEERING

(Dept. 29)

STAPLE INN BUILDINGS  
LONDON, W.C.1

FIFTY-THREE YEARS  
OF  
CONTINUOUS SUCCESS

SOUTH AFRICA BRANCH: E.C.S.A., P.O., BOX 8417,  
JOHANNESBURG.

## COUPON

To NATIONAL INSTITUTE OF ENGINEERING (Dept. 29),  
Staple Inn Buildings, London, W.C.1.

Please forward your FREE Guide to:—

NAME .....

ADDRESS .....

My general interest is in : **ENGINEERING,** (Place a cross against  
**MUNICIPAL WORK,** the branch in which  
**CIVIL SERVICE** you are interested.)

The subject or examination in which  
I am especially interested is.....  
(To be filled in where you already have a special preference.)

**Founded 1885 - - - Over 85,000 Successes.**

(½d. stamp only required if unsealed.)

SOUTH AFRICA BRANCH E.C.S.A., P.O. BOX 8417, JOHANNESBURG

# THIS HOBBY of MODELS is CONSTRUCTIVE

**ALWAYS COMPLETE BUT NEVER FINISHED!** RESOURCE — INITIATIVE — FUN — ALL

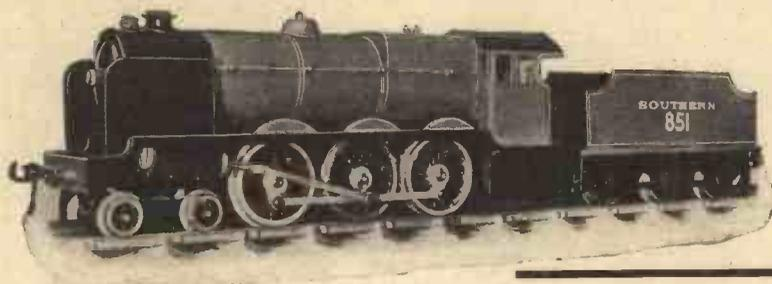

PLAY THEIR PART in the hobby of models. We make and supply railways from gauge "00" (the Twin Trains, which you can run on your dining table!) to gauge 9½ inches (passenger-carrying railways for the garden hauling 50 passengers!). SHIPS of every type and price are made in our Model Shipyard at Northampton.

## GAUGE "O" RAILWAYS



**L.M.S. 4-4-0 LOCOMOTIVE No. 601**  
In producing this model we have had in view exactly the same idea as the L.M.S. railway itself, an inexpensive locomotive capable of traversing sharp curves and negotiating other difficulties on those model lines which are of necessity confined to a limited space. Electric d.c. (8 volts), £2.7.0. Electric d.c. (8 volts) spur drive, or a.c. (20 volts). £2.2.0. Clockwork

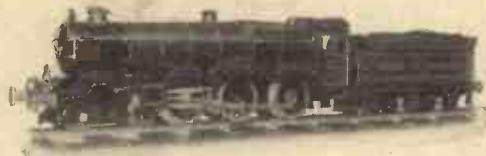

**G.W.R. 4-6-0 EXPRESS "KING GEORGE V"**  
Among locomotive enthusiasts the Great Western "Kings" may well claim to be the most popular express locomotive type ever built in this country. Here is a superb model of this attractive-looking locomotive. Clockwork and electric d.c. (8-10 volts) £8.8.0. A.C. (20 volts), complete with controller for distant control, £9.18.6.

## SHIPS



### "STREAMLINIA"

For years there has been an unsatisfied demand for a commercially made fast motor-boat of modern design, and here is our answer—Streamlinia! Metre size with chine hull, she only draws ¾ in. when loaded, and with her slipper stern and shell back deck, gives a vivid impression of speed! WHY NOT BUILD STREAMLINIA? Complete set of parts costs £8.8.0 and the finished tested model £9.9.0

Our Model Boat Department provides a wide range of reliable and true to scale models of ships of all types, and with but few exceptions all the models and fittings in our Catalogue of Model Ships are made in our own works in England with British labour.

SEND NOW for S.12 of Model Ships. 6d., post free.



## —THE TWIN TRAINS

In the three short years since its introduction the Twin Train Railway has grown to be the most popular and the most realistic miniature railway system yet devised. You have heard of the new scale models of the T.T.R., but our standard trains are still as good as ever and here we show the T.T.R. Express Passenger Set.

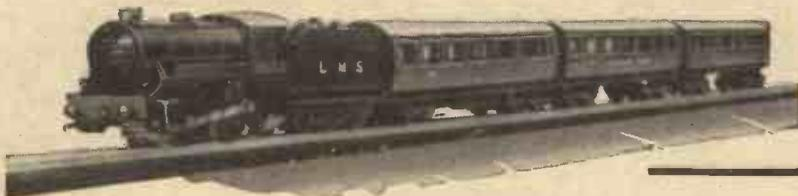

For all details of the Twin Trains get TT.12. Price 2d. The Twin Train Passenger Set, available in L.M.S., L.N.E.R. and S.R. colours. Price 39/- rails extra.

A wonderful new publication, fresh from the presses; devoted entirely to Gauge "O" railways. Fully illustrated in two colours and over 40 pages. You must send for a copy! Ask for G.R.12. Price 3d.

Our Gauge "O" Steam "SUPER ENTERPRISE." Price £3.17.6

# BASSETT-LOWKE LTD. NORTHAMPTON

LONDON: 112, HIGH HOLBORN, W.C.1. MANCHESTER: 28, CORPORATION STREET



# A MODERN "LONG JOHN SILVER"

By W. J. Bassett Lowke,  
M.I.Loco.E.

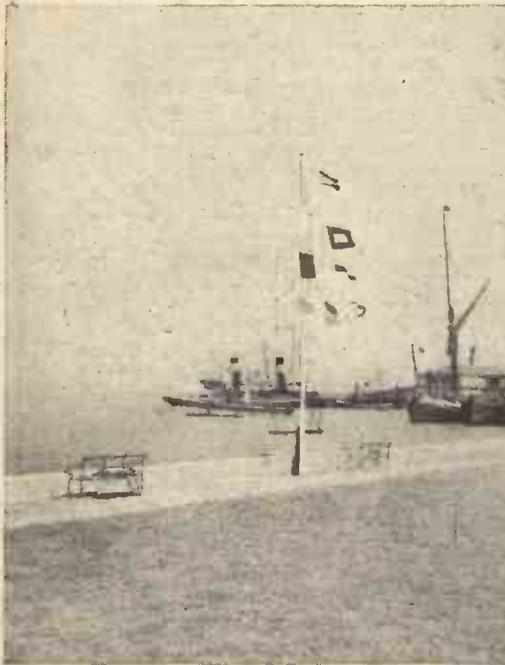

(Above) The main signal staff on the lawn flying the message referred to in the article. (Right) The view from the bridge showing the shrimp cawleys in Bawley Bay, the Watkins tug "Gondia" and C.P.R. liner "Montcalm."

Captain Silver, who is a well-known figure in shipping circles.

HAVING a few hours to spare a short time ago I decided I would pay a visit to my old friend, Capt. Silver, a well-known figure in shipping circles, who has one of the most unique week-end residences I know at the old-world town of Gravesend.

He has taken a small house adjoining the Clarendon Hotel and converted it into a

## "C" Deck

The bridge, or upstairs part of the house, is on "C" Deck, and we reached it by means of an accommodation ladder—there was a notice with the words, "For Navigation Purposes Only—Passengers Are Not Allowed on the Bridge." I must have been favoured because I "walked" these sacred boards that afternoon, which, by the way, were laid by one of the oldest boat-builders in Gravesend. A warning attracted my attention, "Anyone caught putting ash or cigarette ends down any ventilators will be thrown overboard"—I laughed with "the Cap'n" at this little joke of his, but hastily

## Our Contributor Pays a Visit to the Unique Residence of Capt. Silver, which has been Converted into a Fascinating Replica of an Ocean Liner



most fascinating replica of an ocean liner with all the different aspects of a ship, and ship's life. It is called "The Look Out" and in front of the fanlight is half a wheel and a ship's mast-head light. Capt. Silver is known locally as "Long John Silver"—and how well he justifies that title.

I was greeted at the foot of the "gangway" by my host (in reality at the front door with "Gangway" painted over it) and as we entered we passed on either side the foc's'le and the poop and the crew's quarters. I noticed the chairs in the foc's'le and was told they were originally a part of the last sailing ship to serve as a seagoing flagship, H.M.S. *Ganges*—I glanced at them again, with renewed interest, but little realised what wonders I had still to see before leaving this amazing vessel.

(Above) The "Valhalla," a room full of interest and romance. The figure-heads on the portside are: "Golden Cherubs," "Ophis" (King Solomon) 1867, "The Bride" 1863 and "Beda," Norwegian Barque Circa 1870. On the starboard side: "Maria Christine" (French), wrecked off Padstow, 1934. Under her, "Girl of the Period," "Persian Empire" and "Gravesend" (topsail schooner). (Right) Looking forward from the bridge over the Thames.

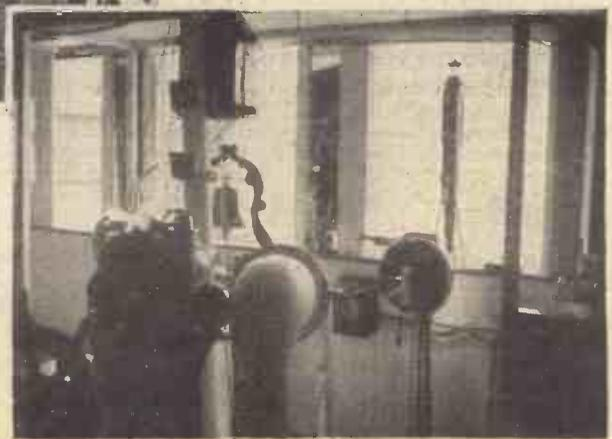

stuffed out my cigarette before following him on to the bridge! I might say here that, to add to the already bewildering realism, special tanks of water are fitted behind the portholes in which there are live fish swimming about.

#### Signalling

The ship's bridge overlooks the Thames, and there is nothing between the house and the river except a road and delightful lawn—the only lawn abutting the Thames in Gravesend. On the left is a small bay for eel and shrimp boats, and in the centre of the lawn is a flagstaff, which has "Long John Silver's" House Flag at the head, and

steam yacht *Alacrity*, and the *Maltese Cross*. The wheel is from the *Umfuli*; the rail on the deck house from one of the first motor liners *Jutlandis*, and the funnel is a model of a Glen—the *Glenogle*. A background of scenery representing the "rolling main," with Bishop's Rock Lighthouse in the distance, adds still more realism to this already amazingly accurate representation of a bridge.

#### The Chart House

The chart house is situated at the end of the main lounge.

But it is the main lounge itself—or "Valhalla" as it is called, which is the heart

*Ganges*). A wheel from the Trinity House yacht *Triton* (1901) also has its place in this veritable "treasure trove."

In "Valhalla" there are, besides the wonders already mentioned, numerous models and photographs, and a souvenir of that ill-fated ship *Titanic* in the shape of one of her lifeboat's life lines.

#### Back to the Middle Ages

I was entertained to tea in the luxury suite of the ship which is decorated in the Moorish style. Many of our ship owners of to-day like to go back to the Middle Ages in their decoration and "Long John Silver" has followed their lead.

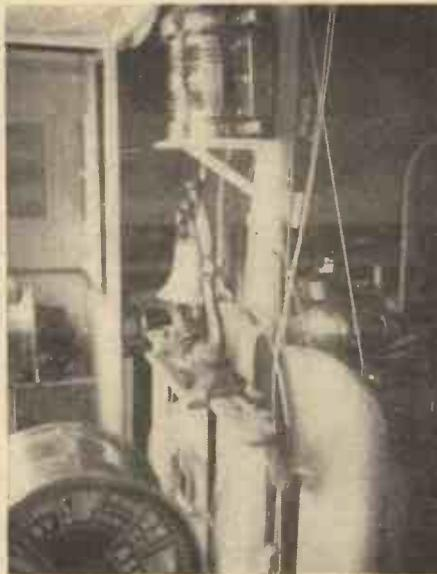

(Left) Portion of the Bridge. The binnacle in the foreground is from the tug "Hussar." (Centre) The Bell of the "Mauretania" on the Bridge. (Right) The Bridge showing the ventilators from the S.Y. "Alacrity," the wheel from the "Umfuli" and the model of the funnel of the "Glenogle," also the rail from the "Jutlandis."

from which he does his signalling. On this particular day I had been down to Tilbury to see some friends off on the *Atlantis*, and, as she sailed by, Capt. Silver's lawn he signalled the following:—

	Q	P	
Welcome	K	Y	Good voyage
	F	U	
	H	—	Pilot aboard.

I was amazed at the detail I found on the bridge—nothing had been considered too unimportant to be included. The bell is from the famous Cunarder *Mauretania*; the sidelights were once a part of the Kaiser's yacht *Imperator* (later named *Welcome*); the mast-head light is from the A.T.L. *Maine*. There is a binnacle from the tug *Hussar* and ventilators from the

of "The Look Out." It is full of the most wonderful treasures and souvenirs that any lover of the sea and ships could wish to find. There are numerous figure-heads, including "Golden Cherubs" (carved by Grinlin Gibbons in 1643, and the oldest merchant ship's figure-head), "Beda," which is the largest in this amazing collection and named after a Norwegian goddess—once the figure-head of a Norwegian barque circa, 1870—and "Girl of the Period," over 150 years old *Persian Empire*. From many famous boats, including *Orotava* and *Wooloomooloo*, there are, round the walls of "Valhalla," a number of lifebuoys. The portholes were once a part of the Tanker *Excelsior* (and there are some more tub seats from H.M.S.

How little we know of the hobbies of others until we come into direct contact with their private lives and, as in the instance of my friend, Capt. Silver, the place they have planned and designed to give them pleasure in their leisure hours.

I left this unique spot, with all its romance and atmosphere of the sea, with one regret—that I had allowed myself too short a time to even glance at the many relics and fascinating models, and I made one vow—that I am going to visit "Long John Silver" again at this week-end retreat he has created for himself, with its museum of priceless treasures connected with the sea through the ages, overlooking the Thames, and its moving panorama of shipping.

## RAILWAY EXHIBIT FOR LONDON

"O" Gauge Enthusiasts will be interested as they will be able to see what is one of the Finest Railways of this Gauge

THOSE who were not able to pay a visit to the Glasgow Exhibition this summer, will have the opportunity of seeing a portion of the big working model railway, constructed by Bassett-Lowke, Ltd., in the British Railway Pavilion, in London this Christmas.

The layout, naturally, has had to be modified and the whole exhibit and scenery rearranged, to make it possible to incorporate the railway in this more limited space, but the four trains of the different railway groups will be shown working as they were at Glasgow. They are the L.M.S. "Coronation Scot," the L.N.E.R. "Coronation" train, the G.W.R. Cornish Riviera express hauled by a model "King George V" and the

Southern Railways' electric "Southern Belle."

From December 21st to January 14th this railway layout will be on view at the entrance to the Charing Cross Station of the London Underground, and gauge "O" enthusiasts will be interested to see what is one of the finest railways of this gauge with examples of the four leading railway companies' express trains, modelled commercially.

#### Model Railways

BASSETT LOWKE, LTD., the well-known model railway specialists, have just issued a comprehensive and well-illustrated catalogue of gauge "O" model railways, priced 3d. One page

of the catalogue is devoted to Twin Trains, whilst on other pages are listed replicas of many famous engines.

"O" gauge is considered the most popular gauge, for in this size you can command an immense variety of locomotives and rolling stock at prices ranging from a few shillings for a clockwork engine, to the finest super-detailed model costing up to £100. It also gives you a choice of three methods of propulsion: clockwork, electricity and steam.

Glancing through the pages we were amazed at the realistic appearance of the numerous models and at the wide range of rolling stock, etc. There are all types of model signals listed and they are correct in every detail and represent the latest standard railway companies' practice. They have practically no iron in their construction and can therefore be used for indoor and outdoor railways.

# A DIVIDING PLATE FOR A LATHE

THE making of a dividing plate by means of which the lathe can be used with a milling spindle attachment for cutting gear wheels, or other work, where accuracy of circular distances is important, is generally considered a very delicate operation if the maker has no master plate from which the setting out of the plate can be done. But for all ordinary purposes in the workshop it is quite possible to set out and divide a plate (which will ensure an accuracy within limits quite close enough for good work) by methods which do not necessitate an elaborate and super accurate master plate or micrometer worm-operated gear.

The method employed is to reduce the chance of error in dividing the circles by doing the actual dividing on a circle much larger than the circles of the dividing plate itself. The illustrations show the arrangement.

## The Circular Plate

Fig. 1 shows the circular plate which it is proposed to divide. It will preferably be of hard rolled brass plate,  $\frac{1}{8}$  in. thick and of the diameter suitable for the lathe. The larger the diameter the nearer the approxi-

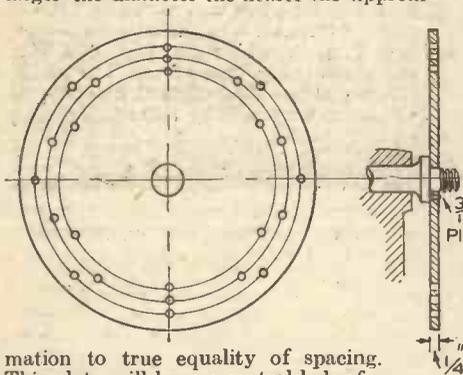

mation to true equality of spacing. This plate will have a central hole of a diameter to fit—a push fit—on the plain part of the lathe mandrel nose in front of the shoulder. It is located by a  $\frac{3}{16}$  in. pin of silver steel. This pin is sweated in a hole in the dividing plate and registers with the hole in the mandrel collar or shoulder as seen in the edge view in Fig. 1.

To effect this the blank or casting of the plate is chucked on the largest face plate running in the lathe bed gap. It should be packed off the plate by packing  $\frac{3}{8}$  in. thick and bolted down by dogs. The hole is drilled and then bored with an inside tool. The size will be taken by micrometer off the lathe mandrel nose before the job is started and a mild steel plug-gauge turned of exactly the same diameter as the plain part of the mandrel nose.

This plug gauge will be used to gauge the hole in the plate and the hole will be turned parallel. The plate is then held on the nose of the lathe mandrel and a  $\frac{1}{16}$  in. hole is drilled through the plate into the mandrel shoulder. This hole is then opened out (by drilling) to  $\frac{3}{16}$  in. It should also be  $\frac{3}{16}$  in. deep in the lathe mandrel collar. The pin in the plate is driven in and sweated and filed off flush in front and eased on the rear projecting part so that it fits, without shake, in the hole in the mandrel. The plate is held in place by the three-jaw chuck or by the catch plate (according to whether the work is held by the chuck or between the lathe centres) and is turned and faced.

## Scribing Rings

Concentric rings are now scribed around

## A Dividing Plate by Means of which the Lathe can be used with a Milling Spindle Attachment for cutting Gear Wheels, or other work.

the plate  $\frac{1}{4}$  in. apart (Fig. 3). The scribe should be held in the tool post and the mandrel pulled round by hand to scribe these circles, which must not be deep. The next job is dividing the plate. Stepping round the lines with a pair of dividers is not accurate enough on this small diameter, and in order to get the needed accuracy the following method is to be adopted. It seems a long method, but it is the only one which will give us the accuracy we want, failing the use of a master dividing head. It is shown in Fig. 3.

The plate A, to be divided, is sweated at its edges, i.e. tacked with solder, to a large

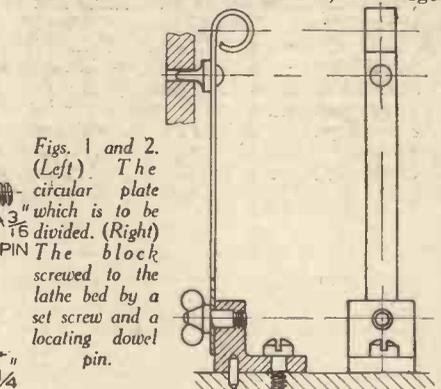

sheet of tinned metal sheet, B, which should be of a size to take a two-foot or larger circle. A hole is cut in the centre larger than the hole in the plate, A, to be divided. But before cutting the hole, as many circles are scribed on the large plate as there are circles to be divided on the dividing plate. The hole in the division plate is fitted with a turned plug, Z, of brass, and to this plug is pinned and sweated a straight edge, Y, which will lie flat on the dividing plate, A, and is cranked down  $\frac{1}{4}$  in. to lie flat on the plate, B.

Thus the straight edge can be pulled

round the circles, bedding on the division plate and the big plate so as to closely touch each as shown in Fig. 4.

## Drilling Operations

With a pair of sharp pointed dividers mark off the requisite number of divisions on the big circles and very lightly centre-punch them with a sharp centre punch. The three circles will have 30, 50, and 80 holes, or multiples of 6, 5, and 4. (Our drawing, for clearness, shows 6, 10, and 8 holes in the middle, centre, and outer circles respectively.) These centre-punch marks are then carefully drilled with a  $\frac{1}{8}$ -in. drill.

The straight edge, Y, is scribed from the centre of the plug in three lines as shown. These represent the three circles on the big plate and on a line radial to the centre of the plug where they cross the lines we drill  $\frac{1}{8}$ -in. holes and open them out to take the turned guide bushes. These are turned with a shoulder and have a  $\frac{1}{16}$ -in. bore dead concentric with the outside. This bore acts as a guide to the guide plug, which will be turned to exactly fit the bore of the guide or bush, and have its end turned down to  $\frac{1}{4}$  in. and rounded so as to engaged with the holes in the big plate. The guide bushes are pressed into the straight edge and sweated and riveted over in a countersink, as shown in the enlarged view, Fig. 5.

It will be seen that by using this arrangement we can locate the rotatable straight edge, Y, so that the edge at X will cross the three circles on the dividing plate, A; and with a fine scribe we can draw a radial line on any of the three circles to correspond with the hole in the big circles, because the outer end of the straight edge is plugged into the holes in the big circles by the small-ended spindle in the guide plug.

Thus each circle on the plate we are dividing will be accurately scribed for centres for drilling. The scribe should have a long, fine point. The straight edge, X, should be in close contact with the plate and the scribe point should be dead close up to the bottom edge of the straight edge at X (Fig. 4).

## Reducing Error

It will be noticed that by using large circles to be divided by the dividers we reduce the chance of error on the small circle. If the large circle is four times the diameter of the small circle, the error—if there is one—in marking off will be the same angular error as on the big circle. If we made the same error on the circles of the plate itself the angular error would be

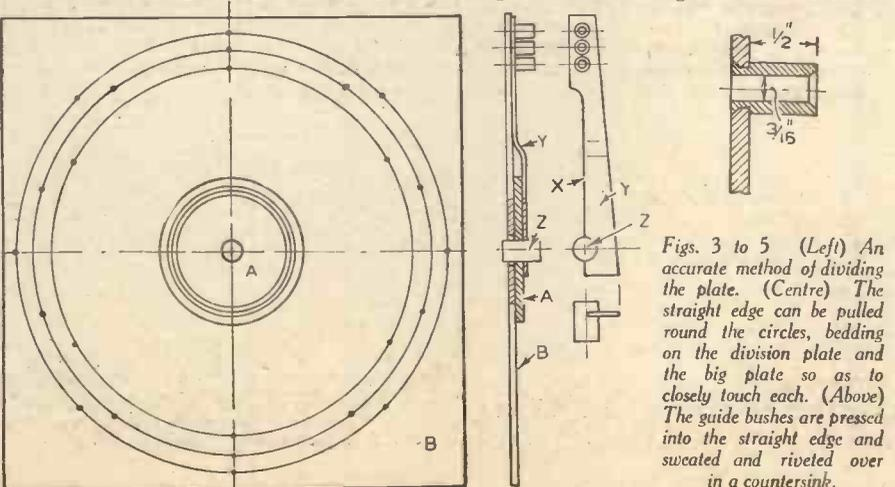

four times as great. Therefore the larger the circles on the big plate the more accurate the divisions on the small plate.

The points of intersection of the radial line decided by the straight edge should be very carefully punched with a sharp centre punch, using a magnifying glass to ensure that the punch mark is dead coincident with the crossing. This is of the greatest importance.

One-sixteenth inch holes are then drilled with a carefully ground, straight-fluted drill in a sensitive drilling machine. The drill should project out of the end of the drill chuck only sufficiently far to clear the

end of the holes through the plate, and then the holes are reamed out with a  $\frac{1}{8}$ -in. reamer to a stop on the reamer made of brass bar, with a grub screw to hold it, so that the reamer goes the same distance through all the holes. Finally the holes are slightly countersunk, as shown in Fig. 2.

To hold the plate in position, the spring stop shown in Fig. 2 is used. It is secured to a brass block by a stud and wing nut, so that it can be swung sideways to register with any of the circles of holes on the plate, and is clamped in that position by the wing nut. The blade is of spring steel, curled over for pulling by the finger and

thumb. The locating pin is of mild steel, case hardened at the end. It should exactly fit the holes in the division plate and a shoulder to bed up against the face of the spring blade. The rear end is turned to fit a hole in the blade, and is riveted over firm and solid with the blade.

The spring blade should be of good thickness and have a fairly strong spring pressure towards the dividing plate, so that the pip goes right through the plate. The block is screwed to the lathe bed by a set screw and a locating dowel pin—the latter engaging with a reamed hole in the lathe bed. This is shown in Fig. 2.

## HOW TO MAKE

# A METRONOME

If you are learning to play the piano by the new method described in these pages, you will find this instrument an excellent device with which to practise scales and exercises.

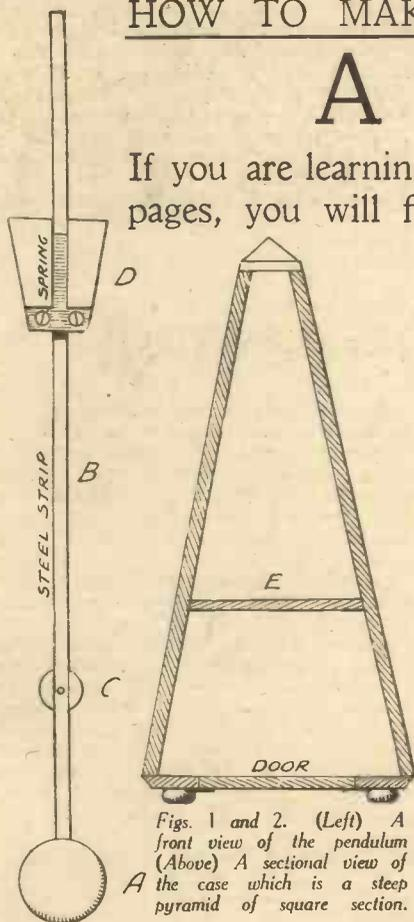

Figs. 1 and 2. (Left) A front view of the pendulum (Above) A sectional view of the case which is a steep pyramid of square section.

**T**HE metronome is a very simple piece of clockwork, but differs from a clock in the fact that its pendulum is weighted at a point above its point of suspension. Those who have used a harmonograph will know that the rate of a pendulum may be slowed down considerably by such means, which in the metronome makes it possible to use a short pendulum and thus ensure that the instrument is not unduly cumbersome.

Fig. 1 shows a front view of the pendulum. A is a small flat leaden weight firmly attached to the flat steel stem B, the length of which may be 7 in. At C, the point of suspension, is a brass boss, which carries the arbor shown in Figs. 3 and 4. This arbor not only serves as suspension for the pendulum, but has attached to it two pallets by which the escapement wheel is allowed to progress one tooth at a time at each beat of the pendulum.

### The Pallets

These are shown in Fig. 3 and are small flat steel plates, set one in advance of the other, so that when one leaves a tooth in the

escapement wheel, the other presents itself to the next tooth, which coming against it with some force makes an audible tick for the guidance of the player.

The escapement wheel is of the "pin-wheel" type—i.e., its teeth are brass pins set radially upon its periphery.

The escapement wheel arbor carries an 8 tooth pinion, seen in Fig. 4, which gears with the toothed wheel attached to the drum. This wheel has about 110 teeth.

### The Mechanism

Fig. 3 is a side view of the mechanism, and Fig. 4 a view looking from below, which shows the plate to which the parts

IF YOU CANNOT PLAY  
THE PIANO TURN TO  
PAGE 222 FOR DETAILS  
OF OUR SIMPLIFIED  
METHOD OF LEARNING

are fixed, but for clearness the inside bearing of the pendulum pivot has been omitted. This plate is screwed to the underside of the floor marked E in Fig. 2. A slot is cut through this floor to allow the head of the pendulum to vibrate freely in the space above.

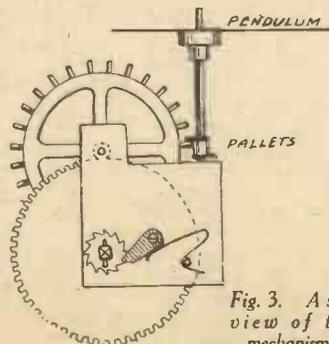

Fig. 3. A side view of the mechanism.

The spring barrel is provided with the usual winding square and ratchet wheel, and also with "stop-work" to prevent over-winding. The latter is a small toothed wheel pivoted to the head of the drum (see Fig. 4), which gears with a single tooth upon the drum arbor. The teeth of this wheel are discontinued at one point, which when reached by this tooth prevents further winding.

### The Lead Weight

Reverting to the pendulum Fig. 1, D is a leaden weight that slides upon the stem, controlled by the light spring shown at its centre.

Fig. 2 shows the usual form of case in sectional view. It is a steep pyramid of square section. The floor E is a fixture. The bottom has a door, clipped in place, to give access to the mechanism for lubrication and adjustments.

### The Head of the Pendulum

The front above the floor E also is removable so as to bring into view the head of the pendulum and to admit of adjusting its rate.

A scale of speeds is fixed behind the pendulum, and it is usual to mark it "presto," "allegro," "andante," etc.

A small brass plate should be fixed at the top of the case behind which the head of the pendulum can be slipped to stop it, and for safety in transport, and the case should be mounted upon 3 ball feet.

There is a vacant space behind the board that carries the scale which acts as a resonator to emphasise the beats.

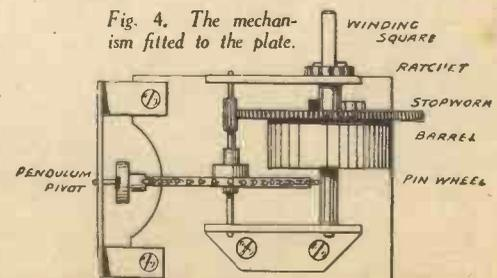
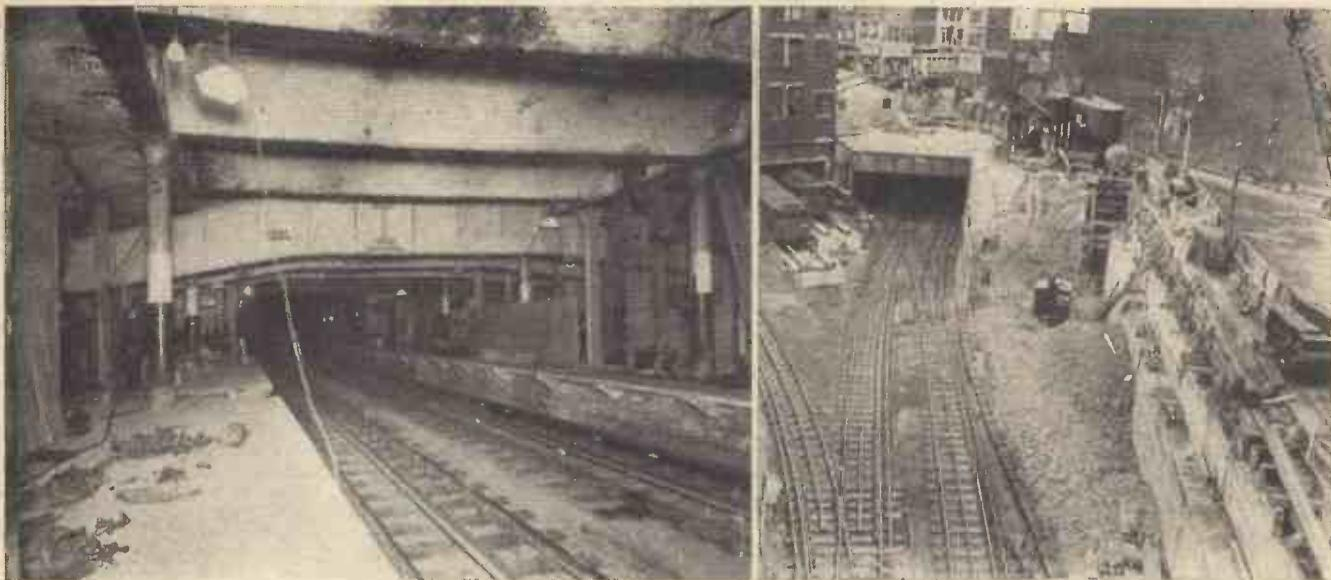

Fig. 4. The mechanism fitted to the plate.



(Left) Showing the main girders in position across the existing station to enable the south retaining wall and cast iron columns to be removed for widening. (Right) Demolition of part of the old station.

## A Miracle of Engineering

ONE of the bedrock principles of mechanics is that no chain is stronger than its weakest link. If the "chain" happens to be a railway system and one particular length of line, and its station, holds up traffic and causes delayed working at other points, then that railway is no better than its weak "link."

The problem of eliminating such a weak spot, faced the London Passenger Transport Board. Aldgate East station, nerve centre for the whole of the Metropolitan and District Lines, was required to "grov up." It had become a bottle-neck. Passenger accommodation on the Metropolitan Barking line had got to be increased by thirty three and a third per cent.; 38 eight-car District-line trains were to be run hourly.

### Trains Too Long

The trouble was, that trains were too long for the Aldgate East platforms. Forming the apex of a very small triangle of underground lines, those platforms were, of necessity, so short that their original accommodation, for six-car trains, had become altogether inadequate. When, in 1914, it became necessary to run trains of eight cars this could be done only by making an 18 in. wide extension of the platform into the tunnel, to allow passengers in the front portion of the train to get out.

Reconstructing the station to bring facilities up to modern requirements entailed gargantuan operations. Part of the new arrangements demanded that the station tunnel (under ground) should be widened to 70 ft., from 50 ft., so that the two tracks could be increased to four; the tunnel also had to be deepened, and, to all w of the lengthening of the lines, a new Aldgate East Station had to be constructed, 170 yds. east of the existing one, below the junction of two swarming East End streets.

The problems involved, included: the construction of the new, wider, and deeper underground tunnel without, meanwhile, interfering with the running of trains; the diversion of cables and mains—gas-pipes, telephone lines, water, electricity, sewers—serving a large portion of London, without any interruption of these essential public services; lowering the existing track a

distance of seven feet at the centre of the station, to allow of the building of two new ticket-offices above the tracks; and driving the new tunnel through the foundations of houses; which had to be provided with new foundations.

### A Huge Trench

Whitechapel High Street lies above the "run" of the underground railway. It was necessary to dig a trench 20 ft. deep and 1,400 ft. long on either side of that street. They divided it down the centre of the roadway with a hoarding and, whilst the trench was dug along one side, street traffic was diverted to the other. The trench completed they built therein one concrete side-wall of the new tunnel, well beyond the correspond-

The old tunnel walls were next to go, then preliminary work started on the lowering of the 1,400 ft. of rails—this being necessary to make room for the two new ticket-offices. They undermined the soil on which the rails were standing, and shored the line up on sections of wooden viaduct, whilst the trains continued to run.

This labour of two years culminated on Sunday, 30th October, 1938, in the complete closing of the station for that one day. The week-end that faced them then—between the passage of the last train on the Saturday night, until the running of the first train the following Monday morning—was a tremendous one, fraught with all sorts of unpleasant possibilities. The work of lowering the rails to their new permanent

## How Aldgate East Station, Nerve Centre of the Whole of the Metropolitan and District Lines was Reconstructed and Modernised

ing wall of the old one. That completed and the pavement relaid, overhead traffic was switched to the other side of the hoarding, and the opposite trench dug out and the farther wall of the new tunnel built in the same way. Then down came the hoarding, and Whitechapel High Street was once more free to take its full volume of pedestrians and road-traffic.

Plans of the underground lay-out of cables, and so on, were supplemented by a model of the area concerned, and a model of the station in its proposed new position had enabled the relaying of the pipes, etc., to be finally decided upon. Thus the work proceeded without a hitch. The time came to get rid of the old tunnel which they had enclosed. First the arch was to go, to make way for the new roof. A temporary "ceiling" of corrugated iron and girders was erected to prevent oddments falling to the line during the demolition. During the nightly four-hour non-running intervals of the trains, girders on turn-table trucks were brought into position, swung crosswise over the tracks, and hoisted up to form the new and permanent roof.

foundations was to be completed.

Eye-bolts embedded in the concrete of the new roof carried numerous chains and blocks whereby the rail lengths, in sections of 240 ft. of double track and sleepers, could be lifted clear of the wooden viaduct whilst the latter was taken to pieces and removed; the rails then being lowered the necessary distance to the prepared bed, to join the other permanent way sections with a one-in-fifty gradient. Temporary platforms and staircases had also to be removed, and finishing touches put to the new booking-office floor.

The removal of weighty odds and ends at high pressure and top speed, through a number of working shafts, was the cause of some extensive hard work. Dismantling the temporary platforms resulted in 1,790 pieces of bulky timber having to be got out of the way; 140 trestles and 153 steel joists which had composed the rail-supporting viaduct; 420 pieces of timber which had formed the temporary six-foot way; and corrugated iron hoarding to the total of 650 ft.

Such, in brief outline, is the story of one of the greatest reconstructural triumphs in underground railway modernisation.

# MAKING A

A "Cannonette" Table is an Ideal  
Below we give Full Constructional  
Fascinating

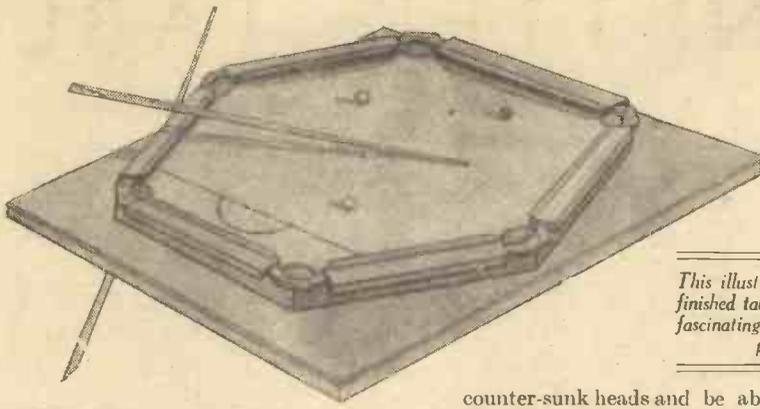

This illustration shows the finished table on which this fascinating game can be played.

THE "Cannonette" table has provided one of the best substitutes for the actual billiard table that has yet been devised, and the following article will provide full particulars for its construction. The "Cannonette" tables can be made in three sizes, 2 ft. 6 in., 3 ft. 6 in., and 4 ft. 6 in. across the flats. For the purpose of this article, the middle size has been chosen. The bed of the table itself should be cut from a sheet of ply wood, if possible  $\frac{3}{8}$  in. thick, but a  $\frac{1}{2}$  in. ply will do if you take care to keep it flat when fixing it to the battens. The hexagon shape should be traced upon the ply in the following manner. Obtain a piece of spare wood about 24 in. long, and at one end drill a hole large enough to allow a pencil to be tightly screwed into it. Measure from the point  $22\frac{1}{2}$  in. and tap in a panel pin as shown in Fig. 1. You can now scribe a circle upon the board 45 in. in diameter, which, when divided into six, will give you the centre for each of the six sides. Having cut the table top to shape, you can now turn your attention to the cardboard template that it is advisable to make for the pocket gaps at each corner. Fig. 3 gives details for marking this out upon a piece of thick card, which is cut to shape, with the edges bent down to form a stop when it is placed upon the corner of the hexagon. After marking each corner carefully from the template, saw neatly round with the aid of a keyhole saw or a coarse fretsaw blade. Partly to increase the strength of the ply, but mainly to support the side panels, there are screwed upon the underneath of each edge, pieces of deal  $\frac{1}{4}$  in. by  $1\frac{1}{2}$  in. by 22 in. long. These are shown in the general plan of the table, Fig. 2.

### Fixing the Battens

The next step is to fix the battens across the width of the table, these also being cut from the same material. Oak can be used for these if extra strength is required, although it will increase the weight of the set when finished. Having pencilled out the position of these battens upon the ply, Fig. 2, place the battens upon them and mark off for length, two of them having square cut ends and two with ends cut at an angle. Fig. 4 shows the battens as they appear before locking together. The screws for fixing the top to the battens should have

counter-sunk heads and be about No. 6 in size. Drill the clearance holes along the lines, six for each batten, and slightly countersink them and lay the top in position upon the battens ready for fixing. Drive the screws well home, and before filling with plastic wood, it will be as well to test the top

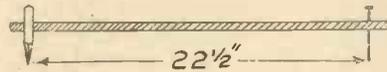

Fig. 1.—The device for drawing the hexagon shape.

with a straight edge. If the top is quite flat upon the battens, fill over the screw tops and set aside whilst you continue with the

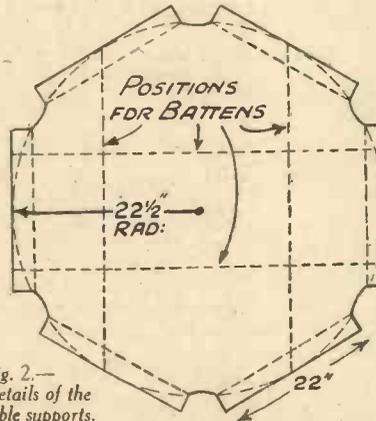

Fig. 2.—Details of the table supports.

rails and cushions. These will not prove very difficult if you proceed with care. In the first place cut your six rails from oak,  $\frac{3}{4}$  in. by  $1\frac{1}{2}$  in. by 22 in. long; these are finished sizes and can be obtained from any cabinet maker's shop, thus saving yourself a heap of shavings and extra work. Smooth each of

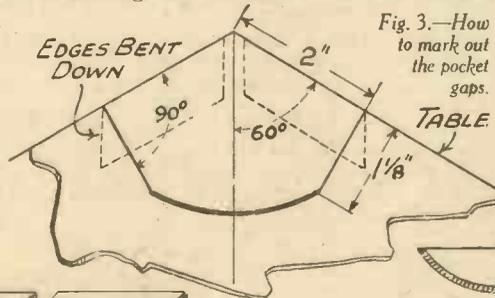

Fig. 3.—How to mark out the pocket gaps.

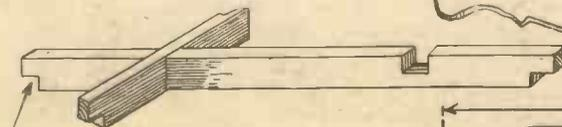

Fig. 4.—The battens before locking together.

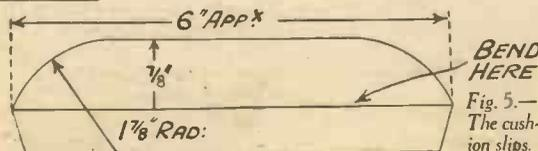

Fig. 5.—The cushion slips.

them well with paper, and give a coat of spirit stain, fairly dark.

### The Cushion Slips

These slips are cut to length  $\frac{1}{4}$  in. less than the rails, which should make them  $21\frac{1}{4}$  in. long. Once again to save time and insure that all curves are the same, a template should be cut as in Fig. 5, from which each slip can be marked and cut. For those of you who are not well equipped with tools, saw straight across the corner upon the outside of the line, holding it afterwards in the vice and shaping it up with the aid of a coarse file, until it conforms with the curve of the template. Before polishing the rails it is probably best to screw into position the slips, that is temporarily, in order that they may be readily fixed when covered. The cushion is made from  $\frac{1}{8}$  in. square section rubber, obtainable from most model aeroplane stores. Each slip will require 18 in. of rubber, so 9 ft. will be needed for all six slips. Taking one 18 in. length of rubber and a slip, attach the rubber at one end by means of a panel pin, taking care not to split the wood and also not to flatten out the end of the rubber. Along the top edge of the slip spread a thin coating of liquid glue over which the rubber is stretched, and finally pinned at the opposite end of the slip. Press the rubber cushion firmly all along its length, keeping it quite flat with the top of the slip. The slips should now appear as shown in Fig. 6. The oak rails having dried from their staining, can now be polished.

### The Baize Covering

At this stage, the table can be covered with the baize, having sand-papered the top perfectly smooth. It is advisable now to obtain the assistance of a friend, as the material has to be stretched very tightly and evenly over the entire surface. If you have obtained the baize in what is known as "double width," you will find that it is wide enough to stretch across the flats of your table, allowing enough to be cut off for use upon the cushion slips. Tack the edges of the baize with drawing-pins as you stretch it over. Having pulled it as tight as possible, run over the entire surface with a fairly hot iron, keeping it moving in one direction only, taking up the extra stretch of the material as you do so. By making two or three snips at the pocket gaps, it will be quite easy to draw the baize down and round the curve. When the rubber cushions have set firmly upon the slips, you can commence covering them with baize, which should be cut into strips long enough to allow the ends

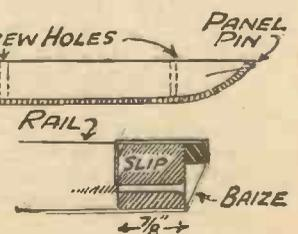

Fig. 6.—The completed cushion slips.

# "CANNONETTE" TABLE

Substitute for an Actual Billiard Table.  
Details and Method of Playing this Game

to be turned and tucked in between the rail and the slip. To commence the covering it is first necessary to place the slip against the rail and insert the three screws, leaving them slack to enable the baize to be inserted. Place the edge of the baize between the rail and the slip and then nip the centre screw home, after which the baize is drawn across, down, and under the slip, where it is tacked. Turning the corner may prove a little difficult at first, but you will simplify matters if you cut away all superfluous material that is inclined to make the corner appear to sag at the ends. When you have obtained a satisfactory end, tighten the screws before drawing down and tacking underneath. The rails are now attached to the board, as shown in Fig. 7, the screws being long enough to pass through the clearing holes in the deal batten and ply, pulling up into the rail. Attention can now be turned to the six sides, which serve the purpose of bracing up the whole table. Each side is cut from  $\frac{3}{4}$  in. oak, 2 in. wide. Paper the sides stain and

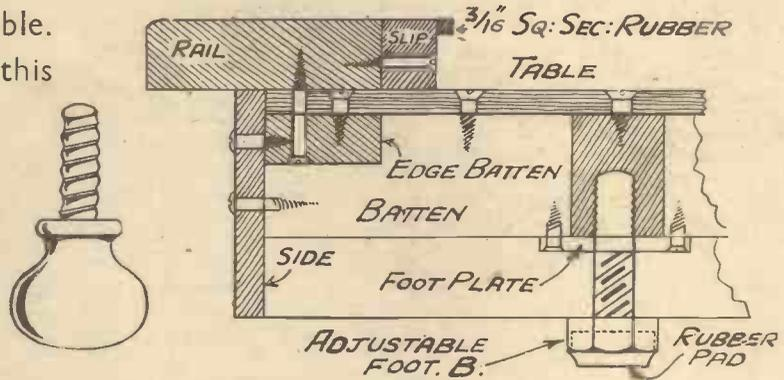

Fig. 7.—The rails should be attached to the board as shown here. The sketch to the left shows one of the screwed feet.

shown in Fig. 8. When you have polished them, clamp one of them firmly down upon the edge of the net at each corner. With the exception of marking the board it is now complete. Measurements and the plan for marking are given in Fig. 9, and should be made with the aid of a baulk pencil or thick black crayon, finishing off with the spots cut from a piece of black silk, each being about  $\frac{1}{4}$  in. in diameter.

finished. It will be seen that two fine slots are cut along the length, commencing with a hole at the left-hand side. Whether these holes are necessary depends entirely upon the tools that you have at hand. If a fret machine or fretsaw outfit is in your possession, then they are not required. If, however, you have to fall back upon a haek-saw, as used by engineers, they will have to be drilled, just large enough to allow the blade to be inserted before cutting along the board.

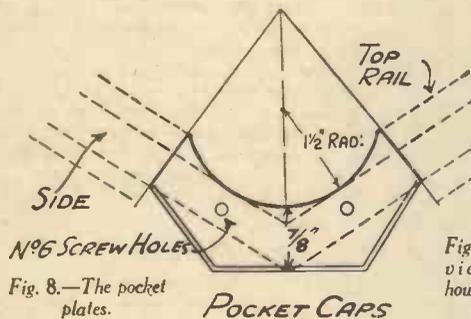

Fig. 8.—The pocket plates.

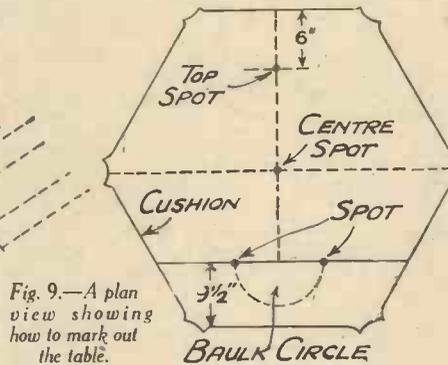

Fig. 9.—A plan view showing how to mark out the table.

### The Pointers for the Board

After you have cut the slots, trim them up with a small flat file, both at the back and front, being careful not to file them wider than necessary, otherwise the pointers which are to be fitted will be too loose. The board should be well papered, stained and polished, setting it aside whilst you prepare the pointers. The material required for these is a piece of thin brass, the thickness of which will allow it to slide freely in the slots. If hard brass is used, care must be taken to bend it against the grain, otherwise it will be found to break at the bend. In Fig. 13 is shown the shaped pointer. Take a pair of tinsmiths' snips and roughly cut across the corner, indicated by the dotted line. Those readers who have had some experience in metal work will find it a simple matter to place all four pieces together, grip them in a vice, and file them up with the aid of a smooth half-round file, but it is advisable for the beginner to do the operation singly. The bend is made next, with the aid of a short rod about  $\frac{1}{4}$  in. diameter. Do not attempt to use a hammer for this purpose; rely upon the strength of your fingers to force the brass round the rod, which is held firmly against it with the thumb of the left hand, whilst the right thumb carries out the

polish as you did with the rails. The four feet are made adjustable for levelling purposes.

### The Four Feet

Ordinary drawer knobs can be fitted, provided that they possess a dowel pin upon which they can be turned. This type of foot is shown in Fig. 7, whilst B illustrates another method, giving them a much better appearance, by taking four  $\frac{3}{16}$  in. hexagon headed screws and drilling the head out to  $\frac{3}{4}$  in. A rubber pad should be inserted and a really neat job results. This type of foot requires, however, a small iron or brass plate into which it can be loosely screwed. The feet should be fitted at the four crossing points of the battens. Pocket nets can be obtained from most billiards table manufacturers, and should be tacked in position at each corner, underneath the table and on the top of the corner formed by the sides. Finally, we come to the pocket plates, made from  $\frac{3}{4}$  in. or  $\frac{1}{2}$  in. oak, and cut to shape, as

### The Score Board

In Figs. 10 and 12 is shown the board as it is cut from a piece of five-ply. Those of you who have cut your hexagon table from a full-sized sheet of wood will find that one or two spare pieces remain, and it is from one of these that the board can be cut. Select a piece that is nice and flat, and after you have cut it out to the measurements given, drill a hole at either end in order that it may be placed upon the wall when

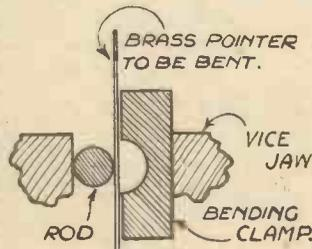

Fig. 11.—Bending the pointer between the jaws of a vice.

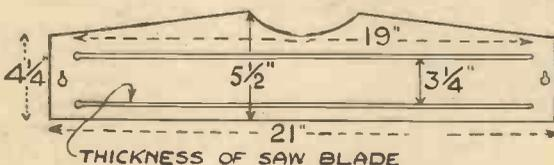

Fig. 10.—Details for cutting out the board.



Fig. 12.—The completed marking board

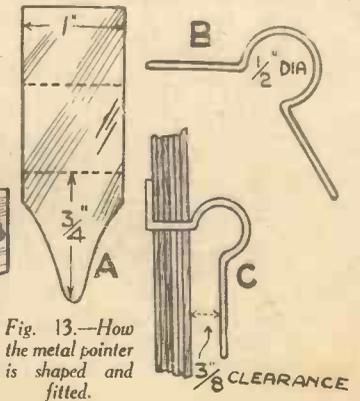

Fig. 13.—How the metal pointer is shaped and fitted.

shaping. An alternative method is given in Fig. 11, which, however, requires a separate block possessing a groove that will enable you to press the brass into it between the jaws of a vice. Before inserting the pointer into the slots of the board, the marking figures should be filled in. Transfers can be obtained for this, and the outlay of a few coppers will save you a heap of tedious work painting them, and will also have a very much better appearance when finished. Assuming that the figures have successfully been applied, you are now able to add the pointers as shown in Fig. 12, taking care not to make the turn-up at the back too tight—they must be free to slide easily along the figures. Having completed the marking board, here are one or two hints about the game, assuming that you are quite unacquainted with the rules of billiards. In the first place, you will require three balls, two white and one red,  $1\frac{1}{2}$  in. in diameter, two cues about 3 ft. 6 in. long, and a spirit level.

#### Hints on Scoring

The first thing to do when commencing the game is to level up the table by means of the adjustable feet. Apply the level in three or four different positions across the table, raising or lowering the feet until satisfactory. When starting the play, the red ball must

always be placed upon the top spot of the table, your opponent retaining his white ball whilst you place your own upon the baulk line or circle at the base of the table. A good starting-off stroke is given in Fig. 14, which will be found quite simple after a little practice. Figs. 15 and 16 also show three

Two: Cannon—Pocketing opponent's ball—Pocketing own ball off opponent's.  
Three: Pocketing red ball—Pocketing own ball off red.  
Four: Pocket both white balls—Cannon and pocket white ball—Cannon, hitting white ball first and pocketing own ball.

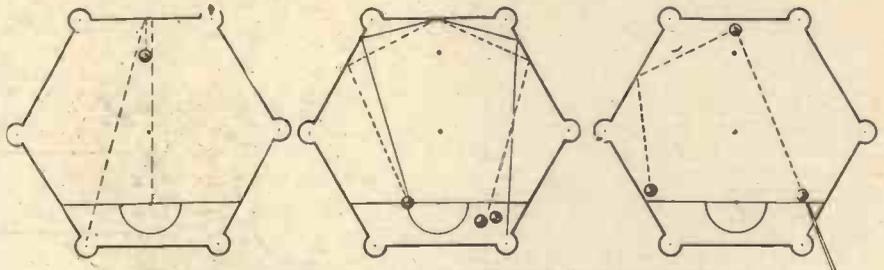

Figs. 14 to 16.—Some useful shots that are well worth practising.

other shots well worth trying over. After pocketing the red ball, it must always be replaced upon the top spot. The player continues play until he ceases to score. Should any player pocket his opponent's ball it must remain in the pocket until player ceases to score, when it is removed and played from baulk. Scoring is as follows:

Five: Cannon and pocketing red ball—Cannon, hitting red ball first and pocketing own ball.

Six: Hitting red and pocketing both balls—Cannon off white on to red and pocket both white balls.

Higher scores can readily be calculated from these figures.

"The Cutty Sark." By Dr. C. N. Longridge. Price 7s. 6d. per volume; post free 8s. Published by Percival Marshall & Co., Ltd., 13-16 Fisher Street, W.C.1.

A COMPLETE account of this famous clipper ship with full drawings, photographs, and instructions for making a perfect scale model. In two volumes, 200 pages each, with plans. Volume I: The story of the ship, and model-making details for the hull, bulwarks and deck fittings. Volume II: Masts, spars and rigging with the builders' specification of the original ship.

"English Warships in the Days of Sall." 72 pages; 24 plates. Post free 3s 10d. Published by Percival Marshall & Co., Ltd., 13-16 Fisher Street, W.C.1.

A BRIEF historical guide for makers of old sailing ship models.

"Railway Modelling in Miniature." By Edward Beal. 133 pages; 20 plates and 270 line illustrations. Price 3s. 6d.; post free 3s. 10d. Published by Percival Marshall & Co., Ltd., 13-16 Fisher Street, W.C.1.

THE book for all model railway enthusiasts and anyone interested in railways. Deals with Planning Building and Operating, with special reference to "00" and "HO" gauges.

"Practical Lessons in Metal Turning." By Percival Marshall, C.I.Mech.E. 210 pages. 220 original illustrations. Price 3s. post free 3s. 3d. Published by Percival Marshall & Co., Ltd., 13-16 Fisher Street, W.C.1.

THE best instruction book on the lathe for young engineers and amateur mechanics.

"The French Polisher's Handbook." Price 2s.; post free 2s. 2d. Published by Percival Marshall & Co., Ltd., 13-16 Fisher Street, W.C.1.

TELLS how to polish from the white; how to renovate furniture, gild and regild, how to polish inlaid, marqueterie, fretwork and pokerwork, with many recipes for stains and polishes.

"Small Internal Combustion Engines." By Edgar T. Westbury. 133 pages; 43 illustrations. Cloth bound. Price 2s. 6d.,

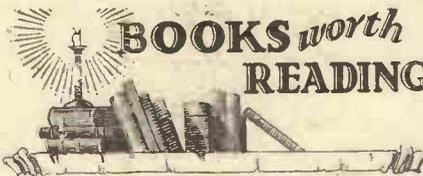

post free 2s. 10d. Published by Percival Marshall & Co., Ltd., 13-16 Fisher Street, W.C.1.

A PRACTICAL handbook on the working principles, installation, and maintenance of small stationary gas, oil, and petrol engines.

"Petrol-Engined Model Aeroplanes." By C. E. Bowden. 174 pages; 93 illustrations. Price 3s. 6d., post free 3s. 10d. Published by Percival Marshall & Co., Ltd., 13-16 Fisher Street, W.C.1.

A PRACTICAL manual and guide to the building and flying of Petrol Model Aeroplanes.

"Modern Optical Projectors." By Edgar T. Westbury. 124 pages; 69 illustrations. Cloth bound. Price 3s. 6d., post free 3s. 10d. Published by Percival Marshall & Co., Ltd., 13-16 Fisher Street, W.C.1.

A PRACTICAL handbook on optical lanterns, episcopes, and the use of projectors in industrial workshops.

"Men Against Death." By Dr. Paul de Kruif. 350 pages. Published by The Scientific Book Club. Illustrated. Price 2s. 6d. to members.

THE October choice of The Scientific Book Club was "Men Against Death," by Dr. Paul de Kruif, published at 2s. 6d. It is the story of the battle of scientists and doctors against disease. Such a story could be written very dully, but Dr. de Kruif relates the stories of great scientific discoveries in a style that is usually associated with adventure stories. Such a "liveliness" holds the attention of the reader, and does not allow scientific facts totally to envelop the story. There are twelve separate stories dealing with such subjects as the discovery of insulin, pasteurization of milk, etc.

"Boys' Book of Bridges." By Charles Boff. Published by G. Routledge & Son. 232 pages. Price 6s.

BRIDGES always possess a fascination, not only for the younger generation, but for many others, and in this interesting book the author gives some of the more romantic instances of bridge building. He tells of the pioneers who blazed the way, and of some of the more unusual types of bridge which may be found in various parts of the world. There are 12 chapters devoted to the subject and amongst these will be found details of bridges that stand on stilts, overhead, tubes, bridges that carry water, bridges without decks and so on. There are thirty-two plates illustrating such well-known bridges as the Virocotir Falls rail and road bridge, the Storstrom Bridge in Denmark, the Sydney Harbour Bridge, the "dangling ferry" bridge at Newport and others equally famous.

"Sun Spots and Their Effects." By H. T. Stetson. Published by The Scientific Book Club. 200 pages; 15 illustrations.

THE majority of wireless listeners are to-day aware that there are such things as sun spots, and they are blamed for the vagaries of radio reception over long distances. In this interesting book the author describes just what sun spots are and their effects on human life. He outlines the factual evidence available, and examines critically some of the more plausible hypotheses advanced. Owing to the lack of certain evidence he does not attempt to reach finality in this book, but gives some very valuable information which will be of use not only to the student, but to the general reader who is anxious to keep in touch with modern theories. The Appendix contains four tables of Sun Spot Numbers.

"Practical Mechanics Handbook." By F. J. Camm. 400 pages; 379 illustrations. Price 6s. Published by George Newnes, Ltd.

THIS is an extremely valuable book, packed with facts, figures, tables and formulae for the mechanic, fitter, turner, draughtsman, engineer and designer. It deals with Mensuration; Powers and Roots of Useful Factors; Trigonometrical Func-

(Continued on page 229)



# DRILLING FOR OIL

The Mechanics of Mineral Oil-Getting Involve the Expenditure of Much Money. To-day the Cost of Boring may Work Out at Roughly £5 Per Foot Depth

**T**HE product of the world's oil-fields—indispensable fuel and lubricant and in its commercial state taking on so many guises—is going to vanish from the earth in a matter of eighty years, if a recent calculation by a Rumanian expert proves well founded.

The world will then be largely dependent on oil derived from coal, by various processes. But coal supplies are not inexhaustible. The estimated duration of the world's known coal seams has been placed at a few hundred years only; before the expiration of which time it is safe to guess that substitutes for both coal and oil will have been discovered and put into general use. Meanwhile, industry is demanding and using ever-increasing quantities of oil—world annual production of crude petroleum is given as 245,000,000 tons—and the search for new oil-fields is being conducted with great vigour; they are prospecting for oil now in British Guiana, and even in Britain, where geological conditions are not too favourable for its discovery in anything like paying quantities.

## Expensive Outlay

The mechanics of mineral oil-getting involve the expenditure of much money, additional to the initial search for this product of decayed animal and plant life at considerable depths in the earth—life which existed at a period (taking the average of various estimates) 1,000,000 years ago. Natural gushes of oil in U.S.A., Canada, Mexico, Rumania, Iran (Persia) and elsewhere forced their attention on the first oil-users, who thus had at their command vast quantities without having been to the trouble and expense of locating and boring.

To-day the cost of boring may work out at round about £5 per foot depth, and after the expenditure of several thousand pounds the new bore may have to be abandoned as a non-economic proposition. The Anglo-American Oil Co. drove a 3,506-foot bore at Grove Hill, in Sussex, in 1937, then had to give up—just one of innumerable instances of a geological "certainty" letting-up under the practical test of active operations.

## Centuries Ago

We go back to ancient Babylon days for evidence that oil was known and used for lighting. We come back to the middle period of the 19th century for the real beginning of the mineral oil age. Oil gushes hitherto had been a nuisance, often a big danger. They sometimes caught fire—ignited by a flash of lightning—and devastated the land all around. Gas, highly inflammable and under great pressure, always forces the oil up when whatever has been capping it down below becomes cracked or has been drilled. The natural gushers just had to burn themselves out once a lightning flash or chance spark had touched them off. And when tried in lamps in place of the customary whale-oil, the stuff burned with an objectionable odour.

When methods of refining it and controlling the flow were discovered, fortunes

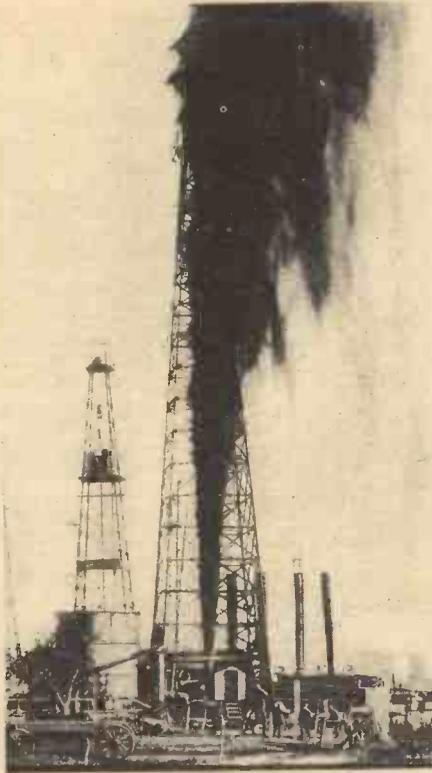

*A gusher liberating black oil in a pressure stream into the air.*

were made overnight. Wells were sunk wherever there seemed likelihood of the treacherous fluid being "struck," and though these early ventures were not by any means all attended with success, they were always worth the gamble.

One of the deepest oil-wells in the world is in Crane County, Texas—12,786 feet, which is nearly two and a half miles. Two years the drilling occupied, at a cost of nearly 400,000 dollars, with a bit turning 200 times a minute, biting gimlet-fashion through sand and rock, through enormous pressures, and heat in excess of the boiling-point of water. The method with such deep holes consists in suspending a bit with a steel cutting-face or studded with low-grade diamonds through a turn-table—steam, electricity or compressed air being the motive power for turning this—at the base of a tall derrick which carries the ever-increasing weight of the drill-pipe and its steel outer casing.

## The Drilling Bit

The bit attached to the end of the drill-pipe may be about 27 in. in diameter at the start of operations—a surprisingly small diameter for a "well," but what it lacks in girth it certainly makes up for in depth. As drilling progresses, smaller bits are substituted until a 4½-in. cutting-face is being operated. The drill-pipe is hollow, its walls not more than one-third inch thick but tough enough to withstand a

pressure of 95,000 lbs. to the square inch, and it revolves in an outer steel casing which is left in the ground—as lining to the bore-hole—when the drill-pipe is finally withdrawn.

To ease the working of the drill and remove rock, etc., which is ground away, mud is caused to flow, under pressure, down through the hollow drill-pipe, leaving the latter near the lower extremity via a one-way valve. This provides a "cushion" of highly compressed mud to take some of the weight (tremendous at the greater depths) of the piping and also serves as a barrier against the escape of gas which might otherwise blow up and wreck the entire proceedings. The remainder of the mud which is unable to find any place for itself takes the line of least resistance—back up to the top through the space which exists between the drill-pipe and the outer casing.

Piping close on two miles long cannot, of course, be handled in one length, that difficulty being got over by means of short lengths which are added, as the depth increases, by means of threaded joint couplings. Ropes passing over pulleys at the summit of the derrick take the strain of drill-pipe and casing, and enable the drill-pipe to be extracted piecemeal from the hole when the job is completed—or when the blunted cutting-face needs sharpening or the bit needs changing for a smaller size, or—and it sometimes happens—when the goddess of ill-luck takes a hand and the drill breaks off. Catastrophic as the latter sounds, a broken-off drill, though it may be 10,000 feet down, can be demolished by tackling the obstruction with a special bit possessing combined sideways and vertical motions and keen-edged enough to sheer through iron or steel.

## A Straight Bore

The difficulty of keeping a straight bore may be very considerable where specially hard strata are encountered at varying depths, the drill naturally tending to be deflected into a line of lesser resistance if it can find it. The engineers in charge of operations are enabled to check the exact course the drill is taking by means of plumb bobs and tiny automatic cameras lowered down the outer steel casing. And, if necessary, deflecting tools can be lowered to coax the drill back into the true vertical.

All this work in the field is but a prelude to mechanical arrangements for controlling the powerful uprush of oil which follows when the subterranean "reservoir" is at last successfully tapped—capping the well, leading the crude liquid away to vast tanks, refining it, shipping and transporting it overseas.

Auxiliary supplies are coming to us by way of the carbonisation of coal; the high-temperature process, as carried out at gasworks; is giving us 40,000,000 gallons of refined motor-spirit yearly. Oil fuel for the Navy and petrol for the R.A.F. are being obtained by the low temperature process. And by the combination of hydrogen with coal, or tar obtained therefrom (the hydrogenation process), still more petrol is being provided.

# Wonderful Value for Money!

Only 1/- Each

## THE HOME ELECTRICIAN

By F. J. CAMM

A practical handbook on the installation of Electrical Apparatus, including Motors, Refrigerators, Bells, Motor-Driven Devices, Lighting, Accumulator Charging, Burglar Alarms, Indicators, etc.

### SIMPLE ELECTRICAL APPARATUS

Interesting and useful apparatus, easily constructed, with which the student is enabled to test for himself the theory and practice of Electricity as laid down in the text-books.

138 illustrations.



Profusely  
Illustrated  
with  
Photo-  
graphs  
and  
Diagrams

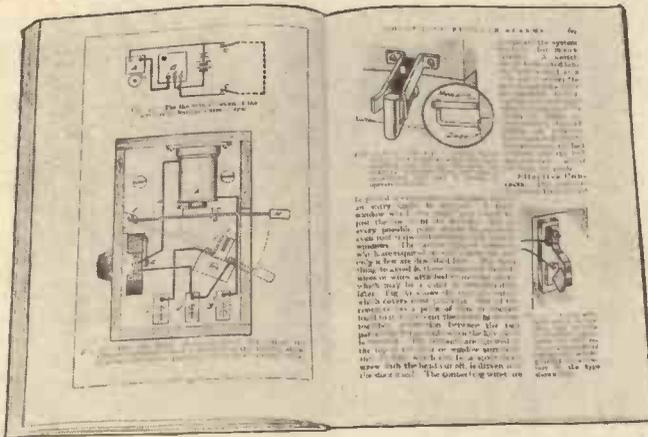

Other titles in this splendid series:

#### ACCUMULATORS.

Expert advice on the Maintenance and Use.

#### MOTOR-CAR UPKEEP AND OVERHAUL.

How to carry out all necessary adjustments and repairs.

#### THE HOME WOODWORKER.

Practical aids for the home worker.

#### MODEL AEROPLANES AND AIRSHIPS.

A guide for the beginner in model aeronautics.

#### 25 SIMPLE WORKING MODELS.

Each requires the simplest materials for construction.

#### THE HANDYMAN'S ENQUIRE WITHIN.

Hundreds of practical ideas and hints.

#### MODEL-BOAT BUILDING.

Sections on sailing and power-driven boats.

#### TOY MAKING FOR AMATEURS.

The construction of innumerable toys of all kinds.

#### LATHE WORK FOR AMATEURS.

All the home mechanic needs to know.

#### HOUSE DECORATION AND PAINTING.

Practical information for amateur and expert.

#### POWER-DRIVEN MODEL AIRCRAFT.

All about petrol, compressed air, steam engines, etc.

#### PRACTICAL LEATHERWORK AND ALLIED CRAFTS.

Fascinating and useful handicrafts simply described.

**COMPLETE THE FORM ON LEFT AND HAND IT TO YOUR BOOKSELLER who will get you the book or books you require, at the usual price, thus saving postage. Alternatively, send the form to the Publishers, with postal order (plus 2d. extra on each book to cover postage), and the book or books will be sent direct to you by return.**

To the Book Publisher, GEORGE NEWNES, Ltd., TOWER HOUSE, SOUTHAMPTON ST., LONDON, W.C.2. Please send me by return the book or books written below. I enclose Postal Order for the necessary amount. (1/2 each book, including including postage.)

.....  
.....  
.....  
.....  
.....  
.....  
.....  
.....

P.O. No. is..... Value.....

Name.....

Address.....

.....

P.M.1.39.

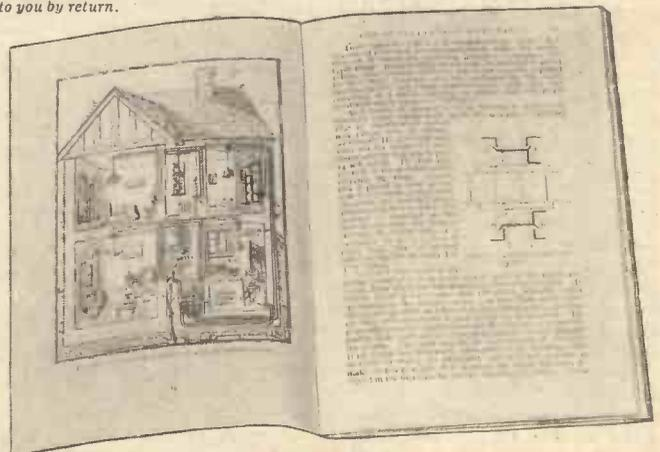

**FILL IN THIS FORM TO-DAY!**

# "MAGICAL" COOKERY



Fig. 6.—A conjurer's cooking pan. The loose lining holds a load concealed in the lid which is afterwards deposited in the pan.

Methods Of Producing Effective Illusions With A Strong Element Of Comedy

By Norman Hunter

(The Well-known Conjurer of "Maskelyne's Mysteries")

Further Articles on the Secrets of Conjuring will appear Regularly and Exclusively in this Journal

**P**ROBABLY the best-known item of magical cookery is that in which the conjurer cooks a cake in a borrowed hat. The usual procedure is to break an egg into a dish, add flour, milk, and other ingredients, and pour the mixture into the hat; much to the delight of everyone except the man who lent the hat. A tray is then clapped over the mouth of the headgear, which is held for a moment over a candle flame. A perfectly genuine cake is then taken from the hat, cut up, and distributed; while the hat is returned without the least sign of damage.

The dish used for mixing the ingredients is chiefly responsible for the illusion. It consists of two parts, the dish proper, which is a metal affair something like a shallow

movement, the dish being dipped in and brought up with an action quite natural to the pouring of a quantity of liquid into a re-

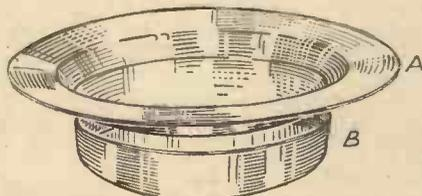

Fig. 1.—A dish with a faked bottom.

soup plate, and a deeper receptacle which fits over the outside, but has no rim. Fig. 1 will show the details clearly.

### Special Dish

In performing the trick, the conjurer holds the two parts of the dish together as one, and borrows a hat—an opera hat if possible but, failing that, a bowler. In returning to the platform he secretly drops the outer part of the dish into the hat. When the mixture has been prepared in part A of the dish, it is poured into the hat where, of course, part B receives it safely. During the pouring the visible dish is raised and then lowered, with a slight flourish. As it is lowered, it is dipped right into the hat, and the outer part of the dish scooped up under it. No hesitation must be allowed in the

movement, the cake being dipped in and brought up with an action quite natural to the pouring of a quantity of liquid into a re-

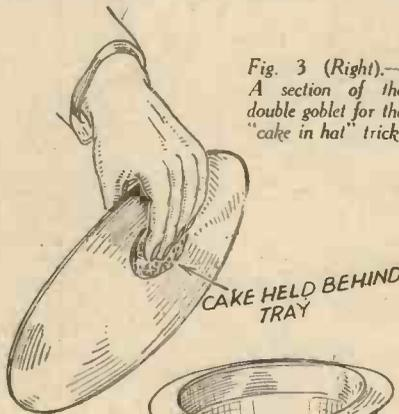

Fig. 2.—The cake is picked up behind the tray and dropped into the hat. The cake is, of course, much larger than is shown in this illustration.

ceptacle. The double dish is then placed aside with the mixture safely trapped between the halves.

This leaves the hat empty. The next step is to cover it with a tray. Behind this tray is the cake, a round, flat one. The cake is picked up behind the tray, and dropped into the hat in the act of covering. See Fig. 2. All that now remains is to hold the hat for a moment over the candle, produce the cake, and cut it up.

### Care Necessary

A certain amount of care is necessary in this form of the trick, to ensure that none of the eggy mixture splashes into the hat. Another type of apparatus reduces this risk

to minimum. This consists of a pair of metal goblets, as illustrated in Fig. 3. The outer goblet is without preparation. The inner goblet has the bottom removed about half way up. Both goblets are outwardly alike.

As before, the hat is borrowed while the goblet is held in one hand. The inner part of the goblet is secretly dropped into the hat in returning to the platform. If the conjurer doubts his ability to do this without detection, he may simply put the double goblet openly into the hat while he shows the various ingredients, then take out only the

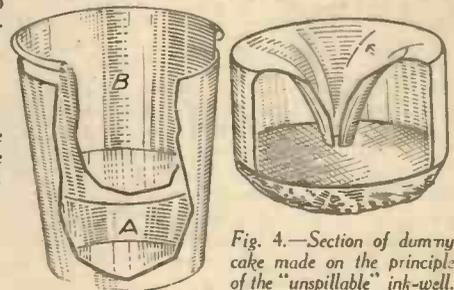

Fig. 4.—Section of dummy cake made on the principle of the "unspillable" ink-well.

outer part. The mixture is prepared in the outer goblet and poured in as before. The inner part of the goblet, which must be left standing upside down in the hat, receives the liquid in the part marked A; the outer goblet being brought down over it as the pouring finishes, and the two taken out of the hat together. The loading of the cake is carried out behind a tray as before or, if desired, a small cake may be placed beforehand in part B of the inner goblet, and so loaded into the hat with it in the first place.

### Another Method

A variation of the first method, in which a flat dish is used, is as follows: having loaded the outer part of the dish into the hat, the conjurer mixes the egg and other ingredients in a glass tumbler, and pours it

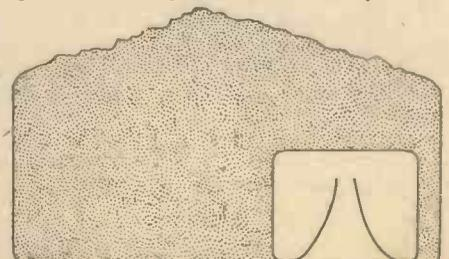

Fig. 5.—The glass ink-well inserted in a genuine cake.

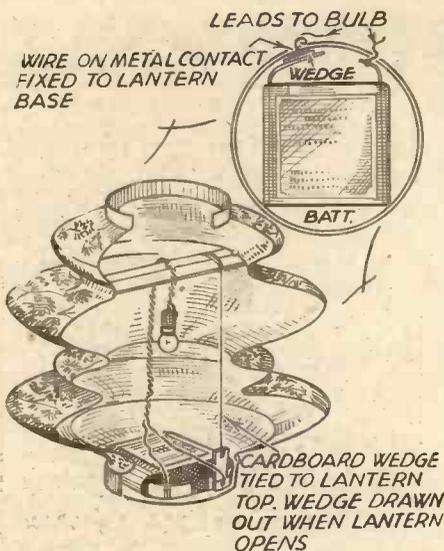

Fig. 7.—Each lamp is fitted with a small electric battery and bulb.

from this receptacle into the hat, and, of course, into the outer part of the dish. He then pretends to have forgotten to add sugar, pours some on to the metal dish and, in tipping this into the hat manages to collect and bring out the other part of the dish containing the liquid. In either method it is safe to prepare the mixture as thick as it will pour out, as there is less likelihood of it splashing.

Another and, in some ways, easier method is to use a dummy cake. This is made of metal and is in the form of an unspillable ink-well. (See Fig. 4.) An ordinary cake tin of suitable size could be converted by soldering a tin cone into the mouth, coating the outside with a mixture of plaster of Paris and glue and then painting it to resemble a cake.

**Dummy Cake**

This dummy cake is loaded into the hat, opening upwards, under cover of placing a tray over the mouth of the hat, as already described. The egg and flour are mixed in a glass placed on the tray. The tray is removed, and the contents of the glass poured into the hat—and into the dummy cake. The cake is, in due course, produced, but cannot, of course, be cut up. A way round this latter difficulty is to give the

dummy cake to an assistant, who takes it off the stage. As he reaches the wings you call to him to bring it back, saying you meant him to cut it up and hand it round. This he proceeds to do, but during his momentary disappearance off-stage he has quickly put down the dummy cake and picked up a genuine one as much like it as possible, which he then brings on.

Yet another variation of the method is to prepare a genuine cake by scooping a hollow in the bottom and inserting a glass, unspillable ink-well as shown in Fig. 5. This cake is loaded in just as the dummy one was in the previous version, and the mixture—not too much of it this time—is poured into the concealed ink-well. This cake can, of course, be cut up and distributed as long as the section containing the ink-well is left undisturbed.

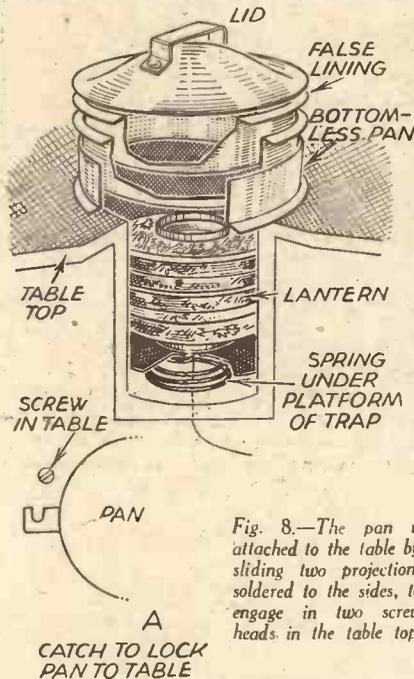

Fig. 8.—The pan is attached to the table by sliding two projections soldered to the sides, to engage in two screw heads in the table top.

Fig. 6 illustrates a type of conjuring cooking utensil. In appearance it is something like a round fish kettle. Having been shown empty, the pan is used as a receptacle for eggs which are broken in, methylated spirit added, and the mixture set on fire. The lid

is clapped on, removed again, and out fly a couple of pigeons.

**A False Lining**

Reference to the photograph shows that, in addition to pan and lid, there is a third part of the apparatus. This consists of a false lining fitting tightly within the pan, or less tightly over the lid. The pigeons are placed in this false pan, and the lid pressed home. Air holes are punched in the lid just under the handle and, as an additional precaution against discomfort for the birds, it is usual to have the pan loaded only a moment or two before being brought on for the trick. The eggs having been broken and the mixture fired, the lid is placed firmly on the pan. As the false lining fits the pan more tightly than the lid, it remains behind in the pan when the lid is removed, releasing the pigeons. Needless to say the putting on of the lid instantly extinguishes the flames, and the false lining is slightly shallower than the pan proper to allow space beneath it for the broken eggs.

For those conjurers who do not care to use livestock, the pan is equally useful to produce other effects. For instance, several sheets of coloured tissue paper may be burned and transformed to coloured paper lanterns, each one alight. The lanterns are, of course, folded and concealed in the lid. Each lantern is fitted with a small electric battery and lamp, as shown in Fig. 7; and a connection to make the lamp light as the lantern expands. My own method for this latter purpose is to tie a small cardboard price tag to the handle of the lantern, close the lantern, and press the tag down between one terminal of the battery and the wire leading to the lamp. This breaks the circuit and the lamp remains unlit. As soon as the handle is lifted to expand the lantern, the tag is pulled out and contact is made so that the lamp lights.

In using this metal pan, attention is drawn to the emptiness of the pan, but little or no reference is made to the lid. This, being held upside down, creates no suspicion that it may contain anything, particularly as everyone is used to putting lids on saucepans and never associate the lid with being meant to hold anything.

**An Elaboration**

An elaboration of this trick, which I performed at Maskelyne's, was designed so that the lid, as well as the pan, could be shown empty. The pan was a large one and the



Figs. 9 and 10.—(Left) Another type of magical saucepan. This is fitted with a shallow inner lining which is carried away in the lid when the saucepan is covered and uncovered again. (Right) Magic with a muffin dish. The loose disc holds a load concealed in the lid. Pressure on the knob of the cover deposits the load in the dish.

false lining fitted moderately loosely, while it fitted the lid tightly, the exact reverse of the normal method. The pan itself had no bottom, and the lanterns—six large ones—were concealed in a trap in the table. The mouth of this trap was open, and the lanterns rested on a rising disc as shown in Fig. 8. Tissue paper was spread over the mouth of the trap to hide the lanterns. The pan, with lining in position, having been shown empty, was put down and the paper removed. The pan was anchored to the table by sliding two projections soldered to the sides, to engage in two screw heads in the table top. See A Fig. 8. The paper was duly burned in the pan, the lid shown empty and put on. A catch was then released, and the spring under the bottom of the trap forced the lanterns up, so that when the lid was removed, carrying with it the lining and the ashes of the paper, the lanterns were ready for production.

Fig. 9 shows another type of conjuring saucepan. This is a deep shape, and the lid is fitted with a false pan which fits tightly. The pan may be placed in the saucepan as shown in the photograph, when it forms a shallow-bottomed lining. Putting on the lid and removing it, causes the false pan to be carried away in the lid. The saucepan is also provided with an outer casing as shown in Fig. 11. This casing fits loosely over the saucepan, and reaches to the ridge seen on the outside of the utensil.

**Using the Saucepan**

The method of use is as follows: the saucepan is loaded with a toy rabbit, and the loose pan placed in position; the outer lining is placed on and the saucepan shown; as the false pan grips the saucepan sufficiently to remain in position by its own friction, the saucepan may be turned upside down and the wand rattled in the upper part to demonstrate its emptiness. The lid may, of course, in this case be shown quite openly. A top hat or opera hat is borrowed, and the pan is placed in to see if it will fit. Actually, this is done so that when the saucepan is taken out of the hat the outer lining may be left behind. Various ingredients are now dropped into the saucepan, going, of course, into the false pan, and some paper is ignited in the hat to form a fire. Of course, it is in the outer casing that the paper burns, and the hat is quite safe. The lid is clapped on and the saucepan held over the flames for a moment, being then dropped into the hat to put the fire out. It is then taken out, and with it the outer casing, bringing away the charred remains of the paper as well, the lid is removed, and the toy rabbit taken out. The idea of a rabbit is to enable the conjuror to announce that he is going to make a Welsh rarebit, then, owing to a mistake in the spell he finds he has a Scotch rabbit instead.

**An Amusing Adaptation**

An additional bit of fun can be indulged in by borrowing a handkerchief and putting this in the hat before loading in the outer casing of the saucepan. This latter has a piece of cotton material in it, treated with a touch of methylated spirit, and this is burned, giving the effect of the borrowed handkerchief being used as a fire. The effect is enhanced by the performer fishing out the burning material with a stick and letting it fall back again.

This, like the other type of saucepan, can, of course, be used for other transformations. By discarding the outer casing, and loading the saucepan with wrapped toffees, a good trick can be managed—by putting torn-up pieces of paper into the shallow pan, putting on the lid, and changing the pieces of paper to wrapped sweets, the distribution of which naturally guarantees the success of the trick.

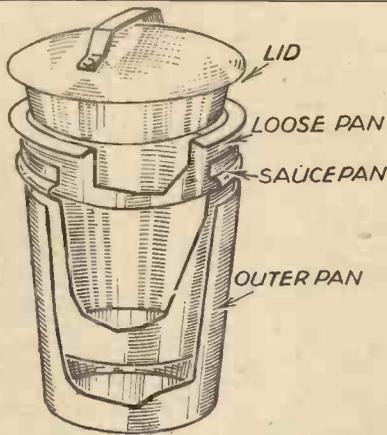

Fig. 11.—The saucepan is provided with an outer casing which fits loosely over it, and reaches to the ridge seen on the outside of the utensil.

Fig. 10 illustrates a utensil which, although not actually a cooking utensil, lends itself well to tricks with food. It is a metal muffin dish with cover. The cover has a lining which can be pressed down about a quarter of an inch by means of the knob on the outside, as shown in Fig. 12. A disc shown in Fig. 10 fits snugly into the cover

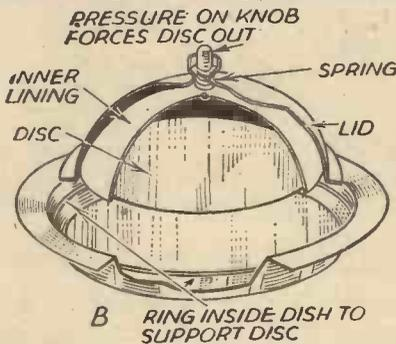

Fig. 12.—This utensil, although not actually a cooking utensil, lends itself well to tricks with food.

and can, by pressure on the knob, be ejected, when it falls into the dish—there to be supported by a flange formed of a ring of metal fixed inside the dish. See B, Fig. 12. The method of using is this: in the cover is placed whatever article it is desired to produce. The disc is then pressed into place. The dish



Fig. 13.—A fake for use with plates. The fake fits as a lining into either plate and becomes invisible. When inverted it resembles a heap of oats, bran or other commodity. The fake is here shown partially covered with oats which are glued on.

having been shown, the cover can be placed upon it, the knob pressed, and the cover lifted to reveal the article on the dish. Some other commodity, such as a spoonful of bran, can of course, be placed in the dish first and the subsequent production presented as a transformation.

**Bran into Eggs**

I have used a dish of this type to change bran into eggs (dummy eggs of course) in a trick the other half of which consisted of a change from eggs to bran in another piece of apparatus, making a "change places" trick of it.

Fig. 13 shows a set of soup plates and a special fake, by means of which a plate, heaped high with bran or wheat, may be changed—simply by covering it with another plate—to a mass of flags, a quantity of cakes, or anything else within reason.

The outfit consists of two metal soup plates enamelled white, and a fake. The fake, shown in the photograph partially coated with oats, is, practically speaking, another soup plate, made of thin metal, and having a slightly turned-over flange round the edge. This fake, if placed into one of the plates, looks like the inside of the plate, and its presence cannot be detected. If inverted on a plate, as long as its convex surface has been coated with bran or some similar commodity, it gives the appearance of a plate heaped high with the article in question.

**A Faked Plate**

The simplest way to use the plates is to load one plate with the articles to be produced, place the fake over it and sprinkle a handful of loose bran, or whatever the fake has been covered with, on top. The plate, apparently heaped with bran, is brought forward, the loose bran is brushed off and the other unprepared plate is inverted over it. When the plates are separated the fake is brought away as the lining of the upper plate, revealing the articles placed ready for production.

A more convincing method, which also demands more space for packing the apparatus, makes use of a third, unprepared plate. The plate with the load, and the fake inverted on it, is stood at one end of a large box containing bran. The two unprepared plates are shown, and one is dipped into the box, being brought up genuinely piled up with bran. The bran is openly poured back into the box, and the plate again dipped in. This time the plate is left in the box, and in its place the prepared loaded plate is brought out, the fake giving it the appearance of a plate actually piled up with bran.

# "MOTILUS" PEEPS INTO THE MODEL WORLD



"Motilus" is a New Model Fan who Always takes his Camera Around when he is "On the War-path" of his Favourite Hobby

## The "0" Gauge Owner.

Now for gauge "0" owner I have been doing a little spying. Not everyone is crazy about these streamliners, popular as they may be. They will therefore be interested in the model of the L.M.S. engine, the "Duchess of Montrose." This smartest of non-streamline locomotives is a member of the "Princess Coronation" class (non-streamlined) constructed at Crewe during this summer, and the model is just the thing for those owners who like to "see the works."

It used to be said of the "Great Britain" that she had a mast named after every day of the week, and when some bright person remarked that there were only six the captain is reputed to have retorted that that was correct because at sea there is no "Day of rest!" This may serve as some introduction to the "Great Britain" waterline scale model, which can be built up from a comprehensive set of parts costing only 12s. 6d. For those of you who have a hankering to build ships and have no tools to speak of, these waterline sets are ideal for they contain tools paint, etc., as well as

A "10½" gauge  
"Royal Scot."

EVERYWHERE I go round London, in the big shops I seem to see these wonderful Twin Trains, and now I find they are going to America. I went into Bassett-Lowke's in High Holborn, and they have secured a few of these American Twin Trains and vehicles out of the American consignment, so if you like American railways you can get them there while the

Maybe some of you have seen the new Twin Train Pacific scale models, but I managed to steal into the model factory, where they are actually being made, and saw a skilled lady artist busily lining Pacific bodies, which is one of the most complicated parts of the finishing. By the

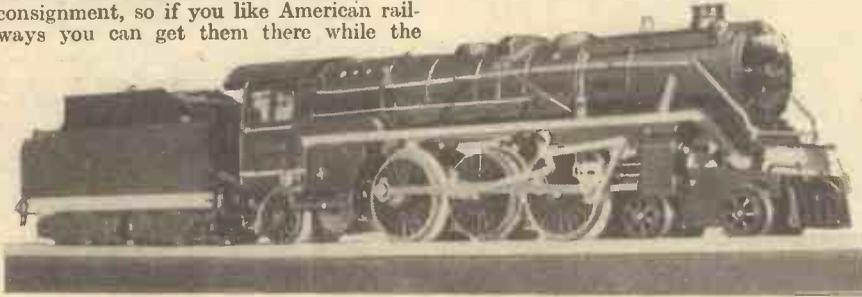

An American-type model locomotive in "00" gauge

supply lasts. I also popped down into the basement where I discovered they have added a new shunting yard to their layout where automatic coupling and uncoupling of wagons and trains operates most realistically. A portion of the line too is lighted to give day and night effect. In Bond's o' Euston Road and Hamleys I saw a good display of Bassett-Lowke products; also "00" gauge and in Hamleys the new Hornby railway in "Dublo." How "00" is gaining in interest!

## Large Model Engine

The biggest model engine I came across on my travels was a 10½ gauge "Royal Scot" which I saw being tested in Bedfordshire. Here it was crossing the viaduct of the model railway at Radwell, and when it is finished and painted, it will run on Lord Downshire's estate, Easthampstead Park, Berkshire. The overall length of this powerful garden railway locomotive is 12 ft., it has a working pressure of 120 pounds to the square inch, and has taken the best part of five months to construct.



An architect's model of the proposed new municipal buildings council suite and sessions court at Wood Green.

way, I see that some of the Diesel two-coach units are now available in L.M.S. colours, just like the Diesel trains that run between Bletchley and Oxford, and Bletchley—Cambridge. They have silver upperwork and roof and vermilion body relieved by black lines.

waterline drawing and instructions. Sets can be either historic or famous, as the "Queen Mary" and "Normandie" are available as well as the "Cutty Sark" and Brunel's other famous floating palace the "Great Eastern."

(Continued on page 214)

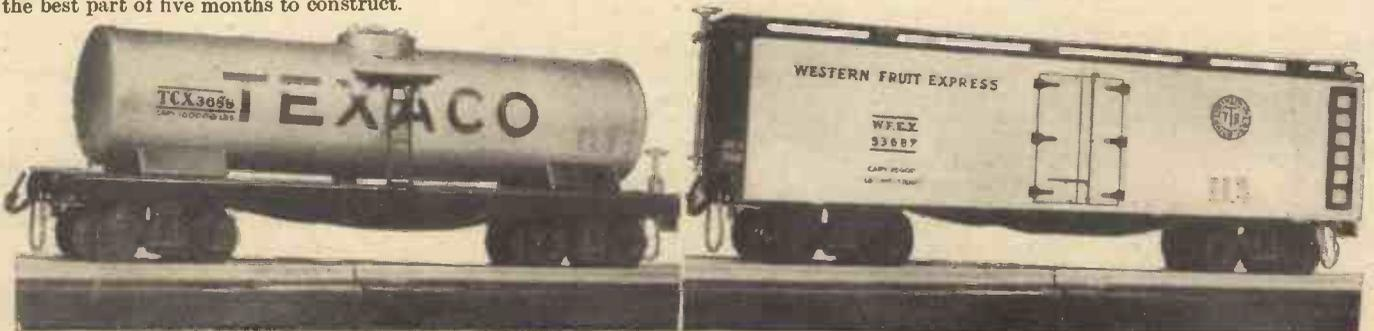

(Left) An oil tank wagon and (right) a goods van.

# The Secret of Synthetic Rubber

## How Chemical Science Has Solved An Age-Old Problem



A sample of synthetic rubber in its raw and unpounded state. Note the enormous amount of "stretch" which it permits.

WHEN Christopher Columbus, during his first visit to America, discovered a number of brown-skinned natives playing a rough sort of game with a ball composed of a material of surprising elasticity he little dreamt of the enormous world-wide industry which was, in the fullness of time, to take its rise from this chance observation of his. Little, too, did the gentle Dr. Priestly, the renowned pioneer of modern chemistry, ever consider that when, in the year 1770, he introduced small pieces of rubber into England, and endeavoured to popularise them for the purpose of erasing pencil marks on paper he was playing an active part in the foundation of one of the world's largest manufacturing activities.

The present-day consumption of rubber is, of course, colossal. Much of the output of the rubber industry is naturally taken up by the automobile industry and by allied interests. At the same time, however, the use of rubber, quite apart from the world of wheels, has become well-nigh universal, and the applications of this ubiquitous material are yearly increasing not only in amount but also in variety.

### A Natural Product

Since rubber is a natural product obtained by the coagulation and chemical treatment of the juice of certain tropical trees, the rubber industry must necessarily rely for its supplies of raw material upon vast acreages of tropical plantations. So far, most of the world's rubber plantations have invariably come more or less up to expectations and have, by dint of careful attention, yielded up their calculated supplies of raw rubber. If, however, anything happened to such plantations, if, for instance, they were destroyed by insect pests or curtailed in extension by reason of increasing land values, it follows that a diminution of the world rubber supplies would immediately result, with, of course, a rise in the prices of manufactured articles containing rubber.

Economists and rubber technologists have long foreseen facts such as these. They have pointed out that the rubber plantations of the tropics cannot go on

increasing in area indefinitely. Thus, they say, there will come a time when the world's output of raw rubber will become exceeded by the demand for the material and naturally when this happens rubber prices will soar.

### Artificial Rubber

There is, in brief, only one possible way of preventing the above state of affairs from setting in and that consists in making rubber artificially. Chemists have analysed



A sample of synthetic rubber obtained from isoprene. Note the clear liquid isoprene above the synthetic rubber at the bottom of the tube.

rubber and, from the standpoint of their own particular branch of science, have shown that it is not by any means an extraordinary complex substance. Yet, despite this fact, rubber has managed to resist all attempts at forcing it to disclose the secret of its inner physical structure. On a manufacturing scale, we cannot even now turn out at economical rates material which is exactly identical with rubber in chemical composition. Very recently, however, it has been made possible to manufacture artificial rubber which approximates very closely to the natural material in physical properties, and, indeed, in some respects, actually excels the latter substance. It is this material which is now coming into our markets and before the conclusion of this article we shall have more to say concerning it.

For the present, however, let us confine our attention to the past attempts which have been made to synthesise rubber, that is to say to make it artificially. A simple experiment which can be carried out by

anyone interested will serve to illustrate the true nature of rubber.

Rig up an apparatus consisting merely of a test-tube fitted with a cork through which a bent piece of glass tubing passes, the other end of the glass tubing dipping into an open-ended test-tube surrounded by a vessel of cold water.

Inside the closed test-tube are placed a few perfectly clean pieces of rubber and the test-tube is gently heated by means of a Bunsen burner or spirit-lamp. What happens to the rubber under this treatment can easily be imagined. It blackens, swells up and chars, giving off dense white fumes. These fumes pass through the bent delivery-tube to the test-tube and in the water-cooled "receiver" test-tube a quantity of a clear, highly-refracting liquid collects. This liquid, which has a peculiar rubbery smell, is called *isoprene*.

### Isoprene

If, now, we take this isoprene and gently warm it up with half its volume of concentrated hydrochloric acid, it quickly turns brown and eventually changes into a solid black mass which possesses all the properties of rubber and, indeed, is actually rubber.

We have, therefore, succeeded in converting some of the rubber into isoprene, and in changing almost the whole of the isoprene back again into rubber.

Experiments conducted upon these lines showed chemists that rubber and isoprene are very closely related. Rubber, in fact, seems to be merely a condensed form of isoprene. Such being the case, the reader, no doubt, will wonder why the problem of synthetic rubber was not solved long ago, since rubber can be so easily obtained from isoprene. There are, in the main, two general reasons why rubber cannot be manufactured from isoprene directly. The first—a very excellent one—is on account of the fact that isoprene is a far too expensive material to be used in rubber manufacture, the second reason being that the rubber obtained from isoprene, although it has the same chemical composition as the natural material, does not possess the physical inner structure of the latter.

### Liquid Rubber

As a matter of fact, the Germans, during the Great War, actually did endeavour to produce rubber synthetically from isoprene. They found that the latter substance could be produced from acetylene, but when, actually, the synthetic rubber was obtained, it was found to be sadly deficient in elastic properties, as well as being unsatisfactory in tensile strength.

The German chemists succeeded, also, in manufacturing rubber from a liquid known as *dimethyl-butadiene*. In this instance

the rubber obtained was better than the isoprene rubber, but the difficulties of making it were very great. For instance, the rubber took eight or ten weeks of continuous processing to produce and for the manufacture of a single ton of it, the handling of no less than 60 tons of expensive and volatile liquid was necessary. Such rubber was made up into tyres for the German military services, but the life of the tyres was exceedingly short, approximating to little more than 1,500 or 2,000 miles running. The rubber produced from dimethyl-butadiene, furthermore, lacked plasticity, could only be vulcanised with great difficulty and, in contact with water, slowly became hard and brittle. No wonder, therefore, that when the war ended, the Germans were glad to discard their synthetic rubbers and to get back to the natural product.

The problem of making serviceable rubber artificially remained unattacked for the next ten or twelve years. During this period, also, the world's supplies of natural rubber increased by leaps and bounds, thereby adding further discouragement to those who would produce the material artificially. It is, indeed, only within very recent years that the problem of making rubber synthetically has been again taken up. This time, however, success in a lasting form has greeted the efforts of the chemist to produce artificial rubber, and there is little doubt of the fact that within the very near future articles manufactured from this new synthetic rubber will be in common use.

#### "Neoprene"

The new artificial rubber, to which the name "Neoprene" has been given, is now manufactured in this country. The raw materials of its production are common enough, comprising merely lime and coke. These are heated in high-temperature electric furnaces wherein they combine together to form that well-known compound, calcium carbide. From the carbide by treatment with water acetylene gas is produced and from acetylene, by means

of a series of chemical reactions, a liquid known as mono-vinyl-acetylene is obtained.

This mono-vinyl-acetylene forms the material from which the new artificial rubber, "Neoprene," is produced. Treated with hydrochloric acid under controlled conditions, the mono-vinyl-acetylene changes completely into a thin, clear liquid known as chlorprene. This liquid, however, is an unstable one. It changes spontaneously into a brown-yellow plastic solid whose properties very closely resemble those of raw rubber. It is this material to which the name "Neoprene" has been given and from which the various grades of artificial rubber are now beginning to be manufactured.

Rubber made from lime and coke, as, indeed, "Neoprene," actually is, not only possesses most of the properties of natural rubber, but, in addition, bears characteristics which are lacking in the natural material. Natural rubber, it is well known, is highly susceptible to attack by oils and greases which deteriorate it and ruin its elasticity and resiliency. Not so the new "Neoprene" rubber, however. This material resists the action of oil far better than even the highest grades of natural rubber.

Again, natural rubbers deteriorate or "perish," as the term is, by exposure to sunlight and to atmospheres charged with ozone and other oxidants. "Neoprene" rubber, on the contrary, resists such perishing influences and has proved itself to be capable of standing up against conditions which would quickly ruin natural rubber.

Perhaps the only unfavourable feature of the new synthetic rubber is its persistent smell which, to say the least, is not very pleasant. By careful refining, however, all but the merest traces of this odour can be eliminated, and the material rendered almost as odourless as a high-grade natural rubber.

"Neoprene," of course, does not represent the final word in rubber synthesis. It is hoped, not merely to produce special and cheapened grades of synthetic rubber but, after further research, to discover a sort of "super-rubber" in which will be combined

at a low production-cost, all the many advantages of natural rubber heightened to a degree without any of its disadvantages, such as its tendency to perish and to "go off" in quality.

## NEW INVENTIONS

### Kitchen Table Roller

THE old-fashioned rolling pin has a powerful rival. But it cannot play the role of a weapon in case of civil war in the home. In constructing a machine for rolling dough, an inventor has set himself the task of producing a compact apparatus with improved means of adjusting the rollers. The device is also characterised by an arrangement which prevents the lubricating oil from contaminating the surface of the rollers. Power to operate the machine is derived from an electric motor. I presume the average housewife has not enough "dough" to make use of this kitchen roller. It should, however, prove handy for the chef, whose work involves the flattening out of many square feet of embryonic pastry.

### In Case of Fire or Bill Sikes

THE British Patent Office has accepted an application for an invention which is claimed to be an improvement in burglar and fire alarms. This relates to alarms of the kind including a gramophone connected to a telephone with means automatically to communicate with a police or fire station and to transmit a message.

Hitherto it has been possible to send a message only in general terms, leaving the telephone exchange in ignorance as to whether a burglary or a fire is occurring. The new invention allows appropriate information to be given. There are two electromagnets energised by physical or thermal conditions, according to the nature of the case. The burglar, therefore, will involuntarily intimate his presence. And fire will, by its very heat, communicate the fact that the building—as the doctors say—has a temperature.

## "MOTILUS" PEEPS INTO THE MODEL WORLD

(Continued from page 212)

### A Model Shipyard

I had the opportunity of looking into a well-known model shipyard in the Midlands and saw the hull of a model *Mauretania* well advanced and ready for shaping. Other model makers there were busily engaged in laying the keel of a huge *Queen Elizabeth* model which goes to New York for the shipping section of the United Kingdom Government Pavilion at the World's Fair opening in April.

In another part of this model shipyard I came across a rather unusual "non-ship" model. This was an architect's model of the proposed new municipal buildings, council suite and sessions court at Wood Green. I had a chat with one of the skilled model makers on this job and he told me

the model was to give the Wood Green Council a clear idea of the project. "Not one in ten town councillors," he said, "can read an architect's plan, but with a model everyone can see at a glance all essentials necessary to revise or pass the scheme." Features of this model are the varying levels. There are the cells beneath the sessions court and the sunken garage which necessitated careful modelling. The building is finished in a representation of correct Dutch brick tiling and stone work, and with its garden and shrubs has a very realistic appearance.

The model is being made for Messrs. Sir John Brown and A. E. Henson, the architects, who won the open competition for these buildings for Wood Green.



Painting the gauge "0" Locomotives "Duchess of Montrose."

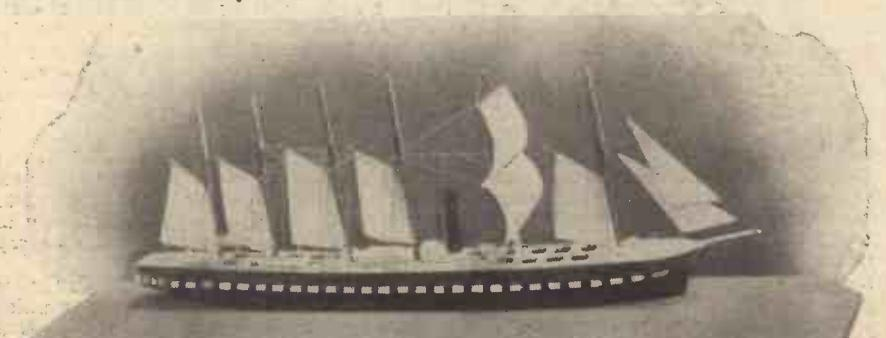

A fine waterline scale model ship.





# GAMAGES

Send for copies of *Gamages Tool Bargain Leaflets for Metalworkers and Woodworkers*

**GUARANTEED TRUE to .001 in.**

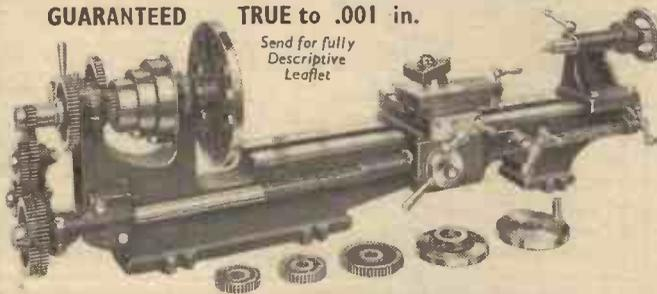

Send for fully Descriptive Leaflet

Also with single clasp nut £5/19/6, or 12 Monthly Payments of 10/9.

The "GAMAGE" 3-inch BACK GEARED, SCREWCUTTING, SLIDING, MILLING and SURFACING LATHE with COMPOUND SLIDE REST

Headstock and Bed are of ample proportions; with large diameter mandrel in long adjustable bearings. Quick Traverse Handle for Saddle Return. Saddle, has machine cut slots. All gears are machine cut. Dimensions: Swing in gap, 8in.; Swing over saddle 3 1/2in.; Mandrel nose 1/2in. Whitworth; Mandrel and tailstock barrel bored 3/4in. clear; Centres, standard No. 1 Morse taper; Cross-slide traverse, 3 1/2in.; Top-side traverse, 3in.; Lead-screw, 1/2in. diameter by 8 T.P.I.; Cone pulley, 3 1/2in., 3 1/2in., 2 1/2in. by 1/2in. width; Back-gear ratio, 6 to 1; Approximate weight 60lbs. With Compound Slide Rest and Back Gear, 20in. between Centres, including 6in. Face Plate, 2 1/2in. Driver Plate Machined Chuck Plate, 10 Change Wheels and Double Clasp Nut.

**£6'7'6**

OR DELIVERED ON FIRST OF 12 MONTHLY PAYMENTS OF 11/6

Carriage Outside Our Extensive Delivery Area, England and Wales, 3/6.

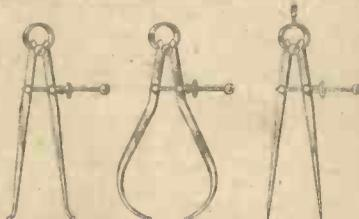

## SPRING CALLIPERS and DIVIDERS

Sheffield made, and splendid value. 5 inch, 2/-; 6 inch, 2/3. Post 4d. EACH **1/9**

## TAP HOLDERS

With six collets for taps up to 7/8 inch. Excellent workmanship and outstanding value. **2/6**



Post 6d.

## TWO SPEED FOOT MOTORS for LATHES

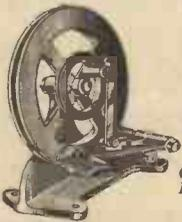

For 1/2 or 5/8 inch round leather belting. Weight of flywheel 15 1/2 lb. Total weight 30lb.

Carriage Forward **15/6**

## 1/4 h.p. D/G ELECTRIC POLISHING MOTOR

Totally enclosed. Compound wound, sleeve bearings, 2,000 r.p.m. For 200/220 and 230/250 volts, D.C. mains only. Carriage outside our extensive delivery area 1/6, England or Wales. **50/-**

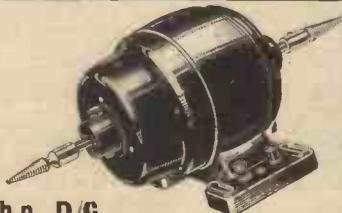

## ELECTRIC DRILLING MACHINES

In bench and floor types. The following is the main specification for both models. Three speeds, sensitive feed; depth of feed 3in.; spindle graduated in 16ths; Stop collar for regulating depth, three jaw, self-centring chuck, 1/2in. capacity. Centre of chuck to pillar 6in. Oilite bronze bearings, diameter of pillar 1 1/2in. Tilt ing and swivelling table 8in. by 8in.

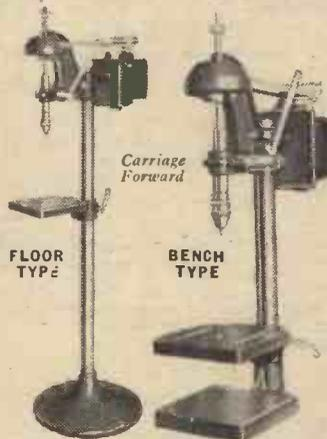

FLOOR TYPE

BENCH TYPE

Bench type (individual details): Maximum distance, chuck to table, 10in. Height to top of frame, 30in. Weight with 1/2 h.p. motor, 67lb. Without motor, 45lb.

With motor

**£8'7'6**

OR DELIVERED ON FIRST OF 12 MONTHLY PAYMENTS OF **15/3**

Without motor, £5/12/6, or 12 Monthly Payments of 10/3. Floor type (individual details): Maximum distance, chuck to table, 33in. Height to top of frame, 50in. Weight with 1/2 h.p. motor, 80lb. Without motor, 59lb.

With Motor, £9/5/0, or Delivered on First of 12 Monthly Payments of 16/9. Without Motor, £6/10/0, or 12 Monthly Payments of 11/9.



## HEAVYWEIGHT WORK BENCHES

British made, and very solidly constructed. Note the general dimensions: Top 72 in. x 17 1/2 in. x 2 1/2 in. Legs 2 1/2 in. sq. Height 34 in.

Carriage forward outside our extensive delivery area.

**21'**

## VEE BLOCKS



Carefully made from close-grained iron castings. Set comprises one pair of blocks and one unbreakable malleable iron clamp.

**4'6** Post 6d.

## SURFACE GAUGES

Accurately made and fitted with fine adjustment device. Overall height 12 inches. Diameter of base, 3 1/2 inches. **7'6**

Post 6d.

## FAMOUS "RED DEVIL" CIRCULAR GLASS CUTTER 1'6

Will cut circles from 2 to 22 inches. Rod is graduated in inches and sixteenths. Supplied with two extra cutting wheels. Post 6d.

## POWERFUL ELECTRIC DOUBLE GRINDERS

Operated by self-contained 1/2 h.p. motor for 222/240 volts A.C. 50 cycles. Single phase, 3,000 r.p.m. 2.7 amps, k.w. 0.25. Diameter of grinding wheels 6 in., 1/2 in. thick. Overall measurements 18 in. long, 9 1/2 in. wide, 10 1/2 in. high.

Weight 60 lbs. With 9 ft. cab tyre flex. **£6**



Carriage 2/-, England or Wales.

OR DELIVERED ON FIRST OF 12 MONTHLY PAYMENTS OF

**10/9**

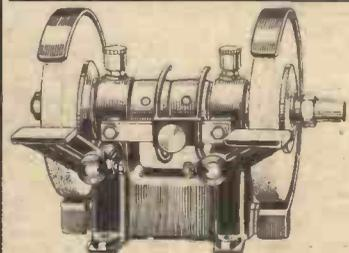

## DOUBLE BENCH GRINDER for POWER DRIVE

Well made in every detail. Fitted with Skefko Ball Bearings, Belt Shifter and Tool Rests. Wheels 6 in. by 1/2 in. Weight 48 lbs. Carriage outside our extensive free delivery area, England or Wales, 2/6. **39'6**

# BEST of ALL HOBBIES

This Beautiful MODEL GAL-LEON can be easily built from a **STUDIETTE GALLEON KIT**—without previous knowl- edge—by yourself or friends. Full instructions, parts, paints etc., are included. The finished model is a lifelong joy. The Galleon illustrated is Drake's "Golden Hind" built from Kit No. 2902. Price 45/- (length when completed 32"). Other famous kits in stock from 12/6 to 100/-, including the "Cutty Sark." **OBTAINABLE FROM LEADING CRAFT SHOPS and STORES, INCLUDING, HARRODS, HAMLEY'S, and SELFRIDGES.** If unobtain- able locally, write to—**STUDIETTE HANDCRAFTS (Dept. P), Kent Street, BIRMINGHAM.**

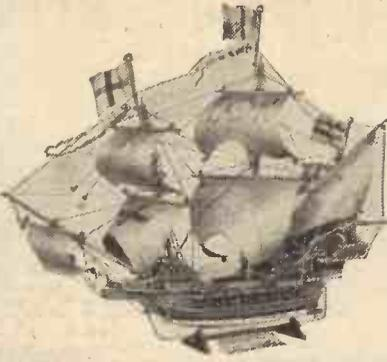

## Studiette MODEL GALLEONS

### Winter Heating

Keep warm in workshop or home with a **PORTABLE**

## TILLEY RADIATOR



The unpleasant conditions of winter—cold winds, rain, snow and ice—are soon forgotten amidst the comforts of the home. The Tilley Radiator being **PORTABLE**, provides warmth in workshop, sitting room, bedroom, bathroom, etc., as required. Burns ordinary paraffin at the low cost of 1d. for 6 hours. Requires no connections or fixing. Absolutely safe. No wick to adjust and causes neither smoke, smell nor mess. Strongly constructed of solid brass, reflector of highly polished copper. **British throughout.** Reduced price 37/6. Remit, or can be sent C.O.D., post and charges paid.

TILLEY LAMP CO. (Dept. P.M.), HENDON, N.W.4

### WILCO ELECTRIC MOTORS

**1/40 H.P. GEARED** to 96 or 47 r.p.m.

First class A.C. Motors 200/250 volts. Self-lubri- cating bearings. Silent running and excellent for model driving, sign display mechanism, etc.

**1/4 H.P. SPLIT PHASE A.C. MOTORS.** Reliable in every way, yet inexpensive to purchase. Extra heavy bronze bearings. 1,425 r.p.m. Carriage paid **55/-**

**SPECIAL BARGAIN 1/40 H.P. UNIVERSAL** Ball-bearing, enclosed type Motors. 200/250 volts. Worth 25/- ea. Our Price only **18/6** or 3 for 18/6 ea.

Any further information on request or send 4d. for Electrical Catalogue.

**L. WILKINSON, 204, Lower Addiscombe Road, Croydon, Surrey.**

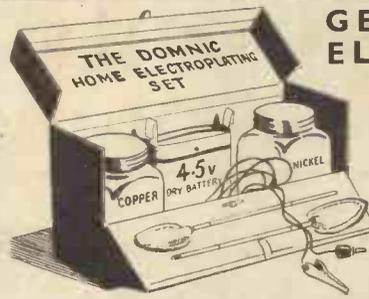

## GENUINE 6/9 ELECTRO PLATING POST Free OUTFIT

This is not an applied polish, but a perfect Electro-Plating Process. Metal is definitely electrically deposited. Not a toy but a scientific apparatus devised by experts.

Safe, easy and simple to operate, no fuss or bother, follow the simple instructions and you will be amazed at the result. Brighten up your home, plate your taps, door handles, fittings, etc., without removing. Do your own Electro-Plating, besides beautifying your home, it becomes a fascinating pastime and is so easy to use, and is permanent.

Packed in neat case with full instructions, Post free 6/9, from **DOMNIC PRODUCTS LTD., Dept. P.M.3, 19 Campbell Road, West Croydon** and from all the Principal Stores.



**MINIATURE PETROL ENGINES . . . for Aero-** planes and Speed Boats. 1 c.c. 3 and 6. Easily made from our Castings, 12/6 per set. Complete Engines ready to run, £3 15.

SEND 3d. FOR PARTICULARS  
**J. HALLAM & SON, Upton, Poole, Dorset**

## R.A.F. planes in MINIATURE

### At Last! WESTLAND LYSANDER

The Model you've wanted by Comet 1 Wingspan 19 in., length 11 in. Detailed plan with many perspective drawings. Full drawings for building detailed motor. Ready turned balsa cowl. Complete kit with all balsa, tissue, cements, dopes, hand-carved flying prop, etc. **3/11** for only



## FINE FLYING SCALE MODELS



### BRISTOL BULLDOG

Wing 18 in., length 13 in. You can build this splendid model, full of detail. Complete kit has everything needed, balsa, quick-drying cement, dope, printed insignia, hand-carved hard-wood flying prop, etc. **3/11**

### GLOSTER GLADIATOR

Wing 18 in., length 14 in. Super detailed model with large, clear, easy-to-follow plan. Auto-line-up fuselage, shock-absorbing undercarriage. Machine guns, engine details. Complete kit has everything needed, balsa, cements, dopes, hand-carved hard-wood flying prop, etc., **5/-**



Satisfaction Guaranteed or Money Refunded

## SEND YOUR ORDER TO-DAY TO

Catalogue: Finely illustrated 28-page book for 3d. **P. M. SWEETEN, LTD.** Bank Hey Street, Blackpool

Please send me by return, for which I enclose P.O. (stamps) . . . Westland Lysander 3/11 . . . B. Bulldog 3/11 . . . G. Gladiator 5/- . . . Catalogue 3d.

Name . . . . . Address . . . . .

Post NOW in a sealed envelope to **P. M. SWEETEN, LTD., BANK HEY STREET, BLACKPOOL**



**Now** IS YOUR OPPORTUNITY TO INSPECT OUR SHOWROOMS AT YOUR LEISURE

Model Railways and Accessories in all Gauges—Waterline Ships and Fittings—Historical Figures—Toys

1939 CATALOGUE NOW READY, BY POST 6d.

(Marklin Agents)

## MULTI-MODELS LTD.

10-11 NEW BURLINGTON ST. REGENT ST., LONDON, W.1

Phone: Regent 5676

## LATHES & ACCESSORIES

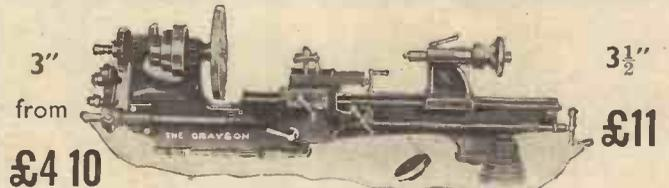

3" from £4 10 3 1/2" £11  
**WRITE FOR FREE LEAFLETS**  
**No. 1 MT. Centres**  
Male 1/4, Female 1/4, 1/2 Plain 1/4  
Wood-screw 1/9 Wood-prong 1/6  
Flat-pad 1/6 Vee-pad 1/8

**Boring Tools**  
1/6 2/- 2/3 2/6 2/9  
**WRITE FOR CATALOGUES OF TOOLS and MATERIALS**  
**E. GRAY & SON LTD. 18-20 Clerkenwell Rd. London**

# Experiments With Colloids

It is Possible for Almost any Solid Material to be Reduced to a Colloidal State, Namely, in the Form of Extremely Fine Particles Dispersed Throughout a Liquid Medium

**M**ATERIAL substances may be divided up into two classes—those which are insoluble in liquids and those which, wholly or partially, dissolve in one or more liquids.

There are, of course, far more soluble materials than completely insoluble ones. Common salt, soda and other similar substances form examples of completely soluble bodies, whilst the metals and many of their oxides constitute types of more or less insoluble materials.

When common salt is dissolved in water, the salt particles, as such, completely disappear. What exactly happens to them we do not know with any great amount of certainty, but we do know that the salt solution can be filtered through the finest of filters without any of its dissolved particles being retained by the filter. Also, we know that when such a solution is examined under a microscope of the highest revealing power—an *ultra-microscope*—it appears perfectly clear, not the slightest trace of the dissolved salt particles being visible.

## Silver and Gold

If we take a metal such as silver or gold and attempt to dissolve it in water we shall meet with failure. Even if we reduce the metal to the state of the finest obtainable powder and then endeavour to dissolve the powder in water, we shall still be unsuccessful. True it is that if we have the metal in extremely fine powder form, the powder particles will remain suspended in the water for a long time before, eventually, they settle to the bottom of the vessel. Nevertheless, they *will* ultimately settle to the bottom of the vessel and the water above them will then be quite free from any dissolved metal.

It is, however, possible to obtain metals and most other substances in so fine a state that, although they do not actually dissolve in water, their extremely fine particles never settle to the bottom of the liquid. So fine, indeed, are these particles that the liquid carrying them appears perfectly clear (yet often highly coloured). Materials which have been made to assume this extremely fine condition are said to be in a *colloidal* state. More commonly, they are simply called "colloids," the latter word coming from the Greek, *kolla*, meaning "glue," since ordinary glue itself is a good example of a colloidal substance.

## Colloidal State

At first undertaken in a very desultory fashion, the study of colloidal materials has, during the present century especially, attained a role of great importance, for it has been found that materials which are in the colloidal state display properties, some of them of considerable practical importance, which they do not exhibit when in the ordinary solid form.

By adopting the requisite means, almost any solid substance may be obtained in its colloidal state, that is to say in the form-

*Preparing the colloid dialyser. Parchment paper, after being softened in water, is moulded into cup formation by means of a wineglass.*



of extremely fine particles dispersed throughout a liquid medium. Some materials are got into their colloidal state only with very great difficulty. Others, however, fall into this condition very easily, and it is, therefore, with such materials that the practical directions contained in this article are concerned.

Any experimenter taking up for the first time the most engrossing study of colloids will find that the instructions for making the various colloidal solutions given in these columns will work well.

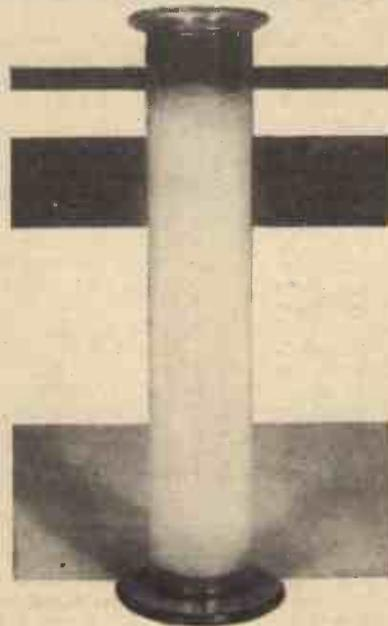

*The home-made "dialyser" which consists of a "cup" made from parchment paper suspended by string in a vessel of water.*

There is, however, one proviso for success in the art of chemical colloid making. It is the proviso of perfect cleanliness. The various test-tubes or other vessels in which the necessary chemical solutions are made up must be scrupulously clean and grease-free, otherwise the experiments may possibly not work. If a vessel has been used for any other purpose, it should be washed out with soap and water and then swabbed out with strong nitric acid and afterwards rinsed in clean water, preferably of the distilled variety.

## Gold Salts

The metal which most readily assumes the colloidal state is gold. Now, gold salts are very expensive to buy, but, fortunately, the making of colloidal gold necessitates very little of the actual metal being employed. Hence, if the experimenter does not possess any photographic gold chloride or other gold salt, he can very readily make a small quantity for himself by placing in a clean watch-glass five drops of strong nitric acid and ten drops of strong hydrochloric acid. This mixture of strong acids, known as *aqua regia*, or "Royal Water," when warmed, will dissolve gold and other precious metals. It is now only necessary to dip a portion of a gold article in the warm *aqua regia* for a few seconds for sufficient gold to be dissolved to colour the acid yellow. When this colouration is noticed, the small amount of acid should be evaporated to dryness on a water-bath and the film of yellow gold chloride which will remain attached to the glass should be re-dissolved in a few drops of distilled water.

Now take a perfectly clean glass beaker or flask and place it in about 100ccs. of water. Add to it about two or three drops of the home-made gold chloride solution and heat the liquid over a bunsen burner or spirit lamp until it is boiling

vigorously. When this happens, add to the vessel about 3 ccs. of a 1 per cent. solution of sodium citrate or citric acid. Immediately, the gold-containing liquid will acquire a purplish-red hue. Add a drop or two more of the gold chloride solution and continue boiling the liquid for a few minutes. The liquid will now acquire a brilliant red colour. It is, indeed, a colloidal solution of pure gold.

Suspended in the liquid are countless millions of almost infinitely fine particles of gold, ranging in diameter from one ten-thousandth to one-millionth of a millimetre. It is their presence which gives to the liquid its characteristic colour. Such particles will never settle to the bottom of the liquid. Hence, left alone, the liquid will retain its characteristic colour indefinitely.

Even if the colloidal solution of gold were filtered through the finest filtering medium known, the fine particles of metallic gold would not be abstracted from the solution. So fine, indeed, are these particles, that they would pass without hindrance through the filter.

#### Colloidal Particles

Under the ultra-microscope, which consists of a high-powered microscope equipped with certain oblique-lighting arrangements, it is possible to see the colloidal particles of gold floating about in the liquid. All colloidal or "pseudo" solutions reveal their constituent particles under ultra-microscopic examination, but true solutions (as, for example, a solution of common salt in water) do not thus exhibit their dissolved particles.

If we place a small quantity of a colloidal solution of gold in a test tube and place in the tube, also, a globule of mercury, afterwards vigorously shaking the tube, the red colour will disappear from the liquid, owing to the fact that the mercury will have actually dissolved the colloidal particles of gold and so removed them from the liquid.

Colloidal gold can be made in many other ways. If, for instance, a drop or two of formalin is added to a solution of a gold salt, a violet-coloured colloidal solution of gold will be obtained. Here, the gold particles existing in the colloidal solution are somewhat coarser than those present in the scarlet and ruby-red solutions.

If to any of these colloidal gold solutions a drop of acid or alkali is added, the colloidal particles of gold will clump together, forming larger and larger particles the solution changing from red to blue and through violet to brown until, eventually, metallic gold will be deposited in the form of a visible black precipitate or powder.

#### Colloidal Silver

Colloidal silver is not difficult to prepare. Add to a solution of silver nitrate an equal amount of citric acid solution. White silver citrate will at once be precipitated. Filter this off, wash it well on the filter paper, and then heat it very carefully in a small test-tube until it no longer gives off fumes. Now, half fill the test-tube with water and shake it vigorously. A red liquid will result. This is a colloidal solution of metallic silver.

By striking an electric arc at a potential of about 110 volts between two silver wires under water made slightly alkaline by the addition of a little bicarbonate of soda, greenish clouds will proceed from the area of the arc. These "clouds" consist of colloidal silver and quickly the liquid will become greenish-brown in colour.

Selenium is another element which is easily obtained in colloidal solution. Heat a few fragments of selenium in a test-tube

with a quantity of iron filings. Iron selenide will be formed. This is put into a small flask having a delivery tube dipping below the surface of water in which a little ammonia has been placed. On pouring hydrochloric acid over the iron selenide in the flask, seleniuretted hydrogen gas will be liberated. This, on coming into contact with the alkaline water, will be converted into brick-red selenium which will assume the colloidal state. This experiment should be performed out of doors on account of the objectionable odour of seleniuretted hydrogen.

Many colloidal solutions are prepared with the aid of a "dialyser," which, in its simplest form, consists merely of a membrane porous to ordinary solutions, but not to colloidal solutions.

#### A Dialyser

To make such a dialyser, all we need to do is to take a circle of parchment paper, soften it by immersing it in water and then mould it over the bowl of a wine-glass so that, when withdrawn from the wine-glass, it forms a shallow cup or dish.

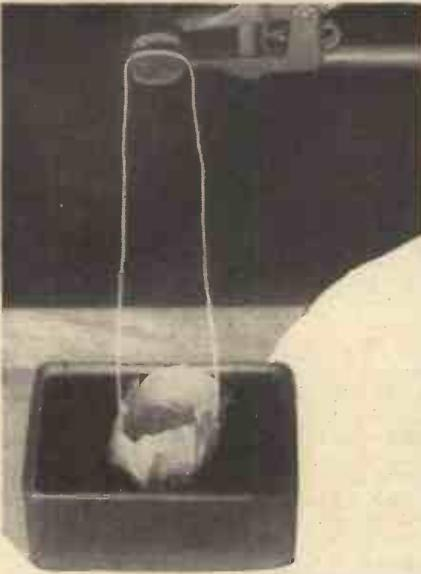

A useful colloidal emulsion of polishing wax and water prepared as described in this article. It makes an excellent polish medium and grain filler for woodwork.

This is now suspended (by means of thin string attached to its edges) with a larger dish.

Suppose, with this dialyser, we wish to make a colloidal solution of Prussian Blue, we proceed in the following manner:—

Dissolve half a gram of potassium ferrocyanide in 25 ccs. of water and, also, half a gram of ferric chloride in the same quantity of water. Pour the latter solution into the former one, slowly, and *without stirring*. Allow the mixed solutions to stand and then filter the liquid. The precipitated Prussian Blue pigment will collect on the filter paper. It should be washed and then dissolved in about 300 ccs. of water containing 15 grams of oxalic acid.

Now pour as much as possible of the oxalic acid solution of Prussian Blue into the parchment-paper bag of the dialyser, and fill the surrounding vessel with clean water so that the dialyser bag actually dips into the surrounding water. Change the latter water frequently—several times a day. After about a week, the dissolved oxalic acid will have passed through the parchment paper bag into the surrounding water, leaving behind the Prussian Blue in

colloidal solution. The latter will have a beautiful deep-blue colour and can be used for tinting other liquids. It consists of extremely fine particles of Prussian Blue (ferric ferrocyanide) in colloidal condition in the water.

#### Dialysed Iron

Similarly, "dialysed iron," which is of medicinal value, and which consists of a colloidal solution of iron (ferric) hydroxide, may be prepared.

Take a small quantity of a solution of ferric chloride and add ammonia to it drop by drop with much shaking until the precipitate of iron hydroxide which dissolves at first, ceases to be dissolved. Now add one or two drops of hydrochloric acid and shake well so that the precipitate of iron hydroxide just dissolves.

Pour this solution into the parchment paper cup of the dialyser, prepared as previously directed, and let it remain undisturbed for ten days, frequently changing the water in the outer vessel. After this time, a dark brownish-red liquid will remain in the dialyser. This is pure "dialysed iron."

If to a solution of photographic hypo we add a drop or two of hydrochloric or sulphuric acid, the clear solution will gradually become opalescent, so that, when looked through, it will transmit orange and red light only. Here we have a colloidal solution of sulphur. The action of the acid, however, will not cease here. Gradually, the solution will become more and more cloudy until it becomes milk-like in appearance. At this stage, the sulphur has grown out, as it were, of its colloidal state and has formed coarser particles of sulphur which, if the liquid is left undisturbed for some time, will settle to the bottom of the vessel.

A similar state of affairs can even more easily be produced. Dissolve a small grain of gum mastic in spirit or acetone, and then pour the resulting solution into a large volume of water, say about 500 ccs. of the liquid. A cloudy liquid will at once result. This will appear faintly yellow by transmitted light and of a fluorescent blue by reflected light. This might, in actual practice, be termed a colloidal solution of gum mastic. Actually, however, it is a "suspension" of the gum in water, for, unlike a true colloidal solution, the fine particles of the gum mastic will, in time, subside, leaving the liquid clear.

#### Suspension of Oil in Water

A very similar effect may be obtained by producing a suspension of oil in water. Dissolve 1 drop (not more) of clear paraffin oil in 10 ccs. of alcohol or acetone, and then tip the oil solution into a large volume (about 500 ccs.) of water. Preferably, the oil solution should be *blown* into the water through a pipette, the end of the pipette dipping about half-way down the liquid.

The liquid so obtained will be clear by transmitted light, but strikingly fluorescent by reflected sunlight, the effect being due to an almost inconceivably minute droplets of oil which are suspended throughout the water. In this instance of one liquid being suspended in semi-colloidal condition within another liquid, the term "emulsion" is used to describe the result, which, in this instance, is said to comprise a fine emulsion of paraffin oil in water.

A great variety of oil emulsions may be prepared in this simple manner. Even hard waxes, when dissolved in acetone or alcohol, can thus be emulsified, and their emulsions are often of considerable use as "grain-fillers" for woodwork and as wax polishes for finished surfaces.

“PRACTICAL MECHANICS” WIRELESS EXPERIMENTER

# THE 1939 SHORT-WAVE TWO

*A Simple Receiver That Provides Maximum Efficiency*

**W**HILE there are many opinions as to the most suitable circuit arrangements for a short-wave receiver, it was decided to combine constructional simplicity with maximum efficiency and use, therefore, the reliable detector L.F. combination.

With only two valves in use it was essential for the design to be such that they would give their maximum gain; for the detector valve, therefore, a straight H.F. pentode is used as this enables a very high magnification to be secured which, when fed into a high-gain output pentode, gives an amazing over-all amplification. Particular attention has been paid, however, to the signal-noise ratio.

In the aerial circuit a plug-in coil is used which enables the correct degree of coupling to be obtained between the aerial and grid circuits on all wave-bands. To allow the utmost efficiency to be obtained on various types of aerials, an alternative aerial socket is provided which has in series with it an air-spaced variable condenser of the pre-set type.

Band-spread tuning is used, the tank condenser being mounted on the left of the panel while the band-spreader is mounted in the centre and controlled by a dual-ratio slow-motion drive.

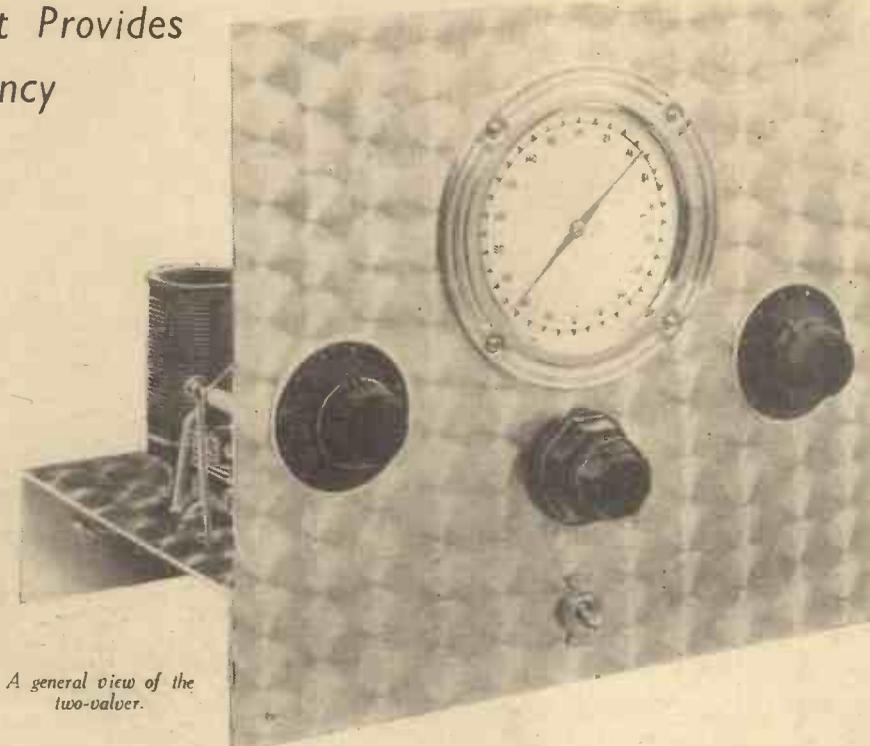

*A general view of the two-valver.*

In the anode circuit of the detector valve is a short-wave H.F. choke, which not only effectively prevents undesirable H.F. currents from passing through into

the L.F. stage, but also guarantees a smooth and progressive reaction control.

The coupling between the detector and output pentode is by means of a parallel-fed transformer, this method being used to safeguard against transformer breakdown and to provide sufficient decoupling of the detector anode circuit to reduce the possibility of instability through feed-back.

As additional precautions, however, the H.T. supply is by-passed to earth through a .5 mfd. condenser; an H.F. stopper is fitted in series with the grid of the pentode and a by-pass condenser joined between the output anode and earth.

**Constructional Details**

With a receiver of this type it is essential to provide adequate screening to prevent undesirable hand-capacity effects, and in this direction metal has been used for both panel and chassis.

These should be drilled and cut according to the dimensional diagrams. If desired they may be obtained, ready-drilled, from Messrs. Peto Scott and this will save quite a considerable amount of time. Assuming that these are being made at home, the chassis should be drilled first, the holes for the valves and coils being cut with 1 1/4 in. drills. At the rear runner the socket strips have to be mounted and you can drill 3/8-in. holes to clear each socket, or drill a 1/2-in. hole at each end and cut away the intervening space to leave a clearance slot. The small holes for the fixing bolts should then be drilled and the strips bolted in position.

On the surface of the chassis it will be noted that several holes are needed through which connecting leads are fed, and these holes may be 1/4 to 3/16 in. in diameter. Two similar holes are needed through which

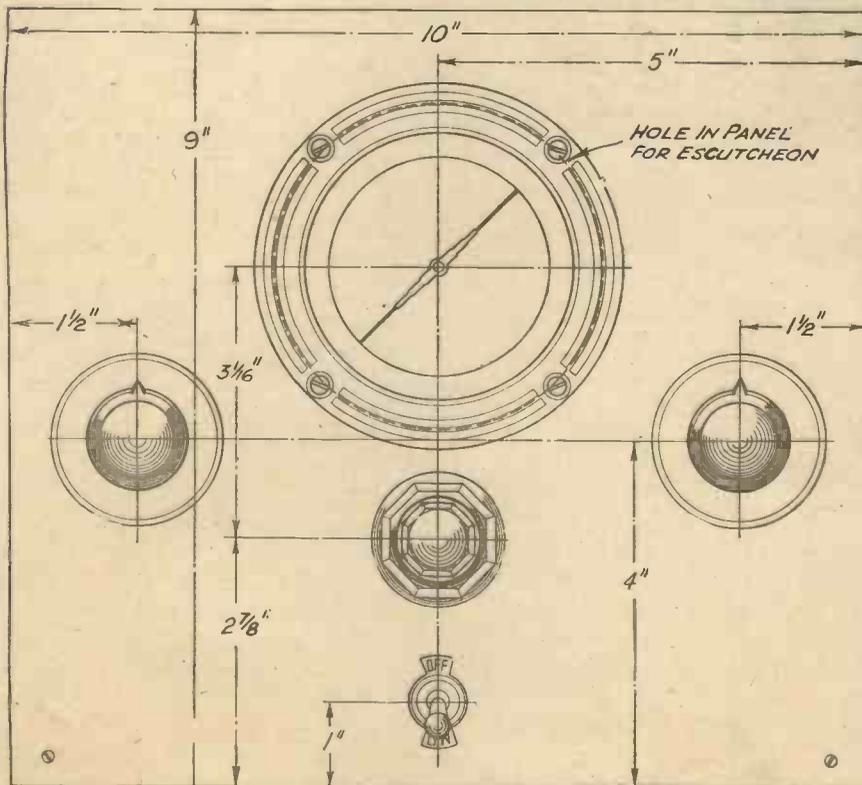

*Panel drilling dimensions for the "1939" 2-valver.*

bolts are passed to hold the aerial series condenser in position, whilst the H.F. choke is similarly held in position by a bolt. Do not mount the choke until wiring is practically finished in order to avoid damaging it.

**Mounting the Condenser**

The band-spreading condenser which is used for the main tuning and which occupies the central position is mounted on a bracket, and in order to make certain that this is correctly placed the panel should be placed in position, the bracket placed on the chassis and the condenser put in with the spindle in the dial and the entire assembly then pushed up to the panel. When the dial is seen to be close enough to the panel the fixing holder of the dial and the bracket may be marked and drilled. Next mount the valveholders and under-chassis components and carry out as much of the wiring as possible before mounting the aerial condenser and the remaining parts.

**Wiring**

The panel may now be placed in position and attached at the lower edge with two bolts. Attach the on/off switch and the band-setting condenser as well as the reaction condenser, and note that the latter only has one connection. The remaining contact (to earth) is taken via the panel and chassis. Complete the wiring, and the receiver is ready for test.

The H.T. at G.T.1 may be 120 to 150 volts, but at H.T.+ experiments may be

made with voltages from 50 to 80. The main aim should be to obtain a value which will give a smooth control of reaction without any erratic behaviour and without overlap. The G.B. should be 6 to 7.5 volts, the higher value being preferable in the interests of H.T. economy.

**Testing**

Connect the aerial to terminal A for preliminary tests, and plug in the coil. Now as the left-hand condenser is slowly turned a station should be received, although it is highly probable that it will be found exceedingly difficult to get the correct setting, owing to the very sharp tuning which is experienced. The centre control then comes into use and acts as a vernier, splitting the settings obtained on the left-hand condenser. The readings on the two dials should be carefully noted so that

settings may be reproduced as desired. The right-hand control should be needed only to bring up the strength of weak stations.

The transfer of the aerial to terminal A1 brings into circuit the pre-set condenser, and this may be adjusted to improve selectivity and to assist in obtaining smooth reaction on the lower wavelengths, where the damping effect of the aerial-earth system becomes noticeable.

**Self-Heating Soldering Iron**

OWING to the popularity of the "Soldo" self-heating soldering iron reviewed in our November issue, it has been reduced in price. In future the complete set, comprising 1 soldering iron, 10 intense heat tablets, a box of fuses and a sample of Soldo compound will be 10s. Extra tablets will be 2s. 6d. per box of 10 including fuses.

**Wiring Diagram of the "1939" S.W. Two**

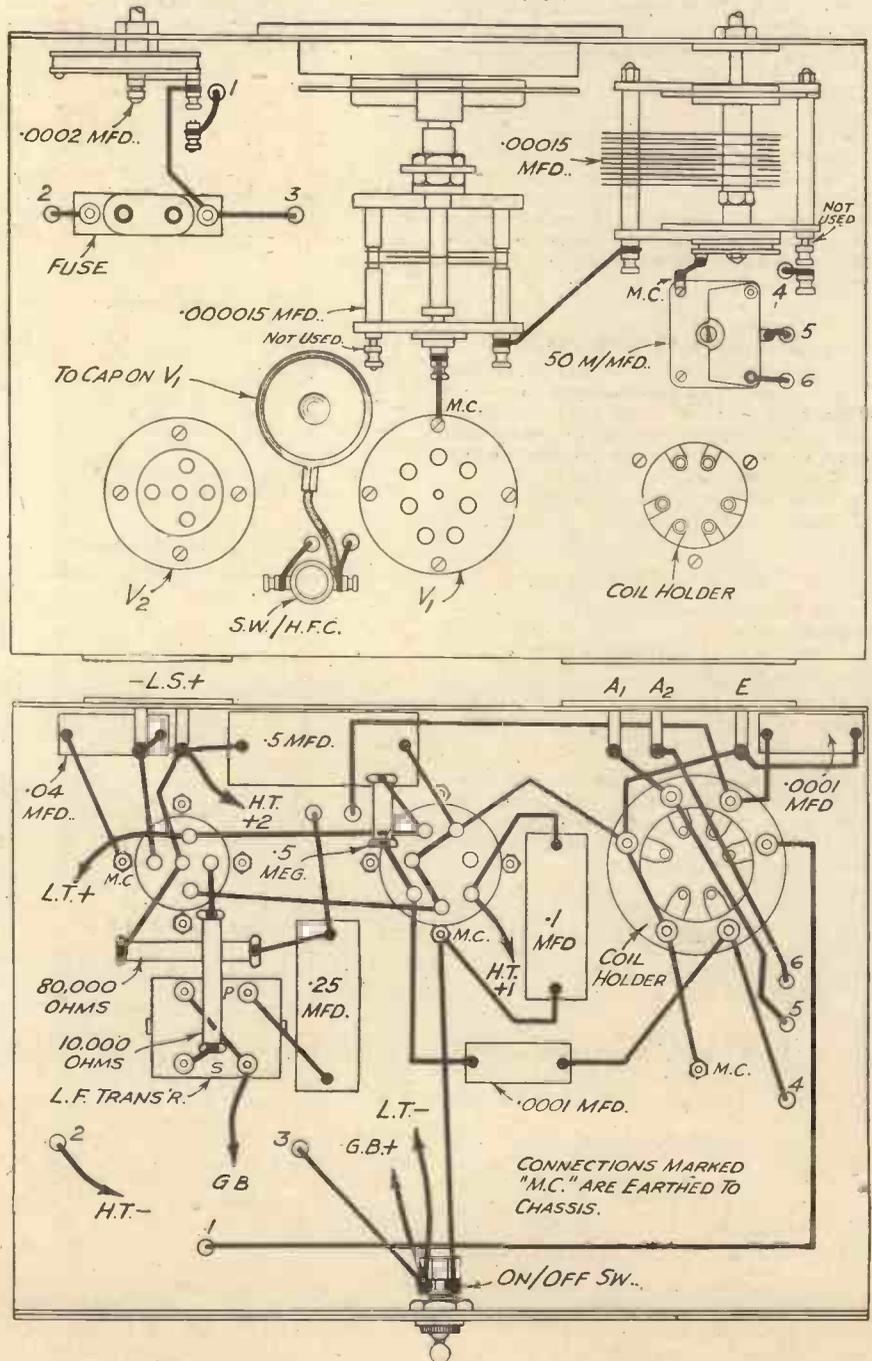

**LIST OF COMPONENTS FOR THE 1939 S.W. TWO-VALVE RECEIVER**

- One Airplane degree marking dial—dual ratio, Jackson.
- Two Tuning condensers .00015—S.W. Special; .000015—Midget U.S.W., Jackson.
- One .0002—Dilecon Reaction Condenser, Jackson.
- One .00005 Aerial series condenser, Jackson.
- One S.P.3 Coil and holder, B.T.S.
- One .0001 type 4601/S. Grid Condenser, Dubilier.
- One .5 type 4608/S. H.T. condenser, Dubilier.
- One .0001 type 4601/S. Anode by-pass condenser, Dubilier.
- One .25 type 4606/S. coupling condenser, Dubilier.
- One .04 type 4601/S. tone condenser, Dubilier.
- One .1 type 4603/S. screen condenser, Dubilier.
- One .5 type 1/2 watt grid leak, Erie.
- One 80,000 1-watt anode resistance, Erie.
- One S.K.T. L.F. transformer, B.T.S.
- Three valveholders—one 7-pin V5, one 7-pin, one 5-pin Y1. V2 Chassis type, Clix.
- One switch—S.102, Bulgin.
- Two scales—I.P.7, Bulgin.
- Two terminal strips—A, A1, and E.L.S., Clix.
- H.F.C., S.W., S.W., B.T.S.
- Panel 10in. x 9in. Alu., Peto Scott.
- Chassis—10in. x 2in. x 7in., Alu., Peto Scott.
- Fuse—100 mA., Microfuse.
- Fuseholder, Microfuse.
- Two Valves, H.P.210, P.P.225, Tungram.
- One pair earphones, Ericsson.
- One 120-volt H.T. battery; one 2-volt 40 A.H. accumulator, Exide.
- One Stentorian loudspeaker, W.B.

## THE MODERN MOTOR ENGINEER

In view of the many recent developments that have taken place in Motor Engineering, it has been considered necessary to bring out an entirely new and revised edition of "The Modern Motor Engineer" to meet the demands of the garage manager and mechanic for a practical up-to-date book of instruction on all phases of their work.

### BREAKDOWNS ON THE ROAD

A feature of special value is the section dealing with breakdowns on the road. Repairs are treated in great detail, and instruction is given in welding, brazing, sheet metal work, machinery and grinding. There is also a section on chassis frame straightening and repairs.

### THE SCOPE OF THE WORK

Among the many subjects which are dealt with in detail are: Garage Lay-out and Equipment—Dismantling, Tuning and Repairs of Engines—Clutches, Gear Boxes, Transmission, Springing and Brakes—Modern Ignition Systems—Armature Winding and Repairs—Carburettors—Tyre Troubles—High-speed Oil Engines—How to cost Garage Jobs—Legal Requirements—etc., etc.

### ELECTRICAL DIAGRAMS

A volume entitled "Electrical Diagrams" is given free to all purchasers of this work. This volume, handsomely bound, contains about 70 electrical wiring diagrams, and electrical data of the most popular English and American Cars and commercial vehicles. Its value to motor engineers cannot be overstressed.

### THE ILLUSTRATIONS

The work is fully illustrated with 32 full-page plates and over 1,600 illustrations in the text, all of which have been chosen for their practical value.

### THE MOTOR ENGINEERS' CHART

Supplied free with this new edition is a specially prepared chart, which shows, by means of diagrams and tables, all the information regarding measurements, etc., which the engineer or mechanic is likely to require in his day-to-day work.

### A FREE BOOKLET

To the Caxton Publishing Co., Ltd.,  
119, Clun House, Surrey Street,  
London, W.C.2.

Please send me, free of charge, Booklet, describing "The Modern Motor Engineer."

Name.....  
Send this form in unsealed envelope  
(½d. stamp).

Address.....

O.16 .....

## MODERN ELECTRIC WIRING

The New and Revised Edition of "Modern Electric Wiring" is a practical guide to the wiring of Private Dwellings, Business Premises, Factories, and Public Buildings, for Lighting, Heating and Power, with chapters on Wireless Practice, Electric Motors, Talking Picture Equipment, and Neon Illumination.

The author has had a wide and varied experience in the practice of wiring, and is therefore able to describe in detail how every phase of the work should be carried out.

### THE SCOPE OF THE WORK

General Principles of Electrical Conductivity—Materials—Wire Gauges—Insulators, Insulation, and Resistances—Systems of Wiring—Safety Fuses—Illumination, Heaters, Cookers, Small Motors, Appliances—Wiring Layouts—Lighting, Heating, and Cooking—Temporary Wiring—Measuring Instruments, Meters, and Mains—Bells and Signals—Domestic Telephones—Testing—Wiring for Wireless Installations—Power Amplifiers, Public Speech and Talking Picture Equipment—The Workshop—Electric Motors and Generators—Principle of Neon Illumination—Specifications, etc.

### THE WORKSHOP

To the ambitious wireman, anxious to commence business, the chapter on the workshop will be full of interest because, apart from equipment and routine (with specimens of time and material sheets), the business side is also discussed and useful hints given as to carrying out work, stock-taking, calculating profits, etc.

### THE ILLUSTRATIONS

"Modern Electric Wiring" contains over 270 illustrations, the majority of which are wiring diagrams, specially designed to demonstrate practical working, and many of them suitable for use in actual practice.

### AN OPINION

Mr. G. B. BENNETT, Tudor Road, Leicester, writes:

"I am delighted with 'Modern Electric Wiring.' It treats a big subject in a manner remarkably easy to understand. It is the best book on Electric Wiring I have seen."

### A FREE BOOKLET

To the Caxton Publishing Co., Ltd.,  
119, Clun House, Surrey Street,  
London, W.C.2.

Please send me, free of charge, Illustrated Booklet describing "Modern Electric Wiring."

Name.....  
Send this form in unsealed envelope  
(½d. stamp).

Address.....

S.16 .....

## SHEET-METAL WORK

This entirely new and practical book deals fully with present-day methods adopted by Sheet-Metal Workers in the most up-to-date factories in the country. It includes not only a sound working knowledge of all the long-established workshop methods, but also describes in detail the most recent developments, especially those employed in Aeroplane and Automobile Manufacture. It also contains valuable chapters on Plastics and Plastic Processes. "Sheet-Metal Work," while essentially a practical book for the practical man, will also be found invaluable by anyone connected in any way with the Trade, as a reference work and as a means of brushing up his knowledge.

### THE AUTHOR

The author is Mr. F. Horner, who needs no introduction to those in the Engineering Trade. He has been assisted by eight recognised experts and the work has been edited by Mr. A. Regnaud, B.Sc. (England), A.R.C.Sc., M.I.E.E., who is the Senior Lecturer at Faraday House Engineering College.

### SOME OF THE SUBJECTS

The principles of Sheet-Metal Working, Sheet-Iron and other Sheet-Metals, Preparation of Sheets, Aluminium Working, Copper Working, Lead and Zinc Working, Art-Metal Work, Tinsmiths Work, Plastics, Shearing Machines, Punching Machines, Bending and Forming Machines, Power Presses, Sheet-Metal Factories, Useful Data, Blanking Presses, Coining and Other Presses, Machines for Miscellaneous Operations, Dies used in Presses, Drawing Dies and their Operation, Dies for Bending, Die-making, Plastic Processes, Resistance Welding, Oxy-Acetylene Welding, Electric Arc Welding, Spot Welding, Soldering and Brazing, Portable Tools, Machines for Can Manufacture, Finishing Processes, Spinning Lathes and Processes, Mass Production.

### ILLUSTRATIONS

The work is profusely illustrated, it contains over seven hundred illustrations in the text in addition to 24 full-page plates. All the illustrations have been chosen for their practical value in helping the reader to follow the text.

### A FREE BOOKLET

To the Caxton Publishing Co., Ltd.,  
119, Clun House, Surrey Street,  
London, W.C.2.

Please send me, free of charge, Illustrated Booklet describing "Sheet-Metal Work."

Name.....  
Send this form in unsealed envelope  
(½d. stamp).

Address.....

BB 16 .....

# The Piano—A New

MAURICE REEVE, THE  
YOU HOW TO PLAY THE  
METHOD. MR. REEVE ALSO  
FROM

This Month the Author Describes  
a Glossary of

texture and scored for many parts—  
voices. It should always be used to  
continue the "joining" process, fre-  
quently referred to in these pages, when  
that process becomes too awkward,  
or impossible, owing to the size of the  
intervals or spans. It should also be



**T**HE piano has two pedals—con-  
trivances worked by the foot to  
communicate with the inside of the  
instrument, the sustaining and the damper.  
The latter can be dismissed in a few words.  
The damper pedal, by shifting the keyboard  
along so that the hammers strike fewer  
strings, increases key resistance, thus  
enabling the player to employ a lighter  
finger touch and produce a smaller volume  
of tone than would otherwise be the case.  
The damper pedal, wrongly styled the  
"soft" pedal, is the left-hand of the two  
pedals.

#### The Sustaining Pedal

The right-hand one, or sustaining pedal  
(it is quite erroneously styled the "loud"  
pedal), is much more important. According  
to the demands of the music, it is perfectly  
permissible to play as softly as possible with  
the "loud" pedal on, and to strike the keys  
with all one's might with the "soft" pedal  
down.

As its correct title implies, its chief  
function is to "sustain"; particularly notes  
that are beyond the normal span. It  
is also used to give a fuller and more reson-  
ant tone to passages of a full harmonic

unfurlingly used by readers at the end of the  
page to maintain the continuity of sound  
when one hand has to release the notes in  
order to turn over. By the way, the hand  
used for turning over should always be the



The four photographs on this page show the author playing the piano and they serve to emphasise the attitude of any pianist as he is likely to be at any given moment during an actual performance. It will be seen that the position of the pianist at the instrument is one of perfect ease and comfort, and he is ready to adapt himself instantaneously to the exigencies of the music. None of the principles of technique explained in these pages, if efficiently carried out, need ever interfere with this golden precept. The photograph on the right emphasises the right hand tilted on to the thumb when playing in the top registers of the keyboard, in order to counteract, as far as possible, the weakness of the fourth and fifth fingers. The same principle applies to the left hand in the low registers. In brief, everything should be made to increase the efficiency of the fingers. If to lean the body over to one side helps to do this, lean it, by all means. Or tilt the elbow and forearm. The distance you sit from the keyboard must vary considerably according to one's height and physique, and the length of one's arms and legs. But, here again, only ask yourself one question. Do I play better sitting like this or like this? The rest need only be regulated by the exigencies of a good style and appearance.



# Method of Learning to Play It

FAMOUS PIANIST, TEACHES PIANO BY A NEW AND MODERN REGULARLY BROADCASTS THE B.B.C.

## the Principles of Pedalling and Gives Musical Terms.

accompanying hand—usually the left, the other hand, playing the melody or musically more important of the two parts, must sustain its notes and join them up to the first notes on the next page.

### Faulty Use of Pedal

Few things spoil performance more than faulty use of the sustaining pedal. And yet few things can be easier if properly understood. In its first stages it is little more than a knack. But it may surprise some people to learn that the secret of good pedalling is good finger work. The perfect



The series of illustrations on this and the next page shows the correct sequence of finger actions during the course of playing the first five notes of the scale of F major. These studies are meant to illustrate the principles of finger and wrist technique, as explained in the text, in actual practice. Observe how each finger is raised in preparation for striking the note in advance of the actual strike, and, most important, how each successive note shows a gradual progress of the THUMB along the keyboard so that, when it has to play its next note, C, it is on that note, and not away back in the vicinity of its previous note. A perfect legato depends very largely on this correct thumb movement. Further note that, on reading C, to be played with the thumb, the hand is thrown forward to cover the next group of notes in the scale, C, D and E, thus repeating the process throughout the entire scale. The general poise and level of the wrist and forearm will be seen to be quite capable of carrying the coin for practice, as suggested elsewhere. In no case should these principles cause the player to "cramp his style" in any way, the arms can remain feeling perfectly free and natural.

co-operation of finger with foot, with the ear acting as judge and final arbiter (as in all things musical) is what we have to set out to obtain.

Firstly, it can be briefly stated that the sustaining pedal, when lowered by the foot withdraws the complete row of dampers from the strings, instead of each individual damper as is the case when we play notes without using the pedal. We must, therefore, bear in mind that, when the sustaining pedal is down, we must only play combinations of notes which harmonise, or which are, in other words, pleasing to the ear. In the case of whole chords, the notes can be released and the hand left free to prepare for its next task. But in the case of single notes, or any legato passage, the fingers are never released from their obligation to join each pair of notes together—as previously explained. In other words, what is really meant by good pedalling being dependent on good finger work is that if the fingers don't give the foot the





See page 223

chance to let the pedal accomplish its mission of "sustaining" the notes, then it is of little use.

**Bad and Correct Pedalling**

The following four diagrams show, firstly *a* and *b*, the two great faults making for bad pedalling, and *c* and *d* what is meant by correct pedalling.

In *a*, a premature damping of the strings, after the chord has been released, leads to a gap.

In *b* the reverse is the case, and by far the worse of two evils. A *delayed* damping of the strings, delayed until the *second* and discordant chord has been struck, leads to two unrelated chords being sustained with a consequent jangle of disagreeable sound. This is almost inevitably followed by *a*, inasmuch as that when the unpleasant "noise" bears down on the player's ear, both notes and pedal are release ! !

What we have to set out to accomplish in *c* and *d*, a perfect join.

**Sequence of Events**

After a passage with sustaining pedal has commenced, the sequence of events from the second note on, are three in number as follows :

- 1.—Note played and sustained with fingers.
- 2.—Pedal up, presuming it to be already down.
- 3.—Pedal down.

In brief—note-up-down—note-up-down—note-up-down—etc. Until the third of these is accomplished, the note cannot be released by the fingers, if this is necessary; until the first is completed the note cannot be struck. In practice all three motions are practically simultaneous—hardly distinguishable from one movement. To re-capitulate, no two chords must sound together which, in unison, are disagreeable to the ear; nor must there be the slightest gap between any two.

**Glossary Of Musical Terms**

**G**LOSSARY of the most commonly used Musical Terms, including those already explained in the text. All are Italian unless otherwise stated. *A capriccio*, *A piacere*.—At will; according to the performer's pleasure or fancy. *Accelerando*.—Increase the speed gradually.



- Acciaccatura*.—A short appoggiatura. (q.v.)
- Accidentals* (Eng.).—Sharps, flats, or naturals that occur in the course of a piece, in contradistinction to those in the signature.
- Adagio*.—Slow—quicker than largo and slower than andante.
- Ad libitum* (Lat.).—At will. That a movement is left to the general discretion of a performer. In scores, that a part or parts may be added or left out.

- Agitato*.—Agitated. Restless.
- Agréments* (Fr.).—Ornaments. Graces.
- Alla breve*.—A quick kind of common time with minims instead of crotchets counted. Usually indicated  $\epsilon$
- Allegretto*.—Moderately lively. Not so quick as allegro.
- Allegro*.—Quick. Lively. Also used as an adverb to imply a movement.
- Allegro assai*.—Very quick.
- Allegro con brio*.—Quick and spirited.
- Allegro con fuoco*.—With animation and fire.
- Allegro con moto*.—An animated allegro.
- Allegro furioso*.—Quick and impetuous.
- Allegro maestoso*.—Quick but majestic.
- Allegro ma non troppo*.—Quick but not too quick.
- Allegro moderato*.—Moderately quick.
- Allegro molto*.—Very quick.
- Allegro risoluto*.—Quick and decisively.
- Allegro vivace*.—Very quick and lively.
- Alto*.—One of the four chief classes of the human voice. More commonly known as *contralto*.
- Ancora*.—Again.
- Andante*.—Walking. A somewhat slow movement.
- Andantino*.—Diminutive of andante.
- Appoggiatura*.—A leaning. A note leaning against another. A grace note. *Short appoggiatura*, also called *acciaccatura*, is now always written as a small-sized quaver or semi-quaver with a stroke crossing the stem. Should only take up a fraction of the principal note. *Long appoggiatura*: observe three rules, (a) when the principal note is divisible into two equal parts the appoggiatura receives one of them; (b) when dotted, and not divisible into two equal parts, the appoggiatura receives the value of the note without the dot; (c) when the principal note is tied to a shorter note of the same pitch, the appoggiatura receives the value of the whole of the long note, and dot if dotted.
- Arpeggio*.—Applied to the notes of a chord when they are struck one after the other instead of together.
- Assai*.—Very.
- A tempo*.—In time. Usually follows a change of time, and denotes that the original time must be resumed.
- Augmented intervals*.—Intervals one semi-tone greater than major or perfect intervals.

The above four diagrams show at A and B the two chief faults making for bad pedalling, and C and D what is meant by correct pedalling.

**A una corda.**—On one string. In piano music, the damper pedal.  
**Accent.**—(1) The regularly recurring stress on certain parts of a bar by which bars and their divisions are articulated; (2) The emphasis laid on certain notes with a view of articulating motives, phrases, periods, etc.; (3) The modifications of tone that aim at bringing out the intellectual and emotional contents of a work.  
**Bar.**—The name of the perpendicular lines crossing the staff which divide musical compositions into small portions of equal length. Also the small portions themselves. These, however, are more correctly called "measures."  
**Bass.**—The lowest of the four chief classes of the human voice. The lowest part of a composition.  
**Bind (Eng.).**—The curved line  $\frown$  between the same two notes, a tie; in all other cases, a slur.  
**Brace.**—The bracket connecting two or more staves.

notation but not in pitch—thus, G flat might be the enharmonic of F sharp.  
**Flat (Eng.).**—The character  $b$  which denotes the lowering of a note by one semitone.  
**Giocoso.**—Gay. Merry. Jocose.  
**Harmony.**—The combination of parts, or voices, to proceed simultaneously, according to accepted rules and regulations. No connection with *melody* or *accompaniment*.  
**Largo.**—Large, broad, stately.  
**Ledger lines (Eng.).**—The short auxiliary lines above and below the staff.  
**Legato.**—Slurred, bound together. That successive notes have to be played connectedly.  
**Lento.**—Slow. One of the slowest movements.  
**L'istesso.**—The same.  
**Loco.**—Place. Signifies a return to the normal pitch after  $8^{VA}$ .  
**Maestoso.**—Majestic.  
**Melody.**—A succession of notes pleasingly ordered with regard to pitch and time. As distinct from *harmony*, q. v.

**Repeat.**—Sign  $||$ : All notes between any two repeat signs, or between a repeat sign and a double bar, to be played a second time. The signs  $\overset{1st}{\curvearrowright}$   $\overset{2nd}{\curvearrowright}$  mean that only that bar required is to be played and not both, each time.  
**Rests.**—The signs which indicate silence, corresponding to the note values.  
**Ritard.**—A gradual slackening of speed. Also *rit*.  
**Rhythm.**—Measured motion; a regular grouping of long and short, accented and unaccented, syllables or sounds.  
**Semiquaver.**—One-fourth of a crotchet, one-sixteenth of a semi-breve.  
**Senza.**—Without.  
**Sforzando.**—Forcing.  
**Sharp.**—The sign  $\sharp$  which raises the pitch of a note one semitone.  
**Signature.**—The signs placed on the staff at the beginning of a piece.  
**Simile.**—Similar.

**Sinistra.**—Left. *Mano sinistra*: left-hand.  
**Slur.**—The curved line placed above or below several notes indicating that they have to be played connectedly. q. v.  
**Legato.**  
**Sopra.**—Above. Upon.  
**Soprano.**—The highest of the four divisions of voices.  
**Sotto.**—Under, beneath.  
**Staccato.**—Detached.  
**Stave.**—Parallel, horizontal lines—five in modern music, on and between which the notes are placed.  
**Stem.**—The perpendicular line affixed to the heads of notes.  
**Tempo.**—Time, part of a bar, movement.  
**Tenor.**—The third, from the top, of the four divisions of the human voice.  
**Tenuto.**—Held, sustained.  
**Tie (Eng.).**—The curved line between the same two notes, indicating that the second of the two notes must not be struck; in practice the value of the first note is doubled.  
**Tonic (Eng.).**—The basis, or first, or keynote of a scale.  
**Troppo.**—Too much. *Ma non troppo*: not too much.  
**Vivace.**—Lively, briskly.  
**Voce.**—Voice.



Showing what is meant by appoggiatura. It means a note leaning against another (a grace note).

**Breve.**— $\text{||}$  Has twice the value of a semi-breve, eight crotchets.  
**Broken chord.**—Arpeggio.  
**Chord.**—Two or more sounds combined according to the laws of harmony.  
**Chromatic.**—In modern music, proceeding by semitones, chromatic in distinction from diatonic, q. v. Chromatic notes are notes altered from the diatonic by accidentals.  
**Clef.**—The character placed at the beginning of the staff to show the absolute pitch of the notes; without a clef the notes would only show their relative pitch.  
**Coda.**—A tail. Added at the end of a piece as a conclusion.  
**Common chord.**—A chord composed of a bass-note, its major or minor third, and perfect fifth.  
**Crescendo.**—Gradually increasing in loudness, shown by abbreviation *cresc.* or the sign  $\text{<}$ .  
**Crotchet.**—One-fourth of a semi-breve.  
**Con.**—With.  
**Da capo or d.c.**—From the beginning.  
**Demisemiquaver.**—One-eighth of a crotchet, one-thirty-second of a semi-breve.  
**Destra.**—Right. *Mano destra*, right-hand.  
**Diatonic (Eng.).**—The scale in which tones predominate. All the major and minor scales.  
**Discord.**—An interval that leaves an air of unrest, of dissatisfaction, and which consequently needs resolving into a consonant chord.  
**Diminuendo or dim.**—Also shown by the sign  $\text{>}$ . Diminishing in loudness.  
**Dominant (Eng.).**—The fifth degree of the scale.  
**Doppio.**—Double.  
**Enharmonic (Eng.).**—Notes which differ in

**Meno.**—Less.  
**Mezzo.**—Half, middle, medium.  
**Minim.**—Half a semi-breve.  
**Mode.**—Species of scale.  
**Moderato.**—Moderate.  
**Modulation (Eng.).**—A change of key.  
**Molto.**—Much.  
**Mosso.**—Moved.  
**Moto.**—Motion.  
**Natural (Eng.).**—The sign  $\natural$  which revokes a preceding sharp or flat.  
**Octave.**— $8^{VA}$ . To be played an octave higher than written, and when written under the bass staff, indicates that the left-hand is to be played an octave lower than is written.  
**Ossia or perdendosi.**—Dying away.  
**Piano.**—Soft.  
**Poco.**—Little.  
**Polyphony.**—A simultaneous multiplicity of sounds. Polyphonic. A piece; or part of a piece, with more than two voices moving simultaneously.  
**Presto.**—Quick. Quicker than allegro.  
**Quaver.**—Half a crotchet, one-eighth of a semi-breve.  
**Ritardando.**—Gradually slower.

JUST PUBLISHED!

**PRACTICAL WIRELESS SERVICE MANUAL**

By F. J. CAMM

A Complete, Practical and Up-to-date Work on the Testing of all Types of Wireless Receivers. It contains 288 Pages and Over 220 Photographs, Diagrams and Plans.

From all Booksellers 5s. net or by post 5s. 6d., direct from the Publishers, George Newnes, Ltd. (Book Dept.), Tower House, Southampton Street, London, W.C.2

## THE METRONOME

**T**HE metronome is an instrument for measuring time, consisting of a graduated scale and a pendulum with a movable weight. The figures down the sides of the panel represent a given number of beats per second. A large number of works and studies have been marked by their composers with an indication of the speed, as represented by the metronome, at which they should be played. The indication is marked thus:  $\text{♩} 68$  or perhaps  $\text{♩} 112$ . That means that you slide the weight on to the required number and the beat of the pendulum will have the value

of one minim or one crotchet per beat, as the case may be.  
 It is an excellent device with which to practice scales and exercises, after they have been thoroughly learned and there is no chance of faltering. It trains the ear to divide beats into fractions by multiplying or dividing the number of notes the fingers have to play per beat. With pieces, it should be used more judiciously, more as an indication, as the musical contents, not possessed by a study or exercise, demands some latitude and less rigidity.

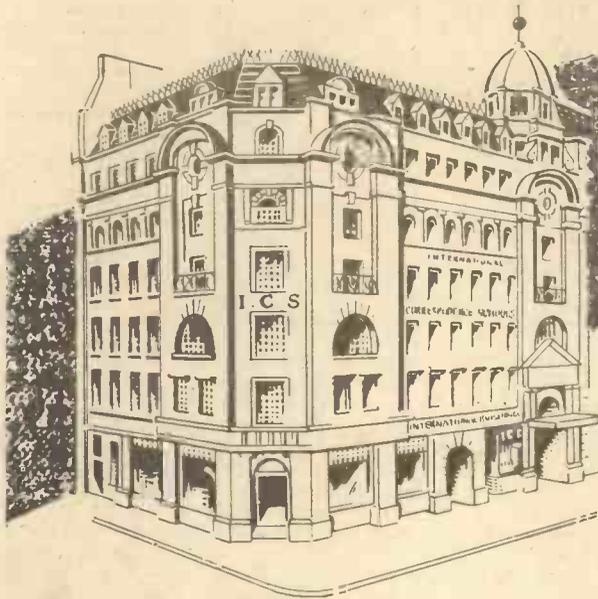

*Your Work -  
AND Your Pay*

This is  
**INTERNATIONAL BUILDINGS  
KINGSWAY, LONDON**

Head Offices of the

**INTERNATIONAL  
CORRESPONDENCE SCHOOLS**

It is the centre from which radiates technical, commercial, and professional instruction that has been of great benefit to tens of thousands of ambitious people.

The I.C.S. is the greatest as well as the largest institution in the Empire devoted to spare-time training. Its prestige is unequalled. Several State Departments have entered into working arrangements with the I.C.S. for the training of men.

More than 1,500 I.C.S. text-books, prepared at International Buildings, are marvels of clearness, accuracy, and practical helpfulness.

There are 80 Instructors at Kingsway, many of them Associates, Members, or Fellows of their respective technical or professional bodies. *All are specialists*, and expert in giving the student *individual attention* throughout his Course of Study.

Among the 400 I.C.S. Courses there is one that can qualify YOU for Promotion and better Pay.

The size of your salary is more or less in accordance with the measure of what you know and therefore can do. The more you know, the greater your pay.

Success—progress won by merit—depends on trained ability. Unless you have studied **IN YOUR SPARE TIME**, you have little chance of promotion, for knowledge that comes through everyday work is not enough.

You must know the principles underlying your work and be familiar with the many processes closely related to that work. *The one and only means of obtaining such knowledge is specialized study.*

No man need be without that extra efficiency which adds so much to his income, security, and happiness. He can acquire it on easy terms, by the simple I.C.S. method of teaching by post.

If you are in the early stages of your career and have not yet had a specialized training, you should start to get one without delay. Or perhaps you feel that your knowledge is a little out of date and ought to be modernized. In either case

**The International Correspondence Schools can help you.**

*Our expert advice on any matter concerning your work and your career is yours for the asking—free and without obligation. Let us send you a booklet dealing with the subject in which you are especially interested. It is packed with valuable information.*

The I.C.S. offer instruction in the subjects given below.

*Write for Special Booklet to-day or use the Coupon.*

**COUPON FOR FREE BOOKLET**

**INTERNATIONAL CORRESPONDENCE SCHOOLS, LTD.;** (Dept. 95), International Buildings, Kingsway, London, W.C.2

Please send me your booklet containing full particulars of the Course of Correspondence Training before which I have marked X. I assume no obligation.

- |   |  |  |   |
|---|--|--|---|
| <input type="checkbox"/> Accountancy              | <input type="checkbox"/> Diesel Engineering        | <input type="checkbox"/> Marine Engineering            | <input type="checkbox"/> Scientific Management        |
| <input type="checkbox"/> Advertising              | <input type="checkbox"/> Draughtsmanship           | <input type="checkbox"/> Mechanical Drawing            | <input type="checkbox"/> Short-Story Writing          |
| <input type="checkbox"/> Aeronautical Engineering | <input type="checkbox"/> Electrical Engineering    | <input type="checkbox"/> Mechanical Engineering        | <input type="checkbox"/> Steam Engineering            |
| <input type="checkbox"/> Air Conditioning         | <input type="checkbox"/> Engineering Shop Practice | <input type="checkbox"/> Mining Engineering            | <input type="checkbox"/> Surveying                    |
| <input type="checkbox"/> Architecture             | <input type="checkbox"/> Fire Engineering          | <input type="checkbox"/> Motor Engineering             | <input type="checkbox"/> Telephone and Telegraph Eng. |
| <input type="checkbox"/> Boiler Engineering       | <input type="checkbox"/> Garage Management         | <input type="checkbox"/> Pattern-making                | <input type="checkbox"/> Textiles                     |
| <input type="checkbox"/> Book-keeping             | <input type="checkbox"/> Gas-Power Engineering     | <input type="checkbox"/> Plumbing                      | <input type="checkbox"/> Welding, Gas and Electric    |
| <input type="checkbox"/> Building                 | <input type="checkbox"/> Heating and Ventilation   | <input type="checkbox"/> Radio Equipment and Servicing | <input type="checkbox"/> Wireless Engineering         |
| <input type="checkbox"/> Chemical Engineering     | <input type="checkbox"/> Hydro-Electric            | <input type="checkbox"/> Salesmanship                  | <input type="checkbox"/> Woodworking                  |
| <input type="checkbox"/> Civil Engineering        | <input type="checkbox"/> Journalism                | <input type="checkbox"/> Sanitary Engineering          | <input type="checkbox"/> Works Management             |

**EXAMINATIONS**

Technical, Professional, Matriculation, and Civil Service. State the one you wish to pass.....

NOTE.—If your subject is not on the above list, write it here.....

NAME..... AGE.....

ADDRESS .....



# NEW INVENTIONS

## New Shoe Polisher

IN the days of Queen Victoria the cleaning of boots was indeed a strenuous task. First, with a hard brush the clotted mud which coated the leather was removed. Then there was spread over the boot a funereal paste which looked like black butter. Next, a considerable quantity of "elbow grease" was imperative. After vigorous rubbing for some ten minutes there appeared a small, clear patch like a spot of blue in a cloudy sky. Further friction enlarged this oasis until the desert of dullness completely vanished.

However, we have changed all that. Nowadays perfected polishes do the work with the rapidity and efficiency of the genie of Aladdin's Lamp. And mechanical polishers have appeared which automatically supersede the erstwhile red-coated shoeblack.

Akin to this type of machine is a footwear-cleaning appliance, which is the subject of a patent pending in this country. The contrivance brushes, scrapes and shines the boot or shoe while it is on the foot of the wearer. Manually rotated, the cleaning device moves over the surface of the footwear. It can also be rocked and tilted in order to be conveniently inclined to the foot.

## Fitting for the Fit

TO-DAY physical fitness bulks large in the public gaze. The cult of athleticism receives as much devotion as it did in ancient Greece. An inventor thinks that, as regards equipment, some physical training centres are capable of improvement. He points out that, at gymnasiums, each member places his vest, shorts and other apparel worn during exercises in a pigeon hole or similar compartment. To effect economy of space, these compartments are close together. This kind of accommodation is open to objection. Not only is it impossible for the articles to be thoroughly aired, but the odours from one set of clothing are likely to contaminate garments in the neighbouring compartment.

To obviate these disadvantages the inventor in question arranges for receptacles, each one of which is a separate and removable container. There are provided walls through which air can freely pass and thus adequately ventilate the container and its contents. And the containers can be removed and stacked.

The sequel should be that our institutions for the production of physical fitness are themselves characterised by fitness.

## Portable Lethal Chamber

"A RIGHTEOUS man regardeth the life of his beast," runs an old Hebrew proverb. But there are sad occasions when it is kind to take away the life of an animal. And any means of doing this swiftly and painlessly naturally appeals to the merciful. The guillotine is associated in many peoples' minds with heartless cruelty. But that dreadful engine was in truth a humane instrument. The axe of the medieval headsman sometimes missed the neck of the unfortunate victim and landed on his shoulder. In the case of the guillotine, the frame of the machine ensured precision on the part of the descending knife. And so, Dr. Guillotin, its inventor, was a benefactor to the victims of the French Revolution.

This preamble introduces an improved

The following information is specially supplied to "Practical Mechanics," by Messrs. Hughes & Young (Est. 1829), Patent Agents, of 9 Warwick Court, High Holborn, London, W.C.1, who will be pleased to send readers, mentioning this paper, free of charge, a copy of their handbook, "How to Patent an Invention."

portable lethal chamber admirably fitted for use in the veterinary profession and in connection with animal welfare work. Frequently, animals meeting with accidents or suffering with incurable diseases have to be destroyed. But it is not always convenient to convey them to an institution where anaesthetics are administered. Consequently, an invention has been devised by a lady to provide a compact and easily carried lethal chamber.

Approximating to the size of a Gladstone bag, it has an aperture for the introduction of the ether and a window enabling one to inspect the occupant. Upon being required, it can be distended to accommodate a domestic pet such as a dog or cat. But, when not in use, it will fold into handbag form.

## The Latest in Roundabouts

THE old English fair, in spite of many competitors in the shape of sports and entertainments, is still a powerful magnet to the masses. And the central feature of the carnival is the roundabout, originally christened the "merry-go-round."

It is interesting to trace the evolution—I almost wrote "revolution"—of this rotatory form of amusement. At first, the high-mettle steeds, each with a name like a race-horse, were relatively stationary. Then, the galloping mount made his appearance on the circular course. Next followed a variety of imitated creatures and objects, such as the ostrich, the yacht, the bicycle, the automobile and the switchback railway car. These were succeeded by what is known as the "chairplane," in which the rider takes the chair in a very airy manner. One of the latest types of revolving imitations is the aeroplane. And, in association with this particular kind of gyrating device, a patent has been applied for in this country by a Frenchman. This inventor has introduced a new characteristic in connection with the roundabout aeroplane. There is already known a roundabout with simulated aeroplanes, in which, by moving the position of wings and rudders, riders individually can affect the movements of the aeroplanes. But it is stated that, in this case, it is indispensable that the roundabout rotate at very high speed, so as to ensure that the action of the air on the surface of the wings and the rudders be sufficient.

According to the new invention, tilting and upward and downward movements of each aeroplane, mounted separately on independent arms, are controlled by mechanism within reach of the occupant. And these movements do not depend on the action of the air on the surface of the wings and rudders. They can, therefore, be controlled at the will of the rider, whatever be the speed of the roundabout.

And so the whirling multitude will be able to "fly through the air with the greatest of ease." By the way, the whole human family are perpetually riding upon that ancient roundabout, the Earth. In addition to turning on its axis once per diem, this gigantic merry-go-round, as I write, is about to complete another grand circular tour round our genial friend, Old Sol.

## Anti-Aircraft Missile

IN these days of intensive preparation for possible war, the anti-aircraft projectile deserves special attention. An inventor has produced an improved projectile of this character, for which an application for a patent has been accepted by the British Patent Office. The originator of this invention contends that the probability of hitting and putting out of service enemy aircraft by means of explosive shells is small, because the area of action of an exploded shell covers a few square feet only. Unless the pilot or the motor be hit, the damage done to aircraft by the exploded shells is almost negligible. We are told that aircraft, although hit many times by bullets and bits of shell, are often not rendered *hors de combat*.

The object of the new device is the provision of a projectile whose probability of hitting and putting enemy aircraft out of service is considerably increased. The inventor states that he makes use of the principle employed in the bolas, which is a hunting instrument used by the gauchos and Indians of South America. The missile consists of two or more balls of iron or stone attached to the ends of a leather cord. When this combination of cord and iron balls, while flying through the air, meets an obstacle, it slings itself round it.

The inventor has produced a projectile containing, folded up, a bolas-like arrangement comprising at least two heavy bodies connected by a cord or wire. The contraption is shot into the air, in folded-up condition, by means of the projectile and is unfolded in the path of the aircraft which it is hoped to destroy. The implement may be enlarged by the inclusion of a quantity of heavy bodies. By using long connecting cords and wires, a star-like construction of wide diameter may move unfolded. As soon as only one of the cords or wires comes in contact with the enemy aircraft, the latter is at once embraced as by the tentacles of an octopus. The destructive power of the arrangement may be considerably augmented, if the attached bodies be of an explosive nature resembling hand grenades.

This hurtling weapon, if it became entangled with the propeller or steering means of an aeroplane, would without doubt seriously embarrass the pilot.

## For the Ladies

WHEN a lady makes up—I am telling, no secret, for she so often does it in public—the fair damsel first removes the metal cap of the lipstick holder. She then produces from her handbag either a separate mirror or the mirror inside the lid of a powder box.

To facilitate my lady's make-up, there has been devised a lipstick holder combined with a pivoted mirror. It has the advantage that only one hand is necessary for carrying out the adornment of the feminine façade. And the falling or loss of the loose lipstick holder cap is impossible. The case is provided with a cover which snaps into the closed position. When this cover is lifted, an oval spiral spring pushes out a sleeve and increases the length of the lipstick so far that the mirror pivoted to the inner side of the cover comes just into the right eye or lip position. I presume the capacity of the average handbag is generally fully occupied. This one-piece lipstick and mirror will not take up so much room therein as the two separate articles at present in use.



## QUERIES and ENQUIRIES

A stamped addressed envelope, three penny stamps, and the query coupon from the current issue, which appears on page 232, must be enclosed with every letter containing a query. Every query and drawing which is sent must bear the name and address of the sender. Send your queries to the Editor, PRACTICAL MECHANICS, Geo. Newnes, Ltd., Tower House, Southampton Street, Strand, London, W.C.2.

### AN INDUCTION COIL

**H**OW can I make an induction coil. I understand the working principle, primary and secondary windings, make and break, etc., but would like details of construction." C.E. (Ireland.)

It would be quite impossible for us to give you complete details of the making of an induction coil, since to do so would involve the writing of a complete article on the subject. There are several handbooks published on "How to Make an Induction Coil," and, no doubt, you could obtain one of these second hand from Messrs. W. G. Foyle, Ltd., Booksellers, Charing Cross Road, London, W.C.1.

Since, however, you have a good knowledge of the principle of the induction coil, the following details may be of assistance to you.

Make up a core consisting of a bundle of iron wires. This core should have a diameter of about a third of an inch and should be about 2½ ins. long. Upon this core wind carefully one ounce of 24's double-cotton covered wire. This forms the primary coil. After winding, the coil must be thoroughly impregnated with molten paraffin wax and it should preferably have a layer of mica, or, at least, of strong paraffined paper laid over it in order to insulate it completely from the secondary coil which is wound on top of it.

For the secondary coil you will want about 3 ounces of 36's double-silk covered wire. This wire must be very carefully wound and it is best to test the winding for electrical continuity by means of a sensitive galvanometer as you wind it.

We presume you know of the make-and-break arrangements of the coil.

A large capacity condenser should be fixed across the secondary coil to prevent sparking at the make and break contacts.

An induction coil built on the above lines will give about a third of an inch spark.

From a practical point of view, it would be cheaper for you to purchase a small second-hand coil from a firm such as Electradix Radios, 214, Thames Street, London, E.C. Such coils can usually be had from about 5/- upwards.

### CELLULOID VARNISH

**I** WISH to make a varnish similar to celluloid varnish, but which will form a much finer film on drying. I have tried chloroform, ether, alcohol, acetone, amyl acetate and various mixtures of these without success." K.M. (Aberdeen).

**T**HE transparent cellulose material, nowadays known generically as "Cellophane," varies somewhat in composition and without knowing the variety you have in use, it is not possible to advise a definitely suitable solvent for it. We are of the opinion, however, that methyl cyclohexanol will prove a good solvent for your material. This liquid is a new introduction and is not very costly, being priced about 1/6 lb. It can be obtained from Messrs. A. Boake, Roberts & Co., Synthetic Chemical Man-

ufacturers, Stratford, London, E.15. It is possible that Messrs. Boake, Roberts & Co. may now have marketed a still more powerful solvent than the latter. However, an inquiry to that source will soon put you right on this point.

If we may be allowed to say so, we see no reason why ordinary celluloid varnish should not suit your needs. It can be made up much more cheaply than any varnish containing cellulose, and, employed at the right concentration, it is capable of providing extremely fine films of celluloid. Use for the celluloid solvent a mixture of equal parts of acetone and amyl acetate and, after dissolving the celluloid, employ for a diluent of this varnish a mixture of equal parts of toluene and ethyl acetate, which, if the varnish is made in any large quantity, will help to cheapen the production and will give a perfectly flat film.

### COATING METALS

**I** HAVE a quantity of brass, steel and cast iron parts and wish to coat them in a similar manner to the enclosed pattern. Can you tell me how the process is

carried out, what material is necessary and where I can obtain it?" J.M. (S.W.9.)

**T**HE small sample which you sent consists of an ordinary oil enamel coated on steel. The enamel has been heat treated in some way after coating on the metal. Exactly how this has been done, we cannot say from a mere inspection of the same, but we think you will be able to get a similar effect by heating the enamelled metal just before the enamel has become quite "set." The metal should be heated above the temperature of boiling water, but not sufficiently for the enamel actually to char.

It is nowadays possible, however, to obtain synthetic enamels which are capable of producing this "crackle" effect by direct coating. Many of these give excellent results and most of them are spirit proof. You can obtain particulars of these from Plax Products, Ltd., 23 Ludgate Hill, London, E.C.4., or from Nobel Chemical Finishes, Ltd., Slough, Bucks. Bakelite, Ltd., 68 Victoria Street, London, S.W.1 also produce these synthetic varnishes, but we are not sure whether they manufacture those suited for the effects you require. However, an additional inquiry to this source would do no harm.

### MERCURY VAPOUR BURNERS

**C**OULD you supply me with the following information on mercury vapour burners:

1. "How is the mercury vapourised in a non-tilting type of burner (i.e.) the "Homesun" (Hanovia).
2. "Can mercury be vapourised and kept in gas form when cold?"
3. "What starting voltage would be needed (i.e. to vapourise) for a burner with the electrodes about 2 in. apart. What would be the running voltage A.C.?"
3. "Does the mercury cover both electrodes in a tilting type of burner?"
4. "Can I obtain a book giving informa-

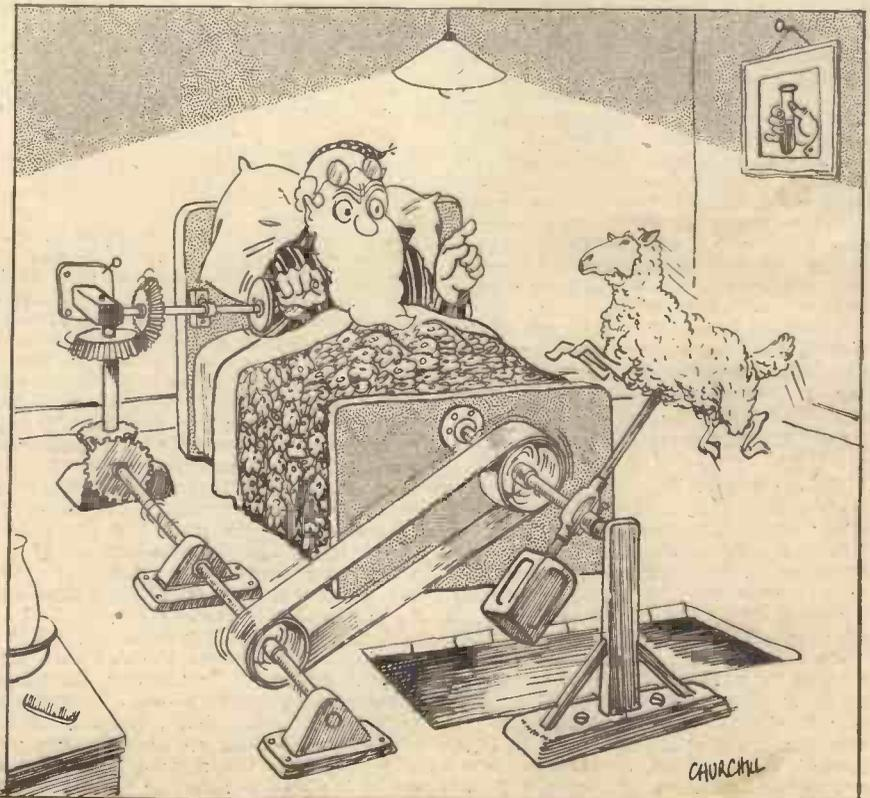

The professor discovers a cure for insomnia.

tion on M.V. burners and lamps?" E.B. (Hants).

1. In mercury vapour lamps of the non-tilting category you name, the mercury is usually contained in a quartz tube containing hydrogen or helium at very low pressure. The presence of this gas is just sufficient to render the tube conductable. The passage of the current quickly heats up the tube, vapourises the mercury, the mercury vapour then taking over the task of current conduction in its normal manner.

2. At normal room temperatures (i.e. about 15° C.) mercury gives off a very slight trace of vapour. Complete vapourisation is only possible above the boiling point of mercury (357° C.) and only at temperatures above this point can mercury be kept in vapour or gaseous form. Incidentally, although mercury is a silvery-looking metal, its vapour is colourless.

3. A mercury lamp can be started on 80 volts, but, for continuous running you require, with an average mercury tube, at least 110 volts A.C. This figure, however, must only be taken as a rough approximation, for the optimum voltage depends upon many varying factors connected with the design of the tube, as, for instance, the length and cross-section of the tube, type of electrodes employed, etc.

4. In the tilting type of mercury vapour lamp, the mercury need not cover the electrodes completely. The metal is contained in little cups at each end of the tube and on tilting the latter the metal runs along the tube, forming a sort of conducting bridge between the electrodes. This bridge is practically an internal short-circuit of the

tube. Hence, it should only be maintained momentarily and the tube should be restored to its original position as quickly as possible after tilting it.

5. Apart from large "general" textbooks on the subject of up-to-date lighting, as, for example, "Modern Electrical Illumination, by C. Sylvester & T. Ritchie, or A. P. Trotter's "Elements of Illuminating Engineering," there is practically nothing of a specific nature relating to the small lamps to which you prefer. You will, we think, do best to obtain catalogue literature on the subject of these lamps from The General Electric Company, Wembley, or from any other large firms of electrical makers.

**SELF-BLOWING GAS BLOW PIPE**

"I HAVE designed a self-blowing gas blow pipe to work without requiring a separate air supply. I have found it very efficient in use. I am considering offering the idea for sale to anyone who could market it. Can you advise me what steps I should take to cover it before doing so?" J. Brown & Son (Grimsby).

AS you have given no particulars of your invention, it is not possible to advise you if it is one capable of being protected. Provided the invention is novel and contains subject matter, it should be possible to obtain protection by letters patent.

You are advised to file an application for patent with a provisional specification which will give you protection for about 12 months, during which time it should be possible to get a firm interested in the invention to market it. Before this is done, it is unwise to divulge the invention.

**BOOKS WORTH READING**—(Continued from page 206)

tions; Metric System; Imperial Weights and Measures; Mechanical Drawing; Principles of Mechanical Drawing; Blueprints; Reading and Using the Micrometer and Vernier; Drills and Drilling; Special Cutters; Reamers; Other Cutters; Small Taps, Dies, etc.; Files and Filing; Marking Out for Machining; Lathe Tools and Tool Angles; Turning Between Centres; Boring; Screw Cutting; Lathe Equipment; Lathe Centres; Lathe Tool-Bits; Grinding Operations; Grinding in the Lathe; The Dividing Head; Gears; Soft Soldering; Silver Soldering and Brazing; Soldering Aluminium; Making Spot Welders; Riveting; Polishing and Finishing Metal; Hardening and Tempering; Case Hardening; Chemical Colouring of Metals; Electro-plating; Chemical Plating; Spray Method of Coating Surfaces with Metal; Rust-proofing Iron and Steel; Bolts; Nuts and Screws; Pattern Making for Castings; Casting Small Parts; Sheet Metal-work; Repousse Work; Sharpening and Setting Woodworking Tools; Wood Finishers; Woodwork Joints; Silvering Glass; Battery Charging; How to Obtain a Patent; Workshop Receipts; Glues, Cements and Adhesives; Repairing Gear Teeth; Temperature Recording Paints; Tables. The book is well indexed.

"Workshop Calculations, Tables and Formulæ. By F. J. Camm. 144 pages. 124 illustrations. Price 3s. 6d. net. Published by George Newnes, Ltd.

THIS book has been planned for draughtsmen, engineers, fitters, turners, mechanics, pattern makers, erectors, foundry men, millwrights and technical students. It deals with the Micrometer and Vernier; Mensuration; Trigonometrical Formulæ; Extracting Square Root; Extracting Cube Root; continued Fractions; Arithmetical Progression; Geometrical Progression; Harmonical Progression; English Weight and Measures; Decimal Equivalents; Horse-

power; Force, Energy and Power; Heat, Time and Velocity; Electrical Units; Comparison of Thermometers; Pulleys; Parallelogram of Forces; Pendulum; Levers; Centrifugal Force; Moments of Inertia; Metric Systems; Screw-cutting; Tool-grinding Angles; Lubricants for Cutting; Spur Gearing; Tapers and Angles; Bevel Gears; Worm and Worm Wheels; Spiral or Screw Gearing; Pulley Calculations; the dividing Head; Differential Indexing; The Slide Rule; H.P. Required to Drive Shop Tools; Table of Cutting Speeds; Proportion of Keys and Cotters; Standard Screw Threads; Drill Sizes; circle-spacing Table; Tapers and Angles; Melting Points of Metals, etc.; Weights of Materials; Twist Drills for Wood Screws; Wood Screw Proportions; Weights of Woods; Powers and Roots of Numbers; Wire and Sheet Metal Gauges; Natural Sines, Cosines and Tangents; Logarithms and Antilogarithms. The book is well indexed.

**BOOKS RECEIVED**

"Pattern Making for Engineers." By J. G. Worner. 390 pages with 558 illustrations. Price 15s. net. The Technical Press Ltd., 5 Ave-Maria Lane, Ludgate Hill, London, E.C.4.

THIS book deals with the important subject of pattern-making in a very comprehensive and practical manner. The book includes thirty-one chapters covering such subjects as the joints in patterns and moulds; core prints; moulding boxes; engine cylinders; flywheels; pipe work; machine tools; loam patterns; pattern-shop equipment, and the storage of patterns. The class of work dealt with in the book is sufficiently varied to prove invaluable in the various branches of pattern-making, and, while the apprentice will find in it a mine of useful information, the practical pattern-maker, the draughtsman, and the designer will peruse it with advantage.



**PELMANISM**

**BRINGS OUT YOUR HIDDEN TALENTS**

"I NEVER THOUGHT I HAD IT IN ME"

*Writes a Pelmanist at the end of his Course,*

YOU would always look back on your course of Pelmanism as the best investment you ever made. You would feel that something had happened to you that made your success in life certain. You would find that your affairs prospered, your income increased, and that you had become more confident in yourself and in your future.

Amongst the defects and weaknesses rapidly and permanently banished by Pelmanism are:

- |                  |                        |
|------------------|------------------------|
| Forgetfulness    | Mind-Wandering         |
| Depression       | Shyness and Diffidence |
| Brain Fog        | Lack of Confidence     |
| Weakness of Will | Unnecessary Fears      |
| Want of Energy   | Lack of System         |
| Lack of Ideas    | Procrastination        |
| Indecision       | Inferiority Feelings   |

Besides banishing these failings, Pelmanism makes and keeps your mind keen, fresh, vigilant, and self-reliant, and develops such valuable positive qualities as:

- |                         |                        |
|-------------------------|------------------------|
| —Concentration          | —Cheerfulness          |
| —Observation            | —Moral Courage         |
| —Optimism               | —Perception            |
| —Strength of Will       | —Initiative            |
| —Originality            | —Ambition              |
| —Mental Energy          | —Self-Control          |
| —Organising Power       | —Personality           |
| —Self-Confidence        | —Presence of Mind      |
| —Directive Ability      | —Reliable Memory       |
| —Conversational Ability | —Constructive Thinking |

—all of which are of indispensable value to every one who intends to achieve success in any Business, Trade or Profession, or in Social or Public Life.

Pelmanism is a sure way to success if you will give it your loyal effort, your honest endeavour, and a regular and definite amount of time until you have completed the Course. A sustained effort over a period of but a few weeks will yield you dividends that will last you your whole life through, and the Little Grey Books will remain close at hand, ready at any moment to give you a steady encouragement in times of stress, indecision or fatigue.

"The Science of Success,"

containing full particulars of the Pelman Course, will be sent free of charge to every reader who writes for it to-day to:

**Pelman Institute**  
(Established over 40 years)

130, Pelman House, Bloomsbury Street, London, W.C.1.

Write or call for this free book to-day.

PELMAN (OVERSEAS) INSTITUTES: PARIS, 176 Boulevard Haussmann. NEW YORK, 271 North Avenue, New Rochelle. MELBOURNE, 396 Flinders Lane. JOHANNESBURG, P.O. Box 4928. DURBAN, Natal Bank Chambers (P.O. Box 1489). DELHI, 10 Alipore Road, CALCUTTA, 102 Chive Street. AMSTERDAM, Damrak 68. JAVA, Malabarweg, Malang.

## HOME SOUND RECORDING at low cost



Blanks now 3/3 per dozen. Electric FEIGH set has ball-bearing centre gear box and geared traverse rod. Set with Tracking Gear, Pick-up and Tone-arm fitted diamond, 37/6. Tracker gear only, less Pick-up and Tone-arm, is 21/6. Diamond Cutter Needles fit all pick-ups, 7/6. 6in. Blank Discs, 3/3 dozen. Complete Acoustic Sets de Luxe, 18/-; No 2, 10/6; Junior Type, 5/6 each complete.

**A.C. CAR CHARGERS.** The NITNDAY will keep your battery fit without attention. Model NAG 100/250 volt mains to D.C. 6/8 volts 1 amp., 15/-. Model N/B6 100/250 volts to D.C. 6/8 volts 1 amp., 25/-. Model N/C6 100/250 volts to D.C. 6/8 volts 2 amps., 35/-. Model N/D12, 100/250 volts to 12 volts 1 amp. Ditto 12 volts 2 amps with 6 volt tap, 55/-. 5 amps., 24/10/-.

**MOTOR BARGAINS** in midsize H.P. motors for A.C. or D.C. 200/230 volts 110th H.P. D.O.T. type totally enclosed K.B. Cover, 2,000 revs. at a price never before offered; 7/6 only Next larger G.M. No. 2 type high speed 1/60th H.P. 4,000 revs., 9/6. Larger still 1/45th H.P. Model G.E. No. 1, 12/6. All as new and first-rate for model drive or light duty.

**MICROPHONES.** New models high efficiency, low prices. The famous W.E. Button type Microphone, 1/- No. 11. Hand or sling mikes, solid bakelite body, 5/-. Super midsize Table stand Bakelite mike with self-contained transformer in base semi-transverse not button, worth a guinea, 10/- only. The well-known W.W.11 table mike with square bakelite case, fitted switch and transformer; detachable bronze table stand, slings for hanging, etc., 12/6 only.

**MOVING COIL MIKES.** Torpedo P.M. moving coil mike, model T.M., needs no battery, directional correct frequency response, ideal for P.A. and recording, 55/-. Table stand, 7/6. Transf., 7/6. Epoch type ditto, a very robust and handsome P.M. M/C mike, 35/-. with table stand, 42/6. Transformer, 2/6.

**3/9 MILLIAMMETERS.**—New. Where the job calls for something simple without calibration for tuning or galvo for testing. Back of panel type, as illus., 8 m.a. full scale. Plain scale and 1in. needle with mica panel, back lamp and bracket. Neat and compact. Can be used as voltmeter with extra resistance. Great bargain at 3/9 p. at free.

**MILLIAMMETERS.**—Moving coil, 5, 10, 25, 50, 200 and 500 m.a., in various sizes, from 2 1/2in. to 8in. dia. Switchboard Meters for all purposes, all sizes.

**TRANSMITTERS, MORSE AND SIGNAL KEYS.** Royal Air Force model, balanced action, all solid brass bar, tungsten contacts indicator. Type KBSL, a guinea key for 7/6. Other keys from 4/6 to 30/-. Learner's outfit compl. 4, 9. Ask for special list. L.T.D. Key List, "K.P." Send 1/2 stamp.

**CRYSTAL SETS.**—Buy one now, you may want it one day. No battery or valves wanted. Efficient reception. Cheap, 7/6 each. Send for Electrical-Scientific List "P.M.," Post Free

## ELECTRADIX RADIOS

218 Upper Thames Street, London, E.C.4

Telephone: Central 4611

## BE A MAN!

### STRENGTHEN YOUR VITAL FORCES!

Are you a victim of Inferiority Complex, Self-Consciousness, Unreasonable Fears, Bad Concentration and Memory, Timidity, Lack of Self-Control, Weak Will, Bad Habits, Thinness, Flabbiness, Nervous Disorganisation, etc.

To trace the cause, write for my free book—  
"DO YOU DESIRE HEALTH?"

Send POST FREE in plain envelope.

Also write to me fully in confidence for a FREE and considered opinion of your case.

Over 30 years' experience in the drugless Treatment of Nervous disorders and ill-health arising from weakening and health-destroying habits and a lack of manly self-control.

All replies and books sent in plain sealed envelopes.

I. W. STANDWELL, Curative Physical Culture Consultant  
Dept. P.M., 329, High Holborn, London, W.C.1

## CLIX

CHASSIS MOUNTING VALVEHOLDERS for every Valve

British American Continental



Send for Folder of all Clix contacts  
BRITISH MECHANICAL PRODUCTIONS LTD.  
79a Rochester Row, London, S.W.1.



### OUTSTANDING EARS CORRECTED

**ORO.** The Universal Ear Shaping Treatment produces amazing, immediate and permanent results. CONSPICUOUS EARS assume their normal position within a few minutes. No mechanical contrivance. Oro is ideal in that each application is INVISIBLE, comfortable and harmless. Prescribed by Doctors. Hundreds of satisfied users. Write for free booklet and testimonials.  
M. TRILEY (R.146)  
45, Hatton Garden, London, E.C.1.

## TOOLMAKING AND TOOL DESIGN

(Continued from page 190)

also need to be made convex, these precautions being necessary to avoid bending the stud when tightening.

### Swinging Clamps

While the clamps just described serve for holding on the edges of work, an alternative form is necessary in certain instances. Use can then be made of a swing type of clamp, such as that illustrated in Fig. 14. The clamp as shown is mounted on pillars, but the pivoting stud and anchor could be incorporated on the edges of a box jig. The stud is made with two diameters so that the nut and washer may be tightened down, leaving the plate or strap free to swing on the larger diameter. The anchor pillar is necked in to receive the slotted plate freely, and the centre of the slot is cut on a radius equal to that of the pillar centres. The distance between the pillars is made to suit requirements and one or more clamping screws may be provided.

A similar form of clamp for use under different conditions is seen in Fig. 15. This plate swings about a pin set in the bossed end of the plate. At the opposite end the plate shuts down on to the edge of the jig. With such a clamp it would be necessary to remove the knurled nut before the plate could be raised if a fixed stud were employed.

To obviate the necessity it is usual to fit a swing stud. Here the stud is bossed at its lower end and drilled to swing about a pin set in a fork or slot cut in the jig body. With this type of clamp it is possible to dispense with the stud and nut and fit a refinement in the shape of a quick-acting latch device. This, naturally, involves more work in the making, but where the job warrants adopting this alternative arrangement the trouble will be amply repaid in the saving in operating time.

### Sliding Bars

A similar effect to that just described may be obtained in a simple manner with a loose square or rectangular bar sliding in suitably shaped holes cut in both sides of the jig body. To render the removal of the clamping screws unnecessary, one of the holes is slotted through to permit the screws to pass.

Owing to the severe work usually imposed on the clamping details of jigs during their use, all studs should be made from high tensile steel and all plates, nuts and the ends of clamping screws hardened.

### Pneumatically Operated Clamps

Where an air line is available it is often possible to incorporate pneumatically-operated clamping devices. For larger classes of jigs it is possible to obtain air-operated units made for this express purpose. Needless to say, where it is possible to adapt such power for this purpose the operator is relieved of much tedious work and its benefit is greatly reflected in output on work of a heavy nature. Apart from this the pressure exerted on the work to hold it in position is always constant.

### READ

PRACTICAL & AMATEUR WIRELESS  
3d. EVERY WEDNESDAY

PRACTICAL MOTORIST  
3d. EVERY FRIDAY

THE CYCLIST  
2d. EVERY WEDNESDAY

You've made a first rate job of it!  
Yes - thanks to VARNENE!



That professional finish which every handicraft worker desires to obtain is more easily ensured by using Varnene, the Oil Varnish Stain that gives such a lasting high gloss. Varnene's tough finish will not readily chip or scratch. It stains deeply and transforms ordinary white woods, into faithful representations of Dark Oak, Walnut, Mahogany, etc. For your own satisfaction insist on Varnene, the finer oil varnish stain.

Obtainable at all Handicraft Stores, Ironmongers, Oilmen, Grocery and General Dealers. In Dark Oak, Walnut, Mahogany, Light Oak, Ebony Black and Clear (Colourless) Varnish.

TINS 6d. 1 1/2 and 1/6

## VARNENE THE FINER OIL VARNISH STAIN

Chiswick Products, Ltd., London, W.4.

V/EL/57

## An Absorbing Hobby

BUILDING A STUART MODEL IS AN ENGROSSING PASTIME, AND THE RESULT A CONTINUOUS PLEASURE

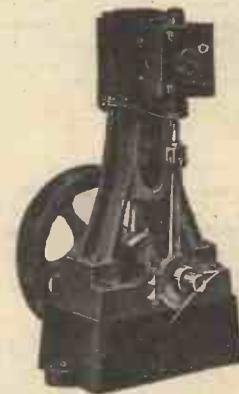

We illustrate:

STUART NO. 10. High Speed Steam Engine. Bore 3/4". Stroke 3/4".

Each set is quite complete—drawings and instructions are included.

If you have a lathe—  
The rough castings - - - 8/6

If not—  
Fully machined set - - - 18/6  
Ditto, with all holes drilled and tapped - - - 25/-

This and many other Stuart engines are fully described in the 72-page CATALOGUE No. 3, 6d. post free.

STUART TURNER LTD.  
HENLEY - ON - THAMES



## CHARGE IT AT HOME

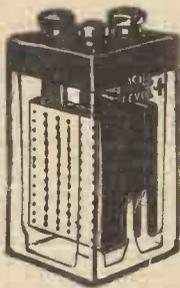

with a "SILEX" Battery Charger. Cheap to run. Prices: 2 v., 1 amp., 8/6; 1 amp., 12/6; 1 amp., 18/6; 6 v., 1 amp., 15/-. Special Car Battery Models: 6 v., 2 amps., 25/-; 12 v., 30/-; Commercial Charger for 1-14, 2-v. cells, 0-3 ammeter, Low, Medium and High tappings, 50/-. Larger Models quoted for. H.T. Accumulator Charger, 150 v., 250 M/A, complete, 35/-. Combined H.T. Eliminator and 1-amp. Charger, 21/-. All above for 200-250 v. A.C. with metal rectifiers, robust mains Transformers, strong steel cases. To Use JUST-PLUG-IN, FIT SPADES SWITCH ON. That's ALL! Send 3d. for Real PHOTO and 7 Days' FREE TRIAL TERMS. Transformers and Rectifiers supplied for any purpose.

**BRIGHTON RADIO SERVICE**  
34 Middle Street, Brighton

## FREE SERVICE FOR READERS

**R**EADERS requiring information concerning goods or services advertised in *PRACTICAL MECHANICS* should give names of Advertisers from whom particulars are desired. Any number of names may be included and we will obtain for you catalogues, lists, and any other information you may be wanting. **THERE IS NO CHARGE FOR THIS SERVICE.**

Readers desiring particulars from a number of Advertisers will, by this method, save time and postage. Half-penny stamp only is required if your envelope is left unsealed. If any Advertiser stipulates that stamps or postal orders are necessary before samples or catalogues are sent, please enclose the necessary amount with your instructions. You are cordially invited to make full use of this Service.

Post this to  
**ADVERT. SERVICE DEPT.**  
PRACTICAL MECHANICS,  
TOWER HOUSE, SOUTHAMPTON  
STREET, STRAND, W.C.2

Please obtain and send to me particulars from the Advertisers in your January issue whose names I give on list attached.

Advertiser | Page No. | Information Required

Attach sheet of paper, with particulars, and your name and address (written in **BLOCK** letters) with date, to this announcement.

## AUTOMATIC TRAFFIC SIGNALS

How They Work

(Continued from page 182)

### Discriminative Detectors

In the case of some narrow streets it is possible for the wheels of traffic to pass over a detector mat, intended for traffic approaching in the opposite direction, after passing the lights. If the detector were of the simple single-contact type previously referred to, this would obviously upset the operation of the system. This difficulty is overcome by the use of a special uni-directional detector, of which the upper contact plate is split. The arrangement of this is shown in Fig. 8. Traffic passing from left to right operates the first contact plate before touching the second. In doing so relay UA is actuated and the circuit of UB is opened by contacts UA 1 and 2. As the right-hand strip is depressed due to the traffic proceeding, relay UA is maintained in operation through contacts UA 3 and 4, and contacts UA 5 and 6 complete the circuit to the appropriate road relay. When traffic is travelling in the opposite direction the circuit of relay UB would have been completed first. This opens contacts AB 1 and 2, so leaving the operating circuit AU broken.

### Variations in Method of Control

It should be added that numerous variations of the usual arrangements of traffic-light operation are possible by the EVA system. For example, a pedestrian push-button can be provided to produce the same effect as that of traffic passing over a road detector. Alternatively, a photo-electric cell can be used to operate the device with either vehicle or pedestrian traffic. It is necessary only to direct a pencil beam of light across the road or footpath on to a photo-cell shielded from all other light; each time the light beam is interrupted the appropriate relays are actuated in precisely the same manner as when a vehicle travels over a detector mat. This method has actually been used successfully, but has not yet been adopted by highway authorities in other than experimental form. There are also two types of detectors for use with tram cars; one operated from the plough (which picks up current from the live rail) and which is electro-magnetic and the other from the overhead trolley. Both are equally effective.

Here are a few interesting facts. If you approach traffic lights which are showing green when you cross the detector they will remain green until you have crossed the road at normal speed. If the lights are red when you approach them they will change to green immediately you cross the detector if the cross road is clear. If a car breaks down or is stopped directly on a detector, the auxiliary timing circuit will come into action and continue to operate the lights until the obstruction is removed.

## REPLIES IN BRIEF

T. A. R. (Yorks).—We do not think the construction of a telephone set too difficult for the boys as they will have access to the tools required. You may use the ear-phones as receivers, one to each set, and use twin bell wire for the line wires, and a 3-volt dry cell at each end. As a telephone set consists of the following main parts, bell or buzzer, mike and receiver, quite a fair amount of work is required in order to complete one. We advise you to get a copy of our book "Simple Electric Apparatus," which gives full details of the mike and buzzer measurement, etc.

# BE A RADIO EXPERT

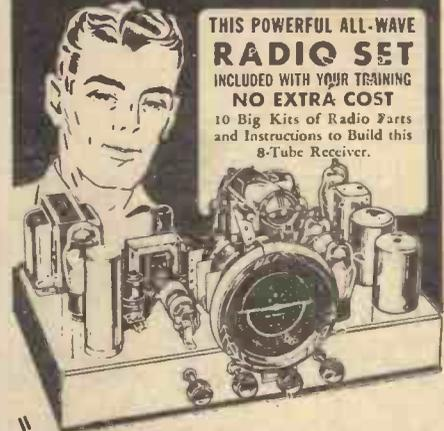

THIS POWERFUL ALL-WAVE RADIO SET INCLUDED WITH YOUR TRAINING NO EXTRA COST 10 Big Kits of Radio Parts and Instructions to Build this 8-Tube Receiver.

## "I Train You at Home In Spare Time for a Good Radio Position"

I prepare you for a Radio service business of your own, requiring no capital... or for a big paying position in Broadcasting, Loud Speaker Systems, Service Work in Stores, Talking Pictures, Short Wave Radio, Radio Operating, Radio Retailing and Distributing, Television, etc. Special Money-Making Lessons show you how to make money by doing spare time Radio Service Work in your neighborhood while learning. Diploma upon graduation.

The distance between us makes no difference, as my internationally known method of training keeps you constantly in lessons. Post coupon today for my FREE 44-page illustrated book.

FREE BOOK

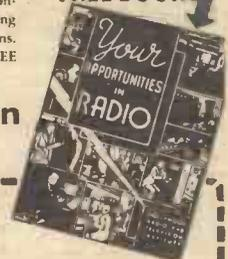

### Post Coupon TODAY!

C. H. MANSFIELD, Pres.  
Department 30.s.  
Hollywood Radio & Television Institute  
810 W. 6th St., Los Angeles, Calif., U.S.A.

Send me free book, "Your Opportunities in Radio," telling how you can prepare me for a good position in Radio

Name \_\_\_\_\_

Address \_\_\_\_\_

## BECK'S CHEMISTRY



EQUIP YOUR LABORATORY WITH OUR APPARATUS & CHEMICALS SETS from:

**2/6 to 105/-**  
(Carriage Paid)

ITEMS ALSO SUPPLIED SEPARATELY WRITE FOR LATEST CATALOGUE FREE!

**BECK** (Scientific Dept. A), 60, High St., Stoke Newington, London, N.16.

## USED MODEL BARGAINS

Send 4d. for our catalogue of perfect second-hand railways and models, and save money.

**GEORGES', 11 Friars Street, Ipswich.**

# BUY, EXCHANGE OR SELL

## TOOLS

1" Die-Stocks, all steel, 1/9 each. Special thin-Grinding Wheels, as used for cutting brass tubes etc., 6" diam, 1/2" hole, 1/9 each; 10,000 large taps, clear cheap—Below.

**Special Offer Best Quality Large Circular Split Dies,** 2" diam. cutting, 1/2", 3/4", 1", Whit.; 1/2" B.S.F.; 1/2" gas; 1" brass 26; 3/4", 20; 31/32", 30 threads. Usual price, 7/6 each; cheap, 2/9 each. Also 2 1/2" diam. cutting, 3/4", 1", Whit.; 3/4", 1", B.S.F.; 3/4", 1 1/4" conduit; 1/2", 3/4" gas. Cost 10/- each; clear 3/6 each. Also 3 1/2" diam. cutting 1" gas, 5/6 each.—Below.

**Hexagon Die-Nuts,** invaluable to all repair shops. Genuine clearance prices: Whit., B.S.F., S.A.E., U.S.S.; also brass 26 thread, sizes 1/2", 3/4", 1", 1 1/4", 1 1/2". Usual price, 7/6 set; outstanding value, 2/9 set. Also 3/4", 1", 1 1/4", in same threads, 4/- set of four. Any four sets 1/2" to 1", 24/-, for thirty-six die-nuts.—Below.

1,200 Best Quality Taps, Tapers, 2nds, Plugs, 1/2", 9d.; 1/2", 1/-; 3/4", 1/3; 1", 1/6, Whit., B.S.F. Also in gas thread, 1/2", 6d.; 3/4", 9d.; 1", 10d.; 1 1/4", 1/-; 3/4", 1/3; 1", 1/6; 1 1/4", 1/9; 1", 2/-.—Below.

600 Large Fine Thread Taps, 3/4" to 1 1/4" diam., 18 to 36 threads. Very handy stock to experimenters, repairers, etc., in useful lots of one dozen assorted taps. Actual value about 30/-; clearing at 5/- per dozen.—Below.

2,500 Extra Long Taps, 1/2" to 1 1/4", in various threads, mostly standard, Whit., B.S.F., etc., 6" to 12" long. Extremely useful for tapping in lathe. Given away at 2/9 dozen. One tap worth this amount.—Below.

12 Only Ball-bearing Double-ended Grinding Heads, to take 1/2" bore wheels. Practically new, 15/- each. Six only stands for same, fitted with rise and fall slide independent each side. Make very good tool and cutter grinders or surface or special grinders. Stands 10/- each, if purchased with grinder.

20 Dozen Double-ended Saw Files, 8" 3/-; 9", 3/6; 12", 4/- per dozen. Also 3", 3 1/2", 4", 4 1/2" Saw Files, 2/- dozen; 5", 6", 3/- dozen.—Below.

700 Pieces Super High-speed Steel, 1/8" square, hardened ready for use, 3" long. Four pieces; 2/9. The stuff for lathe tools.—Below.

2/9 any lot. Eight lots £1.—Below.

- 3/4" Toolholder with four H.S. Tools.
- 3/4" Adj. Boring Tool with H.S. Tool.
- 1/2" Drill Chuck, taper or straight shank.
- 1/8" to 3/8" Silver Steel, 13 pieces.
- 3/4" to 1" Silver Steel, 4 lb., 2" to 4" long.
- 500 Ass. Brass and Steel Screws, etc.
- 100 Steel Hex. Bolts and Nuts, 1/2" to 1 1/2".
- 16 H.S. Drills, 1/32" to 5/32".
- 12 Drills, 1/8" to 3/8". Carbon.
- Set 1" Dies, 1/2", 5/8", 3/4", 7/8", 1", Whit.
- Ditto, B.S.F. 26 threads or S.A.E.
- Set 1/2" to 1 1/2" Taps, same as Dies. T.S. or P.
- Slitting Saws, five 1/32" to 1/4" thick, 1" hole.
- Two dozen Fine and Odd Thread Taps to 3/8".
- Three dozen Tungsten Hack-Saws to 12".
- 18 Grinding Wheels, 1/2" to 1" diam.
- Three H.S. Tap Fluting Cutters, 1 1/2" diam.
- One dozen Ass. Files, 4" to 12".
- Six Files, 12" to 16". Note postage terms.
- Dozen Toolmaker's Needle Files, indispensable.
- Best Carborundum Wheel, 7" by 1 1/2" by 1/2" hole.
- 200 Springs to approx. 6" long.
- 2 1/2" Split Die Cutting, 3/4" gas.

5,000 Dies and Taps to clear. 1 1/2" Split Circular Dies, guaranteed quality. Usual price, 10d. to 1/3 each. Sizes 1/2", 5/32", 3/8", 7/32", 1/2", 9/32", 5/8", in Whit., B.S.F. 40 thread 0, 1, 2, 3, 4, 5, 6, B.A. 6d. each, 5/6 dozen. Also Taps to suit, except 40 thread, all sizes, 4d. each, 3/- dozen; 9/32" and 1/2", 6d. each. Taper, Second or Plugs, Tap Wrenches, Adjustable, 9d.; Die Stocks, 9d.

Small Taps, 7, 8, 9, 10, 11, 12, B.A., 1/16", 3/32". Whit. 6d. each, 5/9 dozen. No dies in these sizes.

Carborundum Wheels, 9" diam., 1" wide, 1" hole, 5/-. Also rougher Wheels, 8" by 1 1/4" by 1" hole, 3/9 each. Good pair for general tool use.

High-Speed End Mills, 1/2", 2/9; 1", 2/- Straight Shank, 3/8" carbon ditto, 1/9.

21 Orders Carriage Paid, except abroad. Money refunded if not satisfied with any of the above bargains.

J. BURKE, 30 TRIPPET LANE, SHEFFIELD, 1.

## HEIGHT DOES COUNT



### so why not be Taller

You can quickly add those vital inches with the aid of a box of Challoner's Famous Formula

### H.T.N. TABLETS

and easy system; well tried and safe. No strenuous exercises or old-fashioned appliances. If one box is insufficient, we guarantee to supply a further box FREE. G. Y. (Watford) writes: "I have never had confidence in any system till I tried yours, now I've gained in height, weight and fitness." Act now! Full particulars 1 1/4d. Sample 7d. Book on height improvement 3d., stamps or P.O. only. Sent under plain sealed cover

THE CHALLONER CO. (late Bond Street), Dept. T72 Laboratory & Works, Hyde Heath, Amersham, Bucks

### PEA BULBS

Light up your railway stations, signals, models, alarm clocks, etc., with these brilliant 4v. 25 amp Opal Pea Bulbs with M.E.S. fitting and 30 in. flex. Light from 4v. Pkt. battery or accumulator.

6 for 1/20  
6 doz. 7/6  
Post Free.

Not less than six supplied

Abroad add 6d. postage

H. FRANKS, DEPT. P, 81 NEW OXFORD ST., LONDON, W.C.1

You NEED this "IMPETUS" MOTOR TOOL an Electric High Speed hand grinder, file, router, etc. that SAVES TIME, EFFORT & EXPENSE. Faster, easier and more accurate. Nothing on the market to touch it at 63/- net. Send for detailed specification NOW and be up to the minute. Super model, £5 5.

**JOHN P. S. STEEL**  
Clyde Street Mills, Bingley.

## HOW TO OBTAIN A PERFECT LOOKING NOSE



My latest improved Model 25 corrects all ill-shaped noses quickly, painlessly, permanently and comfortably at home. It is the only nose-shaping appliance of precise adjustment, a safe and guaranteed device that will actually give you a perfect looking nose. Write for free booklet, testimonials and Money-Back Guarantee terms.

M. TRILETY, SPECIALIST (D.273.) 45, HATTON GARDEN, LONDON, E.C.1

The 'ADEPT' LATHE  
15/32 in. centres, 6 in. between centres.  
With compound slide-rest 22/-, or with hand-rest only, 13/9.  
Screw Tail Stock, 5/6 extra Post 1/-.

THE SUPER 'ADEPT', 33/-  
**F. W. PORTASS, Sellers Street, SHEFFIELD.**

## WORKSHOP CALCULATIONS, TABLES AND FORMULÆ

by F. J. CAMM

A handbook dealing with methods of calculation, solution to workshop problems, and the rules and formulæ necessary in various workshop processes. It contains all the information a mechanic normally requires

From all booksellers 3/6 net, by post 3/9 from the publisher:

**GEORGE NEWNES LTD. (Book Dept.),** Tower House, Southampton St., London, W.C.2

## OUR ADVICE BUREAU COUPON

This coupon is available until January 31 1939, and must be attached to all letters containing queries, together with 3 penny stamps. A stamped addressed envelope must also be enclosed.  
**PRACTICAL MECHANICS, JAN., 1939.**

## TOOLS

**GRAYSON'S** Glass-boring Outfits and Tube Cutters avoid risk.—Below.

**DRILLS, Taps, Dies, Files, Chisels and Punches.** Best quality at keenest prices.—Grayson & Company, 300 Campo Lane, Sheffield.

**BRAND NEW POWER TOOLS** of quality. 10 in. Bandsaws, 54/-. Jigsaws, 22/6. Wood Planing Machines, 80/-. Bench Drills, 11/-. Circular Saws, from 25/-. 3 in. S.C. Toolroom Lathes, from £4 10s. New 1 in. Chromium Plated Micrometers, 12/6. Electric Drills, 32/6. Grinders, Spray Plants, Guns, Air Compressors, etc.—John P. Steel, Clyde St. Mills, Bingley.

**MYFORD LATHE SPECIALISTS.** Cash or no deposit terms from 10/- monthly. Immediate deliveries anywhere.—Nuttalls, 20 Albert Street, Mansfield.

## MICROSCOPY

**THE MICROSCOPE AND ENTOMOLOGICAL MONTHLY,** One shilling. All newsgents, or Is.1d. post free from The Microscope, 20/21 Took's Court, London, E.C.4. Brochure free on request.

**BINOCULAR MICROSCOPE £6,** and other bargains.—Mackett & Company, Manufacturing Opticians, 51 Millers Road, BRIGHTON.

## PHOTOGRAPHY

**PHOTOGRAPHIC MATERIALS.** Plates, Films Mounts, Chemicals, etc. Interesting money-saving lists and samples free.—"Kimber's," 105 Queens Road, Brighton.

"PANTOGRAPHS" make large accurate drawings from small photographs, etc., easily. 1/-.—Cooke, 33 Hawthorn Road, Levenshulme, Manchester.

## WATCHMAKING

**WATCH & CLOCK REPAIRERS.** Send 3d. for complete list of material and tools. Blakiston & Co., Ainsdale, Southport.

## WOODWORK

**CABINET HARDWOODS,** Oak, Mahogany, Ash, Whitewood, Ply-woods. Lowest Prices. Send Cutting Lists.—Wilfred Parr & Co., March Works, Lancaster Road, Leytonstone, E.11.

## WIRELESS

**HEAR AMERICA, AUSTRALIA, JAPAN.** New Receivers, complete, 19/6. Latest list free. Overseas inquiries welcomed.—W. J. Buckle, 63 Avenue Approach, Bury St. Edmunds.

## MONEY-MAKING

**FORMULAS** of the best furniture, Auto Body, Shoe Polishes, Bleaches, etc. Be independent. Start your own business in spare time. Ingredients easy to secure and prepare. Send for list. Some formulas as low as 5/-.—Thomas, Charles & Co., Research Dept., Wellington Buildings, South Castle Street, Liverpool, 2.

## MISCELLANEOUS

**FLYING FLEA** completed except for covering main wing, perfect condition, with or without engine and airscrew. Offers or light car exchange.—Wrigglesworth, 41 York Road, Driffield, E. Yorks.

**CASTING MOULDS FOR LEAD SOLDIERS,** animals and novelties. Sample mould, 2/9. Catalogue, stamp.—Industries, 2 Waldegrave Park, Twickenham.

**HEADPHONES, CRYSTALS, CRYSTAL SETS,** microphones, model aeroplanes, tricks, jokes, etc. Lists with diagrams, FREE, or send 3d. for 40-page ILLUSTRATED CATALOGUE. POST RADIO, 2 COPENHAGEN STREET, London, N.1.

**EXCLUSIVE 16mm. Films.** List free, or send shilling for samples. Cameo Films, Broadway Chambers, London, W.3.

# BUY, EXCHANGE OR SELL

Advertisements are accepted for these columns at 3d. per word (minimum 12 words at 3s.—advertisements of less than 12 words are charged at the minimum rate of 3s.) subject to a discount of 2½% for 6 consecutive monthly insertions or 5% for 12 consecutive monthly insertions. **TERMS:**—Cash with order. Cheques, Postal Orders, etc., should be made payable to George Newnes Ltd. *The Proprietors reserve the right to refuse or withdraw advertisements at their discretion.* All advertisements must be received on or before the 5th of the month preceding date of publication and should be addressed to the Advertisement Manager, "Practical Mechanics," George Newnes Ltd., Tower House, Southampton Street, Strand, W.C.2.

## CANOEES

**BOAT AND CANOE.** Kits from 25/-. All types completed craft. Winter Reductions. List stamp. Trade.—Metacraft (P), Christchurch, Hants.

## CINEMATOGRAPHY

**ART CINE FILMS.** Exclusive 9.5 and 16-mm. Free Films to Cine Camera or Projector buyers. All makes. State wants.—P. M. Dane, 64, Stanley Street, Liverpool 1.

**CINEMATOGRAPH FILMS.** Standard Size from 6d. 100 feet. Machines, Accessories. Sample Films 1/- and 2/6 post free. Catalogues free.—"Filmeries," 57 Lancaster Road, Levetonstone, E.11.

## ELECTRICAL

A.C. & D.C. Electrical Equipment Repair Specialists. Easco, 18pm, Brixton Road, S.W.9.

**SUPER A.C. MOTORS.** Brand New, 1/10 h.p., 30/-; ¼ h.p., 38/6; ½ h.p., 38/6; ¾ h.p., 55/-; larger sizes. Electric Tools, Machines, Pumps, Compressors, etc.—John P. Steel, Clyde Street Mills, Bingley.

## ENGINEERING

**A BALL-BEARING ANNOUNCEMENT.** Miniature Ball-Races, 1½ mm. to 30 mm. o/d. Sample of the smallest standard ball-race in the world, under ¼ in. overall, 2/6 post free. Send 2d. stamp for lists. Dept. P., MINIATURE BEARINGS, LTD., 3 Duke Street, St. James's, S.W.1

## ENGRAVING EQUIPMENT

**ELECTRIC ENGRAVING EQUIPMENT SPECIALISTS.** Send for details of equipment for engraving nameplates, tools, dog collars, etc.—RUBAKEN ELECTRICAL PRODUCTS, MANCHESTER 3.

## I WILL MAKE YOU A BRILLIANT PIANIST



I do not say I may—I WILL, if I accept you as my pupil. I have enrolled more than 2,000 adult pupils these last 12 months, have taught during 34 years, over 49,000 adults of all ages, occupations and degrees of proficiency to play the piano brilliantly. I CAN TEACH YOU, even if to-day you do not know a note, to read and play at sight any standard musical composition. I grade Lessons personally to suit your individual needs, using ordinary musical notation, no freakish methods. SEND p.c. for free booklet, "Mind, Muscles and Keyboard," and form for FREE advice.

Say if Advanced, Moderate, Elementary or Beginner.

MR. H. BECKER, (Dept. 158)

69, Fleet St., London.

## JUBILEE WORM DRIVE HOSE CLIPS



The long-life clip with the ever-tight grip.

The Best Known

For Radiator Joints, Air, Oil, and Water Hose Joints.

We guarantee a Tight Joint.

Stocked by all Garages and Accessory Dealers.

L. ROBINSON & CO., 25 London Chambers, GILLINGHAM, KENT.

## MODELS

**EVERYTHING FOR** electrical rewinds and repairs. Screws, nuts, and washers for model engineers. Lists free.—Lumen Electric Co., Litherland, Liverpool, 21.

**SLIGHTLY USED TRIX RAILWAY GOODS,** list 1½d.—Georges, 11 Friars Street, Ipswich.

**FOR MODELS AND EXPERIMENTAL WORK** send your requirements to—Models, 1 Waverley Place, Salisbury, Wilts.

## METAL WORK

**MAKE METAL TOYS.** Easy, profitable with "Success" Moulds. List Free. Complete trial mould 1s. 6d.—Lee's, 1 Birkin Avenue, Nottingham.

## MONEY-MAKING OPPORTUNITIES

**SALES REPRESENTATIVE** wanted, spare time. 35s. weekly easily made. Richlords, Ltd., 8a, Snow Hill, London.

use **Bakers' SOLDERING FLUID**

"easily the best Soldering Fluid Obtainable." This statement by a regular user of "BAKER'S" expresses the general opinion of the Motor and Engineering Trades. Sold in 6d., 1/- and 1/6 tins, also in bulk.

*For a quick clean job!*

SIR WM. BURNETT & CO. (CHEMICALS) LIMITED  
GREAT WEST ROAD, ISLEWORTH, MIDDLESEX  
TELEPHONE 0474

**THE WEBLEY SERVICE AIR RIFLE Mk II**

NO LICENSE REQUIRED TO PURCHASE Or Use at Home

WRITE FOR DESCRIPTIVE FOLDER

Rooks, Rabbits, Hares, Sparrows and similar vermin can be destroyed by this extremely accurate and powerful Air Rifle. Ideal for Target Practice.

CALIBRE .22-177 With leafsight and Peepsight  
WEBLEY & SCOTT LD. 100, WEAMAN STREET, BIRMINGHAM, 2

## INVENTORS

### VALUABLE GUIDE

General Advice Free. POST FREE 6d.  
**CHATWIN & CO.** Est. 1880  
Regd. Patent, Design and Trade Mark Agents for all countries.  
253 (D) Gray's Inn Road, London, W.C.1.

### MAKE MORE MONEY

£3 to £8 weekly can be earned at home in a wonderful business of your own. No matter where you live you can commence to make money in your spare or whole time. No risk, canvassing or experience required. A wonderful opportunity for anyone wishing to add pounds to their income. Particulars, stamp.  
**BALLARD, York House, 12 Hambrook Road, LONDON, S.E.25.**

## MUSICAL INSTRUMENTS

**BAND GUIDE.** Hints on the Bugle, Drum, Flute. Staff Parade formation, etc. Free, post p.d.—Potter's (Manufacturers), West Street, London, W.C.2.

## PATENTS

**REGINALD W. BARKER & CO.** (Established 1886), 56 Ludgate Hill, London, E.C.4.—Patent and Trade Mark Booklets Gratis.

## PATENTS AND INVENTIONS

**WE SUCCESSFULLY SELL** inventions, patented and unpatented. Write for proof, and tell us what you have for sale.—Chartered Institute of American Inventors, Dept. 104, Washington, D.C., U.S.A.

**AMERICA.** Sell your patents through "INVENTION," leading U.S.A. monthly. Specimen copy 2/6, annually 25/- from British Agents, INTERNATIONAL ENGINEERING CONCESSIONAIRES, LTD., 3 Duke Street, St. James's, S.W.1.

## SITUATIONS VACANT

**G.P.O. ENGINEERING DEPT.** (no experience required). Commencing £3/13/0 per week. Age 18-21. Excellent prospects. Free details of Entrance Exam. from B.I.E.T. (Dept. 579), 17-19 Stratford Place, London, W.1.

**DRAUGHTSMAN.** Numerous vacancies available in Electrical, Mechanical, Structural and other Branches of Engineering; Building; G.P.O. etc. for men age 17-40. Exp. unnecessary if willing to learn. Details of openings, salaries, etc. FREE from N.I.E. (Dept. 372), Staple Inn Bldgs. W.C.1.

## "DOUBLE O" MODEL RAILWAYS

The small gauge with the big appeal

A layout in "OO" takes only ONE QUARTER the space of the same design in "O" gauge. You can have a real Model Railway in a small room. We have the most extensive range of models and specialise in this gauge. Send 6d. in stamps for our new 1938-9 Catalogue. Ask for FREE SAMPLE of scale model Permanent Way.

**GEORGE E. MELLOR (DEPT. P.M.)**

5, Brewis Road, Rhos-on-Sea  
NORTH WALES

## 3½ MYFORD 3½

BEST VALUE—INEXPENSIVE



**DESIGNED AND MANUFACTURED ON THE FINEST ENGINEERING PRINCIPLES.**

Bench-Treadle-Motorised Lathes & Accessories

Send P.C. for free illustrated list (your tool merchants address would be appreciated).

**MYFORD ENG. Co., Ltd., Beeston, Nottm.**

*A Book for  
The Model Railway Enthusiast  
in 1939!*

# INDOOR MODEL RAILWAYS

By  
**E. W. TWINING**  
(The Famous Model Railway Expert)

This book provides the model railway enthusiast with a standard textbook and work of reference, dealing in an exhaustive and authoritative way with the subject. Hundreds of photographs and diagrams drawn to scale.

### LIST OF CONTENTS

- Early small-gauge railways: origin of HO and OO gauges. Gauges, scales and dimensions.
- Electric traction motors, rotation and reversing.
- Prototype locomotives and modelling same.
- Motor mechanism and their adaptation to prototype engines.
- The twin railway, its locomotives and electrical working.
- Electric motor coaches, carriages, waggons and auto-couplers.
- Track, layout and engineering works.
- Third-rail and two-rail systems, control and signalling.
- Architectural features.

Complete the form below and **HAND IT TO YOUR BOOK-SELLER** who will get you "INDOOR MODEL RAILWAYS" for 5/-, thus saving postage. Alternatively, send 5/6 with the form direct to the publishers and the book will be sent to you by return post.

To the BOOK PUBLISHER,  
GEORGE NEWNES, Ltd.,  
TOWER HOUSE, SOUTHAMPTON ST.,  
LONDON, W.C.2.

Please send me by return "INDOOR MODEL RAILWAYS" for which I enclose Postal Order for 5/6 to include all packing, insurance and carriage charges.

P.O. No. is.....

Name.....

Address.....

P.M. 1.39

# Wizard

TRADE  
MARK

## Power Tools •

### SAW BENCHES



These benches are made in three sizes, 6" (Illustrated), 7" and 8". Each size is fitted with a saw guard, adjustable fence, mitre gauge, tilting table, and best steel saw. The 7" size has a rise and fall table, while the 8" size has a rise and a fall spindle.

Price. 6"	£2 14 0
7"	£8 2 0
8"	£12 3 0

Write for illustrated priced Catalogue No. 137C

**WIZARD MACHINERY CO.**  
13 VICTORIA STREET, LONDON, S.W.1

TELEPHONE  
ABBEY 3018

### Ohlsson Petrol Engines

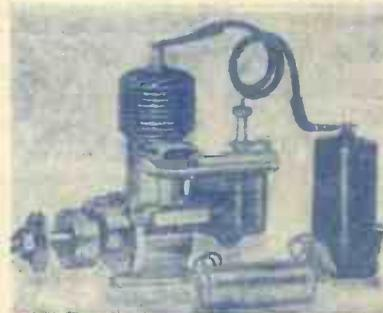

The Perfect Aeroplane engine for planes up to 8 lbs. weight. Bore  $\frac{3}{4}$  in. Stroke  $1\frac{1}{16}$ . Power  $1\frac{1}{5}$  h.p. Weight complete as illustrated 13 ozs. The finish of these engines is as near perfect as it can be made. The crankshaft is hardened and ground. The piston is a perfect compression fit in the cylinder which gives these engines a far greater running life than most engines of this size. Price complete with plug, coil, condenser, carburetter and tank, ready to run.

£4 12 6 Postage 6d.

### The Ohlsson "23" Engine

A smaller engine for planes up to 3 lbs. weight. The bore and stroke is  $\frac{5}{8}$  ins. and develops  $1\frac{1}{7}$  h.p. Price complete as above £4 5 0 Postage 6d.

### Megow Balsa Flying Kits

Kits for 24in. wing span Flying Models of the STINSON RELIANT, WACO CUSTOM, MONOCOUCPE, CONSOLIDATED P/30, FAIRCHILD, HAWKER, FIGHTER, CURTIS HAWK, RICHMAN AND MERRILL'S VULTEE.

PRICE 2/-, postage 6d.



SEND FOR BOND'S GENERAL CATALOGUE PRICE 6d.: THIS WILL INTEREST YOU AS ITS 200 PAGES CONTAIN EVERYTHING THAT THE MODEL MAKER MAY REQUIRE.

**BOND'S O' EUSTON ROAD LTD.**  
357, EUSTON ROAD, N.W.1

'Phone EUSton 5441-2

Established 1887