

OUR MODEL AIRCRAFT CONTEST
FIRST PRIZE £20 • MANY OTHERS!

NEWNES

PRACTICAL MECHANICS

JULY

6^D

*Building
the 'P.M.'*
**MODEL
YACHT**
*Full Details
inside!*





LET ME HELP
YOU
INTO A KEY
POSITION

DO ANY OF THESE SUBJECTS INTEREST YOU?

Accountancy Examinations
Advertising and Sales Management
A.M.I. Fire E. Examination
Applied Mechanics
Army Certificates
Auctioneers and Estate Agents
Aviation Engineering
Banking
Boilers
Book-keeping, Accountancy, and
Modern Business Methods
B.Sc. (Eng.)
B.Sc. (Estate Management)
Building, Architecture, and Clerk of
Works
Builders' Quantities
Cambridge Senior School Certificate
Civil Engineering
Civil Service
All Commercial Subjects
Commercial Art
Concrete and Structural Engineering

Draughtsmanship, All branches
Engineering, All branches, subjects
and examinations
General Education
G.P.O. Eng. Dept.
Heating and Ventilating
Industrial Chemistry
Insurance
Journalism
Mathematics
Matriculation
Metallurgy
Mining, All subjects
Mining, Electrical Engineering
Motor Engineering
Motor Trade
Municipal and County Engineers
Naval Architecture
Novel Writing
Pattern Making
Play Writing
Police, Special Course

Preceptors, College of
Press Tool Work
Pumps and Pumping Machinery
Radio Communication
Radio Service Engineering
Road Making and Maintenance
Salesmanship, I.S.M.A.
Sanitation
Secretarial Exams.
Sheet Metal Work
Shipbuilding
Shorthand (Pitman's)
Short Story Writing
Structural Engineering
Surveying
Teachers of Handicrafts
Telephony and Telegraphy
Transport Inst. Exams.
Weights and Measures Inspector
Welding
Wireless Telegraphy and Telephony
Works Managers

If you do not see your own requirements above, write to us on any subject. Full particulars free.

STUDY AT HOME IN
YOUR SPARE TIME.

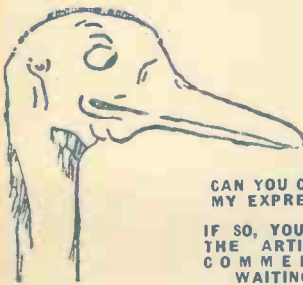

CAN YOU CHANGE
MY EXPRESSION?

IF SO, YOU MAY BE
THE ARTIST THAT
COMMERCE IS
WAITING FOR

Jim Dued

Just try it for yourself.
Trace or draw the outline
and then put in the features.

There are hundreds of openings in connection with
Humorous Papers, Advertisement Drawing,
Posters, Calendars, Catalogues, Textile Designs,
Book Illustrations, etc.

10 per cent. of Commercial Art Work is done by "Frog
Lance Artists," who do their work at home and sell it to the
highest bidders. Many Commercial Artists draw "retain-
ing fees" from various sources, others prefer to work
full-time employment or partnership arrangement. We
teach you not only how to draw what is wanted, but how
to make buyers want what you draw. Many of our students
who originally took up Commercial Art as a hobby have
since turned it into a full-time paying profession with
studio and staff of assistant artists; there is no limit to
the possibilities. Let us send full particulars for a FREE
TRIAL and details of our course for your inspection
You will be under no obligation, whatever.

Jim Dued

ART DEPT. 76.

YOU CANNOT MAKE MONEY
BY SAVING

If you save 10s. per week for 10 years you have
only got £260, but if you spend 2s. 6d. per
week for 12 or 18 months on a correspondence
course, you give your brains a chance to earn
thousands of pounds; then there is no need
to save.

Savings are likely to vanish, but earning
capacity is a permanent investment.

I HAVE HELPED THOUSANDS
OF OTHERS

And when I say thousands, I do not exaggerate,
as I can produce well over 10,000
unsolicited testimonials from grateful students
who, through our Postal
Training, have achieved
their life's ambition.

W. Bennett



Dept. 76, THE BENNETT COLLEGE, SHEFFIELD

EVERY DEPARTMENT IS A
COMPLETE COLLEGE; EVERY
STUDENT IS A CLASS TO
HIMSELF

JOURNALISM
Short Story, Novel Writing and
Play Writing

There is money and pleasure in Journalism and in Story
Writing. No apprenticeship, no pupillage, no examinations,
no utility necessary. Writing for newspapers,
novels or pictures is not a gift; it is a science that
can be acquired by diligent application and proper
guidance. It is the most fascinating way of making
part-time profitable. Trained ability only is required;
we do the training by post. Let us tell you all about it.
DEPARTMENT OF LITERATURE 76

If you attend to this now, it may make
a wonderful difference to your future.

COUPON—

CUT THIS OUT



To Dept. 76, THE BENNETT
COLLEGE LTD., SHEFFIELD.
Please send me (free of charge)

Particulars of _____
Your private advice about _____
(Cross out line which does not apply.)

PLEASE WRITE IN BLOCK LETTERS.

Name _____

Address _____

GET THIS CLEVER LITTLE MINICAM FOR THE HOLIDAYS

THE 'SALEX' MINIATURE

with F/4.5 ZEISS TESSAR



Easily the best miniature camera value obtainable to-day. Takes 16 pictures on $3\frac{1}{4} \times 2\frac{1}{4}$ roll film. Real precision mechanism, and, as will be seen from the illustration, is modern, compact in design and beautifully finished. Equipped with the famous genuine Zeiss Tessar f/4.5 lens and Compur Sector shutter, speeded from 1 sec. to 1/300th sec. Shields for red windows and an engraved depth-of-focus table are provided on the back. Camera is complete with lens cap, flexible release and instruction book. **PRICE ONLY £8 : 8 : 0**

15 Monthly Payments of 11/10

Good allowance on your used camera in part exchange.

Obtainable only at

CITY SALE

AND EXCHANGE (1929) LTD.

59-60 CHEAPSIDE, LONDON, E.C.2

A Small Electric Hand Tool with a high performance



Size 6" x 1 1/2"
Weight, 12 ozs.

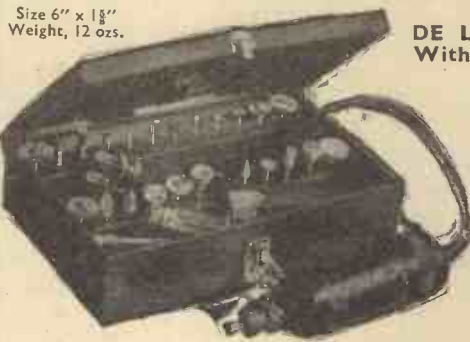

DE LUXE MODEL
With 6 Accessories

£5:10.0

ULTRA DE LUXE MODEL in Steel Case and with 26 Accessories (as illus.)

£7.5.0

Post Free

Universal Motor,

D.C. or A.C., 110v. or 220v.,
25,000 r.p.m.

OVER 200 ACCESSORIES AVAILABLE

H & D LTD.

FOREST RD. South Yardley BIRMINGHAM

Sent on **TEN DAYS' TRIAL** against Cash with Order.

CATALOGUE ON REQUEST

Wizard

TRADE MARK

Power Tools

4" Ball-Bearing PLANER

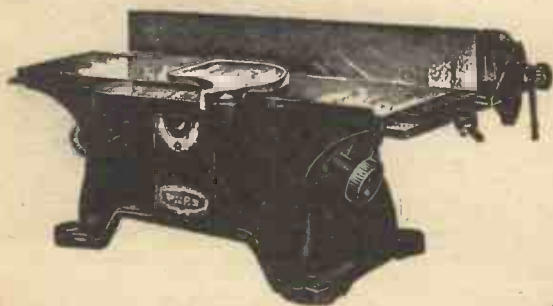

A most useful machine for the practical mechanic. Will handle work up to 4" in one cut. It is fitted with a very efficient guard, and latest type adjustable fence

Price **£9-18-0**

Write for Illustrated priced Catalogue No. 137 C

WIZARD MACHINERY CO.
13 VICTORIA STREET, LONDON, S.W.1.

Telephone: ABBEY 3018

BALSA FLYING KITS



Kits for 24in. wing span Flying Models of the STINSON RELIANT, WACO CUSTOM, MONOCOQUE CONSOLIDATED P/30, FAIRCHILD, HAWKER FIGHTER, CURTISS HAWK, RICKMAN and MERRILL'S VULTEE.

PRICE 2/-.

Postage 6d.

GEARS



We make the finest precision involute cut gears on the market. All will mesh together so that many ratios can be made up. All gears are machined with a large boss and fit

1/16in. shafts.
diam. 3/8in. 1/2in. 11/16in.
Brass 1/16 in. wide teeth ... 6d. 7d. 8d.

3/4in. 1in. 1 1/3in.
diam. 1/2in. 3/4in. 1in.
Steel 1/16 in. wide teeth ... 5d. 5d. 6d.



WHEELS

Celluloid Balloon Type.
diam. 1in. 1 1/2in. 1 3/4in.
Price 6d. pair 8d. pair 1/- pair
Aluminium Wheels—Special Offer:
1 1/2in. diam. wheels, price 2d. pair

PROPELLERS



Special Lightweight Duration Props Made of Light Basswood.

Size 6 8 10 12 14in.
Price 1/6 1/9 2/3 3/6 4/3

BALSA KNIVES

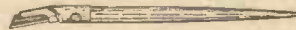

The perfect knife for cutting all Balsa Wood, etc.

Price 9d. complete.
Spare blades 9d. for three.

Postage extra in all cases.

Send for Bond's Illustrated 200-page General Catalogue. Price 6d. It will interest you.

BOND'S O' EUSTON ROAD LTD.
357, EUSTON ROAD, LONDON, N.W.1.

Phone: EUSton 5441-2.

Established 1887

FREE!

This IMPORTANT GUIDE to SUCCESSFUL ENGINEERING CAREERS

After months of intensive effort and research, we are pleased to announce that the 1938 edition of our Handbook, "ENGINEERING OPPORTUNITIES," is now out of the publishers' hands and ready for *free distribution*. Containing 268 pages of practical guidance, this book is, beyond argument, the finest and most complete handbook on Successful Engineering Careers ever compiled. It is a book that should be on the book-shelf of every person interested in engineering, whatever his age, position or experience.

The Handbook contains, among other intensely interesting matter, details of B.Sc., A.M.I.C.E., A.M.I.Mech.E., A.M.I.E.E., A.M.I.A.E., A.M.I.W.T., A.M.I.R.E., CIVIL SERVICE, and other important Engineering Examinations: outlines courses in all branches of CIVIL, MECHANICAL, ELECTRICAL, AUTOMOBILE, RADIO, TELEVISION and AERONAUTICAL ENGINEERING, BUILDING, GOVERNMENT EMPLOYMENT, etc., and explains the unique advantages of our Employment Department.

WE DEFINITELY GUARANTEE
"NO PASS-NO FEE"

If you are earning less than £10 per week you cannot afford to miss reading "ENGINEERING OPPORTUNITIES." In your own interests, we advise you to write (or forward the coupon) for your copy of this enlightening guide to well-paid posts—NOW. *There is no cost or obligation of any kind.*

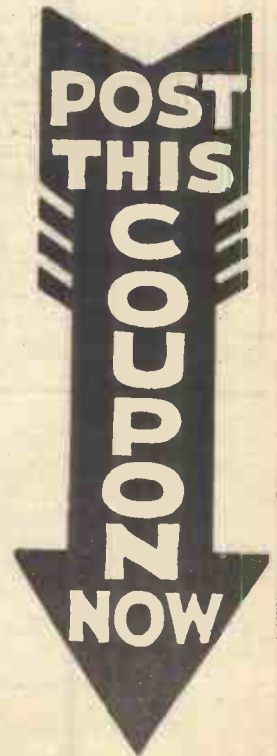

**BRITISH INSTITUTE OF
ENGINEERING TECHNOLOGY**

410a, SHAKESPEARE HOUSE,
17, 18 & 19, STRATFORD PLACE, LONDON, W.1

-----TEAR OFF HERE-----
FREE COUPON

**BRITISH INSTITUTE OF
ENGINEERING TECHNOLOGY,**

410a, Shakespeare House,
17-19, Stratford Place, W.1.

Please forward, **Free of cost or obligation** of any kind,
your 268-page Handbook.

NAME.....

ADDRESS.....

.....

.....

EDITED BY F. J. CAMM

SUBSCRIPTION RATES

Inland and Abroad 7s. 6d. per annum
 Canada - - 7s. per annum

Editorial and Advertisement Offices: "Practical
 Mechanics," George Newnes Ltd.
 Tower House, Southampton Street, Strand, W.C.2.

'Phone: Temple Bar 4363.
 Telegrams: Newnes, Rand, London.

Registered at the G.P.O. for transmission by
 Canadian Magazine Post.

*Copyright in all drawings, photographs, and
 articles published in "Practical Mechanics"
 is specifically reserved throughout the
 countries signatory to the Berne Convention
 and the U.S.A. Reproductions or imitations
 of any of these are therefore expressly
 forbidden.*

PRACTICAL MECHANICS

VOL. V. JULY, 1938. No. 58.

Shortage of Aircraft

THERE can be no doubt that this country is to-day suffering from a great shortage of skilled labour. I have referred on other occasions to this, but recent statements in Parliament have served to accentuate what I have previously written. The aircraft industry has failed to deliver the goods which the country requires and requires urgently. The Government has presumed that the root of the trouble lies in the personnel of the Air Ministry, and whilst I think to some extent this is true, there are other causes of the lack of production of which the Government complains. It is necessary to bear in mind that the Air Ministry was called into existence during the war to control flying. The crude crates on which the pioneers flew were considered in many quarters to be a public menace. A large percentage of the public thought that flying would never be anything more than a hobby of cranks.

In order to safeguard the public the Air Ministry laid down certain rules and regulations concerning the flying and construction of aircraft. Those rules were extremely rigid and did a great deal to advance the progress of aeronautics. The Ministry was largely a piece of legislative machinery, for those were peaceful days and the country could not envisage a war nor the part which aeroplanes would inevitably play in war. Thus, the Ministry insisted upon necessary factors of safety, and they encouraged private experiments, although some regulations hampered and hindered the pioneers who had nothing to gain financially from their experiments. The war developed flying to an extent equal at least to that which would be attained by 20 years of private experiment.

The Ministry, it must be said, was staffed by knowledgeable people; many of them were engineers, many of them had experience of aeroplane design and aeroplane experiments, and some had workshop experience.

Fair Comment

By The Editor

In spite of setbacks the industry has survived. It was bolstered up during the war by Government orders, and after the war when peace was in the air, the industry again languished under the disarmament campaign. Certain manufacturers with vision foresaw that such a campaign was transitory, and that we should sooner or later revert to the old process of preparing against war in time of peace.

Lack of Orders

For the past 15 years therefore the aircraft industry has been doled out with a few orders for military machines and have had to look to civil aviation and orders from foreign governments to keep itself going. The Air Ministry did not relax their regulations. In many ways it has unfortunately hampered private enterprise, notwithstanding the fact that the Royal Aircraft Establishment at Farnborough could not do more than act as a clearing station, a testing laboratory, and a training school.

When we found that in order to maintain our place among nations it was necessary, as Mr. Chamberlain put it, to re-arm on a wartime basis, we found that there were less than a dozen firms in this country making aircraft and most of them were as much as two years behind with their deliveries. Skilled men had been driven from the industry by lack of government support, and financiers had withdrawn their backing because of the paucity of Government orders.

What is Required

Thus you cannot in a night get the personnel and the organisation required

to meet the present demands. It might be imagined that the Air Ministry would relax some of its regulations which are considered to be unnecessary as a first move. In any case the solution to the problem does not lie in the direction of changing Ministers for Air nor in re-organising the Air Ministry. Aeroplanes are built by private firms, and the industry itself needs re-organisation directed by some industrialist with experience of manufacturing methods and the handling of men. The appointment of Committees of Advisers to Ministers is only another way of delaying matters, for it is well-known that Government committees take months to deliberate and all too frequently no notice is taken of the conclusions they reach.

The Government should encourage people to enter the aircraft industry. There are many firms capable of helping in the delivery of aircraft parts who are without work because they are not on the Air Ministry's list. The aircraft industry in this respect is in a peculiarly unfortunate position which does not find a parallel in any other industry for it is under Government control and really dependent upon Government orders.

The Hawker Hurricane £20 Contest

I have received a very large number of entries for our £20 Contest for those who have built our Model of the Hawker Hurricane, Free Blue Print for which was given with our May issue, and which was dealt with also in the June issue. Some further notes appear in this issue, and every competitor has now been notified of the date and time and place of the Contest. It promises to be the most interesting model aeroplane contest held in this country.

Many readers report that they have completed the model and that it flies splendidly. I shall pay for any pictures of the Hawker Hurricane I reproduce.

Glasgow's Tower of Steel

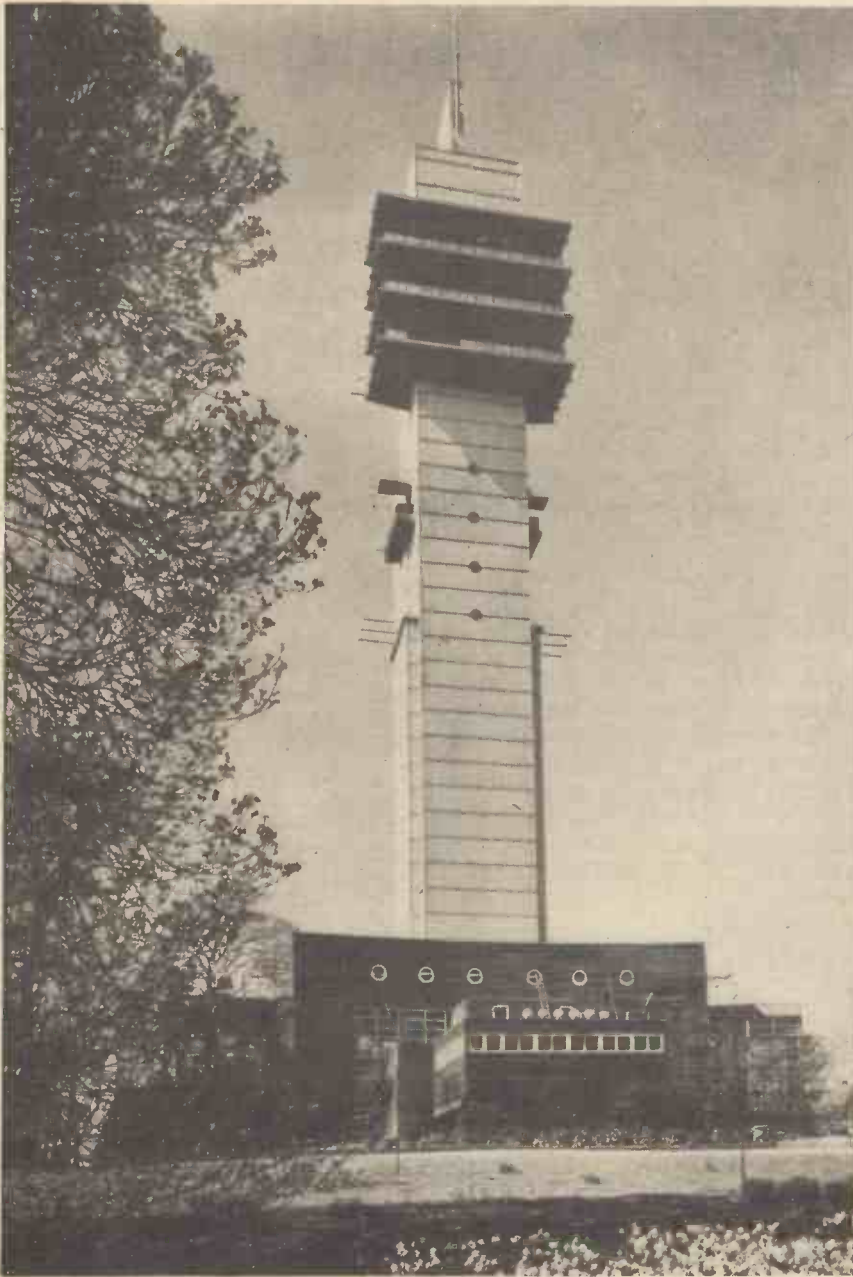

The Tower of Empire, which rises 300 ft. from its base.

DOMINATING the Empire Exhibition at Glasgow is the Tower of Empire which rises 300 ft. from its base, and stands 470 ft. above sea level. To build a structure such as this, entirely of steel, and on a base dimension of 26 ft. x 24 ft. presented a number of serious problems. The first was that of estimating the wind pressure, since the site, Bellahouston Hill, is one of the most exposed in Glasgow. To the stresses calculated for wind pressure had to be added the dead load of the structure itself; the dead load of the weight of spectators on the three balconies and the variable load from the weight of the two high-speed (30 ft. a second), electric lifts which convey visitors to the balconies; and lastly the load due to the whip of the monster flat at the top of the tower.

The Designer

The man who designed this tower, the man who had to solve these problems was T. S. Tait, the famous architect who designed the Sydney Harbour bridge. He found that the maximum downward pressure on any one leg would be 700 tons, and that the upward overturning pull, due to wind and unbalanced balconies that could be developed on any one leg was 400 tons. Like any tall building, the Tower had not only to be held up—it had to be held down also, and the problem of holding it down was made more acute by the very small base area.

The measurements of the foundation necessary to take the estimated compressive and tensile loads was discovered to be 48 ft. x 52 ft. x 21 ft.—a 3,200 ton mass of concrete. This foundation was dug, the

Details Of A Remarkable Structure Which Dominates The Empire Exhibition At Glasgow.

concrete mixed and poured into position in the remarkably short period of twelve days.

Framework

The skeleton of the tower is formed by four main legs forming a rectangle, 24 ft. x 26 ft. Each leg consists of four high-tensile steel angles forming a cruciform section—this cruciform section is maintained from the ground to the balconies, the number of angles used diminishing from four to three and from three to two. Some idea of the massiveness of the design may be gained from the fact that the main legs are formed throughout of 12 ft. x 12 ft. high tensile steel angles, the largest size commercially made. These angles are riveted together throughout their entire length, thereby forming an enormously strong and effective section. Spanning the angles across each face at 24 ft. centres is a system of heavy cruciform section bracing with a system of cruciform section diagonals, tying the whole structure effectively together. At each 24 ft. level, a system of horizontal lattice bracing is used to take up any torque or twist that might develop due to wind pressure. This horizontal bracing also forms a means of support for the internal staircase and lift well.

A Problem

The balconies also presented a problem. Mr. Tait was anxious that the overhanging cantilever portions should be as shallow in depth as possible, and since each of the three balconies had to carry 200 people, solid construction was obviously necessary. These balconies are only 12 ft. above each other so there was not much head-room available for the introduction of deep girders. The difficulty involved was overcome by the devising of a system of interlacing cantilever girders running crosswise and lengthwise at each balcony.

The dimensions of the vane at the top of the tower are 20 ft. x 36 ft. x 2 ft., and it acts, as far as twist is concerned, as a kind of rudder.

A Remarkable View

This remarkable building, from which it is possible to view the surrounding countryside for a radius of 20 miles, was constructed on the same principle as a ship is built. Every blue-print, drawn to a fraction of an inch, is passed in the architect's office; then the pieces are put together on the site—they are bound to fit.

In a recent interview Mr. Tait gave his views on modern architecture. He said: "In architecture now we sweep away all excrescences, we build in streamlines. Why should a building not be as graceful as an aeroplane? One doesn't put cornices and entablatures on a 'plane.

"A modern liner is constructed with elegance of line—an example for the modern architect. Until recently, our buildings could be justifiably compared to an Elizabethan galleon. You wouldn't have a locomotive builder decorating a railway engine with a lofty funnel just because that was the tradition of George Stephenson's time!"

Watch Repairing and Adjusting—

The Study Of Watches Is An Extremely Interesting Hobby, And Below We Give Some Useful Hints On Their Upkeep And Overhaul.



Fig. 1.—A modern Swiss lever movement of the popular 10½ ligne size

WITH high-class watches, one can expect a very close rate of time under both extreme and normal conditions, but the inexpensive watch, by reason of its condition, cannot be expected to keep time within less than several seconds a day. A keen student, however, will soon be able to classify the various grades and execute work accordingly. Any new parts should be faithfully copied, if it is not possible to obtain standard material, in order to maintain the standard of the watch. Good work always reflects credit on the repairer.

Special Names for Parts

The first step is to become thoroughly acquainted with the numerous components of an ordinary watch. Many parts have

Fig. 4.—The balance, balance staff and roller, and the position of the fork of the pallets with regard to the ruby pin.

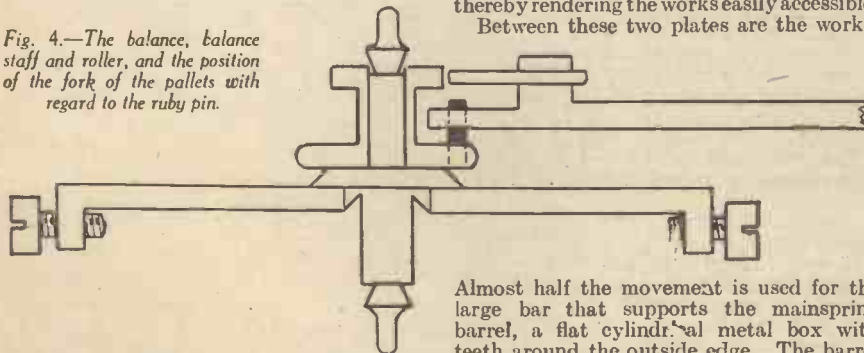

special names, and to be conversant with them will often save considerable time when ordering new material. The enlarged illustration at the head of the article depicts a modern Swiss lever movement of the popular 10½ ligne size.

"Lignes" and "sizes" are the measurements usually used to determine the size of a movement. In Fig. 2 is shown the various diameters of a movement. Of the two main dimensions, that of the largest diameter is usually taken, and the most common measurement is the ligne. As one ligne equals approximately 1/64 of an inch, a 10½ ligne watch measures 3/8 of an inch, which is practically one inch. The American industry favours the "size" as a unit of measurement. Size O equals 1 1/2 of an inch. Each size above size O increases by 1/32 of an

inch, and each size below size O decreases by 1/32 of an inch. 10½ ligne movements are to be found in both gentlemen's and ladies' wrist-watches. Until a few years ago this size was almost universal in ladies' watches, and the cheaper watches still favour

this size.

Thirty-five Screws

Some watches have as many as 150 separate pieces, and of this colossal number there are at least 35 screws. Fig. 3 shows three different types of screw: the cheese-headed plate screw, the flat-headed case screw, and the small jewel screw with countersunk head. The main frame of the movement consists of two plates: the

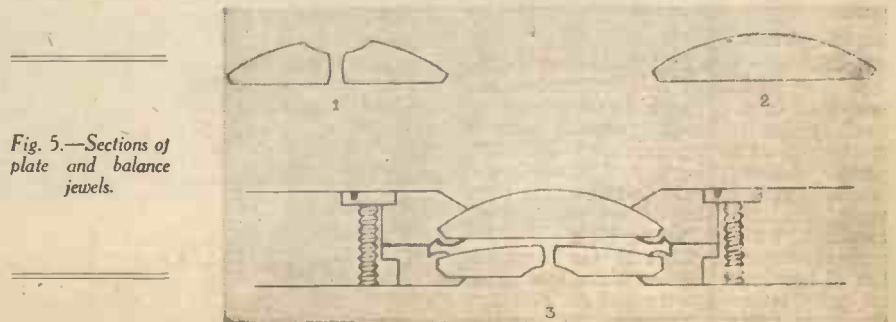

Fig. 2.—The various diameters of a movement.

bottom or dial plate and the top or back plate, which is visible when the case is opened. The modern back plate has changed from a circular plate into a number of sections usually called bars or bridges, thereby rendering the works easily accessible. Between these two plates are the works.

Almost half the movement is used for the large bar that supports the mainspring barrel, a flat cylindrical metal box with teeth around the outside edge. The barrel is fitted with a cover, and the axle upon which it rotates is called the arbor. The arbor has a short hook which engages the inner eye of the mainspring.

Fig. 5.—Sections of plate and balance jewels.



The Great Wheel

The barrel, or main driving wheel, is often referred to as the great wheel, and the other



Fig. 3.—Three different types of screw used in the construction of a watch.

wheels are arranged in the following order. In the centre of the movement and driven by the barrel is the centre wheel; next, the third wheel; then the fourth wheel (the seconds wheel); and finally the fifth wheel (the escape wheel). The remaining section is known as the escapement. When referring to the escapement, this is generally assumed to include the escape wheel, the small anchor-shaped piece called the pallets, which arrests and releases the escape wheel tooth by tooth and the balance and its kindred pieces.

The balance wheel is mounted on a slender axle—the balance staff. Fixed upon the staff above the balance wheel is the hair-spring, and below the balance wheel is the roller. The roller is fitted with a small impulse pin, but when a jewelled pin is used it is commonly called the ruby pin. The function of the roller is to unlock the pallets. Fig. 4 shows the balance, balance staff and roller, and the position of the fork of the pallets with regard to the ruby pin.

Jewels

In jewelled watches, the most popular number of jewels is 15. These jewels are not mere ornaments, but are used to minimise wear. The fifteen jewels are always arranged in this order. Two each for the 3rd, 4th, and 5th wheels and pallets; four for the balance, 2 pallet stones and the ruby pin. Fig. 5 shows sections of plate and

balance jewels. No. 1 is a section of the jewels used for 3rd, 4th and escape wheels; No. 2 is an endstone; and No. 3 shows the arrangement of the balance jewels. There are two sets of jewels, one at each end of the balance staff. In high-class watches, jewel hole and endstone are fixed in separate settings and kept in position by two jewel screws as shown. It will be observed that the balance-jewel hole differs slightly from the ordinary jewel hole. For example, the oil sink is inside on the balance hole and outside on the plate hole.

The pivots, the short projections of the pinions and staffs which actually rotate in the bearings also differ in shape. In Fig. 6 are depicted A an ordinary pivot with a square shoulder and B a balance pivot with a conical (under-cut) shoulder. Type A pivots are used with No. 1 type jewels. In high-class

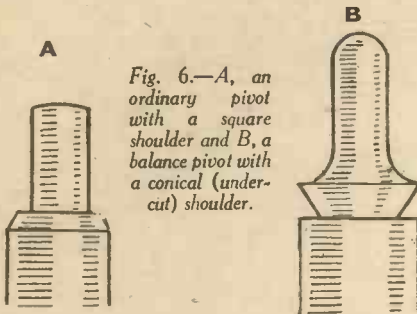

Fig. 6.—A, an ordinary pivot with a square shoulder and B, a balance pivot with a conical (under-cut) shoulder.

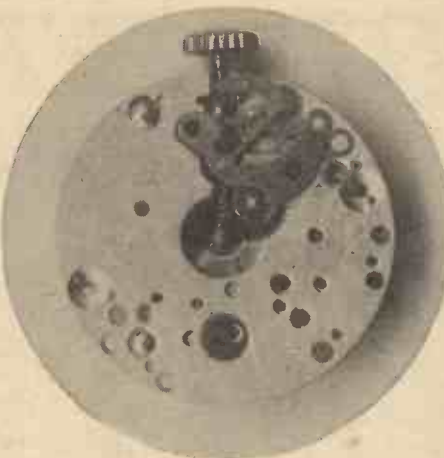

Fig. 7.—A bottom plate.

watches the pallet and escape-wheel pivots are often made conical and provided with balance-type jewels and endstones.

The Bottom Plate

Fig. 7 shows a bottom plate. This carries the small winding and hand-setting wheels and the levers that operate them. The winding shaft passes through two small wheels on the right-hand side, the top or crown wheel engages the smaller of the two flat steel wheels seen in Fig. 1 at right angles.

When winding, the mainspring is prevented from "running back" by the action of the pawl or click which arrests the larger of the winding wheels.

The winding shaft is prevented from being pulled right out by the pull-up piece, which serves the dual purpose of retaining the winder and forcing down, by means of the return lever, the lower wheel on the winding shaft, causing it to engage the intermediate hand-setting wheel. The intermediate wheel gears with the minute wheel—a flat brass wheel having a short pinion and rotating on a stud fixed in the plate—and the teeth of the minute wheel gear with those of the cannon pinion. The cannon pinion is really a small tube with teeth around the bottom and it fits friction tight on the extended pinion of the centre wheel. It is upon this tubular pinion that the minute hand is fixed.

When the winder is pulled out, it depresses the lever and the castle wheel, and the motion wheels (the hand wheels) are engaged and can be turned around to the desired position. Fig. 8 shows the cannon pinion.

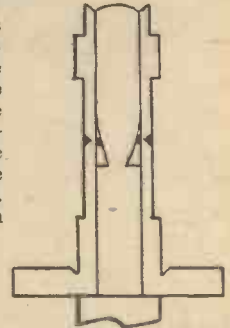

Fig. 8.—A cannon pinion.

DOTS AND DASHES DECIDE YOUR CAREER

Mechanical Devices Which Decide Your Career

THE importance of a wise choice of occupation can scarcely be over-estimated. The consequences, both to the individual and to the community, of a vocational misfit may be extremely serious. It is probably due to the very difficulty of the matter that most peoples' careers have been chosen as a result of chance acquaintances, incomplete knowledge of the person and the work involved and merely temporary considerations.

In the Wrong Job

This problem has, of course, occupied the minds of eminent psychologists for a long time. To be in a wrong job is one of the main reasons for human unhappiness, and it is by no means easy under modern conditions to change one's occupation after a certain age has been reached. The man in the wrong job affects at the same time the efficiency of the firm he works for, he spreads discontent among his fellow-workers and generally constitutes an obstacle to business organisation.

Carefully Devised Tests

Notable advances have been made in the knowledge of human abilities, and it has now been made possible, by means of carefully devised tests, to obtain a more exact estimate of a person's abilities than can be achieved by casual observation. Research work has at the same time been carried on into the nature of different vocations with regard to their effects on human temperaments, and the combination of new knowledge on these two fields has brought about a new position. It is now possible to advise a person as to what work he

should take up with the amazing amount of 92 per cent. probability that the advice based on special tests will result in success. 350 out of 375 young people have made a striking success out of vocations for which they have been judged suitable.

Analysing Work Done

The vocational guidance and research work on this line that have built up such a remarkable record have been developed at the National Institute of Industrial Psychology in London. Many prominent firms in this country have realised the possibilities that lie in vocational tests in the selection of their staffs. They called in experts to analyse the work to be done, find out the special aptitudes required, put them in their order of importance and then test the applicants for the vacancies themselves to see how far their aptitudes correspond to the requirements.

A test for mechanical aptitude. It is possible through this and other devices to find out the mechanical understanding of an applicant.

Dots and Dashes

The results of the new method have produced not only better staff members, but also an improvement of the work itself. The analysis often shows up how processes of work can be carried out more economically, how waste of time and energy can be avoided and a greater output be secured.

The illustration shows one of the devices which enable the Institute to test applicants whether or not they are qualified for certain occupations. In dots and dashes, lines and figures, a person's career is decided.



THE MECHANICS OF BIRD-FLIGHT



A mourning dove in flight.

How Birds Fly and Where their methods differ from Aeroplanes—

By Eric Hardy, F.Z.S.

UP to a certain point the study of bird flight has proved extremely useful to aeroplane designers. From birds they have learnt the necessity of "faring shields" over the wheels, to cut down wind-resistance where wheels cannot be lifted, the "slotted wing device" like the pigeon's "braking" wing or thumb, the art of gliding, etc., but it is foolish to expect many more aeroplane advancements from their study. The mechanics of bird flight differ so much from those required for the demands made upon the modern heavier-than-air machine, that only negligible improvements can be expected from avian sources.

There are four main types of flight adopted by birds. First we have the typical flight in which the wings appear to make an upward and downward movement, next the soaring or sailing flight where the wings are kept extended like those of an aeroplane, thirdly gliding, and finally hovering.

Wing Feathers

The bird-wing is highly resistant to the passage of the air through it as the feathers all lie away from the head of the bird, and birds nearly always rise and hover into the wind. Bird wings are more or less triangular shaped with the base at the body, and powerful muscles are attached to the great keel of the breast bone to pull them down against the resistance of the air, and smaller muscles to raise them into position again. Flight muscles weigh $\frac{1}{4}$ th the weight of most birds, and nearly half the weight of the pigeon. Actually the wing moves slightly forwards, downwards, backwards and upwards, in a sort of screw-like movement, rowing or pulling the bird through the air, so that at the downward stroke the bird's body is not forced directly upwards, but upwards and forwards, its weight allowing it to fall and compensate for this rise between the two strokes. If the bird flapped its wings vertically up and down as generally supposed, it would turn a back somersault. Some birds, like the small finches, woodpeckers, thrushes, wagtails, etc., fly by a hurried flutter of wings, then rest with wings close to the body, which shoots the bird forward until it loses height, and

The illustration given above shows a mourning dove after it was launched in flight. The photograph, made in $\frac{1}{50,000}$ th of a second, reveals in detail the position of the primary and secondary feathers of the wings in a fast downward stroke as the dove sought to gain altitude. Note that the feathers overlap to prevent the passage of air through the wings. On the up stroke the primary and secondary feathers are rotated slightly to allow air to pass through, thus reducing air resistance.

the wings are again brought into action to lift the body; thus we see an undulating or bobbing flight. Some birds, such as rooks, make slow, steady wing beats, while others like the plovers, teal, etc., make very rapid ones. The wing beats of flocks of starlings, wild duck, and golden plover, and those of the peregrine pursuing its prey,

whistle audibly in the wind, and those of the golden-eye rattle (hence fowlers' nickname of "rattle-wing") and of the swan a very musical mewling noise.

Long, Narrow Wings

Birds with long, narrow wings like gulls, terns and swallows are not only fast, but long-distance fliers, those with short round wings like game birds, hawks, tits, etc., are slow, noisy, short-distance fliers. Ragged wing-tips as with eagles, buzzards, herons, and rooks, with wide spaces between the tips of the quills or flight feathers, increase the amount of surface to work against the air resistance. Birds with small wing span and square or rounded tips, usually have the thumb or "braking" wing well developed, and if you hold a wing



A stork in flight. Note the tremendous wing spans.

before an electric fan you will see this little wing or thumb operate automatically. It acts as a braking effect when such birds are settling, by increasing the wing surface, and prevents the bird from turning a somersault. Small hooks on the underfeathers prevent the slots opening too far, but they are flexible and easily interlock to let the slot slip back into place after use. Tail and webbed feet are also used for brakes, especially with gannets and wild duck.

Tails vary in shape according to use for steering or braking. Birds with medium, long narrow tails like sparrows can rise quickly and vertically into the air, those with short, broad tails like eagles, swans, geese and gulls must beat along the surface into the wind to gain lift. Long narrow tail-streamers, as with swallows, enable birds to manoeuvre and double back when travelling at high speeds. Birds that seldom fly much, like the grebes, penguins, guillemots, etc., have only a trace of a tail.

In Flight

In flight the wing is the power, the air the fulcrum and the bird's body the weight, and the wing is fixed to the body skeleton by extra strong joints. The wing is elevated and depressed by two muscles attached to the same bone, the humerus, but the former passes through a hole (the foramen triosseum) at the shoulder joint and is inserted in the upper side of the humerus or arm-bone, and thus is like a pulley device. The body descending by its own weight between the strokes also helps elevate the wings, and the depressed wings must lift as well as propel the body: thus the weight of the body forms a factor in flight. Wind

movements, of course, help immensely and a gliding bird slightly adjusts its wings to take advantage of air currents and avoid "pockets". In calm weather a bird must work its wings much more vigorously than in a breeze; as, in a stiff wind, it need only hold its wings at a slightly upward angle so that they act like a kite and the rapidly moving



A seagull in flight.

air flies the bird. But there is no relation between the weight of the bird and the apparent size of the wings: a heavy bird with small powerful wings like the guillemot of the coasts can attain as much speed as a light-bodied swallow with comparatively large wings. The relation is between the weight of the bird and the velocity of its

wings, the guillemot whirring its little wings until they look like solid bodies, while the swallow winnows with a few beats. If you watch a gull from the stern of a boat, you will see the body rising and falling as the wings are elevated and depressed. The reason a bird would turn a back somersault if wings flapped vertically up and down is that a body in motion tends to fall downwards and forwards, so that the wings must strike ahead of the bird if they are to keep it from falling.

Body Modified for Flight

The bird's skeleton is also modified for flight, the vertebrae of the backbone being few in number and so well united as to form a nearly inflexible column. The breast-bone is developed to an amazing size to give attachment to the base of the flight muscles. The wings are attached to the higher point of the chest so that when outstretched, the weight of the body is beneath them, so that in the air the bird is in a perfect state of equilibrium. The outstretched wing is markedly convex on the upper surface and concave on the lower or undersurface—like an umbrella effect in moderation, but the difference in wind resistance by presenting each surface to the air is like the difference afforded by the two surfaces of an umbrella. When the wing is raised, the feathers are turned a little edgewise, so the wind slips between them, just as an oarsman "feathers" his oar to lessen water resistance when preparing for his next stroke. Soaring is similar to the arrangement of sails on a yacht, arranging the wing to select that component of the force of the breeze to drive the bird in the required direction.

BREAD BY THE SHEET

Sweden has now Perfected a New Method of Making its Daily Bread

FOR the last 7 years Sweden has tried out, become acquainted with and perfected a new method of making its daily bread, a bread which itself is a novelty and steadily increasing in popularity. On account of its crispness the Swedes call it "Kaackbrot" or "crackle bread." In a modern, spick and span factory 6 stoves produce 132,277 lb. of this bread per week. From the moment the flour is blown into the so-called "flour-towers" to the time the finished bread leaves the factory, packed up in parcels of about half a pound, almost everything is done by machinery. The latter works like clockwork and human labour is only required to supervise and lend a hand where the engineers' skill has not yet found a mechanical substitute. In keeping with modern and hygienic methods the machinery is electrically driven, the lighting is electric and even the stoves are electrically fired. It can easily be imagined what a boon these new methods of breadmaking would be to the bakers of this country, who now have to start work when the rest of us are still asleep.

Keeping Air Passengers Warm

No cold feet for passengers on the great Empire air routes! Development of Imperial Airways' Empire services has resulted in large amounts of varied equipment being bought, and an order just placed with Messrs. Ernest Turner, motor trimmings

manufacturers, of King's Cross, is for 150 special lightweight foot-muffs.

A consignment of travelling rugs supplied by the same firm is of interest. Each



Showing how the baked bread is stacked on to small trolleys.

of these woven rugs, although measuring 63 ins. by 46 ins., weighs only 2½ lbs.

Imperial Airways buy a wide range of general accessories for aircraft. The all-important factor of weight, however, means in most cases specially-designed equipment.

Man's £400,000 Figure

Mr. Charles P. Roman has just arrived in this country from the United States to negotiate with Lloyds an unusual £400,000 insurance policy on behalf of Mr. Charles Atlas, the world-famous physical culturist, known as "The World's Most Perfectly Developed Man."

The policy is to ensure that his measurements do not alter in the next five years, and Mr. Roman is prepared to pay premiums up to £10,000 per annum. The measurements are: Chest 47 ins., neck 17 ins., biceps 17 ins., waist 32 ins., calf 16½ ins., and Atlas has maintained these measurements for 20 years.

THE
"PRACTICAL
MECHANICS
HANDBOOK"

Have you reserved
yours?

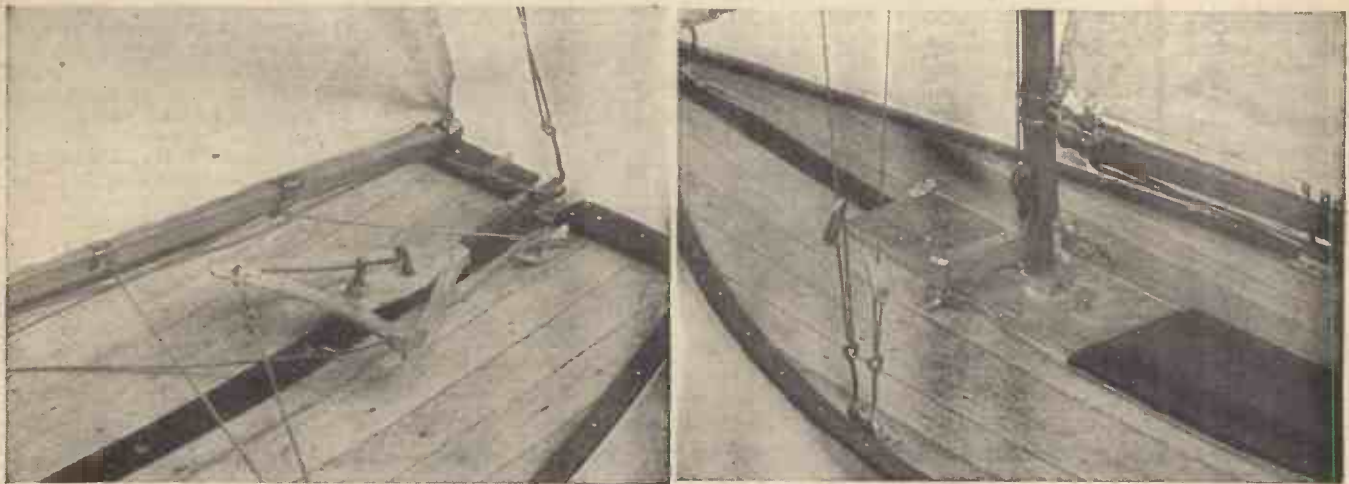

Figs. 9 and 10—(Left) The rudder control. (Right) The mast and boom fixing

BUILDING THE P.M. MODEL YACHT

HAVING cut and drilled or punched the twelve strips for the ribs, take a sheet of graph paper ruled in inches and tenths and mark off as shown in Fig. 12. Then grip a strip in a pair of square-nosed pliers and hold it down on your drawing so that the pliers come with their right edge on the right edge of the stem line where rib 1 makes an angle with the horizontal, keep the centre hole ($\frac{1}{8}$ in.) exactly over the vertical centre line of the drawing, and leave the part of your strip to the left of the pliers parallel with the water line. Hold the pliers firmly with your left hand and with your right bend the strip until it fits exactly over the drawing of rib 1. Scratch a mark to coincide with the top of the rib. Now reverse the rib in the pliers and repeat the process for the other side. Count the number of holes from centre to scratch on each side to make sure they are equal and then cut at the scratches. Again place rib 1 over the drawing and countersink slightly the holes nearest to the middle of the shelf and stringer. Do this, of course, on each half of the rib.

Treat all twelve ribs the same way, taking care to note that rib 8 is longer than rib 7 at the bottom as noted on the drawing. Note also that ribs 2 and 3 bend down the sides of the stem before going outwards and upwards. This is done to avoid cutting deep notches which would weaken the stem.

The Frames

Now take rib 1, place it centrally in the foremost notch in the stem, and through the centre hole mark the position in the

Concluding the Construction of the Model Sloop, described in last Month's Issue.

notch for the fixing screw. Drill $\frac{1}{4}$ in. deep $\frac{1}{16}$ in. hole and fix with a counter sunk $\frac{3}{8}$ in. brass wood-screw using a lead washer over the rib to take up the counter sink and make all firm. Ribs 2 and 3 are through-bolted with 6 B.A. bolts and nuts and brass washers should be used. Now slip ribs 4 and 5 over the bolts through the keel and press them into their notches. Then fit the stem over them, after smearing the joint thoroughly with water-proof glue. Fit brass washers and nuts and screw

down finger tight and then check the stem for alignment with the keel both fore and aft and vertically. In every case make sure that the bottom nuts are drawn well and truly into the countersunk holes in the lead keel or, for ribs 2 and 3, in the stem.

Rib 6 beds on the keel and the washer and nut bear directly on it. Ribs 7, 8 and 9 are bolted on the stern-knee and the greatest possible care must be exercised to see that this join is faultless, because if it is either out of truth at the start or pulls out of truth during planking the yacht will never sail straight in all conditions of wind. Therefore, make sure that the joined surfaces are flat and smooth and at exact right angles to the vertical faces. Use only just enough glue and bolt carefully, keeping the keel and stern-knee clamped together between hard and true surfaces while tightening the nuts. Ribs 10, 11 and 12 are fixed with wood screws and lead washers. The transom is glued and held with an aluminium knee.

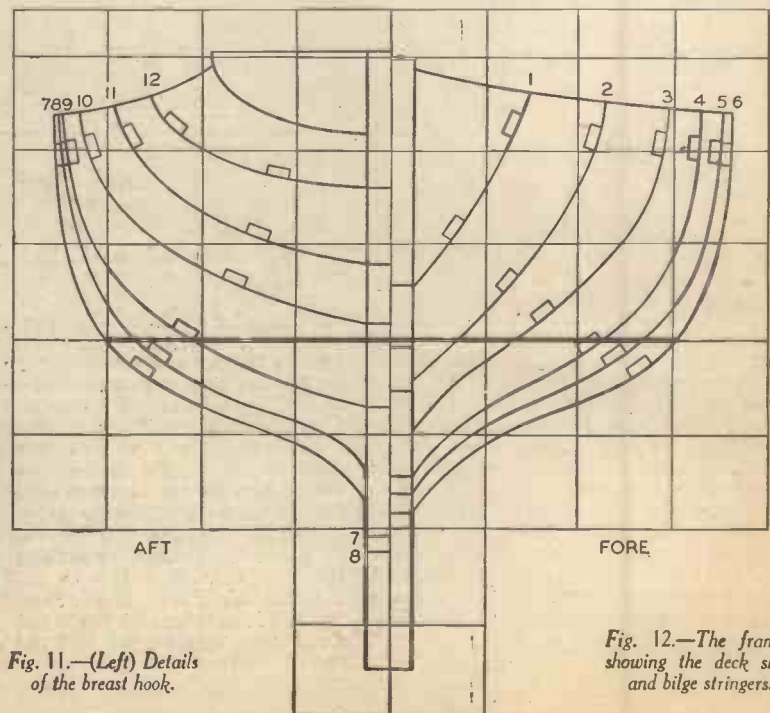
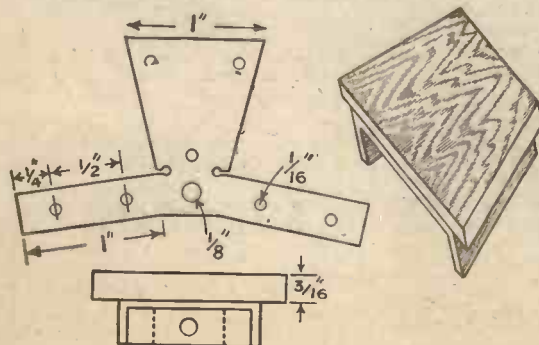

Fig. 11.—(Left) Details of the breast hook.

Fig. 12.—The frames, showing the deck shelf and bilge stringers.

It should be furnished with the four aluminium stringer knees before fixing to the backbone. The brass rudder-tube should also be fitted in the stern-knee and fixed with water-proof glue.

High Water Line

At this stage the builder may wonder why I have made the stern of the ship as high above the water-line as the bows, when it is usual in modern practice to keep the stern low. The reason seems to me adequate; the long overhang is necessary to make the ship sail well in a stiff breeze at a big angle of heel and if the transom were made any smaller the after ends of the planks would be so narrow as to be very difficult to fix satisfactorily. Appearances are safeguarded by an adequate curve in the sheer line.

Proceed to fix the bilge stringer not, as is usual, by beginning amidships, but starting at the lower breast-hook and working steadily aft rib by rib. Check at each rib by reference to Fig. 12 and, to make this easier, stretch a wire from the centre hole on the top of the lower breast-hook to the centre of the top of the transom. Make sure that the stringers are equidistant from this wire at each rib before cutting to length at the after ends and fixing to the aluminium knees at the transom. Before screwing the after-most screws in the knees well home, hitch a wire to first one and then the other, in each case running it round outside the ribs over the fixing screw heads to the foremost screw head in the breast-hook. Make sure that the length is identical on each side.

The Shelf

Remove the centre wire from the lower breast-hook and fix it to the middle of the oak top of the upper breast-hook, keeping it well taut. Now proceed exactly the same way with the shelf except for two additions. Set a cross spall between the two stringers at rib 4, obtaining the length from Fig. 12 (centre line to shelf, twice) and notching the ends to fit the shelf. Measure the distance from the bottom edge of shelf at rib 4 to underside of nut on the holding-down keel bolt of rib 5. Cut two $\frac{1}{4}$ in. strips of aluminium $\frac{1}{4}$ in. longer than the measurement obtained, and drill $\frac{1}{8}$ in. hole centred $\frac{1}{4}$ in. from one end of each. Slip these ends over the keel bolt in rib 5 and screw down the

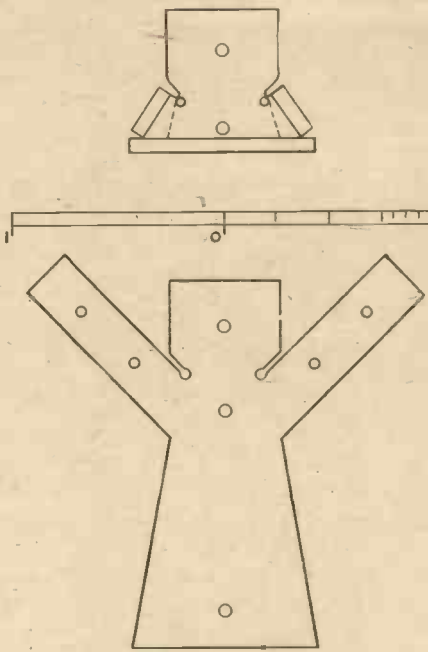

Fig. 13.—Details of the lower breast hook.

which would weaken such small beams, fix them with aluminium angle brackets. Remember to cut the ends of the beams to the angle to coincide with the shelf and notch underneath only just enough to allow for the slope of the top of the shelf near bow and stern. Also remember to screw the brackets or hanging knees to the undersides of the beams before fitting the beams to the shelf. Take the measurements from Fig. 14 but check on completion by seeing that the shelf has a fair curve and no dents or bumps. Cut beam 3 and fit the longitudinal beams or carlines with aluminium lodging knees. Strap the rudder tube to beam 10, but do not bend it, using shims or packing as required between tube and beam. Screw the adjustable mast step to the stem between ribs 3 and 4 and the framework of your ship is complete.

The Planking

Although it is possible to work out

the ribs above the shelf, taking care not to force the batten sideways out of its natural shape. You will have to twist it but not attempt to force it down amidships, where it will stand well above the tops of the ribs.

Now set the points of a pair of pencil compasses $\frac{1}{4}$ in. apart. At each rib put the point on the top of the rib and mark the batten with a little arc above the rib. Then from outside mark a point half-way between the first hole clear of the shelf below it and the next hole below that. Do this at each rib. Remove the batten, lay it flat, outside downwards, and with a batten $\frac{1}{4}$ in. x $\frac{1}{4}$ in. and some weights run a smooth curve touching the tops of all the little arcs and produced onwards to the tops of the stem and transom. Cut a shade ($\frac{1}{32}$ in.) above this curve along its whole length. Turn the batten over and run a fair curve through all the marks on the other side and cut exactly to this curve.

Sheer-Strakes

Using this batten as a template cut two planks from $\frac{1}{4}$ in. mahogany for your two sheer-strakes. Fit closely to the stern-rabbit and glue in, clamp in correct position to ribs 1 and 3, drill and screw with size 1 screws $\frac{1}{4}$ in. long brass counter-sunk to the oak breast-hook top, screwing in this case from the outside of the plank. At each rib, of course, the screws are driven from inside through the holes in the rib into the plank. Use two screws at each rib for each sheer-strake. At the stern, glue and screw to the transom, cutting off flush to the after side. Note carefully that the top of the sheer-strake should be $\frac{1}{8}$ in. above the tops of the beams.

The next plank to tackle is the one next to the keel, and as in the last case the two sides should be worked simultaneously. Take a

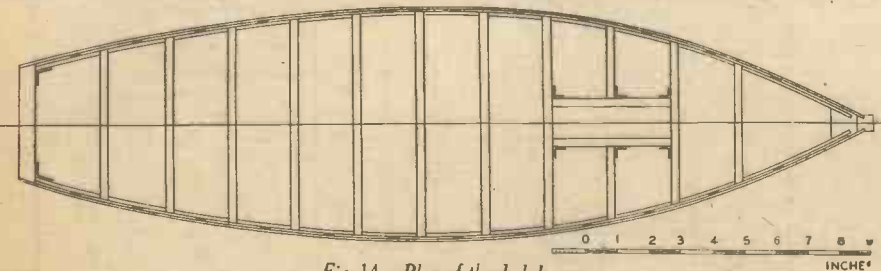

Fig. 14.—Plan of the deck beams.

nut finger-tight. Remove the fixing screws of the shelf from rib 4 and pass the ends of your strips between shelf and rib. Scribe lines on the strips at the top and bottom of the shelf and mark the centres for the fixing holes in the ribs. Remove the strips and make a slight bend at the lower scribed line, drill the holes $\frac{1}{8}$ in. and bend to a right angle at the upper scribed lines. Replace the strips, screw down the nut on the keel bolt and put in the fixing screws holding the strip between one rib and the shelf, the bend in the strip clasping the top of the shelf. Do not remove the cross spall until all the deck beams are fixed.

Fixing the Deck Beams

Instead of notching them over the shelf,

drawings for each plank from the lines of the designer, this would be an extremely tedious and unsatisfactory process. By far the best way is the old one known as spiling, followed by careful fitting of the edges with chalk and plane or file.

Begin at the top with the sheer-strake. Take a spiling batten 3 ft. long and an inch wide by $\frac{1}{4}$ in. thick and clamp one end of it firmly into the top of the rabbet in the stem, after cutting the end of the batten to fit. Clamp it lightly near the other end to the transom so that the top of the batten comes level with the top of the transom. Clamp it or screw it from the inside to a few of

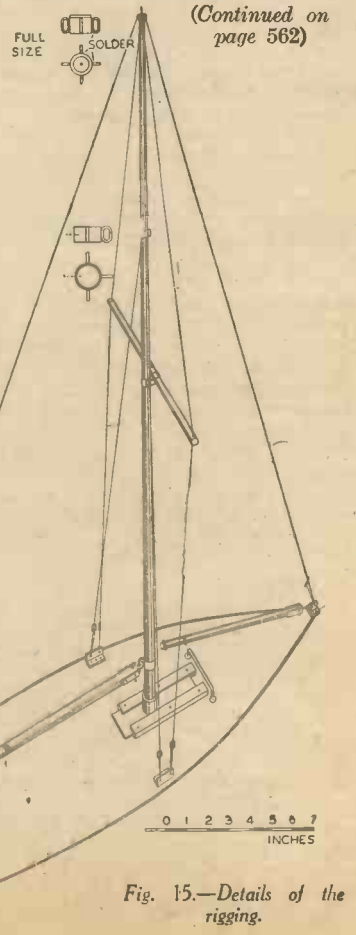
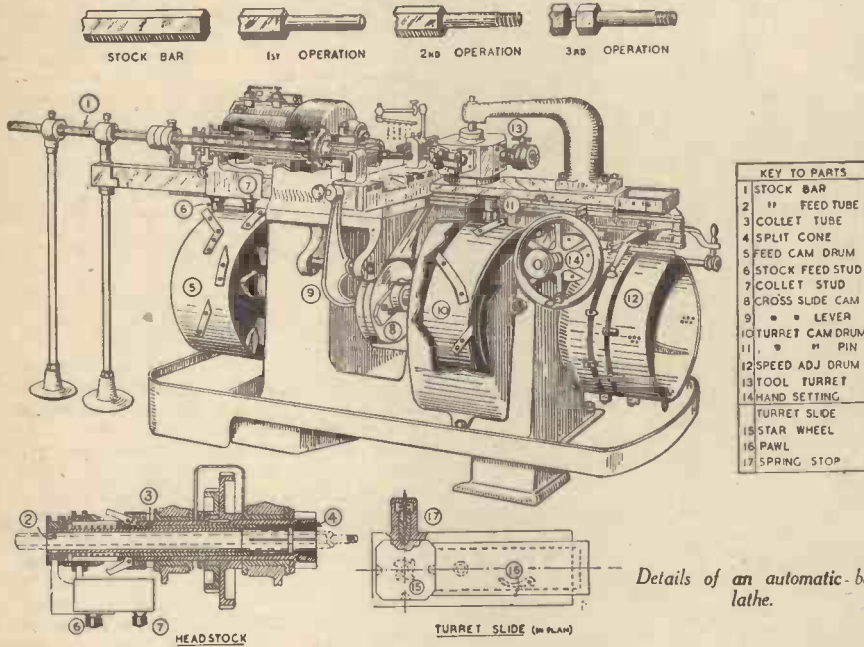

Fig. 15.—Details of the rigging.

(Continued on page 562)

AUTOMATIC LATHES

By E. H. Judd



AUTOMATIC lathes may, so far as general manufacturing purposes are concerned, be broadly divided into two classes—chucking lathes and bar lathes. As their names imply, the former deals with various forms of chuck work, while the latter deals with work produced from the bar, often called screwing machines as they are largely used for the manufacture of bolts, studs and screws.

In both types, when the work piece, or stock, is once placed in the headstock of the lathe, all the operations to be performed on it are carried out quite automatically, and in a more or less similar manner. Take a simple auto-bar lathe as a fair example, and in this instance to produce ordinary bolts.

Principal Components

The principal components of the machine are the headstock, which contains the bar feeding and gripping mechanism; the turret slide, which carries the required number of cutting tools up to six; the cross slide with the cutting off, or parting off tools; and the main camshaft drive on which are mounted large diameter drums on which are bolted movable cams to produce the various functions described below. The lathe may be driven by belts, or by an all-gear head drive.

The Slider

The principal operational functions are as follows. Starting at the headstock end, the bar is first fed in by hand through the hollow mandrel until the front end of the bar is up against the stop on the turret, thus determining its starting point. The roller stud (7), and the slider to which it is attached, operate a pair of levers which pull or push a tube at the other end of which is the split cone or collet (4), forming with an outer cone on the mandrel the chuck that grips the bar. At the starting position this combination is at the left-hand end of its movement, and the collet is open.

The slider and roller stud (6) then moves

to the right, taking with it the feed tube (2), at the inner end of which is a spring collet, or "finger," which grips the bar by friction sufficiently to advance it forward up to the stop on the turret. After that the slider (7) moves to the right, closing the collet and gripping the bar ready for the machining

advance the bar again for the succeeding series of operations.

The turret slide is operated by the cam drum (10), the cams of which press against the roller stud (11), moving the slide forwards and backwards as required. The distance travelled by the slide is regulated by setting the turret tools to give the correct length of travel on the work. In semi-automatic "capstan" or "turret" lathes, not automatically operated by cams, there is usually a set of adjustable stops at the back end of the slide, one for each tool used.

The flat faces of the turret, if of the square or polygon shape, carry the necessary tools, which in this simple example would consist of a plain stop, a roller-steady cutting tool for turning down the shank of the bolt, and a self-opening die-head for screwing the thread.

The Turret

To revolve the turret so as to present each tool in its proper order, there is a star wheel fixed to the bottom end of the central turret pivot. When the slide moves back to the right the pawl (16) catches each tooth of the star wheel successively and rotates the turret the necessary distance for each tool to be presented. The position of the turret is then locked by a spring plunger stop pin (17), which is automatically withdrawn during the rotation of the turret.

A Brief Description of a Simple Type of Automatic Bar Lathe such as is Used for Producing Ordinary Bolts.

operations. Meantime the slider (6) is moved back again to the left position, sliding over the held bar, and is ready to

The operation of cutting off the end of the bolt when completed is done by the cross slide which gets its functioning from the cam (8) through the rocking lever (9). As each bolt is parted off it drops down a chute into the base. A free supply of cutting lubricant is provided by an adjustable pipe and feeder above the job. A cam drum (12), provided with a number of adjustable stops and pegs, controls the speed of operating the turret slide operations. For example, the speed of the screwing die would be different from the cutting speed, or idle feeds. Hand operation is also provided for setting up and adjustment.

Multiple Spindles

When a very large number of similar pieces are required in bar work, it is usual to have a multiple spindle machine, generally with four spindles. The functions of each of the four spindles is similar, so that four times the number of parts can be produced in approximately the same time.

In the auto-chuck lathe the work is generally of larger size, and the number of tools carried by the turret and cross slide greater. Two or more tools may be mounted round a central bar set in one face of the turret, while the cross slide may carry one or more "former" tools which will machine to a definite form of quite considerable length at one cut.

THE P.M. LIST OF BLUEPRINTS

F. J. CAMM'S
PETROL-DRIVEN MODEL MONOPLANE
7s. 6d. per set of four sheets, full-size.

The "PRACTICAL MECHANICS" £20 CAR
(Designed by F. J. CAMM.)
10s. 6d. per set of four sheets.

The "PRACTICAL MECHANICS"
OUTBOARD SPEEDBOAT
7s. 6d. per set of three sheets.

A MODEL AUTOGYRO
Full-size blueprint, 1s.

SUPER-DURATION BIPLANE
Full-size blueprint, 1s.

The
P.M. "PETREL" MODEL MONOPLANE
Complete set, 5s.

The I.C.C. TWO-STROKE PETROL ENGINE
Complete set, 5s.

The above blueprints are obtainable post free from
Messrs. G. Newnes Ltd., Tower House, Strand, WC2

"PRACTICAL MECHANICS" WIRELESS EXPERIMENTER

A SIMPLE DEAF AID

An Easily-Constructed Two-Stage Amplifier For Domestic Use By Readers Who Are Hard Of Hearing



Showing the neat and attractive case of the completed deaf aid.

MANY listeners are unable to hear the normal programmes owing to defects in their ears, and if the volume of the receiver is turned up sufficiently for them it becomes objectionable for the remaining members of the household. Similarly, normal conversation in the home has to be carried out at excessive volume in order that speech becomes intelligible, and thus there is need for some form of amplifier which may be used by those who suffer from this inconvenience. There are many forms of hearing aid now available, but in the majority of cases a simple two-stage amplifier of good gain, in conjunction with a reliable microphone and earpiece will provide the necessary amplification to enable the majority of deaf people to take part in normal conversation. It must be emphasised, however, that deafness can take many forms and consequently it is impossible to guarantee that this, or any other form of hearing aid will be suitable in every case. There are no high-note boosters or other devices of a similar nature in the aid to be described, which is purely a miniature two-stage unit, making use of miniature components and valves, but the gain is very high and in most cases it will be found quite sufficient for the purpose for which it has been designed.

The Circuit

The arrangement incorporated is shown in Fig. 5 whilst the photographic illustrations show the neatness of the design. No handle or other carrying device was fitted to the model as it was intended merely to be used in the home, and stood upon a table. It may, of course, easily be carried under the arm, or if intended for outdoor use a

carrying handle may be attached quite simply to the top of the case. The microphone is provided with a 1.5 volt energising cell, and this is permanently wired. It is a simple matter to replace this when needed. The output from the mike is fed to the first valve through a special miniature mike transformer, and coupling between the first and second valves is by a similar type of component designed for inter-valve use. The bias for the second valve is obtained automatically by means of a half-watt

resistance and small by-pass condenser in the usual circuit arrangement, and the 'phones are plugged into a small jack when required. A volume control combined with an on-off switch is provided so that the level of the output volume may easily be adjusted, and both H.T. and L.T. batteries, although of the miniature type, are provided with terminals or sockets so that connection may more easily be made. The entire apparatus fits into a small box measuring 6 ins. by 4½ ins. by 3 ins. (internal dimensions) and the sample illustrated was made from thin plywood covered with leatherette paper. The valves are the special miniature components designed for deaf-aid apparatus by the Mullard company, and it should be noted that those illustrated are provided with metal screening covers. The makers inform us, however, that stocks of these are limited, and when disposed of the newer types will be of plain glass. This will not affect the working in any way and it is quite in order if you obtain these when ordering your components.

Construction

The amplifier is built on a small aluminium chassis, dimensions of which are given in Fig. 2. Two small holes are required for the valve holders and holes are also required for the attachment of the transformers and through which certain leads are passed. Details of these are clearly given in the wiring diagram. Care should be taken to specify the correct type of valveholder for the valves, noting carefully the type number given in the list of parts, as these are similar in design to those made for the Hivac midget valves, but the two are not interchangeable, the valve leg spacing being

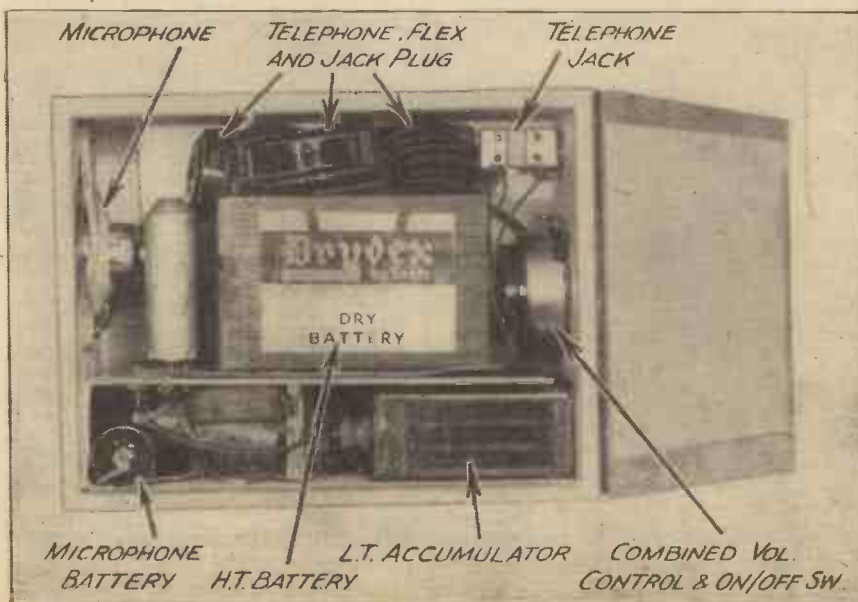

Fig. 1.—A view of the completed Aid, showing how the various parts are accommodated.

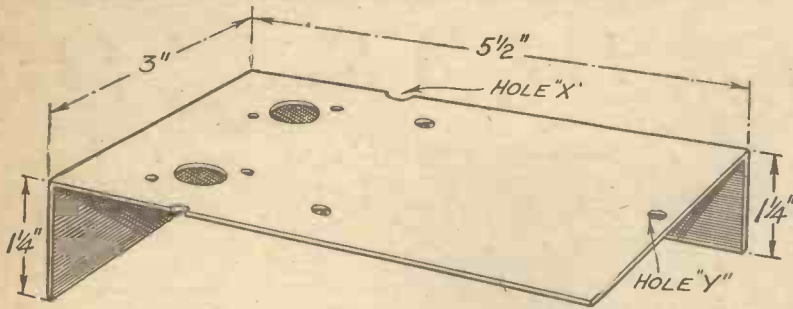

Fig. 2.—The chassis, cutting and drilling dimensions.

slightly different. One fixing bolt for the valveholders is used as a common anchoring point for the L.T. negative lead, whilst in other cases the original wires are used as fitted to the transformers, condenser, and resistance. When the valveholders are mounted the wiring to the filament legs should be carried out before attaching the transformers, as the latter will cover the valveholders and prevent connection. Note, also, that the valve-holder sockets must be carefully bent down towards the chassis to clear the transformer, and care must be taken not to permit the bent-over tags to come into contact with the chassis.

The Cabinet

The cabinet or containing box may, of course, be built from metal if desired, but the wood is quite simple to work and cover. Dimensions are given in Fig. 3 and the large hole for the mike should be cut slightly larger than the overall size of the instrument so that it may be mounted in a "floating" condition. This is accomplished by cutting a star-shaped piece of thick rubber as shown in Fig. 7 and inserting the arms of this beneath the split surrounding ring of the mike. Three small screws with washers beneath the heads will then enable the mike to be screwed into position. At the back of the cabinet two holes are required for the control and jack, and before mounting these components the connecting lugs should be well-tinned. When the case is completed it may be covered with the leatherette paper or in any other finish desired by the constructor, and the equipment is ready for assembly.

One lead from the mike transformer primary has to be attached to the biasing cell, and this may be soldered quite simply to the zinc case. The cell in use was one half of a 3d. torch battery purchased at

the local Sixpenny stores. A lead is then soldered to the top cap for subsequent connection to the large ring of the mike and this also has to be soldered. Connection to the remaining side of the mike is by means

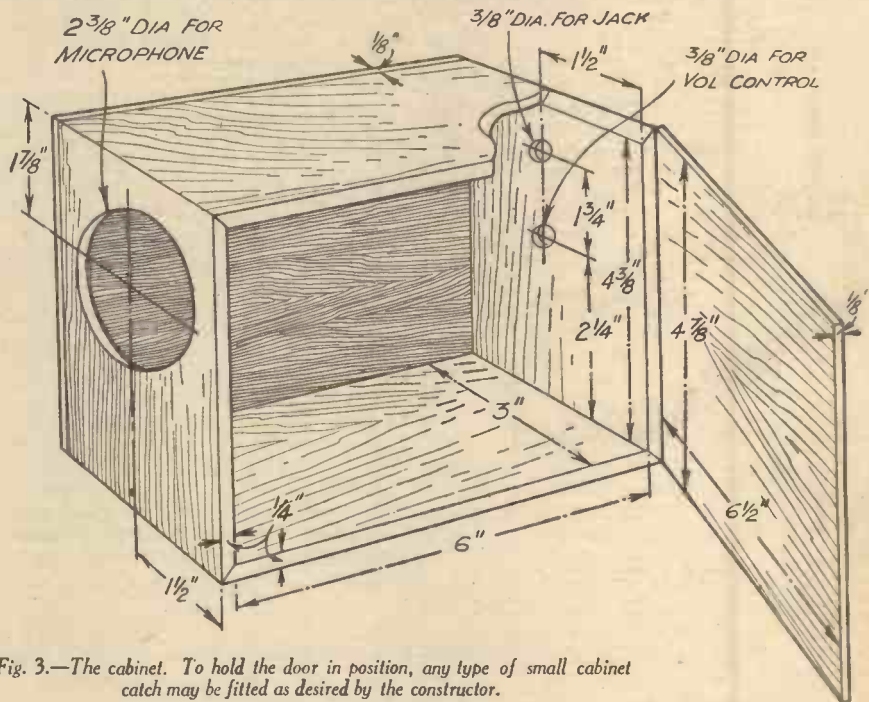

Fig. 3.—The cabinet. To hold the door in position, any type of small cabinet catch may be fitted as desired by the constructor.

of an ordinary small battery plug, attached to the remaining blue lead on the mike transformer primary, the yellow lead being cut off short or rolled up carefully out of the way. A second wire is then soldered to the

case of the cell (or attached at the same time as the transformer lead) for subsequent connection to the L.T. negative terminal. The yellow lead from the second transformer is pulled out and will just reach to the jack whilst still permitting the H.T. battery to be inserted, and when soldering this to the lug on the jack a second short wire should be attached to the same position for subsequent connection to the H.T. positive socket. The flexible lead attached to the second anode lug should be taken up to the other side of the jack and a small nick is made in the edge of the chassis to clear this as shown in the Wiring Diagram. The L.T. positive lead which is brought up at the opposite edge of the chassis is attached to one of the lugs on the on-off switch, whilst a further flexible lead is attached to another lug on the switch for subsequent connection to the L.T. positive terminal.

A plug should then be attached to the H.T. negative lead which is brought through the chassis as indicated and joined to the H.T. negative socket on the miniature H.T. battery.

Using the Device

Plug in the valves and attach the Bulgin plug to the lead to the earpiece. The apparatus is now ready for use and by turning the rear knob in a clockwise direction the apparatus is switched on and volume will be at a minimum. As the control is rotated further the gain will be increased

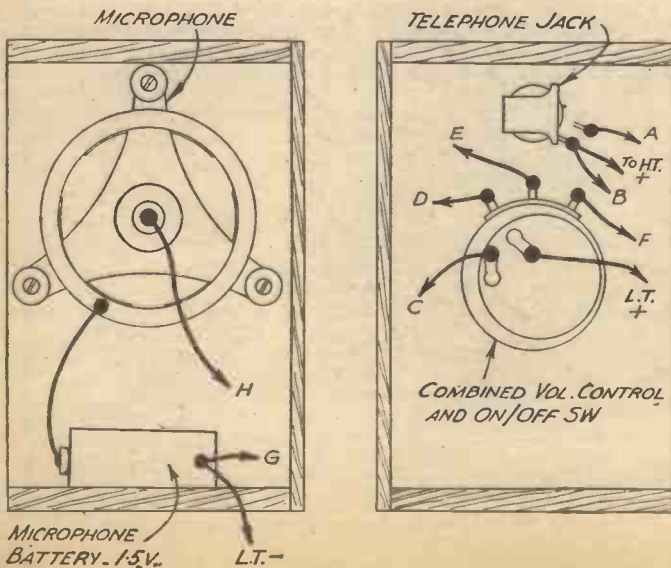

Fig. 4.—Wiring to mike, control and jack. This should be studied in conjunction with Fig. 5

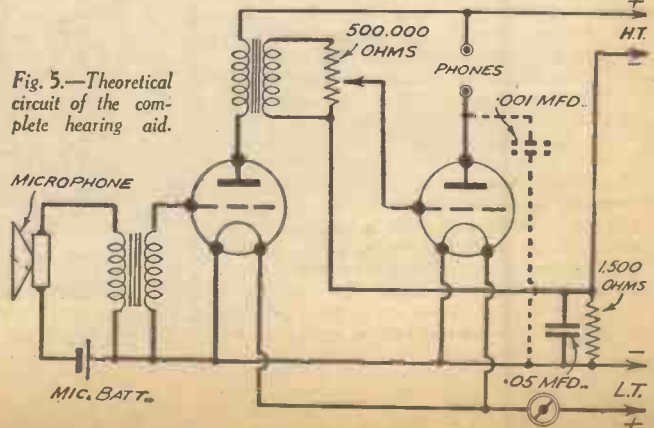

Fig. 5.—Theoretical circuit of the complete hearing aid.

and will build up to maximum. If, of course, the earpiece is left uncovered a microphonic howl will be set up due to feedback between mike and earpiece and thus the two should not be allowed to face each other. The control and jack are fitted to the rear of the case as it is considered that this is most logical when the case is standing on a table. The user will naturally be sitting behind it and it will be directed toward the person who is speaking, or toward the radio. A single earpiece is employed in the design illustrated and was intended to be held when the apparatus is required for use, but special earpieces are available with clips or headband, or alternatively a complete headset may be used. This will necessitate a larger case to enable the additional earpiece and headband to be accommodated above the battery, but this detail is, of course, left to the builder who may alter the case in any desired manner whilst still retaining the main essential—the chassis design.

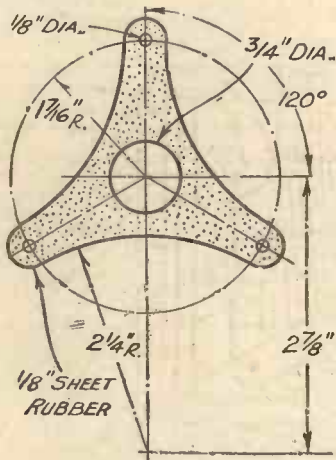

Fig. 7.—Details of the rubber mike support.

Simple Deaf Aid

Regarding the deaf aid described on page 528, it is possible to obtain a complete Pilot Author Kit, with ready-drilled chassis and assembled case with carrying handle, from the Peto-Scott Co., Ltd.

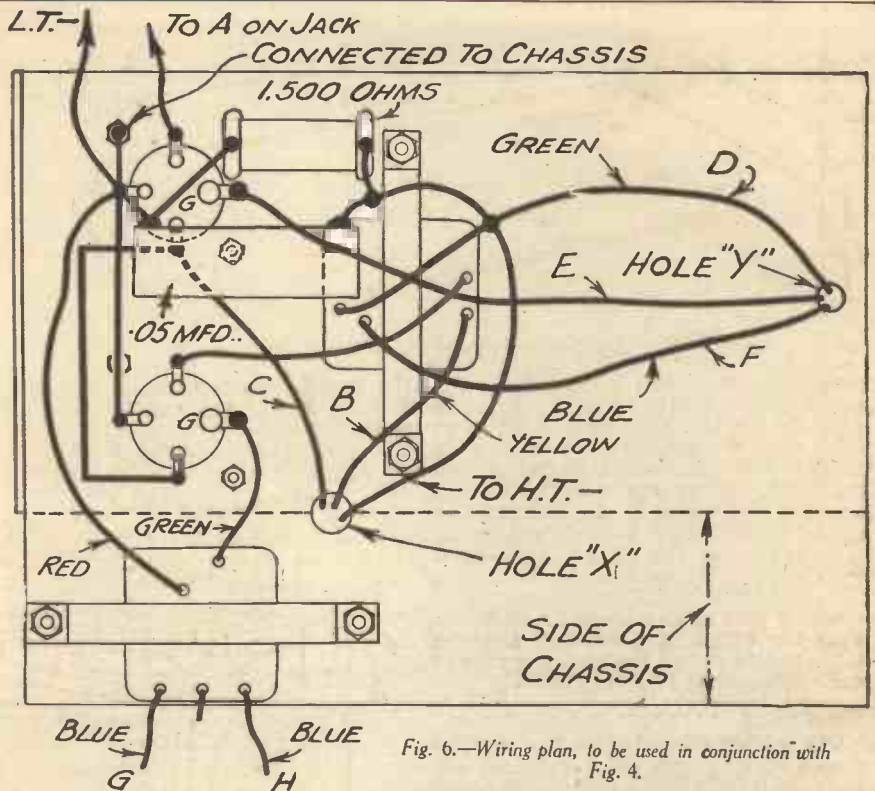

Fig. 6.—Wiring plan, to be used in conjunction with Fig. 4.

LIST OF COMPONENTS

- One microphone transformer, type L.F. 35, Bulgin.
- One Midget L.F. transformer, type L.F. 33, Bulgin.
- Two Midget valve-holders, type V.H.33, Bulgin.
- One combined 500,000 volume control and on-off switch (Lab type), Erie.
- One Midget jack, type J.6, Bulgin.
- One flat top plug for telephone earpiece, type P.15, Bulgin.
- Single telephone earpiece or pair of 'phones, Peto-Scott.
- One microphone, Peto-Scott.
- One 1,500-ohm half-watt resistor, Erie.
- One .05 mfd. tubular condenser, T.C.C.
- One 1.5 volt biasing cell (See Text).
- One type D.A.1 Midget valve, Mullard.
- One type D.A.2 Midget valve, Mullard.
- One type X.325B Midget dry battery, Exide.
- One type PRA3S L.T. accumulator, Exide.
- One chassis and carrying case (See Text).
- Sundry bolts, flex, and two H.T. plugs.

A SIMPLE AIR BUFFER FOR A DOOR

An Ingenious Device Made From A Bicycle Pump

THE device shown in the sketch will effectively prevent doors from slamming. Apart from the annoyance of a door which closes with a bang there is the additional risk that it will cause ceilings and plaster in the vicinity of a door to crack. Many excellent door buffers are on the market, but they are comparatively expensive. An effective one can be made as shown, from a pump. A slot is sawn longitudinally in the solid end of the handle and care should be exercised not to cut into the end of the piston rod. The handle should be removed. In the diagrams A and B are top views of the door and C a section of the pump, 13 ins. long by 1 in. outside diameter. D is the piston tube, E are two leather pistons fitted the reverse way to one another; F is a mild steel plate 1½ ins. long by ½ in. wide by 1/16 in. thick bent up at right angles and having a 1/16 in. hole at one end to take the screw valve H and a 1/16 in. hole at the other end to take a wood screw. G is a half-inch nut cut in half which fits between the pump and the plate F. The part H is made by taking a 1/4 in. Whitworth screw, and re-tapping the hole in the end of the pump for this screw. Bore a 1/8 in. hole in the body of the screw to take a 1/8 in.

bore bearing K and with a 1/16 in. drill make the air hole J. Insert the ball bearing in a 3/16 in. hole and tightly fit a 3/16 in. brass wedge in the hole to prevent the ball coming out. This wedge is shown at L. Next, shape up and slot a brass or mild steel plug to fit in the end of the piston tube. It may be riveted (see NN); now fit screw O. P is a 4 1/4 in. mild steel plate, 1/2 in. wide by

1/8 in. thick. Bore two 1/16 in. holes at each end and bent upwards for 1/4 in. as a P.I. Next, cut a mild steel plate 1 1/2 in. square, with two lugs R.1, 1/4 in. long and 1/8 in. wide. Bore four 1/16 in. holes and bend the lugs down a 1/4 in. as at S.S. The pump can be finished in any colour to suit the finish of the door, wallpaper, etc. T is the lever or rod which may be firmly riveted under the plate R and R.1 at T; U is the vertical section of the wood frame of the hinge side of the door, and V is a section of the wall.

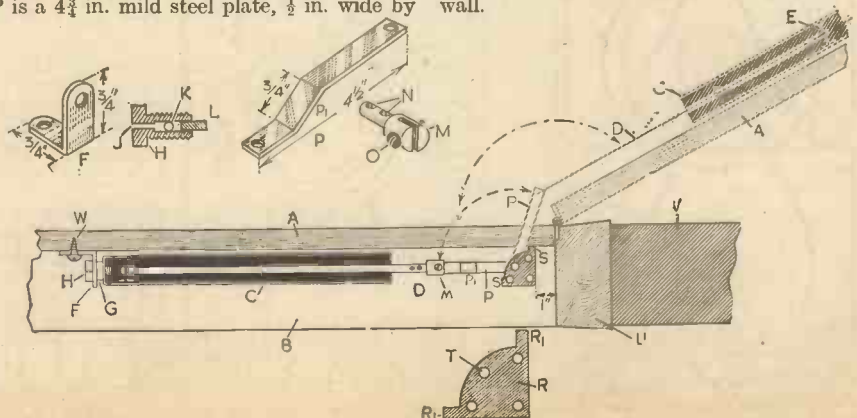

Details of the door buffer.

How Glass Bottles Are Made

How Glass Bottles Are Produced by Mass Production Machinery.

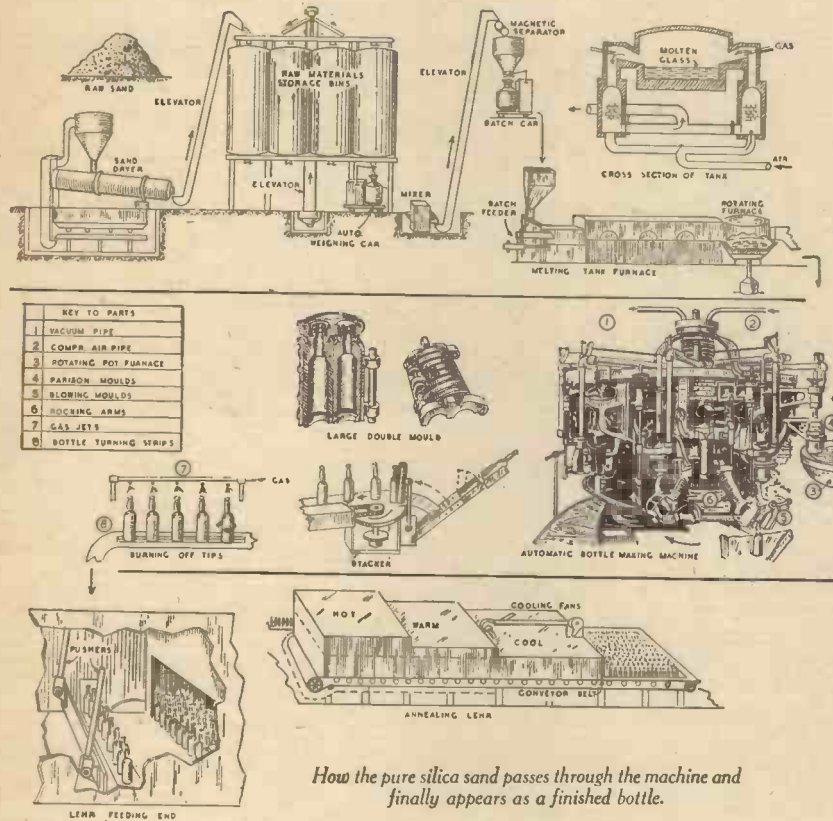

How the pure silica sand passes through the machine and finally appears as a finished bottle.

which revolve around a central column, to which six cam tracks are fixed. Each of these has several cams which control the various functions of forming the bottle. The gathering, or "parison" mould, as the machine revolves, dips on to the surface of the molten glass. The mould cavity is connected, through a valve operated by a cam, to a vacuum line. When the valve opens the glass is forced into the mould. As the mould lifts out of the glass, the tail of the glass is cut off by a knife level with the bottom of the mould. The size of the mould cavity determines the weight of the article, as it is always completely filled.

The Gravity Process

In the gravity process various types of machines such as the O'Neill or the Lynch are used. The molten glass is fed from an auxiliary trough through a hole about 2 ins. in diameter, into the parison mould. A steel plunger, which is given a rotary as well as an up-and-down motion above the hole and concentric with it, forms a cavity in the neck of the bottle.

In both systems, the charge of glass, or "gob" as it is sometimes called, is, after chilling in the gathering mould, transferred to a finishing, or blowing, mould having the final shape of the bottle being made. Compressed air is then admitted, which blows the bottle to shape against the walls of the mould. In the Owens machine the annular ring of gathering moulds is placed above the ring of finishing moulds, while in the O'Neill and Lynch machines the finishing moulds are part of a very similar separate machine placed alongside, and to which the parison is passed. These moulds are made in halves, hinged together at one side, so that they can be automatically opened or closed as each function requires.

As the mould containing the finished bottle passes over the discharge trough, the rocking arm drops, the mould opens out, and the bottle drops gently on to the trough, when a swinging arm tilts the top end of the bottle over, and it slides down the trough. All of these operations are carried out automatically. A large machine of the type illustrated can produce one-pint milk bottles at a rate of 30 a minute when using single moulds, or 50 a minute if fitted with double moulds.

Row of Gas Jets

When the bottle reaches the bottom end of the trough its speed is retarded by light wooden flaps hung across the trough. It then passes on to a table where a stacker

THE mechanical manufacture of glass bottles by modern methods, such as at the Charlton Works of The United Glass Bottle Manufacturers, is a most interesting process. The main raw material used in making glass is pure silica sand, to which are added limestone, soda ash and other ingredients, besides materials used as fluxes, while scrap glass, broken up into granulated form and called "cullet", is mixed with them.

The sand is generally received in a more or less moist condition, so is first passed through a dryer. It is fed into a cylindrical vessel which churns up the sand as it slowly passes through from one end to the other, while heat is applied. On being discharged from the dryer, the sand is carried by a belt and bucket type conveyor up to an overhead dry sand bin. The other ingredients are also cleaned and dried and, with the sand, go to make up the "batch", each constituent being stored in a separate large batch bin. Underneath the bins, to each of which is fitted an outlet shoot with doors, is a line of rails on which runs a motor truck fitted with an automatic weighing machine. The various materials are drawn off from their respective bins in the correct proportional quantities by the truck, and then taken to a mixing machine to be thoroughly mixed before being put in the melting furnace.

A Magnetic Separator

Sometimes the cullet and the batch mixtures are passed over a magnetic separator to extract any iron particles, as a very small amount of this will turn the glass green. Two principal types of furnaces are used in glass-making. The older "pot" type, in which the batch is placed

in pots of from 3 to 30 cwts. capacity, and heated externally, is generally used for smaller quantities and finer qualities of goods. For large scale production, such as for sheet glass and mass production of bottles, the more modern continuous "tank" furnace is used, holding perhaps 130 tons of glass.

This is built in a long rectangular shape, of firebrick and refractory materials, having a long flat bed about four feet deep, and divided into two sections by a bridge wall across the middle, enabling the molten glass from the melting end to pass through a passage below the surface level, thereby avoiding surface scum, to the working end.

Producing Heat

The heat is generally obtained from producer gas, or by oil firing, depending chiefly on which is the cheaper fuel to use at the time. The gases mix with incoming air which is heated by passing it over hot brick surfaces on the regenerative system. The temperature is automatically maintained at about 1470° Cent. by special instrument controls which can keep this within 2 or 3 degrees of the pre-determined figure. The batch, as it comes down from an overhead conveyor, or a batch car, is fed into the furnace by a compressed air pusher mechanism.

The wonderful automatic bottle-making machines are placed at the far end of the tank, and may take their supply of glass from a rotating pot furnace at the end. The molten glass is taken from the furnace in either of two ways—by suction or by gravity. The former system is used in the well-known Owens machine. In its usual form for mass production there are ten independent heads, or glass-forming units,

raises it to the vertical position, and it then travels on to the annealing tank, or "lehr". Some bottles are left with a small tip, or burr, of rough glass at the top end, and in order to remove this a row of gas jets is arranged to play on the bottle ends as they pass along the conveyor. While passing the gas jets the bottles are made to rotate slowly on their vertical axis by a simple means. They stand on two narrow strips of the conveyor, half on one which is travelling, and half on the other which is stationary. The travelling strip gives that half of the bottle a forward movement which tends to turn the bottle round slowly.

Many lehrs are built of brick construction, but a modern form is made as a long metal closed chamber, with the hot end carefully insulated. The bottles are carried along the conveyor in single file into the front end of the lehr. As soon as a complete file has been assembled across the end and opposite the lehr opening, a properly timed pusher mechanism pushes the row into the lehr, continuing this process, file after file, like soldiers in column of march, all standing up on a metal conveyor belt which travels at a very slow speed. While passing through the lehr the bottles are gradually cooled from round about 600°C, as they enter to their final normal surrounding temperature, so as to avoid strains which would distort or crack the glass if cooled too quickly. The time taken in this modern type of lehr is from 1 to 3 hours.

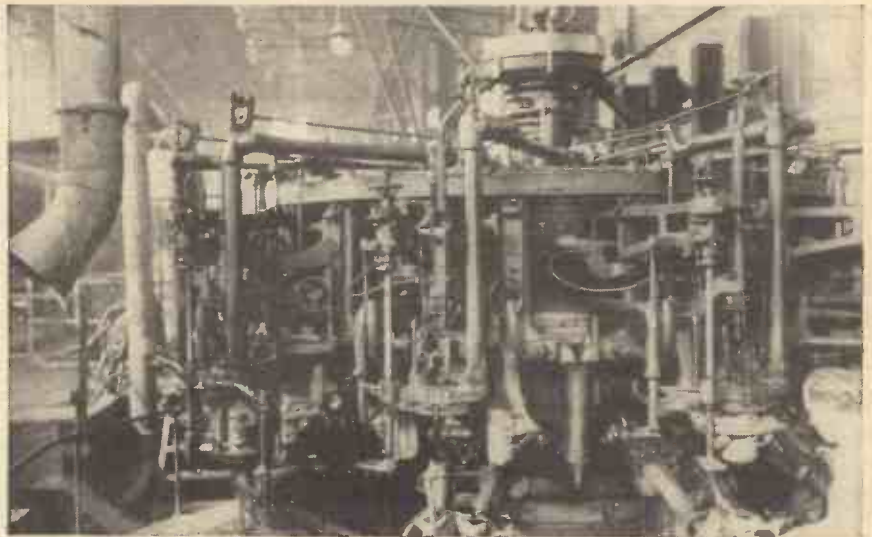

A marvellous machine which converts liquid glass into bottles at the rate of 180 a minute

Marking or Labelling

For marking or labelling the bottles to the particular purchaser's requirements, an ingenious simple process known as the "silk screen" method is sometimes used. The design is cut in a fine silk gauze screen which is spread over with the colour pigment desired, and, with the bottle held

loosely in a horizontal position between two centres, it rotates against the under side of the screen, when the design is quickly stencilled on it. The bottle then goes into a heated lehr when the design is permanently burnt in, and the bottle is then finished ready for packing and despatch.

REMARKABLE MODELS

Details of some of the Interesting Models on view at the Empire Exhibition, Glasgow

A Remarkable Model

AT the request of the War Office, a remarkable model of the Scammell gun tractor has been supplied for display at the Empire Exhibition at Bellahouston Park, Glasgow. This six-wheeled cross-country tractor is so constructed that it will take a heavy load through dry sand, through bush or deep mud, over boulders,

tree stumps, and other obstacles which it would be quite impossible for most other vehicles to negotiate. Its extraordinary capabilities for arduous service of this character are due to the ingenious and scientific design of the vehicle, which provides for the giant low-pressure pneumatic tyres climbing and lifting over obstacles at an acute angle, yet permitting the body of

the tractor to travel on an even keel. The model, which is to the scale of one-sixth natural size, was constructed in their spare time by two of the staff of Scammell Lorries, Ltd. It is perfectly constructed down to the minutest technical detail.

Model Victoria Falls

ANOTHER interesting exhibit at the Empire Exhibition is a model in the Southern Rhodesia Pavilion of the great Victoria Falls. This model is 120 ft. long and 14 ft. deep, and over the lip water continually flows at the rate of 25,000 gallons a minute. As the water plunges over the drop it is aerated to give the impression of foam. In the foreground is the famous rain forest, and the columns of spray, sometimes visible in the original for 70 miles, is here reproduced by steam. Loud-speakers reproduce the deep roar of the actual falls.

Below the falls there is a model bridge, and over this a miniature train runs every few minutes. Cecil Rhodes instructed that the real bridge, which is 400 ft. above the water, should be so constructed that the spray would fall on the carriage windows.

The lighting effects are particularly well done. The morning scene, with dim blues and later with rosy pinks; full daylight with bright yellow, and a rainbow on the spray later; deep night with a white lunar rainbow.

A Million Matches

ALSO at the exhibition is a clock measuring 150 square feet, constructed entirely from a million matches. The length of the minute hand is approximately 7 ft., or half the length of the minute hand of Big Ben. The clock weighs half a ton, and the glue used to fix the matches in position weighed over one hundredweight.



The chassis of the remarkable model tractor.

Jet Propulsion in Theory and Practice

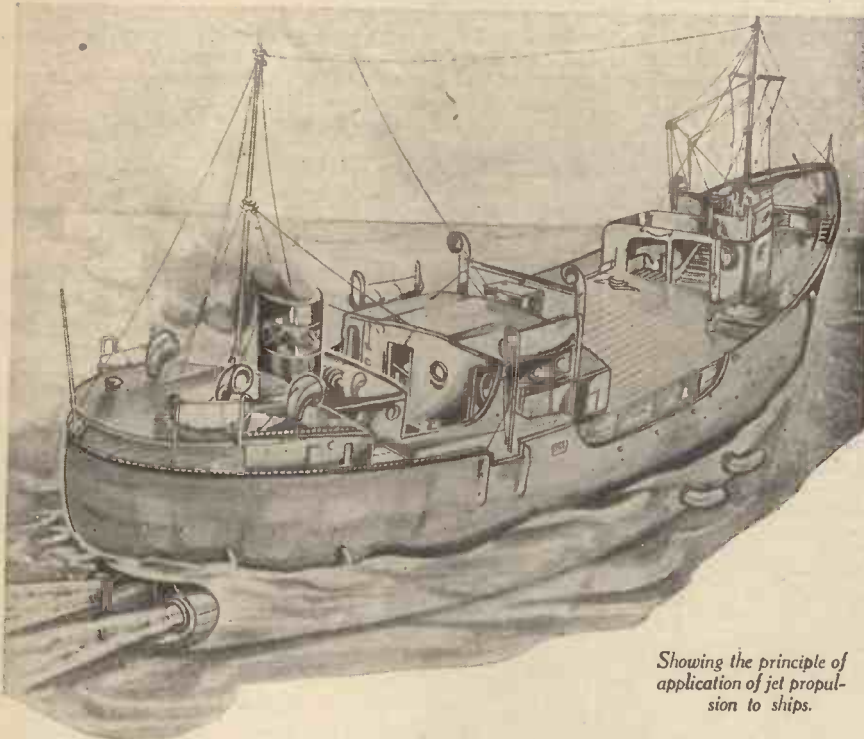

Showing the principle of application of jet propulsion to ships.

THE application of the rocket principle of propulsion to various forms of travel is no new thing. Again and again clever individuals have tried to take the seemingly highly convenient and trouble-free "mechanism" of the rocket and to utilise it for their own ends. Always, however, has failure, more or less complete, resulted from these attempts, for, although the rocket mode of propulsion is, for some purposes, an exceedingly attractive one in theory, it embodies in actual practice too many drawbacks and difficulties for it ever to become a really useful means of locomotion except, perhaps, for one or two very specialised requirements.

"Jet propulsion" is the expression used to denote all the various applications of the rocket principle which have been devised up to the present day, since they all depend upon the operation of one and the same natural physical law, to wit that of the conservation of momentum.

Momentum

Let us, before we go any farther into our subject, get our ideas clear on the exact meaning of momentum. Momentum is not exactly synonymous with motion, for it expresses something more than the latter. Scientifically speaking, momentum denotes the amount or quantity of motion in a body and, in practice, it is measured by multiplying together the mass of the moving body and its velocity.

Thus we may imagine two bodies in motion at different speeds. The first is a light body moving at a higher speed, the second a heavier body moving at a lower speed. It would be possible, however, for these two bodies to possess identically the same momentum.

Consider, now, what happens when a cannon is discharged. Before discharge, gun and shell are at rest. After firing, the shell is given a high velocity in a forwards

direction and thus it acquires momentum. The cannon, also, acquires exactly the same amount of momentum but in the opposite direction. Since, however, the mass (or weight) of the cannon is very many times that of the shell, it follows that the actual backwards motion of the former

An Age-Old Principle Of Mechanics Reviewed In The Light Of Modern Knowledge

is very small and is readily absorbable by means of the recoil mechanism with which it is equipped.

A Simple Analogy

Imagine, again, that you are standing on ice with glass-bottomed shoes on your feet and that you are firing bullets from a particularly heavy rifle, the firing always being in the same direction. Provided, in this instance, that you kept your balance, you would find that gradually you were moving backwards on the ice surface in a more or less perfectly straight line.

Suppose, however, which, of course, is an impossibility—that your rifle had a barrel bent at right angles, so that the bullet was discharged at right angles to your line of vision. In these conditions, you would tend to spin round on the ice after each firing of the rifle.

In every case, the fundamental law is the same, viz.: that when any fluid or body escapes from a vessel in which it has been imprisoned, the vessel acquires a momentum equal to that of the escaping fluid or body, but in the opposite direction. Hence, the vessel tends to move in the opposite direction to that of the escaping fluid.

We shall never know who it was who first

hit upon the elementary application of this principle which, under the name of the "Aeolipile", is now associated with the celebrated Hero of Alexandria, a philosopher who lived about 120 years before the birth of Christ. This device, more properly termed a "reaction steam engine", utilised the principle of the imaginary man on the ice shooting bullets with a right-angled gun. It comprised a hollow ball fitted with right-angled jets on opposite sides. The ball was suitably pivoted on hollow pivots through which steam was conveyed from a boiler. In consequence of the steam's escaping through the jets and thereby imparting momentum to the ball, the latter was caused to rotate rapidly.

Hero's Engine

Hero's engine has never been more than a mere toy, nor will it ever be, for its efficiency is extremely low.

It is well known that the motion of steamships through water is caused by the columns of water which are driven astern on each side of the ship by means of its propellers.

Suppose, now, that in place of its propellers, a ship were equipped with a powerful steam pump which sucked up water through pipes projecting through the

sides of the vessel and discharged it through a couple of jets placed in the position of the propellers at the stern of the vessel. Would the ship, under these conditions, be capable of controlled forwards movement, or would it flounder about hopelessly in a miniature storm of its own creation?

As a matter of fact, the vessel would behave quite normally and, indeed, the jet propulsion of ships in this manner constitutes one of the most successful applications which have ever been made of the rocket principle.

The idea of propelling sailing vessels by means of backwards-projected jets of water can be traced back as far as the year 1729. It was only about the middle of the last century, however, that the principle was successfully applied in actual practice.

In 1866, the Admiralty made comparative trials of two vessels in which they were interested. The first, the *Viper*, a vessel of 1,180 tons displacement, was fitted with the screw propeller system. The second, the *Waterwitch*, of 1,161 tons displacement, had a system of jet propulsion on the lines described in the preceding paragraphs. It was found that the propulsive efficiency of the propeller system was far superior to that of the jet system, and in another series of trials conducted with small boats

which was made nearly twenty years later by Thornycroft, the marine engineer, the same conclusions were reached.

One Advantage

The one advantage of jet propulsion for ships is that it gives an almost vibrationless means of travel through the water. On account of this fact, it was proposed towards the end of the Great War to employ this system of ship propulsion in submarine-detecting vessels, whose motion through the water would thus be rendered almost absolutely silent.

There are, no doubt, many possibilities ahead in the application of jet propulsion to ships, particularly if the efficiency of the system can be placed at a maximum by arranging matters so that a large amount of water is discharged from the jets at a comparatively slow rate.

The rocket system of propulsion applied to land vehicles will be well known to most readers, for it is not a dozen years since the Opel Brothers, in Germany, conducted spectacular experiments with their rocket propelled car, a vehicle which was fitted at the rear with a battery of steel tubes, each containing a specially-devised rocket which was fired electrically from the driver's seat.

The Opels proved beyond any practical doubt that a rocket-propelled vehicle was a possibility. At the same time, however, they demonstrated its hopelessness for ordinary purposes, since their system was not only wasteful in the extreme but was, also, more or less an uncontrollable one.

Rocket Propulsion

The ordinary pyrotechnic rocket, it is well known, derives its upwards motion in consequence of a stream of gas which is discharged to its rear. Now this mode of upwards motion, although as far as we can see, the only possible one for allowing us to make a future escape from the earth and indulge in the adventures—and perils—of interplanetary travel, is an extremely wasteful and unsatisfactory one.

For one thing, the combustion of the rocket's fuel is practically uncontrollable added to which is the fact that the ratio of fuel weight to motive power of the rocket is a very disadvantageous one.

Again, all rockets discharge light gases at a very high velocity. These conditions, however, are just the ones which militate against the economical functioning of a rocket, for, in order to exert its maximum effect, it would be better if a rocket were able to discharge a very heavy gas in large quantity but at a comparatively low speed.

Could we, for instance, devise a rocket which would (controllably) discharge large quantities of a gas as heavy as lead and at a low velocity, then many problems con-

rocket for interplanetary travel, that is to say of the rocket containing a number of charges capable of being released in succession is, at the best, an unsound one, for the piling up of such charges comprises merely a multiplication of their inherent deficiencies.

Yet, for any "long distance" upwards rocket voyage this "stepping" system is the best that can be achieved in the light of our modern knowledge unless, of course, the enormously formidable difficulties of

If a man were standing in glass-bottomed shoes on sheet of ice, firing a heavy rifle in one direction, he would tend to move backward in a straight line.



GLASS-BOTTOMED SHOES

cerned with jet propulsion applied to rocket flight would be solved.

This, however, can never come about, for if there existed such a gas as heavy as lead, its storage or, alternatively, the materials required to generate it, would add such an enormous weight to the rocket that these beneficial conditions would at once be counteracted.

A "Stepped" Rocket

The modern idea of the "stepped"

carrying in a rocket a highly compressed continuous-burning fuel can be overcome.

Even so, however, rocket efficiency would be no higher than it is under present known conditions. For, truth to tell, the age-old system of jet propulsion, although, to the imaginative mind, highly convenient and capable of far-reaching applications has ever turned out in actual practice to be full of disappointment, and to constitute a Will-o'-the-Wisp which has deceived innumerable ingenious minds.

JET PROPULSION FOR BOATS

A Simple And Ingenious System Which May Be Employed For Models

ONE of the earliest methods for propelling boats, and which was also employed in a suggestion for the first steam-engine, is a reaction motor in which a jet of water or steam impinges upon the air or water, as the case may be, the resulting reaction serving to propel whatever the jet is fastened to in a direction

opposite to that of the jet.

We illustrate here a scheme suggested by an inventor for utilising hydraulic jets for propelling small boats. While the scheme is not as simple as the conventional propeller, and its efficiency may be questioned until its value has been demonstrated by actual tests, the idea is a novel one. The propelling

unit consists of a petrol engine which drives a powerful centrifugal pump. Inasmuch as the crank shaft of the engine has a horizontal axis, and the pump shaft is on a vertical axis, it is necessary to use considerable gearing, which no doubt, contributes its quota to the loss of efficiency.

In the scheme suggested by the inventor the impeller shaft is driven by bevel gearing. The water is drawn in through a suction intake, and, after being whirled around at high velocity, it is discharged

through water nozzles placed on the pump casing somewhat back of the centre of buoyancy of the hull. The reason these jets must be placed either in back or ahead of the centre of buoyancy is because the jets perform a dual function. They are not only used for propelling the craft, but, inasmuch as the direction of the discharge openings or nozzles may be changed by a steering wheel which revolves the pump casing to which the nozzles are attached, they also serve to steer the boat.

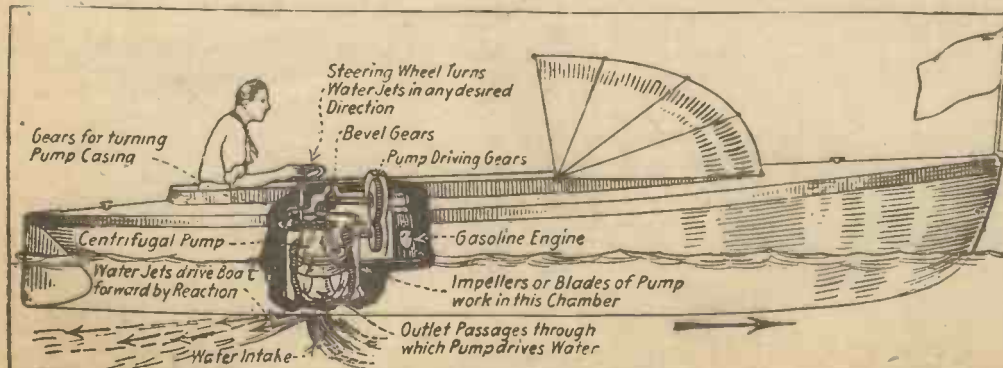

Details of the system.

MASTERS OF MECHANICS

No. 34. The Mechanical Marquis—The Curious Record of Edward Somerset, 2nd Marquis of Worcester, Britain's Earliest Steam-power Pioneer.



Raglan Castle, Monmouthshire, as it stands at the present day. In this now celebrated ruin, the first useful steam engine was born.

IN the year 1663 there appeared in London one of the most extraordinary books which have ever been published.

It bore the fantastic title of: "A Century of the Names and Scantlings of Such Inventions as at present I can call to mind to have tried and perfected, which (my former Notes being lost) I have at the instance of a powerful Friend, endeavoured now in the year 1655, to set these down in such a way as may sufficiently instruct me to put any of them into Practice," and it had for its author an English nobleman, Edward Somerset, Marquis of Worcester, who, for political and military offences against the then all-conquering power of Cromwell and his Roundheads, had languished six long years in the Tower of London.

A strange and, in some respects, an unexplicable personage was this 2nd Marquis of Worcester who fitted romantically and often tragically through certain pages of English history. A curious and a remarkable individual he was, also, from the point of view of scientific history for, although there have not been wanting writers who have attempted to belittle his significance in the world's record of invention, it was he who gave to mankind, if not its first working steam engine in the present-day acceptance of the term, at least its first application of steam power.

The Marquis of Worcester's "Century of Inventions," when read nowadays, appears as little more than an almost hopeless jumble of bits and pieces of curious mechanical ideas all loosely strung together in haphazard fashion and written, for the most part, in an obscure and exaggerated fashion. Yet, perhaps, upon the publication of this book the history of steam power has, to some extent, turned, for in the volume we have an account of what has come to be recognised as the very first commercial application of the power of steam which, so far as we know, was ever made.

Gifted With Mechanical Faculty

Apart from this, however, the "Century of Inventions," despite its somewhat imaginative language, shows its author to have been a man gifted with the mechanical faculty to a very high degree. The volume, in a word, comprises brief descriptions of a hundred curious "inventions" which its author claimed to have made.

How many of these were actually the products of his own brain and how many of them were procured from other sources we shall, of course, never know. Nevertheless, to the historian of invention, the "Century of Inventions" is a rare and a highly interesting work, since, among other matters, it gives accounts of devices and inventions such as the making of machines for dredging harbours, the construction of a self-winding watch, the making of a gun which will fire six shots in a minute (here we have an anticipation of the machine gun), an apparatus for lighting a candle at any pre-determined moment, a calculating machine, a portable ladder which will fit in the pocket and yet, when extended, will reach to a great height, an explosive projectile to sink a ship (again a curious anticipation of the modern torpedo), a flying machine, methods of secret writing, a boat to work against wind and tide and many other devices.

Water-Commanded Engine

Most important of all, however, among the collection of interesting entries in the Marquis of Worcester's "Century of Inventions" is the one which concludes the volume and which the Marquis himself, in his enthusiasm, describes as the "most stupendous work in the whole world," it being a notice of a machine intended to be used for raising water by the power of steam, a device which, on other occasions, its inventor proudly called his "Water-

Commanding Engine."

Before, however, proceeding further with this achievement of the Marquis's life, we must, in order to gain a perspective view of his adventurous career, take up his story at an earlier date.

Edward Somerset was born at Raglan, near Monmouth, in or about the year 1601, the exact date being unknown. He was the son of Henry Somerset, fifth Earl and subsequently first Marquis of Worcester. During his father's lifetime he was by courtesy known as Lord Herbert and afterwards as the Earl of Glamorgan, a title which was conferred upon him in 1645 by Charles I for political services. Upon the death of his father in the following year, he succeeded to the family title and became the 2nd Marquis of Worcester.

The education of Edward Somerset, the future "Mechanical Marquis," was, in part, received abroad. It is to his frequent visits to France that some writers have endeavoured to ascribe his interest in mechanical devices and, in particular, his first conception of his "water-commanding" engine. In regard to the

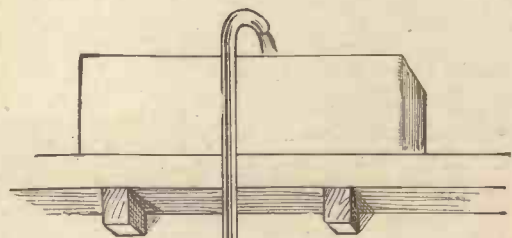

The Marquis of Worcester's first steam engine.

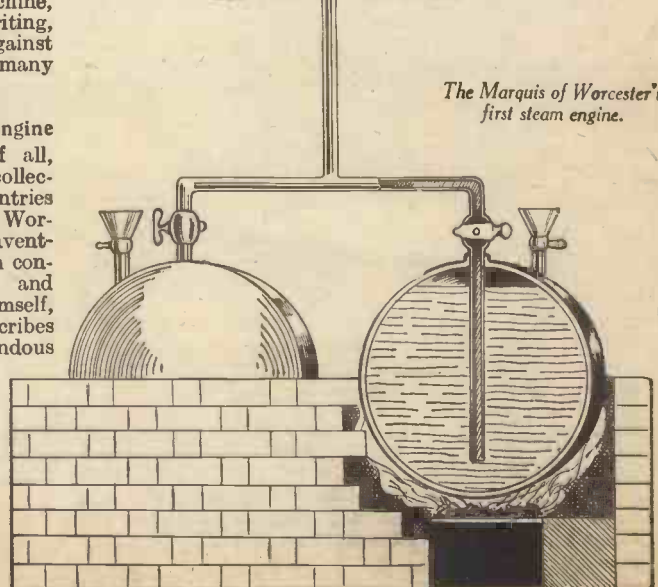

latter invention, Somerset is supposed to have visited one Solomon de Caus who had been imprisoned in France for political offences. De Caus had previously hit upon a method of raising water by means of steam power but he seems never to have put his method into actual practice. There are, however, far-fetched accounts of the young Somerset meeting de Caus and of the latter's imparting certain "secret knowledge" to him. Such narratives, however, cannot be related here and, indeed, they are unworthy of inclusion in our brief story, for they are obviously untrue.

Somerset's Laboratory

In 1628, Edward Somerset, now styled Lord Herbert, married and took up his residence at Raglan Castle, Monmouthshire. Being naturally of a studious disposition, he seems to have fitted up a sort of combined laboratory and workshop for himself in the castle and to have engaged enthusiastically in the search for perpetual motion. The ingenuity of the future Marquis is shown in one of his designs for a perpetual motion machine which consisted of a wheel some 14 feet in diameter and having forty spokes. This was caused to rotate by means of hinged weights attached to the rim of the wheel, the weights on the descending side of the wheel hanging a foot farther from the wheel's centre than those on the ascending side. In this manner, the mechanical Marquis considered that he could make his wheel rotate for an indefinite period, since he imagined that the outwards-dropping weights would represent an excess of energy which would be sufficient to keep the wheel working.

The perpetual motion wheel was actually constructed and demonstrated before the King (Charles I) and his court. The Marquis, however, in his account of the demonstration, is careful to omit a description of the actual result of the trial!

In order to assist him in his constructional labours, Edward Somerset, now Lord Henry and future Marquis of Worcester, imported in the country a clever foreign mechanic, one Caspar Kaltoff. Kaltoff remained in his service almost to the end and there is little reason to doubt that he was responsible for most of the actual constructional work which the Marquis put forward.

"Water Works"

One of the most notable devices brought out by the future Marquis at this time was his "water works" at Raglan Castle, a hydraulically powered system of raising weights and opening doors by means of the flow of water from a central cistern mounted on the summit of the castle tower. It is most probable, also, that during the seven years which the future Marquis spent at Raglan with these mechanical occupations, he hit upon the fact that the force of steam is sufficient to raise water to any height.

His wife dying in 1635, Somerset removed to London, and there gave the demonstration to the King of his perpetual motion wheel previously mentioned. He set up another workshop in the Tower of London and engaged in mechanical occupations of one description or another for a further four years.

After the elapse of this time, he re-married and again went to reside at Raglan Castle. The Civil War in England between the forces of the Crown and those of the Cromwellian faction broke out soon after this time, and Lord Herbert, Edward Somerset, and his family ranged themselves on the side of the King. Somerset himself was appointed "General of South Wales"

and saw much military service in that region.

Raglan Castle was heavily garrisoned. Nevertheless, it had to submit to the forces of Cromwell. The castle was partly destroyed, the laboratory, workshops and mechanical appliances completely destroyed and, in order to escape from the revolutionaries, Lord Herbert and his family had to take refuge in France, in which country he lived in poverty and exile for five or six years.

Returning to England in 1655, he was detected, arrested and conveyed to the Tower, in which grim fortress he spent the following half dozen years in confinement and in writing accounts of his various mechanical devices which he subsequently embodied in his now famous "Century of Inventions."

Training School for Mechanics

The Marquis's imprisonment in the Tower, however, cannot have been a very rigorous one, for after a couple of years, he was released for a period on bail and at this juncture we find him occupying his time in purchasing a site at Vauxhall, on the south side of the Thames, for the erection of his "water-commanding" engine and, also, for the establishment thereon of an "operatory for engineers and artists (*artizans*) to make public works in," or,

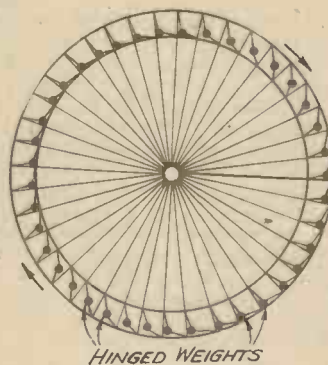

The Marquis of Worcester's perpetual motion wheel.

in other words, a training school for mechanics—the first of its kind in the country.

The Restoration of Charles II brought liberty to the Marquis of Worcester. He made haste to recover as much as possible of his estate which had been forfeited in the Civil War and in the year 1661, we find him patenting four of his inventions, to wit, a boat to sail against wind and tide, an "engine" to give security to a coach, improvements in guns and a self-winding watch. What devices these inventions embodied we do not know, nor indeed, have we any means of ascertaining. All we know is that patents were actually granted for them.

The Parliament of 1662-3 passed a special Act granting to the Marquis of Worcester the patent rights of the "water-commanding" engine which he had erected and successfully worked at Vauxhall, near London. This device is an important one in the history of engineering, for it represents the very first commercial application of steam power which we know of.

A Steam Engine

Of the actual details of the Marquis of Worcester's engine we have very little

knowledge. All we know for certain is that it consisted of a system of boilers in which steam was raised, the steam pressure being then utilised to force the remainder of the water in the boilers up a vertical pipe. The boilers were connected by branch pipes to the one vertical pipe, each boiler being provided with its own filling orifice and delivery tube fitted with a suitable stop-cock. While one boiler was discharging its contents under steam pressure, the others were heating up and while they were discharging their water, the first boiler was being refilled with cold water. Thus a sort of continuous flow of hot water along a vertical pipe to an elevated tank could be obtained by this crude device.

The Marquis of Worcester's "water-commanding" engine, crude in principle though it was, undoubtedly paved the way for the steam pump which Thomas Savery, a Devonshire miner, invented in 1698 and, almost contemporaneously, the elementary piston-containing engine of Denis Papin.

But crudely successful though the Marquis of Worcester's first steam engine may have been, he obtained little, if anything, from it. The newly formed Royal Society looked askance at it and its secretary, Robert Hooke, even ridiculed the idea. To the Court of Charles II, the Marquis of Worcester was merely an eccentric individual whose "machines for raising water by the strength of one man only, within a minute of time, to a height of forty feet through a pipe eight inches in diameter" were as useless and as visionary as his many other curious devices and projections.

Consequently, the "water-commanding" engine, after a brief triumph, was dismantled and its parts dispersed. The Marquis of Worcester returned for a time to his Raglan estate, finding that no man would believe in his favourite invention.

Looked Upon as a Crank

But what little was left of his former property proved of small use to the Marquis. He once more removed to London and spent the few years of life which were left to him in petitioning the Court for recognition of and recompense for his work, both engineering and military. Charles II, however, had little time to devote to an individual whom he now regarded as a wild, impracticable inventor of useless devices and so the Marquis's petitions came to nought.

Disappointed, embarrassed financially, broken-down in health and weary of his adventurous and speculative existence, the Marquis fell into a state of decline from which he never recovered. He died on 3rd April, 1667, was conveyed to the parish church at Raglan for burial and was then promptly forgotten by all.

It is only within the last century or so that the historic importance of the engineering work of the Marquis of Worcester has been realised. At first, it seemed as if nothing would ever be known of his career. Gradually, however, his life history and the record of his curious inventive career were re-discovered. All traces, however, of any actual steam engine or other mechanical devices made by the Marquis had, by this time, completely disappeared.

Yet in his famous book, the "Century of Inventions," the Marquis announced his intention of having a model of his "water-commanding" engine buried with him. In consequence of this statement, a most careful search was made of the Marquis's tomb some years ago. No such model was found among the crumbling remnants in the vault. Such a model, if it ever existed, must have been destroyed centuries ago.

IF YOU DESIRE SUCCESS CONSULT THE I C S

Many men who are thinking about their future feel that they *lack* something, *need* something—something vital to their progress.

That something is TRAINING.

Experience teaches the cold truth that *it is only trained men who step up to responsible and well-paid positions.* That is so to-day and will be so to-morrow.

Come what may, *the good jobs go to those who are big enough to fill them,* and the size of a man is determined in large measure by his training and his ability to apply that training.

The man who, considering to-morrow in the light of to-day, desires a training has a wide choice of schools—good, bad, and indifferent. It is of EXTREME IMPORTANCE to him that he should select a good one. Our advice is

“Investigate before you invest.” That will lead you, in all probability, to the I.C.S., whose first services are advisory and free.

The International Correspondence Schools made tuition by post the great educational power it has become and have provided training for more people than any other similar institution in existence. No other correspondence school has such world-wide fame or has won such outstanding success. None can give such effective training in a wide variety of subjects and for a great many Examinations.

I.C.S. Service is based on expert knowledge and nearly half a century of experience. It consists of SOUND, PRACTICAL, AND COMPREHENSIVE INSTRUCTION WHICH EQUIPS THE STUDENT TO MOVE FORWARD IN HIS CHOSEN CAREER.

If you want the BEST training, we can give it you, on terms that you will find advantageous. It will be to your interest to know in detail exactly how we can help you—how easily, conveniently, and surely.

WRITE TO US TO-DAY

Tell us your particular problem or the branch of business you wish to master. Or use the Coupon below. By return of post we will send you full information and a special booklet.

COUPON FOR FREE BOOKLET

INTERNATIONAL CORRESPONDENCE SCHOOLS, LTD.; (Dept.95), International Buildings, Kingsway, London, W.C.2

Please send me your booklet containing full particulars of the Course of Correspondence Training before which I have marked X. I assume no obligation.

- | | | | |
|---|---|--|--|
| <input type="checkbox"/> Accountancy
<input type="checkbox"/> Advertising
<input type="checkbox"/> Aeronautical Engineering
<input type="checkbox"/> Air Conditioning
<input type="checkbox"/> Architecture
<input type="checkbox"/> Boiler Engineering
<input type="checkbox"/> Book-keeping
<input type="checkbox"/> Building
<input type="checkbox"/> Chemical Engineering
<input type="checkbox"/> Civil Engineering | <input type="checkbox"/> Diesel Engineering
<input type="checkbox"/> Draughtsmanship
<input type="checkbox"/> Electrical Engineering
<input type="checkbox"/> Engineering Shop Practice
<input type="checkbox"/> Fire Engineering
<input type="checkbox"/> Garage Management
<input type="checkbox"/> Gas-Power Engineering
<input type="checkbox"/> Heating and Ventilation
<input type="checkbox"/> Hydro-Electric
<input type="checkbox"/> Journalism | <input type="checkbox"/> Marine Engineering
<input type="checkbox"/> Mechanical Drawing
<input type="checkbox"/> Mechanical Engineering
<input type="checkbox"/> Mining Engineering
<input type="checkbox"/> Motor Engineering
<input type="checkbox"/> Pattern-making
<input type="checkbox"/> Plumbing
<input type="checkbox"/> Radio Equipment and Servicing
<input type="checkbox"/> Salesmanship
<input type="checkbox"/> Sanitary Engineering | <input type="checkbox"/> Scientific Management
<input type="checkbox"/> Short-Story Writing
<input type="checkbox"/> Steam Engineering
<input type="checkbox"/> Surveying
<input type="checkbox"/> Telephone and Telegraph Eng.
<input type="checkbox"/> Textiles
<input type="checkbox"/> Welding, Gas and Electric
<input type="checkbox"/> Wireless Engineering
<input type="checkbox"/> Woodworking
<input type="checkbox"/> Works Management |
|---|---|--|--|

EXAMINATIONS

Technical Institutions and Civil Service (G.P.O.). State which

NOTE.—If your subject is not on the above list, write it here.....

NAME..... AGE.....

ADDRESS.....

MAN-MADE JEWELS



A glass model of the Austrian Yellow Diamond.



A glass model of the Nassac Diamond.

The Principles and Problems of Artificial Gem-stone Production

for much of the brilliancy and "life" of a jewel is caused by its light refracting power, which cannot be imitated by any type of glass.

Artificial gems, however, which are produced by scientific processes and which approximate very closely in composition to the natural gem stone, possess an identical light-refracting or light-bending power to that of the natural stone and, therefore, they cannot be distinguished from the latter in this respect. Indeed, in some instances, the points of distinction between a natural and a high-grade synthetic jewel are very fine and are chiefly concerned with the



A natural crystal. Here, in perfect form, is seen a crystal of garnet embedded in its surrounding rock. A stone of this size would be impossible to produce.

fluorescence of the natural stone under ultra-violet light and, also, the fact that natural stones generally possess very slight flaws which are observable under a microscope, whilst the synthetic variety of stone is usually homogeneous throughout.

Composition of the Stones

In composition, gem stones are mostly made up of common materials containing traces of metallic impurities to which their characteristic colours are due. The basic



A section of a pearl, photographed under a microscope. Note its laminated structure.

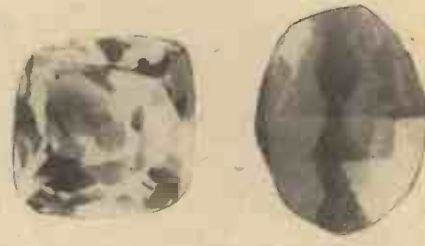

Further glass models of (left) the Ribb or Regent diamond and (right) the Koh-i-noor diamond, the largest diamond in the British Crown jewels.

ingredients of the gems have been fused under pressure in the earth's crust and have crystallised slowly to transparent or semi-transparent masses possessing crystalline structures.

The principle of the thing is, in reality, very simple and can be imitated, in some measure, by any interested individual.

Make a miniature loop on the end of a piece of wire (preferably a platinum wire) and take up in it a crystal or two of ordinary borax. Heat the borax gently in a non-luminous flame. It will melt and fuse into a semi-transparent bead.

Here we have an imitation of a gem stone "matrix," the colourless fused material out of which the stone originated. Now dip this borax "bead" into any chemical solution containing a metal and heat it again, allowing it afterwards to cool once more. This time, the fused glassy mass of borax will no longer be colourless. It will have acquired a definite and sometimes a very pronounced colour, the nature of which will depend upon the chemical solution used. For instance, copper solutions will impart a blue or green colour to the borax bead, Chromium compounds will colour the bead green, iron compounds will turn it yellow, nickel compounds reddish-brown and so on.

Coloured Jewels

It is from this simple experiment that we discover the secret of the colouring of jewels, which is due entirely to the diffusion of traces of metallic impurities through the body of the jewel. Thus, for instance, the brilliant green colour of the emerald is due to traces of chromium existing within it, whilst, for instance, the peculiar and striking purple of the well-known amethyst is caused by the existence of minute traces of manganese in the gem stone.

By fusing up in an electric furnace and under carefully controlled conditions the basic ingredients forming the composition of the jewel which it is wished to make together with the necessary proportion of metallic impurity and by allowing the fused mass to cool down so that it crystallises very slowly, it is possible to manufacture synthetic jewels of fairly high grade. Many jewels for use in watches and other similar mechanisms are made in this manner and even larger stones for use as display or ornamental jewels have been prepared successfully in this way.

If, for instance, aluminium oxide—a constituent of a large number of jewels—is heated in an electric furnace with barium fluoride and a trace of potassium bichromate is added to the mass a product will be obtained which, on slow crystallisation, will give rise to rubies of fair size. Un-

THROUGHOUT the ages gem stones have always been sought after, not only as articles of much beauty but, also, in view of their natural scarcity, as commodities of great value.

Jewels, up to the present time, have always represented a condensed form of wealth and, owing to the very durable nature of most gems, this form of wealth-storage has always been looked upon as one which is incapable of undergoing much depreciation.

But in modern times, jewels have acquired a strictly utilitarian value in addition to the above-mentioned attributes. The diamond, for instance, in some of its less perfect forms, is an absolutely indispensable tool of modern industry, for, being the hardest substance known, it is much employed for the tipping of high-speed rock drills, in addition to very many other applications which are made of it in industry generally. Rubies and similar jewels are used in all high-class watch movements and other delicate mechanisms and there is little doubt that if these high-grade gems and stones were available at reasonable rates in greater numbers, many more applications would be made of them.

The problem of making artificial jewels does not seem to have captured the mind of mankind to the same extent as did the artificial making of gold. Indeed, it is only within comparatively recent times that serious attempts have been made to produce gem stones artificially and, for the most part, the problem has been attacked scientifically with very interesting and positive results.

Expensive To Make

It is, at the present day, possible to make artificially almost any form of gem stone and to turn out an article which will deceive all but the practised expert. But fortunately for the economic state of the jewellery trade, the cost of making such artificial gems in many instances far exceeds that of the natural stones, whilst the uncertainty of the processes of synthetic gem production is very great. Hence, there is little doubt that until some really cheap, certain and effective method of synthesising gems can be evolved and, also, of producing jewels which are indistinguishable from the natural ones the jewellery industry of the present day has very little cause for alarm.

It is obvious, of course, that the cheapest grades of jewellery which are sold in all our modern towns comprise nothing more or less than special types of coloured glass, suitably cut and polished. A glass "gem," however, can never compete with a real jewel, no matter how brilliant its colouring may be,

fortunately, this method is too uncertain and costly for practical application.

Synthetic Sapphires

Many attempts have been made to produce synthetic sapphires. The natural sapphire, "the jewel next to the diamond" consists merely of aluminium oxide or alumina coloured by a trace of chromium and/or cobalt. Fairly successful results with the artificial production of these splendid gems have been obtained by fusing up in an electric furnace various proportions of aluminium oxide, red lead, potassium bichromate and cobalt oxide, whilst rubies, which are not dissimilar in basic composition to sapphires, have been successfully imitated by fusing somewhat similar mixtures.

It must not be imagined that this fusion process is an easy one. Usually, the gem stone ingredients are maintained molten at a high temperature for at least seven days, after which they are cooled down during a period of weeks. After all this trouble has been encountered, it is usual only to find two or three utilisable gem stones in each batch of materials.

There are, of course, some jewels which cannot possibly be imitated. The opal is one of these, for its resplendent colours which, of old, have been compared to a "rainbow on a midnight sky," are caused

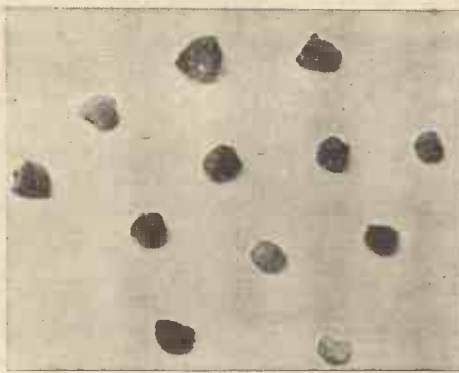

Rough diamonds of poor colour which are employed for drill-tipping and other uses. If such stones could be produced artificially at low cost industry would be greatly benefited.

produced. Indeed pearls produced in this manner are identical with those produced "naturally," for in the latter instance, the irritant or "nucleus" around which the pearl forms obtains access to the oyster accidentally, whereas in the "artificial" pearl-production method, the "nucleus" is inserted purposely into the oyster.

Finally, in our survey of the possibilities of synthetic jewel production, we come to the King of gem stones and, indeed, one of Nature's most perfect materials—the diamond. The diamond, more than any other jewel, has a direct utility owing to its

than pure carbon. Soot, graphite and diamond are all forms of the one element, carbon, the only difference between them lying in the internal arrangement of their atoms. Diamonds have been produced in the earth's crust at remote ages past by the fusion of carbon under great pressure and by its slow crystallisation afterwards.

Now, under ordinary conditions on the earth's surface, it is impossible to fuse carbon, for this element, at normal pressures, vapourises before it melts. In other words, carbon is remarkable as being a material which boils before it melts!

Towards the end of the last century however, Moissan, a French experimental chemist, hit upon a way of getting over this difficulty and of crystallising carbon under pressure. In this way, he succeeded in actually making diamonds and to this day, his process, with certain modifications, is the one which has been used whenever synthetic diamond production has been carried out.

Molten iron has the property of dissolving carbon. Taking advantage of this fact, Moissan heated up iron in a high-temperature electric furnace to about 4,000°C, a truly enormous temperature. Before this temperature had been reached, a certain amount of carbon had been dissolved in the molten metal until the latter became carbon-saturated.

Then, after a temperature of approximately 4,000°C had been attained, the whole of the crucible was automatically dropped into a vessel of cold water.

Expensive Apparatus

As can be imagined, a violent reaction took place. The water immediately boiled and for some minutes the iron remained white hot below the water surface. A crust of solid iron at once formed on the outside of the molten mass, but within the mass the iron still remained liquid.

Now when molten iron solidifies, it expands and thus when the internal core of molten iron solidified against the already solid outer crust an enormous condition of pressure was set up within the mass of metal. Owing to this reaction, the dissolved carbon was thrown out of solution in the iron and subjected to pressure-crystallising influences. As a result, the majority of it was transformed into graphite, but a residue of the original carbon became converted into small diamonds, which remained after the mass of iron had been dissolved away by acids.

In the above manner, real diamonds, of fairly good colour, can be made.

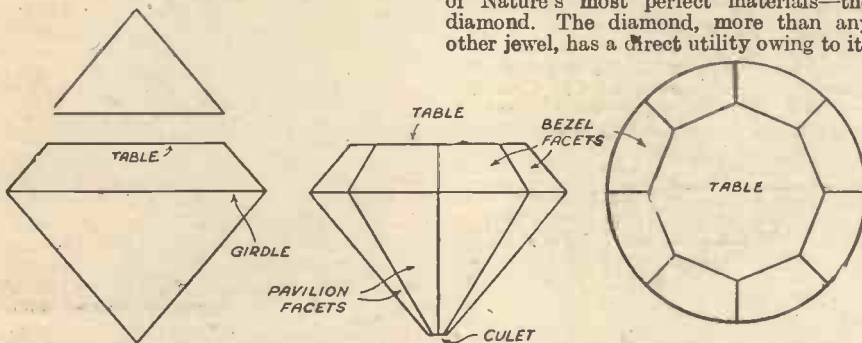

Illustrating various stages in the preparation of the finished gem. (Left to right) Showing how the top of the stone is sawn off to form the table. A side view showing the arrangement of the Bezel and Pavilion facets. A plan view after the Bezels have been cut.

by the refraction of light at different depths of the stone, the latter having a laminated structure which cannot be produced synthetically.

Pearls

Artificial pearls, it is well known, can now be produced and, for the most part, they are entirely indistinguishable from the natural varieties, since, to all intents and purposes, they are natural pearls which have been produced, not by accident in the interior of an oyster, as in the past, but as a result of the deliberate control and manipulation of that creature.

The production of artificial pearls is mainly due to the work of a Japanese, one Kokichi Mikimoto. Mikimoto takes a certain variety of oyster and, under strictly antiseptic conditions, submits it to an exceedingly delicate surgical operation whereby he drills through its shell, opens up a portion of its substance and inserts therein a tiny fragment of fresh-water mussel enclosed in a fleshy membrane taken from another oyster.

The oyster so treated is then returned to its cage which is lowered into the sea.

In the course of time—three or four years—the oyster deposit lime in layers around the pearl "nucleus" which has been introduced into it and, as a result, a pearl, more or less perfect in form, is

exceeding hardness. If diamonds could be manufactured artificially at cheap rates, they would be as much in use as carborundum is at the present time.

The Diamond

The diamond, the reader will probably be aware, consists of nothing more nor less

An Easy-Reference Table of Gem Stones, showing their basic Composition, together with their colour-producing ingredients.			
Gem.	Main Colour.	Basic Composition.	Colour-producing Ingredient.
Amethyst ..	Purple or blue-violet	Silica. (Silicon dioxide) ..	Manganese.
Aquamarine ..	Greenish-blue	Aluminium, silicon and beryllium oxides	Iron
Beryl ..	Bluish ..	Aluminium, silicon and beryllium	Iron.
Carbuncle ..	—See Garnet.	—	—
Carnelian ..	Red ..	Silica ..	Iron
Diamond ..	Colourless ..	Carbon ..	—
Emerald ..	Green ..	Aluminium and beryllium oxides ..	Chromium
Garnet ..	Red ..	Calcium, magnesium and aluminium silicates	Iron, manganese
Hyacinth ..	Red-brown	Zirconium and silicon oxides	Iron
Jacinth ..	—See Hyacinth.	—	—
Jade ..	Green ..	Aluminium and silicon oxide ..	Iron, manganese
Jasper ..	Red-brown ..	Silica ..	Iron, manganese
Lapis Lazuli ..	Blue ..	Aluminium and silicon oxides ..	Sodium, Sulphur
Onyx ..	Brown ..	Silica ..	Iron, Manganese
Opal ..	Milky ..	Silica ..	Iron, magnesium, potash, lime
Pearl ..	Milky ..	Calcium carbonate ..	—
Ruby ..	Red ..	Aluminium and magnesium oxides ..	Iron, manganese, calcium, zinc
Sapphire ..	Blue ..	Aluminium oxide ..	Iron, cobalt
Topaz ..	Blue, green, pink, yellow	Fluoro-silicate of aluminium ..	Iron, cobalt, vanadium
Turquoise ..	Greenish-blue	Aluminium phosphate ..	Copper
Zircon ..	Brown ..	Zirconium and silicon oxides ..	Iron

PROGRESS

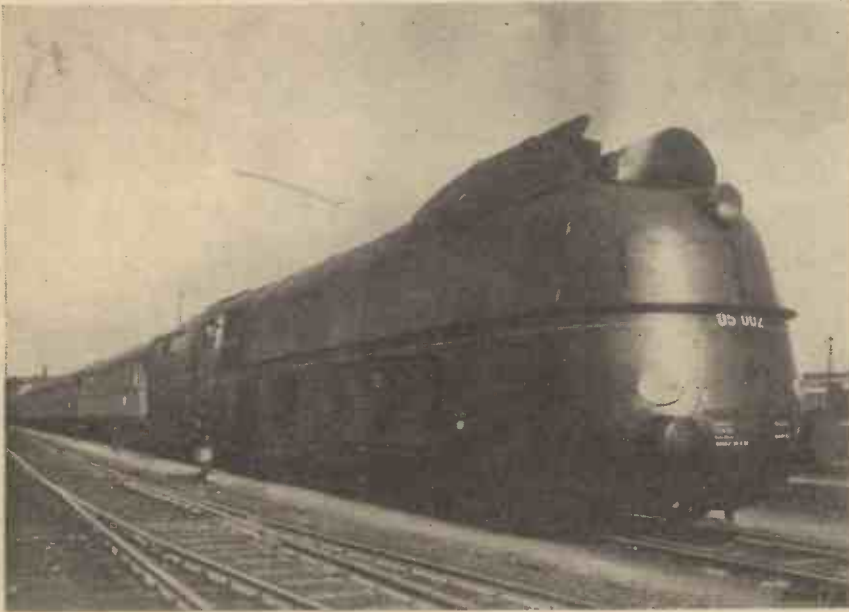

The German streamlined 4-6-4 that attained a maximum speed of 125 m.p.h., the fastest speed on record for steam.

Stanier's "Coronation" 4-6-2, L.M.S.R., 1937
(continued)

The striking white lines on her blue engine and train mark her out from all other British trains. "Coronation" and her sisters turn the scale at 108 tons apiece without tender, and are the heaviest "Pacific" locomotives in the country. On a test run she touched the peak speed of

25 years has held a leading place in the world of railways. But all previous work has been eclipsed by the work of M. Chapelon of the Paris-Orleans-Midi railway, who has devoted most of his time during recent years to research. Chapelon does not streamline locomotive exteriors, but studies and improves the streamlining of

figures in the shade. For heavy gradients in Central France he transformed another earlier "Pacific" into the 4-8-0 as illustrated. This revolutionary machine and its fellows have reached horse-powers up to 4,000—amazing for an engine which weighs, without its tender, only 104 tons.

Borsig 4-6-4 Streamlined Locomotive, German State Railway, 1936

External streamlining is a speed asset, as many countries are realising. The German locomotive illustrated is responsible for hauling the fastest steam train in the world, from Berlin to Hamburg, 178 miles, in 144 minutes, at an average of 74½ miles an hour. Under test it reached 125 m.p.h.—the highest on record for steam. A remarkable feature of the engine is the large diameter of its six-coupled wheels—7 ft. 6 in.—and the 4-6-4 wheel arrangement is also of interest. As you will see, the streamlining is carried by skirting right down

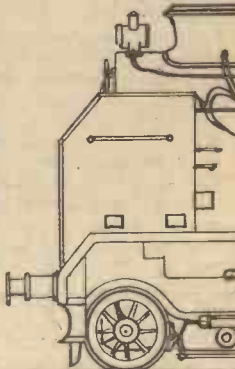

Chapelon's 4-8-0

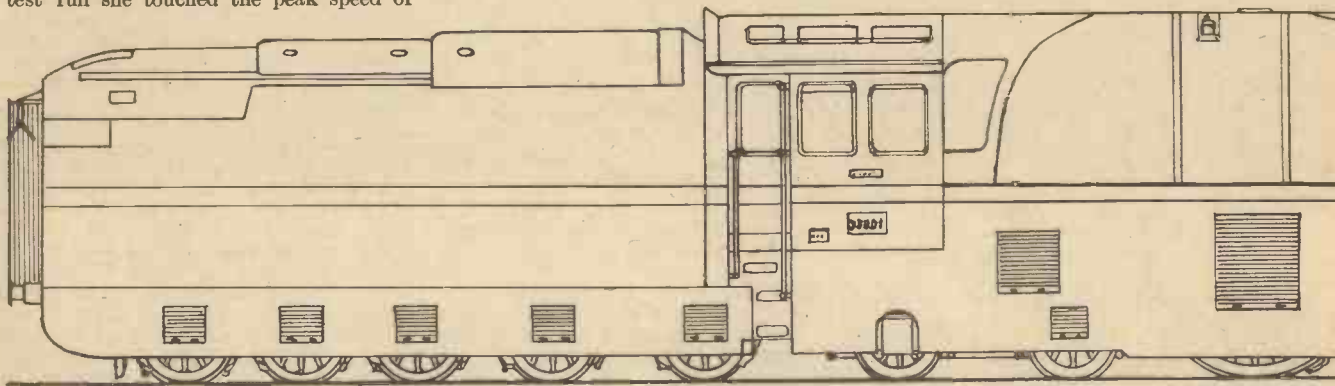

114 miles an hour and covered the 158 miles between Crewe and Euston at nearly 80 miles an hour average.

Chapelon's Rebuilt 4-8-0, Paris-Orleans Railway, France

French locomotive design for the past

The American 4-8-4 locomotive, No. 4410. Built by the Luna Locomotive

Works for the Southern Pacific Railway of America. One of the largest locomotives in the world and hauls the "Daylight," considered the most beautiful train in the world.

their interior economy. He started in 1931 with an old "Pacific," fitting it with larger steam pipes, piston valves, double exhaust pipe and chimney and other gadgets, aiming to improve the "flow" of the steam. The result put all previous locomotive efficiency

almost to rail level; the louvre shutters also allow air to get to the motion while the engine is running and keep it from overheating.

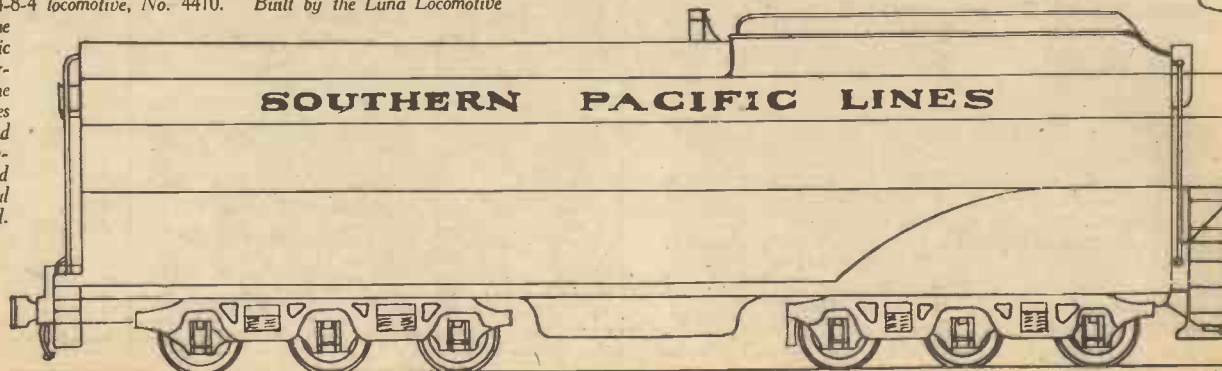

OF THE BRITISH STEAM LOCOMOTIVE—PART VI

The elevations which illustrate this article are all to the same scale, 3 mm. to the foot and are suitable for 16-mm. gauge railways. Detailed drawings are available for those readers interested.

The Sixth And Concluding Instalment Of This Series Covers The Period From 1927-1937

By
W. J. Bassett-Lowke, M.I.Loco.E.

Streamlined 4-8-4 Express Locomotive, Southern Pacific Railroad
America is a country of big things, and its railroads are no exception. This country uses enormously heavy all-steel rolling stock,

train load of 500 tons. To cope with these loads, American designers have produced increasingly large locomotives, till we come to the modern 4-8-4 as this streamlined example from the Southern Pacific railroad.

effort of 62,200 lb., and when "booster," or small auxiliary two-cylinder engine for driving a pair of wheels under the cab, is cut in, the effort is increased to 74,710 pounds or 33 tons. Four axles coupled are necessary

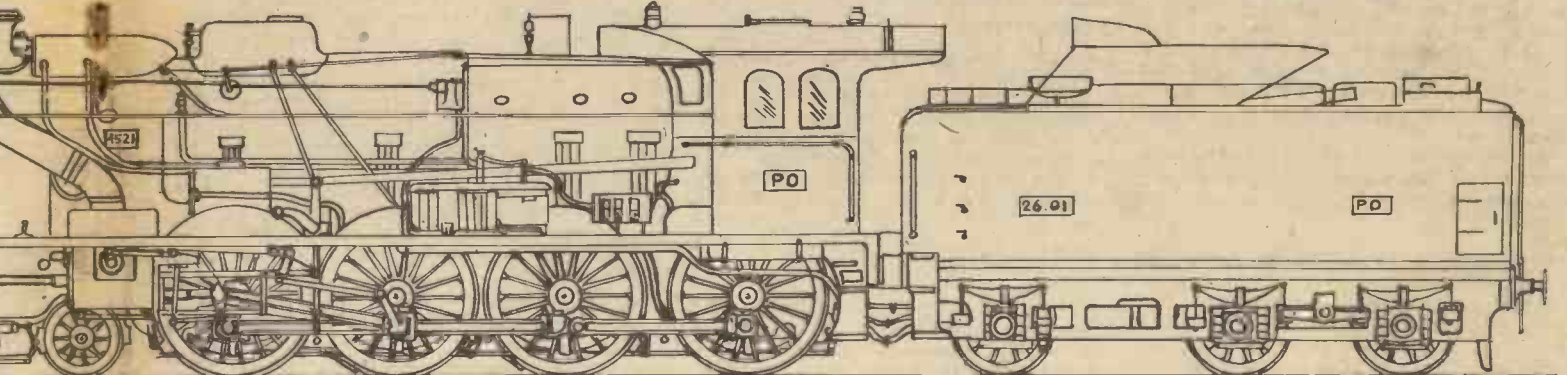

Locomotive of the Paris-Orleans Railway. It is a peculiar looking machine but is one of the most remarkable locomotives in Europe, developing an enormous horse-power for its weight.

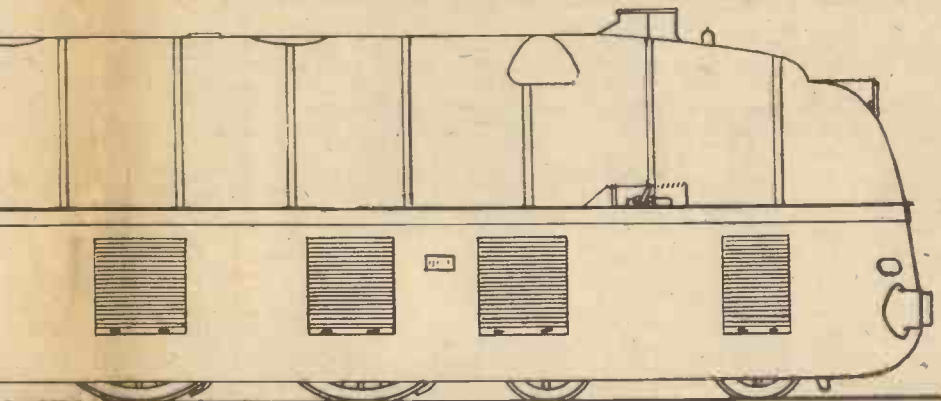

The German State Railways' 4-6-4 streamlined locomotive. It was built in 1936 by Borsig of Hennigsdorf, (near Berlin), and is the fastest steam locomotive in the world.

so that high-speed American expresses often weigh well over 1,000 tons behind the engine tender, compared with the heavy English

With 6 ft. 1½ in. driving wheels, cylinders 27 in. by 30 in. stroke, and a boiler pressure of 250 lb., these engines develop a tractive

force for proper adhesion with this huge power. The machine itself weighs 200 tons, and to it is attached a 12-wheeled tender with 22,000 gallon water capacity, and 6,300 gallon oil capacity. Overall, the engine measures 109 ft. in length. So the biggest American locomotives are more than twice the weight, size and power of ours in Great Britain.

So I conclude my summary of steam locomotive development since its inception 135 years ago. The public demands speed and still more speed, and the Press in its cry for novelty has long condemned steam to the scrap heap. But steam refuses to die, and as these models show, locomotive designers have been stirred to show us the still great possibilities of steam. Despite the advent of electricity, all the longest daily non-stop runs are being made by steam locomotives; and the maximum speed on rails—125 miles an hour—registered by steam beats anything yet achieved by diesel power. Also steam locomotives use our native coal instead of imported oil as their fuel, and you can be sure that steam will outlive us all on earth to-day!

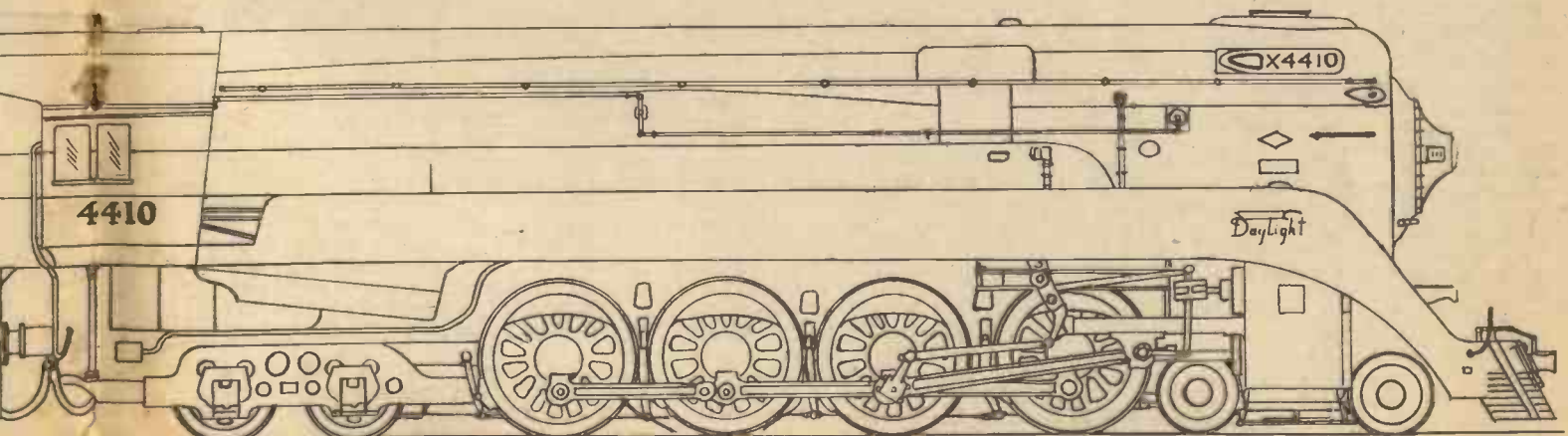

NEW INVENTIONS

"Mike" for Mask

IN fighting aircraft intended to fly at great heights, it is customary to furnish the aviator with an oxygen mask. When the aeroplane is fitted with radio telephone apparatus the microphone is generally mounted in the nose-cap of the mask. Now, although to some extent, the mask excludes from the microphone extraneous sounds such as those caused by the engine and the propeller, there is still picked up an undesirable amount of noise.

To obviate this inconvenience, there has been produced a microphone for an oxygen mask provided with a tubular mouthpiece extending from the microphone into the mask to a point close to the mouth of the wearer. This acts as a voice pipe and materially prevents sounds other than the accents of the airman from reaching the microphone.

It will, therefore, be possible to transmit messages without an unrehearsed obbligato of discordant noises.

A Good Look-out

IN these notes I have already commented upon the hideous design of the gas mask. Since writing that criticism, I observe that there has appeared in the United States a less inelegant mask. This is equipped with expansive lenses which provide the wearer with a wide field of vision. It is claimed for these lenses that they enable one to read, work, walk and make observations in safety. The lenses are made of shatter-proof, laminated and polished plate-glass and it is stated that they afford 90 degrees vertical and 170 degrees lateral vision. The mask is not heavy and the rubber facepiece is moulded to fit the countenance. The head harness prevents pressure on the forehead and when the hat or helmet is worn no discomfort is experienced.

Of course, a wider outlook may increase the liability to fracture of the glass. But, if this mask is effectively gas-proof, aesthetically it is a distinct advance upon the repulsive design hitherto manufactured.

Piano Not His Only Forte

MR. JOSEF HOFMANN, once an infant prodigy and still a virtuoso, is not content with striking brilliant arpeggios on the piano. He is an inventor and has, I understand, devised an hydraulic absorber for cars, a pneumatic system of car-springing, and several other appliances. This eminent musician is at present working upon an invention for increasing the volume of sound in the piano.

The cynic may snarl that the desideratum is some contrivance to reduce the resonance of the instrument—a kind of mute such as is placed in its bell to muffle the tone of the cornet. But Mr. Hofmann has not in view a flat piano, but rather a piano for the non-sound-proof flat. His object is to devise a piano whose volume will be commensurate with the huge modern orchestra with its trombones and other powerful instruments. With this purpose he is perfecting a means of electrical amplification inside the piano.

Mr. Hofmann remarks that, during the last 40 years, there has been little development in the mechanism of the piano. He thinks that an acceleration of action is possible. It is certainly a fact that the organ with its pneumatic and electrical apparatus has outstripped the evolution of its small sister.

However, while the interior of the piano

The following information is specially supplied to "Practical Mechanics," by Messrs. Hughes & Young (Est. 1829), Patent Agents, of 9 Warwick Court, High Holborn, London, W.C.1, who will be pleased to send readers, mentioning this paper, free of charge, a copy of their handbook, "How to Patent an Invention."

has remained undeveloped, the case has received some attention. For example, there has of late been patented a piano whose keyboard cover forms a writing desk.

From such an accommodating instrument it is indeed possible to produce more than one kind of note.

Temporary Cable

IN time of war, as well as on peaceful occasions, electric cables are sometimes temporarily laid. Like a lengthy but attenuated boa-constrictor, the cable undulates over the country, ascending walls and fences in its sinuous course.

It has been the practice hitherto to pay out the cable down to the ground from a drum mounted on a vehicle, the drum and the feed-rolls being driven by chain-drive from the road wheels of the vehicle.

There has just been patented an invention by means of which the cable can be paid out or reeled in without being twisted and without its constitution being undermined by excessive stretching.

The new feature of the apparatus in question consists in the fact that the feed-rolls and cable-drum are mounted on the carrying vehicle by means of a turntable device. This enables the appliance to operate in any direction. And a locking arrangement fixes the turntable in the desired position.

Equipped with this serpentine tentacle, headquarters can, with increased facility, keep in touch with the outposts of the field of battle.

Anti-Kick Apparatus

AN improved restraining device for animals has been accepted by the United States Patent Office. The ancient method of controlling animals consists of the ordinary harness, but the means of discipline has sometimes to be intensified. For various purposes, such as milking turbulent cows and goats, the giving of medicine and the performance of operations, mechanical restraint is imperative.

The new device includes a cradle, a pair of clamps for the head of the animal at one end of the cradle, and foot-operated means for moving one of the clamps.

A significant characteristic of the invention is the fact that there is a restraining device for the hind quarters of the animal. Obviously, anti-kick apparatus is a special feature. By the way, it is not common knowledge that a cow can kick sideways.

Automatic Measure

IN America the word "pants" relates to a garment different from that which it concerns in this country. So, when I learn that the United States Patent Office has accepted an invention entitled, "Pants Measuring Device", I realise that it implies apparatus for ascertaining the dimensions of trousers.

Up to the moment of writing, the practice has been for the tailor to pass a tape down and round the nether garments of the customer and to enter the particulars in his order book. I gather that the revised system involves the use of a flexible measure which is retracted by a spring, and a scale recording the measurements.

Robbed on an Island

A CORRESPONDENT, the victim of a pickpocket who stole his wallet from an inside breast pocket, has written to a London paper asking the best method of guarding money and valuables when carried.

I can sympathize with the writer of this letter as I have recently suffered a similar deprivation. I was robbed on an island, but it was not one of those coral islands on which Long John Silver hunted for treasure. It was in High Holborn, London, on a mid-street halting place where pedestrians take refuge. While waiting to cross the second half of the road, I was accosted by two men who inquired the way to some unknown street. As my mind was occupied in endeavouring to assist them, a third man, like one in a great hurry to cross the street, pushed by me and his two confederates and, as I discovered a few moments afterwards, relieved me of my wallet. And this, not in the still of the night, but in broad daylight—in fact, on a Friday afternoon. The incident illustrates the method of the modern highwayman. He has a knowledge of psychology—I almost wrote Bill—Sikology. He distracts the attention of his victim and avails himself of the psychological moment to lift some of the portable property of the unsuspecting wayfarer.

Mind Your Pockets

HERE is my opportunity to recommend the installation of a thief-proof pocket. First let me remark the futility of the ordinary method employed to safeguard a wad of notes, if one happens to be a Croesus. The hip-pocket is not immune. I know of the case of an embryonic bank manager, the whole of whose month's salary was cut out of his hip-pocket while he bent over the last seat at a variety show. And I know of an instance in which a football fan, after a match, had £3 abstracted from his trousers pocket while engaged in a scrimmage, as he struggled to enter a bus. Some security is afforded by what I will style the profound pocket. That is a pocket deeper than the average pocket. In the tiny abyss of this receptacle, the wallet is unseen. It is the heedless wallet that looks over the edge of the shallow pocket which tempts the light fingers of the street bandit.

But I believe I have discovered a more excellent way in the shape of a thief-proof pocket which has very recently been accepted by the British Patent Office.

Thief-proof Pocket

THE portable safe which I am about to describe is a pocket of the type in which there is a sliding clasp fastener. The chief object of the inventor has been to improve upon this kind of pocket by providing fastening means ordinarily invisible. And he has further arranged that the opening and closing of the pocket may be effected at some distance from the pocket. One feature of the invention is that by a simple action the mouth of the pocket is sealed for its whole length. And the sliding fastening cannot be pulled open without the knowledge of the actual construction of a particular pocket. The operating means is skilfully hidden and is not in a position accessible to a pickpocket. Externally this patent pocket has quite a normal appearance. And, if lined with a fine steel mesh, it will effectively resist cutting, even by a sharp knife.

Like Archimedes, one is moved to cry "Eureka!" as a pickpocket-proof receptacle appears to have been found at last. It should surely be most useful to bank messengers, vehicle conductors and others who carry large amounts of money. DYNAMO.

MODEL AERO TOPICS



Our Model Hawker Hurricane, free blue print for which was given with our May issue.

The Hawker Hurricane Contest

EVERY intending competitor in the Hawker Hurricane Model Aircraft Contest for our £20 prize, as announced in the May and June issues (free blue print with the May issue), has by now received a copy of the rules and notification of the date, time and venue of the contest. A large entry has been received, and it is therefore most important that competitors should be at the judges' post at the appointed minute. Failure to do so may entail disqualification. Competitors will be allowed three flights if time permits. There is still time to build the model.

Competition Results

The following is the result of the Model Engineer's Cup Contest No. 1—

Gliding		Aver. Plugge of 3. Cup secs. pts.	
Name of Entrant			
1. E. Chasteneuf (Blackheath M.F.C.)	...	495.883	27
2. R. F. L. Gosling (Bradford M.A.C.)	...	121.00	26
3. H. J. Penny (Bristol and West)	...	92.16	25
4. A. Lees (Lancs. M.A.S.)	...	80.5	24
5. G. R. Cook (Blackheath M.F.C.)	...	79.25	23
6. B. Withers (Midland M.A.C.)	...	75.9	22
7. V. Pugh (Midland M.A.C.)	...	60.56	21
8. R. Brown (Blackheath M.F.C.)	...	53.53	20
9. R. Copland (Northern Heights)	...	49.55	19
10. V. Meir (Midland M.A.C.)	...	47.73	18

CURRENT NEWS FROM THE WORLD OF MODEL AVIATION

BY F. J. C.

11. T. Wickens (North Kent)...	41.33	17
12. H. E. Taylor (Bradford M.A.C.)	41.16	16
13. J. G. Bolton (T.M.A.C.)	40.73	15
14. C. S. Rushbrooke (Lancs. M.A.S.)	40.00	14
15. B. A. Smith (Woodford M.A.C.)	37.46	13
16. N. Lees (Halifax)	36.36	12
17. A. Tindal (Lancs. M.A.S.)	36.33	11
18. H. Jones (Dartford M.A.C.)	36.00	10
19. R. W. N. Mackenzie (Blackheath M.F.C.)	29.483	9
20. A. H. Lee (Bristol and West)	29.00	8
21. A. H. Jacobs (Woodford M.A.C.)	28.3	7
22. C. W. Needham (Bristol and West)	15.8	6
23. A. Brosham (Bradford M.A.C.)	14.83	5
24. A. W. Crips (Bradford M.A.C.)	12.83	4
25. H. Preston (Bristol and West)	7.43	3
26. N. Harris (Bristol and West)	4.06	2
27. H. Gilbert (Lancs. M.A.S.)	4.00	1

Plugge Cup Points

Blackheath M.F.C.	...	70
Midland M.A.C.	...	61
Lancs. M.A.S.	...	49
Bradford M.A.C.	...	47
Bristol and West	...	39
Woodford M.A.C.	...	20

Northern Heights	...	19
North Kent	...	17
T.M.A.C.	...	15
Halifax	...	12
Dartford M.A.C.	...	10

Petrol Model Insurance

At a recent Council meeting of the S.M.A.E. a request from an insurance company was read. This stated that their policies would have a greater cover if paragraph one of the rules governing power-driven models was altered. The rule now reads:—"No power-driven model to be flown over public open spaces..." It was suggested that this rule should read:—"No power-driven models to be flown from public open spaces..." This suggestion was agreed to.

Glider Record

The S.M.A.E. have approved an application for a record of three minutes, 22.3 seconds for a fuselage glider catapult launch made by H. J. Penny of the Bristol Club. An application from E. Chasteneuf of Blackheath for a fuselage glider record of 22 min. 27 secs. was passed.

Amateurs and Professionals

In view of the excellent work the Council of the S.M.A.E. is doing, in organising and regularising model aircraft flying and the rules governing model aircraft contests, I have raised with them the question of amateurs and professionals. The S.M.A.E. has had a great amount of work to do, and I have no doubt that they had this point in view. Nevertheless I thought it opportune to draw their attention to it, and at a recent Council meeting they referred it to the annual general meeting. My feeling in the matter is that it is unfair to frame competition rules in such a manner that amateurs can compete on an equal footing

with professionals, a condition which does not obtain in most other sports. The professional has the advantage of a workshop, trade backing, unlimited supply of material, plenty of time, plus the experience gained whilst he is earning his living. An amateur, on the other hand, often cannot afford to purchase materials which might give him the advantage in a competition. A crash may put him out of it, whereas the professional arrives on the competition ground loaded up with spares which the amateur cannot afford. I therefore suggest, and my criticism is intended to be friendly, that next year all professionals are banned from model aircraft contests, or alternatively that special contests be arranged for them.

Another disadvantage of permitting professionals to enter model aircraft contests is that amateurs are discouraged from entering, believing that they stand no chance against the professionals.

Another point which I should like to stress is the growing habit of competitors flying models in contests although they have not built the model. In order to avoid any suspicion that a professional has put

This is so in some contests, but by no means in all.

The Women's Engineering Society

I am glad to see that the Women's Engineering Society are interested in model aircraft, for in their official journal the *Woman Engineer*, they have devoted three pages to a very interesting article on model aeroplanes. This takes the form of a report of a lecture by Mr. J. C. Smith, the Hon. Competition Secretary of the S.M.A.E., under the Chairmanship of Lt.-Col. J. C. Moore-Brabazon, M.C., M.P.

A Reader's Model

Mr. D. H. Middleton, of 69 Ardington Road, Northampton, has sent me the photograph reproduced herewith of his latest streamline duration machine which recently won the Northampton Model Engineer Cup for workmanship and design. The contest attracted six models, all but one being designed by the individual who designed Mr. Middleton's model, and who is the proprietor of a model aircraft business. This seems to indicate that my apprehension that professionals keep out the amateurs is not without foundation.

Mr. Middleton tells me that the model shown on its first flight climbed to 50 feet, and did some spectacular stunting. He says that the model has the unpleasant habit of finding thermals and making cross country flights. In good weather she puts up regular times of 2½ minutes.

Bournemouth Model Aircraft Society

The Bournemouth Model Aircraft Society held a most successful gala day on June the 5th, when a great deal of excellent and varied model flying took place in the various contests.

Such galas, combining as they do the

social side with the pastime, should do a great deal to enhance club membership.

Bond's O'Euston Road

I recently spent an interesting couple of hours in that well-known centre for model makers and model engineers—Bond's O'Euston Road. Mr. Phillips guided me round the well-stocked shelves and the nicely equipped workshop. This firm has a most complete stock of materials for model engineering and model making of all types as well as completed locomotives, compressed air engines, etc. They have a full stock of model aircraft material, and Mr. Phillips tells me that his old-established business is busier than ever. It was a hive of activity during my visit, and I was impressed as well as amazed at the thoroughness with which they investigate each customer's order in order to ensure that the customer's wishes are met. Goods are most promptly dispatched.

The 1 c.c. Engine

I am at work on the design of a model to suit the 1 c.c. engine, but I should like to have suggestions from my readers as to the type of model in which they are most interested—high wing or low wing; monoplane or biplane; tractor or pusher; and so on. Readers should remember that the engine is capable of flying a model weighing up to 20 ozs. I know that a large number of these engines are being built, but if readers would be interested in the design of a model to suit them they should write to me now. A postcard will do. This 1 c.c. engine, it will be remembered, is the first to be described in any journal, and blue prints are available for 5s. a set, from the Publisher, Geo. Newnes, Ltd., Tower House, Southampton Street, Strand, London, W.C.2

"The Practical Mechanics Handbook"

There is still time for readers to reserve a copy of "The Practical Mechanics Handbook," at Presentation terms—2s. and two coupons cut from consecutive issues. By acting now you will save yourself three shillings, for when the Presentation Edition is exhausted, this book will take its place in our list of books at 5s.

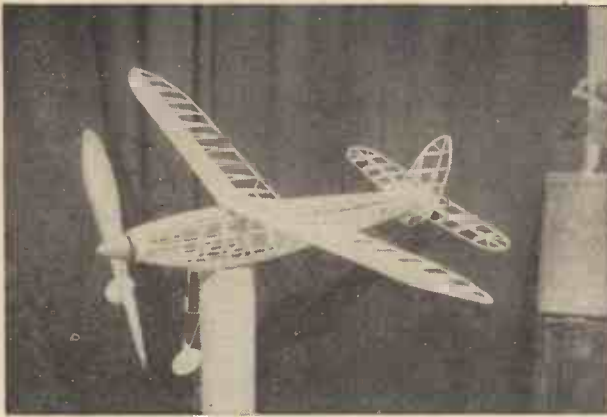

Mr. D. H. Middleton's Streamline Model referred to on this page.

up a nominee who can rightly claim to be an amateur, a rule should be framed that every competitor must have built the model himself.

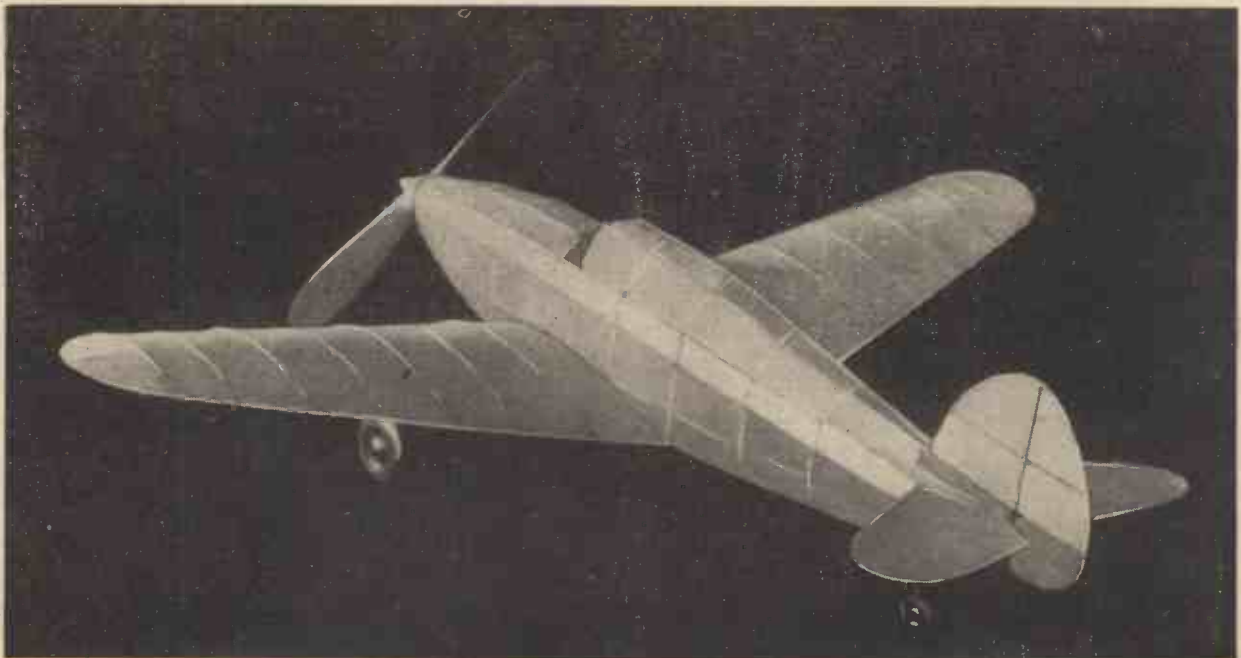

Three-quarter rear view of our Model Hawker Hurricane.

STARGAZING FOR AMATEURS

A NEW SERIES

By N. de Nully

A GUIDE FOR JULY

"CLOSED" nights will commence once more in these latitudes on the 21st, when the Sun will again dip 18 degrees below the northern horizon at midnight (G.M.T.). The Earth has been gradually receding from the Sun during the past six months at the rate of 17,000 miles a day. On the 3rd it will reach its greatest distance—94,455,000 miles—when it is said to be at aphelion. This will be nearly 2,000 miles less than last year but, as usual, more than 3,000,000 farther away than in January. The varying distance is due to the Earth occupying one of the foci of its slightly elliptical orbit, instead of being situated more approximately in the centre. Since nearly all our companion worlds are "out of the picture" just now, let us briefly consider the Earth in the light of a planet. We are really most fortunately

enabling them to pierce the veils that seemingly hide the sky from their view. In shape the Earth somewhat resembles an orange, being slightly flattened at the top and bottom and bulging out a little at the "waist", but it is virtually a sphere, for the difference between the polar axis (7,900 miles) and equatorial diameter (7,926 miles) is comparatively trifling. The average terrestrial density is 5.5 times that of water, against 3.5 for Mercury and 5.25 for Venus; and the times of revolution of each round the Sun are 365, 88 and 225 days respectively. It is the similarity in size, density and the length of its year—and also possibly of its day—that have caused Venus to be romantically termed our "sister planet".

As most people know, the axial rotation of the Earth is accomplished in 23 hours, 56 minutes and 4.09 seconds; and its seasons are due to the tilt of its axis to the extent of 23½ degrees relative to the level of its track in space. As a consequence of this beneficial inclination each pole is alternately presented to the Sun at certain times of the year, when it becomes summer in that hemisphere, and winter in the opposite one. The resultant seasonal gradations are most pronounced in the arctic and temperate zones, there being little difference along the tropical belt. The average speed of the Earth in its orbit is 18½ miles a second, but as it is situated in one of the foci of its slightly oval path, one loop of the latter is rather longer than the other; and it so

happens that the rate of travel is quicker in January than in July. It is in the former month, too, that (fortunately for us in northern latitudes) the Earth makes its nearest approach to the Sun. This moderates the rigours of our winters, while the increased separation in July diminishes the heat of our summers. A compensating mitigation is also provided in the southern hemisphere by the vast expanses of water covering those regions and acting as temperature stabilisers. Taking everything into consideration we must congratulate ourselves that we are evidently living on the most highly favoured of all the eight major planets in the solar system. Placed in closer proximity to the Sun, we should be everlastingly scorched; removed farther away, we should be almost perpetually frozen. Though we should in either case be the inevitable products of our environments, it is possible that our amazing mental and physical faculties might not be so highly developed as they are.

The Moon

The Moon will be at its farthest from us during 1938 at 10 o'clock on the evening of the 11th. Its distance will then have widened to 252,480 miles, or 30,000 miles more than when at its closest a fortnight ago. The strong twilight prevailing will not only be of little detriment to lunar exploration, but a positive advantage in reducing excessive glare. During the first couple of nights of this month the young Moon will offer attractive views of that beautiful rock-girt "sea" the Mare Crisium; and also the magnificent chain of immense detached walled-plains designated Langrenus, Vendelinus, Petavius and Fernelius which extend southwards along the same meridian. Owing to their tilted positions



Sunrise on the great lunar walled plains Ptolemaeus, Alphonsus and Arzachel reading upwards from the bottom. Note Albategnius to the left of the first two.

placed in the scheme of things, being at the very comfortable average distance of 92,900,000 miles from the fierce celestial furnace that abundantly supplies the solar system with light and heat. The interior planets Mercury and Venus are so much nearer to the Sun that they must be subjected to a continuous baking, notwithstanding their dense protective atmospheres. On the other hand, we enjoy a moderate genial warmth, just sufficient to make sentient life both possible and agreeable.

The Earth as a Planet

Third in order outwards from the Sun, the Earth appears to have inaugurated the satellite system with a single "moon", Luna, revolving round it in 27 days, 7 hours, 43 minutes. Neither Venus nor Mercury are similarly equipped; whereas all the exterior planets are even more liberally furnished. In diameter the Earth (nearly 8,000 miles) is larger than Mercury (3,000 miles) and Venus (7,600 miles); but, unlike those two cloud-wrapped globes, it possesses a transparent aerial envelope permitting not only the enjoyment of the health-giving potency of direct sunlight, but also a study of the marvellous universe around us. It also offers frequent clear displays of our variegated markings and polar ice caps to our planetary neighbours. With the exception of Mars, however, it is doubtful if the denizens of the other solar satellites are aware of any environment beyond a diffused twilight filtering through their translucent coverings. It is nevertheless possible that their inhabitants (if there are such) may be endowed with special kinds of vision

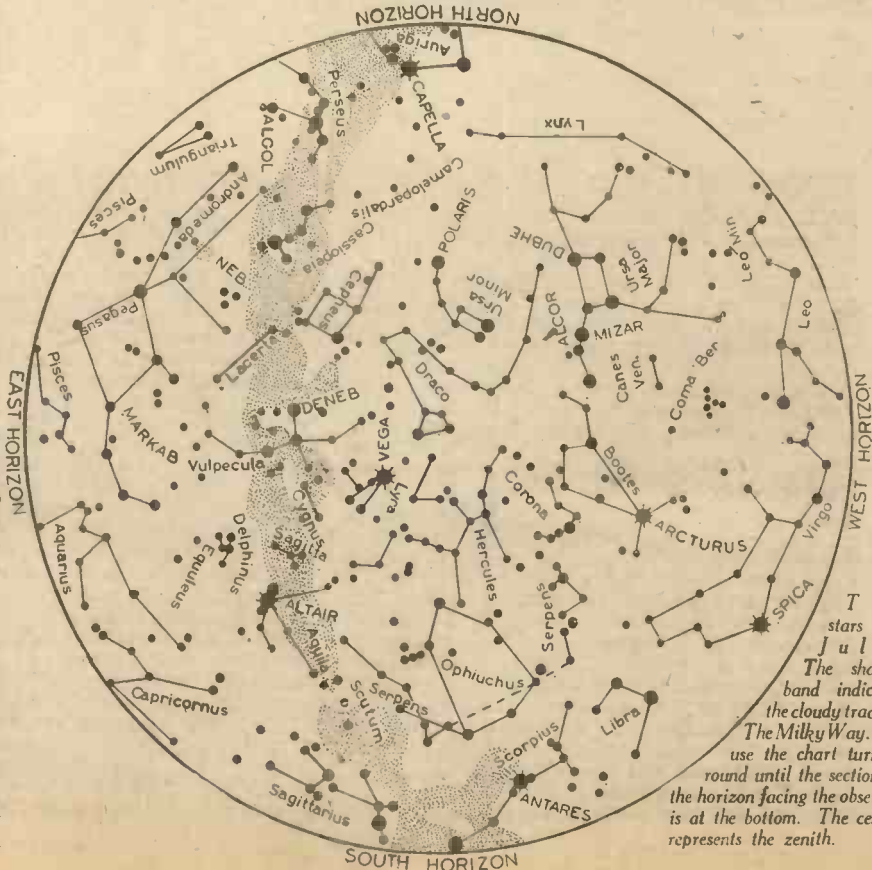

The stars in July. The shaded band indicates the cloudy track of the Milky Way. To use the chart turn it round until the section of the horizon facing the observer is at the bottom. The centre represents the zenith.

close to the curving edge of the disc, these formations appear quite oval, but they are really almost circular. When on the 4th the terminator reaches the phase styled "first quarter", a striking string of similarly gigantic, but contiguous, enclosures will be thrown into sharp relief as they struggle out of the blackness of retreating darkness. Since they lie on that part of the Moon's surface directly facing us, we look straight down into them, so to speak, and see them, as from an aeroplane, without any foreshortening or perspective effects. Among them is Ptolemaeus, the most perfect example of the type. Its area is equal to that of the counties of York, Lancaster and Westmorland combined. Immediately

above Ptolemaeus and impinging on it, is Alphonsus, 83 miles in diameter, with a bright central peak. The smaller adjacent massively bordered compact ring Arzachel, has a complex rampart rising at one place to 13,000 feet above its depressed "floor". Southward of this rugged row (well depicted in the photograph reproduced) the district is much broken; while, to the east stretches the expanse of the Mare Nubium, the comparatively smooth surface of which, still steeped in shade, will be gradually disclosed as the terminator creeps forward towards "full". Abreast, as it were, of Ptolemaeus and Alphonsus, and already bathed in sunlight, is Albatagnius, with a large "crater" set just within its towering eastern

buttress. Quite a small astronomical telescope will show all these features.

The Other Planets

Mercury, though an "evening star", sets too soon after the Sun to be perceptible. Jupiter rises about 11.30 p.m. and Saturn an hour and a half later. Both may be observed in the small hours of the morning. Venus, the only planet conveniently observable at present, is increasing in brightness and, if the sky is clear in the west down to the horizon, our so-called sister world will be found shining conspicuously in that direction soon after sunset. At the beginning of July Venus disappears at about 11.15 p.m. and an hour earlier at the end of the month.



Plaster masks can be made to look remarkably lifelike.

ESTABLISHMENTS such as Madame Tussaud's no doubt have a staff of artists and advanced apparatus for the production of their incomparable work. It may be, however, that few people realise the ease and simplicity with which a plaster mould can be taken from a living face, and how extremely effective can be the resulting cast.

The photo reproduced on this page is a second attempt, and has proved very successful.

A Suitable Subject

The subject (or patient) should be chosen with the hair line back from the forehead so that a line from the top of the forehead to under the chin does not cut off part of the eye socket.

An annular of cardboard about 2 ins. wide is then cut to fit approximately over the face down to this line. A convenient position is then found for the patient to recline, so that when the cardboard is tested over the face it is horizontal. Two pieces of tube are now required for the nostrils. Rubber tube is quite satisfactory so long as the diameter is not large enough to

distort the shape of the nose. Drinking straws are more satisfactory if wrapped at the end with cotton wool to fit into the nose. The tubes should be about 2 ins. long.

The patient's face is then smeared with cold cream and the eyebrows, eyelashes and moustache, if any, treated liberally with vaseline. About $\frac{3}{4}$ pint cold water will be found to be sufficient when mixed with the plaster to cover the face at least $\frac{1}{4}$ in. thick.

White Plaster

The plaster should be of the best white surgical variety, which is obtainable at most chemists, and about 3 lbs. will be ample. The plaster is then mixed to the consistency of thick cream (about 1 lb. to $\frac{3}{4}$ pint water). It should be mixed quickly but thoroughly. The plaster is then laid evenly over the patient's face, with eyes closed of course, and the cardboard will hold it in position. The main features such as eyes and mouth and most of the nose are covered first. It is perhaps best to leave the nostrils free for as long as possible, i.e. as long as the plaster is quite soft. Then place the nostril tubes in position and cover the nose. Any plaster left over is used to strengthen the sides and any thin places, but if it is made too thick on the cheeks the extra weight will be found to distort the soft flesh. About $\frac{1}{2}$ in. thick in any place is quite sufficient.

Although the patient may think the time interminable, the plaster sets in two or three minutes, when by holding the mould and bringing the patient's head forward and down, the mould can be gently removed and left for $\frac{1}{2}$ hour to set hard.

The Mould

The mould is then well lathered inside with a shaving brush and soap and water, and rather more plaster than before mixed

and poured into the mould. Whilst the plaster is still soft, two bolts or a hook can be set in for final fixing. When the plaster is hard the mould is carefully broken away and a mask of astounding detail results.

A little modelling may then have to be done around the nostrils where the tubes were, but this operation is quite simple with the aid of a pocket knife.

The mask, however, having the eyes closed bears a most disconcerting resemblance to a death mask, and as such is rather gruesome.

The next operation is therefore to open the eyes. When the eye is closed the eyeball turns upwards, and the protuberance of the anterior chamber causes a bump on the top eyelid, similarly when the eye is open the anterior chamber is in front.

The Eyeballs

When modelling, the eyeball is obtained from the thickness of the eyelid. When carefully modelled the mask is then ready for painting and a box of student's water colours will be found most suitable. To produce a prepossessing mask it will be found best to scrape away most of the facial details, such as forehead lines, crow's feet, etc., as these collect the colour and are accentuated.

The surface when scraped smooth will be found to take the colour very well, whilst the back of the mask can be used to test the colours. Having used water colours the surface is left with a realistic matt appearance. The whole mask is then coated with clear varnish which sinks into the plaster and preserves the matt finish, and at the same time fixes the colour. One or two coats of varnish on the eyeballs and lips will make them glisten.

A final touch of realism can be obtained by the addition of eyelashes. Artificial eyelashes can be obtained but horsehair is equally effective when attached with glue, and afterwards trimmed.

With the screws or hook set in the cast, the mask can then be mounted to a board enamelled a suitable colour, either in contrast or to match the colouring of the face.

MAKING LIFE-LIKE MASKS

How to make a Plaster Mould from a Living Face

CONJURING with FLOWERS



Fig. 1.—A bouquet of feather flowers which can be compressed into a few inches of space.

NATURAL flowers are rarely used for conjuring purposes. They are usually too fragile and there is the problem of keeping them fresh. The artificial blooms most frequently employed in magical experiments are of two kinds, feather flowers and spring flowers.

Feather flowers can best be described by saying that they are like feather dusters shaped to imitate flowers. Fig. 1 shows a bouquet of such flowers. Each bloom is several inches across but, owing to its construction and the nature of the feathers, it can be compressed into very small space. In the bouquet illustrated I have crushed up three of the flowers in my hand. The entire bouquet when compressed can be packed into a tube not much more than an inch in diameter, yet when allowed to expand it measures about eighteen inches across.

I do not recommend the amateur conjurer to attempt to make his own feather flowers. It is a job for a skilled worker and the professionally made flowers, although rather costly, last almost indefinitely with reasonable care. In case any readers like to try their hand at feather floriculture, however, here is the general principle of construction.

Dyed Feathers

The feathers are first dyed with aniline dyes various brilliant colours and cut to shape, the tips of the feathers being reserved for making the blooms while complete feathers of varying lengths and thickness are used for leaves. Each flower is made on a foundation of wire. Half hard brass wire is the best as it has a fair amount of flexibility. If a bouquet is being made one wire is cut for each flower and the wires are soldered at one end to form a stem, the opposite ends being curved outwards. When drawn through the hand the framework should spring out to its original shape as it is released.

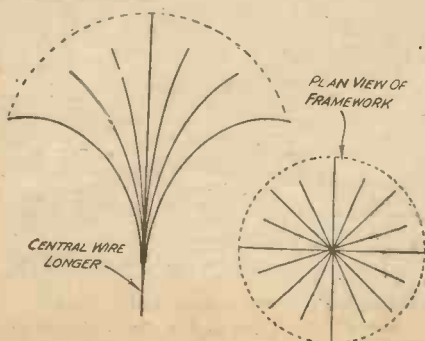

The flowers are now built up on the wires, commencing with the blossoms and passing down the stem with the leaves, each piece of feather being securely stuck to the wire. The bouquet is finished by binding the stem with tape and twisting one wire, which has been left longer than

By Norman Hunter
(The Well-known Conjurer of "Maskelyne's Mysteries")

Further Articles on the Secrets of Conjuring will appear Regularly and Exclusively in this Journal

the others for the purpose, into a ring for convenience in holding the bouquet. (See Figs. 2 and 3.)

Methods of Production

There are various ways of producing a feather bouquet. One method, which I adopt myself is as follows. The bouquet is pushed stem first down inside the collar of the coat, drawn down until the stem can



Fig. 4.—A conjurer's flower pot. The pot is of cloth on a spring foundation, the plant is of feathers and folds down with the pot.

be tucked through the strap of the waistcoat and then adjusted so that it can be easily reached by the right hand. Approach the audience with a large silk handkerchief in your hand. Say that you want someone to examine the handkerchief to make certain there is nothing concealed in it. Go to a spectator sitting in the front row at your extreme right. While he is looking at the handkerchief secure the ring of the bouquet in your right hand and turn with your left side to the audience. Ask the spectator to hold up the handkerchief by two corners. Then remarking that he didn't notice these in the hem, or something similar, draw the top edge of the handkerchief towards you with your left hand, at



Fig. 2.—(Extreme left) The framework for a feather bouquet. Fig. 3.—(Left) Stem of bouquet bound with tape and central wire formed into a loop. Fig. 5.—(Right) Details of the spring flower pot.

the same time whisking the bouquet from under your coat, up under the handkerchief. The flowers appear so suddenly right under his nose that he has had no chance to see where they came from and from the position in which you stand nobody else can see anything but the sudden appearance of the bouquet.

Fig. 4 illustrates another use for feather flowers. This, in its normal state, is an imitation pot of flowers. The flowers are of feathers and the stem is spring hinged to the top of the pot so that the blossoms can be compressed and laid flat on top of the pot. The top of the pot is a disc of metal surrounded by a shallow rim. The bottom of the pot is a smaller disc. Top and bottom are connected by a slightly tapering tube of reddish cloth which covers a coiled spring. The two ends of the spring are soldered to the top and bottom of the fake pot. It will now be clear that the pot and flowers can be pressed flat, but will resume their normal shape immediately on being released.

Keeping the Flowers Compressed

To keep the pot compressed a key slot is cut in the bottom of the pot and a metal stud is soldered to the underside of the top of the pot. When the pot is compressed the stud engages in the slot and holds all secure. Pressing the stud to one side releases the spring. (See Fig. 5) The stem of the flowers is held down by passing it under a small wire arm soldered to the rim of the pot. In its closed condition the pot can be packed with other articles for production from a trick box such as the drawer box described in a previous article of this series.

Another showy flower production consists of a shallow bowl or a tray apparently filled with flowers that seem to be actually growing in it. This piece of apparatus presents no difficulty in making once you have the flowers. A dozen or more according to the size of the tray are required.

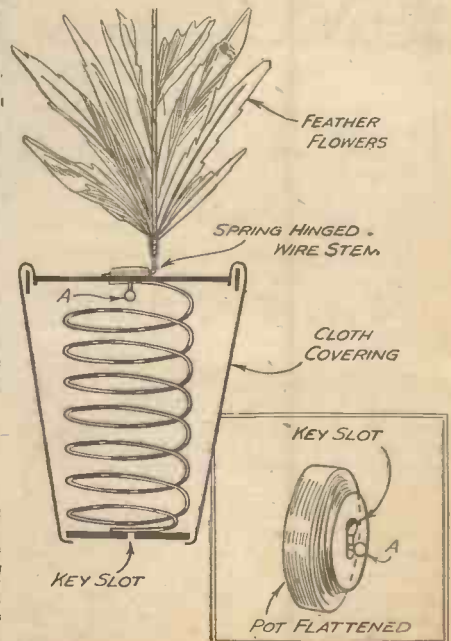



Fig. 6.—Details of the flowers and tray.

Each is a single bloom on a single wire stem with a certain amount of foliage, all made of feathers as already described. Soldered to the stem is a small hinge. The flowers are fastened all round the edge of the tray or bowl so that they can be folded down inwards or raised to stand vertically on the tray's edge. In the latter position they represent very faithfully the effect of a bowl full of growing flowers. See Fig. 6. Figs. 7 and 8 show the details of fixing the hinged stems on to a bowl or tray.

Small springs are now fastened against hinges so that the tendency is for the hinges to remain open, keeping the flowers upright. In each case the edge of the bowl or tray acts as a stop to prevent the hinges opening too far. The flowers should be of varying heights and arranged alternatively short and long all round the bowl. One flower is rather taller than the rest and its wire stem is continued beyond the blossom. In folding the flowers down begin with the one next to the tallest and fold them down in turn all round the bowl. The tallest flower is folded down last and keeps the others in place. A small slit is made in the edge of the tray or bowl as shown in Fig. 8 and a catch attached.

the shape of a petal with a cardboard template and cutting out the lot at once. This procedure is repeated with each petal and the petals are then assembled as shown in Fig. 11. Two of each petal are required for a flower, also two rather larger petals of green paper, rather stronger paper being used for these. Finally the springs are attached by pasting strips of green paper over them, on to the outer leaves.

As many as a hundred such flowers when folded and held in a clip occupy a space only an inch or so in thickness but when released they make a huge pile. To make a bunch of spring flowers it is necessary to attach strings to the blossoms. This is simply done by punching a hole in the stem near the spring and tying a length of green embroidery silk through the hole.

A Bouquet

Fig. 12 shows a simple method of holding

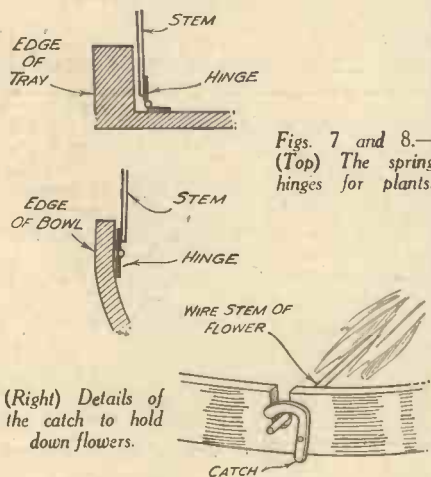

Figs. 7 and 8.—(Top) The spring hinges for plants.

(Right) Details of the catch to hold down flowers.

twenty or thirty spring flowers in bouquet form. The flowers having been fitted with springs are placed in a clip made from a strip of fairly flexible metal bent to the shape illustrated in Fig. 12 (A). The part marked X is slipped under the opposite end of the clip and holds the bunch secure. To

By the use of three large spring flowers, each of a different hue, an effective colour changing flower can be made.

Take a white flower minus its spring and stick a red one also minus spring on one side and a blue one, minus spring to the other side as shown in Fig. 13. A tiny flat weight such as a dress weight must be glued between the flowers at the tip, in the places marked X in Fig. 13. The green outer leaves of all the flowers should be considerably larger than the coloured petals in order to give adequate masking.

Changing Colour

To show the trick, have the flower in a small vase with the white one visible. The weights will close the red and blue ones down on either side. Pick up the flower and holding it by its stem pass the other hand over the bloom. In doing this it is an easy matter to tip the flower sideways so that the red flower opens and the white one closes. See Fig. 13 (A). To change the flower to blue tip it the other way and the weights will drop over, hiding the white and red blossoms and revealing the blue one.

Fig. 14 shows a mechanical tray made for producing four bunches of spring flowers. As will be seen from the photograph the tray has four compartments built into its thickness. Each compartment is closed by a triangular flap of metal hinged to the outer edge with a spring hinge so that the tendency is for the flaps to remain open. When fully open the flaps fit snugly into

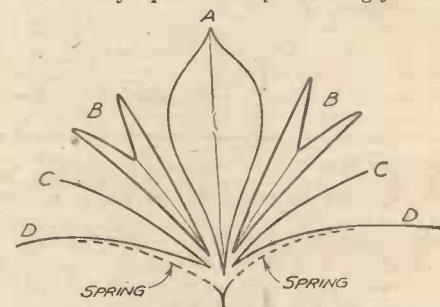
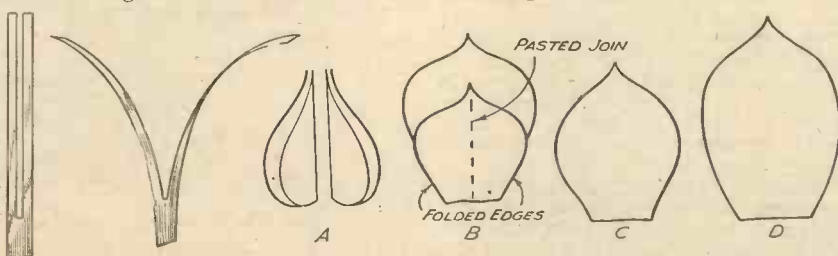

Fig. 11.—Construction of a spring flower.

the corners of the tray. The entire tray and both sides of the flap are painted dead black and the edge of the tray as well as the edges of the compartments and flaps are outlined in vivid yellow. Each compartment is just large enough to take a bunch of twenty-five spring flowers on strings, prepared with cork grips as already described.

Reference to Fig. 15 will show the method of releasing the flaps. There are four feet on the under side of the tray. A stiff wire runs from each foot and is bent up through the centre of the tray into a tiny bolt which



Figs. 9 and 10.—(Left) Spring foundation for flowers. (Right) Method of making spring flowers.

Just before the bowl is produced the catch is snicked aside with one finger and all the flowers spring upright.

"Spring" Flowers

These are sold by conjuring shops in various sizes, ranging from tiny blooms about an inch long to giant flowers as big as a good-sized rhododendron. The principle of construction is explained in Figs. 9 and 10. A strip of thin, hard brass is cut down the centre and the two portions bent apart as shown. These form a simple kind of spring. If the two splayed out ends are brought together they will spring apart again when released. On this spring foundation a paper flower is built up. The various petals are shown in Fig. 10. The flowers are made several at a time by taking a packet of pieces of tissue paper, marking

release the flowers they can be drawn out of the clip or the end X may be pushed aside when the flowers will spring out.

The ends of the strings are fastened together to form the bunch. It is not advisable to tie the strings because after folding and re-folding the flowers a few times the strings will become hopelessly tangled. The most practical method is to take a small cork and cut it in halves lengthways, then take a curtain ring of a size to slip easily over the cork. Lay the ends of the strings along the flat side of one half of the cork, put the other half on top and then push the ring half-way down the cork. The strings are thus sandwiched between the halves of cork and held firmly. When the flowers are to be re-folded the ring is slipped off and the blossoms can be separated for easy packing.

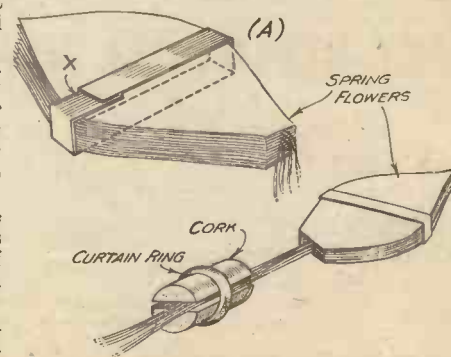

Fig. 12.—Clip and string fastening for bunch of spring flowers.

RADIO

Where you want it!!!



1/-

Complete as illustrated.

Every owner of an Extension speaker will be interested in this Clix Control Panel. It makes it quite a simple matter to control your set or extension speaker from the garden or any room in the home.

All you need is this Control Panel and a supply of twin wire.

Simple wiring instructions are supplied with every Control Panel; buy one and enjoy your radio where you want it.



Clix Folders
"P.M." Free
on request

THE "PRICELESS" PLUG

Wherever there is a mains radio or domestic electric apparatus this Clix 5-amp. 2-pin plug fills an essential service. It gives perfect contact and the pins are non-collapsible. They only cost a few pence, but the service they give is "priceless."

Obtainable through all Radio dealers

BRITISH MECHANICAL PRODUCTIONS LTD.
CLIX
79a, Rochester Row, London, S.W.1.

PETO-SCOTT

KITS TO SPECIFICATION

Practical Mechanics DEAF AID

KIT "A" CASH, C.O.D. 37/- OR 3/- DOWN
CARRIAGE PAID

Comprising all parts for P.M. Deaf Aid including ready-drilled chassis, screws, etc., less valves, batteries, headphones and case. Yours for 3/- down and 10 monthly payments of 4/-.

2 Specified Valves .. 30/-	Peto-Scott double 'phones, type 103.. 45/-
Peto-Scott polished case with carrying handle .. 12/6	Peto-Scott ready-drilled chassis .. 5/-
Peto-Scott special single type 103 'phone with head band .. 25/-	Complete set of Batteries .. 13/-

COMPLETE KIT Comprising Kit "A" specified parts with valves, single special type 103 'phone and headband, carrying case and all batteries. Yours for 10/- down, 12 monthly payments of 10/3 **£5-17-6**

WIDE WORLD RECEPTION ON THIS MODERN SHORT-WAVE ADAPTOR CONVERTER

13-74 METRES

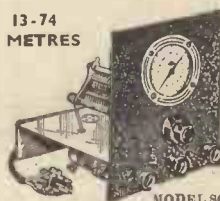

Convert your existing Battery or A.C. set for operation on the short waves with this up-to-the-minute unit. No alterations to your set whatsoever.

- No coil changing.
- Ready drilled enamelled steel chassis.
- Ready drilled black crystalline finish steel panel.

2/6
DOWN

KIT "A" with diagram, assembly and operating instructions. List Value 42/- Special Offer Cash or C.O.D. 29/6 Carriage Paid, or 2/6 down and 10 monthly payments of 3/7.

★ **ERECT AN EFFICIENT AERIAL NOW. ALL-WAVE AERIAL** (Wavelength 13-2000 metres) Absolutely essential for present-day good listening. Complete outfit for instant erection with all aerial and lead-in wire, transformers, insulators, and instructions. List Value 37/6. Special Price 17/6 cash or 2/6 down and 7 monthly payments of 2/6.

SEND NOW for brochure on the Peto-Scott "MAXADE" range of hearing aids (from £5 17s. 6d.). Shortwave and All-wave radio lists.

All Postal Orders must be crossed and currency registered.

PETO-SCOTT Co. Ltd., Established 1919

77 (Pr.M.3) City Road, London, E.C.1. Clissold 9875-6-7
62 (Pr.M.3) High Holborn, London, W.C.1. Holborn 3248

YOUR HOBBY?

WHATEVER IT MAY BE—DON'T MISS THIS **AMAZING RADIO BARGAIN**

3 MATCHED BATTERY TYPE VALVES

WITH 3 VALVEHOLDERS (BRAND NEW)
LIST VALUE 35/- **BARGAIN** POST FREE **5/6**

AN investment for every set owner and constructor, 3 matched, brand new world-famous Phico 2-volt valves, comprising 2 S.G. H.F.'s and 1 Output Pentode, packed in original cartons. Three different valve types indispensable for modern constructor's circuits (available on request) using any number of valves, invaluable also for replacement purposes. Offered to you at a fraction of manufacturing cost. . . .

FAMOUS-NAME SETS, also A.C. and Battery Amplifiers (that can earn you money), hundreds of bargains at the right price! Send NOW for FREE Catalogue.

NEW TIMES SALES CO.
56 (Pr.M.2), LUDGATE HILL, LONDON, E.C.4
EST. 1924
TEL. City 5516

For the Model Railway Enthusiast

INDOOR MODEL RAILWAYS

By E. W. TWINING

LIST OF CONTENTS

- Early small-gauge railways: origin of HO and OO gauges. Gauges, scales and dimensions.
- Electric traction motors, rotation and reversing.
- Prototype locomotives and modelling same.
- Motor mechanism and their adaptation to prototype engines.
- The twin railway, its locomotives and electrical working.
- Electric motor coaches, carriages, wagons and auto-couplers.
- Track, layout and engineering works.
- Third-rail and two-rail systems, control and signalling.
- Architectural features.

Hundreds of photographs and diagrams drawn to scale.

5/- from all booksellers or by post 5/6 from the publishers.

GEORGE NEWNES, LTD.,
(Book Dept.)
Tower House, Southampton Street, London, W.C.2

George Newnes, Ltd.

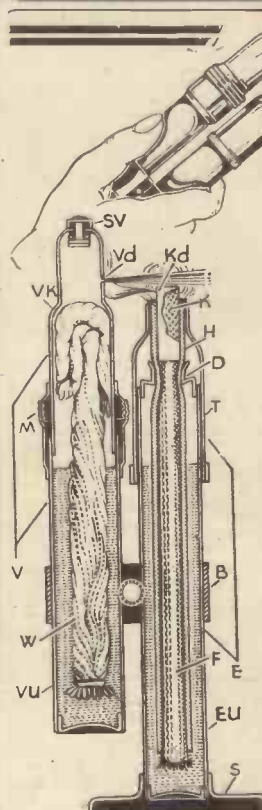

RICOFOR

THE WORLD'S 1938 WONDER UTILITY TOOL

The only lamp adaptable for all known trades:—BRAZING—SOLDERING—MELTING; GOLD, SILVER, BRASS, COPPER, etc.

FLAME 2,550° F. in 15 SECONDS using Petrol, Alcohol, or Methylated Spirit.

SIZE: Only 8 inches high, 2 inches wide by 1 inch. Can be carried in your pocket easily,

NO working parts and **NO** pumping!!!

Present users include:—Mechanics, Locksmiths, Electricians, Gold and Silversmiths, Dentists, Surgical and Medical Instrument Makers, Opticians, Laboratories, Motor Owners, Householders, Plumbers, etc., etc.

ON RECOMMENDATION TRIALS TO:—His Majesty's ARMY—NAVY—AIR FORCE, TELEPHONE AND RADIO COMPANIES.

For further details fill in Coupon.

COUPON
Please send me descriptive illustrated Leaflet of your wonder "RICOFOR" Lamp (P.M.)

NAME

ADDRESS.....

STANHAY St. Andrews, GUERNSEY.
(Not St. Andrews, Scotland)

COSTS ONLY **17/6** POST PAID
THOUSANDS ALREADY SOLD

BRITISH STEEL BODIES BUILT BY BASSETT-LOWKE LTD.



WHAT WONDERFUL WAGONS!

Recently improved methods of production at our Northampton factory have enabled us to reduce the prices all round of our

GAUGE "O" GOODS ROLLING STOCK
In lithographed tinned steel plate.

The L. M. S. Open Wagon illustrated now costs only... **2/6**
and Open Wagons in S.R. and G.W.R. are available at the same price
The N.E. Brake illustrated costs... **3/6**
Also in G.W.R., L.M.S., and S.R.

OF SPECIAL INTEREST
Our S.R. and G.W.R. Covered Wagons, and our L.N.E.R. Refrigerator Van at ... **3/-** each
Our L.N.E.R. Flatrol Wagon (new model) fitted with Cable Drum. Price ... **8/-**

F.B12. "RAILWAY THRILLS."
Booklet of Model Railway Equipment, gauge "O."
NEW B12. List of Stationary Engines and Castings. Sections 1 and 2 6d. complete.

NEW LISTS
A12. Model Railways **6d.** Each Post Free
B12. Model Ships .. Free

T.T.12. THE TWIN TRAIN FOLDER of "OO" gauge trains and accessories **2d.**

BASSETT-LOWKE LTD. NORTHAMPTON
LONDON: 112, High Holborn, W.C.1
MANCHESTER: 28, Corporation St.

UNIT 'X'
THE COMPLETE WOOD AND METAL WORKING MACHINE
pro. pat. 14570

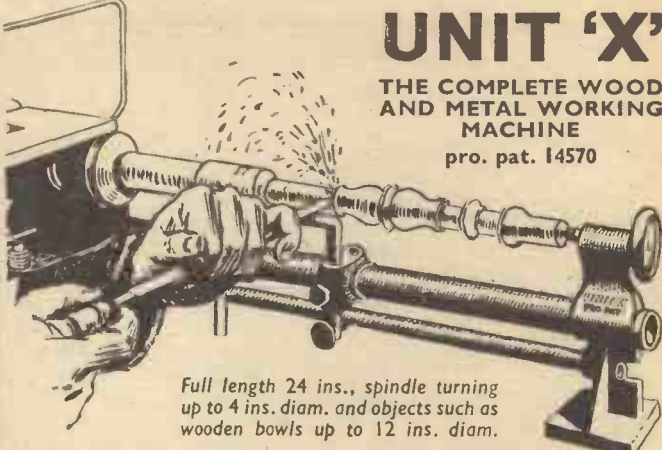

Full length 24 ins., spindle turning up to 4 ins. diam. and objects such as wooden bowls up to 12 ins. diam.

Works with either small motor or treadle. Drills, Grinds, Turns, Bores, Sands, Jigs, Punches, Polishes, Surface Grinds, Circ. Sawing, Moulds, Dove-tailing, Mortising, Grooves, etc., etc.
DOES 101 JOBS IN WOOD OR METAL

EQUIPMENT INCLUDES
Circular Saw, Grinding Stone, Buff, Jigsaw and Blades, Sanding Drum, One Tilting Table, 3/8" Chuck, Punch, Tool Post and Cutting Tool, Spanner, Oil-Can
95/-
COMPLETE
or 15/- cash and 9 monthly payments of 10/-

Send for Leaflet to
TRIANGLE PRODUCTS LTD.
BLAKE STREET, HULME, MANCHESTER 15

FLYING



IF you are air-minded you will enjoy FLYING. Every week it presents enthusiastic, non-technical reading—an air pageant of the world in every issue! With its stirring air fiction, true adventures of Service and civil pilots and the pioneers of flight, its "inside" information on all that is new in flying, and its profuse illustrations, it satisfies the very keenest desire for aerial knowledge.

FLYING

The New Popular Air Weekly
Of all Newsagents and Bookstalls **3d EVERY FRIDAY**

THE SPECIALISTS ANNOUNCE—
THE 1938 "SUPER SPITFIRE"
Britain's "Baby" Engine perfected. Colossal power. Platinum pointed contacts. Easy starter. 14 oz. thrust.
All-on weight, 7½ ozs. £4/17/6 Complete.
AND THE MODEL TO FIT IS THE
"COMET SCORPION"
High-wing Cabin model, 44in. Span. Weighs only 24 ozs. complete. Super Kit with full-size drawings and the difficult parts made, £2/2/- plus carriage. Scorpion drawings Only, 5/6 post free.
OHLLSON, CYCLONE, TROJAN, BROWN & COMET ENGINES. COILS, PLUGS, AIRWHEELS, DOPES, RUBBER & ALL MATERIALS.
1938 Illustrated List, 3d. stamp.
MODEL AIRCRAFT STORES (BNMTH.) Ltd.,
127b, HANKINSON ROAD, BOURNEMOUTH
Telephone: Winton 1922

DENNIS & SMITH
MODEL ENGINEER'S TOOLS, SUPPLIES
FINE JET BLOWPIPE



This Blowpipe is fitted with bypass and single gas control. Foot bellows can be used, but for light work ordinary tubular connection with mouth is sufficient. Price 4/6 each.
FOOT BELLOWS and RESERVOIR .. 17/6 ..
Larger Size Bellows and Blowpipes in Stock.
Send us your Enquiries for all Tools and Materials
83, GOSWELL ROAD, LONDON, E.C.1
Tel.: Clerkenwell 4457. Telegrams: Fereter Barb: London.

holds down the flap operating on the diagonally opposite corner. By pressing the projecting wire against the foot the flap is released and its contents allowed to escape.

Using the Tray

In use, a bunch of different-coloured spring flowers is placed in each of the four compartments. The tray is freely shown, a fan waved in front, a catch released and instantly the tray becomes full of flowers. The bunch is removed and a second bunch produced and so on. An improvement is to drape say a red handkerchief over the tray, then release the red flowers, which will flick the handkerchief off the tray as they expand. Following this a yellow handkerchief may be used to produce yellow flowers and a blue one blue flowers. As a final surprise a small Union Jack could produce a patriotic bunch of red, white, and blue flowers.

Flowers from Seeds

Another easy and effective trick is the sudden conversion of a packet of flower-seeds into the flowers themselves, or at

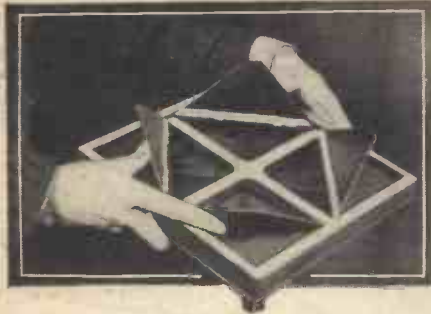

Fig. 14.—A tray to produce four bouquets of flowers. The flowers are the spring flowers described in this article and they are concealed in traps shown in the photograph.

least into a bunch of conjuring flowers that will pass for the real thing at a little distance.

For this, take a large seed packet, empty it and slit it down one side and across the bottom. Paste the opened out packet to two pieces of stiff card so that you have a sort of small book cover with the flower packet showing outside. Fold up a bunch of spring flowers of assorted colours and place them between the covers of your fake packet, attaching the strings to one corner of the paper with an ordinary wire paper clip. Hold the fake packet in one hand and announce your intention of growing the flowers instantaneously by magic. A wave of the hand will cover the opening of the halves of the book cover and the spring flowers, gushing out into a bouquet will hide the fake.

Figs. 16 and 17 show the effect and the main secret of a fairly ambitious "growth of flowers" which can be made quite easily in almost any size to suit individual requirements.

Some bran is poured into a pot which is placed on a tray across the top of a small firescreen. A cone, previously shown empty, is placed over the pot and immediately lifted, when a large bush of flowers is seen in the pot.

The flower bush is the most important part of the trick. A

genuine plant could be used, or real flowers fastened to a wire foundation, but the more convenient method is to make use of the very effective artificial flowers on sale in the shops. Special conjuring flowers are not required.

Take care to use flowers of one colour and all of the same species as the effect is that of growing a bush of flowers, not

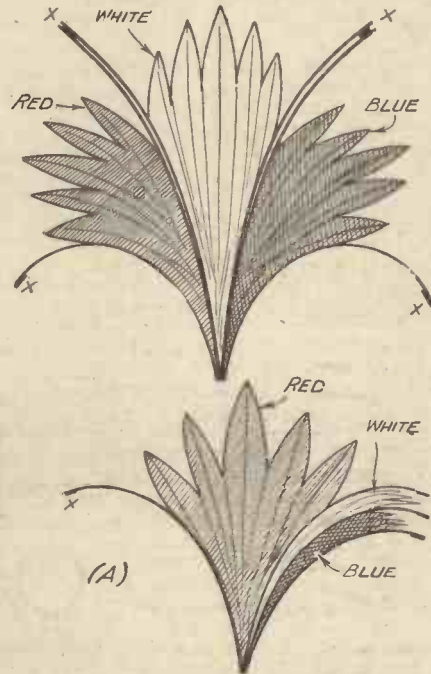

Fig. 13.—A colour hanging flower.

producing a bunch of cut blooms. The flowers and some suitable foliage are made up into a bush terminating at the lower end in a single wire stem and at the top in a ring, the ring being painted dead black as it projects a little above the top bloom. The plant is securely fastened to a disc of thick wood painted black and having bran stuck over its top surface.

Cones Required

Two cones are now required, one fitting



Fig. 16.—(Left) Growing a bush of flowers by magic. This is the final effect.

Fig. 17.—(Right) How the bush is grown. The plant is concealed in the black cone shown behind the screen and the outer cone is dropped over it as the screen is moved away.

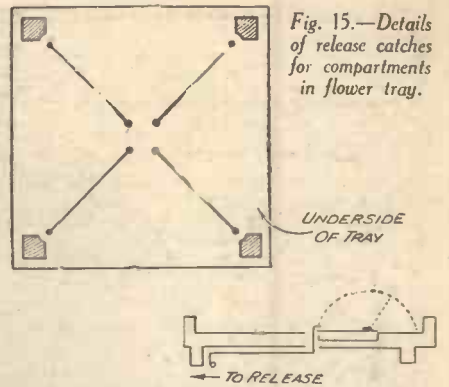

Fig. 15.—Details of release catches for compartments in flower tray.

closely into the other. It is best to cut two pieces of cardboard to the shape shown in Fig. 18, bend them round and fasten the edges with glue and small paper fasteners. Make the cones longer than you will want them, put one inside the other and trim them both to the required length. This ensures a good fit. The inner cone is painted dead black inside and out. The other cone is blackened inside and decorated to taste outside. The wood disc to which the plant is fitted should be an easy fit into the inner cone and should be loose enough to drop out by its own weight.

The pot used is an ordinary fancy papier mâché art pot with four blocks of wood fastened inside an inch or so from the top on which the wooden disc can rest.

The tray has no preparation and the screen is just a simple two-fold type having little or no cut-out space at the bottom.

Preparing the Trick

To prepare the trick, insert the plant into the black cone and stand cone and plant behind the opened screen as shown in Fig. 17. Note that the angle of the screen is towards the audience at this stage. To perform, show the cone first and demonstrate its emptiness. Put it down behind the screen and, of course over the inner cone, at the same time taking the screen away. (See Fig. 17.)

Now show the screen and set it up nearer the audience, this time with the angle of the screen away from the audience. The object of this is that when the plant is produced there is apparently no place where it could have been hidden whereas if the screen were replaced as at first it might suggest the original hiding-place of the plant.

All that remains is to lay the tray over the screen, fill the pot with bran and place the cone over it. In lifting the cone one finger is inserted in the ring and the plant thus lifted inside the cone. To produce the plant simply lift the cone, which will bring with it the inner cone and leave the plant in full view, the various branches drooping as they are released from the cone will create the impression that the bush is actually larger than the cone.

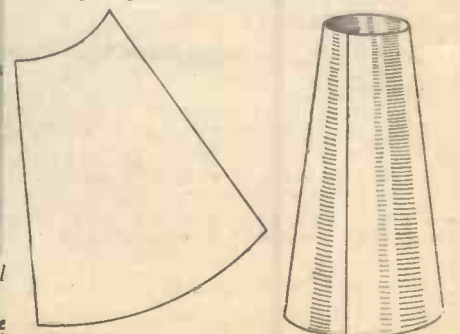

Fig. 18.—Making the cones for the flower growth.

MAKING GEISSLER

This Month we Deal with and Sealing in

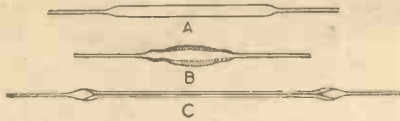

Fig. 1.—Drawing out the seal wire casing.
BOBBIN OF WIRE.

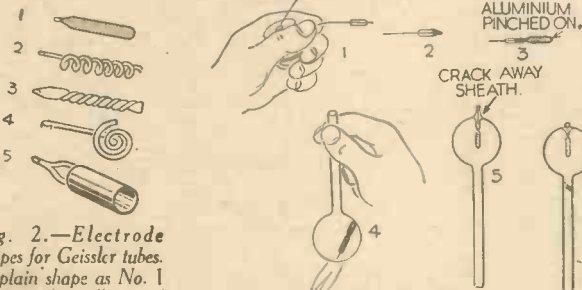

Fig. 2.—Electrode shapes for Geissler tubes. A plain shape as No. 1 is best for all round work.

Fig. 3.—Making and fusing in an electrode.

It was mentioned in the previous article of this series that organic sealing compounds were not quite good enough to make an airtight seal; in fact, any sealed closures or tubular connections into a vacuum system should be of fused glass. It is fairly easy to make a piece of apparatus airtight when there is pressure within as well as without, but to make it vacuum tight is quite another matter. Bubbles of gas the size of a pin head liberate billions of molecules if allowed to get into a highly exhausted vessel. The problem, therefore, of an airtight electrical connection through the walls of the vacuum tube is an important one. This difficulty has largely been overcome by the use of platinum wire which has a co-efficient of linear expansion approximately that of glass, which on the average is 0.0000087 per degree Centigrade. Platinum is very expensive and should only be used on tubes of the very highest vacuum, and for another, it is not necessary for our purpose at present; besides, the use of any material that one must be super-careful about is apt to cramp the style.

The Seal Wire

The makers of alloys have not neglected the all-important seal wires for the various hard and soft glasses, and amongst them we have boro-copper, chrome-iron, nickel steel, etc., each to suit a particular glass. The chrome-iron alloy is fairly well known as having an expansion co-efficient of nearly the same degree as soda and lead glass and is used as a metal case or wall to modern x-ray tubes where it is necessary that the glass seals, etc., should make an airtight fusion.

When ordering chrome-iron wire ask for 36 s.w.g., and if it helps, ask for an expansion co-efficient as near to 0.0000087 centimetre per degree Centigrade as possible.

Making and Sealing-in an Electrode

In most vacuum apparatus of professional make, it will be noticed that the seal wire is encased in glass either as a pinch or as a thin rod with the wire running through the middle; the whole sealed on the inside of the bulb. This practice cannot be bettered as it protects the seal from damage. To begin with, we need a tube of soda glass with a bore of about .5 mm. with an external diameter of 1.5 to 2 mm. Take a three-inch piece of our 2.5 mm. tube and draw out spindles at each end; see that one is closed and the other open. With a spindle in each hand rotate the central portion in the blow-pipe flame

and compress slightly, bringing more tube into the flame. Give a puff through the open end from time to time if there is a danger of the tube thickening to such an extent that it might close. When sufficient glass has been gathered, remove from the flame and draw out into a tube about five inches long. All glass tubes are made on this principle, and the thing to watch is parts of the tube drawing too thin. If part of the tube is about the right size, cease pulling for a moment and it will solidify sufficiently for the rest to be drawn down to the same size. A little practice will soon show the worker when to slacken and when to pull swiftly for a given size of tube. Fig. 1 shows the sequence of the operation. This tube will be used in short lengths to encase the seal wires. The electrode proper is made of aluminium, which is light in weight and the sputtering is slight. "Sputtering" is a term describing the effect metals undergo when used as a cathode. The positive rays (now believed to be atoms) travel in the opposite direction to the electrons, towards the negative cathode, and strike it with such force that infinitesimal pieces of the metal are torn off and deposited on the glass walls of the bulb. Thus, if we used silver as a cathode, the sputtering would produce a mirror. Such a mirror is seen on the inside of radio valves. Short lengths of aluminium strip suffice for our geissler tubes, but other electrode shapes are shown in Fig. 2. Each presents the maximum area possible in contact with the residual gas consistent with reasonable size.

Preparing an Electrode

To prepare an electrode take the bobbin of seal wire and straighten out about 1½ in., but do not cut away just yet. Pass this length through the blowpipe flame to burn up any impurities on the surface. Take it from the flame and with some fine clean glass paper folded between finger and thumb, pull the wire through several times so that it is clean on all sides. Taking care not to touch the wire with the fingers, slip on a short length of the encasing tube, say ⅝ in., leaving ¼ in. of wire sticking out.

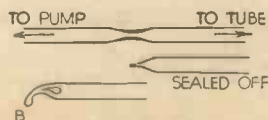

Fig. 5.—Preparing sealing-off tubes.

Place in the blowpipe flame and rotate backwards and forwards as far as the wrist will allow, and the glass will fuse down. Care should be taken not to lock any air on the inside. With a pair of narrow nosed pliers bend the ¼-in. length of wire round into a loop, which is fixed to the glass casing by means of a small piece of soft lead glass or white arsenic enamel glass, so that the free end of the loop is firmly embedded. These enamel glasses are sold as rods about 2 mm. diameter. A special blue glass is also made for this specific purpose, costing about one shilling an ounce, but a small length will last a long time as the quantity used for each electrode is small. The aluminium electrode, of whatever shape decided upon, is bent at the extreme end and pinched on the loop, and the whole electrode

and compress slightly, bringing more tube into the flame. Give a puff through the open end from time to time if there is a danger of the tube thickening to such an extent that it might close. When sufficient glass has been gathered, remove from the flame and draw out into a tube about five inches long. All glass tubes are made on this principle, and the thing to watch is parts of the tube drawing too thin. If part of the tube is about the right size, cease pulling for a moment and it will solidify sufficiently for the rest to be drawn down to the same size. A little practice will soon show the worker when to slacken and when to pull swiftly for a given size of tube. Fig. 1 shows the sequence of the operation. This tube will be used in short lengths to encase the seal wires. The electrode proper is made of aluminium, which is light in weight and the sputtering is slight. "Sputtering" is a term describing the effect metals undergo when used as a cathode. The positive rays (now believed to be atoms) travel in the opposite direction to the electrons, towards the negative cathode, and strike it with such force that infinitesimal pieces of the metal are torn off and deposited on the glass walls of the bulb. Thus, if we used silver as a cathode, the sputtering would produce a mirror. Such a mirror is seen on the inside of radio valves. Short lengths of aluminium strip suffice for our geissler tubes, but other electrode shapes are shown in Fig. 2. Each presents the maximum area possible in contact with the residual gas consistent with reasonable size.

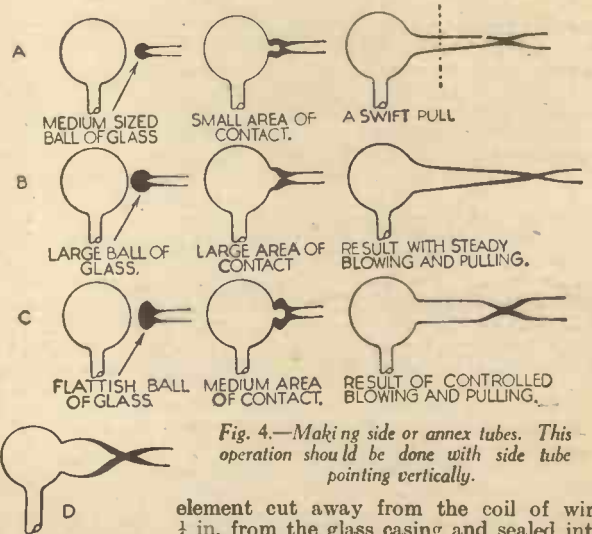

Fig. 4.—Making side or annex tubes. This operation should be done with side tube pointing vertically.

element cut away from the coil of wire ¼ in. from the glass casing and sealed into a bulb. On the end of a piece of 6 mm. tube draw a spindle and blow a bulb at the shoulder. The spindle can be cut off and the hole closed in the flame, and by repeated heatings and puffs the thick glass can be spread out. Slip the electrode into the open end of the tube and the wire will rest on the bottom of the bulb. In this vertical position dip the bulb into a small flame and rotate, when a small patch of glass will soften and the electrode will sink down through the bulb, and the glass casing will fuse home. Remove the piece from the blowpipe, and quickly crack away with pliers the thin glass sheath on the protruding wire, and put the piece back into the flame; straighten out the electrode and blow out any slight deformations. The whole should be heated up in a large flame, but not enough to soften it, and wrapped up in cotton wool and set aside to anneal. This completes the sealing in of a single electrode. The protruding wire can be bent into a tiny loop. Fig. 3 shows the full sequence of making and sealing. The best finish is to bring the wires out to brass caps, and the making and fixing of these will be discussed later.

AND VACUUM TUBES—No. 2

Glass Bulb Making, and the Construction of Electrodes

Side Tubes

One of the most important operations in vacuum work is the fixing of side or annex tubes either to hold an electrode or to give a lead-out to the pump. To attempt such a joint on a thin-walled bulb by the T-joint process would just court disaster, for as soon as a hole was pierced, it would grow bigger and bigger through the ordinary laws of surface tension. Assuming we have a bulb, at the side of which we need a tube, the shank or tube upon which it has been blown should be held in the left hand and a piece of waste glass rod or tube in the right. The latter should be strongly heated until it forms a ball of hot glass, at the same time allow the flame to graze the bulb at the point where the tube is to be made. The ball of hot glass is stuck to the bulb, and holding the pieces with the waste tube pointing vertically, blow steadily, and another bulb will try to form at the place of contact. If we pull steadily at the upper piece we draw this new bulb into a tube. Fig. 4 shows this interesting sequence used to produce different results. This process lends itself to the making of almost any shaped tube, and of any reasonable bore. The main thing is to control both blowing and pulling by keeping an eye on the hot glass and the rate it cools. D, as shown in Fig. 4, is the easiest to do, and the first attempt is likely to be something similar, but here again a little practice will soon show how to get the desired shape. The waste glass can be fused off and the end of the new tube rounded by heating uniformly and blowing. Both bulb and side tube should be heated up all over, and left to anneal in cotton wool.

Sealing-off

The term "sealing-off" describes the disconnection of the finished and exhausted tube from the pump whilst still preserving the vacuum. In the case of a Geissler tube,

the lead-out tube to the pump is fixed usually at the side of one of the bulbs, and when sealed-off leaves a projecting pip. This, of course, should be neat and not unsightly, and undoubtedly the best method is to prepare the tube in the first instance by thickening the glass at the desired place and gently drawing down until there is a constriction with thick walls. To seal-off a tube, a small flame is played about this constriction, and atmospheric pressure will close it, the finished tube being drawn away. It is best to follow up the pip with the flame to prevent a long tail being left. Fig. 5 A shows the sealing-off process. If a seal is not prepared, the result will look like B,

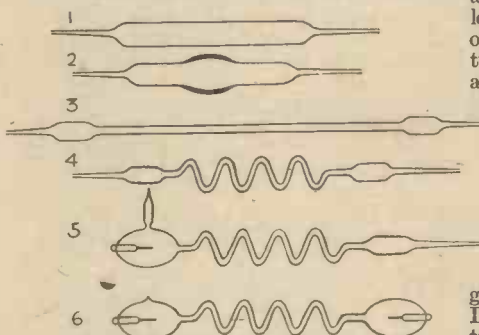

Fig. 6.—Making a more advanced type of Geissler tube.

and it is apt to crack in the concave underside when cooling. The diagram A in Fig. 4 shows a lead out tube of the kind required; this is cut away at the dotted line and a short length of 2.5 mm. tube fused to it. This joint is thickened and drawn down to prepare the seal, which should be annealed.

A Better Type of Geissler tube

A length of 6 mm. bore tube is arranged with spindles at each end, in the centre sufficient glass is collected to draw out a

long small bore tube leaving short lengths of the 6 mm. tube at each end. The small bore tube is now bent to the desired shape, and a bulb blown at one end from the short length of wide bore tube. On the side of this bulb draw out a seal-off tube as described at A, Fig. 4. Cut away the spindle near the shoulder, leaving a hole large enough to slip a completed electrode element into the bulb, and the subsequent closing and rounding of this part of the bulb must be done with the rest of the tube pointing downwards, so that the electrode does not fall into a zone of hot glass where it is not wanted. The electrode is now fused into position, and this, with the bulb and the seal-off tube can be annealed together. The tube is now reversed end for end, and the other bulb blown, using the spindle for this purpose. This spindle is cut as before, and an electrode slipped in. We can now open the seal-off tube on the first bulb at the extreme tip and use this for blowing, when completing the last bulb and fusing home the electrode. A short length of 2.5 mm. tube is fixed to the seal-off tube, and a seal prepared. The Geissler tube can now be exhausted at the pump and sealed-off. The sequence of these operations is shown in Fig. 6.

Important Hints

The secret of a good symmetrical bulb is equality of heating in the glass gathering stage, with constant rotation, and this motion kept going during the blowing. The re-heating of any worked part of a tube should be gradual, and over a slightly smoky flame. It is a good plan to slip a ring of tinsplate over the air-holes of the blow-pipe to get this re-heating flame, the glass being moved about and rotated as much as possible until the outer edge of the flame is tinged with orange. The piece can then be worked without the danger of a fracture. The art of bending tubes is one that needs a little skill. A fish-tail burner that fits the bunsen, can be bought for about a shilling, and this is essential for long graceful curves, where the heating of a substantial length of glass before bending is needed. This burner is shown at 1, Fig. 7. Curves and small bends are fairly easily done with tubes of small bore and thick walls, but large bores and thin walls become a problem as they collapse on slight provocation. The best way to handle these is to see that the heating is uniform, and with one end stopped blow strongly into the other whilst gently turning the piece to shape. A right-angled bend is sometimes called for, and is used in Neon signs to a great extent. This is done by joining up a tube of equal diameter to one that has been closed at the end, and a hole blown through the side, as shown at 2, Fig. 7. It may happen that a tube sealed to the pump and exhausted shows very little illumination, in fact, just a thin blue stream in the centre of the tube. This is due to moisture in the vacuum system, and a gentle heating by waving a bunsen underneath the tube, but not too near, will remedy this. Most vacuum systems have a drying tube inserted between the pump and the vessel to be exhausted, and contains calcium chloride, phosphorus pentoxide or strong sulphuric acid. This drying tube is shown at 3, Fig. 7, and has a ground-in stopper surrounded by mercury to make it airtight.

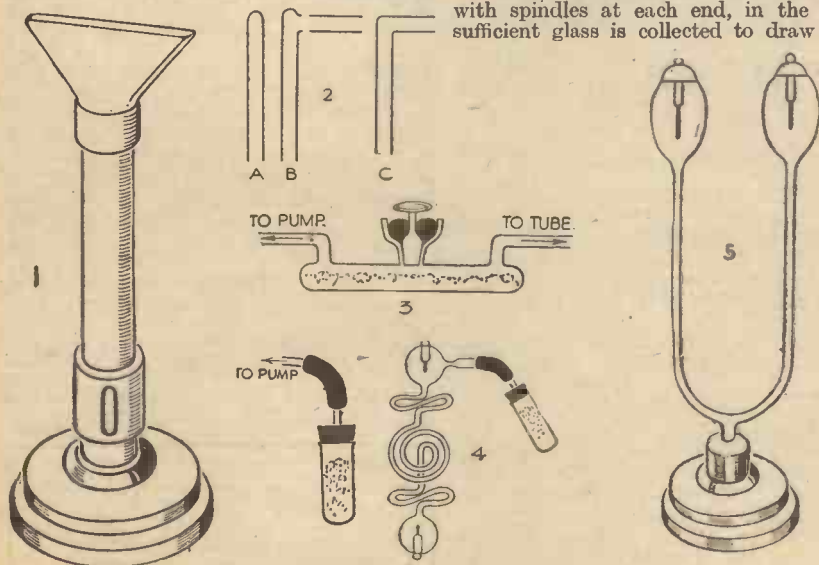

Fig. 7.—Some useful hints for Geissler tube making.

BUILDING A I-C.C. ENGINE

Further Constructional Details of the First I-c.c. Engine to be Described.

Contact Breaker Details

THE contact breaker is comprised of 3 parts, namely, a clip on which is mounted a tungsten point, which is insulated from the crankcase by means of a fibre ring, and the actual breaker arm which is mounted on a clip. The method employed is simple, the parts being made from sheet phosphor bronze, but it permits variation in the ignition setting. It will be noticed that the contact breaker arm is made from slightly heavier material than that employed for the clips. This is necessary in order to overcome the side drag imparted by the operating face on the cam plate. Apart from the sheet phosphor bronze and screws, etc., as specified on the drawings of these details, a pair of tungsten points are also required. These are approximately $\frac{1}{8}$ in. dia. (thin type). Prepare the points by lightening under the heads and reducing the shanks to $\frac{3}{32}$ in. dia. or perhaps a shade larger. The shanks are finally cut off $\frac{1}{8}$ in. long under head to form a short tungsten headed rivet.

The Ring Insulator

This insulator is made from $\frac{3}{8}$ in. dia. bone fibre which is reduced to $\frac{1}{8}$ in. dia. on the outside. The centre hole is reamed $\frac{3}{8}$ in. dia. to fit the spigot on the end of the crankcase and the overall length requires to be slightly less than that of the spigot.

Follow the drawing as regards the dia. of the centre groove which receives the contact clip and make the width of the groove slightly in excess of $\frac{1}{4}$ in. so as to ensure that the clip may be easily adjusted for "timing". The narrow saw-cut allows the bush to clamp on the spigot when the clip is tightened.

The Fixed Contact Clip

Cut a strip of No. 24 S.W.G. from phosphor bronze sheet and file up to exactly $\frac{1}{8}$ in. wide and finish the ends up square so that the overall length of the strip is $2\frac{1}{2}$ in. Make a bend $\frac{1}{2}$ in. from one end of the strip leaving a small radius in the corner, turning up to an angle of 60 degrees approximately, and make a similar bend at $\frac{7}{8}$ in. from the other end. Turn a small eye with a pair of fine round-nosed pliers at the end of the longest bend to accommodate the ignition wire. Bend the clip round a piece of $\frac{1}{2}$ in. dia. material.

Mark out and drill the No. 50 dia. holes for the fixing screw and drill a hole to take the shank of one of the points central in the top of the clip at 90 degrees with the gap. Slightly countersink the hole at the inside of the clip before riveting the shank over, and after neatly sweating, the surplus metal is filed off flush with the inner surface.

The Breaker Arm and Clip

Prepare a strip of No. 24 S.W.G. phosphor bronze $\frac{3}{8}$ in. wide \times $1\frac{1}{2}$ ins. overall with radiused ends. This makes the clip. For the arm a piece of 22 S.W.G. phosphor bronze $\frac{1}{2}$ in. wide \times $1\frac{1}{2}$ in. long with square ends is required. Make a double set in the wider strip to allow the arm strip to lie flush with the inside of the clip, when finished, at a distance of $\frac{3}{8}$ in. from the inside of the first set to the end of the radius. Rivet and sweat the arm strip in position as shown and bend the clip round a piece of $\frac{3}{8}$ in. dia. rod and set the ends out to leave a $\frac{1}{8}$ in. gap. Drill the lugs with a No. 50 drill for the fixing screw

By W. H. Deller

Part VI The Contact Breaker and Valve

(Complete Sets of Blue Prints
are now available at 5s. per Set)

Securely fasten the clip to a piece of rod and make the U bend in the arm by pulling over a piece of $\frac{3}{8}$ in. dia. rod. The remaining sets are made according to the details given with a small pair of flat-nosed pliers. There should be a slight excess on the lifting end of the arm to permit adjusting by filing to suit the cam plate surface. The remaining point is fitted in the manner as previously described.

The Valve Body and Carburettor

The valve body is made from mild steel $\frac{1}{8}$ in. dia. Chuck the material and rough out carefully, leaving a centre portion $\frac{7}{8}$ in. dia. \times $\frac{3}{32}$ in. wide. Drill the centre hole with a No. 25 drill and drill out the bottom $\frac{1}{4}$ in. deeper to $\frac{3}{32}$ in. dia. Flat bottom the larger hole to $\frac{3}{32}$ in. deep. Finish turning, including the thread dia. before cutting off. Cut the thread with a die $\frac{3}{8}$ in. dia. \times 40 threads and screw the part into the crankcase to obtain the position of the tapped hole. Having obtained this, mark out and drill the tapping hole, spot face to form the seating for the carburettor and tap the hole $\frac{3}{8}$ in. dia. \times 40 threads. Remove the surplus metal to form the boss by filing as shown.

The Carburettor Body

Turn the carburettor blank in a similar manner, drilling the centre hole $\frac{1}{4}$ in. dia. and mousing out the bottom end almost to a knife-edge. Screw the part into the valve body after threading and make out the position of the No. 2 B.A. tapped hole.

Remove, and drill and tap this hole straight through. Make a screwed peg in the lathe to fit the cross hole and turn the bosses on each side as indicated. Here again the excess metal is removed carefully by means of suitable files. Before proceeding it should be pointed out that a soft copper packing ring is interposed between the carburettor flange and the face of the screwed boss in the valve as it is necessary for purposes of assembly to break this joint. When screwed home it will be noticed that the thread on the carburettor body projects into the hole in the valve body. This projection must be carefully removed with a file to suit the contour of the drilled hole.

Having done this the hole in the valve body, with the other part in position, is carefully reamed to $\frac{5}{8}$ in. dia. and finished to the bottom with a parallel reamer without lead. Attention is directed to the fact that the finished hole needs to be smooth and clean.

The Jet

The jet is turned from $\frac{1}{2}$ in. dia. brass rod. This part is probably best turned on the centre from off the drilled centre holes, after roughing out and threading. Regarding the drilling, the object is to leave a thin wall of metal behind the $\frac{1}{8}$ in. dia. central cross hole. The thickness of

this wall should be from .005 to .010 in. so that the small hole may subsequently be pierced.

It will be noticed that the No. 2 B.A. threaded portions must form a continuous thread and therefore this needs to be cut before the centre portion is removed. The hole in the end nearest the large shoulder is tapped No. 10 B.A.

Screw the jet into the carburettor body and mark the position of the $\frac{1}{8}$ in. dia. cross hole so that when it is drilled through it will coincide with the centre of the tubular portion of the carburettor body. To pierce the centre hole thread a short piece of .0669 in. dia. silver steel and reduce it to .010 in. dia. \times $\frac{1}{8}$ in. long at one end. File the portion to a point and harden and temper the end. "Stone up" in the lathe to a fine point and pierce the jet by screwing into the thread. The dia. of the hole produced is controlled by means of a nut screwed on the thread.

The Needle Valve

The needle valve may be made as shown, or a milled Head substituted in place of the eye for turning. Provision must be made to prevent the needle from being screwed in too far and thereby enlarging the jet hole. This can be accomplished by fitting a tight lock-nut on the needle valve thread set in such a position that it butts against the shoulder as soon as the needle cuts off.

The Inlet Valve

This part calls for no special comment beyond the fact that it is made from $\frac{3}{8}$ in. dia. silver steel. After hardening and tempering the larger dia. is ring-lapped to perfect sliding fit in the $\frac{3}{32}$ in. dia. reamed hole in the valve body. This valve is operated by the cam plate and is returned by means of a fine phosphor bronze spring which is housed in the $\frac{1}{4}$ in. dia. centre hole and butts against the bottom of the $\frac{3}{32}$ in. dia. hole in the valve body.

The Cam Plate

Made from "non-shrink" tool steel this part represents the final machining work. Material 1 in. dia. is required. This is chucked and faced and turned over the outside to $\frac{3}{8}$ in. dia. for a distance of $\frac{3}{8}$ ins. Centre and drill a $\frac{3}{32}$ in. dia. hole $\frac{3}{8}$ in. deep. Turn the $\frac{3}{8}$ in. dia. to a good finish and counterbore the front to $\frac{3}{8}$ in. dia. \times $\frac{3}{4}$ in. deep. Recess this hole to leave a central boss $\frac{3}{4}$ in. dia. \times $\frac{5}{16}$ ins. high, and part off to leave the piece $\frac{3}{8}$ ins. in length overall. Reverse in the chuck, true up and counterbore the $\frac{3}{8}$ in. hole to $\frac{2}{4}$ in. dia. to leave $\frac{1}{8}$ in. of metal at the bottom. Face the front leaving the $\frac{3}{8}$ in. dia. $\frac{3}{32}$ in. thick and leave a $\frac{1}{8}$ in. ring of metal round the counterbore. File the centre hole out square to fit the end of the crankshaft tightly.

The engine is now ready for final assembly when the cam positions may be marked out and cut. This phase and the running of the engine will form the concluding article.

POWER-DRIVEN MODEL AIRCRAFT

1/-; by post 1/2.

From Geo. Newnes Ltd., Tower House
Southampton Street, Strand, W.C.2

THE 1c.c. TWO STROKE PETROL ENGINE

Further Stage-by-Stage Constructional Details

DEVELOPMENTS OF P.B. ARM AND CLIPS

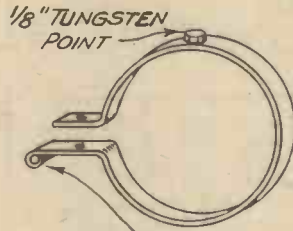
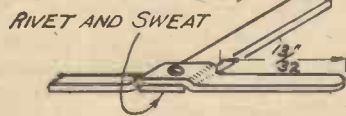
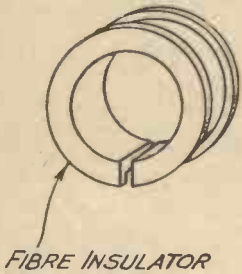
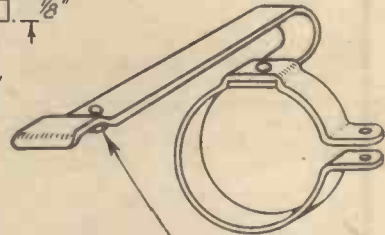
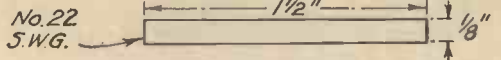
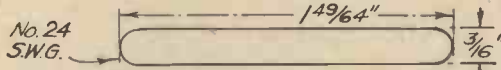
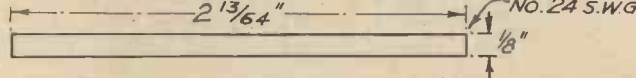

POSITION OF ARM ON CLIP

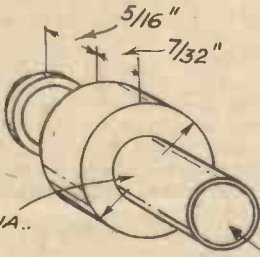

EYE FOR LEAD

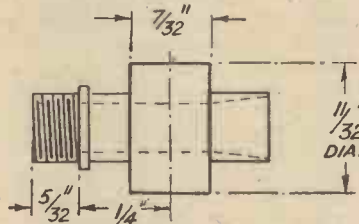

POSITION OF BENDS AT ENDS OF FIXED CONTACT CLIP

NO. 25 DRILL - FLAT BOTTOMED VALVE BODY BLANK

CARBURETTER BODY BLANK

CUT THREAD ON JET BEFORE CLEARING CENTRE

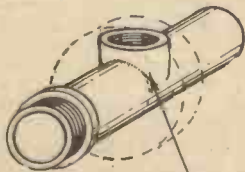

FORM BOSS ON VALVE BODY AS SHOWN

CARBURETTER BODY AFTER FORMING BOSSES

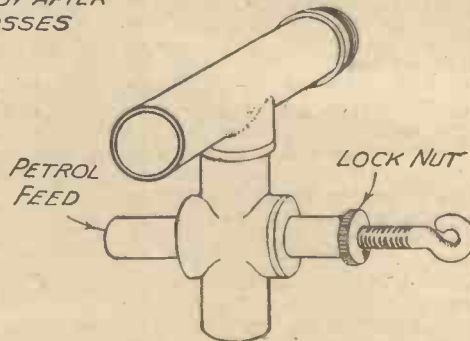
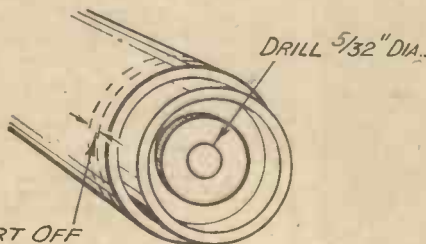

CAM PLATE 1ST. OPERATION

VALVE

COMPLETED VALVE BODY & CARBURETTER



A Motor Cruiser, capable of accommodating a party in real comfort.

COMFORT and SPEED AFLOAT

ALTHOUGH the early summer has this year turned the thoughts of marine motorists toward the water sooner than usual, the early commencement of the season has not caught boat builders and engine manufacturers napping.

In Britannia House, Ampton Street, W.C.1, are hundreds of marine motors, both new and second-hand, outboard and in-board. Here boats are available ranging from a dinghy costing a few pounds, to the last word in motor cruisers capable of accommodating a party in real comfort and conveying them safely and quickly to home, or continental cruising grounds. For the benefit of the uninitiated it may be as well to explain that an outboard motor is a self-contained propelling outfit which is light in weight, and can be clipped to the stern of any small craft instantaneously. Even motor cruisers sometimes employ this type of engine, for various models having a wide range of power are available.

Inexpensive

Motor-boating is neither expensive in capital outlay or upkeep. A really serviceable open boat, built of mahogany and equipped with an outboard motor, can be purchased for so little as £25, moreover, deterioration does not take place in the same exasperating way that is usual with a motor car. If a boat is reasonably well looked after, that is to say painted or varnished each spring, it will be just as serviceable twenty years hence and, again unlike a car, it is not dated, because boat design does not change annually, therefore depreciation from this cause can be forgotten.

The chief difficulty is to get people to taste the experience of motor boating, but once they do this then the result is never in doubt.

A question which is sometimes asked is, "If I buy a boat where can I go and where shall I keep it?" Well, to begin with, this country is not so poor in sheltered cruising grounds as some people would have us suppose, and, what is more, most of them are free and what charges are made are generally nominal. The Thames is delightful and handy for Londoners in particular. Lock dues are not excessive and what an adventure it is to journey right down the

Choosing A Motor Boat

Thames through a short section of canal and continue the voyage of exploration up the Severn!

On the Broads

It is equally feasible to go from London to North Wales, or Yorkshire by water, but the Broads, offering 200 miles of navigable waterways without a lock, make a more popular proposition; moreover, the Broads are almost entirely free from commercial activities which, from the aesthetic point of view, spoil otherwise delightful stretches of canal. Navigable rivers are not lacking,

whilst the Lake District offers many unique opportunities to the marine motorist.

Then, of course, there are over 4,000 miles of navigable river line waters which surround the British Isles available to those more intrepid folk who prefer deep water cruising to that of inland water cruising.

Small craft are available nowadays which present the minimum of transport difficulties when land-locked water is to be reached. These boats, although being constructed almost entirely of wood, fold flat and can be carried on the roof of a small saloon car. Some boating enthusiasts do not even own a hull, but merely take with them an outboard motor such as the Eltq Pal, which costs only £11, and weighs a mere 14 lb. This mighty atom can propel a hired dinghy carrying four people faster than it can be rowed, and with ridiculously low expenditure of fuel.

Storage

The storage of a small boat presents no difficulty whatever, but in the case of motor cruisers, moorings and storage sheds are available at all boating centres, and prices are agreeably small in comparison with the garaging of a motor car.

Mr. J. S. Shillen, who is the managing director of the British Motor Boat Manufacturing Co., Ltd., London, has probably done more to popularise inexpensive motor boats in this country than any other single individual. His vast experience is available for the benefit of all visitors to Britannia House.

Many of those who are keen to take up motor boating and prefer the sea to inland waters, are deterred because they have a negligible knowledge of navigation, but fortunately this need be no obstacle. The ability to read a chart, coupled with common sense, is quite sufficient to enable coastwise cruising to be undertaken with absolute safety.



A popular outboard motor.

LATHE WORK FOR AMATEURS

By F. J. CAMM

96 Pages

1/- or 1/2 by post from Geo. Newnes Ltd.,
Tower House, Southampton St., W.C.2.

OUR BUSY INVENTORS

(See also page 542)

Invincible Helmet

A BOY was once asked the question in the old Scottish catechism, "What is the chief end of man?" He replied, "His head." Physically speaking, he was correct, for the summit of the human form is the cranium, considered in relation to its contents—if any.

Now, although Nature has made very special arrangements to shield the brain, the head of man—at times extraordinarily thick—is not impenetrable. Aware of this fact, a descendant from the ancient Romans, whose legions were accoutred with imposing helmets, has patented in this country a protective head-piece. This is designed to resist not only the tropical sun and tropical insects, but also to protect against flame, blows, thrusts and even projectiles.

The inventor has, in his specification, passed in review various helmets which have preceded his device.

First comes headgear made of cork covered with one or more plies of fabric. This type, to which the usual sun helmets or topees belong, provides protection only from the sun's rays. It is ineffective against higher degrees of heat or against fire and sparks. And it affords but slight resistance to blows. A yet further disadvantage is that it easily falls a prey to tropical insects, especially to certain voracious ants found in hot climates.

Proof is in the Heating

NEXT there passes by a helmet built up from plies of fabric with intervening layers of rubber. This method is employed chiefly in the manufacture of crash helmets for motor-cyclists, airmen and others. Such headgear defends one from blows but does not protect from intense heat. And, unlike the salamander, it cannot live in fire.

Thirdly appears a headpiece formed from split leather stockinette fabric, parchment paper and similar foundation materials, stuck together in a number of plies by means of viscous celluloid solutions. Headgear of this kind, particularly when reinforced with wire fabric or sheet metal, resists blows but not fire and high temperature. The proof of the helmet is in the heating.

This does not exhaust the types of safety head covering referred to by the inventor, but I must not longer delay the description of his own production. His device consists of a number of superimposed webs of material made from mineral fabrics with or without wire reinforcement. This is combined with synthetic resin and shaped and hardened in suitable moulds by the application of pressure and heat. As already stated, it is claimed that this headpiece is impregnable against blows, thrusts, heat, flame, and projectiles—a veritable paragon of helmets. I am tempted to call it an anti-projectile (Dynamo).

THE PRACTICAL MECHANICS HANDBOOK

RESERVE YOURS TODAY!

See page 544

JACK AND JOAN DISCOVER ADVENTURE!



WHY don't you, too, go motor boating? Of all pastimes it's the healthiest and most exhilarating. Just imagine it! Cruising over rippling water bound for some enchanting shore where you can picnic in an exciting new way. Do you know that motor boating costs very little? Remarkably little! Send for our catalogues. You'll be surprised.



CATALOGUES FREE

Send post card for our motor-boating catalogues. State what rivers, canals or lakes there are in your district, and we will send full details on how to enjoy motor boating.

BRITAIN'S LEADING MOTOR BOAT HOUSE

BRITISH MOTOR BOAT MFG. CO. LTD.

Dept. 30, Britannia House, Ampton St., London, W.C.1

INTRODUCING —

NEW D.T.C. THREAD CHART

THE experimenter and model engineer often has to drill holes either for tapping or for clearance and a handy chart showing the sizes of drill needed for drilling clearance or tapping holes is of great value in the work shop. Such a chart is now available from Messrs. E. Gray & Son, Ltd., of 18 Clerkenwell Road, E.C.1, and from its use is known as the D.T.C. chart (drilling, tapping and clearing). It consists of a 4-in. disc of celluloid in various colours upon which is mounted a double radial cursor. Decimal sizes from 0.0135 in. (No. 80 drill) to 0.232 in. are printed circularly, and on the outside, on one side, and from 0.234 in. (letter A drill) to 1 in. on the other. Next, threads per inch, tapping size and clearing size for B.A. Whitworth, B.S.F. and metric sizes follow. There are many other valuable details on the chart which costs 1/-.

FULL-SIZE BOAT KITS

IT is now quite a simple matter to construct your own full-size craft, as it is now possible to purchase kits of parts for making canoes, canoe-dinghies, kayaks, skiffs and outboard runabouts. Each kit comprises a number of galvanised steel sections, cut to shape, edges prepared and ready to assemble. Assembly consists of drilling these sections and bolting them together with interposed water-proofing material. The kit enables one to build a complete craft, but does not include any paint (left to individual choice) or such wood fittings as seats and floor gratings. Bolts, water-proofing material, paddle or oar shafts are all included, and the crate wood in which the kit is delivered will be found useful for floor gratings or keels.

RAWLPLUG SOLDERING IRON

A NEW iron, known as the "de Luxe" is being introduced by Messrs. Rawlplug and is shown above. The bit in this particular model is a fixture and cannot be replaced by the purchaser and the element is of a similar type. The makers claim that this has been done as in the past it has been found that inexperienced replacement of the bit or element often leads to complaints arising from the fact that the work has been carried out in an unskilled manner. The voltage range of the iron has been increased so that the iron is more suited to

the particular voltage available. Thus the iron may now be obtained suitable for 100 to 110; 200 to 210; 220 to 230 or 240 to 250 volts. This eliminates the possibility of the element burning out. The makers state that this iron is as nearly perfect as it is possible to produce and each iron carries a guarantee for six months. The main details of the iron are shown in the accompanying illustration and the price is 9s. 6d.

A CYCLE DYNAMO

CYCLISTS will no doubt be interested in a cycle dynamo set which has now been placed on the market for the extremely

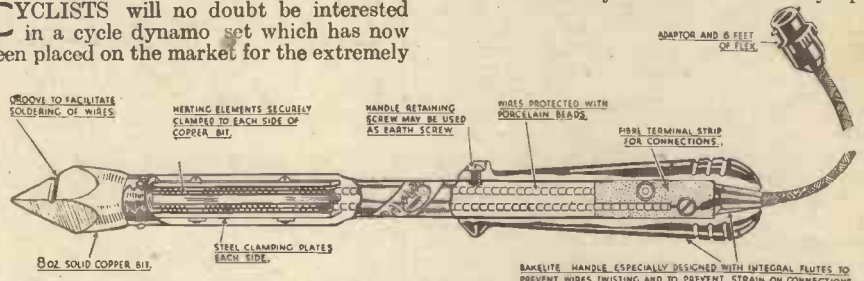

Details of the new De Luxe Rawlplug soldering iron

moderate price of 15s. The set includes a headlamp (3 1/2 in. diameter), tail lamp and a chromium-plated dynamo. A feature of the lamp is that it is fitted with a dipping device.

A FREEHAND LETTERING PEN

THE illustration shows an extremely useful pen which may be used for

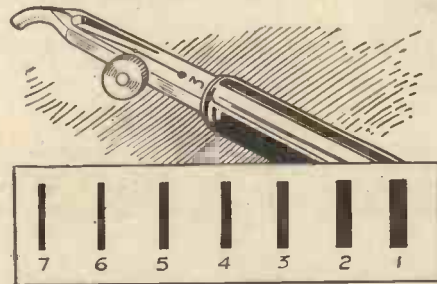

A freehand lettering pen for draughtsmen

lettering engineers' and architects' drawings, ticket-writing, border lining, etc. The "nib", having a round point, enables a line of the same gauge to be drawn in any direction. Made in seven sizes the reservoir of pen No. 1 holds sufficient ink for fifty letters, 5/8 in. in height, to be drawn and the

The address of the makers of any device described below will be sent on application to the Editor, "Practical Mechanics," Tower House, Southampton Street, Strand, W.C.2

capacity of the smaller sizes is proportionately greater. Made in brass with wooden handles, the pens cost 6s. 6d. each.

EXIDE PRICE REDUCTIONS

SEVERAL important price reductions are announced by Exide in the Hycap

range of cells. These are as follows:

TYPE	NEW LIST PRICE.
	£ s. d.
OCG3-C }	8 6
OCG3 }	
GFG4-C }	10 0
GFG4 }	
GKG5-C }	12 0
GKG5-C }	

At the same time Exide advise us that they are now fitting their famous Indicator to all cells in their "CZG" range, with the exception of the CZG2 and CZG8, at prices at present obtaining for the non-indicator range.

The range of "CZG" cells with Indicators is now priced as follows:

TYPE	NEW LIST PRICE.
	£ s. d.
CZG3-C	11 0
CZG4-C	12 9
CZG5-C	14 3
CZG6-C	16 0

Non-Indicator cells are still available but there is no price advantage to customers ordering CZG cells without indicators.

ERRATA

A SLIGHT mistake occurred in Basset-Lowke's full-page advertisement in our April issue. The price of the Twin Train Continental type 4-6-2 "Pacific" model engine was given as 62s. This should have read 65s.



An attractive dynamo set which costs only 15s.

(Right) The "Palpak" hand cleaning outfit which sells at 2s.





QUERIES and ENQUIRIES

A stamped addressed envelope, three penny stamps, and the query coupon from the current issue, which appears on page 563, must be enclosed with every letter containing a query. Every query and drawing which is sent must bear the name and address of the sender. Send your queries to the Editor, PRACTICAL MECHANICS, Geo. Newnes, Ltd., Tower House, Southampton Street, Strand, London, W.C.2.

WIRING AN A.C. MOTOR

WHAT method of wiring is used for a 3-pole A.C. electric motor? Also, is it possible to reverse an A.C. motor without using gears?

"How can I make a circuit breaker for use with electric trains?" (N. P., Essex.)

IF you wish us to give you details of a 3-pole motor you should send us a sketch complete with all details. It should be noted that for a wound field this is the same as for D.C. The motor can be reversed by changing over the connections at the brushes or at the field, but at one only.

A simple circuit breaker can be made on the lines of the ordinary tumbler switch, and we advise you to get one of these and incorporate the "works" in your own housing.

ROCKET FUELS

WHAT are the formulas of the most economic and powerful powder-fuels and the prices of the chemicals concerned?

"Is it possible to produce liquid air or liquid oxygen on a small scale at home? Also, I have made a small experimental rocket boat, and would like your opinion regarding its efficiency." (V. C., no address.)

THE actual power of a power fuel depends as much upon its mode of packing into the rocket or other device as upon its composition. For all ordinary rocket purposes, you will find that a powder of the following approximate composition will serve your purpose (parts by weight): 10 sulphur, about 4d. per lb.; 15 charcoal, about 5d. per lb.; 75 saltpetre, about 6d. per lb.

To the above powder should be added a very small amount of water and about one-quarter per cent of potassium sulphate. If potassium chlorate is added to it, its rate of burning will be increased. It is, however, very dangerous to grind up potassium chlorate with materials containing sulphur.

It is decidedly impossible for you to produce liquid air or oxygen at home, unless you are prepared to purchase a small air compressor and a portable air liquifier, both of which are very costly articles, but which may be obtained from the British Oxygen Company, Ltd., Walthamstow, London.

Many people have tried to construct a serviceable rocket boat, but with little practical success. In your case, you will probably find that the boat is absolutely uncontrollable and that it will either leave the water or dive right into the latter medium. We certainly do not wish to discourage you in your experiments, but we fear that you have a long and difficult task in front of you in your efforts to produce a rocket-propelled sailing vessel.

You should ascertain from the police whether the experimental use of gun-powders contravene the Explosives Act.

MODIFYING AN ELECTRIC CLOCK

I WISH to drive an electric clock direct from my house mains instead of a battery. Can you tell me what coils to

wind to suit 32-volts input?" (J. H., Antrim.)

WE do not advise coils wound to your mains voltage of 32, the chief reason being that the extra voltage induced causes rapid burning of the contacts. If possible, use only two coils of your charging and lighting battery. Failing this try and set up some form of resistance and have two batteries so that one is being trickle charged when the other is in use.

If you wish to experiment with the coils try No. 38 gauge wire.

SPEED INDICATOR FOR A BOAT

I WISH to fit in a boat speedometer that will register up to 7 knots. I have thought of a device, of which I enclose details, and would like your opinion regarding its efficiency." (J. Y., London.)

DESPITE your detailed description of your proposed contrivance for measuring the speed of a vessel through water, we are not at all clear as to its exact formation.

We take it that you propose to fix to the side of the boat a tube in a vertical position, one end of it being below the water level. You do not say which end of this tube you propose to plug. We assume, however, that it is the lower end which will be thus sealed and that a hole or aperture will be provided in the "front" of the tube (below the water level) so that this hole faces the direction in which the vessel is moving. Under these conditions, water will be forced into the tube and it will certainly rise in it owing to forward pressure, thus, as you say, or, rather, infer, displacing a certain volume of air. When the vessel was perfectly still, the water inside the tube would be at the same level as the water outside it.

We are inclined to doubt whether more accurate readings would be obtained if the water were allowed to travel up a smaller bore tube, since, at all speeds, there will always be a kind of "surge" effect due to the forwards lurching of the vessel (unless it traverses perfectly still water) and this "surge" would be intensified in a smaller bore tube than in a larger one. The matter is, of course, a point which calls for practical experiment, but we should say that a tube of medium-size bore should be the one selected for preliminary trials.

Provided that there are no air leakages at the joints, the length of vertical tubing can be almost indefinite and, as you say, you can, at its upper end, provide a gauge reading by air pressure somewhat on the lines of some of the petrol gauges. We fear, however, that you would find it necessary to design your own type of gauge, since no petrol gauge with which we are acquainted would really function satisfactorily on your proposed instrument.

WHY BE POOR?

When Pelmanism Enables You to Double Your Mental Output.

SOMEONE has said that the human mind, being a product of the struggle for existence, is essentially a food-seeking system.

That is to say, it is a system which enables you to earn your living.

Of course it is more than that, or can be made more than that, by proper training and education. But essentially it is that at present.

It follows, therefore, that unless you are fully utilising your mind you are not earning as good a living as you otherwise would do. And there are tens of thousands of people to-day who are only utilising one-half or one-quarter of their mental powers.

Consequently they are Poor.

In fact, Poverty, in thousands of cases (not in all), is due to poor thinking.

The problem, therefore, is how to utilise the whole of one's mental powers. That is the problem which Pelmanism solves.

Pelmanism trains your mind. It trains it scientifically and on the right lines. It develops faculties which you have allowed to fall into disuse. It teaches you not to be Forgetful, not to be Self-Doubtful, not to be Timid or Irresolute, not to allow yourself to be Depressed or to fall into the rut of Routine.

On the other hand, it develops your Initiative and your powers of Observation, it gives you Self-Confidence and Resourcefulness, it enables you to acquire the art of Concentration, it makes your mind keen, alert and energetic, it doubles your Efficiency, and consequently it increases your Earning Power.

That is why so many people write to say that as a result of taking up Pelmanism they have doubled their incomes, secured promotion, and gained other valuable advantages.

Shop Assistant writes: "Financially I have benefited to a great extent and have received an increase in salary since my last lesson." (S.34028.)

Draughtsman: "I have come to a fuller realisation of my powers. My work has an added zest. My powers of Will, Effort, Memory and Concentration are greater." (B.36094.)

Clerk: "Have gained more Self-Confidence and more Personality. Have improved my memory. Have received an increase in salary." (H.34071.)

Commercial Traveller writes: "It has increased my selling abilities to such an extent that my sales are more than double what they were. It has filled me with Self-Confidence." (R.15149.)

Thousands of similar instances could be given did space permit, and more will be found in the book you can obtain free on application to-day.

The Pelman Course is based on the unique experience gained by the Institute in training the minds of over half a million men and women and embodies the results of the latest discoveries in Psychology. It is fully described in a little book, entitled "The Science of Success," which also shows how you can enrol for a course of Pelmanism on specially convenient terms. A copy of this book will be posted you by return, gratis and post free.

Write (or call) to-day to:

PELMAN INSTITUTE
(Established over 40 years)

130 Pelman House, Bloomsbury Street, London, W.C.1

Readers who can call at the Institute will be welcomed. The Director of Instruction will be pleased to have a talk with them, and no fee will be charged for his advice.

PELMAN (OVERSEAS) INSTITUTES: PARIS, 176 Boulevard Haussmann. NEW YORK, 271 North Avenue, New Rochelle. MELBOURNE, 396 Flinders Lane. JOHANNESBURG, P.O. Box 4928. DURBAN, Natal Bank Chambers (P.O. Box 1489). DELHI, 10 Alipore Road. CALCUTTA, 102 Clive Street. AMSTERDAM, Damrak 98. JAVA, Malabarweg, Malang.

VARNENE OIL VARNISH STAIN



will make a better job of it

Woodworkers and Model makers will find "Varnene" Oil Varnish Stain the most efficient method of giving a professional finish to their handiwork. "Varnene" ensures a high-gloss finish of extreme durability. Its stain sinks deeply into the wood, leaving the varnish to provide a tough surface which will not readily chip or scratch. Insist on "Varnene," the finer quality Oil Varnish Stain.

In Dark Oak, Walnut, Mahogany, Light Oak, Ebony Black and Clear (Colourless) Varnish. From Handicraft Stockists, Ironmongers, Oilmen, Grocers and General Dealers.

TINS 6d., 1/- & 1/6.

VARNENE The finer OIL VARNISH STAIN

Ci iswick Products, Ltd., London, W.4.

V/DY/57

An Absorbing Hobby

BUILDING A STUART MODEL IS AN ENROSSING PASTIME, AND THE RESULT A CONTINUOUS PLEASURE



We Illustrate:

STUART NO. 10. High Speed Steam Engine. Bore $\frac{3}{8}$ ". Stroke $\frac{3}{8}$ ".

Each set is quite complete—drawings and instructions are included.

If you have a lathe—		
The rough castings	- - -	8/6
If not—		
Fully machined set	- - -	18/6
Ditto, with all holes drilled and tapped	- - -	25/-

This and many other Stuart engines are fully described in the 72-page CATALOGUE No. 3, 6d. post free.

STUART TURNER LTD. HENLEY - ON - THAMES

DRIVING A SEWING MACHINE

"I HAVE a 1/16 h.p. 240-volt A.C. single phase split phase motor induction motor with which I wish to drive a sewing machine. Could you give me details of a foot control for use with the above motor?" (O. P., Middlesex.)

WE advise you to look up a recent article on making a spot welder, which appeared in our December, 1937 issue. In this, full particulars were given for making a foot control; you require a good tumbler switch and spiral spring and base together with the usual odds and ends.

Connect up as an ordinary switch, i.e., in series with the machine.

WATERPROOF CYCLE CAPE

"I HAVE designed a waterproof cycle cape which I think is novel, and would like your opinion as to its suitability for protection by letters patent." (S. B., Cheshire.)

THE proposed improvement in waterproof cycling capes is not thought to be sufficiently novel to form fit subject-matter for protection by letters patent. Many years ago it was proposed to insert a panel of transparent material in an umbrella so that the user could see through it, and there would be no patentable invention in the use of a transparent panel of celluloid inserted in a cape for an analogous purpose.

A MAINS ELECTRO-MAGNET

"CAN you give me details for constructing a powerful mains electro-magnet, and also tell me where to obtain the necessary parts?" (G. H., Halifax.)

USE a laminated core and make it $\frac{3}{4}$ in. diameter, and use 3 lb. of No. 24 D.C.C. wire.

This type electro-magnet is for use on 230 volts A.C. only. Messrs. Grafton Electric, Ltd., our advertisers can supply the parts.

A POWERFUL ELECTRO-MAGNET

"I WISH to make an electro-magnet to absorb a current of not more than $\frac{1}{2}$ of an ampere. I require the finished coils to be 1 in. in diameter by $1\frac{1}{2}$ in. in length, using $\frac{3}{8}$ in. diameter cores. The magnet will be required to lift a soft iron armature $3\frac{1}{2}$ in. by $\frac{1}{2}$ in. by $\frac{1}{2}$ in." (S. W., Ditchling.)

WE advise you to make up a brass former of thin material to fit the cores and to wind this to its maximum with No. 34 D.C.C. wire. You are expecting rather much of a single coil to lift such a large armature and we would advise you to try and use two magnets.

EQUIPPING A LABORATORY

1. "I WISH to rig up a laboratory and enclose a rough sketch of the proposed layout.

2. "Is a $\frac{1}{2}$ h.p. A.C. motor of ample power for driving belting, etc?"

3. "What type of D.C. dynamo is most suitable for laboratory work?"

4. "Can you give me any suggestions on equipment?" (H. H., Whitley Bay.)

1. YOUR suggested arrangement of a laboratory is quite a good one, provided that you have taken care to have adequate lighting on the experimental benches. Your layout does not indicate the situation of the room windows and it does not disclose whether there are any roof lights. Adequate lighting, preferably daylight lighting, is absolutely essential for experimental work and the layout of any laboratory must be planned with this fundamental in view.

If possible, each experimental bench should be equipped with at least one deep sink and, of course, with at least one or

two water taps. Shelves for reagents and other chemicals should be provided close to the benches, if not actually on them and the laboratory should be fitted up with a "stink cupboard" in which experiments involving the production of unpleasant-smelling or highly poisonous gases and vapours can be carried out. This "stink cupboard" must, of course, communicate with a flue, shaft or suitable ventilator through which the noxious vapours may escape into the open air.

If, by any means, you can equip the laboratory with hot water, it will be an enormous convenience. If possible, also, provision should be made for washing the hands after a long spell at the benches. This implies the supply of soap, towels, etc.

2. For ordinary "light laboratory" use, a $\frac{1}{2}$ h.p. electric motor is quite powerful enough. Such a motor will drive light shafting, operate several mechanical stirrers at a time, operate bottle-shakers, etc. and perform many other useful operations. For heavy lathe or other strictly "mechanical" work, however, such a motor would, no doubt, prove to be under-powered.

3. It is not possible to answer this query satisfactorily, since we are not aware of the purpose for which you require the dynamo in your proposed laboratory. We would, therefore, suggest that you sent an enquiry along to Electradix Radios, Ltd., 214 Upper Thames Street, London, E.C.4, indicating the purpose for which you require a D.C. dynamo and asking them to quote you prices for any new or second-hand instruments which they think might suit you.

4. The main requirements of a laboratory are ample (but not too much) space for experimental working and an adequate supply of store cupboards. If weighing operations are to be carried out, the balance or balances should be kept in a separate room or, at least, on a separate table. Receptacles should be provided for waste paper, broken glassware, etc. A plain wooden floor is the best for most laboratory purposes. Photographic materials—plates, paper, etc.—should be stored outside the laboratory altogether, as these are very liable to become spoiled by fumes. Finally, due regard should be paid to the adequate ventilation and heating of the laboratory.

CORRECTION

REGARDING the article on the G.P.O. Speaking Clock in last month's issue, we stated that the time could only be received in the Metropolitan area. This is, of course, incorrect. Our contributor meant to imply that you can only dial Tim in the Metropolitan area. It is possible, of course, to receive the time signal over the telephone in any part of the country.

Join Newnes' Practical Group PRACTICAL & AMATEUR WIRELESS

The popular Radio and Television Weekly
2d. EVERY WEDNESDAY

PRACTICAL MOTORIST

The owner-driver's weekly which tells you how to repair, overhaul and obtain the best performance from your car.

3d. EVERY FRIDAY

NOTES AND NEWS

The Lumvisor

SUPPOSING you are alone in your house at night, and there is a knock at the front door when no caller is expected, it is extremely difficult to ascertain who the caller is without opening the door. A device has recently made its appearance in this country which enables one to see the caller without being seen, no matter where he or she is standing. The invention is known as the lumvisor, and consists of a series of lenses built into a metal frame. The caller is seen in a three-inch mirror at one end,

be able to see the light long before they reach the aerodrome.

The clock is driven by four "Sectric" turret clock movements, one for each dial, and will thus provide Greenwich time for thousands of people in the surrounding districts.

World's Longest Chain

THE cable ship *Lord Kelvin* recently left Hoboken, New Jersey, to plough ocean cables into the Atlantic Ocean. It had on board what is claimed to be the world's

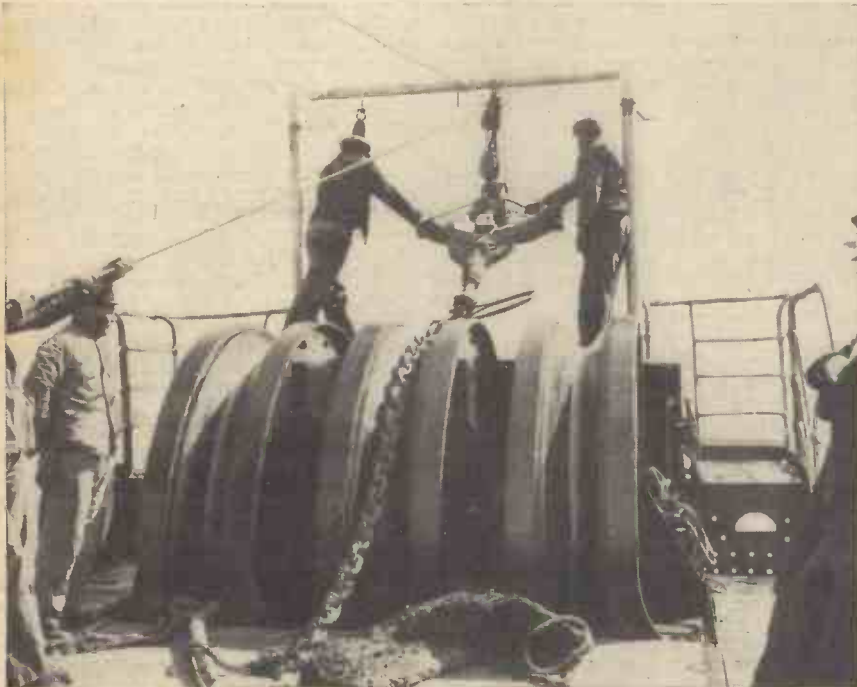

On board the cable ship "Lord Kelvin" showing part of what is claimed to be the longest and most unusual chain in the world. It will be used for ploughing cables into the ocean bed.

yet the only part visible outside the door is a hole the size of a nail head. Some readers may say, supposing the caller spots the lumvisor hole and places his or her hand over it? This should indicate to the householder that the caller does not wish to be seen, therefore, the door should not be opened.

A Beacon for Airmen

A CLOCK which will provide a beacon for airmen flying over London at night and also supply Londoners for miles around with Greenwich time, has just been erected on the new building at Cricklewood, N.W.2, of S. Smith & Sons (M.A.), Ltd.

The chaplets and hands are brilliantly illuminated at night by white neon lighting. It is believed that this is the first clock in London to be illuminated in this manner.

The clock has four dials, each 10 ft. square, and each pair of hands is 5 ft. long. When not illuminated, the clock's figures and hands are black and the face in pure white, thus, owing to Cricklewood being in a high district, the clock can be clearly seen and read some miles away even during the day. At night the neon is switched on, and the clock then provides a beacon which can be seen from many vantage points around London.

Airmen flying to and from Herndon will

longest and most unusual chain. The chain comprises 12,500 nickel steel links, each weighing 3½ lb. It is 4,200 ft. long and weighs 43,000 lb., and is capable of standing as much as 65,000 lb. stress. The ploughing of cables into the ocean bed is designed to protect them from the heavy drags, known as otterboards, which are attached to fishing nets dragged along the ocean bottom by steam trawlers, which are most numerous off the Irish Coast. The otterboards cause an annual damage estimated at £125,000 to the combined cable systems of the world.

The New Thunderbolt

CAPTAIN GEORGE EYSTON'S Thunderbolt has undergone a number of alterations for its next attempt on the land speed record. The car has been fitted with a new body and its length has been increased from 30 ft. to 36 ft. Wheel cowlings which just clear the ground have been fitted to the wheels to prevent air eddies underneath the car. The cockpit has been adjusted and is now raised on each side to form blinkers for the driver. The tail is now tapered and sharpened to form a gradual sweep and the nose is eighteen inches longer. The supercharger intakes have been moved forward and the wind-obstructing bumps over the wheels have been removed.

BARGAINS by ELECTRADIX

ELECTRO-MAGNETS for Mains or Battery. Lift 14 oz. 3/6; 10 lbs. lift 5/-. 6-volt Solenoids, ¼ in. travel, 1 oz. lift, 3/6. 6-volt two-way Relays, 6/-. Remote Radio Control, 1 mile Radio Transmitters, 25/-. Coherers, 5/-. 10,000-ohm Relays, 4½/oz. only, 10/-. Fierce Spark, 8-volt coils, 10/6. Shocking Coils, with handles, 2- to 4/6.

MICROPHONES. Button Mike, 1/-. Bakelite Transmitter No. 11, 5/6. Brass with announce grille 11a, 7/6. Table Mike and Transformer combined, Set PM11, 15/-. Crystal Sets work on any aerial 5/6 and 7/6 for B.B.C. **HOME RECORDERS.** For Radiogram, with 4 blanks, complete and ready for use, 37/6. Spare 10 in. Blanks, 4/- doz. Tone Filters eliminate needle scratch, 1/-.

TELEPHONES. House, Office and Field types, cheap. Hand-combination receiver-transmitters, 7/6. See May advert. Big Alarm Bells, 10 in. dia., 39/-. **DIX-MIPANTA VEST POCKET TESTER.** A versatile moving-iron multi-range meter for service on A.C. or D.C. THREE ranges of volts: 0-7.5, 0-150, 0-300. Used for MILLIAMPS, reads: 12½ m.a., and 75 m.a. In black bakelite case, 2½ in. by 2½ in. with pair 19/6 of test leads and plugs.

MOTORS. All sizes from 1/40 h.p. 15/-. ¼ h.p. D.C. Motors, 25/-. **MORSE KEYS.** Air Force Keys with indicator lamp, K.B.S.L., 7/6. Practice Sets, complete with buzzer, and tape Reel, 3/6. 4/9. Morse Recorder Tape, 6d. roll. Mahog. Case **ELECTRIC SOLDERING IRONS.** Large workshop pattern, 220/250 volts, 6/6. Distant Thermometers with 6/8-ft. tube, 2½ in. dial, 0 to 100 deg. C., 7/6. Small 2-volt Accumulators, 10 amps., 2/-, 20 amps, 3/6, postage extra. A.C. Hand Generators for ringing and circuit testing, 9/6.

WIND DYNAMOS for windmill drive, 6 volts, 10 amps., slow speed, 35/-. Lucas Aero high speed, 6 volts, 5 amps, and 800 volts, 80 m/a, 25/-. Electric Pumps deliver 120 galls. to 6 ft., A.C. or D.C., 67/6. Electric Air Compressors for paint spray, etc., £5 15s. Parcels of Experimental Odd Coils, Magnets, Chokes, Wire Switches, Terminals, etc., post free, 10 lbs, 7/-, 7 lbs. 5/-.

Have you got our new July Bargain Sale List "P.M." of 12 large pages, 100 illustrations of what you want?

ELECTRADIX RADIOS
218, UPPER THAMES STREET, LONDON, E.C.4
Telephone: Central 4611

15/-

15/-

WHY BE THIN?

DOCTORS RECOMMEND

VITAEPON (BRAND)

The Proven Remedy for Thin and Run-down Folk

A Customer writes:

"I have gained 20½ lbs. in healthy muscle from your course of Vitaepon, I am not ashamed to show my physique anywhere."

Vitaepon is the original remedy for thinness. Refuse all cheap substitutes.

Order through any high-class chemist or send P.O. direct to:

WESTCOTT & CO. (Dept. P.M.)

37 Albemarle Street, Piccadilly, London, W.1. A Week's treatment costs 3/-, or 15/- for full six weeks' course. A new book on "Thinness: Its Cause and Cure," sent free with every six weeks' course. Vitaepon is harmless to heart and digestion.

LUTON MINOR with 35-h.p. LUTON ANZANI, Dual Ignition, Starter, £225. Materials, £40. Semi-manufactured, £75. Blue Prints, 25s.

LUTON AIRCRAFT LTD., Phenix Works, Gerrards Cross

GIVE ME 7 DAYS TO PROVE I CAN MAKE YOU A NEW MAN—

I changed myself from a 7-stone weakling to winner of the title "The World's Most Perfectly Developed Man." Let me prove—in 7 days—that my secret of *Dynamic Tension* will make a NEW MAN of YOU—give you glowing health, smashing strength—banish constipation, bad breath, pimples. Thousands praise my natural methods. Write for FREE BOOK of actual photos.

SEND FOR MY FREE BOOK

CHARLES ATLAS (Dept. 10/6), 2, Dean Street, LONDON, W.1.



"Deary me,"
moaned the ten-
derfoot scout,
"Now the jolly old
fire has gone
out."
Cried Scoutmaster
Willie,
"It's a leak in the
billy;
A case for FLUX-
ITE, beyond
doubt!"

See that FLUXITE is always by you—in the house—garage—workshop—wherever speedy soldering is needed. Used for 30 years in government works and by leading engineers and manufacturers. Of Iron-mongers—in tins, 4d., 8d., 1/4 and 2/8. Ask to see the FLUXITE SMALL-SPACE SOLDERING SET—compact but substantial—complete with full instructions, 7/6.

Write for Free Book on the ART OF "SOFT" SOLDERING and ask for Leaflet on CASE-HARDENING STEEL and TEMPERING TOOLS with FLUXITE.

TO CYCLISTS! Your wheels will NOT keep round and true unless the spokes are tied with fine wire at the crossings AND SOLDERED. This makes a much stronger wheel. It's simple—with FLUXITE—but IMPORTANT.

THE FLUXITE GUN

is always ready to put Fluxite on the soldering job instantly. A little pressure places the right quantity on the right spot and one charging lasts for ages. Price 1/6.



ALL MECHANICS WILL HAVE

FLUXITE

IT SIMPLIFIES ALL SOLDERING

FLUXITE Ltd., Dept. P.M., Dragon Works, Bermondsey St., S.E.1



MINIATURE PETROL ENGINES . . . for Aero-planes and Speed Boats. 1 c.c. 3 and 6. Easily made from our Castings, 12/6 per set. Complete Engines ready to run, £3 15.

SEND 3d. FOR PARTICULARS

J. HALLAM & SON, Upton, Poole, Dorset

BE A MAN!

STRENGTHEN YOUR VITAL FORCES!

Are you a victim of Inferiority Complex, Self-Consciousness, Unreasonable Fears, Bad Concentration and Memory, Timidity, Lack of Self-Control, Weak Will, Bad Habits, Thinness, Flabbiness, Nervous Disorganisation, etc.

To trace the cause, write for my free book—

"DO YOU DESIRE HEALTH?"

Sent POST FREE in plain envelope.

Also write to me fully in confidence for a FREE and considered Opinion of your case.

Over 30 years' experience in the drugless Treatment of Nervous disorders and ill-health arising from weakening and health-destroying habits and a lack of manly self-control.

All replies and books sent in plain sealed envelopes.

T. W. STANDWELL, Curative Physical Culture Consultant
Dept. P.M., 329, High Holborn, London, W.C.1

When replying to advertisers please mention "Practical Mechanics"

BUILDING THE P.M. MODEL YACHT

(Continued from page 526)

spiling batten and clamp it into the rabbet in the stern-knee or dead-wood, so that it runs forward just above the keel rabbet and parallel to it. The garboard strake, or bottom plank, should be about 1 in. wide aft tapering to about $\frac{3}{8}$ in. forward. It is not, however, quite as simple as that because, owing to the twist in it for the swelling bilges amidships, the bottom edge will have a curve in it. The proper use of the spiling batten will make this clear.

Marking Out

Having fixed the batten to the dead-wood rabbet, clamp it again to rib 7 and then draw the lower edge in to the stem near where it joins the keel. Cut the batten on a slope so that it lies in the bottom of the stem-rabbet and clamp it tight. Now set your compasses to a gap just a shade wider than the biggest gap between the bottom of your batten and the bottom of the keel rabbet. Then with the point in the angle of the rabbet make little arcs on the batten every inch or so along its length, and closer together where the keel joins the stem.

Remove the batten and lay it parallel to and about $\frac{1}{2}$ in. from the edge of the $\frac{1}{2}$ in. mahogany board from which you are going to cut the garboard strakes. Using a T-square, from the edge of the board draw lines across from the edge of the board to the furthest points of the arcs on the batten. With the compasses set to just under $\frac{1}{2}$ in., mark each line on the board with the point placed at the junction of the line and the arc on the batten. In this way you will have transferred a spiling of the rabbet to the mahogany. Join all the marks in a fair curve, using a batten and weights and then cut just outside this curve. Cut the other or top side of the strake to a straight line, so that it is just over 1 in. wide aft and $\frac{3}{8}$ in. forward. Cut a duplicate strake for the other side of the boat and at once mark them with a chalk S on one (starboard) and P on the other (port). Test for fit and adjust, where required, with a plane.

Drill, screw and glue the garboard strakes into the stern-rabbet, holding them well down into the keel rabbet with clamps. The whole keel rabbet should have been well glued at this stage. Working from aft forwards, screw from inside through the holes in the ribs into the strakes, using $\frac{3}{8}$ in. No. 1 brass counter-sunk screws, two to each rib on each side. Before screwing to ribs 3, 2 and 1 check the fit of the planks in the stem-rabbet, then glue the rabbet, clamp up and screw up to the remaining ribs. Drill and screw nearer the lower edge of plank into the stern.

Work upwards from the garboard strakes with planks about $\frac{1}{2}$ in. aft and $\frac{1}{2}$ in. forward, spiling and cutting and fitting as before and glueing the edges. These planks are called broads. When you reach the counter or horn timber where the stern begins to flare outwards sharply, steam the after end of the plank, about 6 in., very thoroughly, to get the twist into it and sandpaper smooth.

At this stage measure with battens along the curves of the transom, ribs and stem the amount left unplanked, and divide these lengths by five. The resulting measurements will give the width of the five remaining planks on each side at each position. Draw centre lines and with compasses lay off half these distances on each side from points taken by setting off the measured distance from each rib to the next. Cut four of these planks for each side, fit and fix them, using clamps to keep them tight

to the next plank while screwing. Then fit and fix the remaining "closing plank" on each side.

The deck is best cut in one piece from 8-in. sycamore and must be a close fit inside the sheer-strake when pressed firmly down on all the deck beams. The hole for the hatch or cabin-top should be cut before fixing the deck, but the hole for the rudder-tube will be drilled afterwards. Note that the plan of the deck-beams does not allow for an elaborate hatch-way, but if the builder wishes to leave a larger opening, he can cut beam 5 and fit earlines between beams 4 and 6 as was done between beams 2 and 4 for the mast-slide.

Mark off on the deck, very lightly in pencil, the position of the deck-beams and check by putting the deck in position and moving it very slightly to each side in turn to reveal the ends of the beams. On the centre line of each beam mark points $\frac{1}{2}$ in. inboard from the edge of the deck, and drill $\frac{1}{8}$ in. holes and countersink. When dry, rub the deck smooth with fine sandpaper, rule with pencil lines $\frac{1}{8}$ in. apart for planting, and lightly varnish.

Replace the deck in position and fix to all beams except No. 3 with $\frac{1}{2}$ in. No. 0 brass C/S screws.

The Rudder Tube

The hole for the rudder tube can now be made with a length of steel rod of $\frac{3}{8}$ in. diameter, and the tube smeared with water-proof glue and pushed through so that it projects $\frac{1}{2}$ in. above the deck.

The shroud-plates, stay-plates, sheet horse and cleats are bent up from $\frac{1}{16}$ in. aluminium sheet and drilled and counter-sunk as shown and fixed to the deck and deck beams with $\frac{3}{8}$ in. No. 1 brass screws.

The mast is cut from $\frac{1}{2}$ in. planed deal. Plane it nearly to section and finish with sandpaper. The cross tree is cut from the same wood but finish round. Cut it $\frac{1}{2}$ in. too long and grip in the drill chuck and spin it between fine sandpaper held in the fingers. Slide the cross tree in its housing down the mast and fix it with one $\frac{3}{8}$ in. No. 0 screw. Fix the rigging bands and goose-neck and then varnish the mast and cross tree.

Bend up and drill the mast-slide and screw it to the deck, earlines and beams 2 and 4 as shown. Step the mast and rig with fore-stay, back-stay and shrouds. Bowsies are shown for setting up the standing rigging but rigging screws can be used if desired. Wire rigging is not suitable for use with bowsies, as it cuts them and works loose. Proper cordage is easily obtainable and quite necessary and it should be waxed. Note that the main and jib halliards are reeved through blocks and not through holes in the mast and that they are bowed down to eye-plates screwed through the decks to No. 3 short deck-beams.

The boom is cut from $\frac{1}{2}$ in. beech or deal and the boom socket is bent up from $\frac{1}{16}$ in. aluminium drilled as shown and bolted to the boom with 6 BA bolts and nuts. The rigging eyes are easily made from 22 SWG tinned copper wire soldered solid and then drilled. The ends of the wire are then bound round the boom and lightly soldered.

Cut the sails from union silk, but instead of binding the edges other than the selvage turn them in twice and machine them. Hooks and eyes are easily sewn to this hem as shown and will stay put indefinitely. The mainsail is set by hooking to the jack lines on the mast and boom and tightening the halliard. The staysail is hooked to a jack line on the boom and set taut by the halliard.

BUY, EXCHANGE OR SELL

Advertisements are accepted for these columns at 3d. per word (minimum 12 words at 3s.—advertisements of less than 12 words are charged at the minimum rate of 3s.) subject to a discount of 2½% for 6 consecutive monthly insertions or 5% for 12 consecutive monthly insertions. **TERMS:**—Cash with order. Cheques, Postal Orders, etc., should be made payable to George Newnes, Ltd. The Proprietors reserve the right to refuse or withdraw advertisements at their discretion. All advertisements must be received on or before the 5th of the month preceding date of publication and should be addressed to the Advertisement Manager, "Practical Mechanics," George Newnes Ltd., Tower House, Southampton Street, Strand, W.C.2.

CANOE

BOAT AND CANOE. Home Kits from 27s. 6d. All types completed craft. List stamp. Trade supplied.—Metacraft (P), Christchurch, Hants.

CINEMATOGRAPHY

ART CINE FILMS. Exclusive 9.5-mm. and 16-mm. Projectors from 35/-. Cine Cameras 75/-. Used Bargains. Part Exchanges. Catalogue Free.—P. M. Dane, 64 Stanley Street, Liverpool, 1.

CINEMATOGRAPH FILMS. Standard Size from 6d. 100 feet. Machines, Accessories, Sample Films 1/- and 2/6 post free. Catalogues free.—"Filmeries," 57 Lancaster Road, Leytonstone, E.11.

WANTED IMMEDIATELY for CASH—Small lathes, precision tools, fractional A.C. motors—Microscopes, telescopes, binoculars—Modern cameras and enlargers—Home-cine films, cameras and projectors. Highest cash prices paid.—Frank, 67 Saltmarket, Glasgow.

CLOCK MOVEMENTS

CLOCK MOVEMENTS of every description ready for cases. Lists and hints on case making post free.—Needham, 25 Stratton Road, Manchester, 16.

ELECTRICAL

SURPLUS ELECTRICAL PLANT—Battery Chargers, A.C., D.C. Motors, Converters, Polishing Grinders, Circuit Breakers, and repair Specialists. Guaranteed. List Free.—Easco, 18pm, Brixton Road, S.W.9.

SUPER A.C. MOTORS. Brand New, 1/10 h.p., 30/-; ¼ h.p., 38/6; ½ h.p., 38/6; ¾ h.p., 55/-; larger sizes. Electric Tools, Machines, Pumps, Compressors, etc.—John P. Steel, Clyde Street Mills, Bingley.

FORMULAS

Make money with Formulas. Catalogues, literature, 4½d., Smith, 3, Wellington Street, Salford 3.



PROTRUDING EARS

ORO, a simple modern method sets them in position immediately. Invisible—Comfortable—Harmless, used any time by adults and children. Endorsed by physicians and users as the best method for correcting this ailment. Write for free booklet and testimonials to—

M. TRILETY (R 158)
45 Hatton Garden, London, E.C.1.

HEIGHT and FIGURE BUILDING BY SCIENTIFIC METHOD

Enables Everyone to Gain a Tall, Well-Built Figure and Good Deportment.

YOU can add inches to your height and improve your figure by means of a marvellous new appliance known as the "ROTA" HEIGHT AND SPINAL APPLIANCE.

Spine culture is the secret. There are thirty-three spinal bones, "buffered" by pads of cartilage. It is the *quickest growing substance in our bodies.*

The "Rota" scientifically stretches the spine. By so doing, it opens out the bones, and allows the cartilage to grow.

Both men and women who were below normal height have in actual cases added from 1 inch to 4½ inches to their stature.

All who desire a taller figure, stronger nerves, and a physically sound, well-proportioned figure with the good deportment which results from an upright, natural carriage should start straight away on the "Rota" scientific height-increasing and figure-building method.

FREE BOOK Order Now or Apply for **FREE BOOK.** Special price to readers of "Practical Mechanics," 25/- only (Abroad 4/- extra) or 11/- down and Three Monthly Payments of 5/2. CHAS. T. TREVOR (Dept. Pr.M.), 17 Penford St., Camberwell, London, S.E.5.



The 'ADEPT' Bench Hand Shaper

Length of stroke of ram, 3½ ins.; Length of cross travel of slide, 3 ins.; Size of Table, 4½ ins. — 4 ins.; Rise and fall of Table, 2 ins.; Vertical feed of tool slide, 1½ ins.; Maximum distance between tool and table, 3 ins.; Weight, 18 lb. Also the 'Adept' No. 2B.H. Shaper, 6½-in. stroke. Price 26-9-6.

Manufactured by **F. W. PORTASS**
SELLERS STREET, SHEFFIELD

NERVOUSNESS

Every nerve sufferer should send for my interesting book, which describes a simple, inexpensive home treatment for Self-consciousness, Blushing, Depression, Worry, Insomnia, Weak Nerves, Morbid Fears, and similar nervous disorders. This wonderful book will be sent in a plain sealed envelope to any sufferer without charge or obligation. Write NOW and learn how to conquer your nervousness before it conquers you!

HENRY J. RIVERS (Dept. (K.D.8.) 40 Lamb's Conduit St. LONDON, W.C.1.

HAVE YOU A RED NOSE?

Send a stamp to pay postage, and you will learn how to rid yourself of such a terrible affliction free of charge.

Address in confidence—**P. TEMPLE, Specialist**
"Palace House," 128 Shaftesbury Avenue, W.1 (Est. 37 years.)

OUR ADVICE BUREAU COUPON

This coupon is available until July 30, 1938, and must be attached to all letters containing queries, together with 3 penny stamps. A stamped addressed envelope must also be enclosed.
PRACTICAL MECHANICS, JULY, 1938.

LITERATURE

CALVERT'S MECHANICS YEAR BOOK, 1938. Over 190 pages. Illustrated Workshop Hints and Calculations. 8d. post free.—Endors & Co., Progress House, 75 Wood Street, Manchester, 3.

MICROSCOPY

THE MICROSCOPE. The British Journal of Microscopy and Photomicrography, 1s. monthly. All Newsagents, or 1s. 1d., post free, from The Microscope, 20/21 Took's Court, London, E.C.4.

MISCELLANEOUS

"PHOTO-ENGRAVING."—A practical Handbook with complete set of materials for engraving printing blocks, 4/6.—Industries, 2 Waldegrave Park, Twickenham.

A 50-TON stock of Carbons, every size and type, including battery. Low prices. London Electric Firm, Croydon.

CONTRACTING DRAUGHTSMEN. Drawings made from sketches, patterns or ideas. Tracings and prints made. Moderate fees. Write, Rayner, 198, Moor End Lane, Erdington, Birmingham.

MODEL ENGINES

AERO ENGINE SETS.—Baby aero castings as low as 5/9. Tiptop ½ h.p. sets, water or air-cooled 9/9. Charging dynamos, ball-bearing enclosed, from 8 amps, 15/-. Boat propellers, tubes, fittings. Castings made in any metal. Instructive, interesting catalogue 3d. Write—Butler's, Profit-Sharing Works, Wade Street, Littleover, Derby.

MODELS

FOR MODEL AND EXPERIMENTAL WORK send your requirements to—Models, 1 Waverley Place, Salisbury, Wilts.

MUSICAL INSTRUMENTS

BAND GUIDE. Hints on the Bugle, Drum, Flute, Staff Parade formation, etc. Free, post paid.—Potter's (Manufacturers), West Street, London, W.C.2.



How to Obtain

A Perfect-Looking Nose

My latest improved Model 25 corrects all ill-shaped noses quickly, painlessly, permanently and comfortably at home. It is the only nose-shaping appliance of precise adjustment and a safe and guaranteed patent device that will actually give you a perfect-looking nose. Write for free booklet and testimonials.

M. TRILETY, SPECIALIST (D.257),
45, HATTON GARDEN, LONDON, E.C.1.

OO GAUGE MODEL RAILWAYS

On page 507 of last month's issue the Editor gave an invitation to visit us and inspect our range of 00 gauge models. We shall be glad to welcome YOU; there is no obligation to purchase.

If not in London, or unable to come, send for our 1938 60-page, fully illustrated catalogue, price 6d.

WRITE NOW TO
HAMBLINGS
10 Cecil Court, Charing Cross Road, W.C.2.

SKYBIRDS

WORLD FAMOUS AERONAUTICAL MODELS

Now Ready:

THE HAWKER "HURRICANE"
Constructive Set, price 2/6

IF YOU ARE INTERESTED IN SMALL SCALE MODELS

Write for SKYBIRDS FREE LIST, or for a copy of "AIR REVIEW" post free 1d.

The Official Organ of the SKYBIRD LEAGUE

Address:—"SKYBIRDS" (Desk P.M.),
3, Aldermanbury Avenue, LONDON, E.C.2.

BUY, EXCHANGE OR SELL

PATENTS

REGINALD W. BARKER & CO. (Established 1886), 56 Ludgate Hill, London, E.C.4.—Patent and Trade Mark Booklets Gratis.

PATENTS AND INVENTIONS

WE SUCCESSFULLY SELL inventions, patented and unpatented. Write for proof, and tell us what you have for sale.—Chartered Institute of American Inventors, Dept. 104, Washington, D.C., U.S.A.

PHOTOGRAPHY

"PANTOGRAPHS" make large accurate drawings from small photographs, etc., easily. 1/—Cooke, 33 Hawthorn Road, Levenshulme, Manchester.

£500 worth, good, cheap Photo Materials, Films, Plates, Cards, Papers, Chemicals, Catalogue and 4 Samples free.—Hackett's Works, July Road, Liverpool 6.

DON'T TAKE RISKS. Good developers mean good results. Our reliable stock developers keep twelve months after mixing. Satisfaction certain to amateurs and professionals. Best developers ever put on the market. Makes two pints strong developer. 6d. each, 6 for 2/3, 12 for 4/-. Post free.—Hackett's Works, July Road, Liverpool 6.

PHOTOGRAPHIC MATERIALS. Plates, Films, papers, etc. Keen prices. Factory fresh always. Interesting money-saving lists free.—"KIMBER'S," 105 Queen's Road, Brighton.

SITUATIONS VACANT

G.P.O. ENGINEERING DEPT. (no experience required). Commencing £3/13/0 per week. Age 18-23. Excellent prospects. Free details of Entrance Exam. from B.I.E.T. (Dept. 579), 17-19 Stratford Place, London, W.1.

G.P.O. ENGINEERING. Exceptional opportunities for young men age 18-23. Commence £3 13s. per week, increasing to over £12 weekly. No experience required. FREE details of entrance requirements from C.C. (Dept. 275), 335 High Holborn, W.C.1.

BECK'S CHEMISTRY

BUILD UP A HOME LABORATORY

MANY EXPERIMENTS NEED TUBING OF DIFFERENT LENGTHS AND SHAPES. THESE ARE PROVIDED IN THE SET OF

GLASS TUBING

STRAIGHT, ACUTE AND OBTUSE ANGLES, SYPHONS, DELIVERY TUBES, RIGHT ANGLES, ETC., TOGETHER WITH RUBBER CONNECTION TUBING AND MOHR'S CLIP. **2/6** Carr. Paid

Catalogue FREE on request. Booklet of Tested Experiments, 6d. Post Free.

BECK (Scientific Dept. A), 60, High St., Stoke Newington, London, N.16.

use Bakers' SOLDERING FLUID

"Easily the Best Soldering Fluid Obtainable." This statement by a regular user of "BAKER'S" expresses the general opinion of the Motor and Engineering Trades. Sold in 6d., 1/- and 1/6 tins, also in bulk.

"For a quick clean job!"

Sir Wm. BURNETT & Co. (CHEMICALS) LIMITED
GREAT WEST ROAD, ISLEWORTH, MIDDLESEX
TEL. HOUGHLOW 0478

PORTASS LATHES

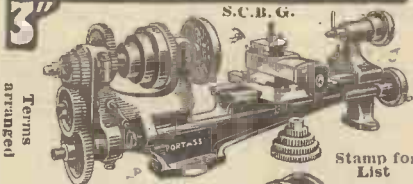

AMAZING OFFER
USUAL PRICE £6.16.0

£3.15.0

MODEL "S." Crate 2/6. Takes 12 1/2 in. bet. cen. To take 18 in. extra 15/-. Compound Rest extra 15/6. Money returned if you are not delighted.

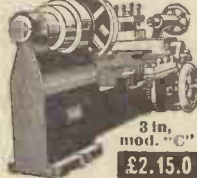

3 in. mod. "C"
£2.15.0

PORTASS LATHES, BUTTERMERE RD., SHEFFIELD

JUBILEE WORM DRIVE HOSE CLIPS



The long-life clip with the ever-tight grip
The Best Known
For Radiator Joints
Air, Oil, and Water
Hose Joints.

We guarantee a Tight Joint

Stocked by all Garages and Accessory Dealers.

L. ROBINSON & CO.,
25 London Chambers,
GILLINGHAM, KENT.

MAKE MORE MONEY

£3 to £6 weekly can be earned at home in a wonderful business of your own. No matter where you live you can commence to make money in your spare or whole time. No risk, canvassing or experience required. A wonderful opportunity for anyone wishing to add pounds to their income. Particulars stamp.

BALLARD, York House, 12 Hambrook Road, LONDON, S.E.25.

You NEED this "IMPETUS" MOTOR TOOL an Electric High Speed hand grinder, file, router, etc., that SAVES TIME, EFFORT & EXPENSE. Faster, easier and more accurate. Nothing on the market to touch it at 63/- nett. Super model, 54.
Send for detailed specification NOW and be up to the minute.
JOHN P. S. STEEL
Clyde Street Mills, Bingley.



INVENTORS

VALUABLE GUIDE

General Advice Free. POST FREE 6d.
CHATWIN & CO. Est. 1880
Regd. Patent, Design and Trade Mark Agents for all countries.
253 (D) Gray's Inn Road, London, W.C.1.

THE WEBLEY SERVICE AIR RIFLE M&D

NO LICENSE REQUIRED TO PURCHASE
WRITE FOR DESCRIPTIVE P O L D E R
Rooks, Rabbits, Rats, Sparrows and similar vermin can be destroyed by this extremely accurate and powerful Air Rifle ideal for Target Practice.
CALIBRE 22x177 With Lightsight and Peepsight
WEBLEY & SCOTT LG. 106 WEAMAN STREET, BIRMINGHAM, 6

SITUATIONS VACANT (continued)

DRAUGHTSMEN. Numerous vacancies in Engineering, Building, G.P.O., etc., for men age 17-40. Experience unnecessary if willing to learn. Details of openings, salaries, etc., FREE on application to N.I.E. (Dept. 372), Staple Inn Bldgs., W.C.1.

WIRELESS CAREERS

Increased Salaries and Pensions make Radio a profitable and interesting profession. We train students for all branches and guarantee appointments. Britain's leading Colleges. Boarders accepted. Write for free prospectus.

WIRELESS COLLEGE, COLWYN BAY

or Wireless College, Calmore, Southampton

TOOLS

GRAYSON'S Glass-boring Outfits and Tube. Cutters avoid risk.—Below.

DRILLS, Taps, Dies, Files, Chisels and Punches. Best quality at keenest prices.—Grayson & Company, 300 Campo Lane, Sheffield.

BRAND NEW POWER TOOLS of quality. 10 in. Bandsaws, 54/-. Jigsaws, 22/6. Wood Planing Machines, 80/-. Bench Drills, 11/-. Circular Saws, from 25/-. 3 in. S.C. Toolroom Lathes, from £4 16s. New 1 in. Chromium Plated Micrometers, 12/6. Electric Drills, 32/6. Grinders, Spray Plants, Guns, Air Compressors, etc.—John P. Steel, Clyde St. Mills, Bingley.

WATCHMAKING

WATCH AND CLOCK REPAIRS. Everything for the watch, clock and model maker. Large stock of watches, clocks, and clock movements, etc. Wholesale prices. List 3d.—Blakiston & Co., Ainsdale, Southport.

WOODWORK

CABINET HARDWOODS, Oak, Mahogany, Ash, Whitewood, Ply-woods. Lowest Prices. Send Cutting Lists.—Wilfred Parr & Co., March Works, Lancaster Road, Leytonstone, E.11.

7/9 ELECTRIC BOAT MOTOR

Postage 6d.

The famous "WILCO" Motodyne is excellent for speed boats, models, etc. Works off 4-volt battery. Very low current consumption.

ELECTRIC AERO MOTOR. These miniature motors are the smallest in the world: very powerful and work on a small dry battery.
3-V MODEL Price 5/6. Weighs 1 1/2 ozs.
4-V MODEL Price 7/6. Weighs 3 ozs.
Very useful for model aeroplanes or railways.



L. WILKINSON, 204, Lower Addiscombe Road, Croydon, Surrey.

A MAN'S NERVES

make all the difference between success and failure. Conquer weak nerves, inferiority complex, nervous fears, timidity, blushing, self-consciousness—we guarantee this or money back. Complete Course sent privately under plain sealed cover, 5/-.
VIRILITY

VIRILITY

To sufferers from general weakness and lack of stamina, the VIRILE MANHOOD Course is a vital necessity. Recommended by Doctors. Sent privately, 5/-. Booklet, "Vital Courses for Men," sent free (plain envelope).—Success Institute, 28 (M.P.40), Dean Rd., London, N.W.2

FREE SERVICE FOR READERS

READERS requiring information concerning goods or services advertised in *PRACTICAL MECHANICS* should give names of Advertisers from whom particulars are desired. Any number of names may be included and we will obtain for you catalogues, lists, and any other information you may be wanting. **THERE IS NO CHARGE FOR THIS SERVICE.**

Readers desiring particulars from a number of Advertisers will, by this method, save time and postage. Half-penny stamp only is required if your envelope is left unsealed. If any Advertiser stipulates that stamps or postal orders are necessary before samples or catalogues are sent, please enclose the necessary amount with your instructions. You are cordially invited to make full use of this Service.

Post this to

ADVERT. SERVICE DEPT.

PRACTICAL MECHANICS,
TOWER HOUSE, SOUTHAMPTON
STREET, STRAND, W.C.2

Please obtain and send to me particulars from the Advertisers in your July issue whose names I give on list attached.

Advertiser	Page No.	Information Required
------------	----------	----------------------

*Attach sheet of paper, with particulars, and your name and address (written in **BLOCK** letters) with date, to this announcement.*



CHEAP BOOKS FOR THE HANDYMAN

THE HOME MECHANIC SERIES

This series of practical handbooks is designed specifically to help the amateur mechanic or craftsman. Each volume is simply written by an expert and profusely illustrated with photographs and diagrams.

From all booksellers

1/6 EACH

ACCUMULATORS
MOTOR CAR UPKEEP AND OVERHAUL
THE HOME WOODWORKER
MODEL AEROPLANES AND AIRSHIPS
25 SIMPLE WORKING MODELS
THE HANDYMAN'S ENQUIRE WITHIN
SIMPLE ELECTRICAL APPARATUS AND EXPERIMENTS
MODEL BOAT BUILDING
TOY MAKING FOR AMATEURS
LATHE WORK FOR AMATEURS
HOUSE DECORATION AND PAINTING
POWER-DRIVEN MODEL AIRCRAFT
THE HOME ELECTRICIAN

Also available direct by post 1/2 from the publishers

GEORGE NEWNES LTD.

(BOOK DEPT.)

TOWER HOUSE, SOUTHAMPTON STREET, LONDON, W.C.2.

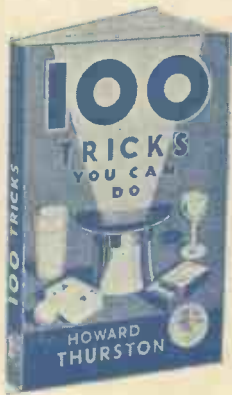

BOOKS for the Entertainer

1/- NET
each.

The Amateur Entertainer Series

★ NEW AND EASY MAGIC

BY NORMAN HUNTER [who writes regularly for "Practical Mechanics"]. A series of Novel Magical Experiments needing no special skill or apparatus for their performance, with suitable patter.

THE BEST TRICKS and How to do Them

BY DAVID DE VANT. Coin Tricks—Tricks with Balls—Card Tricks—Miscellaneous Tricks, etc., etc.

100 TRICKS YOU CAN DO

BY HOWARD THURSTON. Ball Tricks—Card Tricks—Cigar and Cigarette Tricks—Dice and Domino Tricks—Egg Tricks—Match Tricks, etc.

100 MORE TRICKS YOU CAN DO

BY HOWARD THURSTON. Tricks with Cards—Coins—Handkerchiefs—Liquids—Matches—Rings—Sugar—Thimbles—Watches—Paper, etc.

CARD TRICKS Without Sleight of Hand or Apparatus

BY L. WIDDOP. A volume which gives the amateur and semi-professional material for very interesting performances.

THE AMATEUR PERFORMER

How to run a small Concert Party with hints for every member of it, BY W. J. SEYMOUR. The Stage—"Gags"—"Noises off"—Double Turns—Sketches—The Pianist, etc., etc.

THE DRAWING-ROOM ENTERTAINER

BY CECIL H. BULLIVANT. A practical guide to the art of amateur and semi-professional Entertaining, Ventriloquism—Conjuring—The Drawing-Room Comedian, etc., etc.

MY MYSTERIES

BY C. IVOR SMITH. A collection of Tricks and Illusions suited to the capacity of the amateur semi-professional Conjurer.

MORE PAPER MAGIC

BY WILL BLYTH. Entertaining and amusing Models, Toys and Conjuring tricks in which paper is the only material required.

Available from all book-sellers 1/- net each, or direct by post 1/2 from :—

C. ARTHUR PEARSON
(Book Dept.).

Tower House, Southamp-
ton Street, London, W.C.2



Good Pictures Wanted



THE HOME PHOTOGRAPHER, the most helpful photographic paper published in this country, announces five new interesting competitions. The first ("Happy Childhood") closes at the end of July. The subjects set are listed below; they are sure to intrigue every amateur,

- (1) Happy Childhood,
- (2) Summer at Last,
- (3) The Open Road,
- (4) Shopping.
- (5) Mists of Autumn.

Get the July HOME PHOTOGRAPHER, just out, and enter for competition No. 1 now! Cash and valuable consolation prizes will be awarded in each contest.

The HOME PHOTOGRAPHER

The Helpful Monthly for the Amateur

On sale at all Newsagents and Bookstalls, or by post 7½d., from the Publishers, George Newnes, Ltd., Tower House, Southampton St., Strand, London, W.C.2.

6" JULY

George Newnes, Ltd.