

BIG CHRISTMAS NUMBER!

NEWNES

PRACTICAL MECHANICS

DECEMBER



YOU HAVE BEEN WARNED BY RADIO

Professor Hilton on November 19th, 1936, from the B.B.C. broadcast a warning. The warning was to the effect that while there are many really good and reliable Colleges teaching by correspondence, there are many others which are colleges by name only. He said some so-called colleges rented a couple of rooms in a large building in a well-known street. Some made great promises which they did not intend to fulfil. Some claimed successes they could not prove. In some cases the names of prominent men were quoted who were in no way connected with the working of the College.

NOW BE ADVISED BY ME

The big name of a College is no proof of its national standing. The Bennett College has been established over 30 years and our entire building is devoted to Bennett College work. No other business of any kind is either on or attached to The Bennett College. We have seating accommodation for over 10,000. We have a permanent staff of over 190 people on the College premises. Our Professional Staff have all passed their examinations, and our tutors are all experts in their own specialised work. We do not send out any homework to be corrected by tired, spare-time tutors. All students' homework is corrected on the College premises the same day that it arrives, and is returned by evening post. This College is Technical, Scientific, General and Commercial, thus enabling us to cater for all requirements; this is important to Cost and Works Accountants and all who have to deal with rate-fixing, machining-allowance, and it is also of great importance in many of the Civil Service Examinations. This is an entirely British College. Most of our textbooks are written on the College premises by our own professional staff, especially for tutorial purposes. Our tutors specialise in teaching students for the examinations they themselves have already passed.

THERE IS NO OTHER COLLEGE IN THIS KINGDOM THAT CAN CLAIM ALL THE ABOVE ADVANTAGES

It is not necessary for students to attend the College; we can send exactly the same tuition to you by post for a reasonable fee payable monthly. Anyone who reads the journals knows that there are many things advertised that one can study, and any kind of study is good. It is training for the brain, but the

best thing to study, surely, is a course specially prepared to teach you your own vocation, or prepare you for the examination which you have in view. Knowing that you are master of your job gives you self-confidence and personality, but a Diploma from a College is absolute proof of your efficiency. We have agencies in all English-speaking corners of the world. The nature of our business makes us keep in touch with employment requirements in all parts of the world, therefore we specialise in preparing students for the good positions which we know exist, and for all the worth-while examinations.

THE ABOVE VAST ORGANISATION CAN HAVE BEEN CREATED ONLY BY THE SUCCESS OF OUR STUDENTS

There is a tide in the affairs of man which, if taken at the flood, leads on to fortune and success. There are three things which come not back—the sped arrow, the spoken word, and the lost opportunity—this is your opportunity. If it is your desire to make progress and establish yourself in a good career, write to us for free particulars on any subject which interests you, or if your career is not decided, write and tell us of your likes and dislikes, and we will give you practical advice as to the possibilities of a vocation and how to succeed in it. You will be under no obligation whatever. It is our pleasure to help. We never take students for courses unless we feel satisfied they are suitable. Do not forget that success is not the prerogative of the brilliant. Our experience of over 30 years proves that the will to succeed achieves more than outstanding brilliancy.



J. Bennett

LET ME BE YOUR FATHER

Let me tell you how to make a success of your career. If your future is undecided or appears unsatisfactory, let us talk it over together. I want to help, and it will cost you nothing to get my help; you will be under no obligation whatever.

We are prepared to produce, on demand, over 10,000 unsolicited testimonials from successful students, or in default we will hand over £100 to charity.



CAN YOU CHANGE MY EXPRESSION?

IF SO, YOU MAY BE THE ARTIST THAT COMMERCE IS WAITING FOR.

Just try it for yourself; trace or draw the outline and then put in the features. There are hundreds of openings in connection with Humorous Papers, Advertisement Drawing, Posters, Calendars, Catalogues, Textile Designs, Book Illustrations, etc. 60% of Commercial Art Work is done by "Free Lance Artists" who do their work at home and sell it to the highest bidders. Many Commercial Artists draw "retaining fees" from various sources, others prefer to work full-time employment or partnership arrangement. We teach you not only how to draw what is wanted but how to make buyers want what you draw. Many of our students who originally took up Commercial Art as a hobby have since turned it into a full-time paying profession with studio and staff of assistant artists. There is no limit to the possibilities. Let us send full particulars for a FREE TRIAL and details of our course for your inspection. You will be under no obligation whatever.

Jim Duval Art Dept. 76

DO ANY OF THESE SUBJECTS INTEREST YOU?

Accountancy Examinations
Advertising and Sales Management
A.M.I. Fire E. Examination
Applied Mechanics
Army Certificates
Auctioneers and Estate Agents
Aviation Engineering
Banking
Boilers
Book-keeping, Accountancy and Modern Business Methods
B.Sc. (Eng.)
B.Sc. (Estate Management)
Building, Architecture and Clerk of Works
Cambridge Senior School Certificate
Civil Engineering
Civil Service
All Commercial Subjects
Commercial Art
Concrete and Structural Engineering
Draughtsmanship. All branches
Engineering. All branches, subjects & examinations
General Education
G.P.O. Eng. Dept.
Heating and Ventilating
Industrial Chemistry
Insurance
Mathematics

Matriculation
Metallurgy
Mining, all subjects
Mining, Electrical Engineering
Motor Engineering
Motor Trade
Municipal and County Engineers
Naval Architecture
Pattern Making
Police, Special Course
Preceptors, College of Pumps and Pumping Machinery
Radio Service Engineering
Radio Communication
Road-making and Maintenance
Salesmanship, I.S.M.A.
Sanitation
Secretarial Examination
Sheet Metal Work
Shipbuilding
Shorthand (Pitman's)
Structural Engineering
Surveying
Teachers of Handicrafts
Telephony and Telegraphy
Transport Inst. Examinations
Weights and Measures
Inspector
Welding
Wireless Telegraphy and Telephony
Works Managers

If you do not see your own requirements above, write to us on any subject. Full particulars free.

A FEW POINTS OF INTEREST

CIVIL SERVICE.

Thousands of pensionable appointments are made every year: ages 15-24. We guarantee success and our fees are from £4-4-0. No extra charge for monthly payments.

MATRICULATION.

There are many ways of commencing a career, but Matriculation is the jumping-off board for all the best ones.

TECHNICAL SUBJECTS AND EXAMS.

The size of our staff is sufficient guarantee of our efficiency.

PROFESSIONAL AND GENERAL EXAMS.

Seeing that we guarantee success we must be efficient. Our thousands of successes proves that WE ARE.

Why Not Investigate For Yourself?

HOW TO STUDY

In your spare time when it suits YOU. You fix your own time, you do not GO to your studies—the postman brings THEM to YOU. There is nothing that a class-room teacher can show on a blackboard that we cannot show on a white paper. The lesson on a blackboard will be cleaned off, but our lessons are PERMANENT. A class-room teacher cannot give you a private word of encouragement, but a Correspondence Tutor can do so whenever your work deserves it. On the other hand, he can, where necessary, point out your mistakes PRIVATELY.

ENGINEERS

now is your chance to dig yourselves into a Key position and make your future solid. It needs Technical Training; we can give you that by post. Full particulars free. Dept. 76.

YOUR CHANCE

THE MOST SUCCESSFUL AND MOST PROGRESSIVE COLLEGE IN THE WORLD.
DEPT. 76, BENNETT COLLEGE, SHEFFIELD

TO STUDENTS LIVING ABROAD

or on the high seas, a good supply of lessons is given, so that they may be done in their order, and dispatched to us for examination and correction. They are then sent back with more work, and in this way a continuous stream of work is always in transit from the Student to us and from us to the Student; therefore distance makes no difference.

YOUNG MEN

Young men physically fit and whose careers are not definitely fixed should join the Police Force. We have special courses for Entrance and Promotion. Full Particulars Free.

Address: POLICE DEPT. 76.

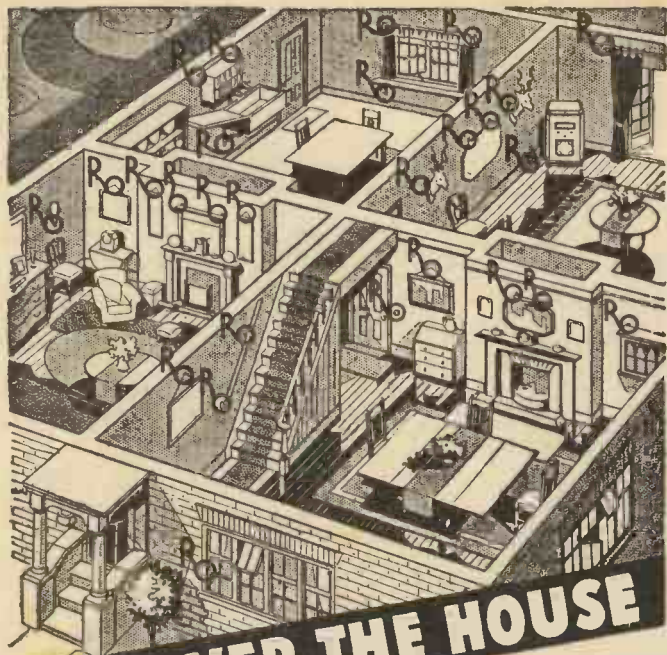

ALL OVER THE HOUSE
THERE ARE DOZENS OF USES FOR

THERE are hundreds of fixing jobs in every home, which can be made quicker, neater and more securely with Rawlplugs than by any other method. There is a Rawlplug suitable for every size of job—from the small No. 3 for lightweight fixtures to the No. 30, which will withstand a direct strain of 4 tons.

Remember—millions of Rawlplugs are used annually by the War Office, G.P.O., Municipal Authorities and by Builders and Electricians everywhere. Rawlplug Outfits, which are sold at 1/6, 3/6 and 5/6 by all Ironmongers and stores, contain complete equipment for all ordinary household fixtures.

Fully illustrated literature free on request to:

THE RAWLPLUG CO., LTD.
 Rawlplug House, CROMWELL ROAD,
 LONDON, S.W.7.



B196.

There is but a short time left to Christmas, and we are sure to have just that piece of trackwork, loco, wagon or coach which you require, either new or second-hand.

We are agents for the leading makers and can supply your wants.

Our own specialities include "00" Permanent Way, the finest made, with brass or N.S. rail and brass sleepers. Every type of point or junction can be supplied from stock, and special work is carried out at short notice.

We have our own workshops and employ only experienced men—while our sales staff comprises enthusiastic and experienced men, under the control of the managing director, who has had 20 years' experience in the model world.

Let us have your enquiries.

MULTI-MODELS LTD

48 BEAK STREET,
 REGENT STREET,
 LONDON, W.1.
 Gerrard 4055

OWN a BILLIARD TABLE

for **1/-** a week.

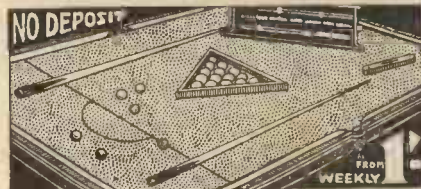

Send for **FREE List.** It will save you money.

Superior Oak finish, leather-covered pockets. Stands on table, complete with Ash Cues, Balls, Marker, and Spirit Level.

Laminated Base.		
3 ft.	16/0	4 ft. 6 in. 29/6
3 ft. 6 in.	19/6	5 ft. 39/6
4 ft.	25/0	6 ft. 52/6
		<i>Carr. Paid.</i>
Superior Quality Solid Slate Bed Tables. 4 ft.	49/6	
5 ft.	74/6	
6 ft.	99/6	
		<i>Carr. Paid Greater London.</i>

SNOOKER SETS.	
Special Selected 17-ball Composition Snooker Sets, complete with polished triangle in neat box. Colour and weight guaranteed.	1 1/2 in. 12/6
	1 1/4 in. 15/0
	1 1/2 in. 17/6
	1 1/4 in. 22/6
	1 1/2 in. 24/0
	1 1/4 in. 27/0
<i>Carr. Paid.</i>	



JAGROSE
2/-
 WEEKLY

JAGROSE all British RACER 47'6

British Made with British Materials, Williams chain wheel and cranks, Dunlop rims, adjustable racing handlebars, rubber grips, Avon red racing tyres, Perry chain, rear calliper brake, bright parts chromium plated, finished four coats best black enamel.

FILL YOUR NAME IN FOR FREE LIST OF CYCLES, ROADSTERS, RACERS AND TANDEM, FROM 47/6.

Name.....

Address.....

JAMES GROSE LTD. EUSTON RD.
 MAIL ORDER DEPT. LONDON, N.W.1.

YOUR OWN HOME CINE FOR XMAS—ONLY 37/6



Why not get one now and enjoy the thrill of movies at home during the party season? We have Britain's best range of models.

PATHESCOPE "ACE"

Simple in operation. Gives brilliant pictures 2 ft. wide or more. Complete with resistance for all voltages from 110 to 250. For 30-ft. or 60-ft. films. 37/6 cash.

12/3 A MONTH
for 24 months.

KEYSTONE "8" PROJECTOR

The Keystone "8"-mm. Projector has features found in considerably higher priced projectors. 200-watt lamp, G. E. Projection lens fully achromatic. Adjustable tilt. Motor rewind. Fan-cooled Manual framer. Capacity 200 ft. 8-mm. film. Sturdy construction. Cast heavy base. Polished glass, silvered reflector. Speed control. Fully guaranteed. £13 13s. 0d.

Generous Exchange Allowances.



104-PAGE CATALOGUE POST FREE.

CITY SALE

AND EXCHANGE (1929) LTD.

59/60 CHEAPSIDE, LONDON, E.C.2



The "G.P." 1/4 H.P. Single Phase MOTOR

is ideal for that
3 1/2" LATHE



Thousands of these Powerful Motors are in Service, giving every satisfaction.

The price is
£2.15.0

Obtainable from all leading
Stores and Tool Dealers.

WE OFFER THE WIDEST RANGE OF ELECTRIC
MOTORS IN THIS COUNTRY

BATWIN ELECTRIC MOTORS

138, SOUTHWARK STREET, LONDON, S.E.1

Telephone: WATerloo 4551



COMING DOWN FOR RE-CONDITIONED HOME-MOVIE BARGAINS!

- | | | |
|---|--|--------------------------|
| Pathescope 9.5 | mm. Kid Projector, with super attachment | £2. 10. 0 |
| Pathescope Imp, motor | and super attachment | £4. 12. 6 |
| Campro 9.5 mm. Com | bined Camera - Projector, | cost £3. 3. 0 £1. 5. 0 |
| Pathe Home Movie Projector, | hand turned, with | resistance £3. 3. 0 |
| Pathescope 200B, with resistance, | cost | £16. 15. 0
£11. 17. 6 |
| Kodascope 8 mm. Model 8-30 Projector, | as new | £6. 10. 0 |
| Kodatoy Projector, hand turned, 16 mm. | | £1. 5. 0 |
| Kodatoy, 16 mm. Projector, motor driven, | with screen | £2. 10. 0 |
| Ensign 100B self-contained 16 mm. Projector | as new | £10. 17. 6 |
| Bell Howell 250 watt 16 mm. Projector, complete | | £17. 17. 0 |

Film Libraries for 9.5 mm., 8 mm. and 16 mm.
Wide range of 9.5 mm., 8 mm. and 16 mm. films for sale, slightly used.

Easy Payments. Three days' approval against full deposit. Demonstrations without obligation. Part Exchanges. Satisfaction guaranteed or full refund.



THE AMATEUR CINE SERVICE LTD.

- ◆ 52-4 WIDMORE RD. BROMLEY, KENT - RAVENSBORNE 0156-7 ◆
- ◆ 6 GRAY'S INN RD. LONDON, W.C.1 - HOLBORN 9894-5 ◆

"Is the 10.23 Garden Express in?" . . .

"CERTAINLY, SIR—OUR TRAINS
ARE ALWAYS ON TIME!"

As an amateur and enthusiastic Station Master yourself, are you quite satisfied with the way your trains arrive and depart? Perhaps you need an efficient Milbro loco? If so, drop a line to "Billie" Mills (one of the three Mills brothers), who knows all the problems of model railway organisation. Ask him for the fine new catalogue—it's only 6d.



Standard Electric Tank Loco
£2. 19. 6

MILBRO TRUE-TO-SCALE models for reliability

MILLS BROS. (Model Engineers) Ltd., Dept. P.M., St. Mary's Road, Sheffield.

MYFORD

MAKES
WINNING MODELS



3 1/8
&
3 1/2

ACCESSORIES

- STANDS
- TREADLES
- FOOT MOTORS
- COUNTERSHAFTS
- ELECTRIC MOTORS
- VERTICAL SLIDES
- TURRETS
- LATHE STEADIES
- CHUCKS
- MACHINE VICES
- SETS OF TOOLS
- ETC. ETC.

UNSURPASSED VALUE LATHES

LISTS:—MYFORD ENG. CO. LTD., BESTON, NOTTS.

NOW YOU CAN

Build YOUR OWN Electric CLOCK



AND GET

GREENWICH TIME

FOR A FARTHING A WEEK!

It costs only a farthing a week to run, this All Mains Synchronous Electric Clock—which you can build yourself at home. Simple to construct, interesting and instructive. A detailed Instruction Book and chart of parts is included in every kit—follow the simple directions and you can't go wrong. No soldering iron necessary.

When assembled, this "Perivale" clock can be fitted into radio cabinets, bookstands, etc., or used as an ordinary mantel or desk clock. Suitable for A.C. Mains, 200-250 volts. Obtainable from leading dealers and stores or by post (include 6d. for postage) from

THE LONDON ELECTRIC CLOCK CO. (Dept. 3710), 15, Park Street (Off Upper St.), Islington, N.1.

SPECIFICATIONS

Kit No. 1. Complete set of parts, and metal drum for enclosing movement. Coin-bronze dial, 5" square, with chapters and hands in an attractive shade of green. Screwdriver, adaptor, flex, oil and grease are supplied free with each kit, and a fully illustrated Instruction Book and Chart of Parts is included.

Kit No. 1a. As above, but with dial corners drilled for mounting in cabinets, etc.

Large sales have reduced production costs . . . YOU get the benefit by a big reduction in price.

ORIGINALLY 25/-

NOW 19/6 COMPLETE

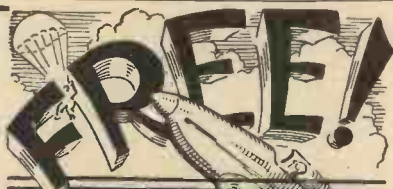

SKYBIRD

Illustrated Leaflet, Membership Form and Price List.

BUILD A SKYBIRD

* SCALE MODEL AEROPLANE * and become a member of the

SKYBIRD LEAGUE

Write: SKYBIRDS (Desk P.M.), 3, ALDERMANBURY AVENUE, LONDON, E.C.2

Everything for "OO" RAILWAYS

TRACK. LOCOMOTIVES. ROLLING STOCK. MECHANISMS. CONTROLLERS. MAIL VANS. CONSTRUCTIONAL SETS. SIGNALS. DRAWINGS. ETC. ETC.

Our catalogue (brought right up-to-date) will be sent on receipt of 4d. in stamps. If you already have a copy send 1d. for our supplementary list.

GEORGE E. MELLOR (P.M. 127)

Allanson Road : Rhos-on-Sea : North Wales.

JUST OUT!

WIRELESS COILS, CHOKES AND TRANSFORMERS: and How to Make Them

By F. J. CAMM

An important new Handbook for every home constructor and anyone interested in radio. With Special Chapters on Selectivity, Break-through, Coil Winders, Coil Troubles and their Remedies. 180 pages, cloth bound, with 126 easy-to-follow illustrations.

2/6 By post, 2/10

GEORGE NEWNES, LTD.

Tower House, Southampton St., Strand, London, W.C.2

ASTOUNDING! BARGAIN! GUARANTEED

FITTED CHESTS OF £6.60 TOOLS



47 Strongly Made Standard Size Tools for

50% EVERY TOOL FULLY GUARANTEED Offer cannot be repeated after present stock cleared.

- | | |
|---|-------------------------|
| 1 Hand Saw, 24" Blade. | 3 Centre Bits. |
| 1 Tenon Saw, 10" Blade. | 1 set of 3 Gimlet Bits. |
| 1 Keyhole and Pad Saw. | 1 Square. |
| 1 Claw Hammer. | 1 Axe. |
| 1 Pin Hammer. | 1 Oilstone. |
| 2 Files (Handled). | 1 Pair Pincers. |
| 1 Rule. | 1 Small Screwdriver. |
| 1 Gouge (Handled). | 1 Large Screwdriver. |
| 3 Chisels (Handled). | 1 Glass Cutter. |
| 2 Brad Awls. | 1 Spokeshave. |
| 2 Gimlets. | 1 Punch. |
| 1 pair Pipe Grips. | 1 Level. |
| 1 pair Construction Pliers and flat grip. | 1 Marking Gauge. |
| 1 Oil Can. | 1 Cork Rubber. |
| 2 Pencils. | 2 Sheets Sand Paper. |
| 1 Soldering Iron. | 1 Rawplug Outfit. |
| 1 Tool Chest. | 1 Instruction Book. |
| 1 Smoothing Plane. | 1 Croid Glue. |
| 1 Brace. | 1 Tin Fluxite. |

FREE To every purchaser of the "Zyto" Guaranteed Tool Chest, a handsome 7/6 cloth-bound copy of "Home Repairs and Renovations."

DON'T DELAY—ORDER NOW.

List of special offers in wood and metal workers' tools free. Post 2d. Please state which you require.

S. TYZACK & SON LTD.

TOOL SPECIALISTS,

341, 343, 345, OLD STREET, LONDON, E.1.

MAKE IT FOR KEEPS

Fix it with 'CASCO'—the Glue that sets like cement

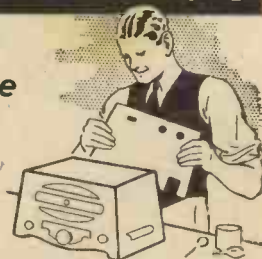

Anything you glue with 'Casco' and 'Casco' glues almost everything, is fixed permanently. Waterproof and heatproof, 'Casco' will withstand any amount of rough usage. Unlike other glues, it sets chemically like cement. Because of its great strength, it is used commercially for making aeroplanes, furniture, etc. Obtainable from ironmongers, oil and paint shops, in handy tins from 6d.



FREE

Try 'Casco' for yourself. Fill in coupon and send in unsealed envelope (1d. stamp) to LEICESTER LOVELL & CO., LTD. (Dept. P.M.1), 14-18, Nile Street, London, N.1, for free sample and free copy of the 'Casco' Gluing Guide.

NAME.....
 ADDRESS.....
 3a

AMBITIOUS ENGINEERS

THIS IMPORTANT HANDBOOK ON SUCCESSFUL ENGINEERING CAREERS

FREE ON REQUEST



After months of intensive effort and research, we are pleased to announce that the 1938 edition of our Handbook, "ENGINEERING OPPORTUNITIES," is now out of the publishers' hands and ready for *free distribution*. Containing 268 pages of practical guidance, this book is, beyond argument, the finest and most complete handbook on Successful Engineering Careers ever compiled. It is a book that should be on the bookshelf of every person interested in engineering, whatever his age, position or experience.

The Handbook contains, among other intensely interesting matter, details of B.Sc., A.M.I.C.E., A.M.I.Mech.E., A.M.I.E.E., A.M.I.A.E., A.M.I.W.T., A.M.I.R.E., CIVIL SERVICE, and other important Engineering Examinations: outlines courses in all branches of CIVIL, MECHANICAL, ELECTRICAL, AUTOMOBILE, RADIO, TELEVISION and AERONAUTICAL ENGINEERING, BUILDING, GOVERNMENT EMPLOYMENT, etc., and explains the unique advantages of our Employment Department.

**WE DEFINITELY GUARANTEE
"NO PASS—NO FEE"**

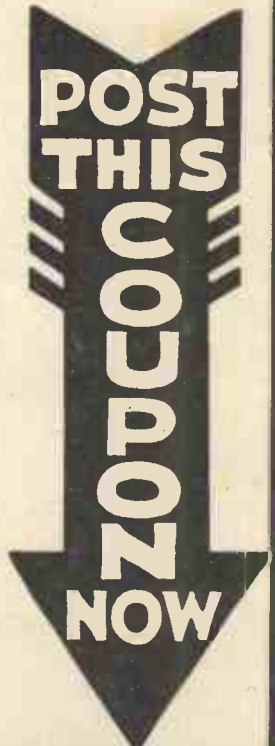

If you are earning less than £10 per week you cannot afford to miss reading "ENGINEERING OPPORTUNITIES." In your own interests, we advise you to write (or forward the coupon) for your copy of this enlightening guide to well-paid posts — NOW. *There is no cost or obligation of any kind.*

BRITISH INSTITUTE OF ENGINEERING TECHNOLOGY

410a, SHAKESPEARE HOUSE,
17, 18, & 19, STRATFORD PLACE, LONDON, W.1

-----TEAR OFF HERE-----
FREE COUPON

BRITISH INSTITUTE OF
ENGINEERING TECHNOLOGY,

410a, Shakespeare House,
17-19, Stratford Place, W.1.

Please forward, Free of cost or obligation of any kind, your 268 page Handbook.

NAME.....

ADDRESS.....

.....

.....

EDITED BY F. J. CAMM

SUBSCRIPTION RATES

Inland and Abroad 7s. 6d. per annum
 Canada - - 7s. per annum

Editorial and Advertisement Offices: "Practical
 Mechanics," George Newnes Ltd.
 Tower House, Southampton Street, Strand, W.C.2.

'Phone: Temple Bar 4363.

Telegrams: Newnes, Rand, London.

Registered at the G.P.O. for transmission by
 Canadian Magazine Post.

PRACTICAL MECHANICS

VOL. V. DECEMBER, 1937 No. 51.

The Closing Year

THIS issue necessarily goes to press some weeks before Christmas, but even so the infectious spirit of the festive season is here. Indeed, it is no doubt due to the publication of Christmas Numbers that a large measure of Christmas atmosphere is due. Christmas is a remarkable institution which loses nothing as year succeeds year. It is the period of retrospection when we survey the events of the past year, and when we endeavour to look into the future; the period when the purse-strings are loosened; when we consider what presents we shall buy for our friends; for journalists it is the time to consider the typographical Christmas Pudding in the form of a special Christmas Number. The ingredients must be carefully mixed to produce a tasty and easily digested whole. Custom has decreed that Christmas Numbers should arrive some weeks before the Christmas holidays, and with a monthly publication there is no alternative to making the December issue, which appears on the first of the month, the Christmas Number. It is an issue in which we can for the nonce depart a little from the formula which comprises the normal issue, and introduce a little levity into the articles so that by means of them you may make apparatus appropriate to the season, perform topical experiments, or learn some of the mysteries of scientific entertainment. Here in this issue you have our fifth Christmas Number, and I hope you will like it. With an ever-growing circulation it becomes increasingly difficult to provide for the needs of all my readers, but I hope (and the circulation of PRACTICAL MECHANICS indicates that it is not a vain one) that I have some measure of success in my efforts to cater for these vast and diversified needs.

Imitation . . .

IF further tribute to the esteem in which this journal is held where needed I could direct your attention to the regularity with which our articles are filched, rifled, pilfered, stolen, and

Fair Comment

By The Editor

lifted in some of the foreign papers, in many cases without acknowledgment of the source. It will be agreed that the editorial material of this journal is not of a hackneyed character; it is most expensive and many of the illustrations alone cost several pounds. The work involved in making the apparatus, preparing special drawings, taking photographs, and preparing the text is heavy and costly, but we do not hesitate to go to that expense in order to provide the best possible editorial features for our readers. Where foreign journals find our material of use it is a matter of journalistic courtesy to acknowledge the source, but few journals do so. The car I designed, constructed, and described in this journal, illustrating the text with numerous stage by stage photographs, and scale and detail drawings, for example, was lifted in a Buenos Aires paper as a series. Now even with acknowledgment it is a little too easy for editors to fill their

The
 Editor and
 Staff Join in
 Wishing Every
 Reader a Very
 Happy
 Christmas

journals in that way, and we expect at least they should ask for permission first. Perhaps editors of foreign

journals who find our material so useful will take this hint that exception is taken to their methods.

The New Year's Programme

WE have described boats, aeroplanes, and motor cars, in this journal, and I am now considering special features for next year. I should, therefore, welcome suggestions from readers regarding constructional articles which they would like to see in this journal. I shall do my best to oblige them, but they should remember that such articles must be of general interest before I can consider them. Too often it happens that a reader with some special requirement will imagine that everyone else will be interested in it. What special wireless set would you like described? What series of articles would interest you? What do you want to make? Would you be interested in a series on Careers? Give the matter careful consideration, and let me have your suggestions. I should also be glad if you would let me know what features you do *not* like.

Indexes

A REMINDER that indexes for Volume IV are now ready and may be obtained at 7d. each post paid. You should preserve these indexes even though you do not have your copies bound. If you keep all of the indexes together in a folder you will be able to look up particular subjects at once and conveniently without having to wade through a pile of back issues. It is beyond question, however, that it is wise to have your copies bound and thus preserve them in a more permanent and readily consultable form. PRACTICAL MECHANICS is a journal which you will want to consult in future years, for it contains valuable information on almost every technical subject. The Questions and Answers Section alone is worth more than the price asked for each issue. Binding cases cost 3s. 6d. inclusive of index. The local book-binder will bind the books for you for a small sum.



Fig. 1.—Changing a matchbox. The box in the hand is apparently placed on the table and the handkerchief removed. Actually it is removed behind the handkerchief and the box on the table is revealed.

THIS month I am going to explain several tricks of a type which anyone can quickly master, for performance at Christmas parties. The various articles required are such as can be found about the home; while no sleight of hand is involved and only quite simple preparations are needed.

RUBBER BAND STRETCHED OVER FINGERS & THUMB

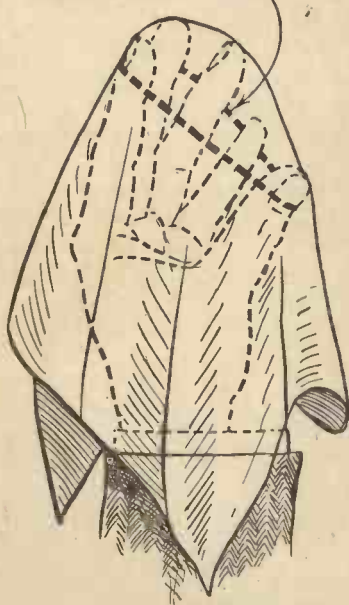

Fig. 2.—How the elastic band is held underneath the handkerchief.

The first trick is called:
The Magic Matches

You begin by showing an ordinary box of matches. You empty out all the matches and place the box in full view on your table. The matches you then proceed to wrap in the folds of a large handkerchief.

“Matches have a way of disappearing very quickly, as most housewives know,” you remark, then, flicking the handkerchief in the air you show that these matches have disappeared even more quickly than usual. You then pick up the box, open it and tip out the matches which have seemingly returned mysteriously to the box.

How to do it.—On your table is a large

*Effective Tricks
that do not Re-
quire Skill or
Special Apparatus
By Norman Hunter*

*Further articles will appear
regularly*

handkerchief and concealed beneath its folds, at the back, is a box full of matches. In your pocket you have a small but strong elastic band.

You show a box of matches of the same brand as the concealed box and tip all the matches out neatly on the table. Let the audience see that the box really is empty, then close it. Fig. 1 shows what you do next. To the audience you appear simply to put the empty matchbox on the table and pick up the handkerchief. What you really do is to put the box down behind the

*POUCH FORMED IN
CENTRE OF
HANDKERCHIEF*

*RUBBER BAND
RETAINS MATCHES
IN POUCH*

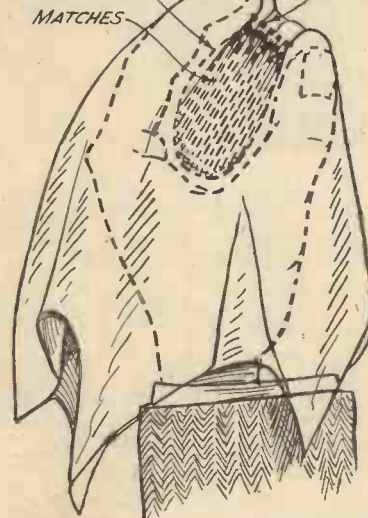

Fig. 3.—Matches pushed down into the handkerchief and elastic band allowed to snap round, enclosing them in a bag.

handkerchief, pick it up again without letting go of it and at the same time pick up the handkerchief with your other hand and throw it over the hand holding the matchbox. As you move away from the table the other box is revealed on the table and this is taken to be the empty one.

Under cover of the folds of the handkerchief you then conceal the box in your partly closed hand, then, while talking about the matches, casually put your hand in your pocket and take it out again. This is a perfectly natural action but it enables you to leave behind the empty matchbox and bring out the elastic band. This you keep concealed.

Now to vanish the matches. Throw the handkerchief over your hand, spreading the elastic band between the tips of your fingers and thumb as shown in Fig. 2. Pick

*SHORT STRIP OF BRAID
PINNED TO LONG STRIP*



LONG STRIP OF BRAID

Fig. 4.—Showing how the tape is faked.

up the matches a few at a time and push them down into the centre of the handkerchief. As soon as they are all in the handkerchief, bend your fingers and thumb and allow the elastic band to snap round the handkerchief, just above the bundle of matches (see Fig. 3). The matches are now held firmly in an impromptu secret pocket in the handkerchief. You can take a corner of the handkerchief and flick it into the air. The matches seem to have disappeared for, as long as the handkerchief is a good one, the presence of the bundle of matches is entirely concealed by the folds. You finish the trick by opening the box and pouring out the matches.

Now for a very puzzling but quite easy trick with some braid or tape:

Saving the Stitches

You show a long piece of tape and taking it by the centre you cut several pieces from it. The pieces are really cut and can be seen to fall to the ground.

After this you explain that by using the handles of the scissors instead of the blades you can produce the reverse effect. That is to say you will make the tape become joined together again without having to sew it. You snip about with the handle ends of the scissors, draw out the tape from your hand and it is one single piece again with no trace of any join.

How to do it.—Use a good wide piece of tape or braid about three yards long. Cut about seven inches from one end and pin it to the centre of the long piece as shown in Fig. 4. If you do this neatly you can hold the braid up with the unprepared side towards the audience and it appears to be a quite ordinary piece of braid.

Now take the braid by the centre and draw it through your closed hand. As you do this you pull out at the top of your hand the centre of the short piece, leaving the



Fig. 7.—The rising cards. White cotton in place of black is shown here for the sake of clearness. Notice how the cards rise when the cotton is pulled. The cotton goes down behind the card and up in front of it.

centre of the long piece hanging down out of sight. Reference to Fig. 5 will make this quite clear. You now cut the braid. You cut it several times. In fact you cut away all the small piece and by pretending to

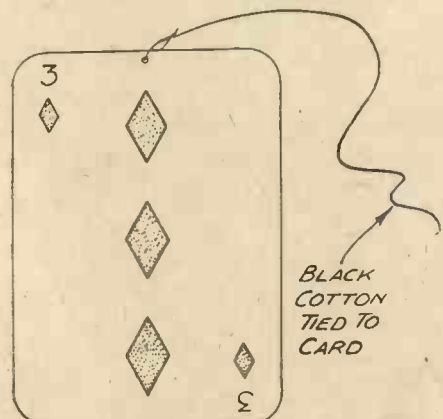

Fig. 6.—How the card is prepared.



Fig. 5.—Restoring a cut tape. This photograph shows how the extra short piece pinned to the long piece of tape is cut away, leaving the long piece intact.

adjust the ends you pull out the pins and let them drop with the short cut ends. To the audience it appears that the braid is now definitely cut into at least two long pieces. Actually of course the long piece of braid is unharmed and, after a little by-play with the scissors, it is drawn out and shown to be whole.

Now for some card tricks. Here is one which I have named :

Call Up Your Card

This is probably the most popular of all card tricks. Three cards having been chosen and returned to the pack, the pack is then placed in a glass. The chosen cards are then called for one by one and they mysteriously rise from the centre of the pack.

How to do it.—There are several hundred different ways of doing this particular trick. Some of them need very expensive apparatus and a good many call for a moderate amount of skill. Here is a simple method which is also easy.

Prepare one card, any card you like, by tying one end of a piece of fine black cotton to it as shown in Fig. 6. Place this card face downwards on your table and lay a handkerchief loosely over it. Measure off a length of thread, the exact length you will be able to work out for yourself when you prepare the trick. Tie a pin or a needle to the free end of it and stick the needle in the tablecloth near the back edge.

That is all the preparation needed. The rest is all in

Start by handing out a pack of cards to be shuffled and have three cards chosen. Do not have the cards replaced but lay the pack face down on the table immediately on top of the prepared card. To do this you must of course pick up the handkerchief, and this action hides the fact that you are putting the pack on an extra card. Now use the handkerchief to polish the glass. This gives an excuse for its presence. Pick up the pack and drop it into the glass. The extra card will be facing the audience and you secretly arrange the cotton across the top of the pack from front to back.

The next thing to do is to take back the chosen cards and push them down into the pack. Each card goes behind the one just inserted and each card carries down with it some of the cotton. You must keep your fingers on top of the cards to prevent those first pushed down from coming up when the others are inserted.

You are now ready for the magical appearance of the cards. Have them named, remembering that the last card you pushed into the pack will be the first to appear.

Hold the glass in your hand and gradually move it forward until the cotton is pulled tight. As you continue this gradual and imperceptible forward movement of the glass, the last card inserted will gradually rise out of the pack. When it has risen about half-way take it out and have the next card called, making this rise in the same way. If you study Fig. 7 you will see exactly how the cotton is arranged and how it causes the cards to rise. Needless to say you use black cotton, not white. I have used white in the photograph to make it show up, but black cotton will be invisible at a moderate distance.

There is another very popular card mystery called :

Stabbing the Card

You have a card chosen and returned to the pack which you spread on the table,



Fig. 8.—Stabbing a card. The duplicate card being dragged from its pocket in the newspaper.

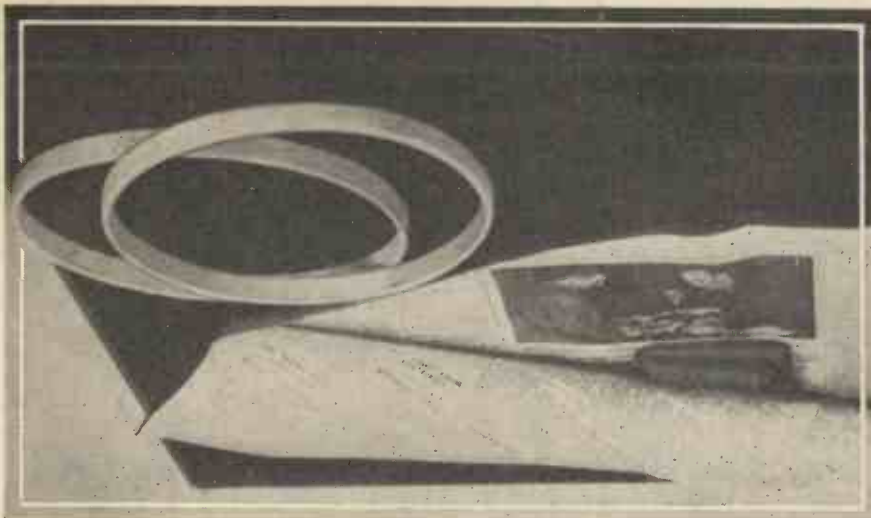

Fig. 10—Silk handkerchiefs from a tambourine. This photo shows how the silks are concealed between a double thickness of paper, the edges of which are pasted together.

faces downwards or permit some member of the audience to do so. You obviously cannot know where the chosen card is and to make the trick seem more difficult you spread a newspaper over the cards. Then, taking a penknife, you stab through the paper, drag the knife out to the edge and lift it when the audience see that you have somehow managed to stab the very card that was chosen.

How to do it.—Covering the cards with newspaper to make the trick seem more difficult actually makes it possible to do it quite easily. If you look at Fig. 8 you will see that the card which is stabbed is not one of those on the table at all but another card which has been hidden in a pocket in the newspaper.

Fig. 9 shows how the card is concealed.

POCKET OF NEWSPAPER PASTED ON ROUND EDGES

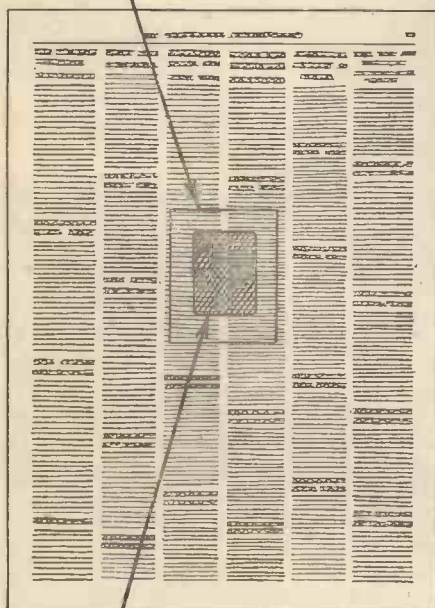

CARD CONCEALED IN POCKET. (FACE TO NEWSPAPER & BACK TOWARDS POCKET.)

Fig. 9.—The concealed pocket in the newspaper for holding the card.

FOLDED SILK HANDKERCHIEFS CONCEALED BETWEEN DOUBLE SHEET OF NEWSPAPER

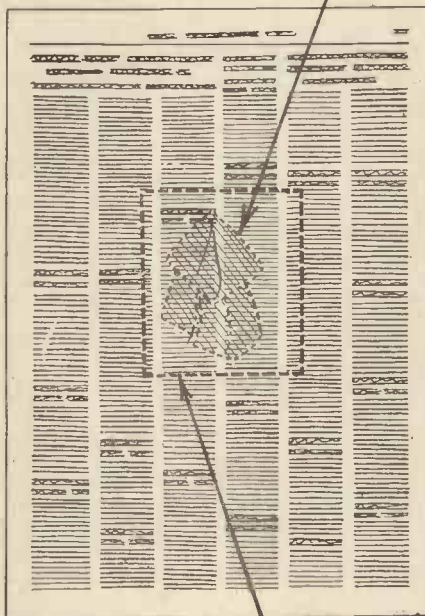

PASTE PAPERS TOGETHER HERE AND HERE—ALL ROUND EDGES.

Fig. 11.—How the handkerchiefs is concealed in the newspaper.

Cut a piece of newspaper about an inch larger all round than the card, put the card face down on the paper and paste the small piece of paper over it, pasting the edges only.

When you lay the paper over the cards you do so with the pocket underneath. It is a simple matter to locate the card in the pocket, then you stab the knife well and truly through paper and card, lift the paper slightly and drag the knife through the paper

Fig. 12.—Vanishing chestnuts. The nuts being scooped into the goblet, falling actually into a second goblet pinned into the back of the table cloth (view as seen from behind).

out to the edge, bringing the card with it.

Of course this means that you have got to be certain in advance that the person choosing the card will take the one of which the hidden card is a duplicate. An easy way to arrange this is as follows. Have the required card on top of the pack and ask someone to call out a small number. Supposing five is asked for. Proceed to count five cards off the top of the pack, starting with the top one and sliding each successive one on top of the one preceding it. Stop at the fifth and hold up the small packet. The original top card will be at the bottom of the pack facing the audience who will not realise that this is the first card counted but take it for the fifth. Of course your card in the newspaper is a duplicate of this card.

Talking of things hidden in sheets of newspaper reminds me of a good way of producing silk handkerchiefs or flags.

The Tricky Tambourine

The tambourine is made by pressing a pair of wooden embroidery hoops on either side of a sheet of newspaper and trimming off the edges. To the audience there appears to be no room for the concealment of any article, yet you instantly break the paper in the centre of the tambourine and draw out several coloured silk handkerchiefs.

How to do it.—The handkerchiefs, folded small and pressed flat, are concealed between two sheets of paper as shown in Figs. 10 and 11. If you like you can use ribbon instead of handkerchiefs. In that case fold the ribbon in pleats, first one way and then the other zig zag fashion and it will draw out of the paper easily.

Hold up the sheet of paper and show it casually, then place it between the wooden hoops, trim off the surplus, break a hole in the centre and produce the silks. It helps the effect if you have a whole newspaper on the table and take an odd sheet out for the trick. Of course the odd sheet is the one you have prepared.

Flying Chestnuts

You throw a few chestnuts on the table and drop a piece of string into a hat. You then scoop the nuts into a goblet and make a throwing movement towards the hat. The chestnuts vanish and are found in the hat, neatly threaded on the string.

(Continued on page 188)



Making a BAGATELLE TABLE

A Table which will Provide Many Exciting Games can easily be Constructed by anyone with a Slight Knowledge of Woodwork

BAGATELLE is an ideal game for winter evenings, and even if readers have little knowledge of woodworking, they need not have doubts of their ability to carry out the construction of a table on which this interesting game may be played.

The table is made with a plywood top fixed to a strong frame. The top, in which there are nine holes, is covered with rails, while the semicircular end is formed by fitting two shaped pieces inside the rails. Cushion slips and rubber cushions are fitted around the rails and the semicircular end, and pegging or scoring holes for 100 up are drilled in the upper edges of the rails.

The Top

For this it is advisable to use a piece of $\frac{1}{4}$ -in. plywood exactly 5 ft. long by 1 ft. 8 in. wide. The holes, which are $1\frac{1}{2}$ in. diameter are set out as shown in Figs. 1 and 2. First mark the centre line, then measure $10\frac{1}{2}$ in. from the top end to mark the position of the centre hole, set out the other holes as indicated, and mark them with a compass. A fret or key-hole saw should be used to cut the holes.

The Frame

The frame to which the plywood top is fixed is shown in Fig. 3. It is made with two side rails 4 ft. $10\frac{1}{2}$ in. long, and four cross rails 1 ft. $5\frac{1}{2}$ in. long by 2 in. wide by $\frac{3}{4}$ in. thick. Deal will be quite suitable, but a better wood such as mahogany or oak could be used if desired. Grooves $\frac{1}{4}$ in. deep are cut in the side rails to receive the cross rails, which are fitted in and fixed

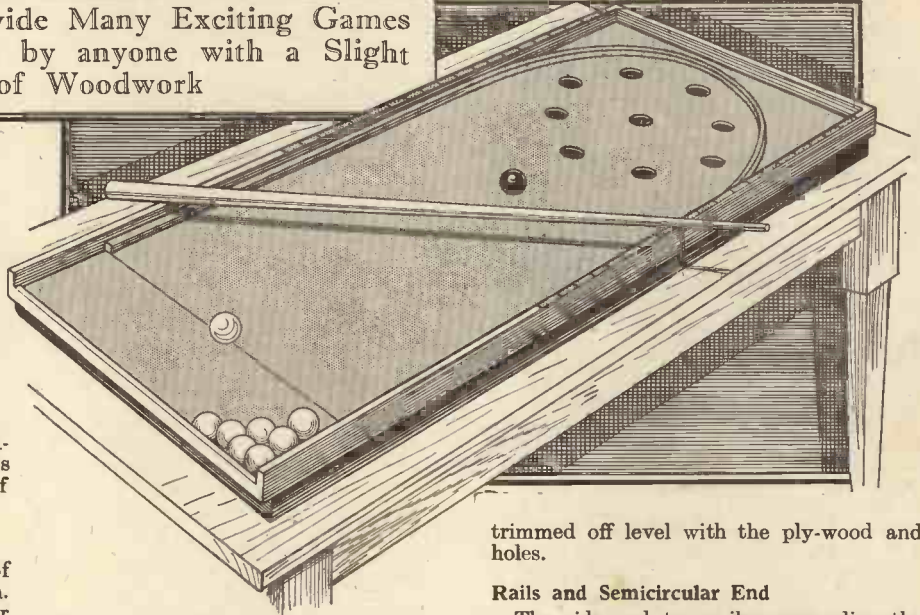

trimmed off level with the plywood and holes.

Rails and Semicircular End

The side and top rails surrounding the board may be from $1\frac{1}{2}$ in. to 2 in. high by $\frac{3}{4}$ in. thick, rebated $\frac{3}{8}$ in. wide by $\frac{1}{4}$ in. deep to fit over the edges of the plywood, but it will be more convenient if the rail at the bottom or playing end is only 1 in. high. Two of the rails are shown fitted to the board at Fig. 4, and sections are shown at

with glue and nails. Care should be taken in making the frame to get it perfectly true, and after it has been allowed to stand on one side for the glue to dry, the edges to which the plywood will be fixed should be planed quite straight and true, a straight edge being used for testing. The top is

Fig. 4.—How the rails are fixed.

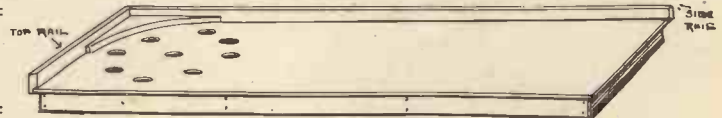

Fig. 5, that of A being of a plain rail, and at B a moulded rail, 2 in. wide. The side and top rails are mitred together; the bottom rail fits between the side rails, and all are screwed up through the plywood.

The semicircular end is formed with two pieces of mahogany or oak $\frac{3}{4}$ in. thick joined in the middle, and cut with the grain running in the direction shown in Fig. 1. The end is $\frac{1}{2}$ in. wide in the middle where the two pieces join, and it should be set out with a pair of compasses set at $9\frac{3}{4}$ in. Screws driven through the plywood are used to fix the end.

Cushion Slips and Cushion

The cushion slips are made with plywood. There are inner and outer slips, and for convenience in fitting each may be in three pieces. Reference to the plan, Fig. 1, will show the slips in place, and they may be joined in the positions indicated, while Fig. 7 shows sections of the slips and cushions. Plywood $\frac{3}{8}$ in. thick is used for the slips, and the outer or wider one is fitted first. Cut three strips of plywood roughly 3 ft. long by exactly 1 in. wide, and preferably across the grain to enable them to be bent easily. Start at the top and fit one strip around the semicircular end, fixing it temporarily with a few screws driven near the bottom edge. Then fit a strip to each side rail and cut their ends level with the baulk line shown in the plan. Next prepare three inner strips $\frac{3}{8}$ in. wide

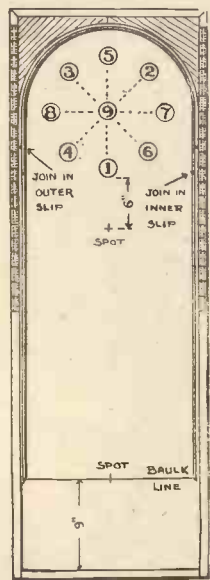

Fig. 1.—The top of the table.

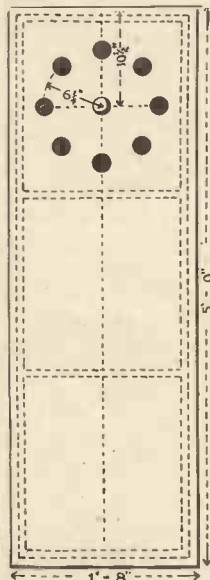

Fig. 2.—Details of the holes.

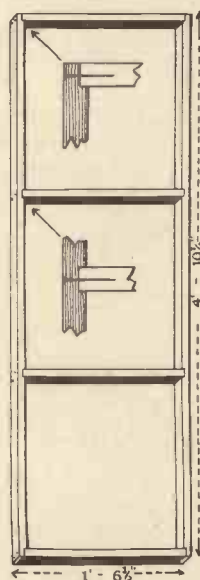

Fig. 3.—The frame to which the plywood top is attached.

fixed down to the frame with fine pins, allowing a $\frac{3}{4}$ -in. overhang all round; the heads of the pins should be punched in, and the holes stopped. Glue is used to fix the baize or West of England cloth covering to the top. It should be cut slightly larger than the plywood; the latter is quickly coated with glue and the cloth stretched tight. Place it down in the middle first and work towards the edges, taking care that there are no creases and that it is pressed down firmly, especially around the holes. A few short tacks could be used to hold it around the edges, as they will be covered by the side rails. It is advisable to have assistance in this operation as the quicker it is done the better, or the glue will begin to set before the cloth has been pressed down all over. When the glue is dry the cloth should be

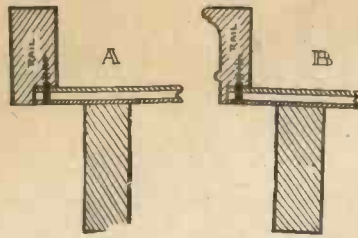

Fig. 5.—A sectional view of the rails.

and fit them inside the wider strips level at the top edges, arranging the joints in slightly different positions from those between the wider strips as indicated in Fig. 1, and bore a number of screw holes for fixing. The rubber cushions should be of strip rubber $\frac{3}{8}$ in. wide by $\frac{1}{8}$ in. thick in section cemented inside the narrow strips level with the top edges. The strips could be removed for this, and the rubber held under pressure while the cement dries. At this stage the slips and cushions should be fixed in place, the meeting ends are carefully fitted, and cleaned off level. The cushions should now be covered with baize. The ideal method is to use one strip of cloth, but if it has to be joined once then it will be best to arrange it in the middle of the end or if twice, then at the sides near the joints in the slips and cushions. The joints should be well pressed to get them as flat as possible. One edge of the baize is first placed between the two plywood slips, and the inner slip is screwed to the outer

as shown at A, Fig. 7. The baize is then brought up over the cushion, the screws which fix the outer slip to the rails and semi-circular end are loosened, the baize is tucked in under this slip shown at B, Fig. 7, and the screws are tightened to hold it and the cushions firm.

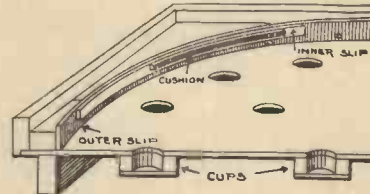

Fig. 6.—The cups for the balls.

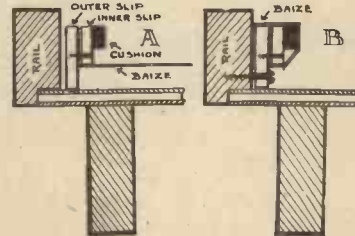

Fig. 7.—Section of the slips and cushions.

Cups and Pegging Holes

Cups for the balls should be fitted under the holes in the board as shown in Fig. 6, and they may be easily made as shown in Fig. 8. Pieces of wood 3 in. by 3 in. by

$\frac{1}{2}$ in. thick are cut to octagonal or circular shapes, and holes $1\frac{1}{2}$ in. diameter are cut in them. A fretsaw will be useful for cutting the shape and the holes. Thin plywood bases are prepared to cover the holes in the cups, and the numbers to correspond with those shown in Fig. 1 are painted on the bases to show through the holes in the cups. The bases are glued to the cups, and the latter are glued under the plywood board. Details of the pegging holes which should be drilled in the top edges of the side rails are shown at Figs. 1 and 9. Lines should be incised or painted on the rails, and the holes drilled with a bradawl or drill to a depth of $\frac{1}{2}$ in.

Nine $1\frac{1}{2}$ -in. balls will be needed, one being red and eight white. The baulk line and spots are marked on the cloth as shown in Fig. 1, and a cue from 3 ft. to 4 ft. long by 1 in. diameter at one end tapering to $\frac{3}{8}$ in. at the other must be provided.

The table should be polished or varnished on completion and, if thought desirable, the base could be covered in with another piece of plywood.

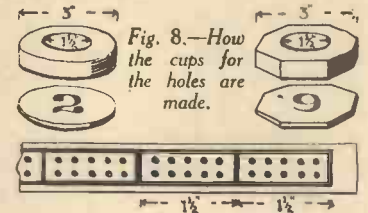

Fig. 9.—The pegging board.

NEW INVENTIONS

Telescopic Umbrella

AN umbrella reducible to a size enabling it to repose snugly in the waistcoat pocket has not yet appeared upon the damp horizon. But an improved collapsible one has made its debut. This umbrella has a stick comprising three sections telescoping one within the other. The ribs are also collapsible, and there is a case to hold the "gamp" when it in its diminished shape. The contrivance is, doubtless, sufficiently compressible to find accommodation inside a trunk, thus relieving the traveller of the inconvenience of carrying it externally.

Sleeves for the Shanks

THE umbrella and the raincoat leave the bottoms of the trousers to the mercy of the stormy weather. Our forefathers made good use of gaiters and top-boots. But, in the present age, those leg coverings are in vogue only in association with riding breeches. Cyclists, it is true, occasionally don a pair of mackintosh trousers which are a near relation to the overall. Obviously, there is room for a convenient and effective means of keeping the nether man immune from moisture. To achieve this end, an American has provided a protector in the form of a sleeve to envelope the shank of the male pedestrian. This sleeve closely fits the knee, but more loosely surrounds the ankle. The means of support includes a clip at the upper forward edge of the sleeve, which slips over the creased edge of the trousers' leg. A hook at the bottom of the sleeve engages what the inventor terms the cuff of the trousers. I presume this is the turn-up. The device apparently is easily fixed and can be removed with equal facility.

The following information is specially supplied to "Practical Mechanics," by Messrs. Hughes & Young (Est 1829), Patent Agents, of 9 Warwick Court, High Holborn, London, W.C.1, who will be pleased to send readers, mentioning this paper, free of charge, a copy of their handbook, "How to Patent an Invention."

A Tip for the Tap

THE tap in the bathroom—and many other taps—can be a source of considerable trouble. At times, on a small scale, it performs the rôle of Niagara. When a washer is defective, for instance, its fluency is like a distant relative of the Deluge. To prevent this domestic flood, an inventor has devised a tap with a special valve, so that, in the event of a defect, the flow is automatically dammed. And repairs can be effected without turning off the water at the main. The appliance may be incorporated with any description of tap. A debt of gratitude from the householder is due to the inventor of this most useful valve.

A Useful Reflector

THE numerous accidents to cyclists emphasize the importance of favourably considering any suggestion having for its object the safety of these users of the roads. The red reflector at the back of the machine has long been a means of protection at night. A variation of this idea is the fitting of a reflector on the centre of the band type of trousers' clip. This again has been improved upon. An invention, recently patented, consists of a spring band trousers' clip of the ordinary kind with the addition that one end of the split band has a lateral limb. Riveted or otherwise fixed

to this side limb is a red reflector. The revolution of the cyclist's leg causes the reflector also to revolve. This rotating reflection points out plainly to motorists that a cyclist is ahead. Moreover, the reflector being on the extreme margin of the space occupied by the cyclist indicates the amount of room which must be allowed by the passing vehicle. Instead of a reflector, there may be provided an electric lamp with a length of flex connected. This device, which is one the principle of the revolving lights used to protect mariners, should be a boom to those in peril on the road.

Footprint Recorder

THE registration of fingerprints—a deterrent to criminals—has now a counterpart in the shape of a foot impression device. Presumably, this is not necessarily intended to be employed in the detection of crime. It would be useful in taking the dimensions of the foot with a view to secure the correct size in shoes. The flexible inked material upon which one puts one's foot down might indeed give a valuable clue to Mr. Sherlock Holmes. But it might, likewise, afford means for the delineation of character. The sole of the foot has wrinkles as well as the palm of the hand. And it is feasible that these lines have some definite relation to character.

The Lure of the Lemon

IT seems that making up is not the monopoly of the fair sex. The practice is sometimes used to enhance the complexion of fruit. In the United States there has lately been patented a process for heightening the natural colour of the citron family. The method includes adding a dye which is calculated to increase the sex appeal of a lemon.

DYNAMO.

CHEMICAL AMUSEMENTS FOR XMAS

Some Straightforward and Harmless Chemical Tricks and Experiments which will serve to give additional interest to the Festive Season.



A simple form of distilling apparatus made from an old tin and a piece of glass tubing. It is suitable for many varieties of chemical distillations.

HOME chemical experiments, no matter whether they are adapted for performance at Christmastide or at any other time of the year, may, so far as the amateur chemical enthusiast is concerned, be usefully classed into two divisions, "trick" experiments designed mainly to mystify the onlooker who, as is often the case, is devoid of chemical knowledge, and "interest" experiments whose appeal is more to the actual experimenter than to anyone else.

So-called "chemical magic" consists entirely of these "trick" experiments, the effects produced by which are, of course, perfectly understandable by anyone having a knowledge of chemistry but are usually of considerable mystery to the "layman."

Mystic Smoke

Take, for instance, the very simple experiment of the mystic smoke. A glass jar—a jam-jar, for example—is stood upright upon the table, preferably against a black background. The jar is, of course, apparently empty. Another jar, also, apparently devoid of contents, is held mouth downwards over the first jar. Rapidly, the lower jar becomes filled with dense white fumes which quickly rise up within it and overflow it, spreading along the table top like a white mist.

The explanation of this striking effect is very simple. Before the experiment begins, the lower jar has placed in it a few drops of strong hydrochloric acid, the upper jar being similarly treated with a few drops of strong ammonia. On coming together, the hydrochloric acid and ammonia vapour interact, forming ammonium chloride (sal ammoniac) which is a white solid and which makes its appearance in the form of a mist.

Another "trick" experiment, simple, yet interesting to all. Take a piece of white cotton or wool and immerse it for a few hours in a moderately strong solution of potassium chromate. Then withdraw it

from the solution, wring it out (but do not rinse it) and allow it to dry. The fabric will now be tinted slightly yellow. Have, now, for the purpose of the mystifying experiment, three glass vessels containing respectively solutions of lead nitrate (or lead acetate), silver nitrate and calcium chloride (or lime-water). Perform the experiment under artificial illumination in order that the slight yellow tint of the treated fabric may not be noticeable.

Colouring Fabric

Tear the above fabric into three portions. On immersing the first portion into the lead solution, it is instantly dyed a brilliant

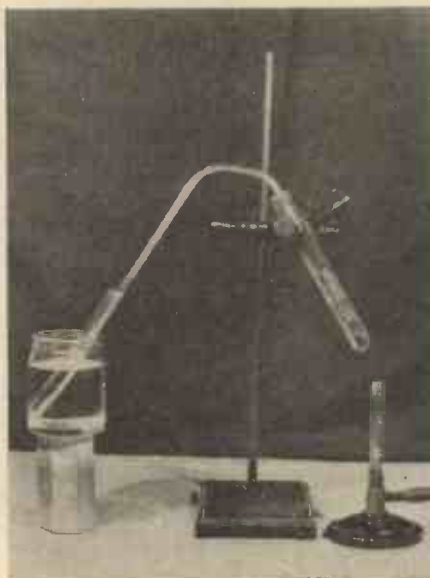

Ammonia from the Christmas table. The simple apparatus for obtaining ammonia from bones.

lemon yellow. The second portion of the fabric, upon being dipped into the silver nitrate solution, turns immediately red, whilst the third portion of the fabric which is placed in the calcium chloride or lime-water solution turns a full yellow, the shade of which may have been deepened by previously adding to the solution a very small amount of cadmium or cobalt chloride.

The explanation of the above effects is straightforward. The fabric is impregnated with potassium chromate and the latter compound interacts with the various solutions to form brightly-coloured chromates, which, being insoluble, remain in the fibres of the material and so "dye" it.

An experiment which may cause some consternation to the "victim" is as follows:—

Borrow a clean white handkerchief, which must be of cotton and not of artificial silk, and immerse it in a strong solution of potassium permanganate. The handkerchief will, of course, be coloured a heavy brown, so that on withdrawing it from the solution it will apparently have been rendered useless. Have in readiness, however, another vessel containing a strong solution of sodium sulphite (the salt used by photographers for developing) to which has been added a few drops of hydrochloric acid. Drop the "coloured" handkerchief in this solution and stir it about for a few moments. To the amazement of the onlookers and, no doubt, to the relief of the owner of the handkerchief, the latter article will rapidly "grow" white, so much so that after a few minutes interval, it can be withdrawn from the solution, rinsed in warm water, dried in front of the fire and finally handed back to its owner in a perfectly white and stainless condition.

The somewhat mystifying effect of this experiment is due to the fact that the brown permanganate stain is rapidly bleached by the sulphite solution. In place of the acidified solution of sodium sulphite, solutions of potassium (or sodium) metabisulphite or bisulphite may be used without the addition of a trace of acid. Needless to say, of course, when acid is added to the sulphite solution only a few drops must be employed in order to avoid injuring the fabric of the handkerchief.

"Artificial Snowstorm"

What we may term the "artificial snowstorm" experiment is an exceedingly pretty one in its effect and is well adapted for a Christmas night's entertainment.

In order to perform this experiment we require an iron tray, such as, for instance, a biscuit-tin lid, a large glass jar, a small spirit lamp or a candle and a small quantity



The snowstorm experiment. Showing the apparatus set up for use.

of benzoic acid, say half an ounce of this latter material which may be purchased as most of the larger pharmacies at a cost of a few coppers.

Stand the iron tray or biscuit-tin lid upon supports which raise it above the level of the table and permit of the candle or spirit-lamp being placed underneath it. Upon the tray place a small plant, a fern or even a few twigs inserted into soil contained in a miniature flower-pot. Scatter on the tray about a teaspoonful of the benzoic acid and finally cover the plant with the large glass jar or belljar as shown in the photograph accompanying this article. Light the spirit-lamp or candle and watch closely the effect produced. Almost immediately, a sort of replica on a miniature scale of a whirling snowstorm will be produced within the jar. Tiny white particles of benzoic acid will be hurled up to the top of the jar and set into a variety of circulatory movements, the final result being that within a few moments the tree, plant, twigs, or whatever article has been placed under the jar will be covered with a heavy deposit of benzoic acid, exactly resembling snow in whiteness and appearance.

Again, the explanation of this effect is simple. Benzoic acid readily "sublimes" or passes off into vapour when heated. The vapour of this compound, upon reaching the upper sides of the glass jar, condenses into fine particles which are deposited upon the article within the jar. Needless to say, this experiment can be performed again and again provided that the benzoic acid "snow" is carefully collected for further use.

Camphor on Water

The curious effect of camphor upon the surface of water forms an interesting experiment. Obtain a large basin full of cold water and place a small piece of camphor about the size of a small pea upon the water surface. Instantly, the camphor will set itself into motion and will sail here and there over the water surface, its action being due to various surface tensile effects. It is important to note that for the success of this experiment, the water must be perfectly free from any trace of grease

or oil. Hence, it is advisable that the vessel or basin containing the water should previously have been well cleaned out with hot soapy water. The effect of grease or oil upon this experiment can be demonstrated by placing a very small droplet of oil upon the water surface. Immediately, the motions of the camphor "boats" will come to an end. Under good conditions, it is possible to equip these camphor "boats" with tiny sails and masts, thus making the experiment still more interesting.

Artificial Parchment

Few chemical readers will have tried their hands at the making of artificial parchment, yet the experiment is a simple one, although not, perhaps, suited for drawing-room use. Have in readiness two dishes, the one containing strong sulphuric acid, the other containing strong ammonia. Take up a sheet of ordinary white blotting paper by means of a pair of tweezers or pliers and immerse it boldly in the sulphuric acid, withdrawing it immediately and quickly transferring it to the ammonia. There will



Showing the result of the miniature snowstorm created within the glass belljar.

be a violent hissing and spluttering as the acid-impregnated paper makes contact with the ammonia. Immediately, however, the paper should be withdrawn from the ammonia and rinsed in water. It will now have the appearance, feel and texture of parchment, being horny, yellowish and exceedingly tough in nature.

Have you ever tried the effect of touching a powdered mixture of equal parts of sugar and potassium chlorate with a glass rod moistened with strong sulphuric acid? Almost immediately, the chlorate mixture takes fire, thus demonstrating the practicability of producing "fire without a flame."

Amateur Photographers

Amateur photographers frequently find that the demonstration of "magic photographs" is of interest at Christmas parties. For this purpose, we require to make beforehand some prints upon ordinary printing-out paper. These prints need not be toned,

but they must be fixed and then well washed. They are then immersed in a solution of mercuric chloride, which will cause the images to disappear. Finally, the prints are washed and dried.

To make the images on the prints reappear, all we require to do is to place each print for a few seconds face downwards upon a sheet of blotting paper which has been moistened with a weak solution of hypo. The effect is almost instantaneous and causes great mystification to persons not "in the know."

A "Magic Photo"

If, in view of the poisonous nature of mercuric chloride, this substance cannot be obtained, another "magic photo" experiment can be made by taking ordinary bromide or gaslight prints and by "bleaching" them in a solution containing equal parts of potassium ferricyanide and potassium bromide. The prints are then washed and dried. For the purpose of the "trick," the bleached prints, which will show a very faint image, are immersed in water and then placed in a glass jam-jar to which has previously been added a few drops of ammonium sulphide. Immediately, the prints will develop up to a sepia tone under the influence of the ammonium sulphide vapour. Unfortunately, however, the latter substance possesses an unpleasant smell. Hence, whenever possible, the performance of the "magic photograph" trick by means of the mercuric chloride method is the more advisable.

The production of ethyl alcohol from sugar is an interesting experiment to perform upon the home scale. All we require, as materials, for this process is a ten per cent. solution of sugar, treacle or syrup and a few small fragments of yeast.

Place the sugar solution in a large bowl or basin near the hearth in order that it may be maintained slightly warm and add the pieces of yeast to it. Within half an hour, the yeast will commence to "work." Bubbles of gas will be seen proceeding from the solution, indicating that the yeast is feeding upon the sugar and converting it into alcohol and carbon dioxide gas. After about twenty-four hours, when the action of

(Continued on page 178)



The "mystic smoke" experiment is a very simple one, yet it usually causes perplexity on the part of the onlooker.

YOUR OWN "RADIO" PROGRAMMES



THERE is a considerable amount of entertainment to be had from so-called "home broadcasting," and the essential apparatus need not be expensive. Moreover, this form of scientific amusement will be found an ideal addition to the games played at Christmas parties. The scheme can be varied in a number of different ways, but the main idea is that members are invited, in turn, to put on their own "show." A time allowance of, say, five minutes can be made, and the "producer" takes his or her place before a microphone in a room away from that in which the loudspeaker is installed. Those who sing or recite can give their "turns" in one of these forms, whilst those who are good at telling yarns or making witty remarks can "broadcast" in this form.

The Microphone

The first requirement is a microphone, and this is connected to the pick-up terminals of the receiver. By making use of the volume control, a variety of effects can be given. Additionally, a good deal of fun can be had by making various noises in front of the microphone and asking members of the party to identify the sounds. Rustling paper, rattling keys, bursting balloons and so forth provide good tests and cause many laughs. If desired, the effect can be improved still further by using a gramophone pick-up and records in addition to the microphone and using a "fader" to bring the pick-up and microphone into circuit as desired. As B.B.C. listeners are aware, remarkably interesting programmes can be produced by mixing speech and excerpts from records.

But let us consider the more practical aspects of the question. The choice of a

Some Ideas for "Home Broadcasting," With A Description of Different Methods of Connecting A Microphone and Pick-Up and Using a "Fader."

microphone must be the first step, unless the reader already has one. There are numerous types on the market, and they can be obtained at prices from a few shil-

lings is most convenient to obtain a microphone of the table type which is supplied complete with transformer, switch, volume control and battery. This can be joined directly to the pick-up terminals of the receiver by means of the leads supplied with the unit. When such terminals are not already fitted to the receiver, they can easily be added.

It is generally best to place the microphone fairly near to the receiver so that the connections to it are short, but if this is not convenient the leads should be of screened wire, the screening being earth-connected. The speaker should be in another room if possible. If it is in the same room the microphone should be shielded from it by means of a cardboard box or sheet of non-resonant material. The reason for this is that should the sound from the speaker reach the microphone a peculiar form of instability will be noticed, which will result in a low-pitched "howl."

Microphone Connections

When using a microphone which is not provided with its own transformer and other "etceteras," the connections shown in Fig. 1 should be followed. It can be seen that there is a microphone transformer (ratio about 1 to 100), an on-off switch, and a 3-volt dry battery. The latter is generally satisfactory, but with some microphones a higher voltage is required. As the current consumption is low, however, quite an inexpensive battery can be used. A volume control is not shown in Fig. 1, but is always desirable. In some cases the low-frequency volume control in the set can be

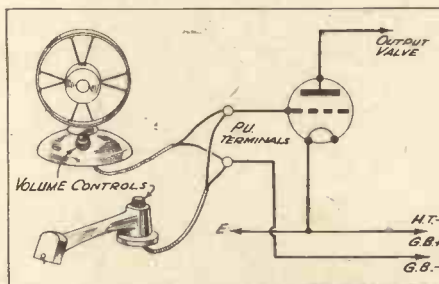

Fig. 2.—How a microphone and pick-up can be used together when each has its own volume control.

lings to several pounds. For present requirements, a microphone costing up to about a pound is adequate, since perfect reproduction is by no means essential. It

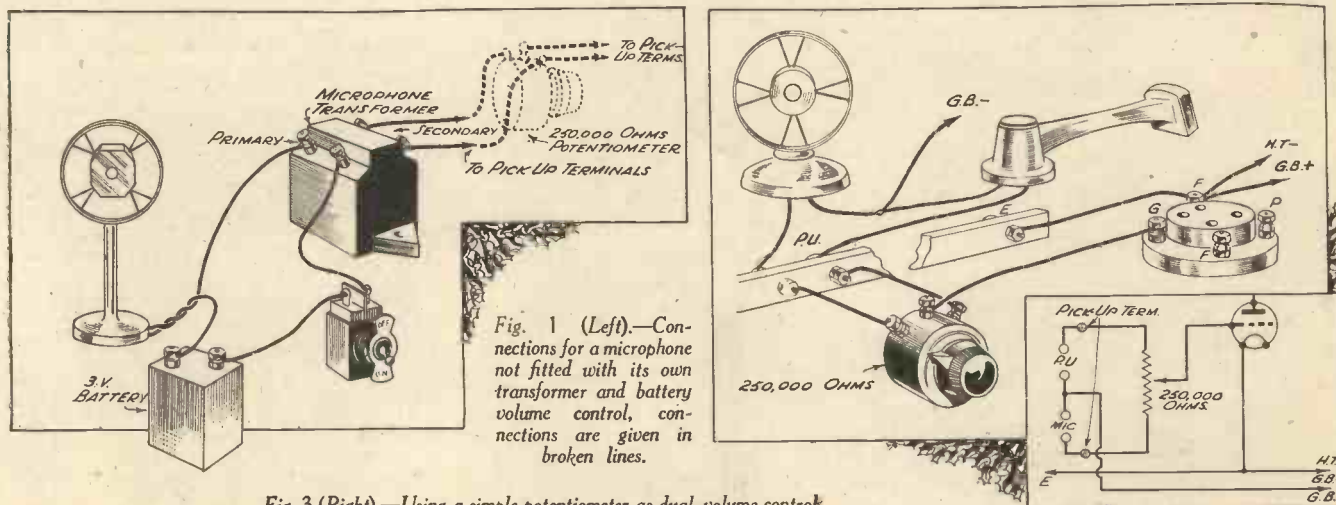

Fig. 3 (Right).—Using a simple potentiometer as dual volume control.

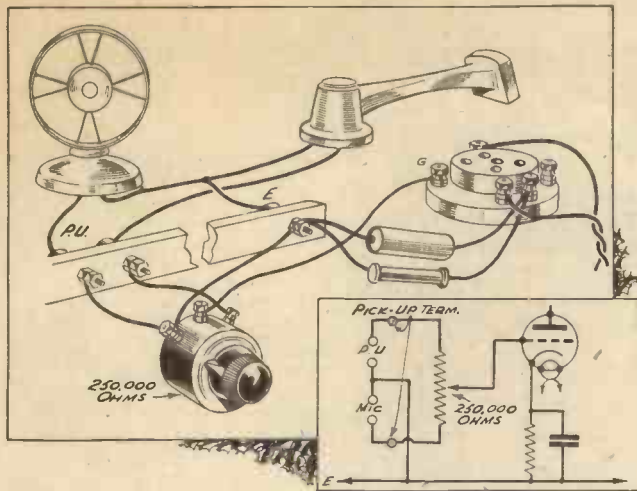

Fig. 4.—Connections similar to those in Fig. 3, but for a mains set.

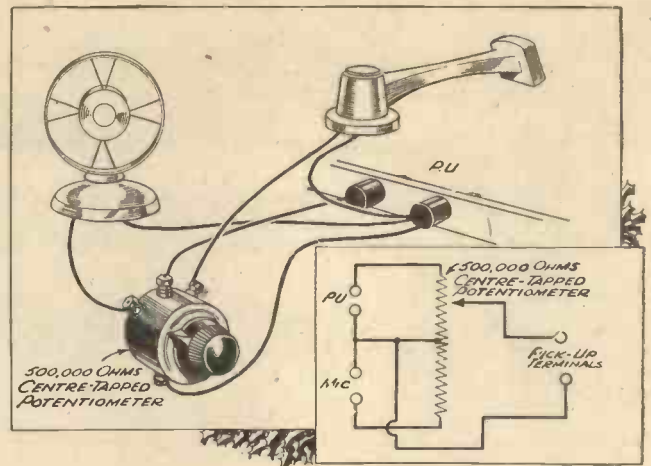

Fig. 5.—“Fader” connections, using a centre-tapped potentiometer.

used. But the voltage of the microphone-energising battery should first be adjusted to the most suitable value. This should be such that there is no appreciable distortion or “blasting” when speaking into the microphone with the control set to its “full-on” position. When an external volume control is required it can be connected between the transformer secondary and the pick-up terminals, as shown in broken lines in Fig. 1.

Combining Pick-up and “Mike”

As was suggested above, a better effect can be obtained by using a pick-up in conjunction with the microphone, when the “broadcaster” can try his skill at compering a programme. Assuming the use of microphone and pick-up, each having their own volume controls (and when the microphone has built-in transformer and battery), the connections can be as shown in Fig. 2, where both instruments are joined to the pick-up terminals of the receiver. When both volume controls are turned full on, the outputs of the microphone and pick-up will be reproduced at about equal strength by the speaker, but by turning down one of the controls, the relative strengths can be varied over wide limits. This arrangement is not ideal, and is incorrect in theory because the two volume controls are in parallel, so that the total

resistance in the grid circuit of the input valve is too low. The arrangement is, nevertheless, good enough for many requirements, especially after a little experience has been gained in operating the

case a 250,000-ohm potentiometer (preferably of the ungraded type) is used as a simple “fader,” the pick-up and microphone being connected in series. In speaking of the microphone in this case, it is assumed that it is attached to the appropriate transformer and battery, of course. When the slider is moved to one end the pick-up is in circuit, and when moved to the other the microphone is in circuit; between these two extreme positions a certain proportion of the output from each is applied to the amplifier. The connections shown apply to a battery-operated set, but corresponding connections for a mains receiver are given in Fig. 4.

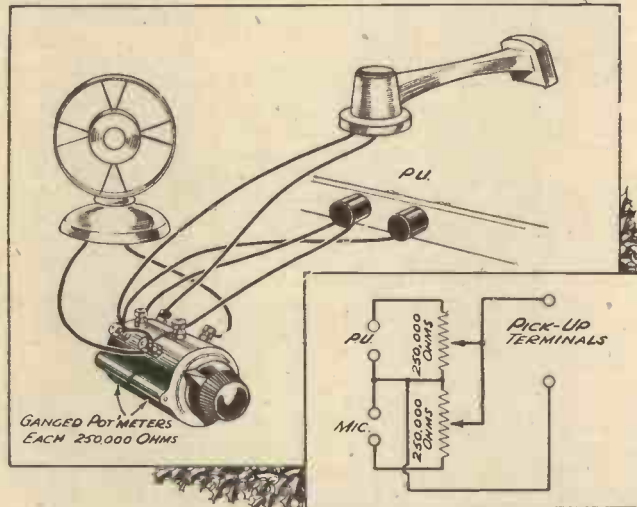

Fig. 6.—An alternative arrangement to that shown in Fig. 5, where two ganged potentiometers are used.

This general system of connections is fairly satisfactory when it is preferred to use ordinary components which will probably be to hand, but somewhat better results can be obtained by using a special centre-tapped potentiometer, as shown in Fig. 5. This is more effective because the pick-up and microphone do not require to be in series with each other, so that one connection from each is always “in the air.” In this case, both instruments are definitely cut out of circuit when the slider is moved to its central position, and either can be brought into use by moving it in one direction or the other from the midway setting.

two knobs.

Dual Volume Controls

Another arrangement which is better in some respects is shown in Fig. 3. In this

RADIO GAMES FOR XMAS

THERE are dozens of interesting party games in which the wireless receiver may be introduced. No doubt many readers have already devised ideas of their own, and the following notes give some of the lines which may be followed during the festive season in adding to the enjoyment of your guests. First, it should be emphasised that any receiver, other than a simple crystal or one-valver which will not operate a loudspeaker, may be used.

Secondly, if the following notes are followed, there is no risk of damage to any part of the apparatus and no risk of electric shocks, even although a mains receiver is employed. As a first essential in the employment of the ordinary receiver, an output filter circuit must be used. This is now standardised in the majority of commercial receivers, and many home-constructors, too, have fitted this in order to feed extension listening points.

Some Suggestions for Using the Standard Wireless Receiver as an Accessory to Various Games

Completing the Circuit

As a basis for the majority of the game in which the receiver is used, the comple-

tion of the speaker circuit may be taken as standard. Instead of two leads from the speaker point, a multiplicity of leads must be fitted as shown in Fig. 1. In some cases all of the leads on the earth side will be required, whilst in others only a single lead from this point will be employed. The simplest of games calling for no additional apparatus is a form of "Blind Man's Buff," where, the players stand in a circle holding the leads from the point marked A in the diagram. Interspersed in these leads are a number of blanks or dummies. These may be any odd pieces of wire, and it is obvious that the numbers of "live" and "dead" leads may be varied according to the requirements of the game. A single lead from point B (the earth side) is then held by another player who stands in the centre of the ring and proceeds from one player to another, touching the bared end of the wire he carries against the bared end of one of the wires being held by the player. The receiver is switched on and tuned to a station, or if there is no broadcasting available, a gramophone record may be played through the pick-up. Failing the use of a pick-up, the aerial may be disconnected and the reaction control tuned up until the set howls, the removal of the aerial acting as a safeguard in the prevention of interference with other listeners who may be attempting to receive some distant station. It is true that some circuits will not radiate such oscillations into the aerial system, but the simple precaution of removing the aerial avoids the necessity of studying the circuit in order to find out whether or not it is of a suitable type. If there is a self-contained speaker in the anode-circuit of the valve this should be silenced by means of an appropriate switch, whilst if no switch is fitted, the speaker should be replaced by an iron-core choke.

Other Schemes

It will now be obvious that when the single player completes the speaker circuit by touching the wire he carried against a "live" wire (from the point A) the signal being received by the receiver, or the reaction howl or gramophone record, will immediately be heard through the speaker. A time limit may be set upon the game, and the player finding the greatest number of "live" points in that time may be declared the winner. Alternatives will suggest themselves to the reader.

An alternative arrangement employing the same system may be built up upon a piece of plywood, covered by a piece of American cloth such as may be obtained from the popular stores at a very nominal figure. That marked in squares and used for shelves is preferable and the size of the square should be just larger than a penny. The cloth may be pinned to the board by ordinary drawing-pins at the edges, and then drawing-pins should be inserted at all the square centres. Now, going round the board, holes should be pierced at various adjacent pins, and through these holes the bared ends of the leads from the extension point already referred to should be threaded. A single loop should then be placed beneath the head of the drawing-pin, and it should be pressed firmly home. In Fig. 2 it will be noted that various pins are left blank, but as the wire will no doubt show and indicate to the players the correct point, short lengths of wire should be placed beneath the remaining pins to act as a misdirection. The game is played with pennies, or discs of metal of a similar size, and the board should be laid upon a table at a distance of about 3 ft. from the player. The receiver is set into operation as already mentioned and

the players throw the pennies on to the board. When a coin rests upon two adjacent drawing pins and these are connected respectively to the output terminals, the speaker will be brought into action. The game may be played with borrowed money, or the banker may take all the coins which fail to operate the speaker. Alternatively, the squares may be marked in ink on white cloth and numbered to indicate the number of coins which are paid out in the event of a successful throw.

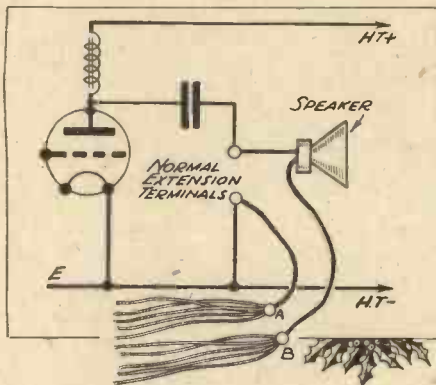

Fig. 1.—How to arrange the output circuit for radio games.

Adding to the Fun

The interest of these two games and others in which the circuit to the speaker is completed is increased when a talk is being received, as the completion of the circuit results in a few words being heard from the speaker and these disjointed sayings very often sound most incongruous, or may have some direct bearing upon something that has just happened or been said by the players. With musical items, of course, this additional fun does not enter into the game.

Other modifications of these schemes will be obvious to the handyman, but there are other ideas which may now be mentioned in brief.

Fault Finding

For the gathering where a number of keen wireless fans are present, fault finding may be arranged. Here one player goes to the receiver and in a given time has to introduce some fault to prevent the receiver from functioning. The other players then enter one at a time and are given a time period in order to locate the fault. The winner is the one who locates it in the shortest time. Alternatively, all the players may enter together and a scramble then ensues in an endeavour to be first to find the fault. In this case, of course, it should be some fairly obvious defect and not an obscure fault. For instance, a valve pulled out of the holder, or a wire removed from a component, but in the latter case care must be taken not to disconnect some point which may result in damage, such as the anode circuit of an output valve.

A NEW HANDBOOK!

An important new Handbook of great interest to every home constructor and, in fact, to anyone interested in radio, has just been published from the offices of this journal. It is entitled "Wireless Coils, Chokes, and Transformers: And How to Make Them."

It contains chapters dealing with coil types and principles; resistance inductance and capacity; choice and use of coils; a simple tubular coil; screened coils, etc.

The book contains 180 pages, is cloth bound with attractive jacket, illustrated by nearly 150 diagrams, and costs 2s. 6d., or 2s. 10d. by post.

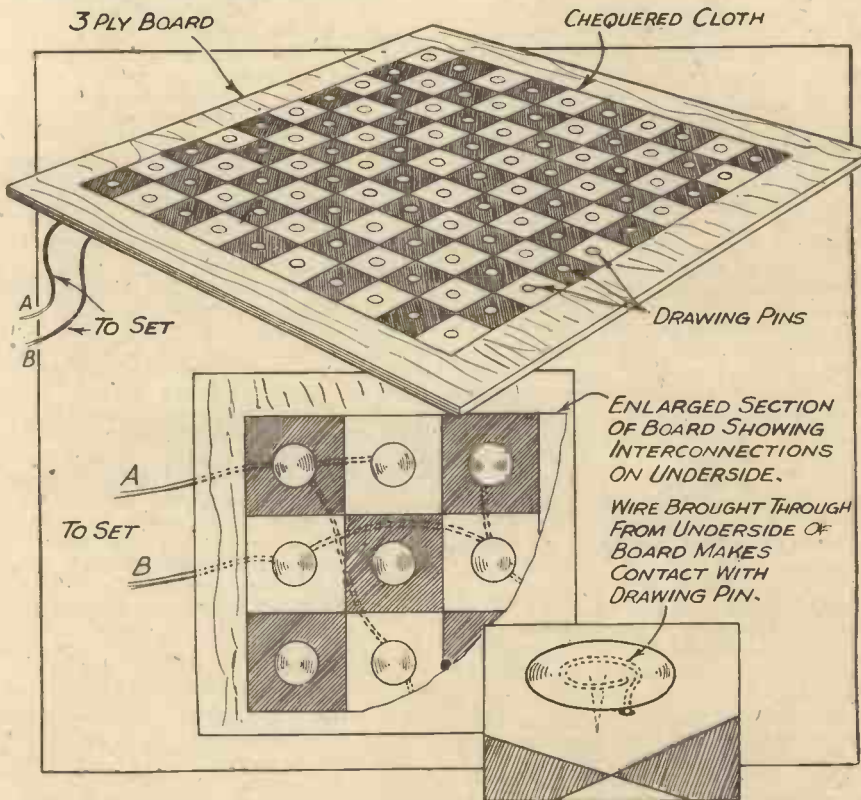

Fig. 2.—An easily made electrical board which can be used with the wireless set to provide entertainment and amusement.

"THOUGHT TRANSFERENCE" GAMES FOR CHRISTMAS

*Amusing Experiments in Mental Telepathy that are Ideal for
Performing at a Christmas Party*

THERE is a number of entertaining Christmas games which have "thought-transference" as a basis. Whether they really prove thought-transference to be a fact will give cause to a lively discussion afterwards and a number of variations of the games to test the validity of the conclusions reached will occur to those who have an investigating turn of mind.

The first of these games is carried out in the following manner. You require a number of fairly seriously-minded people, six or a few more will be found convenient. One of these has to volunteer to be the "subject." It is explained to him that he is to go out of the room and when he comes in again he will be blindfolded and has to attempt to make his mind a blank and act on whatever impulse tells him to do.

While the subject is out of the room, the occupants decide that he shall do something, say, go to the piano and play it, walk over to the sideboard and eat one of the chocolates from the box which is on it, sit on a certain chair or do anything else that is suggested.

The "Transmitters"

Two more volunteers are now required. These two are to be the principal "transmitters." They have to place the tips of their fingers on the temples of the "subject," hands together. One "transmitter" is each side of him and both have to imagine as vividly as possible his performing the actions it has been decided he shall. Everybody else in the room has to keep quiet and aid the game, or experiment, by imagining the subject performing what they wish.

All this is explained and then the "subject" is brought in. If he thinks of nothing he will probably stand quite still for a few moments, one of the "transmitters" on each side of him. The strain of concentrating and the strange atmosphere may cause a titter, but the titters will soon become serious when the "subject" starts moving in what, in nine cases out of ten, is the right direction.

He will walk in curious jerky movements and will move his limbs spasmodically. In fact, he will probably be accused afterwards of faking the effects and, after a successful experiment, the "subject" will be most emphatic about the genuineness of it.

Successful Results

I have taken part in a number of these games and in very few cases have they been completely unsuccessful, and have seen people do such previously-decided acts as moving an object from one part of the room to another, going up to and speaking to a certain person and performing other complicated wishes of the occupants of the room.

It seems necessary for those helping to imagine the "subject" doing what they wish rather than "willing" him to do it.

It also seems to help if they imagine him carrying out their wishes in small stages, i.e. by imagining the next immediate thing he has to do rather than the whole performance. Another aid to success lies in the selection of the individuals taking part; the "subject" should be of the receptive type and the "transmitters" of the positive, self-possessed type. Of course, it is difficult to assure this when they are all volunteers.

Sceptics Convinced

Once a friend of mine was teaching a class of boys and to illustrate some point he described to them this game. The boys thought it a huge joke, one of them, in particular, gibing at it. My friend said he would prove it to them, so he lined them up except the young sceptic, whom he blindfolded. Then he put a hat behind the legs of one of the boys and told the blindfolded boy what had been done and that he was to pick up the hat. A volunteer was taken from the class and with the master on one side and this volunteer on the other: holding the tips of their fingers to his temples and thinking of what he was to do, the blindfolded boy walked straight to the correct place and picked up the hat—much to his own amazement.

That was the case of one sceptic who was convinced. On another occasion, a sceptic—he was of the assertive type who claimed to keep an open mind on all subjects—moved backwards in exactly the opposite direction from which he was intended to go. This seems to indicate a reaction against the aid of the "transmitters." I have also seen the subject move off in the wrong direction and then stop abruptly to set off again, this time correctly.

The question arises whether the two "transmitters" unconsciously lead the subject to where they wish. The only testimony we have that this is not so is their own, which is valueless if they do guide unconsciously, and that of the "subject" which is probably unreliable if he is concentrating and thinks some slight aiding movement on his temples is an impulse of his own to move in that direction. What seems to support this theory is that when an experiment breaks down it is practically always in what the "subject" has to do when he reaches a certain place. Guiding a person to the place "by thought" seems simple, but guiding other actions are not as easy.

An Experiment

To attempt to determine whether the game relies on genuine thought—transference or unconscious help given to the "subject," some friends and I chose a person who had been particularly successful, it seemed, as a subject and invited him to take part in a test. He was to attempt to carry out the wishes of the com-

pany, blindfolded but without the help of people acting as "transmitters." Many attempts were made, both with the "subject" blindfolded and without. They were all failures.

This seems to support the theory of unconscious guiding, although it does not disprove the theory of thought transference. However, try it for yourself.

If you find a good enough subject, who can also play the piano, here is a fascinating variation of this game. Tell him or her to select a number of tunes, say five. Then stand behind him while he is sitting at the piano and place one of your hands on each temple. Think of one of the tunes. The "subject" should attempt to make his mind a blank and then the name of the tune should come to him, and he will start playing it. I know of someone who can do this and there seems no possibility of deceit.

Another Game

Here is another game which has the nature of an experiment, and which can be played by two or more. Those taking part are seated in comfortable chairs in a dimly-lit room, so that they are completely relaxed, and they are all facing one of the walls. On this wall a piece of black cloth or paper is hung, so that it is eight or ten feet from the people taking part. This distance doesn't seem to matter very much.

A "subject" is required again. This should, preferably, be a volunteer. The rest of the company decide on a certain simple shape such as a triangle, square or circle, without the "subjects" knowledge. Everyone then has to sort of project a mental image of the shape onto the centre of the black paper or cloth. The shape should be transmitted to the subject if he stares at the black area and tries to keep extraneous thoughts from his mind.

If the "subject" is particularly susceptible to this form of suggestion, it might be possible to transmit a message, one letter at a time.

Another method of transmitting messages is to cut up twenty-six squares of paper and write a letter of the alphabet on each. Arrange these in a circle on the ground two or three feet in diameter. The subject takes a length of string, which has a weight tied to one end, and holds it so that the weight is about an inch from the ground. If the rest of the company think of a message, letter by letter, his unconscious movements should cause the weight to swing in the direction of the letter being "transmitted."

It is interesting to try this experiment by oneself. Hold the string with its weight as indicated and think of one of the letters. Soon the weight will start swinging towards it. There is no case of thought transference here, of course, it is simply auto-suggestion.

E. B.

A SPOT WELDER FOR USE ON A.C.

The Construction of a Battery Operated Spot Welder was Described in the September Issue of "Practical Mechanics"

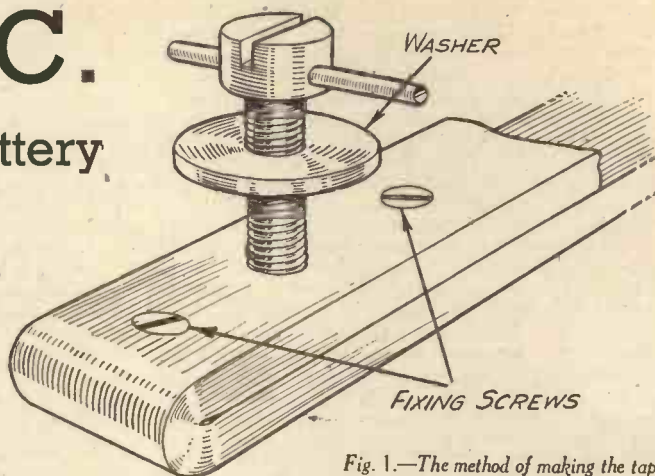

Fig. 1.—The method of making the taps.

THIS article actually describes the method of making the battery-operated spot welder, described recently in these pages, suitable for use on A.C., because the welder itself remains virtually unchanged. Briefly the differences are that this machine is operated from a transformer and the finger push switch dispensed with. A foot switch is used leaving both hands free to hold the work, etc. Start the work by removing the contact switch and then drill another hole through the bottom arm so that the whole may be bolted down to the bench or a large wooden base.

The Transformer

The transformer is the heart of the machine and must be made with care. A 500 watt transformer can be operated from a light socket and is heavy enough for most work, but a 1,000 watt requires a 5 amp. plug and this wattage is too great for the lighting wiring. If possible, try and obtain a second-hand transformer with an open casing rated for your supply and with an output of over 500 watts. On conversion, it will be as efficient as a commercial 500 watt transformer and the work of conversion will be easy. The output required is a maximum of 100 to 200 amps. at 1, 1.5, 2, 3 and 5 volts. In watts this is 500 or 1,000 depending on the current required. Five volts is not often required in the home shop. To carry over 100 amps., large cables are necessary, and as the resistance has to be kept very low we are using sections on the heavy side to allow for drops in voltage across joints, etc. On a core of this size, which must not be less than 3.5 square inches, we can allow

5 turns per volt; thus, one needs a total of 25 complete turns with taps at the 5th, 7½, 10th and 15th turn respectively. The length of strip of suitable section is obtained, and if hard drawn, is annealed. The section must not be less than 0.7 in. x 0.1 in. Now it must be cleaned and then insulated from end to end with good quality tape. Do not try to economise by

and press together, and then run solder between the two to make a solid bar. Drill the bar and tap ¼ in. fine, and fit with a cheese headed screw.

When the transformer is mounted on the base, the taps also are screwed down to the wood by two small wood screws, counter-sunk and passing through the copper, one in front and one behind the tapped hole. The top surface of the copper is dead flat. A suitable washer must be used under the screw in order to make good contact. When different tappings are often required, the screws are fitted with an easily turning head. Do this by drilling a ⅜ in. hole diagonally through the head and then hammer a 2 in. length of ⅜ in. silver steel rod through it. The spade end of the connector is made to suit the taps. Arrange the five taps in a neat row behind the welder. Keep the leads as short as possible. See Fig. 1 for details of the taps, etc.

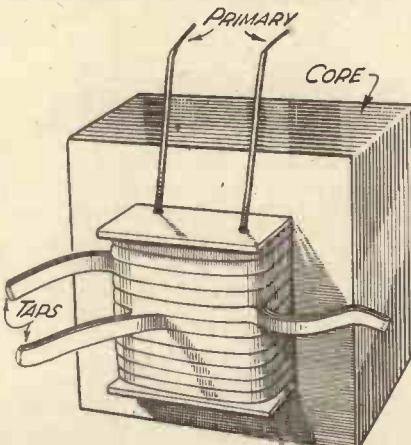

Fig. 2.—The finished transformer.

scrapping off the tape from the section required for taps, but leave this until finished and scrape off afterwards.

The Tappings

The taps are brought out as double lengths of wire to avoid soldering, etc., they should be hammered flat so as to lie neatly together. The starting end is connected directly to the bottom bar as before, while the top bar has the flexible connector for use with the taps. In making a tap, bring out the wire for 6 in., bend it over on itself, and take it back and continue winding to the next tap. Remove the insulation from the bent end, clean the copper

The Primary and Secondary

If a second-hand transformer is used, do not dismantle it but thread the secondary through the spaces; this may sound tedious but remember you are dealing with only 25 turns. It is a matter of minutes with the core clamped in a vice. The reason for this is that we cannot reassemble the core and clamp it as tightly as the maker does. Several that we have made are only about 25 per cent. efficient when tried out again. We have assumed that the primary was suitable for your supply. If not, rewind to suit. This means 1,150 turns to take 5 amps. As the transformer is short rated we can cut the wire size down a little to economise. Winding 1,150 turns on a fixed core when the wire is passed through and through is no joke, we have done it but would advise dismantling the core and winding in the ordinary manner. (See Fig. 2.)

A 500 watt transformer of this type will cost from £7 10s. to make, and so we do not think it necessary to deal with the construction of a new instrument.

The Foot Switch

The foot switch will now be considered. Here we have the same idea as that used for closing the points. Mount both the Bowden Control to the points and the switch on the same base. The switch is a piece of wood 3 in. wide and 9 in. long, and is hinged, at the end nearest the operator, to the

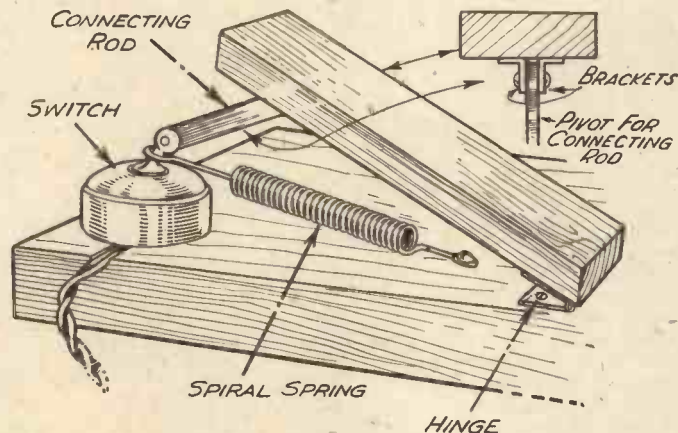

Fig. 3.—Details of the foot switch.

base. The switch proper is a tumble switch with a brass knob. It should be capable of carrying 5 amps. with a quick make and break. A 6d. one will do quite well. This is mounted under the pedals and is connected to it through a brass connecting rod. Make a saw cut at right angles to the pivot in the knob, open it out with a file until it will take a $\frac{1}{8}$ in. strip. You can do this by using two saws in the frame instead of one. Drill a $\frac{3}{8}$ in. hole through the knob. The connecting rod, which is a simple strip drilled with $\frac{3}{8}$ in. holes at each end, is cut from sheet brass $\frac{1}{8}$ in. thick. Put the switch in the off position, place the connecting rod in the knob and push the pin in, now work the switch by manipulating the knob. The pedal must work the switch, and for this, mount two small brackets on the under side of the wood, drill and put in the rod. The best position for the brackets and switch will be found by experiment, but we use it with the bracket on the end of the wood and the switch about 2 in. from the end, the

rod being 3 in. from centres. A powerful spring is hooked round the knob and round a screw in the base so that the switch is *always OFF*. It should take quite a lot of pressure to close the switch and on removing the foot it should fly open. Fig. 3 shows the finished switch. With this means, it is possible to get very accurate time control and good work can be done. Twin flex from the switch is taken up with the Bowden wire to the welder base and there connected to a porcelain junction box. This gives a neat and workmanlike finish. Fig. 4 shows the circuit.

A Press Switch

A simple press switch can be made from bits of brass similar to a bell push, but we do not recommend this because of the difficulty

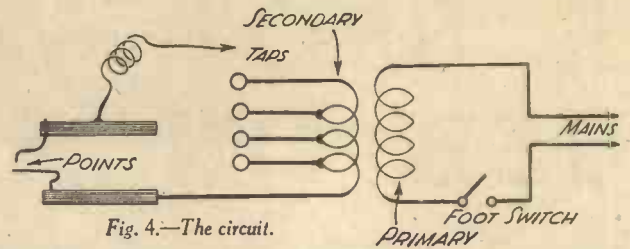

of protection, etc. The whole welder *must* be earthed and so must the foot pedals etc. (See Fig. 5).

Since the transformer is worked off the mains, and the little extra electricity used is not noticed, it is a good plan to arrange a small light just by the points. This should be a six volt car side lamp with switch on the base and is run from the 5 volt tapping. Mount it on a small flexible arm, and cut a tin shade so that the light is exactly as required. It will dim a little when the 5 volt tap is used.

Repairing Gear Teeth

By "Handyman"

REPLACING broken teeth in gear wheels should only be resorted to as a temporary measure of repair, or permanently in lightly loaded machinery, or where replacement of the whole is

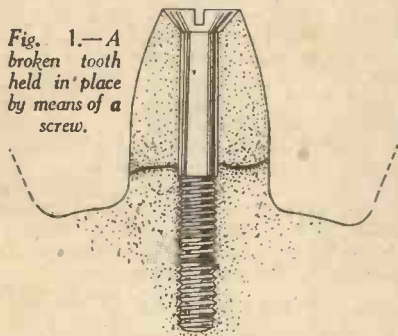
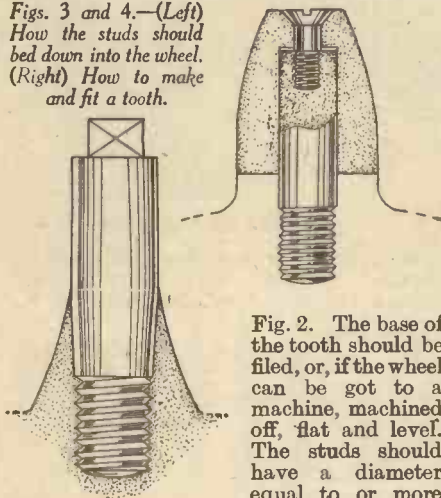

Fig. 1.—A broken tooth held in place by means of a screw.

screws, passed down through the tooth and tapped into the wheel, as shown in Fig. 1. In order to secure perfect re-seating of the fracture, the tooth should be drilled first with a small drill, and the tooth used as a guide for the drilling of the tapped holes in the wheel. The holes in both tooth and wheel can then be enlarged to their correct sizes.

If the tooth is broken in several pieces or is otherwise not usable, a row of studs can be tapped into the wheel, as shown in

Figs. 3 and 4.—(Left) How the studs should bed down into the wheel. (Right) How to make and fit a tooth.



the filed flat, to ensure, as far as is possible, a full tooth.

Small Studs

Under-sized studs will cause jumping and may lead to other broken teeth, it being preferable to fit a smaller number of full-size studs than a larger number of narrower ones, if the width of the wheel leaves such a choice. The holes which have to be drilled and tapped for the fitting of the studs should be marked out accurately, so that the unthreaded portions of the studs fit close together. If possible, the end of the stud should bed down into solid

material and a reasonable amount of the unthreaded portion of the stud enter into the wheel, as shown in Fig. 3. The end of the stud should be filed off square or hexagonal to take a spanner, so that it can be forced home hard. Where the flange of the wheel is thin and will not stand a bedded-down stud, the hole should be tapped right through and a nut used on the under side, and provision made for locking it securely. The tapped holes should be on the tight side to reduce sloppiness or movement.

The studs may then be filed, or machined down to the shape of the other teeth, it being particularly necessary not to cut a "perfect" tooth but one which follows the "wear" line of the old teeth. A hardened steel gauge can be made for this purpose from one of the other teeth.

A more satisfactory job can be made by making a tooth and securing it to the wheel as shown in Fig. 4. The studs which carry all the strain must be a driving fit into the tooth, the screws in the top of the tooth merely holding the tooth down. This method ensures a perfect tooth surface, which is absent with the plain stud method. (Continued on page 173)

Fig. 2.—A row of studs tapped into the wheel to take the place of a broken tooth.

practically impossible. Replacing teeth in small wheels, such as are used in motor-car and motor-cycle gear-boxes, and which would need softening and re-hardening with special equipment, is unsatisfactory and would quickly prove unreliable. Generally, these wheels are designed on the strength of the steel, in order to keep weight and size small, and if the wheel is weakened by drilling or milling, the designed conditions of strength would not obtain.

Temporary Repairs

Temporary repairs to cast-iron, mild-steel, or brass wheels can be effected in several ways. If the tooth has broken clean and is recovered undamaged apart from the fracture, it can be fitted into position again and secured by two or three

Fig. 2. The base of the tooth should be filed, or, if the wheel can be got to a machine, machined off, flat and level. The studs should have a diameter equal to or more than the width of

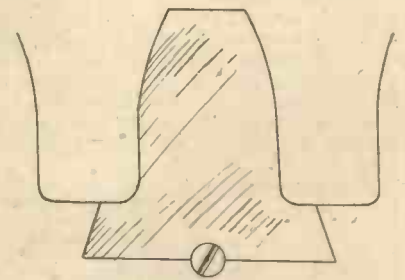

Fig. 5.—A perfect repair.

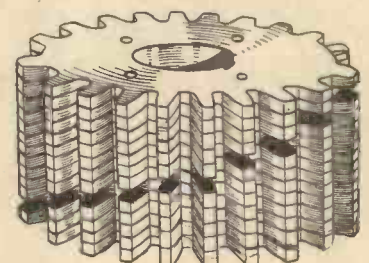
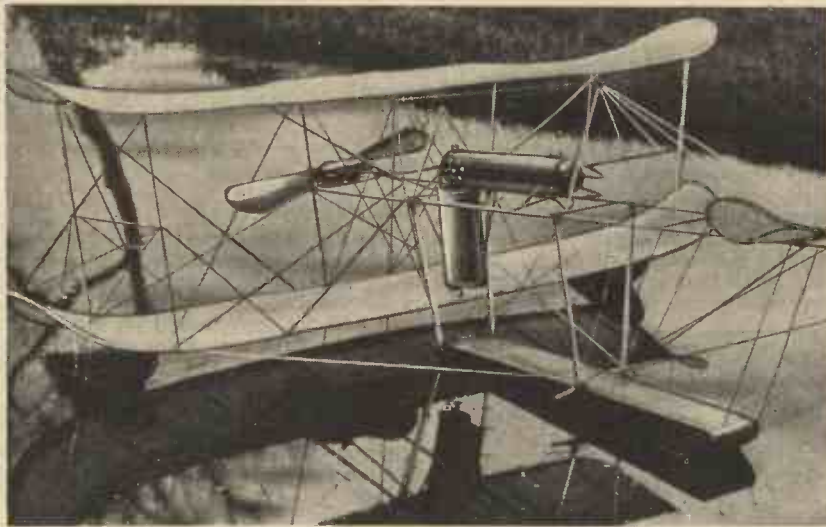

Fig. 6.—How to repair a tooth in a fibre wheel.

SIMPLE HYDRO-AEROPLANES

By V. E. Johnson, M.A.

Some Useful Hints Regarding Their Construction



The author's steam-driven biplane.

model facing a light breeze, rose from the surface of the water after a run of from 8 ft. to 12 ft. I have also seen a light compressed-air driven model weighing 2 lb. with a loading of 12 oz. per sq. ft. rise after a run of about 20 ft., and I have also seen a model weighing nearly 30 lb. with a loading of about 2 lb. per sq. ft. just leave the surface after a run of from 150 ft. to 200 ft. It was driven by a very powerful C.O. motor of short life.

The Floats

In the case of rubber-driven models, almost anything will serve for floats; even very small blown up long rubber balloons—in fact it was, I believe, with such floats that the first model flew. Let us look at it, however, from a more scientific aspect. The floats in this case should be so designed that their "aeroplanic" influence, i.e. their lifting power in air should carry a considerable portion of their weight, and should have a flotation capacity of at least twice that of the entire model. This applies to all floats. In rubber-driven high-powered models this is not essential, but it is not a scientifically designed model if this is not the case. It is essential, however, in the heavier power-driven model. In all models the floats must be so placed as to give the model maximum lateral and longitudinal stability. The latter is most important. On this page is shown a scale diagram of a well-known French hydro-aeroplane. The floats on the model should be placed considerably further out along the wings and the tail float should be larger.

Regarding the length of float and span in

A MODEL hydro-aeroplane is a machine which will, under its own power, first travel along the surface of the water, rise from it, make a successful flight in the air—and then (most difficult of all) land successfully on the surface of the water.

Now the problem of accomplishing this with a rubber-driven model (especially if heavily powered), presents no difficulty, provided the floats are properly designed, are in proportion and correctly placed. The above applies to all save the last, the landing on the water. I have seen hundreds of models, many of which have been excellent, but of good landings not more than 12 per cent. The case of the real power-driven model (excluding large surfaced biplanes driven by compressed air), however, is quite different. Whereas in the former case it need not or in many cases does not hydroplane at all in the true sense of the word—a proper driven power model must do so—the amount of the latter depending on load per sq. ft. wing surface, i.e. wing lift.

Take a simple case of the old type of rubber-driven model with a small plane in front, and twin pusher propellers. I have seen

such a model rise from the water when facing a light breeze after a run of a few feet, and make an excellent flight of over half a minute. The model rubber-driven type of tractor was not quite so quick off the water as this, at any rate that was my experience, and it is more difficult to land successfully. The difference, however, is very slight.

Now taking the case of the power-driven model weighing anything from 4 lb. to 30 lb. or more. Here, the model must more or less truly hydroplane; in other words be capable of travelling along the surface of the water at considerable speed. Six m.p.h. is the speed at which a float really hydroplanes, but what is the loading—or in other words—leaving out wind efficiency, at what speed has the model been designed to fly.

At a velocity of 30 m.p.h., a good aerocurve should lift at least 21 oz. to 24 oz. per sq. ft. This, curiously enough, is about the velocity of the old well-known all-wood rubber-driven Clarke's model flyers. In those days they were termed "projectiles."

It is by no means necessary to have such a high loading. The writer, many years ago, possessed a steam power-driven biplane weighing only 4 lb. which was successful in rising from the surface of the water and in flying. It had a loading of 8 oz. per sq. ft., and the

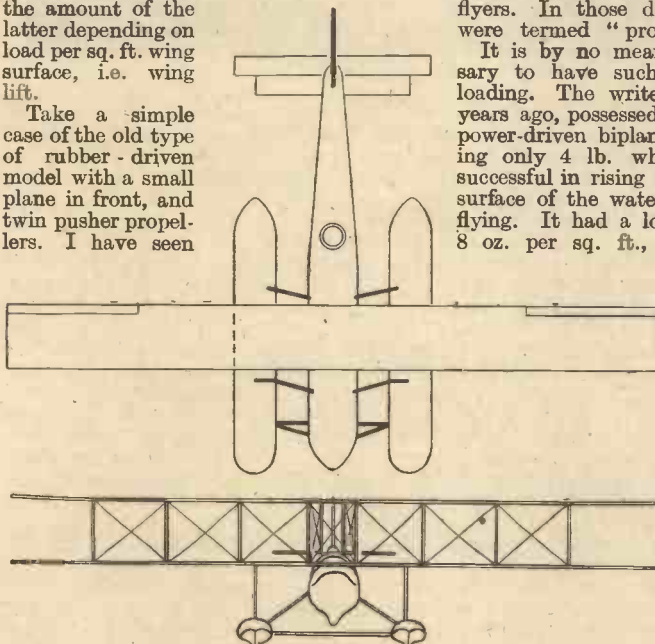

A sketch of a well-known French model Aero-hydroplane.

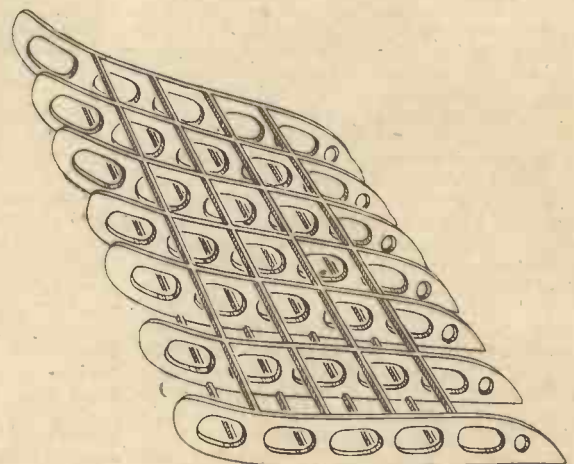

Constructional details of various types of float.

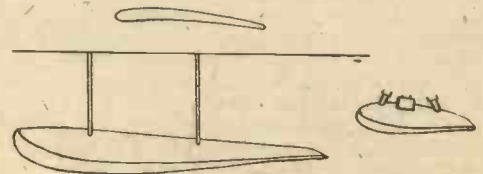

the case of a biplane model (power-driven) 4 ft. 6 in. long containing one central float and one float on each wing tip. When tried out the model did not leave the water until the central float had been extended to 32 in. in length which is considerably longer in proportion than those shown on page 143. The weight of the model was 4 lb. and the size of the long float 32 in. by 3½ in. broad and 2 in. deep—each wing float 10 ins. × 2 ins. × 2 ins. One point that must be carefully attended to is that whatever the type of model used it must be well sustained ahead of its centre of gravity, or the thrust of the propeller, which is considerably above the surface of the water, will cause the model to dive.

In general also the floats should be given a small though decided angle of incidence.

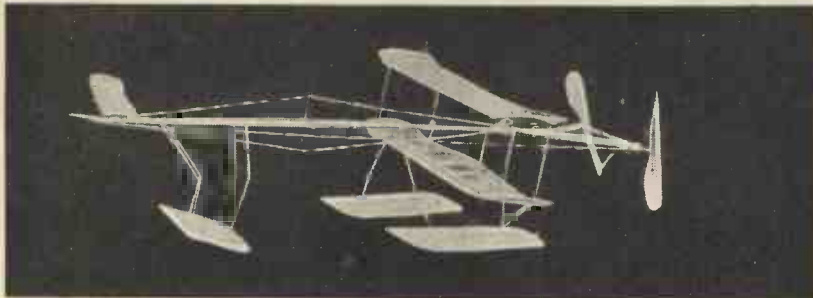

The author's Canard type model.

In all cases the floats should be so placed as to lower the centre of gravity of the machine as little as possible, in other words, the floats should be as close to the lower plane as possible, and the weight etc., be so distributed that the centres of gravity, of pressure, and head assistance, be coincident and the propulsive action pass through this same point. The floats, if small, should be capable of supporting in water at least 16 times their own weight and if for a large power-driven model of from 20 to 24 times their own weight. The writer has personally constructed such floats.

Float Design and Construction

In the case of rubber-driven models, having decided on the shape and size, one of the best woods to use is American white-wood, owing to its lightness and freedom from knots. Cut out two exactly similar pieces for the two sides. Their thickness should not be more than ¼ in. Connect these with four cross pieces the breadth of the float. The actual size of these depends on the size of the float. These are well glued into notches or niches which have been made in the side pieces with a file to avoid splitting the wood. They should fit tightly into the nicks, and also secured by very small dome-headed screws. Leave for eight or more hours to thoroughly set. The exact size of the float is, of course, determined by the size of the model. The next thing to do is to cover the framework with jap silk. Cut out strips long enough to go right round the floats, top and bottom from end to end and overlap about ½ in. or ¾ in. The width should be ½ in. wider than the width of the float on which it is to be glued. First glue one end of the silk to the front of the float, using fairly thick glue. Leave it to set. It is essential that the process of putting on the silk be spread over a certain period of time if the best results are to be obtained, one part must be quite set and firm before another is glued on. It is only by absolute tautness that the maximum flotation capacity can be obtained. When the above is glued, make the rest of the silk thoroughly wet—not just damp but wet—

squeeze lightly and glue on the silk to the edges putting the wet silk over the top edges and along the top of the float as well. Be prepared to keep on doing this for the best part of a quarter of an hour. When as tight as a drum and non-slipping, leave another 8 hours to set. rewet what is left of the silk and work out the rest on the bottom edge, etc., as before. Take great care with the corners, they are best double-faced. I omitted to state that before putting on the silk, all sharp corners and edges should be carefully sand-papered.

Rewet and glue down where necessary and trim off all superfluous edges, making as neat and smooth as possible, and reset to make them absolutely watertight. Shellac varnish is useless, and therefore a good boat varnish must be used. Two coats

a low centre of gravity. Floats for power-driven models are constructed on similar lines, save that all those portions of the float save the top will be covered with veneer wood or better still the thinnest 3 ply about ⅓ in. thick, or the float may be entirely covered with wood. In any case the entire float should be covered with jap silk—which will greatly strengthen it. After being finished and varnished it can with advantage be dipped in melted paraffin wax which will reduce the skin friction in the water.

Different Types of Floats

The first is similar to that used on smaller models and possesses more or less aeroplanic influence, i.e. it is not entirely a dead weight, and has no step, nevertheless it can and does hydroplane and for models of a few lbs. weight only I am not at all sure that this is not the better type. The other shown in vertical section has a somewhat high and long prow, a step—not too deep and a tapering form of stern—some are flat bottomed and some of this section (vertical). Now, such a float has no aeroplanic influence and is carried as a dead weight but it can be driven through the water very easily and for a well-powered model, i.e. a petrol motor carrying a fair capacity of fuel, I should prefer it, especially if the model were a monoplane with a loading of 1½ lb. to 2 lb. per sq. ft.

The other type of float—for a biplane only

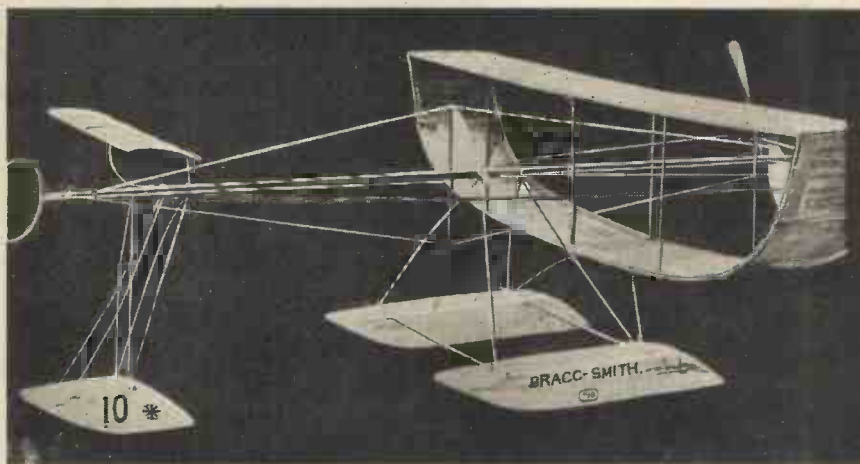

The Bragg-Smith Canard type model.

given at intervals of several days is essential and it is a good plan to give the woodwork a coat before gluing on the silk—especially in the case of power-driven models.

The float is satisfactory, when after a week's immersion, the float has not leaked nor the varnish become discoloured, brittle or has scaled off. Float making is best spread over a fortnight. For the purpose of attaching the floats to the fuselage nothing can beat steel piano-wire. Where the wires cross, bind with very thin copper wire and solder, or better still, silver solder.

They can be fastened to the floats by means of the brass headed screws. Such models will descend on land without any damage and can be flown from quite a small pond. Place the model gently on the water—don't "dab" it down and don't give it a push. The Canard or pusher type of model is by far the easier type to deal with and beginners should commence with this type—by beginners I mean beginners in hydro-aeroplaning. A 10 oz. model is quite large enough to commence with.

Finally, take every possible care to avoid

—consists of one long central float and two smaller floats, one on each wing tip. These floats can consist of two small blown out elongated rubber balloons.

Landing

This is the real crux of the problem—unless the model has a very fine gliding angle—it will (especially if it be a tractor model), dive and upset on landing. What is required is some piece of apparatus which will automatically cause the model to flatten out and land on a more even keel. The only thing, apart from some automatic timing device is some device (I refer here to a tractor model) which, hanging some distance down from the tail, on striking the water would alter the angle of incidence of the tail plane, and so bring this about either directly or indirectly.

In conclusion, in full-sized machines the floats are attached very rigidly to the machine, but in models, this should be avoided as much as possible, or in the case of a landing on land or even a steep dive, they will probably be seriously damaged or torn off.

SCIENTIFIC NOVELTY MYSTIC BOTTLES



SCIENTISTS BAFFLED. UNCANNY. WEIRD. UNIQUE. COMPLETE SET

ONLY **1/6** Post and Box 3d.

Will perform many astounding feats. Unlimited variety of performances. Continual entertainment for everyone. BRITISH PATTERNS. Full instructions forwarded, complete with list of entertainments.

Satisfaction guaranteed or money instantly returned.

INTRODUCING THE NEW 1938 BRITISH MADE "UNIQUE"

SLIDE RULES

THE MOST COMPLETE RULES OBTAINABLE

ACTUAL SIZE 6 1/2 x 1 1/2 ins.

POCKET LOG-LOG RULE

ONLY **3/6**

COMPLETE IN CASE POSTAGE 3d.

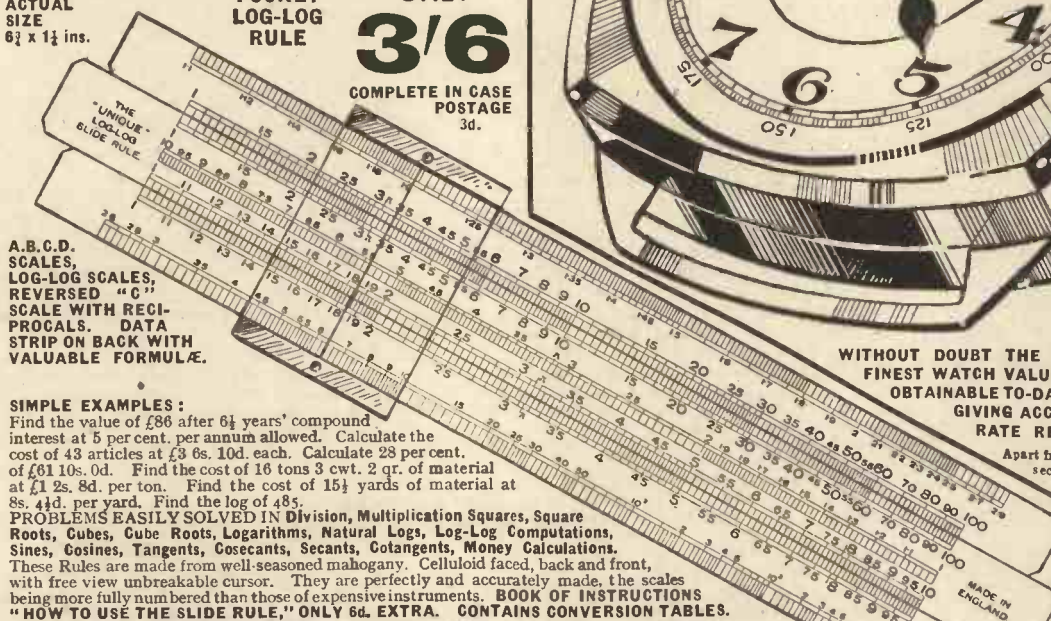

A.B.C.D. SCALES, LOG-LOG SCALES, REVERSED "C", SCALE WITH RECIPROALS. DATA STRIP ON BACK WITH VALUABLE FORMULÆ.

SIMPLE EXAMPLES:

Find the value of £86 after 6 1/2 years' compound interest at 5 per cent. per annum allowed. Calculate the cost of 43 articles at £3 6s. 10d. each. Calculate 28 per cent. of £91 10s. 0d. Find the cost of 16 tons 3 cwt. 2 qr. of material at £1 2s. 8d. per ton. Find the cost of 15 1/2 yards of material at 8s. 4 1/2d. per yard. Find the log of 485.

PROBLEMS EASILY SOLVED IN Division, Multiplication Squares, Square Roots, Cubes, Cube Roots, Logarithms, Natural Logs, Log-Log Computations, Sines, Cosines, Tangents, Cossecants, Secants, Cotangents, Money Calculations.

These Rules are made from well-seasoned mahogany. Celluloid faced, back and front, with free view unbreakable cursor. They are perfectly and accurately made, the scales being more fully numbered than those of expensive instruments. BOOK OF INSTRUCTIONS "HOW TO USE THE SLIDE RULE," ONLY 6d. EXTRA. CONTAINS CONVERSION TABLES.

SALE OF GENUINE SWISS-MADE CHROMIUM-CASED OFFICERS' WRISTLET STOP-WATCHES

NOW ONLY

5/9

POST & BOX 6d.

- Fully Guaranteed Jewelled Lever Movement
- Unbreakable Glass
- Chromium Case
- Shockproof
- NEW MODEL For Sport, Science or Industry



FOR DOCTORS' OR HOSPITAL USE ACCURATE TIMEKEEPERS



Actual Size

WITHOUT DOUBT THE FINEST WATCH VALUE OBTAINABLE TO-DAY GIVING ACCURATE READINGS TO ONE-FIFTH SECOND

Apart from being able to register time to fractions of seconds, these watches are equally suitable for general use. Plain dial for 5/9 each. Post and box 6d. Laminated dials only 6d. extra. Officers' Adjustable Leather Straps only 1/- extra. Officers' Adjustable Chrome Chains 2/- extra.

DESK SIZE LOG-LOG-SINE TANGENT RULE
9 SCALES—EQUAL TO A 20-INCH RULE ONLY
POST 3d. **6/6**

SALE OF GENUINE CHROMIUM-CASED REVOLVING DIALS

Full Hunter Type Watch. Cased Back and Front

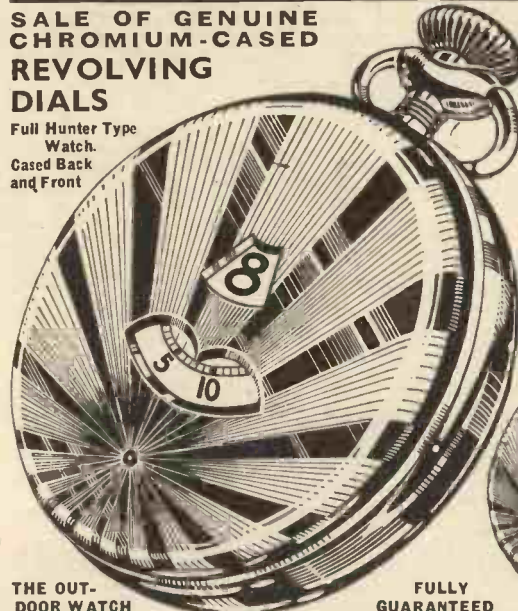

THE OUT-DOOR WATCH

FULLY GUARANTEED

ACTUAL SIZE

SWISS-MADE POCKET WATCHES

ORIGINALLY SOLD BY US FOR 12/6 EACH
NOW ONLY **3/9**
POST AND BOX 6d. TO CLEAR

A HARD-WEARING WATCH

10-inch LOG-LOG SLIDE RULE 5/- Post 3d.

LIGHTNING (VEST POCKET) CALCULATORS

SPEED EQUAL TO EXPENSIVE CALCULATING MACHINE

EACH ONLY **5/9** (POSTAGE 3d.)



Calculate as you read. Addition and Subtraction in Sterling calculations up to £9,999.19.11 1/2

Addition, Subtraction, Multiplication, and Division up to 99,999,999 all on the one machine. Machines willingly sent on 7 DAYS' APPROVAL against remittance. Size 4 1/2 x 2 x 1/2 in.

State whether £ s. d. or Numerical Model required.

WRITE, CALL PERSONALLY OR TELEPHONE HOLBORN 0276
SATISFACTION GUARANTEED OR MONEY INSTANTLY RETURNED

MARINE & OVERSEAS SERVICES LTD. (DEPT. 663) 16, SILVER STREET, HIGH HOLBORN, LONDON, W.C.1

PERCIVAL MARSHALL BOOKS

OF VALUE TO EVERY PRACTICAL MECHANIC

- Practical Lessons in Metal Turning.** By Percival Marshall, C.I. Mech. E. The best instruction book on the lathe for young engineers and amateur mechanics; with 220 original illustrations; 210 pages. Price 3s.; post free 3s. 3d.
- Fitting and Adjusting Bearings.** By Capt. Richard Twelvetrees. A practical workshop handbook. 60 pages; 29 illustrations. Price 9d.; post free 10d.
- Marking Out for Machinists.** By Capt. Richard Twelvetrees. A workshop handbook for apprentices, improvers and engineering fitters. 69 pages; 34 illustrations. Price 9d.; post free 10d.
- Micrometers, Slide Gauges, and Callipers: Their Construction and Use.** A practical handbook on everyday measuring appliances of the engineers' workshop, especially written for mechanics and apprentices. Price 9d.; post free 10d.
- Hardening and Tempering Engineers' Tools.** A practical guide to the hardening and tempering processes used in tool-making in the engineers' workshop. Colour Scale Diagram as frontispiece. Price 9d.; post free 10d.
- Soldering, Brazing, and the Joining of Metals.** A practical instruction book on these important workshop processes. Price 9d.; post free 10d.
- How to Read Workshop Drawings.** By W. Longland. A useful book for draughtsmen and apprentices. 64 pages; 33 illustrations. Price 1s. 6d.; post free 1s. 8d.
- Small Internal Combustion Engines.** A practical handbook on the working principles, installation, and maintenance of small stationary gas, oil, and petrol engines. By Edgar T. Westbury. 133 pages; 43 illustrations. Cloth bound. Price 2s. 6d.; post free 2s. 10d.
- Petrol-Engined Model Aeroplanes.** By O. E. Bowden. A practical manual and guide to the building and flying of Petrol Model Aeroplanes. 93 illustrations; 174 pages. Price 3s. 6d.; post free 3s. 10d.
- Modern Optical Projectors.** A practical handbook on optical lanterns, episcopes, and the use of projectors in industrial workshops. By Edgar T. Westbury. 124 pages; 69 illustrations. Cloth bound. Price 3s. 6d.; post free 3s. 10d.

Write for complete list of popular hobby books and designs, post free.

PERCIVAL MARSHALL & CO. LTD.
13-16N, FISHER STREET, LONDON, W.C.1.

ECONOMIC ELECTRIC CO.

TWICKENHAM, LONDON, S.W.

CYCLE LIGHTING DYNAMO SET

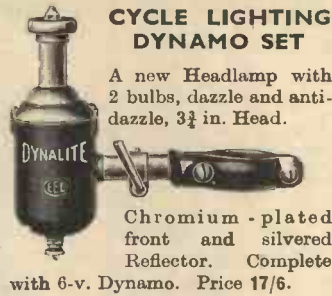

A new Headlamp with 2 bulbs, dazzle and anti-dazzle, 3 1/2 in. Head.

Chromium-plated front and silvered Reflector. Complete with 6-v. Dynamo. Price 17/6.

A.C. ELECTRIC CLOCKS

Guaranteed **ELECTRIC CLOCKS** complete with flex and adaptor, fitted with alarm. Price 18/6. Movement only, 13/-. Good quality **ELECTRIC SOLDERING IRONS** with 3 interchangeable copper bits. A sound job. Price 4/8. Post 4d. **SHOCKING COILS.** Complete with handles. Prices 2/6, 5/6, 9/6.

MICROPHONES



The uses to which the modern "mike" can be put are widely known. For party fun, Detectaphone, etc., they form endless amusement.

PRICES:

Announcer's Mike with adjustable stand, suspended type complete with Transformer. Price 18/6. Post 8d. Microphone only 8/6. Desk pattern with transformer and Volume Control 19/6. Mike only 8/6.

"CLIP-ON" READING LAMP



Can be clipped in any position and shade adjusted to any angle. A useful present. Complete with lamp. Price 4/6.

DRIVE your Model Railway from your Mains. Perfectly safe. Our new Rectifier can be supplied in following outputs: 2, 4, 6 volts, 1 amp 10/6; 1 amp 14/6; 2 amp 18/6; 3 amp 25/6. Will also charge your Radio Accumulator from A.C. Mains.

LIST.—Send for our Illustrated Catalogue containing 70 pages, fully illustrated, of all that you are likely to require—Meters, Motors, Telephones, Coils, Fittings, Transformers and parts, Lighting Sets, Tools and Workshop Material. Sent on receipt of 3d.

The "Rolls-Royce" of Lathes FOR PERFECT MODEL-MAKING

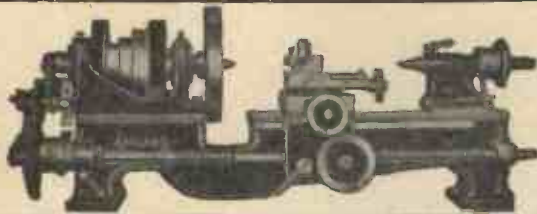

SEND FOR LISTS

HENRY MILNES

P.M. DEPT., INGLEBY LATHE WORKS, BRADFORD, ENGLAND.

Slip this AUTOMATIC BRAZING GUN on Your Gas and Braze 250 Jobs an Hour. Self Blowing, No Bellows, 12/6



Thousands of jobs brazed, silver soldered, re-metalled. Makes and hardens tools: white heat. This very hot and rapid blue flame brazer is in use throughout the World by Engineers, Metalworkers, Electrical Trades, Car and Wire-less Owners, H.M. Govt., R.A.F. *Motor Cycle* writes: "Blo-it-Hot" certainly fulfils claims. Send 12/6 for Gun shown brazing 2-in. tube; medium Gun 7/6; small Gun 5/-. Extra powerful Gun 17/6. Silver solder, braze flux, hints, Post Free, or P.C. for Folder and samples as brazed free. British.

P. M. BOARDMAN, "Monkton," PINHOE, EXETER

BE TALL

Your Height increased in 14 days or money back. The amazing Stebbing system soon brings 3-5 inches increase and new energy. The first original and the one **GENUINE GUARANTEED** Height Increase System. Recommended by **Health and Efficiency**. Complete course 5/-. or Booklet free, privately. **STEBBING SYSTEM**, Dept. M.P., 28, Dean Rd., London, W.1.

JUJITSU-JUDO

Learn to fear no man. The **BEST** self-defence ever invented. Easy to learn. Send for **SPLENDID ILLUSTRATED SAMPLE LESSONS**. Articles, particulars, **FREE** or P.O. 3/6 for a large **PORTION** of my Course. **Secret Kill Fear Free to Pupils**. Garrud's Jujitsu Institute, FELTHAM, Middx. Dept. P., "Yawara," 20 Durham Road, FELTHAM, Middx.

INCREASE YOUR HEIGHT in time for the New Year

The turn of the year is the time for growth. Why not add those extra inches with one box of Challoner's Famous Formula.

H.T.N. TABLETS

and easy system. Well tried and safe. No strenuous exercises or old-fashioned appliances. If one box is insufficient, we guarantee to supply a further box **FREE**. G. Y. (Watford) writes: "I have never had confidence in any system till I tried yours; now I've gained in height, weight and fitness." Act now! Full particulars 1/6. Sample 7/6. Book on height improvement 3d., stamps or P.O. only. Sent under plain sealed cover. Colonial Air Mail reply, except S. and E. Africa, 1/- extra. **THE CHALLONER CO.** (late Bond Street), Dept. N.75, Laboratory and Works, Hyde Heath, Amersham, Bucks

LABORATORY MICROSCOPES



Equivalent to £20 Instruments Triple Nosepiece Objectives 100 x 200 x 300 x Back & Pinion Focusing Supplied to Works & Colleges, etc. **GUARANTEED AGAINST DEFECT** Illustrated List on Request. 27/6 In Special Carrying Case with Operating Instructions & Slides. Sent Per Registered Post, Free. **J. K. M. HOLMES, DEPT. PM3.** "Viczaya," Wolvelsleigh, Gosforth, NORTHUMBERLAND.

WEBLEY AIR PISTOLS

Marvellously accurate for target practice. No license required to purchase. **Senior 45/-, Mark 1 32/6, Junior 21/-, Webley Air Rifle 95/-** Write for List. **WEBLEY & SCOTT LTD.,** 106 WYMAN STREET, BIRMINGHAM, ENG.

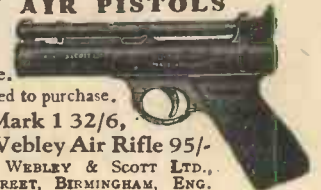

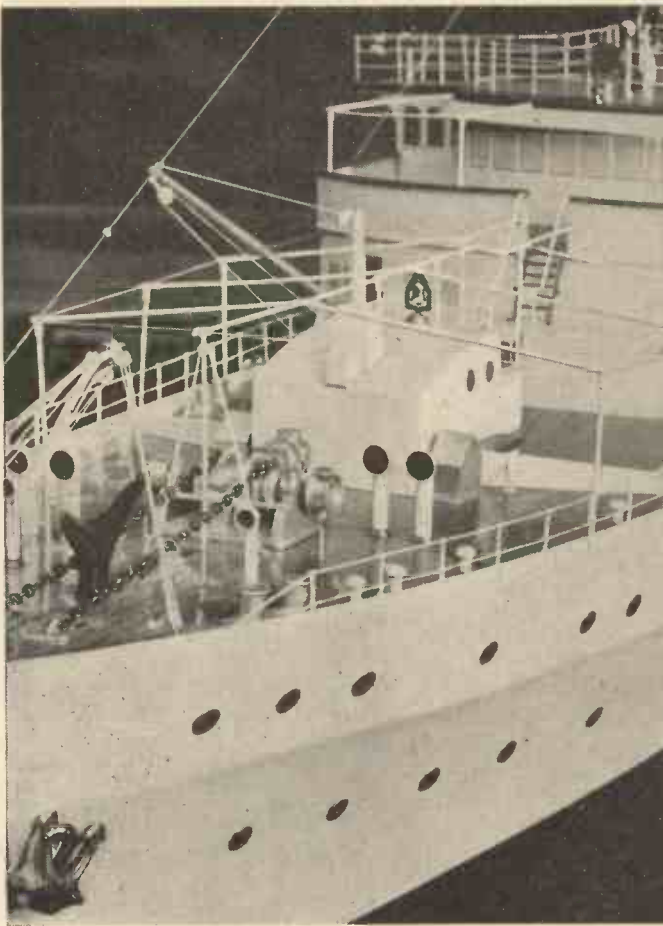

Two views of a model of Mr. T. O. M. Sopwith's motor yacht, "Philante," built to a scale of $\frac{1}{4}$ in. to the foot.

Highlights in the Modelling World

OUTSTANDING MODELS OF THE YEAR.

THEY say that "the music goes round and around," but then so does life in the world of models. At Christmas-time it is interesting to take a kaleidoscopic view of the various types of models which have "made their mark" on the year.

When, in this whirlwind age, we have time to stop and think for a few minutes, we realise what wonderful progress has been made during the past 37 years of the twentieth century.

Model Railways

Take, for instance, the hobby of model railways, which with all the new developments in gauge "0" and gauge "00," is now more popular than it has ever been before. The grotesque "pull-along" of the 1890's—a stubby engine with no resemblance even to the real railway of its time—has been replaced as the years brought wisdom by the "little beauty"



A 30-in. model of a tramp or cargo steamer.

also shown—a perfectly balanced, soundly made and accurately finished working scale model. You have only to read the specifications of these modern railway models—of Welsh tinned steel plate, turned cast-iron wheels, stove enamelled and painted, lined and lettered in correct colours, with all the small fittings accurately represented, to realise the advance that has been made.

Take, for instance, the gauge about which there is so much discussion this year—gauge "00." For years it has been sheltering more or less in the background of the model railway hobby, and now suddenly everyone is talking about the amazing new development engendered in the Twin Train Railway, more a toy than a recreation for scale-model experts, but a working toy which has caught the public's fancy and is rapidly developing along scale-model lines.

To arrive at the maximum of realism, of course, one must travel to a larger scale. A remarkable model of a *Royal Scot* dining-car, 1 in. to the foot, was made for the Johannesburg Exhibition. Everything was made up as on the real coach, including the gas ovens, vacuum pipes, even the tiny tables inside were set with knives, spoons, forks, serviettes, and so forth. The metal under-framing contains some choice model work, and when lit up, the finished model, lined, lettered, and varnished, gives one a very favourable impression of the modern L.M.S. mode to travelling.

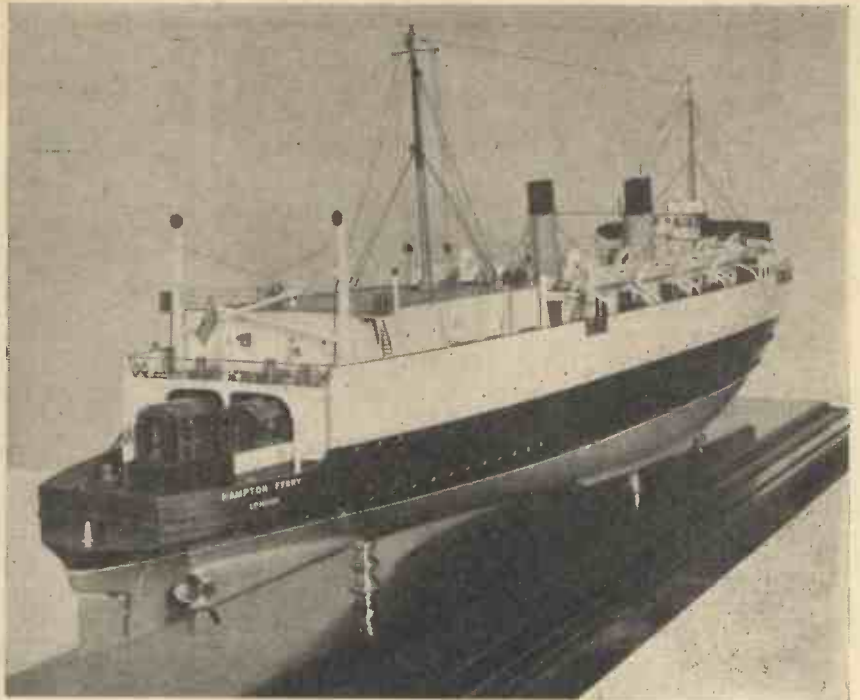

A model of S.R. Dover-Dunkerque train ferry, "Hampton Ferry," built to a scale of 1 in. to the foot.



A model of the steam dribbler of 1890.

Scale-model Ships

But our model high spots are not confined to the model railway world. Travelling farther afield our attention is immediately drawn to a particularly pleasing model of the motor yacht, *Philante*, almost as much in the news as her sister sailing yachts, the *Endeavours*. Her owner, Mr. T. O. M. Sopwith, has an eye for beauty of line, and the model does credit to its original. The scale of $\frac{1}{4}$ in. to the foot allows an enormous amount of detail to be shown. This model, like those built of the *Endeavours* both I and II, was built to the order of the makers, Messrs. Camper & Nicholson.

The Southern Railway train ferry—a journey from London to Paris by train while you sleep—has certainly started up a new trend of thought in journeying, and on this page is shown a $\frac{1}{4}$ in. to the foot scale model of the T.S.S. *Hampton Ferry*,

which is one of the three train ferries which were built for the Southern Railway to operate between Dover and Dunkerque on the Paris-London sleeping car service. The other ships are *Shepperton Ferry* and *Twickenham Ferry*. The actual ships are 360 ft. long, 60 ft. wide, and have a 12 ft. 6 in. draught, and a speed of 16 knots. It is interesting to examine the accommodation—4 lines of railway track on which 12 sleeping cars or 40 goods wagons can be run. By this means passengers can spend the whole of the journey in a Wagon-Lits berth with no change anywhere. The ferries also provide for garage accommodation.

Model Cargo Boat

Many an amateur model maker spends years perhaps on a working-model masterpiece of a ship that has caught his fancy, it may be a rough tanker or on the other

(Continued on page 173)

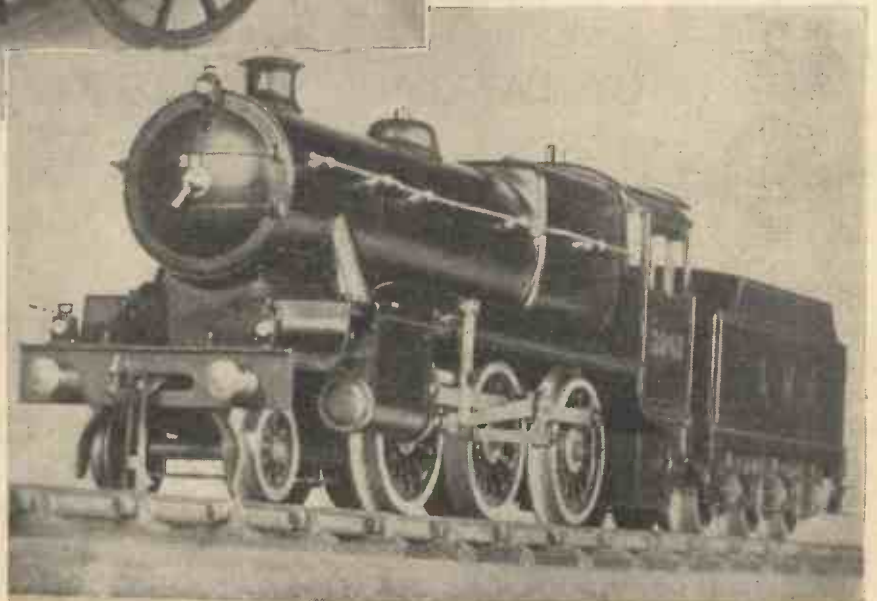

A gauge "0" L.M.S. Mogul type steam engine.

A SIMPLE ELECTRIC ARC LAMP

By "Home Mechanic"

This Type of Lamp is Particularly Suitable for a Cinema Projector or a Magic Lantern

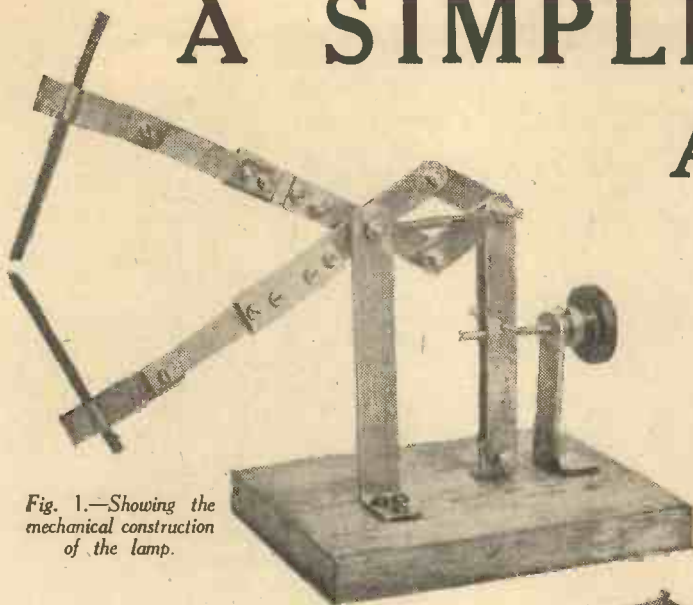

Fig. 1.—Showing the mechanical construction of the lamp.

AN arc lamp is particularly suitable for use with a magic lantern or a cinema projector, for the light is very bright and coming from a small area is easily focussed by the condensing lens.

Readers who have seen large automatic feed lamps having solenoids, levers, dash-pots, etc., may imagine that an arc lamp is necessarily a complicated affair, but such is not the case with the small hand feed lamp described below. The lamp is of the "scissors" pattern in which the arms carrying the carbons move like the blades of scissors, hence the name. It is intended that the lamp should be worked from the mains, but to do this a resistance is necessary, for making which instructions will be given. The lamp must never, on any account, be used without the resistance in series, otherwise the fuses will be blown every time. It is most important to bear this in mind.

This lamp is designed to take a current between 2 and 3 amperes, and either direct or alternating current may be used. With direct current the carbons should be of different sizes, otherwise the positive carbon will burn away about twice as fast as the negative one, but when using alternating current both carbons should be of the same diameter.

The Carbons

Stock sizes of carbons are 5 mm., 6 mm., or 8 mm. For ordinary use with continuous current 5 mm. may be used on the lower carbon—which should be negative—and 6 mm. for the upper or positive carbon, but if you want the lamp to run longer without attention, you may use 6-mm.

negative and 8-mm. positive carbons. The positive carbon is usually of the "cored" variety, i.e. it has a core of softer carbon to make the arc burn more steadily. When using 2 amps on continuous current, with carbons of 5 and 6 mm. diameter, the lamp will burn for about five minutes without attention, after which the light will suddenly go out unless the carbons are brought closer together by means of the adjusting screw. The lower carbon will be consumed at the rate of about 1½ in. per hour, and the upper one at about 2 in. per hour.

The Mechanical Construction

The mechanical construction of the lamp can be gathered from Fig. 1. The upright at the left is fixed to the baseboard and carries the two carbon arms by means of a single bolt at the top, this bolt forming a pivot about which the two arms can move. The second upright is hinged at the bottom and the top end carries two links which are pivoted to the ends of the carbon arms, thus forming a parallelogram. By moving the hinged upright towards the fixed one, the arms are forced apart, thus separating the carbons. A tension-spring pulls these two uprights together.

The shorter upright is fixed to the base, and carries a long screw, which, by controlling the movement of the hinged up-

Fig. 2.—Showing the construction of the resistance. A metal or fibre panel should be placed over the terminal strip to prevent the danger of a short circuit.

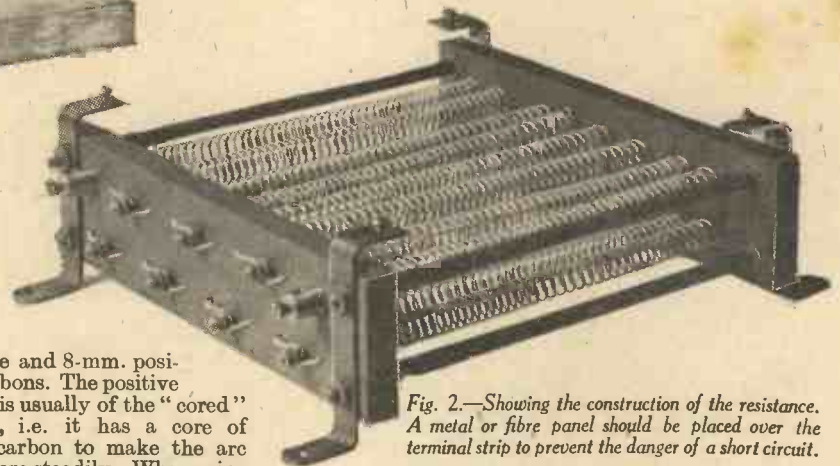

right, adjusts the distance between the points of the carbons. When working the lamp the carbons are adjusted about ¼ in. apart, and the current switched on; the current will not jump this gap unless it is started, so the carbons must be brought into contact and separated again to the required distance. This is done simply by pulling back the knob of the screw and letting go again, thus striking the arc which will continue to burn until the gap becomes too large owing to the burning away of the carbons.

The Lamp

The construction of the lamp is quite a straightforward matter. All the metal parts are of brass; the parts shown in Fig. 3 are the brackets which are fixed to the base. A carries the carbon arms, B is the support for the adjusting screw, and C holds the bottom end of the rocking upright. The main dimensions only are given in the illustrations; the holes for the holding down screws can be drilled to suit any screws you have handy, and their position is not important, though they should be neatly spaced.

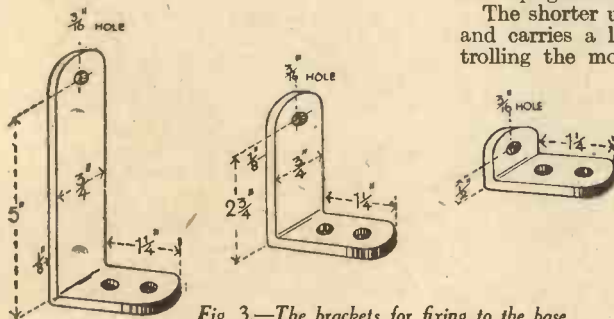

Fig. 3.—The brackets for fixing to the base.

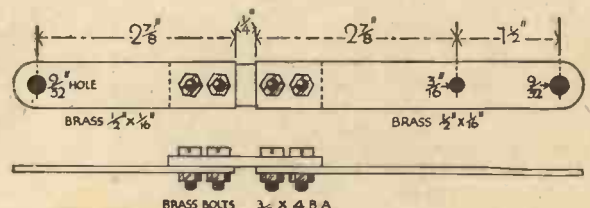

Fig. 4.—The carbon arms.

The carbon arms are illustrated in Fig. 4. Two of these are required; it will be seen that each arm is divided into two pieces with a $\frac{1}{4}$ in. gap between. This is to insulate the carbons from the framework and from one another. The two parts are held together with a strip of red fibre and four small bolts as shown. It is not advisable to use ebonite for the insulation, as it may soften through becoming warm, in which case the carbons would go out of line.

The Uprights

The parts shown in Fig. 6 are simply flat strips of brass; two of each of these

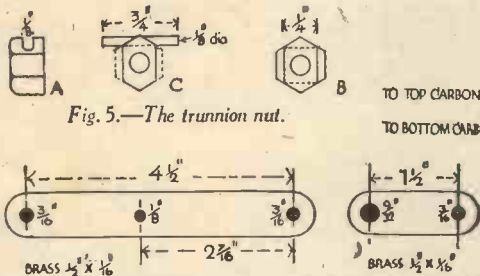

Fig. 6.—The strips for the moving upright and for forming the link.

will be required. The A's are for the moving upright, and the B's form the links connecting the carbon arms to the moving uprights.

The trunnion nut shown in Fig. 5 is made from a 2 B.A. brass nut. First, file a groove as shown at A, until it almost breaks into the thread of the nut, as shown at B. A piece of $\frac{1}{8}$ in. dia. round brass wire is then soldered into the groove, as shown at C. Of course, if the reader has a lathe and a set of taps, he would make this part rather differently, but if made as described it will be quite as effective, and requires nothing special in the way of tools.

Now make two clips to hold the carbons, as shown in Fig. 8. It will, of course be necessary to decide the size of carbons to be used, and make the clips to suit. The carbons are simply held by the springiness of the metal; the clips will not get hot enough to sustain damage unless the carbons are allowed to burn very short.

A piece of oak or other hard wood should be obtained for the base about 7 in. long, 5 in. wide, and $\frac{3}{4}$ in. thick.

Assemble in the following order. First screw the fixed upright to the base about $1\frac{1}{2}$ in. from the front edge and about $\frac{1}{4}$ in. away from the longitudinal centre line, thus allowing the carbon arms to come just about on the centre line. Fit the arms by means of a single 2 B.A. bolt and two nuts, as shown in Fig. 9. The arms should be free to move on the bolt with a minimum of side play, while the upright should be held firmly between the two nuts.

The Links

Next fit the two links to the back ends of the carbon arms by means of 4 B.A. bolts and two nuts to each. Don't screw the bolts up tightly, but allow them to form a hinge joint and lock the two nuts together. The free ends of the two links are brought together, a washer $\frac{1}{8}$ in. thick placed on each side so that the total thickness is $\frac{1}{4}$ in., and outside the washers come the top ends of the two members forming the moving upright. All these parts are then held together by a 2 B.A. bolt and two locknuts as shown in Fig. 9 (which is a view looking on to the top), but are free to move on the bolt. The trunnion nut should

be fitted with the pin in the $\frac{1}{8}$ in. holes between the uprights are bolted together.

The bottom end of the moving upright can now be fixed to its bracket (Fig. 2C) by means of a 2 B.A. bolt, allowing freedom of movement; two $\frac{1}{16}$ in. washers will be required at this point between the uprights and the bracket. Fix the bracket down to the base in such a position that the moving upright is vertical, while the arms are about 60 deg. apart.

The Adjusting Screw

This is a piece of 2 B.A. screwed brass rod $2\frac{1}{2}$ in. long obtainable from model

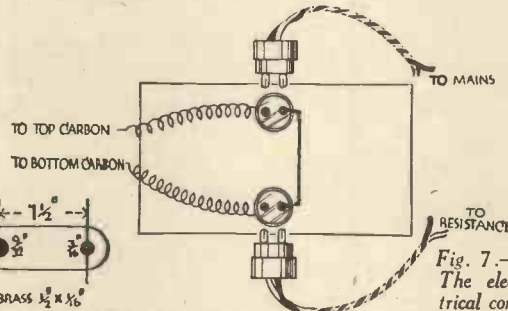

Fig. 7.—The electrical connections.

engineers' stores, and the knob can be taken from some old wireless fittings. Any brass knurled nut will do if you cannot find a nice ebonite knob. Fix the screw and its upright as shown in Fig. 1. It will be necessary to elongate the $\frac{1}{8}$ in. hole in

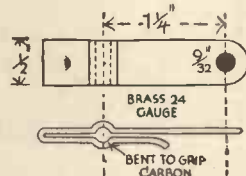

Fig. 8.—The clips for holding the carbon rods.

the upright a little to allow the screw to move up and down sufficiently to follow the movement of the rocking upright. Bolt the carbon clips to the ends of the arms, then fix a tension spring as shown in Fig. 9 and the mechanism is complete.

The electrical connections must now be made. The most convenient way of doing this is to fix two plug sockets to the base as illustrated in Fig. 7. Connect them up as shown by means of a single "flex" insulated wire (i.e. ordinary flex is twisted

double; just untwist this into two separate wires). The wires to the carbons are connected under one of the bolts holding the front end of the carbon arm to the fibre insulation.

Resistance Wire

The length of the wire required for the resistance will depend upon the mains voltage; for any voltage between 200 and 250 two ounces of No. 23 S.W.G. Nickel-Chrome resistance wire will be required. This will have a length of approximately 70 ft. and will have a resistance of about 80 ohms. The construction of the resistance is clearly shown in the photograph, Fig. 2. The top and bottom end pieces are made of slate 2 in. wide, 8 in. long and $\frac{1}{2}$ in. thick, these being held apart by four long bolts and tubular distance pieces, the latter being about 8 in. long. The four iron brackets are about $\frac{1}{2}$ in. by $\frac{1}{4}$ in. and they serve the double purpose of forming feet and holding a cover plate (not shown in photo) to protect the wires. These are sixteen coils of wire, each coil consisting of about 4 1/2 ft. of wire wound round a $\frac{3}{8}$ in. dia. mandrel.

The Coils

The first coil is fixed at one end to a terminal on the top end, while about 1 in. of the other end is straightened and pushed through a hole in the lower end. The second coil has its end pushed through the next hole and the ends of the two coils are connected together by means of a small brass bolt and a couple of washers. All

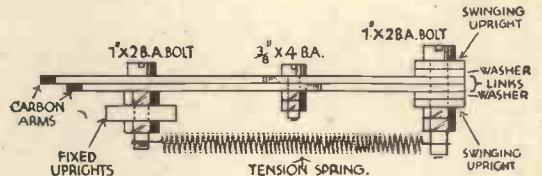

Fig. 9.—How the arms are fitted.

the coils are connected end to end in this manner, the last coil being connected to another terminal. The coils must be stretched across so that they do not sag and must not touch each other except where connected together. The coils must all be connected in series.

Holes can be drilled in the slate with an ordinary drill; the two rows of holes are 1 in. apart, and each hole is $\frac{3}{8}$ in. from the next in the same row. Hard asbestos may be used in place of slate.

NEWNES HOME MECHANIC ENCYCLOPEDIA

By F. J. CAMM

(Editor of "Practical Mechanics")



This invaluable encyclopædia is written in plain language, and deals comprehensively and authoritatively with the following hobbies:

Aircraft, Woodwork, the Lathe, Motor Cars and Motor Cycles, Television, Wireless, Model Boats and Railways, Microscopy, Photography, Cinematography, Astronomy, and Chemistry. This volume also includes sections on Glues, Electric Motors, Electro-Plating, Tools, Accumulators, Inks, Polishes, etc., etc.

Obtainable at all Booksellers, 3s. 6d., or by post 3s. 10d., from Geo. Newnes Ltd., Tower House, Southampton Street, London, W.C.2.

**THE MOST SUCCESSFUL
ELECTRICAL WORK OF THE YEAR**

*Sent to your Home
FREE on approval for 7 days*

If YOU work in
Any Branch of the
Electrical Industry

YOU NEED THIS NEW BOOK

The FIRST and ONLY Book of its kind

The
Electrical Encyclopedia

A Handbook of Modern Electrical
Practice for the Working Electrician

4 Volumes . . 1,480 pages . . Over 2,300 Illustrations

General Editor : S. G. BLAXLAND STUBBS
Assisted by 6 Expert Associate Editors and
32 Highly Qualified Contributors

THIS comprehensive work contains sound, up-to-date, authoritative information written by experts in every branch of the profession, and covers thousands of problems and questions of everyday work. The rapid development of electric technology means an enormous increase of opportunities for the electrical engineer who keeps abreast of advancing knowledge. YOU can seize these new opportunities NOW by the aid of "The Electrical Encyclopedia." Whatever your particular subject or job this work will add to your efficiency and aid your advance in your profession.

**GIFT
BOOK**

Valuable 66-
page Pocket
Book of Refer-
ence Tables
Presented
FREE to all
Purchasers.

Just sign and post the form below and we will send you these four volumes carriage paid, to examine for one week free. You may either return them to us, carriage forward, within eight days, to end the matter, or you may keep them on the very easy terms outlined on the form.

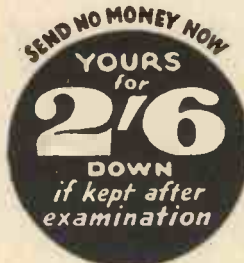

"Practical Mechanics" FREE Examination Form.

To the WAVERLEY BOOK CO., LIMITED,
96 and 97, Farringdon Street, LONDON, E.C.4.

Please send me, carriage paid, for seven days' FREE examination, "THE ELECTRICAL ENCYCLOPEDIA," complete in four volumes. It is understood that I may return the work on the eighth day after I receive it, and that there the matter ends. If I decide to keep the books I will send you on the eighth day a First Payment of 2/6, and, beginning thirty days after, thirteen further monthly payments of 5/- each and a final one of 6/-, thus completing the purchase price. (Price for cash on the eighth day, 70/-.)

Name

Address

Occupation

Parent's signature required if under 21

State if householder Date.....

P.M.13. PLEASE FILL IN ALL PARTICULARS ASKED.

**AN OPPORTUNITY YOU
CANNOT AFFORD TO MISS**

As a reader of "Practical Mechanics" we offer to send you for seven days' free approval a three-volume work that teaches thoroughly every branch of metalworking—

**THE PRACTICAL
METALWORKER**

Entirely NEW and
Revised Edition

Three Volumes—Thousands of Illustrations

HERE is an entirely new and up-to-date edition of a well-known practical work that deals with every phase of modern workshop practice. It combines the theoretical basis of metalworking with the practical instruction necessary for success.

A few of the many subjects dealt with:

- Benches and Simple Tool Equipment
- Files and Filing
- Marking Out Work
- Materials and Their Uses
- Ferrous and Non-Ferrous Metals
- Wire and Wire-drawing
- Production of Small Castings
- Foundry Work
- Miscellaneous Lathe Operations
- Metal Spinning
- Sheet Metalwork
- Spring Making and Wire Working
- Edging and Seaming
- Principles of Mechanical Drawing
- Workshop Arithmetic
- Brazing and Soldering
- Fusion Welding
- Arc Welding
- Resistance Welding
- Welding Plant and Machinery
- The Thermit Process
- Oxy-Coal Gas Welding
- Cutting Metals by Fusion
- Hardening and Tempering
- Polishing, Colouring and Lacquering, etc.

Many chapters have been entirely rewritten in the light of the latest technical knowledge—the latest word on electric welding, for instance. New illustrations have been added, and the whole work has been thoroughly revised and brought up-to-date.

THE PRACTICAL METALWORKER embodies the result of years of practical workshop experience, and gives thousands of hints and wrinkles that enable work to be done better and more easily.

Learn more and earn more. Success comes to the workman with knowledge as well as experience. This book is invaluable to Apprentice and Student. To the ambitious mechanic it provides the Stepping Stone to a better position.

FREE for 7 days

Just sign and post the form below and on acceptance we will send you these three volumes, carriage paid, to examine for one week free. You may either return them to us, carriage forward, within 8 days, or you may keep them on the very easy terms outlined.

"Practical Mechanics" FREE Examination Form.

To the WAVERLEY BOOK CO., LIMITED,
96 and 97, Farringdon Street, LONDON, E.C.4.

Please send me, carriage paid, for seven days' FREE examination, "THE PRACTICAL METALWORKER," complete in three volumes. It is understood that I may return the work on the eighth day after I receive it, and that there the matter ends. If I decide to keep the books I will send you on the eighth day a First Payment of 2/6, and, beginning thirty days after, seven further monthly payments of 5/- each, thus completing the purchase price. (Price for cash on the eighth day, 35/-.)

Name

Address

Occupation

Parent's signature required if under 21

State if householder Date.....

P.M.14. PLEASE FILL IN ALL PARTICULARS ASKED.

THE HOBBY THAT'S DIFFERENT

NEW MODELS—PROMPT DELIVERY—NO INCREASE IN PRICE—THREE GOOD MOTTOES FOR 1937

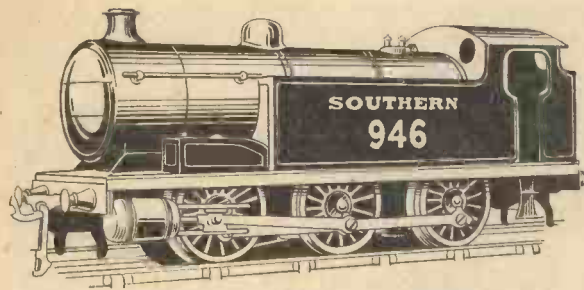

This photo shows a new addition to our range of 6-coupled Tanks, which are now available in S.R., L.M.S. and L.N.E.R. colours. These Standard Tanks are smart and sturdy with good hauling power, as the power units are of first-class quality.

Prices: Clockwork, now reduced to 37/6. Electric d.c. 42/-. Spur drive d.c. 52/6, a.c. 46/-.

N.B.—Also 0.4.0 Shunting Tank, new this season. Gauge "O." Clockwork 21/-. Electric d.c. 26/-. a.c. 30/-.

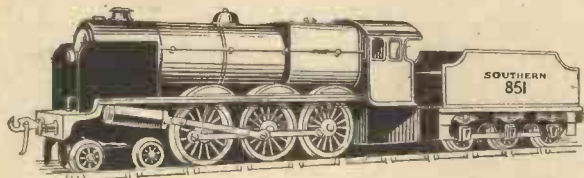

Based on our successful "ENTERPRISE" design, this new 4.6:0 Gauge "O" steam locomotive "SUPER ENTERPRISE" is a massive and handsome engine with all the internal arrangements which make our 4.4.0 models so reliable. Of free lance design externally, it may be had in Southern or L.M.S. colours with smoke deflectors, or L.N.E.R. without them.

Price: "SUPER ENTERPRISE," 18 inches overall, £3 17 6. "ENTERPRISE" 50/-.

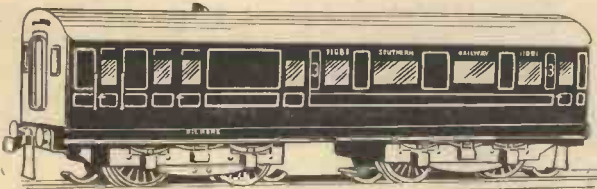

The amazing popularity of the "OO" Gauge Twin Trains in England gave Bassett-Lowke the idea of producing a real "scale model" for this series, and here it is.

The outfit consists of a Third Class Model S.R. Motor Coach working off 14 volts A.C. or 12 volts D.C., two Bogie Coaches, Oval of Track, Controller, Connection and Instruction Book.

Officially approved by the Southern Railway, this model set costs 55/-. NEW TWIN TRAIL FOLDER TT.12 on application.



One of the most popular of Bassett-Lowke "Vans," this L.M.S. Post Office Mail Van is one of the best-value vehicles in their Model Railway Catalogue. With pick-up apparatus you can deliver and collect your model mails at speed!

Last year this model cost 30/-, but with the new batch now in stock BASSETT-LOWKE have been able to reduce the price to 21/-.

Pick-up apparatus from 5/- according to your track.

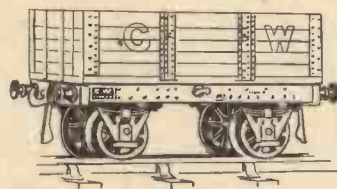

GOODS ROLLING STOCK

has been reduced all round in "O" Gauge. Bassett-Lowke Open Wagons now only cost 2/6, Covered Wagons, Cattle Wagons and Refrigerator Vans 3/- each, and Brake Vans 3/6. There is no change in the high-class finish of this rolling stock, but improved methods of production have enabled them to reduce the price.

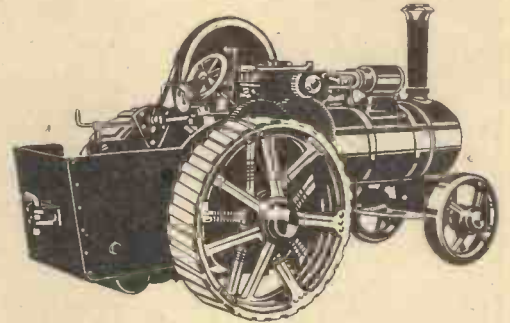

YOU CAN BUY ALL THESE FROM "B-L" LTD.

From List A.12
Locos. Coaches. Track. Points. Wagons. Signals. Postal Vans. Brass and Steel P/Way. Stations. Platforms. Engine Sheds. Drawings. Parts. Station Fittings. Mechs.

From List B.12
Engines, Launches, Steam, Marine, etc. Pumps. Boilers. Cylinders. Gauges. Fittings. Nuts. Bolts. Valves. Castings. Parts. Drawings, etc.

From List S.12
Yachts. Motor Boats. Scale Marine Models. Waterline miniatures. Liners. Tug Boats. Ships' Fittings. Kits of Parts. Blue Prints, etc. **EACH LIST 6d.**

Our Model Traction Engine—still the most popular model for the model builder who wants a real engineering job. Castings and finished parts available with drawings—or finished model painted or unpainted. Special booklet on how to build it costs 3d.

The man who likes to build things will want Section B.12 of Bassett-Lowke's Catalogues, from whence this Traction Engine comes.

S.12 is the catalogue you want for Christmas Gifts to all Ship Lovers, and who does not love the different fascinating types which touch our shores?

Bassett-Lowke have a unique series of super-detail marine models which include Oil Tanker (9 gns.), Cross Channel Packet "Isle of Sark" (11 gns.), Cargo Boat (9 gns.), Naval Pinnace (£6 8s. 10d.), Exploration Ship (9 gns.), and so forth.

Also in addition to a splendid array of sailing Yachts, Motor Boats, and inexpensive craft from a guinea upwards, they have sets of parts for building waterline models of well-known ships from 12s. 6d.

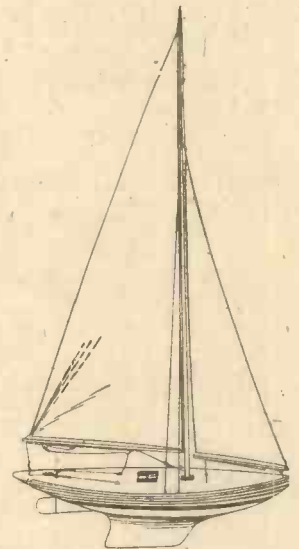

"WHITE HEATHER" MODEL RACING YACHT, from 45/- upwards.

N.B.—Have you seen their 2/- cut-out novelties of the "NORMANDIE" and "QUEEN MARY"?

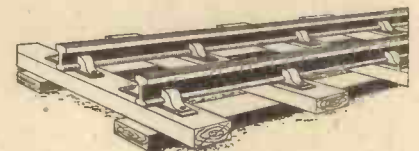

STEEL RAIL

Everywhere raw materials are going up, but Bassett-Lowke have managed to maintain the price of their fine steel rail (shearadised) at 2/6 per length, points 10/6 each, Acute Angle and Right Angle crossings 13/9 each. Also in electric, and special sets of component parts for building your own track.

For other kinds of track see List A.12.

BASSETT-LOWKE LTD., NORTHAMPTON
LONDON: 112 HIGH HOLBORN, W.C.1 MANCHESTER: 28 CORPORATION STREET

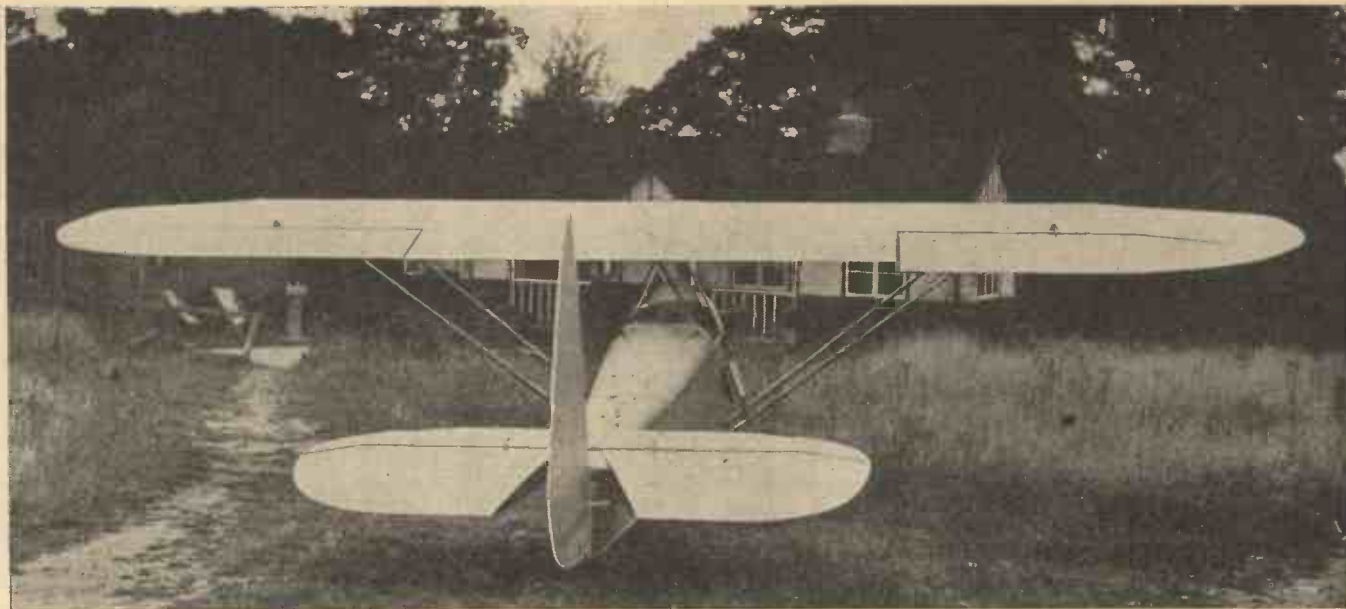

Fig. 1.—A rear view of the plane showing its attractive lines.

Building the "LUTON MINOR" Light Aeroplane

PART III

Tail Plane and Elevator

IN the "Minor" construction the tail plane and elevator are made in one and cut apart afterwards. This method greatly simplifies construction and ensures that the two parts will match up properly when completed. The building of a fairly long component of short chord, such as either the stabiliser (fixed tail plane) or elevator, is not easily accomplished without the aid of an elaborate jig since the unit is very liable to twist and proper alignment is difficult. It is probably easier to build the two combined surfaces of the "Minor" than to build either one separately.

THE TAIL UNIT

Tail Spars

The rear tail-plane spar and the elevator spar are identical and are made of $\frac{3}{8}$ in. spruce, $3\frac{1}{2}$ in. deep, the lengths being trimmed to 7 ft. $10\frac{1}{2}$ in. The ends of the spars taper to $\frac{1}{2}$ in. deep at the tips, the taper being confined to the last 11 in.

The front spar is made from a piece of spruce 2 in. \times $\frac{3}{4}$ in., roughly 6 ft. in length. The two front edges are rounded off to form a "D" section (Fig. 2). Along the top and bottom faces of this spar notches are cut, $\frac{3}{16}$ in. deep, to accommodate the rib noses,

Fig. 2.—Showing section of front spar and notching for ribs. Also method of rib attachment (plywood web omitted for clearness).

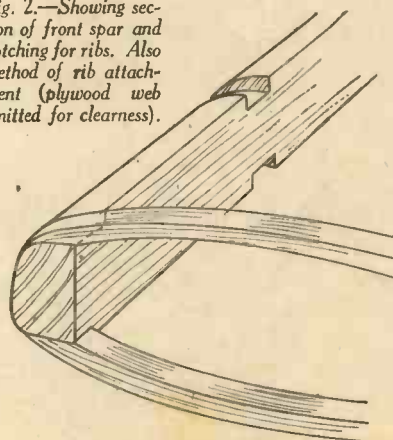

there being 5 notches top and bottom at 12 in. centres, commencing from the centre of the spar.

Tip Bends

The tip bends may be made next in readiness for the assembly. These are made in exactly the same way as the main plane tip bends, but one jig only is necessary. They are made up of 4 laminations of $\frac{1}{2}$ in. \times $\frac{3}{8}$ in. spruce, giving a finished section of $\frac{1}{2}$ in. \times $\frac{3}{4}$ in. The bends are made in one piece from 7 ft. lengths, the extra material being used to form the straight trailing edge (See Tail Assembly, Fig. 10).

Tail Plane Ribs

The tail ribs are very simple units. One jig might be made up for all but the two tip ribs and slightly modified afterwards to deal with these two. Very few "buttons" or blocks are necessary for this jig.

PRICE LIST OF "MINOR" TAIL UNIT MATERIALS

	£	s.	d.
Tail plane, elevator and rudder spar spruce	16	2	
Remainder of spruce, as list above	1	11	3
18 sq. ft. plywood	6	0	
Mild steel sheet, 16 s.w.g. (2 S.3), $1\frac{1}{2}$ sq. ft.	2	0	
Complete set of materials as detailed above	2	15	0
Tail and rudder ribs, made up	2	5	0
Making up tail and rudder bends, extra to materials	10	6	
Or all bends complete, including materials	1	1	0
Complete set fittings (23) made up	2	2	0
Tail unit made up, but uncovered.	17	10	0

MATERIALS REQUIRED FOR TAIL UNIT CONSTRUCTION

- Aero Spruce**
 2 lengths, 8 ft., $3\frac{1}{2}$ in. \times $\frac{3}{8}$ in.
 1 length, 6 ft., 2 in. \times $\frac{3}{4}$ in.
 1 length, $4\frac{1}{2}$ ft., $4\frac{1}{2}$ in. \times $\frac{3}{8}$ in.
 10 ft. of $3\frac{1}{2}$ in. \times $\frac{1}{4}$ in.
 120 ft. of $\frac{3}{8}$ in. \times $\frac{3}{16}$ in.
 90 ft. of $\frac{1}{2}$ in. \times $\frac{3}{16}$ in.
 5 ft. of $4\frac{1}{2}$ in. \times $\frac{1}{2}$ in.

- Plywood**
 18 sq. ft. of $\frac{1}{8}$ in. (1.5 m/m.) plywood.
M.S. Sheet (2.S.3)
 $1\frac{1}{2}$ sq. ft. of 16 s.w.g.

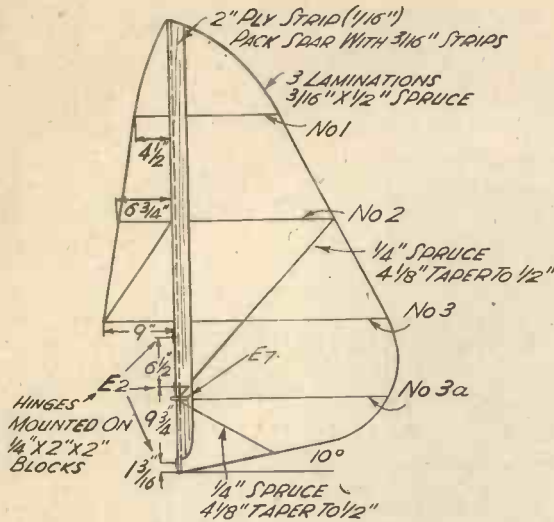

Fig. 3.—Details of the rudder.

Half ordinates are at the following distances in inches from the leading edge: $\frac{3}{4}$, 3, 6, 13, 21, 26, 32, 36 and 40, the chord being 40 in. The half ordinates are 1, 1.4, 1.75, $1\frac{1}{8}$, $1\frac{1}{4}$, 1.83, 1.35, 0.85 and 0.25 respectively. The hinge centre is at $19\frac{1}{2}$ in. from the leading edge.

The rib webs are $\frac{1}{8}$ -in. plywood cut to the shape of the rib, and are unlightened, the flanges being $\frac{3}{8}$ in. \times $\frac{3}{8}$ in. or $\frac{1}{2}$ in. \times $\frac{3}{8}$ in. spruce. In gluing up the ribs leave the front 6 in. unglued, as this will enable the flanges to be slipped over the front spar on assembly, at which stage the final gluing may be done (Fig. 4).

A gap of $1\frac{1}{2}$ in. is left at the centre of the rib, or more exactly at the $19\frac{1}{2}$ in. position, for the spars and hinge gap. This is best allowed for by cutting the ply webs in two separate lengths. The webs are also truncated $\frac{1}{4}$ in. at the leading and trailing edges to allow for the front spar and trailing-edge member. The central rib consists, of course, of the front half only, whilst the elevator central ribs, at the cutaway, are similar to the rear part of the main ribs, but are slightly attenuated.

The main ribs having been made up, the jig can be modified for the two outside ribs

by cutting $1\frac{1}{2}$ in. off each end and slightly modifying the cambers accordingly.

Assembling the Tail Plane

Set out the three spars across two trestles, or a bench, and thread all ribs into their approximate positions. The two main spars may be clamped together with 1 in. blocks inserted between them. Fix all but the two end ribs by glue and brass gimp pins, the spacings being 12 in. in all cases. The two "cutaway" ribs are placed with the ply webs facing together.

Cut and insert the diagonal braces in the stabiliser. These are of $\frac{1}{2}$ in. spruce, $3\frac{1}{2}$ in. deep at the rear spar tapering down to 2 in. at the front spar. In fitting these members care should be exercised to ensure proper alignment of the tail plane by measuring, say, from the centre of the rear spar to the front rib attachments 2 ft. either side of the front spar centre.

Slots should be cut in the intermediate ribs for the diagonal braces to pass through. If small triangular fillets are finally inserted and glued between the rib flange and bracing member, this will considerably stiffen the elevator and provide a better job.

The tip bends may next be fitted by scarfing on to the front spar, screwing to the ends of the other spars, and fitting to the rear edges of the ribs, keeping the spacings 12 in. as before. The outer ribs may also be fixed at this stage.

Notes on making up fittings have already been given in the October issue of PRACTICAL MECHANICS, and will not be repeated. Note that the angle of fitting E5, which bolts to the fuselage for the front tail spar attachment, is $85\frac{1}{2}$ degrees—the plan angle of the fuselage at that point. Fittings E6, for the rear spar attachment, have an angle of $94\frac{1}{2}$ degrees, since these face in the reverse direction to

E5. The tail fittings E1-6 are shown in Fig. 5.

The elevator levers, E1, are bolted to the elevator spar by 3-2BA bolts immediately outside the ribs. The diagonals, running from the levers to the end ribs at the trailing-edge may then be inserted. These may be cut from one piece of spruce $3\frac{1}{2}$ in. deep by about $2\frac{3}{4}$ ft. long, and taper to $\frac{1}{2}$ in. deep at the trailing edge. Similarly the small dope struts, $2\frac{5}{8}$ in. \times $\frac{1}{4}$ in. spruce, may be inserted between the elevator lever root and the cutaway. These struts prevent bowing of the ribs bounding the cutaway, due to dope tension.

Strips of $\frac{1}{8}$ -in. plywood are glued and tacked along the main spars, gluing also to the ribs and tip bends. Packing strips of $\frac{3}{8}$ in. deep \times $\frac{1}{4}$ in. or $\frac{5}{8}$ in. spruce, will first have been glued along the two spars to fill in the spaces between the ribs. These strips are 2 in. wide, though a 3 in. strip may be used for the elevator. Cut away for the elevator levers and for fittings E4, though the latter are not yet fixed in position. It is better to leave the fixture of E3 and E4 until the tail plane can be tried in position on the fuselage, so as to make certain that they match up exactly with the corresponding fuselage fittings—E5 and E6 respectively.

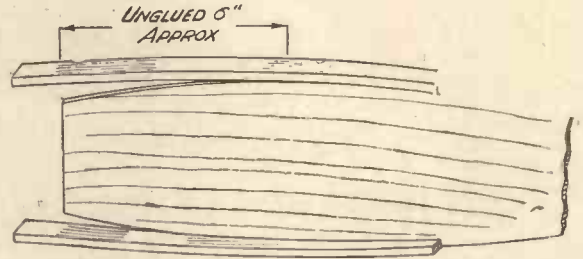

Fig. 4.—Front of tail plane rib left unglued for fixing to the front spar.

Elevator Spar Fairing

Finally, before cutting the two surfaces apart, a ply fairing is fixed to the elevator spar in the cutaway. Two small discs of $\frac{1}{4}$ in. ply, $3\frac{1}{4}$ in. deep \times $3\frac{1}{4}$ in., are shaped to "D" form and are glued to the faces of the two ribs at the cutaway. Preferably the edges of these discs should be chamfered to provide a good gluing surface for the plywood fairing. The piece of plywood is then shaped and glued in position.

This small fairing considerably improves the appearance of the tail; it acts as a torsional stiffening device for transmitting loads along the elevator spar in the event of failure of one of the elevator cables, and it decreases the flight resistance of the aeroplane.

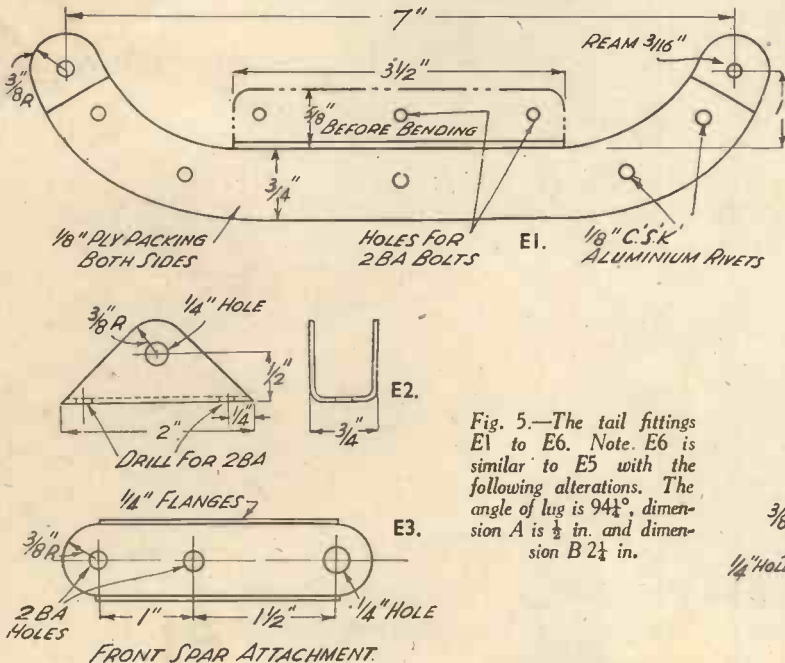
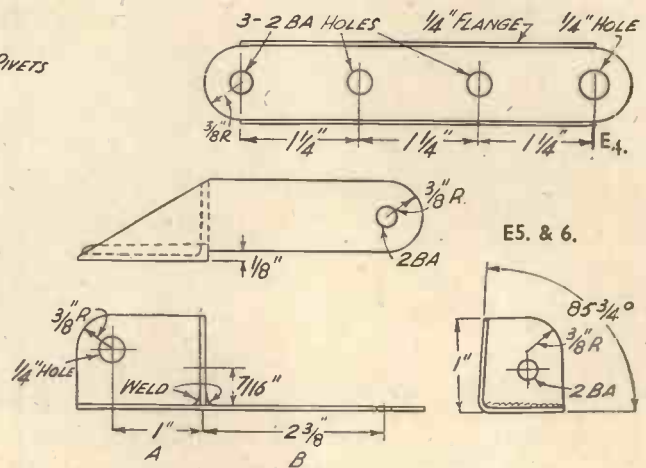
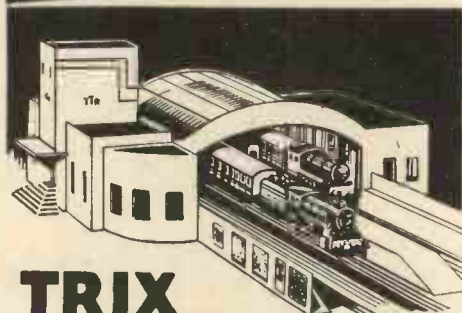
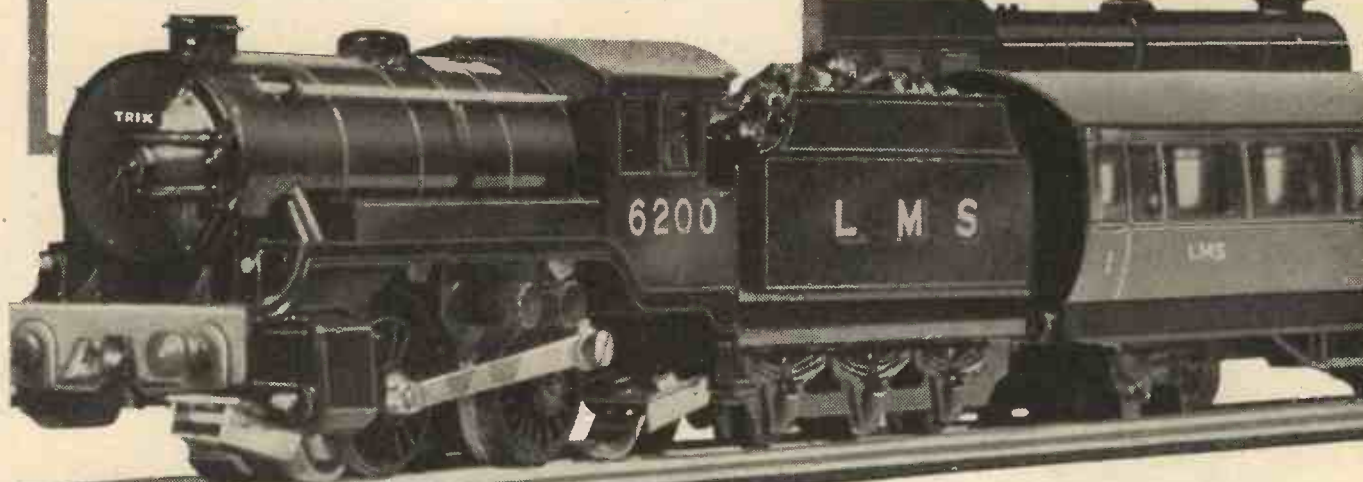

Fig. 5.—The tail fittings E1 to E6. Note. E6 is similar to E5 with the following alterations. The angle of lug is $94\frac{1}{2}$ °, dimension A is $\frac{1}{2}$ in. and dimension B $2\frac{1}{2}$ in.



TRIX

TWIN RAILWAY



TRIX

"MANY-WAYS" STATION SETS

A truly ingenious conception of modern Station construction. Each set of buildings is made up from a few simple, interchangeable units from which you can build anything from a "halt" to a busy terminus. At will, you may convert a closed terminus into a through station, or alternatively divide it into two separate station layouts; and there are many more engrossing possibilities. Ask your Dealer for leaflets describing Sets and units.

You *must* have this latest TTR discovery. It provides Stations that are superbly worthy of the Train.

TWO TRAINS OPERATED ON ONE TRACK

Perfectly proportioned engines and rolling-stock, electrically controlled from House Mains or Accumulators, Trix is quickly establishing itself as the favourite among model railway enthusiasts. Main-line shunting and branch-line operations can be worked by remote control, as the trains couple automatically and two locos. can be run backwards or forwards, fast or very slow, in the same or opposite directions. The permanent way, mounted in sections on Bakelite bases, can be laid down in many and varied layouts.

Write for literature, or see a Demonstration at your nearest Dealer's.

From Toy Shops and Stores everywhere. If any difficulty, write : TRIX LTD., St. John's House, 45/7 Clerkenwell Road, E.C.1.



Undoubtedly the master model-maker of to-day. With Trix all kinds of models can be built, driven, lighted and "put in gear." Write for folder showing the various sets and prices. Remember, too, that when you build with Trix you have no extra parts to buy.

TTR
TRIX TWIN RAILWAY

The Greatest little train in the World



Fig. 6. (left).—Details of the hinges.
Fig. 8 (right).—The rudder lever.

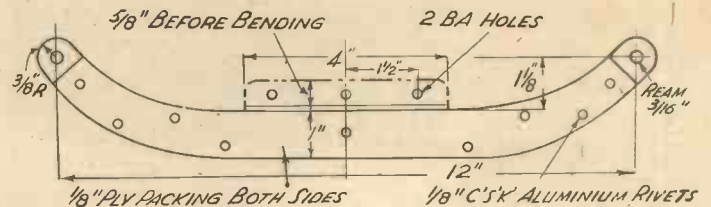

Fixing the Hinges

The stabiliser and elevator may now be cut apart and the ribends, together with the severed tip bends, are cleaned off. Fit the two outer hinges on the centre line of the elevator out spar, join these by a length of cotton and fit the inner hinges in alignment, close to the elevator levers. Similarly fix the outer tail plane hinges, taking care to match up with the corresponding elevator hinges, and by means of thread and offering up the elevator, the central

hinge positions may also be obtained.

Note that to prevent sideways movement of the elevator relative to the tail plane, the hinges should be arranged as shown in Fig. 6, $\frac{1}{4}$ in. pins, or bolts with the threaded portion removed, are inserted in the hinges and the component may be left in this condition for the time being. When final assembly is made these hinge pins will be fitted with washers and $\frac{1}{8}$ in. split pins.

The Rudder

Fig. 3 shows the assembly of the rudder. The spar consists of a piece of spruce, of $4\frac{1}{2}$ in. \times $\frac{3}{8}$ in. section, $4\frac{1}{2}$ ft. long. It is shaped as shown in Fig. 7.

The rib ordinates are given in the table below. Except for rib 3A, which is the same as No. 3, but truncated at the front spar, they are different. This does not mean that three jigs are necessary. The rib shapes having been drawn out on $\frac{1}{8}$ in. plywood and cut to shape, the flanges, of $\frac{3}{8}$ in. \times $\frac{3}{8}$ in. spruce, may be attached round the edges by means of glue and cramps. Slots for the spar can be cut when the ribs are set.

Assemble the ribs and spar, bolt on fitting E7, the control lever (Fig. 8) close above rib 3A, and insert the three diagonal members, taking care that the ribs remain perpendicular to the spar and that no distortion of the spar takes place. The front diagonal is a dope strut and may be either of thin spruce, say $\frac{1}{4}$ in. thick, taper-

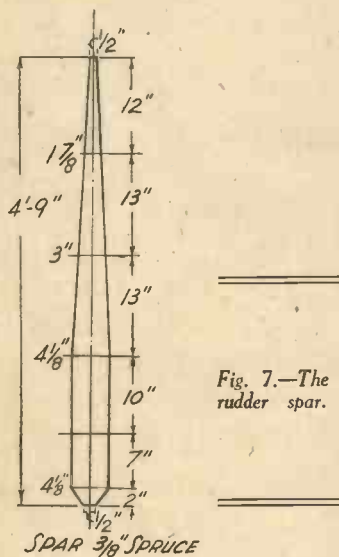

Fig. 7.—The rudder spar.



Fig. 9.—Constructional details of the tail plane.

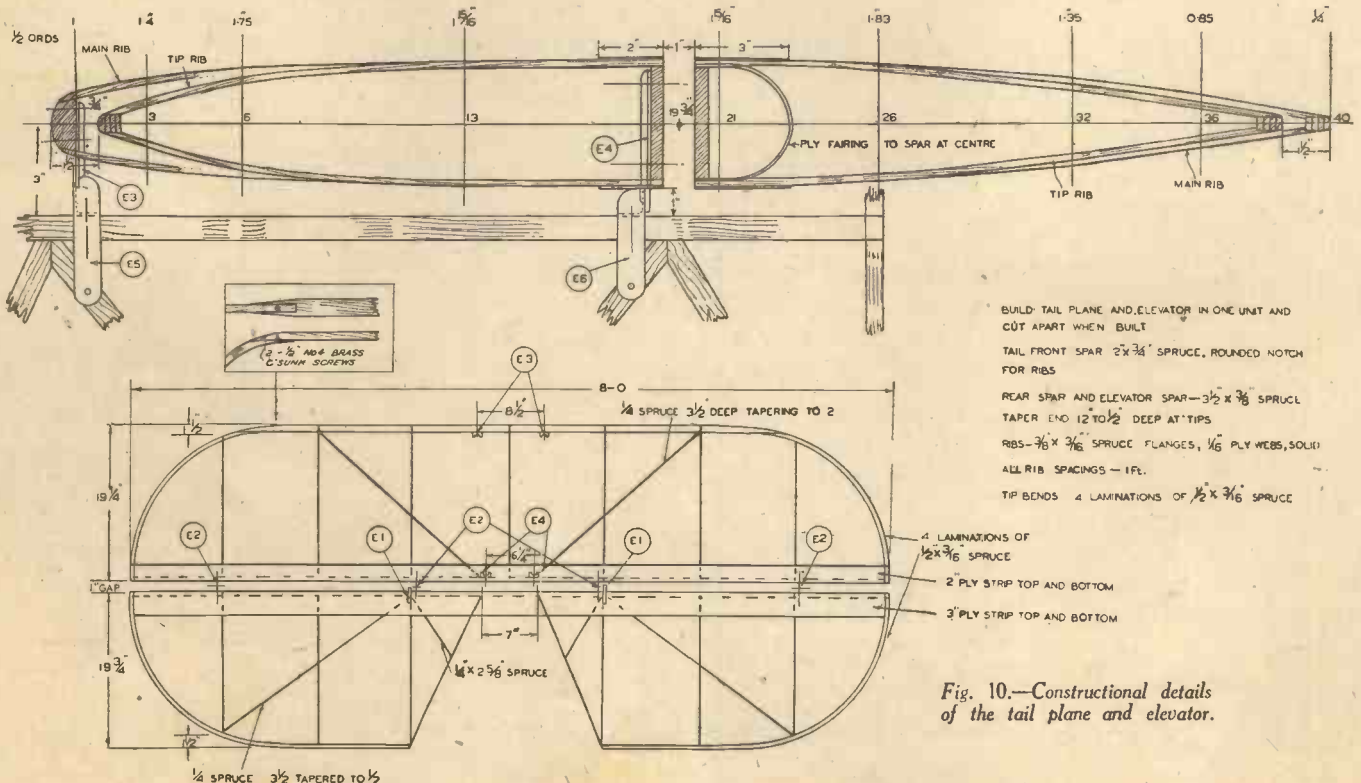

Fig. 10.—Constructional details of the tail plane and elevator.

RIB ORDINATES

No. 1	Dist. from L.E.	1	2	3	4.5	6.5	9	12	15	16.5
	Ord. ins.	1.25	1.65	2.0	2.25	2.3	2.0	1.4	0.75	0.4
No. 2	Dist. from L.E.	1	2	4	6.5	9	12	16	21	25.5
	Ord. ins.	1.65	2.45	2.95	3.37	3.4	3.25	2.63	1.55	0.4
No. 3	Dist. from L.E.	1	2	4.5	9	12	18	24	30	34.5
	Ord. ins.	1.85	2.63	3.7	4.5	4.5	4.05	2.93	1.55	0.4

Rib flanges— $\frac{3}{16}$ in. \times $\frac{1}{8}$ in. spruce. Webs— $\frac{1}{16}$ in. plywood.

that the table of main plane rib ordinates given in the October issue of PRACTICAL MECHANICS contained a number of errors. (Not ours.—Ed.) It may have been noticed that the wing-tip rib chords did not agree with the wing layout and that certain points on the profile curves did not fair nicely into the curve passing through the remaining points.

We are therefore supplying an entirely new table herewith, and this should be used in place of the earlier table.

Where work has already been commenced on the ribs there is no need to scrap the main ribs (No. 1) provided the two points that fell outside the general curve have been ignored. The same applies to the tip ribs provided also that the chords have been corrected, but failing this it would be as well to make up the tip rib again.

ing from front to rear, or of square section $\frac{1}{2}$ in. \times $\frac{1}{2}$ in.

Lastly the 2 in. wide plywood strips are glued to both sides of the spar, packing strips having been first inserted between the ribs, and the hinges bolted in position. The

position of the hinges as given in Fig. 3 should be adhered to.

The tail unit is now complete except for covering and this will be dealt with in a later article. The Author points out



Fig. 11.—A close-up of the engine.

DIST. from L.E. INCHES	RIB 1		RIB 2		RIB 3		RIB 4	
	Upper	Lower	Upper	Lower	Upper	Lower	Upper	Lower
3	3.125	1.98	2.75	1.64	2.4	1.44	1.9	1.09
6	4.5	2.57	3.9	2.15	3.31	1.76	2.62	1.37
9	5.3	2.76	4.62	2.35	3.69	1.94	3.04	1.5
12	5.9	2.83	5.12	2.44	4.25	2.04	3.27	1.55
18	6.5	2.85	5.575	2.5	4.54	2.03	3.31	1.44
24	6.475	2.76	5.5	2.33	4.40	1.87	2.97	1.2
30	6.03	2.53	5.05	2.13	4.00	1.63	2.25	0.98
36	5.27	2.2	4.36	1.89	3.25	1.33	1.47	0.7
42	4.22	1.77	3.49	1.5	2.37	0.99	0.73	0.39
48	3.06	1.32	2.5	1.08	1.46	0.63		
54	1.89	0.85	1.45	0.67	0.52	0.3		
60	0.7	0.38	0.43	0.26				
Chord	63		61.5		56.3		44	
L.E. Radius	1.2		0.96		0.72		0.48	

It is extremely difficult to invent a new name by just sitting down and writing different arrangements of letters. Here is a better way, one which will give millions of word combinations and thousands of pronounceable words and you can make it in ten minutes or so. If you are a crossword puzzle fan, it would enable you to find the missing letter in a second or two, and if you are a family man, your children will amuse themselves for hours with it.

Fig. 1, explains the arrangement. Six columns of letters are shown but there is no reason why many more columns could not be incorporated.

The strips of cardboard carrying the alphabets must be cut dead parallel or they will not draw past one another freely. The sides too, should be cut dead upright to prevent them wedging under one another. This trouble is not so pronounced if really thick cardboard is used. The alphabets may be drawn in by hand, or type written on a separate sheet and then pasted down on the strips. Or perhaps you may have a printer friend whom you can get to do the actual printing for you. At both ends of each strip a hole is punched so that a pencil can be inserted and the strips moved up and down easily. The strips are $\frac{1}{4}$ in. wide and 8 in. long, the alphabets being placed in the middle of the strip. The base piece is 2 in. wide by 8 $\frac{1}{2}$ in. long. Two guide pieces

A NAME INVENTOR

$\frac{1}{4}$ in. wide are glued to the edges up the length of the base. The six alphabet strips are tried side-by-side in the gap to see if they slide easily between the guide pieces. If they are tight, the guide pieces should be trimmed with a razor blade. The top is cut to fit on top of the guides being 1 in. wide and 2 in. long, and the window situated in the centre $\frac{1}{4}$ in. wide and 1 $\frac{1}{2}$ in. long. This window has bevelled edges, which can be cut with a razor blade to make the reading of the letters easy. It can then be glued down and the cover, which protects the whole device, secured with linen *passe-partout*. A double thickness of $\frac{1}{4}$ in. wide cardboard is glued to the underside of the cover to prevent the strips sliding out. Two ordinary press fasteners are used to keep the cover shut, and are both glued and stitched on. The whole device can be covered with paper leatherette.

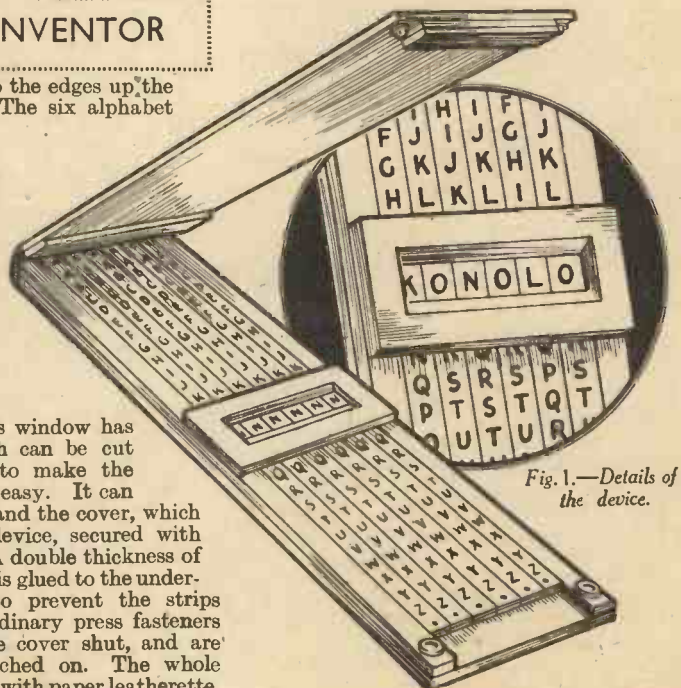

Fig. 1.—Details of the device.



A new cotton-picking machine which plucks as many bolls from the cotton stalk in five minutes as an ordinary hand could pick in an entire day.

splashes. Soldiers may keep dry through the wettest parade. Ink, like water, rolls off leaving no trace.

A New Scotland Yard

A FIFTY-STOREY sky-scraper New Scotland Yard in place of the Yard as it now stands, with a flat roof for police autogiros, is urged by ex-Inspector Harold Brust, formerly of the Special Branch of the C.I.D. He says the existing Yard is "in a state of hopeless overcrowding" owing to the development of police works and methods in the forty years since the Yard was built. Repair shops would be on the floor below the flat roof, and planes needing attention would go down from the roof on a let-in platform.

Other floors would house television, radio, records, photographs, finger-prints, lecture theatres, laboratories, acting school, library cinema, and underground would be a police railway station with its own tube running all over London, with connections to airports. The cinema would show slow-motion films brought by autogiro from race meetings and other crowded places and a score of detectives would watch them looking for pickpockets in the crowds.

Picking Cotton

ON this page we show a new cotton picking machine, which, according to the manufacturers, plucks as many bolls from the cotton stalk in five minutes as an ordinary hand worker could pick in an entire day, and is equipped with electric light for work at night. As the picker, which is self-powered and can be handled by one man, moves down the rows of cotton, the stalks are compressed into a channel

A New American Liner

IT is announced that the U.S. Maritime Commission have accepted a tender of £3,150,000 for the construction of a liner to replace the 48,000-ton *Leviathan*. The bid was made by the Newport News Shipbuilding and Dry-dock Company. The Chairman of the Commission added that a grant of 33½ per cent. of the cost of the new ship had been made to the United States Line in the form of a construction subsidy. Building of the new ship must be completed within 852 days.

An Airship Record

FROM Moscow comes the news that the Soviet airship U.S.S.R. V.6 completed about 3,000 miles after remaining in the air for 130 hours without refuelling. This beats the record of the German airship L.Z. 127 set up in 1935 and creates a dirigible record for distance without refuelling.

Waterproof Dresses and Clothes

IMPERIAL Chemical Industries' Manchester laboratories have discovered a white powder called "Velan," which, when textiles are impregnated with it, liquid runs off them or may be shaken off, like drops of quick-silver.

Ordinary waterproofing acts by coating the material, giving it a hard surface and making it air-proof as well as water-proof, and the process wears away in the process of cleaning. But it is claimed that the new invention, combining with the fabric, en-

THE MONTH IN SCIENCE AND

hances its softness and enables it to retain water-repellant properties no matter how many washings and cleanings it experiences. Silk stockings suffer no hurt from rain

against hundreds of moist spindles twirling on revolving drums staggered tandem fashion. The spindles of one unit pick from the right side of the stalk and the other from the left. A new type doffer—to prevent clogging—strips the cotton from the spindles and drops it into two receptacles from which it is blown through



Lamblin, the French aviator, watched by young plane enthusiasts, as he prepared to leave Orly Aerodrome, France, in his unusual-looking Canard type plane "Nicolas Claud," during an exhibition tour of prototypes of light aircraft. This novel plane is entirely different from the ordinary machine in that it has large wings at the rear and small ones in front. It has a speed of 150 km. an hour and a radius of 550 km.

two pipes into huge cotton bags hung on the rear of the machine.

A Map for the Blind

A BLIND Norwegian has invented an ingenious method of reading maps for the blind. The map, which has been placed on exhibition in Oslo, is the first of its kind in the world and is known as "the electrical map." A relief map is marked with towns represented by copper tacks, and rivers represented by copper wire. Beside the map is a slate marked with the names of the towns in front of each being placed a copper tack. The blind man takes two circuits which are connected with an electric bell, and puts one contact on the copper tack marking the name of the town he wishes to know, then with the other he runs down the column of names. When the right name is reached the bell sounds.

Musical 'phone Bells

THE perfect 'phone bell will make its appearance at the beginning of the new year. The old-fashioned jangling, harsh ringing bells will be withdrawn on December 31st, 1937. The ring of the new bell will be musical and pleasant to the ear. Slightly lower in pitch, the sharpness gone, the sound is like that of cowbells on a Swiss mountainside. It has taken the Post Office two years of experiments at their Dollis Hill research laboratories to perfect it. Two bells have been harmonised to get the right pitch, tone and volume, and the bell has finally been passed by music critics.

storey, bomb-proof, fire-proof and burglar-proof building on a solid rock foundation was recently completed and to guard against the one-in-a-million chance of a burglar getting through the many intricate burglar alarms, a microphone has been fitted in the vaults. This is in circuit with an amplifier feeding a speaker in the central guard room, and thus the guards are at all times able to hear the slightest sound in the vault and thus to detect the arrival of any unauthorised person. A two-way radio communication set with the police outside the building is maintained.

Stratosphere Transmitters

TO report upon the weather conditions in the stratosphere, miniature transmitters have been designed which are capable of being carried by small gas-filled balloons. The transmitter sends out a series of dashes at regular intervals, interrupted by means of a special barometrical device so that the height and speed of travel may be accurately recorded on the ground. The balloon bursts at a certain height and the transmitter descends by parachute. A reward is offered for its safe return. The experiments are being carried out at Kew Observatory, by the Meteorological Office.

An Under-water Gun

NOT content with catching fish on a line, a Frenchman has devised an under-water gun whereby he can shoot them.

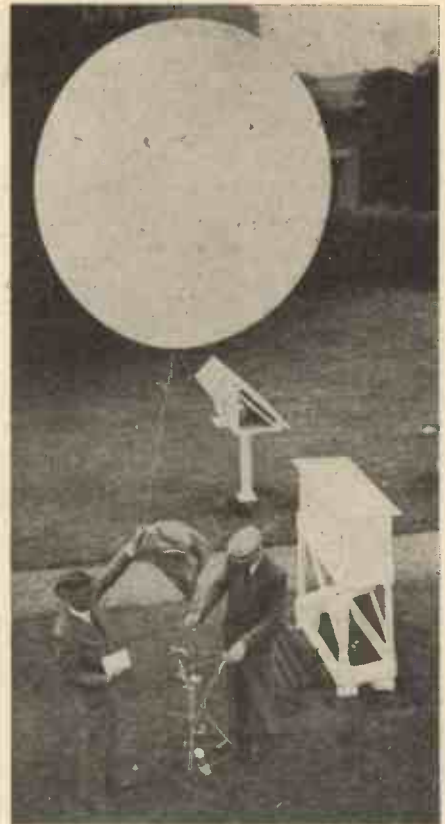

Investigations of the upper atmosphere are being carried on at Kew Observatory, by the Meteorological Office. An empty vessel is sent up on a balloon. At a predetermined height the vessel is opened and closed automatically. When the balloon bursts the apparatus falls on a parachute. Seventy trial ascents have been made during the year, and these have yielded about 40 samples of air for analysis. The illustration shows meteorologists about to launch the balloon with apparatus attached, at Kew recently. Note the parachute, which carries the apparatus to earth again.

THE WORLD OF INVENTION

1,300-h.p. Aeroplane Engine

AN aeroplane engine is undergoing trials at Filton aerodrome, Bristol, which is said to be the most powerful engine of its type in the world. It has taken the Bristol company ten years of research to develop it. The Hercules, as it is called, is a sleeve valve engine with two banks of seven cylinders radiating from the crankshaft. It produces over 1,300 h.p. It will be used in the 40-ton flying boats now being built for the North Atlantic service, and also for new types of military aircraft calling for engine units of over 1,000 h.p.

The advantages of the sleeve valve over the ordinary poppet valve engine are less maintenance, owing to the reduction of moving parts, and economy in fuel and oil. None of the aircraft for which this giant engine is intended is yet ready. In the meantime the Bristol company is subjecting the Hercules to more than 200 hours of flying trials.

Microphone Sentry

A NOVEL method of using a microphone as a burglar detector has been reported from the U.S.A. It is stated that a five-



An interior view of the 500 million candle-power lamp constructed for the Creach d'Ouessant Lighthouse.

to the harpoon, and the other end of the wire is fixed to a reel on the barrel of the gun. When the under-water hunter sees a fish approaching, he fires the harpoon in the hope that he will impale the fish upon it. He then draws in the wire by means of the reel. The costume of the hunter consists of a pair of heavily weighted boots, and a lightweight diving helmet.

Curing Seasickness

A BROOKLYN inventor, Edward Carroll, states that the coming of Diesel engines burning heavy oil may help to put an end to seasickness, and he has just taken out a patent for using the stores on board a ship to counteract the rolling of the vessel in rough weather.

A series of cells, each connected with the next by valves, are used to store the oil. When the ship tips over these valves open in such a way that the oil falls in the direction against that in which the ship's motion is taking place. Thus the weight of the oil steadies the ship. This invention has obvious advantages over the gyroscopic machinery used in some liners to counteract motion, because it does not require any new machinery. It achieves the same result with the oil already needed for propelling the ship.

A Radio Bookcase

THE dreary hours of autumn and winter evenings with their traditional rains, fogs and cold winds make the home firesides very appealing, especially when enlivening music can be brought to those hearthstones with no more effort than the turning of a dial on a radio receiver.

Although an almost endless variety of programmes is available to radio owners, many like to alternate their listening with reading.

To provide the serious minded radio listener with every possible comfort close at hand, Philco Radio have marketed a combination radio receiver and bookcase. Known as Model C.527, this set has provision for the convenient storage of radio programmes under the speaker, and ample space for many a pleasant evening's reading in the book shelves in the set. Once settled comfortably in front of this set, the owner has no need nor desire to stir out of his chair for his evening's entertainment.

A Surgical Marvel

A REMARKABLE portable X-ray machine has now been produced whereby a surgeon can set a bone with such accuracy

that the risk of faulty setting and danger of adhesions are eliminated. On a metal table are set two brackets supporting frames like three sides of a square. The broken limb is pinned by these frames, and by turning handles the surgeon can pull the overlapping bone straight: by rotating other handles he can shift the bone-ends to right or left or up and down. A fluoroscope or "screen"—a device which renders flesh transparent enables the surgeon to see exactly what he is doing and the device holds the limb so firmly in position that he can ensure a perfect join.

Once set, thin wires are passed through the limb, holding the bone firmly in position. Immediately—instead of six or eight weeks later—the limb is strapped up in plaster of paris. Within a week or two the patient would be walking on the broken leg—still in its plaster. The cure would be complete in from four to six weeks instead of ten to twelve weeks.

Stratosphere Aeroplanes

AT a recent national aircraft production meeting in Los Angeles, regular flying through the sub-stratosphere was discussed. A new type of stainless-steel aeroplane,



The Mayo composite flying boat on the Medway at Rochester. Descriptive articles on this flying boat have appeared in PRACTICAL MECHANICS, dated February, 1936 and September, 1937.

RECORD FLIGHTS *this Christmas* with one of these real scale **FLYERS!**



GLOSTER GLADIATOR

Wingspan, 18 in., length 14 in. A real beauty. Auto line-up fuselage, shock-absorbing undercarriage, wing base formers, very large clear plan with all scale details and many working drawings. Absolutely complete kit of parts, quick-drying cement, shrinking dope, silver Japanese tissue, shaped balsa flying prop., wheels, silver lacquer, and all balsa needed. Carriage paid **5/-**

WESTLAND WALLACE

Wing 18 in., length 13 in. The most detailed scale model available at this price; the kit builds a perfect flying replica. Wing slots on top wing, oil radiator, rear machine gun on movable Scarfe ring, detailed motor, etc. The kit is absolutely complete with all balsa, cement, dope, printed insignia, etc. Carriage paid **3/11**



HESTON PHOENIX VERY GOOD FLYER

Wing 18 in., length 13½ in. Retractable landing gear with locking control. Very clear full-size plan. Comet Auto-line-up fuselage. Kit is absolutely complete. Carriage paid **3/11**



HAWKER HURRICANE

Wing 20 in., length 15 in. Movable controls. This Peerless kit makes a beautiful model with good flying performance. Special condensed

Instructions four pages. Fuselage jig. Shrinking dopes and cement are included in the complete kit. Carriage paid **5/-**

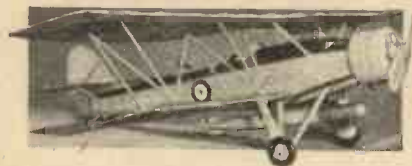

BLACKBURN SHARK

Wingspan 34½ in., length 25½ in. Magnificent model with shock-absorbing undercarriage and new wing jigs. Very large, clear plan with many helpful drawings; swivelling tail wheel, rear machine gun, torpedo.

Special hand-carved light hard-wood prop. Kit is complete with balsa, quick-drying cement, lacquer, shrinking dope. Carriage paid **7/6**

BUILDING THESE MODELS HAS A FASCINATION OF ITS OWN

which has to be tried to be appreciated. Our special quick-drying cement, firm in 30 seconds, is a real joy to use. Your Christmas present problem is solved by giving one to all your friends—and two to yourself! Our guarantee is to refund your money at once if you are not satisfied.

EASY TO BUILD

These three kits are specially recommended as being very easy to build.

PUSS MOTH



Wing 16 in. Mollison's Famous East-to-West Transatlantic flight plane—attractive appearance and fine flyer. An easy model for a beginner. Kit has all parts needed. Post free

2/6



MONOCOUCPE

Wing 15½ in. Splendid little model, very easy to build. Complete kit has all parts needed, including hand-carved prop. Post free **2/6**



SPECIAL LEARNER'S KIT BRISTOL BULLDOG

This kit has eight pages of special instructions and illustrations which explain every action and make it impossible to go wrong. It is a very fine exact scale model of the favourite R.A.F. fighter and shows every detail of the real plane, machine guns, petrol tanks, insignia, etc., etc. Kit is complete with everything needed. Carriage paid **4/9**

★ **CATALOGUE** Send 3d. in stamps for 24 illustrated pages, showing biggest and cheapest range in England. (All kits 2s. postage extra for abroad.)

Give Kits this Xmas and
SEND YOUR POSTAL ORDER TO-DAY
to:—

P. M. SWEETEN LTD.

BANK HEY STREET, BLACKPOOL

Call and see our Trix Twin Train layout—best show in North of England

MAKE YOUR OWN MODEL SHIPS THIS XMAS



FLYING CLOUD. Length 12 in. Fascinating model which is excellent value. Kit has all balsa wood, cement, lacquers, full-size plan, etc. Carriage paid **2/6**

TRUE TO SCALE SHOW MODELS. You will be fascinated by the detail shown in the full-size plans, and the building is made easy with all materials being ready to hand in the kit. Money refunded if you are not entirely satisfied.



SEND FOR CATALOGUE
Send 1½d. stamp for our illustrated catalogue showing 17 kits, also large range of ship's fittings. (All kits 2/- extra abroad.)

CITY OF NEW YORK (left). Length 14 in. Very fine attractive model of sailing ship, with auxiliary motor. Clear full-size plan. Complete kit includes balsa wood, masts, ship's boats, anchor, propeller, wheel, cement, lacquers. Carriage paid **4/-**



CARGO STEAMER. Length 14 in. Easy to build. Kit is complete with balsa, masts, five ship's boats, funnel, propeller, cement, lacquers, etc. Carriage paid **4/-**



CUTTY SARK (left). Length 14 in. Very detailed model of famous clipper ship. Very clear full-size plan; kit has all parts needed, balsa wood, lacquer, two cast metal ship's boats, anchors, wheel, two capstans, spars for masts. Carriage paid **4/-**

SPANISH GALLEON (right). Length 10 in. Splendid model which makes up well. Full kit with all parts needed, full-size plan, balsa wood, masts, cement, two lacquers. Carriage paid **2/6**



SCHOONER BLUENOSE
Length 13 in. The sweetest and swiftest boat you could dream of. Easily built with simple rigging. Complete kit with easily carved balsa wood for hull, and all parts. Carriage paid **4/-**

SEND YOUR POSTAL ORDER NOW TO—

P. M. SWEETEN LTD.
BANK HEY STREET, BLACKPOOL
JUST BEHIND THE TOWER

AVERAGE DURATION IN 8 CONTESTS, OVER 7 MINUTES!

BE UP-TO-DATE WITH YOUR HOBBY! BUILD MODEL PLANES THAT FLY!!

All Model Plane Enthusiasts should send for

"MODEL FLYER'S GUIDE"

A useful reference book containing many hints and tips on your hobby, and full illustrated Price List of Books, Blue Prints, Kits and all Materials. 4d. Post Paid.

28 YEARS' PRACTICAL EXPERIENCE AT YOUR SERVICE

"CLEVELAND" SCALE FLYING KITS

The Original and Best value In Scale Flying Kits
Over 50 Models of Famous Aircraft to choose from
POPULAR PRICES: Super-Detail ½" and ¾" Scale

Send for our FREE C—D PRICE LIST

CONSTRUCTION KITS FROM 2/- Post Paid.

GET IN ON THIS FASCINATING PASTIME. START WITH

"THE CRUISER PUP" 6/6

The ideal Beginner's Model Low Wing Cabin Plane Carriage Paid.

"THAT DELIVERS THE GOODS!" U.K.

"CRUISER PUPS" have made many Flights of over 3 minutes.

THE NORTHERN STAR

Designed by BOB COPLAND, Northern Heights M.F.C. Member of 1936 British Wakefield Team. Average duration of 8 Contests 7 Minutes 75 Second.



HIGH WING SUPER-DURATION MODEL Span 37½ in. Length 27 in. Weight 4 oz. Contains Full-size Detailed Blue Print. Special "BC" 15½-In. Duration Airscrew and ample supplies of all necessary Materials

THE NORTHERN STAR 14/6 Carriage Paid U.K.
BOB COPLAND'S PRIZE-WINNING PLANE—"THE SOARING SUCCESS!"

"The NEW MODEL AEROPLANE MANUAL"

The most comprehensive book on the subject 3s. 4d. Post Paid.

2a HORNSEY RISE, LONDON, N.19
Phone—ARC 2376

PREMIER AEROMODEL SUPPLIES



The new bookcase radio with two units added. The individual parts are obtainable separately.

suitable for this type of flying was also discussed. Colonel Ragsdale, chief engineer of the Budd Manufacturing Co., Philadelphia, who has designed the plane, states that it will have as its outer surface a thin, smooth sheet of stainless steel welded to a corrugated inner structure eliminating riveting. He said that while aluminium is nine times stiffer than steel, pound for pound, a steel wing surface with corrugated skin is ten times as stiff as aluminium. It therefore could carry a greater load with less bracing structure inside, he contended.

Violet Gold

A GERMAN jewellery firm have recently taken out a patent for the production of violet gold. It is possible to produce a purple-coloured alloy by combining 78 parts of gold with 22 parts of aluminium, but with the German invention an excess of aluminium over that of the formula AuAl₃ (78.5 parts of Au and 21.5 parts of Al) is employed. Workable alloys are produced by this excess, and their colours, which range from red through purple to violet, are not influenced. Soft metals such as tin, zinc, silver, thallium, cadmium and bismuth may be used to partially or entirely replace the excess aluminium. It is im-

portant, however, that the precious metals and aluminium are used in an oxide-free condition.

A Glass Train

A RAILWAY train made of glass started from Liverpool on November 1st, on an official tour of this country. The chassis and framework of the train, which

are known as the Glass Age Exhibition, were made at the L.N.E.R. works at Doncaster, and Messrs. Pilkington Bros., at Kirk Sandall, completed the transformation into glass.

The outer panelling of the coaches is covered with over 100,000 mirrors, and the inside of the train is entirely of glass; so are ceilings, walls and floors.

A Two-storey Car

A STREAMLINED motor sedan that becomes a two-storey dwelling with all the comforts of home has been constructed by Mr. A. S. Thompson, a watchmaker by trade, at Ontario, California, U.S.A. Mr. Thompson, after seven years of work and study has produced for vacation touring the vehicle which embodies all the compactness and precision of a watch. Four well-upholstered chairs are converted into a double bed, but a magazine bed, cleverly



Mr. A. Thompson standing beside his two-storey car with the "upstairs" ready for the night.

concealed in the roof when the car is on tour, immediately becomes available "upstairs" when the top is raised, making it possible for four persons to slumber in comfort. Fresh air is assured by a special ventilator system. Included in the rear of the car is a refrigerator and a sink with running water. There is abundant storage space for supplies. The car is of standard width and has a wheel base of 138 in.

INDUSTRY'S NEW METAL

ZIRCONIUM AND ITS CHARACTERISTICS.

PREVIOUS to the war, the element zirconium occupied a status little removed from that of a mere chemical curiosity. Some of its compounds had, it is true, been utilised in the early days of the gas-mantle industry, but, apart from this minor application, the possibilities of using the metal itself in manufacturing processes were hardly considered.

During the war of 1914-18, the Germans actually employed zirconium steels for the purpose of making extremely hard and tough metal for armour-piercing projectiles and also for the manufacture of impenetrable armour-plates and bullet-proof steels, but, owing to the cost of the metal, these applications were not made on any extensive scale.

The discovery within recent years of rich deposits of zirconium-bearing ores has done much to place this steel-like metal on a commercial basis. Already, in America, the metal and its various iron alloys are being produced by various metallurgical concerns and a great amount of attention

is being paid to these products by interested corporations.

The chief commercial source of zirconium is located in the deposits of *baddelyite* or *zircite* in Brazil. This ore comprises chiefly the oxide of zirconium, *zirconia*, the average oxide content of the ore being as high as 80 per cent. It is, therefore, from Brazilian *baddelyite* that the present-day commercially obtainable zirconium is derived.

Zirconium is a silvery-white metal which, at ordinary temperatures, resists to a very high degree atmospheric tarnishing and rusting. It combines with oxygen, however, when heated to a temperature just below red heat and, curiously enough, it shows a strong affinity for nitrogen when heated in an atmosphere of that gas. The product of the interaction between metallic zirconium and nitrogen gas is a solid compound, zirconium nitride, which, when treated with water, evolves ammonia in much the same manner as acetylene is derived from the action of water upon calcium carbide.

Here, therefore, in embryo, is a new method of manufacturing ammonia from atmospheric nitrogen.

The present-day uses of zirconium metal, however, are confined almost solely to its employment in the production of extremely tough and resistant steels. Zirconium steels have now been utilised for the making of high-speed tools and for similar purposes. "Cooperite" is an alloy of zirconium and nickel. It, too, is an exceedingly tough metal of high efficiency, and it is claimed that its resistance to corrosive influences is also very high.

Another interesting alloy is one of zirconium and aluminium, which is said to be almost entirely non-corrodible at all temperatures.

The zirconium-aluminium alloy possesses the highly interesting property of "selective radiation," in virtue of which lamp filaments drawn from the alloy emit a greater amount of light when heated by the electric current than the light theoretically corresponding to the temperature of the filaments. Thus the new alloy acts with extreme efficiency as a converter of heat energy into light, a property which is, of course, pregnant with many future technical and commercial possibilities.

MASTERS OF MECHANICS

Mechanics and Electricity Combined. The Amazing Career of George Westinghouse



George Westinghouse.

"AIR brake had practical trial on passenger train Panhandle Railroad. Proved great success.—GEORGE."

A young man, not yet twenty-three years of age, rushed excitedly into the telegraph office at Pittsburgh, Pennsylvania, one morning in the Spring of 1869 and sent the above telegram to his father at Schenectady, New York. The youth, George Westinghouse by name, was quite an unknown individual so far as the public eye was concerned. But, in a severely restricted circle he had caused some technical comment by reason of his having devised a braking system for railroad trains, a system which was radically different from all the others which had been employed at previous times.

"You can't stop a train in a moment," two old American railroad engineers informed the youthful Westinghouse in reply one day to his query as to why two trains which had been travelling at moderate speeds upon a perfectly straight stretch of track had come headlong into collision with each other.

The incident set Westinghouse thinking about the possible methods of stopping a locomotive or a train suddenly in a case of emergency and it ended, as we shall see later, in his sending of the jubilant telegraphic message above quoted to his father and, soon after, in the establishment of a new engineering industry.

Born in America

George Westinghouse, one of the mechanical and electrical pioneers of America, was born at Central Bridge in the State of New York on October 6th, 1846. He was the eighth of the ten children of George and Emeline Westinghouse and was the descendant of a family of early Dutch settlers in America.

The elder George Westinghouse, at the time of his famous son's birth, was in a moderate way of business as a carpenter and mechanic, but shortly after his son, George, was born, he moved to Schenectady and became a manufacturer of agricultural implements.

It was in Schenectady that young George Westinghouse spent his childhood and his early youth. Westinghouse senior was a bit of an inventive fellow and his workshop was nearly always the scene of strange mechanical devices which were either being constructed or else were being put through numberless experimental trials. Into this atmosphere of mechanics, George Westinghouse the younger plunged himself at a very early age. More than any other of the Westinghouse children he was interested in

mechanics. More than any of them, he imbibed and retained the practical knowledge which the elder Westinghouse handed round so profusely to his growing sons.

Hated School

George, like many another healthy youngster, hated school. Even in more adolescent years, when he voluntarily entered the Union College in Schenectady, his dislike for theoretical and classical

learning persisted. He had no use for mathematics and Euclid. Languages he abhorred, whilst geography, history and the other subjects of the school's curriculum bored him to distraction. His great desire was to be at the workbench, to design and to devise things and to fashion them into actual being with the tools at his disposal.

When still quite a lad, Westinghouse made his first mechanical invention. It consisted of a rotary steam engine and later—on October 31st, 1865—he took out a patent for it—the first of the many patents which he was granted in subsequent years.

The steam engine, however, proved itself to be wasteful and impracticable, despite the fact that its inventor managed to run a boat with it on a neighbouring canal. The peculiar principle of the rotary steam engine of Westinghouse remained dormant for some time, but ultimately it was resurrected and applied to the invention of a water-meter which constituted one of Westinghouse's minor mechanical successes.

At the age of 15, Westinghouse ran away from home and attempted to join his country's army. His father raised objections, however, with the result that the young adventurer was promptly returned to his home by the military authorities. Afterwards, it must be related, Westinghouse actually did enlist in the U.S. forces and, still later, in the American Navy, from both of which services he was, in due course, honourably discharged.

A Mechanical "Car-replacer"

Westinghouse's first invention of any practical import was what he termed a mechanical "car-replacer." When still in his teens, he had, during an interval in a railway journey, noticed a gang of workmen laboriously attempting to lift back on

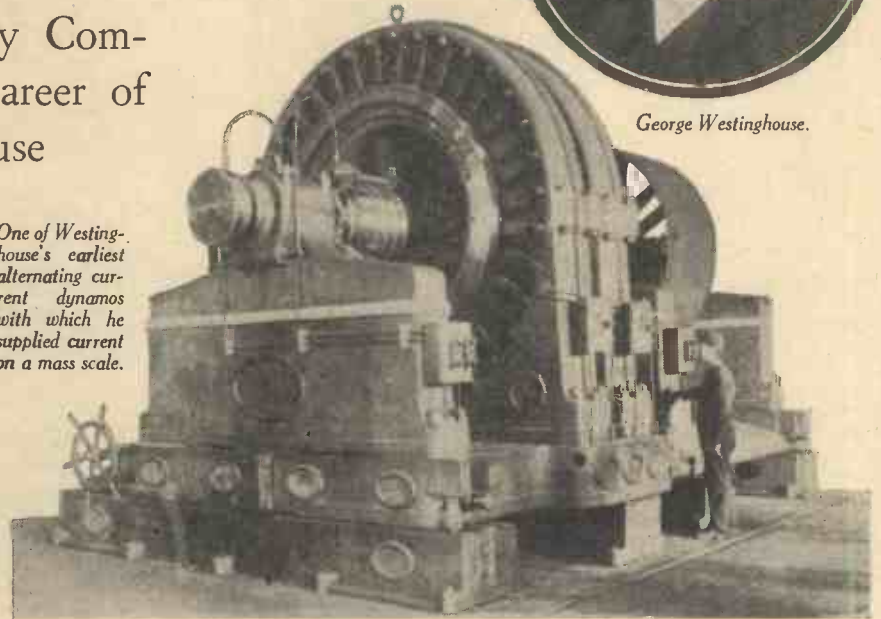

One of Westinghouse's earliest alternating current dynamos with which he supplied current on a mass scale.

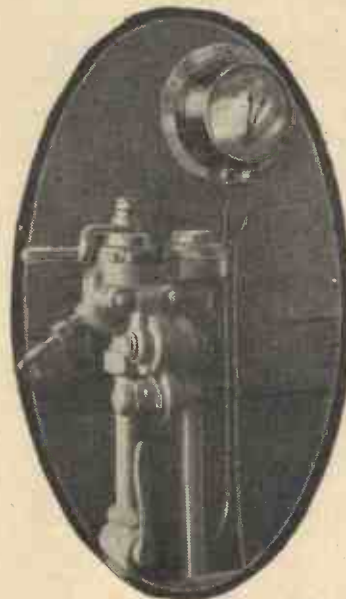

The control valve of a modern Westinghouse air-brake situated in the driver's cab of an up-to-date locomotive.

PLANES for your Xmas Airport

★ Order one of these **SOLID MODELS** SCALE : $\frac{1}{4}$ " to 1 ft.

Each kit has a very detailed full-size plan and material. Send your order to-day—money refunded if not entirely satisfied.



D. H. COMET. Wingspan 11 ins. Length 7 $\frac{1}{4}$ ins.
One of the most beautiful planes ever designed—this model is a faithful replica. Easy to build. Complete kit has all balsa cut to outline, die-cast props., cements, lacquer, and all else needed. Carriage paid **3/6**



FOKKER D.7
Wing 7 $\frac{1}{2}$ in., length 5 $\frac{1}{2}$ in.
One of the most successful Great War Fighters. Kit is easy to build and has all balsa cut to outline, die-cast prop., two Spandau guns, cement, lacquers, etc. Carriage paid **2/6**



MR. MULLIGAN
Wing 8 in. Most attractive replica of America's fastest cabin plane. Finished in cream and gold with printed lettering. Complete kit has all parts needed. Carriage paid **2/6**

ILLUSTRATED CATALOGUE of 12 pages sent for 1d. stamp. All kits 2/- postage extra abroad.

★ SEND YOUR POSTAL ORDER NOW to
P. M. SWEETEN LTD.
Bank Hey Street - - BLACKPOOL

FINE VALUE in CHEMISTRY EQUIPMENT

HERE ARE A FEW EXAMPLES OF THE VALUE WE OFFER

SPECIAL SAMPLE PARCEL. 1A/O
Flask, Beaker, 3 Test Tubes, Thistle Funnel, Glass Tubing, Rubber Cork, Connection Tubing, Stirring Rod. **2/6** post free

GAS PREPARATION OUTFIT. 6A/O
Kipp's Apparatus (sub), Gas Jar and Plate, Beehive Shelf, Delivery Tubes and Deflagrating Spoon with Cap. **5/6** post free

APPARATUS AND CHEMICALS. 15A/C
Bunsen Burner with Tubing, Tripod Stand, Wire Gauze, Evaporating Basin, Pipeclay Triangle, 6 Test Tubes, Test Tube Holder and Brush, Wooden Test Tube Stand, Filter Papers and Funnel, Thistle Funnel, Flask, Beaker, Glass Tubing, Connection Tubing, Stirring Rod, Rubber Cork. **21/-** post free

TEST BOOK AND BOOKLET OF EXPERIMENTS. post free
40 different Chemicals and Reagents all packed in bottles.

A HOME LABORATORY FOR CHRISTMAS

OUR NEW PRICE LIST OF 20 PAGES INCLUDES A WIDE RANGE OF EQUIPMENT AND SETS.

Write now to :

BECK (Scientific) Dept. A 60, High Street, STOKE NEWINGTON, London, N.16

LATEST CATALOGUE FREE

Also for Booklet of Tested Experiments 6d. (P.O.) Post Free.

INTRODUCING THE

"KESTREL" AN AMAZING 33 $\frac{1}{2}$ -INCH SPAN DURATION MODEL

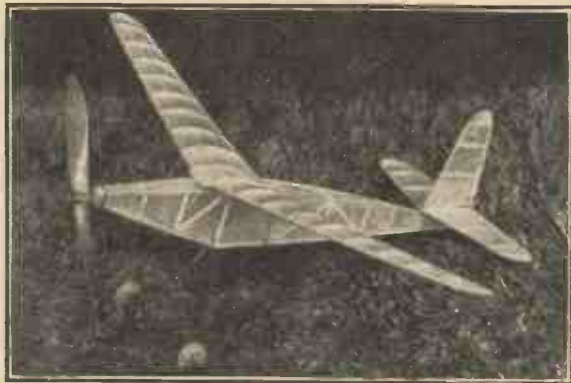

A HIGH-WING DURATION JOB. LENGTH 23 $\frac{1}{2}$ INCHES. SPAN 33 $\frac{1}{2}$. WEIGHT 2 $\frac{1}{2}$ OZ. to 3 OZ.

COMPLETE KIT CONTAINS FULL-SIZE PLAN, FINISHED 12-INCH PROPELLER, RUBBER, CEMENT, DOPE, TISSUE, WHEELS, AND ALL BALSA PARTS.

THE COMPLETE KIT COSTS ONLY 7/- POST FREE, AND IT IS A BRITISH PRODUCTION

MANUFACTURED THROUGHOUT IN GT. BRITAIN BY

S. SMITH

44, LEH STREET, WARRINGTON

WRITE FOR FREE LITERATURE.

TERMS TO THE TRADE ON APPLICATION.

New "MS" Super

AIRWHEELS

FOR PETROL MODELS



4 $\frac{1}{2}$ " Dia. 4 $\frac{1}{2}$ Oz. Pair 9/6 (Complete with Adaptor)

3 $\frac{1}{4}$ " Dia. 3 $\frac{1}{4}$ Oz. „ 6/6 do.

Can be inflated with an ordinary Cycle Pump, and may also be dismantled for repairs.

THE MODEL SHOP

6, COLLEGE ROAD, BARRAS BRIDGE, NEWCASTLE-ON-TYNE

Please send 3d. for fully illustrated Catalogue.

A practical GIFT



for your cyclist friend

To a keen cyclist nothing could be more acceptable than a Smith Cycle Speedo. This combined speedometer and mileage recorder provides him with accurate information at all times. Averages may be worked out and distances confirmed without recourse to maps.

The instrument is finished stylishly in black enamel with chromium bezel and black dial clearly figured in white.

Type A. 1506 Miles p.h. Dial
Type A. 1506K Kilos p.h. Dial



S. SMITH & SONS
(Motor Accessories) Ltd.,
CRICKLEWOOD,
LONDON, N.W.2



SMITH'S

Cycle SPEEDOMETER

AND MILEAGE RECORDER

THE WONDERFUL BABY GNOME BEST FLIGHT TO DATE

3 Hours 40 Minutes.



Span 28 ins. Weight 1 1/4 ozs.

THE KIT THAT IS COPIED BUT UNEQUALLED

The kit includes all necessary stripwood, dope, cement, covering, rubber, bamboo, special propeller block, lightweight balloon celluloid wheels, wire hooks, ready made, etc., and a full-size working blue print.

Price 6/6 carriage paid.

Call and see us at the Schoolboys' Own Exhibition, Imperial Institute, South Kensington, December 28th to January 8th.

MODEL AIRCRAFT SUPPLIES LTD.
171, NEW KENT ROAD, LONDON, S.E.1

Our Catalogue by return 4d. Post Free.

EXPERIENCED MODELLERS PREFER
'BURD' KITS

NOW 6 SIZES TO CHOOSE FROM

- 16-inch span. Six models: Mr. Mulligan, Fokker D7, 1936 Stinson Reliant, Curtiss Hawk, Ryan St., and Curtiss Robin. *Post free* 1/3
- 25-inch span. Six models, including Consolidated P30, Waco Military 'D' Monocoupe, etc. *Post free* 2/3
- 30-inch span. Douglas Observation, Mr. Mulligan, Boeing P26A, 1936 Stinson, Aeronca C70. *Post free* 3/3
- 50-inch span. Curtiss Hawk, P6E, Aeronca K, Ryan St. *Post free* 6/-
- 60-inch span FAIRCHILD 24. What a kit! Two other models. These kits include a 12-inch PROPELLER, READY CUT OUT RIBS and SHAPED COWL where needed. *Post free* 9/6
- 60-inch 'KING BURD' Gas Model. *Post free* £1.1.0
- 30-inch 'Thermalider' Endurance. *Post free* 3/3

ALL KITS
POST FREE

We hold a large range of Selley-Tex Kits.
Wholesale and Clubs supplied.

Send 2d.
for
Giant
Catalogue

ELITE MODEL AIRPLANE SUPPLIES

14, BURY NEW RD., MANCHESTER 8.

to the track two rear "cars" or coaches of a train which had fouled the points, and, in consequence, had "jumped the track."

For two hours, Westinghouse watched the arduous task proceeding. But while he watched, his brain busied itself actively

"car-replacer," which, within a relatively-short period of time, was selling in considerable numbers and being used on many of the principle railroads in America.

The success of the "car-replacer" gave impetus to many of the other notions of Westinghouse's brain. He utilised a lull in business in the summer of 1867 to marry the lady of his choice, one Marguerite Erskine Walker, and then, securely settled as a husband and a householder, his old interest and enthusiasm for mechanical pursuits and inventions reasserted itself even more insistently than it had ever done before.

"You can't stop a train in a moment." The statement to which we have already referred was made to Westinghouse soon after his marriage and about the period at which his inventive faculties were reaching their highest level. Two trains travelling in opposite directions had met on the one stretch of line with disastrous results, despite the fact that their respective drivers had seen each other's approach for some considerable distance ahead.

Westinghouse, with his clear brain and his resilient imagination, saw vividly the crying need for some device which could be relied to stop a train quickly in an instance of emergency. The idea more than fascinated him. It

appeared too clumsy to be worth constructing.

Then he experimented with a steam-braking system, steam being conveyed to a number of piston-brakes under the train coaches. But the troubles experienced with steam condensation quickly convinced him that a steam-braking system would never work reliably and instantly in an emergency.

Happening to pick up a magazine one day, Westinghouse glanced through its pages. His eyes were caught by an article dealing with the construction of the Mont Cenis tunnel through the Alps. He learned in the course of the article that compressed air was being utilised by the Mount Cenis engineers to operate rock drills, the compressed air being carried considerable distances along tubes.

Instantly the long sought-for idea flashed into Westinghouse's mind. Compressed air! Why not do away with the steam in his steam-braking system, and operate the brake-pistons by compressed air, which could be led along the length of the train safely and conveniently in small tubes, would never condense and freeze and which would always be ready for instant use in an emergency?

Financial Aid

Quickly Westinghouse designed the first of the now famous braking-systems bearing his name and obtained a patent for it. Once more, the young man approached his father for additional financial assistance, but Westinghouse père, ever severely conservative, despite his past inventive abilities, again refused aid.

Obtaining outside financial assistance, Westinghouse had several working models of his braking system made and with these he approached the chief railway companies of America. In most instances, his proposals were turned down. "You can't stop a train in a moment" had attained to the status of a semi-traditional belief among railway engineers.

At long last, Westinghouse managed to get the Panhandle Railroad interested in his invention. He was allowed to equip a train with his brakes upon the condition that any damage done to the train by possible mishap consequent upon the trials

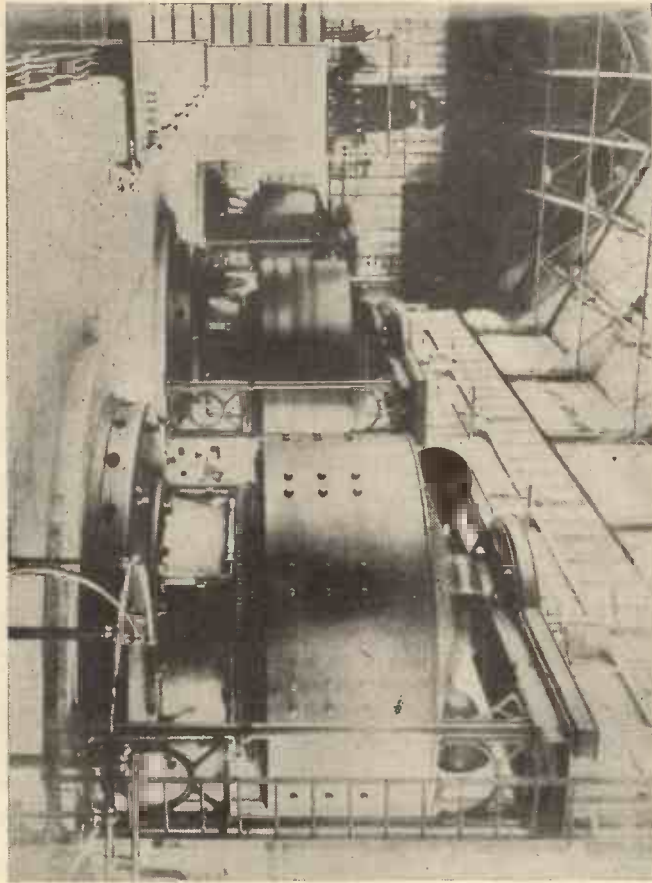

The gigantic hydro-electric installation at Magara which was designed and erected by Westinghouse.

with the details of a new mechanical device which had occurred to him. It was to take the form of a portable set of rails which could quickly be clamped on to the railway track and run off from the latter at an angle. A light locomotive could be run along these auxiliary rails, hitched up to the displaced coaches or "cars" and then made to drag them gradually but surely back on to the main track.

Westinghouse's idea for his "car-replacer" seemed so simple that he wondered why on earth it had never been hit upon before. He tried to interest his father in the notion, but Westinghouse senior was a slowly-plodding, practical man who, maybe, had had enough of his more brilliant son's inventive notions. At any rate, the elder Westinghouse refused to have anything to do with the projected "car-replacer" and he advised his son to drop the fantastic notion and to set himself seriously to the building up of his future career.

His Invention a Success

Undaunted by this parental condemnation, the younger George approached a number of business men in the town. Among them, he found two who were willing to lend him five thousand dollars apiece on the invention. A patent was quickly obtained and, subsequently, Westinghouse began the manufacture and sale of his

overwhelmed him, and, for the time being, he could think of nothing else.

First Attempts

At first he hit upon the notion of braking a train by means of a long chain operating a number of mechanical brakes along the entire length of the train, but the device

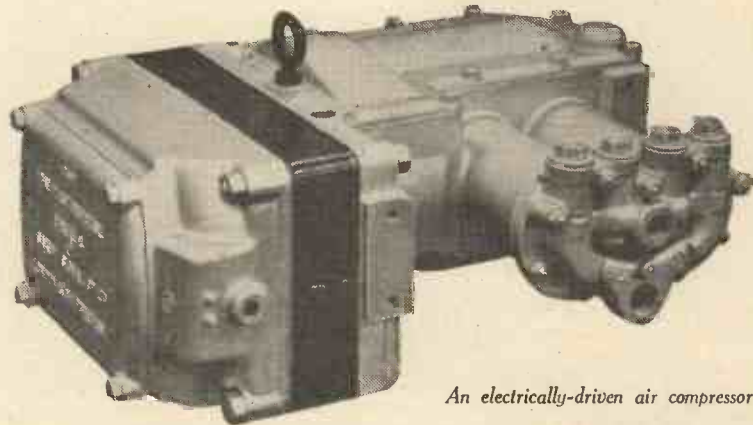

An electrically-driven air compressor.

with his brakes would be made good at his own expense.

A steam-operated pump which was fixed on the locomotive supplied air to the brake system at a pressure of 60 lb. per square inch, a valve mechanism near the driver's seat, controlling the entry of compressed air to the main service pipe of the braking system. Westinghouse himself, various

railroad officials and other interested parties travelled on the train which, when it was travelling at a speed of more than 30 m.p.h., was stopped violently but, nevertheless, safely in less than its own length.

A New Company Started

It was the first time in engineering

history that a train had ever been so suddenly braked. Official incredulity rapidly disappeared. Other railroad companies showered offers of trains upon Westinghouse if only he would allow experiments with his braking system to be carried out upon them.

The result of it all was that Westinghouse, after patenting his new invention and abandoning his car-replacer business, organised a new manufacturing company, the "Westinghouse Air Brake Company," which was incorporated under American law on September 28th, 1869.

So began the air-brake which, in one form or another, is now utilised far and wide. Needless to say, Westinghouse improved considerably upon his early braking system. Indeed, during the decade, 1880-90, he took out no less than 125 patents, many of which were for improvements upon air-braking systems.

The entry of Westinghouse into electrical engineering is a long story and cannot be told in detail here. The success of his air-braking of trains inspired Westinghouse to design numerous other mechanical applications of compressed air power, among which may be mentioned the system of "interlocking" railway signals. He established large factories for the manufacture of his many devices in addition to organising several companies for the exploitation of his products.

It was during the '80's of the last century that the demand for electric power arose. Westinghouse was one of the first to see clearly the many advantages possessed by alternating current over direct current. Strange as it may seem, however, the balance of technical opinion was at that time on the side of direct current for power and lighting purposes. Lord Kelvin, the brilliant British scientist, pronounced judgment against alternating current and so, also, did the equally famous Edison.

Electrical Power

Westinghouse, however, when he decided to enter the electrical industry as the champion of A.C., stuck firmly to his guns. He obtained a contract to supply electrical power to the World's Fair which was held at Chicago in 1893 and, of course, determined to supply alternating current instead of direct.

The Edison Company, which had been



The new all-steel, "Comprestall" air-brake cylinder.

in the running for the contract, declined to allow him to use their lamps. Nothing daunted, Westinghouse, designed electrical lamps of his own. He devised the means of producing some two hundred and fifty thousand of these lamps, besides designing and erecting the largest electrical power station then in existence for the purposes of supplying the necessary current.

A still greater triumph subsequently came to Westinghouse. This was his gigantic feat of harnessing the power of Niagara Falls for electrical energy production. The Niagara hydro-electric stations was Westinghouse conceived and Westinghouse built and, to this day, remains a monument more imperishable than stone to the genius of its creator.

Four Hundred Patents

Two or three years before his death which occurred on March 12th, 1914, Westinghouse relinquished all connection with the organisation which bears his name. Living in semi-retirement, he devoted himself exclusively to mechanical pursuits and to the elucidation of still more mechanical and electrical problems. During the course of forty-eight years of active labour,

Westinghouse took out no fewer than 400 patents, many of which were products of his more mature life.

As the inventor of the air-brake and the pioneer of alternating current supply, the name of George Westinghouse will ever be remembered in technical annals. As a man, he was kindly yet indomitable, gentle yet forcible, visionary yet practical. And, as his one-time associate the famous Nikola Tesla, himself a pioneer of electrical achievement, once remarked, "When others would give up in despair, Westinghouse triumphed. Had he been transferred to another planet with everything against him he would have worked out his own salvation."

Below is a sketch of a wagon fitted with a Westinghouse brake showing a cylinder G in position, which, in conjunction with the following description, should be easily followed by the reader.

The Action of the Ball-valve

When the air is exhausted or sucked from the continuous train pipe A, it is also exhausted from the top and bottom sides of piston B through the holes C and D, through the ball-valve E, and connecting-pipe F.

When air is admitted to pipe A it passes through pipe F into ball-valve E, and thence to bottom side of piston through hole D; a ball lying on the periphery of a vertical hole at the bottom of ball-valve E, and in communication with hole C, prevents the passage of air to top side of piston B.

G is the brake cylinder; H is the piston-rod; K are the brake blocks; L the levers connecting the blocks to the cylinder, sometimes termed the "rigging."

THE P.M. LIST OF BLUEPRINTS

F. J. CAMM'S

PETROL-DRIVEN MODEL MONOPLANE

7s. 6d. per set of four sheets, full-size.

The "PRACTICAL MECHANICS" £20 CAR

(Designed by F. J. CAMM.)

10s. 6d. per set of four sheets.

The "PRACTICAL MECHANICS"

OUTBOARD SPEEDBOAT

7s. 6d. per set of three sheets.

A MODEL AUTOGYRO

Full-size blueprint, 1s.

SUPER-DURATION BIPLANE

Full-size blueprint, 1s.

The

P.M. "PETREL" MODEL MONOPLANE

Complete set, 5s.

The above blueprints are obtainable post free from Messrs. G. Newnes Ltd., Tower House, Strand, WC2

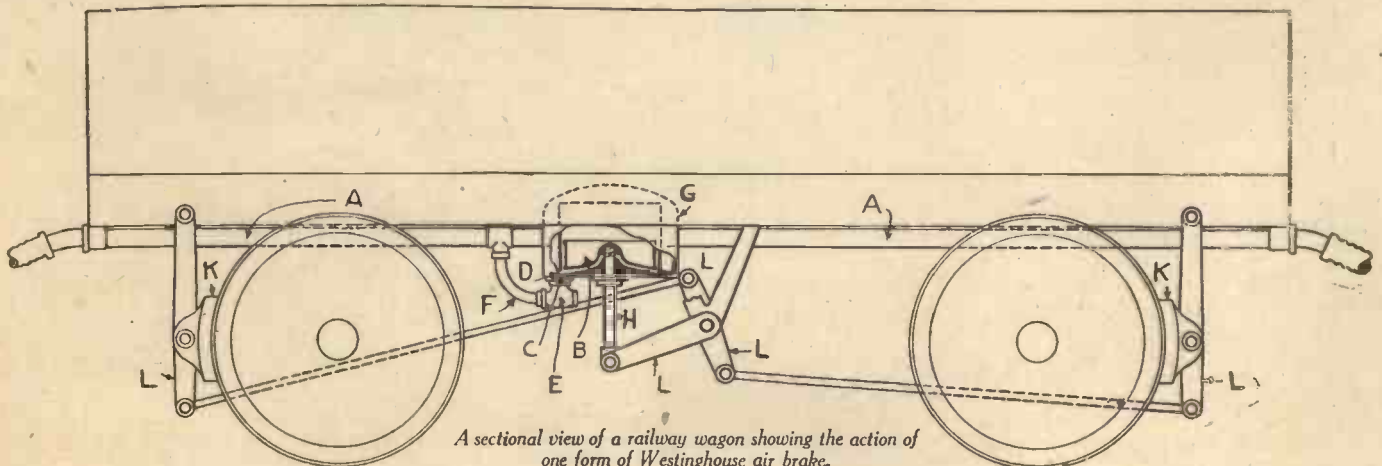

A sectional view of a railway wagon showing the action of one form of Westinghouse air brake.

BETTER VALUE KITS

The Original Value Kits—"LINDBERG."



ONLY 1/6 EACH. Carriage paid in U.K. Overseas 6d. extra.

Kit contains—hard balsa strip; printed sheet balsa; coloured tissue; insignia, markings, printed engine, instrument panel, pilot; rubber; cement; wire; easily assembled propeller; wheels; and fully detailed plan.

HAWKER "SUPER FURY" (Built from Kit)
 BOEING F.4. B.4.; CURTISS "CAMEL"; BOEING P.26A; SOPWITH "HAWK"; U.S. NAVY RACER; "VEGA"; LOCKHEED "VEGA."

NORTHERN MODEL AIRCRAFT COMPANY

37a, FOUNTAIN ST., MANCHESTER, 2.
 23a, TULKETH ST., SOUTHPORT, LANCs.

"NORMAC" HAND-BOOK.

Contains largest range of model materials, etc., in Great Britain. 4d. Post Free. Send Now

OPTICAL GIFTS ARE SURE TO PLEASE!

THE DESIGN-OSCOPE IDEAL GIFT FOR YOUNG AND OLD

3/6 POST FREE BRITISH ISLES

BROADHURST CLARKSON & Co.,

Telescope House, 63 Farringdon Rd., London, E.C.1
 (3 Mins. from Farringdon St. Stn., Metro. Rly.)

25x PENCIL POCKET MICROSCOPE 3/9 POST FREE!



LOOK! THE SPECIALISTS LEAD AGAIN. THEY OFFER A REALLY EFFICIENT ENGINE WITHIN THE REACH OF ALL.

"The Challenger" (6 c.c.)

THE PRICE? £3 . 17 . 6 THINK OF IT
 (Complete on Test Stand with Coll Tank and Condenser).

Full 1 1/2 H.P. at 4,000 r.p.m.
 New Improved Adjustable Spark.
 All Parts Replaceable.
 Gravity Feed.
 Rotary Valve.
 Speed Range 500 to 7,500 r.p.m.
 One Piece Aluminium Alloy Casting.
 Burns 1 Hour on 1 oz. Fuel.
 Weight 10 1/2 ounces.
 Easy Starting.
 Hot Spark Coll.
 Precision Built.
 Thin Steel Lined Cylinder.
 High Speed Bronze Bearings.

Now look at the specification and send at once a 3d. stamp for full list of materials and petrol kits

TO

THE MODEL AIRCRAFT STORE
 127B HANKINSON ROAD
 BOURNEMOUTH

FOR Year'Round FUN ... SHOOT A 'DAISY'



There's one sport you can enjoy the year 'round—and that's target shooting. In winter nail a target on an old box in the basement, and fire away to your heart's content. In summer, go to the fields, where you'll find a thrilling new mark at every turn. Enjoy this sport with your friends. Learn who has the steadiest nerve—the keenest eye. Start your competition to-day. Get a Daisy Air Rifle. Here's the line-up to look over. Pick out the one you like—go to your dealer's and buy it—get the most fun for your money—GET A DAISY.

No. 12 DAISY SINGLE SHOT
 No. 12. Daisy Single Shot. A genuine Daisy at this low price. Also shoots darts. 6/6

No. 11 DAISY 350 SHOT
 No. 11. Nickel plated, 350 shot lever action repeater. Price only 10/6

No. 50 DAISY GOLDEN EAGLE
 No. 50. Copper barrel, ebony black stock, telescopic-type sights. Price 20/-

No. 195 DAISY BUZZ BARTON SPECIAL
 No. 195. "Buzz Barton Special" with famous telescopic-type sights, lever action. Price 13/6

No. 25 DAISY PUMP GUN
 No. 25. Pump action repeater operated by pulling slide towards stock. Back sights adjustable, very accurate, powerful, 50 shot. Price 26/6

Targeteer THE FUN PISTOL



Targeteer is packed with 25 target cards, 500 special shot, and two trick new spinning targets. It doesn't shoot hard enough to hurt anything, yet it's accurate. It's ideal for indoors or out. You'll have plenty of fun with this brand new game pistol. Get yours to-day—for only 10/6.

Booklet of Models sent FREE, address

ROLLINS & SONS (LONDON) LTD.,
 17, ST. BRIDE STREET, LONDON, E.C.4

Stocked by all leading Cycle and Sports Dealers.
 Made in U.S.A.

If you are under 17 years of age, purchases must be made by an adult.
 No Firearms Certificate is necessary.

DAISY AIR RIFLES

WORLD-FAMOUS MACHINE TOOLS.

PRICE £3 . 3 . 0

THE 'ADEPT' No. 1. BENCH HAND SHAPER

The 'ADEPT' LATHE 1 1/2 in. centres, 6 in. between centres. With compound slide-rest 22/-, or with hand-rest only, 13/9. Screw Tall Stock 5/6 extra. Post 1/-.

Also THE SUPER 'ADEPT,' 32/-



Also THE 'ADEPT' No. 2. B. H. SHAPER, 6 1/2" Stroke, Price 26 . 9 . 6. MACHINE VICE 11/-.

Length of stroke of ram 3 1/2". Cross travel 3". Table 4 1/2" x 4".

MANUFACTURED BY F. W. PORTASS, Sellers Street, SHEFFIELD. Write for particulars.

START

That Model Railway
THIS XMAS!

SCALE OO Gauge Model Railways make the most fascinating Hobby possible!

Every addition adds to the Fascination!

See the Editorial Notice about our locos in this issue!

An extensive range of parts for HOME CONSTRUCTION, many costing a few pence only.

The most practical gauge for THE AVERAGE HOME.

HAMBLINGS

THE OO GAUGE EXPERTS

10 CECIL COURT, CHARING X ROAD, LONDON, W.C.2
(Opposite Cameo News Theatre) Telephone: Temple Bar 4704

Write for our 40-page illustrated Catalogue and samples, sending 4d., or if in London, VISIT OUR SHOP. We shall be pleased to see you.

BOND'S

The PERFECT MINIATURE RAILWAY
MAERKLIN "OO" SYSTEM



With the Maerklin "OO" 20-volt A.C. Railway you can run any make of rolling stock on the track and do not need insulated wheels. Also it is perfectly controlled from a switch, with no reversing troubles at points. You always know which way the loco will start, without having to remember which way it was going the last time.

PRICES:			
Locomotive 0-4-0 with tender ...	12/6	Wagon with Awning ...	2/-
Streamlined 0-4-0 loco with tender	15/-	Curved Rails ...	9d.
Diesel Rail Car 0-4-0 ...	15/-	Straight Rails ...	9d.
Electric Outline Loco 0-4-0 ...	12/6	Connecting Rail ...	1/9
Reversing Regulator Switch and Loco Adaptor complete ...	18/-	X Crossing ...	3/6
Loco Adaptor only ...	4/-	Points L.H. or R.H. ...	3/9
Coaches, Passenger, Diner, Sleeper ...	3/-	Electric controlled Points ...	6/3
Luggage Van ...	3/6	Electric Colour Light Signals, hand-controlled ...	3/9
Open Truck ...	1/3	Ditto with Track Cut-out Control ...	7/6
Box Van ...	1/6	Ditto Electric Controlled ...	11/6
Fibre Wagon ...	2/-	2-Button Control Switch for Signals or Points ...	2/3
Petrol Wagon ...	2/-	Buffer Stop ...	1/-
Crane Truck ...	3/-	Station Lamps ...	2/9
Low-sided Wagon ...	1/3	Viaduct Bridge ...	2/9
Side-Tipping Wagon ...	1/6	Transformer 220-240 volts ...	17/6
Banana Wagon ...	1/6		

All prices plus postage.

Send for Bond's 1938 200-page Catalogue if you are interested in Model Making. Price 6d. It contains everything wanted by the Model Maker, including all Tools and Materials.

BOND'S 'O EUSTON RD. LTD.

357 EUSTON ROAD, LONDON, N.W.1

Telephone: Euston 5441-2

Established 1887



There's opportunity for YOU
IN RADIO

Marconi's need 250 Marine Radio officers; trained Radio Engineers and Service men are also urgently wanted.

Either field offers unlimited opportunities to anyone who will spend the very little time and money needed to acquire a sound training.

London Radio College day and postal courses provide the training in the least time; their cost bars no one.

Fully descriptive prospectus from P.M.

LONDON RADIO COLLEGE

LTD.

43, GROVE PARK ROAD, CHISWICK, LONDON, W.4.

Telephone: CHiswick 3244



Wizard Power Tools

TRADE MARK



BAND SAWS

"Wizard" Band Saws are exceptionally well made, and will appeal to those whose needs do not require a machine of large capacity. A most useful tool for the practical mechanic. Made in two sizes, 9" and 12".

PRICES

9" (illustrated) ...	£5 15 0
12" ...	£16 0 0

Please write for illustrated priced catalogue No. 137C.

WIZARD MACHINERY CO.

13, VICTORIA STREET

LONDON, S.W.1

Telephone - - Abbey 3018

STARGAZING FOR AMATEURS

A NEW SERIES

By N. de Nully
A GUIDE FOR DECEMBER

THE Sun enters the zodiacal sign Capricornus (the Sea Goat) at 6 a.m. on the 22nd December. The 20th, 21st and 22nd December will be the shortest days of the year, marking the Winter Solstice and the conventional commencement of that season. With the approach of the sunspot maximum, manifestations of aurorae and magnetic storms may be expected. Only a few weeks ago a magnificent display of the former was seen from a trawler while in the English Channel, off the Cornish coast. The phenomenon lasted half an hour and was described as "like a hundred search-lights." An aurora may be looked for on dark, clear nights. When seen it hangs over the northern horizon like a vast curtain of shimmering luminosity.

Annular Eclipse of the Sun

There will be an annular eclipse of the Sun at the New Moon of the 2nd. Unfortunately, the central line lies wholly in the Pacific Ocean in the same region as that from which the total eclipse of last June was visible. The phenomenon will, therefore, not be seen from this country. Along the favoured track annularity will last twelve minutes which, as in the case of the recent total eclipse, is almost the maximum duration possible. This abnormal prolongation will be due to exactly reversed conditions from those brought about last June. On this occasion the Sun will be almost at its nearest to us and consequently apparently at its largest. The Moon, on the other hand, will be at its farthest from us, and therefore seemingly at its smallest. As a result, the latter will be unable to completely cover up the former, and a ring of brilliant sunlight will be left around the dark obscuring disc of our satellite, even at the central phase. Annular eclipses happen rather more frequently than total ones. Though very impressive, they are not so awe-inspiring as the latter, and have little or no scientific value.

Planets and Comets

Neither Mercury nor Venus are perceptible at present. Mars and Jupiter may, however, still be found in the south-west, low over the horizon. At the beginning of the month Mars sets at 9 p.m. and Jupiter at 7 p.m. Saturn is in the south-south-west, fairly high up. It sets soon after midnight during the first, and shortly before midnight during the last week of December. The breadth of the ring system continues very narrow.

Hubble's Comet is too faint for most observers. Encke's periodic comet was duly picked up at Lick Observatory on September 3rd. It was nearest to the Earth on the 15th of last month, and will be at its brightest on Christmas Day, though not a conspicuous object. A binocular or small telescope will be needed to see it. At the time of writing, the computed position was not available beyond November 15th, for which date R.A. 20 hours 17 min., N. Dec., 30 degrees, 20 min., was given. The comet was then moving rapidly westward and southward. This is the fortieth return, each one of which has been observed. Encke's Comet was discovered in 1819, and has a period of approximately three and a third years.

Gale's Comet, another regular visitor, is also due to put in an appearance this month or early next.

Winter Constellations

The darker nights are rendering some fine star groups more prominent. Directly overhead is Perseus, with its remarkable double cluster of stars and glittering surrounding field. These can be well viewed through a binocular. Adjacent, and to the

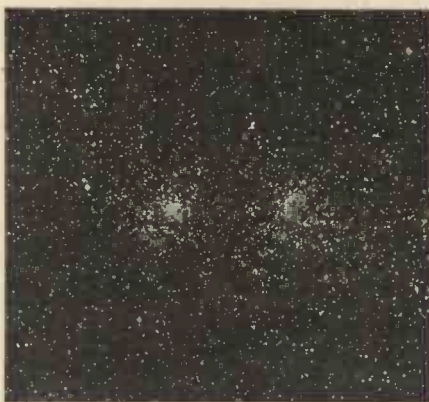

The double star cluster in the constellation Perseus.

west, stretches the straggling constellation Andromeda, containing the most wonderful spiral nebula known. This object is a

complete "island universe" in an advanced state of stellar evolution. Due south, not far from Perseus, sparkle the beautiful Pleiades group in the constellation Taurus (the Bull). Average eyesight can count six components and keen vision may detect a seventh. The slightest optical assistance adds a dozen to the assemblage; while a telescope reveals the existence of scores. Long exposed photographs show that the entire cluster is enveloped in a faint nebulosity. Close by, shines ruddy Aldebaran, the "Eye of the Bull." This giant sun is thirty times the diameter of our luminary, but less intensely hot; which accounts for its reddish hue. In the south-east stately Orion is exhibiting its scintillating "belt" of three diamond-like stars. Huge Betelgeuse glows above and brilliant Rigel flashes below. On clear moonless nights the famous nebula can be discerned as a hazy patch a little way beneath the left hand star of the "belt." After about 10 p.m. Sirius, the Dog Star, will be conspicuous low in the south-east, somewhat to the left of Orion. Farther to the east and higher up, shines Procyon, in Canis Minor; and due east almost half-way to the zenith, are Castor and Pollux, the "Heavenly Twins" in Gemini. Nearly overhead, close to Perseus, is Capella, the chief star of Auriga (the Wagonner). Ursa Major (the Great Bear) stands up like an immense note of interrogation, slightly to the east of north; while dazzling Vega in Lyra (the Harp) occupies a corresponding situation closer to the sky line to the west. In the latter direction the cross of Cygnus, with its chief star Deneb, lies along the north-west.

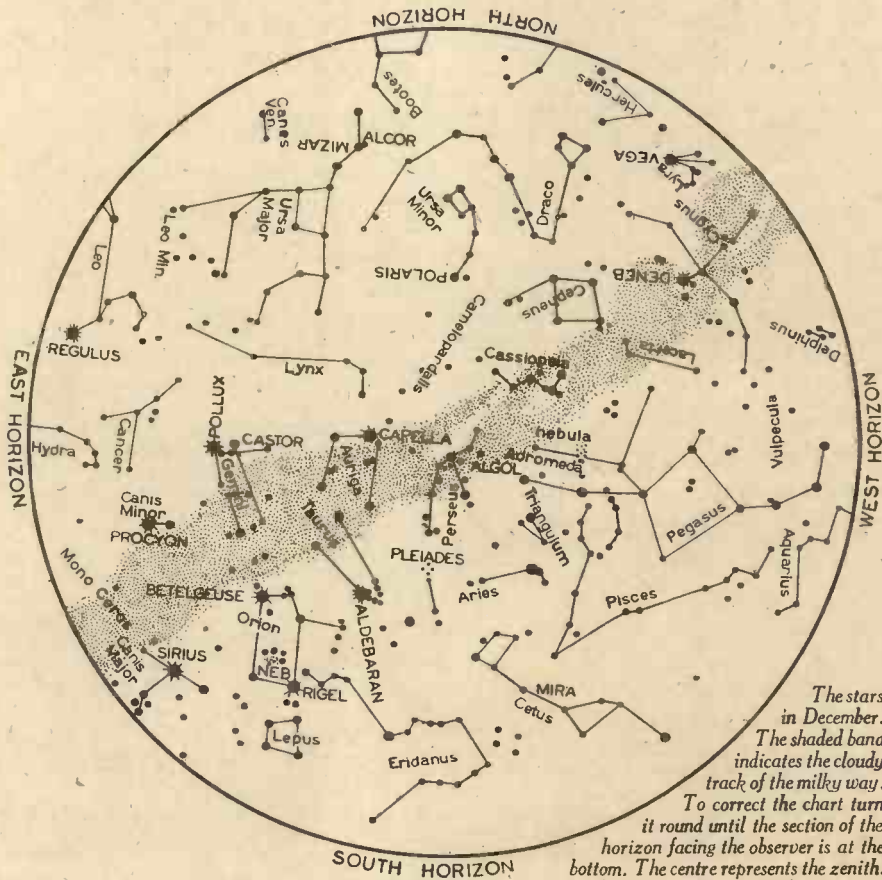

The stars in December. The shaded band indicates the cloudy track of the milky way. To correct the chart turn it round until the section of the horizon facing the observer is at the bottom. The centre represents the zenith.

FIVE MINUTE TEASERS

A SELECTION OF PROBLEMS THAT CAN BE USED AS A BASIS FOR
COMPETITIONS AT CHRISTMAS PARTIES

Gave Them Socks

THERE was a village of 1,000 inhabitants to each of which an eccentric old woman had bequeathed a pair of socks. A number of the inhabitants each had a wooden leg and half the remainder said they did not want socks. How many socks were distributed?

If the Monkey Climbs

ON one end of a rope hanging over a pulley hangs a weight exactly balancing the weight of a monkey clinging to the other end of the rope. If the monkey starts climbing up the rope towards the pulley, what happens to the weight?

Three Men in a Boat

THREE men, A, B, and C, were in a boat and were a mile out at sea. A gun was fired from the shore in their direction. A heard the report, B only saw the smoke, and C saw the bullet strike the water. Which of the three was first aware of the discharge of the gun?

Caught in his Stride

A POLICEMAN was chasing a burglar who was exactly twenty-seven steps ahead of him when they started. The constable took five steps to the burglar's eight, but two of the policeman's steps were equal to five of the burglar's. How many steps would the policeman have to take to catch the burglar?

Quite So

TWO people were in conversation when one said to the other, "You happen to be my father's brother-in-law, my brother's father-in-law, and also my father-in-law's brother." How did this extraordinary relationship come about?

Very Polite

IN a certain mixed school, they had a curious rule of assembly every morning. There were twice as many girls as boys. Every girl made a bow to every other girl, to every boy and to the teacher. Every boy made a bow to every other boy, to every girl and to the teacher. In all, there were nine hundred bows made every morning. How many boys were there in the school?

A Nice Walk

A MAN had a basket containing fifty potatoes. He told his son to place these potatoes on the ground in a straight line. The distance between the first and the second potato was to be one yard, between the second and third three yards, between the third and fourth five yards, between

the fourth and fifth seven yards, and so on—an increase of two yards for every successive potato laid down. Then the boy had to pick them up and put them in the basket one at a time, the basket being placed beside the first potato. How far would the boy have to travel to accomplish the feat of picking them all up? We will not consider the journey involved in placing the potatoes, so that he starts from the basket with them all laid out.

Who was Correct?

A WOMAN was accustomed to buy bundles of asparagus, each 12 in. in circumference, from the grocer. The other day the man had no large bundles in stock, but handed the lady two small ones, each 6 in. in circumference. "That is the same thing," she said, "and, of course, the price will be the same." The grocer, however, insisted that the two bundles together contained more than the large one, and charged a few pence extra. Who was correct?

THE TIME LIMIT FOR
EACH PROBLEM
IS FIVE MINUTES!

The Answers to these
Problems are Given on
Page 189

Try This One

HERE is a little tangle that is perpetually cropping up in various guises. A cyclist bought a bicycle for £15, and gave in payment a cheque for £25. The seller went to a neighbouring shopkeeper, and got him to change the cheque for him, and the cyclist having received his £10 change, mounted the machine and disappeared. The cheque proved to be valueless, and the salesman was requested by his neighbour to refund the amount he had received. To do this he was compelled to borrow the £25 from a friend, as the cyclist forgot to leave his address, and could not be found. Now, as the bicycle cost the salesman £11, how much did he lose altogether?

A Farmyard Poser

IF a hen and a half lays an egg and a half in a day and a half, how long will it take a hen to lay six eggs?

Time Please

HOW many minutes is it until 6 o'clock if fifty minutes ago it was four times as many minutes past 3 o'clock.

Barter

THREE countrymen met at a market. "Look here," said Hodge to Jakes, "I'll give you six of my pigs for one of your horses, and then you'll have twice as many animals as I've got." "If that's your way of doing business," said Durrant to Hodge, "I'll give you fourteen of my sheep for a horse, and then you'll have three times as many animals as I." "Well, I'll go one better than that," said Jakes to Durrant; "I'll give you four cows for a horse, and then you'll have six times as many animals as I've got." How many animals did Hodge, Jakes and Durrant take to the cattle market?

The Two Trains

TWO trains start at the same time, one from London to Liverpool, and the other from Liverpool to London. If they arrive at their destinations one hour and four hours respectively after passing one another, how much faster is one train running than the other?

Curious Numbers

THE number 48 has this peculiarity, that if you add 1 to it the result is a square number (49, the square of 7) and if you add 1 to its half you also get a square number (25, the square of 5). Now there is no limit to the numbers that have this peculiarity, and it is an interesting puzzle to find three more of them—the smallest possible numbers. What are they?

Two Cups

A MAN has two silver cups with one cover for them. The cups and cover together weigh 12 oz. and are in such proportion that if the cover be put on the greater it will double the weight of the lesser, and if put on the lesser will be equal in weight to the greater. What are their respective weights?

Fishy

IN stocking a fish pond a man put in six times as many roach as carp, and the carp were a third as many as the tench. The tench were fewer than the bream by two, and were just half as many as the roach. It was then found that there were 197 fish in all. How many of each sort were there?

HIGHLIGHTS IN THE MODELLING WORLD

(Continued from page 148)

hand a dainty looking exploration ship. It is now possible to tackle the making of such models in a more businesslike way. Not only are finished working models available of exquisite quality but one can buy the sets of parts for constructing, say, a tug-boat, life-boat, cross-Channel packet, naval pinnace, or a cargo boat like the one illustrated. This is a very popular type of craft to be seen on the coast. These ships vary in size from small vessels between 8 and 900 tons to 1,500 tons register and can be easily recognised by the raised structure amidships containing the bridge and the officers' quarters, a funnel, and sometimes a little passenger accommodation. The colour of the funnel and the superstructure varies considerably according to the practice of the owners. You may ask, what is the difference between a tramp and a merchant ship? The tramp is a steamer that is chartered to take a cargo, say, from London to some port as far away as South America and then await instructions from the owners where to pick up the next cargo, sometimes having to go between two ports "in ballast," that is, without cargo. Thus employed the tramp travels from port to port with different cargoes until she has a cargo to enable her to return to her home port.

Though I personally have all models ingrained in my soul, I am more than ever subject to preferences, and when it comes to a choice, I find that nine times out of ten the spell of the sea and its beautiful ships wins over all others.

REPAIRING GEAR TEETH

(Continued from page 142)

A Perfect Repair

Another method which can be used where the wheel can be put on the miller, is shown in Fig. 5 and is as near a perfect repair as possible. A short screw can be tapped into the metal after the tooth has been driven home to prevent it sliding sideways.

This is the best method for repairing teeth in narrow wheels, where the width of the tooth will not allow of the fitting of studs, such as brass clock wheels. In these cases the tooth may be soldered into position.

Fibre or hide wheels, which are made up from a number of discs bolted together, rarely suffer from one broken tooth, but such a condition may be caused by a piece of solid material dropping into them. A repair can be made by unshipping the pinion, knocking through the pins, and redistributing the discs, so that the faulty tooth appears all round the wheel, as shown in Fig. 6.

Bind Your Copies of "Practical Mechanics"

THE binding case for Volume IV, complete with title page and index, is now ready and costs 3s. 6d. by post from the Publisher, George Newnes, Ltd., Tower House, Southampton Street, Strand, London, W.C.2. The index can be obtained separately if desired for 7d. post free. All readers should have their copies of Volume IV bound, and thus be able easily to refer to the contents by means of the fully cross-referenced index.

An Absorbing Hobby

BUILDING A STUART MODEL IS AN ENGROSSING PASTIME, AND THE RESULT A CONTINUOUS PLEASURE



We illustrate:

STUART NO. 10. High Speed Steam Engine. Bore 1/2". Stroke 1/2".

Each set is complete—drawings and instructions are included.

- If you have a lathe—
The rough castings - - - 8/6
- If not—
Fully machined set - - - 18/6
- Ditto, with all holes drilled and tapped - - - 25/-

This and many other Stuart engines are fully described in the 72-page CATALOGUE No. 3, 6d. post free.

STUART TURNER LTD. HENLEY - ON - THAMES

Keep a tube handy!

Ste-Fix

* For all purposes where a really powerful adhesive is required. Indispensable for model-making, cabinet work and all jobs about the house and workshop. Available everywhere in tubes 2d., 6d., and 9d.

- * COLOURLESS
- * NEEDS NO HEAT
- * ODOURLESS

Made by the Proprietors of Stephens' Inks, 57, Aldersgate Street, London, E.C.1

ALWAYS READY TO USE

Build your own MODEL GALLEON

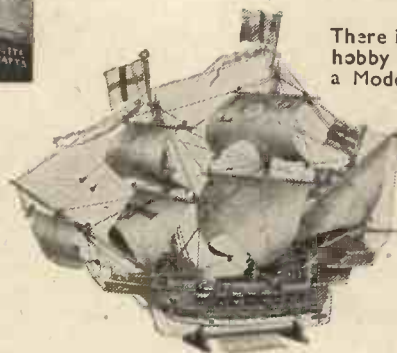

There is no more fascinating hobby than the building of a Model Galleon. You can build one of these beautiful models yourself with a Studiette Model Galleon Kit, which is complete with all parts ready for assembly.

Each Outfit is neatly packed in a strong box.

Every Studiette Kit includes paints, brushes, transfers, sails, etc., and full easily understood instructions for building. A finished model is a thing to be proud of for a lifetime. Kits now available are described below with prices in U.K. Postage 1s. extra.

Model illustrated in centre is Drake's GOLDEN HIND. Length completed 32 in. Kit 45/-.

Prices (in U.K. only) of Kits available:—

The Victory 100/-	Revenge 65/-
Golden Hind 45/-	Santa Maria 32/6
La Bona Esperanza 22/6	Yellow Carvel 12/6

From **GOOD CRAFT SHOPS** and **STORES** (Including Harrods, Hamley's and Selfridges).

If in difficulty send to:

Studiette Handicrafts (Dept. K), Kent St., Birmingham.

STUDIETTE MODEL GALLEONS



WHEELS FOR MODELS

By E. W. T.

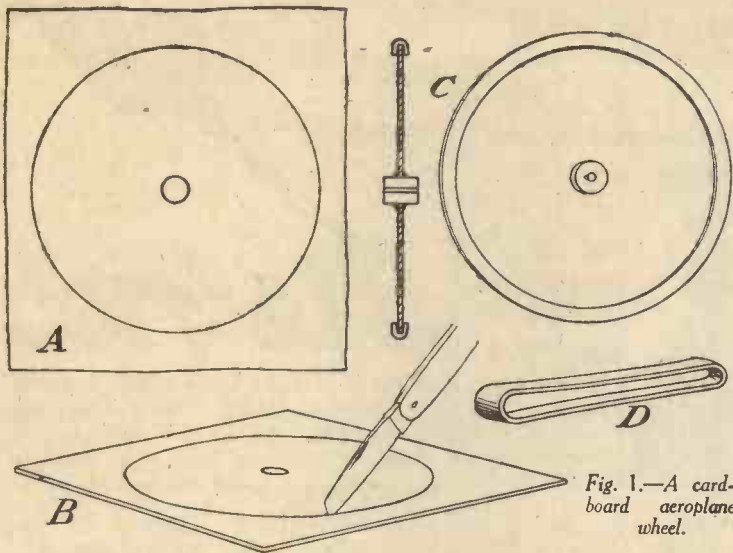

Fig. 1.—A cardboard aeroplane wheel.

The First Article of a Short Series Dealing with the Construction of Wheels Suitable for every Type of Model.

Of all the parts of a model, whatever the model is intended to represent, the wheels, assuming that it is supported upon wheels or has a wheel forming part of its design and construction, presents in most cases the greatest difficulty to the model maker. If it be a locomotive or a steam engine of almost any kind, a wheel, or wheels, are required, which have to be cast in metal and afterwards turned in the lathe. Wheels for road vehicles have either to be turned or built up; in the case of motor cars fitted with tyres, they may be wholly turned or built with laced wire spokes. For horse-drawn carts, carriages, field guns, and gun carriages, they will naturally be built up of wood. Model aeroplanes must have wheels, and, for those which are required to rise off the ground and fly, such wheels must be designed and made so as to be exceedingly light in weight.

The Origin of the Wheel

Has it ever occurred to the reader to speculate as to who invented the wheel? Has he searched an encyclopædia or textbook to discover the name of the genius whose brilliant inspiration provided, for all time, that wonderful thing which alone has made high-speed locomotion and the transport of heavy loads possible? If he has made such a search he has finished his self-imposed task without finding any satisfactory answer to his questions, for the fact is that the origin of the wheel is lost in the mists of antiquity. The ancient Egyptians had it, certainly, in a very advanced state of perfection; and it was probably very old at the time the pyramids were built.

There can be little doubt that it was not invented at all as one perfect unit, but has gradually evolved from the roller, which was undoubtedly put to a considerable amount of use, even after the wheel was introduced, particularly for the transport of quarried stone. It is quite conceivable that some engineer, engaged upon a monumental work, wished to obviate the necessity of repeatedly transferring a roller from the rear to the front of some moving weight and so thought out means whereby the roller could move along with and at the same rate as the weight, so he cut his rollers into two, bored them, and passed axles under his weight, on the two projecting ends of which axle he mounted his rollers. From this arrangement to a pair of flat discs on an axle was but a step, and so the primitive wheel, which may still be seen on carts drawn by oxen in Egypt and the Orient, had its birth.

This little digression is not perhaps important, nor has it much connection with our subject, but it is certainly of interest to those of an enquiring turn of mind.

In these articles will be given some ideas for making wheels for all the various kinds of models met with, and where the method

adopted in the prototype, i.e. the original full-size wheel, cannot be followed in the miniature copy, to give a modified form of construction which will result in similar appearance.

Wheels for Aeroplanes

We will commence with the most simple

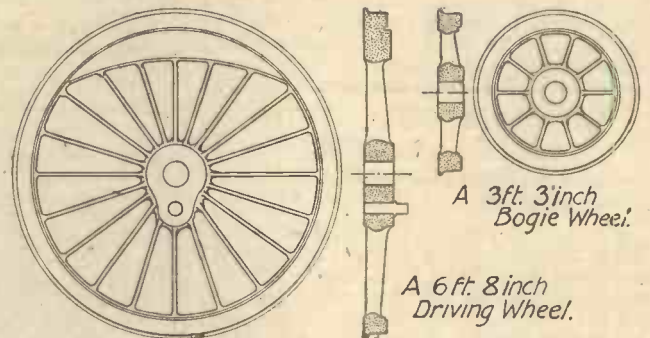

Fig. 3.—Locomotive wheels.

of all wheels, namely those required for R.O.G. model aeroplanes. These must be extremely light and sufficiently strong to bear the shocks of landing.

Whilst it is true that stamped or pressed aluminium wheels can be bought so cheaply that it is questionable whether it is worth while making one's own, there is certainly some satisfaction to be derived from having built the whole model from the beginning to end; besides which, it is possible to make

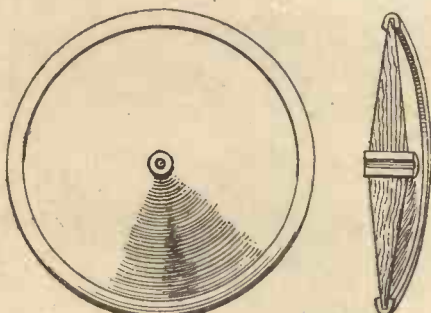

Fig. 2.—A wheel of balsa wood.

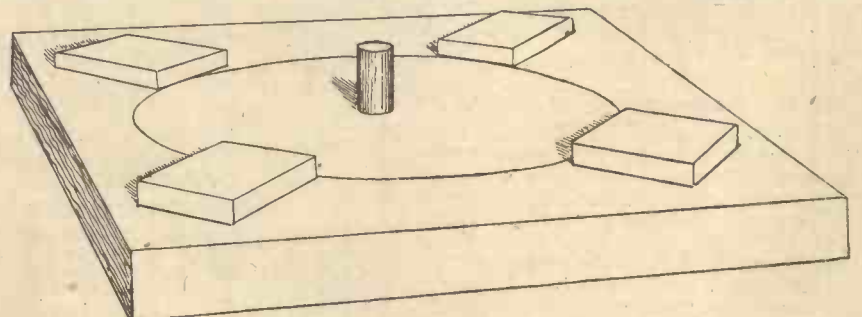
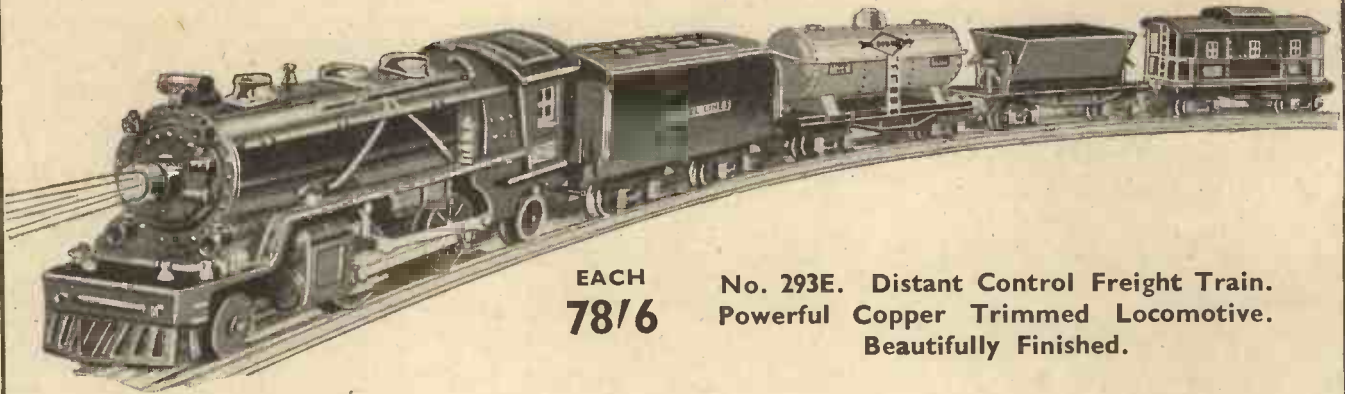

Fig. 4.—A wheel-building jig.

WONDERFUL LIONEL MODELS

WHISTLING — REVERSING — SWITCHING BY REMOTE CONTROL



EACH
78/6

No. 293E. Distant Control Freight Train.
Powerful Copper Trimmed Locomotive.
Beautifully Finished.

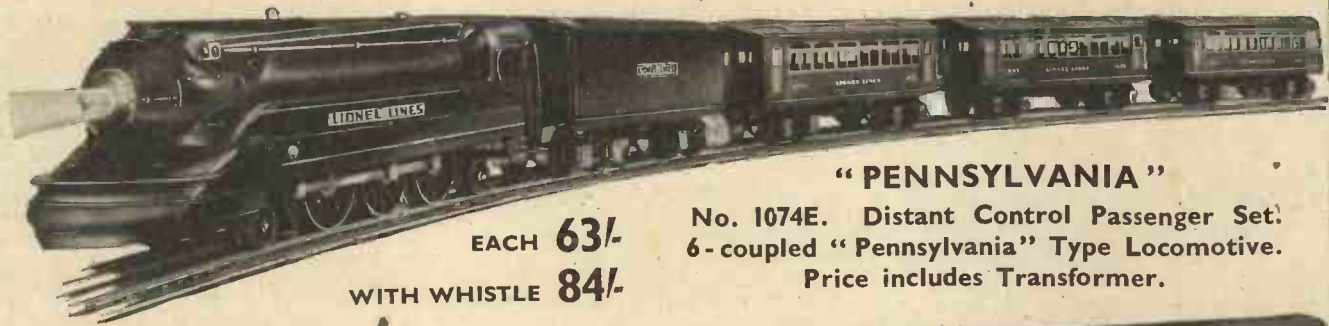

EACH **63/-**
WITH WHISTLE **84/-**

“ PENNSYLVANIA ”

No. 1074E. Distant Control Passenger Set.
6-coupled “ Pennsylvania ” Type Locomotive.
Price includes Transformer.

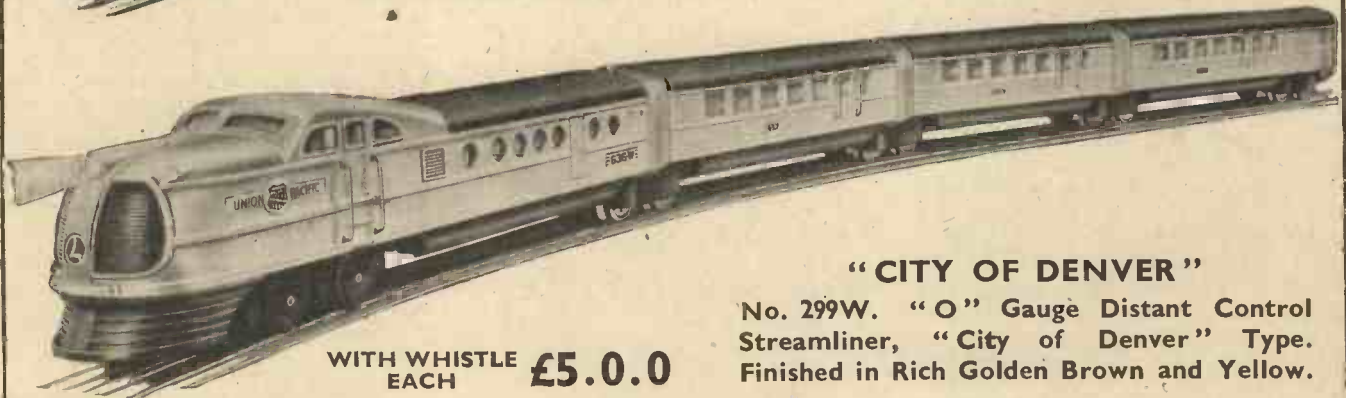

WITH WHISTLE EACH **£5.0.0**

“ CITY OF DENVER ”

No. 299W. “ O ” Gauge Distant Control
Streamliner, “ City of Denver ” Type.
Finished in Rich Golden Brown and Yellow.

WRITE NOW . . .

FOR THE COMPLETE LIONEL CATALOGUE OF
ELECTRIC STEAM TYPE AND STREAMLINED TRAINS WHICH IS
ABSOLUTELY **FREE**

LIONEL SERVICE DEPT. (19)

35 ALDERMANBURY — LONDON, E.C.2

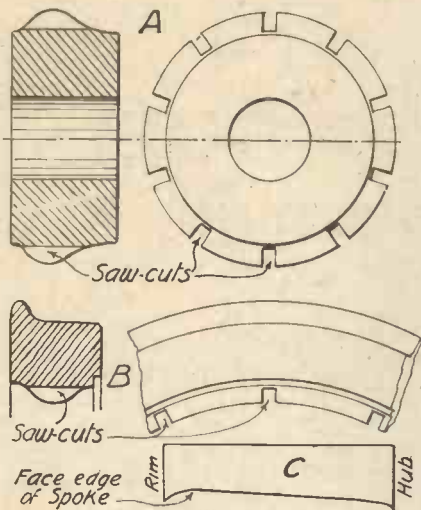

Fig. 5.—Bogie-wheel details.

them even lighter in weight than those of aluminium.

Cardboard Wheels

The simplest of all is the wheel made from a disc of cardboard. With a compass inscribe two concentric circles upon a piece of card about $\frac{1}{8}$ in., or a little less, in thickness, the inner circle with a diameter of $\frac{1}{2}$ in., the outer $1\frac{1}{2}$ in. or $1\frac{1}{4}$ in. diameter, according to the size of the aeroplane. Cut both circles carefully with a sharp pen-knife and glue in the small hole a short piece of hardwood having a fine hole, to fit over the wire axle, drilled through its centre-line, all as shown in Fig. 1, which shows at A the circles drawn upon the card, at B the cutting-out operation, and C the finished wheel. The cardboard and wooden centre should be hardened after completion by soaking the wheel in either celluloid, lacquer, or shellac. A flat india-rubber band D may well be stretched around the periphery to form a tyre and protect the edge of the card from injury.

Balsa-wood Wheels

Another simply made wheel is that cut out from a flat piece of balsa wood. It may have a thickness of $\frac{3}{8}$ in. at the centre, be pared away to, say, $\frac{1}{8}$ in. at the edge all round, and be bushed either with hardwood or a piece of very small diameter metal tubing. Again the periphery can be covered with a rubber band. Views showing this type of wheel are given in Fig. 2.

Railway Models

Under this head we have, besides those for locomotives, the wheels of model coaches and wagons, and it is proposed to deal with not only the several kinds of wheel, but different sizes of these and for non-working tiny models, as well as with those of larger scale which may be steam driven.

It is somewhat surprising that few model locomotive enthusiasts do not make, as ornaments, constructed in cardboard and wood, models of their favourite engines to very small scales, such as $\frac{1}{2}$ in. to 1 ft. or less. Possibly the difficulty of obtaining wheels, or the imagined difficulty of making them, has been a deterrent. So far as the writer is aware it is not possible to buy such small wheels, and so a method of building them, which is extremely simple if a lathe is available, will be given. It is obvious that if these articles are to be of any use they can only be so to those who have a lathe, for very few wheels can be made with-

out this tool, and so it will be presumed that the reader is the possessor of one.

To commence with we will assume that a cardboard locomotive is to be built to a scale of $\frac{1}{2}$ in. to 1 ft. Fig. 3 shows a driving wheel of 6 ft. 8 in. diameter and a bogie wheel 3 ft. 3 in. diameter, drawn to scale and reproduced exactly full size for modelling. Now we are going to build these wheels up, using boxwood for the rims or tyres and also for the hubs, and we are going to lay these in a jig and insert all the spokes cut from thick Bristol board.

The first thing to do, having decided upon the particular engine to be modelled, is to make a jig for each of the wheels, or rather, one jig for each of the different wheel diameters. Suppose that the model is to have 6 ft. 8 in. driving and coupled wheels, 3 ft. 3 in. bogie wheels, and 4 ft. tender wheels, then three jigs will be required. They are quite simply made, and consist of a baseboard about $\frac{1}{2}$ in. thick, with a dowel pin projecting upwards in the centre, and

and insert a dowel pin of the same diameter as that determined upon for the axles of the wheels. This dowel pin must be very accurately placed, for the ultimate truth of the wheels made upon the jig will depend upon the pin being exactly in the centre of the flange circle.

The Tyres and Hubs

Having made all the jigs which will be needed, the next thing to do will be to turn the hubs and tyres. For these use boxwood, which can be bought in pieces, sawn off the trunks or branches of the trees, in lengths of about 6 in.; select pieces having diameters from 1 in. to 2 in. By using the wood in this form the grain will not run across the wheels, but though them, in a direction parallel with the axles. There will thus be no tendency for them to become oval through shrinkage.

Avoid Shrinkage after Building

Actually, however, no shrinkage must take place, even with the grain running as described, for, if it does, the diameter will be reduced, and this will cause all the spokes to become buckled. The best plan will be to ask the supplier to guarantee that the wood is seasoned by having been in stock for a considerable time. Then, having obtained it, turn the rims and hubs for the wheels before doing anything else and lay them on one side, in a warm, dry place, whilst the remainder of the engine and tender is being built. This will give the tyres a chance to contract, if they are going to do so, before the spokes are put in.

Fig. 5 shows the exact form to be given to the hubs and tyres when turning them. A is a section of a hub, B a tyre, and C a profile of one of the spokes. The spokes are to be inserted in slots, which will be formed with a fretsaw; choose, therefore, a saw which will make a cut somewhat greater in width (only a little greater) than the thickness of the Bristol board. The spacing of the slots is important. A bogie wheel will have ten spokes, and the outside circumference of the hub, and the inside of the tyre must be marked out, for this number of saw cuts, with a pair of dividers.

(To be continued)

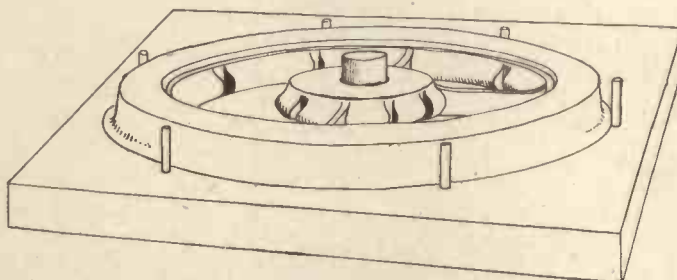

Fig. 6.—Building a wheel on a jig.

either a row of about six pins or four or six little blocks of wood glued on.

The surface of a board should be planed true, and then with a compass draw a circle of the exact diameter of the flange of the wheel which is to be dealt with. Exactly up to this line glue on the little blocks, which should stand up about a quarter of an inch, as shown in Fig. 4. Just where the compass centre marked the wood bore a hole

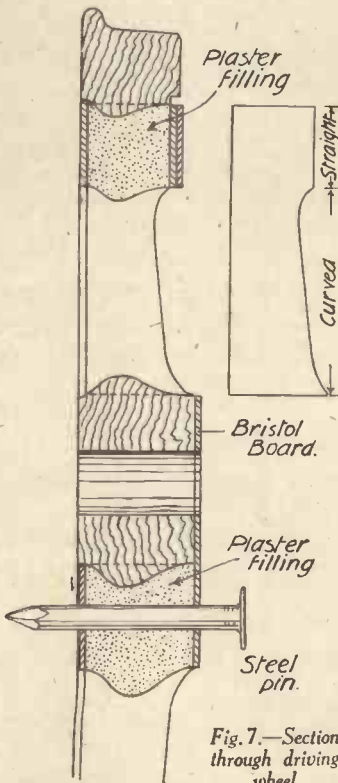

Fig. 7.—Section through driving wheel.

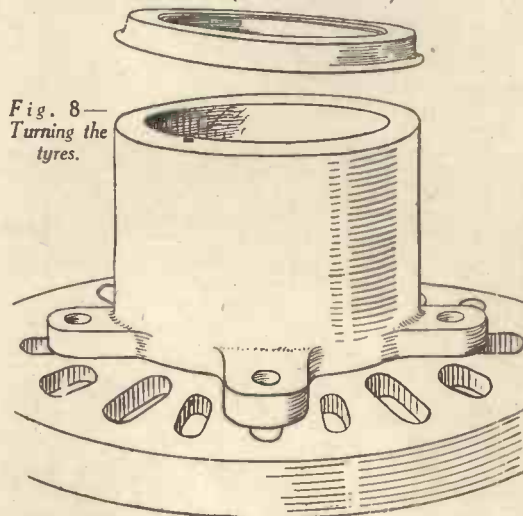

Fig. 8—Turning the tyres.



The growing popularity of petrol-driven machines is indicated by these two illustrations. Almost at every meeting you will see a number of petrol-driven models.

MODEL AERO TOPICS

Pneumatic Wheels

I HAVE received from the Model Shop, 2 College Road, Barras Bridge, Newcastle-upon-Tyne 2, a pair of their new M.S. Air Wheels, $3\frac{1}{2}$ in. in diameter. They make these wheels in two sizes, and intend to produce them in a full range of sizes from 2 in. in diameter to $4\frac{1}{2}$ in. in diameter. They make the wheels entirely themselves including the moulding and vulcanizing of the tyres, blanking the discs, turning the hubs etc. The pair before me is well made and ideal for petrol models and heavy rubber driven models.

Competitions for 1938

AT a recent Council meeting at the S.M.A.E. it was decided to hold on August 7th, 1938, a concours delégance flying competition, the entrance fee for affiliated club members being 6d. and for unaffiliated members, 1s. This is a de-centralised rubber model contest. The National Cup Competition will be held at Fairey's Aerodrome at 3 p.m. on August 14th, 1938.

The Biplane competition will be held on September 4th, 1938, and the Farrow Shield on September 18th, 1938. The Elimination Trials for the latter competition will be held on Sunday, July 3rd, and the Frog Cup Competition on July 17th. It was also decided that gear boxes for Wakefield models should not be purchased ready made.

Timing Duration Flights

ALTERATIONS were made to the competition rules for timing duration flights. Rule No. 7 which says "that duration will be taken from the time the airscrews are released" was altered to read "duration will be taken from the time the model is released." An extra rule was inserted stating that no model in any com-

CURRENT NEWS FROM THE WORLD OF MODEL AVIATION

BY F. J. C.

petition or record attempt must drop any part during such competition or attempt. The Council discussed the question as to whether binoculars were to be allowed by the timekeepers when timing duration flights, in order to bring the S.M.A.E. in line with the F.A.I.; after considerable discussion it was decided by 8 votes to 7 that optical aid should not be permitted. The rule remains, therefore, that the judges stop their watches when the model passes out of their vision. The Council also recommended that in the flying scale model competition only machines to the 1 in. to the foot scale should be allowed. All cups belonging to the S.M.A.E. have to be overhauled and prepared in readiness for the prize giving, and it is requested that all cups should be returned to Mr. Cosh, Mr. Smith, or Mr. York by December 31st.

Model Aircraft at the School-boy's Exhibition

EXHIBITION Committee of the S.M.A.E. request that secretaries of affiliated clubs should approach their members with a view to placing on the S.M.A.E. stand at this Exhibition some of the finest models in the country.

If affiliated clubs have any literature they desire distributed during this exhibition, will they please forward same together with any offers of help in attending the stand. The exhibition will be open from 11 a.m. to 7 p.m., and as this is during the Christmas holidays, it is anticipated that a great many people will be requiring information and assistance.

S.M.A.E. Annual Prize-giving, Dinner and Dance

THE Entertainments Committee of the S.M.A.E. (Messrs. Rippon, Smith and York) announce that the Annual Prize-giving, Dinner and Dance will be held on February 2nd, at Lysbeth Hall, Soho Square, and the tickets will be 7s. 6d. each. The capacity of the Lysbeth Hall is strictly limited. Applications for tickets should be made to any of the above three gentlemen as soon as possible. The Entertainments Committee also announce that all first prize winners of competitions held during 1937, and the six members of the Wakefield Cup team, together with the winners of the National Cup will be guests of the S.M.A.E. and tickets have already been sent to these gentlemen.

The Northern Star Super-duration Biplane

PREMIER Model Aero Supplies of 2A, Hornsey Rise, London, N.19, are marketing a kit of a super-duration high-wing monoplane, designed by Mr. Copland, a member of the successful 1936 Wakefield Team, which brought the Wakefield Cup back to the country. The maker's claim that the average duration of the Northern Star is 7 mins. 75 secs., taken over a series of 8 flights. The model is of $37\frac{3}{4}$ -in. span, 27-in. length, and 4 oz. in weight. The kit costs 14s. 6d., and includes a full-size detailed blue print, a $15\frac{1}{2}$ -in. duration airscrew, and ample supplies of all the necessary material. The model may be flown under S.M.A.E. rules.

Petrol Flying Boat Record

THE S.M.A.E. have approved Capt. Bowden's claim for the record for model petrol-driven flying boats. This model was described in last month's issue. The record is as stated in that issue just over 30 seconds.

THREE AMUSING PROBLEMS

INTERESTING EXPERIMENTS IN INERTIA.

Chemical Amusements for Xmas (Continued from page 136)

PLACE vertically on the top of an ordinary bottle a ring made of stiffish paper some 4 in. or 5 in. in diameter and place on the highest point of the ring a

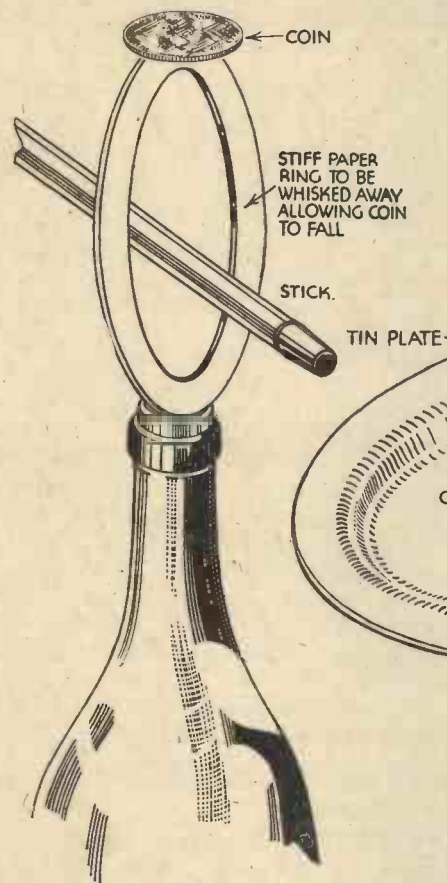

(Above) The penny and the bottle. (Right) The marble and the plate.

coin of rather larger diameter than the mouth of the bottle. Introduce the end of a stick into the paper ring and with a sudden smart horizontal blow hit the paper ring from the top of the bottle. If this is done correctly, the coin will drop vertically (still in a horizontal position) flat on to the top of the bottle, partaking of no horizontal movement at all.

Repeat the experiment with a coin somewhat less than the mouth of the bottle.

The Marble and Plate.

This experiment, one requiring considerable skill and patience, can quite easily be turned into an amusing game. Make a ring of cardboard about the size and thickness of a shilling, and make in the centre of a tin plate a dent the size of a sixpence. Glue the cardboard ring centrally round the dent and challenge anyone to make a small ball or fair sized marble, set rolling, to settle in the dent in the plate.

Unless the following method be tried it will be found extremely difficult to accom-

plish the feat successfully. Allow the ball to roll gently up against the circular ridge of cardboard by gently tilting the plate. Then suddenly lower the plate about an inch and raise it again quickly, and by a slight displacement executed at the same time bring the dent vertically under the ball. If this is done properly the ball will drop into the dent and remain there. The reason is that the ball does not fall quite so quickly as the plate, if the latter be moved fast enough, on account of its inertia, and, since it has no other movement than vertical, it will settle in the dent (preferably central in the metal plate) without touching the raised ring of cardboard.

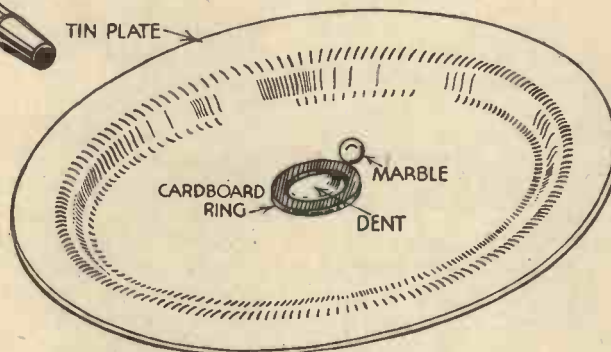

The Knife and the Nut

Stick a knife blade having a heavy handle into the lintel of a door, as shown, only just sufficient to hold. The problem is to make the knife fall on to and crack a nut, placed underneath it on the floor; but the question is where to place the nut. The method of trial and error is not allowed. You must ensure that the knife shall at any rate hit the nut.

One solution is as follows. Pour a little water on the handle of the knife and place the nut on the floor where a drop of water falls from the knife. Just so, but how are you going

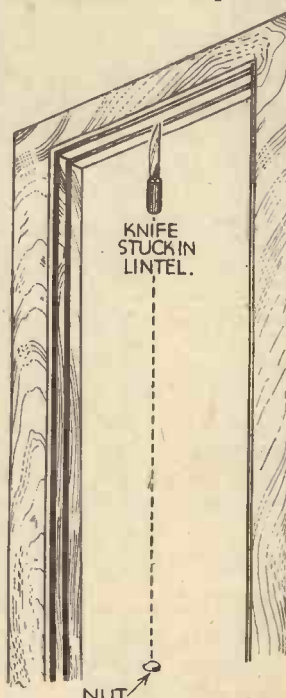

The knife and the nut.

to dislodge the knife so as not to interfere in any way with its vertical fall?

This might be accomplished by drawing the knife away from the lintel by means of a magnet. Perhaps readers have other suggestions?

the yeast has ceased, the solution should be filtered and distilled.

Distilling Apparatus

A simple form of distilling apparatus for an experiment of this kind consists of an old tin can provided with a suitable "neck" in which a cork can be placed. The can, of course, must be quite clean inside. Through the cork in its "neck" passes a piece of glass tubing which is bent at an acute angle a few inches above the "neck" of the can. A few folds of blotting paper rest over the downward portion of the tube, the blotting paper being maintained continually wet with cold water.

The can containing the fermented sugar solution is placed over a gas ring or other heating device and the contents of the can are distilled until about one-third of their volume has passed over. This latter liquid—the "distillate"—contains practically all the alcohol plus a considerable amount of water which has distilled over with it. It is, however, quite suitable for use in many experiments and for various preparations and it possesses the characteristic "fruity" odour of ethyl alcohol. If, however, we wish to obtain it in a pure condition for scientific use, we must add quicklime to the alcohol solution and allow it to stand for several days. During this time, the quicklime will absorb most of the water and, after redistillation, a more water-free specimen of ethyl alcohol will be obtained. After repeating this treatment two or three times, alcohol practically free from water will result.

Ammonia from Bones

There are usually plenty of bones left over at Christmastide. Have you ever tried making ammonia from them? For this purpose, rig up a simple tube of apparatus consisting of a test-tube fitted with a cork through which a glass delivery-tube passes. In the test-tube place a few bone fragments mixed with a lime and caustic soda paste. Heat the test tube with a Bunsen burner—preferably out of doors, for the smell of "burning bones" is not particularly pleasant! If the other end of the delivery tube dips into another test-tube containing water (and, preferably surrounded by a vessel of cold water, in order to keep it cool) the ammonia evolved by the bones will dissolve in the water, which will very soon begin to smell strongly of it.

If we make up a solution of copper sulphate and then add ammonia to it, the solution will take upon itself a dark blue-violet colouration and will become quite clear. This solution is an interesting one inasmuch as it possesses the property of dissolving paper. Take some ordinary white blotting paper and shake it up with the solution. The paper will slowly disappear, the solution remaining more or less clear. Now add a few drops of any mineral acid to the solution. Instantly, a white gelatinous mass will be formed. This is the dissolved paper precipitated in a new form—in, indeed, the form of artificial silk. In this simple experiment, artificial silk has been made on a small scale, as it was on a larger scale in the earlier days of that now colossal industry.



39/-
Post Free.
1/10TH H.P. A.C. MOTOR, 200/250 volts, silent, powerful; no radio interference.

XMAS Gifts WHICH ARE SURE TO PLEASE



3/-
MEDICAL COIL, Operates from a Standard dry battery. Other models up to 45/- each.



3/6
POWER MOTOR.—Works from a flash-lamp battery or accumulator, can also be supplied in parts for home construction at the same price with full instructions; very instructive.



32/-
Post Free.
GEARED MOTOR.—Speed on slow shaft 96 R.P.M., operated from any lighting circuit 200/250 volts A.C. Ideal for sign display mechanisms, model driving, etc. Very powerful and silent.

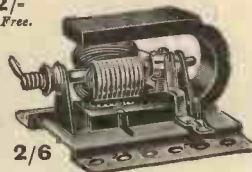

2/6
IDEAL 4-VOLT MOTOR for Meccano models and speed boats, baseplate drilled for easy mounting.



4/6
4-VOLT Permanent Magnet Motor for speed boats, etc.



15/11
Post Free.
"WILCO" POPULAR CYCLE LIGHTING SET, complete with rear lamp, all leads, bulbs, instructions for fitting, etc. Other models from 13/9 to 23/6.

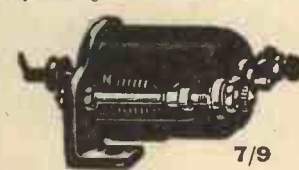

7/9
"WILCO" MOTODYNE, the best 4- to 6-volt motor for boats and models yet produced. Larger size, 11/6.



5/6
TRANSFORMER LAMP. Input 200/250 volts A.C. Output, 4 volts, 1 amp, cost next to nothing to run, ideal for cupboards, etc.

COPPER WIRE.—We have 1 ton for disposal cheap and will make up a bargain parcel of useful sizes, both silk and cotton covered, etc., as follows, including carriage, 1 lb., 2/6; 2 lb., 4/6; 3 lb., 6/6.

Postage 4d. extra unless otherwise stated.

L. WILKINSON, "Electric House," 204, Lower Addiscombe Road, CROYDON.

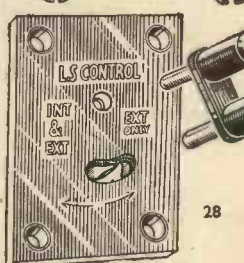
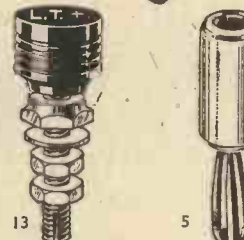
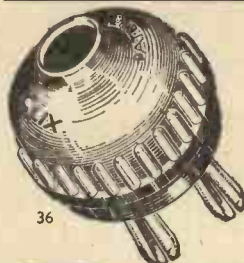

Components Folders "P.M." Free
BRITISH MECHANICAL PRODUCTIONS LTD.,
79a Rochester Row, London, S.W.1

CONTACTS FOR XMAS

Have everything radio and electrical ready for Xmas Festivities. Don't be without a spare 2-pin plug; it's sure to be wanted. Keep a terminal and wander plug or so in readiness for emergency hook-ups. What about control of speakers in distant rooms?

Get all these practical contacts from dealers who stock CLIX.

- 36. WALL PLUG** for radio or electrical apparatus. Type M, 5 amps ... **6d.**
- 13. PANEL TERMINALS.** 4d. With standard engravings
- 5. MASTER PLUGS.** For H.T. or G.B., etc. ... **1 1/2d.**
- 28. LOUD SPEAKER CONTROL PANEL** Gives instantaneous method of switching Extension Speaker in or out and allows internal speaker to be kept in operation or cut out. Price complete as illustrated **1/-**



CHARGE YOUR OWN BATTERY!

This HEYBERD "Tom Thumb" Battery Charger will charge a 2-volt accumulator for **LESS THAN 1d. PER WEEK!** Simply connect the battery to the charger and insert the mains adaptor into the nearest light or power point.

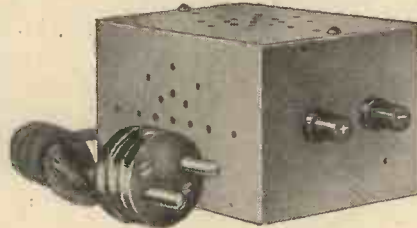

ALL METAL PARTS SHOCKPROOF
SIMPLE TO OPERATE
INCREASES THE LIFE OF THE BATTERY.

Size 3 1/2" x 2 3/4" x 2 1/4"

PRICE **12/6**

Send for free list No. Y.377 describing this remarkable battery charger.

F. C. HEYBERD & CO., 10 FINSBURY ST., LONDON, E.C.2
Tel.: MET 7516 (4 lines).

HOME MECHANIC SERIES

Each 1/- net (or 1/2 post free)

THE HOME WOODWORKER

The various examples of woodwork described in this Handbook have been designed by practical craftsmen. They are modern in style, and their construction is well within the powers of the average home-worker who follows the instructions given.

MODEL BOAT BUILDING

All designs shown in this book have been actually made and tested. All work well and each type is quite simple to make, no elaborate equipment being necessary. Both sailing and power-driven boats are featured.

THE HANDYMAN'S ENQUIRE WITHIN

Hundreds of Practical Ideas and Hints—many not hitherto published. Classified according to the subjects dealt with, an Index being provided to facilitate speedy reference.

TOY MAKING FOR AMATEURS

Over 200 illustrations. Instructions and diagrams are given for the construction of innumerable toys of all kinds, from the simplest to the more complicated mechanical sorts.

25 SIMPLE WORKING MODELS

All the models described in this book can be constructed from the simplest materials and with every modest equipment. None requires lathe-work. 147 illustrations.

GEORGE NEWNES LIMITED

Tower House, Southampton Street, Strand, London, W.C.2

UNIT 'X' Pro. Pat. No. 14570.

THE COMPLETE MACHINE SHOP FOR AMATEUR CRAFTSMEN



Full length 24 ins. Turns objects 4 ins. diameter and certain wood patterns to 12 ins. diameter.

WHAT IT DOES:

- URNS—Wood or Metal.
- DRILLS—Press drills 3/8".
- MOULDS & GROOVES.
- SURFACE GRINDS.
- SANDS.
- JIGSAWS.
- RIVETS.
- CIRCULAR SAWS.
- POLISHES.
- MILLS.
- PUNCHES.
- SPINS.
- DOVETAILS.
- GRINDS TOOLS.

Clean accurate work, to fine limits.

NO LIMIT!!

There is no limit to the number of operations possible on this marvellous machine. It is an engineering education in itself and will develop the mechanical ingenuity of the user. Works with either a small motor or treadle. Supplied with one tilting table that can be fitted in many positions.

WRITE FOR DETAILS DE-LUXE MODEL

Equipment includes Sanding Drum, Wood-turning Mandrel, Lathe-cutting Tool, 2 Saws, Polishing Mop, Circular Saw, Grinding Wheel, Spanners, Oil-can, etc.
95/-, or 15/- cash and 9 monthly payments of 10/- Carriage Free.
Appeals to the Locomotive and Aero Modeller, Woodworker, Constructor and Handyman.

Made by:—**TRIANGLE PRODUCTS LTD.**
Blake Street, Hulme, MANCHESTER, 15.

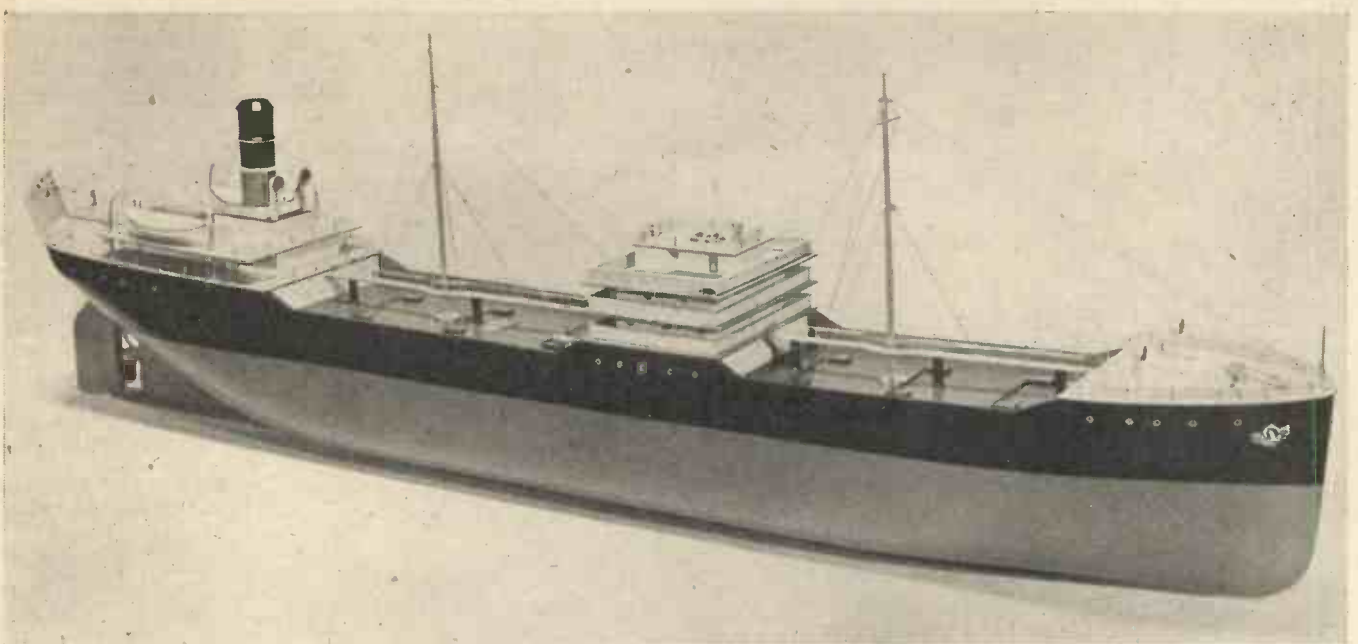

The Bassett-Lowke super-detail working model Oil Tanker.

MODELS AS CHRISTMAS PRESENTS

It is possible to choose a model ship in Bassett-Lowke's latest "S" or Ships list, at prices ranging from 2s. 6d. to £20. For 2s. 6d., you can obtain a model "cut-out" of a ship which is a new idea in model work. Bassett-Lowke have these silhouettes of the *Normandie* and *Queen Mary* carefully painted and finished and attractively boxed, price 2s. 6d. post free, as our illustration shows.

If you want working models turn to page 13 and look at *Triang III* price 21s. clockwork, and 25s. electric. A smart little motor-boat, and if you want a little extra speed and more detailed finish take a look at *Iolanthe II* improved model of the famous and popular *Iolanthe*, complete with smart cabin and costing in clockwork or electric 42s.

For a really splendid Christmas gift what better could you choose than a real working scale model. Bassett-Lowke have the finest and most unique range of these boats in the world, all fashioned by skilled craftsmen. There is the Oil Tanker, always in the picture of sea going life (9 gns.), the cross channel packet *Isle of Sark* (13 gns. complete, £11 10s. for set of parts), the motor-yacht *Azalea* (9 gns.), the Cargo Boat, a ship to be seen at every port (9 gns.), the useful Naval Pinnace (£6 18s.), Exploration Ship (9 gns.), modern motor Life Boat (7 gns.), Tug Boat (£7 12s. 6d.) and the

smart Thames Passenger Paddle Steamer. (11 gns.). All these models are fitted with first class driving units, either clockwork, electric or steam, and many special sets of parts for building can be obtained.

Talking of building models, if this fascinating craft appeals to you, you will surely be

tools included. Bassett-Lowke fittings and parts are specially famous, and suffice it to say that these are as good as ever and several new items have been added.

Model Railways

Messrs. Bassett-Lowke's new railway

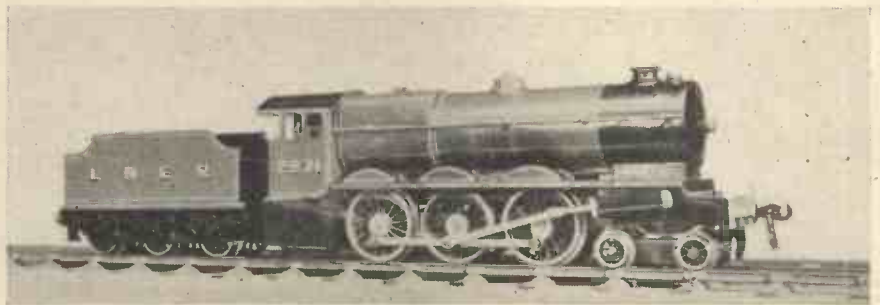

L.N.E.R. model of "Super Enterprise," a new 4-6-0 steam locomotive made by Bassett-Lowke.

interested in the new series of sets of water-line kits which Bassett-Lowke have recently brought out for building 100 ft. to the inch and 50 ft. to the inch waterline models of famous and historic ships, like the *Normandie*, *Cutty Sark*, *Queen Mary*, *Great Britain*, *Great Eastern*, etc. Most of these are 12s. 6d. for the complete set with paints and

catalogue for the Christmas season is now off the presses, and I have had the opportunity of looking at an advance copy.

This year is certainly the peak year in model railway progress, in both design of the locomotives and improved methods of production. First of all there are many improvements in "00" gauge in the Twin-Train Railway introduced by Bassett-Lowke some two years ago. A special booklet of theirs is now devoted to this gauge alone. In addition to the many ways station outfits already described in these pages there are the station figures and other accessories for this scale, and also a complete range of continental type locomotives and rolling stock. Gauge "0" can still claim to be the most popular of all gauges, and Messrs. Bassett-Lowke have introduced many new models this season. Some gauge "0" devotees are steam users, and the "Enterprise," one of their most popular models, and the only inexpensive steam locomotive of its kind on the market, has been supplemented by the "Super

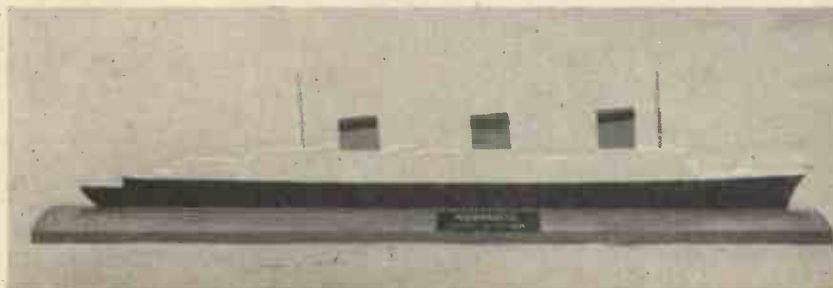

A model "cut-out" of the "Normandie" fitted on a smart blue stand.

Enterprise" a 4-6-0 type. This fine model can be supplied in L.N.E.R. as illustrated, L.M.S., or S.R., stove enamelled and lined and lettered correctly. An 0-4-0 Tank Locomotive of scale dimensions makes a valuable asset for the shunting yard and is very good value at 21s. clockwork, 26s. d.c. and 30s. a.c. It is available in S.R., L.N.E.R., and L.M.S. colours. Then in super-detail comes the L.M.S. "Coronation Scot" and the L.N.E.R. "Coronation." These fine looking modern locomotives are featured as standard lines, complete with their respective trains.

Altogether this new Bassett-Lowke Railway catalogue is most interesting reading, as it covers the subject thoroughly from "00" gauge to $9\frac{1}{2}$ in. gauge.

A Targeteer Outfit

MOST of us obtain a great deal of satisfaction at potting at something with an air-gun or air-pistol. For the modest price of 10s. 6d. it is possible to obtain a targeteer outfit consisting of one Daisy targeteer air-pistol, one metal tube of 500 copper-coated steel targeteer shot of .118 calibre, one set of new spinner targets, and one Handipad of 25 Daisy target cards. The equipment is contained in a three-colour carton, which when opened, can be set up to make an efficient backstop for either set of targets. It is marketed by Rollins & Sons (London) Ltd., 17, St. Bride Street, London, E.C.4. Targeteer shot is also obtainable in red-white-and-blue tubes, each containing 500 pellets, at 4s. a dozen tubes.

Tilley Pressure Lamps

IT is often said of paraffin lamps that they are dirty and smoky, but with the Tilley lamp this is not so, as the paraffin vapour is

2-page index at the back.

Lighting equipment, shocking coils, electric boat motors, transformers, etc., figure prominently in the booklet, together with such interesting items as microphones, house telephones, Wimshurst machines and castings for a featherweight aero engine.

An interesting novelty listed is the robot servant, which can be made to make the early morning cup of tea. By setting an indicator, at a given time the apparatus automatically switches on the kettle, and as soon as the water boils empties sufficient water into the teapot for tea. An alarm is then sounded, a light switched on, and the kettle off. Numerous other electrical novelties are also listed.

Machine Tools for Boys

THE A.C. Gilbert Co., 109, Kingsway, W.C.2, are marketing a number of machine tools which have been specially designed for boys. A powerful and sturdy lathe, driven by a Gilbert induction motor operating on A.C. 110 volts, is marketed at 75s. It has a heavy gauge steel bed, has a sliding tail stock and is sold complete with a tool rest, wrench, chuck and centre spur. The lathe has an overall length of 24 in. Other electrically-driven tools produced by this firm, are a fret-saw at 63s., a hand drill at 32s. 6d. and a bench drill at 75s. or belt driven 35s. They make ideal Christmas presents for the modern boy, and interested readers should write to the firm for their illustrated pamphlet which gives full details of these tools.

"Sturdy" Mains Transformers

THE Sturdy Electric Co., 1, Wesley Terrace, Dipton, Newcastle-upon-Tyne, specialise in transformers, chokes, and coils

find that he can, after carrying out preliminary practice on scrap metal, carry out quite serious work. The welder complete with numerous accessories such as welding goggles, carbons, etc., is supplied in a stout wooden box and sells at 56s.

Chemistry Experiments

A. N. BECK & SONS, 60, High Street, Stoke Newington, London, N.16, have just issued their latest Chemistry catalogue which should be perused by all those who dabble in this fascinating hobby. Chemistry kits are listed at prices ranging in price from 2s. 6d. to 105s., and they have been specially produced to meet the needs of the beginner or the advanced student. A comprehensive list of apparatus and a wide choice of chemicals are included in the catalogue, thus, equipment may be chosen to meet your own requirements. All the apparatus is of standard quality as used in real laboratories. The list will be sent free of charge to all readers making application to the above address.

The Home Ciné

THE Amateur Ciné Service Ltd., for many years well known at 52, Widmore Road, Bromley, Kent, for all Home Movie needs have just opened a new Branch at 6, Grays Inn Road, Holborn, W.C.1 (one minute from Gamage's) which should prove far more convenient for visitors to London to look them up.

Their stocks of both new and re-conditioned Home Ciné equipment and Miniature Cameras is amongst the largest in the country, and they have for long enjoyed a reputation for sound value, personal service and a square deal.

They are offering particularly keen values this month in modestly priced projectors, and back this up with a very complete film library, and easiest of easy payments.

Progress in 00 Gauge

DURING the last three or four years the smallest of the practical model gauges has attracted an increasing number of enthusiasts. Until a year ago, however, when Messrs. Hamblings introduced a model of the L.M.S. Stanier 5 x P 4-6-0, motive power in this gauge was distinctly expensive. During the past year they have added to their range of standard locos and now they offer 4-6-0 express engines of all four groups at the standard price of £5 15s. Not only are these models extremely good value, but purchasers may have every confidence in their performance as they are all powered with the Standard Romford Mechanism for which Messrs. Hambling are the sole distributors.

This season besides adding a "Royal Scot" model to the "first-class" range which already comprises 5 x P and 5P5F of the L.M.S., the G.W. "Castle" and "Grange" L.N.E. football and S.R. "King Arthur" and S15, they produced the L.M.S. Compound and the Southern LI 4-4-0's, the latter of which we illustrate. The Compound is priced at £4 and the LI at £3 18s., these again have the Romford Mechanism and constitute the lowest price tender locos ever offered in 00.



A model of the Southern L1 4-4-0.

completely consumed. The vapouriser is the only part that can become clogged, but this can be easily removed with the fingers, and replaced at a small cost. They give an extremely powerful light of 300 candle power for a period of six hours at a cost of only one penny. The lamps are free from smell, do not require chimneys which are awkward to manipulate and are liable to get broken, and above all there are no wicks to trim. Tilley's make excellent table lamps, wall lamps and standard lamps as well as two types of radiators which sell at 40s. and 79s. 6d. respectively.

Electrical Accessories

ELECTRICAL devices of every description are listed in the latest catalogue issued by Economic Electric Co., 64, London Road, Twickenham. It is a 70-page booklet, attractively illustrated and containing a

for a wide variety of electrical purposes. An important feature of their products is that they are guaranteed for a period of six months against breakdown through faulty materials or workmanship. They undertake the construction of special transformers, if such are required by readers, and also run an efficient repairs and rewinding service. Readers will find that all their needs for this type of apparatus are readily catered for.

A Carbon Arc Welder

A TOOL that will prove indispensable in the home workshop is the battery-operated arc welder produced by Triangle Products Ltd., Blake Street, Hulme, Manchester, 15. This efficient tool is operated from a 12-volt car starter battery, and will make perfect welds on sheet metal up to $\frac{1}{4}$ -in. Any amateur using the welder will

THE ONE AERIAL FOR THE MODERN SET

PIX INVISIBLE AERIAL

PIX LONDON SEI

Highly efficient, self-adhesive aluminium strip gives wonderful pick-up clear of interference—fixed in a jiffy without tools—just press it and it sticks.

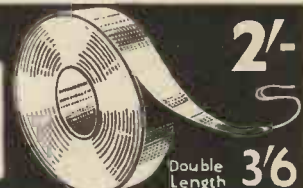

Double Length 3/6



PROF. HORATIO CRANK'S

Practical

Here's a Litter of Fiendishly Funny Jokes to Play on Your Friends this Christmas. Try Them—if You Dare!

By ARTHUR ASHDOWN.

THERE is no season of the year just like Christmas for concentrated fun-making and frivolity. Easter, Whitsun, August Bank Holiday, and the Fifth of November may each bring in their train some specialised form of entertainment but the gaiety is limited. It is considered very bad form, for instance, to eat Easter eggs on August Bank Holiday or to let off squibs at Whitsun. At Christmas, however, no petty restrictions govern the decorum—no snobbish regulations are considered for a moment. "Whoopee," that grand old English institution, holds sway and allows one to go to extremes, which, if indulged in at any other time of the year, would be considered "not quite nice!" Perhaps there is no particular branch of "whoopee" which is more popular than the practical joke, and it was with this thought uppermost in my subconscious mind that I decided to track down some really original and twentieth-century practical pranks. The very essence of a pleasing practical practice, is of course, some form of cruelty. Both the Spaniards and the Chinese are considered to be very hot at thinking up something natty in this department of science, but owing to these nations being otherwise engaged I was unable to call upon their services. It was then, with a flash of inspiration and a whoop of delight that I remembered my old friend Professor Horatio Crank.

Meet the Prof.
When I say that Professor Crank is one of the most stupendous, dynamic, colossal, gigantic, terrific personalities of the era, I understate the case. When I refer to him as a "case"—I am more accurate, for several brain specialists have agreed on this point. For his age (roughly 54-97 English summers) he is what, for want of a better phrase, is called a "scientific neurotic." There is no branch applied mechanics of which is liable

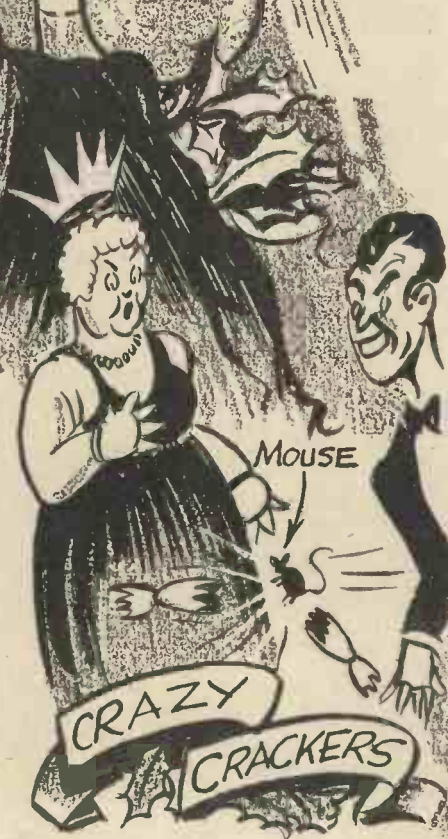

to cause him the slightest contracted eyebrow—there is no branch of the arts or crafts at which he could not be considered both arty and crafty! It is no small wonder therefore, that when he finally consented to co-operate with me on the manufacture of practical pranks, I literally clapped my hands with delight and sat poised at my trembling typewriter awaiting his slightest syllable. Far into the night we toiled—he dictating, gesticulating, chewing gum, and playing a saxophone for inspiration and I crashing the keyboard with concentrated vigour till the paper singed. The grey dawn found us tired but triumphant. Who, after studying our labours, can deny our triumph? Who?—I repeat—who?

Prank No. 1.—Crazy Crackers.
Obtain a box of fresh Christmas crackers, from a source immaterial, and carefully

open each one. Place mice in the crackers (one mouse per cracker) and re-seal. When the crackers are pulled, the mice will jump out and, being made more ferocious by the explosion, will dash all over the place. If it is possible to obtain larger crackers, rats may be substituted. (Have a doctor handy!)

Prank No. 2.—The Flaming Pudding.
In the centre of the Christmas pudding place a large clock spring which has been tightly coiled and kept in this state by sealing wax. When the pudding is placed on the table pour on a large quantity of—not brandy—but petrol. When this has been ignited the heat will be so great that it will melt the sealing wax and allow the clock spring to expand suddenly. Pieces of pudding will be hurled in every direction. As these pieces will still be burning furiously with petrol the results will be screamingly painful. (Have cold cream handy!)



Pranks for the Party

Prank No. 3.—Chirpy Chestnuts

Here's the very prank for the family circle! Carefully (and very secretly) drill one $\frac{1}{8}$ -in. diameter hole in each chestnut and insert a small plug of dynamite. Fill the remainder of the hole with plastic wood and coat the chestnut with inflammable varnish (in order to make them look more tempting), and tastefully arrange in an attractive nut dish. The entire family having gathered good-naturedly round the festive fireplace, display a strong yearning for chestnuts. When the prepared chestnuts are placed in the fire there will be terrific explosions. (Have an ambulance handy!)

Prank No. 4.—The Disappearing Door-mat

A really good practical joke at the very beginning of a party will do much to make things go with a swing. Here is one which starts right at the front door. First of all lift the front door-mat and cut a large hole in the floor-boards. In the cavity below place a foot-bath containing very hot oil. Carefully replace the mat and nail it securely to the floor at *one end only*. When your guests tread on the mat it will give

a small magnet on top. Replace the lids on the pies and secure with strong glue. When the guests are seated at the table, offer a prize to the one who will eat a mince pie in the shortest space of time. The competitors will, of course, eat as quickly as possible and swallow the magnet. The tin-tacks will follow, due to magnetic attraction, and tear their throats to pieces. (Have a veterinary surgeon handy!)

Prank No. 6.—Misleading Mistletoe

Here's a prank with a romantic flavour! Obtain a sprig of mistletoe and carefully conceal a length of $\frac{1}{8}$ -in. rubber tubing to its stem. Hang the mistletoe in an alluring position and connect the tube to the nearest water-tap. When a loving couple are osculating under the spell of the mistletoe turn on the tap to its fullest extent. The couple will be drenched. (Have blotting-paper handy!)

Prank No. 8.—The Shocking Stocking

Christmas is primarily a time for the kiddies so we must arrange a prank to amuse them. This one, although quite elementary in its basic principles should make them yell. When they are sound asleep on Christmas Eve, fill their stockings with treacle and sawdust, and camouflage the top with a cheap toy. When they plunge their arms into the stockings on Christmas morning they will get in a terrible mess and cry themselves silly through disappointment. (Have chloroform handy!)

Prank No. 9.—Riotous Radio

Many special radio programmes are arranged at Christmas time and it is quite, an easy matter to have the whole family grouped around the receiver. This is just as you want them! Obtain a spray gun (such as is used for spraying paint on shop fronts), and incorporate it in the radio cabinet. Allow the nozzle of the gun to protrude slightly. Connect the gun to a supply of cellulose. When the family are seated around the radio, press the trigger of the gun and blow a cloud of cellulose in their faces. It will stick their lips and teeth together and make them feel terribly uncomfortable for days. (Have a naked flame handy!)

Prank No. 10.—Musical Muddle

It is quite usual, during the course of a party, for someone to insist on singing. This prank should put a stop to it. Conceal a cylinder of laughing gas behind a screen and when a very serious song is in progress, turn on the tap. Everyone will start laughing at the wrong time and make the vocalist furious. (Have the vocalist's hat and coat handy!)



Prank No. 7.—Postman's Knockout

No party is ever considered complete without a game of Postman's Knock, and here is a slight twist which will make it funnier (for you!). Screw a staple into the ceiling directly above the spot at which the kissing will take place. Attach a piece of stout cord to the staple and suspend a sandbag. This should be about 5 ft. 5½ in. from the floor. Stand on a chair, out of sight, and hold the sandbag poised. When the kissing is in full swing let go of the sandbag. Acting on the pendulum principle, the sandbag will crash into the faces of the kissing couple and knock them silly. (Have iodine handy!)



way and allow their feet to plunge into the hot oil. It is very much more amusing if the mat has "Welcome" on it in big letters. (Have crutches handy!)

Prank No. 5.—Magnetic Mince Pies

Collect all the mince pies which are to be used at the party and carefully unseal them. Next remove the mincemeat and place several tin-tacks at the bottom of the pie. Cover with a layer of mincemeat and place



QUERIES and ENQUIRIES

A stamped addressed envelope, three penny stamps, and the query coupon from the current issue, which appears on page 190, must be enclosed with every letter containing a query. Every query and drawing which is sent must bear the name and address of the sender. Send your queries to the Editor, PRACTICAL MECHANICS, Geo. Newnes Ltd., Tower House, Southampton Street, Strand, London, W.C.2.

A PROVISIONAL PATENT

"I SHOULD be obliged for your advice on the following:

"In February 1936, I took out a provisional patent for an invention, but as I did not complete this it has now expired. However, can I again take out another provisional patent for the same idea (which was not put on the market)? If so, can I submit the same duplicate specification again or can I refer the Patent Office to the previous one? I employed a Patent Agent in the first place and his name is attached to the specification. If I could remove this then the cost this time would only be £1 for the stamp?" (A. W., South Devon.)

AS you have abandoned your application for patent which was filed with a provisional specification, you can file a fresh application with either a provisional specification or a complete specification, it being understood that no publication by you has taken place between the original date of the first application, and the date of filing the new patent application, since no publication of the invention has taken place by the Patent Office.

It will, of course, be understood that the new application, and any patent granted thereon, will be the actual date of filing the said application, it will not date back to the date of the original application. In order to file the new application, the original application must not be referred to, and the documents required will be the same as for a patent application in the usual way. An application form duly filled up and stamped with a £1 stamp will be required and the specification in duplicate must be filed with the application form.

If the application is filed with a provisional specification, then copies of the specification as originally filed may accompany the application form, provided there has been no change or improvement in the invention as originally covered, such specifications will be signed by you if not made through an agent.

CHEMICAL PATENTS

"I AM studying a course for the Association of the Institute of Chemistry, a degree of which you are probably aware.

"I have come across a little difficulty in regard to the legal side of chemical patents. . . I am aware that ordinarily a patent becomes public property after a period of sixteen years unless an extension is granted.

"Is this so for chemical patents?"

"If this is not so, after what period can it be generally assumed that such a patent has expired?"

"Please understand that I am not desirous of applying for a patent, but as I have come across references to British (and Foreign) Patents of say, twenty years ago, I am curious to know if same are still legal.

"I quite appreciate that this may be difficult for you to answer in a letter, and if you could refer me to a small book on the

subject I would be much obliged." (B. W., Liverpool.)

A CHEMICAL patent, like all other patents for inventions, is granted for a term of sixteen years, provided renewal fees are paid annually after the first four years from the date of the Patent. In exceptional cases a patent may be extended for a further term of not exceeding ten years.

In the case of inventions relating to substances prepared or produced by chemical processes or intended for food or medicine, the substance or product itself cannot be claimed except when prepared or produced by the particular methods or processes of manufacture described or their obvious chemical equivalent. A mere admixture resulting only in the aggregation of the known properties of the ingredients of that substance are not held to be a particular method or process of manufacture.

A NOVEL DOOR HINGE

"IS the following invention worth patenting?"

"It is an ordinary door hinge which has a kind of spring clip in the middle. When the door is closed the spring clicks home, thus holding the door closed, but when the door is pulled open the clip is pulled apart and the door is free to swing open. Small doors could be fitted with this type of hinge and a door lock or catch is not needed.

"The door could not swing open as the clip holds it securely closed." (D. B., Middlesex.)

THE improved door hinge so far as it can be understood without a sketch and fuller particulars, appears to form fit subject matter for protection by patent. It is not possible to express any opinion without fuller details as to whether it is likely to be a commercial success and be worth patenting.

A FOLDING BRACKET

"SOME time ago I submitted a new type of folding bracket for your comment, and you kindly advised me at the time to the effect that it possessed commercial possibilities.

"I have taken out a provisional patent and have approached a firm of manufacturers for quotations, and as you will see by their letters, the article can be produced for approximately 1½d. each.

"In view of this fact, I have approached a branch manager of a well-known store who informed me that it was eminently suitable for their type of trade. However, the snag lies in the fact that all goods supplied to the store must be delivered to their various branches, which to me, would be an enormous obstacle.

"The manufacturers also inform me that the bracket would be of distinct interest to the refrigerating trade. Can you enlighten me on this point?"

"Would you kindly advise me as to the following:

1. "How much do you think the patent would realise by being sold, or can you possibly give me some idea as to how I could assess the value of the patent?"

2. "Firms who, in your opinion, would be likely to be interested."

"Your advice as to the best method of procedure would be greatly appreciated." (F. R., Willesden, N.W.10.)

THE improved folding bracket appears to have distinct commercial value as previously advised. It should be of value in all cases in which brackets are employed. Before entering into further negotiations, it would be advisable for you to obtain a complete specification so as to obtain the result of the official search for novelty as early as possible, you will then be in a better position to make terms for the marketing of your invention. As to the value of the invention, this, like any other commodity is worth exactly what it will fetch, but it would probably be best for you to grant a licence to have the invention worked on a royalty basis, the usual terms being 10 to 15 per cent. of the selling price for small articles.

If you have not obtained professional assistance in protecting your invention, it would be advisable for you to do so.

IMPROVING A 3-SPEED GEAR

"I SHOULD be very grateful for your advice, as to method of procedure, after working out an idea, or improvement on an article, either on paper or the actual model.

"Also, if there are any firms, whom you can trust to make an actual model from your plans.

"For example, supposing I had actually worked out a drawing, whereby an existing 3-speed gear could be improved upon, what steps would you advise?" (P. E., Warrington).

IF the invention is one that is capable of being protected by letters patent, it is advisable to file an application for patent with a provisional specification before entrusting the invention to a firm to have it made. An invention capable of being patented must have subject matter for invention, possess utility and be novel. As you have not given any particulars of your invention, it is not possible to advise you if it possesses sufficient subject matter to be patentable. With regard to novelty the only way of ascertaining this is to search amongst prior specifications for a similar invention.

PARAFFIN EMULSION

"IS it possible to make an emulsion of paraffin? If so will you please describe the method." (N. H., Northumberland.)

IT is a pity that you have not informed us for what purpose you require the paraffin emulsion, for, having such information, we could have given you a more specialised reply.

In general, however, ordinary paraffin oil can be emulsified in many ways:

(a) By stirring it into a very strong and thick solution of soap.

(b) By stirring it into a warm three per cent. solution of gelatine or glue.

(c) By stirring it into a thick solution of sodium silicate (waterglass).

The above methods may, also, be combined. For instance, you may emulsify paraffin oil by stirring it into a warm 3 per

cent. gelatine solution containing soap and waterglass. The exact method of preparing the emulsion must necessarily depend upon the purpose for which it is required and, also, upon the length of time the emulsion is expected to last.

Bear in mind the fact that all emulsions containing glue or gelatine must have a little carbolic acid, oil of cloves or some other preservative added to them in order to prevent the gelatine or glue from becoming mouldy.

MAKING BANGERS

I WISH to make up a large number of 'bangers,' i.e. some sort of small bomb which will explode when thrown on the ground. You are no doubt familiar with the tissue-paper bags about 3/4 in. in diameter which seem to contain small stones, and which explode upon being thrown down. This does not produce a sufficient noise for my purpose, so I will be glad if you will give me further information. I suggest coating lead shot with some detonating composition, as the lead, being heavy, will be more certain of going off without the necessity of being thrown down very hard. Can nitrate of ammonia be used as an explosive in any way? I have an idea I have seen its use, in conjunction with some other substance, advocated, but cannot remember any details." (L. H., Middlesex.)

YOUR task is not an easy one, for, despite the fact that there are plenty of detonating substances available, as, for example, copper acetylide, mercury fulminate, etc., these are, in the main, far too unstable and dangerous for general employment. We would advise you to try coating hard pebbles or lead shot with various mixtures of potassium chlorate, sulphur and antimony sulphide. Stir these materials together very gently, do NOT grind them, and make the resultant mixture up into a paste with thin glue water. Roll the shot or pebbles in the paste and allow them to dry spontaneously (i.e. without heat). Such material should detonate quite effectively when thrown down.

Lead azide is another fairly safe detonating substance, but you may have trouble in obtaining it from chemical-supply firms. The various organic diazonium compounds are excellent detonators, but they are mostly unsafe to use.

Ammonium nitrate has often been employed mixed with nitroglycerine and gun-cotton as an explosive, but we should certainly not recommend you to attempt the making of such materials. A fairly stable explosive (known as Favier's mixture) comprises ammonium nitrate, 88 per cent. and dinitronaphthalene, 12 per cent. This, however, requires detonating with some detonating agent. It is, really, a blasting explosive, rather than a simple detonator.

A DESK THERMOMETER

I HAVE just purchased a desk-model thermometer. I would like to know how it works, and also the best way of dismantling it to examine the interior." (F. A. P., Glasgow.)

MECHANICAL" or dial thermometers of the type you mention are operated by the unequal expansion of a composite bar, strip, rod or spring. This composite strip usually consists of brass and steel which, in expanding and contracting, tends to curve and uncurve. Its movement is transmitted to an indicating needle by a very simple rackwork gearing.

In order to dismantle your thermometer.

remove the metal bezel and front glass. The "movement" will then either drop out or will be capable of removal after extracting two or three securing screws in the dial face. You are not advised, however, to remove the thermometer movement, since these are carefully adjusted and may give inaccurate results if they are disturbed or otherwise interfered with.

ANALYSING A PETROL-BENZOL MIXTURE

CAN you tell me the method of analysing a petrol-benzol mixture to find the percentage of benzol, or alternatively where I can obtain a textbook on the subject?

"Where I can obtain chemicals in bulk? What should the strength of iodine and ammonia be to form nitrogen iodide?" (A. L., Walthamstow.)

THE best way to analyse a petrol-benzole mixture (assuming that both ingredients are present in fairly substantial proportions) is by the method of fractional distillation. In this way, using effective apparatus, a fairly true separation of the two liquids may be made, the petrol distilling over below 70° C. Pure benzole boils at 80.5° C.

Another method of effecting a separation of the two liquids is to subject the petrol-benzole mixture to strong cooling, whereupon the benzole will solidify to a solid mass of crystals. Pure benzol freezes at 5° C.

A book suited to your needs is *Standard Methods of Testing Petroleum and its Products*, which is published by the Institution of Petroleum Technologists at the price of 7s. 6d..

There are very many suppliers of chemicals in bulk. We suggest that you approach Imperial Chemical Industries, Ltd., Millbank, London, S.W.1, and/or Messrs. Harrington Brothers, Ltd., City Road, London, E.1.

Nitrogen iodide is formed by adding powdered iodine to strong ammonia solution or, alternatively by mixing an alcoholic solution of ammonia gas with an alcoholic solution of iodine—strengths immaterial. Whilst we give you this information at your request, we must insist upon remarking, as we have done to other readers, that it is an exceedingly dangerous preparation to make nitrogen iodide, even in the smallest quantities, for it is a terribly powerful and uncontrollable explosive. You would be well advised to leave such experiments well alone.

REFILLING CARTRIDGES

COULD you please tell me the formula for the powder and the method of refilling shot-gun cartridges?" (W. D., Glamorgan.)

CARTRIDGES are nowadays filled with "cordite," which is a mixture of nitroglycerine and guncotton containing a little vaseline or mineral jelly to bind the ingredients together and to render them capable of being drawn out into thin stick form.

Ordinary cartridges contain from 15 to 31 grains of cordite, in addition, of course, to the necessary percussion cap which contains from one to three grains of a detonating substance, such as mercury fulminate or lead azide.

You will find it almost impossible to fill your own cartridges. It is not only difficult for the average individual to obtain the necessary materials, but it is also highly dangerous for him to use them.

Gunpowder packed into a cartridge which is provided with an ordinary percussion cap, will detonate, but its action is irregular,

The Power That Pelmanism Gives

"Is Power That Endures," Says Canon Hannay

The power that Pelmanism gives is Power that Endures.

So says Canon Hannay (George A. Birmingham), the well-known author.

"Pelmanism," he writes, "is not for the elect few only, but is valuable to all men and women. The results endure. Certain habits of mind are formed which are of the very highest value in life. The man who forms them is not merely stimulated to unwonted mental activity for a time, but gains



Canon Hannay (George A. Birmingham)

Power which Endures. This is what makes the pleasant and interesting effort of a course of Pelmanism so well worth while."

What Pelmanism Does

A course of Pelmanism brings out the mind's latent powers and develops them to the highest point of efficiency. It banishes such weaknesses and defects as:

- | | |
|-------------------|-----------------------|
| Depression | "Inferiority Complex" |
| Shyness | Mind-Wandering |
| Forgetfulness | Weakness of Will |
| Unnecessary Fears | Procrastination |
| Indefiniteness | Morbid Thoughts |

which interfere with the effective working-power of the mind, and in their place it develops strong, positive, vital qualities, such as:

- | | |
|----------------|--------------------|
| —Concentration | —Directive Ability |
| —Observation | —Presence of Mind |
| —Judgment | —Self-Confidence |
| —Initiative | —Tact |
| —Will-Power | —Reliability |
| —Decision | —Reliable Memory |

By developing these qualities you add to your Efficiency and consequently to your Earning Power.

In a sentence, Pelmanism enables you to live a fuller richer, happier, and more successful existence.

This is borne out by the letters received from those who have taken the Course, many of which are quoted in

"The Science of Success"

If, therefore, you wish to make the fullest use of the powers now lying latent or only semi-developed in your mind, you should send to-day for a free copy of this most interesting book.

Write (or call) to-day to:

Pelman Institute,
(Established 40 years)
130, Pelman House, Bloomsbury Street,
London, W.C.1.

and by return you will receive a free copy of "The Science of Success," and particulars enabling you to enrol for a course of Pelmanism on specially convenient terms.

Call or write for this free book to-day.

Readers who can call at the Institute will be welcomed. The Director of Instruction will be pleased to have a talk with them, and no fee will be charged for his advice.

PELMAN (OVERSEAS, INSTITUTES): PARIS, 80 Boulevard Haussmann. NEW YORK, 271 North Avenue, New Rochelle. MELBOURNE, 396 Flinders Lane. JOHANNESBURG, P.O. Box 4928. DURBAN, Natal Bank Chambers (P.O. Box 1489). CALCUTTA, 102 Clive Street. DELHI, 10 Alipore Road. AMSTERDAM, Damrak 68. JAVA, Malabarweg, Malang.

AMAZING INVENTION

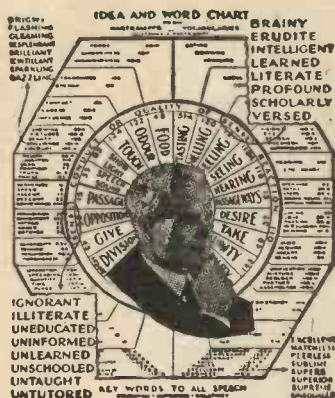

FREE Gives the Right Word at a Glance

This wonderful Idea and Word Chart is of priceless value. Simple and easy to use, it gives the exact word you want, when you want it. It puts words and ideas at your finger-tips. It steers your thoughts into those amazing word channels that make your talks, letters or any use you make of words sparkle with brilliance, charm and power. Gilbert Frankau says: "It is a big advance on anything hitherto produced. . . . It is the best adjunct that I have so far discovered. . . . henceforth it is not going to leave my desk." Every writer and speaker of English is invited to send for a free copy of this wonderful Chart. No cost—no obligation.

PSYCHOLOGY PUBLISHING
(Dept. PR/HV5), CO., LTD.
3, 5 & 12 QUEEN ST., MANCHESTER, 2

For Work after Dark

Mechanics and owners of small workshops, lathe sheds, observatories, etc., should get the

TILLEY LANTERN

(Burns ordinary Paraffin)



Light of 300 c.p. for 6 hours for 1d. Its magnificent light enables work to continue after dark, either in or out of doors. Can be placed anywhere. Made in stout brass, and there are no parts which can rust, corrode, or get out of order. Burns steadily anywhere, unaffected by weather, however severe. Get rid of all antiquated devices and use this marvellously efficient All-British Tilley Storm Lantern. Price 36/-.

Remit 36/- or can be sent C.O.D. Post and Charges Paid.

TILLEY LAMP CO. (Dept. P.M.), HENDON, N.W.4

The Power of Personality

How would you like to understand yourself, conquer fear, bashfulness and timidity, use your opportunities, welcome responsibilities, and make yourself architect and builder of your career?

Mr. Shelley Castle, author of "The Great Discovery," will show you how. Write at once for your free copy of this fascinating little book. It will be sent you quite free of charge or obligation.

Address your enquiry to Mr. Shelley Castle (Suite 149c), Castle House, Jackson's Lane, London, N.6.



and nothing like as satisfactory as that of well-prepared cordite.

If you will take our advice, you will not attempt to refill gun cartridges, for even if you succeeded in so doing, you would still have to handle the percussion-cap material, which is an exceedingly dangerous operation.

THE SARONIUS ROTOR

(1) "EXACTLY what shape is the Saronius rotor? (I believe it is ~ or ~ but should like to know if the curves are semicircles and which shape)

(2) "What is the formula for power and R.P.M. in terms of wind velocity and rotor dimensions?

(3) "What is the mean wind speed at a height of 30 feet in East Anglia? (Flat country, 370 feet above sea-level, free from trees in neighbourhood?)" (G. B., Suffolk.)

(1) THE Saronius rotor is not exactly semi-circular. It is more cup-shaped or hemispherical in formation, the curves overlapping in the manner which you sketch in your letter. A modification of this rotor has perfectly semicircular curves, however but which of these two patterns is the better we are not prepared to say.

(2) The power (or, more exactly, the "thrust") on a wind rotor is given by the formula:

$$\frac{w \cdot AF}{g}$$

where

F = force in lb. weight applied by the wind to the blades.

w = mass of air of wind per second.

g = acceleration of gravity (32.2 ft./sec.).

There is no simple single formula from which the r.p.m. of a wind-blown rotor can be derived. The r.p.m. is dependent upon the type of mounting of the rotor, area, type and angle of setting of blades and also, of course, the "load" on the rotor. Each of these factors necessitate separate consideration in arriving at an estimate of the r.p.m. of a given rotor at a given wind speed.

(3) We have no records of the mean air velocity at a height of 30 feet in East Anglia and we do not think that you are likely to obtain this information except by means of experiment, since there are very few meteorological observatories in your part of the country. We would suggest, however, that you wrote for this information either to the Air Ministry or to the Meteorological Office, London. Wind speed over a flat tract of land varies enormously from month to month, but we do not think that the mean air velocity in our country is at all high. It will probably average about 12—15 miles per hour.

BAKEHOUSE OVENS

"ARE the heating tubes in bakehouse ovens and hot plates chemically filled, or do they contain a little distilled water? Can you give me some idea how these tubes conduct heat so readily, and if a chemical is used does it remain in a liquid state?" (S. P., Bournemouth.)

THE method of heating bakehouse ovens vary a good deal with different types of ovens. You may be sure, however, that the plates and tubes are not chemically filled. In some ovens they contain merely heated air. In others, the "tubes" and plates are made solid, heat being transmitted along them by mere conduction.

In all instances, however, the metal or whatever other material which may be used for tube and plate construction is selected on account of its high specific heat, or, in other words, its high capacity for

absorbing and giving out heat. In the construction of these ovens, every possible care is taken to see that heat transference and conduction along the tubes, plates and other parts is carried on to a maximum degree, these requirements being effected by careful attention to the details of design and the choice of suitable materials. No special chemical, however, is employed in bakehouse ovens, for it would be difficult for any such substance to withstand the heat of the oven. Also, there would be some danger of leakage of the chemical within the oven.

PLASTICS FORMULÆ REQUIRED

"COULD you let me have the formulæ for the following:

"(1) Erinoid.

"(2) Bakelite.

"(3) Synthetic Glass.

"(4) Cellulose Paint, also colouring matter.

"(5) 'Mother of Pearl' Cellulose Paint?" (C. S., Berkdale.)

IT is really impossible to give you formulæ for the substances you mention, since some of these are of unknown composition, chemically speaking, whilst others are complex mixtures. Perhaps, however, the following notes will be of assistance to you:

(1) Erinoid is a plastic material made to resemble horn. It can be obtained in the form of sheets, rods, and tubes, polished or unpolished. It consists of plastic casein (obtained from milk) which has been treated with formalin and then heat-processed and finally rolled, pressed or moulded.

(2) Bakelite is a plastic material made by chemically "condensing" carbolic acid with formalin, whereby a dark-brown powder is obtained. This, when packed into moulds and heat-treated under pressure, fuses and afterwards sets to a hard insoluble material of unknown chemical composition which is nowadays termed "Bakelite."

(3) So-called synthetic glass, is another "plastic" material made by chemically "condensing" urea with phenol, salicylic acid and/or other materials. When the process is very carefully controlled, clear and transparent moulded materials, glass-like in appearance, but not as durable as glass, are obtained.

(4) Cellulose paint can be made by dissolving celluloid scraps in a mixture of equal parts of amyl (or butyl) acetate and acetone until a thick liquid is obtained, and then by grinding suitable pigments into this liquid until the requisite "body" of colour is attained. Almost any form of insoluble pigments may be used for this purpose, provided that they are ground finely enough.

(5) Many "mother of pearl" paints are of more or less secret composition. Quite a number of them, however, have been successfully produced by grinding up the linings of oyster shells to an impalpable powder, and by incorporating this material with the cellulose solution.

WAVING HAIR

"CAN you inform me as to the process of permanently waving hair. I understand that ammonia is used combined with heat derived from steam. I wish to try out the process on some locks of hair that I have by me." (F. H., Surrey.)

PERMANENT waving of hair consists essentially in the physical deformation of the hair at various points along its length which is brought about by heat treatment and by chemical means. In most permanent-

waving systems, the hair is literally "cooked" in an atmosphere of ammonia and steam, and so-called hair-waving oils usually consisting of a solution of ammonium carbonate containing free ammonia. The hair is either wetted with these "oils" and coiled around electrically-heated "curlers" or else the "curlers" are so designed that they are able to contain the waving "oil" and to cause the hair to become bathed in its strongly alkaline vapour when the heating current is turned on.

In either instance, the effect is the same. The alkaline ammonia fumes attack the hair, partly dissolving it and, or course, completely deforming it in those places there they have been allowed to make contact. The consequence is that the hair, deformed at various points along its length, is no longer able to remain straight. It twists and kinks, and when the "cooking" process has been carefully carried out, a very passable imitation of a natural "wave" in the hair is obtained.

In order to make the artificial wave more lasting, various "setting" fluids are subsequently applied to the hair in order to stiffen it and to apply to it a portion of the natural gloss which the process of artificial waving has taken from it.

You will hardly be able to apply the present-day artificial waving process to pieces of hair unless you possess one of the specially-designed heating "curlers" which are used by hairdressers for this purpose. So far as we are aware, there are no books published on the process, the various proprietary permanent-waving appliance concerns having instructional "schools" of their own, and not issuing books on the subject.

ELECTROLYSIS OF SEA-WATER

"I AM experimenting with a certain marine device, but when working at sea it will require a source of hydrogen and oxygen to the extent of 10 cub. ft. and 4 cub. ft. respectively per minute.

(1) "Would you please describe the plant by which I could obtain this by electrolysis of brine (sea-water); please state voltages, type of electrodes, etc.

(2) "Please tell me a few of the reasons why the swash-plate principle is rendered impracticable, and therefore cannot be used as a substitute for the crank." (J. G., Glasgow.)

(1) YOU would not obtain pure oxygen and hydrogen from the electrolysis of sea-water, for the gases would be contaminated with other substances. Probably, however, you realise this fact and have allowed for it in the design of your projected device.

In order to obtain the quantity of oxygen and hydrogen which you state you would require several electrolytical cells, each provided with carbon, iron or lead plates of large area for the negative electrodes and carbon alone for the positive electrodes. Platinum, of course, is the best electrode material, but this is usually far too expensive for general use.

The exact quantity of gas liberated will depend upon the strength of the brine and the amount of current passing through it. Since we do not know the water strength, it is impossible to give you the exact current strength required or the number of cells necessary for your oxygen-hydrogen production. A voltage of 15-20 should suffice amply. The rest of the data you will have to determine for yourself by practical trial with small cells. Do not on any account, employ oxidisable metals for the anodes of your cells, for oxygen is liberated

at the anodes and it will combine with these electrodes if they are made of metals which are capable of undergoing oxidation.

(2) A swash-plate, as you are probably aware, is a metal disc which is mounted on a shaft at an angle to the latter in order to impart an up and down motion to another rod parallel to its shaft. The swash-plate principle has been tried out experimentally on many occasions, but a large number of objections have been raised against it. In the first place, the adoption of the swash-plate principle usually means that the cylinders themselves have to be capable of rotation with the swash-plate, a type of construction which certainly does not make for simplicity in engineering. Again, it is difficult to balance a swash-plate mechanism so as to obtain the gentle rhythmic running which is characteristic of the crank mechanism. The swash-plate principle requires more moving parts, is more complicated of adjustment, and undergoes great wear. For these and many other practical reasons, it has not been able to compete with the time-honoured crank motion.

WRITING ON CHARRED PAPER

"THE office in which I work was completely gutted by fire a few days ago, and on forcing open some of the safes containing records of the firm, found the contents to be very badly charred and the entries in the books to be almost impossible to read. The ledger sheets which were made of fairly stout paper are still whole, but charred entirely black, and I shall be grateful if you could suggest a means of reading the entries. I notice that any writing done in pencil is quite visible; but ink entries do not appear at all." (J. H., Wepener, O.F.S.)

YOURS is not an easy problem to solve. It is impossible to apply any chemical solutions for the purpose of reviving the ink-written characters, for, by so doing, there would be very great risk of the charred pages crumbling away altogether. Also, since the characters would be darkened by chemical treatment, their presence would be rendered still more obscure.

It should be possible for you to discern the ink-written characters by viewing the charred sheets in brilliant sunlight, the sunlight being made to fall upon the paper at a sharp angle. Failing this, you might be able to pick out the characters by looking at the charred sheets (when sunlight-illuminated) under a red glass, when they might be just discernible in a greyish hue.

The most positive way of discerning the characters is to photograph the sheets in sunlight using in front of the lens either a infra-red or an ultra-violet filter, both of which may be obtained from Kodak, Ltd. (Wratten Division), Kingsway, London, W.C.

(2) If the ink originally contained iron, there will remain characters in reddish iron oxide, which will tend to photograph white through an infra-red screen. On the other hand, such characters will probably photograph grey-on-black through an ultra-violet screen.

If, however, the ink did not contain iron, the reading of the charred characters will be rendered much more difficult and you will have to depend upon some application of the unequal absorption or reflection of light by the remains of the ink and the charred paper in order to discern the characters. If you are unable to do this yourself, there is little doubt that the scientific departments of one or your Universities would be pleased to advise you upon the matter or, perhaps, to undertake the work on your behalf.

**BE an EXPERT
HANDYMAN**
Work the Modern way

With **GILBERT
MACHINE TOOLS**



GILBERT
"Junior"
ELECTRIC DRILL

Here's a small, powerful, robust ELECTRIC DRILL for model-makers and handicraftsmen. A labour-saving, time-saving tool, much faster and more accurate than old-fashioned breast drills. Thoroughly tested and proved dependable. Drills wood, metal, tiles, etc. Also has dozens of other uses, such as sand-papering, burnishing, polishing. Takes up to 1/4" drills. Works off house current. Complete with chuck, flex and switch. State whether required for A.C. or D.C. mains—105/115, 200/220, or 230/250 volts. Price, **35/-**

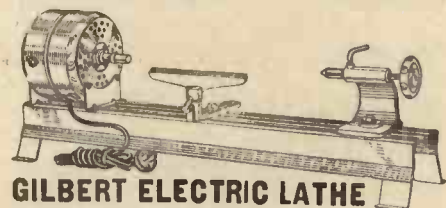

GILBERT ELECTRIC LATHE

Positively the best value obtainable in small power-driven lathes. Opens up wonderful scope in model-making and handicrafts. Has all features needed for turning and other lathe work. Sliding tail stock, adjustable tool rest, chuck and centre spur, motor spindle threaded to take standard face plate. Heavy gauge steel bed. Length 24". Runs at 1,750 r.p.m. For A.C. mains, 50 cycles, **75/-** 100/110 or 200/250 volts. Price, **75/-**
Also ELECTRIC Bench DRILL PRESS, 75/-

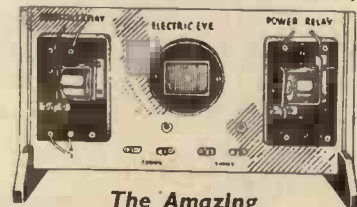

The Amazing
GILBERT "ELECTRIC EYE"

The latest marvel of science. Amazing things can be done with the Electric Eye. Flash of light switches off the radio or opens doors. Bells ring, lights go out, electric fires switched on without human agency. No experimenter or inventor should be without this remarkable device. It has many practical uses. Enables you to do mysterious tricks and stunts. Simple to use. Complete. **25/-**

* If any difficulty in obtaining Gilbert Tools locally, send your order, with P.O. or money order, to us. Money refunded if not satisfied.

ORDER FORM

The A. C. Gilbert Co., 109, Kingsway, London, W.C.2

Please send me the Free Catalogue of Gilbert Tools and Scientific Outfits. Also enclosed please find P.O. value in payment of.....

Name

Address

P.M.2.

TRADE ENQUIRIES INVITED

ELECTRADIX CHRISTMAS BARGAINS

A BARGAIN IN DYNAMOS. Type "C." Our latest for Bungalow, Yacht, or Cell Charging. 140 watt. Enclosed Dynamo, 12-20 v. 12 amps. Ball Bearings, Vee Pulley, 25/-.

Marine Type Switchboard with Ammeter, maximum and minimum Auto Cutout Mains Switch and Fuses, Field Regulator, 25/-.

CRYSTAL SETS. Buy the boy one, they cost nothing to run. No battery or valves wanted. Quiet and efficient reception. 500 shop-soiled sets cheap. Enclosed type, 5/8 and 7/6 each.



SMALL A.C. MAINS MOTORS.—Enclosed, self-start on load. A.C. repulsion, 1/80 h.p. with pulley. Type 40, 1,500 revs., 18/6. Type 36, Ditto, 1/25 h.p., G.E.C., 3,500 revs., 27/6. Induction 1/25 h.p., 1,450 revs., 25/-, 1/10 h.p., 2,500 revs., 35/-. 1/4 h.p., self-starting, 1,425 revs., 55/-.

SMALL D.C. MAINS MOTORS.—1/40 h.p., Type 60, 220 v., K.B. series, 1,750 revs., 15/-.

ROTARY CONVERTERS for A.C. sets on D.C. mains. 7-watt P.M. model, 35/-; 15-watt 220 D.C./220 A.C., ball bearings, lam. field, silent running, enclosed, 65/-. Larger sizes 50 watts, 100 watts and 200 watts to 3 k.w. M.G. D.C. 220 v. to 6 v. 5 amps., 65/-.

DOUBLE CURRENT GENERATORS, D.C., 600 volts 100 m.a., and 6 volts, 3 amps., 22/6.

CONSTRUCTORS. Hand-generated drills to 1/2 in., 1/3. Ceramic 8/W lead-in, brass stem, 6d. 3 in. stand-off 8/W insulators, 6d. Portable valve sets kits assembled in suitcase, partly wired, speaker, aerial, and all parts, less valves, 21/-. Metal rectifiers, chassis type, 180 v. 30 m/a, output, 5/-. Lightning Arrestors, make aerial safe, 1/-.

SLOPE FRONT TEAK CABINETS. New, make fine instrument panel, 10 in. x 7 in. x 11 in., 3/- each.

OAk CABINETS for Short-wave Battery Receivers, 2 or 3 valve, polished Jacobean finish, 13 1/2 in. x 7 in. x 6 1/2 in. deep, oval front, crackle black aluminium panel fitted with geared 9005-mfd. condenser, with sunk dial, 3-way coil switch and a single plate condenser. Sliding back and 10 terminal strip, new, manufacturer's liquidation stock, 15/-.

NEW PANELS. Polished aluminium, 18 and 16 gauge, bright or enamelled, 12 in. x 12 in., 3/-; 18 in. x 18 in., 5/6. Ebonite 1/2 in. panels 24 in. x 24 in. for 5/6.

CONTROL BY RAYS.—We have some 25 Photo Cells for Talkies, Light Tests, Timing Controls, etc., at bargain prices. Response to light 50 microamps per lumen, R.C.A., 25/-; Holders, 1/-; Beck Prisms, 5/6; Focus Lens, 3/6.

SELENIUM CELLS. Light sensitive resistance, gold grids, moisture-proof. L to D ratio 5 to 1, 5/- each. Mounted in Bakelite, 7/6. Super Model in Oxybrass body with window, 10/-.

X-RAY TUBES. As illus. previous issues. Brand new W.O. Hospital Surplus. 7 in. dia. bulb big tungsten electrodes. Full emission. Cost 25. Sale 15/-.

RELAYS. For tiny currents from light cells or for tuned circuit calls. Moving Coil pivoted, work on 50 microamps. Half usual price, 60/-.

MICROPHONES 1/-. Sensitive Microphone Buttons, 1/-; Announcers No. 11 Mike, 5/6; Pedestal type, 18/6. Microphone Carbon Granules. In glass capsule, enough for four buttons. Grade No. 2, Medium, 1/-; No. 3, Fine, 1/6; Carbon, solid-back, blocks, 4d.; Mouthpieces, 10d. Carbon diaphragm, 55 mm., 6d.; Headphones, 2/9 pair. Stamp for illus. Mike booklet.

TRUE-VIEW CAMERASCOPES, Brown's Double Lens, 1/-

"Radio Electrical" Scientific Illus. List "P.M." Free.

ELECTRADIX RADIOS

218 Upper Thames Street, London, E.C.4

Telephone: Central 4611



RADIO turned RADIOGRAM
Electric Motors from 25/- Pickups 9/6. Heads 4/3. Pedestal Anex-a-grams 45 6s. Table-models 44 4s. Portable 23 10s.—all for A.C. mains 22 10s. battery. Automatic record changers, A.C., 46. Acoustic gramophones, portable, pedestal. Spring motors from 4/6, turntables 2/6, concertinas, soundboxes, horns, cabinets, fittings, springs, wheels, cheapest. Unique assortment. Violins, accordions, banjos, etc. List free. Pillar alarm clocks 8/6 approval. THE REGENT FITTINGS CO. (289D), 120, Old Street, London, E.C.1. Telephone: Cle. 5770. Est. 34 years

LUTON MINOR SET PREPARED WING MATERIALS, £10.
TAIL UNIT MATLS. £2-15-0
LUTON AIRCRAFT LTD., Phoenix Works, Gerrards Cross.

CHRISTMAS CONJURING

(Continued from page 132)

How to do it.—The string of chestnuts is already in the hat. You show another piece of string and just toss it into the hat. There is no need to show the hat empty as it does not appear to play an important part in the trick. At the end of the effect you then have only to pick out the string of chestnuts to complete the trick.

Vanishing the nuts is accomplished by having a second goblet in a secret pocket at the back of the table, made by pinning the cloth round the goblet. Pour the nuts onto the table and scoop them into the goblet off the back of the table. Throw them out onto the table again. This gets the audience used to the idea of the nuts being really scooped into the goblet. Next time you do the scooping in, you let the nuts fall into the hidden goblet as shown in Fig. 12 and bring up the visible goblet empty. To make the nuts vanish you have only to make a throwing movement with the already empty goblet. Performed briskly this is a most astonishing little trick.

One final piece of advice. Try each trick out before you attempt to perform it to an audience and have a good stock of little jokes to make while you are showing the effects.

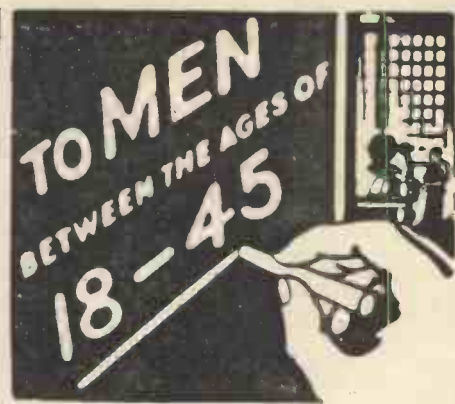

Things are happening to-day which vitally affect you!

If you are about 18, perhaps you are getting settled in your chosen work and already feeling the strain of competition for a better position. If you are in the 40's, your family responsibilities are near the peak, the necessity for money is tense—and younger men are challenging your job. And men of the ages between 18 and 45 face similar problems, in one form or another.

The most valuable employment security to-day is the security a man creates for himself—in himself! Through training, he is able to adapt himself to new conditions, to utilise experience without being handicapped by habit! He masters jobs and makes new jobs. He meets emergencies—and is not overwhelmed by them. And this is an age of emergencies.

For 46 years the International Correspondence Schools have helped thoughtful and ambitious men to acquire the training they need. To-day, with this need more urgent than ever, this world-famous institution offers greater opportunities than ever. Why not permit us to show you the way to greater security and larger earnings? Our expert advice is free. Write to-day.

.. COUPON FOR FREE BOOKLET ..

INTERNATIONAL CORRESPONDENCE SCHOOLS, LTD.,
Dept. 95, International Buildings, Kingsway, London, W.C.2.

Please send me your booklet containing full particulars of the Course of Correspondence Training before which I have marked X. I assume no obligation.

- Accountancy
- Advertising
- Aeronautical Engineering
- Air Conditioning
- Architecture
- Bookkeeping
- Building
- Chemical Engineering
- Civil Engineering
- Diesel Engineering
- Draughtsmanship
- Electrical Engineering
- Engineering Design
- Marine Engineering
- Mechanical Engineering
- Mining Engineering
- Motor Engineering
- Plumbing
- Radio
- Salesmanship
- Steam Engineering
- Textiles
- Welding, Gas and Elec.
- Woodworking

Examinations, state which.....

Name..... Age.....

Address

ASTRONOMICAL NOTES

Recent experiments conducted at Mount Wilson Observatory, California, suggest that the Sun's temperature may not, after all, be quite so high as has been supposed. The readings indicated 4,500° centigrade (8,000° fahrenheit), instead of the generally accepted 6,000° centigrade (11,000° fahrenheit).

Conclusions drawn from records of the varying luminosity of the "new" star which appeared in the constellation Hercules a couple of years ago, assume that there was an outpouring photospheric zone of matter, surrounded by an expanding gaseous shell. This zone suddenly ceased expanding in April 1935, and fell in towards the centre of the star. Nova Herculis is now considered to have contracted to a massive "White Dwarf" at an estimated temperature of 70,000° centigrade (126,000° fahrenheit).

A new theory has been put forward, as to the cause of the mysterious disappearance of Biela's lost short-period comet, which was discovered in 1826. This supposes a collision with the (also lost) Leonid meteors. It seems established that, on January 6th, 1846, the orbits of the comet and the meteor stream crossed; and it is significant that, about that date the diffused mass of the comet was seen to be split in two. Both portions were travelling side by side 157,000 miles apart. They had each then acquired characteristic cometary shapes, by providing themselves with tails and bright nuclei! The pair duly returned together 6 1/2 years later, but have not been seen since. It has hitherto been concluded that the ultimate fate of the twin portions were due to natural senile decay. But it now looks as if sudden destruction overtook them in the form of another and final smash-up at the same celestial crossroads at which the original comet was so badly disrupted in 1846.



"Practical Veneering," by Charles H. Hayward. 163 pages, with numerous line illustrations and half-tone plates. Evans Bros. Ltd., London, W.C.1. Price 3/6 net.

IN this interestingly-written practical book the author points clearly to the value of veneer, and shows that the process is not one that has been evolved simply with the idea of cheapness. He shows that, by using good veneer, a more attractive finish can frequently be obtained than would be possible when using solid wood.

But the main purpose of the book is to show exactly how veneering is carried out; how it can be done in the home workshop and in the factory. The author explains very clearly and fully every process of the work, besides showing how the method of finishing can best be utilised.

There are numerous suggestions for objects that lend themselves to the treatment, whilst every stage of the work is very well illustrated by both line and half-tone pictures.

"Woodworking Machinery for Small Workshops," by W. J. Blackmur. 113 pages and 17 illustrations. Technical Press Ltd., London, E.C.4. Price 3/6 net.

THIS little book is based on a previous one by A. Murray Ball, but has been thoroughly revised and enlarged. It deals

with circular saws, bandsaws, planing machines, moulding machines, sanding machines and the bedding of machinery, among many other allied subjects.

Details are also given of the methods of sharpening and maintaining the machinery dealt with.

3,000 Formulas, Processes, Trade Secrets. Compiled by Dr. N. T. Oliver. Technocraft, 41, Longford Place, Manchester, 14. Price 4/9.

THIS interesting book contains a wealth of information for the handyman, housewife, mechanic, manufacturers, perfumers, decorators, painters, etc. Thousands of people with very little money are launching small businesses to-day, many of which are based upon the formulas, etc., contained in this book. It will show you how to exploit avenues of money-making, that at present seem non-existent. This book contains the material for hundreds of home employment and mail order businesses.

"Modern Locomotives of the L.M.S.," by D. S. Barrie. 34 pages with a number of photogravure illustrations. The Locomotive Publishing Co., Ltd., 3, Amen Corner, London, E.C.4. Price 1/-

ATTRACTIVELY produced in photogravure, this interesting book contains illustrations of many of the locomotives in use on the L.M.S. railway together with a description of each. On the cover is a handsome coloured illustration of the Coronation streamlined locomotive which is the last word in engine design. Mr. W. A. Stanier, the chief mechanical engineer of the L.M.S. railway, has written an interesting foreword to the book.

FIVE MINUTE TEASERS

(Solutions to the Problems given on page 172)

Gave Them Socks

1,000 socks.

If the Monkey Climbs

The weight goes up, and the monkey falls to the ground, according to A. M. Low.

Three Men in a Boat

B, who saw the smoke, would be first; C, who saw the bullet strike the water, would be second; and A, who heard the report, would be last.

Caught in His Stride

The policemen took thirty steps.

Quite So

He proved the relationship by the following remark: "You are my father's brother-in-law because my father married your sister, you are my brother's father-in-law because my brother married your daughter, and you are my father-in-law's brother because my wife was your brother's daughter."

A Nice Walk

Multiply the number of potatoes, the number less one, and twice the number less one, then divide by three. Thus 50, 49, and 99 multiplied together make 242,550, which, divided by three, gives us 80,850 yards as the correct answer. The boy would thus have to travel 45 miles and fifteen sixteenths—a nice little recreation after a day's work.

Very Polite

There must have been ten boys and twenty girls. The number of bows girl to

girl, were therefore 380, of boy to boy 90, of girl to boy 400, and of boys and girls to teacher 30, making together 900 as stated. It will be remembered that it was not said that the teacher returned the bows of any child.

Who was Correct?

They were both wrong. The lady only got half the quantity that would have been contained in a large bundle and therefore ought to have been charged half the original price instead of more.

Try this One

The cyclist rode away with a bicycle that cost the salesman £11, and the £10 "change." Thus the salesman lost £21.

A Farmyard Poser

Nine days.

Time Please

Twenty-six minutes.

Barter

Jakes must have taken seven animals to market, Hodge eleven and Durrant twenty-one. There were thus thirty-nine animals altogether.

The Two Trains

One train was running just twice as fast as the other.

Curious Numbers

The three smallest numbers in addition to 48, are 1,680, 57,120, and 1,940,448.

Two Cups

The greater, 6 oz., the smaller, 4 oz., and the cover, 2 oz.

Fishy

45 tench, 15 carp, 90 roach, and 47 bream.



For extreme modern convenience—for entertainment and interest throughout each part of the home there is nothing so permanently pleasurable; simple to fit; and cheap to buy as the new sort of extension speaker with remote control. In bed . . . in the kitchen . . . wherever you are and whatever the time of day, it lets you enjoy everything the radio has to give. Your dealer has good-looking Stentorian speakers (they match any set) at prices from 34/6. Remote control unit, 15/6. Ask him!



Stentorian

EXTENSION SPEAKERS
the final touch of modern comfort

WHITELEY ELECTRICAL RADIO CO., LTD.
(MECHANICS DEPT.), MANSFIELD, NOTTS.

TRAINED MEN WANTED

Are you interested in Inventing, Designing, Research, Installation, Maintenance, Testing, Servicing, Set-building, or any other of the many well-paid occupations in Radio and Television? Trained men are constantly needed. We can train you for a successful radio career and introduce you to employers, or teach you how to earn good money in your spare time. Our Home-study Courses are praised by leading employers and are conducted by practical radio experts. We specialise in radio and all our energies are concentrated on helping our students to become money-earning radio engineers. Make your hobby pay. Take the first step to success by sending now for full details of T.C.R.C. training.

TECHNICAL & COMMERCIAL RADIO COLLEGE

Fairfax House, High Holborn, London, W.C.1.

Post in unsealed envelope: 3d. stamp.
To: T. & C. RADIO COLLEGE,
 Fairfax House, High Holborn, London, W.C.1.
 Please send me free copy of "Radio as a Career," in plain envelope, and tell me how I can get well-paid employment or profitable spare-time work.
 NAME

ADDRESS

P.M.29

BUY, EXCHANGE OR SELL

Advertisements are accepted for these columns at 2d. per word (minimum 12 words at 2s.—advertisements of less than 12 words are charged at the minimum rate of 2s.), subject to a discount of 2½% for 6 consecutive monthly insertions or 5% for 12 consecutive monthly insertions. **TERMS:**—Cash with order. Cheques, Postal Orders, etc., should be made payable to George Newnes Ltd. The Proprietors reserve the right to refuse or withdraw advertisements at their discretion. All advertisements must be received on or before the 5th of the month preceding date of publication and should be addressed to the Advertisement Manager, "Practical Mechanics," George Newnes Ltd., Tower House, Southampton Street, Strand, W.C.2.

BUSINESS OPPORTUNITIES

INFORMATION !! "WHERE TO BUY" anything, "DIRECTORY" and copy "MAIL-ORDER IDEAS," BOTH for 3/- (DOZEN RAZOR BLADES FREE). "MAKE MONEY" from DRAINED MOTOR OIL, full instructions, 1/-. "PERFECT FIREWOOD SUBSTITUTE," instructions for making, 1/-. Instructions for making own RAZOR-BLADE SHARPENER (including DOZEN RAZOR BLADES), 1/-. "500 EVERYDAY MONEY-MAKING OPPORTUNITIES," 2/-. "MAKE and SELL" polishes, 1/6. "3,000 FORMULAS, TRADE SECRETS, PROCESSES," etc., and "DIRECTORY" where to buy chemicals, both for 4/9 post paid. **BOOK CATALOGUE, FORMULA LISTS, INTERESTING LITERATURE, 4d. stamps.**—"TECHNOCRAFT," 41, Longford Place, Manchester 14.

THE IDEAS LOG. Press acknowledged money-making magazine. 50 plans per issue, gathered from all over the world. No advertising, silly formulas, M.O. inserts or American catch schemes. 6d. P.O. will bring convincing specimen, 2/- for 4 published issues.—Wymer, Publishers, 83 Montague Road, Leicester.

CANOEES

BOAT AND CANOE. Home Constructor Kits from 25/-. Completed craft from 45/-. List stamp: Trade also.—POUNCEY "Meta-craft" (P) Ltd., CHRISTCHURCH.

CHEMISTRY

CHEMICALS and apparatus. Elementary and advanced. Bargain prices.—GRAY, 40 Grange Road, Lewes.

CINEMATOGRAPHY

FILMS, 35 mm. every description, from 5s. Hire programmes 10s.—Baers, 176 Wadour Street, W.1.

ART CINE FILMS. Exclusive 9.5-mm. and 16-mm. Projectors from 35/-. Cine Cameras 75/-. Used Bargains. Part Exchanges. Catalogue Free.—P. M. Dane, 64 Stanley Street, Liverpool, 1.

CINEMATOGRAPH FILMS.—Standard size from 6d. 100 feet. Machines, Accessories. Sample Films 1/- and 2/6 post free. Catalogue free.—"Filmeries," 57 Lancaster Road, Leytonstone, E.11.

"HOME CINEMATOGRAPHS, Mains or Battery." Standard Films cheap. Lists.—Films, 109, Kenlor, Tooting.

MOVIES AT HOME.—How to make your own Cinema Projector. Particulars free.—Moviescope (N), Pear Tree Green, Dodinghurst, Essex.

ELECTRICAL

A.C.-D.C. 1- & 3-PHASE MOTORS. All voltages, from 14/9. List free. **REPAIR SPECIALISTS.**—BASCO ELECTRICAL SERVICE, 18pm, Brixton Road, S.W.9.

½-h.p. A.C. MOTORS. REPULSION INDUCTION 200-240 volts, 50 cycles, £22/6 each. D.C. £12/6.—Johnson Engineering, 86 Great Portland Street, W.1.

SUPER A.C. MOTORS. Brand New, ½ h.p., 30/-; ¾ h.p., 38/6; 1 ¼ h.p., 38/6; h.p., 55/-; larger sizes. Electric Tools, Machines, Pumps, Compressors, etc.—John P. Steel, Clyde Street Mills, Bingley.

BARGAINS !! POWERFUL WATER MOTORS, 6/- Fast ELECTRIC MOTORS, 1/6. 4-volt Dynamos, 25-amp., 5/6. Electric **SOLDER-IRONS,** 2/3. **CRYSTAL SETS,** 5/6 complete. Postages paid. Stocks limited. Send now. Satisfaction or money back. **BIG CHRISTMAS LISTS,** etc., for 4d. stamp.—Waverley Company, Douglas, I.O.M.

ENGINEERING

MODEL parts machined. Light Engineering Repairs. Estimates free.—LEWIS GATENBY, Engineer, 17 Thornton Lodge Road, Huddersfield.

ENGINES

HOT-AIR ENGINE, new, ½ h.p. Cost £20. Drive lathe, £4 15s.—Hughes, Finstall, Bromsgrove.

FORMULAS

GUARANTEED FORMULAS. New Fast Sellers. None better. Lowest prices. Catalogue FREE.—KEMICO, 110 Park Ridge, Illinois, U.S.A.

HYPNOTISM & FIRE TRICKS

"HYPNOTISM," 25 LONG LESSONS, 2/6. "16 FIRE TRICKS—ANYONE CAN DO," 2/-. 8 manuscripts explaining "EIGHT STARTLING MYSTERIES," 2/6. Particulars 2d.—"DEVILLE," 41, Longford Place, Manchester 14.

LITERATURE

AMERICAN TECHNICAL BOOKS. Science Magazines. Sample dozen 4/-. Lists, Books Bought.—E. Final, 15 Nashleigh Hill, Chesham.

MAGIC & NOVELTIES

MYSTIFY YOUR FRIENDS !! Amazing "MIND-READING" feat, 6d. "MYSTERY BELLS" illusion, 6d. Latest "THREE-CARD TRICK," 6d. New novelty "CARD-TRICK" (glass centre), 6d. "LOOP IT" novelty, 6d. "PICK-IT-OUT" trick novelty, 6d. "£1 NOTE PRODUCING MACHINE," only 1s. 3d. "MYSTIC DANCING CHARLIE CHAPLIN," 6d., causes roars of laughter. "ENCHANTED PILLARS," string trick, 6d. "VENTRILOQUISM" course, NINE dialogues, 1s. 3d. Books, or "FUN with MAGNETISM," 1/-. "ELECTRICAL and MECHANICAL TRICKS," 1/-. Also PROFESSIONAL "SECOND-SIGHT" act, £1. Great "THOUGHT-READING" act, 5/-. Send 2/6 for novelties assortment (value about 6/-) and be the LION OF THE PARTY.—"MAGICRAFT," 41, Longford Place, Manchester 14.

METAL WORK

MAKE METAL TOYS. Easy, profitable with "Success" moulds. Lists Free. Complete trial mould, 1/6.—LEE'S, 1 Birkin Avenue, NOTTINGHAM.

MICROSCOPY

MICROSCOPIC OBJECTS—unmounted prepared. Assorted packet 2/-. **MOUNTED SLIDES STOCKED.**—LENG, 183 MANCHESTER DRIVE, LEIGH-ON-SEA.

MICROSCOPES, TELESCOPES, PRISM GLASSES, LENSES. All Optical instruments. Repairs etc.—MACKETT & COMPANY, MFG. OPTICIANS & ENGINEERS, 51 Millers Road, BRIGHTON.

THE MICROSCOPE. The British Journal of Microscopy and Photomicrography, 1s. monthly. All Newsagents, or 1s. 1d., post free, from The Microscope, 20/21 Took's Court, London, E.C.4.

MISCELLANEOUS

DIECASTING IN LEAD. Soldiers, toys and novelties, a practical handbook with complete catalogue of dies. 1/2 posted.—Artec (below).

HOME TOYMAKING. A new practical handbook with 180 attractive designs and illustrations—1/2 posted.—Artec, 2 Waldegrave Park, Twickenham.

CHEAP GOVERNMENT WIRE !!—Great for training fruit trees, peas, beans, roses, arches, greenhouses, tomatoes, raspberries; tying, fencing, etc. Strong, flexible, steel-stranded, and waterproof covered. Several thicknesses, from 17/6 mile (full 1,760 yards). Small lots quoted. Postcard to-day for free samples and list of 300 bargains.—GREEN'S GOVERNMENT STORES, 989 Albert Street, Lytham.

MAKE MORE MONEY

£3 to £6 weekly can be earned at home in a wonderful business of your own. No matter where you live you can commence to make money in your spare or whole time. No risk, canvassing or experience required. A wonderful opportunity for anyone wishing to add pounds to their income. Particulars stamp. **BALLARD, York House, 12 Hambrook Rd., LONDON, S.E.25**

OUR ADVICE BUREAU COUPON

This coupon is available until Dec. 31st, 1937, and must be attached to all letters containing queries, together with 3 penny stamps. A stamped addressed envelope must also be enclosed. **PRACTICAL MECHANICS, DEC, 1937**

MISCELLANEOUS (continued)

LABORATORY MICROSCOPES, 27s. 6d. !! Equivalent to £20 instruments. A Christmas present to be appreciated for life. Exceptional bargains. Triple nosepiece revolving objectives 100x, 200x, 300x. Rack and pinion focusing. Superior brass body. Inclinable claw-foot stand with mirror, etc. See illustration on page 146.—Below.

PRISMATIC BINOCULARS. Professional model. High light transmission power, 8 by 26. Magnificent instruments 67s. 6d. per pair. In case. Worth £10. Guaranteed.—Below.

POCKET TELESCOPES 16-MILE RANGE. 1-in. diameter objective. Length 4 ins. closed. Calibrated draw eyepiece. Superior finish, 1s. 9d. each.—Below.

POCKET MICROSCOPES. ¼ in. diameter tube, adjustable mirror, etc. 50x. 1s. 3d. each.—Below.

STUDENTS' COMPOUND MICROSCOPES 100X. Fully adjustable brass body. Inclinable claw-foot stand with mirror, etc. Superb definition. In box with slides, 3s. 6d.—Below.

4-VOLT UNIVERSAL ELECTRIC MOTORS. Speed 6,000 r.p.m. Complete kit of parts easily assembled. With illustrated instructions in box. 1s. each.—Below.

ALL INSTRUMENTS POST FREE. Postage extra abroad. P.O.'s/M.O.'s, C.W.O., J. K. M. Holmes, Dept. PM.3, "Vizcaya," Wolveleigh, Gosforth, Northumberland.

INTERNATIONAL TRAINS. Secondhand. Catalogue free. Stockists for leading makes. Exchanges. **SPECIAL demonstrations** and display all makes during December.—1 Leigham Court Road, Streatham. Telephone Number: STReatham 8948.

REFLECTING TELESCOPES SUPPLIED. Also our famous mirrors and flats, ice definition. Standard eye-pieces, low powers 15/-, high 17/6. Standard rack-mounts 45/-. Re-silvering per return post. We are the oldest makers. Don't buy cheap rubbish; you would be disappointed.—IRVINGS', 258, Kingston Road, Teddington.

A 20-TON STOCK of surplus Instruments, Magnet, Resistance, etc., Wire. Low prices.—London Electric Firm, Croydon.

OPTICAL BLACK LACQUER, dead matt totally non-reflective. 2/- tin, post free.—MEGSON, 21, Western Road, Leigh-on-Sea.

"THOMSOL"—a new aluminium solder. Permanently repairs breakages, cracks, etc., in aluminium. THOMSOL soldered joint is stronger than aluminium. Solders aluminium to brass, copper, gunmetal. No flux necessary. Sticks 2/3 each, post free.—D. Thomas, Metallurgist, 108 Clodien Avenue, Cardiff.

FREE !! BILLIARD TABLE (size 3 ft., complete) to purchasers of our 12-in.-packet Razor Blades for 3/-. Other gifts. List, stamp.—W. A. S. & S. Berkeley Street, Douglas, I.O.M.

MODELS

STEEL TUBING, seamless, ½ in. to 4 ¼ in., ¼ in. to ½ in. thick. Please say lengths you cut to.—Cotes, 28 Church Walk, Brentford, Middlesex.

EVERYTHING FOR electrical rewinds and repairs. Screws, nuts, and washers for model engineers. Lists free.—Lumen Electric Co., Litherland, Liverpool, 21.

MEDEOR MODELS, 18, Melbourne Grove, S.E.22, South London "OO" Specialists, Trix, Merco.

FOR MODEL AND EXPERIMENTAL WORK send your requirements to—Models, 1 Waverley Place, Salisbury, Wilts.

MODEL ENGINES

MODEL AEROPLANES. Small power. Baby set aero castings, aluminium, from 4/11. 6 c.c. stockist. **CATALOGUE 3d.**—Butler's Aero Works, Littleover, Derby.

MONEY-MAKING OPPORTUNITIES

EXCELLENT Money-making Opportunities constantly occurring. Strongly recommended. Send stamped addressed envelope for free particulars.—Messrs. Green, 17 Church Lane, Hull.

FINE USED MODELS

Send 4d. for our catalogue of perfect used railway and model bargains with details of our purchase service. **GEORGE'S, 11, FRIARS STREET, IPSWICH**

BUY, EXCHANGE OR SELL

MUSICAL INSTRUMENTS

BAND GUIDE. Hints on the Bugle, Drum, Flute, Staff Parade formation, etc. Free, post paid.—Potter's (Manufacturers), West Street, London, W.C.2.

PATENTS

REGINALD W. BARKER & CO. (Established 1886), 56 Ludgate Hill, London, E.C.4.—Patent and Trade Mark Booklets Gratis.

PATENTS & INVENTIONS

HAVE YOU a sound, practical invention for sale, patented or unpatented? If so, write Chartered Institute of American Inventors, Dept. 104, Washington, D.C., U.S.A.

PHOTOGRAPHY

"PANTOGRAPHS" make large accurate drawings from small photographs, printed drawings, etc., easily. 1/—Cooke, 33 Hawthorn Road, Levenshulme, Manchester.

£500 worth, good, cheap Photo Materials, Films, Plates, Cards, Papers, Chemicals, Catalogue and 4 Samples free.—Hackett's Works, July Road, Liverpool 6.

DON'T TAKE RISKS. Good developers mean good results. Our reliable stock developers keep twelve months after mixing. Satisfaction certain to amateurs and professionals. Best developer ever put on the market. Makes two pints strong developer. 6d. each, 6 for 2/3, 12 for 4/—Post free.—Hackett's Works, July Road, Liverpool 6.

PHOTOGRAPHY. Inexpensive and fascinating winter hobby. Plates, Mounts, Films, Chemicals. Books on Photography, &c. Interesting money-saving lists and samples free.—"KIMBER'S," 105 Queens Road, Brighton.

SITUATIONS VACANT

VACANCIES OCCUR for thirty men aged 18-23 in the Post Office Eng. Dept. Experience is not required, but applicants must be willing to study technical subjects. Commencing pay £3 13s., rising to £7 per week and upwards, with pensions. This is the final offer of entry under the easier conditions.—For full particulars apply—B.I.E.T. (Dept. 579), 17 Stratford Place, W.1.

YOU CAN USE YOUR SPARE TIME to start a Mail Order Business that quickly brings you a full-time income. Follow the lead of others who are averaging £12 per week net profit. Get away from the drudgery of a routine job—join the big-money class. No previous experience necessary. Few pounds capital only needed. No samples or outfits to buy; no rent, rates or canvassing. New method makes success certain. Write to-day for FREE BOOKLET to Business Service Institute (Dept. 526D), 6 Carmelite Street, London, E.C.4.

DO YOU WANT A PROFITABLE BUSINESS OF YOUR OWN? We show you exactly how to start and run a business with little capital from your own address. No office, shop or experience is necessary. You receive working details of 201 profit-earning businesses from which to make an immediate start. No risks. No waiting. Results are sure. Just send a p.c. to-day—NOW—for fully descriptive book to Business Service Institute (Dept. 274W), 6 Carmelite Street, London, E.C.4.

ENGINEERING—FREE OFFER
THE NEW ENGINEERING GUIDE explains how all the best jobs are secured. It shows how to obtain such money-making qualifications as A.M.I.C.E., A.M.I.Mech.E., A.M.I.E.E., etc., and describes numerous higher pay courses in Electrical, Aero, Wireless, Engineering, Government Service, etc. FREE on application to NATIONAL INSTITUTE OF ENGINEERING (Dept. 5), Staple Inn Bldgs., W.C.1.

G.P.O. ENGINEERING. Attractive careers for young men age 18-23. Start £3 13s. weekly, rising to £680 p.a. with pension. No experience required. FREE details of openings, etc., from N.I.E. (Dept. 514), Staple Inn Bldgs., W.C.1.

WIRELESS & TELEVISION

MARCONI'S and other Employers require hundreds of trained men.

We train students for ALL BRANCHES OF RADIO at our Residential Colleges in Southampton and Colwyn Bay, and GUARANTEE APPOINTMENTS.

LICENSED BY POSTMASTER GENERAL—RECOMMENDED BY MARCONI'S.
WRITE FOR FREE PROSPECTUS:

THE WIRELESS COLLEGE, COLWYN BAY

or The Wireless College, Calmore, Southampton. London Office, 4 WINTON AVENUE, N.11.



*Cried a knowing young husband of Fowey,
"With burst pipes I joyfully towey,
On such household jobs
I save numerous bobs,
'Cos how? I use
FLUXITE, my bowey!"*

See that FLUXITE is always by you—in the house—garage—workshop—wherever speedy soldering is needed. Used for 30 years in government works and by leading engineers and manufacturers. Of Ironmongers—in tins, 4d., 8d., 1/4 and 2/8. Ask to see the FLUXITE SMALL-SPACE SOLDERING SET—compact but substantial—complete with full instructions, 7/8.

Write for Free Book on the ART OF "SOFT" SOLDERING and ask for Leaflet on CASE-HARDENING STEEL and TEMPERING TOOLS with FLUXITE.

TO CYCLISTS! Your wheels will NOT keep round and true unless the spokes are tied with fine wire at the crossings AND SOLDERED. This makes a much stronger wheel. It's simple—with FLUXITE—but IMPORTANT.

THE FLUXITE GUN

is always ready to put Fluxite on the soldering job instantly. A little pressure places the right quantity on the right spot and one charging lasts for ages. Price 1/6.



ALL MECHANICS WILL HAVE

FLUXITE

IT SIMPLIFIES ALL SOLDERING

FLUXITE LTD., Dept. P.M., Dragon Works, Bermondsey St., S.E.1



THE YEARS MOST INTERESTING BOOKLET ON VARIABLE GEARING
Send for it right away

CYCLIO

GEAR COMPANY LTD
POTTERS HILL, BIRMINGHAM-6

SPECIFIED for the "SIMPLE ALL-WAVE 3"
(See last issue.)



MICROFU Gold Film FUSES 20 stock ratings.

You need one Type F2. 60mA Fuse 6d. and Holder 6d. Send for complete List P.M.

MICROFUSES LTD., 4 Charterhouse Buildings, Goswell Road, London, E.C.1. Phone: CLE 4049

INVENTORS

VALUABLE GUIDE

General Advice Free. POST FREE 6d.

CHATWIN & CO. Est. 1880
Regd., Patent, Design and Trade Mark Agents for all countries.

253 (D) Gray's Inn Road, London, W.C.1

STAMPS

FREE !! Twenty Unused Colonials. "Neurope," 14d. Fifty for 104d.—G. H. Barnett, Limington, Somerset.

TOOLS

5,000 Engineers' Taps, Best Quality, 1/8" to 1/2", Whit., B.A., also fine threads, costing 6d. to 8d. each in usual way, secure a stock now, impossible to repeat when cleared, 2s. 6d. per dozen. Three dozen 6s. 6d. Mention sizes required.—Below.

3,000 Engineers' Taps, 1/8" to 1/2", Whit., B.S.F., and other threads, worth from 8d. to 1s. 3d. each. Dozen assorted to your own sizes as near as possible, 5s. doz.; Three dozen 13s.; Six dozen 24s.—Below.

13/16" to 2" Circular Split Dies, clearance, best quality, genuine Tungsten Steel, fully guaranteed; 2" diameter, screwing 1/8" to 1", all threads, English and American; also 1/2" to 1 1/2" Gas, Brass Threads, etc.; actual value, 8s. each; sacrifice prices, 4s. each; 45s. per dozen.—Below.

1 1/2" Circular Split Dies, as above, all threads, 1/2" to 1 1/2"; also 1/2" to 1 1/2" Gas; present-day price, 5s. each; attractive bargain, 2s. 6d. each; 25s. dozen.—Below.

1" Circular Split Dies, all threads, 1/2" to 1"; remember, best quality, guaranteed; usual price, 1s. 9d. each; do not miss these; 1s. each; 10s. dozen, any thread.—Below.

13/16" Circular Split Dies, all threads, 1/2" to 1", also 0 to 6 B.A.; best quality; cannot be purchased elsewhere under 1s. each; gifts, 8d. each, 6s. per dozen.—Below.

Carborundum Co. Grinding Wheels, medium grit, 1" and 1 1/2" wide, all 1" hole; 6" diameter, 2s. each; 7" 2s. 6d.; 8" 3s. Also 1/2" wide, 1/2" hole; 3" diameter, 9d.; 3 1/2", 1s.; 4", 1s. 3d.—Below.

Sheffield Made Hexagon Die-Nuts, invaluable to all repair shops, etc. Special clearance offer, cannot be repeated when sold, available in the following threads: Whit., B.S.F., also American U.S.S., and S.A.E. Sets 1/2", 3/8", 1/2", 5/8", 3/4", usual price 9s., given away prices, 2s. 9d. per set of five die-nuts, any thread. Also larger 1", 1 1/2", 1", bargain 7s. 6d. per set. A special offer all four sets 1/2" to 1", a total of Thirty-six Die-Nuts for 32s. 6d. Cannot repeat when sold.—Below.

700 Best Quality Whit. Taps, Taper, Second or Plugs, 1/8", 6d.; 1/4", 8d.; 3/8", 10d.; 1/2", 1s.; 5/8", 1s. 3d.; 1", 1s. 6d. each.—Below.

3,000 Pairs Calipers, Pocket Size. One pair each Inside and Outside, 6d. the 2 pairs, good value.—Below.

3,000 Small High Speed Twist Drills, 1/8" to 1/2", actually worth from 4d. to 8d. each. Good bargain, 2s. per doz.—Below.

50 only 1" Gas Taps, Taper or Seconds or Plugs, clear 1s. each.—Below.

500 Square Gas Dies, cutting 1/8", 1/4", 3/8", 1/2", 1" gas. Worth 6s. each. Best quality, gifts, 1s. 9d. each to clear.—Below.

50 dozen Double-ended 3-square Saw Files, 6", 8", 10", 12", 4s. 6d. dozen assorted.—Below.

120 dozen 3-square Saw Files, 3 1/2"-4 1/2", 2s. doz.—Below.

600 Morse Taper Sleeves, 1-2, 1s. 6d.; 2-3, 1s. 10d.; 3-4, 2s. 6d. Best quality, ground finish, British made.—Below.

Our Popular 1s. 9d. Bargain Parcels, and four lots, 6s.
Lot 1, 1 gross Nuts and Bolts, Hexagon, No. 4 B.A.;
Lot 2, 3 gross Assorted Wood Screws up to 2" long; Lot 3, 1 gross Whit. Screws, 1/8", 5/32", 3/16", up to 1" long;
Lot 4, 1 gross Chamfered Bright Steel Engineers' Washers, standard sizes, 1/8", 5/32", 3/16", 1/4", 5/16", two dozen each size; Lot 5, 1 dozen Assorted Files, 4" to 6"; Lot 6, 6 Assorted Files, 6" to 12"; Lot 7, 6 Assorted Shapes, Grinding Wheels, 2" diameter; Lot 8, 1 Twist Drill, Straight Shank, between 1/2" and 1" diameter; Lot 9, 4 B.S.F. Taps, 1/8" to 1/2" diameter; Lot 10, 1 1/2" Whit. Taper Tap; Lot 11, 1 9/32" B.S.F. Tap and 1 1/2" diameter Split Die to suit; Lot 12, 6 Assorted M.M. Dies, 13/16" diameter; Lot 13, 3 Pieces Super High-speed Steel, 1/2" square, 3" long, hardened ready for use; the ideal stuff for high-speed lathe tools.—Below.

5,000 Genuine Carborundum Grinding Wheels, suitable for general Tool Grinding, 3 1/2", 3 3/4", 4" diameter, all 1/2" thick, 1/2" hole; very cheap; 1s. 3d. each.—Below.

7,000 Boxes Small Screws, Nuts, Bolts from 1/8" to 1/2", in Brass and Steel. These are really a wonderful assortment, including Plated Screws and Bolts, Castle Nuts, etc., approx. 500 parts; a necessity to every repairer or builder of small mechanical parts. A bargain worth snapping up, 2s. 9d. per box.—Below.

1,000 Fine Emery Wheels, 2" to 4" dia., 1/2" hole, 1/2" to 1" thick, slightly used, but quite serviceable, 1s. 6d. per doz.—J. BURKE, 30 Trippet Lane, Sheffield.

Special Christmas Bargains

THIS WONDERFUL VEST POCKET RADIO set

An amazing opportunity for readers of this paper to benefit by the scientific achievement of receiving stations at remarkable volume from so small a set. Only 2 1/2 inches square, it requires NO BATTERIES, NO ELECTRICITY, NO VALVES and NO UPKEEP COSTS. Simply add aerial, earth and phones and tune in. You will be amazed at the result. Carry it in your pocket wherever you go—visiting friends, camping, motoring, etc. Price includes beautiful walnut-grained bakelite case as illustrated. Only 3/9, post 3d. Phones 3/9, post 3d. Listen-in tomorrow by sending now. No more to pay.

ONLY 3/9

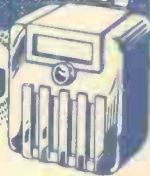

AIRCRAFT PRODUCTS LTD. (Dept. P.W.S.I.),
91, NEW OXFORD STREET, LONDON, W.C.1
Phone: TEM 6559

WONDERFUL PIANO ACCORDION



BARGAIN
24 ONLY
SHOP-SOILED
4 GUINEA
MODELS

To Clear at 35/- Part Carr. 1/-

Only 24 to offer at this price—only slightly shop soiled. We guarantee these accordions to be our regular £4.4.0 models. Please note specification:—No. 2025/12/2. 25 piano keys, 12 Bass, 2 voice, Reeds on separate plates give rich tone. Easy to play. Tutor and carrying case Free. 24 only at 35/- (Cash only), so order at once—Money refunded in full if too late to secure.

The L. R. Supply Co., Ltd., 11, Oat Lane, London, E.C.2

The "MYSTO" Lightweight Electric SOLDERING OUTFIT



JUST PLUG IN TO NEAREST LAMPHOLDER

THE IRON

FOR THE HOME MECHANIC

COMPLETE WITH 2 STICKS OF FLUX CORED SOLDER
from leading Stores, Ironmongers and Electrical Suppliers
W. T. FRENCH & SON LTD. LADYWOOD, BIRMINGHAM, 16

Portable Heating for workshop and home—use the TILLEY RADIATOR



Complete in itself and requires neither connections nor fixing. Being PORTABLE, after warming workshop can be carried to sitting-room, bedroom or bathroom. Burns ordinary paraffin at low cost of one penny for six hours. No smoke, smell, or mess. Beautifully constructed of solid brass, reflector of highly polished copper. Save money on coal, gas and electricity bills—get this All-British Tilley Radiator and have comforting heat throughout the year, when and where you need it. Price 40/-. Remit, or can be sent C.O.D., post and charges paid.

TILLEY LAMP CO. (Dept. P.M.), HENDON, N.W.4

CHARGE IT AT HOME



with a "SILEX" Battery Charger. Cheap to run. Model 252 runs 200 hours for 1 unit of electricity. Prices: 1/2 amp. 8/6; 1 amp. 12/6; 2 amps. 18/6; 3 amps. 25/-, post free. Special Car Battery Models, 6 v. 25/-; 12 v. 30/-; Charging Rate, 2 amps. Commercial Charger, for 1 to 14, 2-v. cells, with ammeter, switches, etc., 50/-; others quoted for. H.T. Accumulator Charger, 150 v., 250 M/A, complete, 35/-. Combined H.T. Eliminator and 1/2-amp. Charger, 25/-. All above complete in strong steel cases with metal rectifiers, robust mains transformers, mains flex, adaptor, and insulated output terminals; guaranteed 2 years. SEND 3d. for Real PHOTO, or have any unit on 7 days' FREE TRIAL. Please state Mains Voltage when ordering.

BRIGHTON RADIO SERVICE,
34 Middle Street, Brighton.



MINIATURE PETROL ENGINES... for Aero-planes and Speed Boats. 6 and 3 c.c. Easily made from our Castings, 12/6 per set. Complete Engines ready to run, £4 10. SEND 3d. FOR PARTICULARS
J. HALLAM & SON, Upton, Poole, Dorset



GOOD SIGHT REGAINED

WITHOUT SPECTACLES, OPERATIONS OR DRUGS
If eyes are weak you need our Eye-Book describing a harmless method by which you can strengthen the eyes and restore the vision without operation, drugs or glasses. It is in the nature of a gentle massage, which stimulates the action of the blood in the eye arteries, that natural sight is improved and the eyes become painlessly and surely moulded to perfect shape. By this means Near Sight, Far Sight, Astigmatism, and other defects are corrected.

See with Naked Eyes not through Glass Windows. A 1s. BOOK on the "Eyes" FREE. Safeguard your eyes. Send no money, only name and address with 3d. (abroad 6 foreign stamps for expenses. NEU-VITA (Dept. J.F.), 163-252, Central Buildings, London Bridge, London, S.E.1, England.

THE PORTASS LATHE & MACHINE TOOL CO. BUTTERMERE RD., SHEFFIELD, ENG.

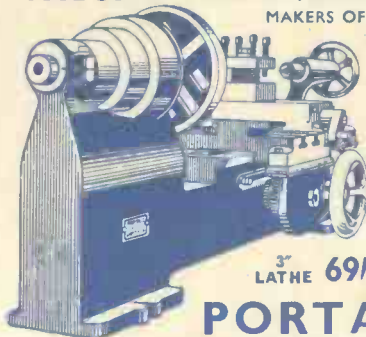

MAKERS OF LATHES
PRICES FROM £2 to £75

PLAIN & S.C. LATHES FROM 2" to 6" Centres

3" LATHE 69/6 NET CASH

PORTASS

The "Quick and Easy" way of SOLDERING

For all electrical work and wherever paste flux is preferred use 'Baker's' Solderine. Popular sizes include: 2-oz. tins 6d. 4-oz. tins 8d. Also supplied in bulk. Obtainable from all wholesalers



SIR WM. BURNETT & CO. (Chemicals) LTD., Gt. West Road, Isleworth, Middlesex. Phone: Hounslow 0476.

JUBILEE WORM DRIVE HOSE CLIPS

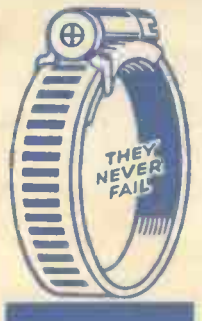

The long-life clip with the ever-tight grip
The Best Known
For Radiator Joints Air, Oil, and Water Hose Joints.
Large sizes stop squeaking brakes.
Stocked by all Garages and Accessory Dealers.
L. ROBINSON & CO., 25 London Chambers, GILLINGHAM, KENT.

THE TECHNICAL PRESS, LTD.

MODERN WOODWORK AND FURNITURE MAKING. Design and Methods of Construction. G. H. Barker, 160 pp. Illustrated. Net 7s. 6d.
ELECTRICAL HANDICRAFTSMAN AND EXPERIMENTER'S MANUAL. A Practical Work on Electrical Mechanisms and Techniques, Inventors and Students. H. R. Langman and J. H. Moore. 200 pp. Illustrated. Net 7s. 6d.
AEROPLANES AND AERO ENGINES. 'An Encyclopedia of Aircraft and Aero Engines.' P. H. Sumner. 272 pp. Illustrated. Net 15s.
RELATIVITY AND ROBINSON. A Treatise for very Simple People. 128 pp. Illustrated. Net 3s. 6d.
SLIDE RULE AND HOW TO USE IT. With a Slide Rule in tuck of cover. C. E. Hoare. Net 4s.
TECHNICAL ELECTRICITY. Principles and Practice. J. E. Phillips and R. W. B. Stephens. 296 pp. Illustrated. Net 7s. 6d.
5, AVE MARIA LANE, LUDGATE HILL, E.C.4.

AIRCRAFT SURPLUS OFFER 10/6 MINISTRY CENTRE SECONDS FLY-BACK STOP WATCH



A mathematical precision instrument not to be confused with ordinary stop watches. Press the winding knob to start—press again to register accurate timing—at the third pressure the hands fly back to zero. Similar to models used by Speed Police, Racehorse Trainers, Track Timekeepers, etc. Large hand registers accurately to fraction of second. Second dial shows minutes. 1/5 second model 10/6, post, etc., 6d. 1/10 second model 12/6, post, etc., 6d. Special job protection chain if desired 1/2 extra. All warranted 10 years. 500 only to dispose of at less than factory cost.

AIRCRAFT PRODUCTS LTD. (Dept. P.S.T.1.)
91, New Oxford Street, London, W.C.1. Phone: TEM. 6559

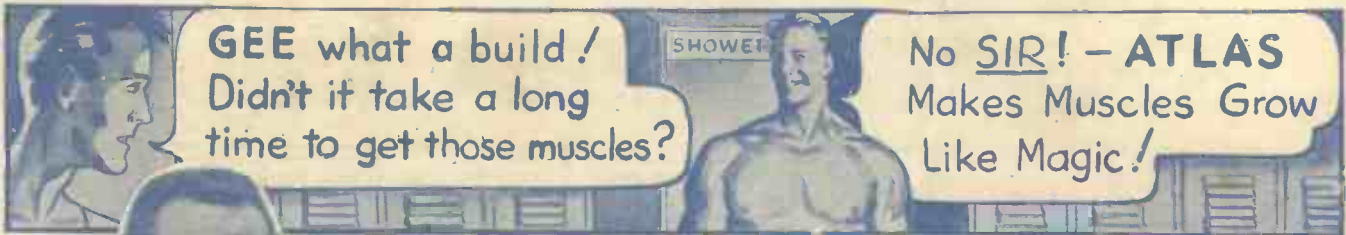

Will You Give Me 7 Days to PROVE I Can Make YOU a New Man?

LET ME START SHOWING YOU RESULTS LIKE THESE

<p>5 inches of new Muscle</p> <p>"At the end of ONE WEEK my arms increased 1 1/2 in., chest 2 1/2 in., forearm 1 in., and gained 4 lb."—C. S. W.</p>	<p>What a difference!</p> <p>"Started a week ago. What a difference already! Have put 3 1/2 in. on chest (normal) and 2 in. (expaused)."—F. S.</p>
<p>Here's what ATLAS did for ME!</p> <p>John Jacobs BEFORE John Jacobs AFTER</p>	<p>For quick results I recommend CHARLES ATLAS</p> <p>"Am sending snapshot showing wonderful progress. Certainly recommend you for quick results!"—W. G.</p>
<p>GAINED 29 POUNDS</p> <p>"Your method gives long, smooth, rounded muscles. When I started I weighed 10 st. 11 lb. Now weigh 12 st. 2 lb."—T. K.</p>	

CHARLES ATLAS

A recent photo of Charles Atlas, twice winner and holder of the title "The World's Most Perfectly Developed Man." Not a studio picture, but a simple enlargement made from an ordinary small snapshot. No muscles are "painted on" or retouched in any way. This is Charles Atlas as he looks to-day.



7-DAY TRIAL OFFER

I COULD fill this whole page with pictures and enthusiastic letters from thousands of fellows in all parts of the world. But what you want to know is—"What can Charles Atlas do for ME?"

That's easy to find out—at my risk! Right in the first 7 days I'll start to PROVE that I can turn YOU into a man of might and muscle. And it will be the kind of PROOF that you (and anyone else) can SEE, FEEL, and MEASURE with a tape! But don't take my word for it. My FREE BOOK tells all about my amazing 7-DAY TRIAL OFFER—an offer no other physical instructor in the world has ever DARED to make! I don't fool around with it. IF YOU want smashing strength, big muscles, glowing health—and the kind of build that makes people look at you in amazement and admiration—I'll show you results QUICK!

Send for My 48-Page FREE BOOK

I myself was once a 7-stone weakling—skinny, sickly, half-alive. Then I discovered "Dynamic Tension." What happened the whole world knows. I twice won—against all comers—the title, "The World's Most Perfectly Developed Man!"

I have no use for apparatus of any kind; "Dynamic-Tension ALONE (and right in your own home) will start new inches of massive power pushing out your chest—build up your shoulders to champion huskiness—put regular mountains of useful muscle on your biceps—free you of constipation, pimples—give you a strong back—make those stomach muscles of yours hard ridges!

Make me PROVE it! Gamble a postage stamp—and send the coupon for my FREE BOOK AT ONCE!

Address me personally: Charles Atlas, Dept. 10-Z, 40, Chandos Street, London, W.C.2.

CHARLES ATLAS

Dept. 10-Z, 40, CHANDOS ST., LONDON, W.C.2.

I want the proof that your system of DYNAMIC TENSION will make a New Man of me. Send me your book "Everlasting Health & Strength" FREE.

NAME

Please print or write plainly.

ADDRESS