

BIRDMEN THROUGH THE AGES

NEWNES

PRACTICAL MECHANICS

OCTOBER

6^D



PACKED WITH
FASCINATING ARTICLES
& ILLUSTRATIONS ON ALL
PRACTICAL & SCIENTIFIC
SUBJECTS



Rawlplug DUROFIX

Durofix resists heat and water, and is ready for instant use without first warming, as is necessary with most cements. It is colourless, and joins made with Durofix are almost invisible. There are hundreds of uses for Durofix in

every home for repairing china, glass, crockery, etc. Sports enthusiasts find Durofix invaluable for repairing sporting goods, such as the binding of Tennis Rackets, Golf Clubs, etc. Sold in Tubes at 6d. and 1/- each.

Rawlplug PLASTIC WOOD

Rawlplug Plastic Wood is a pliable material which can be moulded and fashioned into any shape desired. Hardens when dry and becomes exactly like real wood, when it can be cut, stained, planed or painted. Waterproof and weatherproof. Tubes at 6d. and 1/- and in tins from 9d. upwards.



Available in Natural, Oak, Mahogany and Walnut shades.

FASTAIN Oil Varnish and Stain Combined



You can make your floors reflect like mirrors by using Fastain. Shabby floors are made like new, and worn patches disappear under a beautiful glossy coat of this combined varnish and stain, which does not conceal but enhances the natural grain of the wood. Fastain is also ideal for staining and polishing all kinds of woodwork, cupboards, furniture, fretwork, etc. Sold in eight shades. Tins from 6d. to 2/3.

THE RAWLPLUG COMPANY, LTD.,
Rawlplug House, Cromwell Road,
London, S.W.7



A Book with a Lifetime's Appeal

FOR MODERN PEOPLE
OF ALL AGES

AERIAL WONDERS OF OUR TIME

A Pictured Story of Flying—Past; Present; Future

Edited by
SIR JOHN HAMMERTON



Of all the developments that mark the present era, none is more wonderful than the conquest of the air. Whether we fly or not, we cannot escape from the compelling attraction of aviation. It is an art so new, so spectacular, so limitless in its possibilities that it enthralles layman and expert alike. AERIAL WONDERS OF OUR TIME has been produced at a most opportune moment. Hitherto there has been no adequate or reliable survey of man's conquest of the air. But in this new work the reader finds a treasure-house of enlightening information.

Every Page Stirs the Imagination
For those who seek the why and wherefore of mechanical flight or wish to know the intricacies of pilotage, there is a mine of expert information. The marvels of modern machines are revealed for all to understand. The spirit of the heroic early days has been skillfully recaptured by the writers, and the mighty exploits of gallant airmen during the Great War are vividly recalled to life.

CHIEF CONTRIBUTORS

- | | |
|--|---|
| Sir Alan J. Cobham,
K.B.E., A.F.C. | Sir Alliott Verdon-
Roe, O.B.E., F.R.Ae.S. |
| Lt.-Col. J. T. C. Moore-
Brabazon, M.C., M.P. | Major C. C. Turner,
A.F.R.Ae.S. |
| Major Oliver Stewart,
M.C., A.F.C. | Boyd Cable
Hamilton Fyfe |
| Amy Mollison, C.B.E. | Capt. J. Laurence Prit-
chard, Hon.F.R.Ae.S. |
| David Garnett | |

DON'T MISS THIS!

Just sign and post the form below and we will send you these two volumes, carriage paid, to examine for one week free. You may either return them to us carriage forward, within 8 days, to end the matter, or you may keep them on the very easy terms outlined on the form.

Two Volumes

1,300

Superb
Illustrations

131 Chapters

including:—

Submarine Hunting from the Air; Daring Work of Contact Patrols; Wiley Post Girdles the Earth; If War Should Come; Future Schemes of Air Defence; Luxury Liners of the Air; "Flying Fleas"; Why Aeroplane Wings Lift; Four Centuries of Air Experiment; Curlo-sities and Cranks of the Air; Air "Stunts" and their Importance; Amateurs in the Air; Unsolved Flying Mysteries.

For the Student,

the Pilot,

the Air-minded,

Young and

Old

"Practical Mechanics" FREE Examination Form

To the **WAVERLEY BOOK CO., LIMITED**

96 and 97 Farringdon Street, LONDON, E.C.4

Please send me, carriage paid, for seven days' FREE Examination, "AERIAL WONDERS OF OUR TIME," complete in two volumes. It is understood that I may return the work on the eighth day after I receive it and that there the matter ends. If I decide to keep the books I will send you on the eighth day a First Payment of 2/-, and, beginning thirty days after, seven further monthly payments of 4/- each, thus completing the purchase price.

Price for Cash on the eighth day, 28/6

Name.....
Address.....
Occupation.....
Parent's Signature required under 21.....
State if householder..... Date.....
P.M.7. PLEASE FILL IN ALL PARTICULARS ASKED

FREE!

This IMPORTANT GUIDE to SUCCESSFUL ENGINEERING CAREERS

After months of intensive effort and research, we are pleased to announce that the 1936 edition of our Handbook, "ENGINEERING OPPORTUNITIES," is now out of the publishers' hands and ready for *free distribution*. Containing 268 pages of practical guidance, this book is, beyond argument, the finest and most complete handbook on Successful Engineering Careers ever compiled. It is a book that should be on the bookshelf of every person interested in engineering, whatever his age, position or experience.

The Handbook contains, among other intensely interesting matter, details of B.Sc., A.M.I.C.E., A.M.I.Mech.E., A.M.I.E.E., A.M.I.A.E., A.M.I.W.T., A.M.I.R.E., CIVIL SERVICE, and other important Engineering Examinations: outlines courses in all branches of CIVIL, MECHANICAL, ELECTRICAL, AUTOMOBILE, RADIO, TELEVISION and AERONAUTICAL ENGINEERING, BUILDING, GOVERNMENT EMPLOYMENT, etc., and outlines the unique advantages of our Employment Department.

**WE DEFINITELY GUARANTEE
"NO PASS—NO FEE"**

If you are earning less than £10 per week you cannot *afford* to miss reading "ENGINEERING OPPORTUNITIES." In your own interests, we advise you to send for your copy of this enlightening guide to well-paid posts by filling in and posting the coupon NOW. *There is no cost or obligation of any kind.*

**BRITISH INSTITUTE OF
ENGINEERING TECHNOLOGY**

410, SHAKESPEARE HOUSE,
17, 18 & 19, STRATFORD PLACE, LONDON, W.1.

POST
THIS
COUPON
NOW

TEAR OFF HERE
FREE COUPON

To B.I.E.T., 410, SHAKESPEARE HOUSE,
17, 18 & 19, STRATFORD PLACE, LONDON, W.1.
Please forward, free of cost or obligation of any kind, your
268-page Handbook "ENGINEERING OPPORTUNITIES."

NAME

ADDRESS



PRACTICAL MECHANICS

Edited by F. J. Camm

VOL. IV. No. 37
OCTOBER
1936

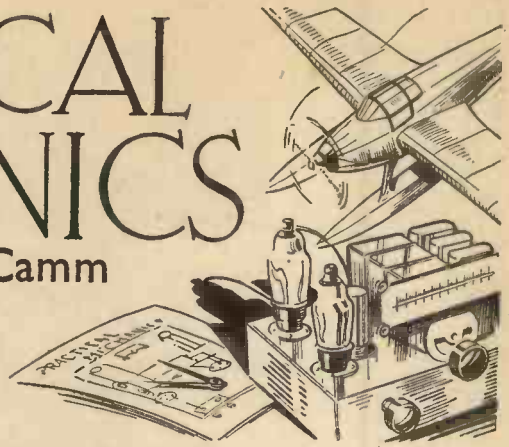

Bind Your Copies of "Practical Mechanics"

THE binding case for Volume III, complete with title page and index, is now ready and costs 3s. 6d. by post from the Publisher, George Newnes Ltd., 8-11 Southampton Street, Strand, London, W.C.2. The index can be obtained separately if desired for 7d. post free. All readers should have their copies of Volume III bound, and thus be able easily to refer to the contents by means of the fully cross-referenced index.

Into the "Dark World"

IN our September 1935 issue appeared an article on the Bathysphere in which is described one of Dr. Beebe's trips 3,000 ft. below the surface of the sea. We now learn that Dr. Beebe recently left on a voyage to continue his researches under the sea. He hopes to use a new type of net, which he can lower 2 miles to catch fish in the "dark world."

A Likely Port

ANGORA may be a port if a £2,000,000 project to construct a ship canal to the Black Sea by convict labour is carried out.

Additional Accommodation

ACCOMMODATION on the airship *Hindenburg* is being increased by building eight additional cabins, making room for 66 passengers instead of 50.

"Flying Flea" Tested

A FULL-SCALE "Flea" was recently tested in the Air Ministry's wind tunnel at Farnborough, Hants. Half a day's testing, it was argued, would demonstrate "the one small point which makes the difference between a safe 'Flying Flea' and a dangerous one."

Compressed Coal Gas

EXPERIMENTS in running motor buses by compressed coal gas instead of petrol are being carried out on Merseyside by the Wallasey Corporation. The gas is carried in two steel cylinders beneath the bus, and, compared with petrol at an average cost of 1s. 1d. a gallon, the coal gas works out at 7d.

All-Steel Hopper Wagons

HEAD, WRIGHTSON & CO., of Thornaby-on-Tees, have received an order from L.N.E.R. for £100,000 for all-steel hopper wagons.

World's Largest Gas Holder

SHEFFIELD GAS COMPANY has ordered a gas holder of 8,000,000 cu. ft. capacity, which will be as high as the dome of St. Paul's, and the biggest in the world.

Safety in Steel

FROM Melbourne comes the news that Victoria's railway coaches will be of steel. The authorities, first to instal air condition-

NOTES, NEWS, AND VIEWS

ing in trains, say that in the event of accident, steel will neither splinter or burn.

Special Stamps

TWO special French postage stamps are being issued to commemorate the recent 100th crossing of the South Atlantic by French planes on the Franco-South America postal service.

Widening New York Harbour

MAJOR-GEN. EDWARD MARKHAM chief of army engineers, has recommended to the Senate Commerce Committee that, to make New York harbour safer for *Queen Mary* and other very large liners, approximately £500,000 should be spent on widening and deepening the channel leading from the sea to the huge piers built on the banks of the River Hudson.

Car Secret Stolen

A CARBURETTOR which is believed to be the most revolutionary device in motoring since the invention of the internal combustion engine, has been stolen. Its inventor, Charles Nelson Page, claims that it will drive a car 200 miles on one gallon of petrol. In December in tests made by automobile officials with the thermometer showing 10 degrees below zero, 209.6 miles per gallon were recorded.

A New Giant Plane

THE new German air liner, the *President von Hindenburg*, is the last word in heavy-oil machines. It has a span of 146 ft., a cruising speed of 131 m.p.h., a landing speed of 75 m.p.h., and a range of 8 hours or over 1,000 miles. The crude oil costs only 9d. a gallon compared with 1s. 6d. for petrol. |

Canton-Hankow Railway

THE Canton-Hankow railway has ordered 24 locomotives and 430 carriages from British firms.

SUBSCRIPTION RATES

Inland and Abroad, 7s. 6d. per annum
Canada - - 7s. per annum

Editorial and Advertisement Offices: "Practical Mechanics," George Newnes Ltd., 8-11 Southampton Street, Strand, W.C.2.

Phone: Temple Bar 4363.

Telegrams: Newnes, Rand, London.

Registered at the G.P.O. for transmission by Canadian Magazine Post

German Shipbuilders

THE number of vessels under construction and in hand at German shipbuilding yards at the end of June was 181, totalling 664,000 tons.

Two Fly-unders

CLEVELAND Bridge and Engineering Co., Darlington, have received a £47,000 contract to build two fly-unders for London.

Largest Airport in the World

WORK has begun on one of the largest air ports in the world, to be built on the Irish Free State coast in County Clare, for the Atlantic services.

The cost will be more than £1,500,000, of which the Free State Government will contribute £500,000.

A Jumping Giroplane

THE smallest passenger-carrying aeroplane ever built lies in a hangar at Hanworth, Middlesex. It is the new Weir jumping giroplane, which can leap into the air from a small back garden. Within two years, when experiments are finished, it will be put on the market at £100 complete.

"Powdered Atoms"

FOR hundreds of years we have thought of matter in one of three forms—solid, liquid, and gaseous. Recent discoveries among the stars have shown there is a fourth form, in which the atoms of matter are themselves completely broken up. "Powdered Atoms" is the name science has given them.

"White Dwarfs"

WE learn that there are "white dwarf" stars whose density is so great that a pinhead of the same matter would break a man's back.

Some Gas!

IT is also stated that there is a gas that would give a tennis ball 1,000 tons weight.

To Tokyo in a Week

THE Japan Air Transport Company is planning to introduce a one-week journey from Europe to Tokyo in conjunction with foreign countries.

An Earthquake Recorded

A SEVERE earthquake in the bed of the Pacific Ocean was recently recorded on a seismograph at West Bromwich.

Airship's Record

THE German airship *Hindenburg* has created a new record by completing the round trip from Frankfort to Lakehurst, New Jersey, and back in 111 hours 50 minutes, including a seven-hour halt at Lakehurst.

Birdmen

- through the Ages



The Saracen who, according to history, equipped himself with wings, jumped from a tower, and lost his life.

PROBABLY the earliest reference to the mystery of artificial flight is in the Bible where in Proverbs xxx., 18-19, Agur, son of Jakeh says: "There be three things which are too wonderful for me, yea, for which I know not: the way of an eagle in the air; the way of a serpent upon a rock; the way of a ship in the midst of the sea, and the way of a man with a maid."

For centuries men toiled to discover the secret of mechanical flight, but the way of an eagle still remains a mystery. We have all read of the venturesome Icarus (son of Daedalus) who, flying too near to the sun by means of wings constructed by his father and attached to his body with wax, fell into the sea (now known as the Icarean Sea) and was drowned. Thus ended his flight from the wrath of King Minos. Of course, this is merely Greek mythology, but the story is still an interesting one and you may read it in *Tanglewood Tales*, written by Nathaniel Hawthorne.

Chinese Kites

Centuries before the birth of Christ the Chinese had discovered some, at least, of the principles of flight. They had learned to build fearsome kites in the form of fantastic dragons, with flowing tails which, suspended over a village or town, struck fear into the hearts of the populace. There are no records as to who produced the first Chinese kite, but it was centuries afterwards that man again turned his

Clem Sohn Has Recently Achieved The Dream of Inventors from the Beginning of Those Periods of Which Man Has Records. Earlier Efforts to Obtain Bird Flight are Discussed in this Interesting Article.

By F. J. CAMM.

attention to the conquest of the air. We have records of most of the early attempts. They seem fantastic to us to-day, but we must remember the time at which they were made.

The Biblical quotation given above holds to-day, for no one has yet discovered the way of an eagle in the form of a flying machine which propels itself as an ornithopter by flapping its wings. I am, of course, here excluding models, for it is quite possible to make a successful flapping-wing model.

Flapping-wing Flight

Later, experiments made in more knowledgeable times confirmed that flapping-wing flight is a practical, and in fact, a technical impossibility, and it was not until inventors turned to the airscrew that mechanical flight was achieved. In this respect it is important to remember that most birds devour more than their own weight in food every day.

Nothing is invented or achieved entirely by one man. A new thought grows like a crystal in solution. It

Pictures are by courtesy of a film company, who produced a film dealing with the history of flight.



The modern birdman, Clem Sohn, during one of his spectacular descents. The trail of smoke which showed the position of the birdman when in flight is given off from a smoke bomb attached between his heels.

has been so with flight. Practical aeronautics began with balloons, which owed their introduction to Cavendish's discovery of the lifting power of hydrogen.

Only a Dream

The magnificent progress through the years which have followed crowded with new and splendid records, is patent to all the world; but a glance should be flung backward also upon those guessers at the truth, and courageous experimenters who prepared the way and, frequently at the cost of their own lives, demonstrated the impracticability of an idea. On such foundations is all progress and scientific endeavour based.

Flight was for ages a fantastic

twelve hours, and prints still exist showing Bergerac equipped with his queer apparatus. But the journey to the moon does not seem so quaint today, when we remember that Piccard and others have been into the stratosphere, and that rocket flying at colossal speeds will be achieved within the next fifty years. There is no reason to suppose that all flight will be in a

hot air. They filled a bag with smoke, but the smoke cooled too rapidly. Their neighbour, an old widow woman whose very name is lost in oblivion, suggested attaching the tray which held the fire to the bag so as to provide continuous heat. It was done, and the first hot-air balloon floated upwards into the air. A few months later, a large and gaily decorated Montgolfier balloon made an ascent before the astonished gaze of the King and Queen of France and a vast concourse of people. Then a cock, a sheep and a duck were sent up and descended unhurt, much to the surprise of the onlookers, who for the most part gravely distrusted the life-sustaining properties of the upper air. Pilâtre de Rozier and the Marquis



Otto Lilienthal, gliding pioneer, who lost his life in one of his experiments.

dream ridiculed by the crowd—but the dream lived and prospered. The great tragedy is that most inventors are before their time! Right up to 1936 we have laughed at early experimenters who, equipped with wings, threw themselves from high towers in an effort to fly. We can no longer laugh, for Clem Sohn has shown it to be possible, by his frequent jumps from an aeroplane in flight, and equipped with surfaces attached between the body arms and legs.

The first reference to such an attempt is that relating to Ollivier of Malmesbury, the Monk who, in the eleventh century, made a pair of wings and sprang from the tower of his monastery, an early *vol plane* which ended in disaster.

Some Pioneers

Roger Bacon, that medieval philosopher who looked so far into the future from behind his prison walls, thought flight might be achieved with "a large hollow globe wrought extremely thin and filled with ethereal air or liquid fire." Bacon (A.D. 1276) spent ten years in prison as sorcerer because of his scientific writings.

Francesco da Lana, in 1670, proposed to build aerial boats to be raised by large globes of thin copper from which the air had been exhausted and a few years later Besnier, a blacksmith, actually constructed a valvular wing apparatus.

Cyrano de Bergerac proposed, by means of feathered wings, to journey from the earth to the moon in less than

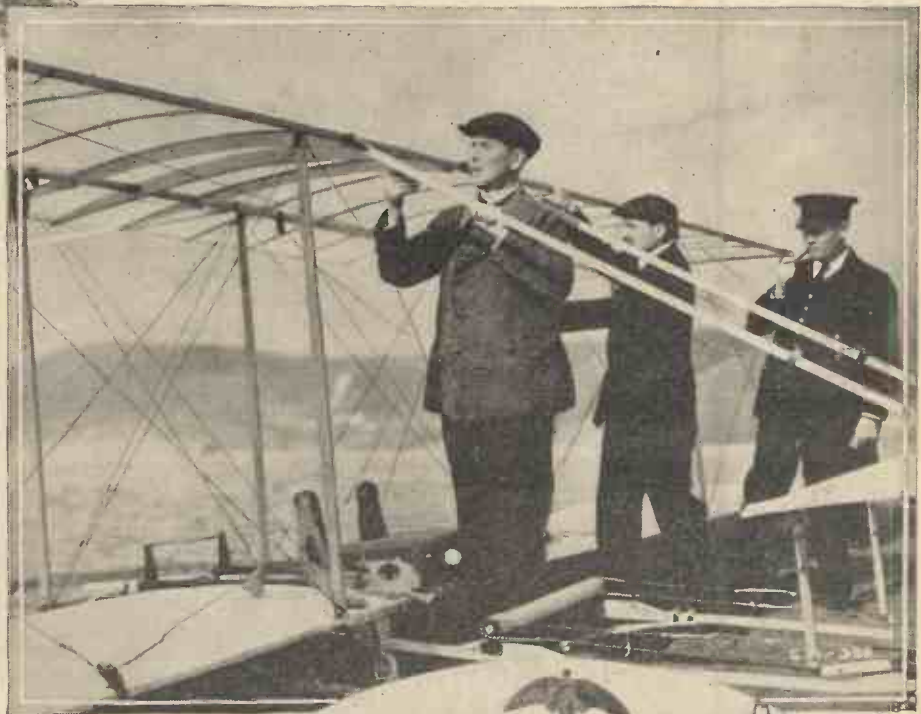

Above: the Wright aeroplane. Below: Ollivier, the Monk of Malmesbury, as demonstrated in a recent film.

horizontal direction.

The First Hot-air Balloon

It was in 1782 that those two ingenious and immortal papermakers of Annonay, the brothers Montgolfier, discovered the lifting power, as they thought, of smoke, but in reality of



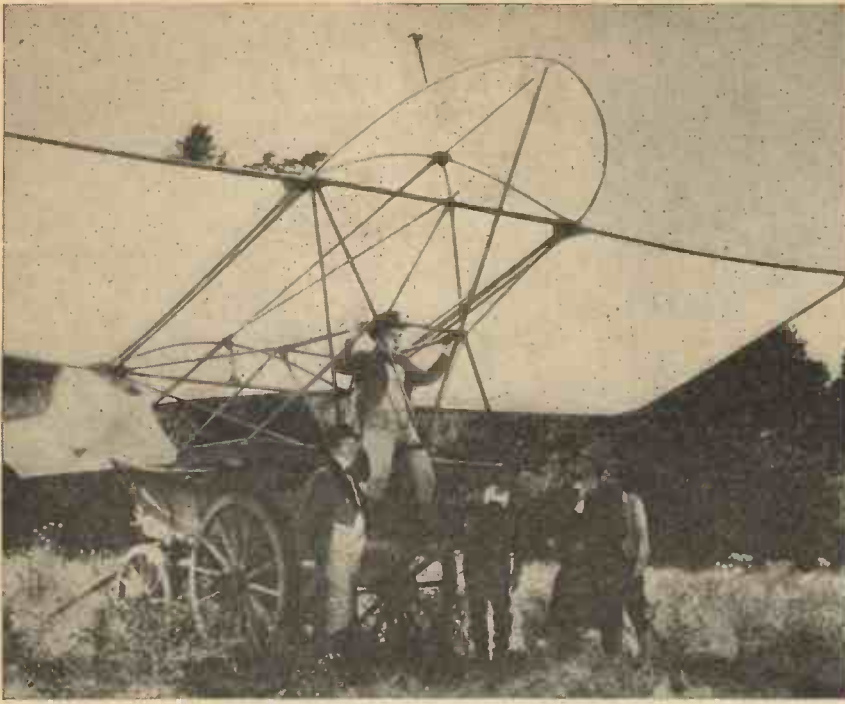

Reconstruction of Sir George Cayley's prophetic idea!

d'Arlandes shared the honour of being the first human beings to mount towards the heavens in a Montgolfier fire balloon. The act was one of superb bravery, under such conditions and with such a balloon. They went up from the centre of Paris, standing on a wicker gallery close to the fire, which they fed with bundles of fuel. Each held a big wet sponge with which to mop out the flames whenever, as frequently happened, the silk envelope took fire.

Discovery of Hydrogen Gas

The discovery of hydrogen gas, or inflammable air, as it was called, was next utilised, and under the superintendence of F. A. C. Charles, the brothers Robert constructed balloons inflated with the new gas. The valve and most of the improvements in the gas balloon were due to the ingenuity of Charles.

Pilâtre de Rozier fell a victim to the recklessness of ignorance. He attempted to combine a fire balloon with an upper envelope of hydrogen gas, and perished in the inevitable explosion and collapse which took place.

Some attempts were made to guide balloons in the air, but with ill-success. The wind proved itself always the master, the oars and sails with which the early balloonists tried to steer were soon seen to be useless. Yet on January 7th, 1785, Blanchard, a Frenchman, and Dr. Jefferies, an American Physician, aided by favouring winds, made a balloon voyage across the English Channel. Their exploit aroused enormous enthusiasm.

In the same year Garnerin invented the parachute, which has often demonstrated in most spectacular fashion the buoyancy of the air.

A Balloon Ascent

James Tytler made the first ascent from the British Isles, in August 1784, using a Montgolfier fire balloon, at Edinburgh. A more successful trip was that of Vincent Lunardi, a young Italian attaché of the Neapolitan Embassy. He rose from London in a gas balloon, amid the wildest excitement, and landed, after some remarkable adventures, at Ware. A stone with a long inscription still marks the spot of his descent.

A very large balloon, with 85,000 feet of gas, took up three men from the Vauxhall Gardens on November 7th, 1785; and, traversing a distance of 500 miles in 18 hours, descended near Weilburg in Nassau. Robert Holland Monck Mason and Charles Green were the occupants of the car. The spherical balloon proved intractable, a blind alley upon the pathway of aviation; but none the less some remarkable feats have been accomplished with it, notably that of Glaisher and Coxwell, who, in the year 1862, rose to an altitude of nearly seven miles in the air.

In Search of the North Pole

The balloon promised to be of value in exploring inaccessible tracts of land, and in 1897 Salomon August Andree, a Swedish engineer, undertook the bold exploit of a balloon voyage in search of the North Pole. On July

11th, he and his two companions, Strindburg and Fränkel, ascended from Danes' Island, Spitzbergen, about 600 miles from the Pole. One carrier pigeon, apparently liberated 48 hours after the start, and two floating buoys were subsequently found, but beyond this silence. The fate of these brave men is still one of the undiscovered secrets of the frozen North.

As early as 1794, balloons were used for military purposes. A military aeronautics school was founded at Meudon, and before the battle of Fleurus, the General and Adjutant ascended with Coutelle, the balloon pilot, to reconnoitre.

Balloons were used during the American Civil War and with notable success at the siege of Paris, when the famous M. Gambetta escaped from the beleaguered city in the "Armand-Barbes." In 1883-4 most of the great powers organised regular ballooning services, and aeronautics as a part of military science dates from that period.

There is no need to dwell upon the developments of aviation from the period of 1914 onwards. Everyone knows that the science of aeronautics had an accelerated development due to the war, equivalent to fifty years of peacetime experiment. It is one of the good things which resulted from the war. To-day we have passenger air services linking up the remotest parts of the earth, and journeys which formerly took months by sea and land are now accomplished in a few days by air, and with less risk. The first aerial post was held in this country in 1911 between Hendon and London, when the late Gustav Hamel demonstrated the practicability of using aeroplanes for this purpose.

Aerobatics

The aeroplane was formerly looked upon as a dangerous device acquiring the utmost nerve for its successful demonstration. The Frenchman, Pegoud, demonstrated before the war at Brooklands that an aeroplane could quite safely be flown upside down. He was the first to deliberately loop the loop. Since then aerobatics has become a science of its own, and every possible evolution can be quite safely performed in the air. The fastest ocean-going liner (taking three years to build!) takes at least three days to cross the Atlantic. *An aeroplane can* do it in hours less than one day, and so the world becomes a smaller place in which to live, for the length of a journey is measured by time and not by miles alone. Each day we are finding it possible to travel a greater

distance in a shorter time, and it is beyond all doubt that within the next fifty years the air will be used almost extensively for commercial and private travel. The rapid rate of growth of mechanical transport renders this not only a necessity but unavoidable, for the roads of England, in spite of road developments, can never accommodate the volume of traffic, which is increasing in excess of road development.

In the Future

It is reasonably certain that small low-powered aircraft will be sold in the not too distant future for private flying in just the same way as a person now buys a motor-car. Aerodromes are being built all over the country, and these will assist towards popularising aerial travel. The aeroplane, apart from being a most potent weapon of war, can also be the arch-angle of peace, for the air knows no boundaries as with states and countries, and the aeroplane will eventually develop the world-wide idea that we are one large family, irrespective of nationality, and that nation can



The parachute, formerly considered the dream of cranks, now the most important life-saving device for aeroplane pilots.

speak peace unto nation.

Shall we see the development of the ideas of those early pioneers who thought that flight could be achieved by flapping wings? We know that the power required for such flight is far greater than that required for screw propulsion, but it is possible that someone may discover a new principle which will erase that disadvantage.

The efforts of Clem Sohn have shown that it is possible for a man to glide through the air with no apparatus other than some pieces of silk stitched between his legs, his body, and his arms. Once launched from an altitude, something less than 1 h.p. would be required to propel an individual for long distances. Perhaps in future one large aeroplane will be employed to take up passengers so equipped and who will take off at given points for any cross-country journey they wish to make. The idea is not fantastic. It would mean that an individual by means of a parachute could land almost vertically in a back garden, thus saving the journey from an aerodrome.

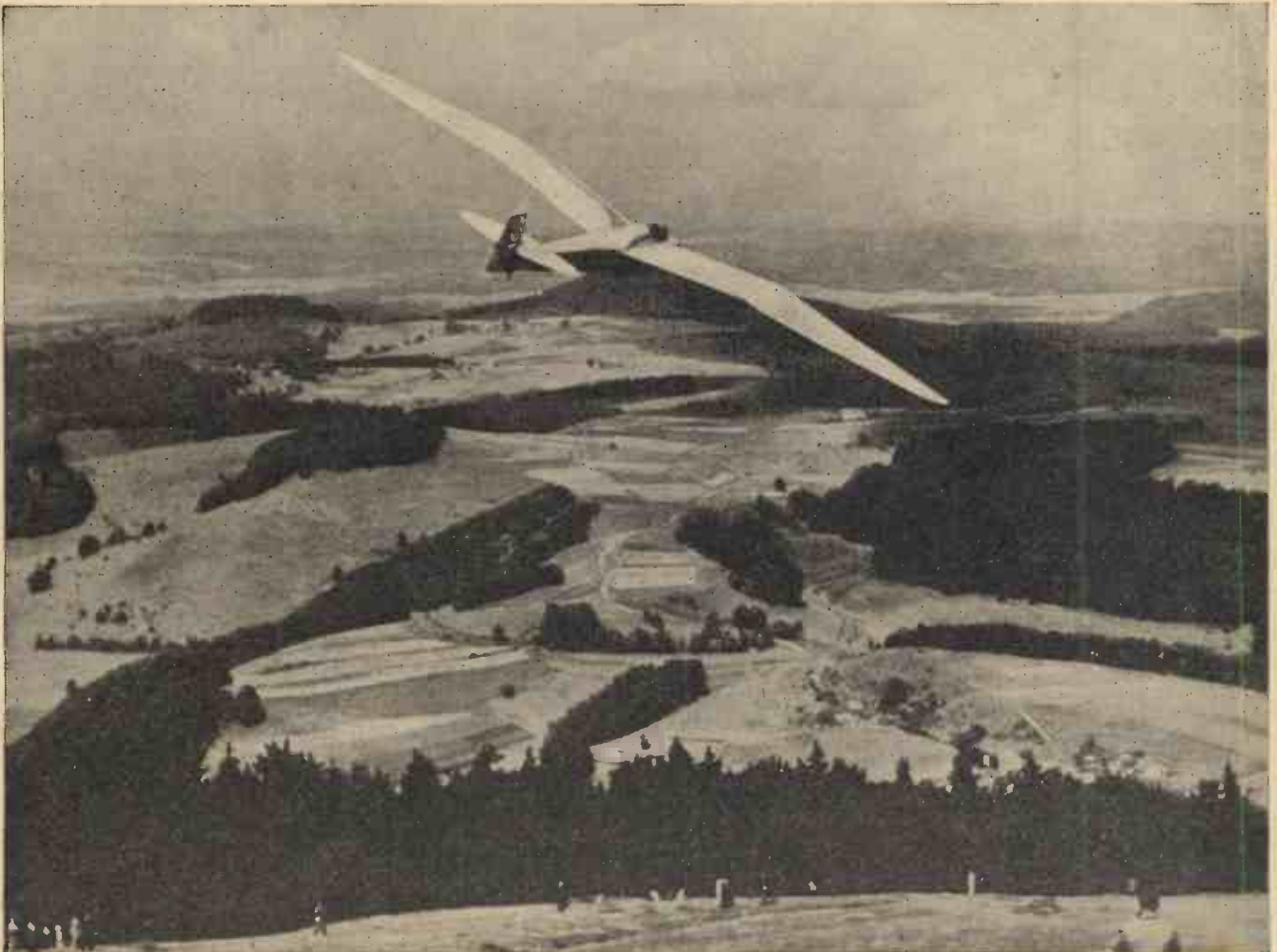

A modern glider, here seen over the Rhon Valley. Early inventors tried for years to sail the air, nowadays gliders remain in the air for hours.

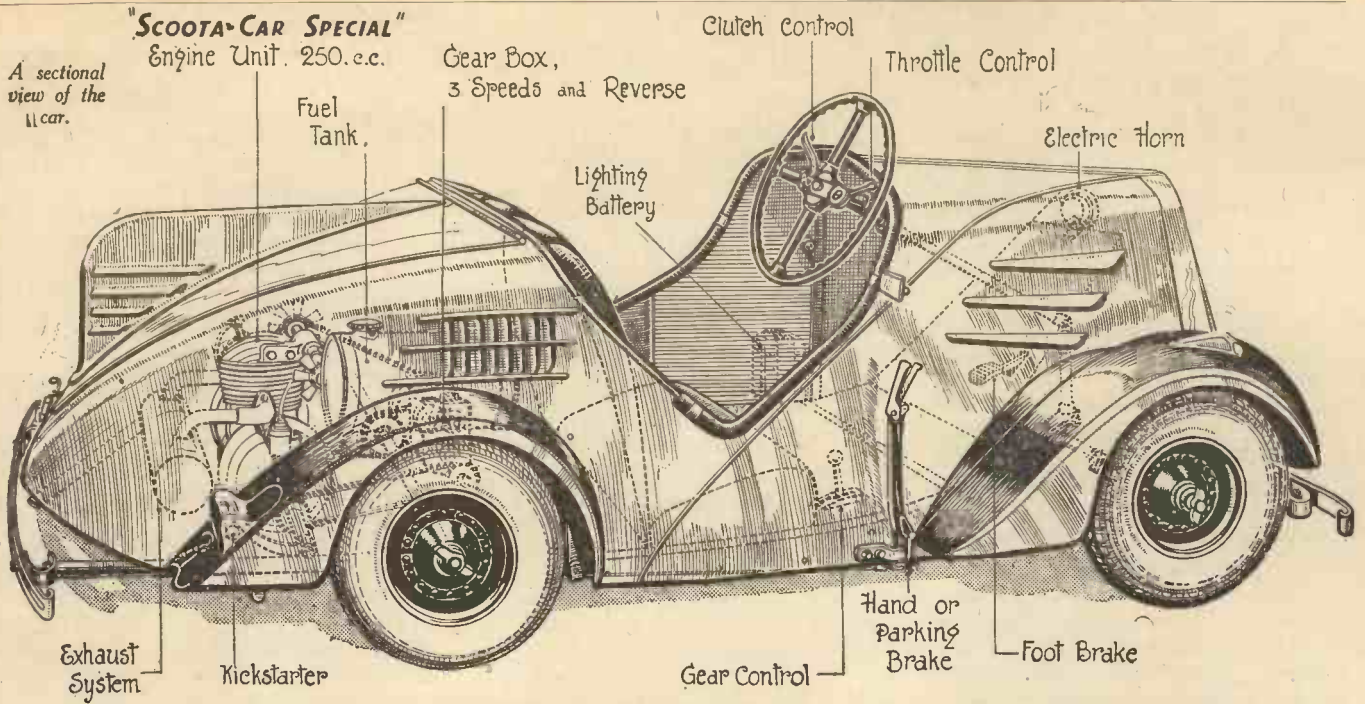

A MIDGET CAR

THE British Motor Boat Manufacturing Company, who were pioneers in British outboard engines, are also pioneers in the midget car field. Hundreds of their Rytecraft Scoota Cars are in use all over the British Empire, and the latest 2½-h.p. three-speed Rytecraft embodies the results of considerable experimental work at the company's works at Britannia House, Ampton Street, London, W.C.1, and actual experience on the road.

Though midget in size—the overall dimensions are only 8 ft. by 3 ft. 6 in.—the Scoota car's performance compares favourably with that of many "baby" cars of twice its dimensions and price, and in reliability and accessibility is far in advance of the "small" cars on the road a few years ago.

Seat Two People

Small though it is, the Scoota car can

A 2½ h.p. Three-Speed Car capable of a Speed of 45 m.p.h.

seat two people in comfort in its smart, semi-streamlined body, and a speed of 45 m.p.h. is easily maintained.

The car is powered by a single cylinder air-cooled engine of 250 c.c. capacity, rated at 2½ h.p. Acceleration is well above the average for this type of engine, while petrol consumption is remarkably low, 80 m.p.g. being achieved without difficulty.

On hills the car's performance is equally impressive. No main road gradient offers any difficulty, and under test she has taken gradients of 1 in 4 under full load with flying colours.

The chain drive is unusually quiet and efficient, much care having been taken to avoid loss of power. Short chains are used in conjunction with a normal type gear box providing three forward speeds and reverse. The change is effected by a short lever operating in a gate.

The cork insert type clutch is smooth and light. The engine and transmission, forming a unit with the back wheels, are carried on a sprung sub-frame bolted to the chassis in such a manner that they can be removed by any owner-driver in three minutes.

Powerful Brakes

Sixteen-in. wheels are fitted with low-pressure, quickly detachable 4-in. tyres. The hand or foot operated brakes are powerful but smooth in action.

The designers of the Rytecraft Scoota car, realising that this type of car will be required to run for long periods with very little attention, have reduced to a minimum the number of parts requiring lubrication. Engine lubrication is entirely automatic, the oil being mixed with the petrol before it is poured into the tank. Under the severest tests the engine shows no tendency to over-heating, natural cooling being supplemented by two fans. The crankshaft runs on ball bearings, and the big end on roller bearings.

As befits a car whose outstanding advantage is its manoeuvrability in congested traffic, the steering is both positive and light. In fact, all the controls are so simple and well arranged that, despite its diminutive size, the Scoota car at once inspires the most inexperienced driver with confidence.

A Nippy Tender

Although the Scoota car can well be used for normal touring its future will most probably be as a nippy "tender" to save the expense of running a larger car for shopping purposes or to enable people living just out of town to become independent of trains, buses, or trams. Its midget size makes garaging a very simple matter. No special facilities are needed, for the car can be put away end up in a very small space.

Rytecraft Scoota cars cost £80 with full equipment, including electric lighting and a choice of colour for the body.

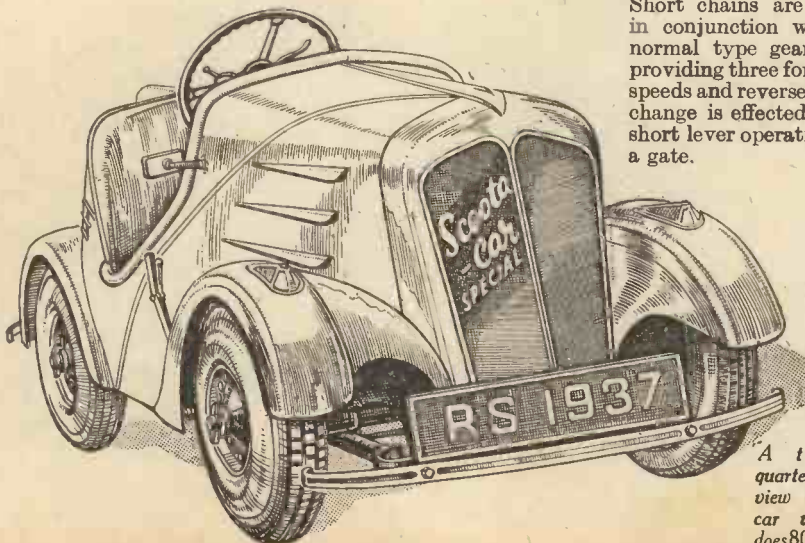

A three-quarter front view of the car which does 80 m.p.g.



Fig. 1.— A simple type of carbon microphone which, when correctly adjusted, is capable of transmitting speech and music.

tion. The two parallel nails are provided with wire leads and they are connected up to a flashlamp battery and to an old pair of headphones in the usual manner. The microphone will now be complete.

Give the slightest tap to the sounding-board base on which the parallel nails rest and it will become an almost deafening roar in the 'phones. Place a watch on the baseboard. Its ticks will in the headphones sound almost like the staccato notes of a machine gun. A fly, a beetle or any other insect confined in a matchbox placed on the microphone baseboard will, if a sensitive adjustment of the transverse nail contact be attained, provide an object lesson in "magni-

probable that the nails are covered with a thin film of oil or grease. Shake them in a hot solution of soda, rinse them well and try again. The microphone will now almost certainly work.

The nail microphone will not, of course, transmit speech, but it will magnify any type of simple impact-sound and, as such, many interesting experiments can be made with it.

A Simple Type

The simplest type of speech-transmitting microphone is that illustrated at Fig. 1, which photograph shows a simple type of carbon microphone.

A similar baseboard to the one employed in the making of the nail microphone is used for the construction of this simple carbon microphone. By means of sealing-wax, plasticine, Chatterton's Compound or any other suitable adhesive material, a large carbon rod is secured firmly to the microphone baseboard in a transverse position. Making very light contact with this carbon rod is another smaller carbon rod whose contact-pressure is controlled by means of a small spring. The two carbon rods are connected in series with a flashlamp battery and the completed microphone rests upon a pad of sponge-rubber or some other vibration-damping material.

This microphone will do—and more, for it is a good many times more sensitive than the latter. Provided that you can attain a satisfactory adjustment of contact-pressure

THE making of microphones has nowadays reached the status of a high art. The modern commercial microphone, such as, for instance, any instrument of the varying types used for broadcasting purposes or public-address systems, is an exceedingly efficient instrument, its practical efficiency being the outcome of the vast amount of research which has been put into its evolution.

With the construction of instruments of the above type we are, of course, not concerned in these columns. The microphones described herein are all very simple ones, their construction being only a matter of moments. Yet, despite their simplicity, and, one might say, their essential crudeness, they possess inherent working propensities, and they will amply reward with experimental interest any electrical or mechanical amateur who cares to construct them.

The Nail Microphone

The first of these microphones is that which we may term the "Nail Microphone." A sketch of it appears at Fig. 5 and it is the very simplest microphone which it is possible to make. Obtain an empty and lidless wooden box, a cigar box, for example. Lay it down on a table, base upwards, and fasten on the upturned base by means of sealing-wax two large nails in roughly parallel positions and separated from each other by a distance of about 3 in. Over these parallel nails place a third nail in a crosswise posi-

Microphones Made at Home

How to Construct a Number of Extremely Simple yet Exceedingly Interesting Working Microphones for Experimental Use

fied footsteps."

This microphone should give no trouble in its working. If you fail to get a good adjustment of the transverse nail, it may be

between the two carbon rods, the microphone, crude as it may seem to be, will transmit speech excellently. The obtaining (and retaining) of contact pressure between the two carbon elements is a matter of some difficulty. The smaller carbon rod is best controlled by a spring composed not of ordinary copper wire but of phosphor-bronze or of some other stiffer metal. In place of a single small carbon making contact with the large transversely fixed carbon rod, you may have two or three small carbon rods making contact with the larger carbon. Their presence increases the adjustment difficulty, but once adjusted, some really fine speech transmission may be accomplished.

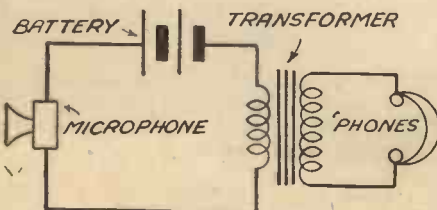

Fig. 2.—A circuit with a transformer included for use with a microphone.

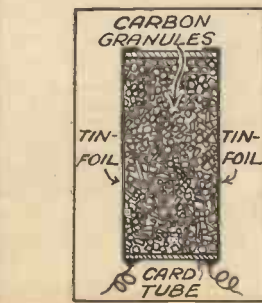
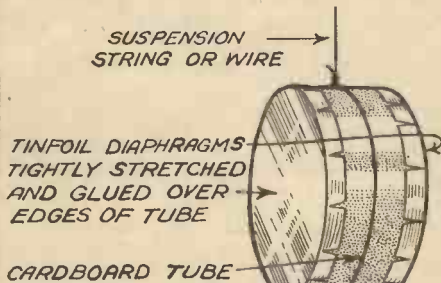

Fig. 3.—We may term this the "pill-box" microphone. Carefully adjusted, it will transmit speech.

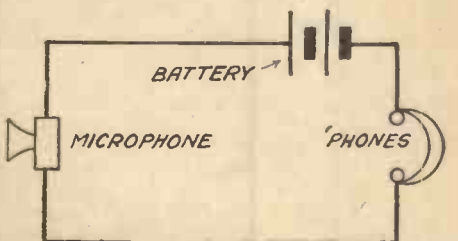

Fig. 4.—A circuit without a transformer which is also suitable for use with a microphone.

Another Type

Another type of working microphone may be made by taking a 1/4-in. strip of cardboard and by bending it round in the shape of a ring, fastening the two ends together securely by means of some strong adhesive. Over one of the open ends of the ring thus formed a circular disc of tinfoil (cigarette "silver-paper" will suffice) is stretched tightly and glued down, an electrical contact by means of a fine copper wire being made to this tinfoil diaphragm.

The circular box thus constructed is then filled brimful with powdered carbon and over the open end is secured another tinfoil diaphragm which is also supplied with a connecting wire. (Fig. 3.)

Powdered carbon is best obtained by crushing up the central carbon rods of a disused flashlamp battery. The powder should not be too fine and it should be washed with hot water in order to dissolve out any impurities. Finally, the dried carbon powder is used as directed above.

The microphone will now be complete. To use it, it should be suspended in some

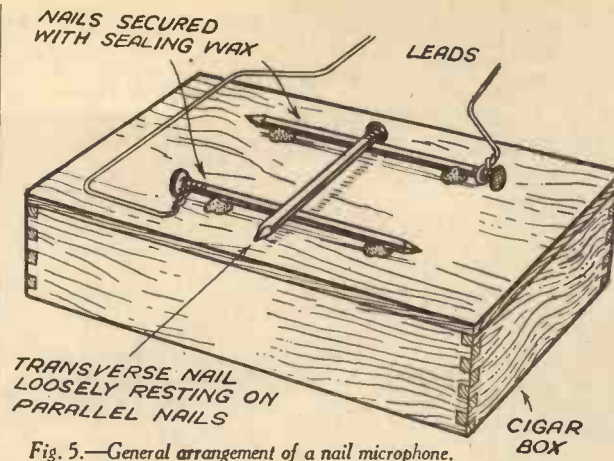

Fig. 5.—General arrangement of a nail microphone.

convenient position by means of string and its connecting leads wired up in series with a flashlamp battery. The microphone will have to be brought into adjustment by gently

will suffice, and from surplus electrical supply concerns such instruments can nowadays be had at a cost of a shilling or so.

tapping it with a pencil. When correctly adjusted, it will transmit speech quite satisfactorily. The microphone must be quite full of carbon powder, but the latter must not be packed too tightly.

In making use of the simple microphones described above, the instruments may be employed with or without a microphone-transformer (Figs. 2 and 4). In every case, however, the use of a transformer gives such superior and more satisfactory results that it is well worth acquiring one for the purpose. Any microphone - transformer

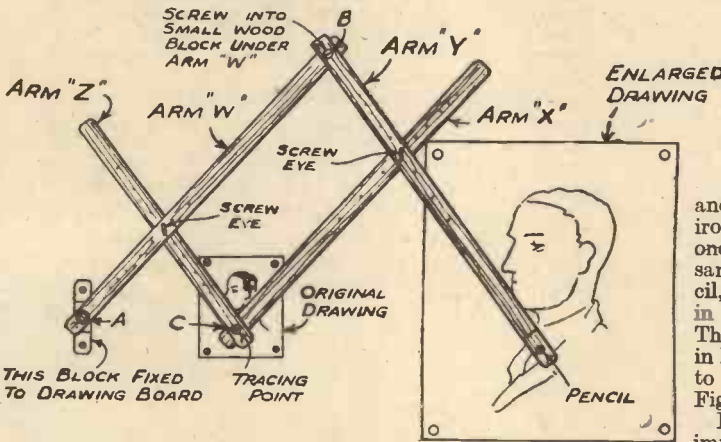

Fig. 1.—The pantagraph completed. The assembling of the parts is shown in this diagram.

A PANTAGRAPH is a simple tool by means of which you may copy, enlarge or reduce drawings and illustrations. The device shown in Fig. 1 consists of the various parts shown in Figs. 2 to 5. Use strips of oak 3/8-in. wide and 1/4-in. thick for the four arms, and carefully mark off the distances shown in Fig. 2. Drill the holes shown to accommodate the screw-eye illustrated in Fig. 5.

At the point A a little bar of wood is attached, as shown in Fig. 3, so that the end of the pantagraph can be screwed down to the drawing-board. The tracing point C consists of a nail with a washer soldered beneath the arm X to keep it in place; the nail should be filed up to a sharp point and serves as the tracing point.

To accommodate the pencil a piece of wood is glued over the end of the arm Y, as indicated in Fig. 2, and a hole is drilled in it of a size to suit the diameter of the pencil. The other joints are made clear from the drawings.

To enlarge a drawing to, say, three times its size, insert the screw-eyes into the holes marked 3, and upon tracing over the drawing with the tracing point, the pencil will trace out the drawing three times the original size.

When it is required to reduced the size of a drawing, the positions of the pencil and tracing point must be reversed, and for this purpose a short stumpy piece of pencil should be pushed over the tracing point

A SIMPLE PANTAGRAPH

and a piece of round iron pointed up at one end and of the same size as the pencil, should be pushed in the pencil hole. The various letters in Fig. 1 correspond to those shown in Fig. 2.

It is absolutely important, if accurate, scale copying is to be done, that the distances of the holes from the points A, C and B (Fig. 2) should be carefully marked out. To ensure this, place the arms W, Y and Z together and scribe the three off at once with a square. Then place the point 8 on arm X level with the point 8 on arm W, and by means of the square scribe off the positions on arm W on to arm X. You will then be quite certain that the positions are correct.

In using the instrument, let the left-hand press on the tracing point and the right hand grasp the pencil. Now guide the tracing point over the drawing to be copied and at

the same time exert a slight pressure on the pencil. As the tracing point is moved over the drawing the pencil will draw out an enlarged copy of the original. A little practice may be necessary to get the best results. You will probably find at first that the pencil lines are wavy, and this is because the pencil magnifies any false movement of the tracer. So for best results make bold and confident movements with the tracing point, and after a little practice you will

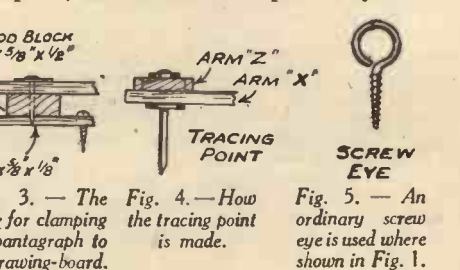

Fig. 3.—The block for clamping the pantagraph to the drawing-board.

Fig. 4.—How the tracing point is made.

Fig. 5.—An ordinary screw eye is used where shown in Fig. 1.

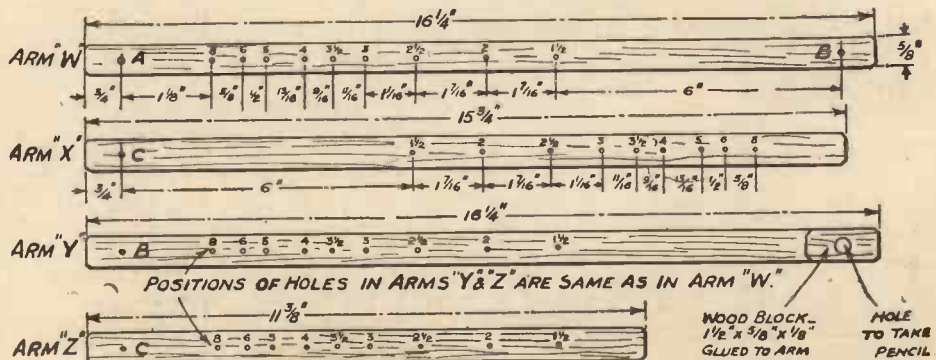
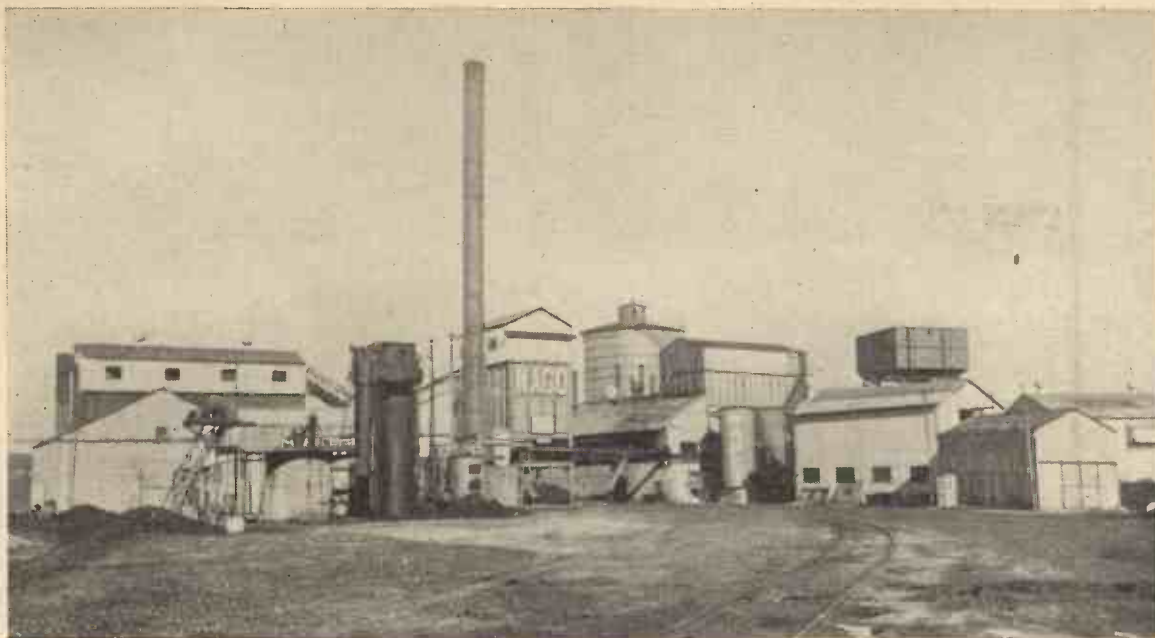

Fig. 2.—How to mark out the four arms of the pantagraph

find that the right hand in holding the pencil will tend to help the left hand. It is a curious fact that when using both hands together in this way they both tend to make exactly the same movements.



A general view of Tipton Works. The waterless holder is shown in the background.

PETROL FROM COAL

The New Processes for Heating a Liquid Coal-Oil Mixture by Low-Temperature Carbonisation of Coal Produce 12 Gallons of Petrol, 20 Gallons of Diesel Oil, and 15 cwt. of Smokeless Fuel from one Ton of Coal and are a big Advance on the Older Methods which attempted the Low-Temperature Carbonisation of Solid Coal. They are, however, Different in Principle from the Hydrogenation of Coal, which produces 180 Gallons of Petrol from a Ton of Coal.

THE production of petrol from coal by low-temperature carbonisation is entirely different in principle from the production of petrol by coal hydrogenation as operated by The Imperial Chemical Industries at Billingham (this process was described in PRACTICAL MECHANICS for December 1935). At Billingham, hydrogen is forced into combination with the coal at a reaction pressure of 2,000 lb. per square inch, and at a temperature of 500°C. By means of this powerful agency, the whole of the carbon substance in the coal is turned into petrol and there is no residue of solid fuel.

In a low-temperature carbonisation process, no hydrogen is forced in under pressure. The coal is simply heated to a temperature of 700°C. and without the use of pressure. In these conditions the distillable matter in the coal is cracked down to petrol and diesel oil. That part which cannot be cracked stays with the carbonaceous matter in the coal as binding pitch, which enables the solid residue from the process to be briquetted into a smokeless fuel of good qualities.

Hydrogenation versus Low-Temperature Carbonisation

The yield of petrol from hydrogenation of coal is 180 gallons of petrol from every ton of coal treated. By low-temperature carbonisation only 12 gallons of petrol and 20 gallons of diesel oil per ton of coal are obtained. The residue of smokeless fuel amounts to 15 cwt. The wide difference in yields is easily explained. Petrol contains 15 per cent. of hydrogen and 85 per cent. of carbon, and coal contains only 5 per cent. of hydrogen to 85 per cent. of carbon. Unless

hydrogen is forced into reaction with the coal, as at Billingham, a high yield of petrol obviously cannot be obtained. Any low-temperature carbonisation process, relying as it does on the natural hydrogen content of the coal, cannot hope to yield more than a limited amount of petrol. Conversely, the excess carbon in the coal which is hydrogenated at Billingham is rejected as solid fuel in a low-temperature carbonisation process.

The comparison is not quite so drastic as outlined above. True, the yield of petrol at Billingham is 180 gallons per ton of coal

processed, but for every ton of coal processed no less than 4 tons of coal has to be used outside to supply power and to supply coke for the manufacture of hydrogen. The net yield of petrol at Billingham is therefore only 30-40 gallons of petrol coming out of the works for every ton of coal which goes in.

Again, the plant at Billingham handles such enormous pressures that the elaboration of its design cost some £3,000,000. Its running requires equally elaborate attention from its maintenance engineers and process chemists. A low-temperature carbonisation process is as safe and simple as an ordinary gasworks.

High- and Low-Temperature Carbonisation

Coal carbonisation is essentially the process of distilling and cracking the volatile matter from coal. Cracking is a term borrowed from the petroleum refiners' vocabulary. It means the breaking down by heat of heavy oils to lighter oils, petrol, and gas. Coal contains 30 per cent. of volatile distillable matter and 70 per cent. of solid carbonaceous residue, which cannot be distilled and is left at the end of any carbonisation process as a coke. The difference between high- and low-temperature carbonisation is a matter of 300°C.; 700°C. for low-temperature carbonisation and 1,000°C. for high-temperature carbonisation.

On gasworks, where their business is to make gas from coal, high-temperature carbonisation is used. The coal is fed into retorts which are maintained at over 1,000°C., which is approaching white heat. The intense conditions of radiant heat remove practically every scrap of volatile



The coal grinding mills.



The Duke of Kent watches the briquette elevator at work at Erith.

matter from the coal and leave it as a hard, solid, porous lump of practically pure carbon. The porous structure is due to the sudden rushing out of bubbles of the volatile matter in the coal. The cracking conditions are intense. The tar which comes off contains over 50 per cent. of pitch. Instead of petrol the heavily condensed ring molecules of benzol are formed. The bulk yield is coal gas to the extent of 13,000 cubic feet per ton compared with the 700 cubic feet obtained in a low-temperature carbonisation process. The gas itself is intensely cracked so that it contains over 50 per cent. of hydrogen instead of the rich marsh gas and hydro-carbons which make up the bulk of low-temperature gas. The yield of liquid products from the gasworks process is only 10 gallons of heavy tar and 3 gallons of benzol from a ton of coal.

The low-temperature carbonisation process is much gentler. It runs at only bright-red heat. The coke contains some pitch and is neither hard nor porous. Instead of winning a high yield of gas, the tendency is all to the preservation of uncracked tars containing much light creosote and very little pitch.

Old Process

The older low-temperature carbonisation processes were, if anything, too gentle. The coal was treated in vertical retorts very similar in construction to the ordinary vertical retorts used on gasworks. The difficulty was that the coal took too long to get heated through. Its volatile matter was therefore slowly distilled off and was virtually uncracked. Large yields of light tar resulted for which there was no commercial use. Further, the coal got into a plastic, sticky condition which made it hang up in the retorts and interfere with the smooth running of the process. As the process could not run on the profits of the sale of its low-temperature coke alone, it was practically discontinued.

New Process

Fuel technologists had not however finished with low-temperature carbonisation. They set out on new and original lines and their pioneerism brought success. Because solid coal took so long to heat through, they substituted a liquid paste of coal and oil. Because cracking conditions were gentle, they gave them longer time in which to do their cracking by sending the

heavy part of the distillates backwards and forwards through the retort. It all fitted in very nicely, because the oil which was needed for making up the coal-oil mixture could be supplied by the heavy ends of the tar, which had to be sent back in any case for re-cracking. That is the real basis of the several different processes of low-temperature carbonisation for which successful results are now quoted. The Mitford process, which is operated by the National Coke and Oil Company at Erith, illustrates one method of incorporating these ideas into a plant.

National Coke and Oil Plant

The diagram on this page shows what is called the flow-sheet of the process. Coal is crushed and powdered down to 1-200th of an inch size. It is then mixed with heavy hot tar-oil, coming back from the end of the process to make a 50 : 50 coal-oil paste. The paste is pumped into the top end of a heat-resistant steel retort which measures 50 feet in length by 5 feet in diameter. This retort is rotated round its major axis inside a firebrick furnace, which keeps a temperature of 700°C.

The coal-oil paste slowly moves down the retort, evolving gas, petrol, and tar-oil vapours which travel to the gas outlet at the top end, while the solid residue emerges as a pasty mass at the bottom discharge. The smokeless fuel drops down into the hopper

of a briquetting mill which presses it into the familiar ovoid briquettes ready for the market.

From the top end the gas and vapour mixture undergo a series of condensing and washing operations. First it is cooled in condensers and the heavy tar-oil fractions fall out of the gas. Then it is scrubbed with creosote oil to absorb and remove the petrol. Finally the gas, stripped of all its valuable constituents, is pushed into a waterless holder, whence it can be drawn as required for heating the original retort furnace.

Diesel Oil

The tar-oil fraction which came down in the condensers is pushed into a topping still. Here it is heated and then flashed off. The diesel oil passes off in the vapour flash to be subsequently cooled and purified. The heavy fractions of tar remain as a liquid, which is run off and recycled back to the coal end of the plant for making up the coal-oil paste. Thus it is recycled again and again to the plant, each time being a little more cracked to petrol on the one hand and pitch on the other.

Petrol

The petrol, we stated, was scrubbed out with creosote oil. It cannot be removed by simple condensation because at the temperature of the scrubbing operation it is all carried as a vapour in the gas. But it is soluble in creosote oil, and by spraying the oil down through the gas in a special washing plant practically all the petrol vapour can be washed out from the gas. The creosote-petrol solution is then put through a distilling plant, where the petrol is again vapourised out in a current of steam, condensed together with the steam, and separated from the water, in which it is insoluble. This is, of course, the way that benzol is washed out of ordinary coal gas.

The remaining plant on the works is devoted to the purification of petrol and diesel oil for the market. The yields of the process described are said to be 15 cwt. of briquetted fuel, 20 gallons of diesel oil, and 12-13 gallons of petrol from one ton of coal. The petrol is of very good quality, having a high anti-knock value. The diesel oil has been tried out and on test gives a mileage per gallon equal to that of the best petroleum diesel oils. If anything it is slightly better, as it has a lower firepoint. If necessary, of course, this diesel oil could be cracked and hydrogenated under pressure to give petrol just as they do with creosote oils at Billingham.

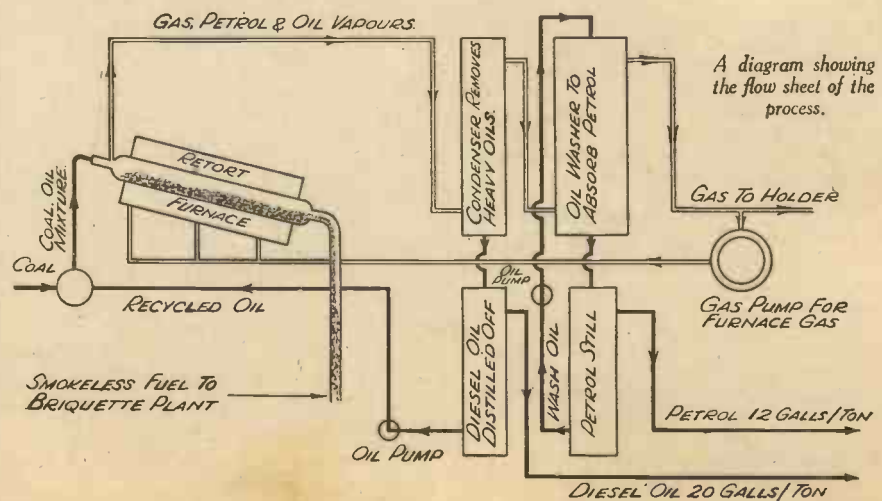

FAIR COMMENT

By The Editor

SO many readers have been kind enough to suggest that I should contribute a page of personal opinions each month, that I take pleasure in commencing such a feature. I shall write of what I see and think and hear. I may not always keep strictly to the ambit of scientific progress, invention and mechanics. I shall express my opinion fearlessly, choosing fair words; I shall congratulate and criticise, view and review, comment and chat on this and that. Possibly a letter from a reader will provide me with an idea worthy of a paragraph for the benefit of other readers. If you disagree with me or my point of view on occasions I shall not mind in the least. I shall give equal prominence to the opposite point of view. I shall not be afraid to be outspoken for I do not believe in utopia and the perfect world. Quite often, puffs are written around unworthy articles which quite rightly ought to be criticised. I abhor that practice known in journalism as the "write-up." If there is any matter upon which you seek my opinion, please write to me if you are prepared to submit to the foregoing basis on which my reply will be founded. I have always been a fearless journalist,

A FRIEND who thinks well of me signalled his kindly thoughts by presenting me with an expensive cigarette lighter the other day. It was beautifully made, and for a time functioned very well indeed. Then the flint wore out, and upon dismantling it to fit a new one I noticed that the flint itself contacted radially with the striker wheel. Surely this is wrong, since the spring tension will cause the flint to act as a brake, so that you have to exert more pressure than should normally be necessary to ignite the wick. It would be better to off-set the flint.

Whilst I was attending to the lighter I thought I would take advantage of the opportunity to adjust the wick. I found that I had to tug and pull at the burnt-down end, but did not really succeed in exposing a new portion of wick until I had removed all of the cotton-wool. Considering that this lighter cost over £2 it is not unreasonable to expect that some provision should be made for adjusting

*Random Remarks on
Diverse Topics*

the wick. This could be done as with an ordinary paraffin lamp by means of a simple screw action. Lighters still have a long way to go before they achieve perfection.

WHILST I am dealing with the question of invention, I am reminded of the letters I so frequently receive from readers who have invented a particular device. They ask if I can put them into touch with interested manufacturers, how much the invention is worth, whether they should approach manufacturers before patenting the idea. I cannot undertake to market inventions for readers, nor is it possible to assess the commercial value of an invention. This depends entirely upon the demand. An excellent idea may fail because manufacturers are loth to scrap their existing stocks and methods, or because the public has become accustomed to a particular form. Ideas do not always fail through lack of merit. It is one of the easiest things in the world to invent, for we are all potential inventors. Every time we make a little gadget or solve some difficulty we have invented something. The successful inventor is usually he who combines a large chunk of business acumen with a small amount of inventive ability and a generous admixture of tenacity of purpose and ability to gauge public demand. It is of no use approaching a manufacturer with an idea which you have not patented. He does not know you, probably, from Adam, and manufacturers are not such trusting individuals that they will believe any Tom, Dick and Harry who happens to approach them with

an idea which is claimed to be original. The only proof is the Patent Specification, and even that is not conclusive proof of originality, for, unless a very careful search is made it is possible that someone has forestalled you, even though the Patent Office accepts your specification. A patent is not a guarantee even that the idea will work, for there are several patents filed each year and accepted by the Patent Office for perpetual motion!

A FRIENDLY hint! Readers are breaking the rules which govern our Free Advice Bureau. They ask for a postal reply, and in many cases forget to stamp the envelope which they address to us. In some cases they enclose an addressed envelope without a stamp on it, and in others forget to enclose the Query Coupon. The answering of technical queries is an expensive business, and we must insist upon a stamped and addressed envelope for a postal reply, and every query must be accompanied by a coupon, cut from the current issue, whether it is to be replied to through the post, or in these columns. An adequate time allowance is made for overseas readers. Our Free Advice Service is intended for regular readers, and not for non-readers. By enclosing the coupon we are assured at least that the querist has purchased the paper. Unfortunately, it is my experience that some readers desiring information will say that they have been readers from No. 1, when an article which adequately answers their question has appeared in the current issue. I am glad to say the bulk of my readers are not so careless with the truth.





The method of yesterday.

THE pneumatic road drill—considered by many to be the invention of the devil—is not actually a drill at all, since the steel point which comes into contact with the concrete does not rotate, but simply forces its way into the concrete and breaks it by a wedging action. Suppose we start correctly by calling it not a road drill but a concrete breaker.

By a strange coincidence the concrete breaker and the mechanical concrete mixer were both introduced about the same time. Both have played a big part in the construction and repair of the many thousands of miles of roads which have been made and re-surfaced during the last eighteen years—the years since the world war. The petrol- or oil-engine driven concrete mixer makes it such an easy thing to lay an 8 in., 10 in., 12 in. or even thicker bed of concrete, but it is much more difficult to break out these beds. Post-war road construction makes it almost impossible to do any but the very smallest amount of excavation work, using the old-fashioned method of driving a diamond-pointed wedge into the surface by means of heavy sledge hammers wielded by a gang of three or four hefty navvies—all of which effort is dissipated in the hopes that, after six or seven minutes of hammering, a piece of concrete about the size of a man's hand might be broken off.

Introduction of the Pneumatic Road Breaker

London saw its first pneumatic concrete breaker at work in New Bridge Street, near Blackfriars Bridge, in 1919. *The Times* reviewed the new machine in their columns as "A Pneumatic Road Breaker, an invention from America, was to be seen breaking up the concrete foundations of New Bridge Street yesterday. In place of four or five men with heavy hammers, driving a chisel into the concrete, only one man is required to place this machine in position. The pick point is fitted into a vertical cylinder, and forced by compressed air fed through rubber piping from a Portable Compressor. An invisible hammer strikes the head of the pick about five hundred blows a minute and under this great pressure it appears to slide into the concrete, which is broken into small lumps. It is claimed that one machine chisel will do as much work in a given time as four chisels operated by navy gangs."

Another London paper reported, "A dragon-like contrivance . . . the resulting vibrations of the pick-head scrapes up chunks of road as large as fair-sized cannon balls. On the first day, the operators were surrounded by spectators, and at lunch-time the particular part of the road where the breakers

THE PNEUMATIC AND HOW

BY

MODERN METHODS

were at work, became a surging mass, so much so that policemen had to move on the crowd in order to keep the road open. Message boys were known to spend many hours fascinated by the "volcanic vitality of the insatiable road eater."

At first, it was not certain whether the workmen would take kindly to the new invention, but they very soon found out that they were less tired at the end of the working day, after using a concrete breaker, than if they had been swinging a heavy hammer for some time.

The economy and saving in time made possible by the mechanical road breakers were quickly realised, and the machines

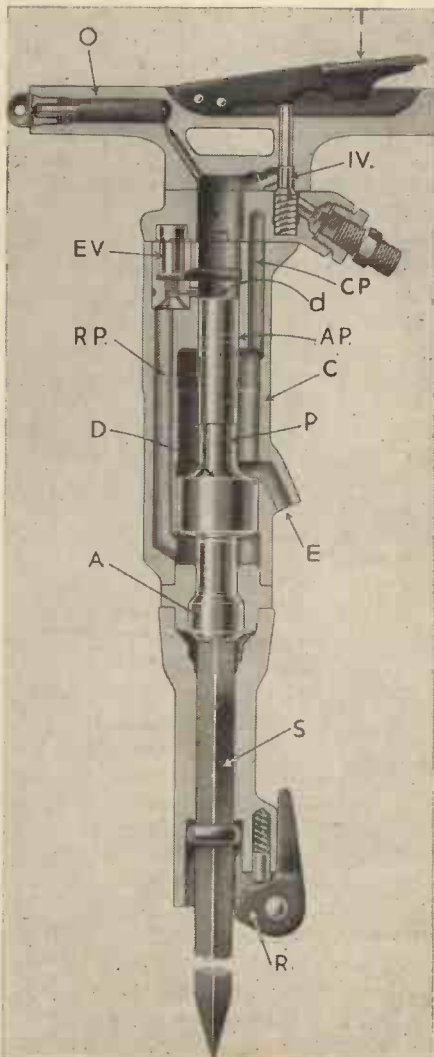

A section through a modern pneumatic concrete breaker.

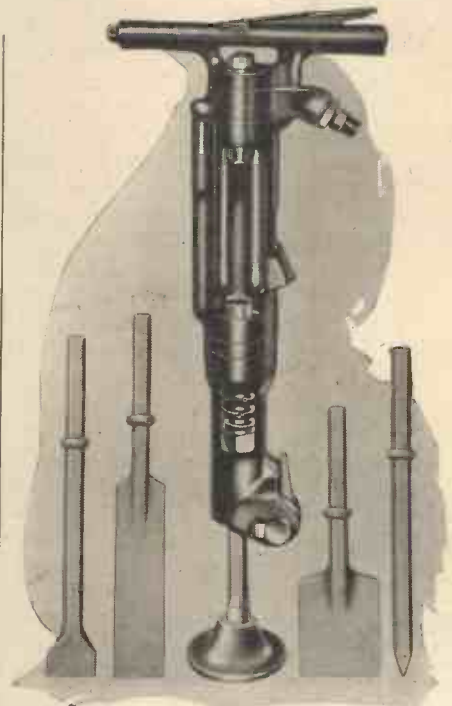

A concrete breaker with various tools which may be used with it, reading from left to right, (1) 3-in. Chisel, (2) 3-in. by 12-in. Blade, (3) Tamping Pad, (4) 5-in by 8-in. Steel, (5) Diamond-pointed Steel.

started to make their appearance throughout London and the Provinces.

Manual Methods versus Machine Methods

The advantage which the modern pneumatic concrete breaker has over the old-fashioned sledge-hammer method of breaking out concrete is difficult to assess, but from experience of similar work carried out by manual labour and by air-driven breakers, it can be shown that each mechanical breaker will do the work of from six to fourteen men, depending on the hardness of the material to be removed. The harder it is, the greater will be the advantage for the machine; indeed, on some large contracts hand excavation would be almost impossible. Some few years ago it was necessary to relay Upper Regent Street, London. The whole road was excavated down to the penning, or sub-foundation; concrete placed to a depth of about 12 in. and the finished surface made good, all within a few weeks. The excavation which had to be done would have taken a hundred men many months had this work not been done by road "drills." This very considerable saving in time which the concrete breaker makes possible, should compensate to some extent for the considerable noise which these machines make,

ROAD DRILL— IT WORKS

STUART YOUNG OF ROAD-BREAKING



Modern concrete breaker fitted with an exhaust silencer.

much to the discomfort of those residing or having their business in the vicinity of the work.

To watch men operating a mechanical breaker, one would maintain that the work must be very tiring and that the operator would be affected by the vibration. Actually, these tools are not difficult to operate, the greatest effort being in lifting the machine after each successive piece of concrete has been broken, placing the pick-point in a new position prior to pressing the throttle valve, and starting up the hammering action. The work is much less fatiguing than swinging a heavy sledge hammer. At the end of the day the operator is less tired, which is all to the good.

It is appropriate that something should be said regarding the terrific noise made by concrete breakers, and the attempts which are being made to curtail it. During the last few years movements have been started to try and eliminate unnecessary noise from our streets, and it is to be admitted that concrete breakers are among the worst offenders in this direction. Most manufacturers of this class of machinery appreciate the very objectionable noise of the road "drill," and have, and still are,

expending a great deal of time and money in trying to eliminate the noise as much as possible. Later in this article there appears a description of how a road "drill" works, and it will be realised how difficult is the problem which the manufacturer is trying to solve.

In trying to design a silencer for the exhaust, the inventor must remember that he is dealing with comparatively large quantities of air, and if his silencer creates back pressure there will be a considerable loss in efficiency and the rate of doing the work will be reduced. A modern concrete breaker usually operates at pressures from 70 to 90 pounds per square inch and requires about 8 cubic feet of compressed air each minute, which is equal to about 50 cubic feet of air at atmospheric pressure. It is the latter figure which has to be taken into account when designing silencers for these machines.

How the Pneumatic Breaker Works

There is a section shown on the opposite page of a modern type of pneumatic concrete breaker, and from it the reader will be able to follow exactly how this machine operates. In order to follow more easily, the explanation of how the concrete breaker works, it is advisable to take a piece of tracing paper and on it make a tracing of the piston, this can then be slid up and down the cylinder, and the various opening and closing of the inlet and exhaust ports, will readily be appreciated.

Air from a portable petrol- or oil-engine driven compressor is delivered into an air receiver which form part of the unit, and



The machine of to-day.

from here is led through stout rubber hose which is attached to the screwed connection shown just above the letters *CP*. The inlet valve *IV* controls the working of the tool, as until this valve is opened by pressing down the trigger handle *T*, no air can enter the breaker. When starting, the piston *P* will most probably be at the bottom of the cylinder, as shown in the section, and resting on the anvil block *A* which, in turn, is in contact with the shank end of the steel pick *S*.

The Cycle Explained

When the operator presses the trigger *T*, air passes the inlet valve *IV*, filling the space above the piston, that is, above the diameter marked *d*. It exerts pressure on top of the piston—effective area *d*. Air from this compartment enters the port on the left and raises the small spool valve *EV*. Air also has access to the return port *RP* through a small hole just below the valve. The air then passes down the return port *RP* and operates on the underside of the piston which has an effective area *D*.

At this time, the space above the piston is open to exhaust *E* and the piston rises due to the effective area *D* being greater than the area *d*. After rising a little way, the piston cuts off the exhaust port *E* and

(Continued on page 42)



A battery of pneumatic concrete breakers in action. These five machines will break out from ten to fourteen times more material in a day than would be possible by manual labour only.

A Centuries=Old Puzzle

The Six-ring Puzzle, which is thought to be of Chinese Origin, is no doubt familiar to Readers. Other Rings can be added if necessary.

WHETHER this puzzle really originated in China seems a doubtful question, but there is no doubt at all that it is one of the best puzzles ever made. It can be made with any number of rings, but the usual amounts are from six to ten. The six-ring puzzle can be done in about one minute (when you know how to do it), but each added ring makes the puzzle take about twice as long to solve, so a little mental arithmetic will indicate that a ten-ring puzzle should take about a quarter of an hour. Working such a puzzle is rather like knitting; you "knit" away for a quarter of an hour, more or less, and eventually the two pieces of the puzzle separate.

The Construction of the Puzzle

First get six curtain rings about 1 in. diameter and some brass wire about 16-gauge, then form an eye in the end of a piece of wire, say 3 in. long, so that the eye holds a ring as shown in Fig. 1. Make six parts like this. Next get a piece of wood or metal or any other material that suggests itself to you, say 6 in. long, $\frac{3}{8}$ in. wide and about $\frac{1}{8}$ -in. or $\frac{1}{4}$ -in. thick. Drill a hole 1 in. in one end, large enough to take the wire freely, put a wire (with ring attached) through the hole, and bend over the bottom end of the wire, as shown in Fig. 2. Then drill a second hole about

the puzzle then appears to you as in Fig. 5. Let the rings and the base hang down from the loop and manipulate the rings with the left hand. For ease of reference let us number the rings 1 to 6, that on the left being No. 1, the others being numbered

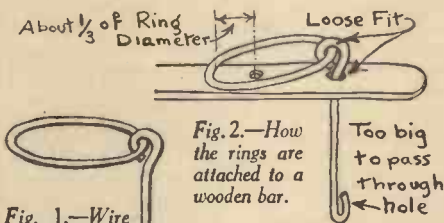

Fig. 1.—Wire rod attached to curtain ring.

Fig. 2.—How the rings are attached to a wooden bar.

consecutively towards the right. Draw the loop through the rings towards the right as far as it will go, lift rings 1 and 2 together over the end of the loop, then push the loop back to the left and drop the rings through as shown in Fig. 6. This illustration shows the rings nearly half-way through the loop, but they will fall right down and rest on the base. Now the secret of the whole thing is that the second ring from the left-

in Fig. 6, draw the loop to the right and allow the rings to drop below the rounded end of the loop. Now draw the loop to the right, lift up No. 1 only, push loop to the left and drop No. 1 through. No. 3 then becomes the second from the end, and can be removed in the usual manner. To remove No. 2, put No. 1 on the loop again (by passing it up from below in the same manner that you put 1 and 2 on together), then remove 1 and 2 together as before. Now 5 and 6 only are on the loop, and No. 6, being second from the end, can be removed. Then proceed as follows:

Put on 1 and 2 together. Remove 1. Put on 3. Put on 1. Take off 1 and 2 together. Put on 4. Put on 1 and 2. This leaves 1, 2, 3, 4 and 5 all on the loop, and the only result so far has been to get No. 6 off. To proceed: Take off 1. Take off 3. Put on 1. Take off 1 and 2. Take off 5. Put on 1 and 2. Take off 1. Put on 3. Put on 1. Nos. 1, 2, 3 and 4 are now on and 5 and 6 are off. Take off 1 and 2. Take off 4. Put on 1 and 2. Take off 1. Take off 3. Put on 1. Take off 1 and 2 and the puzzle is done! There is, of course, exactly as much work to be done in

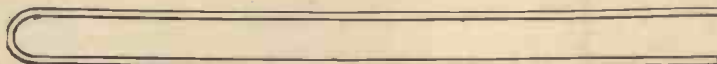

Fig. 4.—The open-ended loop of wire.

hand end of the loop can always be removed.

After removing 1 and 2 as just described, the ring at the left-hand end of the loop is No. 3, and the second from the end No. 4; No. 4, then, is the next ring to come off. It is removed by drawing the loop as far as possible to the right, lifting 4 up over the end of the loop, pushing the loop back to the left, and dropping the ring through in the same

replacing the loop. There is no need to describe the method in detail, for you just work through the instructions backwards.

Sugar from Wood

PRODUCTION not only of sugar, but of alcohol acetone, citric and tartaric acids from wood and other cellulose fibre is to-day assuming the proportions of a large industry. Cellulose is essentially a very large cellular aggregate of molecules formed of carbon and hydrogen.

Decomposed Molecules

SUCH molecules of carbohydrates can be gradually decomposed by acid destruction

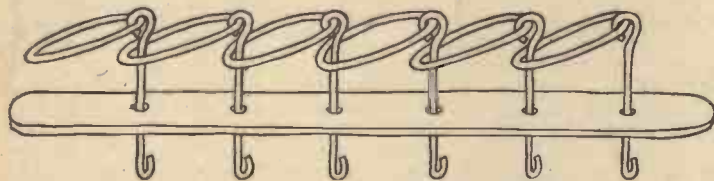

Fig. 3.—The puzzle with all the rings attached.

one-third across the first ring (see Fig. 2) and insert a second wire and ring. Repeat this procedure until all the wires and rings are fixed and the puzzle should look like the sketch in Fig. 3.

The Loop to Complete the Puzzle

A length of about 18 in. of 16-gauge wire is cut off and bent in the middle to form an open-ended loop (see Fig. 4). Thread this loop through the rings and twist the ends together as shown in Fig. 5 and the puzzle will be complete. The problem is to remove the loop.

How it is Solved

To solve the puzzle, take hold of the loop by the twisted end in the right hand with the rounded end pointing to your left;

from the end No. 4; No. 4, then, is the next ring to come off. It is removed by drawing the loop as far as possible to the right, lifting 4 up over the end of the loop, pushing the loop back to the left, and dropping the ring through in the same way as you did 1 and 2. (See Fig. 6).

Removing the Three Remaining Rings

You now remove No. 3, and to do this put Nos. 1 and 2 on

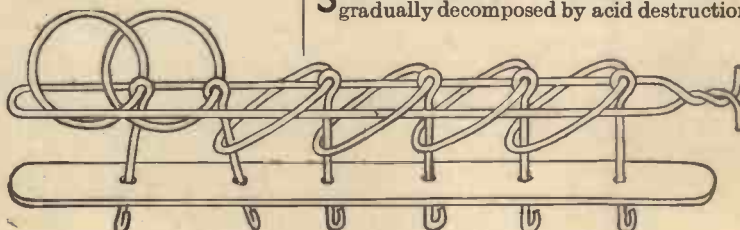

Fig. 6.—The second move in solving the puzzle.

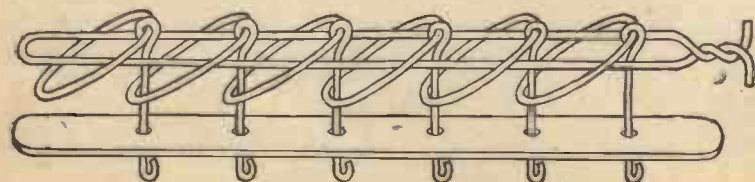

Fig. 5.—The first move in solving the puzzle.

again by reversing the process for taking them off, i.e. push rings 1 and 2 up through the loop as

into sugars and once sugar has been reached then many other types of carbohydrate bodies may be produced from them. Biochemists have discovered ferments and yeast-like bodies which will do the work of acids by much more natural means and at far less cost. It is really the secrets of the brewing industry, which makes alcohol from sugars, extended, discovered and controlled.

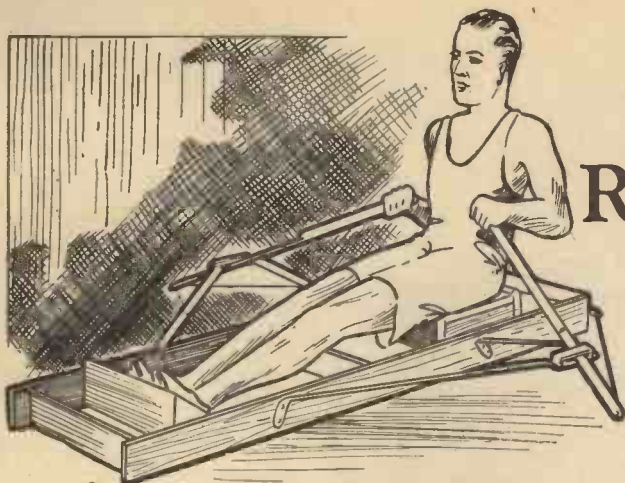

Fig. 1.—The machine in use.

MAKING A ROWING MACHINE OR TRAINER

An Ideal Device for Athletes and Others Desirous of Keeping Fit

A LARGE number of our readers will be interested in the rowing machine, or trainer, shown here. Quite simple and inexpensive to make, the outfit is equally suitable for the home or the club, and is not only useful to those who are keen athletes, but will also help the ordinary individual to keep fit.

The illustration, Fig. 1, shows the machine in use, from which it will be gathered that it is made with a bottom frame which is fitted at one end with a sliding seat, and at the other with a foot-rest. Outriggers are fitted at each side of the frame, and to these the oars or rowing handles are fitted, and the "pull" is obtained by running a length of strong cord from the ends of the frame to a short bar connected to a number of springs fitted between the frame under the seat.

The Material Required

Good quality deal is suitable for making the machine, although hardwood such as ash or birch will give better service if it is used to a great extent. The frame should be made first, the dimensions and method of construction being shown at Figs. 2, 3, and 4. The sides are 4 ft. 3 in. long by 3½ in. wide by 1 in. thick, and they are prepared by cutting a trench 1 in. wide by ½ in. deep right across 1 in. from the end of the reception of the front bar. Another trench of the same size is cut 2½ in. up from the bottom edge right in the centre for the reception of the centre bar, and a recess 1 ft. 6 in. long by ½ in. deep is cut in the bottom edge at the back for the reception of the bottom boards. Three other trenches ¾ in. wide by ¾ in. deep are cut near the front to receive the foot-rest, the front trench being spaced 1 in. in from the front bar, and the others 1½ in. apart. The sides are joined by a front bar 1 ft. 0½ in. long by 2½ in. wide by 1 in. thick, a back bar 1 ft. 2 in. long by 3 in. wide by 1 in. thick, and a bottom 1 ft. 2 in. long by 1 ft. 6 in. wide by ½ in. thick made up in two or three widths as may be convenient. The front and centre bars are fitted into the trenches provided, and are nailed through the sides, the joints being glued. The back bar is simply screwed at the top edges of the sides, while the bottom is fitted in the recesses in the bottom edges of the sides and screwed in place.

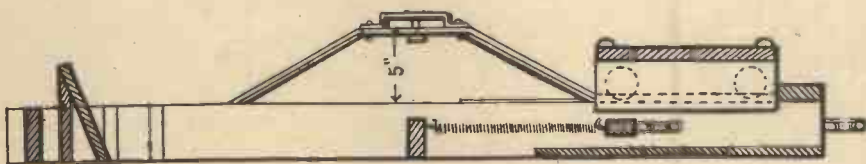

The Oars or Rowing Handles

These are made partly of wood and partly of iron, as shown at Fig. 5. The wood portions are 1 ft. 3 in. long, by 1½ in. square, worked up to the section shown, and suitably shaped for the hands for a length of about

Figs. 2 and 3.—(Above) A sectional elevation of the machine. (Below) A plan view.

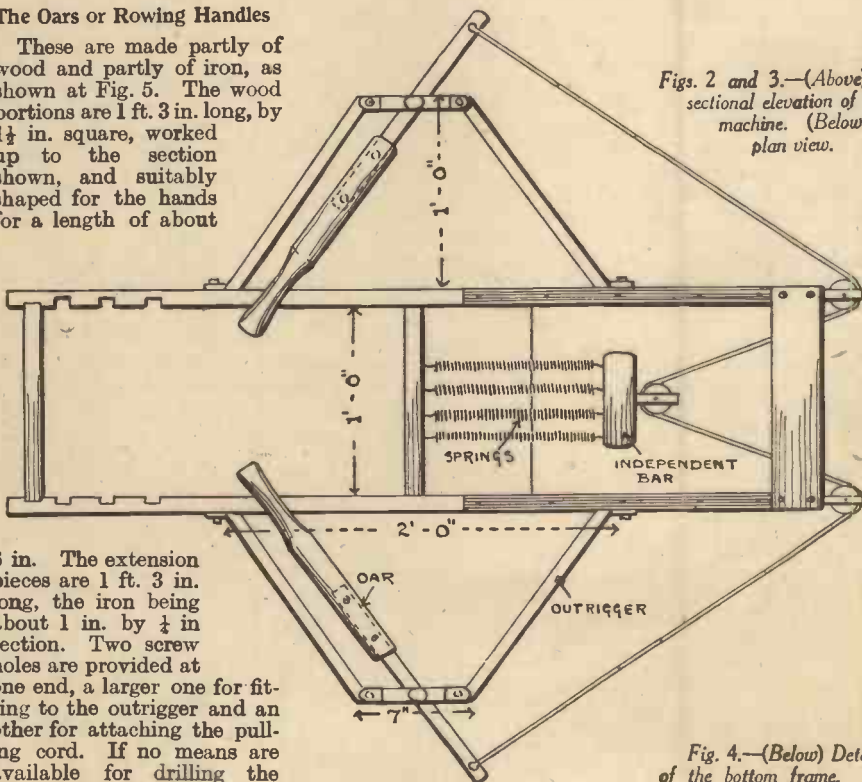

6 in. The extension pieces are 1 ft. 3 in. long, the iron being about 1 in. by ½ in. section. Two screw holes are provided at one end, a larger one for fitting to the outrigger and another for attaching the pulling cord. If no means are available for drilling the

Fig. 4.—(Below) Details of the bottom frame.

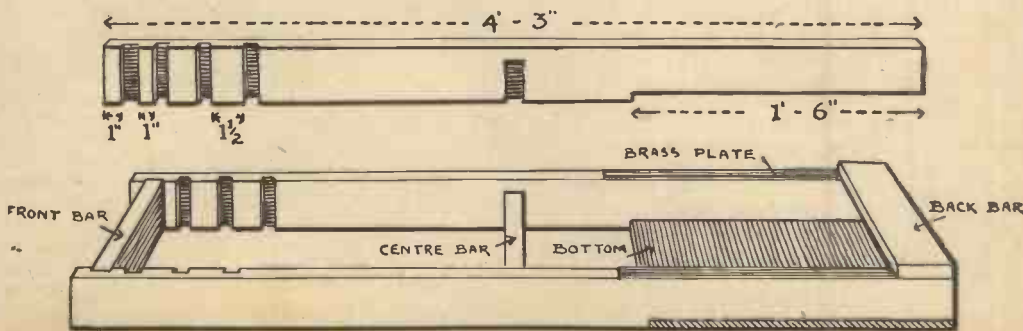

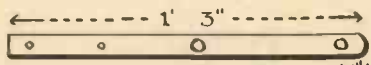

Fig. 5.—(Top Left)
The oars or rowing
handles.

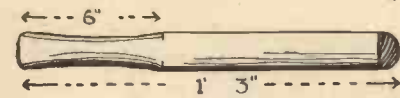

Fig. 6.—(Below) The
outriggers.

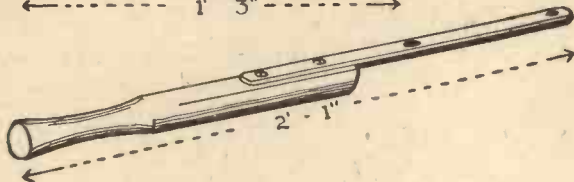

Fig. 8.—(Right) The
sliding seat.

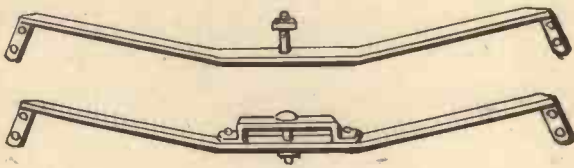
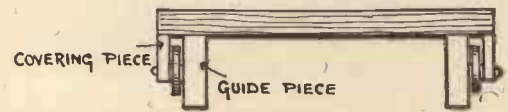

Fig. 7.—The footrest.



7 in. wide by $\frac{3}{4}$ in. thick is nailed on to complete the foot-rest. Small portions of the ends of the back are cleaned off level with the triangular pieces and front. It will be found that the machine will be worked easier if the feet are strapped to the foot-rest.

wide by 1 in. thick. Guide pieces 11 in. long by 3 in. wide by 1 in. thick are glued and screwed under the board 1 in. in from the ends. A spacing block 5 in. long by 2 in. wide by $\frac{1}{2}$ in. thick is fixed outside each guide piece, and outside this again a covering piece 11 in. long by 2 in. wide by $\frac{1}{2}$ in.

thick is fixed, the latter being screwed to the spacing block and through the seat. Small brass or iron wheels 2 in. diameter by $\frac{3}{8}$ in. thick are arranged to revolve between the guide and covering pieces, two wheels being placed at each side. Thin washers should be inserted on each side of the wheels, and screws are run through the covering pieces into the guide pieces to fix them. Small half-round battens could be nailed across the front and back edges of the seat to prevent slipping when the machine is in use. It is also a good plan

to arrange small brass plates on the top edges of the frame to take the wear of the wheels.

The Seat

The seat is made as shown at Fig. 8. The seat board is 1 ft. 2 in. long by 11 in.

to arrange small brass plates on the top edges of the frame to take the wear of the wheels.

holes, the iron may be heated and the holes punched. The iron extensions are screwed under the wood handles as shown in the illustration. The outriggers may be made in either of the methods shown at Fig. 6. Iron 1 in. wide by at least $\frac{1}{4}$ in. thick should be used, and they are turned up to the shape and dimension shown at Figs. 2, 3, and 6. The feet at the ends should be about $3\frac{1}{2}$ in. long, and provided with two holes for fixing to the sides of the frame with screws or bolts. A spill could be riveted into the centre of the straight portion of each outrigger, for attaching the oar, the end being screwed and fitted with a nut to prevent the oar working off. A more satisfactory method, however, is to fit a long staple above the straight portion of the outrigger, riveting it in place, and fitting a bolt through the staple and outrigger by means of which the oar may be fitted, the clearance between the staple and outrigger being sufficient to allow the oar to work freely.

The Oar Springs

The plan of the machine given in Fig. 3 shows the way in which the oars are connected to the springs, and the method of arranging the cord. The springs should be about 10 in. long of the kind used in gymnasium equipment, and they are attached by means of screw hooks to the centre bar of the frame, and to another independent bar at the other end, which should be from 6 in. to 8 in. long by 2 in. wide by 1 in. thick. Pulleys are fixed to the ends of the frame and to the independent bar, and the cord is run from the end of one oar over the pulley at the side of the frame to the pulley on the independent bar, then through the pulley at the other side of the frame to the end of the other oar. The number of springs and the length of cord may be adjusted to suit individual requirements, but it will be generally found that four springs as shown in the plan will be sufficient. Stout elastic may be used in place of the springs, but it will be less satisfactory and weaken quickly if the machine is used to any great extent. The foot-rest shown at Fig. 7 has a back 1 ft. $0\frac{1}{2}$ in. long by 6 in. wide by $\frac{3}{4}$ in. thick, made to fit into the trenches at the side of the frame. Triangular shaped pieces of wood, 4 in. high by $1\frac{1}{2}$ in. wide by $\frac{3}{4}$ in. thick are nailed $\frac{3}{8}$ in. from the ends, the top edge of the back is planed level with the triangular pieces, and a front 1 ft. long by

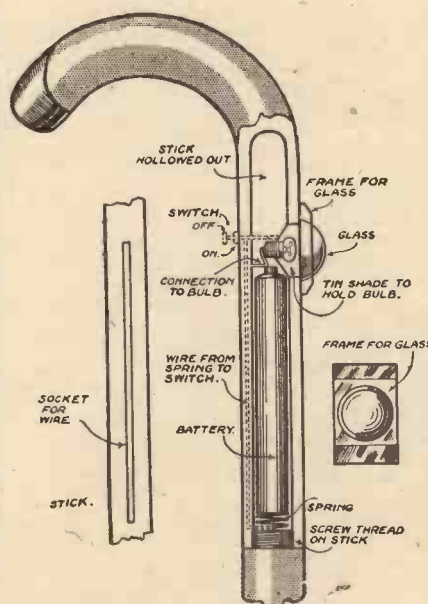

Details of the stick.

A FLASHLAMP WALKING STICK

THE illustration shows in part-section a walking-stick which has been adapted to carry a small battery and flashlamp bulb. It may be switched on and off by means of the small switch whilst in normal use, and will be found extremely useful to those who reside in unlighted streets. It will be seen that the stick has a screw-thread cut in its straight portion. The upper part is hollowed out to receive a pencil battery. A small frame for the bulb and glass is fitted to the front of the stick, and the connections are made as shown. A small spring is placed beneath the bottom of the battery to force it into contact with the electrical connection. No doubt many readers will be able to find from odd electrical apparatus the pieces necessary to adapt the stick in the manner here detailed, but in case they cannot, it is worth mentioning that small sockets complete with reflectors and lenses suitable for the purpose are obtainable from most electricians. The idea may also be adapted for other items of personal use, such as attaché cases, handbags, and so on. The diagram clearly shows all the connections.

A PELMAN TRAINED MIND

WHY, amongst the brainiest and most successful men and women in England to-day, are there so many Pelmanists?

Why does being a Pelmanist lift you right out of the rut?

The answer to these and to many other questions relative to *Your Success* and its assurance through Pelmanism will be found in the book, "The Science of Success," that is yours for the asking. Fill in the coupon below, post it to-day, and to-morrow your copy of "The Science of Success" will be sent you free of charge, post paid. In this book you will read thrilling accounts by Pelmanists themselves of how whole lives have been changed for the better by Pelmanism. Men and women in every walk of life have obtained undreamed-of success through taking this Course.

Your Unsuspected Self

Pelmanism teaches you to rely on yourself; develops the powers that win—courage, self-confidence, and cheerfulness. Every man and every woman has within himself and herself a mine of abilities and possibilities that lie dormant, ready to be brought into service through the proper training of the mind. This is no time to allow these qualities to remain hidden and unused! This is the time to bring them forth and to use them for the benefit of yourself, your dependents and your associates.

Pelmanism is an easy, pleasant, fascinating system of mind training and character building, based on sound psychological principles, plus over 35 years' experience of the Pelman Institute in developing the minds and personalities of over half a million men and women.

Pelmanism may be studied when and where most convenient to you, for the Course is taught by correspondence only. There are no classes to attend. Each student receives individual instruction. The needs and problems of each Pelmanist are considered and studied separately by highly trained, sympathetic, friendly instructors, who love their work. Under this understanding system even the most timid student gains self-confidence immediately.

A Famous Newspaper Owner

The head of a great newspaper must necessarily have a deep comprehension of the human mind. A successful publisher must know and understand all sorts and conditions of people. Therefore what he says is valuable. Read what the late Lord Riddell said of Pelmanism—"Pelmanism is rapidly becoming part and parcel of our daily lives," stated Lord Riddell, and then he told a little story that demonstrates the practical usefulness of Pelmanism in such a simple, yet such a convincing, manner that it is a real tribute to the practicability of Pelmanism. Lord Riddell continued in these words: "A friend of mine has the habit of marking documents which he reads in three different ways. Important passages he marks in blue: less-important passages in red: and the least important in black. The other day he sent for a document. It was brought to him by a new junior clerk, who had turned up the page containing the only passage marked in blue. My friend remarked, 'That is just what I want. How did you know?' 'Well, sir,' replied the clerk, 'you always mark your important things in blue.' 'That's true,' said my friend, 'but I never said so. Who told you?' 'No one; I just noticed it,'

answered the boy. 'You must be very observant,' said my friend. 'I don't think I am so naturally,' replied the clerk, 'but I've studied the Pelman System!' My friend at once took a Pelman Course. To-day he is an ardent Pelmanist."

The counterpart of Lord Riddell's story may be seen in the thousands of testimonial letters constantly received by the Pelman Institute from men and women glad to tell us of the progress, the promotion, the increased incomes they have achieved since becoming Pelmanists.

The Tidy Mind

Pelmanism banishes self-consciousness and nervousness, and helps you to so concentrate on the task in hand that you are bound to succeed in whatever you undertake. Pelmanism directs your energy, and prevents you from wasting it in useless conjectures and mind-wandering.

The Pelmanist has a tidy mind. He wastes no time looking for things or trying to remember where? when? what?

In other words, the Pelmanist does not bungle. He knows what he wants to do, and does it. His leisure time is not all cluttered up with half-formed projects, desires, memories. The Pelmanist keeps his mental house in order, and in consequence has time for his work (uninterrupted by day-dreaming), and after his work is done he has a healthy interest in some sport or hobby that refreshes and recreates his mind and body so that the time that he spends at his work is really productive.

The Pelmanist is courageous, cheerful, quick and accurate in his decisions. He is so interested and occupied with the business of life, its work, its pleasures, and the success he makes of it, that he has no time to spend on being morbid, timid, fearful.

France Honours the Pelman Institute

At the International Exposition of Applied Arts and Sciences held at Liège, in 1930, the Pelman Institute received the same awards and medals as were awarded to the University of Montpellier (one of the oldest Universities), the Normal School of Nancy, the Binet Society of Paris, and the Jean Jacques Rousseau Institute of Geneva. At the Exposition at Nancy in 1932 the Pelman Institute was awarded the Diploma of Honour. In March, 1933, the French Government conferred the Diploma of Honour and a medal on the Pelman Institute.

We shall be glad to send you a copy of "The Science of Success," 48 pages, post free. You can write us fully, or you can make just a bare application by using or copying the form below. In any case your enquiry will be regarded as a confidential communication.

To the Pelman Institute,

130 Pelman House, Bloomsbury Street, London, W.C.1.

Please send me, free and post free, a copy of "The Science of Success," with full particulars of the Pelman Course.

NAME

ADDRESS

Occupation.....

PELMAN (OVERSEAS) INSTITUTES: PARIS: 80 Boulevard Haussmann. NEW YORK: 271 North Avenue, New Rochelle. MELBOURNE: 396 Flinders Lane. JOHANNESBURG: P.O. Box 4928. DURBAN: Natal Bank Chambers (P.O. Box 1489). CALCUTTA: 102 Clive Street. DELHI: 10 Alipore Road. AMSTERDAM: Damrak 68. JAVA: Malabarweg, Malang.

FOR THE YOUNG AND THE OLD
A Practical Course for practical men and women who have in most cases to earn their own living.

There is no such thing as an age limit for the study of Pelmanism. While many young people find a course of Pelmanism the greatest aid in their studies, and a wonderful help in preparing for examinations, and in passing them successfully, many men and women who have long since passed into the autumn of their lives have discovered renewed interest, and, indeed, many say, a mental rejuvenation in Pelmanism.

Remember this: If there is anything you want, such as an increased income, success in your examinations, promotion in business, the professions, or the Services, greater social success, or a general improvement in yourself, your mind and body, your will to have this improvement, plus Pelmanism, will assure you of it.

Sir Herbert Barker

A well-known advocate of Pelmanism says:—

"The world owes an enormous debt of gratitude to the inventors of the Pelman System for discovering a means, so easy and pleasant, by which the Nation's mental equipment can be brought to its very highest possible pitch of efficiency and maintained there.

"I know of no other method to compare with it.

"Benefit Beyond Computation"

"The system brightens our outlook on the glorious possibilities of life; strengthens and quickens our memory and understanding; gives coherence and clarity to our thoughts, and enhances, unbelievably, our capacity for intellectual enjoyment and usefulness.

"I am convinced that benefit beyond computation can be secured by all—whether the student be nineteen or ninety—who will follow the directions given in the Course."

Pelmanism is exceedingly simple and interesting, and readers who would like to know more about the subject should write to-day for a free copy of "THE SCIENCE OF SUCCESS." You can obtain a copy of this book, *free and post free*, by writing to the

Pelman Institute,

130 Pelman House, Bloomsbury Street, London, W.C.1.

Call or write for this free book to-day.

Readers who can call at the Pelman Institute will be welcomed. The Director of Instruction will be pleased to have a talk with them and no fee will be charged for his advice.

A FINE INVESTMENT FOR THE PRACTICAL MAN

"PLUMBING & DOMESTIC ENGINEERING"

MORE THAN
1,500
PICTURES

Some of the largest firms in the various industries have allowed their technical experts to contribute to the work, and permitted our photographers to take a large series of action photographs.

"PLUMBING AND DOMESTIC ENGINEERING" is a completely accurate and fully up-to-date guide on the work and problems of the PLUMBER, the GAS FITTER, the DOMESTIC ENGINEER, and the HEATING and VENTILATING ENGINEER.

The information is presented in a practical manner and abundant use has been made of illustrations, both photographs and line drawings and diagrams.

A staff of no fewer than 30 specialist contributors has been gathered together to give of the very cream of their knowledge and experience.

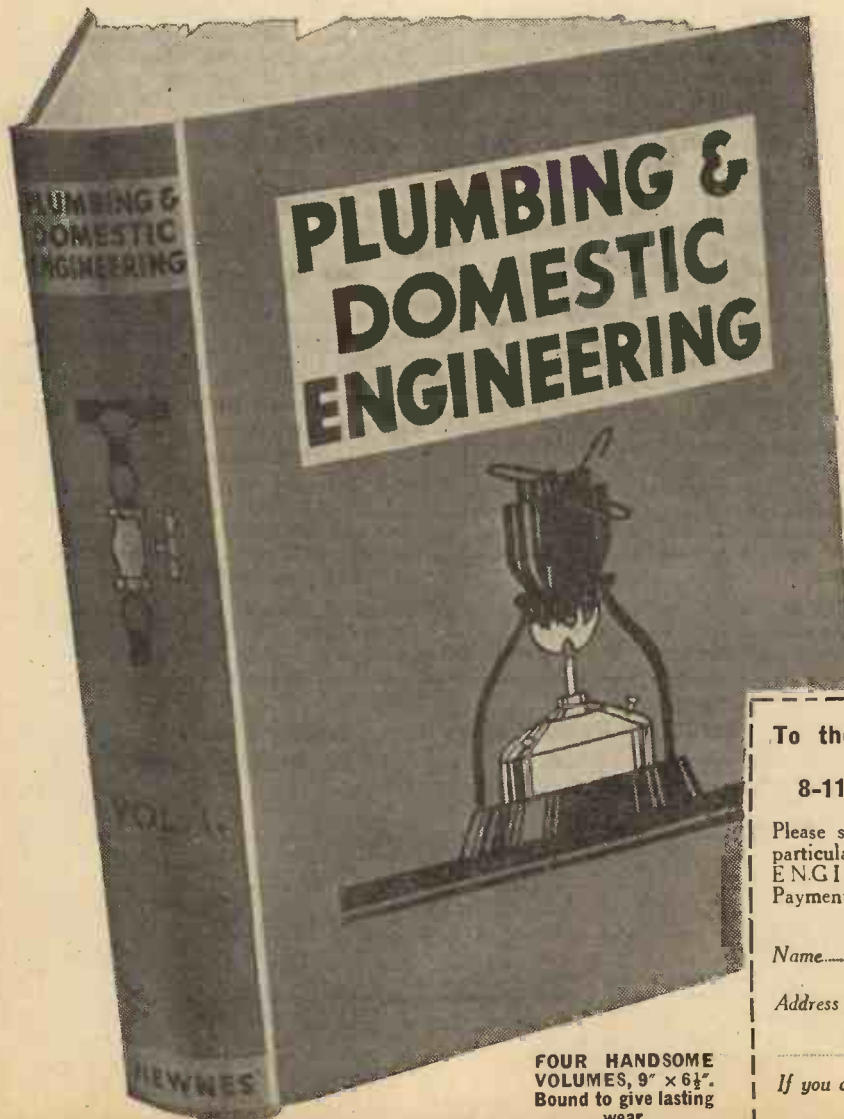

Here are just a few representative chapter headings to illustrate the comprehensive nature of the work:—

Installing Electrically driven Pumps for Country House Water Supply. Electric Water Heating. Installing an Immersion Water Heater. Installing Electric Heaters. Panel Wiring. Electric Wiring for Domestic Lighting, Heating and Power. Electric Refrigerators. Erecting Conduit Wiring Systems. Wiring a Pair of Semi-detached Houses for Electric Light and Power. Modern Ventilation of Buildings. Systematic Examination of the Domestic Services. The Drainage of Buildings. The Law Relating to the Drainage of Buildings. The Construction of Sewage Drains. Jointing and Supporting Stoneware Drain Pipes. The Planning and Construction of Apartments for Soil Fittings, Water-closets, Urinals and Slop Sinks. Installing Sump Pumps. Installation of Boilers, Tanks and Cylinders for Hot-water Supply. Installing a Hot-water Supply System in a Typical Factory. Heating Boilers and their Erection. Color Heating Plant for Country Districts. The Ventilation of Gas Appliances. Chemical Plumbing. Sheet Lead Working. Sheet Metal Working. Water Heating on Shipboard. Useful Calculations, Rules and Tables. General Workshop Arithmetic and Mensuration. Preparation and Interpretation of Specifications. Estimating for Plumbing Work. Business Methods for the Master Plumber. Etc., etc.

Post Coupon Below
for FREE Booklet

To the HOME LIBRARY BOOK COMPANY
(George Newnes, Ltd.)

8-11, Southampton Street, London, W.C.2.

Please send me, without any obligation to purchase, full particulars of PLUMBING AND DOMESTIC ENGINEERING and details of your scheme of Easy Payments with immediate delivery.

Name

Address

P.M., OCT., 36

If you do not wish to cut your copy, send post card mentioning "Practical Mechanics" to address above.

FOUR HANDSOME
VOLUMES, 9" x 6½".
Bound to give lasting
wear.

Masters of Mechanics

No. 14—Pioneers of the Steamboat

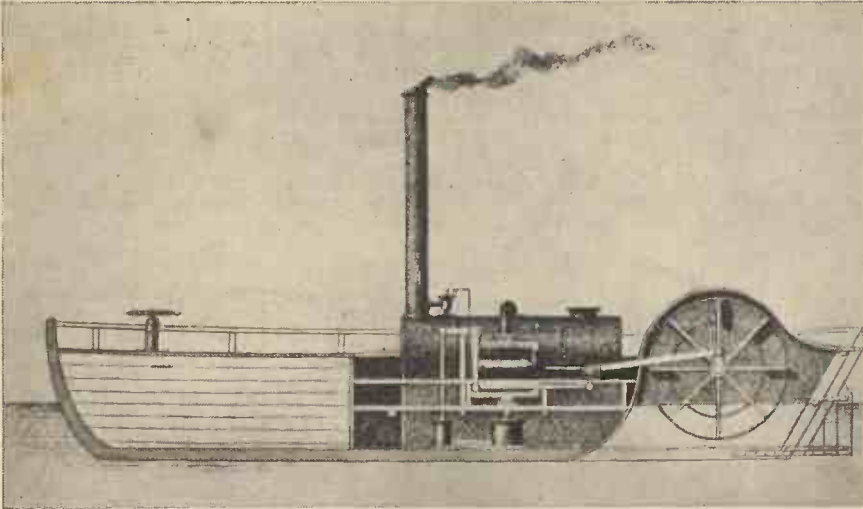

A sectioned drawing of the world's first practical steamboat, the "Charlotte Dundas," built by William Symington in 1801.

THE first individual, Jonathan Hulls by name, who ever attempted to propel a sailing vessel by means of steam power completely failed in his efforts. Years after his death, even, the following doggerel rhyme, expressive of the local derision in which Hull's pioneer steamboat trials were held, went the rounds in his native county of Gloucestershire:

*Jonathan Hull
With his paper skull
Tried hard to make a machine
That should go against wind and tide:
But he, like an ass,
Couldn't bring it to pass,
So, at last, was ashamed to be seen!*

Hulls was probably a pioneer before his time and he apparently met with the traditional fate of all such originative minds. He died—so far as we can ascertain—about the middle of the eighteenth century, but long after he had given up all attempts at the construction of a practical steamboat.

An Outbreak of Activity

The closing years of the same century witnessed quite an outbreak of activity in the direction of attempts at practical steamship building. The time had now become ripe for the rise of the steam-propelled vessel. The world's overseas commerce was rapidly extending in all directions. The newly-evolved steam-engine had been made practicable. It only needed someone of sufficient inventive ingenuity to design and construct a steam-engine suitable for propelling a boat and, also, to build a vessel capable of accommodating the engine and its necessary supply of fuel. Thus it was that towards the close of the eighteenth century many attempts at steamboat construction were made not only in Britain, but in France and in other countries.

The first inventor to obtain really practical success in the construction of a steam-propelled vessel was William Symington, a Scotch mining engineer. Symington was born at Leadhills, Lanarkshire, in October, 1763. In 1786, Symington appears to have been struck for the first time with the idea of constructing a steam-engine which would be capable of propelling a sailing vessel by means of paddle-wheels. He immediately got to work and produced a working model

of a ship. The model was supported on four wheels, two of which were rotated by means of a small steam-engine placed inside the ship. The model was exhibited at Edinburgh in the summer of 1786 and it caused something of a minor sensation. Among the many interested individuals who visited Symington's exhibition was a certain Patrick Miller who, himself, had made a number of furtive attempts to construct a

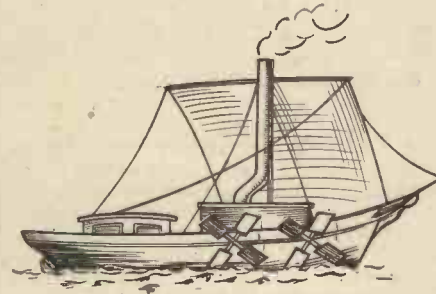

The "Comet" from an early sketch.

steam-propelled vessel. It was a fortunate meeting, for Miller, who was full of ideas, had little constructional ability. The two pioneers, in some measure, joined forces and, as a result, Symington built a steam-vessel which, in 1788, was successful in

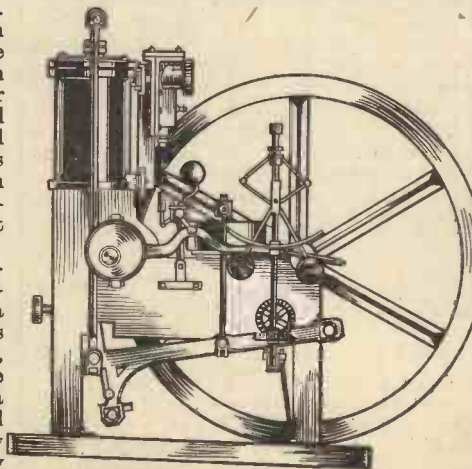

The engine of Bell's "Comet."

negotiating Dalswinton Loch at the rate of some five miles per hour.

Fell to Pieces

At a later date, the same vessel was tried out on the Forth and Clyde Canal. It went through its paces successfully, but the vessel was a slightly-built one, and, eventually it fell to pieces. At this time, Miller, although an individual of considerable wealth, found that his resources could not withstand the continual drains upon them which steamship construction had brought about. Symington, of course, had no financial resources at all and, in consequence, the progress of steamship construction at Symington's hands ceased.

In 1801, Symington found a patron in Lord Dundas who commissioned him to build a steam-propelled vessel for river sailing and, in particular, for acting as a tug for dragging canal boats. The vessel was quickly constructed and it was named *Charlotte Dundas*. It was 56 ft. long and, at the stern, there was an open channel in which the paddle-wheel revolved. Rudders were placed at each side of this channel and they were controlled by means of a series of iron rods.

A 10 h.p. condensing engine supplied the necessary power. The engine, which was one of horizontal pattern, lay on the deck of the vessel. Its connecting rod worked directly the crank of the paddle-wheel.

The "Charlotte Dundas"

The *Charlotte Dundas* was extraordinarily successful and its trials were witnessed by many interested persons. Lord Dundas, however, found himself unable to get the canal proprietors to take up the idea of steam-propelled tugs. Hence, no more orders for steam vessels were forthcoming. Berit of the necessary financial support for his inventions, Symington gradually sank into the obscurity of poverty. He migrated to London, where he died in 1831, almost a pauper.

Among the individuals who witnessed Symington's *Charlotte Dundas* trials was one Robert Fulton, an American, who was an artist by training but an engineer by inclination. Fulton, apparently, made no pretence of the fact that he was there to copy whatever ideas he could from Symington and, strange as it may seem, the generous Symington did not hesitate to give the American all the information he desired.

The Launching of the "Clermont"

The eventual upshot of Fulton's visit to Britain was the launching of the *Clermont* on the Hudson river, in August, 1807. During its construction, the *Clermont* had been termed "Fulton's Folly," but its success at its trials fully justified the faith which its constructor had in the practicability of steam navigation. It was not long before the *Clermont* began to ply regularly as a passenger vessel between New York and Albany and, gradually, other steam vessels of a similar pattern were introduced on the same river.

Fulton did not live long to witness the

triumphs of his steamship pioneering activities. He died in 1815.

Although Fulton, on his own admittance, obtained his basic ideas concerning steam navigation and steamvessel construction from Symington and others, and, on that account, was no originator or inventor in that particular line, he must, however, rank among the very first of the world's steamship pioneers, for it was solely in consequence of his activities that the steam-propelled vessel was introduced to America. Fulton's vessel, the *Clermont*, for instance, was not only America's first steam-propelled ship, but, it was also the first steam-driven boat to ply regularly for hire. It was, in short, the world's first steam-propelled passenger vessel.

The third member of our trio of steamship pioneers is in some respects the most important of them all. He is Henry Bell, a Scotch millwright and a native of Linlithgowshire. Bell, although he received very little education in his youth, had that peculiar inborn mechanical and engineering bent which is the invariable possession of the engineering pioneer. In his early days, Bell set up for himself as a practical engineer, but lack of funds brought about his failure in that direction. He was forced to take work as a carpenter in Glasgow in which trade he gained the reputation of being a bad workman and of being too much of a schemer.

Henry Bell

When Robert Fulton, the American steamship pioneer, witnessed Symington's trials of the *Charlotte Dundas*, Bell seems to have accompanied him. It would also appear that Bell carried out some correspondence with Fulton after the latter returned to America, for writing on the subject years afterwards, Bell remarked: "This led me to think of the absurdity of writing my opinions to other countries and not putting it in practice myself in my own country; and from these considerations I was roused to set on foot a steamboat for which I made a number of different models before I was satisfied."

Whether or no Bell proved to be an efficient carpenter, he managed to get together a little money which he and his wife expended in the establishment of a hotel and bath-house at Helensburgh, then a little village on the Clyde. Mrs. Bell, enterprising as her husband, managed the hotel, whilst Bell himself found time to think out his steam-vessel schemes.

Visitors were brought to Bell's hotel on "passage-boats" which were, in reality, large rowing-boats. Bell, his mind long full of the idea of steam navigation, soon conceived the notion of constructing a paddle-wheel vessel driven by steam to replace the aforesaid rowing-boats. He gave publicity to his schemes and he was laughed at for his notions. Bell's idea of paddle-steamers on the Clyde appeared really humorous to the people of the time and, around Helensburgh, it became almost a standing joke.

Despite everything, however, Bell persevered with his ideas. Finding himself the possessor of increased funds as a result of the success of his hotel on the Clyde, Bell, in 1811, had built at a local works a boat of some twenty-five tons displacement. This he equipped with a 4 h.p. engine of his own design. He named his newly created steam vessel *The Comet*, partly because a comet had at that time appeared in the north-west of Scotland and partly because the name gave the idea of speed.

A Success

Bell's *Comet* was 40 ft. long and it was propelled by paddle wheels placed at each side of the vessel. The engine of the vessel ran steadily and smoothly and it was altogether more robust in construction than had been the engines employed by William Symington and other steamboat builders.

The *Comet* proved immediately successful from a practical standpoint. In January, 1812, it began to ply regularly on the Clyde between Glasgow and Helensburgh. At first few passengers would entrust themselves on the vessel. Gradually, however, the essential safety and trustworthiness of a steam-propelled vessel began to be realised by the public and Bell's *Comet* gained enormous popularity.

In the succeeding year, Bell took his steam vessel off the Clyde and sent it on a tour round the coast of England. By the

chased for him. Such a pittance, however, was all the reward which was granted to the man who initiated and fostered on the Clyde the now enormous industry which has made the name of that river famous in maritime circles the world over.

Worn out by disappointment and privations in his latter life, Bell died in 1830 at the age of sixty-three, a victim, one might say, of his own originality of mind.

It was not until 1838, eight years after Bell's death, that the first British steamship, the *Sirius*, crossed the Atlantic between London and New York, making the complete passage in seventeen days, although, previously, the *Savannah*, an American vessel, constructed along Fulton's lines, had, in 1819, crossed from New York to Liverpool. The *Savannah's* voyage, however, was only partly carried out by the power of steam, due use being made by the vessel of its equipment of sails.

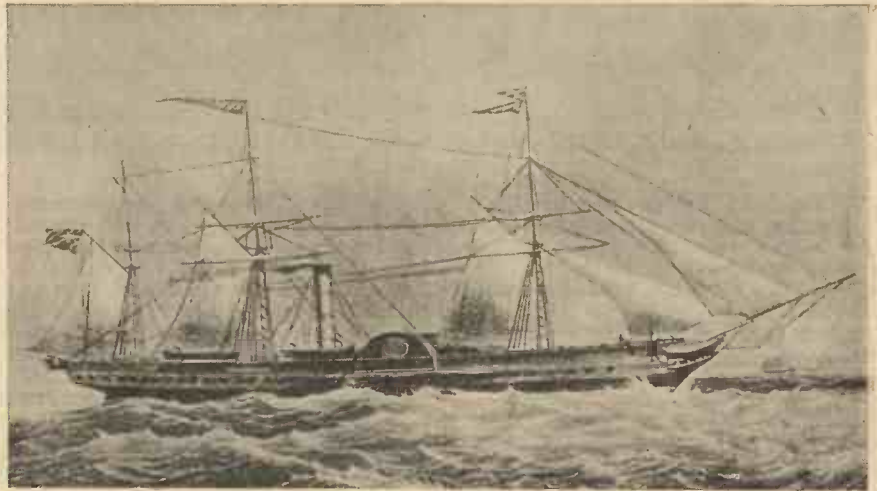

One of the earliest Atlantic-going steamships. S.S. "Caledonia" (1840), one of the first four steamships of the Cunard Company.

public mind, however, it was regarded more or less as a freak; yet there were not wanting individuals who saw in it the beginnings of a new order in matters mercantile and, furthermore, the commencement of a new shipbuilding industry.

The *Comet* was the Clyde's first steamship the first member of a long line of steam-vessels which, in our day, has culminated in the magnificent *Queen Mary*, and the still more gargantuan sister ship of the latter vessel which is being planned.

Unfortunately, however, Henry Bell, the pioneer, with William Symington, of steam navigation and steamship construction, met, like the latter inventor, the seemingly most unjust fate of the originator.

In 1820, the *Comet* was lost during a voyage between Glasgow and Fort William. In the following year another of Bell's steamships caught fire and was burnt almost to the water-edge. As a result of these two mishaps, Bell's resources were depleted to the extent of more than £3,000. Rival shipbuilding concerns which had arisen, having greater command of capital, rapidly drove Bell out of the shipbuilding field and, gradually but surely, the Clyde's first steamship projector sank lower and lower into the mire of want and acute poverty.

First British Steamship Crosses the Atlantic

Bell, indeed, would have ended his days in a condition of utter starvation if it had not been for the conscience of certain Clyde trustees and a subscription among friends which enabled a small annuity to be pur-

INTERESTING NOTES

The Therm and the Unit

THE therm and the unit mean little to the layman. Actually a therm of gas when burnt gives 100,000 British Thermal Units of heat. A unit of electricity, by passage through a suitable resistance circuit, can be converted into 3,413 British Thermal Units. Thus 29.3 units of electricity are equivalent to a therm of gas on a heat basis. The case for gas is not quite so good as this. Electricity can be converted into heat with about 95 per cent. efficiency. The efficiency of gas varies with the amount of heat which is lost up the ventilating flues. Where there is no flue loss as in convective gas heaters and high-efficiency industrial recuperative furnaces, the efficiency figure is round about 90 per cent. Water heaters are 80 per cent. efficient, gas fires and cookers about 50 per cent. Roughly speaking electricity has to be quoted at one-third of a penny a unit, to meet gas at 8d. a therm.

A Real Death Ray

THE death ray has at last emerged from the realm of fiction in the shape of ultra-short wireless waves. The Radio Society of Great Britain has been experimenting with the discovery of a Danish engineer, that ultra-short wireless waves kill insects, and destruction of bacteria is also claimed for them.

OUR READERS AT WORK

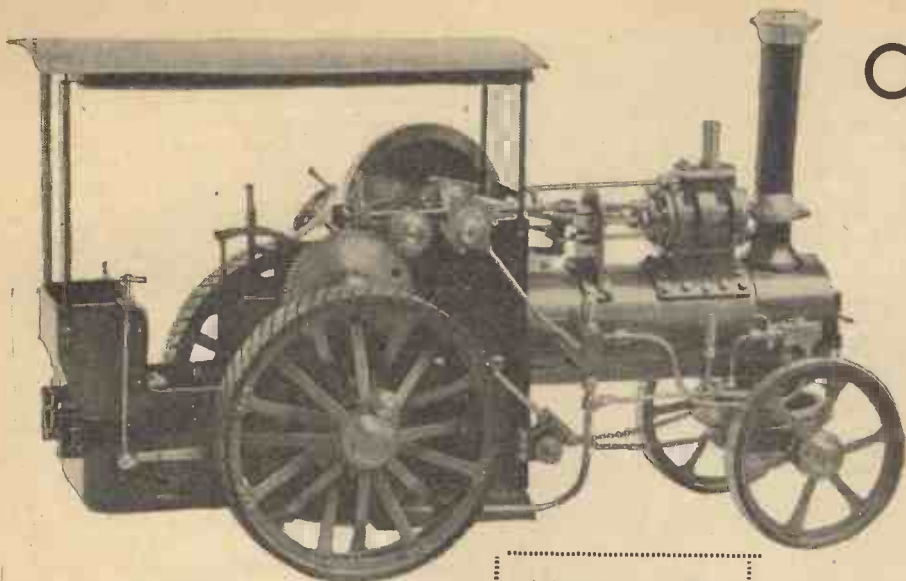

The Illustrations on this page were submitted by Readers of this Journal. We Invite Interested Readers to submit Photographs of any Models, etc., they have made, for Reproduction in these pages.

A 1½-in. scal working model of a Traction Engine made by Mr. J. E. Rushton.



A rotary lawn mower made from a Villiers two-stroke engine. Submitted by Mr. J. E. Rushton.



Mr. J. Rorie seated at the wheel of his £20 car designed by Mr. F. J. Camm and described in these pages. Mr. Rorie states that the car is a great success.

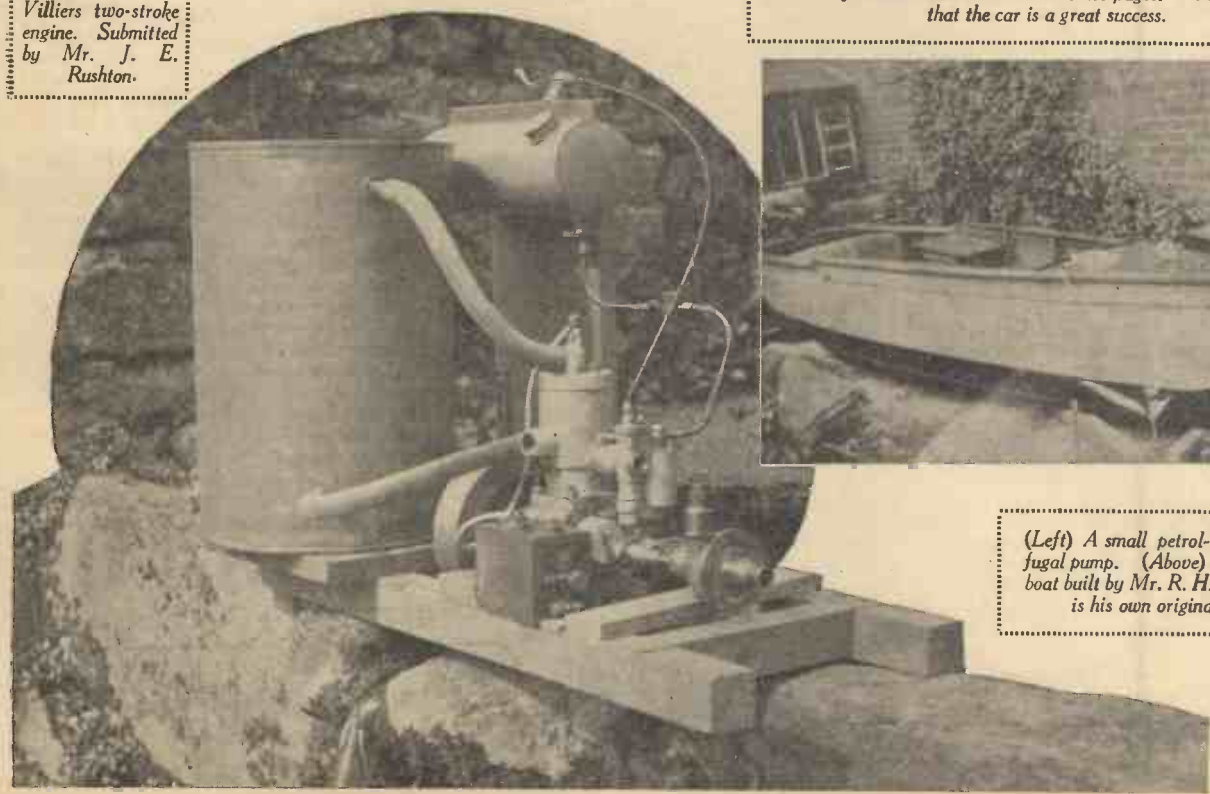

(Left) A small petrol-driven centrifugal pump. (Above) a 16-ft. speedboat built by Mr. R. H. Saxon. It is his own original design.

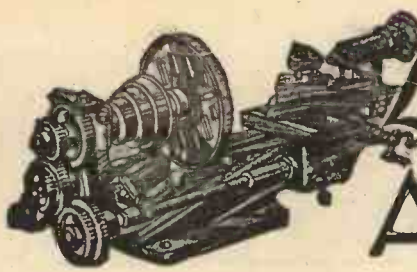

Lathe Work FOR AMATEURS.

LATHE CENTRES

THERE are a good many forms of lathe centres for various kinds of work and some notes on the types of these and their special uses may be of interest. The general type is shown in Fig. 1. Some points about this simple device may be useful. The standard cone has a taper of 1 in 20, which is a Morse standard, so that, in the case of a lathe mandrel having been inadvertently bored into (in doing face-plate work) a Morse standard reamer may be used in a Morse socket held in the barrel of the tailstock and fed into the mandrel very carefully and with plenty of lubricant and any damage reduced.

Similarly, when a tailstock barrel taper has been damaged (a very unusual occur-

no rotation upon it—does not act as a bearing as does the tailstock centre—it is common practice to leave the headstock centre soft—or as soft as the unannealed cast steel leaves it after turning. In this case no grinding becomes requisite.

To enable the centre to be readily withdrawn it should have a couple of flats filed or milled upon it as shown at *AA* in Fig. 1, and these should be at such distances apart from each other as to fit a standard spanner. Both headstock and tailstock centres should be fashioned to suit the same rigid spanner.

The Top Slide

In setting the top slide to cut the requisite taper, mount a Morse taper—shank

The tailstock centre for woodwork is shown in side and end view in Fig. 3. The centre pip *A* locates the work and the ring *B* prevents the work being pushed off the centre—dotted lines show the shape of the centre pip and steady ring *B*.

In some case a running centre is advisable. This is shown in Fig. 4. The centre is hollow and carries a spindle *A* which fits it along the parallel part from *X* to *Y*. The bore is then flared out and ends in a ball race *B* and the spindle *A* is formed with a corresponding ball race at *C*: this takes the thrust and the spindle is held up by a washer and two lock nuts *D* at the tail end. An oil hole should be bored at *E* so that the parallel part can be lubricated.

Such a ball centre at the tailstock end ensures against damage to the work or the chance of it being worn by the rotation and becoming loose between centres.

Running Centre

A simpler type of running centre is shown at Fig. 5. Here the body is of phosphor bronze and the running centre is reduced from *X* to *Y* to form an oil chamber. *A* hole, as shown, is drilled for introduction of the lubricant and the shoulder at *A* should be nicely rounded as shown.

In metal work it is sometimes necessary to centre a piece in which it is not possible to have a centre hole. In such cases a female centre is used as shown in Fig. 6. This may be for either the headstock mandrel or the tailstock barrel or both. It

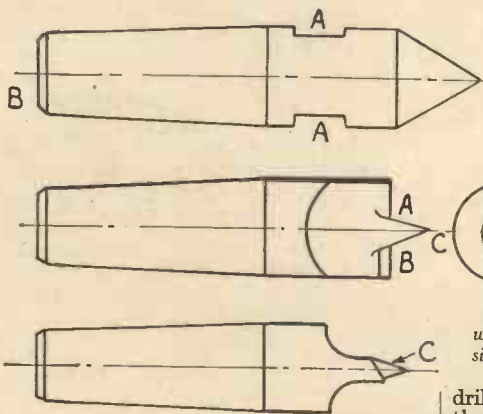

Figs. 1 and 4.—(Left) The general type of lathe centre. (Right) A running centre.

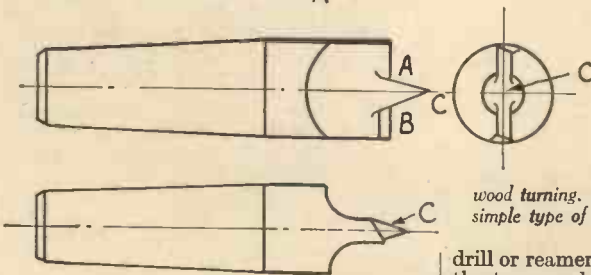

Figs. 2 and 5.—(Left) A lathe centre for hard-wood turning. (Right) A more simple type of running centre.

rence), a Morse taper reamer carried in the taper of the mandrel may be used to clear it. Since the taper is such that the reamer is likely to bind, it should be traversed up very carefully, cutting very finely, and for this reason it is best to pull the mandrel round by the belt and not to use power for the operation.

Hardened Tailstock

The tailstock centre must be hardened. But it is not necessary to harden the headstock centre unless there is available means for grinding it true in position after hardening. There is always a chance of a centre warping when hardening and tempering it. This would be fatal to accurate work in the case of the headstock centre and since it has

drill or reamer in the three-jaw chuck, with the taper end projecting, and use this as a guide for setting over the top slide. Note that Morse tapers over No. 3 size (that is .778 in. at the small end) have a taper of or exceeding .5191 per in. so that it is best to use the No. 1 taper which is dead .5 in. or 1 in 20, the standard for lathe centre tapers.

But the taper shank must run true before setting the top slide to it. The end of the taper should be chamfered as shown at *B*. This is to ensure against the end of the shank of the centre damaging the taper bore.

In the case of hard-wood turning, such as is often necessary in pattern making, the headstock centre has to drive the work and is formed as shown in Fig. 2. The centre and pip is turned circular first and then the chisel edges *A* and *B* (Fig. 2) are filed along and the back clearance filed. These edges give the drive while the centre pip *C* centres the work.

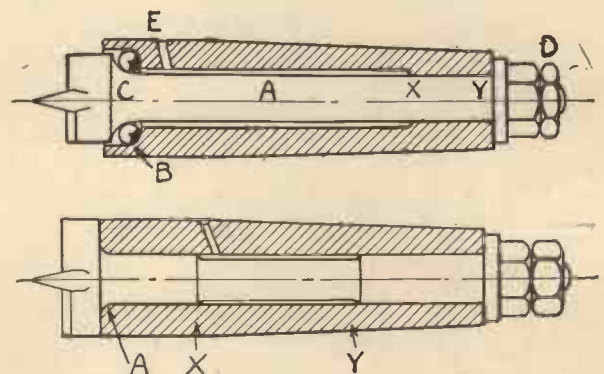

Figs. 3 and 6.—(Left) A tailstock centre for wood-work. (Right) A female centre.

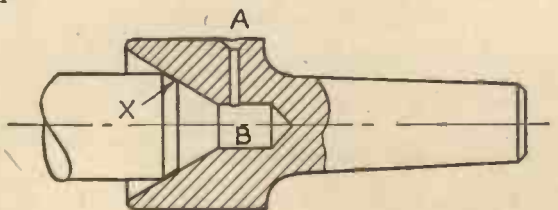
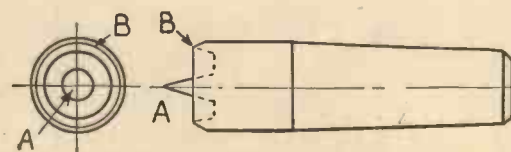

should be hardened inside the cone and, to avoid risk of warping and so going out of truth, it is a good plan to make these female centres of Bessemer steel and case harden the internal cone with "Kasenit," giving it a good soaking at a full yellow red heat with the Kasenit powder melted upon it and then quenching in salt water.

In using such a centre the work should, if possible, be provided with a fair width of chamfer at *X* to exactly the same angle as the internal taper in the centre, which could conveniently be an included angle of 90 degrees as shown. In the case of the headstock centre of this kind it is not necessary to case harden it. Provision should be made in the case of the tailstock centre to apply oil while the work is between centres, since the bearing surface is large. An oil

MAKE EXTRA MONEY IN YOUR SPARE TIME!



Finest Sheffield Tools
 ONLY are included in the New and Improved G.T.L. Tool Chest making it better value than ever.
 ALL BEST BRITISH

With the NEW AND IMPROVED

G.T.L. TOOL CHEST

and Home Repairing Outfit

The New and Improved G.T.L. Tool Chest

YOUR spare time, during the long winter evenings, can be turned to good account if you've a G.T.L. Tool Chest and Home Repairing Outfit. With it you can make a thousand-and-one useful articles for your home and garden, and it opens up a new and inexpensive way of adding to the comfort, convenience and amenities of your property, while saving you literally pounds a year in repairs for which you would otherwise have to pay. Incidentally, it also affords a new, pleasurable way of adding to your income by making articles to sell. So that—with a G.T.L. Tool Chest—instead of spending money in your leisure hours, you will be making it, saving it and enjoying it!

The new G.T.L. Chest for 1936-7 has been vastly improved by the inclusion of additional Tools and improvements to existing ones. Now there are over fifty high-quality articles, all the finest Sheffield Tools, neatly fitted in steel clips, and they come to you direct from the manufacturers after being carefully tested. Everything for every purpose is here, and the G.T.L. Tool Chest stands alone in its quality, completeness and arrangement. This Chest is the original and only G.T.L. Guaranteed Tool Chest.

NO EXPERIENCE NEEDED

A Few Shillings brings you the G.T.L. Tool Chest on 7 Days' Approval at once
 A first payment of a few shillings and the G.T.L. Tool Chest is sent at once to your Home CARRIAGE PAID and packing free. The balance can be paid by small monthly sums to suit your pocket; meanwhile the G.T.L. Tool Chest is making money for you.

A valuable FREE BOOK OF INSTRUCTION, containing over 200 working illustrations, is included in the G.T.L. Tool Chest. If you have never handled a tool, you CAN be sure of immediate success, because this book tells you what to make and shows you step-by-step how to make it.

G.T.L., 12-13 CHISWELL STREET, LONDON, E.C.1.

FREE To Readers of "PRACTICAL MECHANICS"

A Beautiful 16-page BROCHURE describing the G.T.L. GUARANTEED TOOL CHEST and Home Repairing Outfit in detail, and telling how you can save and make money—as tens of thousands of others are already doing.

POST THIS COUPON NOW

To GUARANTEED TOOLS LTD., 12-13 CHISWELL STREET, LONDON, E.C.1

Please send me by return, free of all cost and obligation, your beautifully illustrated booklet of the G.T.L. Guaranteed Tool Chest and Home Repairing Outfit, together with particulars of price, and how I can obtain it at once for a small first payment. (PLEASE WRITE CLEARLY.)

Name

Address.....

P.M.1/10/36

½d. stamp is sufficient if in an unsealed envelope.

WIZARD POWER TOOLS

for the Cabinet Maker, Carpenter,
Model Maker, etc.

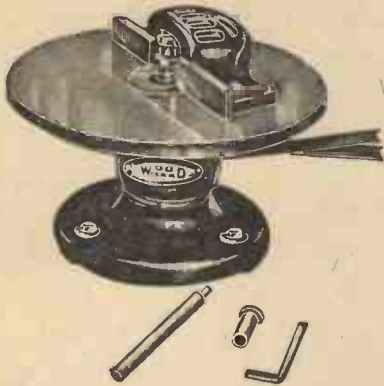

Illustration shows our 10 in. Ball Bearing Shaper
£4 - 18 - 6

Write for illustrated priced catalogue No. 136C. of Jig Saws, Circular
Saws, Band Saws, Lathes, Jointers, Shapers, Drill Presses, Grinders,
Buffers, Sanders, Tools, and Accessories.

WIZARD MACHINERY Co.

13 VICTORIA ST., LONDON, S.W.1

Telephone: ABBEY 3018

AT LAST!!!

"DETECTARAY"

An extremely reliable and
sensitive Photo-electric Cell.

For only 5/-

The product of very extensive research and experiment, having innumerable uses—Sound film reproduction, signalling, counting, colour matching, burglar alarms, advertising, etc. Does not need expensive apparatus, merely a simple amplifier and relay, full details of which are packed with every "Detectaray" cell. Fully guaranteed for 12 months. The Jefferies Bentham "Detectaray" has a unique method of mounting, being similar in appearance to the ordinary 5-amp plug-top. Remember. Only 5/- Postage 3d.

From JEFFERIES, BENTHAM & CO., Trade enquiries
Wades Lane, Teddington, Middlesex. invited.

MODEL PETROL ENGINES

AERO. MARINE. STATIONARY

From 6 cc. to 80 cc.

Prices:

£3.3.0 to £20.0.0

Castings 10/6 to £3.3.0 per Set

Write for catalogue of HALLAM ENGINES. Price 6d.

J. HALLAM & SON

ENGINEERS, POOLE, DORSET

engineering

Our NEW ENGINEERING GUIDE explains clearly how all the best jobs are secured. It shows how to obtain such money-making qualifications as A.M.I.C.E., A.M.I.Mech.E., A.M.I.W.T., A.F.R.Ae.S., etc. How to secure permanent, progressive and pensionable posts in the Government and Municipal Service, and describes numerous "Higher-pay Courses" in CIVIL, ELECTRICAL, MECHANICAL, AUTO and AERO-ENGINEERING; TELEVISION, TALKIE-PICTURE WORK, etc.

SUCCESS—OR NO FEE

We definitely guarantee success. If you fail your examination, or if you are not satisfied in every way with our service, then your full tuition fee will be returned without question.

Write to-day for this remarkable publication and details of our employment service, etc.

NATIONAL INSTITUTE OF ENGINEERING
(Dept. 29), Staple Inn Bldgs., High Holborn, London, W.C.1



ECONOMIC ELECTRIC CO.

TWICKENHAM, LONDON, S.W.

GENERATE YOUR OWN CYCLE LIGHT

and forget all lamp trouble. A fully guaranteed complete set, absolutely foolproof:—comprising heavily plated Head and Rear Lamps, foolproof Dynamo, connections and spare bulb.

NOTE THE PRICE 12/6 Post 7d.



ELECTRIC ENGRAVER. A high-quality instrument not to be confused with the cheap and nasty type. Our engravers do the job. Price 30/6.

Tattooer, open type, 21/6.

Good quality **ELECTRIC SOLDERING IRONS** with 5 interchangeable copper bits. A sound job. Price 4/6. Post 4d.

SHOCKING COILS. Complete with handles. Prices 2/6, 5/6, 9/6.

LIST.—Now that the long, dark evenings are upon us, you will be thinking again of your winter hobby and workshop. Our List contains 70 pages, fully illustrated, of all that you are likely to require—Meters, Motors, Telephones, Coils, Fittings, Transformers and parts, Lighting Sets, Tools and Workshop Material. It costs 6d. to print, but we send it to you for 2d. post free.

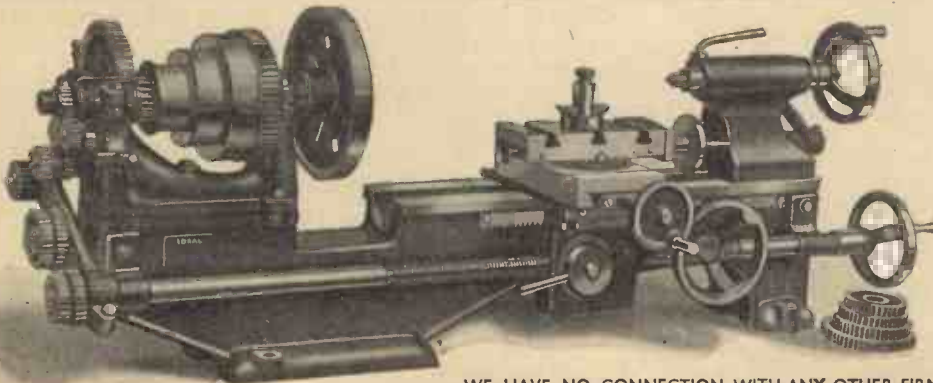

WE HAVE NO CONNECTION WITH ANY OTHER FIRM
AND ALL LATHES SOLD BY US ARE IDEAL LATHES.

"IDEAL— LATHES"

3½ in. S.C.B.G. from £7/18/6

THE IDEAL JUNIOR DE LUXE 3" LATHE.

S.C.B.G. Comp Rest. Quick return to Saddle. Full divided Nut to apron. Price £6/17/6.

IDEAL bench milling machine.
DEFERRED TERMS ARRANGED

LISTS—Stamp please.

J. WILLIMOTT & SON
Neville's Factory,
Chilwell, Notts.

hole is shown at *A*; it should lead into the clearance space *B* and not to the surface of the cone, in which case it might get obstructed by the work and sufficient lubricant could not be introduced.

Long Tapers

In turning long tapers in a lathe not provided with a set-over tailstock the arrange-

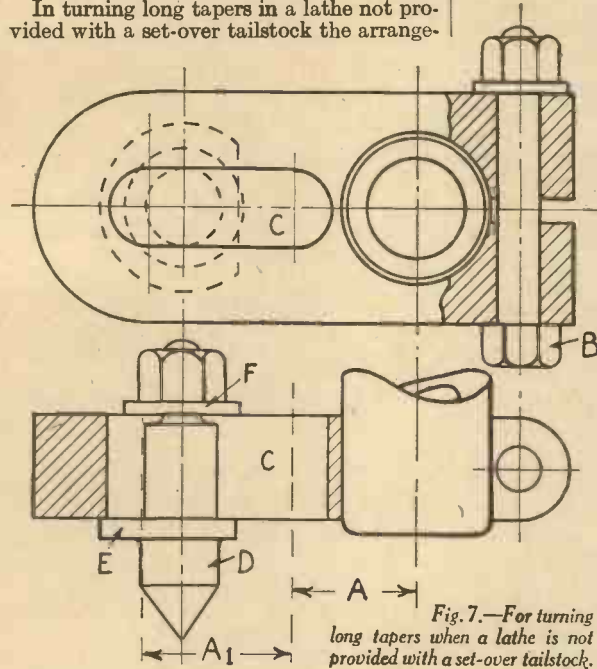

Fig. 7.—For turning long tapers when a lathe is not provided with a set-over tailstock.

ment shown in Fig. 7 will be found useful. To prevent its turning round under the cut it is clamped to the tailstock barrel and can be used for tapers in either direction—large at the tailstock end or large at the headstock end—by simply turning it half round. It cannot deal with tapers of so small a rate as would entail the end of the work being set

ment shown in Fig. 7 will be found useful. To prevent its turning round under the cut it is clamped to the tailstock barrel and can be used for tapers in either direction—large at the tailstock end or large at the headstock end—by simply turning it half round. It cannot deal with tapers of so small a rate as would entail the end of the work being set

nearer the trial centre than indicated at *A*. Its range is the distance *A1*. It is made from a piece of bar cast-steel bored to fit the end of the barrel and counter bored and slotted to take the clamping bolt *B*. The slot at *G* takes the waist of the centre *D*, which has a shoulder at *E* and a clamping nut and washer at *F*. The slot *G* can be bored, chipped and filed out and no great accuracy is required nor fine finish. In Fig. 8 is shown a type of adjustable centre which will give any degree of set off from true alignment within the amount shown at *X*. The body *A* is in one piece with the taper centre shank *B* and is recessed with a taper bore in which fits the taper block *C*. This, when in position with the internal taper of the body *A*, projects an eighth of an inch beyond the face of *A* and an internally screwed ring

D with an internal front flange *E* is screwed along threads on the body *A* and forces the block *D* tightly into the body. The block *D* is bored to take the lathe centre *F* and in the position shown this centre is in line with the taper centre shank *B* which fits in the tail stock barrel. We are looking at it in plan.

Set-off

By rotating the block *C* in the body *A* the lathe centre *F* can be put at any distance within the limits of the distance *X* between the dotted lines, because the body *A* is eccentric to the axis of the centre shank *B* within the limit of the distance *X*; therefore we can get any amount of set-off of the centre relative to the axis of the tail stock. The body *A* is located relative to the tailstock barrel so that whatever the eccentricity of the centre *F* it is at the correct height from the lathe bed.

The taper shank *B* should be a very good fit in the tailstock barrel and should be longer than usual. It should be tapped up firmly, when its position has been ascertained, with a mallet or copper hammer; otherwise the stress of the tool against the

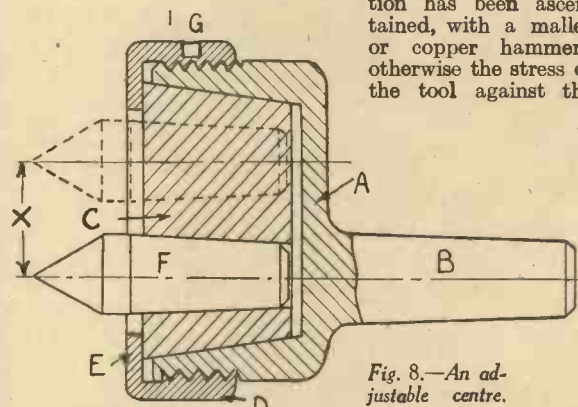

Fig. 8.—An adjustable centre.

work may tend to turn it and upset the line of centre decided on for the rate of taper being turned. This applies also to the screwed ring *D*, which should be tightened, once the correct eccentric adjustment has been made, by a pin spanner in holes in the periphery of the ring, one of the holes being indicated at *G* in our drawing.

A USEFUL STRIP PUNCH

A Device for Punching Spaced Holes in Strip Metal

FOR punching spaced holes in strip metal where a press is not available, the tool shown in the accompanying drawings may be found useful. It can be used between the jaws of a vice, the vice screw providing the pressure to push the punch through the material into the die.

A is a block of cast iron with a central hole three-quarters of its depth and a dead-flat end. This holds the punch. Two holes are drilled parallel to the central hole and equal distances apart. They are to take the guide bars *B* and *C*. They screw into a die holder *D* which may be made of mild-steel bar. This die holder has a central recess to take the die *E*.

To machine the holes opposite to each other, the die holder *D* and the cast-iron block *A* are clamped together and the holes centred on a central line and drilled through both pieces, afterwards they can be opened out.

The Guides

The guides *B* and *C* are of Bessemer-steel bar and screwed Whitworth thread and have shoulders which screw up tight against the die holder *D*, as seen in the end sectional

view. Between the die holder *D* and the punch block *A* are springs *GG*, which keep the punch block and the die holder apart, and between the die holder and the springs is a cast-steel stripper plate *H* which fits the

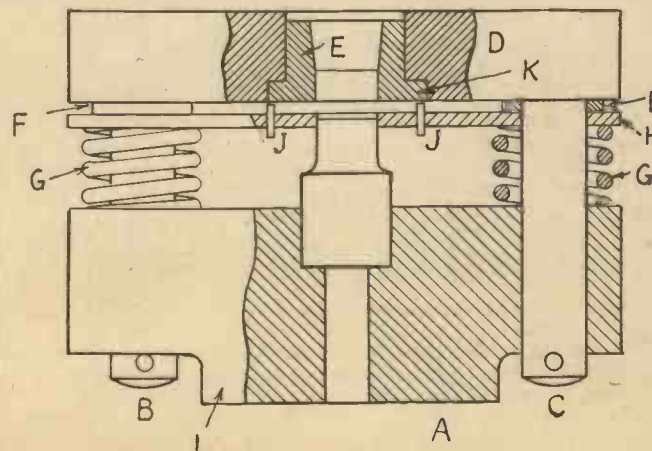

Fig. 1.—The general arrangement of a small strip punch.

punch and lies below the die a distance wide enough to admit the strip to be punched. This is to strip the metal strip from the punch as the punch withdraws from the die. Washers *FF* around the guides keep it away and determine the thickness between *D* and the stripper.

In this stripper plate can be fixed pins *JJ* driven into holes in the stripper plate at a distance apart, and equally from the centre to locate the strip as it is passed through. A stop *M* in Fig. 2 can be adjusted to engage with the end of the hole in the punched strip so as to locate the punched holes at equal distances apart as determined by the adjustment of the stop.

By means of the guide pins in the stripping plate *H* and this stop the holes can be located at correct distances apart and also at correct distances from the edge of the strip being punched. The punch can be any diameter equal to, or less than the blind hole in the block *A*. It is made of cast-steel bar and can be to the shape shown if the hole to be punched is less than the diameter

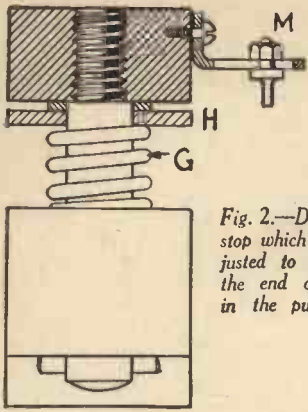

Fig. 2.—Details of the stop which can be adjusted to engage with the end of the hole in the punched strip.

of the blind hole in which it should fit tightly. The die *E* is also of cast-steel bar with a shoulder *K* to hold it in the die holder.

Guide Bars

The guide bars *B* and *C* should not, when

the punch has entered the die, project beyond the bottom of the block *A*. To prevent this, the block is cut away at the sides as shown, and stop pins of cast steel are driven into the guide bars and stop against the block. A central block at *L* (Fig. 1) projects enough to be clear of the ends of the guide bars when the punch has entered the die, so that the tool can be used between the jaws of the vice (Fig. 3). The die *E* is flared to clear the discs which pass out at the back.

Overall dimensions will be made to suit the vice and the size of work for which it is intended, and the drawing can be scaled to suit these conditions; but keeping to even sizes for the bars which can be cut from bright Bessemer stock and will need no machining other than reducing the ends in the lathe and screwing the thread. The die should be hardened dead hard and then let down standing on its flared end on a red-hot bar till the top face shows a full orange red colour, and then quenched. It will expand a little, so the punch must be made last to the size of the die. This should be similarly hardened and tempered and will also ex-

Fig. 3.—Showing how the tool can be used between the jaws of the vice.

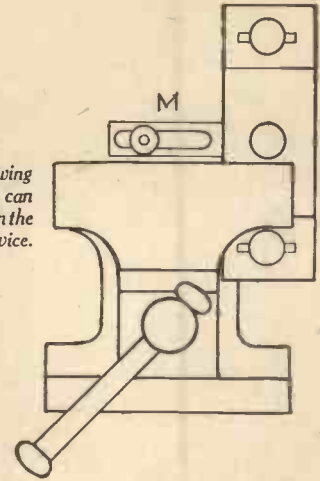

pand a little, but its shape allows it to be ground down with emery cloth to clear. The end of the punch and the face of the die should be ground dead flat.

“ FLYING ” ON THE GROUND

Learning to Fly in a Non-flying “ Aeroplane ”

OF the several difficulties which confront a pupil learning to fly, there is one in particular which may be described as learning the “ feel ” of an aeroplane. The average pupil finds some initial difficulty in learning the proper functioning and co-ordination of the various controls and if he attempts to practice with an ordinary aeroplane, the repair bill is likely to be an expensive one. Generally, of course, the instructor is there to see that no liberties are taken, but the presence of an instructor often tends to make the pupil less reliant on himself, and the little machine illustrated has been designed to give pupils an opportunity of learning all the controls of an aeroplane without running any risk of damaging either himself or the machine.



The Kronfeld Trainer out on the aerodrome for the first time.

The machine has been designed and made by Robert Kronfeld, and, although the first trials are only now in progress, it is stated that it will shortly be placed on the market at a price in the neighbourhood of £150-£200.

It is fitted with a Ford 10 h.p. engine which drives a pusher airscrew, and on full

throttle the machine travels at a rate of about 40 m.p.h. All the controls are exactly similar with those of an ordinary aeroplane and the machine responds in the same way, excepting, of course, that as the wings give no “ lift ” the machine is incapable of leaving the ground.

The inventor, Robert Kronfeld, seated at the controls.

The wings actually consist of two large ailerons only, which are, of course, operated by the control column, and if the control column is pushed over to one side while travelling at a fair speed, the machine banks until the tip of the wing touches the ground. No damage can result, however, because of the wheels which are fitted at each wing-tip.

In a normal take-off, the control column is pushed right forward in order to raise the tail. The same manoeuvre can be accomplished with the Kronfeld Trainer, but even if the tail is raised so far that the nose touches the ground, the front wheel prevents the machine turning over.

The machine is practically fool-proof, and those who have tried it state that the “ feel ” is exactly like that of a conventional aeroplane. One experienced pilot even said that he expected the machine to take off at any moment.

The confidence which a pupil can gain with a machine of this type cannot be over-estimated, and in view of the saving of practice time which it should permit, the machine should have a wide demand among training schools.



This is

International Buildings

Kingsway, London, Head Offices of the

I. C. S.

It is the centre from which radiates technical, commercial, and professional instruction that has been of great benefit to tens of thousands of ambitious people.

The I.C.S. is the greatest as well as the largest institution in the Empire devoted to spare-time training. Its prestige is unequalled. The Admiralty, Royal Air Force, Royal Army Service Corps, and other State Departments have entered into working arrangements with the I.C.S. for the training of men.

More than 1,000 I.C.S. text-books, prepared at International Buildings, are marvels of clearness, accuracy, and practical helpfulness.

There are 80 Instructors at Kingsway, many of them Associates, Members, or Fellows of their respective technical or professional bodies. All are specialists, and expert in giving the student individual attention throughout his Course of Study.

Among the 400 I.C.S. Courses there is one that can qualify YOU for Promotion and Better Pay.

YOUR WORK AND YOUR PAY

The size of your salary is more or less in accordance with the measure of what you know and therefore can do. The more you know, the greater your pay.

Success—progress won by merit—depends on trained ability. Unless you have studied **IN YOUR SPARE TIME**, you have little chance of promotion, for knowledge that comes through everyday work is not enough.

You must know the principles underlying your work and be familiar with the many processes closely related to that work. *The one and only means of obtaining such knowledge is specialized study.*

No man need be without that extra efficiency which adds so much to his income, security and happiness. He can acquire it, on easy terms, by the simple I.C.S. method of teaching by post.

If you are in the early stages of your career and have not yet had a specialized training, you should start to get one without delay. Or perhaps you feel that your knowledge is a little out of date and ought to be modernized. In either case

The International Correspondence Schools can help you.

Our expert advice on any matter concerning your work and your career is yours for the asking—free and without obligation. Let us send you a booklet dealing with the subject in which you are especially interested. It is packed with valuable information. All you have to do is mention your subject and, if you wish, tell us your problem or your difficulty. Write to us to-day or fill in and post the attached coupon. Your inquiry will be dealt with promptly. It may prove to be one of the most fortunate things you ever did.

COUPON FOR FREE BOOKLET

INTERNATIONAL CORRESPONDENCE SCHOOLS, LTD.; (Dept. 95), International Buildings, Kingsway, London, W.C.2

Please send me your booklet containing full particulars of the Course of Correspondence Training before which I have marked **X**. I assume no obligation.

- | | | | |
|---|--|--|---|
| <input type="checkbox"/> Accountancy | <input type="checkbox"/> Draughtsmanship | <input type="checkbox"/> Mechanical Engineering | <input type="checkbox"/> Surveying |
| <input type="checkbox"/> Advertising | <input type="checkbox"/> Electrical Engineering | <input type="checkbox"/> Mining Engineering | <input type="checkbox"/> Telephone and Telegraph Eng. |
| <input type="checkbox"/> Aeronautical Engineering | <input type="checkbox"/> Engineering Shop Practice | <input type="checkbox"/> Motor Engineering | <input type="checkbox"/> Textiles |
| <input type="checkbox"/> Air Conditioning | <input type="checkbox"/> Fire Engineering | <input type="checkbox"/> Pattern-making | <input type="checkbox"/> Welding, Gas & Electric |
| <input type="checkbox"/> Architecture | <input type="checkbox"/> Garage Management | <input type="checkbox"/> Plumbing | <input type="checkbox"/> Wireless Engineering |
| <input type="checkbox"/> Boiler Engineering | <input type="checkbox"/> Gas-Power Engineering | <input type="checkbox"/> Radio Equipment & Servicing | <input type="checkbox"/> Woodworking |
| <input type="checkbox"/> Book-keeping | <input type="checkbox"/> Heating & Ventilation | <input type="checkbox"/> Sanitary Engineering | <input type="checkbox"/> Works Management |
| <input type="checkbox"/> Building | <input type="checkbox"/> Hydro-Electric | <input type="checkbox"/> Scientific Management | |
| <input type="checkbox"/> Chemical Engineering | <input type="checkbox"/> Marine Engineering | <input type="checkbox"/> Sheet-Metal Working | |
| <input type="checkbox"/> Civil Engineering | <input type="checkbox"/> Mechanical Drawing | <input type="checkbox"/> Steam Engineering | |

EXAMINATIONS

Technical Institutions and Civil Service (G.P.O.). State which.....

NOTE.—If your subject is not on the above list, write it here

NAME..... AGE.....

ADDRESS.....

HOME TALKIES

Have you considered this splendid new home entertainment? We have the finest stock of talkie outfits of every make. Gebescope from £95, also Bell-Howell, Marshall, R.C.A., etc. Expert advice and demonstrations given at any time. We specialise in synchronising existing silent film with sound and speech commentary. Why not get in touch with us?



Getting hours of enjoyment from their "Gebescope"

... and Home Movies, too!

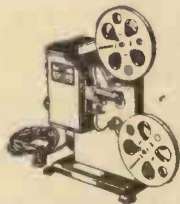

Any outfit can be bought on nine equal monthly payments. We have every projector in stock from about 15/- down, including: Pathscope, Ensign, Bell-Howell, Zeiss Ikon, etc., for 8 mm., 9.5 mm. or 16 mm. films.

KODASCOPE EIGHT-80. 300 watt. lighting. Gives brilliant pictures up to 30 x 40 in. or larger if desired. Motor rewind, still picture device. Fan-cooled lamp house. Takes 200 ft. of 8 mm. film.

£33. Nine monthly payments of 77/-.

Good allowance on your Surplus Apparatus.

Write now for latest Catalogue—Free and Post Free!

CITY SALE

& EXCHANGE (1929) LTD.

59/60 CHEAPSIDE, LONDON, E.C.2

'PHONE: CITY 1124-5-6.

MICROSCOPES FOR ALL

SPECIAL OFFER OF 4 MODELS

Each instrument has inclinable body, swing mirror, stage clips, and is nicely finished in Black Crystalline Enamel and bright Nickel Plating.

SHARP DEFINITION IS OBTAINABLE and GOOD WORK CAN BE DONE

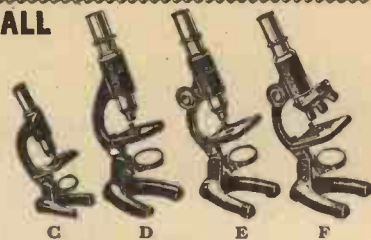

Model C.	Height 5½ in., sliding focus, magnification 25 x linear ..	Price	5/-
Model D.	Height 7 in., sliding focus, circular stage magnification 50 x linear ..	Price	9/6
Model E.	Height 7 in., rack and pinion focusing, magnification 50 x linear, square stage ..	Price	12/6
Model F.	Height 7 in., rack and pinion focusing, triple nose-piece, 3 lenses, magnifications 25 x, 50 x, 100 x, in wood case, with set of Dissecting Instruments ..	Price	30/-

IMMEDIATE DELIVERY FROM STOCK.

BROADHURST, CLARKSON & CO.

Post Free in Great Britain.
63 FARRINGTON ROAD,
LONDON, E.C.1.

The Best Seller of the Technical Books of 1936

NEWNES

TELEVISION and SHORTWAVE HANDBOOK

by F. J. CANN

(Editor "Practical Television," "Practical and Amateur Wireless," etc.)

EVERYTHING ABOUT—Drums, Mirror Screws, Scanning Discs and other Scanning Systems, Neon Lamps, the Cathode-Ray Oscillograph. How to build Short-wave Receivers. How to build Ultra Short-wave Receivers straight and superhet.

Fully Illustrated

280 pages

Only 3/6 net

From All Booksellers

GEORGE NEWNES, LIMITED

George Newnes, Ltd.

CUT IT OUT

— THE LABOUR OF TEDIOUS HANDSAWING :—

Get more accuracy and time on the real job, the preliminary being done on this compact 7-in. saw table 14 in. x 10 in., tilts to 45°, cuts 2¼ in. deep.

Motor driven and specially designed for the home workshop, the price will surprise you—it's one of several such tools from the popular line of

DRIVER POWER TOOLS

Get the Catalogue
—here's the Coupon

CUT IT OUT

SEND CATALOGUE OF DRIVER HOME WORKSHOP TOOLS



Mr.
(P.M.)

E. P. BARRUS LTD.,

35-37 UPPER THAMES ST.,
LONDON, E.C.4.

The Bush Televisor Model T.5 being operated in the family circle.



TELEVISION ARRIVES

OF outstanding interest at this year's Radiolympia, were the receivers shown on several of the stands for the reception of the high-definition television transmissions. Although some manufacturers produced more than one

A Review of the First Television Receivers to be Produced for the Reception of the B.B.C. Television Transmissions from the Alexandra Palace

the picture. No details of this apparatus or the receiver are available, however, and therefore the following review is confined



model, there were only ten different makes of receiver. The tendency of the firms it would seem is to produce two receivers, one for television and sound signals only, whilst the other also incorporates facilities for tuning the normal broadcast sound programmes. Manufacturers have also added to this latter feature the gramophone reproducing apparatus, thus providing an efficient radiogram with the addition of the television equipment.

The makers' names are Bush Radio (Baird equipment), Cossor, Ferranti, General Electric Halcyon, H.M.V., Marconiphone, Philips, and Pye.

All of these receivers employ the cathode-ray tube apparatus for the reproduction of the picture, but in addition to these there is the Ecko-Scophony apparatus which relies upon a mechanical method of reproducing

Left, the internal arrangement of the Bush Televisor Model T.5. The large tube employed with this receiver is clearly shown. Right, the smaller Ferranti model with a directly-viewed screen.





The Marconiphone Model 701 has a reflector to enable the vertical cathode-ray tube to be viewed.

vision, thus enabling the correct picture balance to be obtained merely by tuning to the best volume and quality. Electromagnetic control is employed at the cathode-ray tube for both scanning and focusing, and the vision, sound, and time bases are each built upon a separate chassis. The controls are as follows:

- (1) Tuning.
- (2) Focus.
- (3) Contrast.
- (4) Brightness.
- (5) Sound volume.
- (6) Vision control (adjusting the overall gain of the vision set).

In Model T.6 the vision receiver is a superhet. with a band width of three megacycles, and the sound set is a straight circuit. The power consumption of this set is 160 watts. At the time of going to press the prices of these receivers have not been fixed.

Cossor

In the Cossor range there are two receivers, models 137T and 237T, both of which enable the normal medium and long-wave broadcasts to be received. Model 237T, in addition, incorporates an automatic record changer. The picture in these models is reproduced on a 13½-in. diameter cathode-ray tube, the raster being adjusted to approximately 10 in. by 7½ in., and as will be seen from the illustration of this receiver the end of the tube is viewed direct. A simple switch is provided to change over from the Baird to the Marconi-E.M.I. system, and in addition to this control there is an oscillator trimmer for tuning in simultaneously the vision and sound transmissions, a contrast control, a sound volume

entirely to the first nine firms previously mentioned.

Bush Radio

There are three receivers in the Bush range, models T.5, T.6, and T.7. The first



mentioned is seen, in a family setting, at the top of page 31, and Type T.6 is similar except that internally the apparatus is modified to enable the broadcast programmes on the medium and long waves to be received. This means, of course, that the control layout is modified slightly. Model T.7 is similar, but incorporates an automatic radiogram with Collaro automatic record changer.

In each of these the picture is viewed in a mirror situated in the lid of the apparatus, and the approximate size of the picture is 12 in. by 9 in. in the T.5 and T.7, and 10 in. by 7½ in. in the T.6. In Model T.5 there is a total of twenty valves with a mains consumption of 240 watts. T.6 employs fourteen valves, and T.7 twenty-five valves, in each case the rectifiers and the valves in the sound equipment being included. The circuit employed in the two sections of the equipment is of the superhet. type with separate intermediate frequencies, and a common beat oscillator for the various I.F.s. The band width in the vision part of the apparatus is over 2 megacycles, and the tuning control affects both sound and

Left, the Philips receiver is fitted to a neat chromium stand to increase the height of the viewing screen. Right, the H.M.V. Model 901 which receives television sound and vision only.



control, and a six-point switch providing the following settings: off, gramophone, long wave, medium wave, ultra-short wave sound, and television (with sound). The main tuning control and tuning scale are immediately above these controls. The equipment is built up on three separate chassis—a vision unit, the radio receiver, and a power unit supplying power for these two units. No prices have yet been fixed and no further details of these receivers are available.

Ferranti

There are also two receivers in the Ferranti range, one being designed for use at a distance of about 10 miles and the other for distances up to about 30 miles. Neither of these models will pick up the normal medium- or long-wave transmissions, but the design of the sound section has been so arranged as to take full advantage of the higher fidelity of the U.S.W. transmissions. A cathode-ray tube is also used in these receivers, a 10-in. diameter tube being provided and the approximate picture size being 9 in. by 7 in., with a colour image described by the makers as "electric light white." A switch is also fitted to these receivers to permit of an instantaneous change from Baird to Marconi-E.M.I. system. When the vision equipment is switched on the picture comes automatically into frame, but brightness and contrast controls are provided to enable the picture to be adjusted to the required balance. A single tuning control is fitted to control both sound and vision, but it is possible to receive either sound or vision separately. There are 22 valves in all, with a total mains

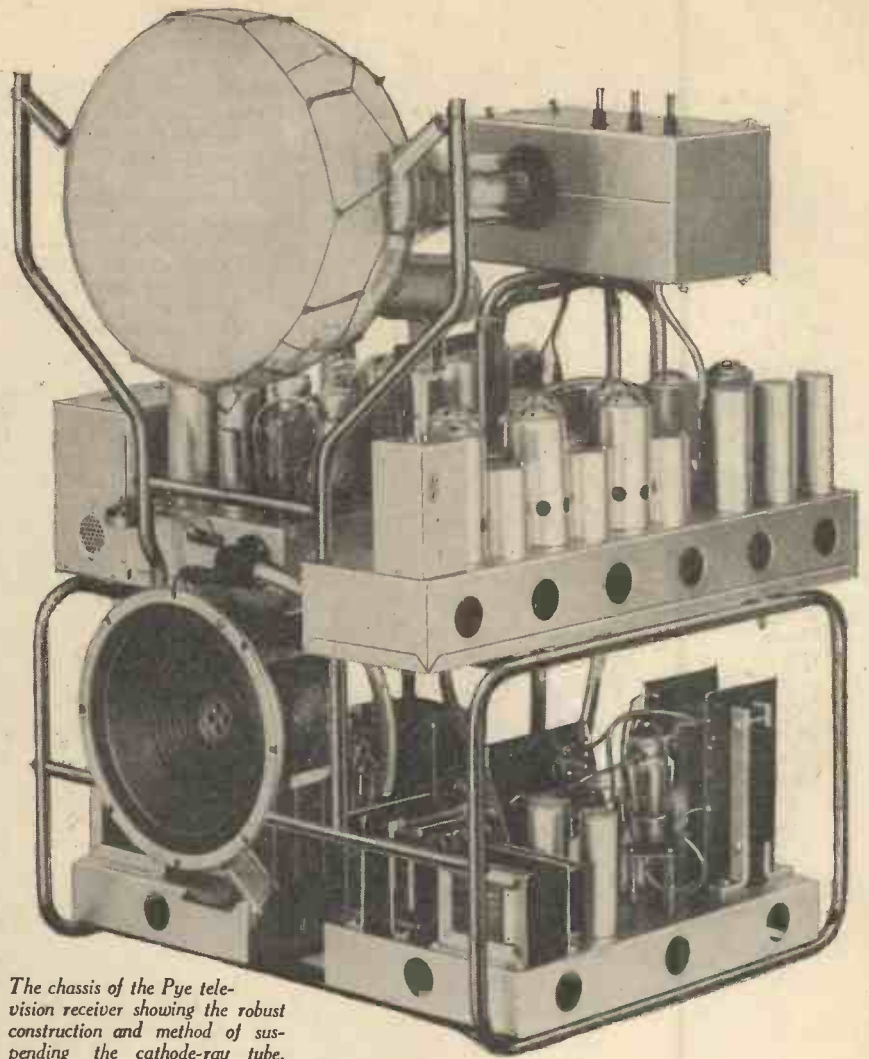

The chassis of the Pye television receiver showing the robust construction and method of suspending the cathode-ray tube.



The G.E.C. all-wave model in which the panel covering the screen has been removed to show the viewing screen.

loading between 300 and 350 watts. The smaller model is of the direct-vision type, and is illustrated on page 31, the price being 85 guineas. The larger model is built with a mirror in the lid and gives a reflected view of the picture; this model costs 100 guineas. No other technical details are available as yet.

General Electric Company

Two cathode-ray receivers are introduced

by the G.E.C., each employing a 12-in. cathode-ray tube providing a picture size or raster approximately 9 in. by 7 in. Again a switch is fitted to make the change from one system of transmission to the other, together with a brilliancy control for the picture. The cheaper model provides only the television (sound and vision) programmes, whilst the other model incorporates also an all-wave broadcast chassis. Tuning for both vision and sound is carried out by a single control, the correct adjustment of sound volume giving the correct picture definition. The small model employs 23 valves in a superhet. circuit, and the larger model has an exactly similar television equipment plus an 8-valve broadcast chassis. No further technical details are available, but prices

have been fixed at 95 guineas and 120 guineas.

Halcyon

Halcyon Radio have produced only one receiver so far, and this employs a 5-valve superhet. for vision reception with a separate mains supply and one vision gain control in addition to the tuning control.

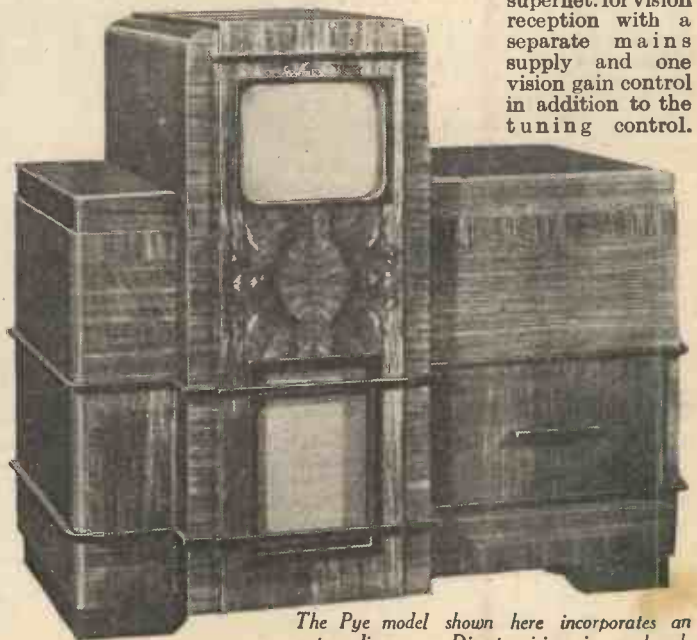

The Pye model shown here incorporates an auto-radiogram. Direct vision is employed.

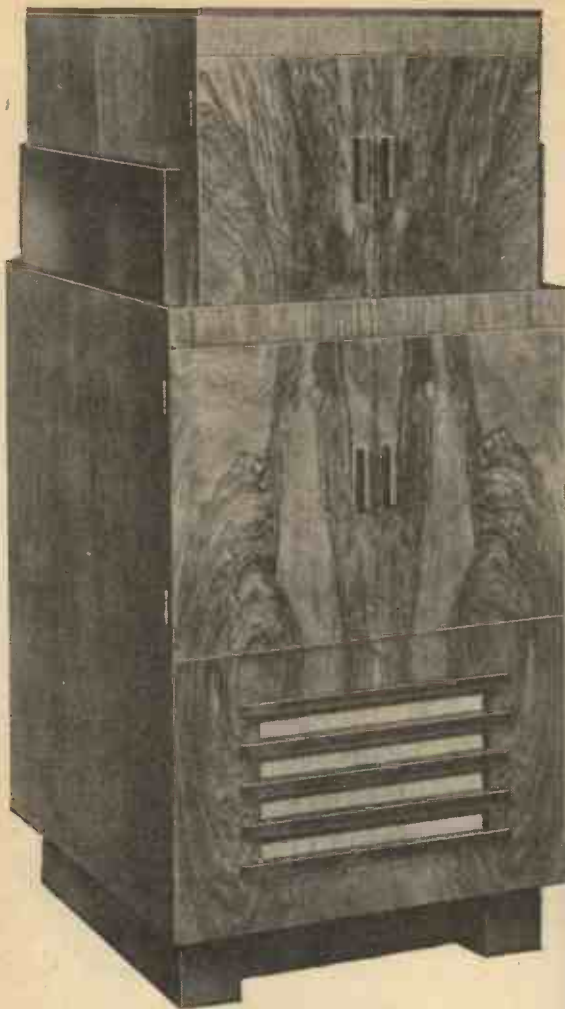

One of the Cossor receivers.

The sound receiver employs a straight circuit of special design in which a triode-hexode valve is employed as combined detector and H.F. amplifier giving excellent results on the 7-metre band. This also has two controls, one for tuning and one for volume. The time base incorporates a gas discharge tube and line and picture controls of novel design are mounted on the front of the cabinet. These operate in both directions, and when turned anti-clockwise they operate the equipment on the Baird system and when turned clockwise they operate on the Marconi-E.M.I. system. The mains unit incorporates both Westinghouse metal and valve rectification. A 10-in. tube is fitted and the approximate raster size is 8 in. by 6 in. There is no provision in this model for the reception of the normal broadcasts, but a combined all-wave broadcast model is being designed. The price of the present model is 90 guineas.

H.M.V.

Two models are found in the H.M.V. range, each employing a 12-in. tube with the reflected method of viewing the picture. The smaller model, No. 901 (price 95 guineas), is designed only for the television wavelengths, but the larger model, No. 900 (price 120 guineas), incorporates a five-band sound chassis providing the normal broadcast programmes as well as the most interesting of the short-wave signals. No details of the equipment are available at the time of going to press.

Marconiphone

A similar scheme is incorporated in the

Marconiphone receivers, a low-priced model (Model 702, at 95 guineas) providing only the television programmes on vision and sound, and a higher-priced model, No. 701, at 125 guineas, incorporating also an all-wave broadcast receiver. The small model has a mains loading of 230 watts and the other model 260 watts, both instruments providing an undistorted sound output of 3 watts. Each receiver incorporates a 9-in. cathode-ray tube, the image being viewed through a mirror. In the case of the small model the picture size appears approximately 9½ in. by 8 in., but in the larger model a lens is interposed in order to give a larger effective image. The vision equipment in both receivers consists of a 6-valve straight circuit and a special equipment is fitted for the picture apparatus. The tuning is fixed, and the following controls are fitted:

Line hold control.

Frame hold control.

Sensitivity control.

Contrast control.

Brilliance control,

and a selector switch to change from one system of transmission to the other.

Philips

Only one receiver is yet released by Philips and this incorporates an all-wave sound section. The picture is viewed direct on the end of a 12-in. cathode-ray tube, and this is protected, when the receiver is not in use, by a sliding panel. The picture automatically appears in frame, and there are only two picture controls, one for brilliancy and one for changing from one system to the other. Hard valves are used in the time base, and all the remaining adjustments are carried out by pre-sets when the apparatus is first installed. The sound receiver is independent and incorporates an 8-valve superhet. circuit feeding a 10-in. loud speaker to provide the best quality from the high-fidelity transmissions on the ultra-short wavelengths. No technical details of the apparatus are yet released.

Pye

Messrs. Pye have also produced two models, one for television sound and vision only and the other incorporating an all-wave radio-gram. The vision equipment is identical in both sets, and a 10-in. by 8-in. raster is obtained. A band-width of 2.5 megacycles is obtained in the vision receiver and the cathode-ray tube is viewed direct. The sound sections have been developed to take full advantage of the high-fidelity transmissions, and a "Duode" speaker is fitted to a straight 4-valve circuit. No price or other details are as yet released.



The arrangement of the tube and chassis of the model shown above.

LIONEL ELECTRIC TRAINS

"ARE WONDERFUL" SAY PROUD OWNERS

MADE IN U.S.A.

No. 751W UNION PACIFIC STREAMLINER WITH WHISTLE £7.7.0

No. 751E WITHOUT WHISTLE £6.6.0 (DISTANT CONTROL)

No. 279E COMMODORE VANDERBILT STREAMLINER £4.4.0 (DISTANT CONTROL)

No. 269E STEAM TYPE FREIGHT TRAIN 72/6

No. 5404E AS ILLUSTRATED, BUT WITH PASSENGER COACHES 72/6 (DISTANT CONTROL)

No. 273W FREIGHT TRAIN WITH WHISTLE £6.6.0

No. 274W AS ILLUSTRATED, BUT WITH PASSENGER COACHES £6.6.0 (DISTANT CONTROL)

THE 1936/7 CATALOGUE IS NOW READY

IT IS FREE TO YOU ON REQUEST (PLEASE GIVE NAME OF FAVOURITE DEALER). SEND CARD TO:—

LIONEL SERVICE DEPT. (10)
35/6 ALDERMANBURY, LONDON, E.C.2

CATALOGUE SHOWS COMPLETE RANGE FROM 32/- AND GIVES COMPREHENSIVE DETAILS OF ALL TRAINS AND PARTICULARS OF INTRODUCTION OF REALISTIC RAILROAD WHISTLE

HE IS 35 AND LOOKS 60

HE IS 60 AND LOOKS 35

BALDNESS BARS PROMOTION

A MODERN MIRACLE

MEDICAL Science has at last discovered a simple method whereby the dormant hair follicles can be restored to VIGOROUS LIFE, enabling them to produce new and naturally coloured hair.

One delighted Client of 89½ who was bald for over 30 years reported that the "C.L.L." treatment produced a FINE GROWTH OF NEW HAIR. The ages of other equally grateful Clients range from 22 to 81. MEDICALLY RECOMMENDED, £1,000 for denial.

Write to-day for a copy of our Illustrated Book entitled "HOW TO ACQUIRE PERFECT HAIR GROWTH." Post free privately from—

THE LABORATORIES (P.M.),
37 New Bond Street, London, W.1.

The ONLY cure in the world for Baldness endorsed by the Press and the MEDICAL PROFESSION.

WONDERFUL SELF-BLOWING SILVER SOLDERING AND BRAZING GUN

12/6



Works on tous gas with flexible tube. No bellows required. Gives White heat. 9 in. Flame, with tap as shown 12/6. 8 in. Flame 7/6; 3 in. to 5 in. Flame 5/-. Post Free. With this easy Blowpipe or Gas Gun anyone can Silver Solder, Braze, Re-metal Bearings, etc., do Tinning, Pipe Work, Plumbing, and thousands of jobs with this outfit, including Silver Solder, Brazing Wire, Flux, easy instructions. Supplied to H.M. Govt., Rolls-Royce, B.S.A., Underground Railways. The "Motor Cycle" writes: "The 'Blow-It-Hot' certainly fulfils maker's claims." Send now. It earns money. British. List Free. P. M. BOARDMAN, Pinhoe, Exeter. Also stocked by Messrs. Gamage, Ltd., Holborn.

LEARN BRITSU

FOR SELF-DEFENCE



If you lack the means of protecting yourself against the attacks of bullies and others bigger than you are, learn Britsu—the wonderful new British system of self-defence. Britsu will give you the science and skill against which mere brute force is powerless.

What is BRITSU?

Britsu is a FULLY GUARANTEED modernised and perfected British system of self-defence based on the little-known centuries-old method of the East. Britsu offers you effective defence against ANY blow, kick or knife attack—ability to release from all holds around throat, body, arms, legs or wrists, either front or rear—power to render your assailant absolutely helpless by means of secret holds, locks and nerve and artery pinches.

STRENGTH NOT NEEDED

You certainly do not need to be strong in order to become proficient in Britsu. It is really the weak man's defence against brute force. It is, however, admitted that the practice of Britsu forms one of the finest and most effective methods of acquiring and retaining muscular development and bodily fitness.

FREE

INTERESTING BOOKLET

Post coupon to-day for free illustrated booklet which tells how you can learn Britsu at Home.

THE BRITSU INSTITUTE,
37 GREYCOAT GALLERIES,
GREYCOAT PLACE, LONDON, S.W.1.

Please send me full particulars of Britsu and your method of teaching the Art, together with details of your guarantee. It is understood that this request places me under no obligation whatever.

Name.....

Address.....

FLYING MODELS ... True to Scale

Great care has been expended to assure accuracy of detail with ease of construction. The full-size plans provided are most straightforward and thorough and the kits themselves are really complete.

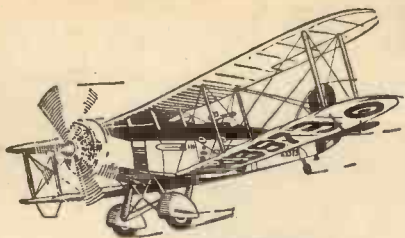

WESTLAND WALLACE

Wing span 18", length 13". Build this beautiful machine. It is a perfect model with a great wealth of detail. The kit contains all printed balsa parts, strip balsa, SILVER tissue, cements, wheels, etc. Complete kit, carriage paid **3/6**



PUSS MOTH

The ideal model for the beginner. Very simple plan. It is both accurate and an excellent flyer. Shaped flying prop. Complete kit, carriage paid **2/-**

Send two penny stamps for the biggest catalogue of scale model flyers in the country. Fully illustrated. (Kits are carriage extra abroad.)



HAWKER FURY Wing span 19½", length 17". This is a beauty. An authentic model of the famous Squadron 1 fighter. Kit wonderfully detailed. Perfect full-size plan. Complete kit, carriage paid **6/6**



HAWKER HIND

Wing span 18½", length 14½". The last word in kits. Every detail is perfect, and close ribbing and bracing ensures sturdy construction and prevents the covering from sagging. Experience is required to build this wonderful model. Complete kit, carriage paid **11/-**

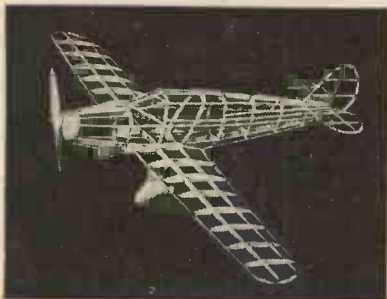

PERCIVAL GULL

Wing span 18", length 12½". An easy-to-build model that flies well. A really sturdy 'bus.' Splendid kit includes all balsa, tissue, flying prop, rubber, cements, etc., etc. Complete kit, carriage paid **3/6**

SEND YOUR POSTAL ORDER NOW TO
P. M. SWEETEN
BANK HEY STREET
BLACKPOOL



MONOCOUPÉ

Wing span 15½", length 10". Another true scale model for the beginner to build. Clear plan, all balsa, tissue. Shaped flying prop, wheels, cements, etc., etc. Complete kit, carriage paid **2/-**

THE 5-MINUTE FLYER

(As described in last month's issue of "Practical Mechanics")

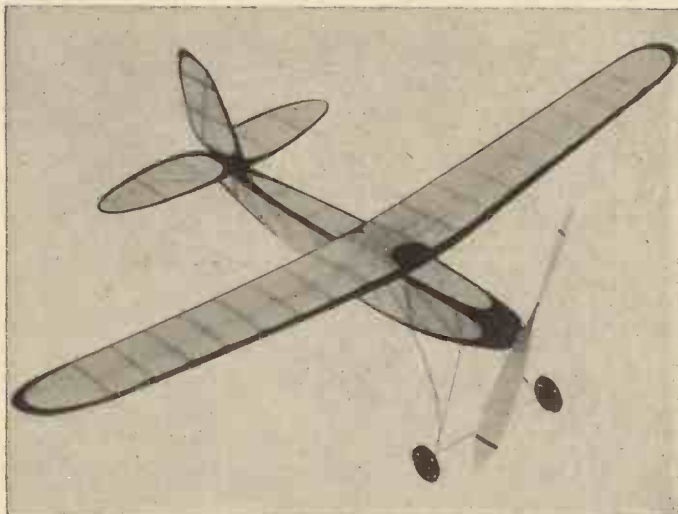

Complete set of Parts 13/-, carriage paid to any part of U.K.
Full-size Blueprint 2/6. Post free.

Write: **MODEL AIRCRAFT SUPPLIES LTD.,**
171 New Kent Road, London, S.E.1.

An Absorbing Hobby

BUILDING A STUART MODEL IS AN ENGROSSING PASTIME, AND THE RESULT A CONTINUOUS PLEASURE



We illustrate:

STUART NO. 10.
High Speed Steam Engine.
Bore ¾".
Stroke ¾".

Each set is quite complete—drawings and instructions are included.

If you have a lathe—
The rough castings - - - **8/6**
If not—
Fully machined set - - - **18/6**
Ditto, with all holes drilled and tapped - - - **25/-**

This and many other Stuart engines are fully described in the 80-page CATALOGUE No. 3, 6d. post free.

STUART TURNER LTD.
HENLEY - ON - THAMES

Finding Propeller Thrust

By D. A. Russell,
A.I.Mech.E.

The "Carriage and Spring Balance" Type of Testing Equipment Described in our July Issue is not Suitable for Testing the Thrust of Power-Driven Models, but the Method Described Below will prove very Satisfactory.



Fig. 1.—A petrol model starting to climb.



Fig. 2.—Well away!

IN view of the several different so-called "formulae" variously quoted as being capable of determining the thrust required from an airscrew to fly an aircraft—I think it is as well that an explanation of *thrust* and what it is, should first be given before passing on to a description of the methods available for arriving at its value for any given aircraft and airscrew.

Suppose we take the case of a body which is to rise vertically, and, for the moment, admit the presence of the air, but neglect its *resistance*. In these conditions it is obvious that the upward vertical thrust required to keep the body in suspension must be equal to the weight of that body—and further, if the body is to rise, the thrust must be more than its weight.

Next let us consider a flat plate gliding downwards through the air—the ratio of its weight to the supporting surface will determine its gliding angle; i.e. the greater the loading per unit area of supporting surface, the steeper will be the gliding angle, and by this means *alone* can we obtain a figure of thrust which bears any relation to the weight.

Actually, if the gliding angle is one in ten, i.e. one foot vertical descent for ten feet of forward travel, then the thrust to maintain horizontal flight would be equal to one tenth of the weight of the plate, and if the gliding angle was one in seven, the thrust would require to be equal to one seventh of the weight.

In Actual Practice

Now let us consider actual practice. The average rubber-driven machine weighs 3 or 4 ozs., and usually has a gliding angle of about one in nine or ten, thus *theoretically* the thrust required is equal to about one tenth of the weight—say $\frac{1}{2}$ oz. But we have to deal with the resistance offered by the air to the passage of the aircraft—and this usually, in a 4 oz. fusilage machine, amounts to about $\frac{1}{2}$ oz. Our thrust required now equals about one fifth of the weight, and for the machine to rise in flight, and also overcome tractive resistance whilst taxiing along the ground, the thrust must be even more. Thus it *does* happen that with 3 or 4 oz. fusilage machines, a

thrust equal to an amount between one quarter and one third of the weight of the aircraft is required to get it off the ground and make it fly. But for this ratio—or for that matter *any* ratio—to be taken as a *basis* for calculations in the design of machines other than light 3 or 4 oz. machines, is quite wrong, and can only lead to false results—for this very important reason, that the resistance offered by the air to the passage of an aircraft, increases as the square of its speed. Since the minimum flying speed

increases as the wing loading, it follows that the thrust must be increased also; yet it is obvious that two machines could be built each of the same weight, but the first having a wing area double that of the second.

It should now be clear that the ratio of thrust to weight can give no indication of the thrust required to fly an aircraft. The wing loading will determine the minimum speed at which the aircraft will fly, and is best calculated, in the first instance, as for a flat plate, after which an adjustment can be made according to the efficiency of the wing section.

Flying Speed Formula

The minimum flying speed of a flat plate may be obtained from the formula:—

$$Pv = \frac{2 \sin a \cos a}{1 + \sin^2 a}$$

where (i) Pv = Loading in pounds per square foot of wing area.

(ii) a = angle of inclination of the wing

For example let Pv = 1 pound per square foot.

and $a = 5^\circ$

$$\begin{aligned} \text{Then } P &= \frac{Pv (1 + \sin^2 a)}{2 \sin a \cos a} \\ &= \frac{1 (1 + .0872^2)}{2 \times .0872 \times .9962} \\ &= 5.7994 \text{ lb. pressure.} \end{aligned}$$

$$\begin{aligned} \text{now } v &= \sqrt{\frac{P}{.0032}} \text{ m.p.h.} \\ &= \sqrt{\frac{5.7994}{.0032}} \\ &= 42.572 \text{ m.p.h. (when } a = 5^\circ). \end{aligned}$$

This, of course, is for a flat plate, but suppose our wing has an efficiency of twice that of a flat plate, then it would lift twice the weight, i.e. sustain a loading of two pounds per square foot—or what is more to the point, require a flying speed equal to $\frac{42.572}{\sqrt{2}} = 30 \text{ m.p.h.}$

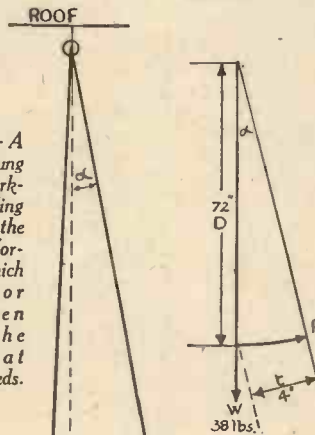
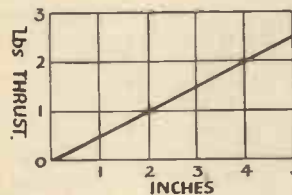

Fig. 3.—A motor slung from the workshop ceiling to measure the distance forward which the motor moves when driving the propeller at various speeds.



The gliding angle for a flat plate can be ascertained from the formula:—

$a = \sqrt{1} \times .875 \times g$
 where a = angle of glide.
 l = loading in ozs. per sq. ft.
 g = has a value of 3.0 for a loading of 3 oz. 1 sq. ft. and gradually increases to 3.3 for loading of 16 oz. 1 sq. ft.

Continuing our example in which l is 16 oz. 1 sq. ft. Then g must be taken as 3.3.

Then gliding angle = $\sqrt{16} \times .875 \times 3.3 = 11.5^\circ$

In the case of our example this will give us a ratio of one in five which, since the wing efficiency has been taken as twice that of a flat plate, will give us an actual ratio of one in ten.

From this we can assess the *theoretically* thrust (neglecting all questions of wind resistance) as being equal to one tenth of the weight of the aircraft.

Thrust Formula

By calculation, the thrust, that which would be developed if an airscrew operated at 100 per cent. efficiency, may be obtained from the formula:—

$$\frac{\pi^2 PR \times .076}{1728}$$

where P = the pitch (in inches).
 R = number of revolutions per sec.
 T = thrust in lbs.

the origin of this formula is as follows:—

- (i) πr^2 gives the area swept by the airscrew.
- (ii) The pitch (P) multiplied by the number of revolutions (R) per second, gives the distance travelled forward in one second.
- (iii) This figure multiplied by the area gives the volume of air displaced.
- (iv) Division by 1728 gives the volume in cubic feet.
- (v) $.076$ is the weight of one cubic foot of air.

Thus the weight of air displaced is calculated. This amount, of course, being equal to the thrust.

In actual practice, 100 per cent. efficiency cannot be obtained and a figure of about 70 per cent. efficiency is usually allowed—but this only applies to light airscrews revolving at relatively slow speeds. The "carriage and spring balance" type of testing equipment, which I have described in an earlier article, cannot be successfully employed for the testing of the larger and much faster revolving airscrews, used on petrol driven aircraft since they can easily absorb up to $\frac{1}{2}$ a h.p. to drive them, and the weight of the necessary motor, probably 30 to 40 pounds, introduces so much friction on the carriage bearings, that reliable results cannot be obtained.

The method I have therefore adopted is to sling the motor from the workshop ceiling, and to measure the distance forward which the motor moves when driving the propeller at various speeds.

Fig. 3 indicates the general arrangements. It is essential that the motor leads are flexible and led from the roof down to the motor to hang just "nice and slack," they must not on any account be led to the motor from one side, as their weight or "pull" may influence the movement of the motor.

Reaction of the Propeller

To the back end of the motor is fixed a suitable measure, a steel rule wired on will be quite satisfactory, and this can be arranged to pass a measuring point as the motor moves backwards and forwards.

There will be a slight tendency for the motor to swing round, due to the reaction of the propeller, and this can be counteracted by a fine wire run from the back of the motor to a suitable point, at least 4 feet away.

The motor should be hung from a good height, not less than 6 feet, and the motor, propeller, and supporting wires, should be accurately weighed.

The distance from the point of suspension to the propeller centre must be accurately measured.

The formula for thrust is $T = \frac{Wt}{D}$

When W = weight of motor, propeller and slings.

t = distance the motor moves forward in inches.

D = distance from point of suspension to propeller centre in inches.

In my own equipment $W = 38$ lb.
 $D = 78$ in.

and a forward movement of 4 in. indicates

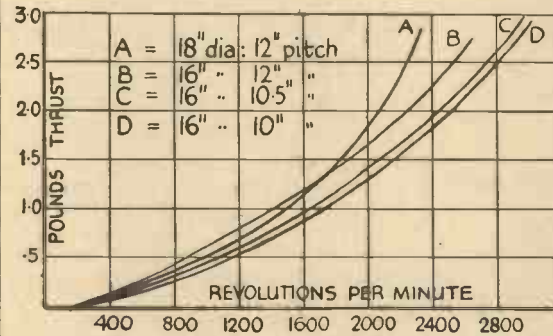

Fig. 4.—A set of readings plotted from the device shown in Fig. 3.

a thrust of 1.95 lb. When testing, readings should be taken at intervals, from say 1,000 revolutions per minute, up to the maximum speed of the motor.

At each reading, first the forward movement of the motor should be carefully measured, and then the speed of the motor.

Readings

A set of readings can then be plotted as shown in Fig. 4. The value of such an equipment is best demonstrated by considering the difference between any two propellers. Take, for example, two propellers both 16 in. diameter but of 10 in. and 12 in. pitch respectively. At a speed of 2,700 revolutions per minute, the 10 in. pitch propeller develops a thrust of 1.86 lbs. for a given power input. This same power will drive the 12 in. pitch propeller at only 2,370 revolutions per minute, the thrust developed being 1.71 lbs. If we now calculate the *theoretically maximum thrusts*, and relate these to the *actual thrusts* we shall obtain a percentage figure of efficiency.

In the case of the 10 in. pitch propeller, if we insert the appropriate figures, we obtain the equation:—

$$T = \frac{\pi^2 8^2 \times 10 \times 45 \times .076}{1728}$$

which gives an answer of 4.1 lb. thrust. Since the actual test figure was 1.86 lb. the efficiency is found to be 45.5 per cent.

In the case of the 12 in. pitch propeller the equation becomes:—

$$T = \frac{\pi^2 8^2 \times 12 \times 39.5 \times .076}{1728}$$

which gives a result of 4.05 pounds thrust. Since the actual test figure obtained was 1.71 lb., the efficiency is found to be 42 per cent.

Theoretically the 10 in. pitch propeller at 2,700 revolutions per minute would move forward 37.5 ft. in 1 second. But, as the efficiency is only 45.5 per cent., the actual speed possible is only 17 ft. per second; whilst in the case of the 12 in. pitch propeller, at 2,370 revolutions per minute the theoretical forward speed is 39.5 ft. per second, 42 per cent of which gives 16.6 ft. per second as the actual flying speed.

Conclusions

Tabulated, the conclusions are as follows:

- 1. For the same given power either of the two propellers will fly a machine at 16-17 ft. per second.
- 2. The 10 in. pitch propeller develops 1.86 pounds thrust as against 1.71 pounds developed by the 1 in. pitch propeller. This is an increase of nearly 9 per cent. or approximately an extra 2-5 ozs.
- 3. For the same flying speed (16-17 ft. per second) and the same engine power, there occurs a difference in speed of over 300 revolutions per minute (actually between 2,700 and 2,370). This indicating that a "higher revving" engine is required for the 10 in. pitch propeller than for the 1 in. pitch propeller.

It should be noted that the efficiency figures which will be obtained by the method described in this article will be on the low side, because the airscrew is, of necessity, discharging against the end of the motor, which being right in the slip stream of the airscrew, has the effect of creating a "back pressure."

In the case of my own motor, which is 9 in. diameter, this amounts to approximately 0.5 pounds at the speeds at which the tests were taken.

Thus the true effective thrust of the 10 in. pitch airscrew was 2.36 lbs. giving an efficiency of 58 per cent, and in the case of the 12 in. pitch airscrew it was 2.21 lb. giving an efficiency of 55 per cent.

RAIL MOTOR-CARS

High speed, rapid acceleration, diesel engined cars are becoming more and more common on English railway systems to carry out local services. The advantage of the cars is low running cost, rapid acceleration to 40 m.p.h., which enables a shuttle service to fit in between main line trains and above all the standard of comfort is very high. The Great Western have for over a year past had A.E.C. rail cars in service, the L.M.S. has now adopted the continental system of pneumatic tyred wheels which make for even more comfort in travel. Tube trains in search of noise reduction may yet adopt the same system. As it is London tubes are being quietened by lining the tunnels with sound-absorbing asbestos shields, by welding rails into long lengths to stop rail beat and by using softer steel for the rails which reduces rail resonance.

Training at 300 m.p.h

THE world's first 300-m.p.h. military training aeroplane will be built in Britain this year.

FLYING MODEL AEROPLANES

SELLEY-TEST KITS. "Lighter than Balsa."
The "SIMPLE" Method of construction. SUPER-Detailed Flying Models. The Practically "Indestructible Model." Several Models from 5/- to 23/- post free.
Rearwin Sport 16-inch wing span, 5/-. De-Luxe Model Boeing F4B4, 24-inch wing span, 20/-. The De-Luxe Models have included an "ADJUSTABLE PITCH ALUMINIUM PROPELLER."

"BURD KITS." A "BURD" always FLIES.
These Kits are complete, even the 1/3 Kit contains a propeller.
16-inch wing span, 1/3, post free. Six Models: Mr. Mulligan, etc.
25-inch wing span, 2/3, post free. Waco Military, Monocoque, etc.
30-inch wing span, 3/3, post free. Mr. Mulligan, Boeing P26A, etc.
60-INCH WING SPAN only 9/6, post free. Fairchild 24, etc.
Read all about these kits in our ILLUSTRATED CATALOGUE, every model illustrated, also FULL LIST of ACCESSORIES, including "LATA" balsa, ADJUSTABLE PITCH ALUMINIUM PROPS., etc. Price 3d.

ELITE MODEL AIRPLANE SUPPLIES,
Dept. 3, 45 TAMWORTH AVENUE, PRESTWICH, MANCHESTER.



The Leading Model Aviation Magazine

EVERY MONTH

Models to Build
News and Pictures
Scale Plans
Drawings
Club Reports
Petrol Planes

Send for FREE specimen copy

From all Newsagents 6d. or The

Barron-Dean Publishing Co. LTD.

24a DEAN STREET, FETTER LANE, E.C.4.

AT LAST . . . 3.5 cc. The GRAYSON "GNOME"

TWO - STROKE

THE IDEAL POWER PLANT FOR SMALL AIRCRAFT
SOLD COMPLETE AS ILLUSTRATED OR IN CASTINGS

Full specification is in print, and will be forwarded to interested clients when ready

Complete Booklet P.E. for GRAYSON and GRAYSPEC ENGINES 3d. post free

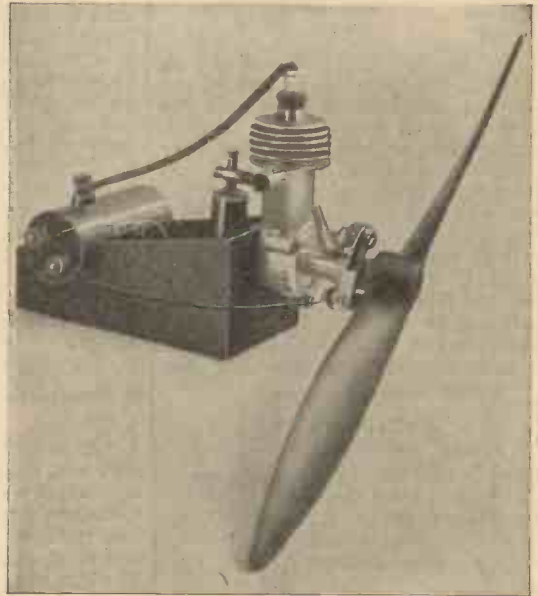

E. GRAY & SON LTD., 18/20 Clerkenwell Rd., London, E.C.1

LINDBERG 5 STAR KITS

***** KITS ARE THE LINDBERG DE LUXE LINE!

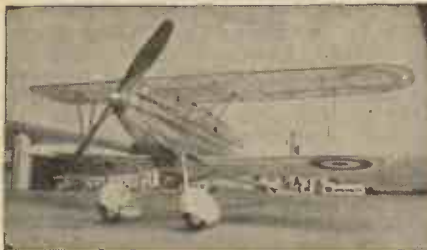

HAWKER SUPER-FURY.
Span 18 1/2". Length 16".
Weight 1 1/2 ozs
Full of authentic detail. Working controls from cockpit. Metal covering from cockpit to spinner. Wheel pants, etc. Ready shaped Shock-absorbing Landing Gear. Complete with all dopes, etc. (Six bottles.)

Carr. paid 9/9 Overseas 2/6
(U.K.) Extra.
Other 5 Star Kits:—
MONOCOQUE .. 9/9
RYAN S.T. .. 9/9
BEECHCRAFT B.17.L.
DOUGLAS O.43.A.

'BABY CYCLONE' PETROL ENGINES.
Send for List of Model Kits, Supplies and Engines.
NORTHERN MODEL AIRCRAFT COMPANY
(Dept. P.M.), 37a, FOUNTAIN STREET, MANCHESTER 2

MSS VALUE KITS MSS

WE HAVE THE 'PICK' OF THE AMERICAN MARKETS

Kits and Supplies for all—Beginner or Expert—Scale. Endurance and Petrol Fans. Of course all our Kits are complete, whether 2/- or 45/- they contain everything required—and that means EVERYTHING. And they ALL fly. Just arrived! Scientific "Miss America" 7-ft. GAS KIT. Price 45/-.

IMP KITS, 15-in. span, 5 models, 2/- each; 22-in., 6 models, 4/- each.

SCIENTIFIC HI FLYERS - 20-in., 23 models, 3/3 to 42/- each.

BUNCH ENDURANCE - - - - from 3/6 to 14/-.

IMP TORNADO MOTOR - - - - 27/6 and 42/-.

BUNCH NEW "GWYN-AERO" PETROL MOTOR,

6 cc. Complete, 87/6

IMP "PAULOWNIA" Props and all Supplies at lowest prices.

New Gas Model Accessories.

Send 2d. for 18-page Catalogue. Full of illustrations and useful hints.

MODEL SUPPLY STORES
(Dept. P.), 46 Derby Road
Prestwich, near Manchester



BRITISH RECORDS held by models built with OUR MATERIALS

FUSELAGE MACHINES

Rising off Ground	9 mins. 50 secs.
Rising off Water	1 min. 46 secs.
Hand Launched	23 mins. 10 secs.

Our petrol engine model, "COMET," during 1935 entered 3 Competitions, won these awards:

First Prize: B.M.A.S. Power Competition.
First Prize: "Hallum" Power Competition.
Second Prize: S.M.A.E. Sir John Shelley Competition.

You can build this model, or the "Sky Rocket" which made the flight of 1935 (Cranborne to Isle of Wight: 35 miles!), from drawings or kits obtained from us.

The "COMET" 18-c.c. 2-stroke petrol engine is the finest on the market, its only fault being that it runs so well that a time switch is necessary if you don't want to lose your model!

Send 2d. stamp for lists, and become a satisfied customer of

MODEL AIRCRAFT STORES
133 Richmond Park Road, BOURNEMOUTH

THE HAWKER "FURY" STILL LEADS!

SO DOES THE CLEVELAND 1/4-INCH SCALE

HAWKER "FURY" FLYING SCALE KIT

ONLY

3/- POST PAID U.K.

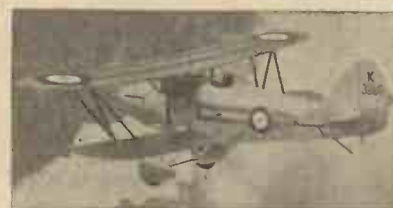

15-INCH SPAN
FINEST VALUE
SUPER DETAIL

PRINT NAME.....

ADDRESS

Please send Kit/or Free C-D List. P.O. Enclosed.

PREMIER AEROMODEL SUPPLIES
2a HORNSEY RISE, LONDON, N.19

MODEL AERO TOPICS

A Fine Job

MR. E. R. LANCASTER, of Ilford, sends me the adjacent picture of the petrol-driven model which I designed and described in recent issues of this journal. This photograph, as he says, shows very clearly "the trim lines admired by all who have seen it." He hopes to complete the model shortly and promises to send me a photograph of it in flight. The construction of this model was described in our issues dated, July, August, September, October, and November, 1935, back issues of which can be obtained for 7½d. each. Blueprints are still available at 10s. 6d. the set of four sheets; they illustrate the model full-size.

Aero Model Supplies, 2A Hornsey Rise, London, N.19, and costs 4d. post paid. It is full of some valuable facts and data, and I am sure that aero modelists will find it a useful combined catalogue and remembrancer. It is fully illustrated, and deals with various kits, blueprints, wheels, rubber, gears, propellers, wire, silks, tissues, etc., and interspersed in the text are important rules governing design.

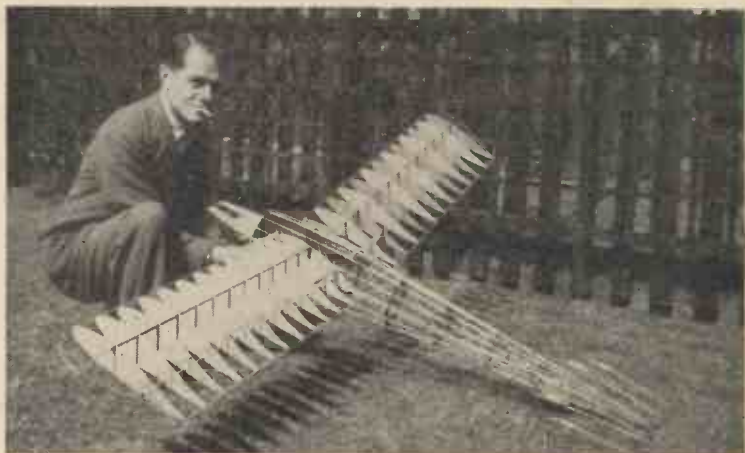

A model of Mr. F. J. Camm's petrol-driven model aeroplane, built by Mr. E. R. Lancaster, of Ilford, from articles appearing in this journal. Blueprints are still available at 10s. 6d. the set of four sheets. They show the model full-size.

A Constructional Model Aeroplane Contest

MESSRS. HAMLEYS, of 200-202 Regent Street, London, W.1, have sent me details of their competition in connection with a new constructional model aeroplane which they market. There are two sections, one for seniors, of 16 years and over, and the other for juniors under 16 years of age. In the senior contest the first prize, which must be competed for annually, is a trophy, a replica of which the winner retains. The second prize is a voucher for £3 3s., and the third prize is a voucher for £2 2s. In the junior section there is a trophy and replica as first prize, whilst the second and third prizes are 2 guineas and 1 guinea respectively. A special award of a 5-guinea voucher is also made in the senior contest and a 5-guinea model aeroplane in the junior contest. The competition is open to all purchasers of certain of the constructional kits which this firm supplies. An entry form can be obtained at the time of the purchase of the kit. The competition commenced on Saturday, August 1st, and closes on Thursday, December 31st. The entries will be judged on January 4th, and the awards made on January 7th. An exhibition of models, including the winning machines, will be held from January 7th to January 16th, 1937. For further details write to Hamleys' Aviation Dept. The competition is, of course, an annual event.

A 1-c.c. Petrol Engine

I HOPE to have some interesting news regarding a 1-c.c. petrol engine which has been specially produced for this journal. I can say at this stage, that the engine is made, and works very well indeed, its total weight, including coil, being under 6 oz. It is of $\frac{1}{16}$ -in. bore, $\frac{1}{2}$ -in. stroke, has a steel cylinder, steel detachable head, hardened steel pistons, steel crankshaft running in a hardened steel bush, hollow hardened steel gudgeon pin, duralumin connecting rod with hardened steel bushes in the large and small ends, hardened steel crank pin, duralumin crank case machined from the solid, and rotary valve system of carburation. This means that it will now be possible to make a petrol-driven model aeroplane, weighing less than 1 lb., and of a

wing span not exceeding 3 ft. At present, petrol-driven model aeroplanes are somewhat unwieldy, heavy, and costly to build. Miniature petrol engines of this sort open up an entirely new field of power-driven model aircraft.

It will be remembered that some months ago a contemporary described an engine which was slightly over 1 c.c. and which it was claimed had worked successfully. My efforts to obtain further details from the maker, however, have been unavailing.

Making Airscrews

MOST builders of model aeroplanes shun making the airscrews, preferring to purchase one ready made. It is true that they may be purchased very cheaply and beautifully finished, but unless you happen to select one ideally suited to the loading you will find it an expensive business arriving at the correct diameter or pitch by purchasing them ready made. Accordingly, I show diagrams which are self-explanatory, indicating how to carve an airscrew. A detailed description amplified by numerous illustrations, of all methods of making airscrews and calculating pitch are given in my small handbook, *Model Aeroplanes and Airships* (1s., by post 1s. 2d.), which is still the standard work on model aircraft designs and construction.

The best materials to use for airscrews which are to be carved from the solid are either mahogany, bass, or American white-wood, and it is important that a hole should be drilled through the exact centre of the blank before carving is commenced. When the screw is almost finished, a piece of wire should be passed through this hole and the airscrew tested for balance. The heavy blade will sink to the lowest point, and it should be sandpapered away and the blades made of equivalent thickness at respective and equivalent distances from the boss to the tip until balance is effected. The width of the blades should also be checked.

In making a laminated airscrew the layers should be alternately mahogany and whitewood; this gives a very pleasing effect. A $\frac{1}{16}$ -in. bolt should be passed through the boss after the laminae are glued, and the blades splayed to the required amount. The whole should then be placed under pressure until the glue is dry, when the blank should be shaped and carved. With a laminated screw there is, of course, much less wood to remove.

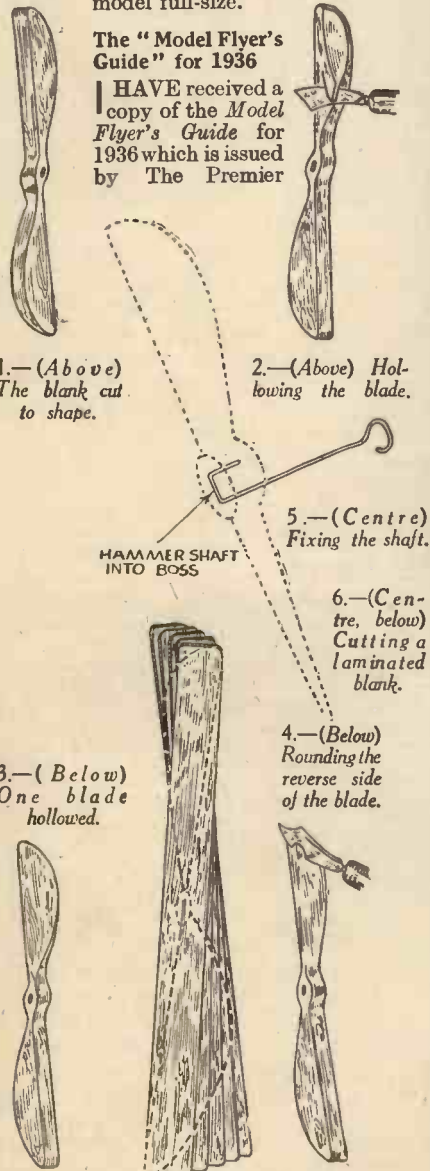

Stages in carving an airscrew.

The "Model Flyer's Guide" for 1936

I HAVE received a copy of the *Model Flyer's Guide* for 1936 which is issued by The Premier

1.—(Above)
The blank cut
to shape.

2.—(Above) Hol-
lowing the blade.

5.—(Centre)
Fixing the shaft.

6.—(Centre,
below)
Cutting a
laminated
blank.

4.—(Below)
Rounding the
reverse side
of the blade.

3.—(Below)
One blade
hollowed.

NEW INVENTIONS

The following information is specially supplied to "Practical Mechanics," by Messrs. Hughes & Youngs, Patent Agents, of 9 Warwick Court, High Holborn, London, W.C.1, who will be pleased to send readers mentioning this paper, a copy of their handbook "How to Patent an Invention," free of charge.

Pocket Sundial

THERE have been a variety of methods of finding out the time of day. King Alfred used a candle for a clock. In the present age, if one has not a wireless set or a wrist watch, one asks a policeman. But with all due respect to our courteous constabulary, that ancient timepiece, the sun, has an unimpeachable record for accuracy. A newly devised pocket sundial has made its debut. The idea of a portable sundial is not absolutely fresh, but this is claimed to be an improvement. The new device includes also a compass. The revolvable dial may be made of cardboard or other non-magnetic material with the usual shadow solar time markings, and it has a sheet metal gnomon—as the pin of the dial is called—in combination with a compass magnet. When placed upon any available horizontal surface, it is stated that this dial will automatically orient itself in readiness for reading time by the sun.

For those in Peril on the Sea

FROM the days of Noah to the present moment, very much thought has been devoted to means for saving people from death by drowning. Another raft has just appeared on the horizon. This new device is capable of use in rough seas, when it is impossible to launch a lifeboat. Preferably of rectangular shape, it comprises a net of flexible ropes or metal cables with a boundary of steel wire. It has floatable members made of cork or similar material secured to the crossing ropes or cables. These floatable parts are arranged in rows in grid-like formation. The net is divided into squares not large enough to admit a person's body. The raft cannot easily be buckled by heavy seas, but it can be rolled up for the purpose of being stored. Robinson Crusoe would have found such a raft eminently useful.

A Comfortable Gas Mask

IN view of a possible outbreak of war and the use of poisonous gas, the gas mask is receiving a considerable amount of attention. One of the latest devices of this character has for its object the provision of a more comfortable means for securing the mask over the face of the wearer. The mask is connected to a cap which will fit lightly and is made of openwork fabric or net elastic. Consequently, it can not only be readily put on and removed, but it will grip the head and hold the mask firmly in position without causing discomfort.

Disinfecting the Telephone

IT is obvious that the 'phone may be a fruitful means of disseminating harmful germs. Therefore, any effectual method of antidoting this evil should be very hospitably received. A recent device has for its object the sterilising of the microphone and the earpiece by the employment of a spray. This may be automatically operated or brought into use by voluntary pressure. The reservoir for the spraying liquid is fixed between the base of the 'phone and the platform upon which it stands. The liquid should be of pleasant aroma, cleans-

ing, volatile, non-injurious, and non-inflammable.

Haircutting by Machinery

THE patient "gents" awaiting their turn in the toilet saloon will be intrigued by a gadget which it is proposed to apply to the electrically driven haircutting machine. According to an inventor, the hairdresser's mechanical assistant in question has not yet attained its zenith. He has, therefore, exercised his ingenuity in order to help the machine along the road toward perfection. This inventor maintains that, owing to the absence of a hair-lifting (not hair-raising) device, the machine now in use does not make for an ideally graduated hair cut. The machine, he contends, should emulate the technique of the old-fashioned method of operating with scissors and comb. In haircutting by hand it appears that the tonsorial expert first slides the closed scissors into the hair and raises a

lock of hair therewith. The inventor has devised a tapered rod or bar, similar in appearance to the closed blades of a pair of scissors. This is attached to the handle of the hair-cutter, and it is claimed that it performs the work *à la* the scissors and comb. It is hoped that this new device, by expediting the cutting of hair, will reduce the intervals of waiting between the reiterations of the cry, "Next gentleman, please!"

Variety of Inventions

THE subjects of recent applications to the British Patent Office again prove the wide area covered by the inventor. Among these are included an apparatus for counting the passengers on vehicles, an improved device for preventing thefts from cars, a new appliance for killing dogs and a drinking-water supply system for birds.

DYNAMO.

Now a NEW Stentorian and a NEW High Quality



IN place of a detailed explanation of multitudinous small improvements which bring the 1937 Stentorian's new sensitivity and fidelity, the reproduction curves below (taken from the 1936 and 1937 Stentorian senior chassis) are published for your inspection.

Even if you have a 1936 Stentorian (by far the finest commercial speaker available till now), this new instrument, embodying a further year's discoveries, will improve your set by just the same margin as the curves show. If you are using any other, then the difference this new speaker brings will be a positive revelation to you.

READ THIS MESSAGE FROM MR. F. J. CANN:

"Once again I can confirm the claims of your engineers to have enhanced even further the already enviable reputation which your speakers enjoy. The 1937 Stentorian, which I have submitted to a thorough test, represents a marked advance on your previous models. If anything, your claims are too modest, for my curves show a greater degree of frequency response at both ends of the register. Last year I asked, 'Can there be a better speaker?' Your 1937 Stentorian Speaker supplies the affirmative answer. All listeners, and particularly constructors, owe a debt of gratitude to the indefatigability of your research engineers."

F. J. Cann

Better volume on weak stations, new clear top notes free from shrillness, full, colourful bass without "thump" and a surprisingly incisive realism are available to you—at a moderate cost. For a reasonable deposit (from 7s. 6d. upwards) you may have from your radio an entertainment quality you have never attained before! Hear this new speaker, and know what 1937 reproduction can be!



In fairness to yourself, hear one! Chassis from 23/6 upwards will be in your dealer's possession soon. He will tell you about convenient H.P. terms, on the large models too, if you are interested.

1937 Stentorian Prices

CABINET MODELS

- 37 80 (Senior) 63/-
- 37 70 (Junior) 49/6
- 37 00 (Cadet) 39/6
- 37 20 (Baby) 29/6
- Duplex ... £8 6

CHASSIS MODELS

- 37 S ... 42/-
- 37 J ... 32/6
- 37 B ... 23/6
- 37 M ... 17/6
- EM/W ... 70/-
- Duplex ... 84/-

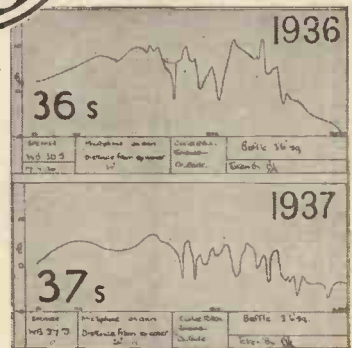

1937 STENTORIAN PERMANENT MAGNET MOVING COIL SPEAKERS. Whiteley Electrical Radio Co. Ltd., Mansfield, Notts.

THE PNEUMATIC ROAD DRILL AND HOW IT WORKS

(Continued from page 15)

the air remaining in the cylinder above the piston is compressed and cushions the piston, preventing it from striking the top of the cylinder. To assist in the storage of this cushioning air, a number of clearance pockets *CP* are available and some of the air is compressed into these chambers. As the piston rises still farther, the passages delivering the air to the return port *RP* are cut off by the top of the piston, and at the same time the space below the piston is open to exhaust, the piston having uncovered the exhaust port *E*. The rising piston is arrested just before it strikes the

top of the cylinder by means of the cushioning effect already referred to, and by this time air port (*AP* shown dotted, as in the sketch it is actually behind the piston), comes opposite the reduced diameter indicated by the arrow *P*, thus allowing air to enter the top of the cylinder and at on the face of the piston marked *D*. The conditions now are, air exerts pressure in a downward direction on the area *d* and also on the area *D*, less of course, the area of the reduced section of the piston. Since the space below the piston is open to the exhaust, the piston is driven down, and partly due to the momentum of the moving mass, strikes a heavy blow on the anvil block *A*. At the time the piston strikes the anvil block it uncovers the exhaust port, thus opening the cylinder above the piston, to the exhaust, and allowing air to escape to atmosphere. The anvil block in

turn, transmits the blow to the hexagon steel pick which does the actual breaking.

The purpose of the anvil block is to secure a good seal for the air delivered under the piston on the return strike and to ensure that the piston will have a true surface on which to deliver its blow. This construction saves damage which would be done to the piston were it to strike the end of the steel pick directly. The simple spool type valve *EV* serves only to control the return air to the bottom of the cylinder, and gives the breaker a much faster action. With the exception of this valve, there is only one moving part—the piston. The pick retainer *R* stops the chisel from falling out of the machine when the man lifts the breaker each time he has broken off a piece of concrete. In the handle there is an automatic oiler *O* which feeds a small supply of oil to the the incoming air thus lubricating the whole machine.

The modern concrete breaker is a very simple piece of machinery, though, due to its heavy duty, must be made very robust. It simply carries out, mechanically, the same duty as a heavy sledge hammer, but is able to deliver a blow many times heavier and nearly a hundred times faster, than can be delivered by hand.

SHERLOCK HOLMES SAYS..

"Don't guess at the trouble
TEST WITH
PIFCO
RADIOMETER"



Pifco goes straight to the heart of the trouble, testing sets, valves and components with equal ease and speed. Any radio set can be tested, either A.C. or D.C. Mains, or Battery operated. Solidly constructed with fine bakelite case, the Pifco Radiometer has readings for high and low voltage, milliamperes, continuity test and a special socket for testing valves.

Get one of these amazing instruments from your local dealer to-day, or write for Pifco Testmeter Folder, post free from:—

PIFCO LTD., WATLING ST.,
MANCHESTER, or London Office,
150 Charing Cross Road, W.C.2.

PIFCO



THE ALL-IN-ONE RADIO
METER FOR A.C. OR D.C.

For electric or battery radio sets. Finished in black bakelite, size of dial 1 1/2 in. by 3/4 in., complete with leads.

12/6
Price

Stamps of the World

MESSRS. WHITFIELD KING & CO., Ipswich, the well-known stamp dealers, have recently produced their 1937 edition of the *Standard Catalogue of Postage Stamps of the World*. This work of reference for stamp collectors is now in its thirty-sixth year of publication.

From the statistical information contained in the preface the *Catalogue* records no less than 62,155 separate varieties of postage stamps which are accompanied by nearly 7,000 illustrations, together with useful geographical notes of the countries concerned. The price of the 1937 edition is 5s.

Aerial Wonders of Our Time

APICTURED story of flying, past, present, and future, edited by Sir John Hammerton, has recently been published in two volumes by the Waverley Book Co., 96, Farringdon Street, London, E.C.4. *Aerial Wonders of our Time*, as the two volumes are called, has been produced at a most opportune moment. Hitherto there has been no adequate or reliable survey of the progressive movement of mankind in its conquest of the air; the past has been obscure, and the present lightly dealt with. But in this new work the reader will find a treasure house of enlightening information. It is unique in its presentation of facts. Not only have the famous and the "high-spots" in flying been dealt with; the names of lesser-known men also find a place in these splendid volumes.

Health and Strength

ONCE a seven-stone weakling, CHARLES ATLAS, to-day holder of the title "The World's Most Perfectly Developed Man," is a remarkable example of determination and concentration. This precious secret of health, fitness, and efficiency, which he calls Dynamic-Tension, taught him not only how to create those benefits in himself, but gave him the deeper knowledge of how to pass them on to others who are seeking everlasting health and strength. To all interested readers who fill in the coupon on page iii of cover, CHARLES ATLAS will gladly send his lavishly illustrated 48-page book free.

ROTAMETERS and RADIOMETERS
PIFCO ON THE SPOT WILL TRACE YOUR TROUBLES LIKE A SHOT

ANY
HANDYMAN
CAN MAKE
THIS.

Making an Enlarging Easel and Baseboard

By "Photographer"



Fig. 1.—The completed enlarging easel.

THE following device is quite simple to make, and will prove a boon to the amateur photographer. The easel slides along the baseboard for rough focusing, and for facilitating various degrees of enlargement and is provided with rising, falling, rotating, and backward tilting movements. It is fitted with spring clamp bars for holding the bromide paper, which is placed into position most conveniently with the easel in a horizontal plane, and subsequently swung back into the exposure position. If the dimensions given are followed, a compact little outfit will be made for use in a small dark-room; but they can, of course, be varied to any extent at will, to suit individual requirements. If so desired, it is an easy matter to increase the length of the baseboard so that the enlarger itself may also be fitted to it.

When the pasteboard is removed, there will be just sufficient play to allow the base to slide along smoothly. The baseboard may now be made by letting in the remaining length of 2-in. by 1-in. hardwood into the two solid blocks which serve as feet.

Details of the Easel

The easel consists of a sheet of the $\frac{3}{8}$ -in. three-ply wood 16 in. by 13 in. Grooves are scored down the back $\frac{3}{8}$ in. from the long edges and parallel thereto, to form resting-places for the lips of the spring clamps. A hole is drilled through dead centre for the insertion of the piece of 2 B.A. studding. The hole is countersunk on the front side to the depth of a 2 B.A. nut and washer, and the studding may then be made firm with a washer and nut at each side. A clearance hole for the back

It will now be seen that the rising, falling and rotating movements are easily made, and that the easel is quickly fixed in any required position. Backward tilting is also available, a wedge being inserted under the hinged foot to hold the easel at the necessary angle. It is a simple matter to insert the negative into the carrier upside down, should the tilting give the reverse effect to that desired.



Fig. 2.—The enlarging frame.

The Following is a List of Materials Required.

- 1 piece $\frac{3}{8}$ -in. 3-ply wood 22 in. by 16 in. by $\frac{3}{8}$ in.
- 1 piece 3-ply wood, 4 in. by 4 in. by $\frac{3}{8}$ in.
- 1 piece planed mahogany or oak, 6 ft. by 2 in. by 1 in.
- 1 piece planed mahogany or oak, 2 ft. 2 in. by 1 in. by 1 in.
- 2 blocks of wood, approximately 9 in. by 3 in. by 3 in., from a firewood dealer.
- 4 brass hinges, 1 in. by $\frac{1}{2}$ in. by $\frac{1}{2}$ in., with 16 $\frac{1}{2}$ -in. countersunk screws to fit.
- 2 brass hinges, 2 $\frac{1}{2}$ in. by $\frac{3}{4}$ in. by $\frac{1}{8}$ in., with $\frac{1}{2}$ -in. countersunk screws to fit.

- 1 small piece of hard, springy brass, $\frac{1}{2}$ in. thick.
- 1 2 B.A. wireless knob.
- 1 piece 2 B.A. studding, two 2 B.A. nuts and two washers.
- 1 sheet cartridge paper.
- 18 1-in. No. 6 countersunk screws.
- 6 2-in. No. 10 countersunk screws.
- 1 bottle varnish stain.
- Small quantity dead-black Dope.

The Spring Clamps

At D is shown one of the spring clamp bars, which are two 13-in. strips of the 1-in. square hardwood fitted at each end, with the special fitting shown at E. The latter consists simply of a brass hinge with a strip of stout, springy brass bent to the required shape and soldered on to one arm of it. Any error in the bending may be easily rectified after the fittings have been screwed down to the bars. The easel itself is finished off by pasting on its face a sheet of cartridge paper ruled off with the different standard sizes of bromide paper up to 15 in. by 12 in. The clamping bars may be given a coat of dead black dope, which is made by stirring lamp-black into turpentine, with a small quantity of gold-size added to prevent the black afterward rubbing off, and the rest of the apparatus

The Easel Base

The construction is shown in some detail in Fig. 3. At B we have the easel base. This is made up from two pieces of the 2-in. by 1-in. hardwood, 6 in. long, and two squares of the $\frac{3}{8}$ -in. three-ply wood, 6 in. by 6 in. These may be cut out, but before they are assembled the upright arm which carries the easel must be prepared and fitted. A piece of the $\frac{3}{8}$ -in. three-ply 14 in. by 3 in. is slotted down the middle for the required distance. This may conveniently be done by drilling a series of clearance holes for the 2 B.A. studding down the centre line, afterwards chiselling out the connecting webs of wood and filing off smooth. The arm is then let into the block of 2-in. by 1-in. hardwood which forms its foot, and the latter attached to the top board of the runner with the two strong hinges. If the points of the screws protrude from the underside, as they no doubt will, they must be filed off quite smooth before proceeding.

The Arm Support

The block of wood which serves to support the arm when the easel is in the horizontal position is screwed on from the underneath with 1-in. countersunk screws, and all is then ready for assembling the baseboard round the runner-board. Lay two strips from a postcard on to two adjacent surfaces of the runner-board, and build the pieces up round them, securing with the 1-in. screws.

nut is bored out of the square backing-piece of three-ply wood, which is secured in place with four of the $\frac{1}{2}$ -in. countersunk screws. The studding should have been left a bit longer than necessary, and may now be cut off to such a length that, when it is passed through the slot in the upright arm, the knob will screw up behind and make all tight.

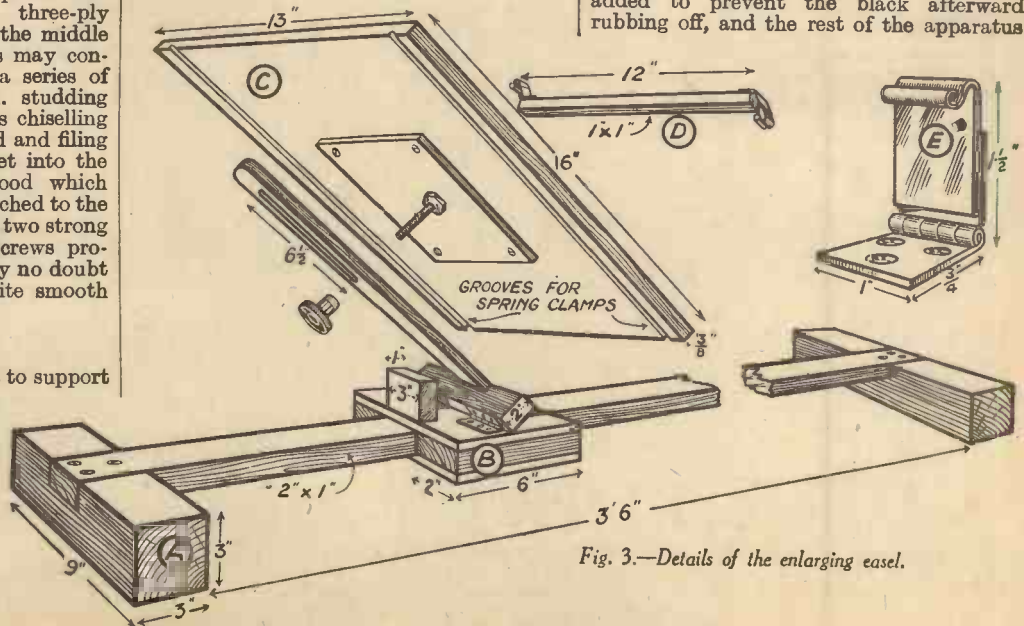

Fig. 3.—Details of the enlarging easel.

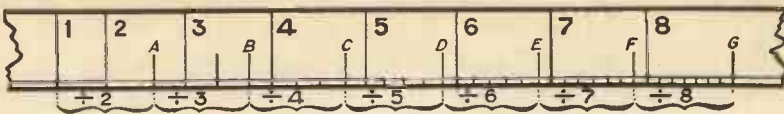

Fig. 4.—The enlarging scale.

may be given a coat of varnish stain to give it a more professional appearance, and to preserve the wood against the damp of the dark-room.

An Improvement

In Fig. 5 is shown a back view of the easel base with the upright arm tilted back at an angle. Fig. 2 shows the easel on its base with one of the spring clamp bars in position and the other lying in front. Fig. 2 is a back view of the same, but with both bars in position, and Fig. 1 shows the complete apparatus ready for use.

The usefulness of the apparatus is considerably enhanced if some simple means is adopted, such as affixing stops on the bench, to ensure that the easel and the negative always occupy the same relative positions, and saw-marks are made across the base-board to indicate the position of the easel for different degrees of enlargement, e.g., same size, $\times 2$, $\times 3$, $\times 4$, etc. One of these marks—that for same size—should

be made after an actual experiment and careful measurement of the image thrown upon the screen. An old negative may be taken and a line scratched on it exactly $3\frac{1}{2}$ in. long. The negative should be inserted and the easel moved along by degrees, focusing at each move, until the image on the easel is also exactly $3\frac{1}{2}$ in. long. The position of the easel base may then be marked with a saw-cut and the figure 1, and the remaining marks made in the following manner:

Marking Out

Starting from the "same size" line 1, mark off in pencil along the runner bar distances exactly corresponding to the focal length of the projection lens, which in our case is the camera lens. Call these marks *a*, *b*, *c*, etc.

Exactly half-way between 1 and *a* make another saw-cut and mark it 2. This will be found to be the position for enlarging two diameters. One-third of the distance from *a* to *b* make another

saw-cut and mark it 3. One-fourth of the distance from *b* to *c* make a saw-cut 4. One-fifth of the distance from *c* to *d* make saw-cut 5, and so on. Each of these marks will indicate the position of the easel foot for the

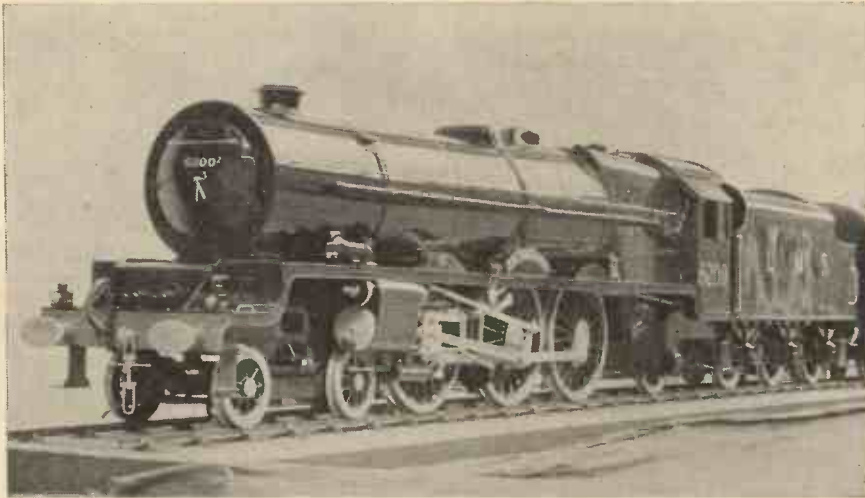

Fig. 5.—The clamp.



Fig. 6.—The clamp holding the enlarging frame.

corresponding degree of enlargement indicated by the number appended to it. Reference to Fig. 3 should make the matter clear.



The locomotive the "Princess Royal" to a scale of 1 in. to the foot.

BRITISH model making will be well represented at the Empire exhibition to be held from September to January at Johannesburg.

Among the exhibits in the United Kingdom Government Pavilion are a large number of models demonstrating the various forms of transport.

Models for South Africa

There is a series of aeroplane models from early gliders to the present modern machines, a series of ships depicting mercantile shipping development from the British coracle to the "QUEEN MARY," and a series of motor-cars from Gurney's steam coach to the up-to-date luxury car.

In the locomotive section the models are larger (1 inch to the foot) and therefore limited in numbers, but the series shows the "ROCKET," a William Adams express passenger locomotive of 1892 and Bassett-Lowke Ltd. have built a special model of "THE PRINCESS ROYAL" for the L.M.S. Railway, and this, together with two of the latest type L.M.S. coaches, corridor and dining car, forms an important part of the railway progress display. Another model of the same scale also constructed by the same firm is the "SILVER LINK" of the L.N.E.R., which might aptly be described as the "locomotive of the future."

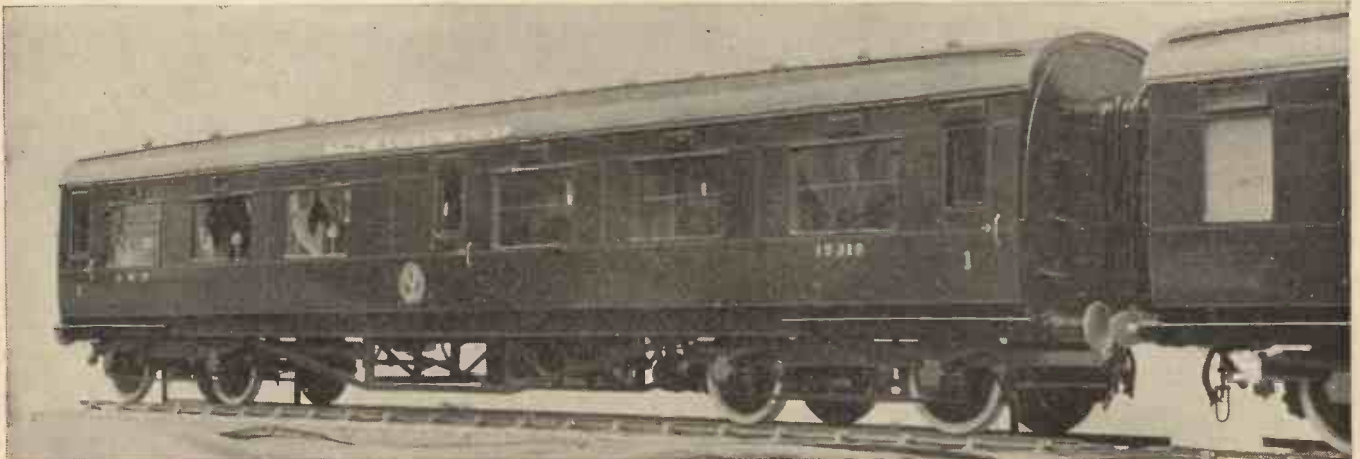

One of the "Royal Scot" type coaches forming part of the exhibit. This is the corridor coach.

The Latest in Railway Modelling

By Edward Beal

Abutments, Wings and Retaining Walls



Fig. 1.—A cutting modelled in lint.

A MOST important branch of civil engineering in relation to railway construction is that embraced in our subject this month, and it includes a number of details such as piers, pilasters, string courses and the various kinds of copings in general use. More usually it is entirely overlooked by the model worker, who is generally content to use anything for a wall and thereby completely spoil his job, besides overlooking one of the most splendid items of detail which serve to make the finished appearance of a layout truly effective.

Retaining Walls

Retaining walls are built for a number of reasons, and they have their own special designs and determinants. Sometimes they

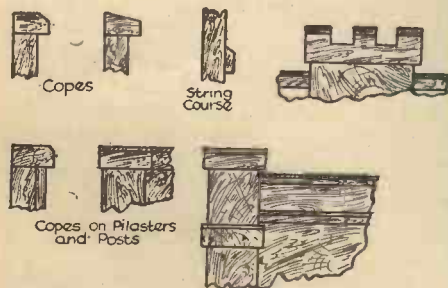

Fig. 2.—Showing copes on pilasters and posts.

are used in forming cuttings in places where slopes would be out of the question since the soil of the neighbourhood is of such a kind that it would not "stay put." On other occasions they are introduced in order to reduce excavation work in cuttings, or for the widening of a cutting which already exists; and they are, of course, necessary in every place where a more or less artificial formation on the high level has to be held up, or retained, to provide for either a track site below or permanent way above. There are also many other special determinants which lead to the demand for this work. Supposing, for example, that a track-survey demands a cutting which at one point would completely undermine the foundations of some building or other above. The building cannot be removed or even

purchased. It is private property in present use. An arrangement has therefore to be made between the parties concerned, and a retaining wall might be built in order to stabilise its foundations.

Wing Walls

Abutments serve to carry the working part of girder bridges or the arches themselves in the case of arch bridges. They are probably called by this name because in the early days they were used to take the thrust of masonry arches. Wing walls are for retaining the slope of earthworks at the back of abutments, and they conform generally to the slope of the earthwork itself.



Fig. 4.—A high and stepped-down retaining wall at Laurencetown Old Station W.M.R.

Sometimes they are vertically faced, sometimes they slope outwards towards their base, at an angle of about 1 in 12. Towards the top they tail off to short horizontal lengths, as they also do towards the bottom, and in calculating the precise vertical height of the wall, these short horizontal portions are not included. Sometimes they are built parallel to the abutment; sometimes they are set back at an angle towards their toes; sometimes again they are set back in parallel to the track or they may take a slight curvature (see Figs. 8 and 9). Abutments, on the other hand, are usually vertical.

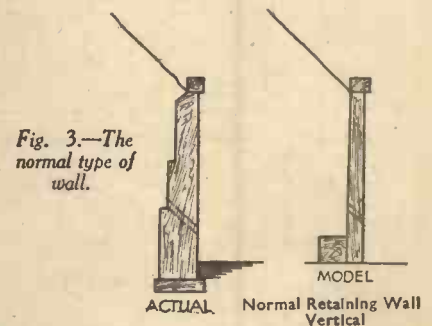

Fig. 3.—The normal type of wall.

In Fig. 2 we have examples of copings, string courses and of posts and pilasters in relation to them. For model work, strip-wood can be utilised on this work, the walls themselves being of fretwood. The surface of the walls may be finished in a variety of ways. A coat of dove-grey flat paint over the entire work provides a fine simulation of concrete, or brick-paper may be used, with stone-paper as an alternative. It is astonishing what a realistic effect can be produced in this manner, though, of course, the arch-work may be represented if so desired in more elaborate embossed wood or cardboard. For all practical purposes, however, the shading work is entirely satisfactory. The copings and arches consist of concrete-brown paper fixed in place with glue.

Figs. 3 and 4 show two types of wall, one the normal, the other the heavier tapered type as used for treacherous slopes. Alongside each sketch of the actual wall there is a suggested form of a model, the latter, of course, simpler in each instance. Fig. 6 gives a suggestion for the modelling of retaining walls in a cutting, and includes the important item of an open culvert such as is installed for the drainage of damp soil. The surface of the water in the drain is represented by means of a strip of celluloid lying on a brown-painted surface.

Get "MODEL-MINDED!"

BUILD AND RUN LOCOMOTIVES, ENGINES, SHIPS

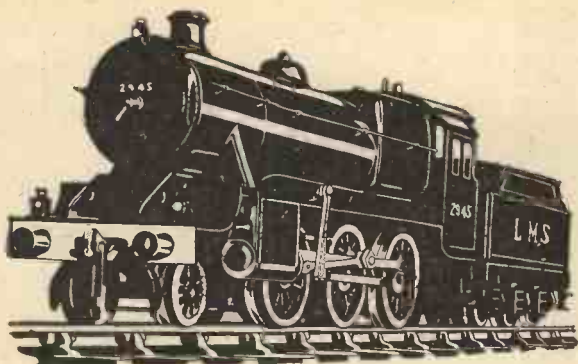

NEW L.M.S. 2-6-0 "MOGUL" TYPE LOCOMOTIVE

BASED on the new locomotives introduced by Mr. Stanier, Chief Mechanical Engineer of the L.M.S., this locomotive has several important innovations. The boiler is tapered; the cab is of entirely new design; the chimney is a new pattern. Its features, with simplified form of Walschaerts Valve Gear, have been faithfully reproduced in our new Gauge "0" model. Prices: electric, clockwork and steam, 5 gns. For details of other locomotives and their accessories see A.12 Model Railway catalogue.

Special folder of the gauge "00" Twin Train novelty, T.T.12, will be sent free and post free to all who are interested in "Table Railways."

SINGLE CYLINDER "BURRELL" TRACTION ENGINE

This 1/2-inch scale Traction Engine is one of BASSETT-LOWKE'S finest achievements. Hand-made throughout, it is 14 1/2 inches overall, 8 1/2 inches to the top of the chimney, weighs 12 lbs. and gives remarkably good power. In a test pulled 30 lbs. with 50 lbs. boiler pressure before slipping.

Finished model (unpainted) £15 15s. Painted £16 16s. Complete set of parts with instructions and drawings for building £12 12s.

Other Engines, castings and parts described in B.12 Model Engine Catalogue.

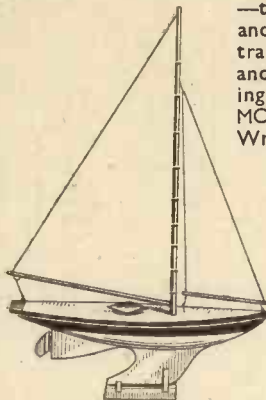
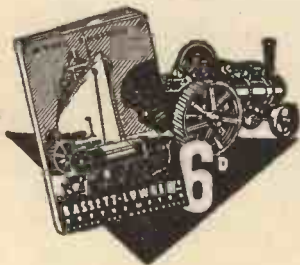

THE "CYGNET" MODEL RACING YACHT

This smart design incorporates all the good qualities necessary for fast sailing in almost all weathers, and is extremely easy to handle.

Pine hull is finished green with gold line above waterline and white below and a standard running rudder is fitted to all sizes. Length, 20 ins. Price £2 10 0. Sails of sails, price 18/6. Length 25 ins. Price £3 5 0. Suits of sails, price 21/-.

Other types of model ships, cruisers, motor boats, waterline sets of parts described in B.12 Model Ship Catalogue.

—this is just the time of the year when model owners and makers get their new stock of locomotives, track, rolling stock, accessories—their castings, parts and finished engines—their sets and parts for building ships of every kind, so it's the PSYCHOLOGICAL MOMENT to START THIS FASCINATING HOBBY!

Write to BASSETT-LOWKE, LTD., at Northampton, for their large catalogues on the subject of models, and decide what you will have from thousands of interesting alternatives.

Most of the new lines for the season are now ready, including the streamline "SILVER LINK" in gauge "0," inexpensive 4-4-0 L.M.S. locomotive No. 601, costing only 2 gns. clockwork, a new Esso Oil Waggon, and a splendid set of parts for constructing the Famous clipper ship "CUTTY SARK."

These catalogues should be on every model maker's bookshelf.

A.12 Model Railways 6d. post free

B.12 Model Engines 6d. post free

S.12 Model Ships 6d. Post free

Free folder "LILLIPUTIAN POWER" sent to those interested. F.B.12

BASSETT-LOWKE LTD.

NORTHAMPTON

London: 112 High Holborn, W.C.1
Manchester: 28 Corporation Street

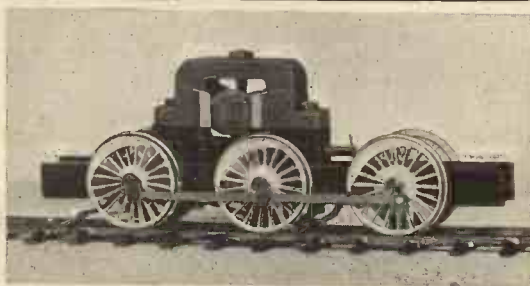

Gauge "00" Electric 6-8 volt. D.C. Mechanisms

We claim these mechanisms to be the most powerful commercial mechanisms made at the price. All are fitted with spoked wheels, 25-1 gear reduction and special cobalt magnet.

PRICES:

4 coupled 24 m/m diam. wheels, 34 m/m centres .. 25/-, postage extra
6 coupled 24 m/m " " 34 & 34 m/m centres 28/6, " "

EXTRAS, 22 or 26 m/m wheels 2/-. Special centres 5/-.



MAINS POWER UNITS

These units will run your 6-8 volt D.C. locomotives off 210-240 volt A.C. Mains. They have an output of 6, 8, 10 or 12 volts D.C. at 5 amps., also a tapping of 20 volts A.C. 1 amp. and 3 volts A.C. 5 amps. for lamplighting, etc.

PRICE **£3/19/6** Postage Extra

If you are interested in model making of any description, send for Bond's Catalogue, Price 6d. It will interest you, as it contains all types of Railway, Ship and Aeroplane Fittings, as well as Tools and Materials.

BOND'S O' EUSTON RD. LTD.

Phone: Museum 7137 **254 EUSTON ROAD, N.W.1** EST. 1887

A NEW HOME HOBBY

00 GAUGE MODEL RAILWAYS

This fascinating hobby is attracting many who are keen on Modelling, as Model Railways give scope for all kinds of modelling from Locomotives and Railway stock to buildings and lineside fittings and can also include models of Docks and Shipping. Our parts are simple to assemble and cheap, and we can give you plenty of ideas.

Start this winter.

Write for our 20-page illustrated Catalogue and samples, sending 4d., or if in London VISIT OUR NEW Shop premises in Charing Cross Road, opposite the Cameo News Theatre

THE CENTRAL SUPPLY OF 00 GAUGE

HAMBLING'S

10 Cecil Court
Charing Cross Road

Extraordinary Bargain Offer

Brand New 200 c.c. S.V. J.A.P. air-cooled Petrol Engines. Latest type, complete with automatic oil pump, magneto platform, and enclosed magneto drive, magneto sprockets, main driving sprocket (1/2 x 1/8) induction pipe exhaust union, etc., etc., as illustrated.

These engines are suitable for all purposes, including Motor Cycles, Motor Boats, Invalid Chairs, Lawn Mowers, Lighting Plants, Air Compressors and Power Plants. Manufacturers' actual price £8 10 0. An exceptional purchase enables us to offer these Engines at the ridiculous price of **35/-**

Case and Packing 2/6 each
Also 350, 500, and 600 S.V. and O.H.V. Engines at absurd prices.
Send for Complete List.

Marble Arch Motor Supplies, Ltd.
286-292 Camberwell Road, London, S.E.5
(Opposite Camberwell Green)

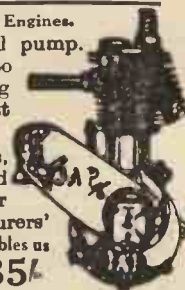



Fig. 5.—A West-Midland Railway Bridge.

Walls and Abutments

The wing walls and abutments illustrated in Fig. 8 are given in plan and elevation. Curved wing walls may be modelled in several layers of thin cardboard stuck together after curving, the whole being coped on the top with a shaped strip. The "earthwork" of the embankment may consist of a solid block of scantling having a strip of roof-felt for a surface formation, this resting on the top of a screen of brown paper or of dyed medical lint which should be of sufficient length to reach well down to the under baseboard, to which it is fixed down with sprigs driven through small cardboard squares about $\frac{1}{4}$ in. by $\frac{1}{4}$ in. The bank or earth may then be painted and its lower part coated with glue on which granite siftings should be sprinkled, the

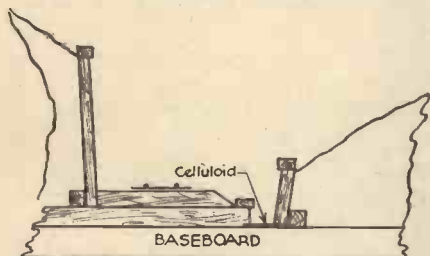

Fig. 6.—Model retaining walls with open culvert.

latter also covering the sprigs. The wooden scantling should, of course, be screwed down to the baseboard itself.

An end view of the arrangement of an abutment is given in Fig. 9. The builder should first decide upon dimension "X"—whether for single or double track. To this should be added twice the width of the pilasters, together with four sets of short, horizontal lengths in the wing-wall copings, and also the two sets of $1\frac{1}{2}$ or $1\frac{1}{4}$ to 1 slopes of embankment, plus the size of the newels. This will give the total and exact width of the whole structure. "X" itself includes, of course, the tracks and

clearances plus the girders of the bridge and the girder clearance. The weep-holes in retaining walls and abutments should be noted. These allow for the draining off of any water which may gather at the back of the wall, and are generally located a little above formation-level.

Errors to Avoid

There are a number of errors which must be avoided in the building of retaining walls. Never show such walls on a model as if they were built upon sloping or "made-up" ground. Do not make the angle of sloping walls at too steep an incline. Do not slope an abutment wall. Do not allow a wing wall to connect with its adjoining structure without the intervening and correct short length of straight coping, unless this is entirely unavoidable. Another snag is that of using the wrong type of brick-paper. Yellow brick

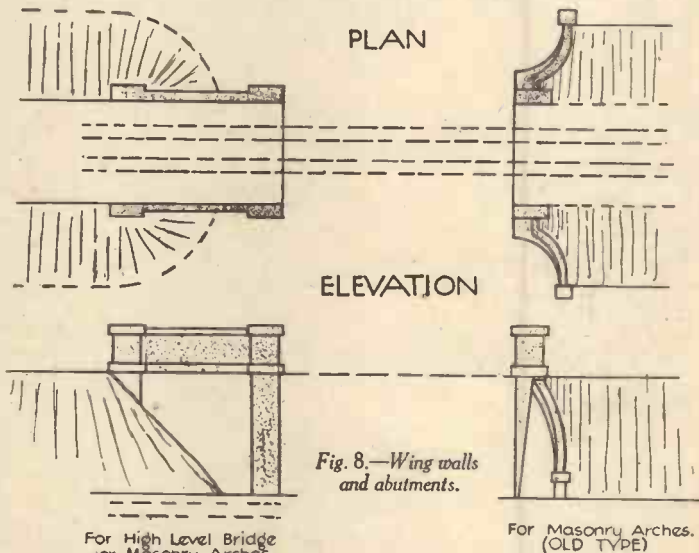
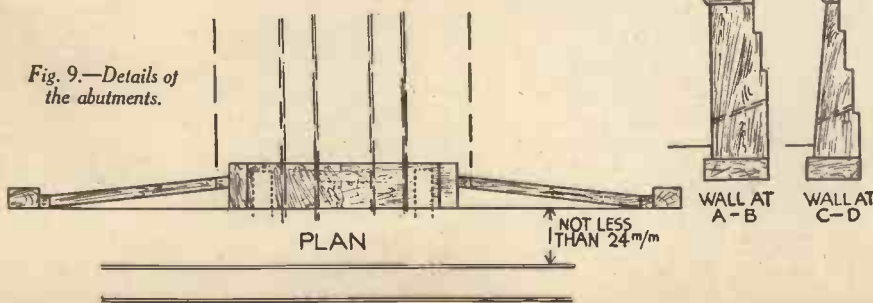

Fig. 8.—Wing walls and abutments.

also good for the purpose. Old stone is also suitable. Even the blue brick should be roughly smoked with a candle when the work is completed, to give it a realistic finish. Yellow or new red brick would not be hopelessly incorrect, but would be much less effective. The brickwork of abutments and retaining walls is usually "coursed," so it is therefore well to avoid a "random" finish to the brick or stonework, though the

Fig. 9.—Details of the abutments.



latter may be used for walls of medium height which do not bear any top weight. It should be observed that pilasters, newels, wing walls and abutments all conform to definite architectural as well as engineering proportions, so that most definitely, "anything" will not do.

LATHE WORK FOR AMATEURS

By F. J. CAMM

96 Pages

1/- or 1/2 by post from Geo. Newnes Ltd., 8/11 Southampton Street, W.C.2

NEW LINES AND NEW LISTS



44 Perfect Contact Components are illustrated and fully described in Clix New Components and Valveholder Folders. Many new Radio and Electrical lines are included.

Clix are consistently specified for Radio Receivers and Apparatus described in "Practical Mechanics."

A post-card request will bring these two-colour Folders to you. Write to Dept. "P.M."

CLIX LECTRO LINX LIMITED
79a Rochester Row, London, S.W.1

'Still keep
going
when the
rest have
stopped'

Exide

and

Drydex

ELECTRADIX BARGAINS



THE SUPERSEDER L.T. 2-V. battery, rectified and smoothed, three tappings, lasts indefinitely. A boon. List 23 1/2s. New, guaranteed, 37/6.

NEW STOCK OF CHARGERS, H.T. & L.T. off A.C. Mains for 3 to 80 Cells. Certain money spinners at bargain prices. All sizes. State wants.

EDISON STEEL CELLS. We have some of these high-capacity discharge cells cheap up to 400 ampere hours.

COIL TURN COUNTERS. for checking the number of turns up to 9,999 on dial, solled, 1/3 each.

MOTOR INTERRUPTORS, for converting any volts, D.C. to A.C., takes 12 V., 15/-.

X-RAY TUBES. Brand new, 7 bulb, 10/- each, packing and carriage 5/- extra.

FLUORESCENT SCREENS, Plate Holders 10 ins. and 15 ins., Coils cheap.

VACUO RESISTORS, wire ends, suitable where a 1-watt resistance is specified. 260,000 ohms, 1 meg., 1 meg., 2 meg. value in ohms, 4d. each.

Wire-wound 6 ohms strip, 6d.; 10 ohms, 7d.; 200 ohms, 1/-. Mica, 35 W., 100 ohms, 2/6.



A wonderful selection in our latest List 'P.M.', free for p.c.

WESTON TABLE TEST SETS in unused condition. Model 301, Moving Coil Weston Voltmeter 0-30, mounted flush in ebonite panel on table brackets, space at back for cell, five terminals and test key. Three Guinea Bargain at 18/6 to clear; limited number.

TELEPHONES. The cheapest tester is a pair of 2/9 Sullivan phones and a 6d. cell for any circuit. For short-wave sets Western Electric 2,000 ohms, 4/3 pair. Ericsson 4/6.

CRYSTAL SETS (for crystal-pure reception). Table type "A," 7/6. Double circuit type "B," 10/6.

HOME RECORDING. New Tracker Sets, geared drive with Cutter Head, Diamond Needle and Blanks. Bradford, 37/6; Feigh, 27/6. Spare blanks, 4/- doz. Electric Gramo. Motors, powerful Panatrop, 23 10s. Small types: Blue Flyer, 50/-; Patent, 45/-; H.M. Victor, 35/-.

35 mm. FILM PROJECTORS. "Williamson" & "Cine Chrome," with Lenses, etc., and Spools, Arc and Lantern, on floor pedestal, motor drive, 26 5s.

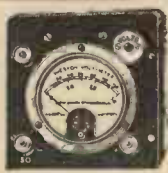

ELECTRADIX RADIOS 218 Upper Thames St., London, E.C.4

Telephone: Central 4611

BATTERIES

Obtainable from all reputable dealers and Exide Service Stations.

Exide Batteries, Exide Works, Clifton Junction, near Manchester. Also at London, Manchester, Birmingham, Bristol, Glasgow, Dublin and Belfast.

New Wireless Components for 1937



The W.B. Baby Cabinet.

RADIOLYMPIA 1936 has come and gone, and with its passing, visitors must have been impressed by the large number of ready-made receivers within the reach of the man-in-the-street. It is equally true, however, to say that components and accessories were very much in evidence, and at the prices at which they are offered, the home constructor must consider himself well catered for.

To help readers who may desire to construct an up-to-date receiver, or modernise their present set, we give details below of a selection of the latest components and accessories which were introduced at Olympia.

Loudspeakers

Of the many first-class speakers that were on view we draw attention to the new range offered by Whiteley Electrical Radio Co., Ltd. Although to outward appearances the 1937 Stentorian range is much the same as last year, the actual internal improvements are perhaps the most spectacular that have been seen at Olympia for some years. New Magnets giving an increase in flux density of more than 15 per cent., exponential cones of an entirely new material, and a completely redesigned "Microlode" transformer are some of the outstanding improvements now included with all models. The chassis models range in price from the famous "Duplex," which incorporates twin permanent magnet speakers, at 4 guineas to the Midget at 17s. 6d. This latter measures but 5½ in. in diameter but gives a performance equal to many larger and more expensive speakers.

Cabinet models are finished in handsome walnut veneer and all except the 29s. 6d. model, have a volume control incorporated.

Apart from the usual range of speakers, the Whiteley Company have this year evolved a most interesting device called the "Long Arm." This can be fitted to three models and in effect it makes it possible to switch the set on and off from an extension speaker in any part of the house without affecting the receiver or any other extension speaker. Thus anyone operating the device cannot disturb people in other rooms. It costs 15s. 6d. and is quite unobtrusive when fitted. It is, of course, the first development for some time to increase the actual scope of the entertainment possibilities of radio. We predict a big demand for it.

A Review of Many of the New Devices Exhibited at Olympia

Valves

Valves for all purposes were exhibited by the High Vacuum Valve Co., Ltd., and the present all-wave interest will no doubt be reflected in the demand for the special short-wave types of valve made by this

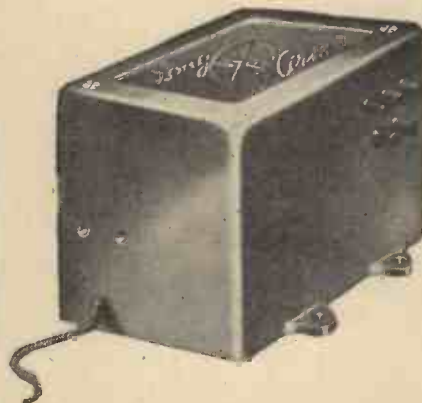

The "Long Arm" is a remote-control device produced by W.B. and gives full control over the receiver at a distant listening point.



This year's Stentorian has a number of improvements, and the model shown above is the Junior which may also be obtained in a cabinet version.



The W.B. Cadet Cabinet.

firm. These are provided with ceramic bases, and the control grid is brought out at the top of the bulb. In addition the special Harries output valve should appeal to all battery users who are out to obtain better quality and more volume. In this valve the suppressor grid has been dispensed with, yet undesirable secondary radiation, which the suppressor grid was designed to overcome, has been effectively prevented by setting the anode at a carefully calculated distance. This "critical" spacing of the anode, and removal of the suppressor grid gives this valve three major advantages over the pentode type: better characteristics, low internal impedance, and low inter-electrode capacity. Thus it will be seen that the Harries valve has the great sensitivity of a pentode type with the low distortion level of a triode.

This firm also includes a complete range of midjet valves in their new season's programme. The latest addition to this range is a new Hivac metal-sheathed triode. Several interesting midjet receivers were also shown by this firm, utilising these valves, both for broadcast and short waves. The following price reductions have taken place in the Hivac range.

BATTERY VALVES Old Prices New Prices

Y220	10/6	9/6
Z220	10/6	9/6
B230	10/6	9/6
QP240	19/6	17/6
TP230	15/6	14/-
SG215	10/6	9/6
SG220	10/6	9/6
VS215	10/6	9/6
HP215	10/6	9/6
VP215	10/6	9/6

MAINS VALVES

AC/HL	9/6	8/6
AC/DDT	12/6	10/6
AC/L	12/6	8/6
AC/Y	15/6	11/6
AC/Z	15/6	11/6
AC/SL	13/6	10/6
AC/VS	13/6	10/6
AC/SH	13/6	10/6
AC/VH	13/6	10/6
AC/HP	13/6	10/6
AC/NP	13/6	10/6
UU120/500	15/-	12/6
PX41	13/6	12/6

All remaining types of HIVAC valves unchanged.

Batteries

The ever popular range of Exide and Drydex wireless batteries continues to be improved and increased in keeping with modern set production.

The latest development in low-tension accumulators — the new Exide "Hycap" Cell — has been specially designed to cope with the increased current consumption of modern higher powered wireless receivers. The popular Exide "visible charge" indicator is incorporated in the "Hycap" series, and all terminal nuts are of the Exide non-interchangeable type.

With the user always in mind, the Exide Company have produced a stack-type wood crate for their

The comprehensive range of Drydex torches, spotlights, hand-lamps, cycle-lamps and gas-lighters continues to be improved and brought up-to-date as occasion demands.

New Bulgin Lines

This firm have introduced many new lines and we draw attention to a new valve tester which operates from A.C. mains of 200-250 volts, 40-60 cycles, and provides all the power needed for the static testing of all types of English pin-base valves. Four sockets for basic types of valves are incorporated, and with its adapters, covers all requirements. With this instrument it is possible to test forty-one different types of valve. Continuously variable G.B. from zero to 50 volts, L.T. from 2 to 40 volts, H.T. from 75 to 400 volts, and screen potential from 75 to 350 volts is generated by the tester. Tapping switches select these potentials. The dual range meter reads 0-15 and 0-60 mA. Valve curves can be easily taken. The instrument is provided with all leads and universal adapters, and is sold complete with full instructions.

Also of interest is the Bulgin condenser microphone which is obtainable with or without a stand. The microphone is electrostatic comprising a stretched and carefully tensioned diaphragm separated

distortion or colouration. A cast aluminium case, which is substantially non-resonant, houses the electrodes and protects the diaphragm from injury. The case, which is finished matt aluminium, is cut to take rubber slings. If desired it can be obtained fitted to a special telescopic universal stand.

New flexible shaft couplings that will couple all $\frac{1}{2}$ -in. dia. shafts with several degrees of flexibility will appeal to the short-wave enthusiast. The present television interest is also clearly indicated by the many small television accessories introduced by this firm.



The HiVac Harries output valve.

high-tension accumulators. As the name implies, the crates of batteries can be stacked neatly; when one crate only is used a detachable metal carrying handle (which is supplied free of charge with all crates) can be used for transportation. The Drydex dry battery range continues to be increased—more than 150 different types are now listed. A valuable part of the user service provided by the makers is exemplified by a range of "X type" batteries. Un-named (home construction) sets, dial illumination, etc., create temporary demand for special batteries, which are made up by this firm and added to the "X" list, which now reaches the impressive total of more than 400 types, and as demand increases, the more popular "X" types are added to the standard list. All the Drydex cartons have been improved considerably by the application of a new glazing process, while in the case of the Drydex/Textet unit a new and typical carton is provided.



The Hycap Exide Model C.F.G.-4.

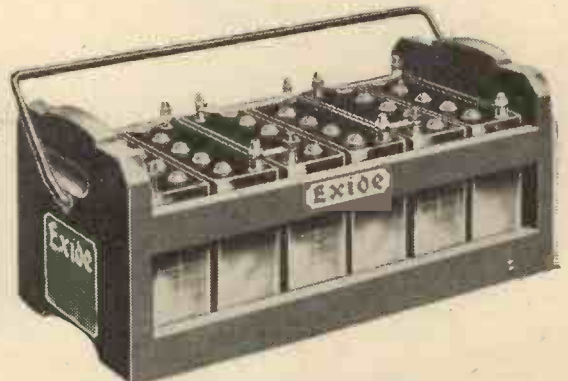

An H.T. accumulator unit from the Exide range.

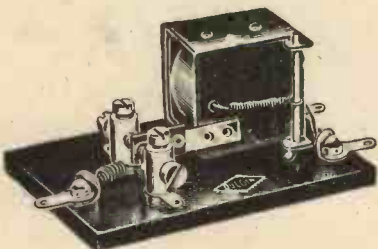
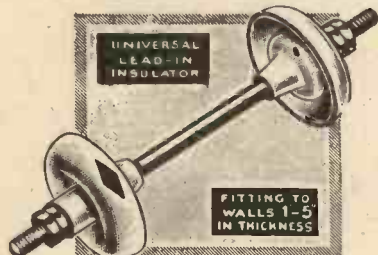

Two of the many new Bulgin accessories which were introduced at Radiolympia.

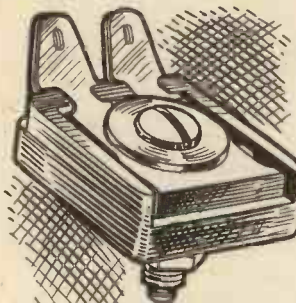

The neat Bulgin mica dielectric pre-set condenser.

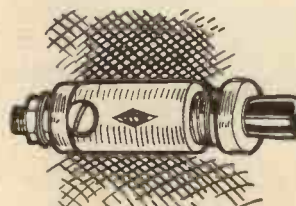

The Bulgin push or pull meter switch.

Testing Apparatus

In addition to the wide range of electrical testing equipment shown by the Automatic Coil Winder and Electrical Equipment Co., Ltd., they also introduced three new instruments.

These were a new Model 7 Avometer which gives 46 ranges of readings, an improved "Avo" Signal Generator, and a new coil winding machine. In addition to the 46 ranges of readings the Avometer embodies a protective cut-out and temperature compensating device. It does not

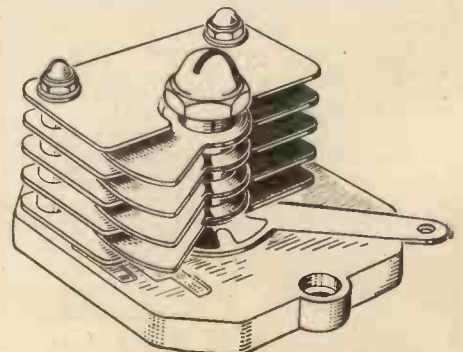

A pre-set condenser from the Bulgin range.

**YOU CAN BUILD
Your Own
RECEIVER!**

★ **KITS OF PARTS** ★
For RADIO SETS, RADIOGRAMS, & AMPLIFIERS

"Now, you Radio Constructions Enthusiasts! here's something that combines your hobby with pleasure and assures you of many days of enjoyment." Now is the time for you to build your own Receiver during the coming winter evenings. For a small outlay you can build a radio receiver for Empire and Foreign Reception that will definitely give you great enjoyment and will be equal in results to any 1936-7 Olympic Show Model. We **GUARANTEE YOU AMAZING RESULTS**, for we supply you free with blueprints and our Technical Experts are always at your service.

SAVE MONEY

OSTAR-GANZ KITS of parts are cheapest and best, for every component is of the finest **BRITISH** manufacture and our prices are within the reach of all pockets. Read the following description and prices and write now for PARTICULARS. There's no obligation.

PRICES:—3-Valve All-Wave Receiver Kit, 19-2,000 m., £5 0s. 6d. Valves £2 9s. 6d. extra. 3 Pentode 4-Valve A.W. Receiver Kit, 20-2,000 m., £6 2s. Valves £3 7s. extra. 6-Valve All-Wave Super Kit, 18-2,000 m., £8 2s. 9d. Valves £5 12s. 3d. extra. Amplifier Kits from £3 9s. 6d. S.W. Adaptor Kit, £2 14s. 9d. Speakers, 35s. Cabinets, 2 gns. *Generous Hire-purchase Terms arranged.*

EUGENE J. FORBAT,

28-29 Southampton Street, Strand, W.C.2.

*Phone: TEMple Bar 4985, 8608.

OSTAR-GANZ

Universal All-Wave, All-Mains A.C., D.C. KITS

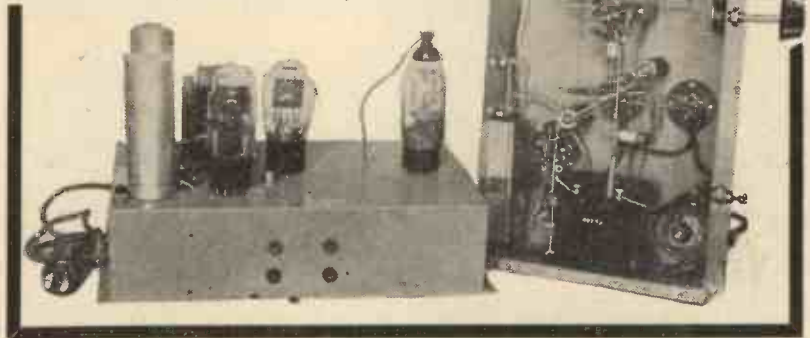

HYVOLTSTAR ★

**UNIVERSAL, ALL-WAVE, ALL-MAINS
A.C., D.C. RECEIVERS**

- IN CHASSIS FORM ●
- TABLE MODELS ●
- and RADIOGRAMS ●

All Models can be had "ON APPROVAL."
Deferred and Part Exchange Terms Arranged.

TWO NEW MODELS!

UNIVERSAL ALL-WAVE REFLEX SUPERHET 4-VALVE MODEL. Price 15 gns. 16.5-2,000 metres in 3 ranges. Adjustable tone control. Twin speed. Provision for gramophone pick-up and external loud-speaker. An exceedingly modern and efficient receiver—cheap in price and running costs. Truly a model of advanced design.

UNIVERSAL ALL-WAVE SUPERHET "8" A.C., D.C. Price 30 gns. 13-2,000 metres. 6 tuned stages. Tuned R.F. amplification on all waves. High speed automatic volume control. Full range tone control. Neon visual tuning. A real craftsman's job with a brilliant performance on long-distance reception. Write for particulars of all Receivers, Radiograms and Amplifiers.

UNIVERSAL HIGH VOLTAGE RADIO LTD.
28-29 Southampton Street, Strand, W.C.2.

*Phone: TEMple Bar 4985, 8608.

PRICES.
Chassis, Table Model,
Radiogram.

FOUR-VALVE SUPERHET.	11½ gns.	15 gns.	21 gns.
SUPERHET FIVE.	13½ gns.	17 gns.	23 gns.
SUPERHET SIX.	14½ gns.	19 gns.	25 gns.
SUPERHET SEVEN.	21 gns.	25 gns.	30 gns.
SUPERHET EIGHT.	25 gns.	30 gns.	35 gns.
SUPERHET NINE.	28 gns.	33 gns.	39 gns.
SUPERHET TEN.	30 gns.	35 gns.	42 gns.

SPECIAL CHRISTMAS OFFER

OF A
NEW ELECTRIC KITCHEN APPLIANCE



Food Chopper—Mixer and Beater—Juice Extractor—
Tin Opener—Knife Sharpener—Drink Mixer, etc.
The **KITCHEN-ETTA** is a complete and efficient
kitchen appliance. Run by air-cooled motor and
controllable in three speeds. Attachments easily
fixed and adjusted. **SIMPLE TO OPERATE.**

Full equipment, bowls, etc., included.

REDUCED from £8 - 8s. to **£3 - 10s.**

LIMITED SUPPLY ONLY AT THIS EXCEPTIONAL PRICE
(Send now for Lists)

DOUGLAS HOLT

Established 1919 Ltd.

9 LITTLE TURNSTILE, HOLBORN, W.C.1.

HIVAC

HARRIES

**THE WORLD'S BEST
OUTPUT VALVES**

The latest and greatest development in valve design
SIMPLY PLUG IN A HIVAC HARRIES AND GET

- GREATER VOLUME
- IMPROVED TONAL BALANCE
- INCREASED CLARITY OF REPRODUCTION

Send for fully descriptive four-colour Folder "M.A."
It tells you all about the advantages of the Hivac
Harries over the pentode type, and gives details and
prices of all types available.

**HIVAC 1936-7
REPLACEMENT CHART**

This new Chart gives you the character-
istics of over 50 types of Hivac valves, and
shows which ones to use when replacing
old valves of other makes. You will also
see that Hivac cost you less, while per-
formance is of the highest standard.
Write for Replacement Chart "P.M."



High Vacuum Valve Co., Ltd., 113-117 Farringdon Rd., London, E.C.1



A micro ammeter—a new line obtainable from Electradix Radios.

supersede the 36-range Universal Avometer, but is designed for engineers who require a still more comprehensive instrument.

The improved "Avo" Signal Generator is an accurate modulated oscillator, designed for laboratory and workshop use. It covers a continuous fundamental range from 3,000 metres to below 20 metres, waveband switching being employed. It gives the choice of internally modulated, externally modulated or pure R.F. signals. Supplied with broadcast and short-wave dummy aerials and screened lead, it will supply an audio signal for bridge measurements, etc.

The coil winding machine known as the "Douglas Model F.A.P.I." is designed for simultaneous winding of coils with paper insertion and final parting off on completion. It has a variable speed of 500 to 3,000 revolutions per minute, and will wind coils from $\frac{1}{2}$ in. to 6 in. in length.

The almost universal adoption of the chassis form of set construction has,



A valuable safeguard. The Clix extension L.S. control panel.

generally speaking, rendered extremely difficult the measurement of value performances under working conditions, owing to the inaccessibility of testing points.

The introduction of the "Avodapter" and "Avocoupler" marketed by this firm has obviated this difficulty and reduced practically every valve test to its simplest form.

Worth a Visit

The home constructor would do well to pay a visit to Electradix Radios who stock

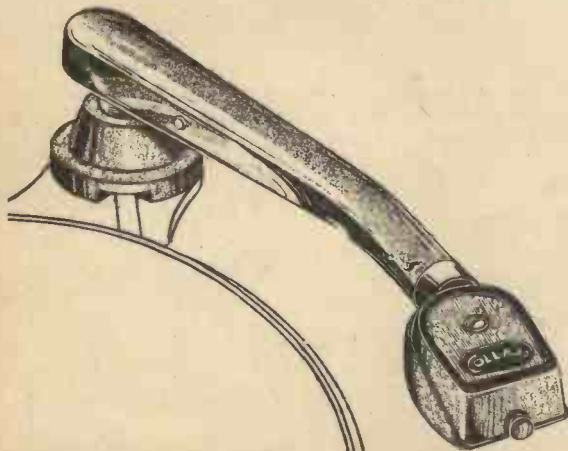

The Collaro magnetic pick-up which costs only £1 2s

a wide range of wireless accessories. This firm are selling a micro-ammeter of the moving coil panel type, suitable for a small current, which is an ideal instrument for the home constructor.

Valveholders, Plugs, etc.

Valveholders, plugs, and sockets of every description were featured on the stand of Lectro Linx Ltd. The latest accessory to be added to the extensive Clix range is a loud-speaker extension panel, a brief description of which is given below.

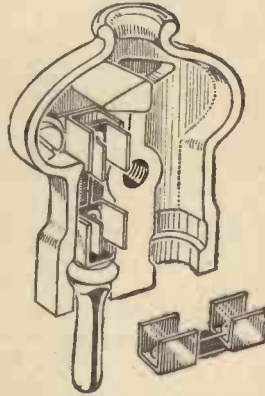

This sectional drawing of the new Clix plug shows the method of construction.

The majority of listeners now employ an extension loudspeaker for use in another room in the house, and although this is generally connected permanently there is no arrangement at the receiver end for connecting this and disconnecting the permanent speaker, or for otherwise making the necessary connections. If it is suddenly desired to bring into use the external speaker and to cut out the permanent speaker, the leads may be disconnected from the one model and the other leads connected, but such a procedure should only be undertaken when the set is switched off, and on no account should the anode circuit of a valve of the pentode type be broken whilst the H.T. and filament supplies are switched on. Even when a change-over switch is employed for the two speakers, the set should be switched off first to avoid open-circuiting the pentode, but the new Clix component illustrated on this page will avoid the difficulty in a simple manner. As will be seen, a small bakelite panel is provided with a socket and a slot and a two pin plug is provided with two different sizes of pins, the smaller being inserted into the socket and the thick pin in the slot. It will be found that the plug may be then

twisted a short distance in either direction, and the pin makes contact in one position inside with a brass contact piece seen in the left-hand illustration, and this enables the two speakers to be joined in parallel or the extension speaker only to be included in circuit, but at no point is the anode circuit broken. This is therefore both a useful device and a valuable safeguard, and it

costs only 1s. The extension speaker leads are, of course, joined to the two pin plug, whilst the internal speaker is connected permanently to the rear of the control panel.

Also of interest is the Clix 5 amp. fuse plug for the protection of radio and other domestic electrical appliances. It will fuse low-power circuits up to 5 amps. and is fitted with two sensitive and reliable fuses of either 1 or 5 amp. ratings. The fuses, which are of the clip-in type, can be easily replaced. It costs 1s. 8d.

Gramophone Motors

In addition to the many existing lines made by Collaro Ltd., they have introduced a new automatic record-changer designed in two models, one for A.C. operation, and one for either A.C. or D.C. It plays 9 in. 10 in. and 12 in. diameter records mixed in any order without pre-setting and accommodates 8 records. It incorporates a Collaro

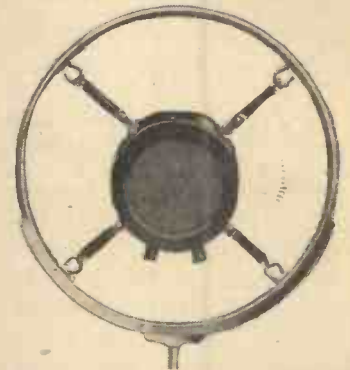

A microphone and stand manufactured by W.B.

induction motor or universal motor for power, and a Collaro type 36 metal pick-up arm. The device is mounted on a rectangular unitplate for fitting into the cabinet, and merely requires fixing down with eight wood screws provided. Pick-up leads of suitable length are fitted ready for attaching to the pick-up terminals on the wireless receiver.

There are, of course, also the popular spring-operated motors as well as the A.C. induction models and universal mains units.

Piezo-Electric Pick-ups

From the view points of frequency response, quality of reproduction and volume of output, the Rothermel-Brush Piezo-Electric Pick-up is to be recommended. An important feature is the lightness in weight as compared with the old style magnetic type. The actual weight on the record is less than 2 oz. A popular model made by this firm is the S8, which is of neat design, finished in brown crystalline, and has an overall length of 10 in. The pick-up should be connected directly to the grid of the input valve. It provides a frequency response of from 52.4 cycles to 8,460 cycles and has an output of 1.8 volts. It costs £2 2s.

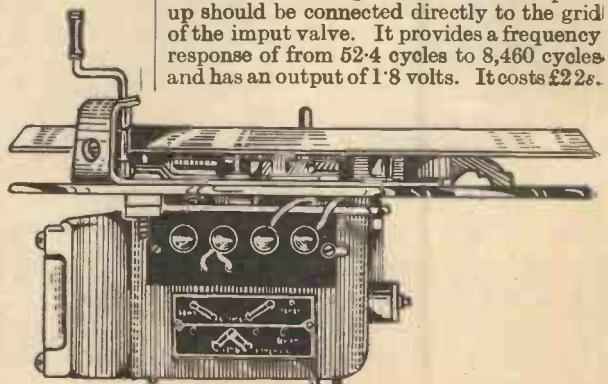

The Collaro induction motor for A.C. mains.

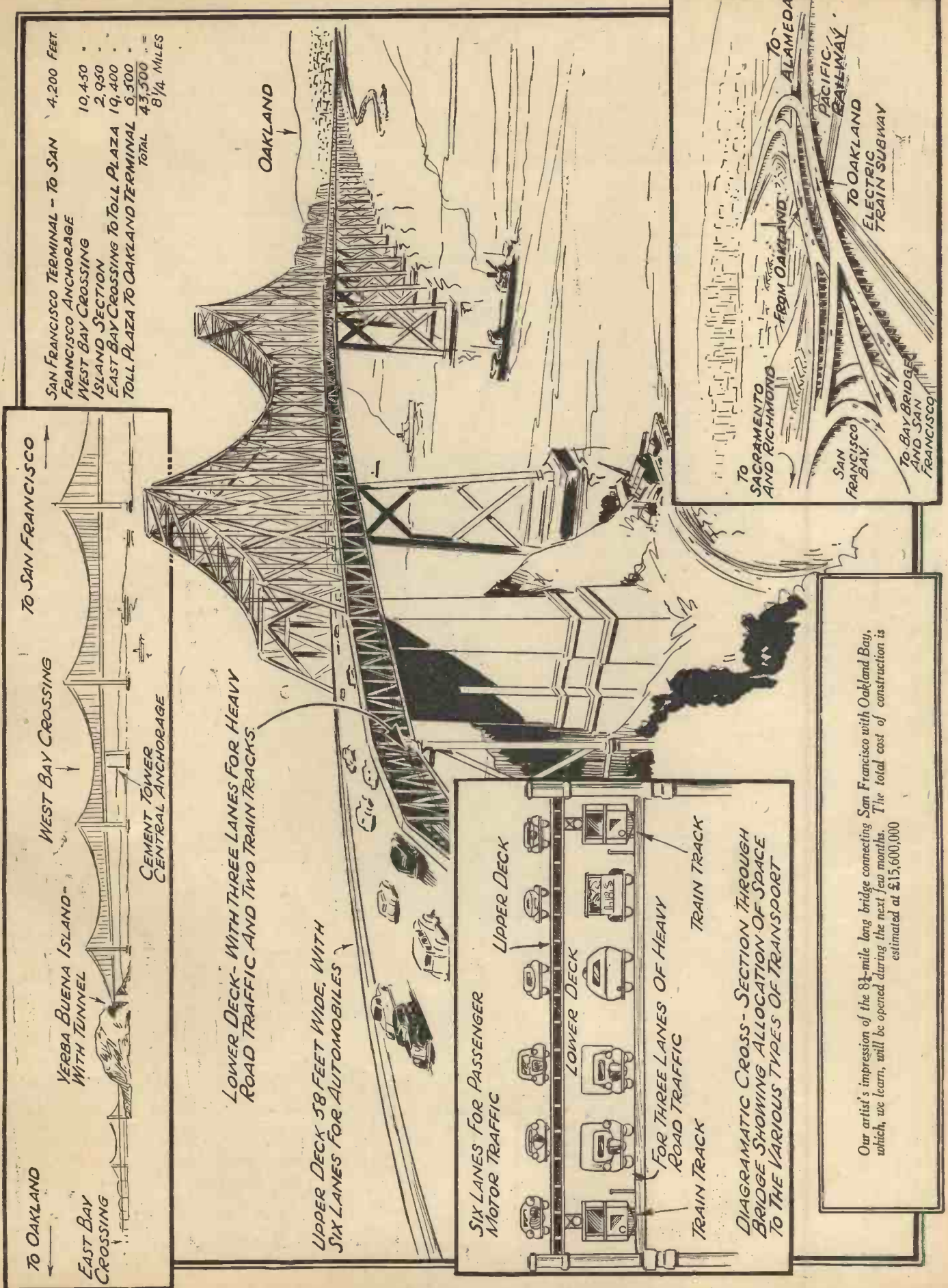

SAN FRANCISCO TERMINAL - TO SAN FRANCISCO ANCHORAGE	4,200 FEET
WEST BAY CROSSING	10,450
ISLAND SECTION	2,950
EAST BAY CROSSING TO TOLL PLAZA	19,400
TOLL PLAZA TO OAKLAND TERMINAL	6,500
TOTAL	43,500
	8 1/4 MILES

Our artist's impression of the 8 1/4-mile long bridge connecting San Francisco with Oakland Bay, which, we learn, will be opened during the next few months. The total cost of construction is estimated at \$15,600,000

This Month in the World

Dry Ice from "Devil's Breath"

DOWN in the desert region of Southern California is located one of nature's strange eruptions called a Devil's Kitchen. The tourist who ventures there finds a group of spluttering malodorous mud geysers. A curious minded American chemist—a woman—who knew the place decided one day to bring away a sample of the fumes and gases spluttering out of the mud. She found it to be practically pure carbon dioxide, formed apparently by the action of super-heated brine on limestone strata.

Shrink Fits by Freezing

TO-DAY there is a big refrigeration business in solid carbon-dioxide; it is incidentally the white fuming substance used to preserve ice-cream in retail tubs, and machinists use it to get shrink fits by freezing the inner member instead of heating the outer member of such a fit. Without telling anyone, this woman bought

sinking a number of pipe wells into the mud strata.

Welding Advances

WELDING, to judge from the recent international welding congress in London, is making bigger strides everyday as the modern method of joining metals. The technique of welding copper, aluminium and even the difficult magnallium alloys, has been perfected. Under-water cutting of steel by divers is now an every day affair.

Cutting Steel Under Water

THE flame supplied with 3 parts of oxygen to 1 part of acetylene burns under water, and cuts steel almost as easily as on land in the open air. The oxygen is sufficient for combustion so that the flame stays alight. The heat is not rapidly taken away from the flame because it generates an envelope of steam which, as it is a gas, is a very perfect insulator of heat. The sizzling hiss

going boat she was allowed to cross the Atlantic to Canada without a wireless set aboard.

Vanished into Thin Air

SHE disappeared without leaving a trace and it is now supposed that she struck an iceberg. As fierce controversy rages in naval architectural circles on the merits of the all-welded construction, the system has received a tremendous set-back. It would not have happened if the ship had only been equipped with a wireless transmission set, even a temporary one would have served.

Air Conditioned Sleeping Coaches

L.M.S. railroad engineers have achieved the last word in luxury travel with their new six-wheel bogie sleeping coaches, destined for the Night Mail service. The sides and floors of the coach are insulated against penetration of noise by felt and cork dust packing. The coaches are of all-welded construction to save weight and to assist soundless running. The greatest luxury feature, however, is the use of steam heated air conditioning apparatus to supply clean air at correct temperature to compartments. The air enters through louvres at ceiling level and exhausts through openings in the foot of the doors.

Thermostatic Dampers

TWO fans driven off one motor under the control of the car conductor supply the air. One delivers straight cold air to the ventilation duct, the other drives a certain proportion of the air over steam heaters. Thermostatic dampers control the separate volumes of air and there is an auxiliary fan-speed control operated by hand. Air conditioning is nowadays the approved method of central heating. All London's larger hotels are equipped with air washing, humidifying and heating plants delivering air through huge six-foot ducts, located many floors down, to the hotel above.

Automatic Glass Blowers

THE production of bulbs for electric lighting, wireless valves and other purposes has for some years past been on automatic production. The modern machine produces bulbs at the rate of 500 a minute exact to size and base fitting. Glass exactly adjusted in temperature and chemical composition is run out in long threads on to a perforated die plate. Air nozzles register exactly on the dies as soon as the glass lies across the holes.

An Air-puffing Machine

MECHANICALLY rotated moulds come up underneath the holes and an air puffing machine rapidly distends the glass into an egg-shell bulb inside the mould. By the time the die reaches the end of the machine the bulb is set and a mechanical finger knocks off its neck from the air nozzle and releases the mould in one movement.

1,000 Bulbs a Day

THE system of nozzles and moulds then travels back to the starting end of the machine. When it is realised that by the old hand blowing method a team of two men could only make about 1,000 bulbs a day, the speed of the robot blower turning out as many bulbs in two minutes seems

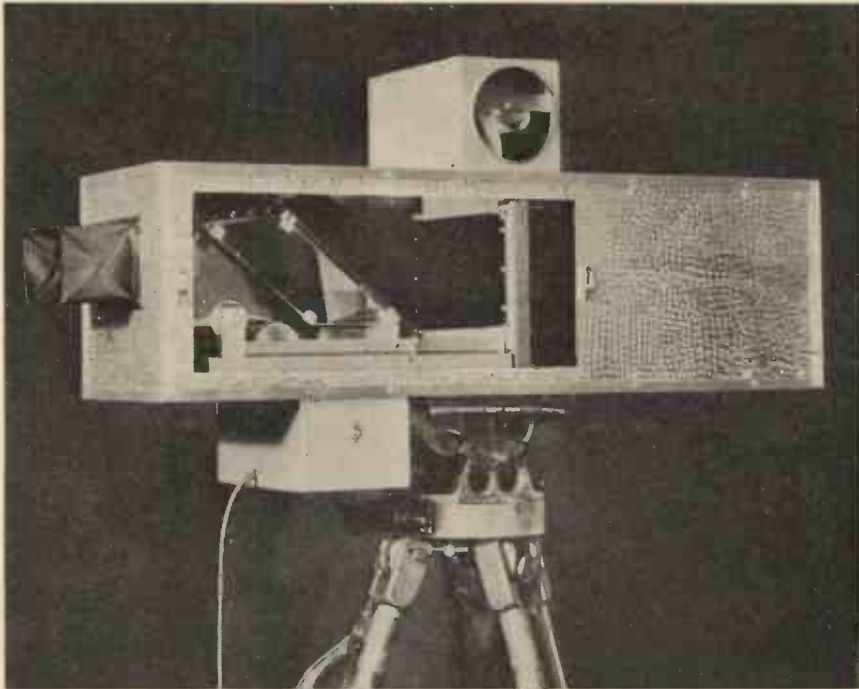

This new instrument, invented by Flavel M. Williams, records on a specially treated infra-red ray film, developing and fixing the negatives in thirty seconds. The device has been installed on the liner "Manhattan." It is designed to extend the visibility of the navigator of a ship from two to four times. The camera will record for the navigator other ships, rocks or the shore line, which he himself cannot see in the fog.

up the lease of the springs for a knock-out price, took a Diesel-powered compression plant down into the desert, and set up a remarkably profitable solid carbon-dioxide manufacture. She had the pull of other sources of carbon dioxide because hers was 100 per cent. pure. Other sources, from the gases of brewing vats and boiler waste gases, contain less than 20 per cent. of carbon dioxide.

The Hottest Spot in America

THE Devil's Kitchen is 300 ft. below sea level, and has the reputation of being one of the hottest spots in America. For all that, a thriving refrigeration business is located there. The enterprise has been extended since the original discovery, by

of a flame burning steel under water is still however, for those who have witnessed it an amazing spectacle.

Mystery of All-welded Ship

IT is a tremendous pity as well as a great tragedy, that one of the first ships of all-welded construction should have disappeared and has evidently been sunk in circumstances of complete mystery. The ship was the *Joseph Medhill*, a motor freighter destined for the Great Lakes traffic in Canada. She was built at Newcastle and was hailed as the world's largest "all-welded ship." All her frames, decks and plates were secured together by welding, a system which saves weight, time and material. As she was not a regular sea-

of Science and Invention

incredible, although the manual feat of one bulb every half minute was no mean achievement of glass blowing craft.

The Rare Metal, Niobium

ON account of its rarity, little attention has been paid to the metal Niobium and very little of the metal has been available

than 80 m.p.h. The average speed over the whole 100,000 works out at no less than 67.1 m.p.h.

Aircraft Design

THE design of fighting aircraft is undergoing a remarkable change—one might almost say that the fashion is changing.

Fastest Military Aircraft in the World

But to-day the new machines are of very different design. All the new fighters are of the low-wing monoplane type, built more like a Schneider Trophy machine than those to which we have grown accustomed. All are fitted with retractable undercarriages, fixed tail units, wing flaps, and all are capable of speeds nearer 400 m.p.h. than 300 m.p.h. The first of these new types is now being tested and one, the Vickers "Spitfire," which has a Rolls-Royce "Merlin" engine, is claimed to be the fastest military aircraft in the world.

A New Canadian Locomotive

LOCOMOTIVE designers appear to work on the principle that records are only made to be broken. Such, at least, is the opinion one gains from the frequency with which new giant locomotives are produced.

The latest giant on the Canadian railways can, however, claim real distinction. Not only is it the largest streamlined engine in the world, but it is also the longest. Its overall length is almost 95 ft. and its working weight is 300 tons. The engine is streamlined from the nose to the drivers cabin.

Oil in Great Britain?

IN spite of the fact that none of the drillings now in progress in various parts of the country have yet shown any indication of success, it is learned that five additional prospecting licences have been granted to the Anglo-American Oil Company. Less likely discoveries have been made, and the geologists say that there is a fair chance of oil being found, but . . . ?

The "Queen Mary's" Sister Ship

IT is announced that the keel of "No. 552" is to be laid in November. Her design will be very similar to the *Queen*



The "Hindenburg" passing over the German highway from Frankfort to Switzerland.

for research. In colour, it closely resembles platinum, and its properties are believed to bear a close resemblance to tantalum. Although its commercial production is very limited, an American firm is now experimenting with it as a constituent of stainless steels and it has also proved very suitable as a material for the electrodes of high-power wireless valves.

London's 'Buses

LONDON owes much to the energy with which the L.P.T.B. has developed bus design and it seems amazing to recall the vigorous protests which were made less than ten years ago at the withdrawal of the open-top type. Mechanically, the present-day buses have progressed out of all recognition and a new fleet of 100 vehicles has just been ordered from Leyland Motors Ltd. to be fitted with engines of the diesel type. Ten of the new vehicles are to be "gearless" buses and will be fitted with the Leyland hydraulic torque converter.

Model Aeroplane Record

IT is announced from Hamburg that a model aeroplane recently set up a new duration record by remaining in the air for 3 hours 14 minutes. It came to earth 57 miles away, but as it is believed that the model was not kept in sight for the whole of the flight, the record would not be accepted at present in this country.

The Silver Jubilee High-speed Train

BY covering the distance of 100,000 miles since October last, the Silver Jubilee Express has achieved a world's record. Actually, the work has been shared between four locomotives, but only one set of carriages exists and not a single mishap of any sort has been recorded. Of the 100,000 miles travelled, more than 86,000 have been covered at over 70 m.p.h., and over 18,000 have been covered at more

Only a few years ago, such machines as the Gamecock, the Siskin, and the Fairey 111F were typical. All of them were biplanes with engines of 300-400 h.p., a top speed in the region of 120 m.p.h. and only very roughly streamlined.

Streamlining

Such machines gradually gave way to the class of which the Hart was a good example, carefully streamlined, and fitted with super-charged engines such as the Rolls-Royce Kestrel of some 600 h.p. These machines were capable of top speeds of the order of 180-190 m.p.h.

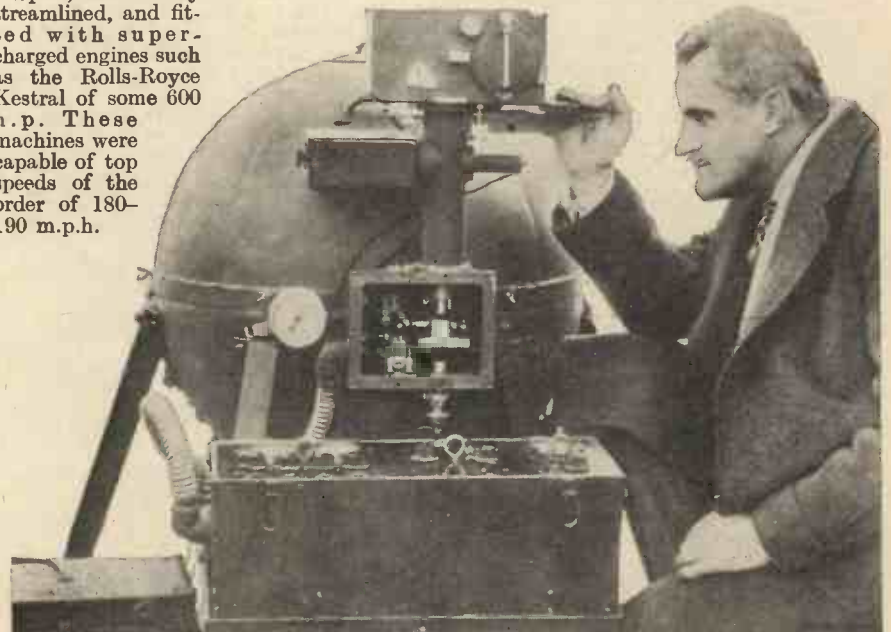

For the first time a Cosmic Ray Meter has been erected on a ship travelling through the Northern and Southern Hemispheres, for the purpose of checking the Variation of cosmic-ray action in the different hemispheres. Under the shield, which affords a screen of lead (through which cosmic rays but not radio-active rays may penetrate) is a body of matter on which the impact of the cosmic rays is registered by means of an electrically-operated device. The readings are thereby recorded on a photographic film, which is changed once a week.



A Selection for the Modern Handyman

MODEL AEROPLANES AND AIRSHIPS. This handbook is intended as a guide to the beginner in model aeronautics. It presents in clear language the first principles of aviation and incorporates these in various forms of simple flying models. Profusely illustrated.

ACCUMULATORS. An accumulator (whether for wireless or the car), if properly used and cared for, is an extremely reliable piece of apparatus. Proper care and proper use can only follow a possession of the knowledge which study of this book will impart.

SIMPLE ELECTRICAL APPARATUS. Interesting and useful apparatus, easily constructed, with which the student is enabled to test for himself the theory and practice of electricity as laid down in the textbooks. 138 illustrations.

THE HOME WOODWORKER. The various examples of woodwork described in this handbook have been designed by practical craftsmen. They are modern in style, and their construction is well within the powers of the average homemaker who follows the instructions given.

THE HANDYMAN'S ENQUIRE WITHIN. Hundreds of practical ideas and hints—many not hitherto published. Classified according to the subjects dealt with, an index being provided to facilitate speedy reference.

MOTOR CAR OVERHAUL AND UPKEEP. There are many to-day who by undertaking their own repairs can afford to run a car, and it is the purpose of this profusely illustrated handbook to explain how the owner-driver may carry out most of the adjustments and repairs which every car sooner or later needs.

POWER-DRIVEN MODEL AIRCRAFT. All about petrol, compressed-air and steam engines, wheels, carburettors, ignition systems, rotary engines, etc., with special constructor's chapters, ranging from compressed-air models for beginners to advanced petrol-engined planes. With 130 sketches, diagrams, and photographs.

Mary and it is anticipated that she will be launched during 1938. The new ship will not of course be named until the launching ceremony, but it is already rumoured that her name will be *King George V*.

has been on exhibition in the Museum, but it has now been overhauled and put into working order once more and, weather permitting, it will be run for the public every Wednesday afternoon at 3 p.m.

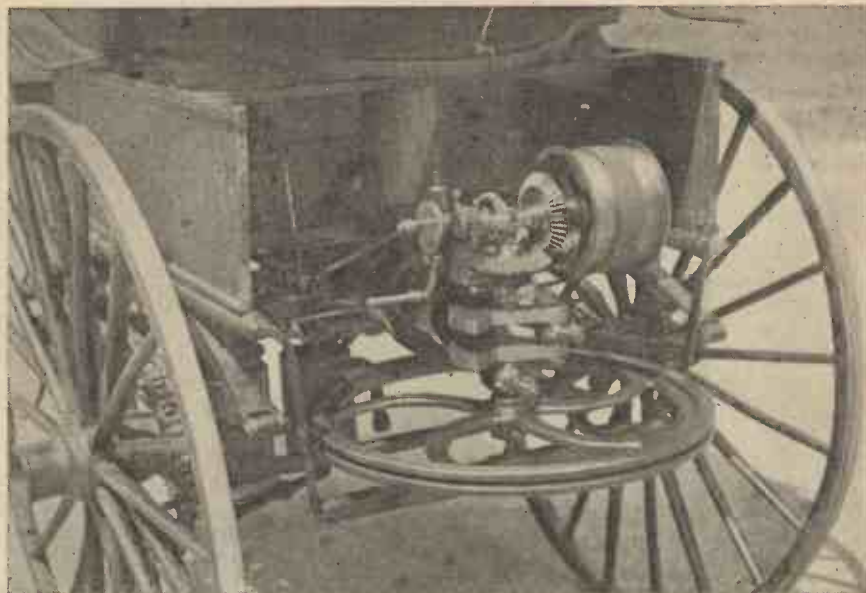

The Benz has a single cylinder horizontal engine, coil ignition, a surface-type carburetter and a belt primary drive. Starting, which is still remarkably easy, is accomplished by pulling round the fly-wheel sharply.

The Oldest Car in England Working Again

ALTHOUGH it was Daimler who invented the light internal combustion engine, it was Benz who first applied it successfully to road vehicles. Benz built his first car in 1885. It was a two-seater, three-wheeled vehicle, rated at about $\frac{1}{2}$ h.p., and is still preserved in the Deutsches Museum at Munich.

Bought for £5

BENZ then built a few more of similar but slightly larger type. One of them must have been brought to this country, for in 1913 one was discovered in the possession of an elderly lady who had kept it unused in her stables for many years. It was purchased from her by the Science Museum for £5!

The car was run in 1914, since when it

1½ h.p. Engine

THE engine develops about 1½ h.p. and drives the car at about 8 m.p.h. It has a single cylinder with a vertical crankshaft and an arrangement of bevel gears and belt drive with fast and loose pulleys connect the crankshaft with a two-speed countershaft. The carburetter, which is almost as large as the engine, is of the surface type, and starting is remarkably easy, by swinging the flywheel.

Solar Energy

IT has been announced by Dr. C. G. Abbot of the Smithsonian Institution, U.S.A., that he has perfected a new form of sun-motor. The new arrangement is claimed to utilise effectively no less than 15 per cent. of the energy received in solar radiations.



"The hare and the tortoise!" The old Benz is capable of about 8 m.p.h.—the M.G. does an easy 80! (See paragraph on this page.)

1/ NEWNES HOME MECHANIC BOOKS

or 1/2 each post free from George Newnes Limited, 8-11 Southampton Street, Strand, London, W.C.2

Money Making IDEAS

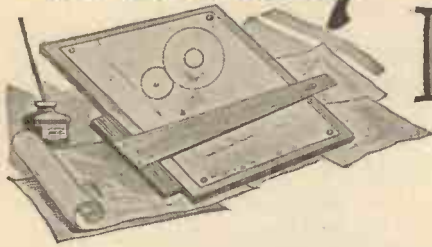

Advice by our Patents Expert

AN IMPROVED TOOTHPASTE TUBE
 "CAN you give me your opinion on the paste tube I have invented. The idea is to do away with the tiresome job of screwing on a cap after use. In the majority of cases the caps are not replaced to the detriment of the contents. I enclose a rough sketch which will illustrate my idea." (S. M., W.I.)

THE improved closure for collapsible tubes is ingenious and is thought to be novel from personal knowledge. If there are no great difficulties in manufacture it should be worth protecting by Patent, and if properly marketed, provided the cost of making it is not too great, should prove commercially successful. The inventor is advised to protect his invention by filing an Application for Patent with a Provisional Specification, which will give him protection for about twelve months, during which time it should be possible to ascertain if the invention is likely to be successful.

AN IMPROVED CLUTCH
 "I SHOULD like your advice as to the commercial value and possibilities of exploitation of a new type of clutch embodying the differential or epicyclic principle (sketch enclosed). I think such a clutch could be made very compact indeed." (F. A., Liverpool, 15.)

THE use of an epicyclic gear solely as a clutch is thought to be novel and forms fit subject matter for protection by patent. As it is also proposed to use the usual gear box we do not think that successful commercial exploitation of the invention will be an easy one. The tendency in modern motor-car practice is to try and eliminate the use of gear wheels, and we do not think that the gradual application of power by means of the gear would be so far superior to a well-designed clutch as to outweigh the drawback of introducing another set of constantly meshing gear wheels between the engine and gear box.

AN AUXILIARY CONTROL
 "CAN you let me know if the following idea is a fit subject for a patent.
 "One very obvious drawback associated with vehicles which deliver from door to door is the fact that the driver must get back into the cab to drive the van, perhaps only a few feet, and when visiting a large number of houses along a road this is a very tedious proceeding, and is, I think, the reason why the railway companies, to quote one example, still use horse drawn vehicles as their parcels delivery services.
 "Now my idea, which is intended for use on electric delivery vehicles, is as follows.
 "From the sketch enclosed it will be seen that the vehicle could be controlled by means of a single lever without the driver having to climb back into his seat. The vehicle cannot run away from the driver

because in the event of its speed exceeding the walking speed of the driver, the control lever automatically assumes a position which will reduce the current and bring its speed down to that of the driver.

"Of course, the vehicle would have a normal set of controls so that it could if necessary be driven in the ordinary way." (D. W., Middlesex.)

THE auxiliary control for electrically propelled vehicles, forms fit subject matter for protection by Letters Patent and is thought to be novel. The commercial value of the invention will depend not only on the demand for such a device, but also the way it is marketed. With regard to demand, there is no question that for the particular class of vehicle it is intended to serve, it would meet a want, but the only question arises as to whether there are sufficient vehicles, in which it would be useful, as to give any great commercial value to the invention. You are probably in a better position to know the possibilities of the trade in such vehicles. Should you desire to proceed further with the protection of your invention and require professional assistance, you should get in touch with a reliable patent agent as advertised in these pages.

A COUNTING DEVICE
 "DURING my spare time from my professional duties I am a keen amateur mechanic and electrician, having done a fair amount of work in radiology.
 "I would value your advice on an idea I have perfected, as to its validity, value and novelty, etc.
 "It is a device for registering, at any given moment, the number of passengers occupying seats (for instance, on a bus or other vehicle) and saves the conductor running up to the top deck during the rush hour. It may also be used for theatres, etc., although I fancy it's greatest usefulness would be on public vehicles." (R. L. M., London, N.I.)

THE proposal for providing a device for registering the number of passengers occupying seats in a public service vehicle is thought to be novel from personal knowledge. A device carrying out such a proposal would form fit subject matter for protection by Letters Patent, and should have a good chance of being commercially successful if adopted by the Transport Board for London, in which case it would also probably be adopted by Provincial authorities and companies running public service vehicles. You are advised to file an application for patent with a provisional specification and then submit your invention to the Transport Board. By this means you will probably be able to ascertain the likelihood of having your invention adopted at the minimum cost of protection. The inventor is advised to employ professional assistance in making his Application for Patent, and should get into touch with a reliable patent agent as advertised in these pages.

Courses of Study for EXAMINATIONS

University Correspondence College

Founder: WM. BRIGGS, LL.D., D.C.L., M.A., B.Sc.
 Principal: CECIL BRIGGS, M.A., M.C.

Founded in 1887, U.C.C. has a resident staff of Specialist Tutors. Students are prepared for the Matriculation and Intermediate and Degree examinations of London University; also for School Certificate, Civil Service, Royal Society of Arts Exams., etc.

Special Advantages offered by U.C.C. include extremely low fees, which may be paid by instalments. Textbooks are lent free to students for London Matriculation, and for other exams. they may be borrowed from the College Library at a small charge.

U.C.C. Successes.—More than 1,000 U.C.C. students pass London University Examinations each year. Over 6,000 Matriculated during the twelve years 1924-1935.

FREE GUIDES. The U.C.C. Prospectus gives details of Courses, Tutors, Fees, Library, etc. A copy may be had together with a *Special Free Guide* (mention Exam.) post free from the Registrar,

62 Burlington House, Cambridge

An American Lady named Doe (Jane B., if you really must know)!
Writes: "Your Fluxite's just grand!
But I don't understand How this gun's gonna bump off my Joe."

See that FLUXITE is always by you—in the house—garage—workshop—wherever speedy soldering is needed. Used for 30 years in government works and by leading engineers and manufacturers. Of Ironmongers—in tins, 4d., 8d., 1/4 and 2/8. Ask to see the **FLUXITE SMALL-SPACE SOLDERING SET**—compact but substantial—complete with full instructions, 7/6.
Write for Free Book on the ART OF "SOFT" SOLDERING and ask for Leaflet on **CASE-HARDENING STEEL and TEMPERING TOOLS** with FLUXITE.

TO CYCLISTS! Your wheels will NOT keep round and true unless the spokes are tied with fine wire at the crossings AND SOLDERED. This makes a much stronger wheel! It's simple—with FLUXITE—but IMPORTANT.

THE FLUXITE GUN

is always ready to put Fluxite on the soldering job instantly. A little pressure places the right quantity on the right spot and one charging lasts for ages. Price 1/6.

ALL MECHANICS WILL HAVE

FLUXITE

IT SIMPLIFIES ALL SOLDERING

FLUXITE Ltd., Dept. P.M., Dragon Works, Bermondsey St., S.E.1

ARE YOUR EYES NORMAL?



IF NOT, you need our Eye-Book, that tells of a new natural method of strengthening the eyes.

WITHOUT SPECTACLES
OPERATIONS OR DRUGS

A self-home-treatment in the form of a gentle massage that stimulates the eyes by restoring the normal circulation of the blood—that is all your weak eyes require. But it does more—it moulds the eye, painlessly but surely, to its perfect shape. This is necessary to correct near-sight, far-sight, astigmatism and kindred defects. It is absolutely safe, not coming in direct contact with the eyes, and five minutes' daily manipulation in your own home is all that is required to counteract eyestrain and headache, to abandon glasses, to preserve the sight and keep the eyes healthy.

Don't look at the world through a window. See with naked eyes, as Nature intended

1/- BOOK ON "EYES" FREE

To expose the spectacle folly and teach the natural care of the eyes, the Book is being distributed at cost. If you wear spectacles and your eyes are affected in any way, or you wish to safeguard your good sight, we shall be glad to send you a copy.

Send no money, only enclose your full name and address with 3d. stamps (6 foreign if abroad). Do this wise act to-day.

Address Publishers:—
NEU-VITA (Dept. J.F.), 163-252, Central Buildings, London Bridge, London, S.E.1, England.



SPECIALISTS IN
TECHNICAL
ILLUSTRATIONS

Write or 'phone us at

HIGH HOLBORN HOUSE,
HIGH HOLBORN, W.C.1.

Hoz. 8638.

"WILCO" MAINS MOTORS

Universal type for A.C.
or D.C.

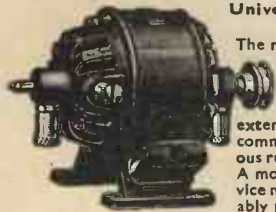

The model illustrated is a
1/30th H.P. R.P.M.
3,000 on load. Iron-
clad type with lubri-
cators, flexible cord,
extended shaft, 8-part
commutator for contin-
uous running, 200/250 volts.
A most reliable, long-ser-
vice motor reason-
ably priced at . . . **30/-**

Our totally enclosed 1/10th H.P. model for A.C. mains is also splendid value. 39/-.

For complete range of geared and ungeared motors, send for 40-page Catalogue "P.M." 3d. Post Free.

"Wilco" goods from all dealers; if any difficulty order direct.

L. WILKINSON 204 Lower Addiscombe Road, CROYDON

MAKE MORE MONEY

£3 to £6 weekly can be earned at home in a wonderful business of your own. No matter where you live you can commence to make money in your spare or whole time. No risk, canvassing or experience required. A wonderful opportunity for anyone wishing to add pounds to their income. Particulars, stamp.

BALLARD, 71 Graces Road, LONDON, S.E.5

PRACTICAL MECHANICS



Replies to Queries and Enquiries

If a postal reply is desired, a stamped addressed envelope must be enclosed. Every query and drawing which is sent must bear the name and address of the sender and be accompanied by the coupon appearing on page 63. Send your queries to the Editor, PRACTICAL MECHANICS, Geo. Newnes Ltd., 8-11 Southampton Street, Strand, London, W.C.2.

CHEMICAL PAPER

"(1) **H**OW is the chemical paper made that registers the humidity of the atmosphere by changing from pink to blue? Can it be made at home?

(2) What chemical or other action takes place when milk or other liquids turn sour?

(3) I have recently taken out a patent, and have received a letter from the Institute of Patentees asking me to become a member. Do you advise becoming a member of the Institute for practical help and service?" (J. B., Somerset.)

(1) **T**HE chemical paper to which you refer can readily be made at home. Obtain a small quantity of cobalt chloride from your local chemist and dissolve it in a little warm water so that a fairly strong solution is made. Soak white blotting-paper in this for a few seconds. The blotting-paper will be coloured pink by the solution. When, however, the blotting-paper is held in front of a warm fire, it will turn blue and, afterwards, the blue colour will change again to pink when the paper is withdrawn from the fire. The colour-change depends upon the fact that water-free cobalt chloride is blue. This compound, however, has such a strong affinity for water that it absorbs it from the atmosphere and, in so doing, becomes converted into a pink compound of cobalt.

(2) Milk and similar liquids can turn sour from several causes—usually, however, by the sugars, starch, and other substances in milk undergoing fermentation under the influence of a bacterial organism, the *lactic ferment*, which is present in the air and falls into the milk. The lactic ferment has the power of converting sugars into lactic acid. The milk, therefore, changes in composition. Its sugars are transformed into lactic acid, a sour liquid. Moreover, owing to the increasing acidity of the milk, the albuminous matters, such as casein, which are normally soluble, are rendered insoluble. Thus the milk curdles and we call it "sour."

(3) The Institute of Patentees is a very excellent organisation, particularly for inventors who make repeated applications for patents of one description or another. The Institute can assist a patentee with its advice in many ways. To an inventor who has taken out only a single patent and who does not intend to take out any more, the Institute of Patentees would, naturally, be of minimum service. For an inventor who is keenly interested in patent matters and who desires frequent help and service in connection therewith, we should strongly advise membership of the Institute of Patentees.

TRAPPING GAS FUMES

"**W**HEN certain paints are heated in a gas stove they discolour, and as I am using an ordinary domestic gas stove for experiment, can you suggest a substance

which could be fixed like a shelf above the gas jets, this substance being required to pass the heat but trap or absorb the gas fumes which cause patchy discoloration of the painted articles.

"In commerce this is overcome by using a triple-coated stove. Between the outer and first inner lining is a heat-retaining material, and again inside this is what is in effect a huge box into which the work is put. The fumes flow round the box but cannot enter it and contaminate the paint. Can you suggest a material to shut off the fumes?" (H. C., Birmingham.)

YOU might try one or two old sacks impregnated with a strong solution of lead acetate or lead nitrate placed on a shelf some distance above the gas jets. The lead salt would trap a considerable proportion of the sulphur products of the gas fumes which discolour the paint and would itself be turned black in so doing. Care, of course, would have to be taken to see that the sacks did not take fire. Coarse asbestos sheet could be impregnated similarly and this would be quite fireproof.

We are inclined to think, however, that it is not a practical proposition to trap all traces of the gas fumes in an ordinary gas stove and if the above suggestion does not work, we fear the only solution of your problem will be to imitate, on a small scale, the lined inner box which you describe in your letter.

REMOVING RUST

"**I** POSSESS a marine engine and one of the cylinder water-jackets is choked with salt and rust. Can you suggest a solution to dissolve the said deposits?" (J. B., Sleema.)

YOU do not give any indication of the size of your marine engine. Nevertheless, you will find that ordinary caustic soda (sodium hydrate) is the most efficient and the least expensive remover of rust and scale in the water-jacket. Fill the water-jacket with a ten per cent. solution of caustic soda and allow the solution to remain therein for about half an hour. Afterwards drain the solution away and fill up with fresh solution. Repeat three times and finally rinse out the water-jacket extremely thoroughly with clean, warm water in order to remove every trace of the caustic soda. If you cannot obtain caustic soda, ordinary washing soda (sodium carbonate) may suffice, but its action is much milder.

CHROMIUM PLATING

"**C**OULD you give me advice on the following? I wish to chromium-plate some parts of my bicycle. What chemicals, etc., will I need, using a flash-lamp battery (4.5 volts), and how much will

they cost? Also where can I get them?" (W. Y., Co. Durham.)

THE following are the ingredients of an effective chromium-plating bath: Chromic acid, 6 grams; chromium sulphate, 1 gram; water, 250 cubic centimetres.

The temperature of the bath should be maintained at about 100° F. The current voltage should be about 4-6 volts. The anode or positive pole of the bath is of lead strip, the article to be plated comprising the negative pole of the bath.

The plating chemicals above mentioned can be obtained cheaply from any wholesale firm of laboratory suppliers. Good results, however, must not be expected from home chromium-plating, mainly on account of the fact that a very heavy current density or amperage is required for the process. An ordinary flash-lamp battery will most decidedly not give results.

DYESTUFFS

"(1) I REQUIRE a list of all the chemicals and natural dyestuffs and the colours they produce. Is there a firm I can write to for same?"

"(2). What is PECTIN?"

"(3). What are ESTERS?"

"(4). What is PATCHOULI and its uses?"

"(5). Can you tell me something about GUM-RESINS?" (R. F., Sussex.)

(1) THERE are considerably more than 60,000 chemical dyestuffs and colouring matters. Hence, it is impossible to obtain a list of them all. If, however, you write to Imperial Chemical Industries Ltd. (Dyestuffs Division), Millbank, London, S.W.1, you will, no doubt, be able to obtain lists of many of the present-day commercial dyestuffs.

(2) Pectin is a soluble compound obtained from the fleshy pulp of certain fruits, as, for instance, apples. It has the property of gelatinising fruit pulps and extracts, its name, in fact, being derived from the Greek word "pektikos," meaning *congealing*. Hence, it is much used in a purified and concentrated condition for adding to jams and fruit preserves in order to ensure their "setting" or solidification.

(3) Esters are compounds resulting from the interaction between an acid and an alcohol. Thus, ethyl alcohol and acetic acid can, under suitable conditions, be made to interact and to produce *ethyl acetate*, which is the acetic acid ester of ethyl alcohol. Again, formic acid and propyl alcohol can produce *Propyl formate*; and so on.

(4) Patchouli is a perfume which is obtained from the dried branches of the patchouli shrub, which grows in the tropics. The name is also given to the shrub itself and to its leaves. It is soluble in alcohol or spirits and is used in small quantities as an ingredient of certain synthetic perfumes, chiefly for incorporation with soaps, cosmetic creams, bath-salts and the like.

(5) Gum-resins are natural compounds of gums and resins, chief among which are scammony, gamboge, and euphorbium, which are used to a slight extent in medicine. They are obtained from the roots and bark of certain tropical trees. They are insoluble in any one solvent. When treated with alcohol, the resin is dissolved and, if afterwards treated with water, the gum enters into solution.

Myrrh is a gum-resin which contains, in addition, a certain proportion of an essential oil—oil of myrrh. Hence, it is correctly termed an oleo-gum-resin.

FIRE-PROOFING CLOTHES

"I HAVE discovered a solution which, if put in the starch in which clothes are prepared, renders the material fire-proof. Do you know of a solution such as this? Would it be worth taking out a patent?" (J. H., Tottenham.)

MANY fire-proofing solutions are known and most of them are, within their limited range of usefulness, more or less efficient.

Your fire-proofing solution would only be patentable if it contained some novel ingredient and/or if some new field for its employment were claimed.

DOMESTIC REFRIGERATORS

"AFTER reading your article on domestic refrigerators I understand that an ammonia system is dangerous if a leak should occur, but with carbon dioxide there is no danger. You do not say whether sulphur dioxide is dangerous or not.

"I am living in a flat over a butcher's shop. In the shop is installed an automatic refrigerator. It consists of a compressor and is fan-driven by an electric motor, with condenser, etc., as described in your article. I am anxious to know what refrigerant is used in this machine, and if this refrigerator is safe if a leak should occur." (G. J., Birkenhead.)

WE believe we are correct in stating that the refrigerator you mention is one of the ammonia type. However, there is extremely little danger in its working, for, if even the slightest leakage took place, any person in the vicinity would quickly be made aware of that fact owing to the pungent odour of ammonia. It would be impossible, say, for an individual to be suffocated in his sleep by ammonia fumes. The same remarks apply more or less to the same extent to sulphur dioxide gas. Carbon dioxide is a practically odourless gas. It is very heavy and, therefore, would not rise to an upper room.

RUST IN A WATER CISTERN

"ON inspecting the galvanised-iron cistern situated in the attic of my house, I have found rusting has taken place on the inside below the water level. The rust is in spots in the form of a kind of growth about $\frac{3}{4}$ in. in diameter and $\frac{1}{2}$ in. thick, in fact the spots look just like rust-encrusted rivet-heads. A very dark brown patch on the metal is revealed by lightly scraping this "growth," which at once crumbles and sinks to the bottom. As the cistern was new when the house was built sixteen months ago, this rusting, to my mind, seems somewhat premature. I should therefore be very glad if you could advise me of any treatment which I could apply to the inside of the cistern to prevent or delay further rusting. The water in the cistern is not used for drinking or cooking purposes." A. S., Kent.)

YOUR problem is a very common one. The "growths" on the side of your cistern are not actually a sign of rust-corrosion, for if you carefully remove one of them you will find the metalwork more or less intact underneath. Such "growths" frequently take place in cisterns fed with hard and iron-containing water and we fear that there is no cure for the annoying trouble short of fitting up a special water-softener to treat the water before it enters the cistern. The "growths" consist mainly of chalk and other insoluble mineral products which have been slowly deposited on the sides of the cistern. They are coloured brown owing

RISE TO THE HEIGHT

Of Popularity and Success



Short people can be made taller with the aid of a box of Challoner's Famous Formula—

H.T.N. TABLETS

and easy system: well tried; harmless and safe. No strenuous exercises or old-fashioned appliances. If one box is insufficient, we guarantee to supply a further box FREE of all charge. E.H. (Sutton) writes: "Results beyond expectations and I am as pleased as Punch." Act NOW! Send 1½d. stamp for full particulars in sealed envelope. Sample 7½d. Book on height improvement 3d. P.O. or stamps only. Colonial Return Air Mail 1/- extra.

THE CHALLONER CO. (late of Bond St.)
Department J90, Laboratory and Works:
HYDE HEATH, AMERSHAM, BUCKS.

For Winter Warmth in Workshop and Home

TILLEY RADIATOR

Ideal for warming small rooms and especially useful where heat is only temporarily required. Being PORTABLE, after warming workshop can be carried into the home, even when alight. Complete in itself and requires neither connections nor fixing. Burns ordinary paraffin at the low cost of one penny for six hours. Causes neither smoke, smell nor mess.

Beautifully constructed—the oil container being of solid brass and the reflector of highly polished copper. Save money on coal, gas and electricity bills—get this All-British Tilley Radiator and have comforting heat throughout the year.

Remit 38/6, or can be sent C.O.D., post and charges paid.
TILLEY LAMP CO. (Dept. P.M.) HENDON, N.W.4

Engineers' Guide

Bright Prospects and Big Pay Opportunities for the trained man

Write to-day for this great Guide which contains world's widest choice of home-study engineering courses—over 200—and shows how to obtain a recognised Qualification such as A.M.I.Mech.E., A.M.I.E.E., A.F.E.Ae.S., etc. Mention branch, post or qualification that interests you, to THE TECHNOLOGICAL INSTITUTE OF GREAT BRITAIN, 123 Temple Bar House, London, E.C.4. (Founded 1917. 19,000 Successes.)



To Success

For Work after Dark

Mechanics, amateur and professional, and owners of small workshops, lathe sheds, observatories, should get the

TILLEY LANTERN

(Burns ordinary Paraffin)
Light of 300 c.p. for 6 hours for 1d.

Its magnificent light enables work to continue after dark, either in or out of doors. Can be placed anywhere. Made in stout brass, and there are no parts which can rust, corrode, or get out of order. Burns steadily anywhere, unaffected by weather, however severe. Get rid of all antiquated devices and use this marvellously efficient All-British Storm Lantern.



Remit 3/6- or can be sent C.O.D.
Post and Charges Paid.

TILLEY LAMP CO. (Dept. P.M.), HENDON, N.W.4

Baker's
SOLDERING
FLUXES

Sold in 6d. and 1/- tins at all Cycle
Accessory Dealers, Tool Shops,
Ironmongers, etc.

Write for your free copy "Joining of Metals" to

SIR W. M. BURNETT & CO. LTD.
GREAT WEST ROAD, Uxbridge, MIDDLESEX

TELEPHONE: HOUSLOW 0478

"THEY LAUGHED AT FIRST

but when I began to play—a hush fell upon the room. I played the first few bars of Beethoven's immortal "Moonlight Sonata." My friends sat spellbound. When the last notes died away the excitement on their faces! "Who was your teacher?" "How do you get that lovely singing tone?" "I receive similar letters daily from students of MY POSTAL LESSONS for the PIANO who started without knowing a note. If already a player, I'll MAKE YOU PLAY BETTER beyond your dreams. I have enrolled 2,600 adult pupils these last 12 months, have taught over 46,000 during 32 years, and I CAN TEACH YOU. Ordinary musical notation only used (no freakish methods), enabling you to read and play at sight any standard musical composition. Send p.c. for FREE book and advice. Six Moderate, Elementary or Beginner. MR. H. BECKER (Dept. 58), 69 Fleet St. LONDON, E.C.4

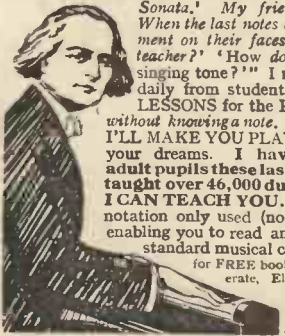

TROUSERS MADE TO MEASURE

Any Waist fitted, 28 in. to 58 in. or larger.

Inside Leg, 26 in. to 36 in. or longer. We cut and make from tested cloth of Blue, Grey, or Brown.

Please state waist, inside leg, side seam and width of bottom required.

5/11 6/6 8/6

Post 6d. or C.O.D.

C. HAROLD NURSE,
108 BORDESLEY GREEN, BIRMINGHAM 9.

NERVOUSNESS

Every nerve sufferer should send for my interesting book, which describes a simple, inexpensive home treatment for Self-consciousness, Blushing, Depression, Worry, Insomnia, Weak Nerves, Morbid Fears, and similar nervous disorders. This wonderful book will be sent in a plain sealed envelope to any sufferer without charge or obligation. Write NOW and learn how to conquer your nervousness before it conquers you!

HENRY J. RIVERS (Dept. 40 Lamb's Conduit St., E.C.4) LONDON, W.C.1

to the deposition of iron oxide and/or iron carbonate from the iron-bearing water. Such "growths" are, of course, clean and harmless and their presence does not pollute the water or render it unfit for drinking. They can be removed by scraping, but they will re-form.

MAKING A VACUUM PUMP

"WILL you kindly give me some idea of how I can make a vacuum pump in metal to work off the water tap. I wish to create a vacuum in a small rubber cone 1½ in. diameter by ½ in. deep, and the suction must be strong enough to lift a metal disc about the size of a penny.

"I enclose a sketch of a pump I made quite recently. The amount of vacuum the pump made was too little for my requirements. Would you be good enough to correct my mistakes." (R. D., Bucks.)

THE pump which you illustrate in your drawing cannot possibly give the desired results, since the force of the falling water is not sufficient. The water inlet tube should meet the outlet tube in a fine jet. Provided you adhere to this principle of construction you will obtain the required results.

It might be pointed out that such water pumps are obtainable fairly cheaply in metal or in glass from any firm of laboratory suppliers, as, for instance, Messrs. Philip Harris & Co. Ltd., Birmingham. It is, therefore, hardly worth while to expend a good deal of time on a home-constructed article of this nature which, more likely than not, will not give as good results as the commercially manufactured article.

REGISTERING PULSE MOVEMENTS

"I HAVE become interested in an apparatus called a pylograph (for registering pulse movements on smoked paper). I wonder whether you can give me the method of assembly. I possess all the necessary apparatus, but do not know the correct manner in which to assemble it.

"The apparatus consists of a mercury manometer, a device for recording, a bulb for supplying air (detached from blood-pressure apparatus), a flask and H-piece with stop-cock in the cross-bar. (T. P., Bow, E.3.)

WE think that the instrument you refer to is a *sphygmograph*, which is the recognised instrument for graphically recording pulse movements. Judging from your description of the parts which are in your possession, we do not think your sphygmograph components are complete and for this reason and, also, on account of the fact that there are several modifications of the apparatus, we cannot give you a sketch showing the assembly of the apparatus.

If, however, you refer to any modern work on physiology or clinical medicine, you will find therein a full description of the various forms of sphygmograph. Two such works—usually available in any public technical library—are Hutchinson & Rainy: *Clinical Methods*, and Bainbridge & Menzies: *Essentials of Physiology*.

PETROL VAPORISATION

"IN connection with an idea I am developing, would you kindly let me know to what pressure petrol must be subjected in order to stop all vaporisation." (N. S., Birmingham.)

IT is not possible to answer your query with exactitude, since petrols differ so greatly in detail characteristics. The figures which we give, therefore, must be taken only as approximate ones.

At ordinary temperatures, an average

high-grade petrol (devoid of benzole content) has a vapour pressure equal to 2.6 milligrams of mercury. At 0° C. the V.P. of an average petrol is equivalent to .6 mm. of mercury. At -25° C. the V.P. is very small, but it is still detectable. It is only when a temperature of about -50° to -60° C. is attained that the V.P. of petrol becomes practically unappreciable.

ITEMS OF INTEREST

The National Model Aeroplane Competition

THE National Competition was held as arranged, and despite the inclement weather, rain, and a real gale, the following fourteen clubs were represented: Luton and District; Northern Heights; Lancs M.A.S.; Brighton and District; T.M.A.C.; Park Model Air League; Midland; Leamington; North Kent; Blackheath; Hayes; Bournemouth; Wembley; Bristol.

There were forty-two entries. The results were as follows:

1st, R. Copland, Northern Heights. Average of 3 flights, 95.3 sec.; 2nd, H. Simmons, Blackheath M.F.C. Average of 3 flights, 87.73 sec.; 3rd, C. W. Needham, Bristol. Average of 3 flights, 84.13 sec.; 4th, C. Haig, Midland M.F.C. Average of 3 flights, 78.38 sec.

During the day several competitors with entries for the Power Competition, which had been postponed, tried to get their models in trim, but without very much success. Those with machines still flyable were asked whether they wanted to fly off, and as most of them had travelled great distances, they agreed to do or die. There was only one competitor, E. A. Ross, who managed to get his machine to fly in circles as the rules stipulated. The original time laid down by the rules was two minutes, but as the wind was so high it was decided, so that the models should be kept inside the aerodrome, to reduce the time to 60 seconds. This Mr. Ross did exactly, gaining twenty points for the performance. Both Mr. A. E. Brooks and Mr. F. Harris lost all points, their machines failing either to make right- or left-hand circles. The winner's machine was a High-wing Monoplane with an eight-foot span, powered with a Brown engine, the total weight being 3½ lb.

Electrodes Like Curtain Rods

IN Denmark a window was equipped with electrodes strung like curtain rods down either side. Insects were induced to fly in, by bait placed inside the window. Immediately the rods were connected to the transmitter, passing insects dropped dead in mid flight. Even large wasps and flies were so killed. It is a long step, however, to the destruction of larger organisms at a great distance from the transmitter.

Hambling's New Premises

THE well-known "00" specialists, Messrs. Hambling's, are, as from October 1st, opening new shop premises at No. 10 Cecil Court, Charing Cross Road. The new premises are very close to their present offices and are immediately opposite the Cameo News Theatre in Charing Cross Road (the Alhambra end). We have been asked by Hambling's to extend an invitation to all to visit, without any obligation, their new premises, where they will be welcome and shown the wonderful range of models that are now available in "00." In the shop also will be working tracks, and models can be seen under working conditions.

BECK'S CHEMISTRY

- 1 Flask 150 c.c.
- 1 Beaker 100 c.c.
- 1 Thistle Funnel
- 3' Glass Tubing
- 3 Test Tubes
- 4" I.R. Tubing
- 1 I.R. Cork

SPECIAL SAMPLE PARCEL

2/6

POST FREE



BECK (Scientific Dept. A), 60 High St.,
Stoke Newington, London, N.16.
WRITE FOR LATEST CATALOGUE—FREE !!!



The New Model Aeroplane Manual

3s. nett. Crown octavo, 284 pages, published by Percival Marshall & Co., Ltd., 13-16 Fisher Street, Southampton Row, W.C.1.

THIS book appeared originally as the Model Aeroplane Manual. In its new form it represents a vast improvement over the preceding volume. It is packed with facts, figures, formulae, designs, photographs, hints and tips, and represents an excellent digest of current model aircraft practice. It is a valuable work of reference, and should be in the hands of every model-aeroplane enthusiast. It deals with materials, fundamentals, wings, fuselages, tail units, under-carriages, coverings, doping, finishing, rubber motors, propellers, flying scale models, speed models, hints and tips, flying a model, and includes full constructional details of a beginner's fuselage model, a high wing monoplane, an advanced balsa model, the Hornet Moth, a petrol monoplane and an ungeared low-wing monoplane. The book concludes with some useful abacs for the fuselage formulae, and for the multiplication and division of numbers, and for finding the log, square or cube, square root and cube root of numbers. A really practical, useful and interesting volume.

Workshop Facts and Figures

1s. 6d. nett. Crown octavo, 94 pages, published by Percival Marshall & Co., Ltd., 13-16 Fisher Street, Southampton Row, W.C.1.

This is another handy volume in the series of practical handbooks published by Percival Marshall. The apprentice, amateur mechanic and model engineer, not too well up in mathematics will find this book of great use. It deals with the signs used in arithmetic, workshop signs and abbreviations, fractions, decimals, the metric system, mensuration, geometry, functions of the circle, graphs, conic sections, stresses in material, work and power, screw-threads and screw-cutting, gearing belt driving and shafting, drills, gauges, cutting speeds, taper turning and a collection of really useful formulae applying to engineering and electricity. The final section deals with useful knots.

Foundations for the Study of Engineering

7s. 6d. nett. Crown octavo, 259 pages, published by The Technical Press, Ltd., Ludgate Hill, E.C.4.

This book, by Mr. G. B. Hall, E.S.C., is a useful work for engineering students, dealing with the subjects usually taken in engineering examinations. It explains velocity and acceleration, force and the laws of motion, work, energy and power, action of forces, graphic statics, friction and lubrication, simple machines and mechanisms, properties of material, mechanics of fluids, thermometry, measurement of heat, heat transmission, facts relating to combustion, the steam boiler, the steam engine and the internal combustion engine. There are numerous examples with answers at the back. The book is well planned, well written and well illustrated.

HOME MOVIES

You cannot do better than consult us for every need, including Film Library, Film Processing and Tinting, and our huge range of re-conditioned outfits and accessories at really attractive prices.

MECCANO

We handle the complete Meccano and Hornby Train range, and offer on all our products full postal approval facilities, part exchanges and easy payments

Full lists and literature free

POSTAL SERVICE A SPECIALITY

Amateur Cine Service Ltd.

(DEPT. M.52),

WIDMORE ROAD, BROMLEY, KENT

JUBILEE WORM DRIVE HOSE CLIPS



The long-life clip with the ever-tight grip

The Best Known

For Radiator Joints, Air, Oil, and Water Hose Joints.

Large sizes stop squeaking brakes.

Stocked by all Garages and Accessory Dealers

L. ROBINSON & CO.,
25 London Chambers,
GILLINGHAM, KENT.

PRACTICAL HINTS ON PATENTS

Sent free on application.

THE IMPERIAL PATENT SERVICE
First Avenue House, High Holborn, W.C.1.

Preliminary Consultation Free.

FOYLES

Booksellers to the World

New and second-hand books on all technical subjects. Catalogues free on mentioning interests.
119-125 CHARING CROSS RD., LONDON, W.C.2
Telephone: Gerrard 6680 (12 lines).

THE "00" & "HO" GAUGE SPECIALIST

All interested in Model Railways should send two 1½d. stamps for my latest list of specialities. My all-brass scale model permanent way is guaranteed, and the price is reasonable.

Latest addition—Fully equalised Coach Bogies, 3/6 per pair.

GEORGE E. MELLOR

ALLANSON ROAD, RHOS-ON-SEA, N. WALES

GRAMOPHONE

ATTACHMENTS for Radio, electric motors 25/-, Pick-ups 9/6, Portable Gramophones 12/-, spring motors 4/6, walnut pedestal Anaxagram £5, Soundboxes 1/6, Tonearms 2/6, Horns 2/6, Cabinets 4/-, 1,000 needles 1/6, gears, springs, accessories cheapest. Trade discount. Thousands to clear. Liquidating stock bargains. Catalogue free.

REGENT FITTINGS COMPANY,
289D—120, Old Street, London, E.C.1.

WEBLEY AIR PISTOLS

Marvellously accurate for target practice.

No license required to purchase.

Senior 45/-, Mark 1 30/-,

Junior 20/-, Webley Air Rifle 80/-

Write for List. **WEBLEY & SCOTT LTD.,**

106 WEAMAN STREET, BIRMINGHAM, ENG.



BE TALL

Your Height increased in 14 days or money back. The amazing Stebbing System soon brings 3-5 inches increase and new energy. The first, original and the one GENUINE GUARANTEED Height Increase System. Recommended by Health and Efficiency. Complete Course, 5/-, or Booklet free, privately.

STEBBING SYSTEM, Dept. M.P., 23, Dean Rd., London, W.1.

There are 101 uses for HARBUETT'S Plasticine in the work-shop

Plasticine, in 16 colours, 1s. per lb.

Write for illustrated price lists to:—
Harbutt's Plasticine Ltd., 241 Bathampton, Bath.

YOU CAN USE YOUR SPARE TIME

to start a Mail Order Business that quickly brings you a full-time income. Follow the lead of others who are averaging £12 per week net profit. Get away from a drudgery routine job—join the big-money class. No previous experience necessary. Few pounds capital only needed. No samples or outfits to buy; no rent, rates or canvassing. New methods make success certain. Write to-day for FREE BOOKLET to Business Service Institute (Dept. 819c), 6 Carmelite Street, London, E.C.4.

DON'T BE BULLIED



Learn to fear no man. The BEST self-defence ever invented, namely, JIJITSU. Easy to learn. Send 2 penny stamps for BELENDED ILLUSTRATED LITERATURE. Photo ARTICLE. Testimonials and particulars, or P.O. 1/- for FIRST PART of my course. You will be more than delighted. A Japanese Secret, Kill Fear Cure, Free to pupils. Dept. P., Blenheim House, Red Lion Lane, Fetham, Middlesex.

INVENTORS:

VALUABLE GUIDE

General Advice Free. POST FREE 6d.

CHATWIN & CO. Est. 1880

Regd., Patent, Design and Trade Mark Agents for all countries.

253 (D) Gray's Inn Road, London, W.C.1

BUY, EXCHANGE OR SELL

Advertisements are accepted for these columns at 2d. per word (minimum 12 words at 2s.—advertisements of less than 12 words are charged at the minimum rate of 2s.), subject to a discount of 2½% for 6 consecutive monthly insertions or 5% for 12 consecutive monthly insertions. **TERMS:**—Cash with order. Cheques, Postal Orders, etc., should be made payable to George Newnes Ltd. *The Proprietors reserve the right to refuse or withdraw advertisements at their discretion.* All advertisements must be received on or before the 5th of the month preceding date of publication and should be addressed to the Advertisement Manager, "Practical Mechanics," George Newnes Ltd., 8-11 Southampton Street, Strand, W.C.2.

CINEMATOGRAPHY

ARTISTIC CINE FILMS. Exclusive 9.5-mm. and 16-mm. productions. List Free. Projectors, Ciné Cameras.—P.M. Dae, 64 Stanley Street, Liverpool, 1.

CINEMATOGRAPH FILMS. Standard size from 6d. 100 feet. Machines, Accessories. Sample Films 1/- and 2/6 post free. Catalogues free.—"Filmaries," 57 Lancaster Road, Leytonstone, E.11.

WANTED for prompt cash. Home Ciné-Cameras, projectors, films, accessories, microscopes, telescopes, binoculars, optical and mechanical goods. Mathematical and precision instruments. Small lathes. Modern cameras. Enlargers.—Frank, 67 Saltmarket, Glasgow.

"FILM-CRAFT."—Here is a fascinating series of authoritative textbooks for everyone interested in the Cinema as the newest of the arts. The Filmcraft series, each 3s. 6d. net, includes volumes by Pudovkin, Adrien Brunel, G. E. Kendall, D. Charles Otley, Percy W. Harris. Each 3s. 9d. post free from George Newnes, Ltd., 8-11 Southampton Street, Strand, London, W.C.2.

CHEMISTRY

CHEMICALS and apparatus. (Elementary and advanced. Bargain prices.—GRAY, 40 Grange Road, Lewes.

CLOCKS

PRACTICAL MECHANICS SYNCHRONOUS ELECTRIC CLOCK (July issue P.M.). We supply a complete kit of raw material, metal screws, wire, wheels, etc., less dial and case, for 21/- C.O.D., post free. This kit has the designer's approval. Glasgow and district readers may inspect the original clock in our showrooms.—FORBES BROTHERS, LTD., 52 Sauchiehall Street, Glasgow, G.2.

ELECTRICAL

ELECTRIC MOTORS, 1/10th and ½ H.P. A.C. and D.C. 200/240 volts. New and second-hand from 35/-.—EASCO, 18 Brixton Road, S.W.9.

SURPLUS ELECTRICAL and Engineering Materials, low prices.—The London Electric Firm, Croydon.

ELECTRIC LIGHTING, 5/- a point; progressive wiring diagrams and instructions, 6d., materials, wholesale prices; lists free.—P. Symax & Co., 263 Lichfield Road, Birmingham, 6.

SUPER A.C. MOTORS. New 1/10 h.p., 28/-; ½ h.p., 36/6, 46/- and 50/-; 1 h.p., 70/-, and larger sizes.—John P. Steel, Bingley.

ENGINES

ENGINES. Built Butler's Practical Model Petrol Engine, ½-h.p., castings, 9/9. Interesting, Catalogue 3d. Charging Dynamos, Boat Propellers, Sterntubes, Shafting Blocks.—Write Butler's Profit-sharing Works, Wade Street, Littleover, Derby.

WANTED:—Model Petrol Engine about 15 c.c., particulars.—Jagger, 10 Rose Street, Hull.

FORMULAS

FORMULAS, PROCESSES, TRADE SECRETS. Lists and Literature, Ideas, etc., 4d. stamps.—"Technocrat," 41 Longford Place, Manchester, 14.

HYPNOTISM & MAGIC

"HYPNOTISM," 25 long lessons, 2/6. Secret of "Squeezing Girl in Two," rope feat, 2/6. "Escapology" act, 2/6. Lists and literature, 4d. stamps.—"Technocrat," 41 Longford Place, Manchester 14.



"They shall grow not old, as we that are left grow old: Age shall not weary them, nor the years condemn. At the going down of the sun and in the morning We will remember them."

We can best remember them by offering the hand of friendship to their comrades who survived, so many thousands of whom, because of sickness or because they are growing old, are today in dire need of help.

Please help the British Legion to help these men and their families by giving as generously as you can for the Poppies you will wear on

POPPY DAY Nov. 11

DONATIONS will be welcomed, and these should be addressed to the local Poppy Day Committee: or to Captain W. G. Willcox, M.B.E., Organising Secretary, Earl Haig's British Legion Appeal Fund, 29, Cromwell Road, London, S.W. 7. LADIES willing to act as Poppy Sellers are asked to apply to their local Poppy Day Committees or to the above address.

LITERATURE

THOUSANDS AMERICAN MAGAZINES. Science, Mechanics, everything. Parcel, samples and catalogue, 1/7.—P. M. Final, 15 Nashleigh Hill, Chesham, Bucks.

GARDENS OF ENGLAND AND WALES. Crown 8vo, 148 pp., 1s. net. New edition for 1936, illustrated and indexed list of gardens open to the public under the Queen's Institute Scheme.—Country Life, Ltd., 20 Tavistock Street, London, W.C.2.

LITERATURE (continued)

"SUNG BEFORE SIX," by Oliver Linden. Illustrated by Treyer Evans, 3s. 6d. net.—"This is a delightful book of verses, constituting the candid criticisms of a child on his parents, relatives, and those about him, and on life in general. They touch a very human chord, and are always amusing."—"Yorkshire Observer." Obtainable at all Booksellers and Newsagents.—George Newnes, Ltd., 8-11 Southampton Street, Strand, London, W.C.2.

"A DOCTOR TALKS."—The most fascinating medical book in the world. The human machine simply and entertainingly explained with 150 amusing sketches by Fouet. Of all Booksellers, 5s. net.—George Newnes, Ltd., 8-11 Southampton Street, Strand, London, W.C.2.

"WIRELESS FOR THE MAN-IN-THE-MOON," by Columbus and Declbe, 2s. 6d. net.—Writing about the book, the "Midland Daily Telegraph" says: "It is both good fun and sound theory."—At all Booksellers and Libraries, or from George Newnes, Ltd., 8-11 Southampton Street, Strand, London, W.C.2.

MORE THRILLING THAN FICTION.—Newnes' Wide World Library contains the finest true-life travel and adventure books, great literature and exhilarating reading. Each 2s. 6d. net from all Booksellers.—George Newnes, Ltd., 8-11 Southampton Street, Strand, London, W.C.2.

WALKING TOURS AND HOSTELS OF BRITAIN, by Sydney Moorhouse. Foolscap 8vo, with maps, 3s. 6d. net. The first comprehensive book covering 14 best districts of Britain with maps and information about routes, stopping places, etc. Officially recognised by the Youth Hostel Association.—Country Life, Ltd., 20 Tavistock Street, London, W.C.2.

METAL WORK

MAKE METAL TOYS. Easy, profitable with "Success" moulds. Lists free. Complete trial mould, 1/8.—LEE'S, Bentinck Road, Nottingham.

MICROSCOPY

MICROSCOPIC OBJECTS. Unmounted, prepared. Assorted Packet 2/-. Mounted Slides stocked.—Leng, 183 Manchester Drive, Leigh-on-Sea.

MISCELLANEOUS

"HOME TOYMAKING" just published with 180 designs and illustrations of practical fascinating toys. Posted, 1/2.—Industries (below).

ALUMINIUM-ALLOY MOULDS for casting lead soldiers, cowboys, etc., at home. Sample mould, 2/9. Catalogue free.—Industries, 13 Gordon Avenue, Twickenham.

MODELS, tools, motors. Send for list.—Queens Engineering, 60 Queens Road, Battersea, S.W.8.

MODELS

EVERYTHING FOR electrical rewinds and repairs. Screws, nuts, and washers for model engineers. Lists free.—Lumen Electric Co., Litherland, Liverpool, 21.

FINE BARGAINS in used models and toys, catalogue 4d.—Model exchange, 11 Friars Street, Ipswich.

BUY, EXCHANGE OR SELL

MODELS (continued)

ARE YOU HANDY With Your Hands?—If you like making and mending things you ought to know about the "Home Mechanic" Series of 18 Handbooks. They cover a wide field, from model and toy-making to motor-car upkeep and radio construction. Each is complete in itself and fully illustrated. Price 1s. each, or 1s. 2d. post free from George Newnes, Ltd., 8-11 Southampton Street, Strand, London, W.C.2.

"WORKING MODELS and How to Make Them." Edited by F. J. Camm, Esq.—This book will appeal to all who are handy with tools. Contains complete instructions for the making of every kind of working model. Each model has been actually constructed in accordance with the details given and subjected to stringent tests. The instructions and diagrams are so clear that even the most elaborate model can be built without fear of failure, 3s. 9d. post free from the publishers, George Newnes, Ltd., 8-11 Southampton Street, Strand, London, W.C.2.

AN INVALUABLE Handbook. ACCUMULATORS. Up to date, practical, dealing with every type of accumulator, methods of charging them at home, care and maintenance. This little book also explains how to erect a charging station. This is one of Newnes' Home Mechanic Books. Ask your Newsagent to show you other Titles in this Helpful Series, each 1s. net or 1s. 2d. post free from George Newnes, Ltd., 8-11 Southampton Street, Strand, London, W.C.2.

MONEY-MAKING

ONE SHILLING will enable you to make £2 weekly in your spare time.—Basil Dengate, 2 Pound Road, East Peckham, Kent.

EXCELLENT MONEY-MAKING OPPORTUNITIES constantly occurring, strongly recommended. Send stamped addressed envelope for free particulars.—Messrs. Green, 17 Church Lane, Hull.

MAKE MONEY from old drained motor oil, instructions 1/-. "150 Ways of Making a Living," and interesting literature, sent for 1/6.—"Technocrat," 41 Longford Place, Manchester 14.

MUSICAL INSTRUMENTS

BAND GUIDE. Hints on the Bugle, Drum, Flute, Staff Parade formation, etc. Free post paid.—Potter's (Manufacturers), West Street, London, W.C.2.

PATENTS

REGINALD W. BARKER & CO. (Established 1886), 56 Ludgate Hill, London, E.C.4.—Patent and Trade Mark Booklets Gratis.

PROTECT YOUR IDEAS. Free Advice, handbook and consultations on patents and trade marks.—King's Patent Agency Limited (B. T. King, Patent Agent), 146a Queen Victoria Street, London, City 6161

PHOTOGRAPHY

"PANTOGRAPHS" make large accurate drawings from small photographs, printed drawings, etc., easily, 1/-. post free.—Cooke, 33 Hawthorn Road, Levenshulme, Manchester.

£500 worth good, cheap Photo Materials, Films, Plates, Cards, Papers, Chemicals, Catalogue and 4 Samples Free.—Hackett's Works, July Road, Liverpool 6.

DON'T TAKE RISKS. Good developers mean good results. Our reliable stock developers keep twelve months after mixing. Satisfaction certain to amateurs and professionals. Best developer ever put on the market. Makes two pints strong developer. 6d. each, 6 for 2/3, 12 for 4/-. Post free.—Hackett's Works, July Road, Liverpool 6.

PHOTOGRAPHY (continued)

PHOTOGRAPHIC MATERIALS. Plates, films, papers, chemicals. Good, cheap. High-class papers also for competition work. Lists and samples free.—KIMBER'S, 61 Grand Parade, Brighton.

LIGHTNING (VEST POCKET) CALCULATOR

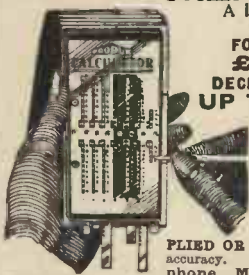

A 1936 MECHANICAL MARVEL
FOR £ s. d. UP TO
£9,999/19/11½
DECIMALS—NUMERALS
UP TO 99,999,999
Easily fits the pocket.
Size 4 1/2 in. x 2 in. x 1/2 in.
EACH ONLY 5/9
Postage 3d.

Full instructions sent. Figures can be ADDED, SUBTRACTED, MULTIPLIED OR DIVIDED with speed and accuracy. Write, call or telephone Museum 8331. State whether £ s. d. or Decimal model required. SENT ON 7 DAYS' APPROVAL AGAINST REMITTANCE. Satisfaction guaranteed or money instantly returned. ORDER NOW. **MARINE & OVERSEAS SERVICES, LTD.** (Dept. 11), 43 Woburn Place, LONDON, W.C.1

DO YOU WANT A PROFITABLE BUSINESS OF YOUR OWN?

We show you exactly how to start and run a business with little capital from your own address. No office, shop or experience is necessary. You receive working details of 201 profit-earning businesses from which to make an immediate start. No risks, no waiting. Results are sure. Just send a p.c. to-day—NOW—for fully descriptive FREE book to Business Service Institute (Dept. 59Y), 6 Carmelite Street, London, E.C.4.



The 'ADEPT' LATHE

1 1/2 in. centres, 6 in. between centres. With compound slide-rest, £1, or with hand-rest only, 12/6. Screw Tall Stock 5/- extra. Post 1/-.
THE SUPER ADEPT, 30/-.

F. W. PORTASS, 83a Sellers Street SHEFFIELD.

ARE YOU TIRED OF YOUR JOB?

IF you are tired of your present position and feel that you are worthy of something better, send for our booklet and learn how to quickly qualify for a higher position and better pay. Expert postal tuition in Book-keeping, Business Training, Secretaryship, Hotel Book-keeping, Salesmanship, Journalism, etc., from 2/- per lesson. Prospectus and testimonials free.

LONDON SCHOOL OF COMMERCE (Dept. P.M.-1), 116 HIGH HOLBORN, LONDON, W.C.1

BLUSHING FREE

to all sufferers, particulars of a proved home treatment that quickly removes all embarrassment, and permanently cures blushing and flushing of the face and neck. Enclose stamp to pay postage to Mr. M. Temple (Specialist), "Palace House," 128 Shaftesbury Avenue (2nd Floor), London, W.1. (Est. 35 years.)

SITUATIONS VACANT

POST OFFICE ENGINEERING. Good positions open to youths and men, age 17 to 30. Start £3 13s. weekly at age 17. Free details of vacancies from N.T.O. (Dept. 307), 835 High Holborn, W.C.1.

SITUATIONS VACANT (contd.)

RADIO MEN WANTED.

Messrs. Marconis anticipate requiring 200 Marine Wireless Operators in the next few months. TRAINING PERIOD 8/12 MONTHS. APPOINTMENTS GUARANTEED. TRAINING FEE CAN BE PAID AFTER SECURING AN APPOINTMENT IF DESIRED. BRITAIN'S LEADING WIRELESS TRAINING CENTRE. COLLEGE ON SEA FRONT. BOARDERS ACCEPTED. WRITE FOR FULL PARTICULARS: **WIRELESS COLLEGE, COLWYN BAY.** Or London Representative, 4 WINTON AVENUE, N.11.

STAMPS

FREE !! Twenty Unused Colonials, "Neurope," 1 1/2d. Fifty for 9d.—G. H. Barnett, Limington, Somerset.

TOOLS

SPECIAL OFFER.—Ball Bearing Low Benches, Rise and Fall table, plain and mitre fences, 6 in. saw 39/6 each. Stamp particulars.—Below.

IMPORTANT TO SMALL LATHE OWNERS. Automatic Centring Lathe Attachment. This device accurately centre-drills any round stock from 1/2" diameter to full capacity of lathe. A boon to lathe users, for lathes with centres up to No. 1 Morse, Price 6s. 6d.; send size.—P. Blood, Armitage, Eugeley, Staffs.

GRAYSON'S Glass-boring Outfits and Tube Cutters avoid risk.—Below.

DRILLS, Taps, Dies, Files, Chisels and Punches. Best quality at keenest prices.—Grayson & Company, 300 Campo Lane, Sheffield.

THE MYFORD 3-in. LATHE. Have you seen our new superior model with additional refinements. Standard model still in production. Economical in first cost. Generous in design. Proclaimed best value on the market. Write for illustrated list and instruction booklet, or ask your local Tool merchant.—Myford Engineering Co., Neville Works, Beeston, Notts.

NEW POWER TOOLS. 10-in. Bandsaws, 50/-; Jig Saws, 21/-; Bench Drills, 22/6; Circular Saws, Electric Drills, Grinders, Spray Plants, Guns, Air Compressors, etc.—John P. Steel, Bingley.

A.J.W. Gas blowpipes. Invaluable for soldering, brazing. Sample 3/-. approval.—WRIGHT, 10 Mitchell Street, E.C.1.

3 Tons Bright Steel Wood Screws, 1/2" to 3" long, a special quick clearance offer, 3 lb. assorted 2s. 6d.; very good value.—Below.

Genuine "Crown" Lathe Chucks, self centring, precision quality guaranteed accurate. Two sets hardened and ground steel jaws, 3", 2 3/8"; 4", 2 9/16"; 5", 3 3/8"; 6", 4 1/2"; 7 1/2", 5 1/2"; 8", 6 1/2"; 10 1/2", 8 1/2"; 12", 10 1/2". Carriage paid.—Below.

160 Large End Mills, 1/2" to 1 1/2" diameter, clearing at 3 for 4s. 6d.; Nos. 2 and 3 Morse Taper Shank.—Below.

FREE ADVICE BUREAU COUPON

This coupon is available until Oct. 31st, 1936, and must be attached to all letters containing queries. **PRACTICAL MECHANICS, OCT., 1936**

FREE SERVICE FOR READERS

Readers requiring information concerning goods or services advertised in **PRACTICAL MECHANICS** should give names of Advertisers from whom particulars are desired. Any number of names may be included and we will obtain for you catalogues, lists, and any other information you may be wanting. **THERE IS NO CHARGE FOR THIS SERVICE.**

Readers desiring particulars from a number of Advertisers will, by this method, save time and postage. Half-penny stamp only is required if your envelope is left unsealed. If any Advertiser stipulates that stamps or postal orders are necessary before samples or catalogues are sent, please enclose the necessary amount with your instructions. You are cordially invited to make full use of this Service.

Post this to

ADVERT. SERVICE DEPT.,
PRACTICAL MECHANICS,
8-11 SOUTHAMPTON STREET,
STRAND, W.C.2

Please obtain and send to me particulars from the Advertisers in your October issue whose names I give on list attached.

Advertiser	Page No.	Information Required
------------	----------	----------------------

Attach sheet of paper, with particulars, and your name and address (written in **BLOCK** letters), with date, to this announcement.

BUY, EXCHANGE OR SELL

TOOLS (continued)

120 Bundles Silver Steel, 1/16" to 3/8", diameter, 16 assorted pieces, 18" long, 4s. bundle.—Below.

Independent Chucks, four reversible steel jaws, best quality, heavy engineers' pattern, 8", 45s.; 8", 57s. 6d.; 10", 72s. 6d.; 12", 90s.; 14", 105s.; 16", 125s.—Below.

Independent Chucks, amateur, light pattern, suitable for small Lathes, Four Reversible Jaws, Hardened and Ground. Fully guaranteed, complete with Key and Face Plate Bolts, 3", 13s. 6d.; 4", 24s.; 6", 32s. 6d. each.—Below.

20 Only 1" Micrometers, decimal equivalents marked on frame, usual price, 27s. 6d. each, an opportunity, 16s. 6d. each, all complete in plush-lined case.—Below.

1" to 2" Micrometers, 23s. 6d.; 2" to 3", 30s.; 3" to 4", 36s.; special quotation for full set High Class Micrometers, 0" to 6", complete on polished wood stand.—Below.

Drilling and Milling Machine Vices, a quantity for disposal at extremely low prices. Send for illustrated lists.—Below.

500 Lathe Tool Holders, 3/4" Square Shank, suitable for Lathes up to 4". Fitted with Super High-speed Tool, 1s. 9d. each, worth double.—Below.

300 Boring Bar Tool Holders, 1/2" Square Shank, 3/4" Round Adjustable Bar, 3s. 9d. each.—Below.

150 Genuine Norton Grinding Wheels, sancer shape, suitable for small tool and twist drill grinding, 4 1/2" dia., 3/4" thick, 1/2" hole, 1s. 6d. each, 15s. doz.; also 6" dia., 3/4" thick, 1/2" hole, 2s. 3d. each.—Below.

30 Bundles Bright Mild Steel, round, 3/8", 1/2", 5/8", 1" dia. in 5' to 6' lengths, 10s. per bundle.—Below.

600 High-speed Centre Drills, three assorted sizes, small to medium, suitable for model makers, 1s. for three.—Below.

3 Tons Best Sheffield Files, Flats, Half Rounds, Square, Rounds, in rough and second cut sizes, 8", 8", 10", 12". This is a very special bargain offer, wonderful value, three dozen assorted, 10s.; also large files, 14", 16", 18", dozen assorted 8s. 6d., carr. forward.—Below.

250 Bundles Bright Drawn Mild Steel, approx. 5' length each piece, sizes 1/2", 5/32", 3/16", 1/4", 9/32", 5/16", 3/8", 7/16", 1/2" round, 5s. 6d. per bundle of 50; also Square Bright Steel, sizes 1/2", 3/16", 1/4", 5/16", 3/8", 7/16", 1/2", 5' lengths, 6s. bundle.—Below.

5,000 Small Slitting Saws, 1/2" dia., 1/32" thick, clear at 2s. per doz.—Below.

2,000 Slitting Saws, 2 1/2" dia., 1" hole, 1/64" to 1/4" thick, six assorted, 3s. 6d.—Below.

1,300 Sets Hexagon Die-Nuts, Sheffield made, Whitworth, B.S.F., also American thread, U.S.S. and S.A.E. suitable for Ford and other American cars 1/2", 5/16", 3/8", 7/16", 1/2", worth 7s. set, our clearing price, 2s. 9d. set; all the above four sets, 10s. lot.—Below.

300 Drill Chucks, takes to 1/2", three jaws. No. 1 Morse taper shank or 1/4" straight shank, 2s. 9d. each.—Below.

500 Gross Tungsten Steel Hacksaw Blades, 8", 9", 10", 12", 1s. 3d. per doz.; 12s. per gross; also Machine Blades, 12" x 1", 2s. doz.; 20s. gross; 14" x 1", 3s. doz.—Below.

1,200 Best Quality Straight Shank End Mills, standard sizes, 1/2", 1s. 3d.; 5/16", 1s. 4d.; 3/8", 1s. 6d.; 7/16", 1s. 9d.; 1/2", 2s. each. All right-hand, suitable for use in lathe.—Below.

800 Sets 1" Circular Dies, Screwing 1/2", 5/16", 3/8", 7/16", 1/2", Whitworth and B.S.F. Clearing at 2s. 9d. per set. Both sets 6s. Die stocks to suit 1s. 9d. each.—Below.

5,000 Small Grinding Wheels, suitable for Flexible Shaft use, etc., 3/8" to 1" diameter, assorted thicknesses, etc., brand new, unused, 2s. per dozen.—Below.

60 Only, Genuine Norton Grinding Wheels, suitable for general shop use, 9" dia., 1" wide, 1" hole, 4s. 9d. each, also few 1 1/2" wide, 5s. 9d. each.—Below.

1,000 Fine Emery Wheels, 2" to 4" dia., 3/8" hole, 3/8" to 1" thick, slightly used, but quite serviceable, 1s. 6d. per doz.—Below.

10s. Orders Carriage Paid except where stated otherwise, steel bars and files carriage extra.—J. Burke, 30 Trippet Lane, Sheffield.

TOOLS (continued)

PLAIN LATHES 30/-, compound rests 15/-, Foot Treadles 40/-, Constructors' Saw Bench Fittings 12/6, Treadle and Power Saw Benches, Circular Saws, Lists 2d. Easy payment.—Brown Brothers, Accrington.

USED GUARANTEED BARGAINS. Electric motors from 1/2 h.p. from 12/6. Electric drills 1/2 max. £1, also 3/4 max., 27/6. Electric grinders, 16/-, Vacuum cleaners from 15/-.—A.C.R. Co., c/o Grout Service Garage, Ronalds Road, Holloway Road, N.7.

WATCH MAKING

WATCH AND CLOCK REPAIRS. Everything for the watch, clock and model maker. Large stock of watches, clocks, and clock movements, etc. Wholesale prices. List 3d.—BLAKISTON & CO., Ainsdale, Southport.

JOHN MORRIS, Clerkenwell, Ltd., Expert watch and clock makers, complicated work and new parts to all Watches and Clocks. Jewellery repairs. Estimates free.

JOHN MORRIS. Best house for all Tools and Materials. Wheel and Pinion cutting. Stamp for list, 64 Clerkenwell Road, E.C.1.

WATCH, CLOCK AND JEWELLERY REPAIRS a speciality. Materials, Tools, Invar Steel and wheel-cutting. Catalogue 6d. Shockproof Watches from 2/3. List 1/4d.—Young & Son, Material Dealers, Chippenham.

WIRELESS

SHORT WAVE on a crystal set. Full building instructions and crystal, 1/2 post paid.—Radiomall, Tanworth-in-Arden, Warwickshire.

FIFTY TESTED WIRELESS CIRCUITS, by F. J. Camm, 2s. 6d.—This handbook contains every modern circuit, complete with instructions for assembling, component values, and notes on operation. 2s. 9d. post free from George Newnes, Ltd., 8-11 Southampton Street, Strand, London, W.C.2.

"THE MATHEMATICS OF WIRELESS," by Ralph Stranger.—This book is essential to the amateur who wants to gain a further knowledge of the subject without loss of time—or temper! Fully illustrated, 256 pages. 5s. 3d. post free from George Newnes, Ltd., 8-11 Southampton Street, Strand, London, W.C.2.

A DICTIONARY OF WIRELESS TERMS, by Ralph Stranger. A Wireless Work of Reference that should be on the bookshelf of every keen amateur. Compiled by a master of lucidity, it gives the meanings of all Technical terms in general use. Price 2s. 6d. from all Booksellers and Newsagents.—George Newnes, Ltd., 8-11 Southampton Street, Strand, London, W.C.2.

FOR THE RADIO ENTHUSIAST.—"The Wireless Constructor's Encyclopedia," by F. J. Camm (Editor of "Practical and Amateur Wireless"), third edition. Compiled by one of the most accomplished designers and writers on the practical side of Wireless, it covers the whole field. A veritable Treasury of Wireless Knowledge. Price 5s., from all Booksellers and Newsagents.—George Newnes, Ltd., 8-11 Southampton Street, Strand, London, W.C.2.

EVERYMAN'S WIRELESS BOOK, by F. J. Camm, 3s. 6d. net. An invaluable book of reference explaining the operation, upkeep and overhaul of all types of wireless receiver. 200 illustrations. From all Booksellers and Newsagents.—George Newnes, Ltd., 8-11 Southampton Street, Strand, London, W.C.2.

WOODWORK

SELECTED MAHOGANY, ETC., FOR P.M. SPEED BOAT.—Below.

CABINET HARDWOODS, Oak Mahogany, Ash, Whitewood, Ply-woods, etc. Lowest Prices. Send Cutting lists. Planing free. Speciality Prime Jap Oak, all thicknesses.—Wilfred Farr & Co., March Works, Lancaster Road, Leytonstone, E.11.