

COMPLETING OUR OUTBOARD SPEEDBOAT  
NEWNES

# PRACTICAL MECHANICS

AUGUST

6<sup>D</sup>





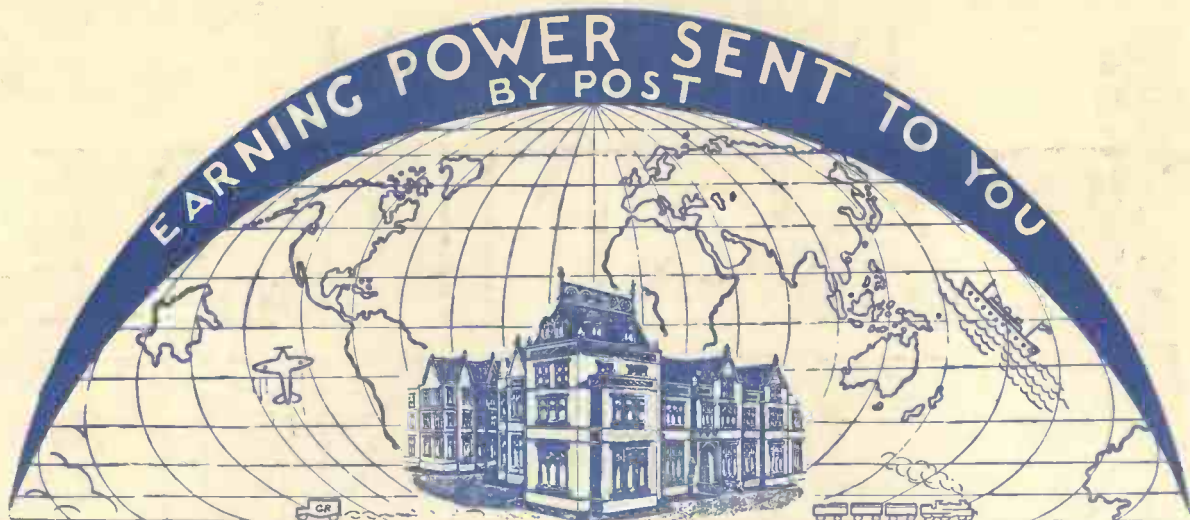

## Open Letter to Mr. Somebody and his Son

DEAR SIR,—The natural desire of most parents is to give their children a fair chance in life in the form of a good College Training, also there are many young men who would like to go to College but for some reason are not able to do so. Let us tell you here and now you can get a Complete College Training without having to go anywhere, and at a reasonable monthly fee for tuition. For well over 30 years we have been training students for all the Key positions, by post, in all parts of the world. Distance is nothing when you are studying by your own fireside.

The nature of our business makes us keep in touch with employment requirements, therefore we specialise in preparing students for the good positions which we know exist, and for all the worth-while examinations.

Write to us for FREE particulars of any subject which interests you, or if your career is not decided, write and tell us of your likes and dislikes, and we will give you practical advice as to the possibilities of a vocation and how to succeed in it.

You will be under no obligation whatever, it is our pleasure to help.



CAN YOU CHANGE MY EXPRESSION?

IF SO, YOU MAY BE THE ARTIST THAT COMMERCE IS WAITING FOR.

Just try it for yourself; trace or draw the outline and then put in the features.

*Jim Duck*

There are hundreds of openings in connection with Humorous Papers, Advertisement Drawing, Posters, Calendars, Catalogues, Textile Designs, Book Illustrations, etc. 60% of Commercial Art Work is done by "Free Lance Artists" who do their work at home and sell it to the highest bidders. Many Commercial Artists draw "retaining fees" from various sources, others prefer to work full-time employment or partnership arrangement. We teach you not only how to draw what is wanted but how to make buyers want what you draw. Many of our students who originally took up Commercial Art as a hobby have since turned it into a full-time paying profession with studio and staff of assistant artists; there is no limit to the possibilities. Let us send full particulars for a FREE TRIAL and details of our course for your inspection. You will be under no obligation whatever.

*Jim Duck*

Art Dept. 76.

## YOU CAN HAVE A COLLEGE TRAINING IN ALMOST ANY CAREER FOR A FEW SHILLINGS MONTHLY

Accountancy Examinations  
Advertising and Sales Management  
A.M.I. Fire E. Exam.  
Applied Mechanics  
Army Certificates  
Auctioneers & Estate Agents  
Aviation Engineering  
Banking  
Book-keeping Accountancy and Modern Business Methods  
B.Sc. (Eng.)  
B.Sc. (Estate Management)  
Building, Architecture and Clerk of Works  
Cambridge Senior School Certificate  
Civil Engineering  
Civil Service  
All Commercial Subjects  
Commercial Art  
Concrete and Structural Engineering  
Draughtsmanship, all branches  
Engineering, all branches, subjects and exams.  
General Education  
G.P.O. Eng. Dept.  
Heating and Ventilating  
Industrial Chemistry  
Insurance  
Mathematics

Matriculation Metallurgy  
Mining, all subjects  
Mining, Electrical Engineering  
Motor Engineering  
Motor Trade  
Municipal and County Engineers  
Naval Architecture  
Pattern Making  
Police, Special Course  
Preceptors, College of Pumps and Pumping Machinery  
Radio Service Engineering  
Radio Communication  
Road Making and Maintenance  
Salesmanship I.S.M.A.  
Sanitation  
Secretarial Exams.  
Shipbuilding  
Shorthand (Pitman's)  
Structural Engineering  
Surveying  
Teachers of Handicrafts  
Telephony and Telegraphy  
Transport Inst. Exams.  
Weights and Measures Inspector  
Welding  
Wireless Telegraphy and Telephony  
Works Managers

If you do not see your own requirements above, write to us on any subject.

Also ask for our New Book (Free of Charge)  
**THE HUMAN MACHINE**  
Secrets of Success

## SIGNS of the TIMES

The Budget has restored  
**POLICE OPPORTUNITIES**

The Air Force is to be increased  
**AVIATION must DEVELOP**

Pay Cuts have been restored  
**CIVIL SERVICE**

Suitable to both sexes. Ages 15½ to 24.  
**G.P.O. ENG. DEPT.**

CUSTOMS AND EXCISE; INSP. OF TAXES, ETC. NO EXPERIENCE REQUIRED. OPEN EXAMS.

**MATRICULATION**

There are many ways of commencing a career, but Matriculation is the jumping-off board for all the best ones.

We prepare candidates for all  
**INSTITUTE EXAMS.**

TECHNICAL, ACCOUNTANCY, SECRETARIAL, INSURANCE, ETC.

**Engineers & Draughtsmen**

All Branches — Employers are advertising for them.

TELEPHONY, RADIO and MOTOR ENGINEERING are expanding rapidly. There are lots of vacancies. Our postal courses will make you eligible. Advice on all careers Free.

## IT IS THE PERSONAL TOUCH WHICH COUNTS IN POSTAL TUITION

### YOUNG MEN

Young men physically fit and whose careers are not definitely fixed should join the Police Force. We have special Courses for Entrance and Promotion. 1/- per week brings success. Full Particulars Free.

Address:  
POLICE DEPT. 76.



Dept. 76. THE BENNETT COLLEGE, SHEFFIELD.

Engineers, now is your chance to dig yourselves into a Key position and make your future solid. It needs Technical Training: we can give you that by post. Full particulars free. Dept. D.76.



# PRACTICAL MECHANICS

Edited by F. J. Camm

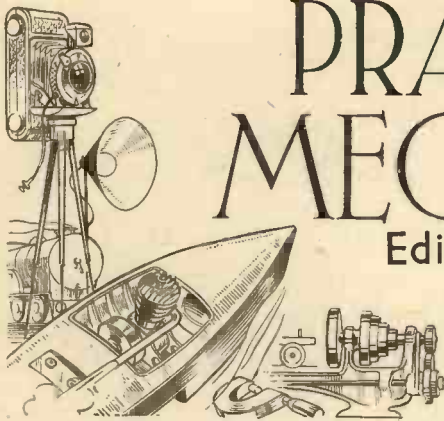

VOL. III. No. 35  
AUGUST  
1936

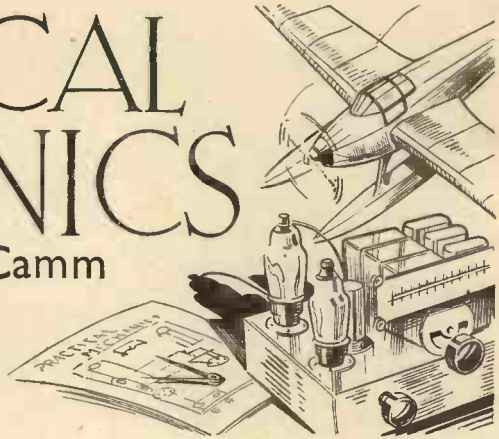

## A New Use for Hydrogen

**A**N important increase in the efficiency of high-speed turbo-alternators has been achieved by the G.E.C. of America who have just built a 40,000-k.W. alternator which is cooled by hydrogen gas instead of by air. Not only does hydrogen reduce the windage losses by 10 per cent., but on account of its better heat conductivity, it removes more heat from a given surface for the same temperature drop.

## Smoke Abatement

**M**OST people have heard of "Smoke Abatement," and many of us have probably seen the slender tails of thin white smoke which now issue from some factory chimneys which used to belch forth clouds of dirty soot-laden smoke over the surrounding city. But how many of us know how this improvement has been effected? We shall be able to learn how it is done at an exhibition which will be opened in October at the Science Museum.

## Empire Quartz

**A**N important discovery has just been made by the finding of deposits of quartz crystals in Uganda in a locality where alluvial gold is now being washed. The rapidly growing importance of quartz for radio, television, depth sounding, and many other scientific applications renders the discovery of an Empire supply of great value as the principle sources of supply have hitherto been Brazil and Madagascar.

There is a great deal of waste in the preparation of quartz plates, as the crystals used must be of large size—at least 1-2 in. in diameter and they must be absolutely free from flaws and have well-developed crystal faces. From a hundredweight of raw crystals, only a few ounces of finished plates can usually be obtained. The specimens sent from Uganda are, however, reported to be of excellent quality.

## The "Queen Mary" and "The Aquitania"

**A**LTHOUGH the *Queen Mary* did not break any records during her maiden voyage, her sister ship the *Aquitania* broke her own record during the same week—a record which has stood since 1914. She has just been fitted with new propellers, and the efficiency is shown by her having travelled 634 miles in a single day, her previous record having been only 607.

## A Russian Highway

**W**E are accustomed to think of our Great North Road as a really great road, but it will indeed be dwarfed by a

highway upon which work has already been started in the U.S.S.R. The new road is planned to lead from Moscow to the Pacific and it will be known as the Stalin Highway.

## Bakelite Bearings

**O**NE would not have thought at first that bakelite was a suitable material for machine bearings—and certainly not for heavy machinery. It is, however, now being used instead of white metal and bronze in the bearings of even large rolling mills. The use of bakelite has been found to reduce the power consumed by 30 per cent. and it has a "life" of six to eight times that of metal bearings.

## The Longest Bridge in the World

**W**HAT is believed to be the longest bridge in the world has just been completed across the Mississippi at New Orleans. Including the approaches, the bridge is nearly 4½ miles long, while the main spans total ¾ mile. The bridge is intended for both road and rail traffic and has two rail tracks, an 18-ft. roadway, and two footpaths.

## Gas-driven Cars

**I**T is announced from Moscow that mass production is shortly to commence of motor cars propelled by wood-gas which will be produced in a generator carried on the car.

## Palladium

**O**N account of its non-tarnishing qualities, gold-leaf has found many applications in the past for decorating purposes. A rival to gold-leaf has now been found in palladium, which is now being produced commercially in both America and in France.

Palladium is so malleable that it can be beaten into sheets only four-millionths of an inch in thickness and about 30,000 such leaves each 4 in. square would only weigh 1 oz. The leaf is untarnishable, of a beautiful silvery-white colour and although the

metal is rare, it is at present rather less costly than either gold or platinum.

## New Sound-film Process

**I**T is reported from America that a new process of "talkie" recording has been developed by R.C.A.-Photophone Corporation which will result in greatly increased quality of reproduction.

The new process is based, like others, on the modulation of a ray of light, but instead of using visible light, a narrow spectrum of ultra-violet rays are used. It is stated that sharper images can be recorded, and this permits the recording of higher frequencies with improved quality.

## Gold in Wales

**G**OLD exists in many parts of Wales and has attracted amateur gold-seekers for centuries. The quantities found hitherto, however, have been very small, but it is learned that the modern processes of extraction may render practicable the re-opening of a site worked more than 2,000 years ago by the Romans. The site is in the upper part of the Conway valley, half-way up Moel Siabod, a mountain 2,860 ft. high, and the recent tests on 300 tons of ore are reported to have yielded very satisfactory results.

## Radio Picture-transmission

**T**HE present-day possibilities of picture-transmission are scarcely realised by the general public, and a recent event shows what can be done when necessary. A submarine cable off the coast of S. Africa broke, but the only cable repair ship in the vicinity had no chart necessary to locate the break. So the chart, with all the essential information, was wirelessed from London to Melbourne and thence to the cable ship, which was then able to proceed to the spot and effect the repairs.

## Motor Car with Wings

**I**T is reported from America that an aeroplane-motor car has been built to combine the functions of both in a single vehicle. It is stated that the vehicle is a three-wheeler and that the controls have been designed on conventional lines. It is believed, however, that no air tests have yet been made.

## A Turbine Locomotive

**I**T is reported from the U.S.S.R. that a turbine-driven locomotive is now under construction. The condensing plant which is essential to economical running is to be carried in a separate tender behind the coal tender.

## SUBSCRIPTION RATES

Inland and Abroad, 7s. 6d. per annum

Canada - - 7s. per annum

Editorial and Advertisement Offices: "Practical Mechanics," George Newnes Ltd., 8-11 Southampton Street, Strand, W.C.2.

Registered at the G.P.O. for transmission by Canadian Magazine Post.



# Building the "PRACTICAL MECHANICS"

## Outboard Speedboat



Completing Our Easy-to-build Speedboat, Which Can be Built for Under £15. A Set of Blueprints (three sheets) are Available for 7s. 6d.

### Planking the Sides

**T**HE material used for the side planks may be either spruce or mahogany. Spruce is lighter, but supplies of good quality stuff are more difficult to obtain than mahogany.

Planks 8 in. wide  $\frac{5}{8}$  in. thick and 11 ft. long will be required, three being used on each side.

Since the seam battens which we have fitted run behind the seams of the planks it is obvious that the distances between the centre lines of these battens represents the shape of each plank.

The centre plank should be fitted first, and to do this tack one end of your plank on to the bevelled side of the stern post, allowing a little surplus wood to project beyond it, and bend it round the frames till it reaches the transom, to which it may be secured by a clamp.

Secure the plank to the other frames in a similar manner.

The plank should now cover the two seam battens, and is ready for marking off, which is simply done by running a pencil round the upper edge of the top batten and round the lower edge of the lower batten.

Now remove the plank and it will be seen that you have marked out a dimension which is the overall distance from top to bottom of the battens.

We do not, however, require the plank to cover the battens, but to come only half-way up them as they have to cover the seam, and form a landing for the remaining planks. Therefore it will be necessary to mark a line  $\frac{3}{8}$  in. inside each line previously scribed.

This requires patience and must be carefully done, and when completed the plank can be sawn down these lines a fraction clear of the mark, and afterwards trued up with a plane. Mark out and cut the centre plank for the opposite side before fitting the first,

so that you fit both as it were at the same sitting, and do not subject the framework to the pull of an odd plank for any lengthy period.

When you are ready to fix these planks, smear the seam battens, frame edges, and stern with a mixture of half white lead and half putty mixed to the density of soft

butter with linseed oil, and coloured pink with red lead.

The stern end of the plank should now be drilled with a row of four holes, to take No. 8 screws, and countersunk for the heads. Now tack the plank back again using the original tack holes as a guide to ensure its going back in the same position.

You can now counterbore for your screws, as you cannot drive them direct into the oak without doing so, and when all is ready secure the plank by driving in the screws, which should be  $1\frac{1}{4}$  in. No. 8 brass countersunk head.

The plank is now clamped back as before to the frames and transom, and is bored and screwed to each frame with four screws per frame. These screws may be  $1\frac{1}{4}$  in. as there is plenty of thickness of wood for them to enter.

The edges of the plank will ultimately have to be secured to the seam battens, but we can leave that part of the job until all the planks are on. Any surplus wood overhanging at the stern or transom can now be trimmed off.

When the centre planks are on each side, the next ones will be the top planks, which it will be noted are shaped. To do this place the edge of your plank along the edge of the one you have just fixed, and clamp it to the frames, tacking the end to the stern as before.

If the edges lie together without any gaps or spaces, all well and good, but if the contact is not regular the high places must be planed down until it is a perfect fit.

When this has been done, and the plank clamped up in position, it is only necessary to run your pencil round the top of the gunwale, remove the plank and cut out to this line.

The plank will then be fitted in exactly the same way as the centre one.

When both sides are finished the lower plank can be taken in hand, but since it will



Fig. 24.—A close-up view of the propelling and guiding mechanism.



be an awkward job in this position, and since the boat is now strong enough, the shaw and supports can be taken away, and the boat turned over, when the operation of putting on the remaining planks is in every way similar to the top ones you have just done.

The planking so far completed, the edges must be secured to the seam battens, which is best done with small copper nails, driven right through

and clenched. It may, however, be necessary to drill small holes to prevent the wood splitting. A nail every two inches should be put in, but do not put the top and bottom row opposite each other, they should be staggered or the batten will be appreciably weakened.

For the chine and gunwale fastenings, screws are preferable as a lot of nails driven through here looks bad. Use No. 6 screws, 1 in. long every inch and a half along the chine and every two and a half inches along the gunwale.

Provided you have driven your fastenings well and put plenty of white lead mixture on you need have no fear about these seams being water-tight. If there are any irregularities in the seams, they can be caulked with ordinary putty. Slight gaps will take up when the wood swells.

**Bottom Planking**

The temporary setting up batten can now be removed and the bottom prepared for planking. The bottoms of the frames will have to be faired up in a manner similar to that of the sides, with the exception of the fact that in this case they are done in position and not removed. By placing a batten down the length of the boat the high edges can be seen and these must be carefully planed down so that the planking when put on will be fair on them all.

The seam battens can now be fitted in a manner similar to the side ones, and letting them into the chines where they meet it; do not, however, let

them into the side planking.

Where the centre batten meets the stern post this must, of course, be let into it. The battens should be tacked at each frame position, but care must be taken with the centre rail not to put the tack in the centre of the slot, as a screw will ultimately pass through this point to secure the keel.

Provided that all these battens fit flush, we can now proceed to plank the bottom, which is a comparatively simple job.

The planks are 6 in. wide with the exception of the two centre ones, which are 5 in. wide. Although the boat is only 10 ft. long, it is as well to order the planks in

11-ft. lengths, so that any end splits which frequently are found in timber can be cut away; further, the planks will be easier to bend if a little longer. The planks are laid very simply, and no marking off is called for because this was taken into consideration when working out the positions of the batten slots.

The first plank to be laid will be one of the 5-in. ones, lay this along the boat so that its edge falls along the centre line of the middle seam batten, and clamp it in this position. It may now be secured by screws to the tran-

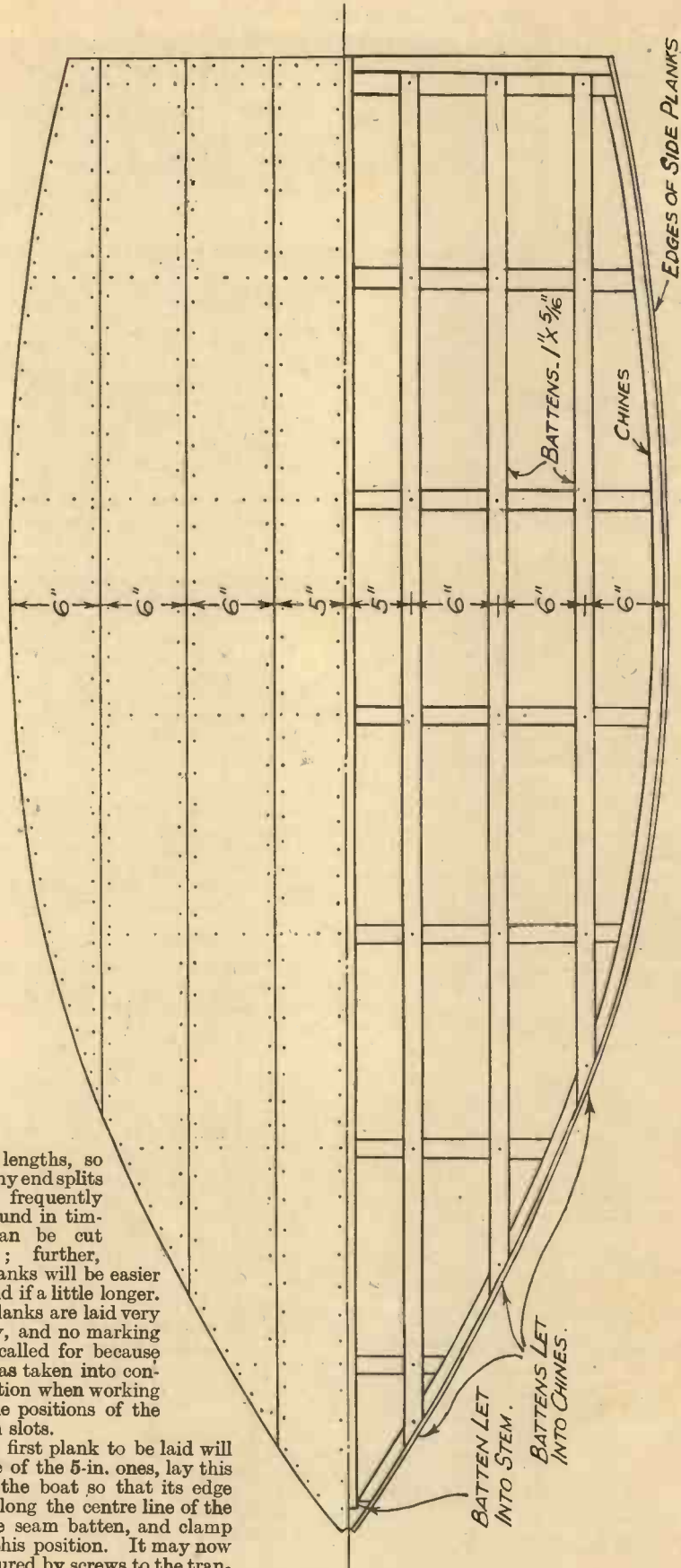
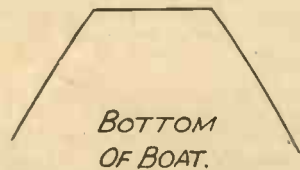
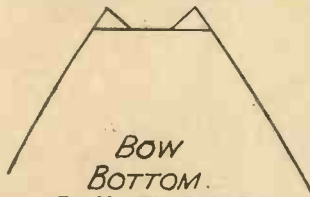

Fig. 27.—The method of fitting the seam battens and planking.



som and each frame, until the stern is reached, where it is secured by a screw into the bottom of the post. You can now trim

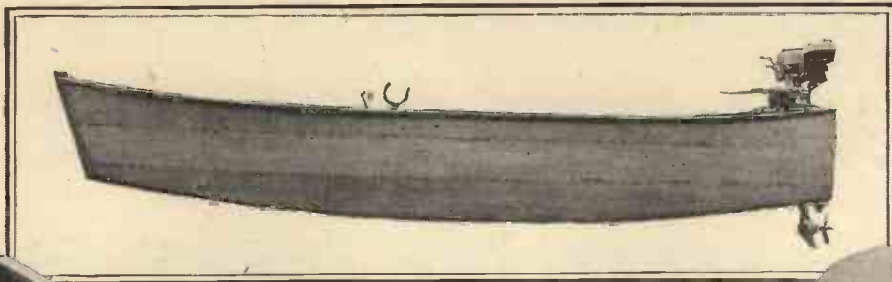

Fig. 28.—Three views of the finished boat—top, side, and bottom.

the plank off round the chine line and flush at the transom; the forward plank end is now screwed to the chine with No. 6 brass screws 1-in. long, spaced every 1½ in.

It is, of course, taken for granted that you have liberally smeared the edges of the frames, battens, and chines with the white lead putty mixture previously mentioned. The next 5-in. plank may now be fitted on the other side of the centre line in a similar

*SURPLUS STEM SAWN OFF  
FLUSH WITH GUNWALES*



*FLAT FRONT READY  
FOR FITTING FALSE STEM.*

Fig. 29.—The surplus top of the stem post cut flush with the chines.

manner. Having fitted the two centre planks, you will observe that the outer edges fall on the centre line of the two next battens, that is if you have spaced them correctly.

You can now proceed with the remaining planks, putting them on alternately gradually working outwards on each side from the centre, and trimming each one off as it is laid.

**Trimming Off**

In trimming off these planks, it is as well to cut somewhat wide with the saw, and complete the work with a small sharp and

finely set plane. When all your planks are laid you must then secure the edges to the seam battens. Nailing is rather an awkward job, since it is necessary to drive them all first then turn the boat over to clench them. If you are lucky enough to have an assistant you can raise the boat up on blocks, and with your assistant inside can keep your hammer on the nail heads while he clenches them. An alternative method is to use screws which should be ½ in. No. 6; it is more expensive and a longer job, but gives better results than doubtful single-handed nailing. If you use the screw method turn the boat over and screw through the batten into the plank. If you put the screw heads on the outside you will have to fill in over each head with putty to make a sound job, whereas if you put them on the inside this labour is saved. Fig. 27 shows the bottom partly planked.

With the bottom planked you have now well broken the back of the job, and only details remain, the first of which will be to fit the false stem post.

**The False Stem Post**

With the boat still upside down, run a very sharp plane down the outside of the stem until the edges of the side planks are square to the ¼-in. flat or front edge of the stem. Fig. 25 shows the state of affairs before planing, and Fig. 26 the desired result.

Now the planking is ⅝ in., but since we have planed it on the diagonal the resulting cross section of the plank is a fraction under ¾, thus we should have a flat surface, a

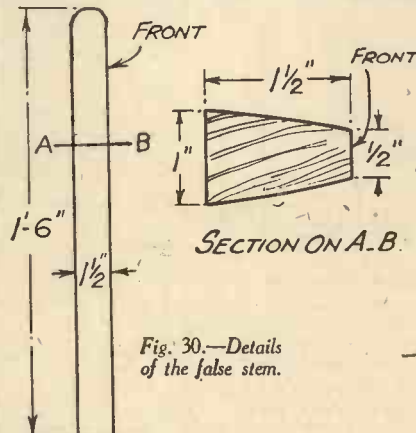
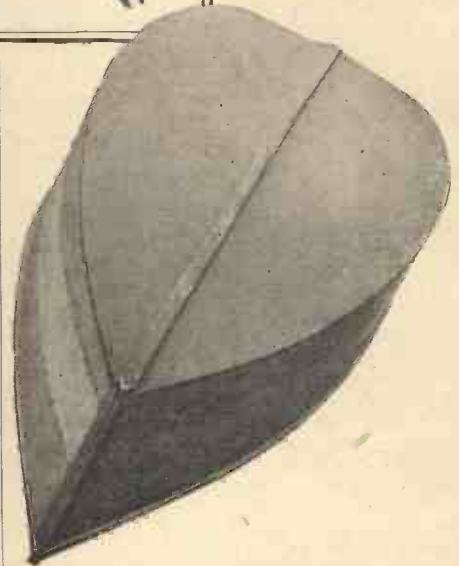

Fig. 30.—Details of the false stem.

bare 1 in. wide made up, of course, of the two planks each ½ in., and the ¼ front of the stem.

Get this true right along the stem and with a straight edge see that the surface is fair for its entire length. Next turn the boat over and cut off the surplus top of the stem post flush with the chines. Fig. 29 shows the work at this

stage. The false stem can now be made from a piece of 1-in. × 1½-in. oak about 18 in. long; this is bevelled so that the back edge, or rather surface, is 1 in. and the front ½ in.; one end is



rounded off as shown in Fig. 30.

Starting from the top end make a dot 3 in. down, and then one every 2 in. for a distance of 12 in. Now bore holes to take a No. 8 screw and countersink them. Apply some white lead putty mixture to the planed front surface of the boat, and with some 2½-in. screws fix the false stern as shown in Fig. 31, screwing into the actual stern post, the screw holes, of course, being on the centre line of the false stem.

The amount which the top or rounded end of the post projects above the boat is of no importance other than appearance. Too much, however, is unsightly, and it is essential that at least 1½-in. shall project below the boat which can be trimmed off when the keel has been fitted which is our next job.

**The Keel**

The keel is simply a piece of 1-in. × 1-in. oak, run down the entire bottom of the boat along the centre seam. This may be fixed in position with a few screws placed about 18 in. apart, taking care not to drive them right through planking and seam

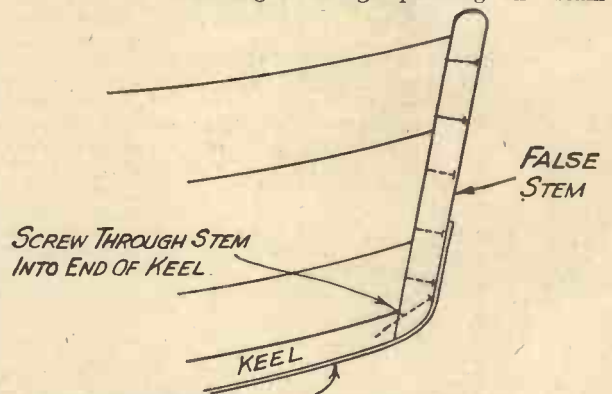

Fig. 31.—Fitting the false stem.



batten. Screws 1½ in. long will be sufficient as they are only intended to hold the keel in position until the main fastenings are put in. The keel should, of course, be bedded on a liberal coat of white lead putty mixture before fitting.

The stem end of the keel must be bevelled to fit snug up against the false stem post, which may now have its surplus cut off and the corner thus formed rounded off. The completed bow assembly of stem and keel is shown in part section, Fig. 31. The keel should terminate at about 4 in. short of the transom.

**Protecting the Keel**

If the boat is to have a lot of rough work on the beach, or is likely to be repeatedly dragged along the ground, this keel should be sheathed with ¼-in. × 7/8-in. brass strip, which can be carried right up to and round the bend of the stem, up which it may extend for 3 in. This may be drilled for, and secured by a number of No. 6 ½-in. brass screws at 3-in. intervals.

A further means of protecting the bottom is to put on some bilge keels. These are simply pieces of 1 in. × 1-in. oak, each 3 ft. long, screwed on each side of the main keel to the boats bottom about midway between the keel and the sides, and in the centre of the boat measured fore and aft.

These, too, may be metal shod, but it is not important as they are so easily renewable.

**Finishing the Keel**

Having completed this part of the work, we turn the boat right side up, and complete the fitting of the keel by passing screws through the holes in the frames, which were made earlier in the job for securing them to the setting up batten. These screws should be 3 in. long No. 8 brass, you will, of course, need to counterbore for these with a long gimlet before you can drive them into the oak. The heads of these screws can be stopped over with mahogany colour plastic wood, and the ones in the false stem with natural colour plastic wood.

**The Knees**

The next thing to consider will be the strengthening knees, of which there are three on the gunwale line and two at the bottom of the craft. The first to be considered will be the two that brace the sides to the transom and are known as "quarter

knees." Fig. 33 shows the shape of them and their position. These knees are sawn out of 1-in. oak, and should have sides 7 in. long, so that our plank will need to be 7 in. wide. There are two knees of this size, so

we require a piece 14 in. × 7 in.; allow waste and sag 18 in. × 7 in. To make these you must first measure the angle which the sides of the boat, make with the transom, this can be done with a bevel gauge if you have one, or you can place a piece of stiff

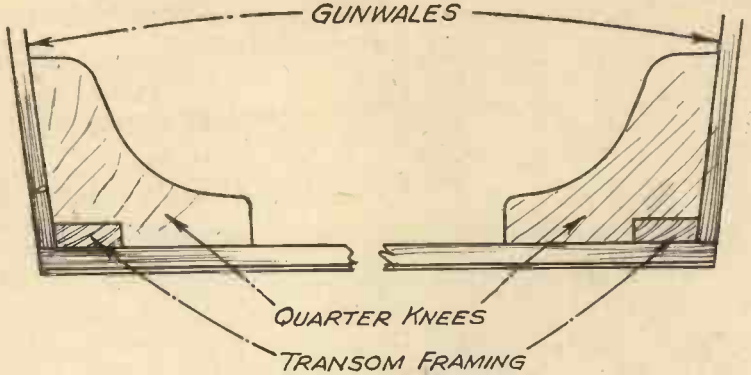

Fig. 33.—Fitting the quarter knees.

clearly. You can now cut out along these lines, the curved end with a bow saw or pad saw.

**Fitting the Knees**

The fitting of these knees is a somewhat tricky operation and requires patience and care. First you will have to cut out a notch to allow the knee to pass over the transom framing and set fair against the transom itself. You will notice that the sides slope inwards and the transom backwards, therefore you will have to bevel your knee to fit. This is best done by trial and error, taking a little off at a time, and trying the knee up in position.

Since you will have to do this a good many times before you get a perfect fit, try to get the boat near the vice as the continual walking to and fro is most irritating and fatiguing. When you have got the knees properly shaped, you can round off the corners of the curve to neaten the job up, and proceed to fit them.

In professional work they are usually riveted right through with long copper rivets, but our purpose will be equally well served by fitting them by means of screws passed through the boats side and gunwale, on the one side and the transom on the other, taking care to get the knee flush with the top of the gunwale. Use No. 8 screws, 2½-in. long. These knees must be well fitted and secured, as apart from their purpose of bracing the sides to the transom, they take a considerable amount of the thrust of the motor in driving the boat forward.

The next knee to fit is up in the bow and

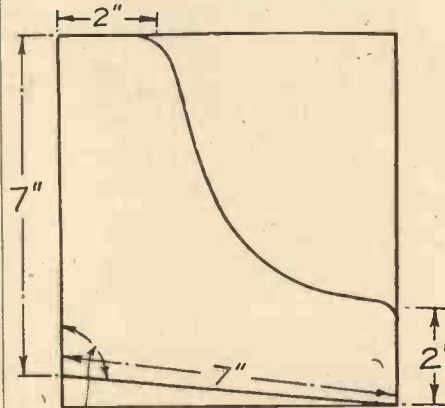

ANGLE OF SIDES AND TRANSOM.

Fig. 32.—Details of the knees.

cardboard over the corner made by the sides and transom and mark upwards with a pencil, a third method is to use a folding rule, if the joints are not too loose, in the same way as you would use a bevel gauge.

Now transfer and mark this angle on to your timber, make each limb of the knee 7 in. long. At the end of each line draw a line 2 in. long at right angles and join them by a gentle curve. Fig. 33 shows this more

Fig. 34.—A perspective sketch of the finished hull.

Blueprints (3 sheets) cost 7/6, and are obtainable from Geo. Newnes, Ltd., 8/11 Southampton Street, Strand, W.C.2.

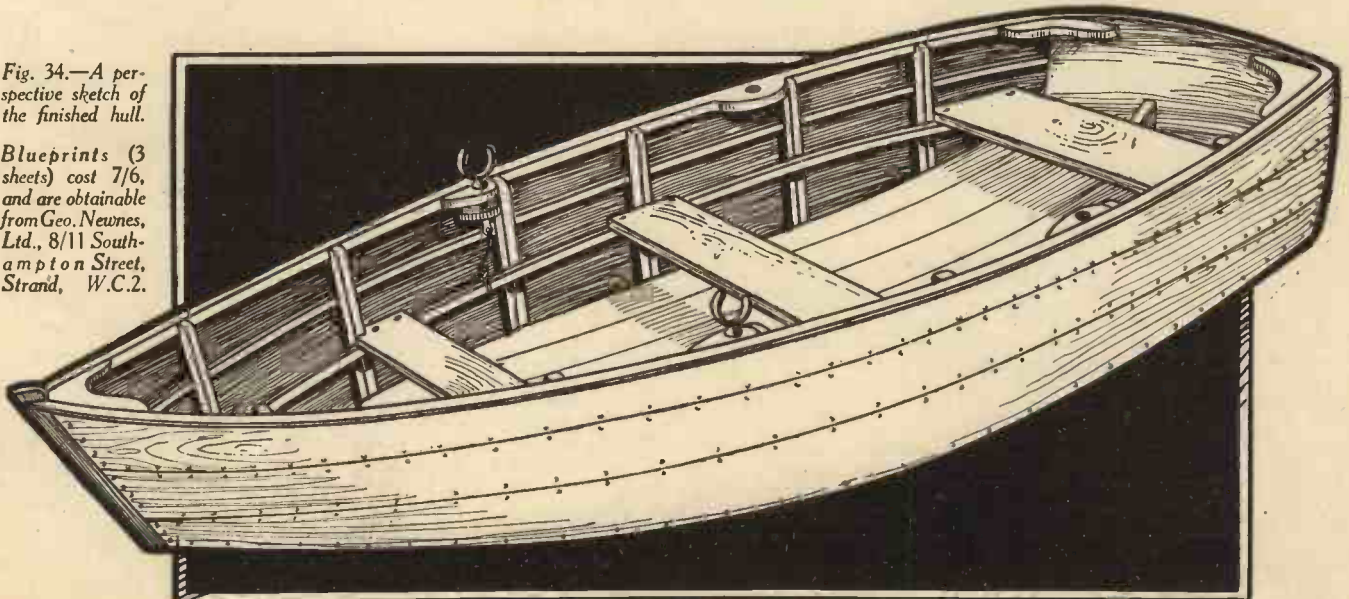



**YES!** YOU CAN

**DISTEMPER IT YOURSELF**  
*Without brushes, ladders, or effort*

You can distemper or paint any of the walls in your house with a CRYSTAL patent SPRAY GUN, the new modern method of painting and distempering.

**YOU DO NOT NEED A BRUSH!** You just fill the CRYSTAL patent SPRAY GUN with distemper or paint, attach it to your electric vacuum cleaner, press the trigger and you get a perfectly atomized spray that will cover your walls with an even surface. So simple anyone can use it.

Makes one coat do the work of two. Quicker, less exhausting than the old way with a brush. Covers yards in less than a minute. No aching backs, blistered hands; no messy cleaning of brushes.

The CRYSTAL patent SPRAY GUN paints anything—walls, floors, ceilings, furniture; and can be used for any liquid—paint, distemper, lacquer, enamel, stain, creosote, varnish.

FREE.—Send coupon for FREE BOOKLET giving full details.



*There are a hundred and one uses for the Crystal Patent Spray Gun in your home. You will be amazed at the saving it can effect in brushes and material alone and in general utility.*

**CRYSTAL**  
Patent  
**35/-** **SPRAY GUN**  
THE NEW WAY TO PAINT

To the Crystal Manufacturing Co. Ltd. (Dept. P.M.1),  
145 Crystal Palace Road, S.E.22.

Please send me Free Booklet "Painting Without a Brush," showing how I can use the Crystal Patent Spray Gun.

Name .....  
Address .....  
Usual Dealer (if known).....

(Post in 3d. unsealed envelope).

**LET US SPRAY!**

**The way to PLEASURE!**



Here's a grand way to spend summer weekends—to add zest and sport to your holidays. Go motor boating! You can revel in a whole variety of different pleasures. Cruise along nearby streams. Explore inviting rivers. The sea can be enjoyed in a new way. On the water the air is fresh; you are free from crowds; you'll come ashore fit, healthy, ready for anything.

And motor boating is extremely inexpensive if you have an Elto Outboard Motor. Fixes to any boat in two minutes. Simple to handle. Reliable—will give years of service.

The Outboard Motor selected by "Practical Mechanics" for the outboard speedboat described in this issue.

The **ELTO "ACE"**  
**Outboard**

Price £12 10s. Weighs only 22½ lbs.

**WRITE TO-DAY** for our fully descriptive illustrated literature on motor boating and boats. Ask for Catalogue No. P.M.2.

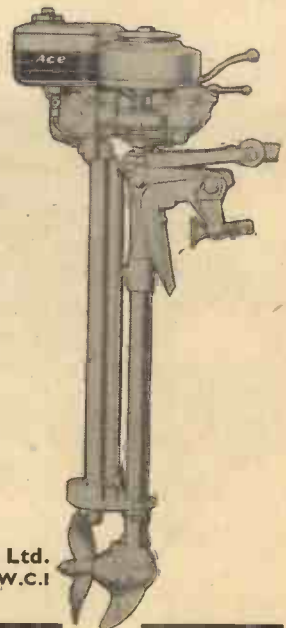

**BRITISH MOTOR BOAT Mfg. Co. Ltd.**  
Britannia House, Ampton Street, London, W.C.1  
Telephone: Terminus 6361 (5 lines)



braces the sides at the gunwales to the stern. Fig. 35 shows how it is fitted, and the method of marking out, etc., is the same as the quarter knees, but not quite so difficult; it is secured in the same way. Great care should be taken to get graceful curves in the cut-away portion, as a well-proportioned breast hook as this part is called can make the appearance of a boat, and whilst technically there is no need to curve it out, the old boatbuilders' adage that "straight is the line of duty but curved the line of beauty" very much holds true here.

When you have the breast hook fitted either plane or rasp it up fair and smooth with the top of the main stern post, finishing off with sand paper.

The length of the breast hook should be about 7 in., but is not critical.

The next knee will be in the forefoot of the boat and braces the bottom of the stern post to the boats bottom, its rests on the seam batten and is secured by long screws

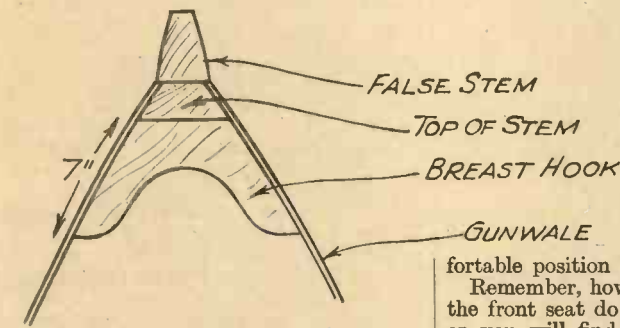

LOCATION OF BREAST HOOK.

Fig. 35.—Fitting a knee upon the bow.

deeply countersunk as shown in Fig. 37. The knee should be 7 in. x 7 in.

A similar knee fitted in the same way is used to brace the transom to the bottom at the stern of the boat, and since the method of fixing, etc., is identical with the one just described, repetition is unnecessary.

**The Seats and Fittings**

Having fitted the knees we can say that we have completed the hull and only the seats and a few fittings remain.

The seats are fitted onto a rail which is termed a "riser" and runs fore and aft on each side of the boat inside the frames to which it is secured by screws, two screws at each position where it touches a frame.

This riser is made from mahogany 1 1/2 in. x 5/8 in., and extends from the transom framing to about 6 in. forward of frame No. 1.

It is fitted 1 ft. 3 in. above the floor of the boat, this measurement being taken from the boat's bottom planking to the top edge of the riser, measured at the middle of the boat, and runs straight fore and aft, and does not conform to the curve or sheer of the boat.

Once these risers are fixed the fitting of the seats is simple.

The stern seat is made from mahogany 14 in. wide 3/4 in. thick, and is cut to the width of the risers at the transom and screwed to them.

The centre seat is 8 in. wide, 1 in. thick, and fitted in the middle of the boat and screwed to the risers. The forward seat is 8 in. x 1 in., secured in a like manner, and its position is such that there is a space of 3 ft. 6 in. between its rear edge and the front edge of the centre seat.

**The Rowing Chocks**

The rowing chocks to hold the rowlocks can next be made and fitted; these are produced from oak 1 1/2 in. x 1 1/2 in., and each 6 in. long, they must be shaped slightly on one side to conform with the curve of the boat's side; the other side has its corners rounded off.

A hole is bored through the centre to take the plate bearing of the rowlocks, and the size of this hole must be governed by the size of the rowlocks purchased. Fig. 36 shows how they are made up. Fig. 38 shows the fitting arrangement, a second piece of oak should be fitted a few inches lower to steady the rowlock. They are fitted by means of 2 1/2-in. screws passed through the planking and gunwales from the exterior of the boat.

**The Rowlocks**

The exact positions for these rowlocks is best determined by temporarily clamping them in position, and then sitting in the boat with a pair of oars resting in them, experiment until a comfortable position is arrived at.

Remember, however, that for the ones in the front seat do not get them too far aft or you will find that the person on the

**CORNERS ROUNDED OFF.**

**HOLE FOR ROWLOCK**



Fig. 36.—The rowing chock, made from oak 1 1/2 in. square.

centre seat is in the way when you are rowing from the forward position.

Good all-round positions, however, are as follows. Fit the front set so that the hole in the chock is 12 in. aft of the centre line of the seat and the centre set 14 in. aft.

**The Rubbing Band**

The next item is the rubbing band, which must be fitted round the boat from stem to transom on the outside level with the gunwale, this can be made from 1/2 in. x 1/2 in. oak, bent round and secured every 6 in. with a 1-in. No. 6 wood screw. The front end should be tapered off for 3 in. down to nothing, where it meets the false stem post, and rounded off at the transom end.

With a finely set sharp plane you can now plane the edges off all along, giving the band a half-round appearance.

**Floor-boards**

Floor-boards must now be made

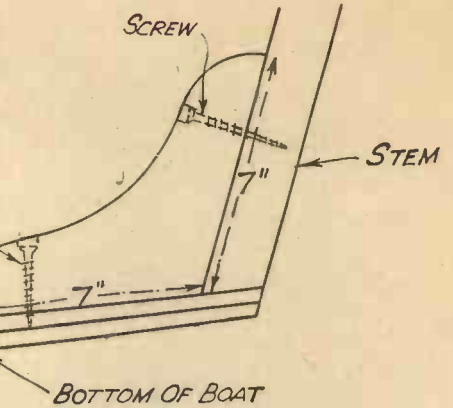

Fig. 37.—Method of fitting the fore knee.

up as it is unwise to tread or put any local weight on the bottom planking itself.

These boards need not be shaped, all that is required is some planks of good clean deal 4 in. wide, 1/2 in. thick, and long enough to reach from just under the stern seat to just forward of the front seat.

Lay one along the centre of the boat, then one on each side of it resting on the frames. Now continue to add planks until the width between the frames is made up with the exception of a few inches, as the boat narrows down towards the bow so you fit shorter planks, alternatively you can, of course, shape the planks if you want a smarter looking job.

Having got your planks set out it is usual to fit them together in groups of two or three by fitting battens underneath.

This makes a quicker job of removing them for cleaning out, and as the groups of planks have a greater weight and area they will stay in position without any fixing.

The final item of construction will be to screw a ring bolt in the inside of the stem about half-way up, to which you can attach a rope for tying your boat up.

We can now get busy with the sand-paper, and rub all the woodwork down preparatory to finishing.

The bottom inside should receive three good coats of paint up to the top of the chines. Black is too drab looking, so don't use it. Someone is sure to think it's tar to stop the boat leaking.

Grey looks well, and is perhaps the most suitable colour.

The bottom outside may be to choice. Standard boat colours are green, red, white, and blue; any of these will look well against the varnish which is used for the rest of the job. Give three good coats, allowing each to dry well.

This also applies to the varnish, which should be of good quality yacht varnish.

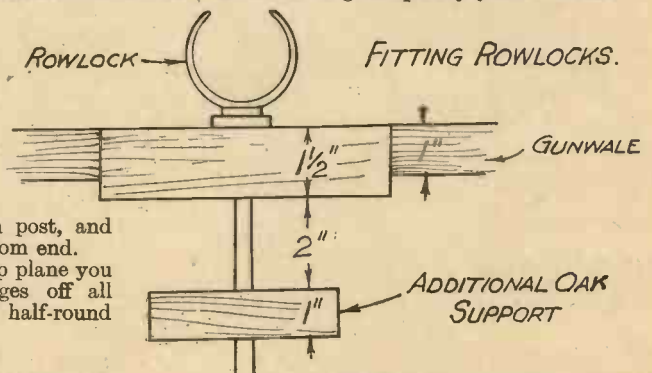

Fig. 38.—Fitting the rowlocks.



# COAL GAS :

Inside the Gas Industry is a Story of Modern Engineering Methods of Making Coal Gas and Recently Invented Ap-

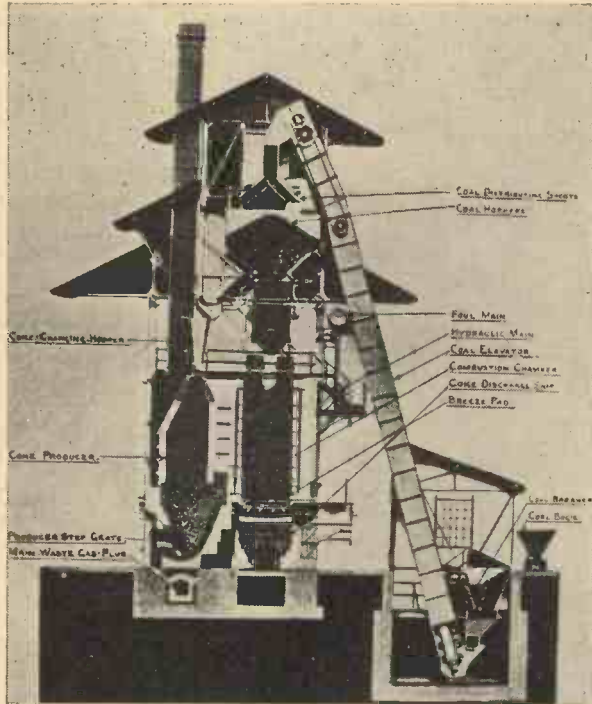

Fig. 1.—Cross section of vertical chamber oven in which coal is charged at the top, carbonised, steamed to make water-gas, and finally discharged as red-hot coke at the bottom. The term "coke producer" refers to the furnace used for heating the carbonising chamber.

**G**AS manufacture is Britain's foremost coal consuming industry. In 1934 it used 16 million tons of coal against the 13 million tons used on railways, 11½ million tons for iron and steel, and 10 million tons consumed by electric power stations.

### By-products

Coal is our most important chemical asset. The manufacture of gas has become the national distributor of the chemical wealth of coal to a host of industries. In 1935, gas-works produced 50 million gallons of motor benzol, which is half Britain's gallonage of home-produced motor spirit, and 210 million gallons of tar was sold to tar distilleries. Thence dyestuffs, pharmaceutical and our newly-founded plastics moulding industries were supplied with their raw materials. Residual pitch and tar to the extent of over 100 million gallons was sent out for road surfacing. By-product sulphur and ammonia yielded 129,000 tons of sulphate of ammonia for agriculture, and finally, 10 million tons of coke was supplied to smokeless central heating plant and domestic boilers.

Coal conservation is the secret of the success of the gas industry. When coal is carbonised, over 80 per cent. of its heat energy is conserved and distributed. Less than 25 per cent. of the energy of a ton of coal is conserved when it is burnt under a boiler and converted into electricity.

### Modern Gas-works

Gas-works have made a tremendous technical advance since the war. Mechanical handling, and new and intensified methods of gas production, have improved the hundred-year-old ways of the industry beyond recognition.

Coal, formerly unloaded and stoked by hand, is now borne swiftly overhead from ship to retort by intricate systems of conveyor belts. Machines project coal into white-hot retorts, with the speed of water

sprayed from a fire hose. In other systems, retorts are built vertically so that coal travels down them automatically, and emerges as cold coke at the bottom.

### By-product Plant

From a retort house or oven battery, the gas travels along steel mains 6 ft. in diameter. Super speed fans pick it up and boost its pressure to drive it through the purification plant. At the same time, tar vapour is thrown out by shock centrifugal force. The gas is successively cooled in condensers, washed in rotary washers to scrub out ammonia, and purified from hydrogen sulphide by slow passage through boxes full of iron oxide. Benzol is then removed by filtration through active carbon or

### Use of Gas

Although gas has been in common use for over a hundred years, it is at the present moment finding fresh markets and new applications. The introduction of thermostatic ovens, high capacity water heaters and gas refrigerators has given gas practically the monopoly of heating jobs in the modern mechanised home.

An industrial market has been created by the introduction of thermostated furnaces and batch ovens for vitreous enamelling, and for casting and tempering steels and alloys in the motor-car industry.

### Gas Governors

Gas is usually distributed in mains at pressures up to as much as 100-in. water gauge. But it is used at pressures of only 2 in. The only exception is high-pressure street lighting lamps which derive their brilliant light from high-pressure air injecting burners.

Between mains and appliances pressure transformers, i.e. gas governors, are fitted. The governor steps down variable high pressure to a steady working pressure. If electrical engineers had such infinitely variable transformers at their command, half their problems with overloads and voltage flicker would vanish.

The action of a gas governor is very simple. In Fig. 2 gas enters at the underside of a cone-seated valve which is suspended from a spring-loaded diaphragm.

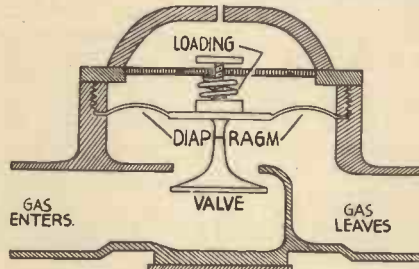

Fig. 2.—The gas governor.

by washing with oil. A yield of over three gallons of motor spirit per ton of coal is recovered by this means

Finally, the gas is stored in vast waterless holders ready for distribution. These are virtually enormous cylinders with a confining piston which floats up and down on the gas, retaining it as its level rises and falls. London's largest holder of this type holds eight million cubic feet of gas, and stands over 300 ft. high, measuring 80 ft. in diameter. Holders act as a reservoir to meet peak loads without upsetting the smooth running of the gas-making plant.

From the holder, fans pick up the gas and boost up its pressure to drive it through the distribution mains. But first water vapour is removed from the gas by scrubbing it with strong calcium chloride solution, because condensed water and its product, rust, upset the modern highly organised systems of gas distribution.

Such is a description of a modern gas-making system such as exists at Beekton which is London's and the world's biggest gas-works. Similar systems are in operation in all our larger towns and on modern gas grids such as those in South Yorkshire and the Ruhr district in Germany.

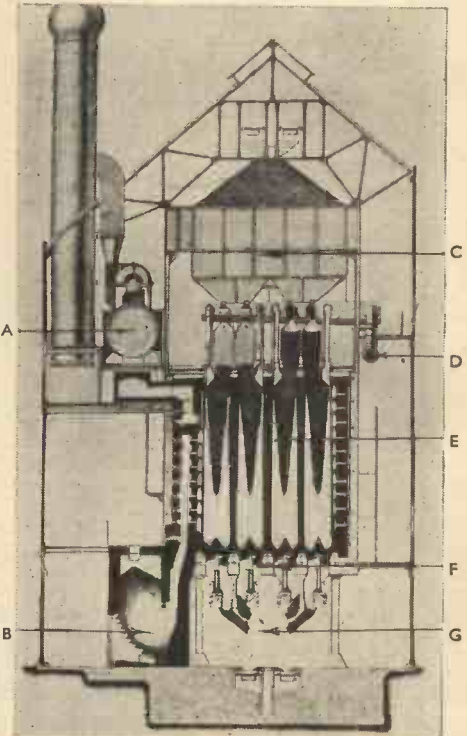

Fig. 3.—Continuous vertical retort in which coal travels from top to bottom of retort continuously and automatically, and emerges as cold coke at the bottom.



# HOW IT IS MADE

Development and Ingenious Inventions. Modern appliances for Using Gas are described in this Article

The valve is kept open by its own weight plus the spring loading on the diaphragm. The upward force of the outlet gas pressure thrusts up on the diaphragm, and tends to close the valve. If the outlet pressure tends to increase over the pressure setting of the spring loading, the diaphragm is thrust up and carries the valve with it.

## Gas Thermostats

Once a steady working pressure has been obtained on an appliance, volume throttling can be used to give a steady rate of gas supply and therefore a steady heat input.

In Fig. 5, a thermostat is drawn in section. Gas enters and passes through a ring-seated throttle valve before it goes to the outlet, and thence to the burner. The valve is operated by a rod of invar-steel encased in a copper sheath. Invar steel does not expand when heated, copper does. This bimetallic rod is inserted in the gas heated space.

So long as the heated space is below a set temperature, the steel rod thrusts on the bottom of the copper tube and keeps the ring valve open against the force of a loading spring. But as the set temperature is approached, the copper sheath gets longer and longer, and its end tends to retreat from the end of the steel rod. The spring can thus come into play to shut down the ring valve. The result is that the gas burner on the outlet is cut down to a mere weep at a set temperature.

## Instantaneous Water Heaters

The instantaneous water heater provides an example of the high-loading capacity of a domestic gas system. These heaters turn out over two hundred gallons of water an hour with a gas consumption of about 250 cubic feet. Over 80 per cent. of the potential heat of the gas burnt is turned into water heat, so compact and efficient is the design. An electric load of 1,000 amperes at 330 volts would be needed to perform the same service.

The action of these appliances is highly ingenious. They light themselves up as soon as any hot tap to which they are connected is turned on. A restrictor orifice is placed in the water service leading to the heater, and so long as the water does not flow, the pressure on both sides of the orifice is the same, and nothing happens. But immediately water flows at the turning-on of the water tap, the pressure downstream of the restrictor is less than that upstream. This pressure differential operates a diaphragm which turns on the main gas valve. The gas comes on at the burners and is lit by an auxiliary pilot flame. Fig. 6 shows the principle in simplified form.

In the latest models there is a master valve kept open by the heat of the pilot flame playing on a bimetallic strip. Thus, when the pilot flame is not on, the main gas cannot come on. This is an anti-explosion device. To keep a steady hot-water temperature, there is yet another valve operated by thermostatic control on the gas supply.

## Gas Refrigerators

Gas refrigerators are considered to be the doyen of gas appliances. They actually

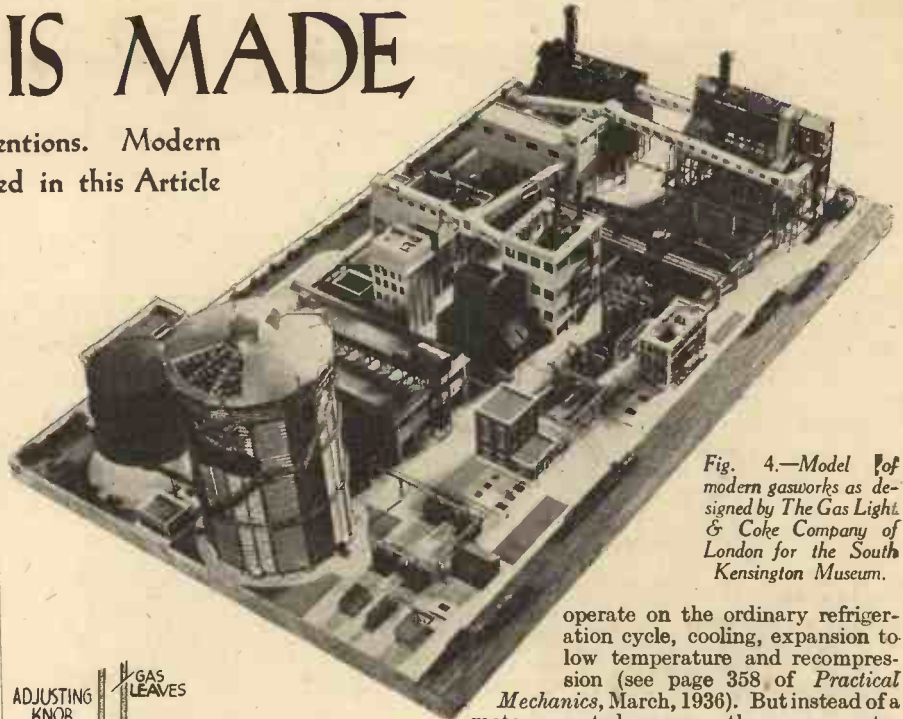

Fig. 4.—Model of modern gasworks as designed by The Gas Light & Coke Company of London for the South Kensington Museum.

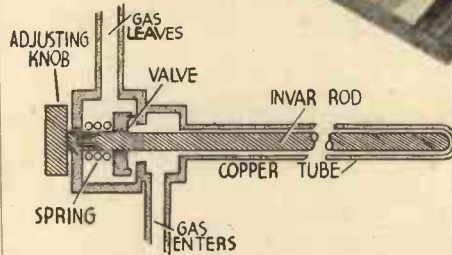

Fig. 5.—Section through a gas thermostat.

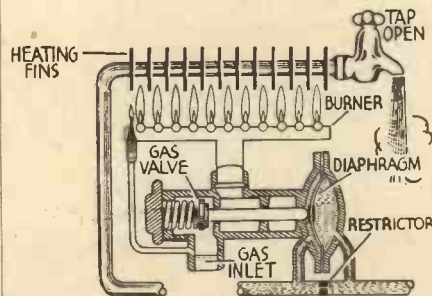

Fig. 6.—Principle of the instantaneous or "geyser" water-heating system.

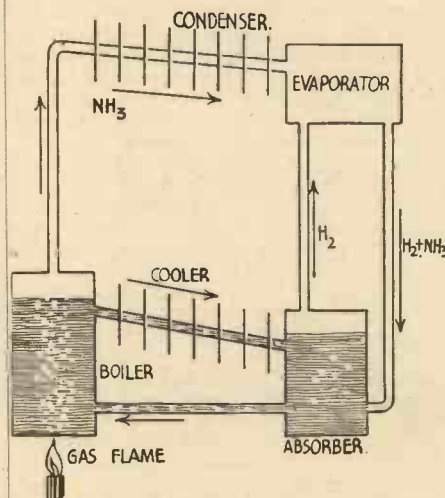

Fig. 7.—Section through a gas refrigerator.

operate on the ordinary refrigeration cycle, cooling, expansion to low temperature and recompression (see page 358 of *Practical Mechanics*, March, 1936). But instead of a motor-operated pump, they use water circulated round a secondary cycle by a gas flame to effect recompression. It is a highly ingenious application of pure thermodynamic principles taken straight from the physics book. It gets over that bugbear of mechanical refrigeration—wear and tear of motor-operated units.

In a gas refrigerator there are then two cycles—the refrigerating vapour cycle and the absorption liquid cycle. (See Fig. 7.)

The vapour cycle is boiler, cooler, evaporator, absorber. Concentrated ammonia solution is boiled in a boiler, and ammonia gas is evolved, hot and under pressure. It passes through an air-cooled condenser which turns it into liquid ammonia. It then passes into an evaporator filled with hydrogen, where the liquid ammonia evaporates producing a low temperature.

The cold mixture of hydrogen and ammonia vapour drops through a descension pipe to the absorber and bubbles up through weak solution which has arrived from the boiler. Ammonia is absorbed and hydrogen bubbles back through a rising pipe to maintain the atmosphere in the evaporator.

The liquid cycle is simple. The strong ammonia solution is stripped of its ammonia in the boiler, rises up to the top, and overflows through a cooler to the absorber. There it picks up fresh ammonia and travels back to the bottom of the boiler.

Notice that there is no expansion orifice from vapour condenser to evaporator. The condenser is to be likened to a bottle of liquid ammonia opened in a room filled with hydrogen. The evaporator chamber is the hydrogen filled room. The ammonia simply evaporates and passes out through the neck of the bottle into the room. The reason is that although the total pressure in the bottle is exactly the same as in the room, the partial pressure of the ammonia over the surface of the ammonia, is greater than the partial pressure in the room. Evaporation of the ammonia produces a chilling effect on the bottle.

The gas flame sets the tempo of the cooling cycle, from rapid rate of circulation and rapid cooling, to slow and slight cooling. It is controlled by a thermostat which can be adjusted to give any desired degree of cooling.



**T**O some people a watch is nothing more than an ornament, to others a mere box of tricks that helps them keep appointments and regulate the day's work. The remainder treat their watches with a reasonable amount of care. This last group includes those with mechanical knowledge, who realise the precision with which such small parts must function, those whose fear of damage and its consequent financial loss makes them respecters of watches and those who are conscientious enough to believe that such delicate instruments should only be handled by competent workmen.

#### The Swiss Lever

Fig. 1 is an enlarged view of a modern Swiss lever wristlet movement, ladies' style, jewelled in fifteen positions, as viewed from the back. The actual diameter is 23 mm. In this case the balance and balance bridge have been removed to show the escapement, as also has the bridge that supports the mainspring barrel or container and part of the winding mechanism.

#### The Various Parts

First we have the mainspring barrel—this is a cylindrical brass box around the edge of which are teeth—sometimes referred to as the great wheel on account of its size. This box is fitted with an axle and a snap-on cover. It contains the thin ribbon of steel called the mainspring. When fully wound,

the mainspring is coiled tightly in the middle of the box; as the watch works, the mainspring coils itself against the side of the box. The movement of the mainspring in going from the central to the outside position provides the motive power.

Examining the movement in an anti-clockwise direction, we come to the second of the wheels, the centre wheel, called thus by reason of its position. This wheel is fitted with an axle or arbor, one side of which is elongated. The elongated side carries one of the small wheels which operate the hands. Next in order we see the third wheel, fourth wheel, which also has an elongated axle, much smaller than the centre wheel, as it carries the second hand, and the fifth wheel, always referred to as the escape wheel on account of its action.

These three wheels are the first we have encountered whose axles rotate in jewelled bearings.

The fifth or escape wheel must receive a little more attention, by reason of its action, which is entirely different from any other wheel. Ordinary teeth are used with a normal wheel and pinion gearing. But not so with the escape wheel—the teeth of this

# THE WORKS OF A MODERN WATCH

## Some Interesting Facts About the Principles of Timekeeping Mechanisms

William G. Pike, F.B.H.I.

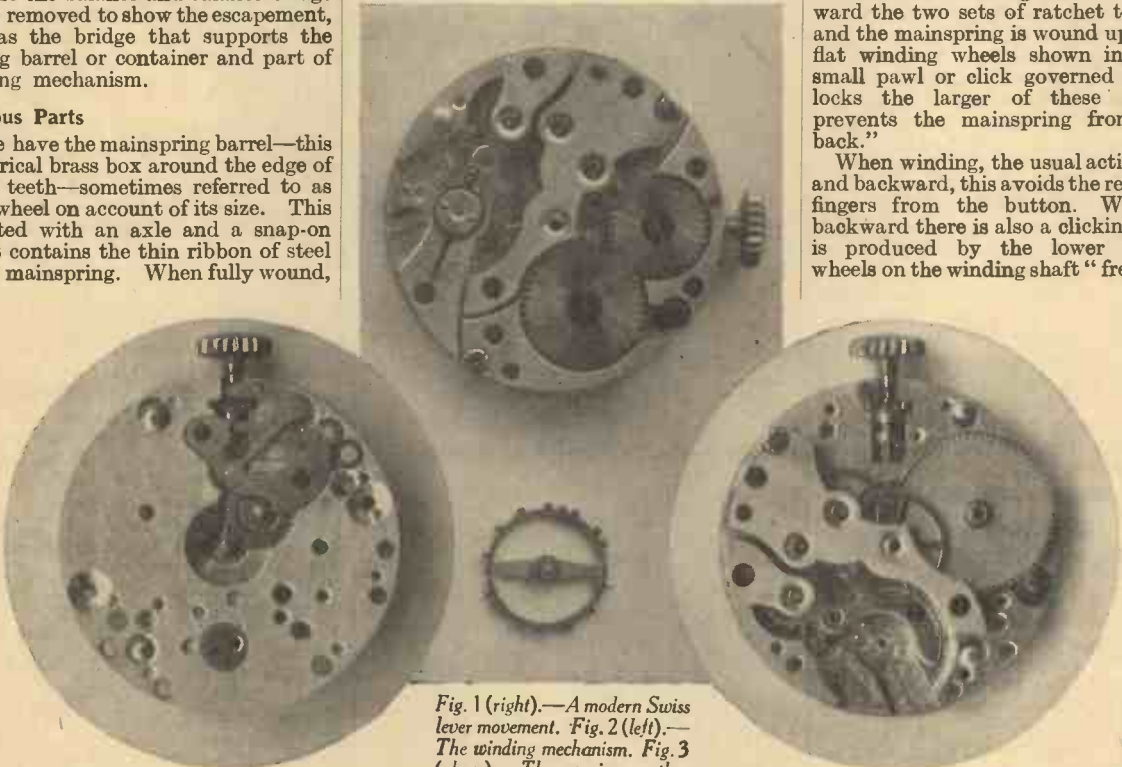

Fig. 1 (right).—A modern Swiss lever movement. Fig. 2 (left).—The winding mechanism. Fig. 3 (above).—The various other parts of a watch.

wheel are angular. Some teeth taper to a point; others, of which this is an example, terminate with a head. Such a wheel is known as a club-toothed wheel. The escape wheel as a rule is provided with fifteen teeth and its contact with the anchor-shaped piece known as the pallets is intermittent. The pallets are provided with two jewels, one the entry and one the exit, and the wheel makes contact with these alternately. The jewels fit into slots, and upon the accurate placing of these depends, to a certain extent, the angle of vibration of the balance. Theoretically the time of vibration should be constant in all positions. The escape wheel locks and unlocks 18,000 times per hour (some English levers 15,000).

The extended arm of this small anchor piece is shaped like a fork to engage the jewel pin attached to the balance, and the whole piece is mounted on a very short axle (staff) which runs in jewelled bearings. The top jewel is carried in a small semicircular bridge. The axle has to be very short on account of its position, which is below the balance, the end of the balance

axle and the pallet axle terminating on the same plane.

#### The Winding Mechanism

To the extreme right of Fig. 1 can be seen part of the winding mechanism. The winding button and shaft, and two of the winding wheels. The longer of the two has orthodox teeth at the lower end and ratchet teeth at the top. The other wheel which gears with the smaller of the two winding wheels in Fig. 3 is also provided with a set of ratchet teeth. The lower half of the winding shaft is made square and the longer wheel has a square hole. Actuated by a spring and a lever which work in the groove clearly visible, this wheel moves up or down the shaft as required. These wheels are referred to technically as the crown and castle, one by reason of its position and the other owing to its shape.

When the winding shaft is turned forward the two sets of ratchet teeth engage, and the mainspring is wound up via the two flat winding wheels shown in Fig. 3. A small pawl or click governed by a spring locks the larger of these wheels and prevents the mainspring from "running back."

When winding, the usual action is forward and backward, this avoids the removal of the fingers from the button. When turning backward there is also a clicking heard; this is produced by the lower of the two wheels on the winding shaft "free wheeling."

#### The Winding Apparatus

Looking at Fig. 2, we see the remaining parts of the winding apparatus. The piece that retains the winding shaft and also acts as a pull-up piece for setting the hands. The lever that works in the groove of the castle wheel, the spring that operates the ratchet mechanism, a small steel intermediate wheel—the teeth of which are just visible—and the one-piece spring and cover plate. This plate, which is secured by two small screws, keeps the various small pieces in place.

When it is necessary to operate the hands, the button and shaft are pulled out as far as possible. This causes the pull-up piece to depress the lever. The lever carries the castle wheel down the shaft until it engages the small steel wheel.

In the centre can be seen the cannon pinion. This is really a small tube with teeth at the lower end, and it is a snap-on friction fit on the elongated spindle of the centre wheel. It is upon this tubular pinion that the minute hand is fixed.

Engaging this pinion and the intermediate wheel is the minute wheel and pinion.

(Continued on page 624)



# OUR £20 CAR

## Details of the Brake System

BY F. J. CAMM

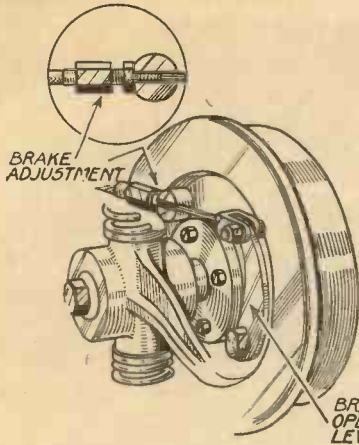

Details of the Fixtures at the front brake stator plates.

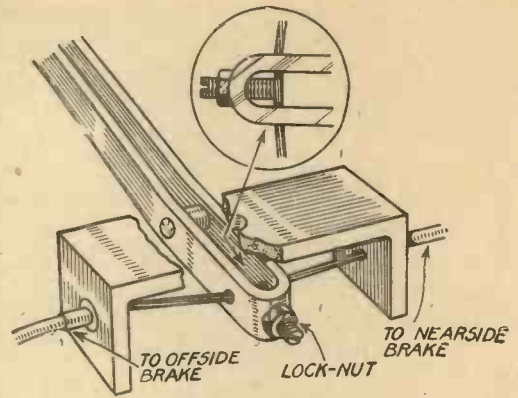

One cable couples both front brakes, and is yoked as shown here to the hand lever.

VERY many replicas of my £20 Car are now nearing completion in various parts of the country, and one or two have, I understand, already been completed. So far as I am aware, the first reader to complete the car was John Rosie, of Myre Wide-wall, St. Margaret's Hope, Orkney, who writes:

"After following your plans and ideas for building a three-wheeled car, I have succeeded in doing so. This model was finished some weeks ago and runs splendidly. I had often thought of such a construction, in fact I had almost decided to

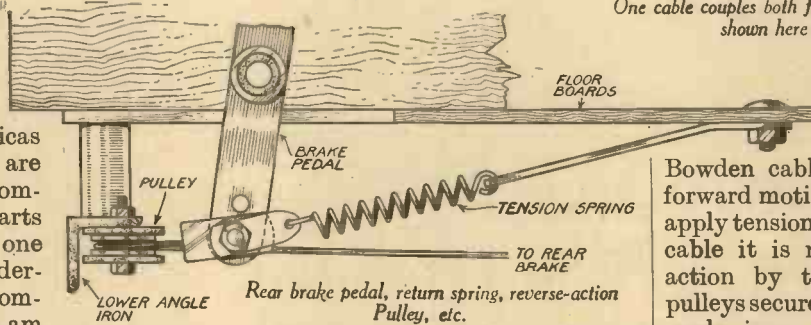

I will forward one for your examination. My registration number is BS 1566.

"For my body, I chose 3-ply, and then covered same with a light gauge of zinc, which finishes the little F.J.C. very nicely indeed. This I think is the first car ever built in Orkney. I thank you, and await your reply."

Several readers have asked for more explicit instructions concerning the braking system, and accordingly I reproduce herewith five detailed drawings of

Bowden cables, and in order that the forward motion of the brake pedal can apply tension or "pull" on the Bowden cable it is necessary to reverse the action by taking the cable round pulleys secured to the lower front axle angle iron. I used ordinary sash-pulleys for this. They are quite cheap and may be purchased from any ironmonger. You will observe that the cable casing for the rear brake extends to a point immediately beneath the driver's seat, and a stop-plate is fitted as shown. Additionally, a tension-return spring is fitted to the brake pedal in the position shown. It should be slightly off-set to clear the cable. A separate detail showing the disposition of the pedals, pulley, yoke end, tension spring, and spring anchor strap (of 1/8 in. mild steel) is given above.

I also show a sketch revealing details of the fixtures at the front brake stator plate. One piece of cable connects the two front brakes. The casing is divided at the point where it passes through the hand-brake yoke. The cable is locked as shown in the separate detail. The cable and casing should be left

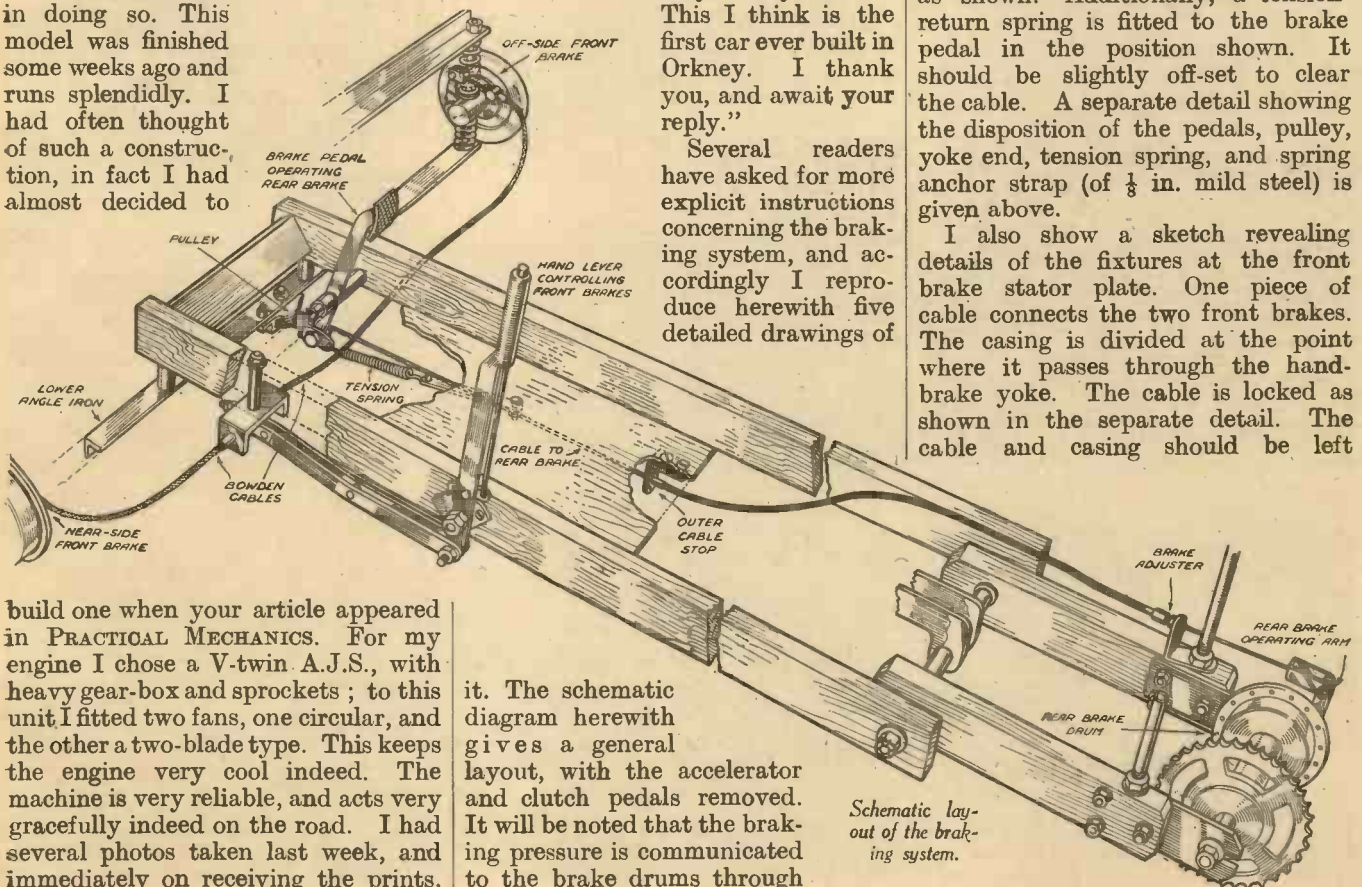

build one when your article appeared in PRACTICAL MECHANICS. For my engine I chose a V-twin A.J.S., with heavy gear-box and sprockets; to this unit I fitted two fans, one circular, and the other a two-blade type. This keeps the engine very cool indeed. The machine is very reliable, and acts very gracefully indeed on the road. I had several photos taken last week, and immediately on receiving the prints,

it. The schematic diagram herewith gives a general layout, with the accelerator and clutch pedals removed. It will be noted that the braking pressure is communicated to the brake drums through

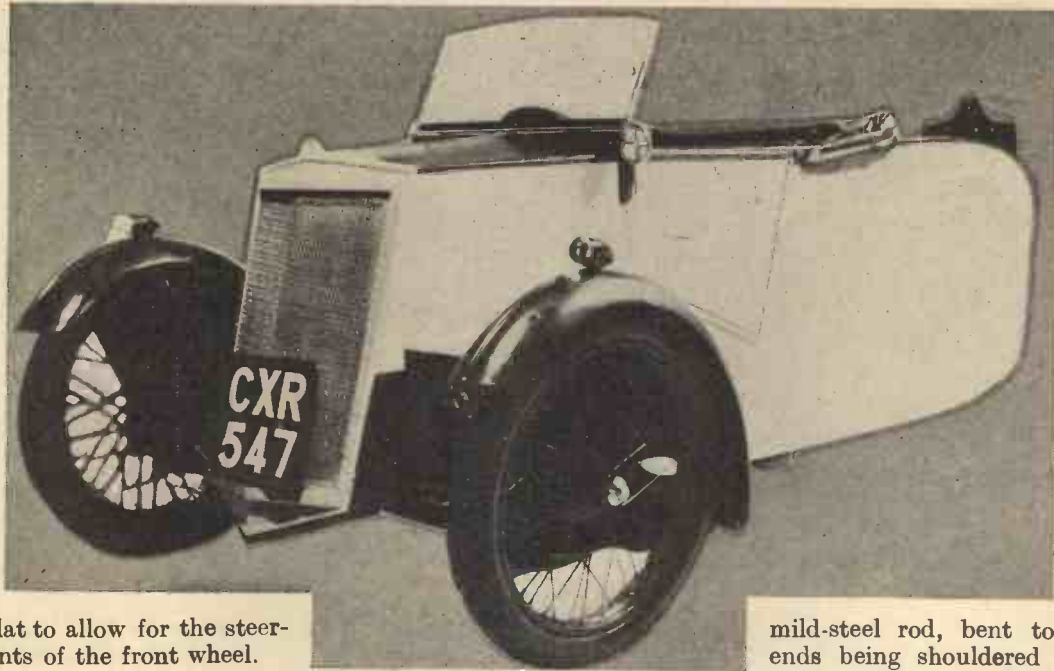

Front View of our £20 Car

sufficiently flat to allow for the steering movements of the front wheel.

### Fixed Wings

Those readers who prefer to use fixed type of wings instead of the sports type as shown in the photograph which orientate with the front wheel, should use  $\frac{3}{16}$ -in. three-ply which will bend quite easily to the required curvature of the body. They should be cut together so that they make a pair, and finally fitted to the body line so that there are no gaps. Fixture to the body should be by means of angle plates bolted to the three-ply dummy bonnet, using large washers under the nuts to distribute the pressure. Mark off the line of the wing on the body, fasten the angle plates and then pull the wing over to it. Half-round beading may be fastened on the outside of the wing to give a finish.

Another type of wing can be made from  $\frac{1}{4}$ -in. round

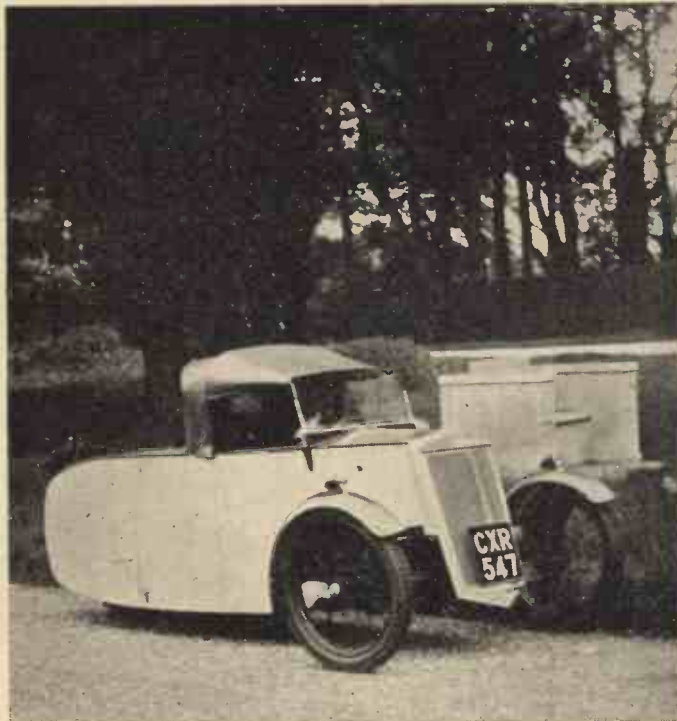

The Completed £20 Car.

mild-steel rod, bent to shape, the ends being shouldered and screwed for fastening to the body. This framework can be covered with

American cloth and so has the great advantage of being practically indestructible. It

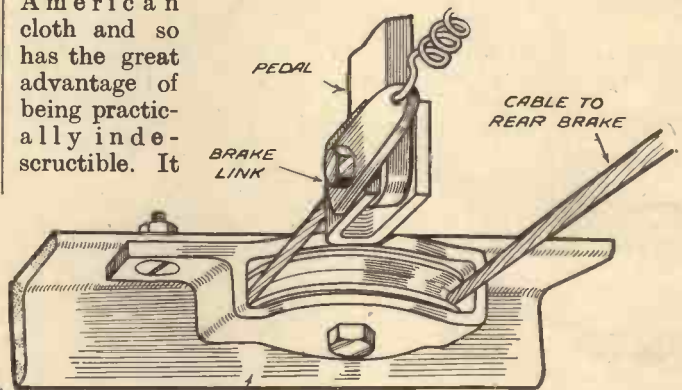

AXLE ANGLE IRON  
Details of the Pulleys.

is certainly lighter. Blueprints of this car are still available, and consist of four sheets giving all of the dimensions; they cost 10/6 per set from Geo. Newnes, Ltd., 8-11 Southampton Street, London, W.C.2.

### Sports Mudguards

On the other hand, the wings fitted to my own car may be purchased ready-made from James Grose, Ltd., and are standard Austin Seven balanced front sports mudguards. They are easily attached to the brake stator plates by means of countersunk bolts which should be fixed to the stator plates by tapping the bolt holes.

The mudguards can be obtained in black finish or in the bare metals, so that you can finish them to conform to the colour scheme of the rest of the car. They should be fixed at such a radius that the wheel has at least 2-in. clearance.

The lamps are, of course, fitted to the wings. Use double-pole lamps and twin shrouded cable for wiring. The latter must be of the 5-amp. variety, obtainable from most garages and any electrician's. It is quite cheap.

If I can be of further assistance to readers they merely have to communicate with me.



# A PERPETUAL FOUNTAIN FOR THE GARDEN

AS a garden feature the fountain is a charming accessory, but if no natural head of water is available, it cannot be made a success unless one is prepared to incur an annual charge by the water company.

## The Principle

The fountain to be described overcomes these difficulties by using the same water over and over again, employing a wind motor to pump it to a raised cistern, whence it descends by gravity to the jet, thence to the basin to be raised again, the action being continuous so long as there is enough wind to move the vanes of the motor.

Fig. 1 shows the general arrangement of the basin, jet and piping.

## The Basins

This may be made of concrete and faced with cement mortar. First erect a length of  $\frac{1}{2}$ -in. iron gaspiping, through which the  $\frac{1}{4}$ -in. compo delivery pipe (A) has been passed, and stay it temporarily; then using a mould as shown in Fig. 2, bring the basin to a fair surface.

Next make the column and small basin. For the former procure a length of iron gaspiping that will just pass over the  $\frac{1}{2}$ -in. pipe. Make a cone of stout cardboard, fix the pipe so that it stands centrally within the cone, and fill up with cement mortar (see Fig. 3). When nearly set remove the cardboard, pass a rod through the pipe, support it at its two ends as shown in Fig. 4 and shape the column to a pleasing curve by rotating it and using a scraper or saw-blade in the manner of a lathe tool.

The fashioning of the small basin may be done as follows. Fix upright in a board, an iron rod, pack it round with stiff clay, and work the clay to a regular convexity representing the inside of the basin by means of a wooden mould (see Fig. 5). Then with a mould shaped to the outer contour of the basin, using cement mortar, fashion the lower surface of the basin. When set, remove the clay and enlarge the central hole so that it will pass over the  $\frac{1}{2}$ -in. piping.

## Assembling the Parts

You may next assemble the parts. Pass the column over the pipe and bed it in cement on the bottom of the basin, then add the small basin, cementing it to the top of the column, taking care to set it level.

A channel should have been cut through the side of the large basin to receive the suction pipe (B), Fig. 1. To the end of this pipe fix a fine rose as used on hose fittings,

## Wind-operated

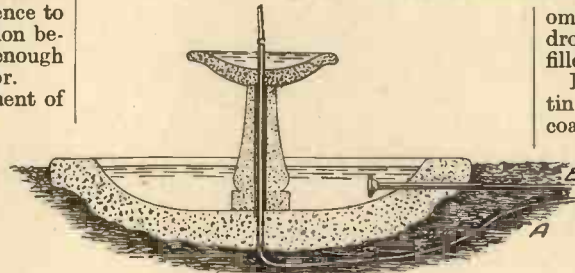

Fig. 1—Section through the Basin and Fountain.



Fig. 2—Mould for making the Basin.



Fig. 3—Method of making the Column.

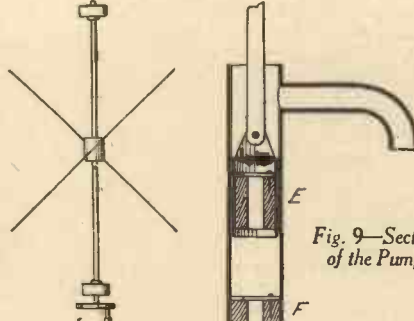

Fig. 8—The Shaft.

Fig. 9—Section of the Pump.

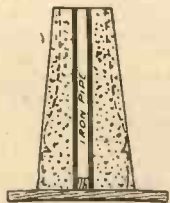

Fig. 4—Coring the Column.



Fig. 5—Method of making the Small Basin.



Fig. 6—The Nozzle.

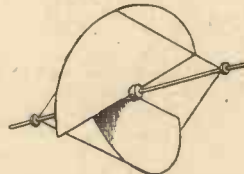

Fig. 7—The Wind-operated Motor.

omitting the tap. The pipe then may be dropped into its channel and the latter filled in with cement mortar and made fair.

For the nozzle, that from a cheap oil tin may be used. Procure one with a coarse internal screw thread. Perforate a cork for the compo pipe, force the cork into the base of the nozzle with a screwing action and work it over the end of the compo pipe (see Fig. 6). So much of the piping as protrudes from the basin may be neatly covered with cement.

This completes the fountain proper. We have now to consider the means for raising the water and delivering it to the fountain.

## Wind-operated Motor, Etc.

The motor, as already stated, is to be wind operated. It is shown in perspective view in Fig. 7 and in plan in Fig. 8. Cut the vanes from sheet zinc, each to semi-circular shape. A short brass sleeve must be sweated to the shaft. Make two saw cuts on opposite sides at right angles to each other, insert the vanes and solder them in securely. Add wire stays as shown in Fig. 7. The shaft should have collars at each end as indicated in Fig. 8, and a crank (C) for driving the pump. Mount the shaft in bearings erected upon a stout baseboard.

This form of motor has the merit that it will work from whichever quarter the wind is blowing.

A small tank will be required, which may be of zinc, set in a wooden bearing, or slate, or an iron drum may be used. A capacity of, say, two gallons would be sufficient.

Erect in some convenient spot upon a wall top or a wooden pedestal, preferably in a not too conspicuous position. The motor may be attached to the top of the tank, and the pump, presently to be described, attached to its side. This will be an easy matter if the tank is cased in wood.

Carry the delivery pipe (A) to the tank and connect it near the bottom. The suction pipe (B) is to be connected to the pump suction.

This is shown in section in Fig. 9 and has a barrel of brass tube. The plunger (E) is a short length of similar tube that just fits it. A perforated hardwood plug is driven into the plunger as shown, at the head of which is the rubber valve. It is a disc of rubber sheet, with a C-shaped cut forming a flap. Secure with fine pins.

At the head of the plunger its two sides are continued upwards on opposite sides and fitted with the cross pin to which the connecting rod is attached. At the foot of the barrel a similar valve (F) is fitted.



# THE LATEST PROJECTED

By H. J.

## A Brief Survey of the Phases of Development Which have been Followed in Obtaining Projected Television Images.

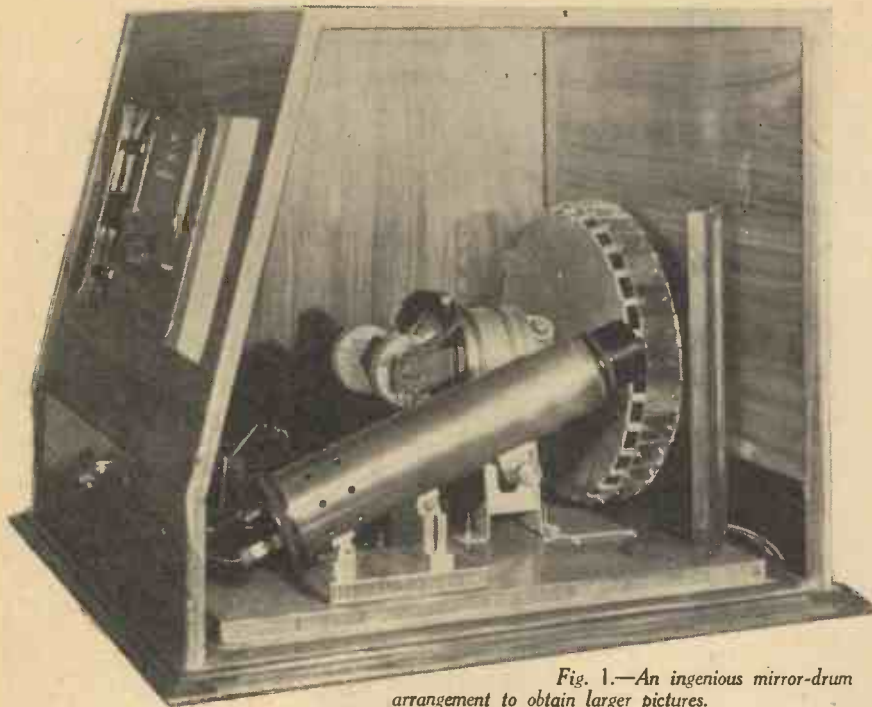

Fig. 1.—An ingenious mirror-drum arrangement to obtain larger pictures.

FROM the very early stages of television development inventors have always had in mind the idea of receiving equipment capable of projecting the television pictures on to some form of screen which was detached from the actual reproducing apparatus. For big screen working, schemes of this character are inevitable if the results are to be capable of showing to large audiences, but even for the home the same requirement has been asked for by certain sections of the public. No doubt this is the natural outcome of home cine working, and although modern practice as exemplified by present day high-definition television pictures has modified matters somewhat, from time to time reports are published showing that projected television pictures are still being sought after.

### Using a Lens Disc

Low-definition television certainly provided the first steps in this development, but the prime difficulty was to secure a source of illumination which was bright enough to be projected on to a screen when modulated by the incoming television signals from the radiated carrier wave. The flat-plate neon lamp was quite unsuitable for this purpose, but the point-source lamp or hot-cathode neon lamp met with a partial success when used in conjunction with a lens disc. Instead of small plain apertures being punched in the disc face near the outer edge, each aperture was replaced by a small inset lens. Behind this was placed the hot-cathode neon lamp whose intrinsic brightness was varied by the television signal. By focusing this light on to the spiral trace of lenses in the disc, it was possible to obtain rather dim pictures on a translucent screen placed a short distance away as shown in Fig. 2. The results were certainly to be preferred to those secured with a plain apertured disc and a flat-plate neon lamp, but an accurately made lens disc was rather expensive, and with the low-definition standards then operating, did not justify being made up for commercial purposes.

### A Mirror-drum Development

The later development of the mirror-drum scanning unit in its many practical forms was an improvement which very soon became evident in the various types of television receiving sets which showed projected images of a larger size and improved brilliance, when compared to their lens disc prototypes. As an example of this arrangement in which use is made of the hot-cathode neon lamp, reference can be made to Fig. 1. Here the neon lamp was housed in the inclined tube casing, while at the far end of the tube was a lens focusing the modulating light beam on to a vertical mirror set at an angle of 45 degrees to the vertical plane of the neon lamp. An examination of Fig. 3 will make this clear and the beam of light was reflected from this mirror on to the separate canted mirrors of the drum. As the drum revolved at its synchronous speed of 750 revolutions per minute, this light beam was reflected back by the individual drum-mirrors on to the vertical mirror so that thirty consecutive picture strips were traced out. These were again reflected on to a front translucent screen (see Fig. 3 for the

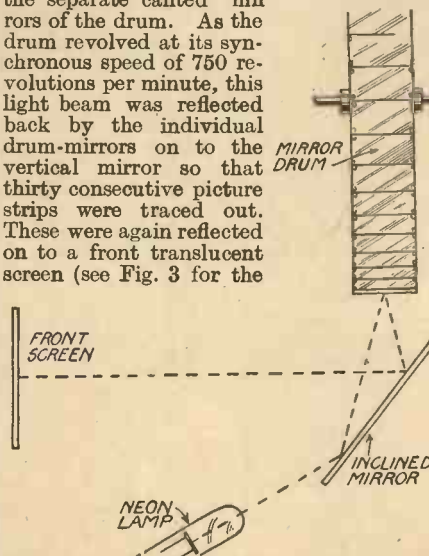

Fig. 3.—Showing the path of light for the arrangement shown in Fig. 1.

light path traced) accommodated in the front of the cabinet shown in Fig. 1. The resultant pictures observed with this arrangement, synchronism being established by the familiar cogged wheel method, were a great advance on the disc machines, but they still had the characteristic orange red colour of the neon lamp and failed to satisfy the standard of brilliance then required by the set user.

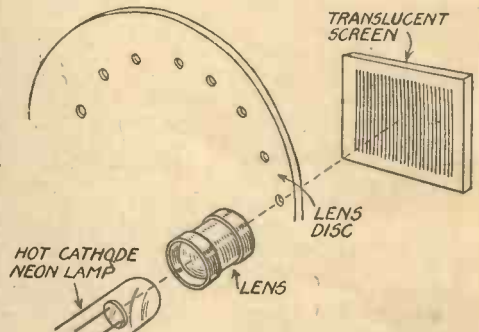

Fig. 2.—Using a lens disc and a hot-cathode neon lamp to obtain projected television pictures.

### Using a Light Valve

At about this period considerable research work was being undertaken in an effort to produce a form of Kerr cell which did not require a high operating voltage under normal working conditions, and yet maintained a reasonable light efficiency. Within certain voltage limits this cell has a linear characteristic between light intensity and polarising voltage when used in conjunction with two light polarising prisms. In other words, if a steady beam of light from a constant light source is focused on to the combination, voltage variations applied to the cell will produce equivalent variations in the emergent beam of light, the range being from almost a complete black out to a full white.

Finally, a commercial model was introduced, the cell (accommodated in a hermetically sealed glass tube) together with the polarising prisms, condenser lens and lamp being mounted in a holder. This unit was then employed in conjunction with a mirror-drum projector type television receiver having a translucent screen 9 in. high by 5 in. wide at the front. As indicated in Fig. 4 which shows Mr. Baird with the first model of this form of set, the screen was pulled out with side bellows to prevent the ingress of extraneous light, and the resultant television images were cer-



# DEVELOPMENT IN TELEVISION IMAGES

Barton Chapple, B.Sc., etc.

tainly a considerable improvement from the point of view of colour (almost black and white) and brilliance. Other forms of the same scheme either as complete receivers or component parts for home constructors soon became available in order to take advantage of the service transmissions of low-definition television, then being radiated by the B.B.C.

### Other Forms

By employing large type cells, it was possible to obtain quite large screen pictures and in Fig. 5 is shown a laboratory arrangement made up in this way with the mirror-



Fig. 5.—A laboratory arrangement to obtain large-size pictures with a Kerr cell.

drum in the foreground and the screen at the rear. To enlarge the picture, demonstrations of multizone equipment were given, two, three and more channels being employed. Fig. 6 portrays quite simply a pictorial arrangement of this scheme, and for the first daylight transmission of the Derby on a big screen by Baird in 1932, three zones were employed, the signals being transmitted over land lines to a London Cinema.

The rapid development of high-definition television, however, was instrumental in initiating a new line of attack on the question of projected television images together with a segregation of cinema screen size pictures and home size pictures into different forms. It is known that for the former, mechanical methods are still being pursued in certain quarters, and no doubt the results of this work will be shown to the public in due course.

### Intermediate Film Arrangements

On the other hand, greater promise seems to be attached to the intermediate-film projector receiver for big screen working, and there are two forms in which it has been made and demonstrated. About two

years ago the Fernseh A.G. of Germany constructed equipment in which a continuous loop of celluloid film was employed. The film with the unexposed emulsion upon it, was passed through a camera of the continuous motion type (i.e. it passed through the "gate" at a steady uninterrupted speed) and on this was projected the television pictures as received by radio by means of a rotating concentrically apertured disc. The light modulation was effected by a Kerr cell similar to those described earlier in the article, and after a complete photographic process (developing, fixing, washing and drying) the finished positive print was fed through a standard cinema film projector and shown to the audience on a large screen. On emerging from the projector the film then passed through tanks where the emulsion and in consequence the recorded picture, was washed off. After this the clear celluloid was re-emulsified and dried and continued its journey through the recording camera to begin the process all over again. Although effecting a considerable saving in film cost, certain technical disadvantages were encountered and the results were not up to a very high standard.

### An Improvement

This scheme has now been superseded by another form of intermediate film recording, this new arrangement being used by both Fernseh A.G. in Germany and Baird Television Ltd. in this country. The radiated television picture is received and transferred to a cathode-ray tube to be seen on the fluorescent screen. The picture-frequency time base is then rendered inoperative so



Fig. 4.—Mr. Baird with the first mirror-drum Kerr cell receiver combination.

that every separate and distinct horizontal picture line is traced over the same path on the screen of the recording tube. This line is focused on to the unexposed emulsion on a film contained in the continuous motion recording camera. As the film is passed through the camera at a steady rate of 25 frames per second, both vision and sound

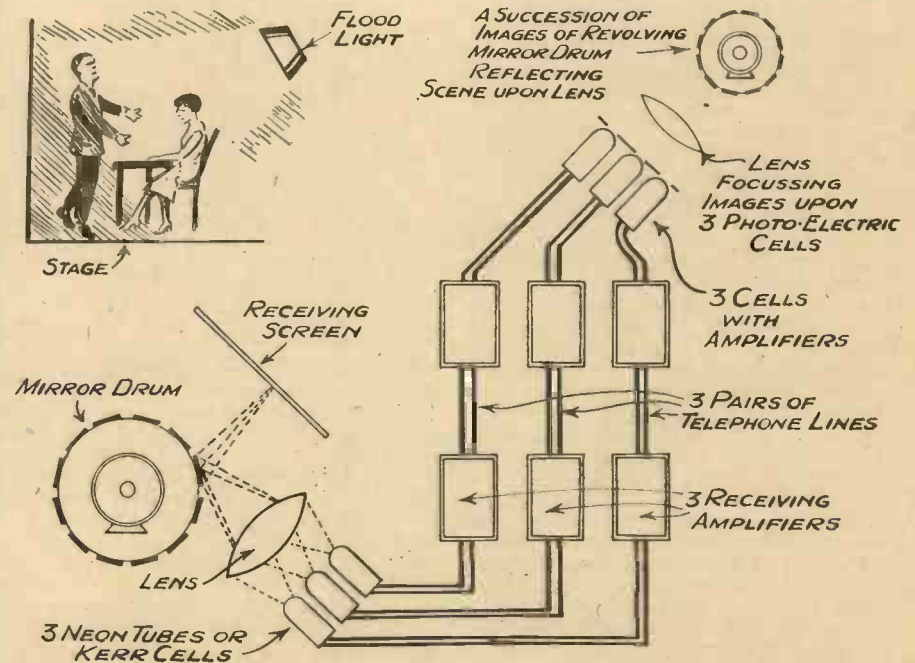

Fig. 6.—A multizone scheme portrayed pictorially.



are recorded on it, the former as a series of consecutive lines just the same as would be seen in a normal received television picture, and the latter as a variable density track on

and dried in a very short space of time (under two minutes in practice) and then passed into a standard cinema film projector, so that the resultant pictures are

"thrown" on to a full size cinema screen and the sound taken off in the sound head. That the complete equipment can be assembled in quite a compact form is borne out by referring to Fig. 7 which shows the Fernseh apparatus used at last year's Berlin radio show, but it must be remembered that in this case only 17.5 m.m. film was employed and not the standard 35 m.m. The results obtained by this method, however, are understood to be most promising and no doubt more will be heard concerning it when

method of securing projected television pictures is being developed and this uses what is called a projection tube. Strictly speaking, this is nothing more than a special form of cathode-ray tube which is capable of reproducing on its fluorescent screen an intensely brilliant picture about 3 in. to 4 in. wide. The brilliance and detail is of such a high standard, however, that by placing a lens in front of this picture it can be projected on to a separate screen a few feet away. This scheme is only in the process of development, but according to reports which have already been published, screens up to 4 ft. wide have been filled with a picture in this manner. In Fig. 8 is shown a tube made for this purpose by the Italian "Safar" company, and not only has the screen to be made of special glass, but to eliminate optical distortion, special precautions in manufacture have to be taken. To obtain the required degree of brilliance for large pictures, quite high voltages have to be employed, but if the degree of electron bombardment of the screen is carried beyond certain limits, the screen disintegrates. This scheme, however, after a measure of research, will undoubtedly provide an alternative method for projected television pictures and is an arrangement which falls into line with modern electronic practice whereby mechanical mechanisms are replaced by electrical devices that have harnessed the power of the electron for commercial purposes.

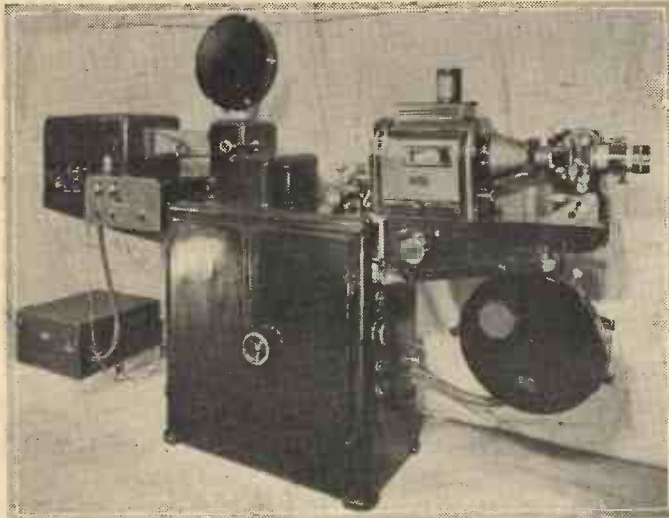

Fig. 7.—The Fernseh A.G.'s intermediate film television projection receiver which produces pictures of the size of a cinema screen.

the film in the usual way. After leaving the camera the film is fed through processing tanks where it is developed, fixed, washed

the high-definition television service starts. Although no technical details have been published it is known that yet another

### THE WORKS OF A MODERN WATCH

(Continued from page 618)

The hour wheel, to which is attached the hour hand, has been removed for convenience. This wheel is driven by the minute wheel pinion and rotates upon the cannon pinion. The number of teeth in these wheels and pinions varies, but the ratio is always constant. It is, of course, a ratio of 12 to 1. Therefore when the button is pulled out, all five wheels are in gear and the hands can be moved forward or backward.

There is very little left for description in Fig. 2. The two bright spots are the sinks into which fit the legs of the dial. When the dial is in place, it is locked by means of screws with semicircular heads.

The small disc on the left-hand side, although less conspicuous, is really more important. This disc, into which is fitted the bottom balance end jewel, covers the bottom balance jewel bearing. The balance spindle rotates in the jewel bearing and pivots upon the end jewel—which is a plain flat jewel—when turned face downwards. The disc fits in a shallow recess and is secured by a small screw.

Fig. 3 shows the remaining parts of the watch. In this view the balance bridge and assembly is inserted and the barrel bridge or bar with winding wheels. The balance bridge assembly consists of no fewer than eleven parts.

The shorter end of the index or regulator is provided with two slender pins between which the hairspring vibrates. The regulator is secured by an endpiece which has two screws to prevent it moving sideways when the regulator is altered. The jewelling is precisely the same as in the bottom plate. The hole for the hairspring stud, together with its locking screw, can also be clearly seen. The winding wheels on the barrel bridge have been referred to previously.

At the foot of Fig. 3 is shown the balance, bottom side upwards. The hairspring is removed in order that the features of the

balance may be more clearly defined. The actual diameter of the balance is 8.5 mm.

High-class watches usually employ a bi-metallic balance, that is, one which consists of two metals fused together. The rim is cut to allow the balance to expand or contract, as the case may be, to counteract the effect caused by change in temperature. The halves of the rim are free at one end and fixed at the other to the central arm, which is made of steel. The inner part of the rim is also of steel, and the outer, which is of brass twice the thickness of the inner, is fused on to the steel. Brass expands more than steel. The effects of an increase

in temperature is such that the brass in struggling to expand causes the rim to bend inwards, thus slightly reducing the size of the balance. A decrease in temperature has the reverse effect. A number of holes are drilled and tapped in the rim, and the compensation is varied by altering the positions of the screws.

Fixed to the lower half of the balance staff can be seen the roller and jewel pin. This pin is the small semicircular white spot clearly visible at the edge of the roller. This roller engages the fork of the pallets, and, according to the vibration of the balance, locks or unlocks the escape wheel.

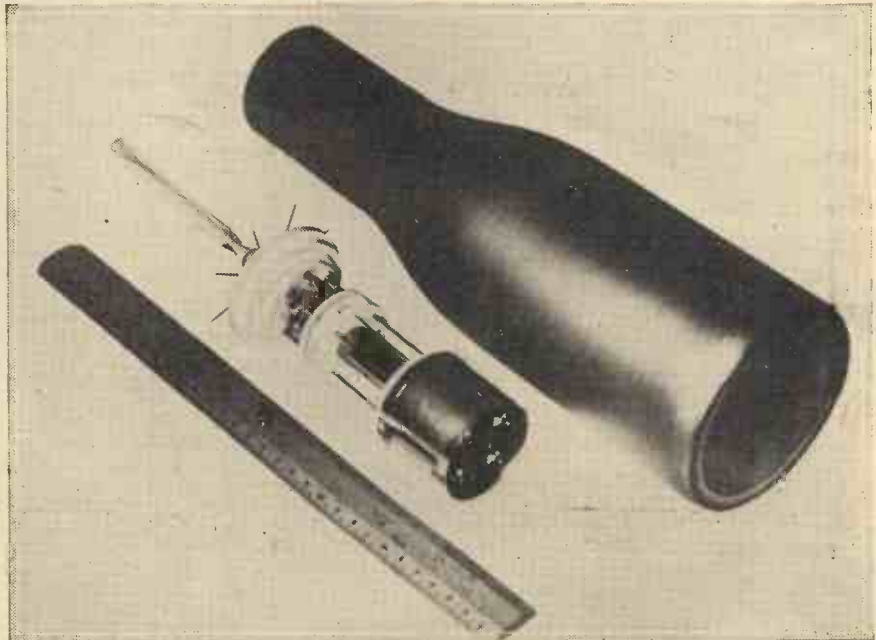

Fig. 8.—Showing the new "Safar" (Milan) cathode-ray tube for projection reception of television images. The diameter of the tube screen is only 8 cm. and produces an image measuring 27-30 cm. (roughly 11 in. by 14 in.).





The Great Pylon, Karnak.



Figures of gods, Karnak.

# EGYPT'S MIGHTY TEMPLES

IN previous articles we have shown that Egypt was long supreme in the realm of mechanical achievement. The Great Pyramids are immeasurably the largest buildings ever constructed, the mighty statues such as the Sphinx, and some other colossi have never been exceeded in ancient or modern times, and even the Aswan Dam was long the world's greatest, and in some respects is still the most remarkable achievement of its kind in the whole world.

In sacred architecture her supremacy is unquestioned, and her mighty temples draw tourists from all over the world. To name one of them only, the great Temple of Karnak is not only the largest in the world, but is big enough to contain every cathedral in England!

All this is the more remarkable because it is so exceedingly old. We are proud of our ancient Cathedrals, and rightly so, but when the first stones of the oldest of these were laid, the Temple of Karnak was *already* nearly three thousand years old! The temples of Greece are justly famous all over the world, both for their antiquity and their beauty; but when the *oldest* of these was first erected, the earliest Egyptian temples were *already* as old as the first Greek temple is to-day. This means of course that the Egyptians were the first great temple builders, and it is likely that they invented the pillar, as well as the pyramid; and gave the world the first writing.

## How Were they Erected?

Another astonishing thing about these temples, is the gigantic size of individual blocks of stone, and single pillars. Several of the statues with which they were adorned scaled about a thousand tons, and plenty were only a little below this figure. The pillars are so large that mere figures can scarcely convey their size. Thus in the great Hypostyle Hall of the Temple of Karnak, the roof was supported by 134 columns, the largest of which (with capital) was 80 feet high and 33 feet in circumference, so big that the base of it would fill a large living room and twice as high as an ordinary dwelling house. Almost every inch of stonework, whether pillar, wall or ceiling was polished and covered with bas-reliefs or inscriptions, and this was the usual plan with all the temples.

One of the first puzzles is how it was

## HOW THEY WERE BUILT

WRITTEN AND ILLUSTRATED BY GEORGE LONG, F.R.G.S.

possible, before the age of machinery, to raise these lofty pillars, walls and pylons. Fortunately for the historian, the builders have left some of their "scaffolding" behind at Karnak, and we can see for ourselves how it was done.

As the great wall was raised tier upon tier, a huge slope of bricks made from sundried mud, was raised, and up its sloping side the stones were dragged on runners. When the work was finished the mud bricks were removed, but wares prevented this job's completion and the huge mass of mud scaffolding still remains.

It is astonishing, too, that most of these stupendous structures were put together without mortar or cement. The huge pillars were constructed of separate drums from six to twelve feet in diameter, and usually 3½ feet high. Each drum was dove-tailed into the one below, and the stones were so accurately shaped and so carefully polished that—as an old Roman writer puts it—it was impossible to put a needle between the blocks. The walls were also made of accurately shaped, and beautifully polished blocks, which I fancy were merely held together by the weight of the structure, but the top row were all fixed to each other by clamps of bronze. At Karnak we can see the grooves cut in the stones for the clamps, which were stolen at least two thousand years ago by robbers. The wall is so soundly built, however, that even without the clips not a stone has left its place.

The temples were built centuries before the arch had been invented, so that all doorways are simple post and lintel affairs, built of huge blocks of stone. The roof was flat and made of huge slabs of stone also. It is very interesting in walking round these ancient temples to see the elaborate methods employed by the cunning old priests to impress and terrify the simple worshippers.

## The Interiors

Thus the interior of the temples was always very dark, the wall and pillars were covered with bas-reliefs of gods and goddesses. Hideous and terrifying figures lurked in every corner, and gazed down from walls and roof. There were gods or goddesses with heads of the elephant, the lion or the jackal, in fact all of them had human bodies with heads of an animal, bird, or reptile. Hathor had the head of a cow, Anubis that of a jackal, Sakhmet—most feared of all—that of a lioness, and there were frogs and birds and beetles as well.

## The Shrines

Some of the shrines were cunningly arranged to impress and terrify. Groping timidly through the dark interior of the vast temple at Karnak, the frightened worshipper would suddenly come upon a small dark shrine, containing a huge black marble statue of a god or goddess whose hideous head shone with an unearthly radiance, because of a cleverly contrived hole in the roof which admitted a shaft of sunlight.

This idea was very cleverly exploited. Sometimes the opening was so designed that the god was illuminated for only a short time each day, and in others perhaps for only a short time on a few days in the year. Certain temples were oriented eastwards or westwards so that the rising or setting sun would suddenly illuminate their dim recesses with blood-red rays, and fling grotesque shadows across the marble floor.

## The Hieroglyphs

Then also the mysterious hieroglyphs (the strange picture writing, which has only been deciphered in modern times) must have filled an illiterate visitor with awe and wonder. Even in modern times savages have been enormously impressed by a written message, and we may be certain that four or five thousand years ago, when it was a secret known only to the priests, the marvel was infinitely greater.

Some symbols are very common. That most frequently met with is the looped cross, which is known as the "Loop" or "Key of Life" and of course represents the Life Force. The Lotus bud and blossom shown side by side, bear the same signifi-





Original scaffolding at Karnak.



Top of the wall at Karnak showing slots for brass clamps.

cance, and are the most beautiful of the decorative subjects found in the temples. A massive pillar betokened stability, and a long rod with a knob at the end (i.e. a primitive club) symbolized power.

#### Dignity and Beauty

Even the least imaginative individual who visits these temples to-day is profoundly impressed, for even in ruin their dignity and beauty combine to produce an overwhelming effect.

We may well imagine that this influence was far greater when they were first erected, and the dread of the Gods of Egypt had much to do with the power and stability of that Empire of the Pharaohs, which dominated the world long before the Cæsars, and held dominion for a longer period than has any other world power.

Let us consider what must have been the

effect on some savage chieftain from the forests of Africa or the plains of Asia, who visited these temples four or five thousand years ago. The greatest building in his own land was a hut with walls of mud and a roof of thatch, not more than one story high. How amazing these soaring temples must have seemed to him! He approached the Temple through a stupendous avenue of Sphinxes and entered through a massive gateway hewn in a mighty pylon whose soaring summit overtopped the loftiest palm tree. He then passed through a courtyard into the hypostyle hall, whose large roof was upheld by a forest of huge pillars which were covered from base to capital with mysterious symbols and dread figures of deities; and entered the shrine of godhead. Here every device that skill could invent, or cunning could devise, was employed to overwhelm the visitor with

superstitious terror. The mighty bulk of the idol was wreathed in pitch darkness, but its hideous head was bathed in an unearthly radiance. And as he knelt there trembling, there came dreadful noises from the dim recesses of the temple, a roar as of some terrifying beast, the clash of cymbals or the boom of drums.

#### When the God Spoke

And then the god vouchsafed to speak, and in a terrible voice declared the doom, which must overcome the impious wretch who dared resist the might of Egypt, while joy and gladness were the portion of faithful worshippers. And in proof of this our chieftain would be conducted to the Shrines of Isis or Hathor, where throngs of gloriously beautiful temple maidens awaited him, and with dance and song invited him to their glamorous embraces.

#### Perpetual Motion ?

THERE can be no such thing as perpetual motion, because friction must eventually dissipate energy in the form of heat, but a very near approach to perpetual motion has been achieved by an electric bell which is on exhibition in the Oxford University Museum.

The bell was made in 1840, and it was removed to Oxford in 1860 when it had been ringing for twenty years. It has never been moved since, and it is still ringing!

Encased in glass, it consists of two copper cylinders and 5,000 paper discs coated with sulphur. These form a self-charging battery and, although nobody can tell for how long it will continue to ring, it is quite certain that sooner or later the battery will require replacement.

#### Waterloo Bridge

THE foundations of old Waterloo Bridge have now been removed and, far below the water-level in the river, the engineers are now engaged in "drawing" the piles on which the foundations rested, much in the same way as a dentist draws teeth.

According to the old records, each pier rests on 320 piles of oak, beech, and elm driven into the bed of the river. The piles are about 20 ft. long and more than 12 in. in diameter, and it is due to the rotting of the timber that the bridge has had to be pulled down.

Drawing of the old piles is accomplished by building a coffer-dam around the base of the piers, and when the water has been

#### ITEMS OF INTEREST

pumped out, the workmen attach chains to the tops of the piers, which are then drawn out by a powerful crane.

#### Metal Shears for Cutting the Narrowest Curves

TIN shears operated by a flexible shaft, and capable of cutting curves down to  $\frac{3}{8}$ -in. radius, even if the sheets are of a fair thickness, will shortly be obtainable. The design of the tool renders it very handy, and in no case is the view of the cutting line obscured. By a simple hand manipulation the cutters may be changed for other tools for grinding, drilling, and polishing.

#### Automatic Stamp Machines

THE machines which have been installed by the Post Office during the last few years for serving postage stamps after office hours have now become familiar to all. We thought that these machines were a new invention, but it will be found that such machines were actually in use fifty years ago.

#### Location of Buried Pipes

STREET records are sometimes mislaid or not kept up to date, with the result that it is sometimes necessary to dig up large areas of roadways in order to find a missing pipe. Detection of missing pipes

by means of compass needles have been in practice for many years, but a greatly improved instrument has now been produced which can detect pipes buried to a depth of 10 ft. and at horizontal distances of up to 100 ft.

The detector consists of a special survey compass with adjustable magnets which eliminate the earth's magnetic field, thus making it more susceptible to magnetic disturbances caused by a pipe. Special means are used to concentrate the magnetic flux at the needle, and the accuracy of the instrument is such that pipes can be located to within one diameter of the pipe itself. Even non-magnetic pipes can be detected provided it is possible to send a current through the pipe to produce the required magnetic field.

#### Rapid Heat Treatment

A NEW method of heat treatment has been developed for the hardening of steel parts such as the crankshafts of motor cars. Hitherto the parts have been hardened for the prevention of wear by the nitriding process, which occupies an average time of forty hours.

The new method involves the heating of the parts in a high-frequency electric furnace and the heating period takes only seven seconds. The coils of the furnace are hollow, and as soon as the steel parts are at the right temperature they are rapidly quenched by jets of water squirted through holes in the coils. The whole process takes only 45 seconds.





*Sir Joseph Whitworth.*

# MASTERS OF MECHANICS

## No. 12.—Sir Joseph Whitworth, the Apostle of Engineering Accuracy

**P**ROBABLY many a passer-by along one of the dingy side streets of Manchester, in the year 1833, looked up casually and read the newly-painted wooden sign which had recently been hung over the shop-door of a small premises then occupied by a young and enterprising mechanic, but not one of those now long dead and forgotten Mancunians ever for an instant imagined that the youthful tool-maker who had just then set up a small business in their city would ever fashion for himself not only riches but, also, a degree of fame, destined to become as undying as the world's engineering activities themselves.

Unfortunately, we have no records of the earliest details of Whitworth's life and the story of his career is particularly detail-less when it comes to his setting up his first tool-making business in a small shop-premises near the centre of Manchester. All we know concerning these early days of Whitworth is that his first Manchester venture was extraordinarily successful and that, after he had been established in his shop for a year, he moved to larger premises alongside the Rochdale Canal, near to Manchester's Piccadilly. Shortly afterwards he leased a suite of offices and, within the space of a few years, his tool-making works underwent still further expansion and gradually overflowed, as it were, into the surrounding property.

### A Man of Vision

Whitworth, from his first setting up in business, knew what it is to meet with success. Hardly an inventor, hardly an industrialist ever existed whose life-history shows a record of more continuous success than does that of Joseph Whitworth, "Tool-maker from London." Included among the elements of Whitworth's success was certainly the propitious time in which he lived, but, of more significance than that, perhaps, was the fact that Whitworth was not an ordinary trained mechanic content with the making of a good living and the building up of a successful business. He was, on the contrary, a man with a vision, an individual whose ideals rose far above the engineering customs of his day and, withal, a skilled mechanic whose penetrating insight into matters engineering enabled him to realize the many constitutional defects of mechanical practice and, ultimately, to eliminate them.

They call Sir Joseph Whitworth—he received his baronetcy in later life—the "Apostle of Engineering Accuracy" and

a truer title than this would be impossible of creation. Before the rise of Whitworth, engineering standards were practically non-existent. As regards the dimensions of small and interchangeable parts, such as nuts and bolts, various screw threads and so on, the entire engineering industry was in a hopeless state of confusion. Master mechanics and toolmakers were all at sixes and sevens with themselves. Each engineering works possessed its own system of screw threads, each individual toolmaker, in fact, worked to standards of his own making.

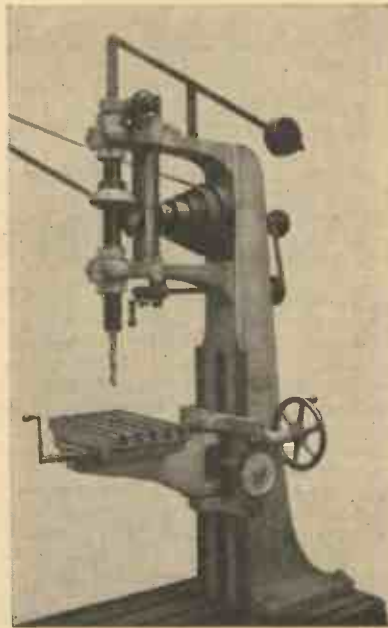

*A fine machine drill designed by Whitworth during his early days.*

### A Formidable Obstacle

The total lack of any system of standardisation of mechanical parts and components proved a great obstacle to the early engine makers. George Stephenson, for instance, and, before him, James Watt and other engine-builders, lamented the fact that, when undertaking the repair of their engines, they were not able to get nuts and bolts to fit the replacement parts. Thus, in those days, if you wished to effect a repair to a piece of machinery, you were faced with the task of making your own nuts and bolts and of forming your own screw threads. Engineering standardisation had not arisen, nor, indeed, had any great attempt at the accurate making of machine parts.

Joseph Whitworth, the individual who introduced a new era into engineering

practice, was born at Stockport, near Manchester, on December 21st, 1803. At the age of 14, he entered his uncle's cotton mill at Leeds with a view to learning the business and of becoming a partner in the concern. Within a year or two, however, Whitworth left the business, finding that he had no taste for it, and he managed to procure a number of temporary jobs at various engineering foundries in and around Manchester. Later, he left for London and, after obtaining a position in Maudslay's foundry at Lambeth, he served a form of assistantship with Messrs. Holtzapffel and Clements, who were famous London tool-makers.

It was after his period with Holtzapffel and Clements that Whitworth set up for himself in Manchester. Business in the engineering world of that day was good. Machine parts were becoming more and more in demand. The country, as one writer put it, was growing "machinery mad."

### Introducing Surface Plates

Whitworth's passion for accuracy in engineering measurements was formed during the early days of his mechanical training. He grew to hate the rule of thumb methods which so greatly prevailed in the machine shops of the period. His business, young Whitworth vowed, should not be dominated by rule of thumb devices and practices. The tools and machine parts which he turned out should be constructed, as far as possible, to accurate dimensions and he would endeavour to devise satisfactory methods of working to such degrees of accuracy.

The first invention of Whitworth was his method of making true planes or "Surface Plates." These are metal surfaces which are perfectly flat. Previously, such planes had been made by rubbing two approximately flat surfaces together with abrasive material between them. Whitworth showed, however, that such a method of making true planes could never succeed satisfactorily and that usually it merely rendered the surfaces more inaccurate than they were in the rough. He showed that the better way of preparing these plates was by mechanically scraping away the "high spots" from the surfaces. By this means he was able to make surface plates of such a degree of flatness that if two were gently squeezed together so as to exclude the air between their surfaces, they remained in firm contact in virtue of the external atmospheric pressure and it was often very difficult to separate them.

Whitworth's name is undoubtedly most deeply associated in the mind of the modern mechanic and engineer with the system of standardised screw threads which he introduced. In a paper which he read before the Institute of Civil Engineers in 1841,



Whitworth outlined his proposed system of thread sizes and he made an appeal for a greater degree of standardisation and of accuracy throughout the engineering industry.

The time was ripe. Little opposition to the idea of standardised screw threads was encountered and, within a year or two, the standard thread sizes introduced by Whitworth were in daily use all over the country. The chief railways immediately adopted his standardized system of thread cutting and the Royal Dockyard engineering shops embraced the system with almost visible enthusiasm.

#### Measurements and Armaments

Previous to his introduction of standard threads, Whitworth had realized the necessity in some departments of engineering of having some means of measuring with great accuracy the distance between two plane surfaces. In consequence, he developed a new form of measuring machine, an instrument which was able to measure distances with a hitherto unheard-of accuracy. A machine measuring distances with an accuracy of one ten-thousandth part of an inch was turned out by Whitworth in 1833. These delicate measuring machines attracted a great deal of Whitworth's attention. Ultimately, he produced a machine which he claimed was capable of measuring a distance of a millionth of an inch. This masterpiece now reposes in the Science Museum at South Kensington, London. Its delicacy of measurement is, of course, beyond all practical requirements and it is consequently more of theoretical than of practical interest.

In the October of 1853, an event occurred which brought still greater fame to Whitworth and, incidentally, unbounded profits to his business. This was the outbreak of the Crimean War. Whitworth branched out as an armament manufacturer. At the request of Lord Hardinge, the Army's Commander-in-Chief, he began to build rifle-making machinery. The government of the day urged him to investigate the whole subject of rifle construction and, if possible, to devise a better and a more efficient type of rifle than that which then existed. As a result, the celebrated "Whitworth" rifle arose. It was officially tested against other makes of rifles and, for accuracy of aim, efficiency and general construction, it won hands down. Whitworth rifles and, later, cannons made in the Whitworth works, were shipped off overseas. The accuracy which Whitworth had introduced into engineering and machine construction methods had, it was found, uses in wartime as well as in the days of peace.

#### The Whitworth Scholarship

In 1868, Whitworth founded the scholarships which are named after him. He gave annually a sum of £3,000 for scholarships to be awarded for "intelligence and proficiency in the theory and practice of mechanics and its cognate sciences." In the following year, Whitworth received his baronetcy and it was not long before he retired from active participation in engineering practice.

Sir Joseph Whitworth died at the age of 83 on January 22nd, 1887, at Monte Carlo, where he had been residing in consequence of his indifferent health. The great proportion of his fortune he left to trustees. £100,000 was left by Whitworth for the permanent endowment of his scholarships. Nowadays, as is well known, the possession of a Whitworth Scholarship is taken as the mark of an able engineering and scientific mind, the letters *Wh. Sch.* being indicative

of practical as well as of theoretical ability.

Whitworth was undoubtedly a great character in the Victorian engineering world. The success which attended all his efforts did not spoil him. He gave freely and, during his lifetime, he was noted for his philanthropical activities.

To the end, Whitworth retained his love for accuracy. It is related, for instance, that, in a spare moment, it occurred to him that the action of an ordinary pair of scissors in which one blade was slightly bent over the opposing blade was mechanically incorrect. In an endeavour to prove



A micrometer screw-gauging machine made by Whitworth. It is one of the three instruments of this type which he constructed.

his contention, he made a pair of scissors, the blades of which had perfectly flat surfaces, were set perfectly parallel and slid over each other in true contact.

Whitworth's "ideal" scissors, beautifully made though they were, had one point of disadvantage. They would not cut! Thus, for once, at any rate, was it demonstrated that inaccuracy of construction gave more practically satisfactory results than the ideal accuracy of perfect mechanical creation.

#### The Spring Wheel

One of Whitworth's lesser-known pro-

ductions was the spring wheel which he invented. This he produced in several different forms. Spring wheels are those in which circular or band-shaped springs take the place of spokes and serve to absorb the shocks on the rim of the wheels. The introduction of the pneumatic tyre made spring wheels unnecessary for ordinary vehicles. Nevertheless there are mechanicians who assert that spring wheels still have their uses and that, very probably, this old invention of Whitworth's may see considerable development in the future. It is interesting, also, to note that, during

the latter days of the war, when rubber was extremely scarce and, indeed, unobtainable in Germany, many of the cycles left by the German armies during their final retreat were found to be equipped with spring wheels similar to those originally devised by

Sir Joseph Whitworth eighty years previously.

In habits, Whitworth was slow and painstaking. He seldom took anything for granted. New notions, novel ideas which occurred to him, facts, contentions, theories—all were submitted by him to careful examination before they were finally accepted. Such was the rule of the man's life. Such, in many respects, was the fundamental secret of his success. At the death of Whitworth, nearly fifty years ago, the many sciences associated with engineering and mechanics lost a devoted follower and a true lover of them.

## DRILLING FOR OIL

NEW records are continually being created in the depths to which oil wells are sunk—the greatest depth so far attained being some 13 miles. Such immense depths have brought about the development of a very specialised drilling technique. Deep wells are now sunk by means of a large rotary cutter driven by steam or oil engines.

Near to the surface, the diameter is often as much as 4 ft., and it continues at this diameter until the first hard stratum of rock is encountered. The drill is then withdrawn and the well lined with steel piping. Drilling and lining proceeds in stages, the diameter becoming smaller at each stage, until, at a depth of 7 or 8 miles, it is generally only about 4 or 6 in.

The drill shaft is hollow and is made in lengths of 20 ft. which are fitted together by coned and screwed joints. The shaft weighs about 60 tons per mile.

In order to remove the debris cut away by the drill, a mixture of mud, cement and water is pumped down the hollow shaft of the drill. This muddy paste not only acts as a lubricant and fills up the porous walls of the well, but it is of the greatest importance also when bringing the well into use. When the oil is reached, it is at a very high pressure, but on account of the mud compound it cannot escape. By diluting the mud with water, however, its weight is reduced and a point is reached when the oil commences to flow.

The tremendous depths of modern oil wells makes one wonder how the shafts are kept vertical during the drilling. The answer to this is that nobody knows, and

it has been stated that a fortune awaits the person who can devise some satisfactory method of ascertaining exactly how much the bore deviates from the true vertical.

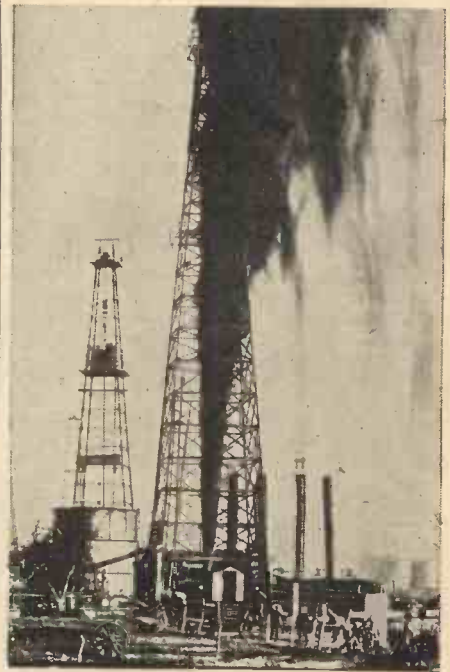

A "gusher" liberating black oil in a pressure stream which gushes into the air.



# Explosives Explained

What They Are—How They Are Made—And How They Are Utilised. A straightforward and Non-technical Article which places in a Nutshell the entire subject of Military and Peacetime Explosives, and the principles of their Utilisation

**G**UNPOWDER was the first explosive substance known to man. Almost certainly, the ancient Chinese were aware of it centuries before it was first introduced to the medieval world by Schwarz, a German monk, and by our own Roger Bacon about the year 1310.

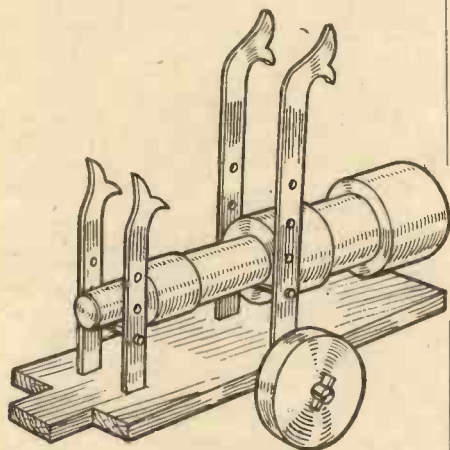

other type of sharp blow, it will explode with great violence.

The year after gun-cotton's discovery, an Italian chemist introduced nitro-glycerine to the world. This is made by treating glycerine with a mixture of nitric and sulphuric acids under controlled conditions. Nitro-glycerine is a heavy yellow oil. It is said that it is possible to plunge a lighted match into it without harm. Be that as it may, the fact remains that nitro-glycerine is a highly dangerous liquid to handle. If it is subjected to slight shocks it will explode with terrible violence, and on account of this fact its transport and use was for a time forbidden in many countries.

In 1863, Alfred Nobel, a Swede, found that a certain absorbent earth called *kieselguhr* would soak up many times its own weight of nitro-glycerine and that the resultant product, which was of a plastic consistency, could be handled with perfect safety. At the same time, the explosive properties of the nitro-glycerine were in no way diminished by this treatment. To this new material, Nobel gave the name "Dynamite." Incidentally, he made a vast fortune out of it.

## Cordite and T.N.T.

Nobel—an expert on explosives—made another invention of far-reaching importance. He found that by dissolving gun-cotton in nitro-glycerine and adding a little vaseline or some other mineral grease to the mixture, he could produce a fairly safe explosive which combined the powers of gun-cotton and nitro-glycerine, and which could be moulded into convenient shapes. Nobel produced his new composite explosive in the form of small rods or cords, and to it he applied the name "cordite."

Cordite is one of the most important explosives known. It is used in all rifle cartridges, high-power shells and in many other similar devices (Fig. 2).

Before leaving the subject of the composition of explosive materials, and dealing with the matter of how they are used in actual practice, we must at least glance at another important group of ex-

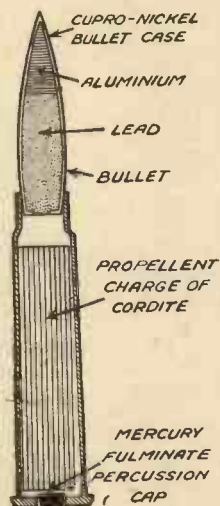

Fig. 2.—A section through an unfired modern rifle cartridge.

plosives—the "aromatic" group, so-called because they are produced from aromatic materials found in coal tar.

The first of these explosives and a highly important one, is picric acid, or *tri-nitro-*

*phenol*, which is made by treating purified carboic acid with a nitric-sulphuric acid mixture. All the nations use this yellow powder, known as picric acid, in their military explosives. The British call their picric acid explosive mixtures *lyddite*, the French term theirs *melinite*, and the Japanese apply the name *shimose* to their picric acid products. Fundamentally, however, all these explosives have the same basic constituent.

The other highly-important aromatic explosive is the now well-known T.N.T., otherwise *tri-nitro-toluene*, which achieved great military fame during the last war. Like picric acid, T.N.T. goes by a variety of names. *Trinol*, *tritol*, *tolite*, *trillit*, *trotyl* are only some of them. T.N.T. is a brown-

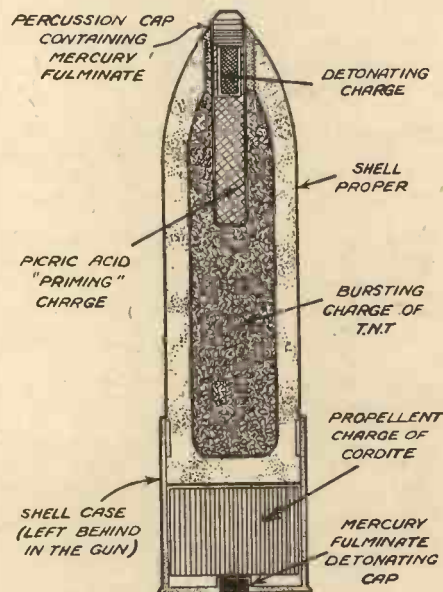

Fig. 3.—A section through a modern high-explosive shell.

yellow solid material which can be handled with perfect safety. It needs a great shock to explode it, but once subjected to such a force, it explodes with great violence and is, on this account, universally employed as the "bursting charge" of shells and aerial bombs.

## Modern Shells

The average shell contains explosives of a variety of types. Glance for a moment at the illustration, Fig. 3, depicting a section through a modern explosive shell. It will be noted that it contains a propellant charge and a bursting charge. The propellant charge is always composed of cordite or of some cordite mixture, the cordite being exploded by a small detonator-cap containing mercury fulminate placed at the base of the shell. By the explosion of the cordite, the shell proper is propelled through



the gun barrel and so on to its destination. When the shell strikes the ground, the percussion fuse placed at its top is actuated. This fuse also contains mercury fulminate, and the explosion of this material sets off a detonating charge which, in its turn, explodes a "priming charge" of picric acid mixture, and this finally explodes the large T.N.T. bursting charge of the shell.

It will thus be seen that the explosion of a shell is gradually built up from a series of small explosions, each greater in force than the succeeding one, the whole culminating in the mighty explosion of the T.N.T. charge.

An aerial bomb is constructed upon exactly the same principles as a shell which is fired from a gun, the only difference being that, since the bomb drops from the aircraft under the influence of gravity, it does not require a propelling charge to send it to its destination (Fig. 4).

### Rock Blasting

Dynamite is the explosive which has the most peacetime uses, mainly because it is clean in use, controllable in action and is handled without danger. Rock-blasting is almost always carried out by means of dynamite, the dynamite being made up in "cartridges" (Fig. 5) which are placed in a hole drilled in the rock (Fig. 6) and electrically exploded by means of a "detonating cartridge" containing a detonating charge of mercury fulminate. According to the number of dynamite cartridges placed in the rock the force of the blasting operation is increased or decreased.

Rifle bullets are simple explosive devices. All they consist of is the miniature "shell," or bullet, behind which is packed a definite quantity of cordite. The cordite is exploded by means of a small amount of mercury fulminate contained in the detonating cap of the cartridge, the sharp striking of this cap by the hammer of the rifle mechanism being amply sufficient to set the fulminate into full detonation.

### Properties of Mercury Fulminate

We have mentioned this mercury fulminate a great deal. It is, indeed, a highly important substance, a material upon which nearly all types of explosive agents depend. In many respects, mercury fulminate is one of the most violent explosives known. It is made by dissolving mercury or quicksilver in nitric acid and treating the mixture with alcohol. So violent and uncontrollable is the fulminate, however, that its manufacture, even under conditions of modern scientific control, is still a very hazardous process. The transport of the fulminate is absolutely forbidden in nearly every country, and only small quantities of it are made at a time so that any possible explosion of the material may be kept down to a minimum. Despite all these precautions, however, there have been very many mercury fulminate fatalities.

Mercury fulminate, a white glistening salt-like material, has the property of exploding whenever it is given a light sharp blow. Its resultant explosion is sufficiently violent to "start" the explosion of more powerful, but far more sluggish explosive bodies such as cordite, picric acid mixtures and dynamite.

### Nitrogen Chloride

There are known to science certain explosive materials even more violent and uncontrollable than mercury fulminate. So uncontrollable and treacherous, however, are they that they cannot be used for any practical purposes. Of these materials,

perhaps the substance known as *nitrogen chloride* is the best known. Nitrogen chloride is easily made from sal-ammoniac and, in outward appearances, it takes the form of a heavy pale-yellow oil. Let this oil be subjected to the slightest shake, the

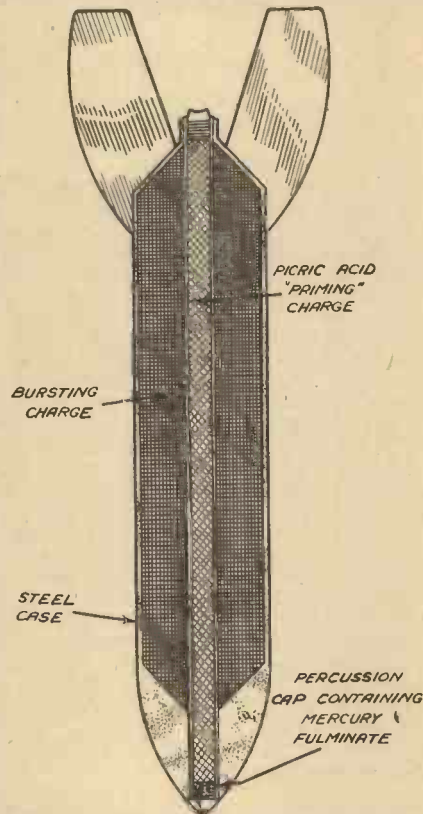
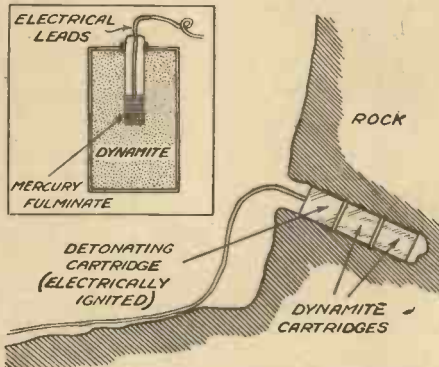

Fig. 4.—A section through an aerial bomb, showing method of construction.

impact of a few grains of dirt falling upon its surface or even to a slight sudden rise in temperature and it will explode with the most fearful violence. Nitrogen chloride has even been known to explode spontaneously, with any outward causation at all. No wonder, therefore, that such a deadly



Figs. 5 and 6.—(Inset). A section through a dynamite detonating cartridge, showing mercury fulminate detonator. (Right) showing method of using dynamite for rock blasting.

material can find no useful application.

Nitrogen iodide—made from ammonia and iodine—is another uncontrollable explosive, less violent, perhaps, than its close relative, nitrogen chloride, but nevertheless sufficiently dangerous to render it useless for utilitarian purposes. Another similar group of highly-dangerous and uncontrollably explosive materials are the "diazon-

ium compounds," made from benzene and its related liquids.

### Causes of Explosive Properties

What causes a material to exhibit explosive properties and what happens when such materials explode? Such questions are frequently asked, but they are answerable but incompletely, for we do not know the precise inner mechanism of explosive action.

All explosives contain the element nitrogen, which, as we are all aware, is the most abundant constituent gas of the earth's atmosphere. Formal chemistry books tell us that nitrogen is an inert element. Rather, however, we should look upon it as an active, albeit an unsociable element. When in combination with other atoms, nitrogen frequently exhibits a tendency to part company from its companions, and when there are many like-minded nitrogen atoms in a chemical compound, the tendency for the nitrogen atoms to fly apart becomes so strong that they scatter themselves and break up the formation of the other atoms under the slightest provocation.

In mercury fulminate, this slight provocation comes from the mechanical shock of the hammer of the gun. In picric acid explosives, gun-cotton, cordite, dynamite, T.N.T. and other explosives, this necessary shock is usually provided by the local explosion of the mercury fulminate detonator. The nitrogen atoms in the explosive suddenly break company with the other component atoms. This dis-union of atoms takes place so suddenly and the atoms fly apart from each other with such an enormous amount of force, that what we call an explosion occurs. The velocity and force of the scattering atoms is so enormous, that the resistance of objects in the vicinity of this chemical disruption are broken down, usually with the complete destruction of such objects.

It is very probable that the science of explosives is still in its infancy. By a series of step-by-step explosions, it may ultimately become possible to devise mass explosions of such enormous magnitude that whole areas of land may be completely disrupted by the force of a single giant explosion. We can, however, only make use of explosive materials which are controllable in their action. That is why, perhaps, more powerful and more potent explosive agents have not as yet been forthcoming.

## Science Notes

### A New Atlantic Record

THE German airship Hindenburg recently flew across the North Atlantic from Lakehurst, New Jersey, to Frankfurt in 45 hours 39 minutes, thus making a new record. The previous record was 49 hours 3 minutes.

### A "Robot" Controlled Air-Liner

THE Australian National Airways are adding to their fleet a new Douglas air-liner with "robot" pilot controls.

### A Record Train Run

THE Flying Scotsman recently completed the run from London to Aberdeen in 10 hours 27 minutes, the fastest time on record.

### Training at 300 m.p.h.

THE world's first 300-m.p.h. military training aeroplane will be built in Britain this year.





Fig. 11.—The model commencing to climb.

# PETROL-DRIVEN LOW-WING MONOPLANE

The Third Article on the  
Monocoque Fuselage Model

By C. E. Bowden



Fig. 12.—The model well away.

### Covering with Balsa Sheet

THE next phase of the fuselage construction is the covering of the whole affair with a skin of  $\frac{1}{8}$  in. thick balsa wood. Light-weight balsa sheet  $\frac{1}{8}$  in. thick should be obtained, about 6 in. wide  $\times$  2 ft. or 3 ft. long. White balsa wood is best here.

The whole fuselage is covered with this sheet balsa wood, and has to be done in sections. Where there are any double curves or difficult bends, a smallish sheet should be cut and soaked for about 3 minutes in boiling water. The stringers are then smeared with glue and the sheet of balsa is placed on top of the stringers. Model aeroplane elastic is then wound around the fuselage tightly. This is left on until the glue is set.

Having commenced by covering a portion at the nose end, the constructor should leave it to set and cover a tail end portion. By the time this is done the original portion is set and the elastic can be removed. It will be found that areas of about 6 in.  $\times$  9 in. or perhaps longer can be covered at a time. Finally, it may be found that there are a few small spaces that have not been covered. By careful shaping of small pieces of balsa sheet, these can be covered.

When the whole fuselage has been covered and all the elastic removed, any poor joints in the covering should be filled up with touches of plastic wood. For instance, where wire hooks and tubes protrude through the balsa covering, it is excellent practice to fill the area around with a little plastic wood. This will add strength to these fittings.

The whole fuselage should now be carefully rubbed down with sandpaper until all joints have disappeared.

### Final Covering of Silk

Now comes a very important phase of the fuselage construction and one that makes the whole a very strong affair indeed. The whole is covered with silk and doped.

There is a simple and effective technique here that is worth knowing.

First of all, a section of thin Jap silk is cut, measuring 6 in.  $\times$  18 in. This piece of silk is placed on the fuselage, and down the centre photopaste is liberally smeared and worked through the silk by the fingers. From this central smear, further smears in lateral and radial directions are worked into the silk, whilst the silk is smoothed out taut.

In this way by a very liberal use of photopaste, the silk is put on without any

wrinkles and a coating of photopaste is mixed in with the silk. This coating of paste fills in the top pores of the absorbent balsa sheet covering without sinking deeply in. Thus, when the doping takes place, the balsa does not unduly absorb the dope and get heavy as a result.

Having covered the whole of the fuselage with silk and a liberal dose of photopaste, allow it to dry, and as soon as it is nearly dry, dope the fuselage with full strength clear celloan aeroplane dope. Do not, in any circumstances, use model strength dope. It is this liberal coat of full strength dope that sets a firm hard skin and makes the monocoque fuselage extraordinarily tough and strong. The combination of oval form stringers, balsa skin, silk covering and dope produce an exceptionally strong and light fuselage of pleasing shape. The reader will appreciate that practically the entire fuselage, except for a few special formers of 3-ply, is constructed of balsa wood, but owing to the method of construction the fuselage is far stronger than the normal rectangular fuselage constructed out of birch, three-ply formers, and spruce. The fuselage is then given two coats of coloured dope to suit the owner. My

model is all white except for the lining and lettering, which is in red.

### The Undercarriage

This component should now be tackled, because the constructor will doubtless want to fit his engine and then run it up and get the hang of it, and also run it in if it is a new engine, whilst he is constructing the wings, etc.

The undercarriage is constructed with two main legs, behind these legs there are two circular springs which allow the legs to go backwards first, and then upwards.

A moment's consideration will make it clear to the reader that a petrol model does not land with its nose up and tail down, as in the case of a full-sized aeroplane where the pilot holds off his machine until he gently stalls it on to the ground in a 3-point landing. In this case the undercarriage legs have to take an upward shock only. The petrol model glides into the ground, and the success of the landing depends upon a nice flat gliding angle of the model. I shall deal with this point later. As the undercarriage has to take up a backward blow at the wheels, the

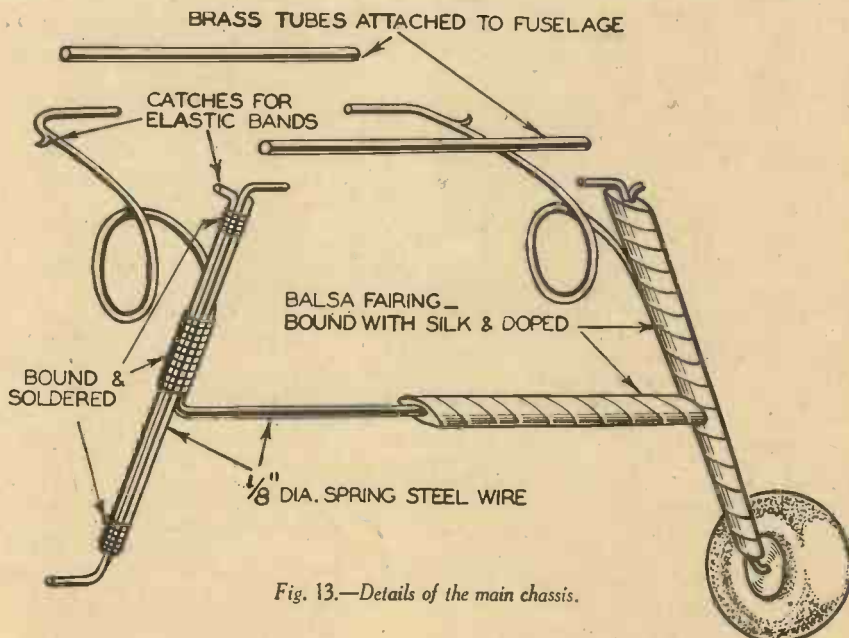
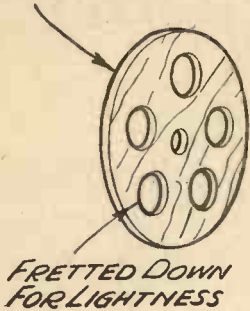

Fig. 13.—Details of the main chassis.



1/8" THICK 3 PLY DISC  
4 1/2" DIA



WOODEN DISTANCE  
PIECES

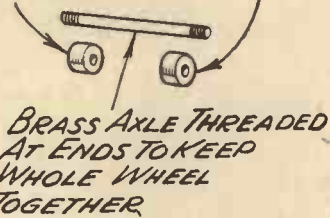

FINISHED WHEEL WITH  
BALSA DISCS GLUED ON  
OUTSIDE AND STREAM-  
LINED WITH SANDPAPER

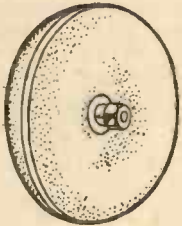

Fig. 14.—Method of making wheels.

springs that take the backward and their upward shock of landing. The front ends of these springs are bound to the reinforced legs and soldered. The rear ends of the springs are turned inwards to form similar prongs but 1 in. long, as in the case of the front legs. These prongs are slightly longer to prevent them jumping out of their rear tube due to landing strains. Small 18 s.w.g. wire hooks are soldered on in front of the turned-in prongs. These are to keep the stout elastic bands in position. These bands, as in the case of the front legs, pass under the fuselage and keep the two circular springs hard up to their tube.

It will now be realised that the under-carriage is detachable for ease of transport.

These two rear circular legs or springs will require

two more springs exactly the same size. Thus we place one extra spring beside one of the springs already *in situ*, and we bind the two together with motor adhesive tape.

undercarriage, therefore, has to allow of an upward movement.

The undercarriage fitted to this model complies with these requirements, and if the constructor makes it correctly, he will never have any trouble with it.

Any undercarriage which is an attempt to copy full-sized design is doomed to failure on a petrol model. I have tried them and spent a great deal of time repairing them.

Moreover, the undercarriage fitted to this model will tend to save the fuselage and model generally from damage, for it has a large range of movement in the right direction, and provided the glide is reasonable, will bounce the nose up on landing, due to its forward position, and knock the tail down.

Some 10-gauge spring steel piano wire (or 1/4 in. outside diameter) is required to make the undercarriage.

The reader should study Fig. 13 which is a sketch of the undercarriage details.

It will be observed that the two legs have their bottom ends turned outwards to form stub axles for the wheels, whilst their top ends are formed inwards for 1/4 in. to form prongs to insert into the front duralumin tube that has already been fitted to the fuselage.

There is a cross bar of the same wire about one-third of the way down between the legs. The ends of this cross bar are turned up and bound with florists' wire and soldered. This cross bar splays the legs out to the correct distance. Down each leg there are two reinforcing lengths of the same spring steel piano wire. One of these has a small turn outwards at the top end for 1/4 in. This forms a catch for the retaining elastic bands that will keep the tops of the two legs hard into their tube.

These two reinforcing lengths of piano wire are carefully bound with florists' wire to each main stub axle leg. The whole is then well soldered.

Now we have to make the two circular



Fig. 15.—Rear view. Note the position of the clock, and also rear retaining elastic bands for the low wing.

The other spring is also reinforced in a similar manner. If this is not done it will be found that the undercarriage will have too much "give" for the job in hand.

After taping the circular springs together, they should be varnished and allowed to dry.

Now comes the final stage of the undercarriage construction.

Each main leg and the cross bar has to be faired with balsa wood.

This fairing is constructed from 1/4 in. thick balsa sheet. Each leg has a length of balsa placed in front of it and behind it and strips of balsa on each side making a sandwich. The wood is liberally smeared with quick-drying aero glue and rapidly bound round with model aeroplane elastic until the glue sets. The elastic is then removed, and the balsa fairing is carefully trimmed up with an old safety razor blade and finally sandpapered to a streamline shape.

Finally the legs are bound carefully with strips of silk about 1/4 in. wide, photopaste

being liberally used whilst binding. When dry, the legs and cross bar are doped with full strength aeroplane clear dope and allowed to dry hard.

It will be appreciated that no curious tools are required to make this undercarriage other than a vice, and a stout pair of pliers and a great deal of determination in the bending of that very thick piano wire!

The wheels shown on the model are some original wheels made by Dunlops for my first record holder "Kanga." They weigh 4 oz. each and are 4 1/2 in. in diameter.

I recommend constructors, however, to make their own wheels up from three-ply balsa wood. These are the type I use on several of my models, or alternatively, the wheels I described in PRACTICAL MECHANICS some time ago made up from 4 1/2 in. diameter sponge rubber balls specially made for me by the Dunlop Rubber Company, can be made up.

If cheapness and simplicity is the main consideration I suggest that the reader should cut out two discs of 1/8 in. thick three-ply, 4 1/2 in. diameter. These should have brass axles of the correct size to fit on to the wire stub axles of the undercarriage. The brass axles should be 1 1/2 in. long, and on each side of the three-ply discs, small circular reinforcing pieces should be threaded over the brass axle. These pieces of wood should be 1 in. diameter. The brass axles are threaded at each end and have a nut at each end to keep the whole affair together. Now two balsa circles of 1/4 in. thick balsa should be glued to each side of each wheel. These circles can then be sandpapered so that the wheels are stream-lined like the latest aero wheels fitted to full-sized machines.

The wheels are then doped to fill up the pores of the balsa, allowed to dry, and then painted to waterproof them. A pair I made in this way have been most satisfactory on another 8 ft. span high wing model I have, and they look well. On no account make the wheels of lesser diameter than 4 1/2 in. if you want your model to take off normal grass. And do not make them larger or you will make your model unstable due to placing too much side area low down below the centre of gravity. The wheels I have just described should weigh from 3 1/2 to 4 oz. each.

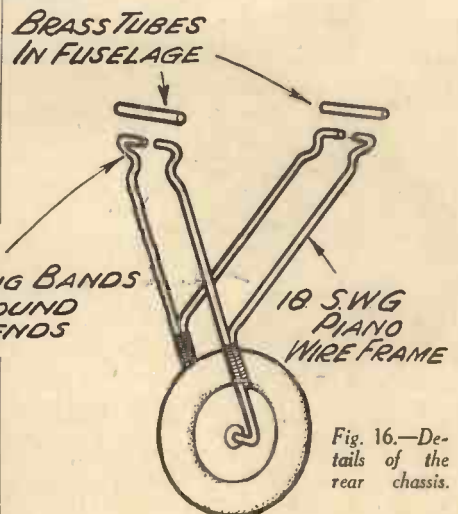

Fig. 16.—Details of the rear chassis.



# Making A Model Dirigible

By V. E. JOHNSON

*How a Simple Lighter-than-air Vessel May be Built up, and Driven through the Air by Means of an Electric Motor*

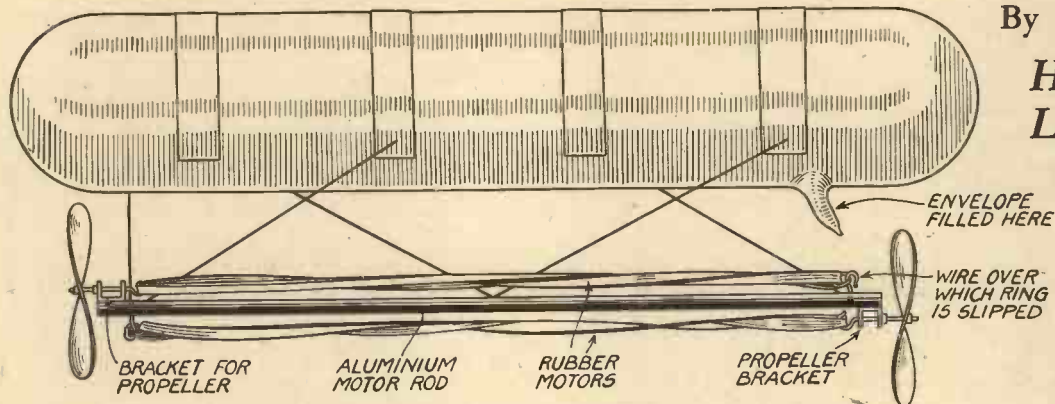

Fig. 1—The complete dirigible showing the method of mounting the motor.

ONLY one shape is worth consideration—the Zeppelin—a long cylindrical body with semispherical ends.

This would consist of one of those long and straight types of thin rubber balloons such as can be purchased at certain toy shops—the largest obtainable. If one of these were filled with hydrogen, lifting capacity of which is twice that of coal gas, it would, of course, have to be filled from hydrogen compressed in a cylinder obtainable from a chemist. Then if the nacelle, i.e. the rod carrying the motor were made from drinking straws which vary slightly in size—being stuck together with lightly gummed cigarette paper, and the propeller made of very thin steel wire covered with goldbeater's skin, and but little rubber used, the nacelle and rubber motor being the full length of the balloon, then—although I have not actually tried it—I feel pretty sure that such a model would fly, i.e. that the supporting hydrogen would carry the necessary weight of the balloon which would have to be well inflated. The nacelle would be supported by guy threads as described later (see Fig. 1).

We know that 1,000 cu. ft. of hydrogen lifts 70 lbs., and we can easily calculate the buoyancy of any model from the following formula:

Vol. of cylinder = height × area of base  
 $= h \times \frac{22}{7} r^2$ , where  $h$  = height and  $r$  = radius of circular base.

Vol. of sphere =  $\frac{4}{3} \pi r^3$  where  $r$  = radius of sphere.

Lateral surface of a cylinder (excluding ends) = height × circumference of base =  $\frac{22}{7} r.h.$

Surface of a sphere =  $4 \frac{22}{7} r^2$ .

From this, knowing the weight of the rubber balloon, nacelle and rubber motor, we can work out any individual case.

### A Real Working Model

For this purpose the model should not be less than 12 ft. long and 2 ft. in diameter. It is constructed of gold beater's skin, a very thin tough membrane prepared from the large intestine of an ox. It cannot be obtained in larger pieces than 24 in. ×

14 in. It weighs only 0.11 oz. per sq. ft. The buoyancy of such a model is 34.24 oz. The entire surface area is approximately 76 sq. ft.

Allowing 10 per cent. for overlapping for joints, the weight of our envelope works out at  $76 \times .11 \text{ oz.} \times 8.36$ . The buoyancy of such a model is therefore  $34.24 \times 8.36 = 28.88 \text{ oz.}$  A very large amount of netting, more than ample for interior supports (if needed), motor, propellers, etc. Unfortunately there is a drawback to this model, as such an envelope will retain the gas for only a short time. If, however, the skins be coated on both sides with elastic varnish, its gas holding properties will be much increased.

If you wish to make a thoroughly efficient job, you must employ a triple skin coated as above. Such envelopes can be built to

weigh slightly less than .328 oz. per sq. ft. (The figures are taken from an actual model.) Now this would make the weight of our model  $76 \times .328 = 25 \text{ oz.}$  approximately, leaving a buoyancy of about 9½ oz., quite enough, since our nacelle need weigh only 4 oz.; propellers ½ oz.; rubber 4 oz.; sundries ½ oz. If you were content to use a single skin and inflate your model with coal gas, you would have a lifting capacity of 17.12 — 8.36, which equals only 8.76 oz. But if you were only prepared to increase your 12 ft. × 2 ft. by one-half, you would have a buoyancy of 3½ lbs. or, with a little more than double the material you have increased your lifting capacity from half a pound to three pounds and a quarter. Hence the reason why the modern dirigibles are of such immense size. Therefore, the actual size rests with the constructor.

Constructional Details—The Cylindrical Portion

The construction of the cylindrical part of the envelope is easy enough. The piece of goldbeater's skin must be placed in a vessel containing some soft or rainwater

(preferably filtered) a day or two before use. In the water should be dissolved some fish glue in order to add to the adhesive properties of the skins. Smooth oiled board must be used to prevent sticking and some means must be provided to keep the skins taut whilst drying; any irregular sides or ends must be trimmed down with a blunt pair of scissors.

The only satisfactory way to build up the cylindrical portion is to construct a light cylindrical framework and cover it with oiled cardboard the size of the proposed model.

### The Semi-spheroidal Ends

Suppose the diameter of these is 2 ft. First find the circumference  $2\pi r$  or  $2 \frac{22}{7}$ . 1 ft. = 6.29 ft. Divide this by 4 quotient 1.57 ft.

Now in Fig. 2 B A represents this scale. Divide the circumference by 24, i.e. double the number of gores, the quotient is 3.14 in., this is the length of A C or A D. Next divide A B into 18 equal parts and draw lines parallel to C D through the points of division. Find the actual length of the required lines by multiplying 3.14 in. by the decimal given in the respective lines in Fig. 2. This gives the right-hand side of the gore, the left hand side being the same. C B D in Fig. 2 represents a complete gore for the required ends. The pattern gore should be made of cardboard, or better still of tin. When cutting out the actual skin gores about half an inch should be left for overlapping. Some difficulty will be met with in joining up the second semi-spheroidal end on to the cylindrical body because the envelope must be withdrawn before this is done.

Slide the envelope off the framework, and cut a slit large enough to admit the hand—near the end not yet enclosed; this should afterwards have fitted round it a funnel-shaped projection or bag which can be left open to be used for inflating the envelope.

Having completed the envelope and allowed it to dry, it should be inflated with air by means of a foot pump and every leak carefully attended to—it should then be given two coats of elastic varnish—keeping it fully inflated all the time.

### Filling the Airship

The question of filling the envelope with

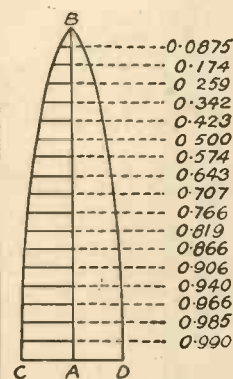

Fig. 2—Details of the semi-spheroidal ends.



# BALSA MODEL AEROPLANES



Real Flyers

We are offering the finest American Kits of parts ever put on the market for the Model Aeroplane builder. All Kits are complete, including all Balsa wood, Japanese tissue, wheels, pins, wire, elastic and full-size Drawing with instructions.

### PRICES

Kits for 16-in. wing span flying model of the Fokker D1, Nieuport XVII-CI, Fairchild 22, Curtiss Falcon, Curtiss Goshawk, Fokker Triplane, Waco Model C, Howard "Ike."

Price per Kit, **1/3**. Postage 3d.

Kits for 26-in. wing span flying model of the Fokker D8, Nieuport XVII-CI, Rearwin Speedster, Fairchild 22, Monocoupe 90A, Ryan Low Wing, Stearman, Curtiss Hawk.

Price per Kit, **2/6**. Postage 4d.

Super Kits for building up 24-in. wing span models which can be fully controlled from the cockpit; everything wanted is included in these Kits to make a Stinson Reliant, Curtiss Swift, Albatross D-5A, Spad, Hell Diver, Douglas O-38.

Price per Kit, **7/6**. Postage 6d.

Send for Bond's General Catalogue, price 6d. post free; this contains everything wanted for the Model Aeroplane maker, Model Railway builder from Gauge "00"—3-in. Scale, or the Model Ship builder; also all Tools and Materials required.

## BOND'S O'EUSTON ROAD LTD.

254 EUSTON ROAD, LONDON, N.W.1  
 'Phone: MUSEUM 7137. ESTABLISHED 1887.

# THE BETTER VALUE KITS!

SEND P.O. for one of these fine 12-in. span FLYING SCALE MODELS!

## 1/6 LINDBERG KITS ARE UNBEATABLE!

Illustrated is the famous War-time Model S.E.5. (Photo is of actual model.) Other models are:—Fokker Triplane; Boeing P.26.A; U.S. Navy Racer; Curtiss 'Goshawk'; Monocoupe 90; Fairchild '24'; Sopwith 'Camel'; Hawker 'Super-Fury'; Chester Racer; Boeing F4.B.4; Vought 'Corsair'; Curtiss 'Hawk' P.6E; Lockheed 'Vega'; 'Macchi-Castoldi.' Only 1/6 each or 3 for 4/-. Carriage Paid.

Kits contain full-sized plan, instructions, printed balsa wood, insignias, cement, tissue, propeller, rubber, etc., etc. Simple to build and fine flyers!



New Illustrated Price List of all types of Flying Models, 24d. post free.

Northern Model Aircraft Co. 37a FOUNTAIN ST., MANCHESTER

## BRITISH RECORDS held by models built with OUR MATERIALS

FUSELAGE MACHINES		
Rising off Ground .. .. .	9 mins. 50 secs.	
Rising off Water .. .. .	1 min. 46 secs.	
Hand Launched .. .. .	23 mins. 10 secs.	

Our petrol engine model, "COMET," during 1935 entered 3 Competitions, won these awards:

- First Prize: B.M.A.S. Power Competition.
- First Prize: "Hallum" Power Competition.
- Second Prize: S.M.A.E. Sir John Shelley Competition.

You can build this model, or the "Sky Rocket" which made the flight of 1935 (Cranborne to Isle of Wight; 35 miles!), from drawings or kits obtained from us.

The "COMET" 18-c.c. 2-stroke petrol engine is the finest on the market, its only fault being that it runs so well that a time switch is necessary if you don't want to lose your model!

Send 2d. stamp for lists, and become a satisfied customer of

**MODEL AIRCRAFT STORES**  
 133 Richmond Park Road, BOURNEMOUTH

# WIZARD POWER TOOLS

for the Cabinet Maker, Carpenter, Model Maker, etc.

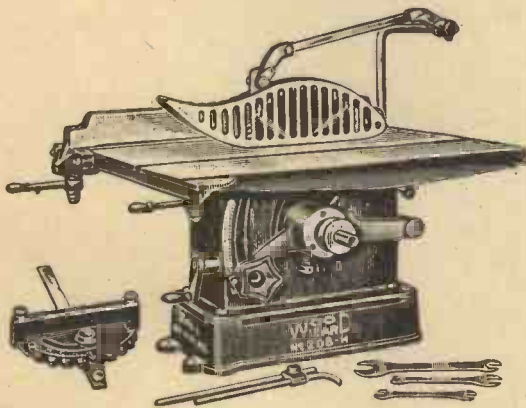

Illustration shows our Universal 8" Saw Table £14 5s.; other sizes—7" £9 10s.; 6" £3 3s.

Write for illustrated priced catalogue No. 136C. of Jig Saws, Circular Saws, Band Saws, Lathes, Jointers, Shapers, Drill Presses, Grinders, Buffers, Sanders, Tools, and Accessories.

## WIZARD MACHINERY Co.

13 VICTORIA ST., LONDON, S.W.1  
 Telephone: ABBEY 3018

# MSS VALUE KITS MSS

WE HAVE THE 'PICK' OF THE AMERICAN MARKETS

Kits and Supplies for all—Beginner or Expert Scale. Endurance and Petrol Fans. Of course all our Kits are complete, whether 2/- or 42/- they contain everything required—and everything means EVERYTHING. And they ALL fly.

- IMP KITS, 2/- 15-in. span, 5 models; 4/- 22-in. span, 6 models.
- SCIENTIFIC HI FLYERS - - - from 3/3 (20 in.) to 42/-
- BUNCH ENDURANCE - - - from 3/6 to 14/-
- IMP TORNADO MOTOR - - - 27/6 and 42/-
- BUNCH NEW "GWYN-AERO" PETROL MOTOR, 6 c.c. Complete, £4.

IMP "PAULOWNIA" Props and all Supplies at lowest prices. New Gas Model Accessories.

Send 2d. for 18-page Catalogue. Full of illustrations and useful hints.

**MODEL SUPPLY STORES**  
 (Dept. P.M.), 46 Derby Road  
 Prestwich, near Manchester



## MICROSCOPES FOR ALL

### SPECIAL OFFER OF 4 MODELS

Each instrument has inclinable body, swing mirror, stage clips, and is nicely finished in Black Crystalline Enamel and bright Nickel Plating.

SHARP DEFINITION IS OBTAINABLE AND GOOD WORK CAN BE DONE

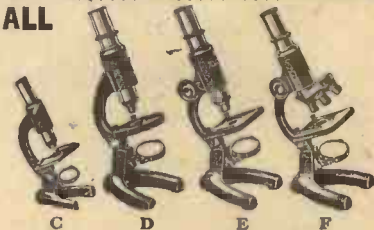

- Model C. Height 5 1/2 in., sliding focus, magnification 25x linear Price 5/-
- Model D. Height 7 in., sliding focus, circular stage magnification 50x linear... Price 9/6
- Model E. Height 7 in., rack and pinion focusing, magnification 60x linear, square stage ... Price 12/6
- Model F. Height 7 in., rack and pinion focusing, triple nose-piece, 3 lenses, magnifications 25x, 50x, 100x, in wood case, with set of Dissecting Instruments. ... Price 30/-

IMMEDIATE DELIVERY FROM STOCK.

**BROADHURST, CLARKSON & CO.**

Post Free in Great Britain.  
 83 FARRINGTON ROAD, LONDON, E.O.1



# MODEL AERO TOPICS

by F. J. CAMM



A replica of Mr. F. J. Camm's petrol-driven model aeroplane recently described in this journal. The model shown was made by Mr. S. J. Crouch.

## The Wakefield Cup Returns to England

It is with pleasure that I report that the British Wakefield Team was successful in beating the Americans on their own ground and recapturing the Wakefield Gold Challenge Cup. The winning machine was that made and flown by A. A. Judge, of England, with a fine flight of 4 min. 9.9 sec. The runner up was P. Copland (England) and J. B. Allman (England). The result of this competition shows that soundly constructed English models are every bit as good as the flimsy balsa models which are flown in America. The competition provided an excellent comparison between the sturdy English construction and the American balsa system of construction. My congratulations to the S.M.A.E. and particularly to Mr. York, the Press Secretary of it, for the successful fruition to which they and he have brought this international contest.

The contest took place at Detroit, Michigan, on July 3rd. Members of the team were entertained to dinner on their return to England by Viscount Wakefield at The Monico on July 13th.

## Shelley Cup Result

HEREWITH is the result of the Lady Shelley Cup Seaplane Competition, held at Danson Park, Bexleyheath, Kent:

1st.—H. W. Bexley, Luton and District M.A.S., Average 63.5 secs.

2nd.—T. H. Ives, Blackheath M.F.C., Average 49.4 secs.

3rd.—R. F. Hook, Blackheath M.F.C., Average 47.75 secs.

## A 2½ c.c. Petrol Engine

RECENTLY referred in these notes to a Canadian 2½ c.c. petrol engine, and I

have now received details from the makers, who tell me that the Elf engine has been specially designed for model aeroplanes of small wing span and of a total weight not exceeding 1 lb., although they claim that it will fly a plane weighing 2½ lb. They

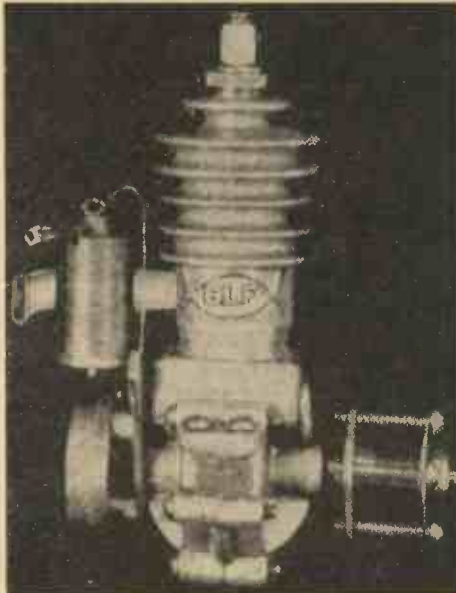

The 2½ c.c. "Elf"—full size.

state that they have a 3 ft. wing span model which has made 83 flights to date with no damage except an occasional split in the leading edge of the wing. The engine has been in severe crashes with no injury

whatever. I show a photograph which illustrates the engine full size. A stock engine has run over 12 hours a day for a total of 100 hours, and it shows no sign of wear. Its maximum power is .035 h.p. at 4,700 revolutions per minute. The engine runs approximately 40 min. on 1 oz. of fuel at a speed of 3,500 revolutions per minute, and develops a thrust of 9 oz. The carburettor has an adjustable jet but no air adjustment. The Elf is, of course, a 2-stroke of the 4-port type, air-cooled and lubricated on the petrol system. The bore is .542 in., the stroke 19/32 in., and the piston displacement 2½ c.c. or approximately ¼th cubic inch. The cylinder and crankcase are sand cast of aluminium and the cylinder is fitted with a thin steel liner. An important feature is that the timer is of the automobile type, completely enclosed with hardened cam and cam-plate. The spark coil is designed to operate on one dry cell of the micro or "fountain-pen filler" type. The carburettor is of the single jet type fed from a float chamber, and the tank is connected to the float chamber with a thin rubber tube. The spark plug is of Champion manufacture, and is of the one-piece type, ¼ in. by 32 threads per inch, and weighs ¼ oz. The two-bearing crankshaft is turned from solid drill rod and fitted with steel counterpoise weights. The piston is an aluminium casting and has three cast-iron piston rings. The connecting rod is of aluminium and the hollow gudgeon pin is of floating type. The engine weighs 4 oz., the propeller ¼ oz., the spark coil and condenser together weigh 2½ oz. The Elf Engine can be inverted and a reversed carburettor can be supplied if necessary. When ordering it is necessary to state which type is required. The engine complete costs 21 dollars 50 cents, the English equivalent varying with the rate of exchange. Capt. Bowden speaks very highly of this engine, and states that it starts easily (more easily than most engines of higher c.c.) and runs remarkably smoothly and evenly. He has fitted one into a plane, and gives details as follows.

## A Model for the "Elf" Engine

THE makers of the "Elf" Engine claim that a balsa model of from 3 ft. to 5 ft. span can be built around the "Elf" and the total weight should work out at between 12 to 18 oz.

Doubtless the above type of model would be very successful in good weather, but I, personally, prefer a more robust model for the English climate. Accordingly I have constructed a 4 ft. 4 in. span low wing model with Monocoque fuselage. The total



The Elf-engined model built by Capt. Bowden.



weight of the model works out at 28 oz.

On page 635 is a photograph of the model. I have only just finished this model and shall shortly put it through its flying trials.

The engine is mounted on a detachable engine mounting. This mounting is an elektron casting made up from a small wood pattern I constructed from 3-ply wood. The petrol tank is housed in one of the dummy hollow balsa wood cylinder fairings.

The two "fountain-pen" flash lamp cells are housed in the open cockpit just aft of the celluloid windscreen.

The undercarriage and the tail wheel are detachable and a pair of floats can be fitted for flying off water if desired.

The fuselage is constructed on a backbone of balsa wood with oval formers of balsa wood. The outer skin is formed from a multitude of  $\frac{1}{8}$  in. by  $\frac{1}{8}$  in. balsa wood lengths stuck side by side with glue and then sandpapered down to about  $\frac{1}{16}$  in. thick.

#### Federation Aeronautique Internationale

THE following rules for model aircraft admitted for international records, have been drafted.

By a miniature model one understand any reduction of the full-sized machine, but of a size not capable of carrying a human load. The load with regard to the surface should be a minimum of 10 grammes per square decimetre (i.e. 3 oz. per square foot in English measurement). The model aircraft must have a wing-span of between 70 centimetres (i.e. 27½ in.) and 3 metres 50 centimetres (i.e. 11 ft. 6 in.). Only models with a closed fuselage will be admitted for record flights. The dimension (S) of the section of the fuselage or additional fuselages, in relation to the length (L) is defined: for flying models and seaplanes

$$S = \frac{L^2}{200}; \text{ for gliders } S = \frac{L^2}{300}$$

In the case of tail-less aeroplanes, the section of the fuselage (or fuselages) presenting itself in the form of a swelling of the wing, shall be the surface of an ellipse inscribed within the swelling; the ellipse having for its major axis the vertical height of the swollen part and whose minor axis is one-third of the major axis. If A is one-half of the major axis, the surface of this ellipse is  $\frac{11a^2}{3}$ .

The ratio of wing span to length of fuselage is limited to a maximum of 1:1. No part of the model must become detached during the attempt on the record.

#### Categories of Model Aircraft.

Three types are permitted: (i) Landplanes. (ii) Seaplanes. (iii) Gliders.

#### Motive Power admitted for Categories (i) and (ii).

(1) Rubber motor (this must be enclosed in the fuselage).

(2) Mechanical motor (inflammable fuels are prohibited).

(3) Gyroscopic power.

**Definition of Category (iii)—Gliders.**—For classification in this category, the entire apparatus shall support itself in the air by means of fixed or movable planes, without any form of translation other than that of throwing forward.

#### Records recognised for Aircraft Models.

**Landplanes. — Hand-launched.** — Duration. Distance in a straight line. Altitude. Speed.

**Rising off Ground.**—Duration. Distance in a straight line. Altitude. Speed.

**Seaplanes.**—Duration. Distance in a straight line. Altitude.

**Gliders.**—Duration. Distance in a straight line. Altitude.

#### Conditions of Launching Models.

**Hand-launching.**—The person launching the model must remain on the ground.

Launching from the ground from an arranged track (i.e. R.O.G. board).

(In the event of launching from an arranged track, the latter should not be raised more than 30 centimetres (1 foot) above the ground.) The model shall be released without any push.

**Seaplanes.**—The model must take off from the water; no push is permitted. It must also alight on the water after its flight.

**Gliders.**—(a) **Hand-launching.**—The person launching the model must remain on the ground.



A 7 ft. wing span model weighing 4 lbs. and built by Mr. T. J. Rayner, of Shoreditch.

(b) **Launching by catapult.**—The length of the catapulting cable (not extended) is limited to 3 metres (i.e. 9 ft. 8 in.).

(c) **Launching by windlass.**—During the launching the windlass shall not be displaced. Three-quarters of the length of the cable shall be taken for the height of the releasing point.

For the different categories above, the launching shall on no account be made from an aeroplane, balloon, kite, etc.

#### Special Conditions Concerning Records.

For categories (i) and (ii) (namely, landplanes and seaplanes) the time shall be taken at the moment the model is released.

For category (iii) (gliders) the time shall be taken at the moment the model liberates itself from the preparatory launching device.

Regarding the termination of the flight, the time shall be taken when the model touches the ground or water, hits an obstacle, or disappears from view of the timekeeper.

A duration record shall not be beaten by a superior time unless the latter is 10 seconds more than the previous record.

The loss in altitude between the position of launching and the point of landing shall not be more than 2 per cent. of the distance flown in a straight line.

#### Distance Records in a Straight Line.

The distance of the record shall be that measured between the point of launching and the point of landing. When the distance covered does not permit direct control, the distance shall be measured on a map of which the scale shall be at least 1/50,000.

The loss in altitude between the position

of launching and the point of landing shall not be more than 2 per cent. of the distance flown in a straight line.

Until the record attains a distance of 1,000 metres (3,281 ft.) the difference between two distance records must not be less than 100 metres (328 ft.); above 1,000 metres the new distance record shall exceed the previous record by at least 5 per cent.

#### Altitude Records above the Launching Point.

Altitude records shall only be beaten by a difference equal to or superior to 50 metres (i.e. 164 feet).

For measuring the altitude, it is prescribed to employ the small barographs especially instituted for model aircraft.

#### Speed Records.

The speed will be measured over a base of 50 metres, covered in both directions and at not less than a half-hour interval. The time will be taken at the moment of entering and leaving the 50-metre base. The mean of the two times shall give the time of the record.

For the record to be beaten, the speed must exceed the previous record by a speed of at least 1½ metres (4.92 ft.) per second.

#### Records for Category (ii) (Seaplanes).

In the case of record flights for seaplanes, these latter shall be obliged to take off from the water and alight on the water.

For the distance records, the flights shall be accomplished on a lake, so that their positions of "Take off" and "Alighting" may be measured with precision.

The S.M.A.E. Council has duly considered these and has passed certain observations of them. We consider that:

(1) The factor of 200 and 300 in the denominator of the formula governing the cross-sectional area of fuselages for flying models and gliders respectively is too high; as this tends to return to a fuselage approaching spar-model dimensions—the thing that the S.M.A.E. has striven to overcome.

It is important to note that the factor of 100 and 200 respectively introduced by the S.M.A.E. many years ago has been adopted by the two foremost countries in model aeronautics in the world, namely America and Great Britain, and yet the F.A.I. deem it fit to change this. The S.M.A.E. (as the body governing model aeronautics in Great Britain) is not in agreement.

(2) The method of measuring altitude appears to us unsuitable for the average rubber-driven model owing to the weight of the barograph intended for the purpose, also owing to the inaccuracies of barometric devices for determining relatively small differences in altitude.

(3) The value suggested for the establishment of one speed record above another is inadequate. The increase in speed of the model stipulated (namely 1½ metres per second) appears almost immeasurable; for the distance travelled by the model (at a speed of 30 m.p.h.) during the smallest interval of time which can be accurately measured by stop-watch, namely  $\frac{1}{2}$  second, is 9 feet.

These major points together with other minor ones make us feel that the F.A.I. regulations have been drawn up with insufficient judgment in the methods of testing the performances of model aircraft. We would, furthermore, like to put on record our regret that the S.M.A.E. was not given the opportunity of being consulted in the compilation of rules intended for world use.

Hon. Sec., E. F. H. COSH.



**N**OW that swimming days are with us again, it is useful to consider the mechanics of the various strokes. An analysis of these will show whether we are wasting effort and will give us ideas for improving our swimming.

**The Principle of Archimedes**

It is an established fact that the human body is buoyant. According to the principle established by Archimedes, a body will float when it has displaced its own weight of water. This is due to the pressure of the surrounding water, which originally held in place the water now displaced by the body.

In order to make your body float with the nostrils above the water, therefore, very little effort is required. A mere leisurely paddling of the hands and feet will easily provide sufficient pressure to lift the mouth above the surface of the water. Hence, rapid movements are unnecessary. It follows, therefore, that the greater part of the energy used in swimming should be devoted to propelling the body.

**Action and Reaction**

It is a principle of mechanics that action and reaction are equal in magnitude and opposite in direction. That is to say, a pressure on some object produces a resistance of equal magnitude, acting in the opposite direction to the actuating force. Thus in walking one gives a backward thrust on the earth, and the reaction of the earth to this thrust moves the body forward.

In swimming, no matter what stroke is used, it is the reaction of the water to the pressure placed upon it which causes the body to move. For example, by pressing down on the water with the hands it is possible to raise the body in the water. Similarly, an upward sweep of the hands, such as is made during a surface dive, causes the body to sink. The body always moves in the opposite direction to the force exerted on the water.

When swimming, therefore, remember that a backward pressure means an equivalent push on the body in a forward direction, a downward pressure will make progress easier by giving a lift to the body, while a slight upward pressure will submerge the body and make progress more difficult.

**The Breast Stroke**

In this stroke the legs should be brought together as violently as possible, as it is from this movement that the greater part of the propelling power is derived.

Fig. 1 shows that the legs sweep together along the arc of a circle. The reaction of the water is directed, at any moment, along a tangent to that circle. At one particular instant this reaction acts along the lines X and Y in the figure. Now it is usual in mechanics, when considering the result of a force, to resolve it into two component forces, acting at right angles to each other, in accordance with the well-known theorem of the Parallelogram of Forces. Doing this to the forces X and Y, it is seen that the two side components, A and B, cancel each other, being equal in magnitude and opposite in direction.

# THE MECHANICS OF SWIMMING

## A Scientific Analysis of some Swimming Strokes

By **SIDNEY BOOCOCK**

Hon. Instructor of the Royal Life-Saving Society.

Therefore much wastage of energy is inevitable in this stroke.

The components at right angles to A and B represent the propelling effect of the forces X and Y, and are marked P in the figure. It is obvious that the greater the

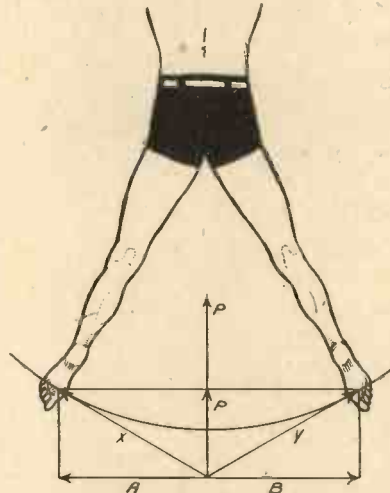

Fig. 1.—Diagram showing how the reaction of the water may be considered as two component forces at right angles.

force exerted in bringing the legs together, the greater will be the accompanying reaction, and the more rapid the movement of the body through the water.

**The Arms**

At the time the legs are closing, the hands should be stretched out, with palms down on the surface of the water, so that they act as a support to prevent the body from being unduly submerged and thus increasing the retarding effect of the water. At the same time the head should be lowered, so that the water covers the nostrils. The nose will then act in much the same way as does the bow of a boat. In this position the breath must be expelled through the nose. This underwater exhalation of breath is important, yet is often neglected.

Following this position, the arms should

be swept downward and backward. A common mistake is to omit this downward movement, and consequently there is much strain and wasted effort as the swimmer endeavours to lift his head in order to breathe. The downward stroke will raise the mouth above the water sufficiently for air to be taken in with a gulp. There is no time to breathe out during this stroke, hence the importance of doing this while the nostrils are submerged. Avoid taking the arms too far back. To do so increases water resistance without giving compensating propulsion. There is also a tendency with this

fault to make the latter part of the stroke an upward one, which has the effect of pushing the body deeper in the water than need be, again causing resistance to be increased.

The Amateur Swimming Association recommends bringing the arms to a position below the body, in which they are at right angles to each other.

**Speed-boat Action**

The crawl stroke is one which, on the whole, is done worse than any other. Done correctly it is not tiring, as many people believe. Has not the English Channel been "crawled"? The wasted energy in this stroke, as it is attempted by a large number of swimmers, is due largely to a wrong position in the water. One frequently sees a wildly thrashing swimmer, with head down, exerting tremendous efforts for a few yards, then lifting up a red face to snatch a gulp of much-needed air. This is wrong. In the first place, the head and shoulders present a comparatively large area to the water, and consequently the resistance to forward motion will be very great. The body should be curved from head to toe, the nose cutting the water. The resistance of the water ahead then lifts the body, thus making progress easier.

The greatest power in this stroke comes from the legs, and the thrashing drive is very like the screw of a power boat, tending to raise the body in the water in much the same manner as a speed-boat rises.

A common mistake in the arm movement is to keep the arm straight until it is raised from the water for the recovery. A glance at Fig. 2 will show that this must inevitably depress the shoulders and increase the area of opposition to the water. The figure makes it obvious that once the arm has reached the vertical position at right angles to the body, the elbow must be bent if an upward movement of the arm and a consequent downward movement of the body are to be avoided.

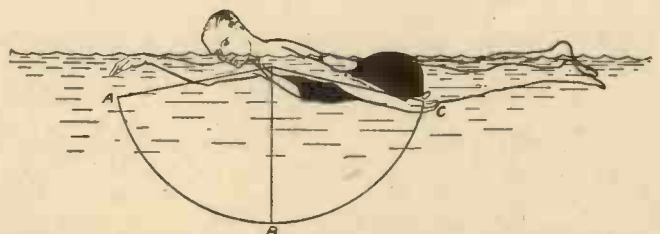

Fig. 2.—Diagram showing effect of arm movement in crawl and side strokes. A gives a forward and lifting reaction. B marks the limit of the lifting stroke. C gives a forward and downward motion—(wrong).



# MODEL YACHT PERFECTION



The "SOUTHWOLD" Racer. Here is a new yacht for the summer season. The design of the "Southwold" Racer is based upon years of experience and backed by an expert knowledge of sailing craft large and small. Each model has been tested on an open stretch of water for speed and holding a course. Every racing enthusiast can now possess a real prize-winning yacht, at a very reasonable price.

Prices: 19 in. long, £2/12/6.  
 20 in. long, £3/10/-.  
 24 in. long, £4/12/6.

Sails Mast and Spars only from 10/6.

Details of other yachts and ship models are given in the new **BASSETT-LOWKE Ships Catalogue S.12, 6d.** post free.

A.12. Model Railways, 6d.

B.12. Model Engines, 6d.

Free Leaflet, "Lilliputian Power." F.B.12 and T.T.12, the Twin Train Folder.

**BASSETT-LOWKE LTD.**  
**NORTHAMPTON** London: 112 High Holborn, W.C.1  
 Manchester: 28 Corporation Street

**AT LAST!!!**

## "DETECTARAY"

An extremely reliable and sensitive Photo-electric Cell. For only **5/-**

The product of very extensive research and experiment, having innumerable uses—Sound film reproduction, signalling, counting, colour matching, burglar alarms, advertising, etc. Does not need expensive apparatus, merely a simple amplifier and relay, full details of which are packed with every "Detectaray" cell. Fully guaranteed for 12 months. The Jefferies Bentham "Detectaray" has a unique method of mounting, being similar in appearance to the ordinary 5-amp plug-top. Remember. Only 5/- Postage 3d.

From **JEFFERIES, BENTHAM & CO.,** Trade enquiries invited.  
 Wades Lane, Teddington, Middlesex.

## The ELECTRIC EYE

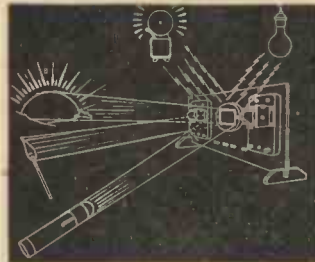

A device based on the principles of photo-electricity, which can be put to innumerable uses in the home. A beam of light shining on the sensitive plate of this ingenious apparatus will immediately turn on the Radio, start up Alarm Bells, etc., as soon as ray is broken. It can also be used in the opposite way, and automatically switch on the electric lights when darkness falls. Its unlimited scope for experiment will amaze old and young alike. The younger generation will derive endless entertainment from its possibilities; electric trains and all electrically driven toys can be controlled by this apparatus.

Write for illustrated brochure of this wonderful device

Selling at the very low price of **£1.6.0** post paid. Limited Supply only.

**DOUGLAS HOLT (Estd. 1919) LTD.**  
 (Car and Radio Accessories)  
 9 LITTLE TURNSTILE, LONDON, W.C.2

*A Real Motor-Driven  
 Wood Planer  
 for your  
 Home  
 Workshop*

**E. P. BARRUS, LTD.**  
 35-37 UPPER THAMES ST., LONDON, E.C.4

**SPECIALLY DESIGNED, COMPACT FULLY ADJUSTABLE MOTOR-DRIVEN 4" PLANER BANISHES TEDIOUS HAND PLANING. 3 HIGH-SPEED STEEL KNIVES**

**RIGID**

**SMOOTH AND QUIET AT TOP SPEED**

**THE CHEAPEST PRACTICAL PLANER ON THE MARKET**

**PRICED WITHIN REACH OF EVERY HOME WORKER**

It's **DRIVER** No. 525

Send the coupon and know more



SEND ME

**DRIVER**  
**MOTOR-DRIVEN**  
**TOOLS CATALOGUE**

MR.....

(P.M.) .....

COUPON



# Direct Explosion Gas-Pumps

A Method of Raising Water from a Low to a High Level by Means of an Explosion of a Combustible upon the Surface of the Water

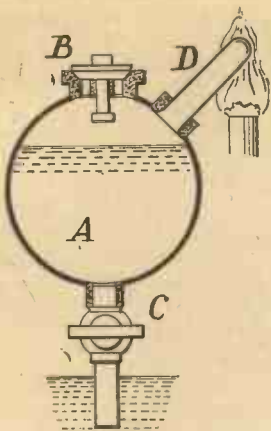

Fig. 1.—A spherical type of gas pump.

ONE of the earliest problems of mankind was that of raising water or of transferring it from one place to another. One of the most interesting methods of conducting water from a low to a high level is that embodying the application of direct pressure—due to the explosion of a combustible—actually upon the surface of the water very much in the same manner as steam was applied by Savory many years back. Simplicity is the outstanding feature of any such pump, for parts such as pistons, crankshafts, connecting rods, flywheels, bearings, and so on become redundant. The water to be dealt with flows into a substantial metal chamber provided suitably with valves. Ignition and rise of pressure occur and the contained water is forced along a delivery pipe into a high level tank. This brief statement does not make the *modus operandi* of such pump very clear perhaps, and later in these notes a more detailed description of a well-known gas-pump will be included.

### Problems of Design

The first problem is to ascertain what proportion of a vessel can be filled with water (from a source beneath it) by the expedient of exploding gas and air in the vessel and discharging the contents through a non-return valve. Fig. 1 shows the apparatus used. A spherical chamber *A* had on its upper side a non-return valve *B* opening outwards, and on its lower side an inlet pipe *C*—controlled by a tap and normally dipping below the surface of water in a container. At *D* there was a thin blind-ended tube—2 in. in length perhaps, and beneath this tube was a small spirit lamp. These two simple parts form the ignition apparatus and although their operation seems rather obvious, actually it is not so. The explosion in the chamber *A* takes place at atmospheric pressure—no compression was attempted. If the tube *D* had been rendered incandescent in all probability the mixture would never have reached the incandescent part and there would have been no explosion.

An experiment was conducted in this manner. The ignition tube being loaded as described, a small amount of gas was allowed to enter the chamber through the pipe *C*, which was then dipped under water. Heat

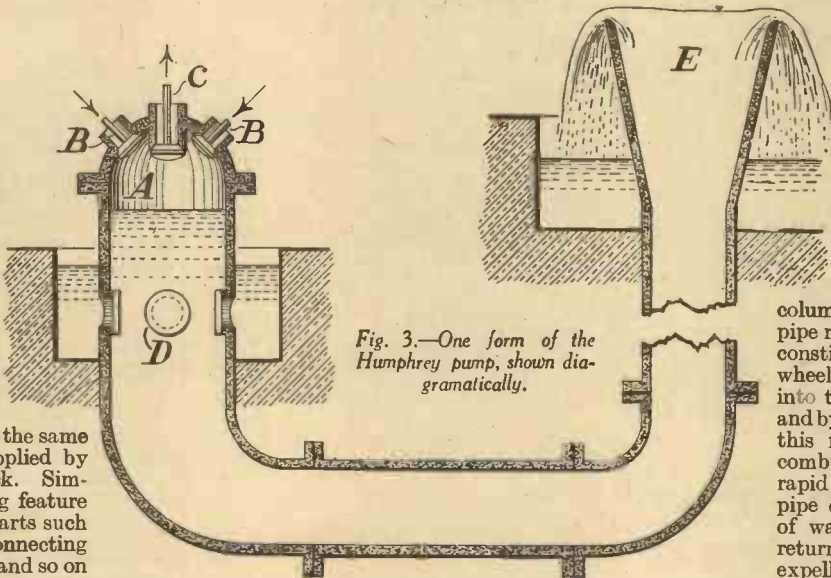

Fig. 3.—One form of the Humphrey pump, shown diagrammatically.

was applied to the ignition tube and an explosion occurred almost at once. Rapid discharge of products took place through the valve *B*, a partial vacuum being formed, and on opening the cock *C* water rapidly flowed into the chamber. It was indeed possible to fill the chamber about *three-quarters* full of water by this process.

### Suction and Delivery

It consequently seems adequately proven that a satisfactory suction stroke can be secured by merely causing an explosion in a suitably valved chamber. There seemed no doubt at all that the water can be driven out of the chamber by explosion pressure.

Suction and delivery of the water are thus accomplished. Suction and delivery of the explosive charge should not be difficult—nor should it be difficult to devise a suitable cycle of operations. Actually the steps taken to produce a pump that pumped were very arduous and no less than *four* systems were tried before the design reached the stage shown in Fig. 2.

The water valves—suction and delivery—are clearly indicated, the combined gas and air valve—a ball valve—is at the top of the apparatus and there was an ignition valve controlled by a flexible diaphragm adjacent to the ball valve. Two other unusual features must be mentioned. One part of the exhaust found its way out with the discharged water and, two, a jet of water thrown into the chamber considerably cooled the remainder of the exhaust. Air entered at *A* and gas at *G*. The pump made about 24 strokes per minute and lifted 1,000 gallons per hour to a height of 20 ft.

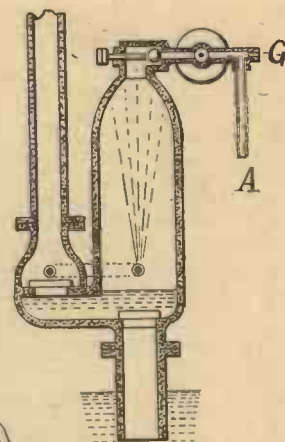

Fig. 2.—A successful pump design.

### The Humphrey Machine

Mr. Humphrey developed a very novel and interesting machine. This machine embodied a combination of hydraulic principles. A

column of water in the delivery pipe reciprocated to and fro and constituted a kind of "fly-wheel." Part of the water thrust into the delivery pipe returned, and by its momentum compressed this fresh charge in the pump combustion chamber. Water in rapid movement in the delivery pipe entrained a further supply of water behind it, and on its return flow to the pump chamber expelled the exhaust gases therefrom. Note that all these operations are performed by the *backward and forward* swing of a heavy column of liquid enclosed in a pipe. This *pendulum* action is the essence of the Humphrey pump.

Fig. 3 shows one form of the pump in a purely diagrammatic form. *A* is the combustion chamber. *B-B* are gas and air inlet valves, and *C* is an exhaust valve. The water inlet valves are indicated at *D*. Water flows into the high-level tank at *E*. Other details of this pump are fairly obvious.

### Sequence of Operations

The following is the sequence of operations—all of which take place with great regularity. Imagine an explosion—and consequent rise of pressure—in the chamber *A*. The pressure acting upon the surface of the water, thrusts the column towards the outlet *E* and delivery of some of the water takes place. In the meantime, as the pressure has dropped—by expansion, water flows into the system through the valve *D*. Eventually the column of water—its energy exhausted—comes to rest. Now there is nothing to resist a return flow of the water column towards the combustion chamber *A*, and, the exhaust valve *C* being open, the burnt gases are discharged. But a sudden closure of the exhaust valve causes some of the gases to be trapped and compressed. Expansion now brings about another swing of the water column outwards, while the inlet valves being suitably controlled permit a fresh charge of combustible to be drawn into the explosion chamber. A fourth swing of the pendulum-like column of water brings about compression of the gases, followed by ignition, combustion, and so on.



# This Month in the World

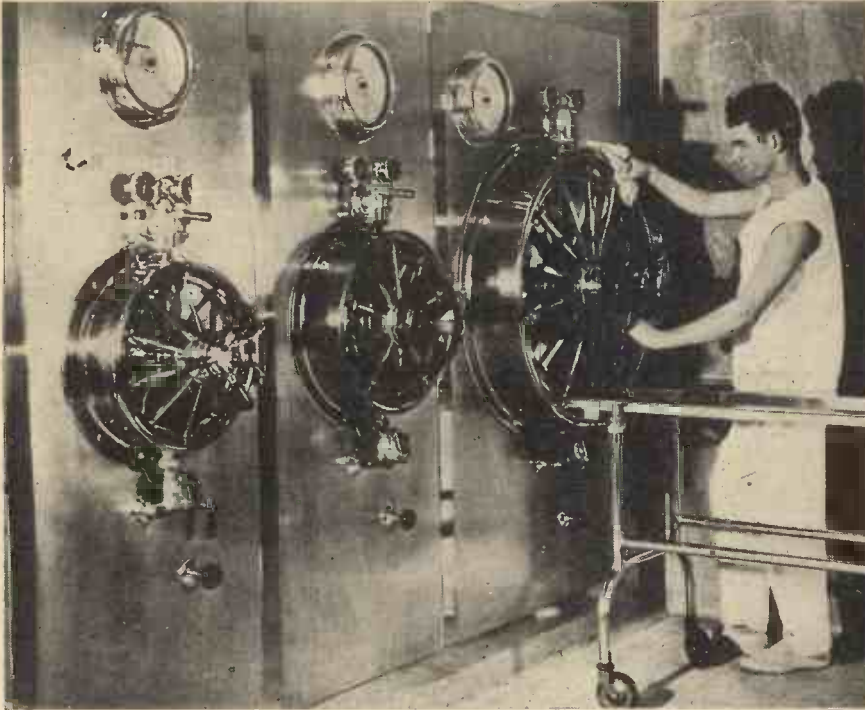

Germs may go into this machine, but they never come out. This sterilisation machine is part of the modern equipment in the Naval Hospital in Philadelphia, recently completed. Here surgical instruments, bandages, gauze, etc., used for the treatment of patients, are rendered antiseptic.

## A Radium Telephone Exchange

THE Royal Society of London, considered the world's premier scientific society, founded by the atomic physicist, Robert Hook, in the reign of Charles II, always gathers the latest scientific discoveries together for its annual conversation. This year a radium telephone exchange, supersonic sound waves and a demonstration of the fact that metallic surfaces actually become liquid when polished, were among the more interesting items.

Radium investigators used to count every particle emitted in radium decompositions, by watching the flash of impact on a screen sensitised with zinc blende. Now by using an apparatus very similar in action to an ordinary wireless detector valve, coupled to an amplifying circuit, the particles of radium decompositions can be made to ring themselves up on a telephone exchange, operate a teleprinter and issue the final result on a recording tape. The device makes possible far more rapid observation

of atomic decompositions and transmutations than was formerly possible.

## Not so Dusty

Coagulation of smoke and dust particles is a close concern of the purer air move in industry to-day. New method of making fine dust particles settle is to subject them to inaudible sound waves. That is, supersonic sound waves of very short wavelength are produced in the dusty atmosphere which in some way get hold of the fine particles and cause them to collect together into large smuts and heavy grains which settle out quickly.

## Polished Metals

It has often been stated that when a metal is polished the surface actually melts and flows as a liquid. This was demonstrated by rubbing two metals together and reading the temperature of the rubbing surface by means of the thermo-electric current set up. That is, the two surfaces were made to act as their own thermocouple. A surface temperature of over a 1,000° C. was measured in this way, although the main mass of the metals was at ordinary temperature. The temperature was higher than the metal point of the two metals, so that the actual surface must have been molten. Polishing is thus demonstrated as the fluxing of the atomic layers in the surface of the metal under local conditions of high pressure and temperature.

## A Super Streamlined Locomotive

A locomotive incorporating the most highly perfected and advanced design yet produced by aerodynamic science for the reduction of wind resistance has just been completed at the Pennsylvania Railroad Company's works at Altoona, Pennsylvania, U.S.A. At 60 m.p.h. the wind resistance is cut by a third; at maximum speed the saving is equivalent to nearly 300 h.p.—all due to the beautiful streamlining. Months of tests in wind-tunnels, ruthless scrapping of many designs and painstaking experiments by technical experts all went to produce this modern marvel of the railway track, which shortly will be assigned to regular passenger service.

## Calor Gas

Bottled butane is now being distributed in Great Britain under the name of Calor Gas. Butane is produced in the cracking

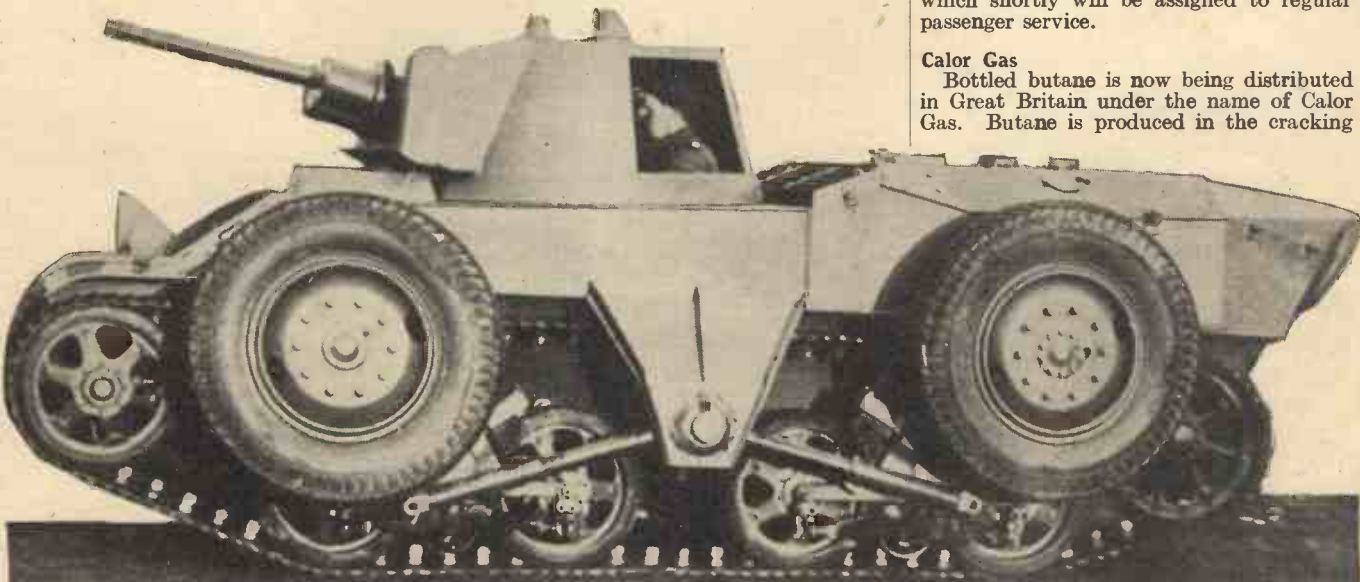

The modern tank which has been introduced into the Swedish Army. It can cover rough ground on chains or ride on the usual wheels, and the changing operation is made with only a switch and takes 18 seconds. The speed on the chain ribbon is 25 to 30 m.p.h. and on the wheels 50 m.p.h. It has a crew of three and is well equipped with guns.



# of Science and Invention

stills of petroleum distilleries, but the main source of British supply is the coal hydrogenation plant at Billingham which produces butane as a by-product.

Butane is akin to petrol in properties, but it is so volatile, that at ordinary temperature and pressure, it is a gas and not a liquid. It is so near the liquid border line, however, that under so low a pressure as 23 lb. to the square inch (no more than the pressure in a motor-car tyre) it forms a liquid. Butane can be therefore distributed safely in steel bottles. The bottles used are light in construction and have a regulating valve at the top to reduce pressure. They contain a supply of butane which is about equivalent to 1,000 cubic feet of coal gas. The butane may be burnt on ordinary gas appliances if these are fitted with specially made aeration nozzles of very fine bore.

## Photographing Engine Explosions

Actual photography of the travel of the

out like an expanding comet, with the original spark as its head.

## New Uses for Plastic Resins

The uses of plastic resins are becoming more and more diversified. The two latest are bakelite bearings for rolling mills, and a special tannin-bark resin which can be used for water softening.

The wear on the bearings of the heavy steel rolls in a steel-rolling mill is extremely hard on such materials as phosphor bronze. Whitmetal bearings are quite useless as they get deformed under the excessive pressures. Special laminated bearings of fabric cemented together with bakelite have been introduced with success. The bakelite seems to combine the properties of hardness and give, in the right degree, does not require oil for lubrication and has a life about twice that of the hardest phosphor bronze.

Resins used in water softening were

to Mount Palomar in Southern California, a distance of 3,300 miles, represents one of the most unusual freightage tasks undertaken by a railroad. In the first place, the cost of the mirror runs into millions of dollars, it weighs 20 tons, and stood 17 ft. off the rails when loaded. Its route had to be carefully chosen so that bridges allowed headroom. The closest shave was at Buffalo where there was only 3 in. to spare. Another difficulty was the high centre of gravity of the disc, packed as it was like a penny on edge. To prevent the load from tipping over at corners, a ballast weight of steel rails was welded to the underside of the crocodile rail car. The actual packing of the disc consisted of a steel crate with an internal packing of felt. The crate was fastened down on rubber shock-absorbing blocks by spring-washed bolts. Everything seems to have been worked out for a safe journey. It arrived safely in California and was unloaded on to one of the huge

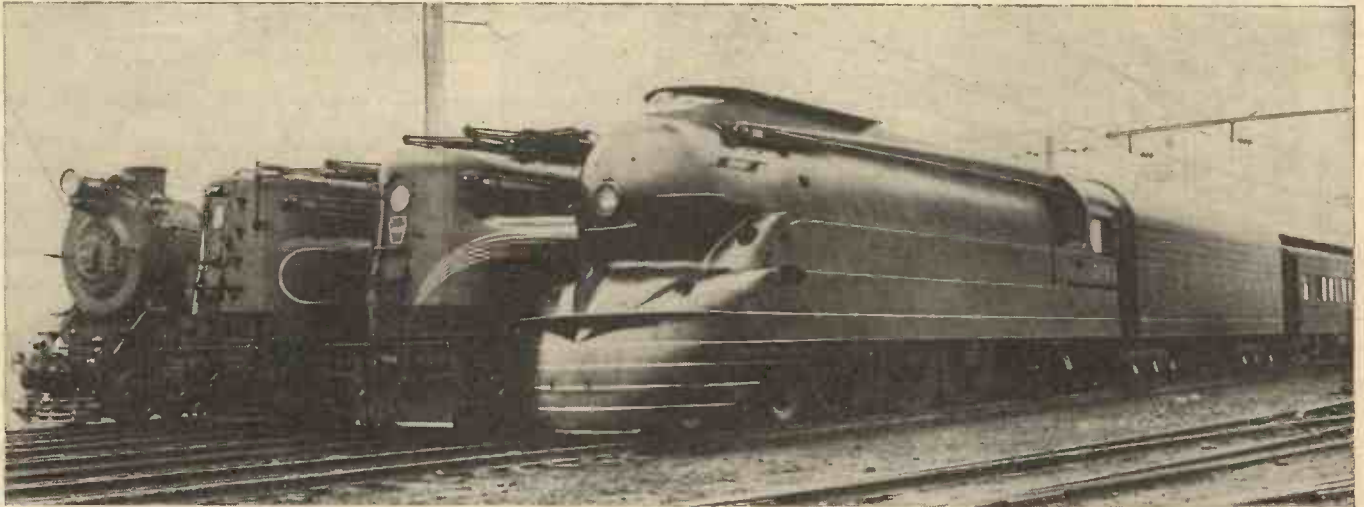

Showing the new Pennsylvania Railroad Company's streamlined locomotive (nearest camera) with two other types of streamlined engines, and (extreme left) an old-type engine.

spark and explosion in a cylinder head is used as a method of improving engine design and studying fuel behaviour in petrol and Diesel engines. General Motors, in America, have described an engine and camera test set designed for the purpose. The cylinder head has inset into it a window of clear fused quartz, a material which combines transparency with resistance to temperature and sudden high pressure. The instantaneous pressure in the cylinder head is over 400 lb. and the temperature close on 3,000° C. The camera is designed to take thirty exposures in the time of the explosion, and the explosion lasts roughly about four thousandths of a second. High-speed camera work is necessary. The device used mounts the film on the inside of a drum which whirls across the path of the image of the explosion. The light from the explosion is just about sufficient to register on the film, so that all that is necessary is to set the drum going at the proper speed, and start up the engine with the silica window obscured by a focal plane shutter. Then a timing gear, driven off the engine, draws the shutter for one cycle of the engine only. The result is a series of photographs showing the course of one explosion. The series of pictures shows that the explosion travels

shown at a recent exhibition of chemical plant. They are a totally new departure, but behave in exactly the same way as the ordinary zeolite sands used to do, in the Permutite system of water softening. They probably have a big future, as they can be more cheaply made than zeolite, and can be made to perform a far more diversified series of operations in water treatment.

## Rubber Cement and Concrete

Latest production of the rubber chemists is a rubber concrete made by mixing a special rubber latex with fine concrete aggregate. The new material is resilient and waterproof like rubber, but has the wear-resisting properties of concrete. It is suggested as an ideal material for road surfacing, tennis courts and swimming baths. Another material is a rubber cement which will really stick to metals and expand and contract with them without warping from the surface. It is an extremely useful preparation for lining petrol tanks to prevent leakage, and acid tanks to prevent corrosion of the metal.

## 200-in. Mount Palomar Telescope Mirror

The transport of the 200-in. telescope mirror from Corning Glassworks, New York,

lorries which have been used in connection with the building of the famous Boulder Dam. Now that it is delivered at Mount Palomar, it will have to undergo a polishing and grinding process which is expected to last the best part of three years. Meanwhile astronomers are already talking about a 500-in. disc.

## 60 M.P.H. Railcars

TWO oil-driven, streamlined Diesel-engined railcars have been ordered by the London Passenger Transport Board for service early next year on the Chesham-Chalfont and Latimer (Bucks) branch of the Metropolitan line. Each car will seat 70 passengers and be capable of a speed of over 60 m.p.h.

## One Ton per Cubic Inch

A STAR so dense that every cubic inch of it must weigh a ton has been discovered by astronomers at Mount Wilson observatory. The star, known as Ross 627, is said to be 210,000,000,000,000 miles from the earth.

## A Gliding Record

MR. P. A. WILLS set up a new gliding record recently by gliding 110 miles. The previous best was 96 miles set up by Mr. G. Collins.



# WHICH OF THESE IS YOUR PET SUBJECT?

## CIVIL ENGINEERING GROUP

Specifications.  
Road Engineering.  
Hydraulics.  
Municipal Engineering.  
General Civil Engineering.

Structural Design.  
Structural Engineering.  
Reinforced Concrete.  
Sanitary Engineering.  
Geology.

## SURVEYING GROUP

Valuations.  
Heating and Ventilating.  
Clerk of Works.

Surveying and Levelling.  
Building Construction.

## COMMERCIAL ENGINEERING GROUP

Salesmanship.  
Advertising.  
Languages.

Commercial Engineering.  
Cost Accounts.

## MECHANICAL ENGINEERING GROUP

Works Management.  
Press Tool Work.  
Maintenance Engineering.  
Metallurgy.  
Sheet Metal Work.  
Welding.  
Diesel Engines.  
Refrigeration.

Heat Engines.  
Workshop Practice.  
Fitting and Erecting.  
Inspection.  
Ironfounding.  
Pattern Making.  
Draughtsmanship.

## WIRELESS GROUP

General Wireless.  
Advanced Wireless.  
Television.

Talking-Picture  
Engineering.  
Radio Servicing.

## AUTOMOBILE ENGINEERING GROUP

Garage Management.  
Electrical Equipment.

Claims Assessing.  
High-speed Diesels.

## ELECTRICAL ENGINEERING GROUP

Traction.  
Electrical Supply.  
Electrical Meters.  
Electrical Design.  
Installations.  
Electrical Engineering.

Mains Engineering.  
Telegraphy.  
Telephony.  
Alternating Currents.  
Neon Lighting.  
Power House Design.

## AERONAUTICAL ENGINEERING GROUP

Aerial Navigation.  
Aeroplane Design.

Aero Engines.

One of these examinations would multiply your earning power! **WHICH ONE?**

A.M.I.C.E.  
A.M.I.Struct.E.  
Sanitary Inspectors.  
A.M.I.H. & V.E.  
A.M.I.Mech.E.  
A.M.I.P.E.

A.M.I.W.T.  
M.I.M.T.  
A.F.R.Ae.S.  
B.Sc.Degree.

G.P.O. Supt. of Traffic.  
Patent Office Examiner.  
Handicrafts Instructor.  
Inspector of Factories.  
Aircraft Apprentices.

Inst. Mun. & Cy. E.  
M.R.San.I.  
F.S.I.  
A.R.I.B.A.  
L.I.O.B.  
F.A.I.

City & Guilds.  
A.M.I.Fire.E.  
A.M.I.E.E.  
A.M.I.A.E.  
A.M.I.Ae.E.  
A.M.I.R.E.

London Matriculation.  
G.P.O. Prob. Inspector.  
Air Navigators' Certificate.  
Ground Engineers' Certificate.

May we send you full particulars of our unique tutorial organisation? Whatever your requirements, whether you desire a complete course of instruction, or tuition in some specialised subject, our Organisation is so planned that it will dovetail into your needs exactly.

**"NO PASS—NO FEE."**

As an indication of the strength of the B.I.E.T. Tutorial Organisation, it should be clearly noted that we guarantee to return full fees to any student who does not pass his chosen Examination successfully. In short, "If you do not pass, you do not pay."

Send to-day for a free copy of "ENGINEERING OPPORTUNITIES." This valuable 268-page Guide shows clearly and definitely the way in which you may carve out a successful career in your chosen branch of Engineering, irrespective of your age, education or experience. Among a host of other things, it gives details of all the above-mentioned Courses and shows the easiest way to prepare (in the privacy of your own home) for any of the recognised Examinations we have listed.

"ENGINEERING OPPORTUNITIES" should most certainly be in your hands. Send for your copy at once—free of cost or obligation.

## BRITISH INSTITUTE of ENGINEERING TECHNOLOGY

410, SHAKESPEARE HOUSE, 17-19, STRATFORD PLACE, OXFORD STREET, W.1

Overseas Enquiries to : P.O. Box 3597S, Sydney. P.O. Box 4701, Jo'burg. 219 Bay Street, Toronto. P.O. Box 1025, Bombay.



## STRIPS AND PLUGS



There was a time when receivers used to bristle with Terminals, but modern practice now relies upon the perfect and speedy contact secured through the use of Clix Strips and Plugs.

**CLIX ARE SPECIFIED**  
for the  
**P.M. THREE-RANGE**  
**SHORT-WAVE THREE**

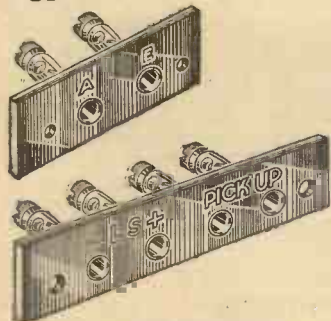

Ask your dealer for

- CLIX SOCKET STRIPS**  
Engraved A.E. or L.S. 6d. each  
Engraved—LS+, PICK-UP 8d.
- CLIX WANDER PLUGS**  
All standard engravings 1½d.
- CLIX SPADE TERMINALS**  
For your Accumulator 1½d. ea.
- CLIX VALVE HOLDERS**  
Standard Type V.1 (4-pin) 8d. each

CLIX ILLUSTRATED FOLDERS  
"P.M." GIVE DETAILS OF OVER  
40 PERFECT CONTACT  
COMPONENTS

Obtainable from your Dealer

**CLIX** LECTRO LINX LTD.  
79a Rochester Row, London, S.W.1

## REPLACE WITH

# HIVAC

THE SCIENTIFIC  
VALVE

BRITISH MADE

Two million is a very fair estimate of the number of batteries and mains valves replaced in a year by the British public. If your set has lost its ability to bring in a good selection of stations at good volume, try replacing with HIVAC Valves. They cost less, but are equally efficient to those which cost 25% more.

HIVAC ARE SPECIFIED FOR THE  
"P.M. THREE-RANGE S/W THREE."

Types H210 3/9 .. D210 3/9 .. P215 4/9

FREE. Send now for a copy of the HIVAC VALVE GUIDE "P.M."  
**HIGH VACUUM VALVE CO., LTD.**  
113-117 Farringdon Road, London, E.C.1



# The PRACTICAL MECHANICS WIRELESS EXPERIMENTER

THE short-wave receiver that was described last month utilised a plug-in coil which could be changed for various wavelengths. The advantages of such an arrangement are great flexibility, ease of adjustment, and the provision of broadcast reception on the standard wavelengths. The principal drawback is that it is necessary to switch off, open the cabinet, and change the coil when it is desired to explore

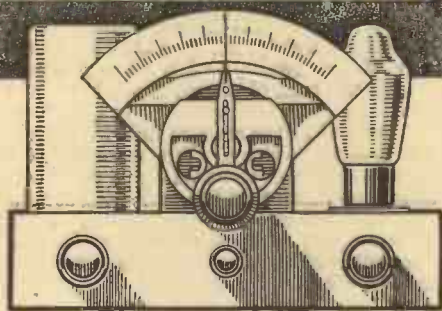

higher standard of performance, but it is tricky to set up and not always easy to handle. The simple reacting detector valve may, however, yield phenomenal results under certain conditions, and it is really surprising what can be heard with even the simplest aerial and a well-adjusted detector valve. The addition of two good L.F. stages will bring up the strength of such signals, and by using a mixed coupling, that is, one stage of resistance-capacity coupling and one transformer (parallel-fed), the quality of the signals will reach quite a high standard. To ensure stability the detector stage is also decoupled, and a stabilising resistance is included in the reaction circuit to ensure that this important part of the receiver will provide smooth control throughout all parts of the tuning scale.

A further refinement is the inclusion of a potentiometer across the L.T. supply, with the grid leak joined to the arm

## THE P.M. THREE-RANGE S.W. THREE

Designed especially for the short-waves, this receiver incorporates a special short-wave coil which covers the total band from 12 to 95 metres in three separate steps

a different band of frequencies. In addition, of course, some space has to be provided for the storage of the various coils which are required. In the present receiver a special type of short-wave coil has been used, and this is wound in three separate sections, each of which contains both the grid and reaction coils, and by using a special switch it is a simple matter to change from one coil to another and thus cover a wide waveband without the necessity of changing the coils.

### The Circuit

The receiver is built around the standard detector and 2 L.F. arrangement which has



Another view of the receiver showing the neat appearance of the chassis.

of the potentiometer so that the most effective bias may be applied to the grid. In the interests of economy a simple power valve is fitted in the output stage, although, if desired, this could be replaced by a pentode to provide greater volume.

### Construction

The construction is just as simple as the circuit, and a standard metallised wooden chassis is employed upon which the receiver is built up. This chassis is, as most readers are aware, made from plywood, which is afterwards sprayed under pressure with a metallic composition, providing the advantages of a metal chassis but retaining the ease of working of a wooden chassis. A front runner is provided on the chassis specified, and to this the aerial-series condenser, the wave-change switch, and the reaction condenser are mounted. The chassis surface is connected to earth, and therefore it is essential to insulate the two condensers

been found to provide the most satisfactory performance in the hands of the ordinary experimenter. The superhet may be capable of a much



Three-quarter front view of the Three-range Short-Wave Three showing the neat layout of components.



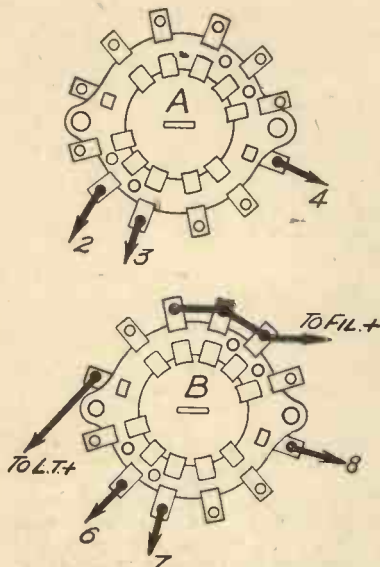

Showing the connections for the rotary wave-change switch.

from this surface. This is carried out simply by scraping away the metal round the holes which are drilled for the two components, an ordinary penknife serving for this purpose. If desired, a countersunk hole may be drilled to accommodate the nut of the fixing bush, but this is not essential.

**LIST OF COMPONENTS FOR THE P.M. THREE-RANGE S.W. THREE**

- One Three-Range Short-Wave coil, type S.W.66 (Bulgin)
- One .00015 mfd. tuning condenser with type 1049 slow-motion drive (Jackson Bros.).
- One 30 m.mfd. variable condenser, type 2141 (Jackson Bros.).
- One .0002 mfd. reaction condenser, type 2095 (Jackson Bros.).
- Six fixed resistances, 1 watt type: 2 megohms (R1); .5 meg. (R4); two 25,000 ohms (R5, R6); two 5,000 ohms (R2, R7) (Erie).
- Five fixed condensers: two .25 mfd. (C6, C8); two .01 mfd. (C5, C7) .0001 mfd. (C4) (T.C.C.).
- One H.F. choke, type H.F.3 (Wearite).
- One filament potentiometer, 500 ohms (R3) (B.T.S.).
- One Niclet 3½ to 1 L.F. transformer (Varley).
- One Multiple switch (B.T.S.).
- Two socket strips, A.E. and L.S. (Clix).
- One component mounting bracket (Peto-Scott).
- Three 4-pin type chassis-mounting valveholders (Clix).
- Six wanderplugs: H.T.2, H.T.1, H.T.—, G.B.—, G.B.—1, G.B.—2 (Belling Lee).
- Two Spade terminals, L.T.—, L.T.+ (Belling Lee).
- One metallised chassis, 10 in. + 6 in. with 30-in. runners (Peto-Scott).
- Three valves, H210, D210, P215 (Hivac).
- One 120-volt Superlife H.T. battery (Drydex).
- One 9-volt G.B. battery, type H1001 (Drydex).
- One 2-volt accumulator, type DMG-C (Exide).
- One Junior Stentorian loudspeaker (W.B.).
- One pair 2,000-ohm headphones (Ericsson).

Mount the two condensers and then the two-section switch, noting carefully that this has afterwards to be wired in a certain order, for which purpose the two sections have been marked Plate A and Plate B. A separate diagram of the connections to these plates has been included to avoid difficulties. Next mount the L.F. transformer to the underside of the chassis, and then screw the valveholders into position. The terminal strips are then attached at the rear of the chassis, and if an unprepared chassis has been obtained, it will have been necessary to cut 1-in. holes for the valveholders and either slots or individual holes for the terminal strips. When mounting the valveholders and terminal strips great care should be taken that the projecting sockets do not come into contact with the metal surface, and, although not essential, the precaution of scraping away the metallising may be taken.

**Wiring**

The wiring may now be commenced, the coil and variable condenser being left until the wiring is practically finished in order to avoid the risk of damage to these com-

ponents. The thickest wire should be employed for wiring, as certain components are suspended in the wiring, and it is essential to guard against any movement of these during use as that may affect tuning. Similarly, the movement of various interconnecting wires might lead to erratic tuning, and thus short and rigid leads should be aimed at. The two diagrams of the switch plates will simplify the task of connecting the coil, and the leads should be taken through the holes in the chassis ready for subsequent attachment to the tuning-coil lugs and variable condenser.

Note carefully that certain points are marked "M.B.," and at these points a perfect connection must be obtained. A large clean washer between the head of the bolt or screw and the wire will ensure good contact. To complete the screening effect of the chassis it is desirable to connect the front runner to the upper surface by means of an entirely separate lead. Although the surface is sprayed after the assembly, there is a risk that during the construction work the runner may be knocked or otherwise moved so that the metallised surface cracks at the point of juncture of the top of the

**The Top and Underneath Chassis Wiring Plan of the P.M. Three-Range S.W. Three**

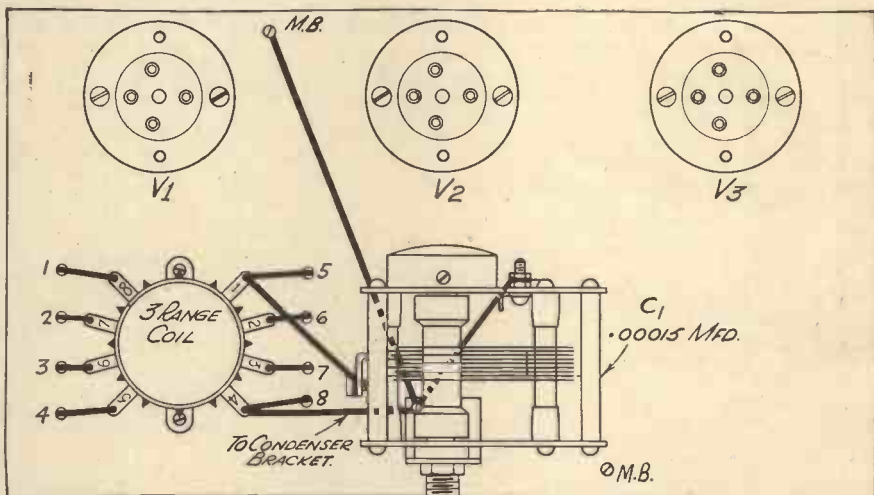

M.B. = METALLISED BASEBOARD.

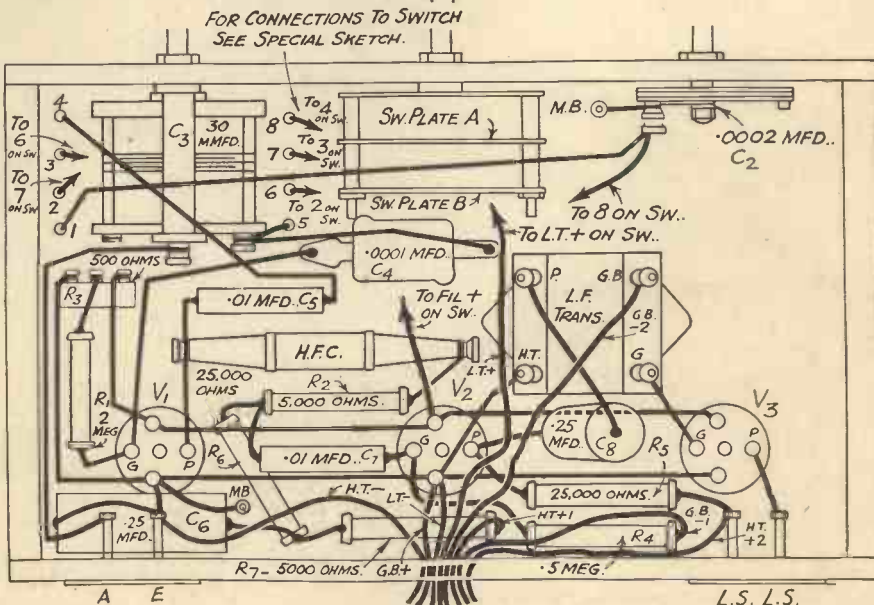



**TURN IDLE HOURS  
TO  
PLEASURE  
and  
PROFIT**

*These books will help you* *Up-to-date Authoritative*

**THE HOME WOODWORKER.**

The various examples of woodwork described in this handbook have been designed by practical craftsmen. They are modern in style, and their construction is well within the powers of the average homemaker who follows the instructions given.

**THE HANDYMAN'S ENQUIRE WITHIN.**

Hundreds of practical ideas and hints—many not hitherto published. Classified according to the subjects dealt with, an index being provided to facilitate speedy reference.

**MOTOR CAR OVERHAUL AND UPKEEP.**

There are many to-day who by undertaking their own repairs can afford to run a car, and it is the purpose of this profusely illustrated handbook to explain how the owner-driver may carry out most of the adjustments and repairs which every car sooner or later needs.

**POWER-DRIVEN MODEL AIRCRAFT.**

All about petrol, compressed-air and steam engines, wheels, carburettors, ignition systems, rotary engines, etc., with special constructor's chapters, ranging from compressed-air models for beginners to advanced petrol-engined planes. With 130 sketches, diagrams, and photographs.

**MODEL AIRSHIPS AND AEROPLANES.**

This handbook is intended as a guide to the beginner in model aeronautics. It presents in clear language the first principles of aviation and incorporates these in various forms of simple flying models. Profusely illustrated.

**ACCUMULATORS.**

An accumulator (whether for wireless or the car), if properly used and cared for, is an extremely reliable piece of apparatus. Proper care and proper use can only follow a possession of the knowledge which study of this book will impart.

**SIMPLE ELECTRICAL APPARATUS.**

Interesting and useful apparatus, easily constructed, with which the student is enabled to test for himself the theory and practice of electricity as laid down in the textbooks. 138 illustrations.

From all Booksellers and Newsagents.

**Each 1/- net  
NEWNES  
HOME MECHANIC  
BOOKS**

Each 1/2 post free from Newnes, 8-11 Southampton St., Strand, W.C.2.



*Said the Chancellor, knitting his brow,  
"This 'leakage' I cannot allow;  
Next time, with FLUXITE,  
I'll seal the thing tight—  
I must keep my secrets somehow!"*

See that FLUXITE is always by you—in the house—garage—workshop—wherever speedy soldering is needed. Used for 30 years in government works and by leading engineers and manufacturers. Of Ironmongers—in tins, 4d., 8d., 1/4 and 2/8. Ask to see the FLUXITE SMALL-SPACE SOLDERING SET—compact but substantial—complete with full instructions, 7/6. Write for Free Book on the ART OF "SOFT" SOLDERING and ask for Leaflet on CASE-HARDENING STEEL and TEMPERING TOOLS with FLUXITE.

**TO CYCLISTS!** Your wheels will NOT keep round and true unless the spokes are tied with fine wire at the crossings AND SOLDERED. This makes a much stronger wheel. It's simple—with FLUXITE—but IMPORTANT.

**THE FLUXITE GUN**

is always ready to put Fluxite on the soldering job instantly. A little pressure places the right quantity on the right spot and one charging lasts for ages. Price 1/6.



ALL MECHANICS WILL HAVE

**FLUXITE**

IT SIMPLIFIES ALL SOLDERING

FLUXITE Ltd., Dept. P.M., Dragon Works, Bermondsey St., S.E.1

**ENGINES FOR BOATS**

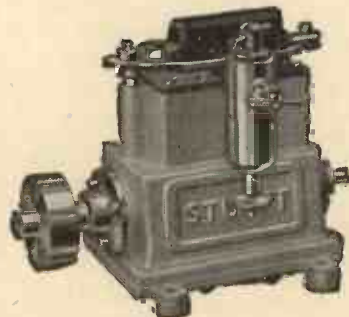

THE STAR

Finished as illustrated. Height 3 3/4 ins. Post Free **30/-**

Other Engines of similar designs:—

CASTINGS .. .. from 12/6

FINISHED ENGINES .. from 45/-

These and many other designs, as well as boilers and fittings, are fully described in the Stuart Catalogue No. 3. 6d. Post Free.

PLEASE SEND FOR YOUR COPY  
**STUART TURNER LTD.  
HENLEY-ON-THAMES**

**HERE  
ARE  
YOUR**

**Exide**

**AND**

**Drydex**

**BATTERIES**

for the

**"Three-range  
S.W. Three"**

as specified by the designer

For L.T. Exide DMG-C, 2 volt, 70 amp. hrs. 12/-

For H.T. Drydex Super-Life, 120 volt. - 10/6

For G.B. Drydex H1001 - - - - 10d.

Obtainable from Exide Service Stations and all reputable dealers.

**EXIDE BATTERIES, EXIDE WORKS,  
CLIFTON JUNCTION,  
NEAR MANCHESTER**

Also at London, Manchester, Birmingham, Bristol, Glasgow, Dublin, and Belfast



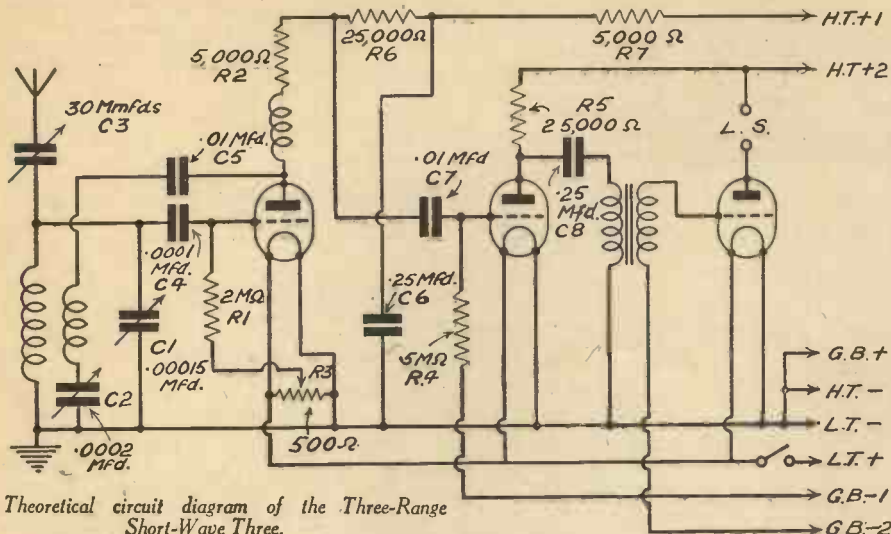

Theoretical circuit diagram of the Three-Range Short-Wave Three.

chassis and the side, and therefore this precaution should be taken.

**Testing**

Connect the H.T., L.T. and G.B. batteries, plugging H.T. + 1 into a tapping between 80 and 120 volts; G.B.-1 into the 3-volt tapping and G.B.-2 into the 7½-volt tapping. These tapping points may subsequently be modified when the receiver has been tried out. The voltage at H.T.+1 will affect the reaction control, and a value should be selected which enables the reaction condenser to be turned almost to the full-in position before oscillation takes place. If too low a voltage is used, the condenser may be turned to maximum without causing oscillation, whilst if too high the set will burst into oscillation suddenly before any adequate build-up has been obtained.

Turn the aerial-series condenser to a mid-way position and switch on. Rotate the reaction condenser until a breathing sound is heard in the loud-speaker, and then

slowly adjust the tuning condenser. If a chirp is heard, the reaction condenser should be turned back towards minimum, and an endeavour should be made to use both C2 and C1 together so that the receiver is kept on the verge of oscillation. When a signal is heard, the reaction control may be adjusted to build up the strength to the maximum, and this may serve to guide the user in the correct adjustment of the condenser.

If no reaction is obtainable and maximum H.T. is employed, the aerial-series condenser should be adjusted slightly, and it will be found that this is in some cases just as critical as the reaction control in obtaining smooth effects over the entire waveband.

**NEW INVENTIONS**

The following information is specially supplied to "Practical Mechanics" by Messrs. Hughes & Youngs, Patent Agents, of 9, Warwick Court, High Holborn, London, W.C.1, who will be pleased to send readers mentioning this paper, a copy of their handbook, "How to Patent an Invention," free of charge.

**Portable Baby Carriage**

ABOUT a quarter of a century ago there was invented a travelling-bag in the shape of a wheel. One wheeled one's luggage to the railway station. However, this method of dispensing with a light porter has not become the vogue. But another inventor has returned the compliment in the form of a baby carriage which can be folded up so that its dimensions do not exceed those of an ordinary case. It can be carried like a handbag and should prove a great convenience to parents upon the occasion of their annual visit to the seaside.

**An Escalator for Apples**

THE usual method of gathering apples is to place a ladder against the trunk of the tree, to fill a basket with the fruit, and either climb down with the load or hand it to some person at the foot of the ladder.

In the case of tall trees and of a large amount of fruit having to be picked, this rudimentary method involves a considerable amount of labour. To overcome this difficulty there has been devised apparatus comprising an endless belt conveyor having open-mouthed pockets mounted on an easily portable frame. This frame is provided with hinged struts. When set up near the fruit tree, the weight of picked fruits placed in the pockets at the top of the conveyor causes the latter to carry the fruit to the bottom of the frame, after the fashion of a moving staircase.

**Reflections under an Umbrella**

NOT so long since I had occasion on this page to report the invention of an umbrella with a window. A later device—this time hailing from the other side of the Atlantic—arranges for an umbrella to be fitted with an internal mirror. When the umbrella is in use the mirror appears immediately in front of the fair lady carrying the umbrella. Consequently, in the event of a shower of rain, she can unobtrusively estimate the effect on her charms, and, if necessary, renew her make-up.

**Inventory of Inventions**

A SURVEY of the subjects of recent inventions discloses the usual variety. To mention only a few, applications accepted by the British Patent Office relate to bomb-release mechanism for aircraft and mounting of guns on aircraft, which are suggestive of preparation for war; a noise subduer for wireless receivers for cars, and life-guards for motors; collapsible tents (which it is hoped always perform their office of collapsing at the right moment); and automatic writing apparatus designed to record the thoughts of the subconscious. Yeomen of the Guard who wish to avail themselves of His Majesty's permission to shave will be interested in several inventions concerning the razor. A new gas-detector for mines may avert the catastrophe which makes the occupation of the miner so precarious. And, last but not least in importance, is a sound insulation mat for walls, which may minister to the comfort of those who dwell in flats, preventing one's neighbour's wireless set or his crude performances on the piano from disturbing one's rest.

DYNAMO.

By F. J. Camm  
**ACCUMULATORS**

How to Get the Best Out of Your Car or Wireless Batteries—a Little Book that will Save You Pounds.

Illustrated. With 84 Diagrams and Sketches.

Only 1/- net. From All Booksellers.

A NEWNES HOME MECHANIC BOOK

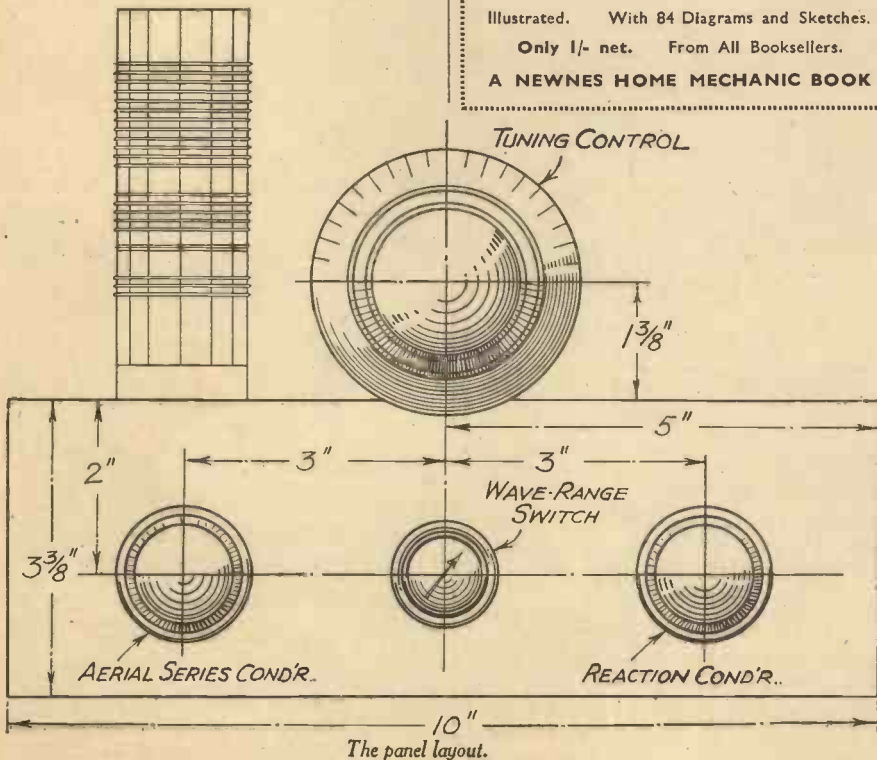

The panel layout.





# THE KNITTING MACHINE

A MODERN knitting machine appears to be a highly complicated and delicate piece of machinery, as indeed it is, but it is difficult to find a machine which works a simpler principle.

A simple experiment will make this clearer than a whole volume of printed matter.

Six pieces of stout springy wire, about 3 in. long, should be bent to the shape of the bearded needle shown in Fig. 3. Now cut six shallow slots in a strip of wood about an inch wide. The distance between the slots, and also their depth, is immaterial. Place the wires, which will now be referred to as needles, in their slots, or tricks, as they are technically known (see Fig. 2).

A yard or so of fine string (the yarn or thread) may now have six small loops formed in it and each loop slipped on to the shank of a needle so that it is behind the beard. Allowing a little slack between each needle, lay a length of yarn in the loops of all the needles (see Fig. 5). Press the beards of the needles down until they touch the shanks and slide the original loops off the needles, as in Fig. 6. The first row, of course, has now been made, and in precisely the same manner as a complicated machine would have done it. Slide back the loops which are hanging on the needles and again "lay the thread" in the loops of the needles. "Press" the beards, slide the loops over and another course has been made (see Fig. 7).

Invented by Rev. John Lee in 1589

Now that the principle has been demonstrated, and it should be noted that it was invented by the Rev. John Lee in 1589, it is proposed to describe the action of a particular machine. Many modern knitting frames employ a different type of needle, known as a "latch needle," Fig. 4, which obviates the "pressing" as the movement of the needle causes the loops to close the latch and slide off, the latch opening again to take the next layer of thread.

The needles are moved by means of cams, and as these cams pass the butts of the needles the latter are forced up or down.

There are two main classes of machines, or frames. The flat bed or rotary which can make up to twenty-four similar articles

simultaneously, and the circular frame which is much smaller, and produces stockings, for example, one at a time, but in rapid succession.

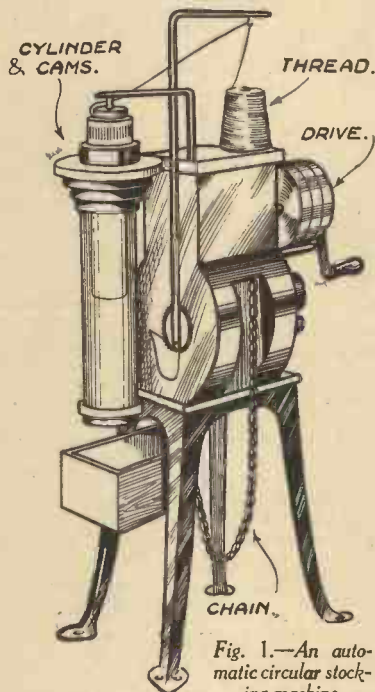

Fig. 1.—An automatic circular stocking machine.

### The Cylinder

The main part of a circular machine is the cylinder, usually of steel of inside diameter

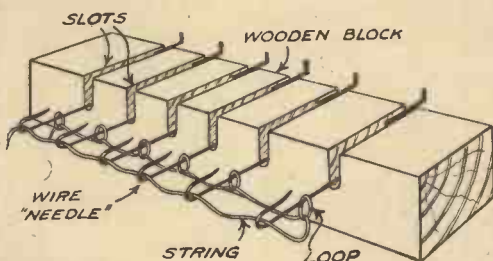

Fig. 2.—A simple experiment showing how the machine works.

3½ in. to 4 in. Inside the cylinder are the tricks, vertical slots to hold the needles, which may number, say 260. The cylinder revolves on its bed on which are fixed the cams, although in some cases the cams revolve round the cylinder. A number of guides are also fitted, to lead the thread to the needles.

In the case of stockings, a row of loops is run on to the needles and the machine started up. The needles, passing by the guides, receive their thread and the cams cause them to make a stitch. After a definite number of rows has been made, other thread guides come into operation to introduce the next type of thread required, a scissor attachment cutting the previous yarn.

### Shaping the Ankle

This is continued until the top is finished, when a further change is made. Again the machine carries on, until yet a third operation takes place. The effect of this is to raise the cylinder, thereby preventing the needles from drawing their full supply of thread. The result of this is to cause the stitches to be tightened and thus shape the leg down to the ankle. At this point, a decided change takes place in the operation of the machine. So far, the cylinder has been revolving continuously in one direction, making what is known as circular fabric. Now, if you examine the heel of a stocking or sock you will notice a kind of seam down the sides of the heel which is produced by continually narrowing the fabric down to the point of the heel, when the process is reversed and the fabric widened. To effect this, those needles which are knitting the front of the ankle, or rather, the instep, are raised to such a position that they are out of action. The front of the stocking is, therefore, left hanging on its needles. To make the heel, the cylinder is caused to oscillate instead of rotate, thus only knitting on the remaining needles. The oscillating movement is derived from a quadrant drive from the main shaft. In the sketch of the drive, Fig. 8, a clutch will be seen. In its right-hand position it drives the cylinder normally and through the gears on the extreme right, but when moved to the left the quadrant gear is engaged. The movement of the clutch is caused by a cam on a drum, which in turn is moved by a ratchet arrangement operated by a special link in a chain.

### The Heel

To revert to the making of the heel. At the end of each half revolution of the cylinder a needle is lifted out of action by "pickers" until at the point of the heel there may be only three or four needles operative. A further movement of the cam drum then takes place, and brings the needles into action again, one or two at a time as desired. When the heel has been completed the remaining half of the needles is lowered and circular work resumed for the making of the foot. The toe is made in a similar manner to the heel.

Now for a short description of the more important parts. Referring to the sketch



Fig. 3.—A bearded needle.

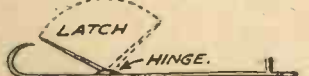

Fig. 4.—A latch needle.

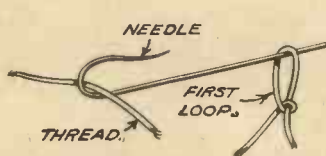

Fig. 5.—Allowing a little slack between each needle, lay the thread in the beard of the needle.

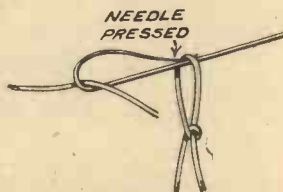

Fig. 6.—Press the beard down and slide the loop of thread over it.

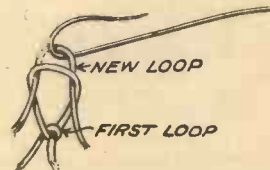

Fig. 7.—How a second stitch is made.



of the cam system, Fig. 9, it will be seen that there are six main cams. The needles, represented by short vertical lines, move along the top of *E*, up *A* (where they receive their thread), down and under *C* until they reach *B*. The passage of the needle down

the side of *B* causes the loop already on the needle to be "knocked off" over the new thread, as in the model, thus making another stitch. The needle next rises up *F* and proceeds on a level path until it reaches *A* again.

The chain which causes the various changes to take place is composed of special and plain links and some of the latter are illustrated. Fig. 10 causes the stitch to be tightened for the calf and ankle, Fig. 12 slows the machine down, alters the movement of the cylinder and brings the "pickers" in and out of action, whilst Fig. 11 removes the stocking from the needles and drops it from the machine.

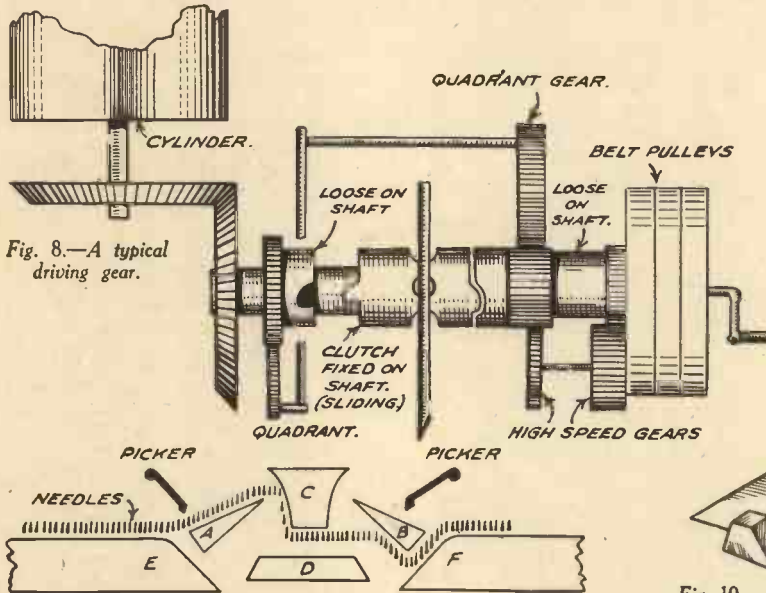

Fig. 8.—A typical driving gear.

Fig. 9.—Showing how the cam system works.

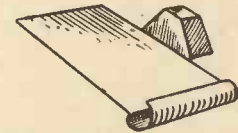

Fig. 11.—The link for removing the stocking from the needles.

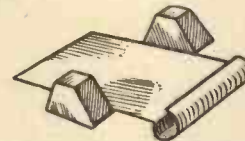

Fig. 10.—A special link which causes the stitch to be tightened.

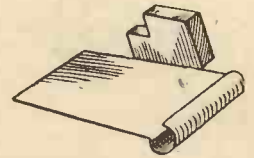

Fig. 12.—This link slows the machine down, alters the movement of the cylinder, and brings the pickers in and out of action.

**Satin Walnut.**—Also known as red-gum, alligator wood and bilsted; this is not obtained from a walnut tree, as the name would imply. The wood is of handsome appearance due to peculiar dark markings which improve the appearance of its light brown surface. It is easy to work, and planing produces on it a lustrous surface. The wood twists and warps considerably, especially if the boards have not been obtained by cutting the log radially. Its even texture makes it very suitable for carving, and it is used in considerable quantities for bedroom furniture.

**Seasoning.**—All timber has to be seasoned, before it is suitable for use, the reason being that the free sap must be removed. There are innumerable methods of seasoning, but these all divide themselves up into two classes, natural and artificial. One method of natural seasoning is to lay the logs in running water for several hours, after which they can be removed and stacked to dry. Another method of natural seasoning is to allow the timber to dry whilst stacked in such a way that there is a free circulation of air round it. In this process the timber must be well protected from sun and wind and dried very slowly to avoid cracking.

Natural seasoning is rather slow, and artificial seasoning is generally resorted to for that reason. One system is to place the logs in ovens through which hot air is passed. Another method is to force steam through the pores of the wood under high pressure to boil out the sap. Additionally, however, there are many other chemical methods of artificial seasoning, and these are too involved to allow of their treatment here.

Nearly every form of artificial seasoning impairs the quality of the timber by reducing its weight, durability, and elasticity.

**Sycamore.**—An excellent hardwood grown largely in Great Britain, and often known as plane wood. With the exception of

## INTERESTING FACTS ABOUT WOOD

holly, it is the whitest of woods, and is therefore used to a fair extent for inlaying. It is extremely close grained, and is an excellent material for turning in a lathe. A fine glossy surface can be obtained by planing, and the wood takes an excellent

finish when stained and varnished. Sycamore is largely used for mangle rollers, cutting boards, and all forms of turnery, as well as for various musical instruments.

**Teak.**—This is a hardwood which is grown principally in Burmah, Java, and Ceylon. The tree grows to a diameter of from 2 ft. to 3 ft., and therefore the timber can be obtained in very wide boards. When freshly cut, the wood is green, but it soon changes to dark brown on exposure to the air. It is very straight grained, and contains a resinous aromatic oil, and this hardens in the pores and makes the wood somewhat difficult to work. At the same time it acts as an excellent preservative, and prevents the attack of insects. The oil is also a good preservative for iron, and teak is therefore used very largely as a backing for the armour plating of iron-clad vessels.

Teak is lighter in weight than oak, but is otherwise rather similar; it is also stronger and more durable when under water. It is largely used for laboratory furniture and for shop and ship fittings.

**Walnut.**—Walnuts are grown in this country as well as in America. The wood is of the hardwood variety, and is dark brown in colour, having peculiar and beautiful markings. Because of this it is largely used for making better-class furniture and for shop fittings. The wood is also used very widely for veneer work, where it is most frequently quartered. Walnut is generally rather difficult to work, on account of the twisted grain, but if properly handled and planed up with a sharp and well-set tool an extremely fine surface can be produced.

**Yew.**—This is a soft wood obtained from the tree of the same name. The wood is reddish-brown and is often used for inlaying and similar decorative purposes. It is strong and flexible, and it is interesting to note that it was formerly used for making the bows of archers.

### WEIGHTS OF WOODS

The Weights of dry woods are as follows:

Substance	Weight lbs. per cub. ft.	Substance	Weight lbs. per cub. ft.
Alder	33	Ironwood	75
Almond	43	Jarrah	57
Ash, American	46	Juniper	37
Ash, European	43	Launcewood	57
Ash, Mountain	43	Larch	38
Bamboo	25	Lignum-vitæ	62
Beech, Common	46	Lime of Linden	32
Beech, Australian	33	Logwood	57
Birch, American	42	Mahogany, East	
Birch, English	38	Indian	43
Boxwood, Cape	52	Mahogany, Cuban	47
Boxwood, West		Mahogany,	
Indian	49	Australian	69
Boxwood, Common	76	Mahogany,	
Cedar, Cuban	28	Spanish	53
Cedar, Virginian	33	Maple, Bird's-eye	36
Cedar, Indian	82	Maple, Hard	42
Cherry, American	36	Maple, Soft	38
Cherry, English	38	Oak, African	59
Chestnut, Sweet	40	Oak, American	54
Chestnut, Horse	35	Oak, Danzig	52
Cocus	96	Oak, English	46
Cogwood	67	Pine, Pitch	44
Cork	16	Pine, Red	34
Cottonwood,		Pine, White	27
American	34	Pine, Yellow	28
Cypress	40	Plane	35
Dogwood	49	Poplar	26
Ebony	73	Rosewood	55
Elder	40	Satinwood	58
Elm, American	44	Spruce	30
Elm, Common	42	Sycamore	40
Fir, Danzig	38	Teak	38
Holly	53	Walnut	41
Hornbeam	45	Whitewood	33
		Willow	33
		Yew	52



**N**O model maker can afford to ignore the art of finishing metalwork, and this article explains every detail of the processes involved. Many amateurs' workshops can be greatly improved by the addition of a few polishing wheels and emery wheels, provided, of course, that there is power available to drive them. Once the "kit" is purchased (cloth wheels, emery wheels, soaps, etc.), there is practically no further expense, as the materials are very lasting, even with hard usage. Every kind of polishing job which is finished off with polishing mops is very much more satisfactory than the job which is simply wiped over with a rag. In this article it is intended to give full details of the art of polishing, and to give solutions to many problems which the novice may meet.

**Power Necessary**

The first obstacle which crops up is the question of power. Quite frankly, if there is a lot of heavy buffing to be done, at least a 1 h.p. motor is required with a speed of 2,000-3,000 revolutions per minute. A squirrel cage motor is most suitable for the purpose as regards economy and stability. Such a motor will answer the purpose for every phase of first-class polishing. On the other hand a light polishing machine can be driven by a ½ h.p. motor, which will be found quite satisfactory, enabling all metals of fairly good surface to be brought up to a very nice finish.

In large factories the polishing shop is particularly interesting. There may be anything up to thirty wheels of different kinds and speeds, being driven from overhead pulleys; the whole place is covered in water, and the polishers wear waterproofs. An enormous amount of dust is created by the wearing away of wheels, but the water helps to counteract this. The real idea of the water, however, is to act as a sort of lubricant, for enabling the work to be turned out to a fine degree of finish; the water is kept trickling down on the rapidly revolving wheels.

**Preparing Castings**

When castings come out of the moulds they are first ground on coarse emery wheels, where all the bumps and hollows are removed, then passed on to finer wheels until eventually they are cloth polished with a super-finish soap, and a very high speed wheel.

Regarding the different wheels which are used; the emery wheel is simply made of wood or felt with a sheet of emery cloth glued round; it is a constant source of trouble inasmuch as it is extremely difficult to get it to run on its spindle perfectly true. The central hole in the wheel is usually too large for the spindle, and to overcome this the wheel is often clamped up tight. If much pressure is put on such a wheel it will shift, and if it does it will play havoc. Even when they are only slightly out of true they make considerable noise when in use.

**Mounting Emery Wheels**

A good remedy for this is as follows: Turn a piece of steel the exact diameter of the spindle on which the wheel is to be mounted, and place it into a piece of wood, as shown in Fig. 1, and place the emery wheel on the wood. Care must be taken to get the spindle set square in relation to the wood. Place the wheel as central as possible and measure carefully from the outside edge of wheel to the opposite side of shaft, continuing all the way round. The distance at which to set the callipers is easily calculated from the diameter of the wheel and the spindle. When all is carefully

adjusted, pour in molten lead, filling up the space between the spindle and the hole in the wheel. This method will be found to give excellent results. When clamping up the wheel a couple of cardboard discs inserted between the clamping washers and the wheel will increase the driving friction without tightening up too much with the risk of cracking the wheel.

Having fixed up the emery "bob," a few words concerning its use will be helpful. When using them it is important that a plentiful supply of grease or oil be used as a lubricant, otherwise the casting will turn out a burnt colour which cannot be removed; this, of course, is owing to the excessive friction caused when grinding.

**POLISHING AND FINISHING METAL**

When the metal to be polished contains scratches they should always be removed in this manner.

**Cloth Wheels**

Next come the cloth wheels. These are made chiefly of linen sheets piled together. On some wheels these sheets are stitched together and are called stitch mops; they are used for "roughing." Owing to centrifugal force these wheels are quite hard when running. Another serviceable "mop" is the scratch mop, and is made of wire bristles—a most excellent tool for scratching off old rust, etc. The lubricant used on the cloth chiefly consists of bath brick and rotten stone, and a super-finish soap is made of lime. The lubricant should be constantly rubbed on the wheel and the latter should never run dry or shiny, otherwise it will not polish efficiently. To remove scratches keep applying a fair quantity of soap, and let the wheel rub on the one spot for a while. When all the scratches are removed it is time for a final finish. This should be done



Fig. 1.—Method of mounting emery wheels.

on another wheel using the lime soap; the operator should work systematically, that is, start at the bottom and work in a horizontal motion, upwards; when done in this manner the job will have no "wheel marks" in it. The work in hand, especially on a high speed motor, should always be gripped firmly, and on no account should a sharp edge be allowed near the wheel or else it will tear the job from the operator's hands. These remarks are most important and an amateur will soon see for himself that there is quite an art in getting a perfectly glassy surface. If, however, the job is carried out as above a really excellent

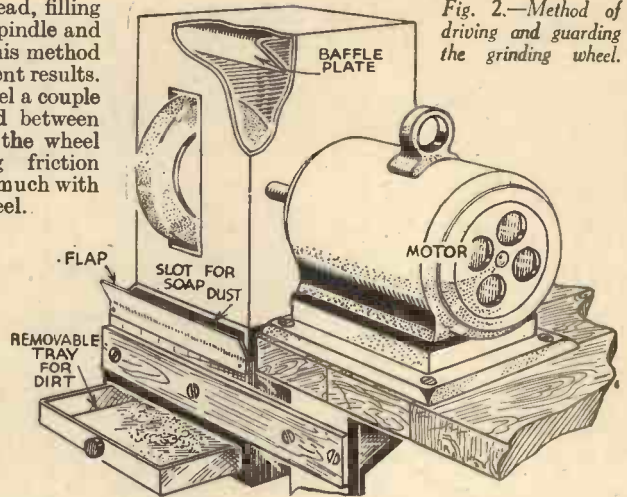

Fig. 2.—Method of driving and guarding the grinding wheel.

finish can be obtained. Any dirty soap marks which still remain on the work can be easily rubbed off with a drop of petrol.

**Brushing Wheels**

Another class of wheel is the "brushing" type, under which class come brass-wire, steel-wire, and nickle-silver wire wheels.

The brass wire fine wheel is used for putting a fine dead surface on coloured gold work, for finishing sand-blasted gold and silver, and for producing a very dead finish on silver work. The medium brass wire wheel is used for coarse frosting and scratching before plating, and also for bronzing, brassing, coppering, etc., while the coarse type wheel is for scratching before burnishing, and for cast brass, copper, and iron articles after pickling.

The steel wire fine wheel is used for all work requiring a coarse dead frost, and for bronzed jewellery, bronzed brass and copper work. The fine type is for frosting aluminium and general scratch-brushing, while the coarse type is for heavy work, castings, etc.

Finally, the nickle-silver wire wheels are used for retaining a white finish on silver and nickle, and also on aluminium articles prior to chrome plating.

**Spindle Speeds**

The speed at which brushing wheels are revolved is an important matter. It should be remembered that wire wheels must always run more slowly than bristle or fibre wheels; also that the larger the wheel and the coarser the wire, the more slowly it must revolve. The following speeds are recommended for average working conditions:—

Small bristle and fibre wheels	2,500 r.p.m.
Large bristle and fibre wheels	2,000 r.p.m.
Fine wire scratch wheels	1,600-1,700 r.p.m.
Medium wire scratch wheels	1,200-1,500 r.p.m.
Coarse wire scratch wheels	700-1,000 r.p.m.
Extra heavy wire scratch wheels	500-600 r.p.m.

To prevent wire brushes and wheels rusting when not in use lay them in a basin of water in which a little lime has been added.

If the dust created by the wearing of these wheels becomes a serious question, a guard can be made as shown in Fig. 2.

The guard is made from sheet steel, and bent to shape and riveted. The baffle plate (Continued on page 652)



# Home-Made Safety-Glass

How to make Non-Splinterable Glass in Your Own Workroom



This picture clearly shows the difference between ordinary and safety-glass.

**S**AFETY-GLASS which in nature and efficiency approximates very nearly to the character of the commercial article can be made by any interested amateur with very little trouble. Probably, of course, a little practice in the art may be required by the beginner before he hits the right conditions, but skill in the home-making of unsplinterable glass is soon acquired and, after a few preliminary attempts, the home worker will be in a position to turn out material of quite reasonable efficiency.

## The Principle

The principle underlying the nature of safety-glass is well known to most amateurs. Unsplinterable glass consists of two glass sheets between which is sandwiched and firmly cemented a thin sheet of perfectly clear celluloid or some other suitable transparent material. In some of the latest unsplinterable glass products, the use of a separate celluloid or other transparent sheet is avoided, the intervening layer between the glass sheets being made up of a special synthetic transparent cement-like material of more or less secret composition.

To make safety-glass at home, one requires, besides the necessary thin sheets of glass, a press of some description. If you can pick up an old copying press (and such articles are nowadays going for a shilling or two each) this will do very nicely. In lieu of a proper press, you will have to make use of a system of heavy weights placed upon a flat slab, but this system is not reliable in its results, since the pressure is never evenly distributed.

## The Transparent Cement

The first step in the making of safety-glass is the preparation of the transparent cement. This latter consists of celluloid dissolved in a mixture of acetone and amyl acetate. Both of these latter strong-smelling liquids can be obtained cheaply from most druggists and from many paint stores. You will require about 4 ounces of each and the cost should not exceed 1s.

Place in a well-corked bottle a mixture of

equal parts of acetone and amyl acetate together with a number of clean transparent celluloid cuttings. Allow the mixture to stand overnight. The celluloid will have partly dissolved in that time and it will subsequently dissolve completely by means of a vigorous shaking. The resulting liquid should have the consistency of thin syrup. If it is thicker add a further quantity of the two solvent liquids and, conversely, if it is thinner, dissolve more celluloid in it.

When the celluloid cement has been obtained of the right consistency, filter it through fine muslin, and store it away in a cool place and in a perfectly clean and dry well-stopped bottle. If possible, use a glass-stoppered bottle for this purpose so that bits of cork do not contaminate the liquid.

## The Simplest Method

Now there are one or two different ways of making safety-glass by means of this celluloid cement. The simplest method consists in flooding a quantity of the cement on to the surface of a clean sheet of glass and in leaving it to dry. A thin film of celluloid will be deposited on the surface of the glass and if the glass is lightly struck with a hammer, the probabilities are that, although it will break, it will not splinter and that the broken pieces will keep together, being prevented from flying apart in virtue of the adhering celluloid film. This simple method of safety-glass making, however, is not reliable. Moreover, safety-glass so made cannot be used out of doors, for the celluloid protective film is easily perishable.

To make good-quality safety-glass, proceed as follows:—

Obtain two perfectly clean sheets of glass of the required size and pour on each of them a quantity of the celluloid cement liquid prepared as above. Note that the cement should be poured on the glass sheets. This is a better method than brushing the cement on to the surface of the glass, for, if carefully done, the little pool of cement which is poured on to the centre of the glass sheet spreads and covers the entire sheet of

glass with a cement layer of uniform thickness.

## Fixing the Two Pieces Together

The glass sheet thus treated should be put away for a few hours in a perfectly level position and in a dust-free situation for the cement to dry.

When the cement is dry, coat each cement-treated surface again with the celluloid cement in just the same way as before, but this time using rather less of the cement. After this, place the two treated glass surfaces together while the cement is still liquid, taking care to exclude air bubbles and then place the sheets in a press for a couple of days. If, as already mentioned, a suitable press is not available one can improvise a sort of press by sandwiching the glass between perfectly flat wooden or cardboard boards or slate slabs and by piling weights on top of the upper sheets, although this method is never really reliable in its results.

After two days in the press, the cement glass sheets should be removed and the exuded and dried celluloid around the edges of the now composite sheet of safety-glass should be scraped away with a knife.

## Sealing the Edges

Now take some cobbler's "heelball" or some other form of heat-softening wax-like composition, and, after rendering it soft by heating, run it round the edges of the sheet of safety-glass, forcing it down into the groove which will be present in the edges of the sheet. Finally, trim the wax away from the edges, and rub the latter smooth with a little sandpaper. The wax forced into the edges of the sheet will act as a "seal" and will prevent moisture getting at the celluloid and so deteriorating it.

The sheet of safety-glass so made will not splinter when it is broken. It can be struck with a heavy hammer, and, although, if the blow be excessive in force, the glass may actually powder under the impact and become utterly disintegrated, it will not break into a multitude of flying pieces. Moreover, such glass is quite weatherproof and will stand up to any climate.

## Another Method

Still another way of preparing safety-glass at home consists in actually cementing a thin sheet of clear celluloid between two sheets of glass. The two sheets of glass are flooded with the celluloid cement and the celluloid sheet is carefully placed between them, the whole then being placed in the press for a day or two.

This process is more difficult than the previous one and it is doubtful if it gives a product which is in any degree more "unshatterable" than the safety-glass prepared by the preceding method.

Success in the home-making of safety-glass is mainly a question of care and practice. At all stages, the glass must be perfectly clean and dry. Dust, also, at all stages must be excluded rigorously, otherwise the final product will be "specky."

If, at any stage, the celluloid film dries milky or opalescent, it is a sign, provided that you are using good clear celluloid in the making of the cement, that the rate of the cement's drying is too rapid. In order to slow this down, add more amyl acetate to the cement.

Finally bear always in mind that the liquids used in the making of celluloid cement, besides the necessary celluloid itself, are highly inflammable. Care, therefore, must be taken at all times to exclude naked lights from the neighbourhood of their manipulation.



# ELECTRIC SHOCKS

There are many Natural Sources of Electric Shock of which Man must be Wary. A few of these are Described Below.

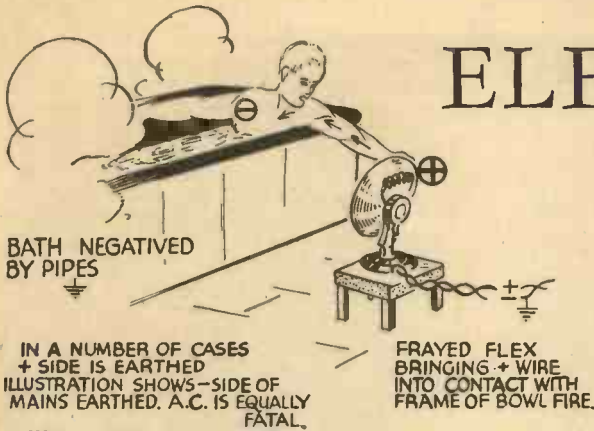

Whilst in the bath you should beware of touching any live conductor.

SINCE the earliest days it has been common knowledge that electricity has the power to give the human frame a shock which if sufficiently severe may prove fatal. Even before the days of batteries and generators of electricity what might be termed natural electrical phenomena had made itself felt in more senses than one. The most common source of shocks of this kind is, of course, atmospheric electrical disturbances producing discharges between clouds or between cloud and earth known as lightning. When an unfortunate individual gets in the path of one of these discharges, more often than not it kills him.

There are other natural sources of electrical shock, however, of which man must be wary. Some fish have within their bodies certain organs which have the power of producing a sudden potential difference between various parts—for instance, head and tail. There is no continuous current but a series of separate impulses or short shocks. In some cases the shock is sufficient to knock a man down. In the case of the electric cat-fish the voltage developed may be as high as 450 volts. Other fish of this type are the electric eel and the electric ray which is found in the Mediterranean Sea and is a relative of the common skate.

### Electricity To-day

In recent years the science of electricity has developed to such an extent that there are few homes to-day in which some electrical apparatus or instrument cannot be found even if it is only an ordinary electric torch. Unfortunately, the proverb "Familiarity breeds contempt" is just as true in relation to electricity as other things and electricity is now such a familiar thing

in every sphere of our daily life that the temptation to treat it without the care it deserves leads to many accidents. Periodically we read in the daily press of the accident of this character that prove fatal. Low-tension supplies are known to be safe but why is the high-tension supply so often treated with the same indifference.

The human body is a conductor of electricity, because of the moisture and fluid in

fatal than if the same voltage is received at two comparatively small areas such as the fingers. It is possible to receive a shock of several thousand volts without any serious permanent effect, but it is interesting to note that execution by electrocution is carried out in America with only 2,000 volts. However, in this case, precaution is taken to ensure good contacts by moistening with brine.

With modern radio apparatus, particularly of the all-mains type, most experimenters have at some time experienced a shock while making an adjustment. Although we are continually adjured to make certain that the mains are "off" before attempting to touch any of the component parts, there is always the temptation to take the risk with the result that a sharp "bite" is often received to remind us of our foolishness.

One point which is sometimes overlooked, is that with an all-mains receiver it is possible to still receive a shock after the mains are switched off. This is due to the fact that with good quality smoothing condensers, the charge will remain on them for quite an appreciable time after the ener-

*If you ever witness a person receive a severe electric shock be careful when rendering first aid.*

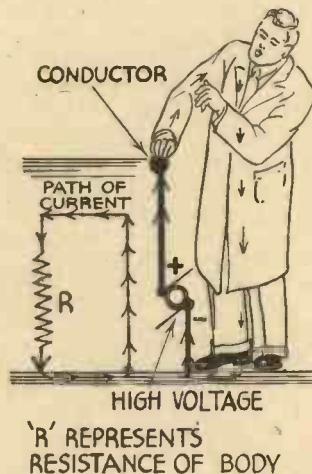

it, but of comparatively high resistance. However, no two bodies are the same as resistors. The resistance will vary over large figures due to the differences in the natural oils and perspiration and also in the thickness of the skin, while varying conditions of heart and nervous system will largely decide the after-effects of the reception of high-voltage shock. For this reason, it is impossible to lay down any hard and fast rules for determining the voltage value that will be fatal in all circumstances. Whereas one man can comfortably hold, without even a jump, two conductors with a potential difference of 200 volts, this voltage has been sufficient to kill others. Not only does this depend on the person but also on the way the shock is received.

### Shock in a Bath

Take, for example, a case where the recipient of the shock is in a bath of water and takes hold of some live conductor, say, a faulty electric radiator. This shock is much more likely to be

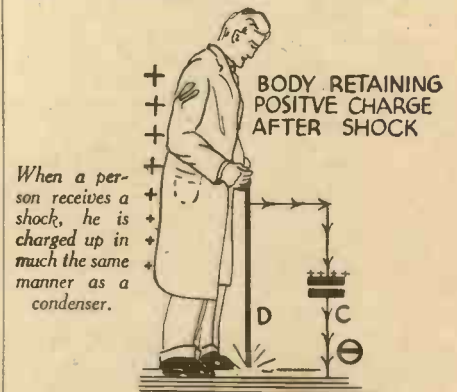

gising voltage has been removed unless some method is adopted for discharging them. It is always possible to be certain that they are dead if the precaution is taken of shorting them before any adjustments are attempted. They should be discharged through a resistance for preference as there is the risk with a dead short of puncturing the dielectric due to sudden surge. Fluctuating currents produce the most unpleasant results. A.C. is particularly vicious. A steady D.C. current gives a shock on first touching the contacts but

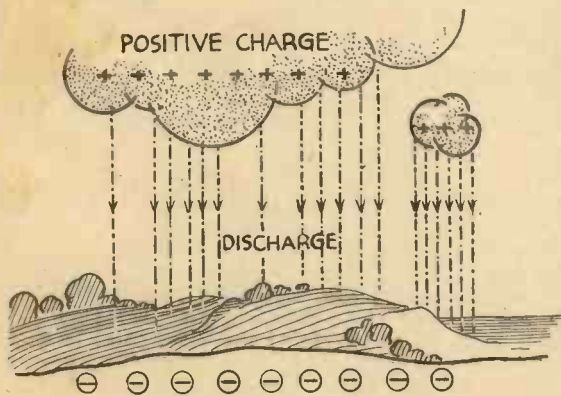

Electrical discharges between clouds and the earth.



produces no further sensation if the contacts are held, provided of course, that the voltage is not sufficient to kill in the first instance. You can try this for yourself on your H.T. battery if you possess a battery set.

Radio-frequency current, even of a high voltage, does not give any shock. The well-known "skin effect" of R.F. current is responsible for this. These currents do not travel through a wire or conductor but over the surface. Likewise the passage of R.F. currents is not through the body but over the surface of the skin and no shock is therefore experienced. The only sensation is a slight tingling at the place coming into contact with the conductor. This is due to resistance at the point of contact and will produce a burn with comparatively low currents. It is of course possible to be badly burnt with A.C. and D.C. shocks. Electrical burns, unlike ordinary fire burns, seem to penetrate into the flesh. No doubt in very much the same manner as one of the carbon electrodes in an arc lamp becomes pitted by burning.

If you are ever unfortunate enough to witness a person receive a shock of high voltage, be extremely careful in rendering assistance. In many cases the muscles are contracted involuntarily by the shock and the victim is unable to use them to release

himself from the conductor. If it is not possible to switch off the current he must be removed by force as soon as possible. It must, however, be remembered that he is

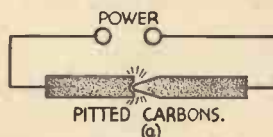

Electrical burns, unlike ordinary fire burns, seem to penetrate into the flesh, in much the same manner as one of the carbon electrodes in an arc lamp.



now a conductor and therefore caution must be used or the would-be rescuer will soon be in the same predicament as the person it was intended to release.

## Non-Conductors

Rubber mats and gloves, although correct in theory, are seldom available in an emergency of this kind when time is an important factor. Anything can be used which will enable a purchase to be obtained on the helpless person while at the same time insulating the rescuer's body from the current. A piece of dry material, paper, straw, brick or wood will be sufficient unless the voltage is exceptionally high when there is the risk of sparking across a short space. It must be remembered that any dampness on these insulators immediately destroys their efficiency.

After the person has been freed from the conductor, first-aid can be applied by wrapping him up in something warm, and if necessary administering a stimulant. If the breathing has been effected, artificial respiration must be adopted. Burns are treated in the same manner as ordinary fire burns.

It has often happened in cases of this kind that the person receiving the shock is charged up, after having been released, with a high voltage, in a similar manner to a condenser. Anyone coming into contact with him is then liable to receive a secondary shock of almost equal severity to the original.

hydrogen has already been dealt with. Bear in mind that hydrogen and air form an explosive mixture when brought near a naked light.

To endeavour to inflate the balloon from an ordinary gas jet is quite useless, owing to lack of pressure. Some kind of force pump or pressure bag, provided with a suction and delivery valve is essential—or if the pressure bag has a tap at the end not fitted to the gas jet then by alternately turning on first the gas tap and turning off the pressure bag tap and doing this alternately and pressing on the bag when the gas tap is off and the other on, the balloon can be filled.

In any case before starting to inflate the envelope it should be well pressed together to squeeze out all the air and any pump or pressure bag must also be worked a few times to get rid of the air with which they are initially filled. If you construct your own force pump it is much better to use gas-taps than valves—in spite of the extra trouble of turning them on and off.

## The Nacelle or Car and the Motor

A small model of this type can only be driven slowly through the air and twisted

should be set at such an angle as to prevent the air from rushing through the slot for the wheel.

## A Polish for Brass and Copper

Take  $\frac{1}{2}$  lb. of rotten stone,  $1\frac{1}{2}$  oz. of oxalic acid, and  $\frac{1}{2}$  oz. of gum arabic. Finely powder these ingredients, then make a paste by stirring into the dry ingredients  $1\frac{1}{2}$  oz. of sweet oil and as much water as necessary.

## Hints on Polishing Ebonite

To polish ebonite thoroughly is a very tedious operation. Most of the work required by the amateur may conveniently be polished in a lathe. After having cut the piece out roughly with a hacksaw, file it to size, using a rough file and taking care not to scratch it on any side that may be already polished. Next use a smooth file

## MAKING A MODERN DIRIGIBLE

(Continued from page 633)

rubber must be used as a motor, say two strands twisted practically the full length of the airship—several thousand turns should be possible—rubber of course well lubricated—do not use any form of geared motor. The twin motors should run from 5 to 10 minutes, and the propellers should not turn at a greater speed than 500 revolutions a minute.

The simpler the form of the nacelle, i.e. the motor rod, the better. For a 12 ft. x 2 ft. model it can consist of a single magnalium or aluminium tube stayed with any necessary kingposts and very fine steel wire. Or you can use instead, three much finer tubes arranged so as to form a triangular-shaped girder, stayed with the same and braced with steel wire as before if necessary. Everything must be kept as light as possible. The nacelle must be hung from the envelope as shown in Fig. 1 and not by parallel vertical threads—swinging backwards and forwards must be prevented.

## POLISHING AND FINISHING METAL

(Continued from page 649)

on it, finishing up with a "dead" smooth file.

Having proceeded so far the work may be taken to a lathe. First use a rather coarse emery wheel, keeping it revolving at a high speed, and above all, for the reason aforementioned, use plenty of oil. Continue using emery wheels, finishing up with a "dead" smooth one. Do not use a finer wheel until all the scratches produced by the previous one are removed by the wheel then being used, for this is the cause of nasty scratches appearing on an otherwise finely polished surface, and to attempt to remove

## The Propellers

These should be constructed of thin steel wire covered with goldbeater's skin and of such a size and pitch that the motor drives them—as already stated—at about 500 revolutions a minute. In proportion these propellers are much larger than those used on model aeroplanes.

## Elevation—Steering

Steering in a horizontal direction can be accomplished by a rudder placed just behind the rear propeller, the framework should consist of thin steel wire covered with goldbeater's skin. For elevation, horizontally revolving propellers are the best, these can be much smaller than the driving propellers, and can be geared to the rubber motors; a simpler way would be to place them horizontally in the slip stream of the driving propellers—I have not actually tried it in practice but such a tiny elevating force is necessary that I do not see why this should not work. On a larger model separate motors could, of course, be used. Finally, so dispose all your weight that your dirigible rides on an even keel perfectly horizontally, and make everything as smooth and neat as possible in order that "skin-friction" be reduced to a minimum.

them afterwards requires a large amount of time.

Having arrived at this point the work should begin to present a fairly good surface. The next step is to use a cloth wheel, using plenty of soap and water. This operation will take considerable time and energy unless the amateur has "power" for his lathe.

During the whole of the polishing operation care should be taken to see that the corners of the work are kept "sharp."

The ebonite should now present a fairly good polish, and it will, in most cases, suffice for the amateur to stop here; but if he desires to obtain a still higher polish he may do so by proceeding as in the last operation, substituting rotten stone soap for bath brick. It will be found that if this method is carried out carefully, excellent results are obtainable.



# THE HOT-AIR ENGINE

*A Low-Power Prime-Mover of Simple Form*

By B. JOY

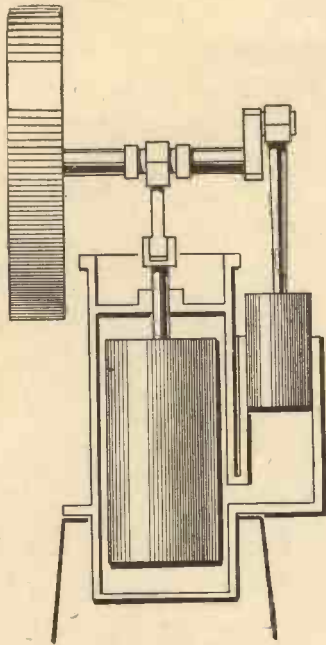

Fig. 1—The simple hot-air engine.

AT a period of engineering development in which the high-speed, high-pressure heat engine so very well performs its many duties, it is not unnatural that a simple little low-power heat engine, depending only upon the expansion and contraction of air in a closed chamber, as does the hot-air engine, should fall into disuse. Such engines are emphatically not capable of providing the high horse-power required for driving modern machines. The bulk and weight of the "caloric" engine—as it was at one time called—is out of all proportion to the power given forth. Indeed it would almost appear that the hot-air engine has no longer a practical use.

Nevertheless, under some conditions these little machines—so free from trouble are they—can be put to work under the care of totally unskilled persons. They will continue to run almost indefinitely with but a few drops of oil to render their joints free and workable and a little water to quench their—not by any means excessive—thirst. And they will do this without any noise or fuss: nor will they emit any foul gasses to pollute the atmosphere, for the hot-air engine does not possess an exhaust. There are things which this motor perfectly well manages to do without—springs, valves, tappets, for example—and the writer has never heard of one of these engines breaking down.

## Low Working Pressure

There are two main reasons for the extremely modest supply of horse-power capable of being provided. In the first case the working pressure is a very low one. One doubts whether the pressure within the cylinder rises 5 lb. per square inch above that of the atmosphere or falls the same amount below it. Secondly, the revolutions of the crank shaft do not in any way compete with those of the petrol engine. Four, five or six hundred revolutions to the minute is quite a good speed for these little motors. (It is indeed a little surprising that the air contained in the system can change its volume with such rapidity merely by contact with the smooth cylindrical walls of the hot and cold chambers.)

The working principle of the majority of these engines is similar though the constructional details have considerable variation.

The working method is thus: A body of air is contained in a closed system. This body of air is transferred from one part of the system, which is retained at a high temperature, to another part which is kept cold. The air is thus alternately heated and cooled. When heated, *increase of volume* occurs which enables pressure to be exerted upon a piston. When cooled the volume of the contained air is *decreased* so that the superior pressure of the atmosphere outside the system can exert itself upon the piston in an opposite direction. Thus although the cylinder—as in the petrol engine—is single ended, the hot-air engine is double-acting.

## The Piston and Cylinder

The piston is usually of fairly normal design—except that as the working pressure is low—rings are not usually fitted. The chamber in which the air is alternately heated and cooled is of cylindrical form and

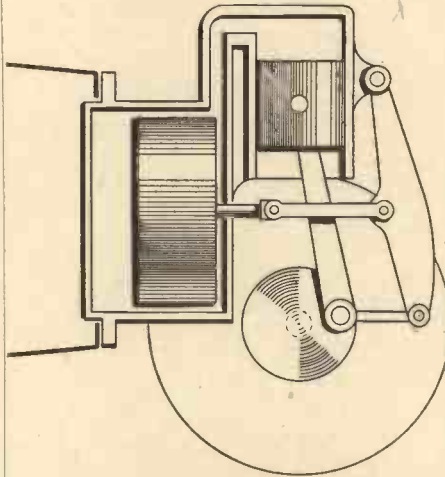

Fig. 3—Another type of hot-air engine.

contains a "displacer," also of cylindrical form, but of slightly less diameter than the containing chamber. The displacer is somewhat shorter than the chamber: thus when the displacer is moved from one end of the chamber to the other the contained air is "displaced" from the hot to the cold side of the container, and *vice versa*. The container is at all times in communication by way of a port with the working cylinder—no interposed valve is necessary.

It will have been realised that the working piston and displacer must have definite relative positions, the one to the other. These parts are, therefore, either coupled to the same crankshaft, the cranks being placed at 90 degrees with the displacer crank leading, or some form of linkage is arranged which produces an equivalent result.

## The Heating Agent

According to the dimensions of the engine the fuel employed as a heating agent may be coal, coke, oil, gas, or in very small examples, methylated spirit. And as regards cooling, engines of fair capacity require water whilst quite small examples can be air-cooled. These engines are not self-starting but like their superior brethren

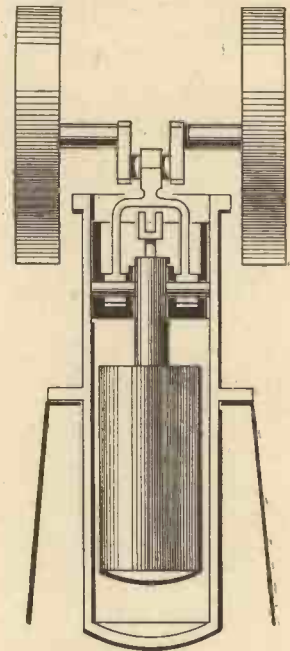

Fig. 2—Modified hot-air engine.

—petrol engines—require a few revolutions by hand or otherwise.

## Types of Hot-air Engines

Now a few well-known types of hot-air engines will be discussed with the aid of diagrams. Fig. 1 shows perhaps the simplest and most direct construction. Both displacer and piston are connected to the cranks of a common crankshaft—the displacer chamber being heated by flame beneath it and cooled by water above it. As the two cranks are disposed at 90 degrees to one another, the displacer will be either at extreme top or bottom position when the piston is at half-stroke position—and therefore capable of exerting its greatest thrust on its crank-pin. The reader of these notes should observe that in passing from one side of the displacer to the other through the narrow circular passage indicated in the figure, transfer of heat takes place *on* from the displacer. For example, the hot air passing upwards on descent of the displacer parts with some of its heat to the displacer, whilst the reverse action takes place when the displacer travels downwards, and adds to the efficiency of the machine.

In Fig. 2 a modified form of engine is illustrated. Here the displacer and working piston have a common axis. A small hollow trunk-like extension of the displacer passes centrally through the piston. The connecting rod is forked to clear this obstruction and the gudgeon pins are in duplicate. The displacer is reciprocated by a system of linkage not shown in the diagram, but the relative movements of piston and displacer are similar to those described in connection with the previous figure.

Fig. 3 indicates, again diagrammatically, a once very popular form of engine. In this case, in place of the two leading moving parts—displacer and piston—being coupled to crank-arms disposed at right angles to one another, these two parts themselves move on axis at right angles. Hence both parts can be—and are—coupled to the same crank-pin. A balanced disc-crank is used. The piston reciprocates on a horizontal axis, whilst the displacer moves vertically up and down. In order to conveniently couple the displacer to the crank and adjust the stroke of the former a system of links and an overhead rocking arm are brought into use.



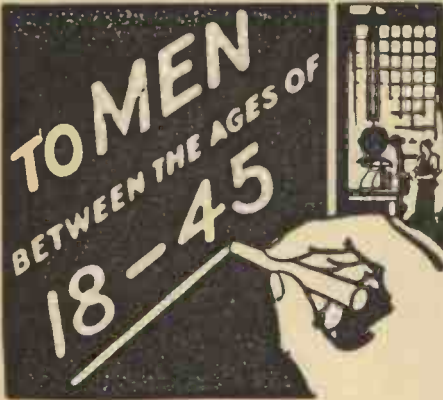

Things are happening to-day which vitally affect you!

If you are about 18, perhaps you are getting settled in your chosen work and already feeling the strain of competition for a better position. If you are in the 40's, your family responsibilities are near the peak, the necessity for money is tense—and younger men are challenging your job. And men of the ages between 18 and 45 face similar problems, in one form or another.

The most valuable employment security to-day is the security a man creates for himself—in himself! Through training, he is able to adapt himself to new conditions, to utilise experience without being handicapped by habit! He masters jobs and makes new jobs. He meets emergencies—and is not overwhelmed by them. And this is an age of emergencies.

For 45 years the International Correspondence Schools have helped thoughtful and ambitious men to acquire the training they need. To-day, with this need more urgent than ever, this world-famous institution offers greater opportunities than ever. Why not permit us to show you the way to greater security and larger earnings? Our expert advice is free. Write to-day.

.. COUPON FOR FREE BOOKLET ..

INTERNATIONAL CORRESPONDENCE SCHOOLS, LTD.,  
Dept. 95, International Buildings, Kingsway, London, W.C.2.

Please send me your booklet containing full particulars of the Course of Correspondence Training before which I have marked X. I assume no obligation.

- |   |  |
|---|--|
| <input type="checkbox"/> Accountancy                    | <input type="checkbox"/> Mechanical Engineering        |
| <input type="checkbox"/> Advertising                    | <input type="checkbox"/> Mining Engineering            |
| <input type="checkbox"/> Aeronautical Engineering       | <input type="checkbox"/> Motor Engineering             |
| <input type="checkbox"/> Architecture                   | <input type="checkbox"/> Plumbing                      |
| <input type="checkbox"/> Bookkeeping                    | <input type="checkbox"/> Radio                         |
| <input type="checkbox"/> Building                       | <input type="checkbox"/> Railway Equipment and Running |
| <input type="checkbox"/> Chemical Engineering           | <input type="checkbox"/> Salesmanship                  |
| <input type="checkbox"/> Civil Engineering              | <input type="checkbox"/> Steam Engineering             |
| <input type="checkbox"/> Draughtsmanship                | <input type="checkbox"/> Textiles                      |
| <input type="checkbox"/> Electrical Engineering         | <input type="checkbox"/> Woodworking                   |
| <input type="checkbox"/> Engineering Design             |  |
| <input type="checkbox"/> Marine Engineering             |  |
| <input type="checkbox"/> Examinations, state which..... |  |

The I.C.S.I. teach wherever the post reaches and have a wide variety of courses of Study. If, therefore, your subject is not in the above list, write it here.

Name .....

Address .....

# SIMPLE MOVING PICTURES

A Simple Piece of Apparatus Capable of Producing Moving Pictures

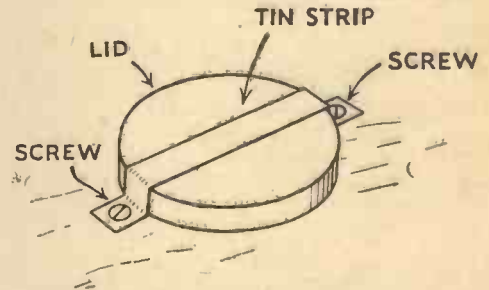
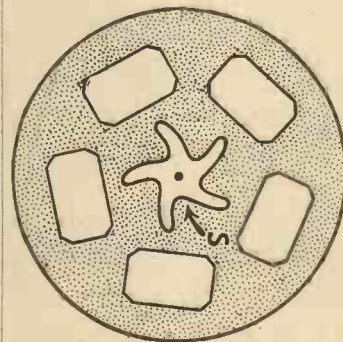

Fig. 1.—The finished apparatus.

BY means of the simple apparatus described here, it is possible to produce moving pictures of an amusing character from snapshots taken with an ordinary camera. Details of the parts required to

make the device are given in Figs. 4, 7, 8, and 9.

The piece marked S, shown in Fig. 7, should be cut from 1/4-in. plywood. It will be seen in Fig. 4 that the photographs are stuck on a cardboard disc A and disc B should be stuck over A in such a way that the photographs show through the holes C, D, E, F, and H. S must then be fixed to the centre of disc B as shown in Fig. 2.



Figs. 2 and 3.—(Left.) The five-armed device fitted to the centre disc and (right) How the stone weight is held in place by means of a tin lid.

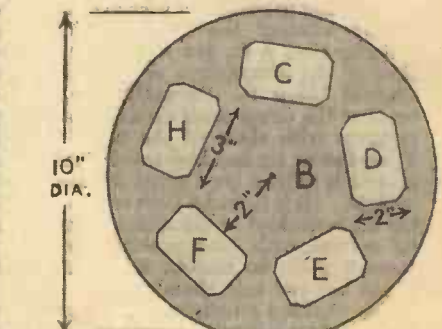
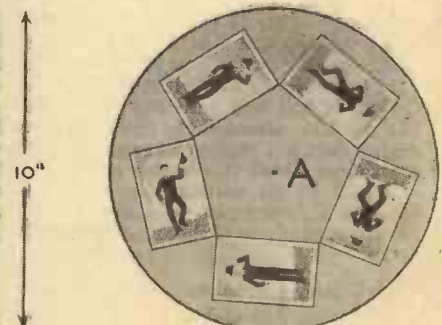
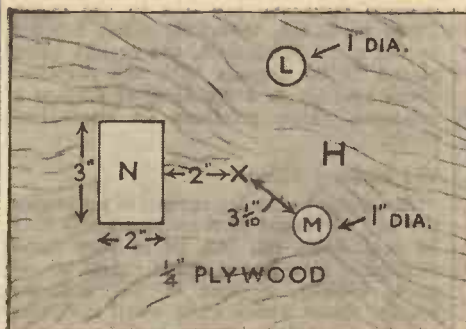
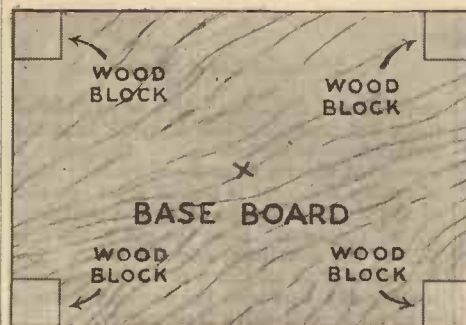

Fig. 4.—Details of the back and front and the two discs.



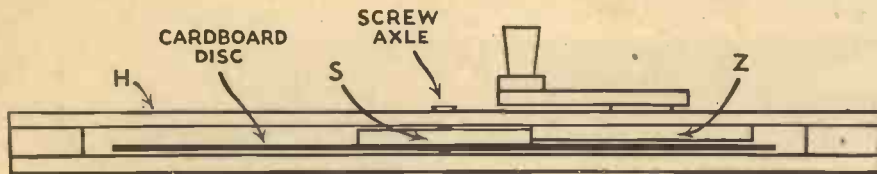

Fig. 5.—A side view of the apparatus.

**Constructional Details**

Attach the circular piece of wood *W*, Fig. 8, to *Z* at the position indicated by the dotted circle, and then fix *Z* in position as shown in Fig. 6. A detail sketch of the handle which is attached to *W* is given in Fig. 9.

It should be noted in Fig. 6 that *W* works in the hole *M* like an axle, and *Z* can be made to revolve by turning the handle.

**Baseboard Fixtures**

The method of fixing *H* to the baseboard is shown in Fig. 1. Four small wooden

apparatus, and is indicated by *X* in Fig. 4. Obtain a weight, such as a small circular stone, and drop it in the hole *L*, Fig. 4, so that it rests on the cardboard disc. Then fix a suitable cover over the hole to keep the stone in position. The lid of a cocoa tin will be found to be ideal for this purpose, and may be fixed as shown in Fig. 3.

As the stone is intended to prevent the disc from skidding when the apparatus is working, it must be the correct size and weight.

If it is too heavy or too light the efficiency of the apparatus will be effected. Therefore it is advisable to experiment with a

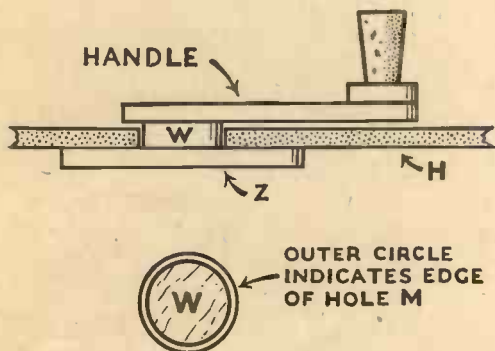

PLAN SHOWING HOW *W* FITS INTO HOLE *M*

Fig. 6.—How the handle is fitted into place.

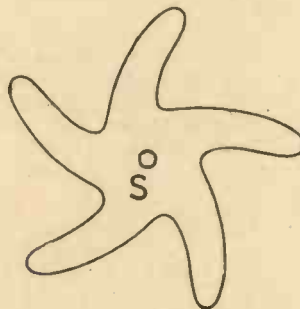

Fig. 7.—Showing the five-armed device.

blocks are attached to the baseboard and *H* is simply mounted on these with screws. See also Fig. 4. A long wood screw serves as an axle for the cardboard disc, which, when in position, rests on the baseboard underneath *H*.

**The Screw Axle**

The position of the screw axle is clearly shown in the sketch of the complete

number of stones before selecting one. When this has been done the apparatus is ready for use.

**Suitable Photographs**

Perhaps the most suitable subjects for the moving pictures are a boxing match or a person dancing.

The dancing effect is obtained by taking five photographs of a person in five different attitudes suggestive of dancing.

When the photographs have been mounted in the apparatus and the handle is turned, the moving pictures can be seen in hole *N*, Fig. 4.

The same principle is used for making the moving pictures of the boxing match, or any other subject.

The effect is caused by *Z* engaging *S* in such a way that the cardboard disc revolves in a series of equally spaced movements (see Fig. 5).

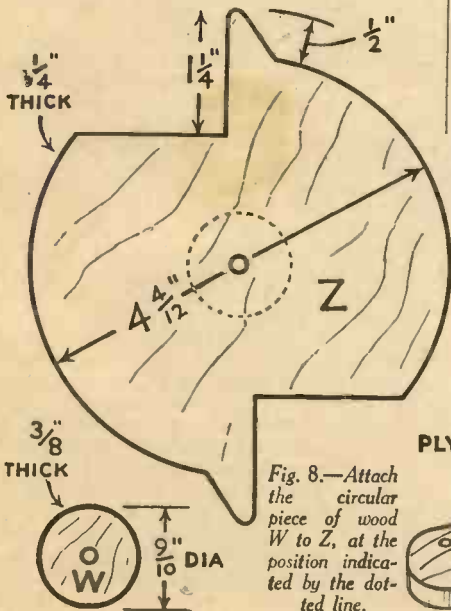

Fig. 8.—Attach the circular piece of wood *W* to *Z*, at the position indicated by the dotted line.

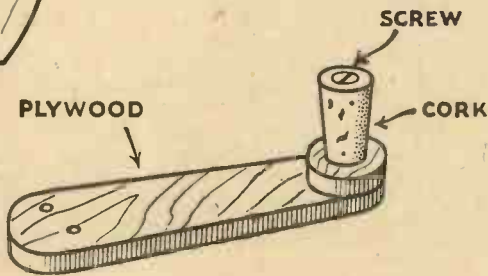

Fig. 9.—Details of the turning handle.

# Don't leave things to 'Fate'—let PELMANISM help you carve out your own path

What do you think we are meant to do with our lives? Are we to take what Fate gives us from day to day; or are we to guide our own destiny to the best of our advantage? Surely the latter way is the way to Success and Happiness.

**The Drifters**

Those who drift gently wherever the stream of life takes them very soon find themselves in a backwater. These people have lost the urge to better themselves. No wonder they become discontented, for they have no purpose in life.

**What Pelmanism does for you**

A course of Pelmanism kindles the flame of your ambition and prevents you 'giving in' to life. It trains your powers of thought and develops other sides to your nature, helping your personality and inner character to become stronger, your vitality and capacity for enjoyment greater.

Confidence and initiative are given to the bashful and reserved; keen, retentive memories take the place of forgetfulness and absent-mindedness. In fact, Pelmanism proves itself a training for every kind of man and woman in every kind of life.

The course is very simple to take, and if you don't want to pay the full fee straight away, you can make a start by forwarding a small first instalment. In any case, send the coupon below for the remarkable free book entitled "The Science of Success."

**What Pelmanism has done for others**

"I have derived great benefit from the course. An all-round improvement in memory and self-confidence, there are no fears now; I have recently carried through two engineering jobs said to be impossible by experts and due largely to Pelmanism."—Engineer (H. 5269).

"Within six weeks I received promotion to a better and more responsible position. This has been entirely due to your training as I have more self-confidence and am keener and more accurate at my work."—Shop Assistant (H. 5033).

"I have been appointed Manager and Buyer at a salary of nearly 150 per cent. increase over my last position. I must give credit to my Course in Pelmanism."—Manager (P. 39212).

**GET THIS OFF TO-DAY!**

**TO THE PELMAN INSTITUTE,**  
130 Pelman House, Bloomsbury Street,  
London, W.C.1.

Please send me, gratis and post free, a copy of "The Science of Success" and full particulars of the Correspondence Course in Pelmanism.

NAME .....

ADDRESS .....

Occupation .....

All correspondence is confidential.

PELMAN (OVERSEAS) INSTITUTES: PARIS, 80 Boulevard Haussmann. NEW YORK, 271 North Avenue, New Rochelle. MELBOURNE, 396 Flinders Lane. JOHANNESBURG, P.O. Box 4928. DURBAN, Natal Bank Chambers (P.O. Box 1489). CALCUTTA, 102 Clive Street, DELHI, 10 Alipore Road. AMSTERDAM, Damrak 68.



## ELECTRADIX BARGAINS

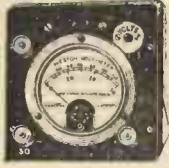

**WESTON TABLE TEST SETS** in unused condition, Model 301, Moving Coil Weston Voltmeter 0-30 mounted flush in shunt panel on table brackets, space at back for cell, five terminals and test key. Three Guinea Bargain at 18/6 to clear, limited number.

**TELEPHONES.** The cheapest tester is a pair of 2/9 Sullivan phones and a 6d. cell for any circuit. For short-



wave sets Western Electric 2,000 ohms, 4/3 pair. Ericsson, 4/6.

**CRYSTAL SETS** (for crystal-pure reception). Table type "A," 7/6. Double circuit type "B," 10/6.

**THE SUPERSEDER L.T. 2 V. battery**, rectified and smoothed, three tappings, lasts indefinitely, a boon. List 23 5s. New, guaranteed, 37/6.



**NEW STOCK OF CHARGERS.** H.T. & L.T., off A.C. Mains for 2 to 80 Cells. Certain money spinners at bargain prices. All sizes. State wants.

**EDISON STEEL CELLS.** We have some of these high capacity discharge cells cheap up to 400 ampere hours.

**COIL TURN COUNTERS**, for checking the number of turns up to 9,999 on dial, solled, 1/3 each.

**MOTOR INTERRUPTERS**, for converting any volts, D.C. to A.C., takes 12 V., 15/-.

**X-RAY TUBES.** Brand new, 7 bulb, 10/- each, packing and carriage 6/- extra.

**FLUORESCENT SCREENS, Plate Holders** 10 ins. and 15 ins. Coils Cheap.

**VACUO RESISTORS**, wire ends, suitable where a 1-watt resistance is specified, 250,000 ohms, 1 meg., 2 meg., value in ohms, 4d. each. Wire-wound 6 ohms strip, 6d.; 10 ohms, 7d.; 200 ohms, 1/-; Mica, 35 W., 150 ohms, 2/6.

**HOME RECORDING.** New Tracker Sets, geared drive with Cutter Head, Diamond Needle and blanks. Bradford, 37/6. Feigh, 27/6. Spare blanks, 4/- doz. Electric Gramo. Motors, powerful Panatrope, 23/10/-. Small types, Blue Flyer, 50/-; Patent, 45/-; H. M. Victor, 35/-.

**35 mm. FILM PROJECTORS.** "Williamson" & "Ciné Chrome," with lenses, etc., and Spools, Arc and Lantern, on floor pedestal, motor drive, 26/5/-.

**NEW STOCK OF CHARGERS.** H.T. & L.T., off A.C. Mains for 2 to 80 Cells. Certain money spinners at bargain prices. All sizes. State wants.

**EDISON STEEL CELLS.** We have some of these high capacity discharge cells cheap up to 400 ampere hours.

**COIL TURN COUNTERS**, for checking the number of turns up to 9,999 on dial, solled, 1/3 each.

**MOTOR INTERRUPTERS**, for converting any volts, D.C. to A.C., takes 12 V., 15/-.

**X-RAY TUBES.** Brand new, 7 bulb, 10/- each, packing and carriage 6/- extra.

**FLUORESCENT SCREENS, Plate Holders** 10 ins. and 15 ins. Coils Cheap.

**VACUO RESISTORS**, wire ends, suitable where a 1-watt resistance is specified, 250,000 ohms, 1 meg., 2 meg., value in ohms, 4d. each. Wire-wound 6 ohms strip, 6d.; 10 ohms, 7d.; 200 ohms, 1/-; Mica, 35 W., 150 ohms, 2/6.

**HOME RECORDING.** New Tracker Sets, geared drive with Cutter Head, Diamond Needle and blanks. Bradford, 37/6. Feigh, 27/6. Spare blanks, 4/- doz. Electric Gramo. Motors, powerful Panatrope, 23/10/-. Small types, Blue Flyer, 50/-; Patent, 45/-; H. M. Victor, 35/-.

**35 mm. FILM PROJECTORS.** "Williamson" & "Ciné Chrome," with lenses, etc., and Spools, Arc and Lantern, on floor pedestal, motor drive, 26/5/-.

Send for Radio-Electrical-Scientific List "P.M."

## ELECTRADIX RADIOS

218 Upper Thames Street, E.C.4.

Telephone: Central 4611.



**"CORREX" ROLL FILM DEVELOPING TANKS ARE THE BEST!**

The "Correx" Roll Film Developing Tank represents the simplest, safest and most certain way of developing roll films. Any amateur using a "Correx" according to the simple instructions can be sure of obtaining properly developed negatives.

- "Correx" Tank for V.P. Films ... .. 25s. 0d.
- "Correx" Tank for 3½ x 2½ in. films ... .. 25s. 0d.
- "Correx" Tank for 4½ x 2½ in. films ... .. 30s. 0d.
- "Correx" Thermometer (Fahr.) ... .. 2s. 6d.
- "Correx" Developing Powders, 6 pairs ... .. 1s. 6d.

SANDS HUNTER & CO. LTD., 37 Bedford St., Strand, W.C.2.

## "WILCO" MAINS MOTORS

These Induction Type Motors, for 200/220 or 230/250 A.C. supply, have heavy ground-steel shafts with large, bronze bearings. Constant lubrication is by thick felt oil-retaining washers. Silent and powerful running, H.P.M. 3,000.

1/10th H.P. Model, costs only **39/-**

1/40th H.P. Model **22/6**

Supplied complete with lead and plug.

There are also "Wilco" geared and ungeared types for A.C. or D.C. 40-p. Catalogue "P.M." 3d.

All "Wilco" goods can be obtained from your Local Dealer; if any difficulty, write us.

**L. WILKINSON, "Electric House,"** 204 Lower Addiscombe Road, CROYDON.

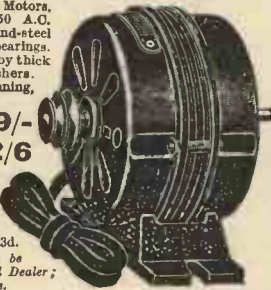

# Money Making IDEAS

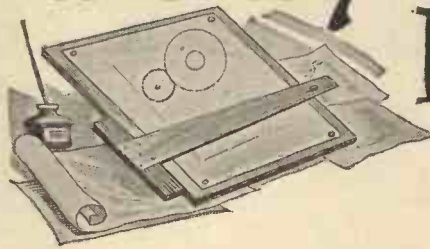

Advice by our Patents Expert

### A CAPTIVE TUBE CAP

"WILL you please advise me if you think the enclosed idea, for a captive cap for collapsible tubes, is novel and fit subject for letters patents, also, what commercial value do you think it will be?" (H. L., Yorks.)

THE improved cap for collapsible tubes, is from personal knowledge thought to be novel and forms fit subject matter for protection by letters patents.

The invention is ingenious and appears to be a practicable construction. If the invention is novel and is practicable, as it appears to be, it should have a distinct commercial value. We would advise you to apply for a patent application with a provisional specification, which will give you about 12 months in which to ascertain if the invention is likely to be a success.

### FOR CYCLISTS

"I HAVE devised a type of stem and clip, which, when fitted, would provide handlebars of practically every type. The stem is cylindrical, and on it is a clip which is free to move from the extreme end of the stem to the bearings. It can also be turned upside down.

"I wonder if this idea is of any use." (T. S., Edinburgh.)

THE suggested stem and clip for handlebars is ingenious and should be a practicable construction, but it is difficult to see how such a device can be protected.

The clip is not thought to be novel, neither is the stem, the latter relying for its novelty on its particular shape, which, if novel, but this is doubted, could be registered as a Design. The clip, which need not necessarily be used with the particular-shaped stem, might possibly also be registered as a Design. It is not thought that the clip contains sufficient subject matter to support a valid Patent, and the stem could certainly not be patented, neither does the combination of the clip and stem form a combination which can be validly patented.

### A NEW TYPE OF SAUCE BOTTLE

"I WOULD appreciate your advice and opinion on the following idea.

"I have found that sauce bottles have a habit of falling over and breaking other articles on a table, and I have therefore designed a bottle to overcome this difficulty. The cap does not project over side of the bottle and therefore it would not make any difference to packing cartons. The sauce is poured out by slightly turning or tipping the bottle." (L. M., Bucks.)

THE suggested shape for sauce bottles if novel, could be registered as a Design. It is not fit subject matter for protection by Patent.

It is not thought, however, that the particular shape of bottle is novel. It is believed that a liquid dentifrice sold under the registered Trade Mark "Odol," if not at present sold in somewhat similar-shaped bottles, was so sold before 1914. Should this prove to be the case, it would, of course, not be possible to obtain registration for the particular shape, irrespective of its contents.

### SELLING IDEAS

"BEING of a very inventive turn of mind and not being able to afford the expense of model-making and Patent protection, can I sell good inventive ideas to manufacturers?" (D. D., Pontardawe.)

UNLESS you are prepared to protect your inventions by filing Patent Applications, it is not possible, without running grave risks, to obtain financial help in getting your inventions marketed. Many firms will refuse to consider any inventions unless it is first protected, for obvious reasons. As you are not in a position to afford the cost of Patent protection, the only alternative is to interest a friend for a share in any ultimate profit, to advance sufficient funds to enable the inventions to be protected.

### A SELF-INKING RUBBER STAMP

"ENCLOSED is a sketch of a rubber date stamp that is fitted with a self-inking device. As you know the present type of stamp has to be inked by a separate pad after every stamping. My idea would make the stamp self-contained and entirely automatic.

"Do you think there is any possibility in this idea? If so, could you please let me have the names and addresses of any firms you think would be interested." (O. S., Worcester.)

THE broad idea of making an india rubber stamp self-inking, is not thought to be novel. We believe that india rubber stamps provided with an inking roller are already on the market, but the particular construction proposed may be a novel one, and if so would form subject matter for protection by Letters Patent. We advise you to make a search amongst prior Patent Specifications relating to the subject before expending money in either making a model or protecting the invention.

It is not advisable to submit any invention to firms likely to be interested in an invention before protection is obtained. If, after a search has been made, and the invention is found to be novel, it would be as well to protect the invention by filing an Application for Patent with a Provisional Specification before submitting it to firms interested in such devices.

The following are names and addresses of firms interested in rubber stamps: H. Savage Ltd., 96/98, Old Street, London, E.C.1; Wood & Palmer, 23, Ivy Lane, Newgate Street, London, E.C.4; Albert & Edwards, 6, Bow Lane, Cheapside, London, E.C.4.



**PRACTICAL MECHANICS**

*Replies to  
Queries and Enquiries*

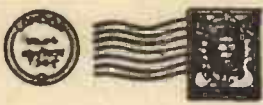

If a postal reply is desired, a stamped addressed envelope must be enclosed. Every query and drawing which is sent must bear the name and address of the sender and be accompanied by the coupon appearing on page 117 of cover. Send your queries to the Editor, PRACTICAL MECHANICS, Geo. Newnes Ltd., 6-11 Southampton Street, Strand, London, W.C.2.

**PLASTICS AND SYNTHETIC RESINS**

"RE the query and answer on p. 323 of your February issue on 'Plastics and Synthetic Resins,' I should like to make these additional queries.

"(1) Can I obtain 'Viscose' or 'Plastic cellulose' ready for use, and if not, at what stage of its manufacture can it be got?

"(2) Where this can be obtained.

"(3) I believe viscose can be poured (hot?) into moulds, and if this is so, of what metal should these moulds be made? Can plaster moulds be used if treated somehow? I desire as polished a surface as possible without much working.

"(4) I desire various colours, is this possible?

"I desire to use this material as a substitute for certain small enamelled plaster models, and would appreciate any further information you can give me." (W. D., London, W18.)

YOU can obtain plastic celluloses from several sources. Probably the most suitable for your purpose would be "Celastoid S.G.," which is a specially soft plastic cellulose acetate. It is odourless and will only burn when in direct contact with a flame. This material is obtainable from British Celanese, Ltd., Spondon, Derby.

Viscose can be moulded hot or cold, but this material is more suitable for drawing out into threads. Commercial moulds for plastic moulding are almost invariably composed of special tough steel which is sometimes chromium-faced. There is, however, no reason why you should not make a success of cold moulding, using plaster moulds. Such moulds could be given a smooth surface by impregnating the plaster with size solution and subsequently by polishing the plaster surface, first with the finest sandpaper and finally with a little jewellers' rouge.

Some plastic materials can be dyed by the addition of aniline dyes. Others can be coloured by the incorporation of insoluble pigments. As regards this matter, therefore, it will be a case of trial and experiment on your part.

A good book on the subject which you might be interested in is: *Synthetic Resins and Their Plastics*, by C. Ellis. (35/- nett.) This, however, deals more exclusively with the usual types of heat-moulding compositions.

**HOMBERG'S PHOSPHORUS**

"CAN you please give me some details of the manufacture of Homburg's pyrophorus, which, I believe is made by heating alum and flour in some way.

"Is it possible to buy pyrophorus already prepared, if so, could you let me know where I can obtain it?" (W. Y., Hornsey.)

BY "Homburg's pyrophorus" we presume you mean Homburg's phosphorus,

which is an impure form of calcium chloride. This material does not luminesce well and it is not manufactured commercially. You can, however, if you wish, prepare it by dissolving lime in strong hydrochloric acid and by strongly heating the residue mixed with a very small quantity of flowers of sulphur. The product must be exposed to strong sunlight before it will show luminescent powers.

A much better luminescent material is "luminous zinc sulphide," which can be obtained from The British Drughouses, Ltd., Graham Street, City Road, London, N.1.

**SILVERING MIRRORS**

"PLEASE advise on the constituents of the mercury-tin amalgam for 'silvering' mirrors and the method of applying same." (F. M., Folkestone.)

THE mercury-tin amalgam used for mirror-silvering consists of one part of mercury to four parts of tin. Owing to its difficulty of application, amalgam silvering is not much employed nowadays, chemical silvering, or the chemical deposition of silver in mirror condition, being used instead.

Tin amalgam is usually applied to glass surfaces in the following way:

A sheet of thin tinfoil, free from tears or creases, is laid down upon a perfectly level iron surface. A layer of mercury is then poured upon the tin so that it covers it evenly. The glass to be silvered is then slid on the mercury-covered tin foil in such a manner that no air bubbles are left between the two surfaces. Weights are then placed on the glass and it is left undisturbed for three days. After the elapse of this time, a tin amalgam will have been formed and it will adhere tenaciously to the glass, provided that the latter has been well cleaned and is free from grease.

A tin amalgam may, also, be prepared separately and then "wiped" on the clean glass surface, but, by this method, it is difficult to get even the cleanest glass surface to "take" the amalgam evenly.

**BREAKING DOWN WATER**

"I HAVE been experimentally breaking down water by electrolysis, working with a voltage at 200 A.C. I find that after a very short time, the plates and container get very hot, and the water gives off a vapour and boils away.

"Am I using too high a voltage, or should I have special plates." (R. P., London.)

THE sole cause of your trouble is that you have been attempting to electrolyse water with an alternating current supply, which, from a practical standpoint, is impossible. You must use a direct current for the purpose. Also, a voltage of between 6 and 12 volts is quite sufficient for the purpose and a higher voltage should not be used. Special plates are not required, but

**HEIGHT DOES COUNT**



**Achieve It Easily**

Short people can be made taller with the aid of a box of Challoner's Famous Formula—

**H.T.N. TABLETS**

and easy system: well tried: harmless and safe. No strenuous exercises or old-fashioned appliances. If one box is insufficient, we guarantee to supply a further box FREE of all charge. E.H. (Sutton) writes: "Results beyond expectations and I am as pleased as Punch." Act NOW! Send 1½d. stamp for full particulars in sealed envelope. Sample 7½d. Book on height improvement 3d. P.O. or stamps only. Colonial Return Air Mail 1/- extra.

THE CHALLONER CO. (late of Bond St.)  
Department J49, Laboratory and Works:  
HYDE HEATH, AMERSHAM, BUCKS.

**Engineers' Guide**

Bright Prospects and Big Pay Opportunities for the trained man

Write to-day for this great Guide which contains world's widest choice of home-study engineering courses—over 200—and shows how to obtain a recognised Qualification such as A.M.I.Mech.E., A.M.I.E.E., A.F.R.Ac.S., etc. Mention branch, post or qualification that interests you, to THE TECHNOLOGICAL INSTITUTE OF GREAT BRITAIN, 122 Temple Bar House, London, E.C.4. (Founded 1917. 19,000 Successful.)



To Success

**BE TALL**

Your Height increased in 14 days or money back. The amazing Stebbing System soon brings 3-5 inches increase and new energy. The first, original and the one GENUINE GUARANTEED Height Increase System. Recommended by Health and Efficiency. Complete Course, 5/-, or Booklet free, privately.

STEBBING SYSTEM, Dept. M.P., 28, Dean Rd., London, W.1.

**WEBLEY AIR PISTOLS**

Marvellously accurate for target practice.



No license required to purchase.

Senior 45/-, Mark 1 30/-,

Junior 20/-, Webley Air Rifle 80/-

Write for List. WEBLEY & SCOTT LTD.,

106, WEAMAN STREET, BIRMINGHAM, ENG.



# BECK'S CHEMISTRY

**EQUIPMENT  
APPARATUS AND CHEMICALS  
FOR STUDENTS' LABORATORIES**

**SPECIAL PARCEL OF APPARATUS:**

- 1 Flask, flat bottom, 150 c.c.; 1 Beaker, spotted, 100 c.c.; 3 Test Tubes, 4 in. x 1/2 in.; 1 Thistle Funnel, 20 cm.; 3 ft. Glass Tubing; 1 Rubber Cork, 2 holes; 4 inches Rubber Connection Tubing; 1 Glass Stirring Rod; New Catalogue.

**2/6**

POST FREE

If this selection of apparatus is not what you require, write for NEW CATALOGUE containing full details of other sets from 2/6 to 105/-.

**BECK (Scientific)** 60 HIGH STREET, STOKE  
Dept. A.) NEWINGTON, LONDON, N.16  
Booklet of Experiments 6d. (P.O.) post free.

## The DOSSSETT Studio

**SPECIALISTS IN  
TECHNICAL  
ILLUSTRATIONS**



Write or 'phone us at  
**HIGH HOLBORN HOUSE,  
HIGH HOLBORN, W.C.1.**

HOL. 8638.

**"UNO"**  
TRADE MARK  
**PEN STENCILS**

for  
Lettering

POSTERS · SHOWCARDS · PRICE TICKETS  
ENGINEERS' & ARCHITECTS' PLANS, ETC.

OBTAINABLE FROM THE PATENTERS AND MANUFACTURERS—  
**A. WEST & PARTNERS, 36 BROADWAY, LONDON, S.W.1.**  
AND ALL DRAWING OFFICE MATERIAL DEALERS.

## PRACTICAL HINTS ON PATENTS

Sent free on application

**THE IMPERIAL PATENT SERVICE**  
First Avenue House, High Holborn, W.C.1.

Preliminary Consultation Free.

### INVENTORS:

## VALUABLE GUIDE

General Advice Free. POST FREE 6d.

**CHATWIN & CO.** Est. 1880

Regd., Patent, Design and Trade Mark Agents for all countries.

253 (D) Gray's Inn Road, London, W.C.1

## THE WEBLEY SERVICE AIR RIFLE MK II

NO LICENSE REQUIRED TO PURCHASE  
WRITE FOR DESCRIPTIVE FOLDER

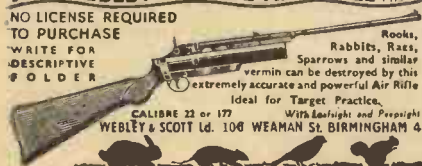

the water should be made acid by the addition of a few drops of sulphuric acid in order to render it readily conductible.

### MAKING NAIL POLISH

"I WISH to make some celluloid varnish to be used as 'Nail varnish.' I have tried dissolving celluloid cut up into small pieces with amyl acetate. The result is quite satisfactory except that the resulting product does not dry glossy. I have also tried celluloid dissolved in a mixture of amyl acetate and acetone, but here again it will not dry glossy.

"Is there anything else which can be added to get the desired effect?" (C. B. J., Peterborough.)

WE are surprised to learn that your experimental nail varnishes have not dried out in the glossy manner required. Celluloid dissolved in 2 parts amyl acetate and 1 part acetone should give a varnish having the desired proportions. Probably your solvents, or the vessels which contained them, held a little moisture. This would inhibit the glossy drying of the varnish.

As an alternative, we suggest that you make up a solution of cellulose acetate in amyl acetate.

We take it that you have been using good quality clear celluloid and not some substitute translucent material which sometimes passes muster for genuine celluloid.

### OXIDISING ALUMINIUM

"I FIND that if I roughen the surface of a clean aluminium plate (e.g. by sandpapering), smear a small quantity of soap over the surface, and rub the surface with mercury, clustering structures composed of a greyish-white powder are formed with amazing rapidity. The rate of growth is approximately 1/4 in. to 1/2 in. during the first half-hour. The reaction takes place after about 1 hour, and may be repeated until the metal is eaten away.

"Is the powder aluminium oxide? If so, is this method of rapidly oxidising aluminium in the air a known method?" (G. E. K., Derby.)

THE phenomenon which you write about is perfectly well known to men of science, although few individuals appear to have actually observed it for themselves.

When the mercury is brought into contact with the soaped surface of the aluminium, the mercury is broken up into a number of tiny globules. These enter into combination with the aluminium surface, forming an amalgam with it. Now, aluminium amalgam is easily oxidised. So rapid, indeed, is the oxidation of this material that it takes place visibly. The aluminium surface, as the saying is, "grows whiskers," such "whiskers" or filaments consisting of aluminium oxide mixed with small traces of mercury and, as you observe, the action can be repeated until all the aluminium is eaten away.

Any grease smeared on the aluminium surface would act as well as the soap. Indeed, without the aid of grease, a clean aluminium surface would show the same effect when brought into contact with mercury, although its rate of oxidation would be very much slower.

So far as we are aware, no commercial application has been made of this reaction in view of the fact that it is impossible to stop the reaction at any given stage, the mercury eating more and more into the aluminium until all the latter is oxidised away.

### DRILL CHUCKS

Straight or No. 1 Morse Taper Shanks  
Cap. 1/2 in. 3/4 in. 1 in.  
1/6 2/3 3/4 ea.



**ALL METAL TWO-SPEED  
HAND DRILL**

**SPECIAL OFFER**



**THE "IDEAL" POCKET  
MICROMETER**

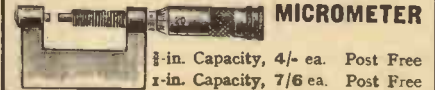

## E. GRAY & SON, LTD.

18-20 CLERKENWELL RD., LONDON, E.C.1  
Established 1822

## JUBILEE WORM DRIVE HOSE CLIPS



The long-life clip with the ever-tight grip

The Best Known For Radiator Joints, Air, Oil, and Water Hose Joints.

Large sizes stop squeaking brakes.

Stocked by all Garages and Accessory Dealers

**L. ROBINSON & CO.,**  
25 London Chambers, GILLINGHAM, KENT.

# Baker's SOLDERING FLUXES

Sold in 6d. and 1/- tins at all Cycle Accessory Dealers, Tool Shops, Ironmongers, etc.

Write for your free copy "Joining of Metals" to

**SIR W. M. BURNETT & CO. LTD** (CHEMICALS)  
GREAT WEST ROAD, ISLEWORTH, MIDDLESEX  
TELEPHONE: HOUNSLOW 0476

## DON'T BE BULLIED



Learn to fear no man. The BEST self-defence ever invented, namely, **3 UITS U.** Easy to learn. Send 2 penny stamps for **SPLENDID ILLUSTRATED LESSONS**, Photo **ANTI-TOLE**, Testimonials and particulars, or P.O. 1/- for **FIRST PART** of my course. You will be more than delighted. A Japanese Secret, Kill Fear Cure, Free to pupils. Dept. P., Blenheim House, Bedfont Lane, Feltham, Middlesex.

## MAKE MORE MONEY

£3 to £6 weekly can be earned at home in a wonderful business of your own. No matter where you live you can commence to make money in your spare or whole time. No risk, canvassing or experience required. A wonderful opportunity for anyone wishing to add pounds to their income. Particulars, stamp.

**BALLARD, 71 Graces Road, LONDON, S.E.5**



# BUY, EXCHANGE OR SELL

Advertisements are accepted for these columns at 2d. per word (minimum 12 words at 2s.—advertisements of less than 12 words are charged at the minimum rate of 2s.), subject to a discount of 2½% for 6 consecutive monthly insertions or 5% for 12 consecutive monthly insertions. **TERMS:**—Cash with order. Cheques, Postal Orders, etc., should be made payable to George Newnes Ltd. *The Proprietors reserve the right to refuse or withdraw advertisements at their discretion.* All advertisements must be received on or before the 5th of the month preceding date of publication and should be addressed to the Advertisement Manager, "Practical Mechanics," George Newnes Ltd., 8-11 Southampton Street, Strand, W.C.2.

## CANOES

**CANOE and BOAT Constructor sets** from 25/-. Canoes, dinghies from £22/-. List stamp, Trade.—Pouncy Products, Wareham, Dorset.

## CINEMATOGRAPHY

**MOVIES AT HOME.** How to make your own Cinema Projector. Particulars free. Movioscope (N), Pear Tree Green, Dodinghurst, Essex.

**ARTISTIC CINE FILMS.** Exclusive 9.5 mm. and 16 mm. productions. List Free. Projectors, Cine Cameras.—P. M. Dane, 64 Stanley Street, Liverpool, 1.

**CINEMATOGRAPH FILMS.**—Standard size from 6d. 100 feet. Machines, Accessories. Sample Films 1/- and 2/6 post free. Catalogues free.—"Filmeries," 57 Lancaster Road, Leytonstone, E.11.

**WANTED for prompt cash.** Home Ciné-Cameras, projectors, films, accessories, microscopes, telescopes, binoculars, optical and mechanical goods. Mathematical and precision instruments. Small lathes. Modern cameras. Enlargers. Frank, 67 Saltmarket, Glasgow.

**"FILM CRAFT."**—Here is a fascinating series of authoritative textbooks for everyone interested in the Cinema as the newest of the arts. The Filmcraft series, each 3s. 6d. net, includes volumes by Pudovkin, Adrien Brunel, G. E. Kendall, D. Charles Otley, Percy W. Harris. Each 3s. 9d. post free from George Newnes, Ltd., 8-11 Southampton Street, Strand, London, W.C.2.

## ELECTRICAL

**ELECTRIC MOTORS, DRILLS, GRINDERS, BATTERIES,** all voltages, from 18/-. Lists free. Repair specialists.—EASCO, Electrical Service, 18 Brixton Road, S.W.8.

**SURPLUS ELECTRICAL** and Engineering Materials, low prices.—The London Electric Firm, Croydon.

**ELECTRIC LIGHTING,** 5/- a point; progressive wiring diagrams and instructions, 6d., materials, wholesale prices; lists free.—P. Symax & Co., 263 Lichfield Road, Birmingham, 6.

## ENGINES

**350 BLACKBURNE Engine** complete with Sturmev Gear Box. Perfect, 35/-.—Marshall, 5 Maple Road, Bournemouth.

## FORMULAS

**OVER 15,000 PROCESSES AND FORMULAS** at your service, from 1/- upwards. **MAKE MONEY** from old Motor Oil, instructions 1/-. How to **SILVER PLATE**, instructions 1/-. Lists, literature, 4d. stamps.—"Technocrat," 41 Longford Place, Manchester.

## LITERATURE

**7,500 different American, English Mechanics, Science, etc. Magazines, Books.** Assorted Samples, 1/6. List free.—P. M. Final, 15 Nashleigh Hill, Chesham, Bucks.

**WALKING TOURS AND HOSTELS OF BRITAIN,** by Sydney Moorhouse. Foolscap 8vo, with maps, 3s. 6d. net. The first comprehensive book covering 14 best districts of Britain with maps and information about routes, stopping places, etc. Officially recognized by the Youth Hostel Association. Ready this spring.—Country Life, Ltd., 20 Tavistock Street, London, W.C.2.

## LITERATURE (continued)

**GARDENS OF ENGLAND AND WALES.** Crown 8vo, 148 pp., 1s. net. New edition for 1936, illustrated and indexed list of gardens open to the public under the Queen's Institute Scheme.—Country Life, Ltd., 20 Tavistock Street, London, W.C.2.

**"SUNG BEFORE SIX,"** by Oliver Linden. Illustrated by Treyer Evans, 3s. 6d. net.—"This is a delightful book of verses, constituting the candid criticisms of a child on his parents, relatives, and those about him, and on life in general. They touch a very human chord, and are always amusing."—"Yorkshire Observer." Obtainable at all Booksellers and Newsagents.—George Newnes, Ltd., 8-11 Southampton Street, Strand, London, W.C.2.

**"A DOCTOR TALKS."**—The most fascinating medical book in the world. The human machine simply and entertainingly explained with 150 amusing sketches by Fouet. Of all Booksellers, 5s. net.—George Newnes, Ltd., 8-11 Southampton Street, Strand, London, W.C.2.

**"WIRELESS FOR THE MAN-IN-THE-MOON,"** by Coulombus and Decibel, 2s. 6d. net.—Writing about the book, the "Midland Daily Telegraph" says: "It is both good fun and sound theory."—At all Booksellers and Libraries, or from George Newnes, Ltd., 8-11 Southampton Street, Strand, London, W.C.2.

## MODEL PETROL ENGINES

### AERO MARINE STATIONARY

The NIPPER AERO 6 c.c., complete with 14" propeller, coil, condenser, petrol tank. Weight 15 ozs. Price **£4/5/0**

Complete set of casting and print, 10/6

Write for catalogue of HALLAM ENGINES. Price 6d.

## J. HALLAM & SON ENGINEERS, POOLE, DORSET



The 'ADEPT' LATHE  
14 in. centres, 6 in. between centres.  
With compound slide-rest, £1, or with hand-rest only, 12/6.  
Screw Tail Stock 5/- extra. Post 1/-.  
THE SUPER ADEPT, 30/-

F. W. PORTASS, 82a Sellers Street, SHEFFIELD.

## MAGIC, HYPNOTISM

**"HYPNOTISM,"** 25 Long lessons, 2/6. **"PARLOR MAGIC,"** hundred tricks, illustrated, 1/3. Lists, catalogue of money-making Books, 4d. stamps.—"Technocrat," 41 Longford Place, Manchester.

**PERPLEXITIES AND TANTALISERS.**—"The Strand Problems Book" is the finest collection of puzzles of all kinds ever assembled, mathematical, geographical, literary—acrostics and codes, by W. T. Williams (Tantalus) and G. H. Savage. Only 2s. 6d. net, from all Booksellers.—George Newnes, Ltd., 8-11 Southampton Street, Strand, London, W.C.2.

## MICROSCOPY

**MICROSCOPIC OBJECTS**—unmounted prepared. Assorted packet 2/-. **MOUNTED SLIDES STOCKED.**—LENG, 183 MANCHESTER DRIVE, LEIGH-ON-SEA.

## MISCELLANEOUS

**BALL-BEARING Plummer Blocks.** ½ in. 1/9 to 1 in. 4/6, Journals half-price. Shafting, Pulleys, Cones, Countershafts from 10/-.—HALL'S, 30 Collindale, ERITH.

## MODELS

**EVERYTHING FOR electrical rewinds and repairs.** Screws, nuts, and washers for model engineers. Lists free.—Lumen Electric Co., Litherland, Liverpool, 21.

**PERFECT secondhand model bargains,** catalogue 4jd.—Model Exchange, 11 Friars Street, Ipswich.

## MONEY-MAKING

**ONE SHILLING** will enable you to make £2 weekly in your spare time.—Basil Dengate, 2 Pound Road, East Peckham, Kent.

**EXCELLENT MONEY-MAKING OPPORTUNITIES** constantly occurring, strongly recommended. Send stamped addressed envelope for free particulars.—Messrs. Green, 17 Church Lane, Hull.

## MONEY-MAKING BOOKS

**BOOK OF 3,000 FORMULAS, RECIPES, PROCESSES,** etc. (368 pages). Also "DIRECTORY" where to buy Chemicals (Wholesale). BOTH sent for 4/9. 500 Methods of making money in spare time, 2/-.—"Technocrat," 41 Longford Place, Manchester.

## MONEY-MAKING OPPORTUNITIES

**START PROFITABLE BUSINESS** in own home, making coloured crayons for writing on Glass, Celluloid, Earthenware, etc. Newest Selling Sensation. Repeat sales. **FORMULE and COMPLETE INSTRUCTION GUIDE,** sent anywhere for 10/-. Samples sent for 2/6.—"Technocrat," 41 Longford Place, Manchester.

## MUSICAL INSTRUMENTS

**BAND GUIDE.** Hints on the Bugle, Drum, Flute, Staff Parade formation, etc. Free, post paid.—Potter's (Manufacturers), West Street, London. W.C.2.

## PATENTS

**REGINALD W. BARKER & CO.** (Established 1886), 56 Ludgate Hill, London, E.C.4.—Patent and Trade Mark Booklets Gratis.

## PHOTOGRAPHY

**"PANTOGRAPHS"** make large accurate drawings from small photographs, printed drawings, etc., easily, 1/-, post free.—Cooke, 33 Hawthorn Road, Levenshulme, Manchester.



# BUY, EXCHANGE OR SELL

## PHOTOGRAPHY (continued)

**£500** worth good, cheap Photo Material, Films, Plates, Cards, Papers, Chemicals, Catalogue and 4 Samples Free.—Hackett's Works, July Road, Liverpool 6.

**DON'T TAKE RISKS.** Good developers mean good results. Our reliable stock developers keep twelve months after mixing. Satisfaction certain to amateurs and professionals. Best developer ever put on the market. Makes two pints strong developer. 6d. each, 6 for 2/3, 12 for 4/-. Post free.—Hackett's Works, July Road, Liverpool 6.

## PRINTING

**"PHOTO-ENGRAVING."** A practical handbook with complete set of materials for engraving printing-blocks, 4/6.—Industries, 13 Gordon Avenue, Twickenham.

## SITUATIONS VACANT

### RADIO MEN WANTED.

Messrs. Marconis anticipate requiring 200 Marine Wireless Operators in the next few months.

TRAINING PERIOD 8/12 MONTHS.

APPOINTMENTS GUARANTEED.

TRAINING FEE CAN BE PAID AFTER SECURING AN APPOINTMENT IF DESIRED. BRITAIN'S LEADING WIRELESS TRAINING CENTRE.

COLLEGE ON SEA FRONT. BOARDERS ACCEPTED.

WRITE FOR FULL PARTICULARS:

**WIRELESS COLLEGE,  
COLWYN BAY,**

Or London Representative, 4 WINTON AVENUE, N.11.

## STAMPS

**RARE** Free Stamp (Choice of 10 cat. to 5/-). Ask Summer Clearance Sale List, hundreds of bargains and great gift scheme.—Burgess & Co., Pembury, Kent.

## TELEVISION

**TELEVISION.**—Newnes Television and Short-wave Handbook, by F. J. Camm, deals authoritatively with Scanning Systems (Drums, Mirror Screws, Discs, etc.), Neon Lamps, The Cathode-Ray Oscillograph, How to Build Short-wave and Ultra-short-wave Receivers. Fully illustrated. 3s. 6d. net. From your Bookseller.—George Newnes, Ltd., 8-11 Southampton Street, Strand, London, W.C.2.

## TOOLS

**GRAYSON'S** Glass-boring Outfits and Tube Cutters avoid risk.—Below.

**DRILLS,** Taps, Dies, Files, Chisels and Punches. Best quality at keenest prices.—Grayson & Company, 800 Campo Lane, Sheffield.

**THE MYFORD 3" LATHE.** The Modern Tool of proved design. As supplied to the leading Engineering Firms of the Country, also well-known "Model Engineers." Be sure you have a "Myford" if you want the best. Illustrated Booklet and address of nearest agent from Myford Eng. Co., Neville Works, BEESTON.

## FREE ADVICE BUREAU COUPON

This coupon is available until Aug. 31st, 1936, and must be attached to all letters containing queries.

PRACTICAL MECHANICS, AUGUST, 1936

## TOOLS (continued)

**"A.J.W." GAS BLOWPIPES.** Invaluable to Mechanics for Soldering, Brazing, Tool Hardening, Metal Melting. Sample C.O.D. 3/- Agents wanted.—Wright, 10 Mitchell Street, E.C.1.

**3 Tons Bright Steel Wood Screws,**  $\frac{1}{2}$ " to 3" long, a special quick clearance offer, 3 lbs. assorted, 2s. 6d.; very good value.—Below.

**2 Tons Best Quality Twist Drills,**  $\frac{1}{2}$ " to 1" diameter, straight shanks. These drills are perfectly new, unused, but are somewhat soiled. We are making this a very special clearance line at the ridiculous price of 5 lbs. assorted drills for 3s. 9d. These drills are best American and British makes, and are certainly a gift at the price.—Below.

**160 Large End Mills,**  $\frac{1}{2}$ " to 1 $\frac{1}{2}$ " diameter, clearing at 3 for 4s. 6d.; Nos. 2 and 3 Morse Taper Shank.—Below.

**120 Bundles Silver Steel,** 1/16" to  $\frac{1}{4}$ " diameter, 18 assorted pieces, 13" long, 4s. bundle.—Below.

**Best Quality British Made Lathe Chucks,** a special purchase enables us to offer the following chucks at much below usual prices. Fully guaranteed high class Precision Chucks, four jaws, reversible, independent chucks, jaws hardened and ground, 3" dia., 18s. 6d.; 4", 24s.; 6", 32s. 6d. each; complete with key and faceplate bolts.—Below.

**Precision Self-centring Chucks,** two sets hardened and ground jaws, 3", 24s.; 4", 26s. 6d.; 5", 30s.; 6", 36s.; 9", 52s. 6d.; 12", 85s. each.—Below.

**20 Only 1" Micrometers,** decimal equivalents marked on frame, usual price, 27s. 6d. each, an opportunity, 16s. 6d. each, all complete in plush lined case.—Below.

**1" to 2" Micrometers,** 23s. 6d.; 2" to 3", 30s.; 3" to 4", 36s.; special quotation for full set High Class Micrometers, 0" to 6", complete on polished wood stand.—Below.

**Drilling and Milling Machine Vices,** a quantity for disposal at extremely low prices. Send for illustrated lists.—Below.

**120 Boxes Swiss Files,** superfine, as used on tool and instrument work, one dozen assorted shapes for high class work, fine tool or gauge making, 4s. per dozen.—Below.

**150 Genuine Norton Grinding Wheels,** saucer shape, suitable for small tool and twist drill grinding,  $\frac{1}{4}$ " dia.,  $\frac{1}{8}$ " thick,  $\frac{1}{2}$ " hole, 1s. 6d. each, 15s. doz.; also 6" dia.,  $\frac{1}{4}$ " thick,  $\frac{1}{2}$ " hole, 2s. 3d. each.—Below.

**30 Bundles Bright Mild Steel,** round,  $\frac{1}{8}$ ",  $\frac{1}{4}$ ",  $\frac{1}{2}$ ", 1" dia. in 5' to 6' lengths, 10s. per bundle.—Below.

**600 High Speed Centre Drills,** three assorted sizes, small to medium, suitable for model makers, 1s. for three.—Below.

**3 Tons Best Sheffield Files,** Flats, Half Rounds, Square, Rounds, in rough and second cut sizes, 6", 8", 10", 12". This is a very special bargain offer, wonderful value, three dozen assorted, 10s.; also large files, 14", 16", 18", dozen assorted 8s. 6d., carr. forward.—Below.

**250 Bundles Bright Drawn Mild Steel,** approx. 5' length each piece, sizes  $\frac{1}{8}$ ", 5/32", 3/16", 7/32",  $\frac{1}{2}$ ", 9/32", 5/16",  $\frac{3}{8}$ ", 7/16",  $\frac{1}{2}$ " round, 5s. 6d. per bundle of 50; also Square Bright Steel, sizes  $\frac{1}{8}$ ", 3/16",  $\frac{1}{2}$ ", 5/16",  $\frac{3}{8}$ ", 7/16",  $\frac{1}{2}$ ", 5' lengths, 6s. bundle.—Below.

**5,000 Small Slitting Saws,**  $\frac{1}{2}$ " dia., 1/32" thick, clear at 2s. per doz.—Below.

**2,000 Slitting Saws,** 2 $\frac{1}{2}$ " dia., 1" hole, 1/64" to  $\frac{1}{8}$ " thick, six assorted, 3s. 6d.—Below.

**1,300 Sets Hexagon Die-Nuts,** Sheffield made, Whitworth, B.S.F., also American thread, U.S.S. and S.A.E. suitable for Ford and other American cars  $\frac{1}{2}$ ", 5/16",  $\frac{3}{8}$ ", 7/16",  $\frac{1}{2}$ ", worth 7s. set, our clearing price, 2s. 9d. set; all the above four sets, 10s. lot.—Below.

**300 Drill Chucks,** takes to  $\frac{1}{2}$ ", three jaws. No. 1 Morse taper shank or  $\frac{1}{2}$ " straight shank, 2s. 9d. each.—Below.

**500 Gross Tungsten Steel Hacksaw Blades,** 8", 9", 10", 12", 1s. 3d. per doz.; 12s. per gross; also Machine Blades, 12" x 1", 2s. doz.; 20s. gross; 14" x 1", 3s. doz.—Below.

**1,200 Best Quality Straight Shank End Mills,** standard sizes,  $\frac{1}{2}$ ", 1s. 3d.; 5/16", 1s. 4d.;  $\frac{3}{8}$ ", 1s. 6d.; 7/16", 1s. 9d.;  $\frac{1}{2}$ ", 2s. each. All right-hand, suitable for use in lathe.—Below.

**800 Sets 1" Circular Dies.** Screwing  $\frac{1}{2}$ ", 5/16",  $\frac{3}{8}$ ", 7/16",  $\frac{1}{2}$ ", Whitworth and B.S.F. Clearing at 2s. 9d. per set. Both sets 5s. Die stocks to suit 1s. 9d. each.—Below.

## TOOLS (continued)

**5,000 Small Grinding Wheels** suitable for Flexible Shaft use, etc.,  $\frac{1}{2}$ " to 1" diameter, assorted thicknesses, etc., brand new, unused, 2s. per dozen.—Below.

**60 Only, Genuine Norton Grinding Wheels,** suitable for general shop use, 9" dia., 1" wide, 1" hole, 4s. 9d. each, also few  $\frac{1}{2}$ " wide, 5s. 9d. each.—Below.

**1,000 Fine Emery Wheels,** 2" to 4" dia.,  $\frac{1}{8}$ " hole,  $\frac{1}{4}$ " to  $\frac{1}{2}$ " thick, slightly used, but quite serviceable, 1s. 6d. per doz.—Below.

**10s. Orders Carriage Paid** except where stated otherwise, steel bars and files carriage extra.—J. Burke, 30 Trippet Lane, Sheffield.

## TRAILERS

**BOAT TRAILERS,** to carry P.M.'s Outboard Motor Boat, from £15/15/0. Set of metal parts to make own Trailer from £11/10/0.—Particulars, Walter F. Young, 11 Burlington Road, Thornton Heath, Surrey.

## WATCH MAKING

**WATCH AND CLOCK REPAIRS.** Everything for the watch, clock and model maker. Large stock of watches, clocks, and clock movements, etc. Wholesale prices. List 3d. BLAKISTON & CO., Ainsdale, Southport.

**WATCH, CLOCK AND JEWELLERY REPAIRS** a speciality. Materials, Tools, Invar Steel and wheel-cutting. Catalogue 6d. Shockproof Watches from 2/3. List 1½d.—Young & Son, Material Dealers, Chippenham.

## WIRELESS

**FIFTY TESTED WIRELESS CIRCUITS,** by F. J. Camm, 2s. 6d.—This handbook contains every modern circuit, complete with instructions for assembling, component values, and notes on operation. 2s. 9d. post free from George Newnes, Ltd., 8-11 Southampton Street, Strand, London, W.C.2.

**"THE MATHEMATICS OF WIRELESS,"** by Ralph Stranger.—This book is essential to the amateur who wants to gain a further knowledge of the subject without loss of time—or temper! Fully illustrated, 256 pages. 5s. 3d. post free from George Newnes, Ltd., 8-11 Southampton Street, Strand, London, W.C.2.

**A DICTIONARY OF WIRELESS TERMS,** by Ralph Stranger. A Wireless Work of Reference that should be on the bookshelf of every keen amateur. Compiled by a master of lucidity, it gives the meanings of all Technical terms in general use. Price 2s. 6d. from all Booksellers and Newsagents.—George Newnes, Ltd., 8-11 Southampton Street, Strand, London, W.C.2.

**FOR THE RADIO ENTHUSIAST.**—"The Wireless Constructor's Encyclopedia," by F. J. Camm (Editor of "Practical and Amateur Wireless"), third edition. Compiled by one of the most accomplished designers and writers on the practical side of Wireless, it covers the whole field. A veritable Treasury of Wireless Knowledge. Price 5s., from all Booksellers and Newsagents.—George Newnes, Ltd., 8-11 Southampton Street, Strand, London, W.C.2.

**EVERYMAN'S WIRELESS BOOK,** by F. J. Camm, 3s. 6d. net. An invaluable book of reference explaining the operation, upkeep and overhaul of all types of wireless receiver. 200 illustrations. From all Booksellers and Newsagents.—George Newnes, Ltd., 8-11 Southampton Street, Strand, London, W.C.2.

## WOODWORK

**SELECTED DASH FOR MOTOR WORK.**—Below.

**CABINET HARDWOODS,** Oak, Mahogany, Ash, Whitewood, Ply-woods, etc. Lowest Prices. Sent Cutting lists. Planning free. Speciality Prime Jap Oak, all thicknesses.—Wilfred Parr & Co., March Works, Lancaster Road Leytonstone, E.11.



# FREE SERVICE FOR READERS

**R**EADERS requiring information concerning goods or services advertised in *PRACTICAL MECHANICS* should give names of Advertisers from whom particulars are desired. Any number of names may be included and we will obtain for you catalogues, lists, and any other information you may be wanting. **THERE IS NO CHARGE FOR THIS SERVICE.**

Readers desiring particulars from a number of Advertisers will, by this method, save time and postage. Half penny stamp only is required if your envelope is left unsealed. If any Advertiser stipulates that stamps or postal orders are necessary before samples or catalogues are sent, please enclose the necessary amount with your instructions. You are cordially invited to make full use of this Service.

Post this to

**ADVERT. SERVICE DEPT.,**  
PRACTICAL MECHANICS,  
8-11 SOUTHAMPTON STREET,  
STRAND, W.C.2

*Please obtain and send to me particulars from the Advertisers in your August issue whose names I give on list attached.*

Advertiser	Page No.	Information Required
------------	----------	----------------------

*Attach sheet of paper, with particulars, and your name and address (written in **BLOCK** letters), with date, to this announcement.*

# IF YOU ARE A CYCLIST . . .

JOIN

THE  
**Cyclist**

## ROAD CLUB



Here is the coat badge of the Club. Actual size: 3 in. diameter. Colour: silver, black and green. With strong safety-pin fastener

**Badge, Handbook, Touring Facilities, Free Advice, Great Free Insurance for Readers!**

"THE CYCLIST" ROAD CLUB is a great new project open to every Registered Regular Reader of "The Cyclist" between the ages of 16 and 65. Join now! The advantages of membership are many and the benefits cater for the cyclist's real needs:—

GREAT FREE INSURANCE

£3 a Week Disablement Benefit and £50 Fatal Accident Benefit

SPECIAL TOURING FACILITIES

With information on accommodation and charges

CERTIFICATE OF MEMBERSHIP

Tastefully produced for framing if you wish

SPECIAL C.R.C. MEMBER'S BADGE

Enabling members to recognise one another when on the road

COMPETITION EVENTS FOR MEMBERS

SPECIALY PRODUCED ANNUAL HANDBOOK

Filled with valuable information, Rules of the Club, etc.

Full particulars will be found in

THE  
**Cyclist**

**OUT  
NOW**

EVERY  
WEDNESDAY

**2<sup>D.</sup>**

*George Newnes, Ltd.*

All applications respecting Advertising in this Publication should be addressed to the ADVERTISEMENT MANAGER, GEORGE NEWNES LTD., 8-11 Southampton Street, Strand, London, W.C.2. Telephone: Temple Bar 4368.



# "Give Me Your Measure and I'll Prove in the First 7 Days You Can Have a Body Like Mine!"

— Charles Atlas

No other Physical Instructor in the World  
has ever DARED make such an offer!

I'LL give you PROOF in 7 days that I can turn you, too, into a man of might and muscle. Just think of it? Right in the first week under my guidance you will see and feel the improvement! Then as my weekly instructions arrive in your home you continue to re-build, renew and "overhaul" your body. By the end of three months you are the owner of a powerful body that you will be proud to display anywhere, anytime! People will notice the ruddy glow of health in your face, the sparkle in your clear eyes, your broad shoulders, and they will seek your company. You will be the fellow who will walk off the prettiest girl and the best job while the others wonder how you did it.

## I've No Use For Apparatus!

I haven't any need for apparatus that may strain your heart and other vital organs. I don't "dose" or doctor you. DYNAMIC-TENSION is all I need. It's the natural, tested method for developing real men inside and out. It distributes added pounds of powerful muscles over your body, gets rid of surplus fat, and gives you the vitality, strength and pep that win you the admiration of every woman and the respect of any man.

Are you underweight? I'll add pounds where they are needed! Are you fat in spots? I'll show you how to pare down to fighting trim. And with the big muscles and powerful evenly-developed body that my method so quickly gives you, I'll also give you through-and-through health—health that digs down into your system and banishes such things as constipation, pimples, bad breath and the hundred-and-one similar conditions that rob you of the good times and the good things of life.

## Let DYNAMIC-TENSION Do The Work

Write your name and address carefully on the coupon. I'll send you absolutely free a copy of my new book, "Everlasting Health and Strength." It reveals the secrets of DYNAMIC-TENSION that changed me from a 7-stone, flat-chested weakling into a husky fellow who won the title of "The World's Most Perfectly Developed Man" against all comers! And it shows how I can build you into an "Atlas" Champion the same way.

## 48-Page Book FREE

It tells you all about my special DYNAMIC-TENSION method, and what it has done to make big-muscled men out of run-down specimens. It shows you, from actual photos, how I have developed my pupils to the same perfectly balanced proportions of my own physique. What my system did for me and these hundreds of others it can do for you too. Don't keep on being only half of the man you CAN be! Find out what I can do for you. Where shall I send your copy of "Everlasting Health and Strength"? Put your name and address on the coupon, and post it to-day. CHARLES ATLAS, Dept. 10-H, Shell-Mex House, London, W.C.2.



### CHARLES ATLAS

Dept. 10-H,  
Shell-Mex House, London, W.C.2.

I want the proof that your system of DYNAMIC-TENSION will make a new Man of me—give me a healthy, husky body and big muscle development. Send me your book, "Everlasting Health and Strength"—FREE.

NAME.....  
(Please print or write plainly)

ADDRESS.....

**POST  
COUPON  
TO-DAY**

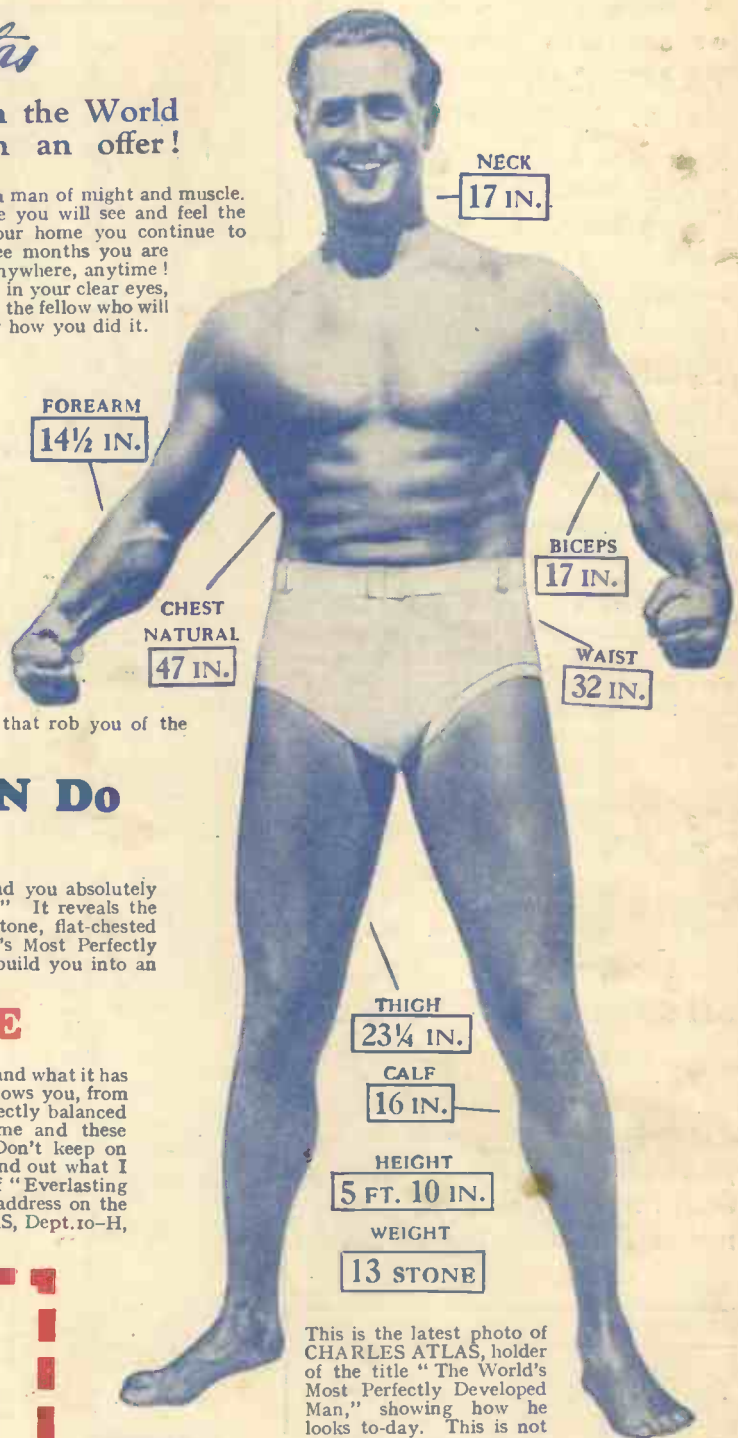

This is the latest photo of CHARLES ATLAS, holder of the title "The World's Most Perfectly Developed Man," showing how he looks to-day. This is not a studio picture, but an actual un touched snapshot.