

GREAT CHRISTMAS DOUBLE NUMBER!

NEWNES

# PRACTICAL MECHANICS

DECEMBER



*Ingenious Ideas for*

# 14

**HOME ENTERTAINMENT**

MAGIC, THEATRICALS,  
RADIO, CHEMISTRY,  
ELECTRICITY, ETC.



# SIGNS of the TIMES

The Budget has restored  
**POLICE OPPORTUNITIES**

The Air Force is to be increased  
**AVIATION MUST DEVELOP**

Pay cuts have been restored  
**CIVIL SERVICE**

Suitable to both sexes. Ages 15 to 24.  
PERMANENT, PROGRESSIVE,  
PENSIONABLE POSITIONS.

**G.P.O. ENG. DEPT.**  
CUSTOMS AND EXCISE, INSPECTOR OF  
TAXES, ETC. NO EXPERIENCE RE-  
QUIRED. OPEN EXAMS.

## MATRICULATION

There are many ways of commencing a career,  
but Matriculation is the jumping-off board for  
all the best ones.

We prepare candidates for all  
**INSTITUTE EXAMS.**  
TECHNICAL, ACCOUNTANCY,  
SECRETARIAL, INSURANCE, ETC.

## ENGINEERS and DRAUGHTSMEN

All Branches—Employers are  
advertising for them.

**TELEPHONY, RADIO and MOTOR  
ENGINEERING** are expanding rapidly.  
There are lots of vacancies. Our postal  
courses will make you eligible. Advice  
on all careers Free.

Also ask for our New  
Book (Free of Charge)

## THE HUMAN MACHINE

Secrets of Success



CAN YOU  
CHANGE MY  
EXPRESSION?

IF SO, YOU MAY BE  
THE ARTIST THAT  
COMMERCE IS  
WAITING FOR.

Just try it for yourself,  
trace or draw the out-  
line and then put in  
the features.

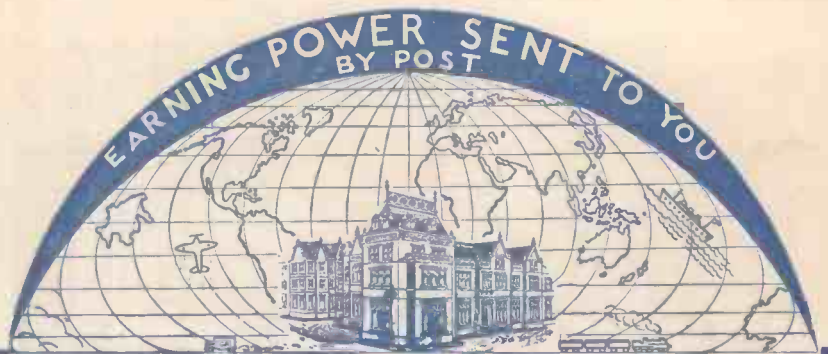
*Jim Duck*

There are hundreds of openings in connection  
with Humorous Papers, Advertisement Drawing,  
Posters, Calendars, Catalogues, Textile Designs,  
Book Illustrations, etc.

60 per cent. of Commercial Art Work is done by  
"Free Lance Artists" who do their work at home  
and sell it to the highest bidders. Many Commer-  
cial Artists draw "retaining fees" from various  
sources, others prefer to work full-time employ-  
ment or partnership arrangement. We teach you  
not only how to draw what is wanted, but how to  
make buyers want what you draw. Many of our  
students who originally took up Commercial Art  
as a hobby have since turned it into a full-time  
paying profession with studio and staff of assist-  
ant artists; there is no limit to the possibilities.  
Let us send full particulars for a **FREE TRIAL**  
and details of our course for your inspection.  
You will be under no obligation whatever.

*Jim Duck*

Art Dept. 76.



STUDY AT HOME IN YOUR SPARE TIME

## OPEN LETTER TO PARENTS

Dear Sir or Madam,—When your children first arrived they brought with them a wonderful lot of sunshine. Later you became proud of the intelligence they displayed, but still later you became anxious as to what would become of them in the future. Perhaps you were anxious when you visualised them as grown men and women. Even with plenty of money it is not always easy to select the right career, and a parent is sometimes inclined to ask advice of some relative and in ninety-nine cases out of a hundred that relative knows nothing at all about the possibilities of employment. Why not let me relieve you of some of your anxieties? In fact, why not let me be their Father? We do not profess to act as an employment agency, but the nature of our business compels us to keep an eye upon the class of men and women that are wanted and who wants them. There are some people who manufacture an article and put it on the market to sell. We do not do that, we work in exactly the opposite direction. We find out what employers want and we train our students to fill those jobs. We have to be experts in the matter of employment, progress and prosperity. If you have any anxieties at all as to what your sons and daughters should be, write to me, or better still, let them write to me personally—Fatherly Advice Department—and tell me their likes and dislikes, and I will give sound, practical advice as to the possibilities of a vocation and how to succeed in it. Yours sincerely,

*J. Bennett*

## YOU CAN HAVE A COLLEGE TRAINING IN ALMOST ANY CAREER FOR A FEW SHILLINGS MONTHLY

- |   |                                   |             |
|---|-----------------------------------|-------------|
| Accountancy Examinations                              | Insurance                         | Mathematics |
| Advertising and Sales Management                      | Matriculation                     |             |
| A. M. I. Fire E. Exam.                                | Metalurgy                         |             |
| Applied Mechanics                                     | Mining, all subjects              |             |
| Army Certificates                                     | Mining, Electrical Engineering    |             |
| Auctioneers and Estate Agents                         | Motor Engineering                 |             |
| Aviation Engineering                                  | Motor Trade                       |             |
| Banking   | Municipal and County Engineers    |             |
| Boilers   | Naval Architecture                |             |
| Book-keeping, Accountancy and Modern Business Methods | Pattern Making                    |             |
| B. Sc. (Eng.)   | Police, Special Course            |             |
| B. Sc. (Estate Management)                            | Preceptors, College of            |             |
| Building, Architecture and Clerk of Works             | Pumps and Pumping Machinery       |             |
| Cambridge Senior School Certificate                   | Radio Service Engineering         |             |
| Civil Engineering                                     | Radio Communication               |             |
| Civil Service   | Road-Making and Maintenance       |             |
| All Commercial Subjects                               | Salesmanship                      |             |
| Commercial Art  | Sanitation                        |             |
| Concrete and Structural Engineering                   | Secretarial Exams.                |             |
| Draughtsmanship. All branches                         | Shipbuilding                      |             |
| Engineering. All branches, subjects and examinations  | Shorthand (Pitman's)              |             |
| General Education                                     | Structural Engineering            |             |
| G.P.O. Engineering Dept.                              | Surveying                         |             |
| Heating and Ventilating                               | Teachers of Handicrafts           |             |
| Industrial Chemistry                                  | Telephony and Telegraphy          |             |
|   | Transport Inst. Exams.            |             |
|   | Weights and Measures Inspector    |             |
|   | Welding                           |             |
|   | Wireless Telegraphy and Telephony |             |
|   | Works Managers                    |             |

If you do not see your own requirements above, write to us on any subject.

## HOW TO STUDY

In your spare time when it suits YOU. You fix your own time, you do not GO to your studies—the postman brings THEM TO YOU. There is nothing that a class-room teacher can show on a blackboard that we cannot show on a white paper. The lesson on a blackboard will be cleaned off, but our lessons are PERMANENT. A class-room teacher cannot give you a private word of encouragement, but a Correspondence Tutor can do so whenever your work deserves it. On the other hand he can, where necessary, point out your mistakes PRIVATELY.

## TO STUDENTS LIVING ABROAD

or on the high seas, a good supply of lessons is given, so that they may be done in their order, and despatched to us for examination and correction. They are then sent back with more work, and in this way a continuous stream of work is always in transit from the Student to us and from us to the Student, therefore distance makes no difference.

IT IS THE PERSONAL TOUCH WHICH COUNTS IN POSTAL TUITION

EVERY DEPARTMENT IS A COMPLETE COLLEGE EVERY STUDENT IS A CLASS TO HIMSELF



Dept. 76, THE BENNETT COLLEGE, SHEFFIELD.

# Practical Mechanics

VOL. III. No. 27  
DECEMBER  
1935

Edited by F. J. CAMM

SUBSCRIPTION RATES :  
Inland and Abroad, 7s. 6d. per annum  
Canada - - 7s. per annum

Editorial and Advertisement Offices : "Practical Mechanics," George Newnes Ltd., Southampton Street, Strand, W.C.2.  
Registered at the G.P.O. for transmission by Canadian Magazine Post.



### World's Largest Electric Clock

THE largest electric clock in the world has just been completed for the Rand Airport, South Africa. The dial has a diameter of 30 ft., while the minute hand has a length of 17 ft., and the hour hand 14 ft. 6 in.



### Iraq Pipeline

IT is reported from Bagdad that the heaviness of the crude oil now being obtained has rendered the new pipeline unusable. A road and railway will probably be built to

take its place at a cost of £3,500,000.

### New Liners

ACCORDING to the American Press, the construction of two new liners, each larger and faster than the *Queen Mary*, is under consideration. It is estimated that they would cost £10,000,000 each; their length would be 1,250 ft., and they would be capable of steaming at 38 knots.

### Gliding Records

GLIDERS have been towed by aeroplanes to heights of more than 10,000 ft. before now, but the U.S.S.R. will attempt records with a stratosphere glider now under construction. A special balloon is being made to take the glider to a height of 60,000 ft. At this height, the glider will be detached from the envelope, and it is estimated that the glider will then attain a speed of more than 250 m.p.h. What happens to the balloon after detachment is not stated!

### Bananas Ripened by Gas

EVERY week about 10,000 bunches of bananas are ripened in Birmingham by gas. Forty ripening rooms are now in use, and by means of a band conveyor, bunches of green bananas are taken from the railway trucks to the ripening rooms, where the temperature is controlled by thermostats. After a week's treatment, the bananas are ready for market.

### A Super Ticket-machine

A MACHINE which not only prints and issues tickets, but also counts up the day's takings, has been installed in one of the booking-offices at Liverpool Street Station. The machine is the first of its kind in the

## Notes, News, and Views

world, and by the pressure of a button, it can issue a ticket from one of 3,040 different types. It simultaneously records the cost of the ticket and the totals are added continuously, so that the total receipts can be ascertained at a glance.



### The "Queen Mary"

RAPID progress is being made in fitting out the new Cunarder. The masts and funnels are now in position and all the heavy machinery is installed. It is expected that dock

trials will commence in May.

### Lost Radium

RADIUM needles are extremely valuable, and an ingenious instrument has just been devised at the National Physical Laboratory to find lost radium. The instrument consists of a neon lamp, the gas in which is momentarily ionised by the radium emanations. The resulting change in conductivity is amplified to work a loud-speaker, and when near a mere trace of radium, the loud-speaker emits a "clucking" noise.

### The Smoke Nuisance

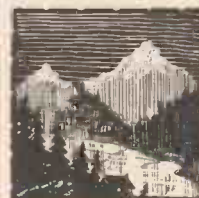
THE latest application of photo-cells is an instrument to indicate when too much smoke is passing up a factory chimney.

the stokers to attend to the furnace.

### Smokeless Boilers

A BOILER has recently been invented in Sweden which results in smokeless combustion even from highly-bituminous coal.

Instead of allowing the air to pass upwards through the burning fuel, it is passed downwards, the air entry being at the top and the flue to the chimney at the bottom. Before reaching the chimney, the smoke has to pass through the hottest part of the furnace, thus ensuring complete and smokeless combustion.



### Across the Alps in a Glider

A SWISS airman has just flown across the Alps in a glider. He was towed to a height of 10,500 ft. and ascended to 12,000 ft. Crossing the Simplon Pass at

a height of 9,600 ft., he eventually landed at Bellinzona, Canton Tiano.

### Earthquakes in London

A SEISMOGRAPH has just been installed at the Science Museum for the recording of earthquakes, and an alarm will shortly be fitted to give warning when an earthquake is taking place. During the past month, no fewer than four earthquakes have been recorded on the instrument.

### Bind Your Volumes

WILL readers please note that the Index to Volume II of PRACTICAL MECHANICS is now available at 7d. by post from the publisher, George Newnes, Ltd., 8-11 Southampton Street, Strand, London, W.C.2. Binding cases, complete with title page and index, cost 3s. 6d. by post from the same address. A bound volume of PRACTICAL MECHANICS is a Golden Treasury of knowledge—a storehouse of the most reliable facts and information on every branch of modern scientific progress, endeavour and invention. A bound volume also makes a useful Christmas present, and you may turn to it during the fireside hour to refresh your memory on some favoured topic as well as have it to hand in your workshop as a guide to workshop methods and processes.

The  
Editor and Staff  
Join in Wishing  
Every Reader  
A Happy  
Christmas



# Staging a Play at Home

Practical Information on the Erection of a Stage for Home Productions.

**W**HEN arranging the Christmas party a great amount of time and trouble is usually spent in arranging a list of games and stunts to amuse the guests, but it is really surprising how seldom the presentation of a play is included in the programme. It is all the more surprising in view of the fact that a great amount of

found suitable for a not-too-ambitious production may be erected, as shown in Fig. 1, from boxes and planks. Mineral-water cases will be found to make an excellent foundation, and builders' planks laid on top and nailed to the cases will hold the whole structure together. It should be remembered, however, to have plenty of "founda-

### An Ambitious Structure

Should a more ambitious structure be required a stage built up in the manner shown in Fig. 2 will be found quite useful. This, of course, entails a certain amount of carpentry work, but this is of such a simple character that it is a job which may be tackled by even an amateur. An advantage of this type of stage is that it is collapsible, and may easily be stored away for use with future productions. The portion illustrated represents one section, and the number of these which are to be employed is governed by the space available.

### The Proscenium

An excellent site for the stage is at an opening between two communicating rooms,

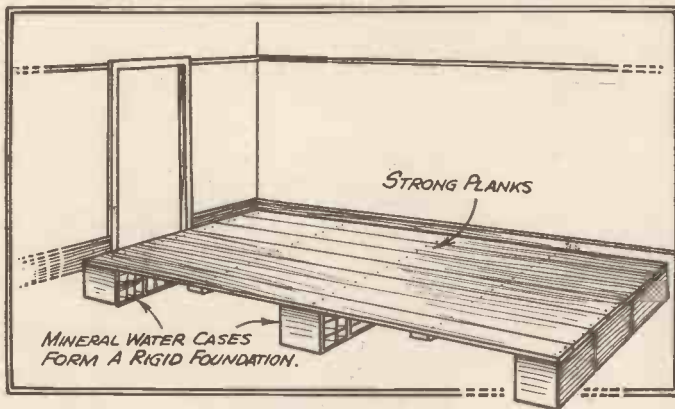


Fig. 1.—(left) A simply-constructed stage made from boxes and planks.

fun is derived from the actual preparation of the play, if carried out properly.

### Erecting the Stage

It is possible, of course, to act the play on the ordinary floor of the room, but we will assume that we are really ambitious and are going to present quite a "professional" effort—and therefore the first thing is a stage. An excellent dais, which will be

Fig. 2.—(Right) This type of stage, built up of collapsible sections, is easily stored away when not in use.

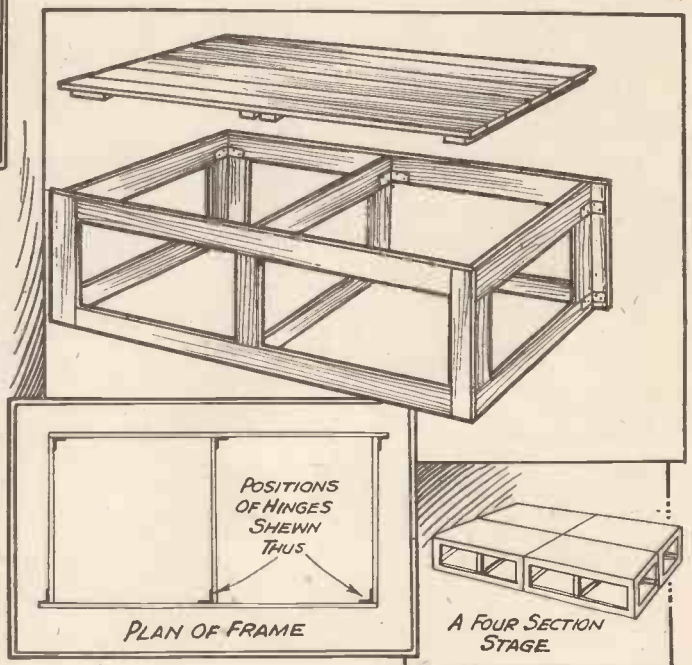
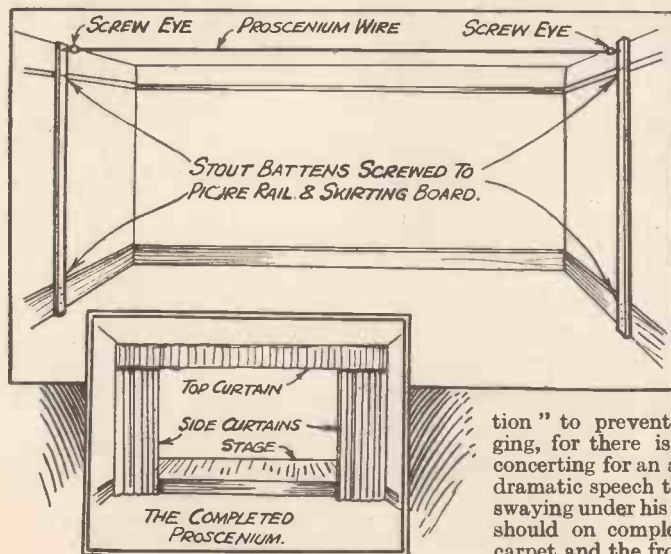


Fig. 3.—(Left) This sketch shows how the proscenium is erected.



tion" to prevent the planks from sagging, for there is nothing quite so disconcerting for an actor in the middle of a dramatic speech than to find the ground swaying under his feet. The whole stage should on completion be covered with carpet and the front boxed in.

for here the proscenium is ready made, and as these openings are often covered with curtains, the problem of the curtain is automatically solved. We will assume, however, that we are not placed in so fortunate a position and that we are staging the play in the room in which the audience is to be seated. As we have gone to the trouble of erecting the stage we should do the job properly and cover in the front of our stage and erect a proscenium. A very simple and effective method of doing this is shown in Fig. 3. Here, as will be seen, two

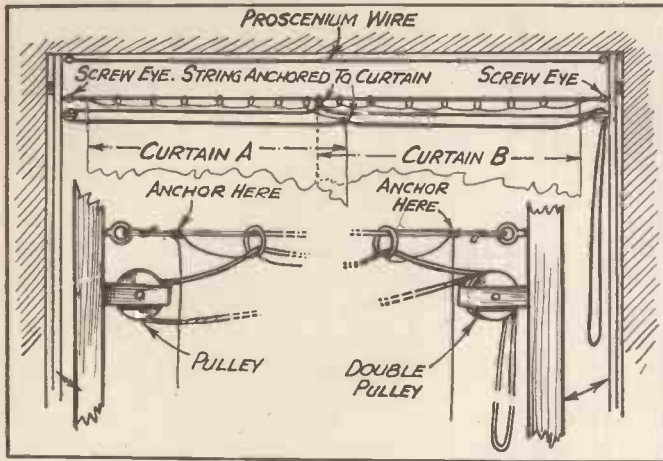


Fig. 4.—The draw-type of curtain is a very convenient arrangement for screening the stage.

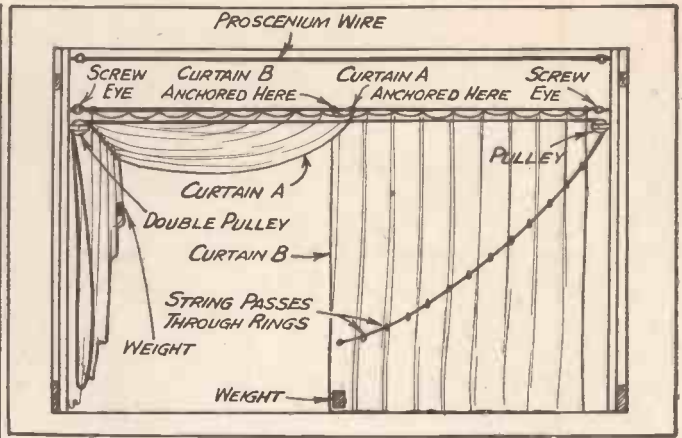


Fig. 5.—An alternative method of raising the curtain, known as the tableau curtain.

stout battens are fixed, one to each of the side walls, by screws into the picture-rail and the skirting-board. (House-proud people may be afraid of the damage done by the screws, but these holes are easily filled with plastic wood, and a touch of stain will complete the repair.) Into the top of the battens, screw-eyes are fixed and a wire is tightly stretched between them. Light, but opaque material is hung in a strip at each side, and a narrow strip suspended right across the room. Thus we have our proscenium completed, and our "theatre" is now definitely taking shape.

**About the Curtain**

Our next job is the curtain, and a very convenient method of arranging this is shown in Fig. 4. This again is supported upon another wire which is stretched in the same way between the two battens. The distance between the curtain wire and the proscenium wire should be about 6 in. less than the depth of the top strip of the proscenium. An alternative method of raising the curtain is shown in Fig. 5, but unless the room is very lofty this type of curtain should not be used, as it will tend to cut down the height of the opening.

**The Scenery**

Curtains draped on the back wall form the simplest way of overcoming the scenic problems, and are very effective for certain plays.

Strips of curtain for side-wings complete the dressings for this type of setting, but folding screens will do the job excellently.

For those who are prepared to go to a little trouble very realistic scenery may be built up, and a glance at Fig. 6 will show the construction of a typical screen. The number of these which will be required will again depend on the type of set desired and the size of the stage. The best covering for the screen is canvas, but stout paper will be found very suitable if a temporary set is needed. It is interesting to note that suitable covering paper for this job is obtainable already printed. It is possible, for instance, to obtain panelled oak windows, fireplaces, drawing-room decorations, or outdoor scenes, and all of these may be mounted and used in the manner explained above. This paper is also supplied mounted on calico and this, of course, will stand much more handling.

**Lighting the Stage**

A word or two about lighting may prove useful, for it should be remembered that this may either make or ruin the play. One



Fig. 6.—A useful scenery frame. The number of these required will depend on the type of set required and the size of the stage.

point to make sure of is not to have too much top lighting, as this will tend to throw the face into shadow. It is possible, of course, to write a book about stage lighting, but for our homely purposes the system shown in Fig. 7. will be found quite satisfactory. As will be seen, the footlights are mounted on a piece of wood, and cardboard boxes act as reflectors and shields. It is as well to have all the stage lighting going to a separate switch-board, which should be situated behind the stage and in the charge of the "stage electrician." One

point arises here and that is—fuses! It is, therefore, necessary to have spare fuse wire and an electric torch handy.

**A Word on Production**

Although advice on production does not strictly come within the scope of this article, perhaps a few pointers in this direction are justified in view of the considerable amount of trouble to which we have gone to build to our theatre.

If you have never tried a play before, the best type to start with is a short one-act affair. Whether it is comedy, drama, or mystery of course depends on your individual taste and the acting ability of your cast. If the play is dramatic don't choose one with too many characters, as an overcrowded stage will tend to destroy the effect and hamper the actors. Keep the furniture arrangement as simple as possible, and rehearse the play beforehand in the space which you know will be at your disposal. Although it is just for fun, it is well worth spending a little extra time and putting over a really good show.

Several publishers issue books of short plays suitable for production by amateurs at home, and such are usually of the one- and two-act type. The short "curtain raiser" is best for home production.

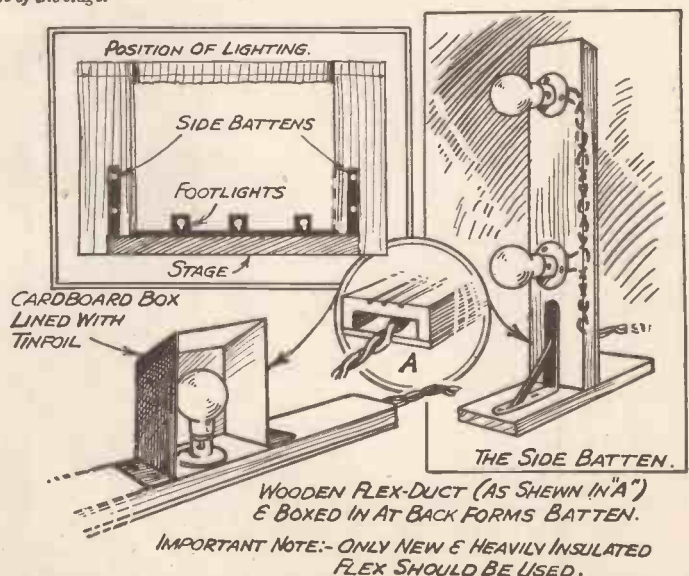


Fig. 7.—An ideal lighting arrangement. It should be remembered that inadequate lighting may ruin the play. Avoid having too much top lighting as this will tend to throw the faces of the actors into the shade.

# OPERATING FROM A.C.

*Methods of Breaking Down Explained, and Details given*

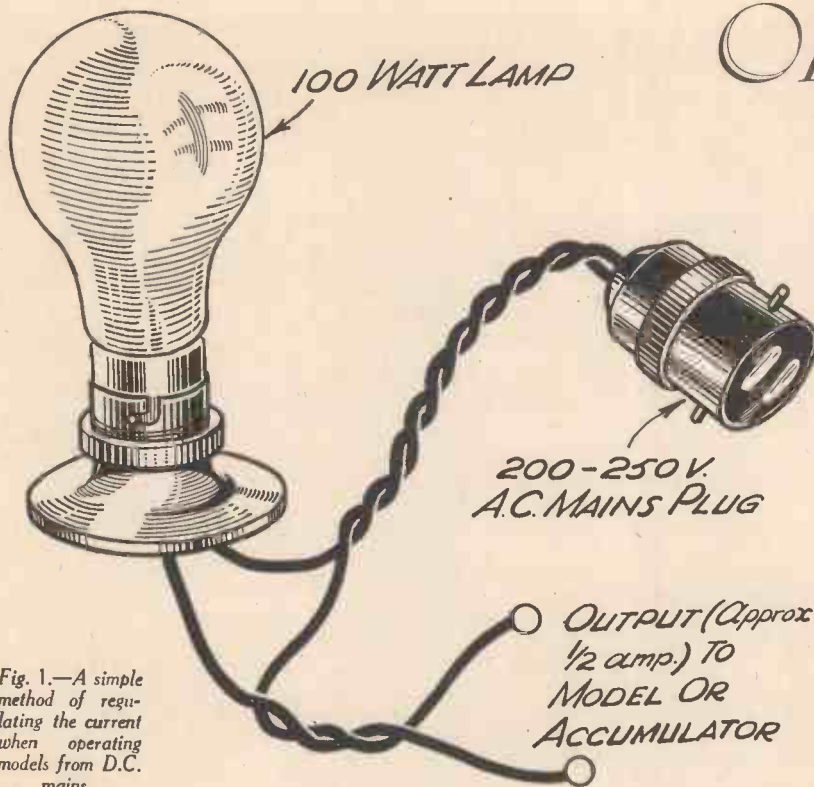


Fig. 1.—A simple method of regulating the current when operating models from D.C. mains.

The charging circuit is the same as that shown in Fig. 1, and care should be taken to ensure that the connections to the battery are of correct polarity; this can be determined by dipping the ends of two leads from the output terminals into a solution of salt in water. The negative lead will liberate a comparatively large quantity of gas in the form of bubbles, while the positive lead will give off fewer bubbles. In making the test the leads should be well insulated from the hands by means of rubber tubing or something similar.

### Low-voltage D.C. from A.C.

When the power supply is A.C.—and this is rapidly being standardised throughout the country—it is a perfectly simple matter definitely to step down the voltage without waste and without the least risk of obtaining a shock when using the model, no matter how carelessly the output leads are handled. The apparatus required is rather more complicated and expensive, but the cost is easily justified if the electrical device is used for fairly long periods. What is actually required is a mains transformer for stepping down the voltage, and a rectifier for turning the A.C. output from the rectifier into D.C. The complete apparatus is identical with an A.C. trickle charger such as is used for battery charging at a slow rate, and a charger of this type provides a very con-

**T**HERE are many occasions when it is more convenient, as well as more economical, to obtain the electrical energy for operating model trains and motors of all kinds from the mains than from batteries and accumulators. For some reason, however, there is a general tendency to avoid using the mains supply because it is thought that there is a danger of receiving a shock. Such a possibility cannot be entirely ignored, but it certainly need not exist if reasonable and sensible precautions be taken, and if the correct methods of breaking down the voltage are followed.

The majority of models are designed to operate from a D.C. supply of between 4 and 12 volts, the current consumption varying between less than  $\frac{1}{2}$  amp. and about 3 amps. These voltages are by no means difficult to obtain when A.C. mains are available, but the position is not quite so satisfactory in the case of D.C. mains where, strictly speaking, the voltage of the supply cannot be reduced.

### Using D.C. Mains

It is possible, nevertheless, to obtain the same effect by limiting the current to that required for the device to be operated; this is done by including a resistance in circuit as shown in Fig. 1. In this arrangement the resistance takes the form of a 100-watt lamp which, assuming the mains voltage to lie between 200 and 240, will pass a current of just about  $\frac{1}{2}$  amp. Thus, if a motor rated at, say, 6 volts,  $\frac{1}{2}$  amp. were connected to the two terminals indicated the voltage obtaining between the terminals would be 6, or very nearly so. In the same manner, a 4- or 12-volt motor could be connected, and the approximately correct voltage would be obtained.

This method is, however, not recommended for two reasons: the first is that it is uneconomical since the greater part of the mains supply is wasted; the second is that there is a risk of receiving a shock unless great precautions are taken to ensure

that all parts connected to the mains (including the terminals of the motor) are very thoroughly insulated. If the method is to be employed, the user should first satisfy himself that he has a fair knowledge of electricity and that children will not be able to touch the model in use.

### An Intermediate Accumulator

It is far more satisfactory when using D.C. to employ it for keeping an accumulator charged, the accumulator being used alone for actually driving the apparatus.

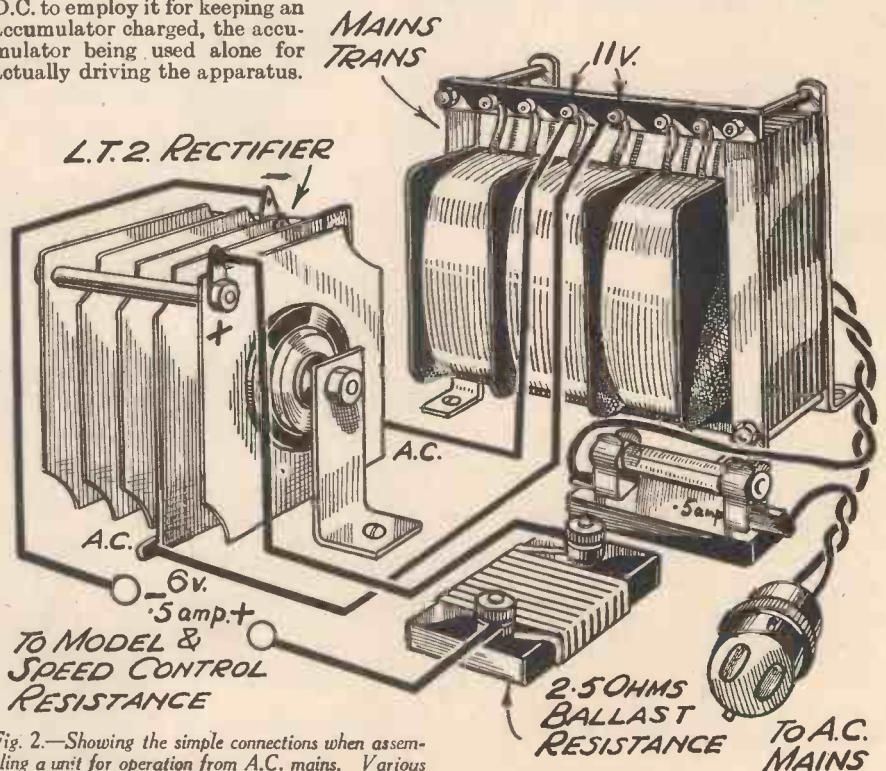


Fig. 2.—Showing the simple connections when assembling a unit for operation from A.C. mains. Various outputs can be obtained by using appropriate rectifiers and transformers.

# ELECTRIC MODELS & D.C. MAINS

*the Voltage of A.C. and D.C. Mains Supplies are for the Construction of Mains Transformers*

venient means of deriving the necessary supply. There are several suitable chargers on the market, and a well-known make is the Heyberd, one type of which is shown in Fig. 4. Three models are made at prices from £1 15s. to £4 10s.; the cheapest has an output of  $\frac{1}{2}$  amp. at 2, 4 or 6 volts, the second provides 1 amp. at 2, 6 or 12 volts, and the third 1 or 2 amps. at 2, 6 or 12 volts. The most suitable of these units naturally

desired by following the instructions given in the issue of this magazine dated January, 1934. First it is necessary to decide upon the rectifier, and the main details of a few of the most frequently used types are given in a table on this page, whilst the method of connection is shown in Fig. 2. It will

DETAILS OF WESTINGHOUSE RECTIFIERS

Type	D.C. Output Volts Amps.	Resistance ohms	A.C. Input Volts
L.T.2	6 0.5	2.5	11.0
L.T.4	6 1.0	1.75	11.0
L.T.5	12 1.0	1.75	22
L.T.6	6 2.0	1.0	11.0
A.4	9 2.0	1.5	14.0
A.6	6 3.0	0.5	9.0

depends upon the output required, and thus upon the particular model or piece of apparatus to be operated. All three are similar in that they are provided with a length of flex and mains plug, tappings for different mains voltages, a plug for varying the voltage output and a pair of output terminals.

### A Home-made Unit

When it is preferred to assemble one's own transformer-rectifier unit, this can be done by using a Westinghouse metal-oxide rectifier in conjunction with a mains transformer of appropriate type. Both of these items can be bought ready-made, or the transformer can be made at home if

Fig. 4.—A portable trickle charger which is suitable for working many electrical models.

be seen that the A.C. input voltage to the rectifier is greater than the D.C. output and also that a "ballast" resistance is included in the circuit. The purpose of this is to maintain the voltage uniform, irrespective of the actual current load.



Fig. 3.—A transformer suitable for running models from the mains. It is fitted with a variable control which gives voltage increases in one-volt steps.

### Transformer Details

A transformer for any of the 6-volt-output rectifiers can be made as described in the article mentioned above by using as a core six dozen pairs of Stalloy stampings. The primary winding should consist of 2,000 turns of 36-gauge enamelled wire tapped after 1,600, 1,720 and 1,840 turns (for 200-, 215-, 230- and 250-volt mains supplies), and the secondary should be wound with 20-gauge d.c.c. wire, allowing 8 turns per volt, according to the required input voltage shown in the table.

In some cases, particularly for large-gauge model railways, a supply of 12 volts, 3 amps. D.C. may be required, and this can best be obtained by connecting two type A.6 rectifiers in series, as shown in Fig. 5, to a transformer giving two outputs of 9 volts each (two secondary windings, 72 turns of 20-gauge d.c.c. wire each). Other "doubled" outputs can be obtained in the same manner, but it might be mentioned that rectifiers of the L.T. types should not be connected in parallel.

### Obtaining 20 Volts A.C.

Many model railway engines are designed to operate from 20 volts A.C., and this supply can be obtained directly from a transformer without the need for a rectifier. A suitable transformer can be obtained ready made from a firm such as Heyberd, or it can be made by using a primary as mentioned above, and using as secondary 160 turns of 24-gauge d.c.c. wire. The current output from this winding may be up to about 1.5 amp.

When using any of the circuits referred to it is a wise precaution to include a safety fuse in the mains lead to one of the primary terminals of the transformer. This is shown in the Figs. and the rating should be  $\frac{1}{2}$  amp. With regard to the "ballast" resistance, this can easily be made by using 22-gauge Eureka resistance wire, the resistance of which is 1.1 ohms per yard. The correct length can be determined by dividing the figure just given into the resistance value appropriate to the rectifier in use, as given in the table. The wire may be wound on a strip of fibre fitted with terminals as shown in Fig. 2, the turns being slightly spaced, and the wire being wound on tightly to prevent the turns from slipping

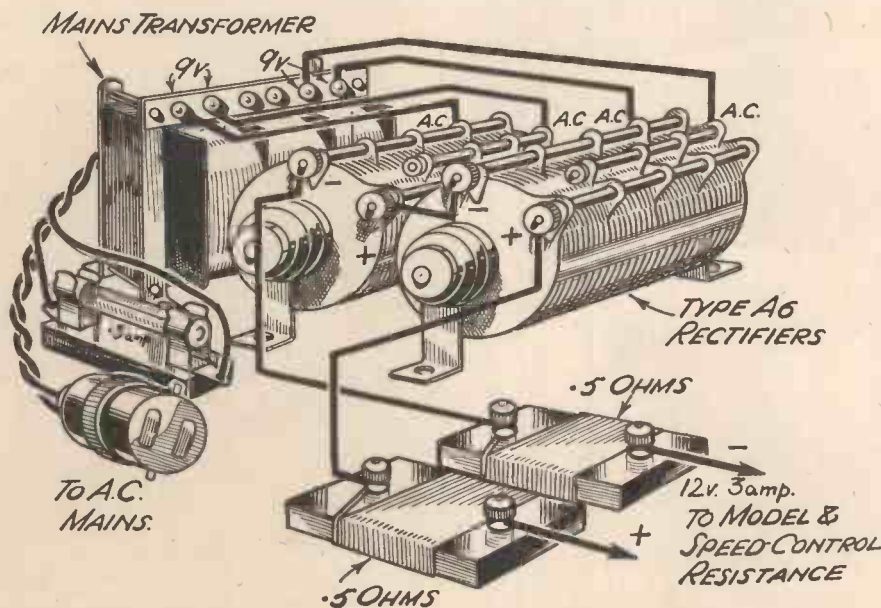
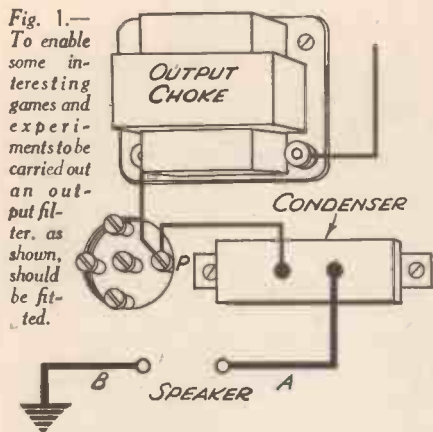


Fig. 5.—With these connections the normal D.C. voltage output is doubled by using two rectifiers of the A.4 or A.6 type in series.

Fig. 1.—To enable some interesting games and experiments to be carried out an output filter, as shown, should be fitted.



EVERYONE is intrigued by electrical games, or games in which mechanical novelties are introduced, and the following arrangements will be found simple to make and will at the same time afford a novel entertainment at Christmas parties and other gatherings. Commencing with a scheme which calls for no constructional work, we will take the party game which is based upon an old-fashioned children's game combined with the modern method of selecting a gift from a "Snowball." In this, as most readers are probably aware, a number of ribbons are attached to gifts enclosed in a ball of cotton-wool. This is placed on the party table, and after the meal each member of the party takes a ribbon, and when the signal is given the ribbons are pulled, thus drawing away from the ball the chosen gift. For our version of this arrangement an ordinary wireless receiver is called into use. This must be fitted with an output-filter arrangement, which, for the benefit of those who are not

wireless enthusiasts, is illustrated in Fig. 1 in a diagrammatic form. It will be seen that the loudspeaker is joined between the last valve and earth, and there are thus two wires, marked A and B in the diagram. From this sketch it will be gathered that the wire marked B may be taken from any earthed point, and therefore the first thing to do in preparing for this game is to remove the wire in the receiver which corresponds with wire B in the sketch. This applies, of course, only to those wireless receivers in which a built-in loudspeaker is incorporated, and if a separate speaker is in use it will only be necessary to remove the external wire which is joined to earth.

**A Simple Arrangement**

It is now necessary to obtain a small quantity of wire—ordinary thin double-cotton-covered wire is quite suitable—and this is cut into lengths of about five or six feet. These wires are all bound together at one end, taking care to preserve the insulation of each piece, and at the same time a much longer lead is incorporated, as shown in Fig. 3. To preserve the individual insulation the simplest scheme is to bind the wires about 1 in. from the ends and then to turn back each wire. Alternatively, a number of holes may be drilled in a thin strip of ebonite and the wires anchored in these holes, the long lead being passed along

# Wireless and

## Some Easily Made and Efficient Devices for use

the rear of the strip and carried forward with the rest at any desired point, so that it cannot easily be identified by the players. A lead is now attached to a convenient earth point, or attached to the wire B which was disconnected from the loudspeaker. The members of the party assemble and are handed the grouped ends of the wires from which to make a selection, and when each member has a lead, one remaining member takes the earthed lead. The ends which are held are bare, as also is the end of the earthed lead. The players stand in a semi-circle, the member holding the earthed wire stands in the centre, and passes to various members in turn, touching the wire he is carrying against the end being held by that member. If the wireless set is switched on and tuned to a station (or a gramophone record played through a pick-up) signals will be heard from the speaker when the circuit is completed, and the member who was holding the essential wire then has to take his or her place in the centre with the earthed wire, the various leads are mixed together and a further selection made, and so the game proceeds.

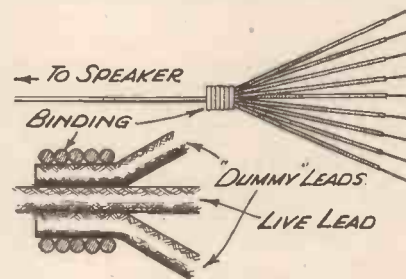
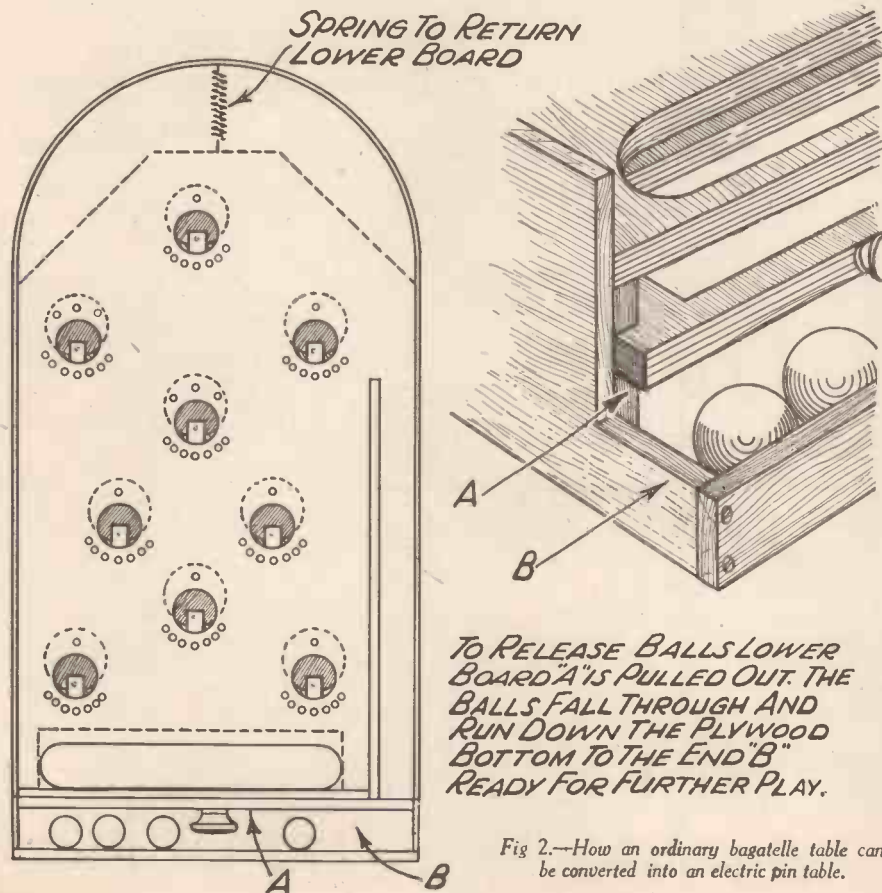


Fig. 3.—The arrangement of leads for a simple game in which the wireless receiver is employed.

A time limit may be imposed or forfeits paid after so many selections have been made. Other variations will probably occur to readers based upon the same idea.

**An Electric Pin-table**

Many readers no doubt have one of the older types of bagatelle table at home and this may be converted fairly simply into one of the more modern pin-tables in the following manner. (If you have not such a table one may be constructed from three-ply wood to any desired pattern.) In place of the small brass cups in the older type of board a hole must be drilled. The size will depend upon the balls to be used and these are obtainable up to 1 in. in diameter, in steel if desired. A weighty type of ball should be adopted in preference to the lighter type of rubber ball. A second ply board is required almost as large as the original table, and this must be provided with a series of holes forming the same pattern as on the original table, but the holes must be very much larger. Across each hole in this second board a double contacting piece is fitted and it may be built up from thin brass strip and 1/4-in. ebonite as shown in Fig. 6. The two strips are screwed or riveted to the piece of ebonite, suitable dimensions being as given. These may be modified according to the size of the board.



TO RELEASE BALLS LOWER BOARD 'A' IS PULLED OUT. THE BALLS FALL THROUGH AND RUN DOWN THE PLYWOOD BOTTOM TO THE END 'B' READY FOR FURTHER PLAY.

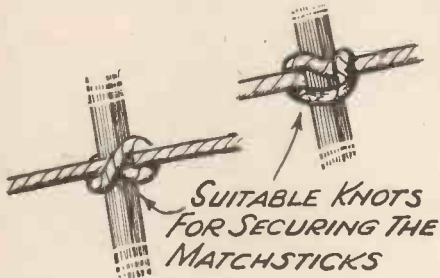
Fig. 2.—How an ordinary bagatelle table can be converted into an electric pin table.



# Electrical Games

During the Winter Nights and for Party Purposes

At the ends of the two strips a depression is punched by means of a blunt nail, or if a more permanent job is desired a piece of silver wire may be soldered to form a better contact. In Fig. 7 one hole is shown and the position of the contacts as well as the lower hole may be clearly seen. When



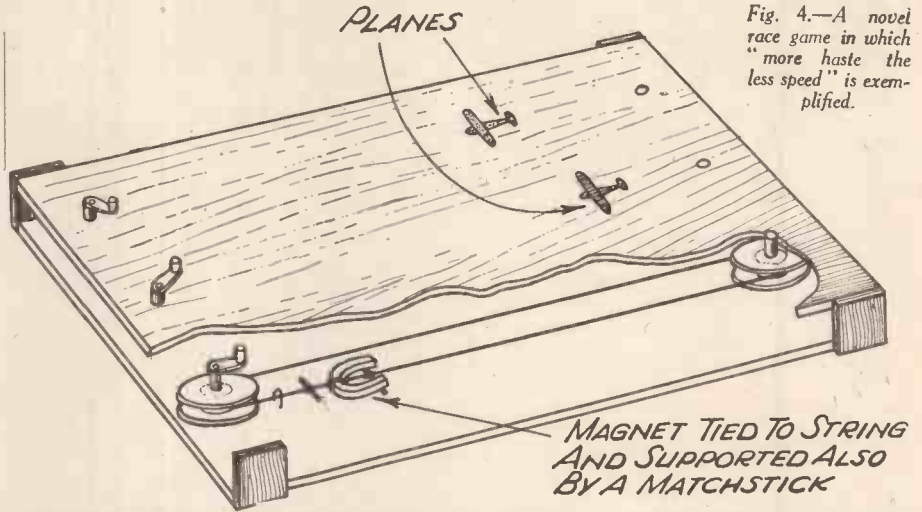
the ball drops into the hole it presses the two contacts together and these may be made to light a numbered board, a coloured lamp or other device to suit your own particular needs. The electrical circuit will be as shown in Fig. 8 and this may be duplicated for each hole. To release the balls when they have all been played the lower board is made to slide in between two thin fillets arranged beneath the main board, and a simple handle may be fitted so that the board is drawn back and then pushed into position when all the balls have fallen through, or a spring may be fitted to return the board to its original position.

### A Race Game

Race games are always popular, and by adopting the attractive force of magnets a very thrilling game may be made up in the following manner. Obtain a large sheet of plywood, as wide as may be convenient. Support this on a hollow framework made from thin battens so that there is a fairly wide space between the ply board and the table surface. At one end fit a number of pulleys which may be turned from metal or built up from three separate discs of wood. The number of pulleys will depend upon the width of the board and the number of players who wish to take part. At the opposite end of the board fit a similar number of pulleys each of which is fixed to a spindle projecting to the top of the board and on which is mounted a small handle. The general arrangement is shown in Fig. 4, in which one handle is shown in the form of a disc of plywood with a vertical rod projecting, and in the other two

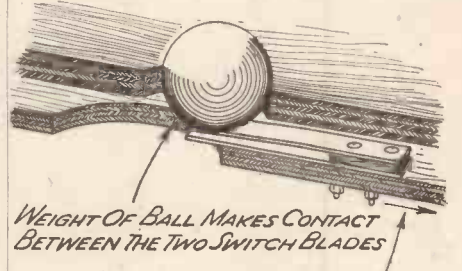


Fig. 4.—A novel race game in which "more haste the less speed" is exemplified.



cases strips of metal are adopted with a vertical pin to enable it to be rotated. Beneath this diagram is a sketch showing how the two pulleys are arranged, and it will be seen that round these is passed an endless band of stout cord, which is given one complete turn round the pulley attached to the handle to provide a certain grip. An inch or so from this pulley the cord passes beneath a small wire hoop or through an ordinary screw-eye, and looped on to the cord is a matchstick or similar stop. Immediately in front of this is tied an ordinary penny magnet, or, if you wish to make a more efficient job, an electro-magnet, picking up current by means of lengths of flexible wire. A small cross piece (a matchstick will do) will support the poles of the magnet as shown in Fig. 4. The surface of the board is now treated either by painting or by pasting up some paper to resemble the ocean, a stretch of country or any other desired scene, and a number of articles are

across the board the resistance should not be too great but should be sufficient to prevent it from being slid along too easily. It will now be seen that the magnet passing beneath the board will exercise its attractive effort and will draw along the model, but this is where the novelty of the game arises. Owing to the thickness of the ply board, and the slight drag due to the weight



THIS BOARD SLIDES TO RELEASE BALL WHICH FALLS RIGHT THROUGH

Fig. 7.—The heavy balls make contact as shown here and may be used to give various forms of indication.

of the models, the magnet must be drawn along fairly slowly, or it will not pull the model. Thus, each member takes a handle and turns the magnet to the top of the board (stops will enable the actual position of the magnet to be ascertained by touch). The objects are placed at the starting point at the top of the board and immediately above the magnets.

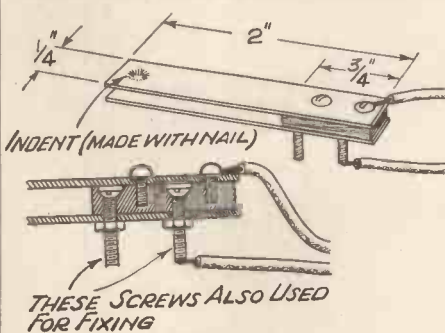


Fig. 6.—How to make up the contacts for pin table signalling.

then made up to agree with the type of illustration. For instance, if an ocean picture is formed, some small celluloid boats of the water-line variety may be purchased, whilst if a stretch of country is adopted, small celluloid aeroplanes may be obtained or built up from wood.

The models are next weighted by placing a strip of iron on the underside and this should be smoothed or prepared by sticking a piece of notepaper on it. When drawn

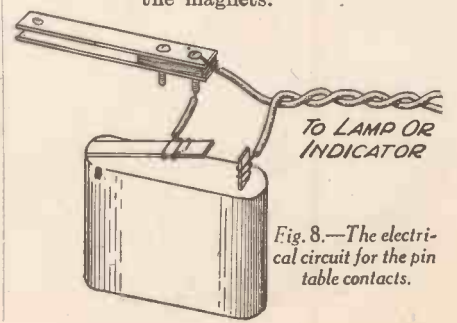


Fig. 8.—The electrical circuit for the pin table contacts.

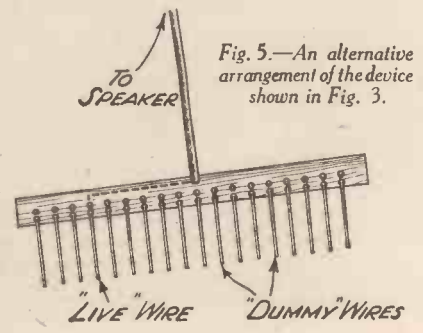


Fig. 5.—An alternative arrangement of the device shown in Fig. 3.

# Scientific Magic

Some Ingenious and Simple  
Tricks that will Provide  
Considerable Amusement  
at a Party

## The Returning Can

When this can is rolled along the floor it will greatly surprise your friends by returning to you. Obtain an old cocoa tin and punch two holes about 1 in. apart in the bottom and in the lid. Cut a fairly strong rubber band, thread through the holes, and tie a weight, as shown.

## Lighting a Candle Without Using a Match

Make a paste of 2 parts potassium chlorate and 1 part sugar, by separately grinding the sugar and potassium chlorate to a fine powder and mixing with water. Dip candle wick into paste and allow to dry. The matchstick is prepared by partly burning it and dipping the charred end in sulphuric acid. Contact of match and wick will light the candle.

## Magic Matches

You are able to strike a match producing either a red, white, or blue flame at will, according to the request of the audience.

The matches are prepared by soaking the wooden part not the heads, in three different solutions.

A solution of strontium salt will produce a red flame, potassium salt a white flame, and lithium salt a blue flame.

The colours are identified by cutting the ends of the matches to slightly different lengths, and tapping down to one end of the box.

## The Magic Fluid

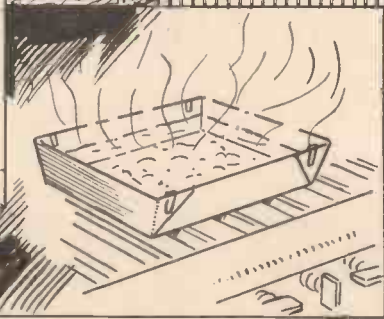
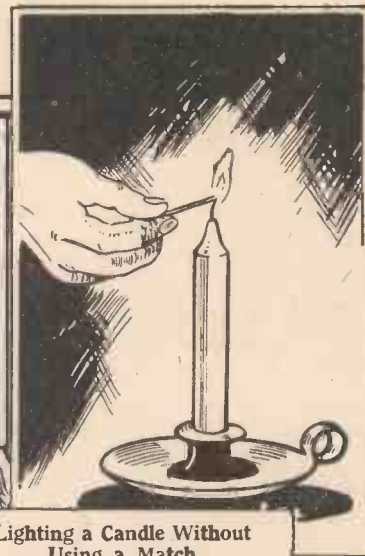
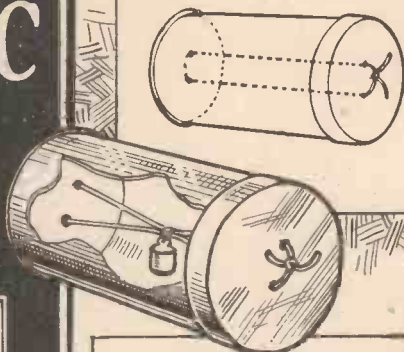
A bottle of ordinary-looking liquid is handed to a friend, asking him to pour it into a tumbler. To his amazement he will be unable to do so, however, for the liquid has solidified.

Sulphate of soda is mixed with hot water to form a saturated solution. This is poured into a clean bottle, practically filling it, and corked while hot.

When handing the bottle to the friend, pull the cork and allow time for the air to act on the liquid by making a few remarks.

## Boiling Water in Paper

Cut a piece of stout paper into a square and fold into the form of a container, as shown in the sketch. Secure the corners with paper clips or pins. The container is filled with water and placed over the gas flame. The water will boil without the paper burning if the flame is kept low.



# MAGIC FOR CHRISTMAS

**N**O Christmas party is complete without a conjurer, and some of the most interesting illusions rely for the effect upon mechanical apparatus which may, or may not, be augmented by sleight of hand. The well-known escapes from sealed boxes and tanks of water are illustrations of actual mechanical magic as distinct from the card-manipulator or cigarette magician's box of effects. When, however, the two types of effect are combined there often results an illusion which is actually incomprehensible to the onlooker, and no amount of guessing will provide a solution as to how it is done. Our artist has used our first effect for the subject of the cover illustration, and this particular effect will provide a real demonstration of the truth of the above remarks. The effect, as seen by the audience, is as follows: the magician enters, carrying the usual pack of cards. These are still in the sealed package in which they were purchased, and the Excise seal is broken before the eyes of everyone, and the Joker removed. The cards are shuffled and the magician steps into the audience and permits about half a dozen members to select a card. These are carefully examined and a note taken by each member of the card he or she has chosen, or the cards may be individually autographed. When everyone is satisfied that a free selection has been made, and the cards are duly noted, they are returned to the pack and the magician returns to the stage *without turning his back on the audience*, and the cards are held on high to show that no substitution takes place. On returning to the stage the cards are again shuffled and placed in an ordinary glass tumbler so that they may still be in full view.

## A Model Broadcasting Station

The magician leaves the stage and returns wearing a pair of headphones and carrying a model broadcasting station, complete with wireless masts on the roof. He stands this on the stage on a table and turns it round to show that there is no connection with any other object, and next brings forward a loud speaker which is also placed upon a chair or table and has no wires leading to it. The magician now announces that he is going to call up a brother magician in "Cantralia" or "Iceamerica" or other distant country and ask him to identify the cards which have been selected, and he manipulates a small knob on the side of the model broadcasting station, adjusting the phones over his ears carefully until suddenly a flash is seen from the top of one of the masts. The flash repeats and suddenly both masts commence to flash, and then from the loud speaker, comes a voice with an American accent, or broken English as you desire, greeting our magician and replying

## Some Interesting Tricks and Illusions Which May be Constructed by the Average Handyman for Presentation During Xmas Festivities

to his remarks. He asks the distant magician if he can carry on with the experiment, and on receiving an affirmative answer he removes the pack of cards from the tumbler and walks to the front of the

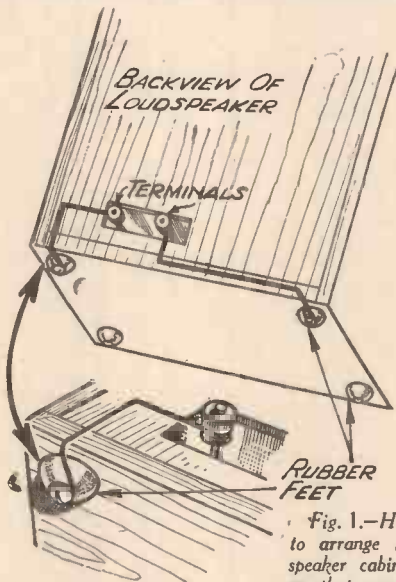
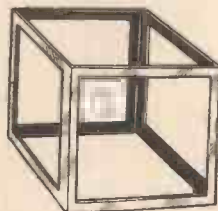


Fig. 1.—How to arrange the speaker cabinet so that sounds may be heard with no apparent connecting wires.

stage. He calls out "ready," or otherwise states that the distant magician can carry on, and our magician says, "Now the first



THREE CUBES (DIFFERENT COLOURS)

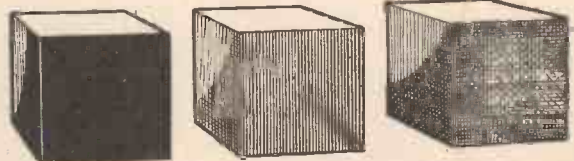


Fig. 3.—The cubes and box for the vanishing cube mystery.

card was chosen by Mrs. Gibson (or other member of the audience). Can you tell me what card she chose?" The voice from the speaker then says, "Yes. She selected the Four of Spades and you will find it

as at first, retaining the selected cards in the same position, and place in the tumbler.

## The Loud Speaker and Wireless Set

The broadcasting station is merely a model built from cardboard and serves no useful purpose other than a mask for the remaining operations. It may be built to any pattern desired, and the masts should carry small flash-lamp bulbs at the top. These may be internally connected to an ordinary flash-lamp battery, the circuit incorporating a switch on the back which may be operated by you when pretending to get into touch with the distant magician. The loud speaker is of standard pattern adapted as follows. The terminals are provided with thin leads which are carried down the

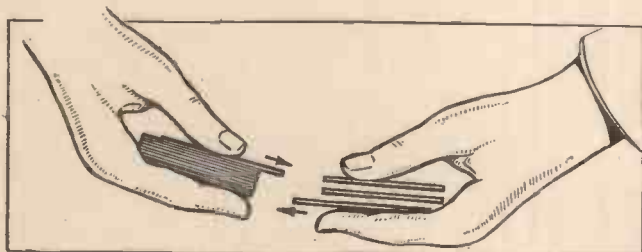


Fig. 2.—Method of false-counting cards. The arrows show the direction of movement of the top and bottom cards.

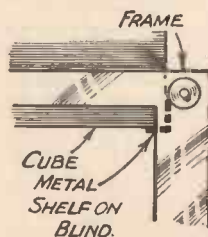


Fig. 4.—This diagram shows how the cube pulls down the blind for the cube mystery.

edges of the cabinet and terminate at the small rubber feet which are provided at the corner of cabinet speakers of this type. The screws which are inserted in these feet are unscrewed until the heads come level with the rubber, and the leads from the speaker are soldered or otherwise attached to these screws. The chair or table upon which the speaker is to be placed has leads from an outside room brought into it, laid under or along a carpet, and these are carried up the legs of the table or chair and at the top terminate in two narrow strips of brass. These are laid on the top of the chair or table in such a position that when the speaker is placed down the two rear feet will rest upon the strips, and thus the speaker will be joined to the distant point. At the latter an ordinary amplifier and microphone are provided and the situation of these should be such that the words of the performer may be heard by a confederate.

#### Manipulating the Cards

When the cards are to be identified, the confederate simply calls out the pre-arranged cards but may "place" them where he wishes in the pack. That is to say, supposing the first card to be named is the Ace of Spades, he may state that the card is the second, third, eighth, or even twenty-first from the top, and the performer "finds" the card in this manner. In view of the method of arranging the card which has previously been described, the first card to be identified will be on top. If the confederate states that this card will be found five down from the top, the performer takes the pack in his left hand and passes it across to his right pushing off the top card and counting "One." The left hand is swung back to the left side, passed across the body again and a second card pushed off on top of the first one with the word "Two," and so on up to four. If done deliberately, but not too slowly, the method of counting off simply appears as though the effect is to enable everyone to see that only one card is removed each time. When the fourth is slid off, at the same time the bottom card of those in the right hand is pushed on to the top of the remaining cards in the left hand, the passage of the top card from left to right hiding the movement of the bottom card from right to left. It then only remains to turn over the top card in the left hand, which will be the fifth in this case, and it is the correct card. The same procedure is adopted for each card, and it will be noted that the performer need not know at what position in the pack the card is to be found until the distant magician announces the fact from the loud speaker. Fig. 1 will make the various working details quite clear.

#### The Vanishing Cube

An old idea (the vanishing dice) may be transformed in the following manner, and even old hands will be absolutely unable to detect the method of accomplishing the vanishing of a 4-in. cube. Bringing

forward a tray upon which may be seen three or four coloured cubes, the performer announces that these are solid blocks of wood, each of which as may be seen bears a different colour. They are handed to the audience to pass round for inspection, and the weight alone is sufficient to guarantee that they are actually solid. These can be made from a length of garden-fence support, 4 in. square. Cut off in 4-in. lengths you have a neat cube which is very weighty. Colour with one of the modern Japanese lacquers, using contrasting colours such as yellow, red, blue, and white. Each cube is coloured on every side with the same colour and thus is capable of close inspection. On completion of the examination the audience are asked to select one of the cubes, and this may be freely done in any

desired manner. When a decision is reached the performer steps into the audience and collects the remainder upon the tray and returns to the stage, permitting the member who has selected the cube to retain it in the meantime. From a side table the performer picks up a hollow-sided box which is freely exhibited on all sides. Asking for the chosen block, this is slowly lowered into the hollow box, and as the sides are cut out the cube may be seen to pass into the box until it rests upon the bottom. It is then stood on the table, covered with a silk, and then the whole placed upon an ordinary glass cake-stand or other similar "trick-proof" device, which is removed from the table. The edge of the silk is raised to permit the block to be seen still in position, then a pass with the wand, or the utterance of the magic words, and the handkerchief is whisked away to reveal the box—empty, and it may be exhibited on all sides and the wand passed through from side to side or from top to bottom.

#### A Simple Dodge

The box which is used is made from thin brass angle-girder, riveted and soldered to form the shape shown in Fig. 3. It will be seen that the top portion is left large enough to permit of the block being passed into it, and across one side is fitted a small roller-blind arrangement. A length of thin brass tubing is provided at one end with a needle-point pivot and inside is a coiled spring. One end is anchored to the tubing and the other attached to the pivot at the end, which is a close fit inside the tube but is not fixed to it. Attached to the tube is

a length of coloured silk accurately matching the cube. To obviate the necessity of forcing one of the colours on the audience, use three cubes and have three duplicate boxes, each bearing a coloured blind corresponding to one of the blocks. These are hidden, and the correct one produced after a block is chosen. Alternatively, any well-known colour-force may be adopted to enable a single box to be used. A suitable force would be to prepare three cards with the three colours printed one on each. Show the cards, mix, and fan them backs to the audience, taking care to keep the forcing colour in the centre. Pick out a member of the audience and ask him to select a card by saying, "Which card would you like, sir, the centre one or the two outside ones?" If he says the latter, throw these down saying, "That leaves the centre one for the trick," and show it. If he

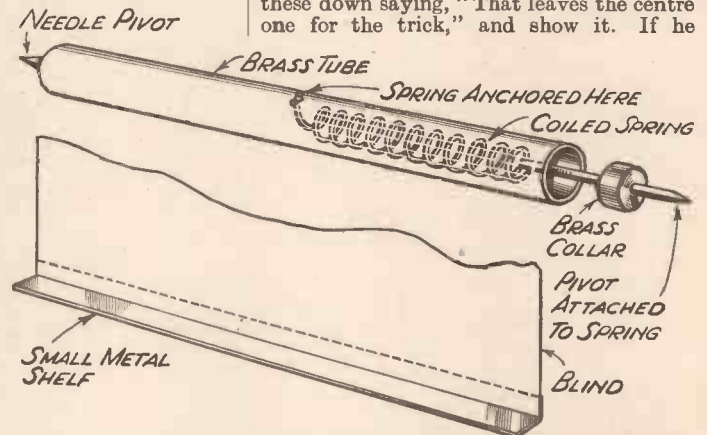


Fig. 5.—Full constructional details of the roller-blind used in the cube mystery.

should say the centre one, turn it round and show the colour he has chosen.

As the block is lowered into the box it bears on a turned-over metal edge to the blind and so pulls it down. As it goes down with the block the illusion is complete, and the metal is gripped by a small spring catch. When resting on the bottom the entire apparatus may be shown on all sides showing that the block is actually inside the box. As the box is turned round for inspection it is not returned to its correct original position, but is kept with the original top to the rear. When placed on the table it is stood in front of a well (top to the rear) and in the act of covering it is given a slight backward tilt and the block falls into the well. All that remains is to place it on the glass stand, raise the silk to enable the blind to be seen, re-cover and release blind, then wave wand and show block vanished.

An alternative effect may be produced by using a plain box, that is, without blind, and omitting the final inspection before vanishing. This method may appeal on account of the simplicity, but the final inspection of the blind gives the effect a really remarkable air and removes any doubt of trickery.

"Creative Woodwork," by W. T. James and J. H. Dixon, 257 pp. with numerous line and half-tone illustrations. Published by Sir Isaac Pitman & Sons, Ltd., Pitman House, Parker Street, Kingsway, London, W.C.2. Price, 8/6.

HERE is a well-produced handbook which will prove useful alike to the student, the teacher of handicraft and the amateur craftsman. It has been written by two teachers of handicraft who have had a lifelong experience of their work, and as such it is both authoritative and clearly written.

#### BOOK RECEIVED

Commenting by describing the performance of the simpler woodworking operations and suitable tests for students, the work outlined is nicely graded up to a very high standard. The idea throughout is in keeping with the best modern teaching methods of causing the student to think for himself and to progress along original lines. Although many of the exercises and tests are of necessity conventional there is also a good deal which is new.

Nineteen pages are devoted to three excellent opening chapters on general teaching methods for handicraft in modern schools, and if we may be allowed a single criticism it is that the chapter on drawing is rather too curtailed, being only five pages in length. Nevertheless we can recommend the book to all handicraft teachers and intending teachers, especially those who have not had the advantage of being trained in up-to-date colleges. Even for the experienced teacher the book will be of immense value in supplying new ideas which may be added to the teacher's "stock-in-trade."

# CHRISTMAS ILLUMINATIONS

*A description of the Methods of Connecting Coloured Lights of Various Kinds to either the Lighting Mains or Accumulators.*

COLOURED lights generally form part of the scheme of decoration for the Christmas party, whether they are arranged on the Christmas tree or among

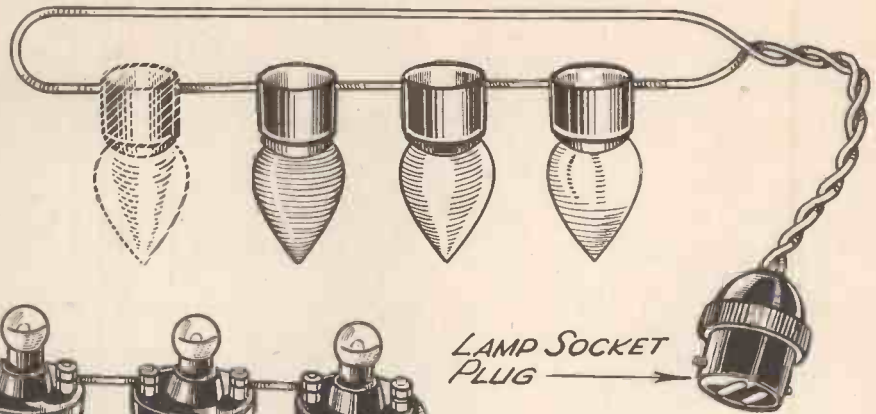


Fig. 1.—Showing the series connections of the strings of miniature coloured lamps, which are available for voltage supplies from 200 upwards.

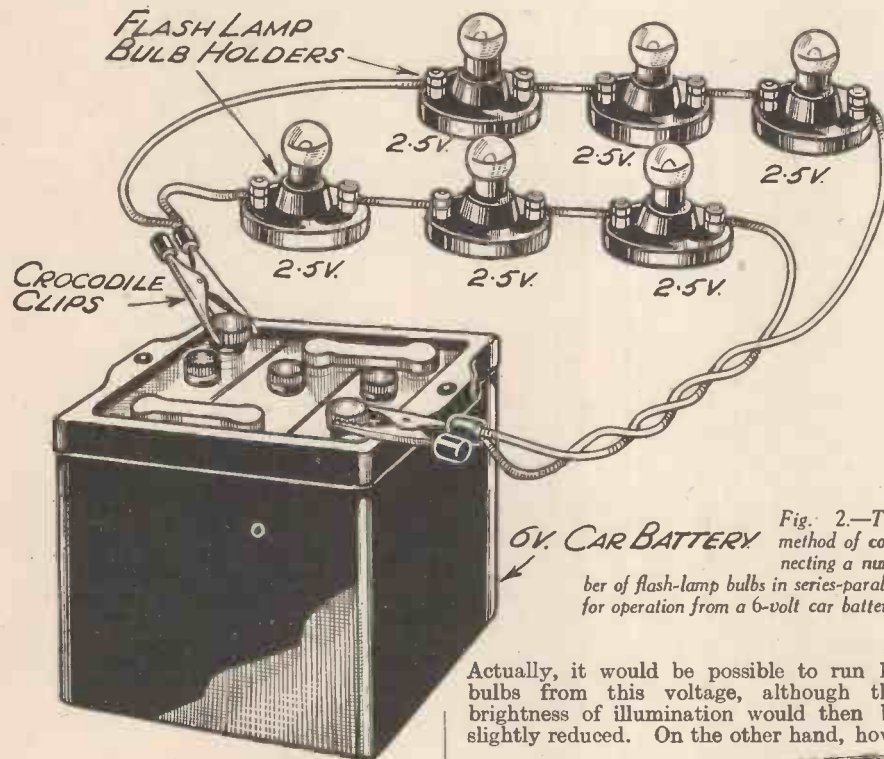


Fig. 2.—The method of connecting a number of flash-lamp bulbs in series-parallel for operation from a 6-volt car battery.

Actually, it would be possible to run 16 bulbs from this voltage, although the brightness of illumination would then be slightly reduced. On the other hand, how-

ever, the life of the bulbs would be prolonged to a certain extent, and in any case full brilliance is seldom needed. The sets of coloured lights referred to can be obtained ready wired and in suitable numbers for all mains voltages from 200 upwards.

### Using an Accumulator

When it is proposed to use an accumulator for supplying the lights, the best course is to use a number of flash-lamp bulbs wired in series-parallel. The method of connection is illustrated in Fig. 2, where it is assumed that bulb holders of the small porcelain-base type are to be used. These, incidentally, can be fixed on to the branches of the tree by passing a loop of string through the screw holes, or they can be mounted on a thin wooden lath when the lights are to be among the bunting. In Fig. 2, a 6-volt car battery is indicated, and the wiring assumes the use of 2.5-volt bulbs of the type sold for use in small pocket torches. There are three bulbs in each series "loop," giving a total

the streamers. Suitable lights can be easily and cheaply arranged to-day whether the house is wired with electricity or not, for there are bulbs suitable for almost every working voltage. Thus, if a mains supply is not available it is a perfectly simple matter to use an accumulator, which may consist of two or three of the cells used for operating the wireless set, or the car battery removed from the car for the occasion.

### The Simplest Method

In the first place we may consider the simplest and most convenient method of coloured illumination, and which is applicable when a supply of either A.C. or D.C. current is available. This consists of using one of those strings of small lamps of many colours which are popular with shopkeepers for brightening their window displays. These can be bought fairly cheaply complete with a very-well-insulated connecting cable and lamp-socket plug. The bulbs are each rated at 14-16 volts, and the holders are all joined in series as shown in Fig. 1. The number of bulbs required depends upon the voltage of the supply, and can be found by dividing the voltage by 15 (the average voltage rating of each lamp). Thus, if the supply is 230 volts A.C.—a usual figure—a set of 15 bulbs would be appropriate.

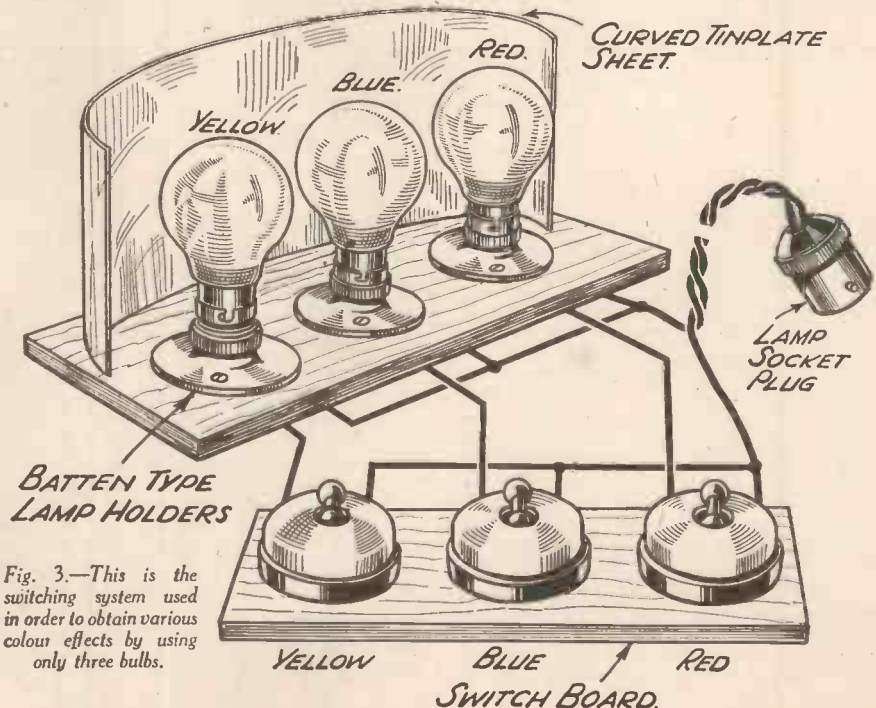


Fig. 3.—This is the switching system used in order to obtain various colour effects by using only three bulbs.

voltage rating of 7.5; here again, however, it is an advantage slightly to under-run the filaments as long as the greatest possible amount of light is not required. There may be as many "loops" as required, or at least up to thirty, since the current passed through each will be no more than .25 amp.

#### Use Stout Connecting Wire

As shown, the bulbs are all comparatively close together, but they can, of course, be arranged as required by using good lengths of twin flex for each circuit. A word of warning should be given here that if the connecting wires are long and consist of thin wire it is quite likely that the bulbs will do no more than glow dimly because of the high resistance of the connections. For this reason there should be no attempt at economising, for it is well worth while to

hotter when in use so that the cellulose is more liable to flake off.

#### Vari-coloured Stage Lighting

It is often desired to provide a means of coloured lighting for household amateur theatrical parties, and the simplest method is that shown in Fig. 3, where bulbs of three different colours are arranged side by side inside a simple reflector made from a sheet of bright tinplate. The colours used are yellow, red, and blue, and by combining these a variety of different colour effects can be obtained. For example, besides the three primary colours of the bulbs, to be obtained by putting each in circuit separately, a purple illumination can be obtained by switching on the red and blue bulbs together, green by using the yellow and blue together, orange by combining the yellow and red, something approaching normal white light by using all three, and so on.

For this purpose, it is convenient to have each lamp in circuit with its own switch and to mount the switches together on a simple control box or panel. If the switches are marked with the colours

of the lights with which they correspond, it is quite easy to obtain the required regulation. There is one difficulty which occurs when the lights are fed from an ordinary lamp socket, which is that the total consumption when all three lamps are in use should not exceed about 120 watts; this means that each lamp should be rated at 40 watts only. An alter-

native method is to use higher-power lamps and to feed them from different sockets, but this is rarely convenient.

#### A Better System

Another method, and one which is satisfactory in nearly all circumstances, is to have two sets of 40-watt lamps, each fed from a separate socket and placed on opposite sides of the extemporised stage. In this case double-pole switches of the type used for mains switching in wireless sets, and known as Q.M.B. switches, can be used and wired as shown in Fig. 4. Care should be taken that the switches used are capable of handling up to 250 volts at about .5 amp. Great care must also be taken to see that the ends of the wires near to the switch contacts are insulated and kept well away from each other so that short-circuits cannot take place.

#### A Word of Warning

Were it not for the fact that the rule is often overlooked, it would be unnecessary to mention that nothing but the best-

quality lighting flex should be used for all connections made to the mains supply. This material is rather expensive—an average price is about 3d. per yard—but it is safe and may prevent a good deal of trouble in the way of partial short-circuits and electric shocks to the user of the equipment.

## Items of Interest

#### One-way Paint

THE American Society for Testing Materials reports that a paint will shortly be produced which will permit moisture to pass in one direction only—from the underlying wood out to the atmosphere, thus tending to preserve the wood longer.

This reminds us of an advertisement in the catalogue of a well-known tool manufacturer who claims that his glue pot is unrivalled for conducting and retaining heat. (The italics are ours!)

#### The World's Largest Artificial Lake

THE completion of the Boulder Dam on the Colorado River, U.S.A., terminates a task which has occupied 5,000 men for nearly six years. The dam has cost £24,000,000, and is 727 ft. high, 560 ft. thick at the base, and 45 ft. thick at the top, where the length is nearly 400 yds.

The dam has been built in a canyon through which the river flows, and the lake which will be formed will be 115 miles long and 40 miles wide at the widest part. Although it has been filling since last February and although it is now filled to less than one-sixth of its capacity, it already forms the largest artificial lake in the world. Its construction will bring electricity, domestic water, and irrigation to a vast area, and over one million acres of desert land will be converted to fertile soil.

## Plating Processes

Since the advent of chromium-plating, other stainless plating processes have been developed, which, however, do not rely so much on an inert oxide layer for their non-tarnishing qualities as is the case with chromium, as on the "nobility" (or the capacity for resisting chemical action) of the deposited metal itself. In particular, the deposition of metals of the platinum group has seen considerable progress during the last three or four years. Platinum, palladium, and rhodium, have all been successfully deposited upon articles of good quality to provide a veneer of these rare metals, and articles so treated have been found to resist tarnish to a remarkable degree. An important application has been the deposition of these metals on sterling silver. Rhodium-plating in particular has proved effective in preventing this tarnishing. It is the whitest of the platinum group of metals and its colour is very similar to that of silver, while its chemical resistance is superior to both platinum and palladium.

Index and Binding Cases for Vol. 2 of PRACTICAL MECHANICS are now ready. Indexes cost 7d. by post, and binding cases complete with title page and index costs 3s. 6d. from Geo. Newnes, Ltd., 8, 11 Southampton St., Strand, W.C.2.

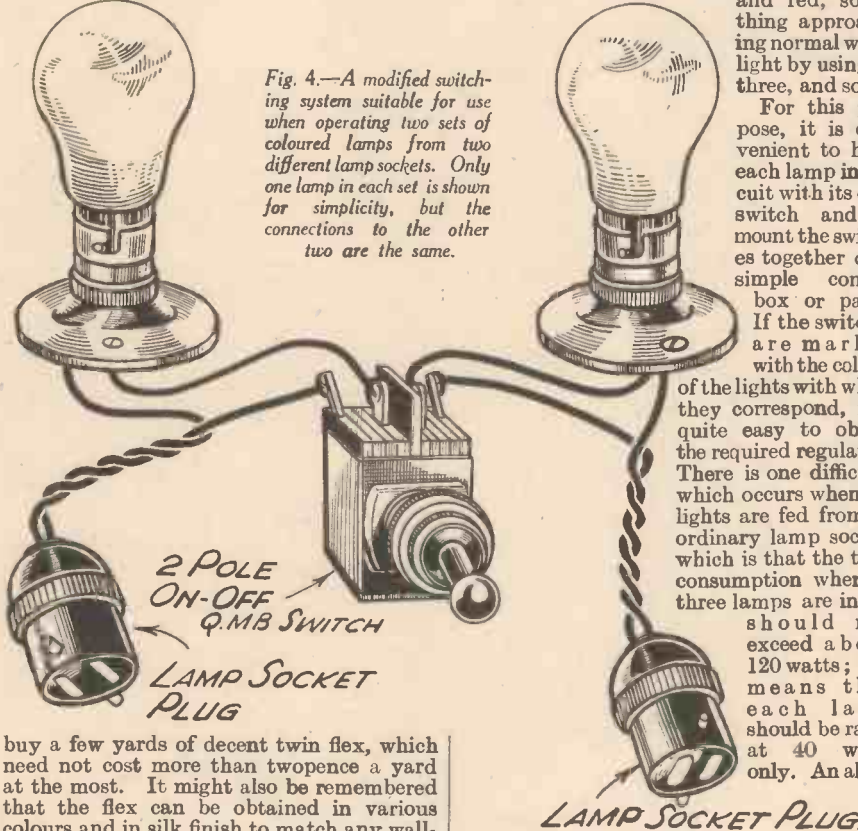


Fig. 4.—A modified switching system suitable for use when operating two sets of coloured lamps from two different lamp sockets. Only one lamp in each set is shown for simplicity, but the connections to the other two are the same.

buy a few yards of decent twin flex, which need not cost more than twopence a yard at the most. It might also be remembered that the flex can be obtained in various colours and in silk finish to match any wallpaper or furnishings.

#### Colouring the Bulbs

It is possible to obtain coloured bulbs of the flash-lamp type, but it will probably be found cheaper and more convenient to use ordinary plain bulbs and to colour them oneself. The easiest method of doing this is by using some of the cellulose lacquer which can be bought so cheaply nowadays from both sixpenny stores and suppliers of handicrafts materials. Three or four tins of different colours may be obtained and the bulbs, after being warmed slightly by having them lighted, should be dipped into the cellulose and immediately removed. In doing this the lacquer should be rather on the thin side (thinners are available from the suppliers) and the bulbs should first be placed in their holders so that they can be left to dry without the need for handling them. Incidentally, this method of colouring can also be used with completely satisfactory results in connection with ordinary electric-light bulbs. In this case, however, it is better to use vacuum bulbs than those of the gas-filled type; the latter become

# NOISES OFF!

*and How they are Produced*

In this Article the Reader is Taken "Back-stage" and Shown How Various Effects are Produced

**I**N very small type at the foot of the theatre programme one usually sees the name of a gentleman who is somewhat tersely described as the "stage manager," but very few of the public ever stop to think just why he is there. His job, paradoxical as it may seem, is to be quite unobtrusive and yet at the same time to make as much noise (off the stage) as the plot demands. He may be called upon to imitate either a front-door or a telephone bell; a galloping

Fig. 2, and both rely on dried peas. In one case a cardboard tube is used and in the other the peas are swirled round in a bowl. For a nice steady downpour, however, a revolving wooden drum containing dried peas should be used. This apparatus, by the way, is also useful for waves on the sea-shore. It is advisable, however, to substitute shingle for the peas, and to place wooden vanes longitudinally across the inside of the drum so that an intermittent "swish" is obtained.

### Wind Effects

Two methods of producing the sound of wind are shown in Figs. 3 and 4. In the former a piece of corded silk ribbon, about 4 in. wide is tightly stretched across a wooden frame, and when rubbed sharply to and fro with a piece of wood, as shown in the inset drawing, quite a good effect is produced. The simple piece of apparatus shown in Fig. 4 is made in a few minutes, and by the tension of the rubber band the wind may be induced to howl in any convenient key. A wind-machine, as used in professional productions, is a somewhat large affair and usually takes the form of a wooden water-wheel, the vanes of which contact with a stout strip of canvas about 12 in. wide. The wheel is, of course, mounted on brackets and is capable of being revolved by a handle. By turning slowly a low moan is produced, and by speeding up it is possible to obtain a shrill scream.

### A Galloping Horse

This effect is usually produced with the aid of two coconut shells. Although per-



SILK RIBBON STRETCHED TIGHTLY ON WOODEN FRAME

Fig. 3.—A wooden batten rubbed on corded silk gives a realistic wind effect.

haps one of the oldest stage effects, it is very difficult to better this method. Two wooden boxes, however, as shown in Fig. 5, will be found quite effective and if fine shingle is strewn on a table, the horse may be induced to gallop up a gravelled drive.

Crashes of various kinds are often called for in the script of a play, and although there are, of course, innumerable ways of reproducing them, it is always as well to have some order in the chaos or the resultant noise may be out of all proportion to the one desired. The little machine shown in Fig. 6 is very useful for at least part of the crash. The drawing is self-explanatory,



Fig. 1.—How the noise of thunder is produced.

horse or a waterfall; a train in the distance or a crash of thunder; a cow or a klaxon horn; a rainstorm or a lawn-mower; in fact, any sort of noise which the somewhat heartless author may call for in his script as "noises off."

The extraordinary realism which has been attained by this department of the theatre to-day is very high, and therefore it is interesting to go "back-stage" and discover the methods by which a variety of noises are produced. No doubt, there are many readers this Christmas who will be producing plays; therefore some of the tricks of the trade may be found useful.

### The Crash of Thunder

Let us start off with a good crash of thunder. This is one of the easiest effects to produce, as a glance at Fig. 1 will show. A sheet of tin will produce quite a good effect, but should a really nasty storm be required a full-sized thunder sheet should be used. This, as will be seen from the inset sketch (Fig. 1) is suspended from the roof and shaken to and fro. Continuing with our storm, the rain has now to fall. Two assortments of "rain" are illustrated in



Fig. 2.—Two rain effects are shown above and a third is described in the text.

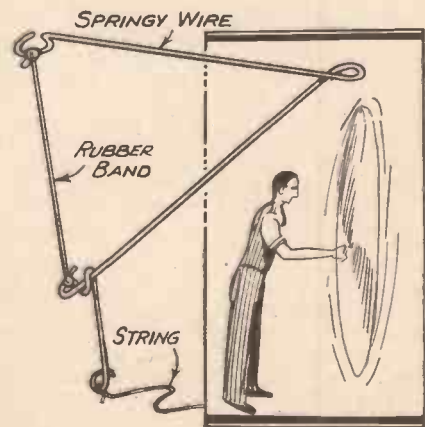


Fig. 4.—A simple method of producing the sound of wind.

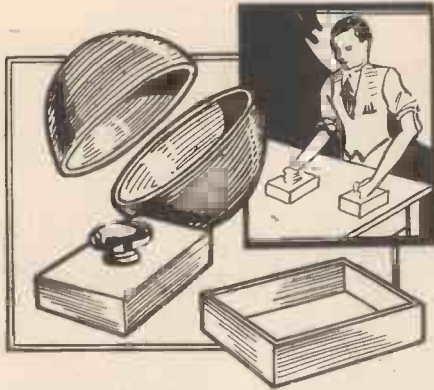


Fig. 5.—Two coconut shells or wooden boxes enable a person to produce the noise of a galloping horse.

and it is, of course, just a variation of the well-known football rattle. A boxful of broken china produces quite a handy effect and may be used in conjunction with other crash effects.

**A Difficult Play to Stage**

One of the most difficult plays to stage, from the effects point of view, is "The Ghost Train," for as those readers who have seen the play will remember, the noise of the train passing the station played a large part in the show. The play has, however, been produced very successfully by amateurs, so perhaps a word or two on train noises will be useful. Fig. 8 shows one method of obtaining the wheel noise, which

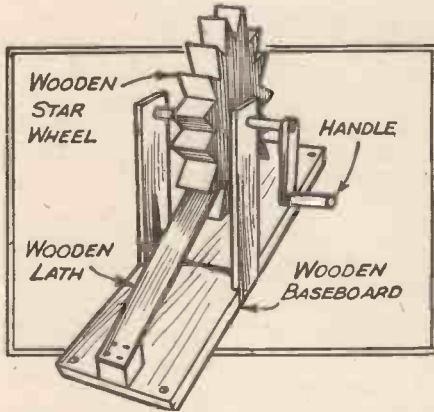


Fig. 6.—A useful little machine which may be used in crash effects.

is, of course, a continuous background to an effect of this description. As will be seen from a glance at the sketch, a number of roller skates run round a metal drum and the battens fixed to the latter tend to give the "bomperty-bom," "bomperty-bom" which is always associated with the noise of a train. Engine noises are manufactured in various ways. A bass drum supplies a suitable deep rumble, while other high-pitched drums beaten to synchronise will be found satisfactory. Iron bars pivoted together and "clanked" give the impression of the mechanical noise of the engine, while compressed air allowed to escape, at appropriate intervals, from a cylinder gives a very realistic steam effect. The whistles are, of course, only reproducible by employing actual whistles, varying in pitch as required. To work a realistic train effect a team of stage hands is required and the stage manager should take the part of the conductor, for it is only by

working absolutely together that the rhythm of the train is produced.

**Noise Effects from Records**

All the effects which have been described depend on what one might call mechanical means, but specially made

**A USEFUL LIST OF PRESENTS.**  
**NEWNES HOME MECHANIC BOOKS.**

- THE HOME WOODWORKER
- MODEL BOAT BUILDING
- THE HANDYMAN'S ENQUIRE WITHIN
- TOY MAKING FOR AMATEURS
- 25 SIMPLE WORKING MODELS
- MOTOR-CAR OVERHAUL AND UPKEEP
- ACCUMULATORS—CAR AND WIRELESS
- MODEL AEROPLANES AND AIRSHIPS
- POWER-DRIVEN MODEL AIRCRAFT
- SIMPLE ELECTRICAL APPARATUS
- LATHEWORK FOR AMATEURS

All the above books are obtainable from all Newsagents, price 1/- net, or from George Newnes, Ltd., 8-11 Southampton Street, Strand, W.C.2, price 1/2 post free.

records are now obtainable which will reproduce the effects through amplifiers. Unless, however, the apparatus is very well designed, it is better to rely on the old-fashioned methods.

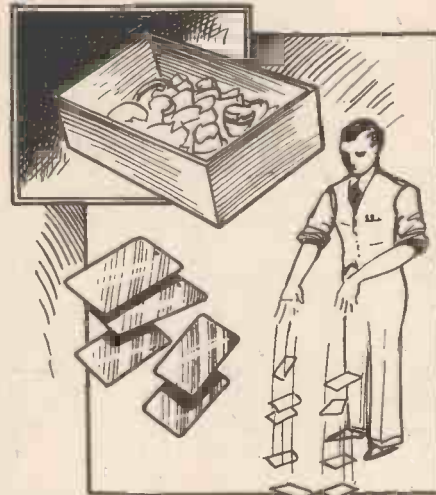


Fig. 7.—A box of broken china makes a realistic crash, while the metal plates, when dropped, produce the sound of breaking glass.

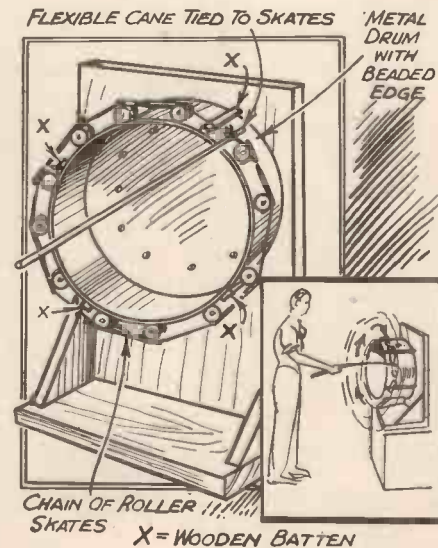


Fig. 8.—One method of imitating a train in motion.

**DOMESTIC ENGINEERING**

**H**AS it ever occurred to you how much the comfort and convenience of modern civilisation depends upon the domestic engineer? Our homes, offices and works would soon become uninhabitable were it not for the essential services, water and drainage, and most of our comfort would be non-existent were it not for the work done by the gas-fitter, the electrical engineer and the heating and ventilating engineer.

In equipping modern buildings, the activities of the plumber and domestic engineer, the gas-fitter, the heating and ventilating engineer, and the electrical engineer are interwoven with each other. We are, therefore, interested to learn that a comprehensive work, entitled *Plumbing and Domestic Engineering*, is now to be issued in about thirty weekly parts.

In accordance with the usual practice in the case of technical serials issued by the house of Newnes, this publication deals with all branches of plumbing and domestic engineering, also heating and ventilation, in a manner which can be readily appreciated by any practical man.

The purely theoretical side of the subject has been kept down to a minimum, but all practical details regarding the methods of planning, installing and maintaining the essential services in houses and large buildings are dealt with by clearly written articles which are illustrated by line diagram and action photographs.

Readers who are interested in any of the above-mentioned subjects should certainly see a copy of Part 1, which contains a most interesting Free Chart printed in colours to illustrate some of the current systems of hot-water supply and central heating.

Apart from those directly interested in domestic engineering, anyone who has a practical interest in building will find this work most useful for reference purposes. It is edited by Mr. E. Thomas Swinson, F.R.San.I., R.P. No. 1 was published on October 16th, price 1s.

**"ROUND THE WORLD WITH RAWLPLUGS."**

**T**HE Rawlplug Co., Ltd., have produced a 20-page booklet, lavishly illustrated, dedicated to those who are interested in knowing how their business has developed. To-day Rawlplugs are as universally used as the wood-screw, and are known and used in every civilised country in the world. Fifteen years ago a very small factory sufficed to meet the demand for Rawlplugs, whereas to-day there are large factories in London, Birmingham, Leeds, Berlin, Paris, and New York.

Recent additions to the list of Rawlplug tools include a highly efficient mechanical hammer which saves considerable time and labour when drilling.

The above company have also firmly established on the market such well-known branded goods as Durofix—the heat and waterproof resistance, plastic wood, and a dozen other universally known products. They are also the largest distributors of bathroom fittings and the second largest distributors of British screws.

If you are interested write to the Rawlplug Co., Ltd., for a copy of *Round the World with Rawlplugs*, which will be sent free of charge.





# The Home Telephone



## Details of a Simple Room-to-Room Telephone System

**A**LTHOUGH the telephone as supplied and fitted by the G.P.O. has become such a commonplace thing in our lives its method of working is still, to many people, a great mystery, and as such appeals to the imagination.

It is strictly forbidden to tamper in any way with the commercial model and it

phone system should, therefore, be of interest to many readers who, through reason of cost or genuine interest, prefer to make their own transmitting and receiving apparatus.

The main items required are (1) Two pairs of suitable. (2) Two cigar boxes. The "fifty" size should prove large enough. (3) Two buzzers. There are many of these on the market, the only important detail being size; they must not be too bulky. (4) Two flashlamp batteries, and (5) two neat bell-pushes. These, supplemented with odd pieces of brass, screws and nuts, are the chief requirements. And now for constructional details.

which is a view of the completed unit, will make this clear.

The microphone is made from one of the earpieces, which requires slight alteration. The cap is first removed and the centre hole made larger, either by filing or with a fret-saw. A mouthpiece is then constructed from stout paper or thin cardboard, and

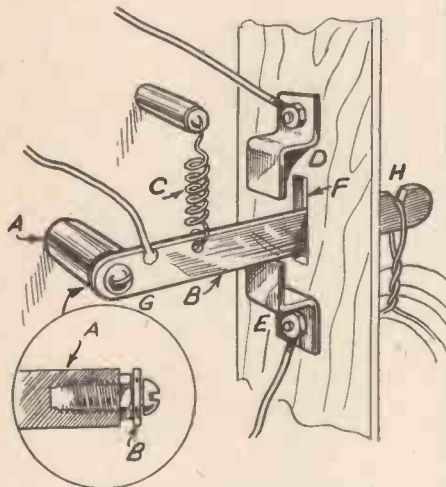


Fig. 1.—The receiver hook and switch, showing constructional details.

becomes necessary to buy or make a telephone outfit if any experiments are to be carried out. Likewise, a simple telephone system from one room to another has to be constructed or purchased, and in the event of the latter course much of the interest is undoubtedly lost through not understanding the "works."

The following details of a simple tele-

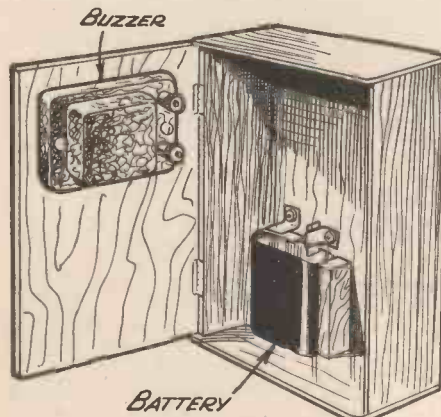


Fig. 2.—Fitting the battery and buzzer.

### The Receiver Hook

The receiver hook claims attention first, and Fig. 1 illustrates how it works. The lever *B* pivoted at *G* can move up or down and touch either of the two contacts *D* and *E*. In its released position i.e., whilst using the phone, the spring *C* keeps in the top position, making contact with *D*. At the end of the conversation the receiver is hung on the end *H*, the weight overcoming the tension of the spring and changing the contact from *D* to *E*.

*A* is a supporting pillar fixed to the back with a countersunk screw, the spring being likewise fixed. *F* is a slot in the side of the "cabinet" to take the receiver hook. A flex lead is soldered to the latter and completes the most difficult part of the outfit.

The battery is placed inside the cabinet and two brass strips make connection with the contacts. The battery rests on the bottom (see Fig. 2) and fixed on the inside of the lid at a height sufficient to clear this is the buzzer. It is fixed on the lid in preference to the back, as the former acts as an excellent sounding-board with consequent increased volume.

On the lower half of the lid (outside) is fitted the bell-push, the top being reserved for the microphone; a glance at Fig. 4,

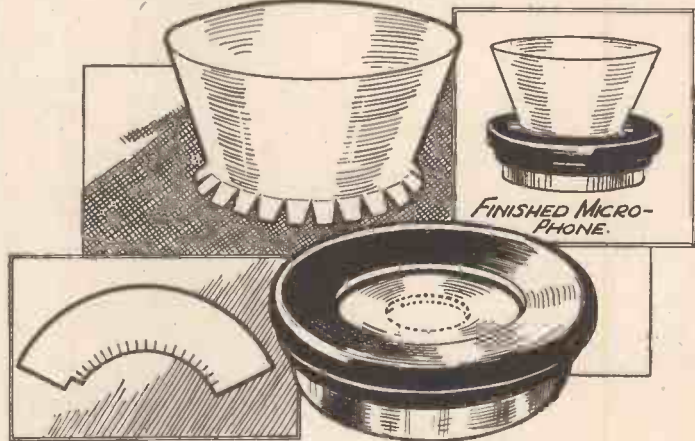


Fig. 3.—The method of making the microphone is shown above.

fixed to the cap with fish glue, this being allowed to set thoroughly. Fig. 3 gives all the necessary information in pictorial form.

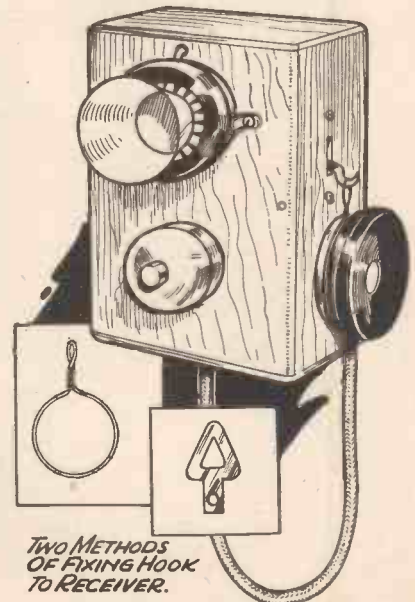


Fig. 4.—Showing the professional appearance of the finished telephone.

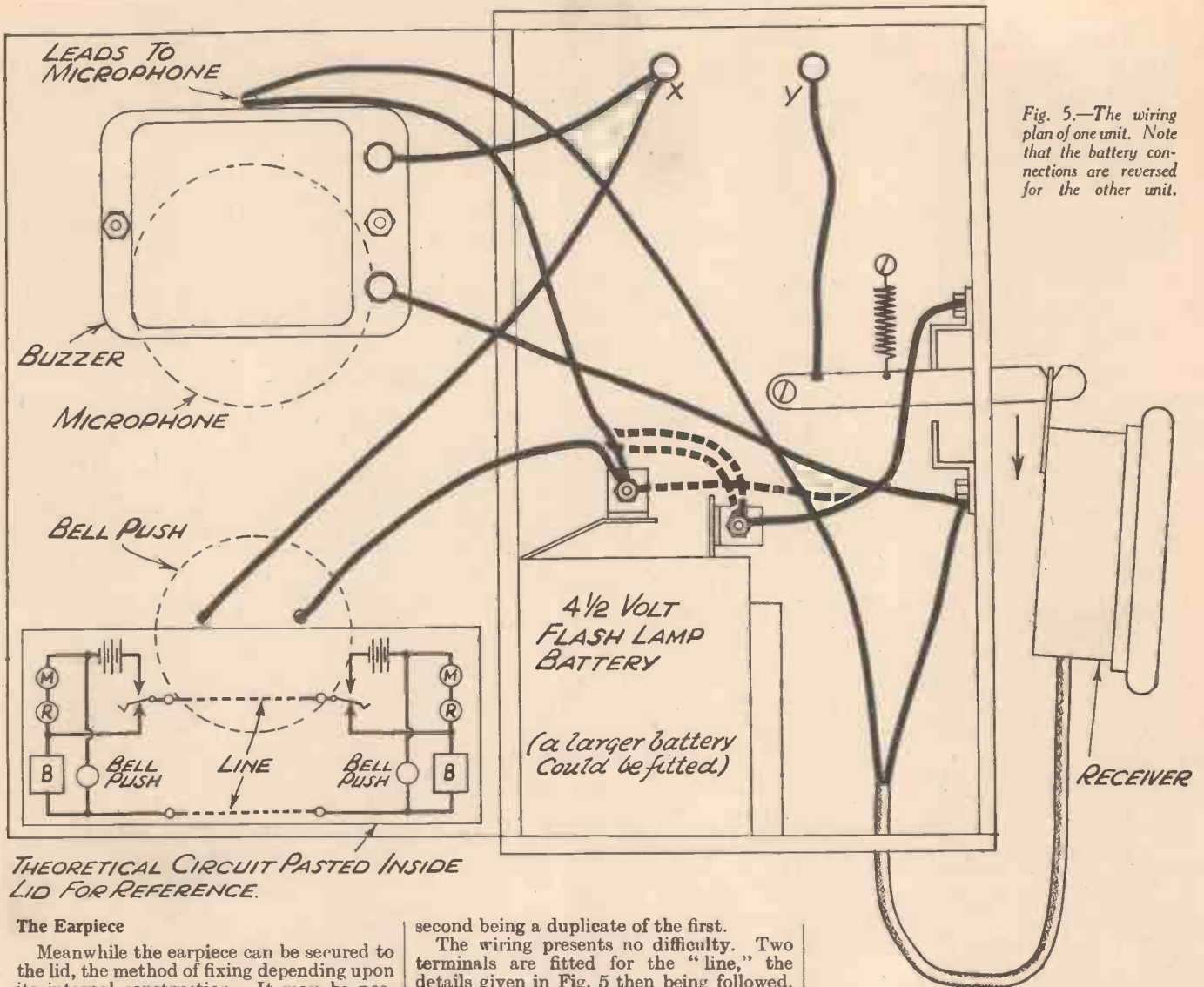


Fig. 5.—The wiring plan of one unit. Note that the battery connections are reversed for the other unit.

*THEORETICAL CIRCUIT PASTED INSIDE LID FOR REFERENCE.*

**The Earpiece**

Meanwhile the earpiece can be secured to the lid, the method of fixing depending upon its internal construction. It may be possible to drill two holes in the back and use nuts and bolts, or it may be necessary to solder two brackets on the sides, these being fastened with nuts and bolts. If soldering is out of the question, possibly due to the case being made of aluminium, two further nuts and bolts can be used.

This detail is of necessity an individual one, and some simple method will soon suggest itself to the enthusiast. For the time being the cap can be left off.

The other earpiece is used as the receiver and only requires the addition of a hook to complete it. This again is a simple but individual problem which can easily be decided.

It will be appreciated by now that only one unit has been described. This point is immaterial as both units are identical, the

second being a duplicate of the first.

The wiring presents no difficulty. Two terminals are fitted for the "line," the details given in Fig. 5 then being followed. The two units differ slightly at this point; the polarity of one of the batteries is reversed as shown by the dotted connection.

When the ear-piece caps have been replaced, the units are ready for test. Bell wire can be used for the "line," but it is essential that terminal + of one unit is connected to terminal + of the other unit, otherwise the batteries will be in opposition, and in the event of no signals the effect of changing the "line" wires should first be tried.

**How it Operates**

Operation is simple. Caller A lifts his receiver and presses the button. This operates the buzzer of listener B, who lifts his receiver, putting the buzzer out of action, because although it is still in circuit

the current, which now has to pass through the transmitter and receiver as well, is insufficient to operate the magnets and it acts simply as a low resistance. The action in the reverse direction is similar.

This completes the details, and the constructor should now have a handy telephone which should prove reliable and trustworthy. Nevertheless, owing to its extreme simplicity it has one or two minor faults.

Perhaps the worst of these is that the speaker also operates his own receiver, and as a result "gets an earful" of his own voice. With a twin line this could only be eliminated by a complicated method of switching, but for those readers who are prepared to use a triple line the alternative wiring will be given next month.

**One-way Paint**

THE American Society for Testing Materials reports that a paint will shortly be produced which will permit moisture to pass in one direction only—from the underlying wood out to the atmosphere, thus tending to preserve the wood longer.

This reminds us of an advertisement in the catalogue of a well-known tool manufacturer who claims that his glue pot is unrivalled for conducting and retaining heat. (The italics are ours!)

**IN THE WORLD OF SCIENCE**

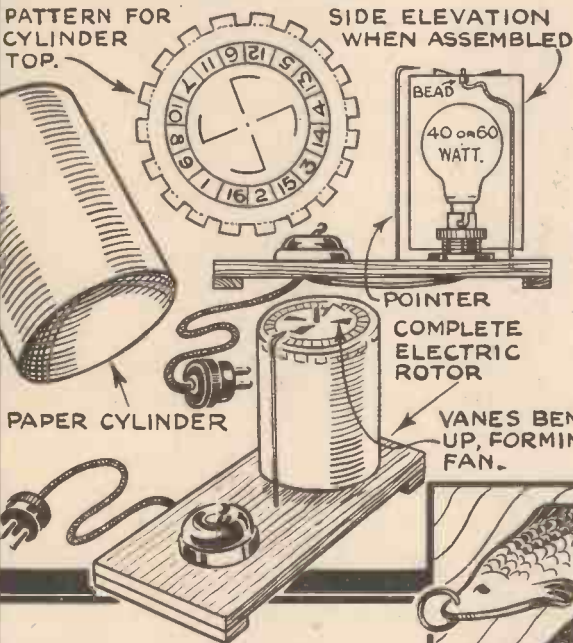
**The World's Largest Artificial Lake**

THE completion of the Boulder Dam on the Colorado River, U.S.A., terminates a task which has occupied 5,000 men for nearly six years. The dam has cost £24,000,000, and is 727 ft. high, 560 ft. thick at the base, and 45 ft. thick at the top, where the length is nearly 400 yds.

The dam has been built in a canyon through which the river flows, and the lake which will be formed will be 115 miles long and 40 miles wide at the widest part. Although it has been filling since last February and although it is now filled to less than one-sixth of its capacity, it already forms the largest artificial lake in the world. Its construction will bring electricity, domestic water, and irrigation to a vast area, and over one million acres of desert land will be converted to fertile soil.

# Easily Made PARTY GAMES

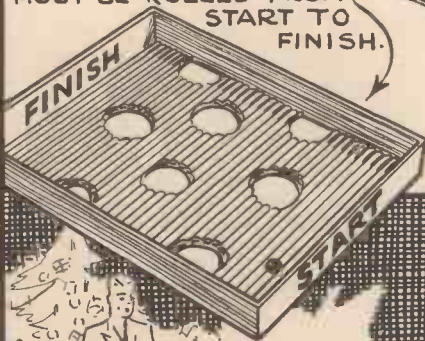
THIS REVOLVING CYLINDER IS OPERATED BY THE HEAT FROM AN ELECTRIC LAMP. THE POINTER INDICATES WINNING NUMBER WHEN LAMP IS SWITCHED OFF AND CYLINDER COMES TO REST.



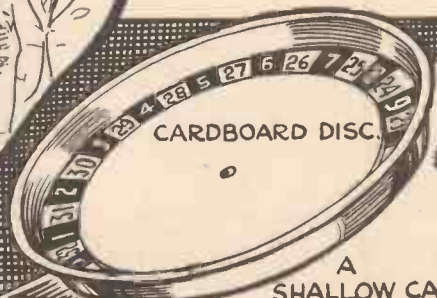
MINIATURE GOLF SCORING BOARD IS MADE FROM 3-PLY OR CARDBOARD. THE TOP-SCORE HOLE SHOULD BE JUST LARGE ENOUGH TO ALLOW THE BALL TO PASS THROUGH.



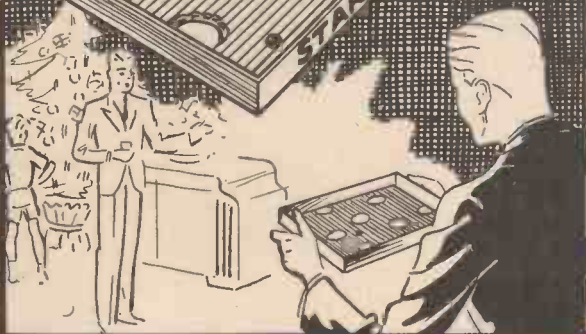
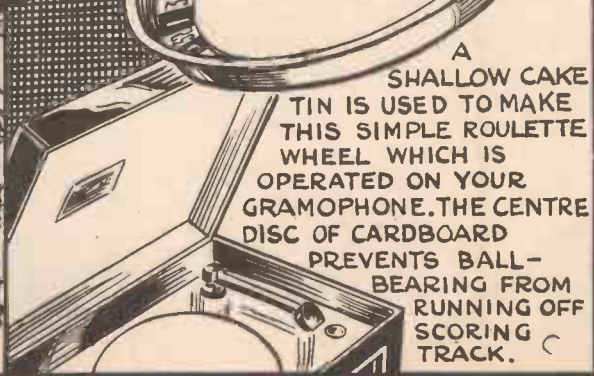
AN INTERESTING GAME MAY BE MADE WITH CORRUGATED CARDBOARD IN SHALLOW BOX LID. HOLES ARE CUT RIGHT THROUGH AS SHOWN TO FORM HAZARDS THE GAME IS PLAYED WITH A BALL-BEARING WHICH MUST BE ROLLED FROM START TO FINISH.



WITH ROD AND LINE THESE CARDBOARD FISH ARE HOOKED THROUGH RING. PAINTED VARIOUS COLOURS THE FISH MAY REPRESENT DIFFERENT SCORES.



A SHALLOW CAKE TIN IS USED TO MAKE THIS SIMPLE ROULETTE WHEEL WHICH IS OPERATED ON YOUR GRAMOPHONE. THE CENTRE DISC OF CARDBOARD PREVENTS BALL-BEARING FROM RUNNING OFF SCORING TRACK.





An Imperial Airways liner in the light from one of the new G.E.C. landing floodlights at Croydon Aerodrome.

## Safer Aerodrome Lighting for Aircraft

*To-day the British Airport Lighting Equipment is Without an Equal in Any Part of the World*

**T**HE rapid growth of air travel to and from this country, and the opening up of many new aerodromes, focuses attention on the need for the efficient lighting of these important travel centres, for like our great terminal railway stations, they have to function at all hours of the night as well as by day.

A large amount of research and careful thought have been devoted to the subject by the G.E.C., and its engineers have for some time been busily engaged in developing lighting equipment expressly for aerodrome use. Their efforts in this direction have been extremely successful and to-day British airport lighting equipment is without an equal in any part of the world. At Croydon airport, for example, where a new lighting installation is now in operation, the lighting is probably superior to that which is in operation anywhere else in this country. Even great airports of Le Bourget in France, and the Tempelhof Airport in Germany, perhaps the best lighted on the Continent, are not nearly so well equipped to ensure safety in night flying.

### 6-kilowatt Floodlights

Croydon, by its new installation of aerodrome floodlights manufactured by the G.E.C. to conform with the British Air Ministry's Specification is, possibly, now regarded as the foremost lighted airport. Around its landing area have been installed a number of powerful floodlights, each rated at six kilowatts, to enable aircraft to land

or take off at any hour of the night. These are arranged in positions which enable appropriate lighting to be switched on according to the direction of the wind. They are



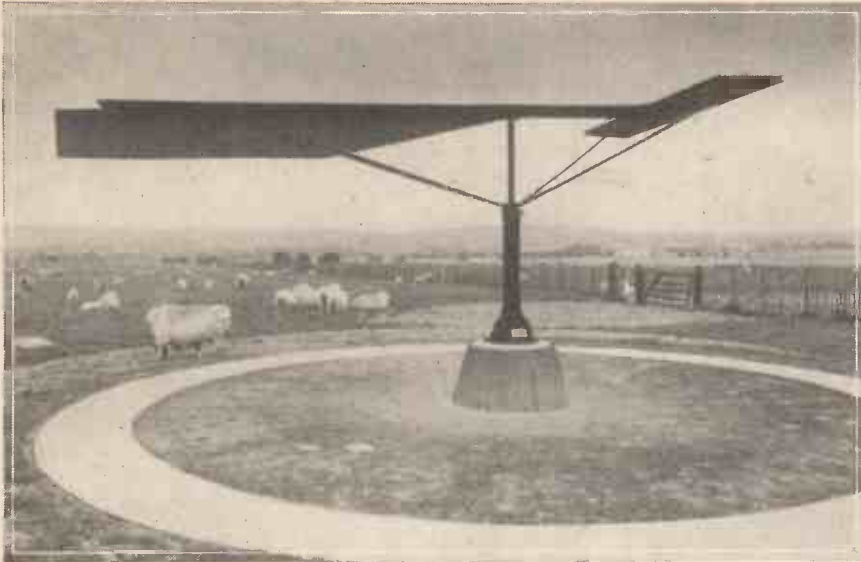
A night view of the new cone-type boundary light at Croydon Aerodrome.

equipped with optically-worked silvered glass reflectors of parabolic contour, and each gives approximately one-million beam candle power. Each floodlight is fitted with three rows of powerful lamps, and gives a very wide horizontal spread of light for illuminating a large ground area, with a vertical divergence sufficiently small to prevent any excess light from going upwards, which might cause dazzle to the pilot when encircling the aerodrome before landing.

**Illuminates 4,500,000 sq. ft.**

Each floodlight has a horizontal spread of about 150 degrees and illuminates an area of over 4,500,000 square feet. These floodlights are fitted with remote-control gear so arranged that any group of two or three floods may be operated from the control tower according to the direction of the wind. They light up immediately to full brilliance, and if the wind should change in direction during the approach of aircraft, the appropriate floodlighting for landing can be switched on immediately, so that craft can land "into the wind." The illuminated area is over half a mile across.

Previous to the installation of this fixed system of G.E.C. floodlighting around the aerodrome at Croydon, a mobile-lens type of floodlight was used to assist pilots in landing at night, and this had to be moved to various parts of the aerodrome according to the direction of the wind. If the wind suddenly changed during the course of landing, the



The latest type of G.E.C. illuminated wind-direction indicator at Croydon Aerodrome.

mobile floodlight had to take up a new position, whereas in the case of the new fixed floodlighting installation, lighting changes are effected by the touch of a switch in the control tower. The G.E.C. floodlight is claimed to be the first efficient aerodrome floodlight to employ a mirror optical system, superseding the lens type previously used.

#### Boundary Light System

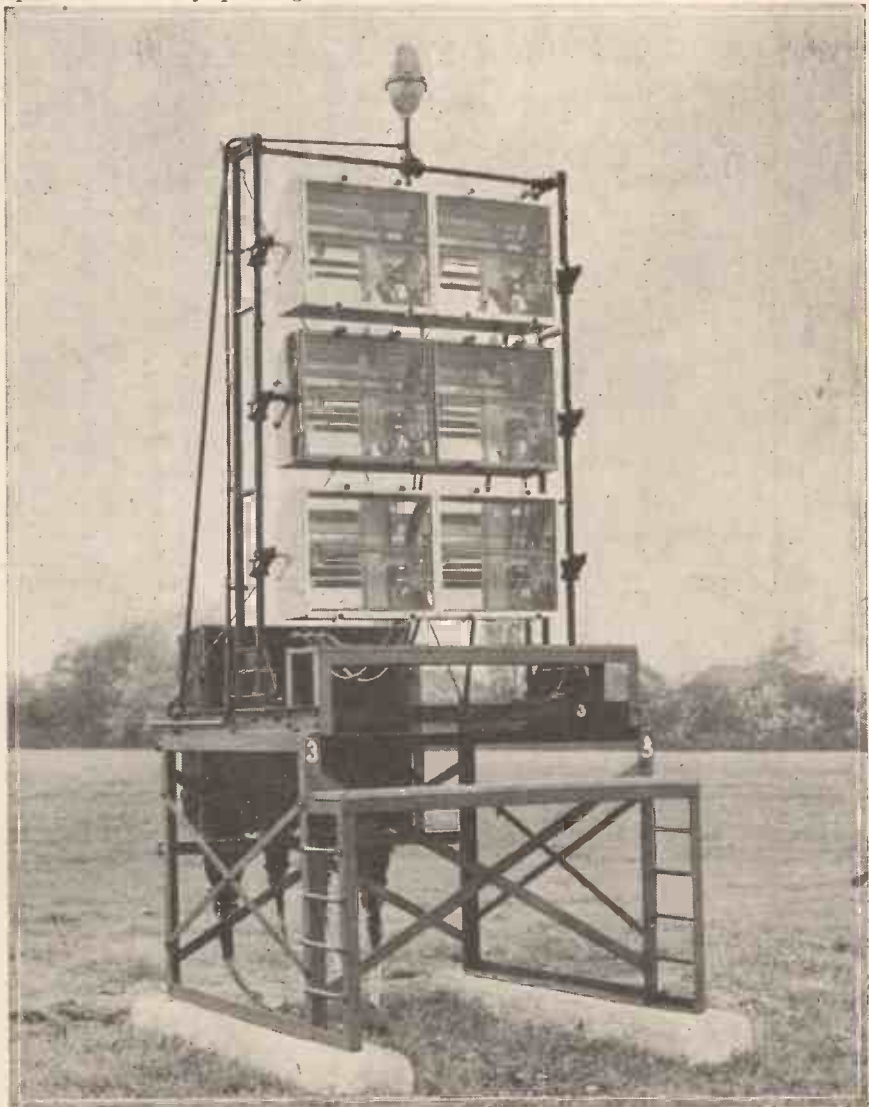
A special boundary-light system is also in operation at Croydon, to indicate to aircraft the exact extent of the landing area. This consists of orange-coloured globes mounted on standards 2½ ft. high, installed at regular intervals of 100 yards round the outer edge of the landing area. These specially-coloured globes are readily distinguished and do not conflict with other lights in the immediate vicinity of the aerodrome. The boundary lights work on what is known as the constant-potential-series system which has been adopted by H.M. Air Ministry after much careful experimental work, in order to obviate high voltage above ground, and the consequent risk of damage by shock or fire. These special lights are fitted with a device consisting of an easily-replaceable "weak link" which breaks in the case of collision, thus preventing any mechanical damage to a machine should it happen to hit one of them.

The aerodrome beacon at Croydon is one of the most powerful in the world, and on an average clear night is visible over 60 miles away. It is of the red neon type, consisting of a number of neon tubes arranged in the form of a truncated cone on a metal framework. The beacon flashes a Morse signal indicating the name of the aerodrome. The light source, although capable of being seen many miles away, is of low intrinsic brightness over a wide area and does not dazzle pilots. Its distinctive red glow in haze or mist provides pilots of aircraft with a good indication of their position when visibility is bad.

#### Wind-direction Indicators

As a result of recent Air Ministry tests a new type of G.E.C. illuminated wind-direction indicator to aid night landings has also been installed at Croydon. This device is a T-shaped structure 20 ft. long with a 20 ft. cross-piece. The upper part of the T is painted white and studded with electric

lamps at 1-ft. intervals under weatherproof glass covers. It is controlled entirely by the wind acting on a streamlined vane which keeps the device always pointing into wind.



One of the new 6-kilowatt landing floodlights at Croydon Aerodrome.

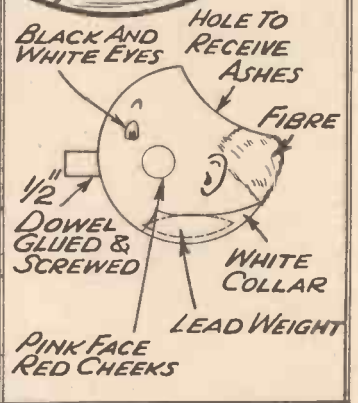
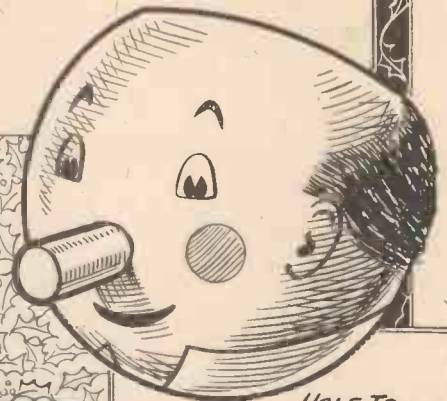
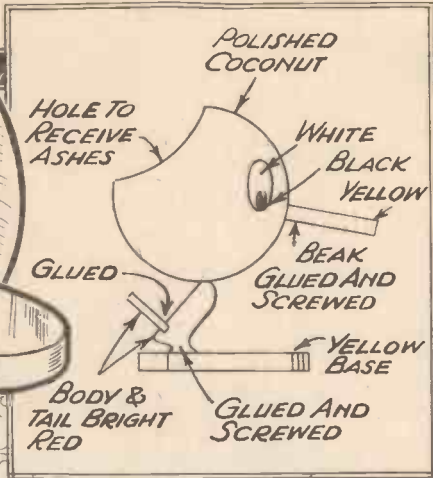
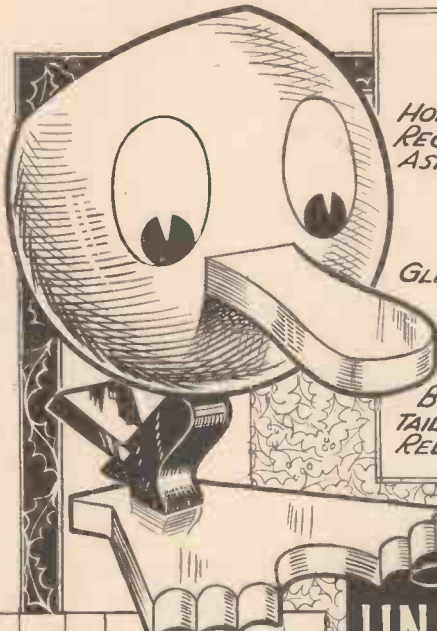
It is visible at night over a very wide area.

One of the most interesting lighting devices at Croydon consists of a line of red neon tubing, 1,100 ft. long in the middle of the aerodrome to aid aircraft landings during foggy weather. This is divided into twelve sections, fixed below ground under a strong glass covering. The tubing emits red light and is visible from the air as a 1,100-ft.-long red line, easily recognisable in fog or mist, when floodlighting tends to become ineffective due to atmospheric conditions. This special fog landing arrangement is the only one of its kind in the world.

#### Adequate Lighting

The new lighting arrangements at Croydon have excited admiration in aviation circles, and authorities all over the world are waking up to the fact that in successful Empire Aerial Navigation everything depends on the adequate and efficient lighting of all aerodromes. In this connection it is of interest to learn that many aerodromes, both in this country and overseas, are now being equipped with systems of lighting similar to that at Croydon.

The G.E.C. is supplying equipment for the Brighton, Bristol, Cardiff, Gravesend, Gatwick, Liverpool, Leeds and Southampton aerodromes in this country, and for many important Empire Airways aerodromes abroad.



## Make these UNIQUE ASH TRAYS

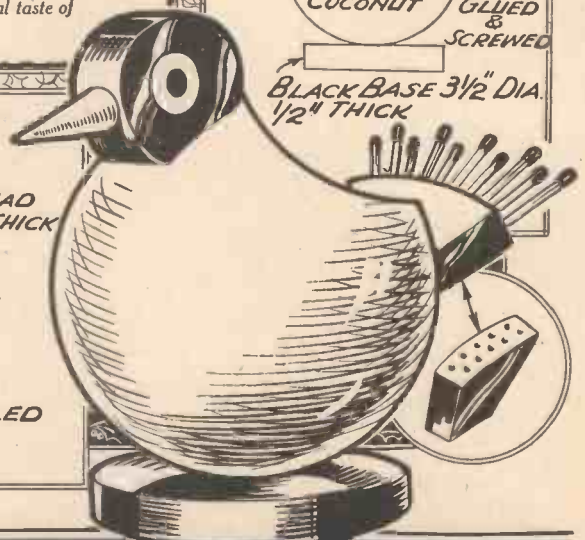
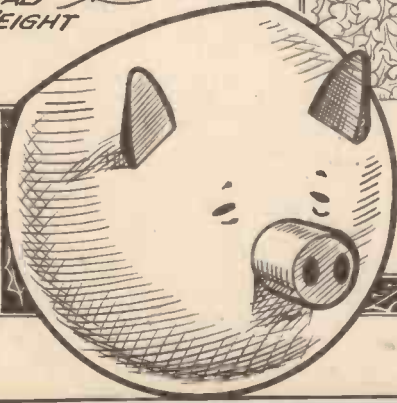
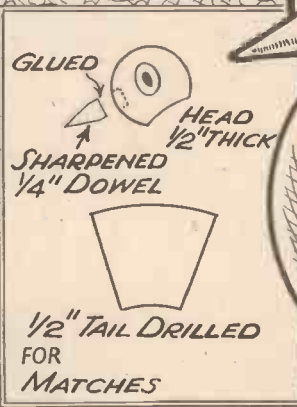
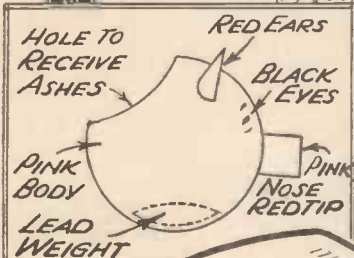
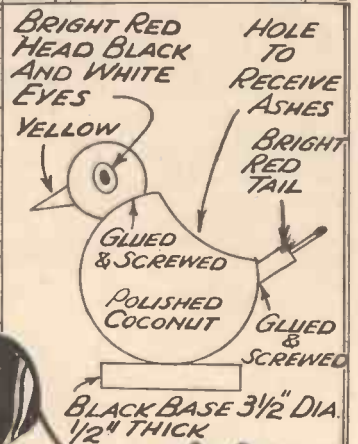
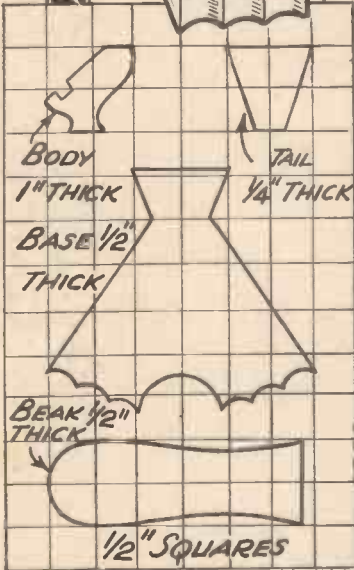
These quaint, colourful ash-trays are all made from coconuts, and are excellent novelties to make for gifts or for sale to your friends. The cost of making is slight and the finished article merits a good price. Choose coconuts as round as possible and clean off the fibre with a flat rasp.

In the case of the old man model at top right-hand corner, a little fibre is left to represent hair. With a key-hole saw, cut the large hole to receive the ash. Scrape out the nut and smooth up the hole with a half-round rasp and sandpaper. Now mark out and drill the various holes. Sandpaper the shell, finishing off with a very fine paper, until it takes on a highly smooth surface.

For the two birds the shell is left in its natural colour and rubbed over with ordinary furniture polish. Due to the hardness of the shell this gives a very pleasing finish.

Cut out the wooden parts as shown in the sketches and sandpaper smooth. Assemble the parts with glue and wood-screws. When a screw is inaccessible to the screw-driver, drill a hole in the shell, insert and hold the screw with the fingers, and twist the wooden part. A washer, made of sandpaper and slipped over the wood screw on the inside of the shell, will grip the shell and hold the screw fast.

For the two models without a base, lead weights are used. These are pounded to fit the shape of the shell and made fast with glue. The models are coloured with bright enamels. The features being put in last after carefully drawing out in pencil. The colours indicated are merely suggestions and may be altered to suit the personal taste of the reader.



# Ghost and Spirit Photographs

*A Topical Article in Which the Author Suggests Various Methods of Producing Realistic Ghost Photographs*

By G. LONG,  
F.R.G.S.

(Left) Great Bayhill Manor, Kent, which forms a suitable background on which to superimpose a ghost.

(Right) Okehampton Castle also provides a suitable background for spooks.



**G**HOSTS are a favourite topic at Christmas, and the amateur photographer can easily make some convincing ghost photographs during the holidays. The subject of spirit photography is a fascinating one. Spiritualists claim that if the spirit of a deceased person is present in a room when a photograph is being taken, an image of the apparition will register on the plate. Some mediums are said to be very successful in this class of work, and many hundreds of photographs are in existence which are said to be genuine photographs of the spirits of dead persons, which have been recognised by their near relations. It is further asserted that—although many frauds have been detected—some of the spirit photos were obtained under conditions which rendered trickery impossible.

It must be admitted at once that it is possible to photograph many subjects which are invisible to the human eye, and which therefore the photographer could not see when exposing his plate. Thus the astronomer when making a photographic chart of the heavens, frequently discovers on the sensitive film images of stars which no human eye has ever seen. This is because a faint star can impress itself on the negative during a long exposure, although it is too weak to be visible to the eye. The well-known X-rays enable the operator to obtain photographs of the interior of the human body, which clearly show foreign bodies such as bullets. The latest discovery in photography, enables the photographer, by means of infra-red rays, to photograph distant mountains which are quite invisible to the eye, owing to fog or mist. It seems reasonable to suggest, therefore, that if ghosts exist, they would register on a photographic plate, even though they might be invisible to the man working the camera.

## Double Exposures

Expert photographers, however, remain sceptical. They know that apparent ghost photographs can be easily made by double exposure, and they believe that a skilful operator might even produce fakes under conditions which are supposed to make imposture impossible. They recall the famous challenge to the spiritualists made some years ago by Mr. Maskelyne, who declared



Dunvegan Castle, Skeye, showing the ghost in the right-hand corner.



A Christmassy scene at Evesham with the ghost abroad.

that he (as an expert conjurer) would undertake to produce any of the "supernatural" effects claimed by mediums, and many of us believe that methods exist by which fake spirit photos can be made even under the stringent precautions spoken of by the mediums. We will consider some of these ideas later.

The first spirit photographs originated in America, not long after the invention of photography itself. In October 1862 the *Spiritual Magazine* recorded that a Dr. Gardiner had announced that after he had been photographed in the studio of a certain Mr. Mumler, an image was found on the same plate which proved to be a portrait of a cousin who died some years earlier. The enterprising photographer did a roaring trade for some time, but was later prosecuted for fraud. The case was dismissed, for lack of sufficient evidence. There were several "spirit" photographers in London during the next few years, of whom the best known was Buguet, a Frenchman, who figured in a sensational trial in France in May 1875. He was charged with producing alleged spirit photos by fraud, and made a full confession. Out of a hundred and twenty "spirit" photos produced by him, evidence of recognition was given in forty. In one case the same head was "recognised" as the sister of one sitter, the mother of another, and the friend of the third. Buguet fully explained his method. At first he used the heads of three or four assistants to play the part of ghost, but as the business increased, he feared constantly to repeat the same features. He therefore constructed a lay figure, which variously draped, served as the body of the ghost. He purchased a large number of wax heads which were used with the body as occasion required, and the ghostly image was impressed on the plate used for the living sitter, by double exposure.

## Amateur "Spirit" Photographs

We will now consider how the amateur photographer can make spook photos. The most realistic effects are produced when the ghost is semi-transparent so that images of solid objects can be faintly seen *through the body*. This result is obtained when a very short exposure is given to the photo of the

ghost, and a full exposure to the rest of the subject. The double-exposure can be made on the same plate as the main photograph, or on another. The latter is the simplest method; we will consider it first. Drape a friend in a white sheet, and pose him in a horrifying attitude against a dark background, the darker the better, and make a very short exposure. When this is developed you should have a thin image of the ghost, and nothing else on the plate. If the image is too strong, or if faint indications of the background are visible, they can be removed by placing the negative in a bath of Farmer's reducer until the right density is reached. Farmer's reducer is made as



At Raglan, with the ghost apparently walking on the water.

follows: Saturated solution of ferricyanide of potassium 1 part, hyposulphite of soda solution (1 to 5) 10 parts. You now have a negative with a faint image of the ghost, and the rest is clear glass, and if you place this negative in the printing frame with a film negative of a churchyard, castle or abbey ruin, you will obtain a very convincing ghost effect. It is possible to use a glass negative for the main picture, but the definition is not so good as with a film, owing to the thickness of the glass. A very spectral "halo" effect can be produced by the following method. Stain the film slightly yellow—immersion in the Farmer's reducer frequently does this—and then cut it off the plate, leaving a narrow margin round the head of the ghost, which in the picture will have a nimbus like a saint. Another ghostly effect can be produced, which is suitable for small objects such as a skull, or a hand grasping a dagger. Pose the object in a dark room, before a black background, which must not be too close, and photograph it by the light of one or more electric torches, which are shining on the object and do not illuminate anything else. If a panchromatic plate or film is used, an exposure of one to two minutes at F6 should be sufficient, and the effect is very striking, as the object in the photo seems to be self-luminous, and to blaze with an unearthly light.

It is important to make the photos of these ghostly objects in proper scale with the main photograph in which they are to appear; the usual mistake by beginners is to have them too large.

#### Double Exposures

Double exposure on the same plate is the method used by the spirit photographers

who desire their negatives to be accepted as genuine. The lay figure, or other model, for the ghost was given a very brief exposure in the studio, before posing the customer. His portrait was then taken with a full exposure on the same plate, *without moving the camera*. Amateur photographers should set up their camera on some firm object, a tripod is best, and give a brief exposure of the subject containing the ghost. About one-tenth of the correct exposure should be about right, the ghost moves away, and you then give a second full exposure without moving the camera. The result shows a churchyard, ruin, or wood, containing a shadowy image of the ghost. A personal element can be introduced by getting a friend to pose, in an attitude of extreme terror, in the second picture, so that the finished result shows him meeting the spook. Films are better than plates for this class of work, except when it is desired to cut the film to make a nimbus. We will now consider how fake spirit photos may be obtained, even when stringent precautions are taken to prevent fraud. Nearly all these tests take place in studios, and the usual procedure is for the plates to be handed to the photographer by an independent observer, and are taken away and developed by the latter after exposure. The simplest and most obvious fraud would be for the photographer to attend the séance with an exactly similar dark slide, containing plates which had already been faked. A clever conjuror could easily make the substitution without being detected. If, however, conditions were too severe to permit the substitution of a dark slide, another plan could be tried. If a faint image of the spook were made on a sheet of transparent glass, and placed *inside* the camera in front of the actual plate, the image would register on the plates actually exposed, even if they were taken to the séance, and brought away by an honest, independent observer.

But the spiritualists say that cases have occurred in which the honest independent investigator took his own camera and plates to the studio, exposed them, and developed them afterwards. Nobody else was permitted to touch the camera, or plates, and yet a spirit appeared. What about this? While I have no personal experience to guide me, I have made a few experiments with fluorescent substances, which cause one furiously to think, and it is possible that prolonged research on these lines might yield interesting results. It is well known that there are light rays, invisible to the human eye, which can yet impress an image on a photographic emulsion, as for instance X-rays, ultra-violet rays, and radium emanations, and it seems possible to paint or smear an image on a background with some substance giving off such actinic rays, which would be invisible to the human eye, and yet would powerfully affect a photographic plate.

#### An Interesting Experiment in Spirit-writing

Here is an interesting experiment, which may produce "spirit-writing," and, if it fails to do so, the material can be turned into home-made luminous paint afterwards. Obtain a small quantity of sulphide of barium from the chemist. I used two ounces costing a few pence. It should be kept in a corked bottle, as moisture ruins it. It is a greyish brown powder, with a strong sulphur smell. My first idea was to make a solution in water and use this as an "ink" for spirit-writing, or a paint with which to produce spirit pictures. Unhappily this failed, as moisture destroys the fluorescent

effect, probably by converting the sulphide into sulphate. I therefore tried various methods of producing sketches or writing which would be invisible to the eye, but yet would photograph clearly. My results were not completely successful, but were interesting and suggestive. I obtained some thick Nature mounting paper, the colour of which almost matched the barium powder, and smeared on it letters and words with the powder on a finger-tip. I must admit that in strong sunlight the lettering was faintly visible, but I feel sure it would pass unnoticed under those studio or séance conditions, in which other "spirit photos" are taken, and it certainly photographed clearly. Records of prosecutions certainly establish that "Spirit Photography" is a highly profitable profession, so it would, of course, pay those who specialise in it to perfect their technique, indeed they may have stumbled on new discoveries. A scientist tells me that a solution of sulphate of quinine gives striking results, and the salts of barium or strontium are efficient if protected from moisture by varnish. It may be that a cloth background would form a better surface than the paper which I used. There are also a number of colourless solutions, which have a strong absorption in the ultra-violet region, and which (while invisible to the eye) would photograph strongly with blue-sensitive photographic emulsions. The research scientist in the laboratory of one of our greatest photographic manufacturers, has suggested to me that the photographic intensity of such "spirit-writings" could be much stimulated by subjecting them to ultra-violet rays. The rays themselves would be invisible, and their source would not be detected by the uninitiated; while the fluorescence of the lettering might fall below visual perception, and yet be of suffi-



The white lady of Stanton Harcourt.

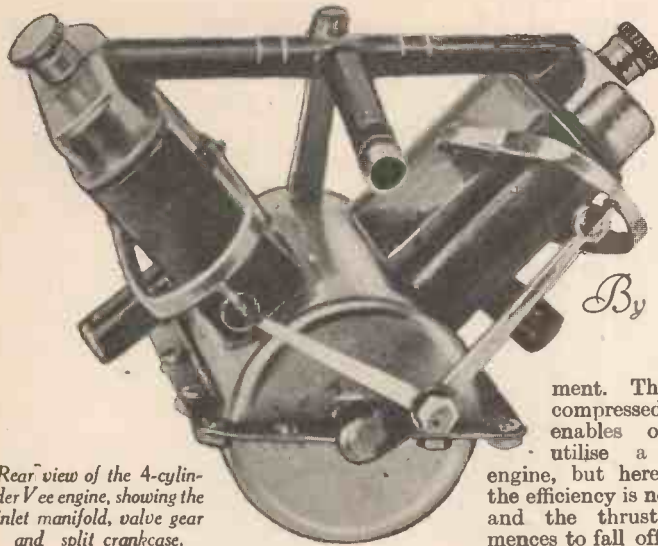
cient intensity to affect a photographic emulsion.

There are a number of drugs, herbs, and alkaloids known to science which exhibit a blue or violet fluorescence under the action of ultra-violet light rays. These remarks on "spirit-writing" are intended merely as suggestions to other experimenters. I do not claim to have solved the problem, but am satisfied that there is here a rich field for experiment and research which would provide amusement for the long winter evenings.



# A New 4-Cylinder Model Aeroplane and Boat Engine

By F. J. Camm.



Rear view of the 4-cylinder Vee engine, showing the inlet manifold, valve gear and split crankcase.

**M**ANY efforts have been made to supersede elastic as a motive power for model aircraft, and latterly, with considerable success. During the past three years the miniature petrol engine has come into its own and vanquished elastic from the points of view of duration and distance. Flights of over an hour have been made in America, the length of flight being limited only by the amount of petrol carried. Only recently an engine of 1 c.c. ( $\frac{1}{2}$  in. bore by  $\frac{1}{2}$  in. stroke) has been made and successfully run at a speed of 6,000 revolutions per minute, driving an airscrew of 8 inches in diameter.

The great advantage of the petrol engine is that the torque is constant, and longitudinal stability is hence unaffected by the considerable variation in thrust as is the case with an elastic motor. One is also enabled to keep the weight well forward, which has advantages apart from the question of stability.

Engines operated by superheated steam have been used, but not very successfully up to the present. They are sometimes erratic in their behaviour, difficult to run, and unreliable mechanically, and I do not feel that they afford vast scope for further improve-

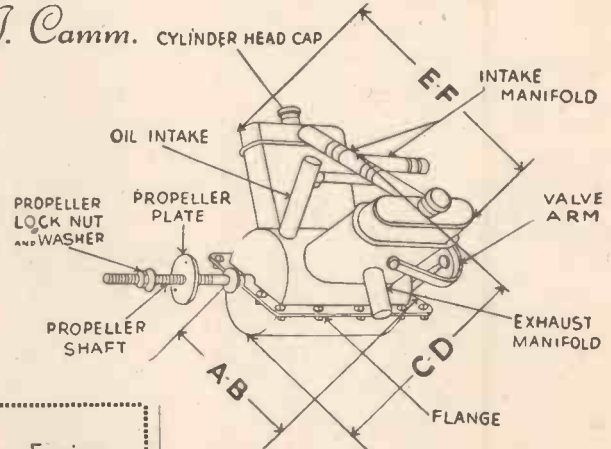
ment. The use of compressed air enables one to utilise a small engine, but here again the efficiency is not high and the thrust commences to fall off as the pressure in the container grows less.

### AC.CO Gas

Some years ago, one or

A Powerful Vee-type Engine, worked by compressed air, or by a non-inflammable gas. It weighs only  $3\frac{1}{2}$  oz.

two small French engines were marketed, operated by CO<sub>2</sub>, notably the Fieux (gas generation being by means of the Prana Sparklet Bulb), but it was difficult to obtain a reasonable duration of run. Recently, there has appeared



This diagram illustrates the main parts of this powerful yet light engine.

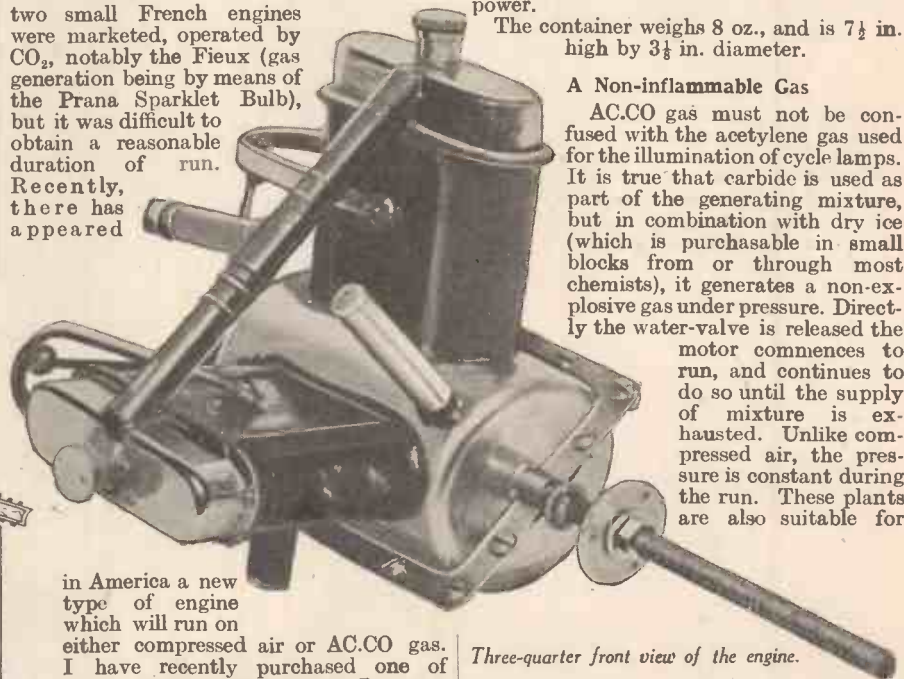
an interesting 4-cylinder Vee model of the same bore and stroke, but weighing  $3\frac{1}{2}$  oz., and developing about 30 per cent. more power.

The container weighs 8 oz., and is  $7\frac{1}{2}$  in. high by  $3\frac{1}{2}$  in. diameter.

### A Non-inflammable Gas

AC.CO gas must not be confused with the acetylene gas used for the illumination of cycle lamps. It is true that carbide is used as part of the generating mixture, but in combination with dry ice (which is purchasable in small blocks from or through most chemists), it generates a non-explosive gas under pressure. Directly the water-valve is released the

motor commences to run, and continues to do so until the supply of mixture is exhausted. Unlike compressed air, the pressure is constant during the run. These plants are also suitable for



Three-quarter front view of the engine.

in America a new type of engine which will run on either compressed air or AC.CO gas. I have recently purchased one of these plants (which are of Japanese origin, but obtainable from America), and find it far superior to compressed air.

The gas is generated in a brass container with inner chambers for dry ice and carbide on to which mixture water drips, thus generating AC.CO gas instantaneously and at high pressure for a considerable period. The engine and container are easily mounted inside the fuselage. The engine is supplied in two types—a vertical 2-cylinder model of  $\frac{1}{2}$  in. bore and  $\frac{1}{2}$  in. stroke, weighing  $2\frac{1}{2}$  oz., and developing  $\frac{1}{2}$  h.p. at 3,500 revolutions per minute, and

driving model boats. The flexibility of design permits the motors to be mounted in practically any type of aeroplane or boat.

Examination of the illustrations will show that the crank-case is of the split or divided type and may easily be mounted in a cradle made of thin aluminium. The cradle will, of course, act as adaptor for mounting into any type of boat and fuselage nose or nacelle. An inlet manifold feeds both sides of the 4-cylinder model and short exhaust stubs are fitted to the bases of each cylinder block. Slide valves are fitted to the tops of the cylinders and are totally



The container is first filled with carbide, as shown on the left, and the latter is then covered with dry ice. When inverted, as on the right, and water is allowed to drip on to the ice and carbide, a non-inflammable gas is given off at high pressure.



This illustration shows the carbide and dry-ice container for the 4-cylinder Vee engine for model aeroplanes and model boats.

wood of all kinds and in all sections, elastic, petrol engines, fabric, dope, balsa wood, kits of parts, blue-prints, and complete models of all types. You cannot do better at Christmas-time than to present a model aeroplane or a kit of parts to a friend who is interested in this absorbing and modern hobby. Lists and catalogues are available from the various firms. I list them below as they occur to me. Mr. A. E. Jones, of 97 New Oxford Street, London, W.C.1, has been established in the model aircraft industry for more than a quarter of a century, and he supplies everything from complete models down to the smallest brass pin. His models are guaranteed to fly and to withstand extremely rough usage. He also supplies the well-known Atom Minor and Andritch Petrol Engines.

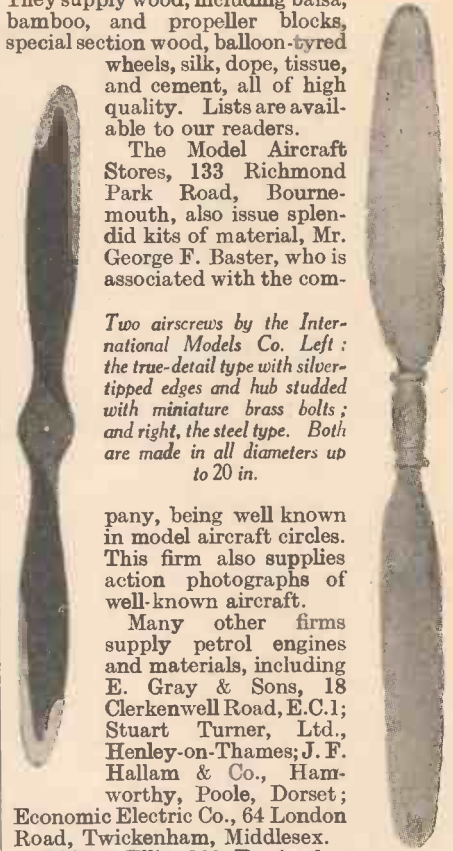
The Model Aircraft Supplies, Ltd., 171 New Kent Road, London, S.E.1, are famed for their kits, materials, and complete models. Mr. York of that company is an experienced model-maker of many years' standing, and is well known for his work and for his successes in competitions.

The Northern Model Aircraft Company, of 11A High Street, Manchester 4, also issue kits of materials for such well-known models as the Fokker D VIII, the Nieuport Scout, the Lockheed Vega, the Hawker Super Fury—the kits costing from 3s. to 13s.

They supply wood, including balsa, bamboo, and propeller blocks, special section wood, balloon-tyred wheels, silk, dope, tissue, and cement, all of high quality. Lists are available to our readers.

The Model Aircraft Stores, 133 Richmond Park Road, Bournemouth, also issue splendid kits of material. Mr. George F. Baster, who is associated with the com-

pany, being well known in model aircraft circles. This firm also supplies action photographs of well-known aircraft. Many other firms supply petrol engines and materials, including E. Gray & Sons, 18 Clerkenwell Road, E.C.1; Stuart Turner, Ltd., Henley-on-Thames; J. F. Hallam & Co., Hamworthy, Poole, Dorset; Economic Electric Co., 64 London Road, Twickenham, Middlesex. William Ellis, 182 Farringdon Street, E.C.4, supply kits of parts for flying models of the Flying Flea and other well-known aircraft, whilst A. J. Holladay & Co., 3 Aldermanbury Avenue, E.C.2, are famous for their Skybirds Series of models, model aerodromes, and kits of parts.



Two air screws by the International Models Co. Left: the true-detail type with silver-tipped edges and hub studded with miniature brass bolts; and right, the steel type. Both are made in all diameters up to 20 in.

Many other firms supply petrol engines and materials, including E. Gray & Sons, 18 Clerkenwell Road, E.C.1; Stuart Turner, Ltd., Henley-on-Thames; J. F. Hallam & Co., Hamworthy, Poole, Dorset;

Economic Electric Co., 64 London Road, Twickenham, Middlesex.

William Ellis, 182 Farringdon Street, E.C.4, supply kits of parts for flying models of the Flying Flea and other well-known aircraft, whilst A. J. Holladay & Co., 3 Aldermanbury Avenue, E.C.2, are famous for their Skybirds Series of models, model aerodromes, and kits of parts.

enclosed; they are operated by a small auxiliary external crank fixed to the rear end of the crank-shaft, operating rockers by means of short connecting-rods. A new feature is that provision is made for filling the crank-case with oil. Lubricating caps are also fitted to the heads of each cylinder.

#### How the Gas is Generated

The diagrams show how the generator is prepared for flight. The screw cap is removed from the bottom and the plunger handle is pushed down, which then opens the entrance to the water chamber and closes the entrance to the gas-generating chamber. Now place in the gas chamber small pieces of carbide and some dry ice, broken so that the pieces are of about the size of grains of salt; then replace the screw cap, place the generator in the fuselage and lift up the plunger handle, having previously filled with water chamber. The motor will at once commence to run.

Any reader interested in these motors may obtain the address of the manufacturer by writing to the Editor. Adequate supplies are available for immediate delivery. It takes about a fortnight from the despatch of order to receipt of goods. The price of the 4-cylinder model is about 30s. in English money (inclusive of generator), and of the 2-cylinder model about 25s. The 2-cylinder motor alone costs 15s. and the 4-cylinder model 25s.

THIS is an appropriate time to draw the reader's attention to the splendid service now rendered by various model aircraft firms, who are now able to supply

#### BLUEPRINTS OF F. J. CAMM'S PETROL-DRIVEN MODEL MONOPLANE

(Described and Illustrated in July, Aug., Sept., Oct., and Nov. Issues)

The following full-size blueprints are now ready and may be obtained, at the prices mentioned, from the publishers: George Newnes Ltd., 8-11 Southamp-ton Street, Strand, London, W.C.2.

Sheet 1, price 1s.

This blueprint gives the shape of each bulkhead, the engine cradle, and the stiffeners.

Sheet 2, price 1s.

Shows the rudder and tail full size with methods of fixing.

Sheet 3, price 4s.

Shows the fuselage full size in side elevation and plan, the holding-down strap for coil, chassis construction, rear wheel and suspension, switch and ignition circuit, wing fixings, and method of bracing.

Sheet 4, price 1s. 6d.

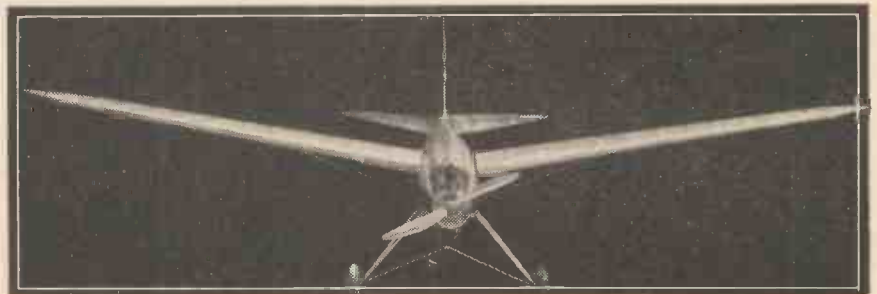
Full-size plan of the mainplane, full-size rib section and wing couplings.

Sheet 5, price 6d.

Full-size plan of engine adaptor for the Atom Minor, Hallam, Grayspec, Andrich, and Economic engines.

Sheet 6, price 6d.

The Ignition and Switching System.



Front view of Mr. F. J. Camm's Petrol-driven Monoplane.



## The "Maids of the Mist" And Their Story

**D**ANGER always forms part of the background of a sailor's life, and few vessels complete a voyage without encountering either storm or fog. There is one little ship which daily performs the world's most hazardous trip. It is very short (a mere couple of miles or so from harbour and back again), but every yard of it is a grim struggle against the world's most tremendous torrent, through leaping waves and blinding spray to the verge of a cauldron where a million tons of water thunder down to the abyss, with a roar so deafening that those on deck cannot hear each other speak. For some minutes it skirts the edge of destruction, where the slightest failure of engines or steering gear would involve instant overwhelming disaster, and then returns to its tiny rock-cut harbour. If the surface of the water is terrifying to the landsman, the bottom of the river is still more frightening to the sailor, because he knows that no anchor could hold on those water-scored boulders, and smooth rock channel; and so if power failed the little vessel must be carried down the rapids to that frightful whirlpool which has cost so many brave men's lives.

The name of this steamer is *The Maid of the Mist*, and she is one of a succession of *Maids* which for nearly a hundred years have navigated these dread waters.

### The First "Maid of the Mist"

The first *Maid of the Mist* was built in 1846, and though her engines were feeble, she managed to navigate the neighbourhood of the Falls without accident. In 1854 a larger and better boat was constructed which was at the time regarded as a wonder ship. She was 72 ft. long, 17 ft. beam, and 8 ft. depth of hold, with engines of 100 h.p. For seven years she made the exciting trip to the Falls, till her owner accumulated a small fortune and decided to sell the boat and retire. A customer was soon found, but the difficulty was delivery of the goods. The *Maid* was lying in her tiny harbour on the Niagara river, shut in on both sides by sheer cliffs nearly two-hundred feet high. Upstream all progress was barred by the Falls, and downstream there is a rocky gorge seven miles long, through which roar and thunder the most dangerous rapids in the world, culminating in the frightful whirlpool, 1,150 ft. in

### The "Maid of the Mist" is a Small Ship That Daily successfully Navigates the Torrent Below Niagara Falls

diameter, with great ridges 12 ft. higher than the level of the stream. The perils of such a trip were appalling. No human being had ever passed through that maelstrom and lived to tell the tale, but logs from broken rafts were often carried over the Falls, and their progress had been watched. Mighty tree trunks, 50 ft. long, and 3 ft. in diameter, had been observed rushing round the whirlpool for five or six weeks at a time. Often they would be hurled bodily clear of the water, only to fall back again and be hurried along like straws on a millstream.

### Robinson of the Falls

So when the owner asked for volunteers to pilot the *Maid* beyond the rapids, most of the hardy watermen said it was quite impossible. The then captain of the steamer, however, was a man of very remarkable calibre. He was already known as "Robinson of the Falls," and had performed several amazing rescues of drowning persons at the very verge of the Falls above. No other man, before or since, had rowed a small boat through the rapids above the Falls, and escaped being carried over the abyss, and to him belongs the honour of piloting a steamer through the rapids and whirlpool below.

His first daring exploit, the rescue of a man named Chapin, at the very verge of the Falls, had taken place twenty-three years earlier; but though now middle-aged he declared he would pilot the *Maid* if he could obtain a crew. The engineer, Mr. Jones, at once volunteered, and a brave mechanic named McIntyre joined them. They made careful preparation for a voyage such as no mortal man has performed before or since. The hatches were battened down, and every loose object was removed. At 3 p.m. on June 15th, 1861, they started from the harbour, watched by an enormous crowd. Robinson and McIntyre were at the wheel, and Jones controlled the engines. Within two minutes of leaving the harbour the boat

was caught by the rapids and was swept towards the whirlpool at a terrific speed. The rapids consist of great ridges of water 10 to 12 ft. high, where the centre of the stream is piled high above the sides. For two miles the steamer was whirled at a dizzy speed towards the sharp bend in the walls of the gorge, where the world's most frightful whirlpool boils and seethes for ever. Robinson tried to hold on the inner side of a lofty ridge of water, but a huge wave smashed against the rudder, and swung the craft broadside. Immediately a mighty surge of foaming water swept the deck, carried away the funnel, and flung the two helmsmen prostrate on the planking. Robinson was the first to spring to his feet, he seized the wheel, and placed a foot on McIntyre to keep him on board. Scarcely had he done so, than with a tremendous shudder the *Maid* was seized by the whirlpool and spun dizzily round. With a supreme effort, the single helmsman set her bows at the neck of the pool, and cut right through it. A cascade of water again swept the deck, as the gallant little craft leapt free, and sped down the rushing stream towards calm waters at Lewiston.

Meanwhile poor Jones, the engineer, was imprisoned below the closed hatch-way. He could feel the plunging of the ship, and hear the roar of the waters, and admits that he never expected to emerge alive. Afterwards he said that he was on his knees in prayer for most of the voyage, and would add dryly, "There was never so long a prayer."

The effect on the heroic Robinson was even more tragic. "He was," said Mrs. Robinson, "twenty years older when he came home that day, than when he went out." Before that terrible voyage he loved the river, but afterwards he abandoned it, as if "through a slightly opened door, he had seen a vision which awed and subdued him."

### Later "Maids"

Bigger and better *Maids* have been built since, and one of them is plying the river to-day, but Robinson's wonderful exploit has never been repeated. The modern *Maid of the Mist* is admirably constructed for her unique task. She is very sturdily built, with powerful engines and twin screws. She is broad in beam to prevent

overturning, and her decks are high to raise the passengers above the swirling waters, and all her bulwarks and rails are swathed in waterproof sheets to give some protection against the leaping waters. The spray, however, drives aboard in such tremendous volumes, that both passengers and crew are muffled to the eyes in thick oilskins. The trip itself is both the shortest and the most thrilling that I have experienced. We descend to the small harbour, where the

boat lies quietly, but immediately she ventures out into the river we feel the grip of the torrent, as we head our way towards the American Fall. Daintily she picks her way, with twists and turns like an agile dancer on the tips of her toes. If the American Fall is impressive, the Horse-shoe cataract is overwhelming. It is not possible to go quite as close here as to the American Fall, because the falling waters form an arc of a circle, and a steamer within its radius

would surely be overwhelmed by the stupendous curtain of water which is at least 24 ft. in depth at the lip of the fall.

Thanks to the sturdy construction of the ship, and the uncanny skill of her helmsman, the voyage is practically devoid of danger, and many thousands of visitors make it every year. All hail, then, to the *Maid of the Mist*, which the skill of the mechanic, and the courage of the crew, has made world famous. G. L.

## A New Pattern-Making Method

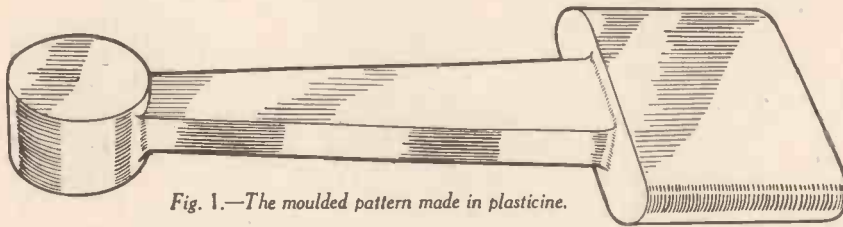


Fig. 1.—The moulded pattern made in plasticine.

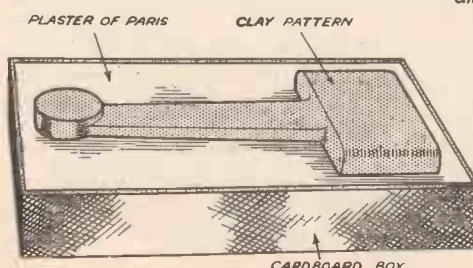
WHEN a number of small parts of somewhat intricate design have to be cast in any non-ferrous alloy, as is often the case in model making and in small light mechanical and engineering jobs, it becomes necessary to make a pattern. It is advisable that the pattern should be as exact as possible in order to facilitate machining, and in order to give a good appearance to the finished model or machine.

The making of small wooden models is a delicate and a tedious process. The method here to be described avoids the troubles connected with such small wood working, and enables awkward shapes to be made easily and quickly ready for the foundry moulders. The plan is to use plasticine—the clay-moulding compound.

The part is fashioned with the plasticine to the size and shape of the finished article, and is allowed to dry thoroughly. This clay "pattern" (to use the founder's term) could be used directly to make the sand mould in the foundry, but it would not withstand continued use. It would be fractious and would also bend and become distorted with the ramming, and probably could only be used for one casting. To overcome this difficulty the plasticine pattern is used to make a plaster of paris mould, from which is easily cast a lead replica of the plasticine pattern, and this lead replica can be used as the pattern to be sent to the foundry and from which any amount of other pieces may be moulded and cast in the metal intended for the job.

### The Pattern

In Fig. 1 we have a supposititious case, in which *A* is the pattern moulded in plasticine. A box (it may be of cardboard) is filled to the level of the top with soft plaster of paris, and the plasticine pattern is laid in it while soft to a depth which will bring the plaster to a level a little higher than half



of the depth of the pattern. The plaster is then, when nearly set, carefully scraped away so that its upper surface is level with the top of the box and half the height of the plasticine pattern, as shown in Fig. 2, and the plaster is allowed to set hard and the pattern lifted out.

The mould is next taken from the cardboard surround, carefully so that the latter is not injured, and at each side and at each end a slanting half-circular groove is cut down from the top surface as shown in Fig. 3. The top surface (which will be the parting surface) and the four slanting

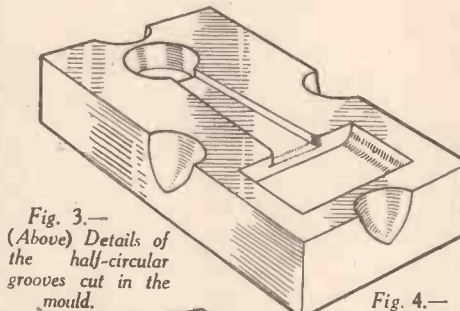


Fig. 3.—(Above) Details of the half-circular grooves cut in the mould.

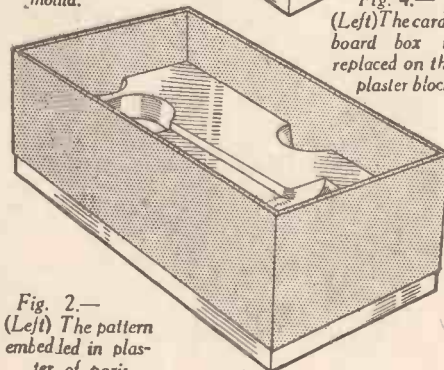


Fig. 4.—(Left) The cardboard box is replaced on the plaster of paris

side grooves are varnished with a shellac spirit varnish which dries quickly. The cardboard box is now replaced on the plaster block so that it reaches high up above the surface (Fig. 4). The plasticine pattern is carefully replaced in the mould shape it has made and the whole remaining space is filled with fairly liquid plaster and allowed to set.

### A Simple Method of Making Small Models with Plasticine as the Mould-making Compound

#### Two Halves of the Mould

When hard, the surrounding cardboard box is removed and we have a plaster mould in two halves which will produce the original shape. The slanting grooves at the sides will have formed corresponding projections on the top block of the plaster. All that remains is carefully to drive (from the inside to prevent the drill breaking through into the mould) a runner hole for pouring the lead, and two vent holes to allow the gases to escape and ensure the lead filling the mould.

We now have a plaster of paris double mould (Fig. 5) with side lugs which locate the two halves accurately in position, and can weight down the top half, or clamp it with a clamp, and pour the lead in to form a strong lead pattern, an exact replica of the plasticine model, and can obtain as many as desired and send them to the foundry for casting the part we want, in any metal desired.

The lead pattern will stand up to the foundryman's handling, and since we can supply several and easily cast new ones if they get damaged or out of shape, we have a means of getting as many castings as we want, while the supplying of several patterns to the foundry facilitates work enormously when a good many of the same pieces are required, for the plaster mould remains intact. The same procedure can of course be followed whatever the first pattern is made of, and since the wood is at times awkward because of its grain making it friable in small intricate pieces it is often an advantage to cut out a rough wooden model with no great accuracy but of ample size. It can be used in the manner shown to get a lead casting. The lead casting should next be trimmed with files, etc., and used as a pattern for the foundry or as a pattern from which to make another plaster mould as described. Thus several patterns can be made at little extra work and expense.

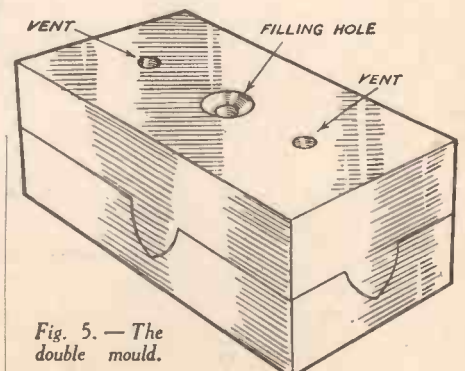


Fig. 5.—The double mould.

# PRACTICAL PRANKS for the PARTY! BY OUR QUITE UNPRACTICAL MANIAC.

ANY PERSON DISCOVERED ATTEMPTING THESE PRANKS SHOULD NOT BE ENCOURAGED TO REMAIN ALIVE!



GREAT FUN THIS!  
 CONNECT THE LOW TENSION LEADS OF YOUR FRIENDS BATTERY SET TO THE MAINS & PUT A LIGHTED CHINESE CRACKER IN THE CABINET.



CAST IRON SWATTER.



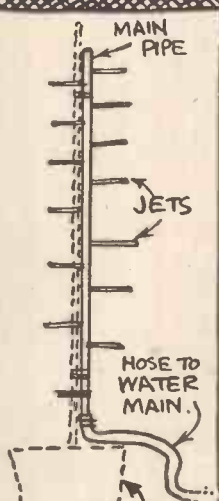
PULLEY. DISLODGING STRING.



SWATTING THE BLANC MANGE!  
 PRESS THE SWATTER LIGHTLY INTO THE CEILING DIRECTLY ABOVE THE CHOCOLATE BLANC MANGE. WHEN YOUR FRIENDS ARE ALL SEATED, DISLodge THE SWATTER. IT WILL FALL ON THE BLANC MANGE & SPREAD IT IN ALL DIRECTIONS. SHRIEKS OF LAUGHTER WILL FOLLOW!



JUST THE GAME FOR GROWN-UP CHILDREN!  
 ASK THE GUESTS TO STAND ROUND THE CHRISTMAS TREE, SHUT THEIR EYES & WISH. RUSH OUT & TURN ON THE WATER & THEY WILL GET DRENCHED!  
 TECHNICAL EXPLANATION:- A PIPE WITH SEVERAL SMALL JETS (AS SHEWN IN THE INSET SKETCH) IS HIDDEN IN THE TREE & CONNECTED TO THE WATER MAIN. THE TREE OF COURSE IS JUST A BLIND!



THE TUB & THE TRUNK OF THE TREE ARE SHEWN DOTTED.

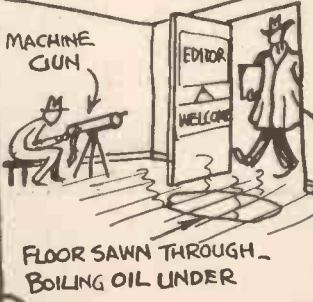


ASK YOUR BEST FRIEND TO HAVE A CIGARETTE BUT—

PUT A MOUSETRAP IN THE BOTTOM OF THE BOX & CONNECT IT TO THE MAINS. THIS IS A TEST OF TRUE FRIENDSHIP!

*Editor's Note:- Readers may rest assured that this sort of thing will not happen again and, too, have a practical joke in hand!*

A PARTING JEST!—LET DOWN ALL THE TYRES OF YOUR FRIENDS CAR & CONNECT THE EXHAUST PIPE AS SHEWN. IF THE PIPE IS FILLED WITH SOOT IT'S MUCH FUNNIER!



FLOOR SAWN THROUGH—BOILING OIL UNDER

ARTHUR ASHDOWN '35.

# MAKING AN ARC RESISTANCE

## Describing a Simple Piece of Apparatus and also How the Value of the Resistance is Calculated

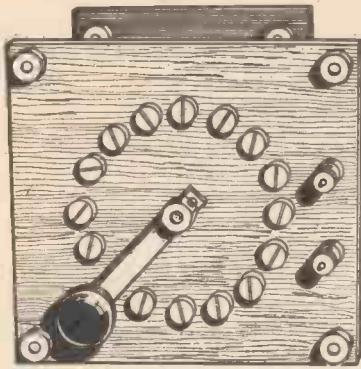


Fig. 1.—The finished arc resistance, showing the position of the studs.

**A** QUERY frequently asked is: How can I make an arc resistance, and how is the value of the resistance calculated? My mains are 200 volts A.C. From this small amount of data readers expect the electrical experts to solve their problem, yet they have not stated the size of the carbons or the amount of current that can be passed. At this point it may be as well to mention that this is a very common fault with electrical queries; readers rarely give sufficient information. In asking a query, put down everything you want to know, number the questions and give as many details as possible. To return to the above problem, we will assume that the reader has access to a 5-amp. power-plug point. Then the maximum current that can be taken is 5 amps. An arc taking this current is quite sufficient for average experiments, and is ample for a small lantern;  $\frac{1}{4}$  in. or  $\frac{3}{8}$  in.-diameter carbon rods should be used for serious work, although ordinary battery carbons can be tried when experimenting.

A potential of 50 volts is needed for the arc, thus 200 - 50 or 150 have to be absorbed by the resistance. By Ohm's Law the value of this can be found; the voltage divided by the current flowing gives the resistance, thus 150 divided by 5 gives a value of 30 ohms for the resistance. A wire must now be chosen which will pass 5 amps without overheating; in air-cooled resistances a rise to 100 degrees Centigrade is permissible, but it is dangerous to exceed this figure. On consulting wire tables, we find that No. 18 will pass 6 amps. This is above our value, but it is better to be on the safe side. This gauge has a resistance of 200 ohms per 1,000 yards. Thus for 30 ohms we need 150 yards. The above figures are for an ideal resistance, but the cost puts it beyond the average reader as something like 5  $\frac{1}{2}$  lb. of wire is needed, also the size presents a serious problem. We know, however, that wires as small as No. 22 can be used with perfect safety. This size passes 2.2 amps for the usual rise of 100 degrees, but can be used up to 4 amps. For a small arc we should advise No. 20, and about 50 yards or  $\frac{1}{2}$  lb. will be required.

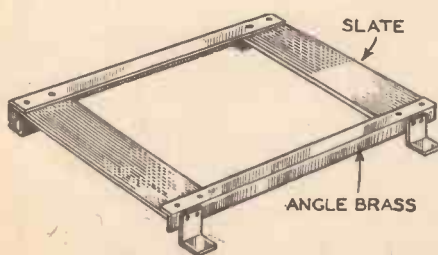


Fig. 2.—A suitable frame for the resistance.

### Construction

The simplest method is to build up an insulated frame from angle iron or rod and slate or ebonite. Ebonite must not be used if the temperature of the resistance is allowed to rise more than a few degrees. Slate is to be preferred, and is quite easy to work if the usual precautions are observed. The

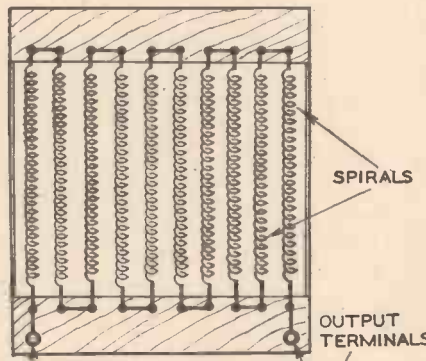


Fig. 3.—The connections for the resistance.

frames are for holding the wires in the form of spirals, so it is necessary to know the amount of wire to be used before the general dimensions of the frame can be determined. Assume that we have 50 yards of wire, then this can be most conveniently cut into 10

must be at least 11 in. long and about 2 in. wide. Drill the necessary holes in each one; the spirals are secured by  $\frac{1}{4}$ -in. diameter bolts and the connections made as in Fig. 3. The wire can be easily and quickly looped by using a pair of snip-nosed pliers. The first and last spirals are connected to a pair of heavy terminals. It is often quite a good plan to connect the last few coils to sockets of the ordinary wireless type, a plug being connected to the terminal through a length of stout flex; thus the resistance can be quickly varied to suit the existing conditions. Four small bracket feet for mounting must be cut from sheet brass to hold the frame about 1  $\frac{1}{2}$  in. from the bench and wall.

A more compact resistance can be made by mounting the coils round the circumference of a circle. The same spacing is necessary; thus the circle must have a periphery of 12 in., the radius thus being about 2 in. The end plates are held apart by four lengths of brass rod about  $\frac{1}{4}$  in. in diameter and threaded at the ends. The connections are as before, but in this case it is very easy to arrange a switch arm so that the resistance can be varied at will. Instead of connecting the wires to small bolts, they should be attached to studs or large cheese-headed bolts. These form one series of contacts. The arm is a short length of  $\frac{1}{4}$  in.-thick brass strip about  $\frac{1}{2}$  in. wide. It is fitted with a small ebonite knob removed from some wireless component, and must be arranged to move freely over the circle of contacts (Fig. 1). It is secured to a bolt which must be fitted with a lock nut or other similar device. A good way of doing this is to drill the fixing nut with a small hole at right angles to the axis of the bolt, and tap it a suitable size for a small set screw; the nut can be locked in any position (Fig. 4).

The slate used can be of the ordinary roofing variety, cut it to shape with a hack saw. Dry it and smooth the face with sandpaper. If any metal streaks show up then reject that piece. When drilling, use a sharp drill and feed slowly, having a block of hard wood beneath the slate. If too much pressure is used the edges will chip off when the drill is nearly through. Do not overload the resistances to such an extent that the coils become red hot. Once annealed they will sag and short-circuit each other or burn the bench.

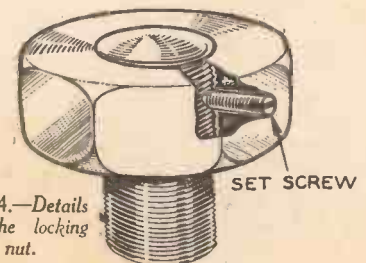


Fig. 4.—Details of the locking nut.

By F. J. Camm

## ACCUMULATORS

How to Get the Best Out of Your Car or Wireless Batteries—a Little Book that will Save You Pounds.

With 84 Diagrams and Sketches

Only 1/- net

From All Booksellers

**A NEWNES HOME MECHANIC BOOK**

Illustrated

5-yard lengths, and these spiralled on a  $\frac{1}{4}$ -in. diameter wooden rod or mandrel. The spirals should be pulled out so that each turn is separated by about  $\frac{1}{4}$  in., the length of the spiral giving the distance between the two plates of the frame.

The coils must be spaced with at least  $\frac{1}{4}$  in. between them; thus for 10, the plates

# Masters of Mechanics

## In This Fifth Article of the Series we Deal with the Creator of the Turbine

**T**HE basic idea of the steam turbine goes back to the very beginnings of mechanical invention. When inventors first attempted to make use of steam power one of the first notions which occurred to them was to arrange for a jet of steam to impinge upon a series of vanes set around the edge of a wheel. The steam, it was considered, would blow the wheel round and thus provide useful motive power. In theory, the idea was quite simple and it was thought out long before the piston and the cylinder were invented.

One of the best-known steam engines of this type was that which has now come to be known as "Branca's machine." It was the invention of one Giovanni Branca, an Italian architect, and it was described by him in a book published in 1629. Whether Branca ever actually constructed the engine which he describes and illustrates in his book is open to question. Nevertheless, the fundamental idea was there: that of the blowing round of a series of vanes by means of steam.

### Principle of Branca's Engine

Doubtless many steam engines of this type were tried out, but they must all have been completely unsuccessful, otherwise subsequent inventors would not have busied themselves with the construction of cylinders and pistons, and with more or less complicated methods of obtaining rotary motion from the up-and-down movements of the pistons. In principle, the engine described by Branca is so simple and so devoid of complicating mechanisms that the early engineering pioneers must have been firmly convinced of its uselessness before they relinquished the idea of it in favour of the more complicated reciprocating or piston-and-cylinder steam engine.

As a matter of fact, the earlier steam-engine inventors were right. The Branca engine and all other engines designed on similar lines, although, in basic principle, they constituted veritable steam turbines, were all useless for the reason that it was impossible to arrange for a sufficiently high speed to be given to the moving parts in order that the whole of the steam's energy of motion could be utilised. Moreover, steam engines of this type were difficult to control. The steam simply rushed out of the jet with excessive velocity, and if the vanes offered much resistance, the impinging steam merely rushed past or glanced off them. If, on the other hand, the steam jet contrived to operate the engine, the wheel revolved so rapidly that before long it was racked to pieces.

The reciprocating steam engine had long been perfected and applied to the world's uses before the question of the rotary steam engine was again taken up. This time, the problem of obtaining rotatory motion from steam without the intervention of an oscillating piston was tackled by an individual who, in addition to possessing inborn genius, had

the advantages of a scientific and an engineering training.

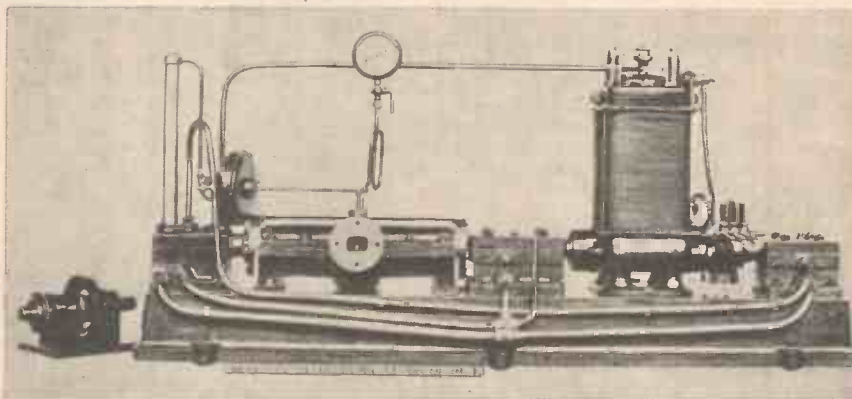
### The Hon. C. A. Parsons

The Hon. Charles A. Parsons, for such is the name of the originator of the modern steam turbine, was born in London on June 13th, 1854. He was the fourth son of the third Earl of Rosse, a famous astronomer and the builder of a 6 ft.-diameter reflecting telescope which was for many years the world's largest. The instrument was erected at Birr (at one time called Parsonstown), co. Offaly, Ireland, and one can hardly doubt that the youthful Parsons, as he examined the magnificent engineering structure of his father's telescope and looked upwards into the vault of the heavens through its gigantic mirror, resolved to devote his life to the pursuit of mechanical

London—had an output of 10 brake horsepower and its driving-wheel ran at a speed of 18,000 revolutions per minute.

Parsons' idea was simple enough. Instead of allowing the energy of the steam to be utilised in one rush, as it were, Parsons divided up the total expansion of the steam into a number of successive steps. At each stage some of the steam's energy was given up and utilised. Very little energy was wasted. Consequently, the turbine engine showed itself to be a highly-efficient machine.

In its essential principles, the Parsons turbine comprises a large circular drum or chamber, called the "cylinder." This is fitted around its inner circumference with sets of vanes, or "guide blades," as they are called. Within the chamber or cylinder revolves a large barrel or wheel which is fitted with projecting vanes around its edge,



The first Parsons turbine, built in 1883. It ran at a speed of 18,000 revolutions per minute and drove an electric-lighting dynamo.

science in one or more of its many branches.

After Parsons had completed his education at St. John's College, Cambridge, he was for a time employed as an apprentice by the great Armstrong-Whitworth company. Afterwards, he went to Messrs. Kitson, of Leeds, and, in 1883, he entered into a junior partnership with Messrs. Clarke, Chapman and Company, of Gateshead, Newcastle-on-Tyne. It was during his association with this firm that the Parsons turbine engine was originated and placed on the market.

### The First Steam Turbine

Parsons had always been interested in the subject of steam power, and he was struck by the fact that an engine which obtained its motive power by the blowing round by steam of a series of vanes fixed on a wheel would be an exceedingly simple and efficient machine if only the steam power could be controlled and utilised to its maximum degree. Parsons was, of course, not the only engineer who attacked the problem. Nevertheless, he was the inventor who first succeeded in constructing a satisfactorily working steam turbine. This he did in the year 1883. The first Parsons turbine built in that year—it is now in the Science Museum at South Kensington,

or periphery. Steam enters the cylinder and rushes through the first row or set of fixed vanes. These guide the course of the steam and direct it on to the first row of vanes fixed to the inner revolving drum or wheel. Thus the inner drum revolves under the influence of the steam flow. The steam, in escaping from the first row of vanes on the revolving drum, next passes against a second row of fixed vanes on the inner circumference of the cylinder. The fixed vanes again divert the steam on to a second row of vanes attached to the revolving drum. Further energy of motion is extracted from the steam and the process is repeated several more times until, eventually, the steam issues from the cylinder at nearly normal pressure, having had all its energy of motion usefully extracted from it.

### The First Condensing Turbine

The first "condensing" turbine engine was built in the year 1891, and in 1894 it was applied experimentally to ship propulsion in the steam yacht, *Turbinia*, a vessel which was 100 ft. long and which possessed a displacement of 44 tons.

After three years of trials and disappointments, success with the marine turbine engine was achieved, and the hitherto-unattained speed of 34½ knots was realised. S.Y. *Turbinia* was demonstrated at the Royal Naval Review at Spithead in 1897. The demonstration served to emphasise the fact that, for marine use, the steam turbine possesses many important advantages over the older forms of reciprocating steam engine.

In 1889, the Hon. C. A. Parsons dissolved his partnership with Messrs. Clarke, Chapman & Company, of Gateshead, and he founded his own firm of Messrs. C. A. Parsons and Company, Ltd., at Heaton, Newcastle-on-Tyne. The newly-founded firm gradually attained a position of universal renown, although it was not until 1900 that the pioneer work of Parsons became widely recognised abroad. At the present day, the firm originated by the Hon. C. A. Parsons manufactures not only marine turbines, but also various types of turbine engines for land use. Dynamos, transformers, and various other types of electrical apparatus are also produced by the firm.

#### Advantages of the Turbine

The main advantages of the steam turbine over engines of the reciprocating type are to be seen in the fact that a turbine engine weighs less than half the weight of a reciprocating engine of equivalent power, that it is cheaper to build, occupies less room, and requires less steam to drive it. A turbine engine is simpler to work. It is devoid of reciprocating pistons, valves, and other complicating mechanisms. Consequently, it is more foolproof and is less likely to give rise to trouble than is a large and heavy reciprocating engine. The turbine engine runs smoothly, far more so than does the best of reciprocating engines. Hence, it constitutes an ideal engine for ship propulsion. The turbine engine, by lessening ship vibration, has added enormously to the comforts of passenger travel on the high seas. In modern times, the largest ocean-going liners are equipped with six Parsons turbines. Four of these drive the ship forward, the remaining two being employed for reversing the ship's motion.

For large vessels, both naval and mercan-

tile, of high speed, the combination of Parsons turbine with water-tube boilers is supreme. In the case of vessels of below 4,000 tons displacement, the turbine is at present in severe competition with the oil engine and with the older forms of reciprocating steam engine.

On land, practically every electric-power station of any importance is steam-turbine operated, the Parsons turbine having completely displaced the older reciprocating engine for this type of work since it can be built in sizes which would be quite impossible with the older type of engine.

In 1898, the turbine's inventor, the Hon. C. A. Parsons, was elected a Fellow of the Royal Society. He was created a K.C.B. in 1911, and was awarded the coveted Order of Merit (O.M.) in 1927. During the world war, Sir Charles A. Parsons occupied himself with engineering and electrical work of vital importance, being, at that period, a member of the Central Board of Inventions and Research.

A master of mechanics, indeed, and the most original pioneer of steam engineering which the modern world has known.

**C**ASE-HARDENING is an effective method of preventing undue wear on mild-steel surfaces which are moving in contact with each other.

The principle involved is the introduction of carbon into the surface of the metal. It is the carbon component in steel which differentiates it from iron; steel is, indeed, iron with a large percentage of carbon. It is the carbon which enables cast and tool steel to be hardened by heating and suddenly cooling. Tool steel has a high percentage of carbon. Mild steel (such as Bessemer) and wrought iron have little carbon, and these cannot be hardened except by introducing carbon afterwards, and then only the surface for a certain depth (dependent on the nature and length of the process) can be hardened.

The advantage of case-hardening is that while the surface can be hardened to glass hardness the bulk or core of the piece remains malleable, so that we can have external hardness where we want it without the brittleness which makes cast steel hardened dangerous in many cases.

#### Mild Steel

Case-hardening of mild steel is used in the case of the bracket spindles, cones, and cups of bicycle ball-bearings.

A steel with as low as 0.1 to 0.2 per cent. of carbon will not harden, but it can be case-hardened by heating it in contact with carbonaceous material in an iron box or a fireclay crucible in a hot fire and sealed against the atmosphere. The carbonising material may be any animal carbon, such as ground bone, charred leather, or other simple form of animal charcoal. The cuttings from horses' hoofs at the forge make excellent case-hardening material.

Wood charcoal, soaked in an aqueous solution of sodium carbonate and dried and powdered, makes a good case-hardening compound. There are on the market some special preparations of carbon which have the advantage that they are always the same, and once the time and temperature suitable for any job have been ascertained by usage the effects can be guaranteed again, because the compound will be the same. This is not always so when bone, leather, etc., are used.

#### Grinding

A piece can be case-hardened after machining and finishing—grinding, etc., and this is where the process is useful to

## Case-Hardening

An Advantage of this Process is that it Enables the Surface of Steel to be Hardened to Glass Hardness whilst the Bulk or Core of the Metal Remains Malleable

the mechanic. He can make his part to size and harden afterwards. Other methods require grinding to truth after hardening—an expensive process. Grinding can of course be used if a very fine accuracy demands it, but it must be remembered that the depth of case is not great, and if grinding penetrates the case, then the job will be spoilt.

Articles to be case-hardened are packed, in contact with the carbon substance, in cast-iron, wrought-iron, or fireclay boxes. A piece of good bore steam pipe with a cap screwed on each end makes an excellent case-hardening box for small pieces. The part or parts to be cased are packed in the box or tube so that they are entirely surrounded by the carbon element and do not touch each other or the walls of the box or tube. There should be a good layer of the carbon over every part. If a box is used it should be sealed (luted) with fireclay at the joint of the lid or other covering, so as to exclude the air. It should be brought gradually to a good yellow heat in a coke hearth with a gas blow-pipe fixed to blow upon it at a regular heat and keep it at that. A temperature of 1,700 degrees is enough, but since the amateur will have no means of measuring this, it may be said that a good yellow glow all round the receptacle will indicate a heat which will do the job. The time required will depend on the bulk of the pieces and the depth of case required.

For small parts, such as our readers may wish to case, an hour or two would be enough and would give a depth of carbon case of somewhere near a thirty-second of an inch.

If a gas muffle furnace is available it should be used, but the ordinary gas blow-pipe, if it can be supplied with air by a fan electrically driven, is the best medium for getting the heat required.

If a closed coke stove with a long chimney is available, enough heat can be obtained by carefully regulating the draught, and charcoal will give, in such a stove, even greater temperatures than coke.

A test piece should be put in with the work—any piece of the average size of the others, and which may be broken for test afterwards so that if the case is not deep enough the process can be continued, will be suitable. To test for depth of case let the piece cool down and then heat to a full yellow heat, and plunge into clean, cold salt water; next break the piece or grind an end so that the fracture or ground surface shows the hardened part, and the depth will be revealed.

If a part of the surface requires to be left soft, it should be covered with a coating of fireclay so that it cannot come in contact with the carbon material, and will therefore not absorb the carbon into itself. But it must be ascertained that the clay adheres to the surface and that it is quite dry before putting the piece in the box.

In some cases a part which is required to be soft is made of bigger diameter, and then, after the first cooling it is turned off while the whole is soft and before the heating and quenching which harden the carbonised case.

#### A Case-hardening Compound

Yellow prussiate of potash and an equal amount of common salt will make a good case-hardening compound for thin-surface hardening in the open fire or blow-pipe.

The part to be heated is blown to a full yellow colour and the compound sprinkled on. It will fuse and adhere to, and run round, the metal, and the process should be continued, keeping the heat up and continually applying the powder and allowing it to melt and run round the job. Then while at full heat the part is quenched as rapidly as possible in a good volume of clean cold salt water.

The same method is used when case-hardening with the patent "Kasemit" compound. It can be used in the brazing hearth with a gas blowpipe heating the part to a full yellow heat and melting the "Kasemit" powder on and letting it soak into the metal by repeated applications.



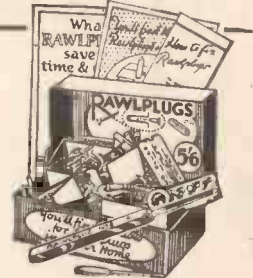
# Every Handyman needs these Products - ESPECIALLY AT CHRISTMAS !

## RAWLPLUGS

*For a hundred and one Fixing Jobs*

There are dozens of things which need fixing in every home. A Rawlplug Outfit is indispensable for these jobs, and you should make certain that you have an outfit handy for the hundred and one jobs which are bound to crop up just before Christmas.

Anyone can make firm fixtures with Rawlplugs. No special skill is required to carry out neat, permanent jobs quickly and easily. Rawlplug Outfits contain complete equipment, tools, instructions, etc.



**PRICES:**  
 Popular Outfit . . . . 1/6  
 Household Outfit . . . 3/6  
 Handyman Outfit . . . 5/6  
 Craftsman Outfit . . . 5/9

## RAWLPLUG DUROFIX

*The Heat- and Waterproof Adhesive*

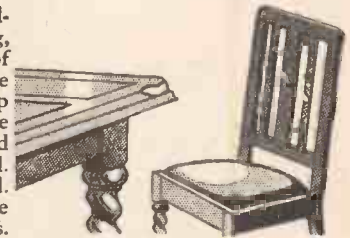
A MEND IN NEED—FOR CHRISTMAS BREAKAGES. Christmas time is hard on crockery—so Durofix should be in every home ready to mend the breakages. It's heat- and waterproof, and there is nothing else to equal Durofix for this type of repair. There are dozens of other uses, too, such as mending kiddies' toys and sports goods, making little Christmas gifts and so on. Always keep a tube of Durofix in the house. Sold in orange tubes at 6d. and 1/-.



## RAWLPLUG PLASTIC WOOD

*Wood in Putty Form*

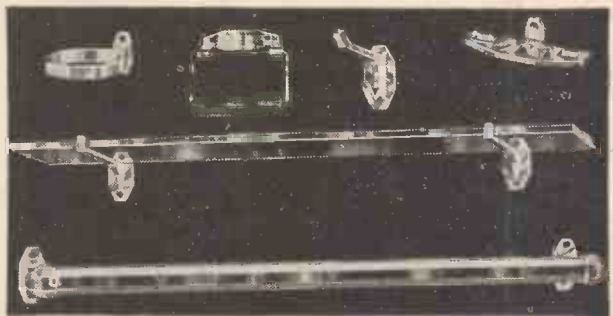
FOR PERMANENT REPAIRS. Cracks in woodwork need filling, chipped frames need repairing, and dozens of wooden articles need the attention of Plastic Wood. Here is the ideal product for those last-minute repairs which always seem to crop up at Christmas time. Rawlplug Plastic Wood can be moulded to any shape, but when it has been exposed to the air, it hardens and becomes just like real wood. It can then be cut, planed, painted and varnished. Nails and screws can be driven into it. Available in tubes at 6d. and 1/-, and in tins from 9d. upwards.



## RAWLPLUG SUPER-CHROMIUM FITTINGS

*The Ideal Gift*

If you're looking for something very attractive, yet useful—something which will last a lifetime and yet is not expensive—ask your Ironmonger to show you the Rawlplug Super-Chromium fittings. They are beautifully modern in design, solidly made, and heavily chromium-plated. Complete Outfits cost £1. 1s., but all fittings may be bought separately. Let Rawlplug fittings solve your gift problem.



*Fully illustrated literature describing these and other Rawlplug Products free on request.*



**THE RAWLPLUG CO., LTD.**  
 RAWLPLUG HOUSE  
 CROMWELL RD., LONDON, S.W.7

# How to Build the

# "FLYING FLEA"



### The Profile of the "Flea"

THE pointed leading edge has been designed for those conditions in which it is actually better than any other profile—for proof of this look at the wings of the super-racing machines of the Schneider Trophy—but it would present an inferior efficiency, for example, if one climbed at a high angle of incidence, providing that the motor allowed us to do so.

For simplification, lightness, and speed of work this pointed leading edge is unrivalled. It is also more solid, which is very much more important.

### Assembly of the Wings

Place your spar on two trestles, with its points turned towards the ground. Thread the ribs on it in order, with their lower sides uppermost.

### Further Constructional Details, Including the Mounting of the Engine

400 mm., and the remaining ribs are 315 mm. apart.

Turn the skeleton upside down, and place in position the twin joining blocks measuring 6 mm. x 12 mm. x 120 mm. Nail on to the main spar, and simply glue on to the web of the ribs in such a manner that all the lower surfaces of the ribs are parallel, which can be verified with a spirit level.

The small rear spar is in two pieces, right

allows it to join the turn-up of the ribs, following the curve of the main spar.

These two half-spars are joined between the two middle ribs by two 10 mm. x 20 mm. strips 400 mm. in length.

Glue them together before threading them into place, and make quite certain that the glue holds properly by nailing or binding them. If you are afraid of deformation of the trailing edge of the wing, before you bind up the little spar by means of a cord and a kingpost, bend up its points as you did in the case of the large spar.

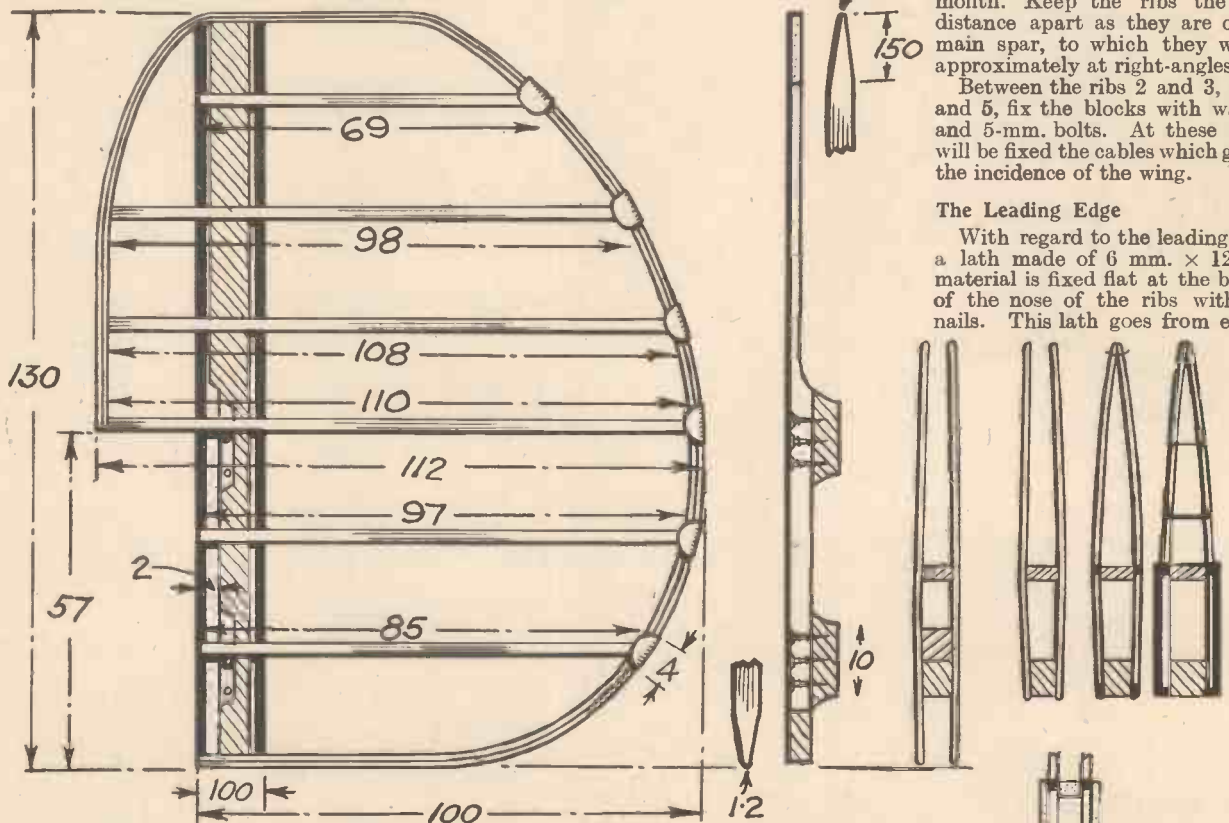
The little spar of the rear wing is made out of one single piece 3 metres 200 mm. long, constructed in a similar manner.

The bottom strip of each rib is directly nailed with a single nail to the small spar. After this, block the upper surface of each rib with little bits of lath 6 mm. x 12 mm., as in Fig. 23 last month. Keep the ribs the same distance apart as they are on the main spar, to which they will be approximately at right-angles.

Between the ribs 2 and 3, and 4 and 5, fix the blocks with washers and 5-mm. bolts. At these points will be fixed the cables which govern the incidence of the wing.

### The Leading Edge

With regard to the leading edge, a lath made of 6 mm. x 12 mm. material is fixed flat at the bottom of the nose of the ribs with two nails. This lath goes from end to



A block measuring 6 mm. x 12 mm. x 70 mm. is placed under each rib, is nailed and glued on to the spar by two fine, long nails (Fig. 25, shown last month). Let them dry for two hours.

The two middle ribs are separated by

and left, each one threaded through its seven ribs all of a kind, and through the one of different pattern. Each half-spar is made out of two strips of 10 mm. x 20 mm. (or one strip of 20 mm. x 20 mm. split), 2 metres 700 mm. long, whose elasticity

Fig. 27.—Showing the construction of the framework of the rudder.



end of the spar. If it is necessary to make it of more than one piece, then join together by bevelling. Another lath, also placed flat, is fixed to the first one, and then the third one, which is stood on edge, is attached. This latter is simply glued, and is bound strongly into place with a thread, which makes one turn about every 30 mm.

Proceed in a similar manner for the trailing edge; in this case the first lath is fixed between the tail end of the ribs by two semi-circular gussets. As a safeguard against breaking the laths when bending them, it is well to moisten each with a rag soaked in water five minutes before starting work.

Two gussets join the two edges—the leading edge and the trailing edge—in the point at the end of the main spar. Two other gussets join the trailing edge to the small spar (see the plan of the wing, Fig. 20). After it is dry—one night—trim up the edges with a file.

The fuel tanks are placed in the front wing between the central ribs—one tank in front of the main spar, of 12 litres capacity; the other behind it, of 15 to 20 litres. This capacity gives altogether a total of about four hours of flight and a range of 400 kilometres.

These tanks are placed on strips of 3-mm. plywood, glued and screwed under the central ribs, the main spar, and the leading edge. They are afterwards wedged in their compartment and finally kept in place by the covering.

Without the tanks, the wing skeletons weigh 31 lb. and 20 lb. for the front and rear respectively, and require five hours' work to assemble.

**Covering**

The material for covering the wing is generally sold in a width of 1 metre. For the front wing six of these widths, 3 metres 10 cm. long, will be joined on a sewing machine along their edges. Cover the skeleton of the wing with this piece of material, of which the free edges will be at the trailing edge of the wing (Fig. 26).

Stretch it first along the whole of the bottom of the wing, nailing the turned-up edge at the trailing edge and proceed as follows:

1. Tack it between ribs No. 1.
2. Tack it then at rib 6, pulling it tight between 1 and 6.
3. Tack it on the back (tack every 40 mm.) between 1 and 6, making certain that it is quite straight as regards the run of the thread.

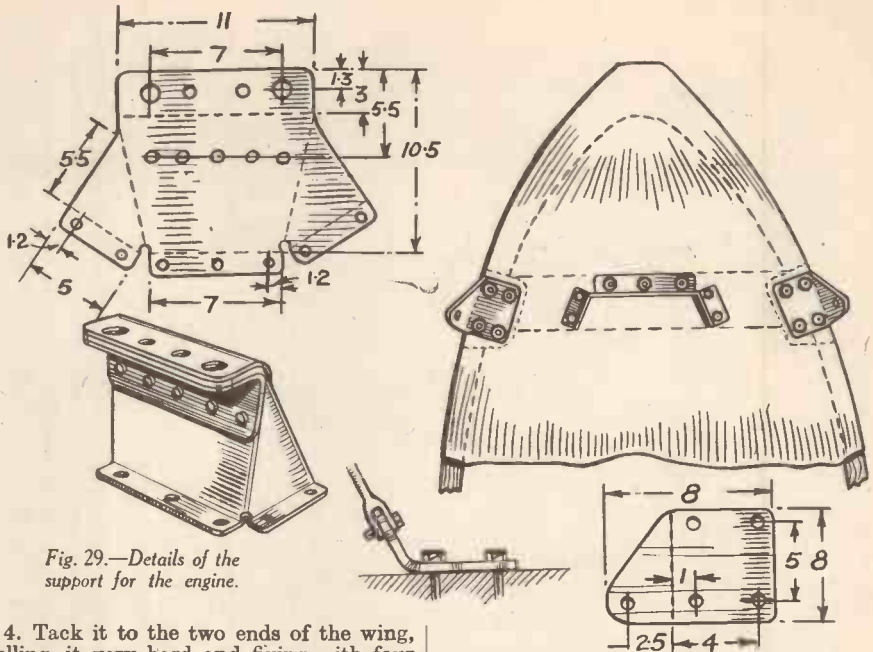


Fig. 29.—Details of the support for the engine.

4. Tack it to the two ends of the wing, pulling it very hard and fixing with four tacks.

5. Now tack between the ends of the wing and rib No. 6, pulling it tight in the direction of the span.

6. Now stretch the bottom face by pulling the cloth from the direction of the leading edge, and put in one tack at the nose of each rib.

7. Turn the wing over and tack it on its back, pulling firmly, and following the same order as on the bottom face. Note that the free edge is eventually tacked (after turning over) along the lower surface of the trailing edge.

**Applying the Fabric**

Now finish the rounded parts of the leading edge. Tacking is best carried out when holding the wing vertical, standing on its leading edge. An assistant holds it upright, and at the same time can hand you the box of tacks. Stand on a small stool about 200 mm. high, and get right opposite your work.

Do your work when the weather is warm and dry, or else in a room which is reasonably warm. Cut off the excess of the cloth, leaving after the final tacking a free margin of about 40 mm.

The skeleton is now enclosed in a sack like an ordinary mattress. Sew it through from side to side along each rib, with the aid of good hemp string and a mattress needle 22 cm. long. Knot the string every 80 mm. without cutting the thread between the knots, which will be on the top of the wing. Pull the string quite tight. This sewing, due to the dihedral of the wing, helps to stretch the cloth covering very firmly. The time for the covering is about four hours, and for the sewing two hours.

All round the rounded ends and along the trailing edge, the spare strip of 40-mm. material referred to before should be glued with cellulose varnish, moistening the cloth well with this above and below, and leaving it to dry completely (five or six hours).

**Doping**

Choose a warm, dry, sunny day. Operate outside in the shade in the afternoon. Fill a bowl with the doping varnish and, taking up a good brushful with a "cod's-tail" brush 60 mm. long, apply a layer, rubbing it well into the cloth, which becomes semi-transparent. Spread well any excess dope all round with strokes of the brush.

Do not economise with the dope; its purpose is not to make the wing look pretty but to stiffen the covering. Carry on progressively from front to rear, rib by rib. On going on to the next strip run over the blobs which formed on the earlier one, but do not take too much trouble about it.

Provided that the weather is warm you can start on the second layer two hours after the last stroke of the brush. Two layers are enough; an extra layer on the back is better; four layers are better still.

All joints should be covered with a band of notched fabric. One applies the dope bit by bit to the surface and then to the band, which is rubbed down with a brush soaked in dope. When it is dry, watch it to see that the notches do not tend to spring up, and press them down with the fingers.

Before it dries, wash the brush in soap and water, when the dope will come off in little white pellicles.

The two wings are entirely constructed, assembled, covered, and varnished in eight days. They weigh each as follows:

The wing with the tanks for petrol and oil about 44 lb., and the tail wing about 26 lb.

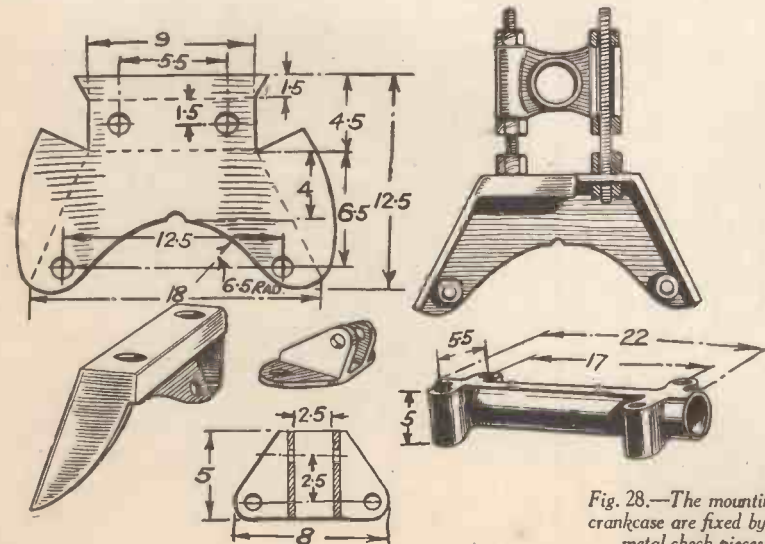


Fig. 28.—The mounting lugs for the crankcase are fixed by bolts between metal check pieces as shown.

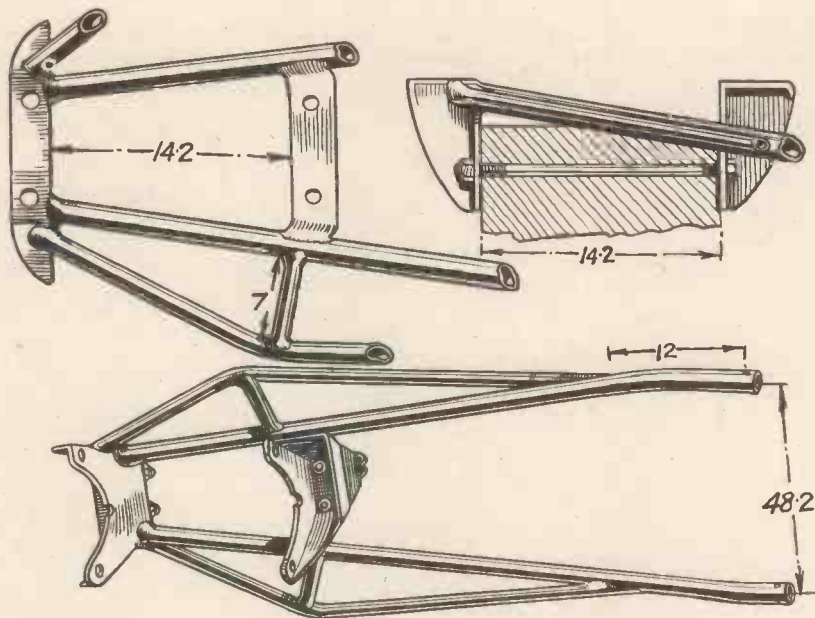


Fig. 30.—Further details of the engine mounting.

**Rudder**

The construction of the rudder follows the principle of the single spar (Fig. 27).

A lath in 20 mm. x 20 mm. material carries a reinforcement of hardwood, and is thinned down to 20 mm. x 12 mm. section. With the lath of 20 mm. x 12 mm. section it forms the flanges of the spar. Nail on the top of it at every 200 mm. strips 6 mm. x 12 mm., forming ribs cut off to the lengths indicated. The upper ribs go beyond the spar in order to make the leading edge and compensating surface; the

lower ones do not go in front of the spar. Fill up the space between the ribs with strips of 6 mm. x 12 mm. section running along each flange on both sides, and cover with a strip of 3-mm. plywood, 100 mm. wide and 1 metre 300 mm. long, with the grain in the direction of the length. This plywood strip goes 12 mm. beyond the sharpened ends of the flanges. In the empty space so formed, place two strips chosen from material with good straight grain, curved after being damped for ten minutes, then bound and glued after having

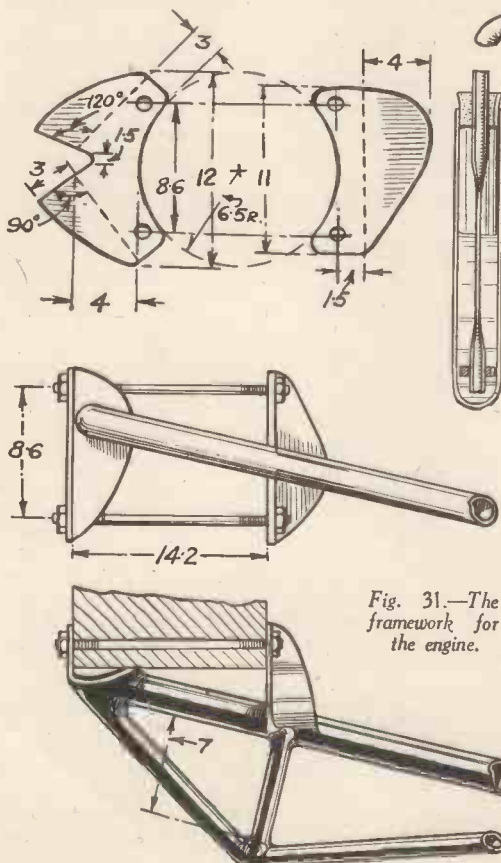


Fig. 31.—The framework for the engine.

The air-frame is now finished, and it remains to adapt to it the motor-aircrew group.

**Mounting**

The inclined triangular platform of the body allows for the very easy installation of any kind of engine. The principle of mounting is as follows:

1. A lower piece supporting the weight of the engine.
2. A structure which triangulates the engine on the inclined platform.
3. This structure is also triangular in plan.
4. The crankcase of the engine will receive directly the support for the mounting of the airscrew shaft.

All this means that the engine will be placed head downwards or inverted, for ease and security in the mechanical installation, and for the improvement it gives to the pilot's vision.

The mountings are of a type which can be used as models for any other kind of engine whether two- or four-stroke, with or without reduction gearbox.

**The Support for the Engine**

Most engines have a detachable head, which is fixed to the cylinder by four bolts. The two rear bolts will be replaced by threaded rods (ask the makers for these) in order that they may hold the head on top of the metal fitting, made of 2-mm. material and reinforced with two angle pieces, the whole being solidly riveted together with 5-mm. rivets (Fig. 29). This metal fitting will be bolted along its lower side on the cross-bar of the platform of the fuselage.

Do not omit, at the same time, to put in position the metal fittings for the bracing which encloses the crossbar and the lyre-shaped piece of wood between them and the gussets by four 6-mm. bolts. After you put the engine in position, you would find it very difficult to drill the holes for these bolts.

**The Engine Supports**

It is assumed that you have bought an engine without reduction gear and that you wish to construct this gear yourself.

The reduction gear, of which a description follows, is suitable for an engine for elementary practice flying above an area where landing is easy. It may be that after a dozen hours of flight your mounting will have given no trouble. After all, all motor-cycles to-day

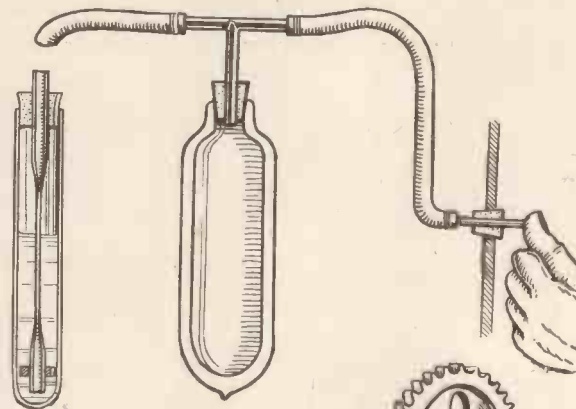


Fig. 32.—A statoscope made from a thermos bottle, to enable the aviator to see if he is going up or down.

been nailed on to the ribs. As in the case of the trailing edge of the wings, gussets help to fix the edge to the tails of the ribs.

A web of 1.5-mm. plywood makes the rib rigid. The rudder is covered with fabric just like the wings, and four coats of dope are applied.

The time required for making the skeleton is four hours; for covering, one hour. The weight is about 4½ lb.

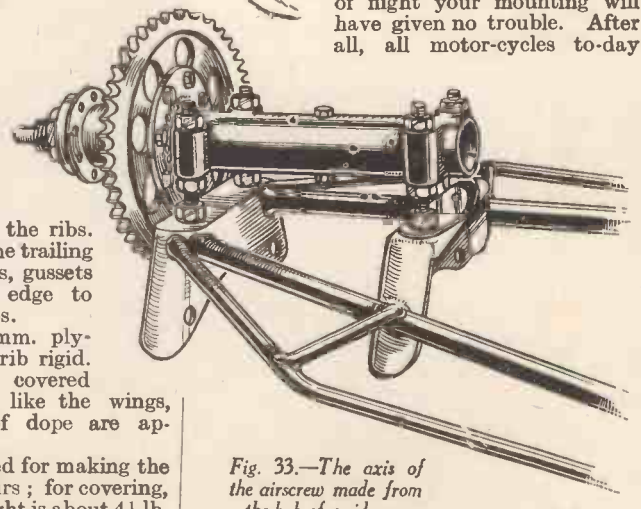


Fig. 33.—The axis of the airscrew made from the hub of a sidecar.

transmit power by chain, and the problem which you have to solve is exactly the same.

The engine mounting is work for a welder, and the professional will find it easy to make. In places where you cannot get welding done you must replace the tubes by angle iron of 30 mm., riveted to the fastenings which are modified to meet your requirements. The rivets may be made of drawn rod of 6 or 7 mm. diameter.

**Engine Position**

Place the fuselage level in line of flight, that is to say, with its back portion horizontal. The engine is placed upside down with its two bolts in the holes of the fitting. For the moment do not fasten any nuts. With a piece of cord fasten it to the foot of the pylon so that its crankshaft is horizontal. Make sure that the engine is straight with the axis of the fuselage and is not leaning either to right or left. The mounting lugs of the crankcase will be fixed by bolts (in 10-mm. screwed rod) between the cheek piece of 2-mm. metal (Fig. 28). Make certain that the top edges are quite parallel (Fig. 30).

Offer up to them from the side a tube made of 16 mm. x 20 mm. material, so that when it is soldered to the two cheek pieces it fits into the fitting at the foot of the supports of the *cabane*. It would be a good thing to bend, after heating to red heat, the end of the tube a little so that it comes straight into this fitting. Fit the end of the tube on to the front cheek piece, mark all the necessary points and take it to the welder.

The welder will fix the tube on to the second cheek piece. Protect the engine by rags soaked in water, which should be ready to place on the weld as soon as it is finished.

Take all the assembly and triangulate it by the cross piece and the arc, of which the end that comes close to the fitting will last be welded in a position at a distance of 100 mm. from this fitting.

The axis of the airscrew will be

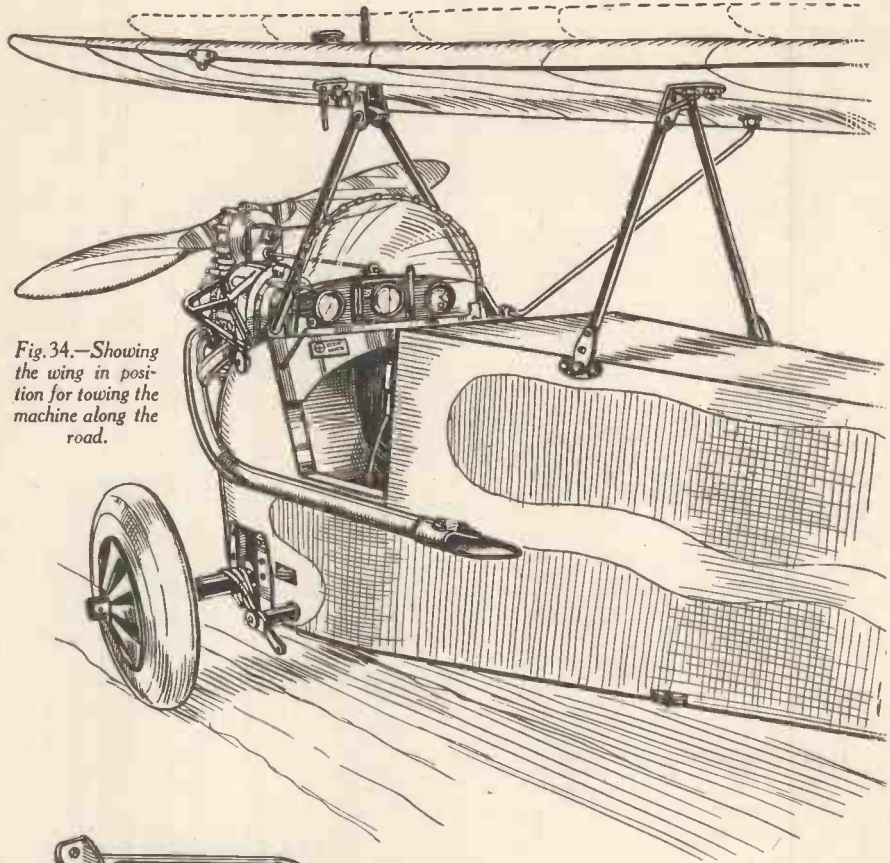
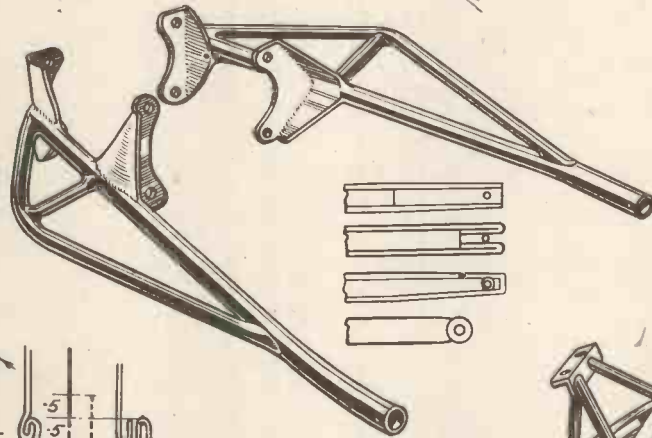


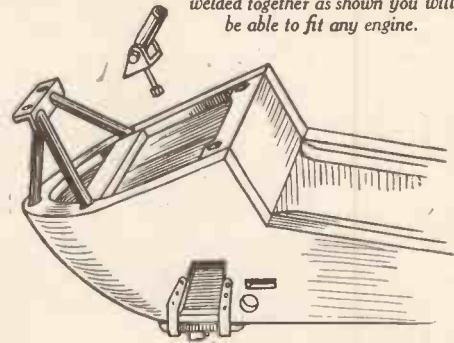
Fig. 34.—Showing the wing in position for towing the machine along the road.



thereby the piece which was meant for an engine with a reduction gear.

Since this mounting is only bolted to the upper lugs of the crankcase, do not forget to

Fig. 36.—With tube and steel welded together as shown you will be able to fit any engine.

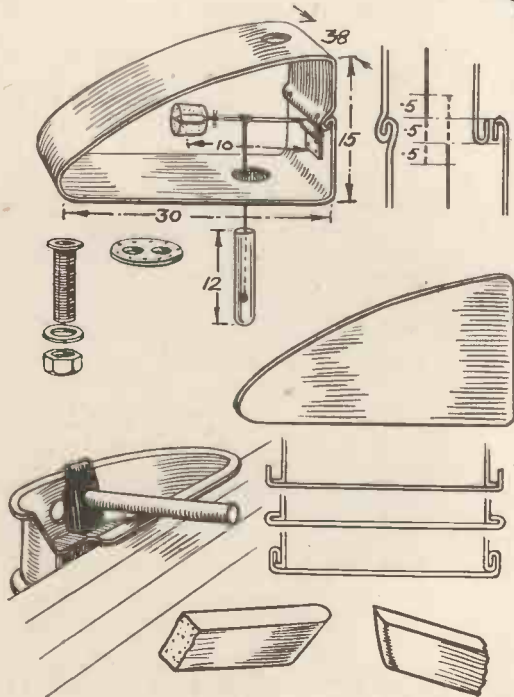


clamp the lower lugs by two other 10-mm. bolts.

**Axis of Airscrew**

The axis of the airscrew is the hub of a front wheel of a motor-car, cycle-car, side-car, etc. The axle is fixed and bolted to a tube. The hub of the wheel, mounted on ball-bearings, carries at one end a toothed wheel driven by chain from the engine, and at the other end the airscrew.

A 3-mm. flat steel plate, riveted (twenty 4-mm. steel rivets) to the rear rim of the



carried by a tube to which will have been welded lugs made of four tubes in 16 mm. x 20 mm. x 50 mm. material, which will slide on four 10-mm. screwed rods and of which one will regulate the position by the screws. A fitting will be fixed to the screwed rods of the rear platform to receive the foot of the front strut of the pylon, replacing

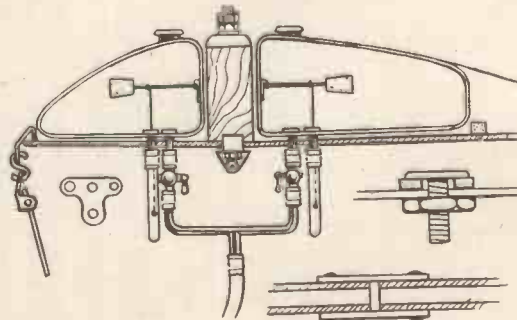


Fig. 35.—Details of the petrol tanks.



# POPULAR FLYING

**6<sup>D.</sup>  
MONTHLY**

**December  
Number  
Out Now**



The National Aviation Paper for everyone interested in Flying—whether you belong to a Club or take a “flip” at a flying display.

*Special Contents of the December Number:*

**THE IMPERIAL WAR MUSEUM**  
Illustrated with Works of Art from its Walls.

**JAGDGESCHWADER No. 1.**  
The History of the Richthofen Circus.

**“CONTRETEMPS AT LONGCHAMPS”**  
How a British Pilot landed on the Race Course during the Grand Prix—and also landed in gaol.

By Air to  
**“THE WHITE MAN’S GRAVE”**

**A JOB OF WORK**  
A Canadian Epic of the Air.

Other features include Gliding, Models, Latest Air News, etc.

## *Profusely Illustrated*

Get “Popular FLYING” To-day! Now on sale at all Newsagents and Bookstalls.

*G. Arthur Pearson, Ltd.*

## “LE POU DU CIEL”

EVERYTHING FOR THE FLYING FLEA

Buy from the constructors of this amazing little aircraft—Spruce, Ply, Metal Fittings, Wheels, Complete Wings or Fuselages in any stage of construction—in essentials

ANYTHING AND EVERYTHING

Send stamped addressed foolscap envelope for lists

**E. G. PERMAN & CO.**  
24/5/6 BROWNLOW MEWS,  
GRAYS INN ROAD, LONDON, W.C.1

## “FLYING FLEA”

**WE STOCK EVERYTHING!!!**

Complete Parts, Spruce, Ply, Dope, Glue, Fabric.

Thirty high-grade Tools to build same, 50/-.

Send stamped addressed envelope for Lists.



LAY BUILDINGS, LONDON ROAD,  
CHELMSFORD - ESSEX

'Phone: 3331 CHELMSFORD.

## FLYING FLEA

COMPONENTS MADE TO YOUR SPECIFICATIONS.

WRITE FOR QUOTATIONS.

ENGINEERING DEPARTMENT,  
Britannia Works, Lincoln.

**KEENEST PRICE S**  
for all Materials, Manufactured Parts and complete FLYING FLEAS.  
**DUNSTABLE SAILPLANE CO.,**  
Luton Aerodrome, Barton, Beds.

WHEN REPLYING TO ADVERTISERS PLEASE BE SURE TO MENTION “PRACTICAL MECHANICS.”

IF YOU ARE INTERESTED IN BUILDING THE “FLYING FLEA,” THESE FIRMS ARE AT YOUR SERVICE.

WE SUPPLY ALL PARTS FOR BUILDING

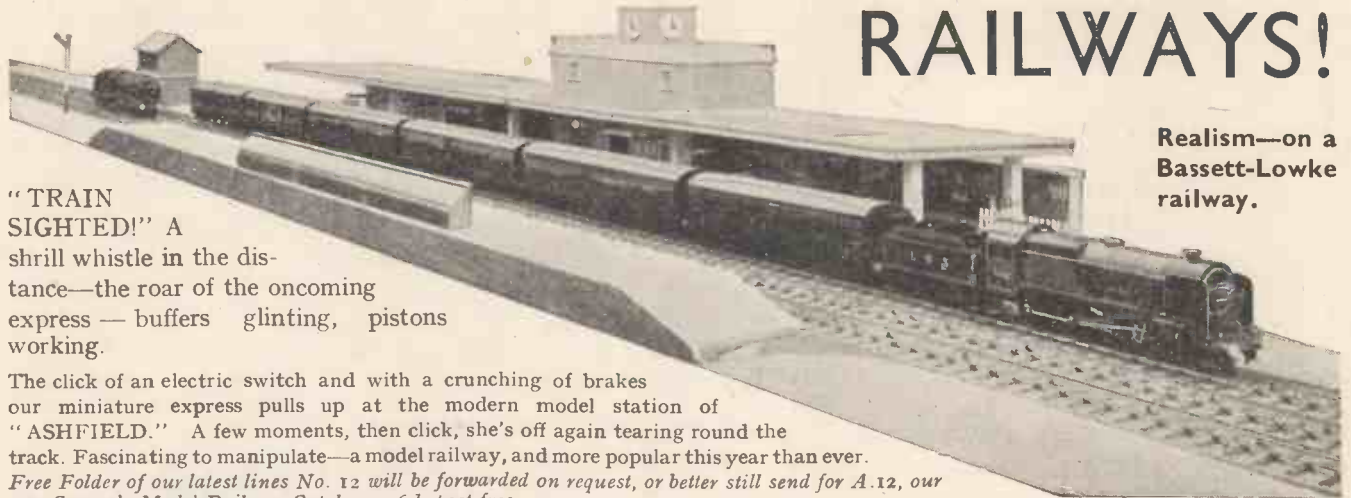


Build this wonderful 'plane and learn the delights of flying. We supply all parts exactly to the inventor's specification. Complete fuselage, wings, or any separate part. Save yourself time and trouble and ensure that your “Flea” will be completely airworthy.

Write for full details of parts and prices.

**LONDON AIRCRAFT,**  
Marshall's Yard, 3a Seaton St., London, N.W.1

# SUPERB VALUE IN MODEL RAILWAYS!

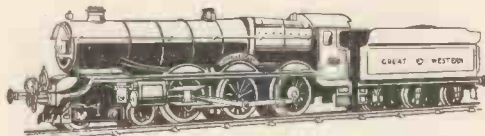


**Realism—on a Bassett-Lowke railway.**

**"TRAIN SIGHTED!"** A shrill whistle in the distance—the roar of the oncoming express—buffers glinting, pistons working.

The click of an electric switch and with a crunching of brakes our miniature express pulls up at the modern model station of "ASHFIELD." A few moments, then click, she's off again tearing round the track. Fascinating to manipulate—a model railway, and more popular this year than ever.

*Free Folder of our latest lines No. 12 will be forwarded on request, or better still send for A.12, our new Season's Model Railway Catalogue, 6d. post free.*



**G.W.R. 4-6-0 Express Locomotive KING GEORGE V, No. 6000.**

A fine super-detail working model of the most popular engine of the G.W.R., which went to America. An important new production this season.

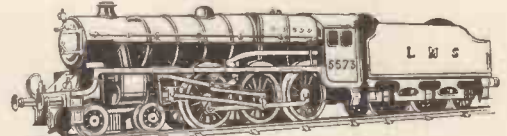
Prices: Gauge o. Clockwork or electric d.c. 8 gns. electric a.c. with directional distant control (20 volts) and controller. **£9. 18. 6.**



**Standard Tank Locomotive, No. 5374.**

Power is a great asset of this smart-looking Tank locomotive, fitted with first-class mechanisms.

Prices: Gauge o. Clockwork or d.c. electric. **42/-** A.c. electric. **45/-**



**L.M.S. 4-6-0 Express Locomotive, No. 5573.**

An excellent example of the change in L.M.S. locomotives since the advent of Mr. Stanier. Available in the standard colours, or special Jubilee Black and Silver. Mechanisms the best of any class. Super-detail finish.

Prices: Gauge o. Clockwork or d.c. electric. **7 gns.** Electric a.c. 20 volts, with directional distant control and controller. **£8. 15. 0.**

## A Sensation! The Bassett-Lowke Twin Train Table Railway!

Two electric gauge "oo" trains running on the same line at different speeds, in the same or opposite directions, forwards or backwards, fast or slow.

Here is something entirely new, and far ahead of anything of the kind ever attempted before, a scale miniature train system which can be operated in one quarter of the space usually needed.

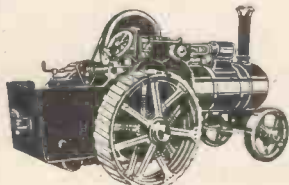
And the price, 35/- only for the Passenger train, 30/- for the Goods—complete with track and controller—unprecedented value.

Each vehicle is fitted with automatic couplings, the steel rails are mounted on a patented moulded base, carrying the trains round the sharpest bend. To join the rails point and crossing is the work of a second, and it is just as easy to take them apart.

No description of these trains can possibly do them justice. You must put your hand on the switch before you can realise what a revolution has been created in model railways. Write for free booklet of the **Bassett-Lowke Twin Train Table Railway No. T.T.12**—for full details and be one of the first boys in your town to own a "Twin."



*The "Twins" together—showing the complete Passenger and Goods Trains. (Foreign.)*



*Burrell Traction Engine.*

### Scale Model ENGINES, SHIPS and FITTINGS.

Besides Model Railways, we have a catalogue devoted to Engines, Boilers, Castings, Fittings and Parts, called **B.12.**, price 6d. post free. Details of this fine Traction Engine are given in it. Why not go in for Model Engineering this winter? Send for this catalogue.

Model Ship Lovers will find everything they want in our Ships Catalogue, **S.12.**, price 6d. post free—Yachts, Motor Boats, Scale Model Ships—Fittings of every description! Why not build a 10-inch model of the "QUEEN MARY"? Full set of parts and instructions. Price 5/-. Postage 6d. Also super-detail "NORMANDIE" set. Price 11/6d. Postage 6d.

*Motor Boat "IOLANTHE."*

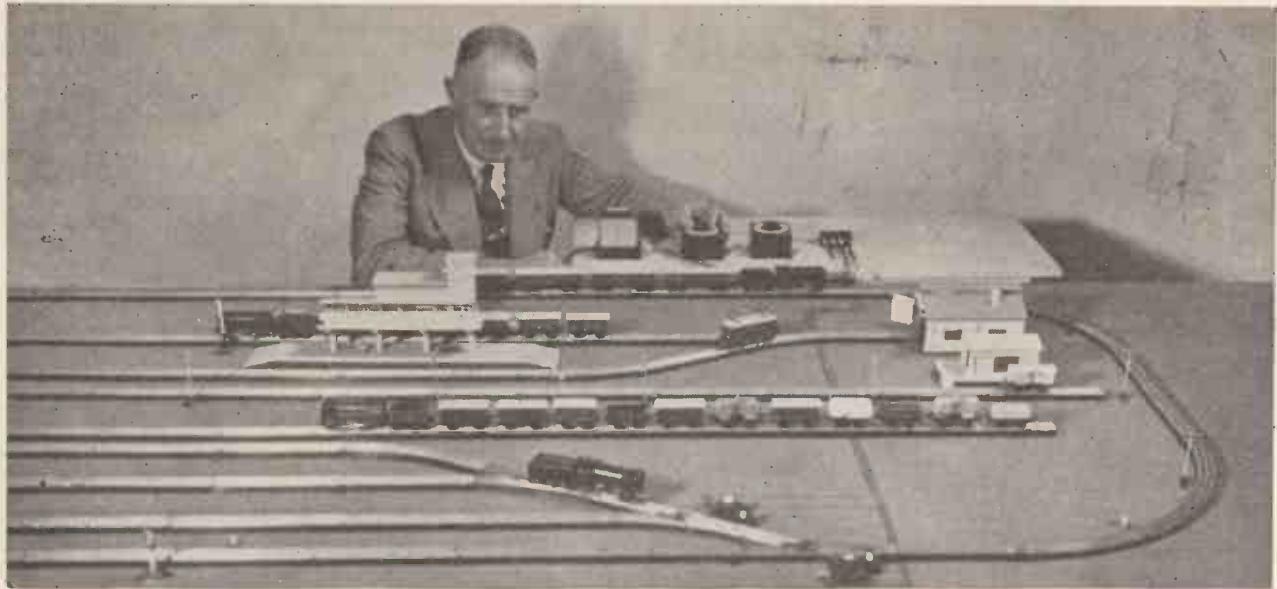


## BASSETT-LOWKE LTD. NORTHAMPTON.

Manchester Office and Showrooms :  
28 Corporation Street.

London Office and Showrooms :  
112 High Holborn, W.C.1.





*The complete layout in operation, showing controllers and transformer*

# New Twin-Train Table Railway

Two Trains Running on the Same Track, at the Same Time, Under Separate Control, Backwards or Forwards, Fast or Slow—is the latest Development in "00"-Gauge Model Railways

By W. J. BASSETT LOWKE

It was in 1924 that "00" gauge— $\frac{1}{8}$  in.—was first introduced into this country, by a model railway expert and myself, as an inexpensive clockwork and electric tin-plate railway. It had an enormous vogue as a toy. Enthusiasts appreciated the advantage of being able to house a

model and electrical engineer—to the one by reason of its attractive modelling, and to the other because of its unique method of manipulation.

The photographs afford you a close examination of the layout. There are the smart station and island platform, both well in keeping with the spirit of modernity which is invading British railways. The up-to-date engine and goods sheds, fitted

with ventilating louvres, hinged doors and transparent windows, the powerful-looking expresses and accurately-finished vehicles, are excellent designs for the small cost involved, and produce a realistic Southern Railway system in miniature.

## The Locomotive

The locomotive itself merits special attention. The body of this, designed on

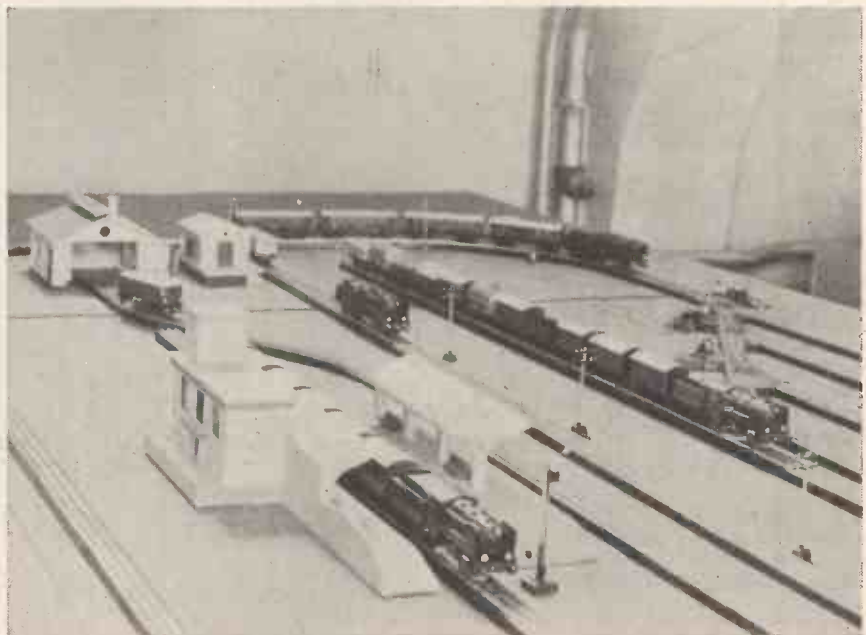


*The electric mechanism. A most delicate, well-designed and constructed unit, very strongly built, with magnetic sequence reverse. The collecting shoes are clearly shown. These can be put on the left- or right-hand side of the model, or both on the same side, according to the method of operating the train.*

comprehensive layout in one quarter of the space needed for an ordinary model railway. The only drawbacks were lack of power in the mechanism and the absence of "scale" realism in the vehicles and accessories, but these were enough to prevent the toy railway ever becoming a serious model consideration.

## Overcoming Difficulties

In creating the Twin-Train Table Railway those disadvantages have been thoroughly summed up, and to a great extent overcome. This railway appeals both to the



*Another view of the layout, showing the terminus station with island platform in the foreground.*



The "Twins" in the hand, giving an idea of their size.

the lines of a modern express, is die-cast—making a substantial housing for the universal motor, which works off either alternating or direct current. The electric mechanism is of the field-magnet type, and with alternating current a transformer with an output of 14 volts is used, while for direct current, three 4-volt accumulators connected in series will give the best results. The controller for regulating the speed and reversing the train is placed in between the transformer or accumulator and the track.

No complaint of lack of power can be lodged against the trains on this outfit. Under test an experimental locomotive, with a train of fifteen coaches, one loaded with nails, was set on a run equivalent to 300 miles. At express speed, or dead slow, now in forward, now in reverse, this powerful little engine plodded on, eating up the miles, and at the end of the long test finished up as good as ever.

#### The Method of Operation

The method of working the twin trains on



One of the new-pattern points with bakelite base, showing electrical operation and ground signal.

the same track is a simple and ingenious idea.

All three rails of the track are specially insulated, and when the two trains are in operation, the collecting shoe on one of the locomotives takes the current from the outer rail, while the other locomotive picks it up from the inside rail, and the centre rail is used as a common return. Each train has its own separate controller and therefore can be operated independently of the other, and directed forward or backward on the same piece of track at any speed the owner pleases.

The controller, complete with safety fuse, is very easy to manipulate and gives perfect control of the locomotive. The small button fitted in the centre of the control knob is for reversing the model.

#### Insulated Wheels

All the wheels of the locomotives and rolling stock are insulated to prevent short circuits on the two running rails, and if a model-railway owner wishes to use the Twin-Train track for ordinary "00" railway rolling stock, the wheels must either be insulated, or the connections altered and the railway operated by the ordinary method of control, but then of course two trains cannot be worked at the same time, unless the track has been sectionised.

#### The Tender, Coaches, etc.

The tender, coaches, and rolling stock are



of good quality tin-plate, with cast bakelite wheels, and each vehicle is fitted with automatic couplings, an innovation which has improved gauge-"00" model railway working, especially when shunting operations are in progress. There is a particularly fine



An express train overtaking a goods train on a loop. The express will join the goods line a short distance along, and the two trains continue their journey individually controlled on the same track.

selection of wagons on the system, including open, covered, coal, timber, oil tank, refrigerator wagons, and brake vans, and most of these vehicles cost no more than one shilling. The coaches comprise a bogie passenger brake van, bogie passenger coach, and suburban coach, fitted with cellophane windows and finished, as the locomotive and tender, in correct Southern Railway colours: green with yellow lettering and lining. The signal is a single-arm type operated by hand, and the small telegraph poles dotted about the system, costing only 3d. each, are useful accessories.

#### The Rails

The tinned-steel rails, points, and cross-



The controller. The milled knob is the speed control, and the centre button the reversing switch.

ings, are mounted on a patented base of bakelite, setting a new standard in track construction. This base is cast to represent sleepers and ballast, and the smart joints keep the track rigid, impossible to break or bend. It is only the work of a moment to take apart two pieces, and another second to join them up again, forming a firm track layout with no buckles; on which the trains can run smoothly. This innovation makes it possible to construct your layout on the dining-room table, dismantling it quickly when necessary, or you can keep it permanently fixed in your work-room.

At the present time this new gauge "00" railway is foreign made, but it is fully protected by patents and arrangements are speedily being made for manufacturing it in this country.

[I have witnessed a demonstration of this twin-train railway, and can confirm the statements made in this article. The scheme is most ingenious and reliable, and the parts extremely well-made and designed. Good value for money.—Ed.]

# Installing DOMESTIC ELECTRIC APPLIANCES

The Concluding Article of a Short Series

**S**PECIAL series—parallel switches are on the market, and are very useful in cases of corridors and passages, etc.; two small-candle-power lamps can be wired up so that for normal working they give the maximum light, i.e. in parallel, but if the passage is only used occasionally they may be left in series. This is very useful when children are running about, as the dim light prevents accidents, and the saving soon pays for the extra charge for installing.

### Three-point Switches

Three-point control has as many if not more applications as two-point, but it is seen even less. Large halls with several doors opening on to them still have only one switch to control the light. A more convenient arrangement is a switch by each door and one on the stairs or the landing above; bedrooms opening on to a common landing should also have a switch at each door. Three-point control is a useful development of two-point. Two two-way switches are needed for the first and last switches on the run, the other switches are of a special type of double pole changeover, known as intermediate. If you are not familiar with this circuit, then wire one up

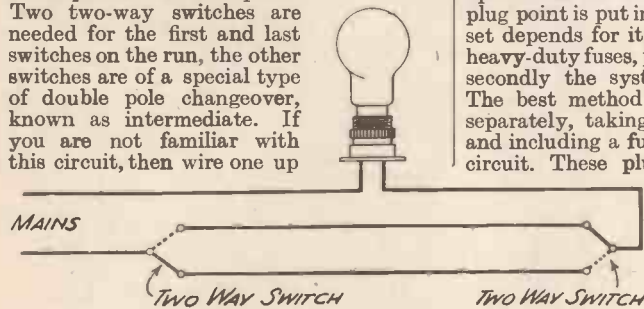


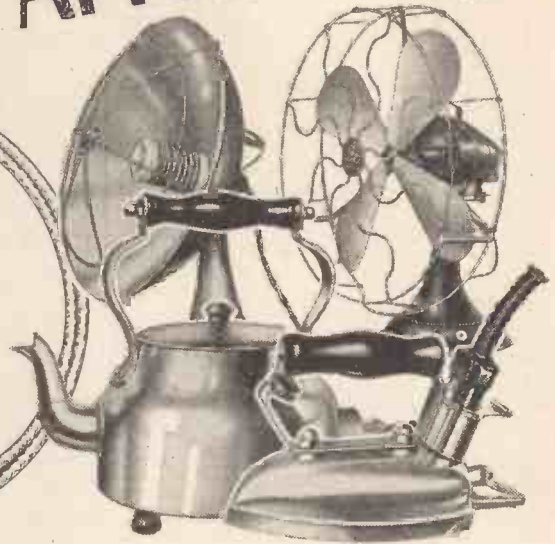
Fig. 1.—Simple two-way circuit.

on the test bench, using a dry cell and flash-lamp bulbs. The two end switches can be of the usual type, but for the intermediate use a double pole changeover of the wireless type, so that the connections and changes are clearly visible. The trouble expended on this will be well repaid when doing the actual installation. It will be noticed that only two wires are run between the switches, no matter how many are connected up. Four connections are made to the intermediate switches, and in the circuits these are shown as four circles joined up with a dotted line. Instead of using the intermediate switches, two two-way may be used coupled up both mechanically and electrically (see Fig. 1). These two switches should be mounted on the same panel, but are not so neat or easy to install as the intermediate, don't forget that the two end switches are ordinary two-way. As mentioned above, any number of control points can be added, Figs. 1 and 7 showing them for two- and three-point control.

### Wireless Points

In these days of mains receivers, it is often necessary to instal a new point for

An Instructive Series on Installing Electric Bells, Improving Existing Bell Installations by Fitting Indicators, and Obtaining the Greatest Service from Electrical Apparatus which Constitutes One of the Main Items in a Modern Home



their operation. The simplest way of doing this is by looping from a nearby power point, but this has many disadvantages apart from the disturbance caused when the plug point is put in use. In the first place the set depends for its protection on a pair of heavy-duty fuses, perhaps 15-amp. ones, and secondly the system may be overloaded. The best method is to wire up the point separately, taking leads from the busbars and including a fuse of the correct value in circuit. These plugs need not be of the power type, but it is often an advantage to use an interlocking switch plug, as this will save disturbances when the set is in use. The same notes apply to electric clocks. The makers often include a sketch illustrating how the clock is to be connected by looping to a power plug. This system is quite satisfactory, but has the disadvantages outlined above, also the use of heavy-consumption devices at the plug may

cause the clock to slow down or fall out of step. We have noticed this happen every time a large fire was switched on: the clock is in parallel with the plug.

### Power Plugs

Domestic appliances are generally used on the power circuit, and provided with a suitable plug and earthing connection. All power plugs must be fitted with an earth pin, and the connection made and broken according to the conditions laid down in

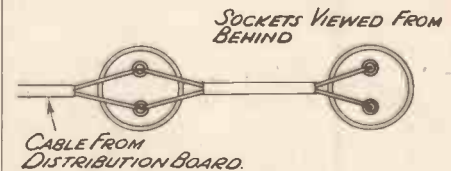


Fig. 2.—Simple example of looping.

Regulation No. 13 of the Home Office Regulations dealing with the use of electricity in workshops and similar places. Domestic apparatus is rarely properly earthed, generally because the householder fits the plug himself, the contractor having installed the socket. To earth an electric iron, drill a hole in the metal support and pass a nut and bolt through. The wire is then twisted into a loop and secured. Special plugs are available with earthed projections that make contact with the iron frame; these are quite useful, but the above method is to be preferred. The normal domestic flat-iron receives very rough treatment, often being knocked on to the floor and left on until nearly red hot; thus it is advisable when connecting up to use the best possible connector and three-core flex. Connectors can be had for 6d., but these are hardly worth fitting.

### Electric Fires and Irons

Electric fires and irons, in the small sizes, are generally sold with an ordinary adapter for use on the electric-light point; thus these are not provided with an earthed

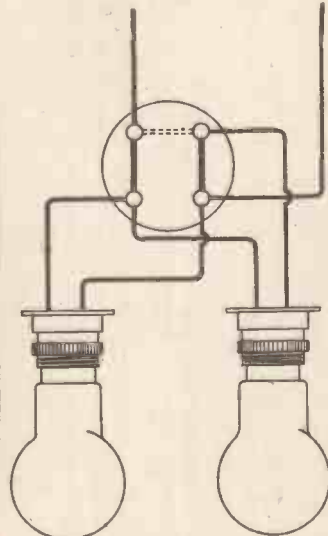


Fig. 3.—Dim and bright controls, using special switch. Bright connection shown solid, dim as a dotted line.



Fig. 4.—Mechanically and electrically coupled switches, for multi-point control.

point. Whenever possible use power plugs, but in cases where power is not laid on fit special earthed adapters. In these the pin is provided with a connection so that it may be connected to the frame of the apparatus being used. The lamp holder is also earthed; connection to earth from the apparatus is made by the pin of the adapter touching the holder. In positioning power plugs always try to ascertain for what purpose they will be used; for example, in a kitchen a plug is needed for an electric iron; thus it can be mounted three feet above the floor. This saves flex and is very convenient to use, since the plug will be at the table height or slightly above it. Place soc.

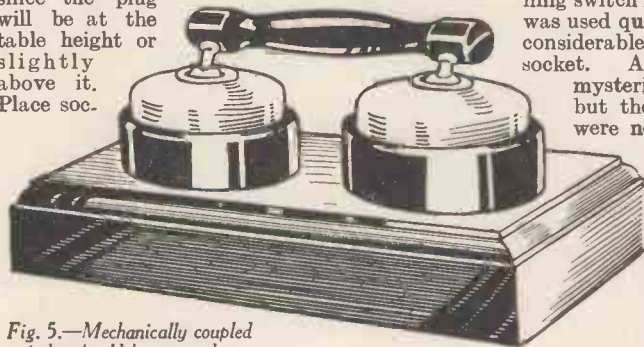


Fig. 5.—Mechanically coupled switches should be mounted on a small panel before installation.

kets so that plugs can be withdrawn easily and at such a height above the floor that the hand can be put all round to obtain a good grip. When installing plug points for operating a vacuum cleaner, do it so that the greatest area will be covered by each plug. These areas should overlap.

**The Garage**

The home garage is generally completely neglected, and if the owner has a single light installed he may consider himself lucky. In these days of economical battery chargers, which revive the battery overnight, some form of power plug is a necessity. It should be installed in an accessible position fairly high up on the wall. A switch plug would be more convenient than an ordinary one (see Fig. 6). If the complete apparatus is mounted over the bench it will form an ideal home charging station, as wireless batteries can be brought out and connected up and left in safety. A plug is very useful when an engine warmer is employed and also for a fire when work is done at night. Of course, if one has electric drills, tyre inflators, etc., then power plugs become an absolute necessity.

**Fittings and Accessories**

An article of this type would not be complete without some notes on fittings and accessories. Bakelite is very popular today; switches, holders, adapters and anything that can be moulded is made in this or similar material. The shock-proof skirted holders are very good, as are the adapters, but for switch covers the material is hardly strong enough. The modern tumbler switch has a composition or porcelain base, but the cover is of bakelite and is only strong enough to afford electrical protection and not mechanical. Their great advantage is

the treatment is doubtful, instal metal-covered, but earthed switches. Charwomen and cleaners frequently operate switches with their hands wet and often with a wet floor-cloth in the hand. This of course is fatal unless earthed switches are fitted and even then the practice is not to be encouraged. Some apparatus is fitted with self-contained switches, and if the apparatus is above reproach the switch will be also, but things like two-way and single adapters with self-contained switches must be regarded with suspicion unless of good make. We once examined and used a cunning switch in an iron adapter. This was used quite a lot, as the plug took considerable force to pull from the socket. After a time, however, mysterious shorts would occur, but the switch and connector were never at fault. On test

everything was O.K., but on working the switch it arched badly, and on some occasions flashed over blowing the fuse. Mechanically it was perfect, but close examination showed a thin film of burnt bakelite on the whole of the inside of the switch; thus once the arc had started it could flash across. Cleaning stopped the trouble, but after a few days the same thing happened more seriously, burning the user's arm, so this type of switch is not used any more. Cheap switches marked 6 amps. 250 volts are not to be taken too seriously. On test with 5 amps. at 230 volts, a combined switch plug warmed up quite considerably, and the condition of the contacts after breaking this load six times was rather alarming. That the best is cheapest is nowhere more apparent than in an electrical installation.

**Installing an Electric Bell**

It often happens that one is called in to add an extra bell to an existing installation. This must of course be done as quickly and as cheaply as possible. A typical example is a house circuit with front- and back-door bell pushes, the bell ringing in the kitchen, and another bell ringing upstairs as the first one cannot be heard on the top floor. The simplest way is to extend the wiring and have the bells in series, another two cells must be added, in this case there are two sets of contacts vibrating and

unless these synchronise, which is impossible, ringing is intermittent and not loud enough. The second method is to connect relays to operate the bells, but as this means purchasing extra apparatus and will take more time to instal, it will be probably out of the question.

**A Satisfactory Method**

From practical experience we have found the following method to work extremely well. The present installation has three bells in series, one with a 3 1/4-in. gong. It is operated from a 12.5-volt NiFe accumulator, and seven pushes are in the circuit with an indicator. The method is to remove the contacts from the new bell, so that the existing bell works it. The present bell must have fairly substantial contacts, clean these and set for normal working; examine the new bell, observe that one end of the electromagnet is connected to an insulated terminal and the other goes to the contact screw. This wire should be removed and connected to the other terminal on the frame; the bell may now be inserted in the circuit.

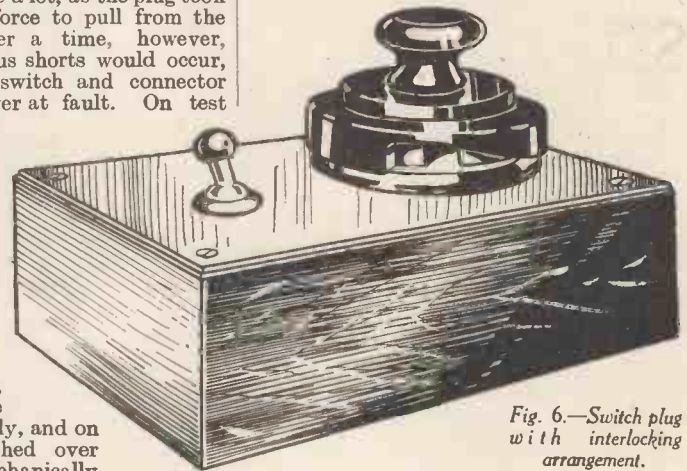


Fig. 6.—Switch plug with interlocking arrangement.

**A Number of Advantages**

This method has several advantages, one being that a cheap bell with inferior contacts may be used, the larger ones from the 6d. stores answering quite well, and again only one extra cell will be required even if a considerable length of wire is added. There is no objection to adding more than one bell providing that it is treated in this method. After installing, observe the contacts on the master bell; if these are arcing considerably, try the effect of removing a cell—if this fails a condenser from a wireless set will cure the trouble. It should have a value of 2 to 4 mfd. and be connected directly across the contacts.

**A NEW HANDBOOK!**

LATHE WORK FOR AMATEURS  
1/-, or 1/2 by post from George Newnes Ltd.,  
8-11 Southampton Street, Strand, W.C.2.

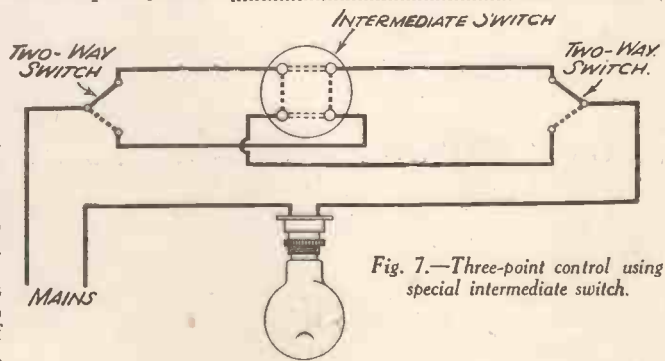


Fig. 7.—Three-point control using special intermediate switch.

# THAPEX

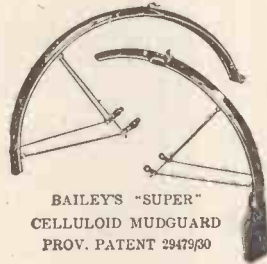
PRACTICAL XMAS GIFTS  
for YOUR CYCLING FRIENDS



*For real Winter Protection  
fit your machine with these:*

Made of  
**EXTRA THICK  
CELLULOID**

Rigid:  
Strong:  
Wonderfully  
light:




BAILEY'S "SUPER"  
CELLULOID MUDGUARD  
PROV. PATENT 29479/30

*In 26 in. and 28 in., and ordinary section or  
Narrow Racing Section. Black, White, or  
Standard Colours.*

REFLECTOR  
WITH THICK  
WHITE  
CELLULOID  
PATCH MOULDED  
TO FIT MUDGUARD  
APEX FAIRYLITE  
No. 107

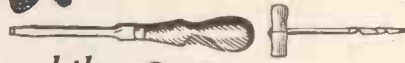


This is one of several types. Ask your dealer for a reflector made by Apex and know that you will receive a British made article that will give every satisfaction in use.

 This is the Famous  
**BAILEY'S SUPER PUMP**  
METAL LINED, CELLULOID  
COVERED, CANNOT WARP NOR  
LEAK.

Manufactured by APEX INFLATOR CO., LTD.  
Aldridge Road, Perry Barr, BIRMINGHAM, 20

*A Screwdriver*  
*- a gimblet*



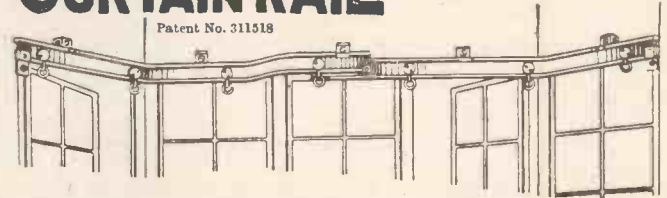
and the



**CURTAIN RAIL**

*is ready to hang  
your curtains*

Patent No. 311518



perfectly. Any handyman can erect. Fits all shapes  
of windows—square bays, round and oval.

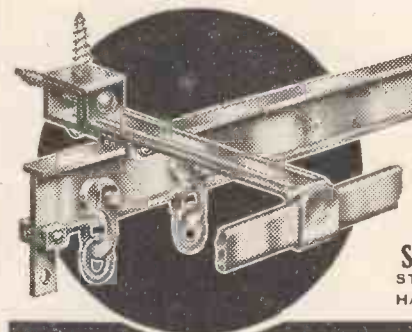
Most fittings **SOLID CHUNKS OF BRASS** and whole system is a  
thoroughly sound job. Stands hardest wear  
—woodwork would have to give way first.

**IN FOUR QUALITIES.**  
Strong (Brass) ... 1/- ft.  
Light (Brass) ... 9d. ft.  
Steel (Rustproofed) ... 9d. ft.

White (Aluminium  
Alloy)... ... 9d. ft.  
Complete with all fittings.

From all ironmongers. If  
any difficulty write for  
nearest stockist's name.  
Beware imitations.

Any length cut to order



**SMITH AND DAVIS LIMITED,**  
STAMPED BRASSFOUNDERS  
HAMPTON ST. BIRMINGHAM

## UNIVERSAL MAINS A.C./D.C. MOTORS

A Universal (A.C./D.C.)  
Mains Motor as illus.  
Approx. 1/100 h.p.  
200-250 v. 2,500  
R.P.M. 15/-



1/40 h.p. 200-220 v.  
2,850 R.P.M. Universal  
Motor with single-  
ended shaft. 35/-

New B.T.H. Universal  
250 v. 2,000 R.P.M.  
run vertically or hori-  
zontally. Price with  
tance, 30/- post free

Motor, 1/50 h.p. 100-  
50-100 cycles. May be  
zontally. Silent run-  
special sliding resis-  
U.K.

### INDUCTION MOTORS (A.C. ONLY) 200-250 v.

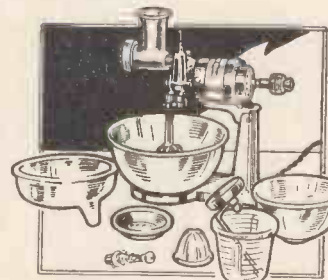
1/25 h.p., with Shaft and Double-V Pulley. 2,000 R.P.M. 13/-  
1/10 h.p., similar to above but larger and Single-V Pulley, 35/-  
1/25 h.p., fitted with coarse and fine grinding wheels, 21/-  
A.C. only Induction Fans, 200-250 v. Prices 15/6, 19/6, 35/-, 45/-

Our 105-page Catalogue is interesting to all. 3d. pos: free.

**GRAFTON ELECTRIC CO. (Dept. P),**  
54 GRAFTON ST., TOTTENHAM COURT RD., LONDON, W.1

## Special Christmas Offer of a

### New ELECTRIC KITCHEN APPLIANCE



Food Chopper—Mixer and Beater—  
Juice Extractor—Tin Opener—Knife  
Sharpener—Drink Mixer, etc.

The KITCHEN-ETTA is a complete  
and efficient kitchen appliance. Run  
by air-cooled motor and controllable  
in three speeds. Attachments easily  
fixed and adjusted.

**SIMPLE TO OPERATE.**  
Full equipment, bowls, etc., included.

**REDUCED from**  
£8. 8s. to **£3. 10s.**

**DOUGLAS HOLT**  
Estd. 1919 Ltd.  
9 Little Turnstile, Holborn, W.C.1

**LIMITED SUPPLY ONLY at this  
EXCEPTIONAL PRICE**  
(Send now for li:ts)

# A Motor for Driving Small Models

## Converting Car Starter Motors to Squirrel-cage Machines

IN our issue for June 1934, an article was given on how to convert car starter motors and dynamos to A.C. machines. In spite of many difficulties, this proved popular, as many readers followed the instructions and obtained quite good results. Of course, as readers found out by experience, the machines warmed up quite rapidly, making the fitting of a fan a necessity; but as some were only used as short-period motors on grinders, etc., this was not very important. Some readers have had considerable trouble when converting starter motors, as these machines are only fitted with plain bearings and heavy brush

with new wire. The easiest way of removing the fields is to unscrew the poles, as these are separate from the carcass. Wind four coils with No. 30 d.c.c. wire, putting on as much as possible. Leave a little over for connections and tape each one before removing the former. The coils are connected up to give alternate north and south poles, and the ends of the two last coils are connected to a length of flex to serve as the leads to the machine. Fit this with an adapter or two-pin plug.

Take the armature and well clean the commutator. Bind it from one end to the other with a single layer of bare No. 20 wire, twisting the ends firmly together. This should effectively short-circuit all the segments. The windings which leave the other end of the armature must be filed bright for a distance of  $\frac{1}{2}$  in. and wire bound round to short-circuit them. The armature is now finished and virtually forms a squirrel-cage rotor.

### Reassembly

Reassemble the motor, taking care that the bearings are in line and that the armature turns freely. Lubricate it with light machine oil. If it is very stiff, run the motor in by a belt drive from another machine or, failing this, let it run for some time without load until the armature is quite free. With motors that are mounted to run vertically washers must be placed on either end of the shaft to take up the thrust. The motor should first be tested on the mains with a large lamp or small electric fire in series. If the behaviour is quite satisfactory then the resistance may be dispensed with.

Motor-car engine starters are of either the "inboard" or "outboard" type with an extended shaft of about 6 in. Of course, the Bendix gear is removed, and with the "outboard" type the third bearing can be dispensed with, leaving the motor as a cylinder without any projections. The "inboard" type has only two bearings. Cut the shaft down to a suitable length and decide on the pulley and drive required. This generally presents some difficulties to the amateur, but as only a very little power will be transmitted, a small pulley can be used. A wooden pulley, either cut from  $\frac{1}{2}$  in. wood with a fret saw, or turned in the lathe and drilled to provide a driving fit on the shaft, can be used. It should be grooved according to the belt.

A better and more useful plan than this is as follows. Centre the shaft and drill it to a depth of  $\frac{1}{2}$  in. Tap the hole to a

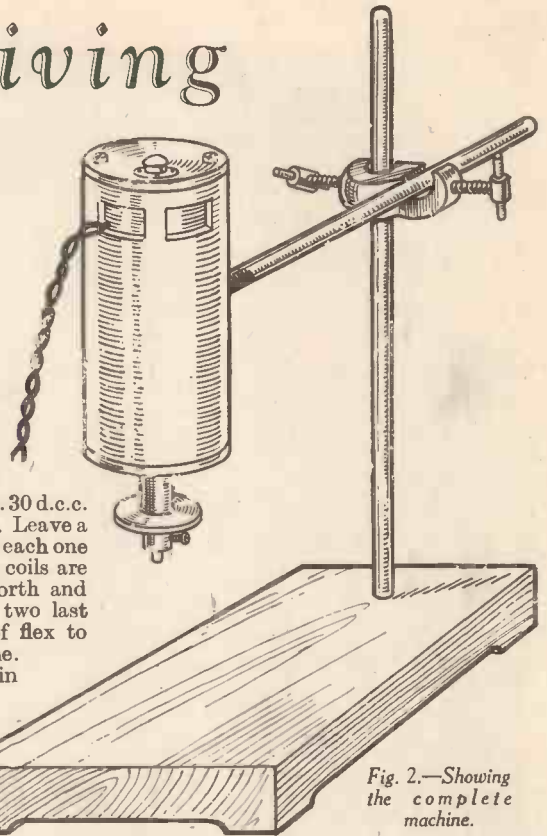


Fig. 2.—Showing the complete machine.

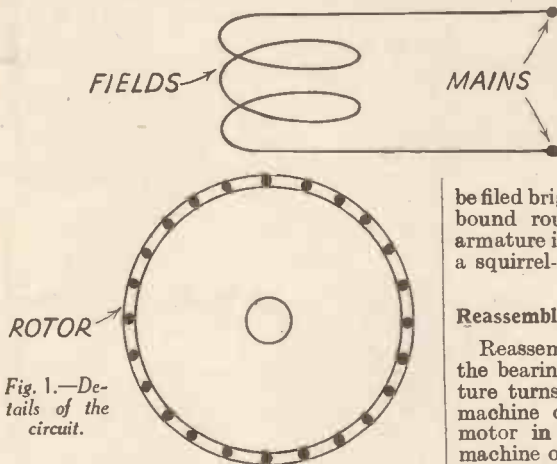


Fig. 1.—Details of the circuit.

gear. When these motors are rewound for small outputs a great amount of the power is absorbed in overcoming the resistance of the journals and brushes. These machines have an armature wound with stout strip and a field (in series) of a similar material. The conversion to small power outputs is very simple; simpler, in fact, than the methods described in a previous issue.

### A Motor for Driving Models

Many readers require a small motor for use in driving models and other light experimental apparatus, such as stirrers, for periods up to an hour or so, and a converted car starter is ideal, but it has the disadvantage of not being self-starting; against this, however, there is the advantage of constant speed and silence when working, and perhaps most important of all the motors will run in the direction in which the initial start is given. Small-speed control can be effected by a series resistance.

Start the work by stripping and cleaning all the parts, remove the brush gear and field windings. Make a former by using the old field coils as a pattern so that four field coils may be wound easily and quickly

suitable size so that it will take a length of threaded rod. This operation is quite simple and can be performed without a lathe. It is to be recommended as it allows of the easy changing of pulleys and gears, and a chain drive can also easily be fitted up.

### Mounting the Motor

The mounting of the finished motor should not present any difficulties as it is easily held by two 1 in. straps passing over it and secured to a base with  $\frac{1}{2}$  in. screws. In the experimenter's laboratory, a universal method of mounting is preferable, since the motor can be adjusted to any height and position, and is thus very suitable for operating stirrers in individual pieces of apparatus and a hundred and one other jobs. A heavy retort stand of the usual pattern should be selected for the motor support with a strong clamp boss. A hole is drilled in the motor case at the mid point between the ends and tapped. Into this a 9 in. length of  $\frac{1}{8}$  in. steel rod is screwed. The above operation is best done before the motor is finally assembled, so that there is no fear of any metal chips dropping inside and fouling the bearings and armature and poles. A moment's thought will convince the reader that the motor can be put into almost any conceivable position and those who have used the commercial article will appreciate this easily and cheaply home-made one.

The best type of motor to convert is a 6-volt of the "inboard" variety. Before buying one from a "scrap" dealer test the bearings for wear, and if possible have the motor tested on an accumulator. If it runs satisfactorily then it will be quite suitable for conversion. Take great care with the insulation; remember that it is desirable to put as much wire as possible on the fields.

# FREE Descriptive Books

On these excellent up-to-date Trade Teachers will be sent to you without cost or obligation to order. Electrical students and ambitious mechanics anxious to master the expert Trade Knowledge belonging to electrical developments and electrical and gas expansion are reminded that this is not the time to stint oneself of the newer Trade Knowledge. Study of Trade Books means increase of *your* Trade Value.

All Illustrated by Educational Pictures, Plates and Diagrams.

## JOINERY & CARPENTRY

Edited by RICHARD GREENHALGH, A.I.Struct.E.

Assisted by a Staff of Expert Contributors, including  
 THOMAS CORKHILL, F.B.I.C.C., M.I.Struct.T., M.Coll.H.  
 Lecturer in Building Trades, Walthamstow Technical Institute; Silver Medal  
 Worshipful Company of Carpenters; Examiner to Lancashire and Cheshire Institute,  
 and National Union of Teachers.  
 C. H. HANCOCK, F.B.I.C.C.

Lecturer in Carpentry and Joinery at L.C.C. School of Building, London; Examiner  
 in Carpentry and Joinery to City and Guilds of London Institutes.  
 F. J. DOWSETT, A.I.Struct.E.

Chief Lecturer in Geometry and Staircasing at L.C.C. School of Building; Author  
 of "Advanced Constructive Geometry."

Practical, Concise, Up to Date. Complete in Six Light Volumes of a  
 size that can be slipped into a man's pocket. The Theory and the Working  
 Principles of the Trade are clearly explained; after which there are  
 sections on:

- |           |               |                  |
|-----------|---------------|------------------|
| Tools     | Setting Out   | Steel Square     |
| Workshop  | Shop Fitting  | Timber Buildings |
| Equipment | Circular Work | Centres          |
| Machines  | Staircasing   | Formwork         |
| Joints    | Handrailing   | Scaffolding      |
| Fixings   | Fittings      | Underpinning     |
| Doors     | Timber        | Plant            |
| Panelling | Floors        | Mechanics of     |
| Windows   | Partitions    | Carpentry        |
| Geometry  | Roofs         | Calculations     |

**SEND FOR A FREE BOOK**

THE NEW ERA PUBLISHING CO., LTD., 12-14 Newton  
 Street, High Holborn, London, W.C.2.

Please send me free illustrated Booklet on JOINERY AND  
 CARPENTRY, with particulars of your plan of small monthly  
 payments after delivery.

Name .....

Address .....

Date..... P.M.30

## Electrical Wiring and Contracting

For Men Engaged in Installation Work  
 Edited by H. MARRYAT, M.I.E.E., M.I.Mech.E.

With Expert Contributions on:

- |                            |                                |
|----------------------------|--------------------------------|
| Workshop Science           | Private Lighting Plant         |
| Drawing                    | Lamps and Illumination         |
| Electricity and Magnetism  | Motor Starters and Regu-       |
| Alternating Current Work   | lators                         |
| D.C. Generators and Motors | Heating and Cooking            |
| Mathematics                | Electric Signs                 |
| A.C. Generators and Motors | House and Office Telephones    |
| Installation Work & Layout | Electric Bell, Alarm and       |
| Power and Light Switching  | Clock Systems                  |
| Measuring Instruments and  | Converting Plant               |
| Testing                    | Estimating                     |
| Wires and Cables           | Lifts, Installations and Main- |
| Primary and Secondary Bat- | tenance                        |
| teries                     |                                |

A Priceless Help for Builders, Mechanics  
 and Electrical Fitters who wish to master  
 the details of the electrical contractor's work.

**FREE ENQUIRY**

THE NEW ERA PUBLISHING CO., LTD., 12-14 Newton  
 Street, High Holborn, London, W.C.2.

Please send me Book on ELECTRICAL WIRING AND CON-  
 TRACTING with specially easy terms of payment after  
 delivery.

Name .....

Address .....

Date..... P.M.30

## NEW EDITION of the— ELECTRICAL EDUCATOR

By SIR AMBROSE FLEMING, M.A., D.Sc., F.R.S.

The huge success that attended the first issue of this truly foundational  
 "Educator" has induced the Editor and Publishers to publish this new  
 edition, arranged in a more convenient form and embodying the latest  
 electrical information with details of newest developments, especially  
 as these concern Telegraphy and Telephony and electrical expansion  
 in every branch of industry. This Work teaches the student the first  
 principles in each department of electrical knowledge; it covers the  
 whole wide field of heavy current Electrical Engineering and Wireless  
 Telegraphy. The teaching is such as can easily be understood by students  
 with a good general education; while the more advanced phases are  
 dealt with by specialists and will be found useful by men who are already  
 skilled in electrical work. Articles by such well-known specialists as  
 SIR WM. BRAGG, SIR ROBERT HADFIELD, and others will, it is hoped,  
 induce many mechanics to study this profitable knowledge. We ask  
 you to see our

Handsomely Illustrated FREE Book

THE NEW ERA PUBLISHING CO., LTD., 12-14 Newton  
 Street, High Holborn, London, W.C.2.

Please send me free of cost or obligation to order, your book  
 on THE ELECTRICAL EDUCATOR.

Name .....

Address .....

Date..... P.M.30

## Plumbing and Gasfitting

Presenting Theory, Practice and Methods in

- |                    |                  |                       |
|--------------------|------------------|-----------------------|
| Gas Distribution   | Internal Fitting | Sanitary Fitting      |
| Industrial Gas     | and Testing      | Drainage and          |
| Gas Service Laying | Pipe and Pipe    | Sanitation            |
| Hot Water Supplies | Bending          | Joining, Fixing, etc. |

**A PRACTICAL UP-TO-DATE TEACHER**

of a Trade in which Revolutionary Developments have taken place.  
 Edited by PERCY MANSER, A.R.S.I., W.P.

The plumber of old time was chiefly a worker in lead. But with the  
 advance of science other metals have been introduced. The plumber  
 of the present day finds he must be skilled in the knowledge and use  
 of these. Should he be desirous of becoming a qualified craftsman in  
 the cutting, bending, and screwing of such metals by brazing and  
 fusion welding, he will find the practical teaching he needs in this book,  
 as well as simply written explorations of the new methods in every  
 department.

**FREE BOOK**

THE NEW ERA PUBLISHING CO., LTD., 12-14 Newton  
 Street, High Holborn, London, W.C.2.

Send me booklet on PLUMBING and GASFITTING, with  
 all particulars as to payment after delivery out of income.

Name .....

Address .....

Date..... P.M.30

Enquiries for South Africa should be directed to the Central News Agency Box 1033 Johannesburg.

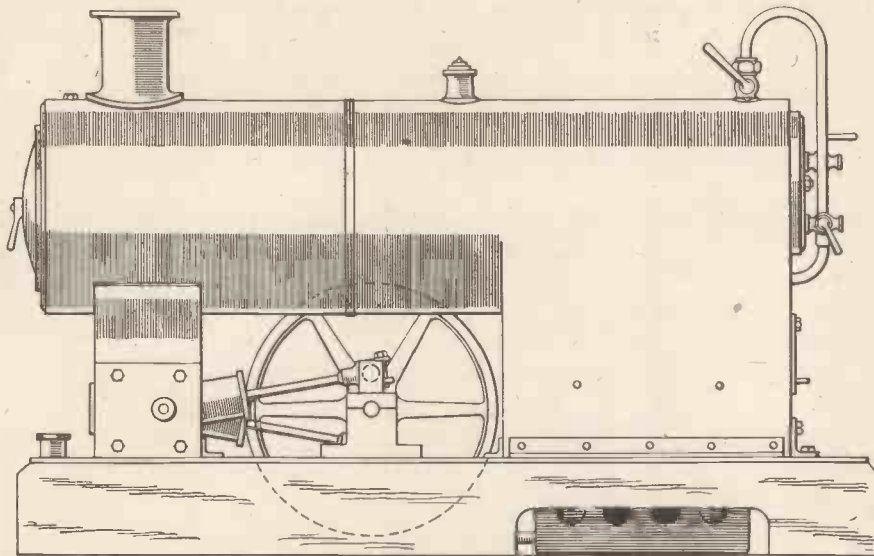


Fig. 1—Side elevation of the complete model undertype engine and boiler.

**T**HIS model forms a very compact and self-contained steam plant, the engine being arranged below the boiler, as shown in Fig. 1. Two single-acting oscillating cylinders are used, and these drive a fairly heavy flywheel through the medium of a double-throw crankshaft. The front ends of the cylinders, together with the steam distributing blocks, are housed in the smokebox saddle. The bedplate, on which the bearings, firebox, etc., are mounted, consists of a piece of planished steel plate, which forms a covering for the wooden base, or plinth.

The boiler is of the enclosed water-tube type, the inner, or boiler proper, provided with three water tubes, being housed in an outer casing which conserves the heat from the methylated spirit lamp which is used for fixing. A side view of the finished engine is given in Fig. 1.

**The Bedplate**

As previously mentioned, planished steel is preferable for this, but failing that, hard sheet brass  $\frac{3}{16}$  in. thick may be used, cut out to the dimensions given in Fig. 2. Lines should be carefully scribed to mark the position of the rectangular holes and also the centres of the holes to take the fixing screws. The hole for the firebox and the two holes marked *A* for clearing the piston-rod heads can be drilled and then cut out with a cold chisel, and afterwards filed up squarely to the scribed lines. The semi-circular slot *B*,

in the front part of the bedplate, is for accommodating the filling tube of the spirit lamp, and the eight holes, *C*, are to take wood screws for fixing the bedplate to the wooden base. These holes should be countersunk, so that the heads of the screws lie flush with the surface of the bedplate. The remaining holes should be drilled and tapped  $\frac{3}{8}$  in. for the fixing screws for the crankshaft bearings and the cylinder steam blocks. The angle pieces which fix the firebox in position are screwed down to the bedplate, but the holes to take these screws

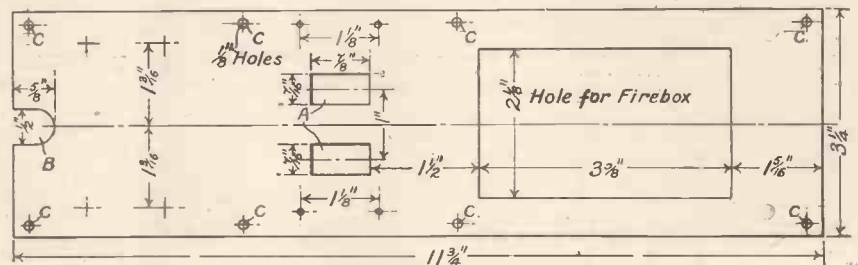


Fig. 2.—Setting out the bedplate.

can be marked out after the firebox is constructed.

**The Plinth**

For the wooden baseboard or plinth a

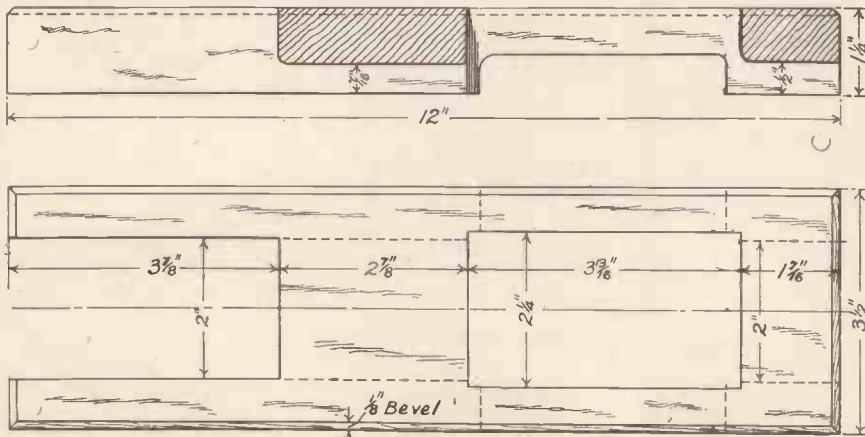


Fig. 3.—A section and plan of the wooden plinth.

# Working

The Construction of a  
with in this

block of wood will be required 12 in. long, 3 1/4 in. wide, and 1 1/4 in. thick. This should be planed up to these dimensions, and the top edge chamfered at an angle of 45 degrees, as indicated in the two views given in Fig. 3. After marking out the positions of the holes for the lamp reservoir and firebox these parts can be sawn out and the edges trimmed square with a rough-cut file and afterwards with fine glasspaper. This being done, the channels underneath can be chiselled out to the dimensions given. After smoothing the edges of these channels, place the bedplate on the plinth so that it registers with the edges, and mark out the position of the slots *A*, and then gouge these parts out with a small chisel, forming semi-circular slots  $\frac{3}{8}$  in. deep, as indicated in Fig. 6, for the purpose of clearing the piston-rod heads as previously mentioned. The bedplate can now be screwed down by  $\frac{3}{8}$ -in. wood screws.

**Crankshaft and Flywheel**

The crankshaft is a built-up one and can be made from silver-steel rod,  $\frac{3}{16}$  in. diameter, with pieces of mild steel  $\frac{1}{8}$  in. thick for the webs. These should have holes drilled through them with the centres exactly  $\frac{1}{2}$  in. apart, the holes being square with the faces of the webs and a tight fit to the shaft. After pushing the webs on the

latter, the pieces of rod for forming the crank-pins can be pressed in place, and the cranks adjusted to their correct positions according to the dimensions given in Fig. 7. Having done this, carefully counterpunch the positions of the holes for the small pins and drill these holes through with a  $\frac{1}{16}$ -in. drill.

Pieces of  $\frac{1}{8}$  in. steel rod,  $\frac{1}{8}$  in. long, can be used for the pins, which should be driven in so that their ends project slightly, as shown. These ends can be filed down flush afterwards.

All the joints can now be well sweated with solder, and when cool, proceed to cut away the part of the shaft between the webs, and file the ends flush with the inside faces of the webs. The projecting ends of the crank-pins must also be filed down flush with the outer faces of the webs, and all superfluous solder removed. If care is taken in the construction a strong and serviceable crankshaft will result.

In order to prevent lateral play when the shaft is in the bearings, two collars are provided, and these can be cut off from a piece of iron rod,  $\frac{3}{4}$  in. diameter, and drilled



# Model Steam Engines

## Small Undertype Engine and Boiler is dealt Fifth Article of the Series

to fit the shaft. The collars are fixed in position by means of small grub screws, after the bearings are screwed down.

A suitable brass flywheel, 3½ in. diameter and provided with six spokes, can be obtained from a model-makers' supply stores. The wheel must have a plain 3/16 in. hole through the boss, and a grub-screw for fixing to the shaft.

### Bearings

These are intended to be made from a piece of stick brass 1/4 in. thick, and both

the bottom faces of each cap and the top faces of the lower parts of the bearings must be filed quite flat so as to form a good joint, after which the caps can be sweated in position.

The bearings can now be filed up squarely to the scribed lines and holes drilled for the crankshaft, after which two holes 1/8 in. diameter can also be drilled through each cap into the bearing block, as shown at F.

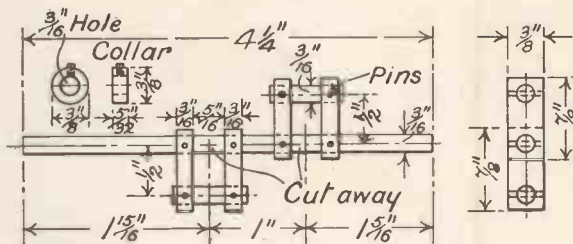
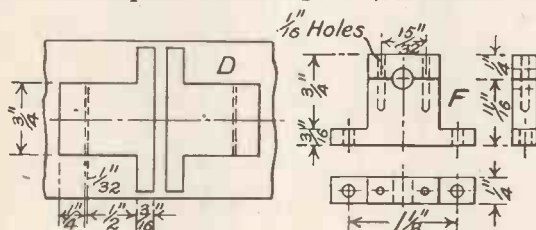
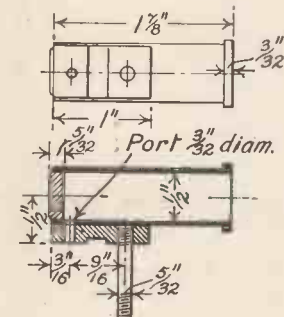


Fig. 7.—Details of the double-throw crankshaft.

the crankshaft a smooth sliding fit.

The bearings can now be screwed down on the bedplate, the crankshaft placed in position, and the caps bolted down after seeing that the shaft revolves freely without any shake.

Fig. 4.—(Below) Cylinder details and Fig. 5 (Right) The method of cutting out the bearings.



These holes should be enlarged to clear 3/8 in. bolts down as far as the soldered joint, and tapped out below it with a 3/32 in. tap. The holes to take the bolts for fixing to the bedplate can be drilled out 3/8 in. clearing size.

Now hold each bearing for a few seconds in a bunsen flame to separate the caps, and when cool remove all traces of solder and face up carefully by rubbing the surfaces over with a fine-cut file. Bolt the caps in place and then face up the sides with a file if necessary, and reamer out the holes for

bearings can be marked out on the same piece, as shown at D, Fig. 5, and roughly sawn out with a hacksaw. The top parts forming the caps can then be sawn off, and

### Cylinder Details

The cylinders, which have a bore of 1/2 in. and a stroke of 1 in., are intended to be built up with two pieces of solid drawn-brass tubing, with pieces of brass sweated on for the port blocks, in the manner described in the August issue. Select a piece of tube a bare 1/2 in. inside diameter, cut off two pieces 2 in. long, and carefully square up the ends with a file. Each piece should be exactly 1 1/4 in. long when finished. Clean the bores of each tube with a dowel rod of suitable diameter wrapped round with a piece of fine emery paper, using a little machine oil as a lubricant.

The port blocks can be fashioned out of pieces of 1/4 in. x 1/4 in. stick brass, one side of each block being filed concave to fit the cylinder barrel after the holes for the steam ports and pivot pins have been drilled. For the latter, cut off two 7/8 in. lengths of

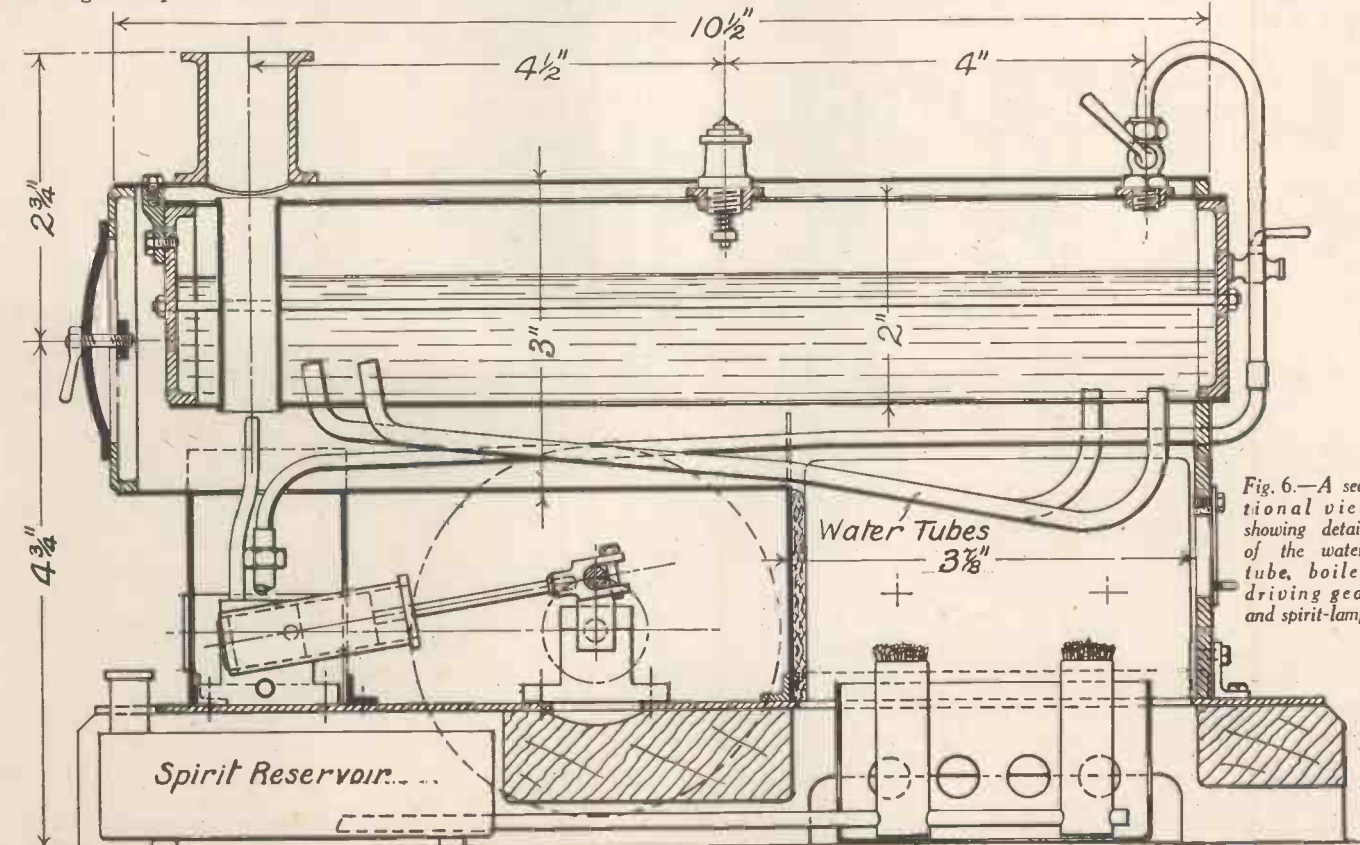


Fig. 6.—A sectional view showing details of the water-tube, boiler, driving gear and spirit-lamp.

# WHICH OF THESE IS YOUR PET SUBJECT?

## CIVIL ENGINEERING GROUP

Specifications.  
Road Engineering.  
Hydraulics.  
Municipal Engineering.  
General Civil Engineering.

Structural Design.  
Structural Engineering.  
Reinforced Concrete.  
Sanitary Engineering.  
Geology.

## SURVEYING GROUP

Valuations.  
Heating and Ventilating.  
Clerk of Works.

Surveying and Levelling.  
Building Construction.

## COMMERCIAL ENGINEERING GROUP

Salesmanship.  
Advertising.  
Languages.

Commercial Engineering.  
Cost Accounts.

One of these examinations

A.M.I.C.E.  
A.M.I.Struct.E.  
Sanitary Inspectors.  
A.M.I.H. & V.E.  
A.M.I.Mech.E.  
A.M.I.P.E.

A.M.I.W.T.  
M.I.M.T.  
A.F.R.Ae.S.  
B.Sc.Degree.

## MECHANICAL ENGINEERING GROUP

Works Management.  
Press Tool Work.  
Maintenance Engineering.  
Metallurgy.  
Sheet Metal Work.  
Welding.  
Diesel Engines.  
Refrigeration.

Heat Engines.  
Workshop Practice.  
Fitting and Erecting.  
Inspection.  
Ironfoundry.  
Pattern Making.  
Draftsmanship.

## WIRELESS GROUP

General Wireless.  
Advanced Wireless.  
Television.

Talking-Picture  
Engineering.  
Radio Servicing.

G.P.O. Supt. of Traffic.  
Patent Office Examiner.  
Handicrafts Instructor.  
Inspector of Factories.  
Aircraft Apprentices.

Inst. Mun. & Cy. E.  
M.R.San.I.  
F.S.I.  
A.R.I.B.A.  
L.I.O.B.  
F.A.I.

## AUTOMOBILE ENGINEERING GROUP

Garage Management.  
Electrical Equipment.

Claims Assessing.  
High-speed Diesels.

## ELECTRICAL ENGINEERING GROUP

Traction.  
Electrical Supply.  
Electrical Meters.  
Electrical Design.  
Installations.  
Electrical Engineering.

Mains Engineering.  
Telephony.  
Alternating Currents.  
Neon Lighting.  
Power House Design.

## AERONAUTICAL ENGINEERING GROUP

Aerial Navigation.  
Aeroplane Design.

Aero Engines.

## WHICH ONE?

City & Guilds.  
A.M.I.Fire.E.  
A.M.I.E.E.  
A.M.I.A.E.  
A.M.I.Ae.E.  
A.M.I.R.E.

London Matriculation.  
G.P.O. Prob. Inspector.  
Air Navigators

Certificate.  
Certificate.

May we send you full particulars of our unique tutorial organisation? Whatever your requirements, whether you desire a complete course of instruction, or tuition in some specialised subject, our Organisation is so planned that it will dovetail into your needs exactly.

**"NO PASS—NO FEE."**

As an indication of the strength of the B.I.E.T. Tutorial Organisation, it should be clearly noted that we alone guarantee to return full fees to any student who does not pass his chosen Examination successfully. In short, "If you do not pass, you do not pay."

Send to-day for a free copy of "ENGINEERING OPPORTUNITIES." This valuable 268-page Guide shows clearly and definitely the way in which you may carve out a successful career in your chosen branch of Engineering, irrespective of your age, education or experience. Among a host of other things, it gives details of all the above-mentioned Courses and shows the easiest way to prepare (in the privacy of your own home) for any of the recognised Examinations we have listed.

"ENGINEERING OPPORTUNITIES" should most certainly be in your hands. Send for your copy at once—free of cost or obligation.

## BRITISH INSTITUTE of ENGINEERING TECHNOLOGY

410 SHAKESPEARE HOUSE, 17-19 STRATFORD PLACE, OXFORD STREET, W.1

Australasian Enquiries: P.O. Box 3597S, Sydney. South African Enquiries: P.O. Box 4701, Johannesburg. Canadian Enquiries: 219 Bay Street, Toronto. P.O. Box 1025, Bombay.



# The ELECTRICAL ENGINEER

The New 6d. Weekly  
for USERS of Electrical  
Plant and Power.



THE ELECTRICAL ENGINEER is designed for Engineers responsible for the selection, installation and maintenance of electrical machinery. Whether you are an Electrical Installation Engineer, a Cinema Engineer, a Maintenance Engineer in a Supply undertaking, or on the engineering staff of a power-driven works or factory, or in any branch of industry where an engineering knowledge is useful, you will find the information in the ELECTRICAL ENGINEER invaluable. The ELECTRICAL ENGINEER strikes an entirely new note. You must see this new weekly.

Some of the famous contributors in early numbers:

Col. R. E. Crompton, C.B., R.E., F.R.S.,  
M.Inst.C.E., M.I.E.E., etc.  
Sir Ambrose Fleming, M.A., D.Sc., M.I.E.E.,  
F.R.S.  
Allan Monkhouse, M.I.E.E.  
Sir Noel Ashbridge, M.I.E.E.  
W. J. H. Wood, M.I.Mech.E., M.I.E.E.  
A. T. Dover, M.I.E.E., A.A.I.E.E.  
etc., etc.

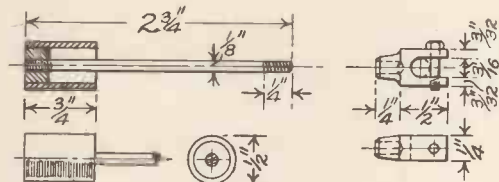
**6D** EVERY FRIDAY

Get your copy to-day. Now on sale  
at all Newsagents and Bookstalls.

$\frac{3}{8}$ -in. mild steel rod, and cut threads on the end as indicated in Fig. 4. File the recesses in the faces of the blocks and slightly countersink the top of the screwed holes for the pivot pins. The working faces of the blocks can now be prepared by rubbing them in turn on a piece of plate-glass, using pumice powder and machine oil as an abrasive medium. Having done this, the blocks can be sweated in place on to the cylinder barrels after tinning the surfaces which come in contact.

Now take the drill that the cylinder ports were made with and continue these holes through the cylinder walls, the burr on the inside being afterwards removed by passing the dowel rod and emery paper through the cylinder barrel again.

For the front ends, two brass discs will be required,  $\frac{3}{8}$  in. thick, which should be a



good fit in the cylinders. These ends can be sweated in place. The other ends of the cylinders are left open and narrow rings of rectangular section may be soldered on, as shown, to give a finished appearance.

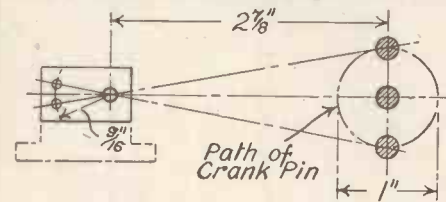
**Pistons**

The pistons can be made from pieces of brass tubing which must be a good push fit in the cylinder barrel. Cut off two pieces of tubing  $\frac{1}{2}$  in. long, file the ends square, and in one end of each piece of tube, solder a brass disc  $\frac{1}{4}$  in. thick, having a centre hole drilled and tapped with a  $\frac{1}{4}$ -in. thread, as shown in Fig. 8. Remove all superfluous solder with a file.

For the piston rods cut two  $2\frac{1}{4}$ -in. lengths of  $\frac{1}{4}$ -in. diameter mild steel rod, and with a screw-plate thread the ends of each rod for screwing into the pistons and piston-rod heads respectively. These piston-rod ends,

or "big-ends," one of which is shown in Fig. 8, can be made from pieces of stick brass.

After drilling the holes for the crank-pins, saw away the parts not required with a fine hacksaw so as to bifurcate the ends, and carefully finish the inside of the slots with a file. Drill a  $\frac{1}{8}$ -in. hole squarely through the ends of each head, then enlarge the hole in each top lip to  $\frac{3}{8}$  in. diameter and tap out the holes in each bottom lip to take the



Figs. 8 to 10.—(Left) Details of the piston and piston-rod head. (Above) Diagram showing how the position of the steam ports is ascertained. (Right) Each steam-distributing block is made in two parts sweated together.

end of a  $\frac{3}{8}$ -in. bolt. The holes must be carefully drilled in the first place, so that the crank-pins fit snugly in place without any shake after the bolts are screwed in position.

For the pivot-pin springs, steel or hard brass wire No. 21 S.W.G. can be used.

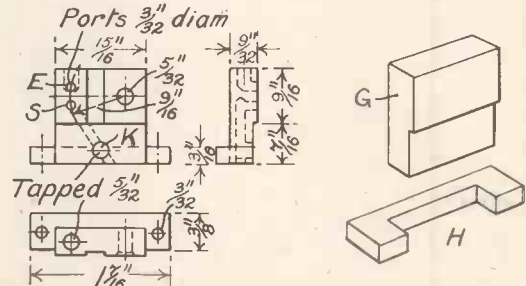
**Steam Distributing Blocks**

These are each made with two pieces of stick brass shaped as shown at G and H, Fig. 10, and sweated together, after the holes for the steam and exhaust ports have been drilled in the upright parts G.

The relative positions of these ports are determined by the throw of the crank and the distance of the centre of the pivot pin from the centre of the crankshaft, as shown in Fig. 9. After preparing the working face of one block, set out the position of the ports, as indicated, and then proceed to

mark out the ports on the other block from the reverse side, so that the hole for the pivot pin comes on the left side. The holes can now be drilled, as indicated in Fig. 10, the exhaust port, E, being made with a size larger drill than is used for the steam port S, which is  $\frac{5}{16}$  in. diameter. For the vertical hole which meets the exhaust port use a  $\frac{1}{4}$ -in. drill, and then tap it with a  $\frac{3}{32}$ -in. tap to receive the screwed end of the exhaust pipe.

It will be noticed that an oblique hole has to be drilled from the bottom of the block to join the steam port. This is to allow of communication with the hole K into which the steam pipe is screwed. The bottom part of the oblique hole can be plugged by means of a short piece of brass wire sweated in. Drill the hole for the pivot pin squarely through and slightly



countersink it, after which the recess across the face can be filed out.

This being done, the working face can now be prepared by rubbing it on a piece of plate-glass as before described, after which treat the other block in the same manner, bearing in mind that the position of the ports is reversed, as previously mentioned. The holes for the holding-down bolts can be drilled  $\frac{3}{32}$  in. clearing size.

Two 1-in. lengths of  $\frac{3}{8}$ -in. brass tubing screwed at the ends for a distance of  $\frac{1}{4}$  in., will now be required for the steam-pipe connections. These pieces of tubing are to be screwed into the holes tapped to receive them in the steam blocks.

(To be continued)

EVERYONE is familiar enough with the thunderstorm which is the most striking manifestation of electricity in the lower atmosphere, but, even on a day free from storminess, there is a good deal of electricity about. The surface of the earth, and particularly elevated objects such as the tops of trees and houses, are negatively charged in fine weather, while the air immediately above possesses a positive charge. As a result of the electric attraction, the positive charge passes into the ground, tending to neutralise the surface charge of the earth. But, in spite of this influence, the surface charge persists and the cause of the persistence is at first puzzling. The situation is analogous to that of a man who can go on cashing cheques without reducing his bank balance. Clearly, in such a case, one must suppose that other cheques are being paid in at some branch of the bank, even though the accountee does not know his benefactor. Many suggestions had been put forward concerning the manner of compensation in the electrical problem, but only recently has the real benefactor been identified.

It is now realised that investigators were on a wrong track in making measurements of the earth's charge on land, for there the real nature of the natural changes is obscured by the influence of smoke and dust in the atmosphere. The surface charge seems to increase with the amount of

**Atmospheric Electricity**

atmospheric pollution. The effect of the introduction of summer time, for example, is clearly shown in records of the earth's charge, showing that, after 1916, the smoke from fires raised the value of the earth's charge one hour earlier in the morning than previously.

Not till measurements were made over the oceans by American observers in the non-magnetic ship *Carnegie* was the real hourly variation of the earth's charge apparent, and then it was found that there was a maximum effect all over the world at the same universal time (7 p.m. G.M.T.). It is now believed that the maintenance of the earth's charge is due to the influence of thunderstorms, which are found to send an appreciable amount of negative electricity into the ground. A kind of profit and loss account has been made out and it has been shown that the daily supply of thunderstorms is sufficient to replenish the negative charge and to produce the hourly variations observed.

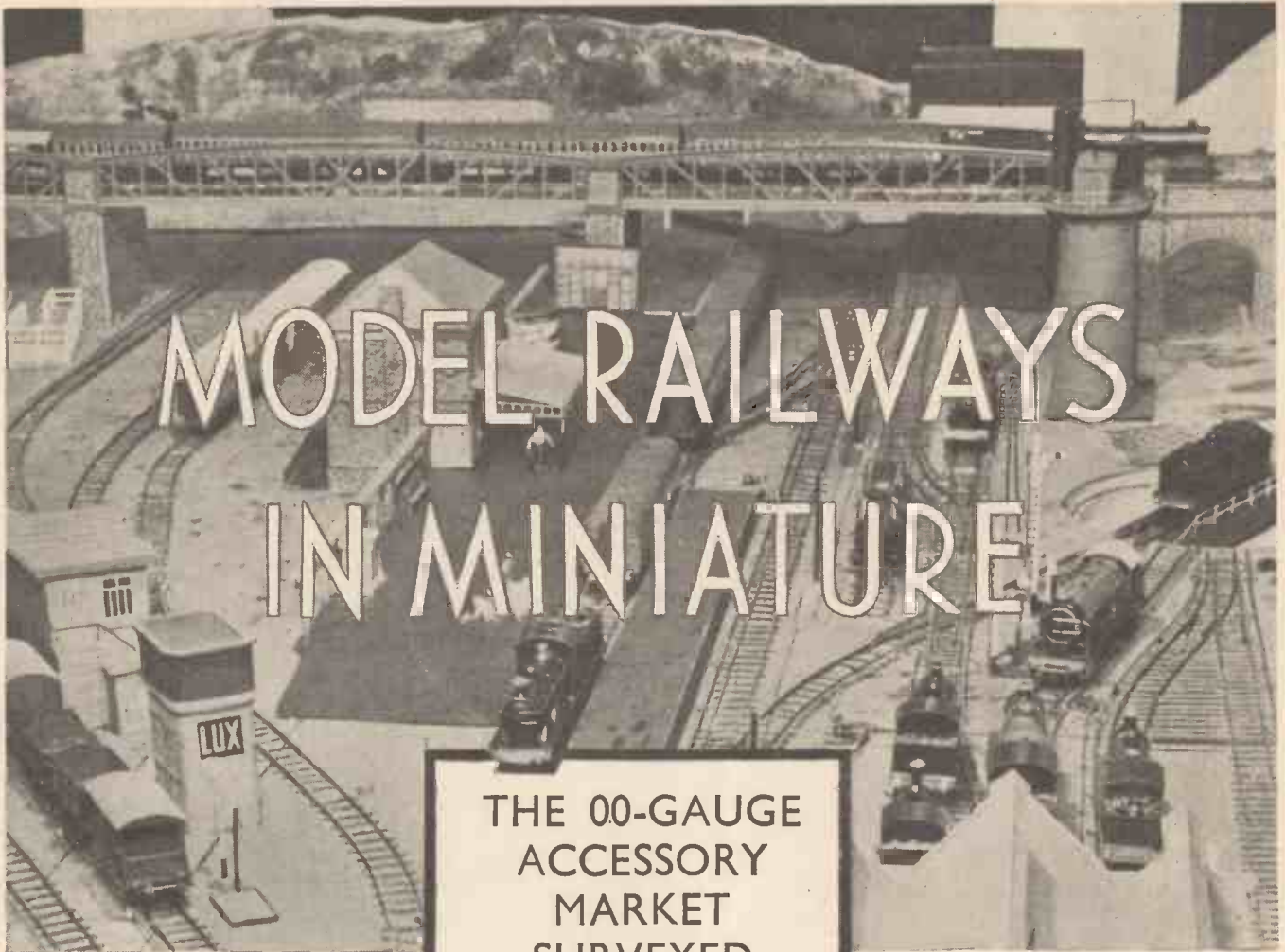
In the upper atmosphere the electrification is a thousand times denser than it is in the lower atmosphere. The marked solar control of the density indicates unmistak-

ably that the ionisation is due to solar radiation and, as so often happens in physics, the problem to be solved is whether the radiation consists of waves or particles. The matter has been tested in radio observations made in recent solar eclipses and the results have decided very definitely in favour of the theory that the cause of the electrification is ultra-violet light, and not a swarm of solar particles as some had supposed.

A difference in the behaviour of the lower and upper levels of the ionosphere has been recognised recently. The lower stratum is found to be about twice as dense in summer as in winter, due to the more direct influence of sunshine. This is exactly the amount of variation predicted by theory. But for the higher region there is not the expected increase in summer. To account for this anomaly the theory has been put forward that, at a height of 150 to 200 miles, the atmosphere is raised to a high temperature by the sun. Expansion results from this heating so that the electricity is attenuated in density.

To account for the observed facts it appears necessary to assume that at this level the summer noon temperature is at least 2000 degrees F.

The density of the ionosphere appears to follow the sunspot cycle of eleven years, and it will be of great interest to continue the measurements now in progress until the next sunspot maximum in 1939.



# MODEL RAILWAYS IN MINIATURE

## THE 00-GAUGE ACCESSORY MARKET SURVEYED

By Edward Beal

**B**EFORE proceeding to an entirely new series of articles on constructive work for small-scale railways, it might be an excellent thing to mention in a more or less comprehensive manner the components and accessories that can be obtained commercially. Beginners of the class for whom this series is intended are rarely familiar with the field, and they can have no knowledge of the enormous advance that has been made in the provision of parts and materials for 00-Gauge and HO-Gauge modelling. We will therefore endeavour to give some idea of the sources of supply and the goods obtainable, at all events for the former standard. Two or three years ago it was not possible to obtain any assistance commercially when starting to make 4-mm. scale models. There were one or two types of solid wheels, a single range of wagon axle-guards, one foreign engine mechanism, and a few examples of finished wagons and coaches. The situation to-day is much more advanced; the prospective model-maker need lack nothing in the form of standard aids to his work, mainly obtainable at very nominal charges. It is, in fact, possible to buy everything required as readily as was formerly possible for the larger and older standards.

### Familiar Names.

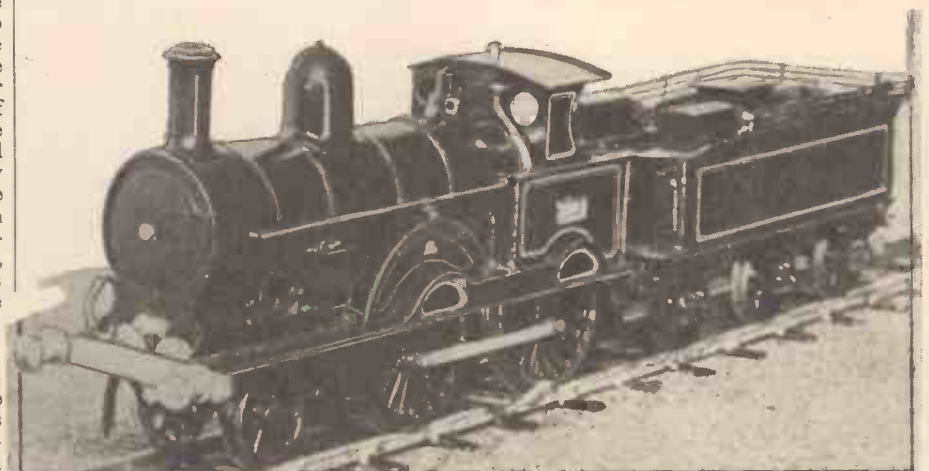
The reputable manufacturers include names that are already very familiar as advertisers in this magazine: Bassett-Lowke Ltd.; Walkers & Holtzapffel Ltd., of 61 Baker St.; A. Stewart-Reidpath Ltd., of Herne Bay; the Leeds Model Co., of

Hunslet; Hamblings, of 26 Charing Cross Road; Miller, Swan & Co., of Wimbledon; Merco, of 64 Watson St., Dundee; Windsor Model Co., of The Parade, St. John's Hill, Clapham Junction; Romford Model Co., Romford; G. E. Mellor, of Rhos-on-Sea, N. Wales.

It is, of course, hardly possible to mention in this survey every firm which deals with fittings for this scale, and even the foregoing firms vary greatly in the amount of material they produce and the interest they show in this standard.

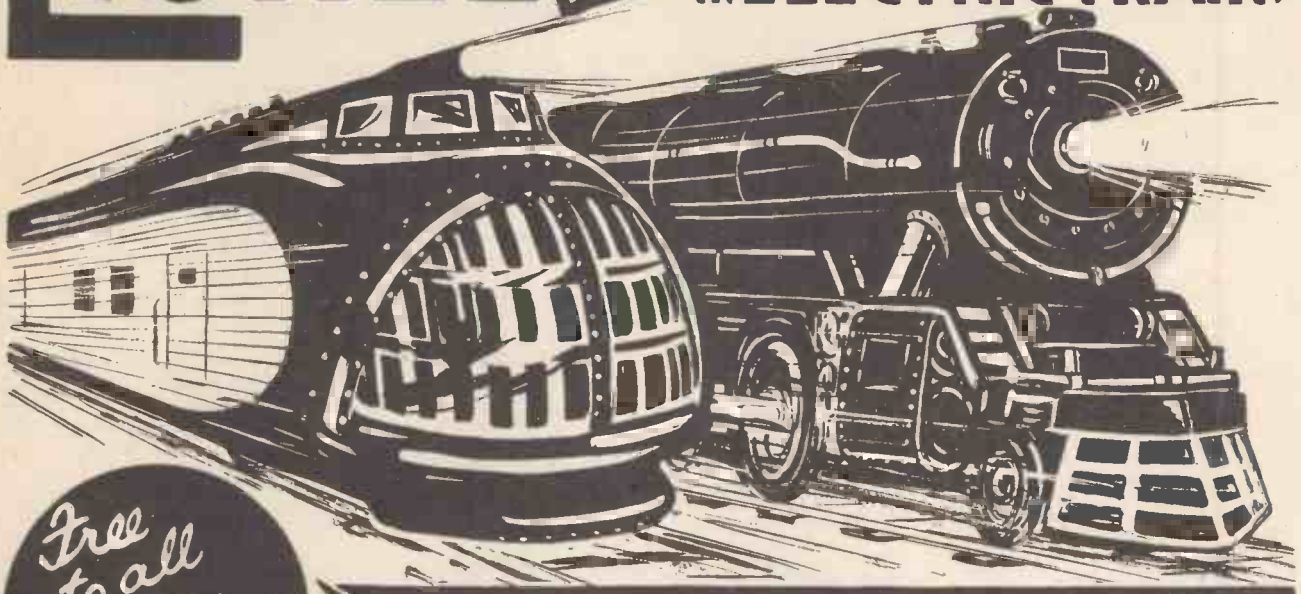
### Wide Range of Locomotives.

One manufacturer has a small range of scale locomotives which are excellent—notably a 4.4.0 passenger tender engine, a slightly rebuilt example of which is illustrated. As listed, however, this model is a reliable and useful machine of free-lance



A model 00-Gauge Hardwicke locomotive fitted with Reidmore mechanism and made by Stewart-Reidpath Ltd.

# LIONEL — THE NAME THAT MEANS THE BEST IN ELECTRIC TRAINS



(MADE IN U.S.A.)

*Free to all Train Enthusiasts*

A beautifully illustrated catalogue, showing trains, wonderful accessories and interesting track lay-outs, sent absolutely free on request.

Write to Sole Distributors:

**S. GUTERMAN & Co., Ltd.**

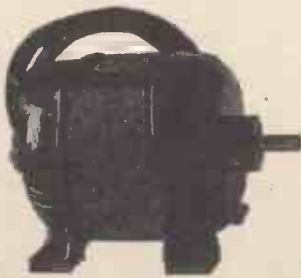
(LIONEL SERVICE DEPT. 4)  
35/36 ALDERMANBURY, E.C.2.

When writing please give name of your favourite dealer

LIONEL ELECTRIC TRAINS ARE OBTAINABLE FROM MOST HIGH-CLASS STORES AND TOY SHOPS



## GIVE THESE TWO PRACTICAL & USEFUL GIFTS FOR XMAS !



A SESSIONS Synchronous Electric Clock gives "Greenwich Time all the time." The only Electric Clock with a two-year guarantee.

Price : £1  
Delivered Free.

NOTE: READERS ORDERING BOTH ARTICLES WILL RECEIVE A BATWIN ELECTRIC CIGAR LIGHTER FREE DURING DECEMBER ONLY.

Waterloo 4551.



This sturdy MOTOR will drive that 3½-in. lathe and give ample extra power for Workshop Drives of all description. No Starter or Special Switch required. For A.C. 200/250 Volts only.

Price : £3  
Delivered Free.

**BATWIN ELECTRICAL APPLIANCES LTD.**

138 SOUTHWARK STREET, LONDON, S.E.1.

MADE IN U.S.A.

## SCALE RAILWAYS IN MINIATURE

### "OO" GAUGE IS

the most practical Gauge for the average home

YOU can build a Railway system in miniature with the fascination of complete Electric Control giving passenger running or shunting. Price to suit all. "OO" gauge is the lowest price scale Model Railway. Read the interesting article in this issue and then send 3d. for complete lists of Locos., Rolling Stock, etc., and full range of the Merco building papers which have made "OO" gauge modelling possible. We supply sets of parts as follows:—

- Complete set of parts for scale, solid body coaches, everything included - 6/-
- As above, but with glazed type windows (available in L.M.S., G.W., N.E., Southern) 6/6
- Set of wagon parts with couplings - - 2/3
- Set of van parts with couplings - - - 2/6
- Complete set of parts for building 0-6-0 Electric Tank Loco., easily assembled - 30/6

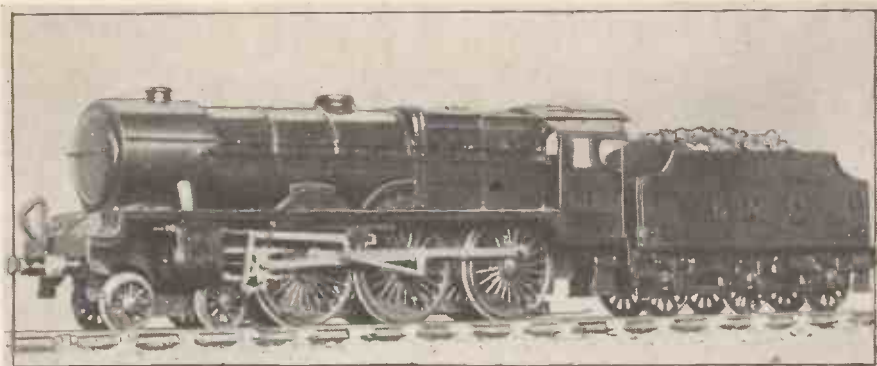
Send now to:

## H'AMBLING'S

26 Charing Cross Road, London, W.C.2.

SHOWROOMS, 1st FLOOR.

TEM. BAR 4704.

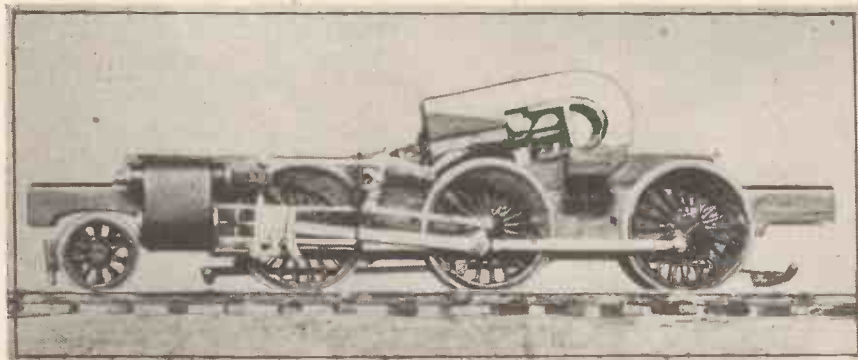


An OO-Gauge model locomotive made by Miller, Swan & Co.

design, which is fitted with a good motor. The latter may be had as a separate unit, and may be applied to a number of larger and more modern locomotive types having large boilers, though it is unfortunately too large itself for small-boilered carcasses. They also supply a good track in which the chairs

sleepers, though of solid brass, are of suitable thickness to align with the common tinplate sleepers sold by other firms. He also supplies finished buildings, and a range of rail-built roof trusses for stations and large goods sheds.

A full range of OO-Gauge goods is stocked



A Miller, Swan & Co. chassis for L.M.S. Mogul locomotives.

are cast on small plates which slip over the edges of the wooden sleepers. A good range of finished signals, parts for Bing motors, engine wheels, engine transfers, and boiler mountings are also to be found in their list. They stock a very excellent point lever, and are to be recommended for all kinds of modelling material, such as sheet brass, tinplate sheeting, small screws and bolts.

Walkers & Holtzapffel's 6-coupled tender goods engine is a thoroughly satisfactory product, having its mechanism in the tender, with a universal-joint drive to the coupled engine wheels. Their track has real merits of its own, but it takes a little longer to make up from the standard parts, having sleepers with chairs cast on, through which the rail is forced by the builder. They also supply coaches, and rolling-stock fittings such as buffers, lamp tops and bogies, and their signals as supplied finished are superb. Various small buildings and track-side features may also be had complete, as well as hand-built locomotives to order.

Miller, Swan & Co. have mechanisms, track, and a new range of signals, building locomotives to order which embody first-rate workmanship. A photo of their motor and one of their engines may be seen. Their signal and point solenoid-meters are so far the only standard ones on the market for this gauge, and are very satisfactory.

#### Plans of Layouts.

George E. Mellor designs layout plans for a small fee, and provides a type of soldered track, finished or in parts, in which the

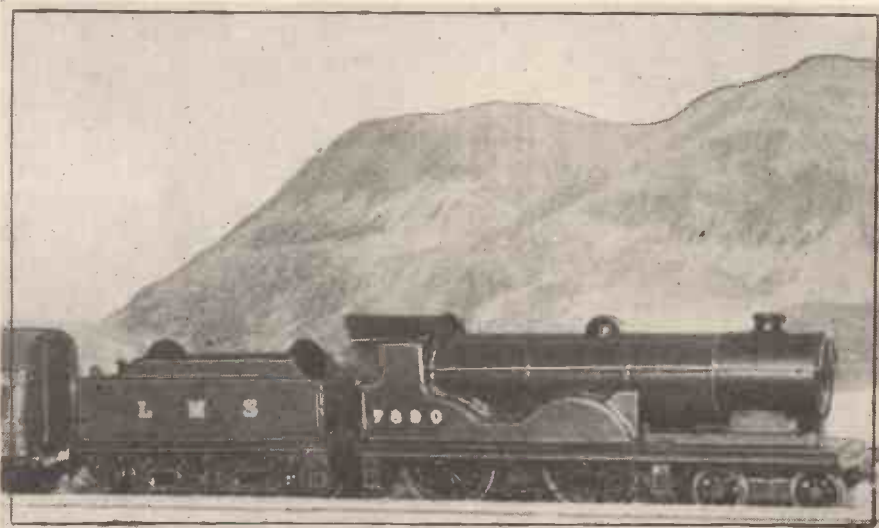
by A. Stewart-Reidpath. Outstanding among these is the new and entirely commendable Reidmore mechanism which is the cheapest locomotive motor on the British market, and may be had with 4-coupled, 6-coupled, 8-coupled or 10-coupled wheels of many differing dimensions. This motor has peculiar running characteristics of its own, one of which is its capacity to run some inches after the current has been switched

out, thus avoiding the sudden unrealistic dead stop. The gearing of the mechanism can also be had with varied ratios, suitable for fast passenger traffic or for dead-slow goods and shunting. Reidpath track has stout brass sleepers soldered to the rail, with standard 26-in. radius curves. From this firm are also to be had point-levers, wagon parts and complete chassis, wooden wagon components, finished coaches and parts for the same, as well as locomotive boiler mountings, layout designs and all the range of Merco materials.

Hamblyns are a comparatively new firm who have distinguished themselves by putting before the public many urgently-needed items, some of which are entirely unique. They retail, for instance, the first and only range of accurately finished human figures to this scale—passengers, workmen, train staff, together with porters' trollies, auto-machines, station seats, milk churns, and time-table boards. They have a fine and low-priced built-up lever-frame for fitting within the restricted limits of a scale cabin, and a really good set of parts for making upper-quadrant scale signals. Westinghouse pumps for locomotives, working corridor connections, doors, gradient posts, coach ventilators, and a good range of scale locomotives in great variety also figure in their catalogue. A noteworthy example of the latter is the G.W.R. pannier tank engine, which may also be had in finished parts while another splendid line is that of finished engine boilers complete with mountings and where necessary tapered—in short, with all the difficult work done.

The Miniature Exhibition Railways Co. of Dundee (known familiarly as Merco) are agents for all Reidpath OO-Gauge goods and are the originators of innumerable accessories. These include all the lithographed coach and wagon sides, the building papers, including brick, stone, slate, and window sashes, as well as wooden coach parts, including solid or built-up bodies, solid brass scale bogies (L.N.E.R. and L.M.S.) which give absolutely perfect wear and running, solid wood van bodies, and so forth.

The Romford Model Co. have a reliable and very silent mechanism and produce engines and rolling stock to order. The Windsor Model Co. have a good range of scale platform fittings. The Leeds Model Co. stock an excellent series of white letter wagon transfers for O-Gauge, several sizes of which are admirably suited for OO-Gauge.



A rebuilt Bond passenger engine.

# BOOKS WHICH HELP

- Small Alternating Current Motors.** By A. H. AVERY, A.M.I.E.E., A.I.P.I. A practical handbook describing Types, running characteristics and general applications with rules for the estimation of new windings. Fully illustrated. Price 1s. 6d.; post free 1s. 8d.
- Model Sailing Yachts: How to Build, Rig and Sail Them.** A practical handbook for model yachtsmen; illustrated. Price 1s. 6d.; post free 1s. 8d.
- Model Steamers and Motor Boats: How to Build and Run Them.** 120 pages; 90 illustrations. Price 1s. 6d.; post free 1s. 8d.
- The Model Aeroplane Manual.** A practical handbook on Building and Flying; well illustrated. Price 1s. 6d.; post free 1s. 8d.
- Everybody's Book of Aeroplanes.** By R. BARNARD WAY. A popular guide to the principles of Construction and Flight and to the ready identification of the notable machines of the day. Well illustrated. Price 1s. 6d.; post free 1s. 8d.
- Model Aeroplanes Simply Explained.** By M. R. KNIGHT. An introduction to the principals of Model Aviation, with complete instructions for building the successful flying model "Avis." A fine book for beginners. 101 pages; 84 illustrations. Price 1s.; post free 1s. 2d.
- The Locomotive.** Simply explained. Right up-to-date. Clearly explains the construction and working of a steam locomotive, and gives examples of modern engines on British railways. Price 9d.; post free 10d.
- Practical Lessons in Metal Turning.** By PERCIVAL MARSHALL, C.I.Mech.E. The best instruction book on the lathe for young engineers and amateur mechanics; with 220 original illustrations. Thousands have praised it. 210 pages. Price 3s.; post free 3s. 3d.
- Working Model Railways.** How to Build and Run Them. A descriptive guide to the fascinating model railway hobby, with practical hints on starting and running a complete model railway system. Price 9d.; post free 10d.
- How to Read a Workshop Drawing.** By W. LONGLAND. 64 pages; 15 illustrations. Most useful to beginners. Price 9d.; post free 10d.
- Small Dynamos and Motors.** How to Make and Use Them. Explains the principles on which dynamos and motors work, and gives drawings and instructions for building small useful machines. Price 9d.; post free 10d.
- Soldering, Brazing, and the Joining of Metals.** A practical instruction book on these important workshop processes. Price 9d.; post free 10d.
- The Model Engineer.** Every Thursday, 4d. Full of interest to all technically minded.

A forty-page List of Books and Blue Prints post free on receipt of a postcard.

**PERCIVAL MARSHALL & Co., Ltd.**

14 FISHER STREET, SOUTHAMPTON ROW, LONDON, W.C.1

# RUN YOUR MODELS FROM THE MAINS

**SHENPHONE MODEL POWER UNITS** are available for all voltage A.C. mains. They are specially designed for the operation of model electric railways, etc., and supply smooth continuous outputs suitable for this work. Prices from £3 3s. Here are details of three NEW models:

**Model C 85A.** Supplies a smooth D.C. output of 8 volts 5 amps. Incorporates a reversing-speed controller enabling the user to run the locos. in either forward or reverse direction, vary the speed, and stop them. Automatic Cut-out, which completely safeguards the track, locos., and unit from damage due to short circuit of the track, etc., saving the bother of replacing fuses, Ammeter, Pilot Lamp, and On-off Switch. Also special terminals are provided, enabling accumulators of from 2 to 8 volts to be charged at 1 to 5 amps. (including car accumulators). Complete and ready for use.

Price £6 6 0

**Model C 125A.** Similar to above, but with maximum output of 12 volts 5 amps. (Charge up to 12 volt acc.)

Price £6 15 0

**Model C 155A.** Similar to above, but with maximum output of 15 volts 5 amps. (Charge up to 12 volt acc.)

Price £7 15 0

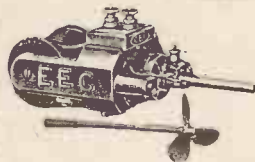
Complete illustrated list of Power Units and Point Motors on request.

**SHENPHONE ELECTRICAL PRODUCTS**

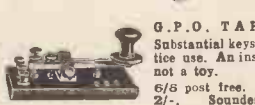
226 HIGH ROAD, LEYTON, E.10

Telephone: LEYtonstone 1362

# ECONOMIC ELECTRIC CO. TWICKENHAM, LONDON, S.W.



**THE NEW "MIDGET" MOTOR**  
The smallest and most powerful motor on the market.  
Size: 3 1/2 in. long, 1 1/2 in. wide, 2 1/2 in. high.  
Weight 7 1/2 oz. Low centre makes it ideal for boat or loco. 4 VOLTS.  
PRICE: 5/3, post 4d.  
British Made by E.E.C.



**G.P.O. TAPPERS**  
Substantial keys for practice use. An instrument, not a toy.  
6/6 post free. Buzzers, 2/-; Sounders, 9/6.



**MICROPHONES**  
For the Xmas Party great fun can be obtained by connecting one of these mikes to your receiver.  
Price 8/6.  
Bottom type 1/- p.p. Complete Broadcaster, 20/- p.p.

Our 70-page list contains a variety of small Mains Motors—for example, our 1/50 h.p. Ball Bearing Motor. Price 28/6, post 9d. Also over 500 other models for all purposes. Send for a copy now, 2d. post free.

# TAKE ADVANTAGE

of the benefits of the Westinghouse Metal Rectifier as described in the article in this issue, and send at once for a copy of "THE ALL-METAL WAY, 1936." It contains many circuits, and deals fully with all aspects of A.C. Mains Radio, location of faults, prevention of hum, detection, automatic volume control, etc.

The attached coupon and 3d. in stamps will bring you a copy.



# METAL RECTIFIERS

Westinghouse Brake & Signal Co., Ltd., 82 York Road, King's Cross, London, N.1

COUPON

I enclose 3d. in stamps. Please send me "THE ALL-METAL WAY, 1936."

Name.....

Address.....



**CLIENTS GAIN 2 to 6 inches ROSS for HEIGHT!**

A. J., age 20, gains 5 ins. in 5 1/2 weeks.	NO APPLIANCES
Miss L. F., 30, " 2 ins. in 5 weeks.	NO DRUGS
Miss C. A., 40, " 1 1/2 ins. in 6 weeks.	NO DIETING
L. K., age 20, " 6 1/2 (5 ft. 8 ins. to 6 ft. 2 1/2 ins.)	

Increased my own height to 6 ft. 3 1/2 ins.  
Thousands of testimonials from all over the world.  
FEE £2 2s. Convincing testimony 6d. stamp.  
Height Specialist,  
**MALCOLM ROSS, Scarborough, England.**

# HO-OO GAUGE TRACK

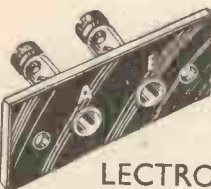
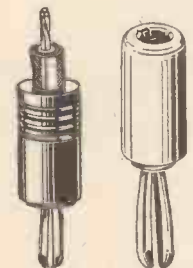
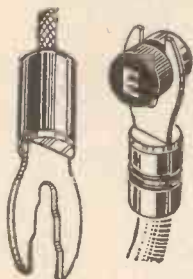
Brass Rail in 3-ft. lengths, 1/6 per doz. Brass Sleepers, 1/- per 100.  
Fishplates, 4d. per pkt. Spikes, 3d. per pkt.

**LAID TRACK**, 9-in. lengths, straight or curved, 3/- per doz. lengths.  
Points, L. or R., 2/9 each. Crossovers, Facing or Trailing, 7/- each.

Stamps value 3d. will bring you latest list of specialities.

**GEORGE E. MELLOR, ALLANSON ROAD, RHOS-ON-SEA, NORTH WALES.**

# "CLIX" PERFECT CONTACT



If you were to ask any radio service engineer, which was the most common fault found when servicing receivers, the answer would be "contacts." Extreme care is always taken in the wiring up of a job, but just because valveholders, plugs, sockets, etc., are small components their contact quality is often overlooked.

For years now the designers of sets described in "Practical Mechanics" and all the British radio publications have consistently chosen CLIX, because Clix have and still do specialise in producing the finest and widest range of Perfect Contact Components. To prevent Clicks—Ask for CLIX.

## CLIX SPADE TERMINALS

An important feature embodied in each of the 3 sizes of Clix Spade terminals is the metal shoulder piece which prevents acid creeping up to the leads. The wiring contact is positive metal to metal and the jaw in all models is designed to give full surface contact with small, medium or large terminal stems.

No. 2—is Standard for Accumulator contacts or H.T. connections to set. Prices: Large 2d. Small 1½d.

No. 3—is Heavy Duty model intended for bringing aerial or earth leads direct to set without having to make breaks or joins. Lead-in hole in insulators allows leads up to 3/8" diameter to be used without stripping insulation tape from wires. Supplied with Red or Black insulators. Price 3d. each.

## CLIX CONNECTION STRIPS

Some users call these Terminal Strips, but actually they are for Plug and Socket contacts with Terminals to facilitate wiring (Note illustration). There are four types available with engraved markings as listed below. These Clix Connection Strips make for speedy contact while at the same time you do secure perfect contact. We recommend Clix Solid Plugs at 2d. each for use with these.

- Type "A." Engraved Mains Aerial. In-Out. 6d. each.
- .. "B." Engraved A1.A2.E. - - - - 7d. "
- .. "C." Engraved -L.S.-. Pick-up. - 8d. "
- .. "D." Engraved A.E. or L.S. (Seeillus.) 6d. "

Ever since "Practical Mechanics" has been published, Mr. F. J. Camm has specified Clix Perfect Contact Components. Be on the safe side—"Use CLIX and prevent CLICKS."

## CLIX "MASTER" PLUGS

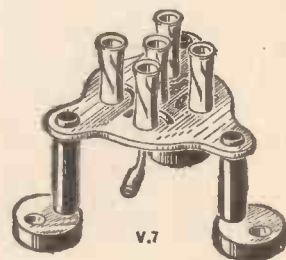
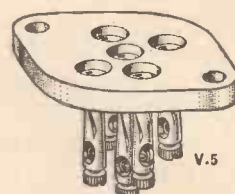
The most important feature in these is the efficiency of the pin, which is non-collapsible and is so constructed that it will give perfect contact with the varying sizes of sockets so often found in different makes of H.T. batteries. These Clix plugs give full surface contact in sockets up to 1/2" diameter. They are supplied with long or short insulators and standard markings. Price: 1½d. each.

There is a model for Heavy Duty work, on the lines described for Clix Heavy Duty Spade Terminals. The Plugs cost 3d. each.

Then there is a model for Mains work. Price: 4d. each. Finally, there is a 5-amp. model which costs 4½d.

## CLIX VALVEHOLDERS

The Clix valveholder V.5 is a low-loss type with ceramic base. Designed for short-wave work. Type V.1 is our well-known standard type, while Type V.7 is excellent for short and ultra short work where baseboard mounting is preferred. Details and prices of the full range are given in new Folder "P.M." Free for a postcard.



LECTRO LINX LIMITED, 79a ROCHESTER ROW, LONDON, S.W.1

# CLIX

# DON'T HESITATE!

Put New Life Into Your Old Set

The marked deterioration of the performance of your set is invariably caused through gradual loss of emission in the Valves; there is no cure for this other than by replacing them with reliable counterparts.

NOW, you may say that you cannot afford to buy a complete set of new valves—right—then buy them one at a time and start off with the output stage by fitting a HIVAC Power Valve. The results will more than justify your choice. If you are in doubt as to the correct types to purchase send us the name of your set or a list of the old valves and we will advise you by return of post which Hivac Valves to use.

HIVAC Specified  
for the  
"Two Pound Two"  
L 210 ... 3/9  
Z 220 ... 10/6



Here are some of the HIVAC Power Valves which are in demand for replacements:

P 215 .....	4/9
P 220 .....	5/6
PP 220 .....	6/6
Y 220 .....	10/6
AC/L .....	12/6
AC/Y .....	15/6

For characteristics see Hivac Valve Guide "P.M." free on request.

# HIVAC

THE SCIENTIFIC VALVE

High Vacuum Valve Co. Ltd.,  
113-117 Farringdon Rd., London, E.C.1.

BRITISH MADE

## ELECTRADIX XMAS BARGAINS

**HOME RECORDING.** For Record Making on your own grammo. Acoustic de Luxe Model "MI-VOICE," complete in maker's carton. List 45/-, Sale Price, 21/-.

**TRACKING GEAR** for electric pick-ups: centre drive P. 4/6. Screw Traverse Spindle C.M., 7/6. Cutters: Diamond 7/6. Sapphire 3/6. Blank record discs, 4/- doz.

**PROJECTOR LENSES.** Pathe, Busch, etc., from 3/3. Odd Lenses, all sizes, from 1/- each. **PRISMS,** right angle and pentagon, from 1 in., 5/ all sizes.

**X-RAY OUTFIT** comprising 16-in. Coil, Rotary Interruptor, two 7-in. Bulbs and Fluorescent Screen, £5. High Voltage Transformer for Mains 230 v. to 5,000 v. 20 m.p.a. 20/-.

**X-RAY TUBES,** 6 in. dia. 10'-. Packing 2/6.

**NEON TUBE,** decoration 2-colour, 5 ft. x 4 ft. glass mounted. See working, £5 10/-.

**COMMUTATORS:** For Dynamos and Motors. Engine built. 24 copper segments, mica insul. Finely finished. Worth 7/6. Sale 2/6. **A.C. Motors,** 25/-.

**Foot Switch Control,** 18/6. **MICROPHONE UNITS** are a complete microphone. Usually sold at 3/6. Our price 1/-.



**For Broadcast at Home No. 11** is a general purpose, robust mike 5/6. **No. 11A.** Special in solid brass body, unequalled at the price. 7/8.

**"P.M." No. 11 Table Mike.** This is a splendid Microphone for speech and music, and has a 2-in. mike. The bakelite case, containing the transformer, is on a bronze pedestal. 15/-.

**HEADPHONES,** 120-ohm. Sullivan Headphones, W.D. model, at a tenth of cost. For circuit testing, fault spotting, broadcast listening, microphone experiments. Aluminium body and headphones. Maker's price to-day is 15/-.

**CRYSTAL SETS** for crystal-pure reception. Desk type B, all bakelite, full B.E.O. range, 8/11. Headphones, 2/3 and 4/8.

**BATTERY RECEIVER BARGAINS.** Two-valve B.H. bakelite, 20/-; 2-v. Lissen, 17/6; 2-v. Marconi, 25/-.

**Three-valve Etesca,** 25/-; 3-v. Marconi, 20/-; 3-v. Victor G.E.O., 30/-.

**Valves extra.**

**SUPERHEETS,** 6-v. Radio L.L., with valves, 66/-.

**Western Electric,** less valves, £5.

**RADIOGRAMS.** Electronomic A.C. Console, with valves, £8. Lissen ditto, £6. Battery Radiogram, spring motor, £4.

**SMALL MOTORS.** A.C. 230-v. Induction enclosed, 3/4 h.p., 18/-.

**Sturdy 1/4 h.p. ditto,** 35/-.

**A.C. Electric Drills,** ditto to 1-in. with chuck and flex, 39/8.

**Bench double-end Electric Grinders,** 2 emery wheels, 21/-.

**Universal type motors,** 1/8 h.p., 35/-.

**D.C. Motors,** 6 volts, 12/6. 60 volts, 14/-.

**110 volts,** 15/-.

**220 volts,** 18/-.

**A.C. CAR BATTERY CHARGERS,** £3/17/6.

**Trickle Chargers,** 37/6.

**LESDEX FOOT CONTROL SWITCH,** 2 O.M. and B. Switches in cast-iron case with conduit inlets. Spring-operated Pedal, 18/6.

1,001 other Bargains for Laboratory, Amateur and Pro.

**BIG ILLUSTRATED SALE LIST "P.M." FOR 14d. POST FREE.**

**ELECTRADIX RADIOS,**  
218 UPPER THAMES STREET, E.C.4.  
'Phone: Central 4611. 'Grams: Electradix, Cent., London.



ALL RADIO  
QUESTIONS  
ANSWERED  
FREE

# The PRACTICAL MECHANICS

Every Question  
must be accom-  
panied by the  
Coupon on  
page iii of Cover

## Wireless Experimenter

It is surprising to find that, comparatively speaking, only a few listeners take advantage of the short-wave wireless transmissions. It is difficult to find the real reason for this, but it may perhaps arise from two causes:

(1) The wide choice of programmes on the medium and long wavebands.

(2) The mistaken impression that short-wave work is costly and difficult.

Probably it is the second reason that deters the greatest number from experi-

### THE TWO-POUND TWO SHORT-WAVER

Full Constructional Details of a Novel Two Valve Receiver designed for use on a Wave-band length of 10-77 metres.

For good short-wave reception it is absolutely essential to have a really smooth reaction control, and, apart from the necessity of ascertaining the correct detector anode voltage to ensure this, a fine degree of accuracy is required in the reaction control. Erratic or coarse motion must be avoided, and then it is possible to bring in the weak signals which would otherwise not be possible. By having a calibrated scale and a ten-to-one reduction in its drive, the condenser employed in the actual receiver has proved most reliable.

#### Particular Points

Another factor which has to be watched in the case of a short-wave set is the high-frequency choke. First of all it must be free from any resonance peaks in the wavelength range covered, and the turns so spaced that they have a very low self-capacity. The component chosen embodies these two points, being wound a-four small honeycomb coils on a special hollow former. Compactness and a small external field is thus assured, while the wire ends enable it to be mounted directly in the under-chassis wiring.

By employing a compact low-frequency transformer it is possible to accommodate this component below the chassis, while the ratio chosen gives just the right amount of step-up for a circuit of this character. Finally we have the pentode output valve  $V_2$  giving the additional power required when listening to the more distant stations.

#### The Cabinet

The first work to be undertaken in build-

The finished receiver and coils ready for insertion in the cabinet.



fication for these coils gives their wavelengths when tuned with a .00015 mfd. condenser, but as the  $C_2$  condenser specified is only .0001 mfd., the new ranges for the coils are as follow: Type LB (light blue spot identification) 10 to 21 metres; type Y (yellow spot

menting on the shorter wavelengths, and the Two-Pound Two Short-waver is an attempt to prove that the cost involved is very small, while the skill required to operate the set is acquired after a night or two's handling of the controls.

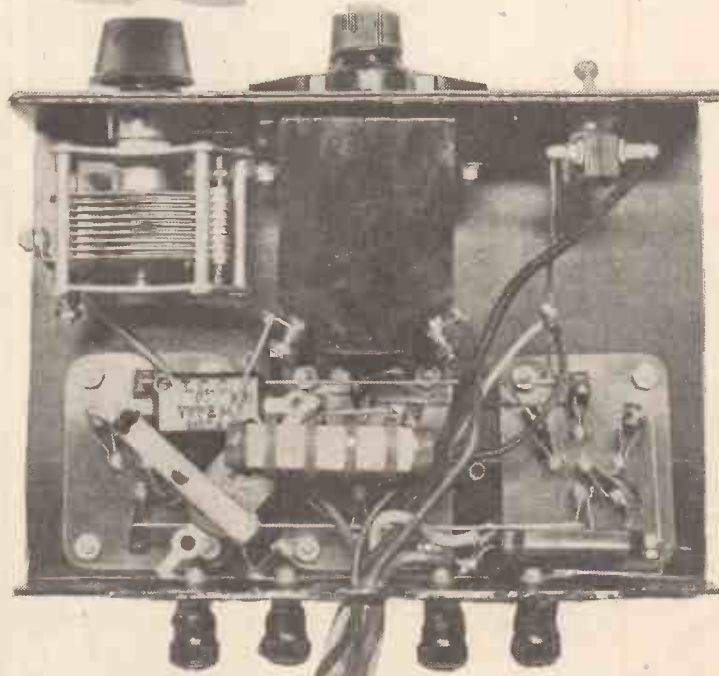
Externally the dimensions of the complete receiver are only 7 in. wide, 6 in. high, and 5 in. deep; while the panel, chassis, and cabinet are made from black sprayed aluminium to give a high-class finish. Neatness and compactness are not its only important features, however, for the performance in long-distance reception of the short-wave stations is outstandingly good.

#### The Circuit Used

The theoretical diagram shows the circuit which has been employed. Like most short-wave sets, it is quite simple and straightforward, possessing no really novel features. The aerial feed is taken through a .0001 mfd. fixed condenser  $C_1$  to the top of the aerial tuning coil  $L_1$ . This coil, together with the reaction coil  $L_2$ , is wound on a small-diameter ribbed four-pin former. The turns are space-wound with 22-gauge enamelled wire, the ribs being slotted to ensure coil rigidity. The maker's speci-

identification) 18 to 37 metres; and type R (red spot identification) 33 to 77 metres. This covers the most important of the short-wave transmissions, and embraces those stations which can be received readily under normal conditions of environment.

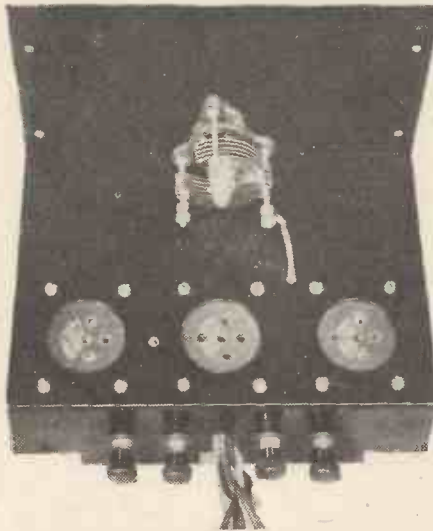
The first valve  $V_1$  is a straightforward leaky-grid detector, and the reaction feed from this valve's anode is via coil  $L_2$  and variable condenser  $C_3$ .



Study this view of the underside of the chassis in conjunction with the wiring diagram on the next page.

ing this midget set is the making of the panel, chassis, and cabinet, although if preferred the last-named can be left until the set is completed and tested. In any case, the dimensioned drawings on page 178 give all the information required,  $\frac{3}{8}$ -in. aluminium being used throughout. If preferred, the chassis, panel, and cabinet can be obtained complete from Messrs. Peto-Scott and Co., Ltd. Drill the chassis to take the valve-holders and terminals, and then fix these items in place.

Actually, the panel and chassis are quite separate pieces of metal, but the mounting



This illustration shows the clean appearance of the chassis. Note that only one wire comes through from the underside. This is joined to the variable condenser.

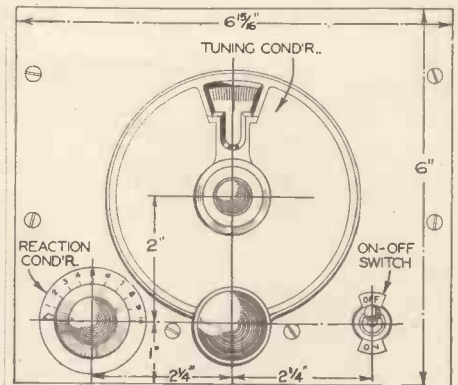
of the on/off switch, transformer, and reaction condenser (the first and last items with one-hole fixing and the remaining item with two countersunk head bolts), grip the panel and chassis edges together very rigidly.

Component positioning is indicated very clearly in the accompanying photographs and wiring diagram overleaf, and these should be studied carefully when adding the remaining items to the set. Note that each terminal, except the one marked "earth," is insulated from the aluminium, but the reaction and tuning condensers make their earth return connection through the aluminium. When making these earth contacts see that the black paint is cleared away carefully, or a defective contact will arise, and this will mar the set's performance.

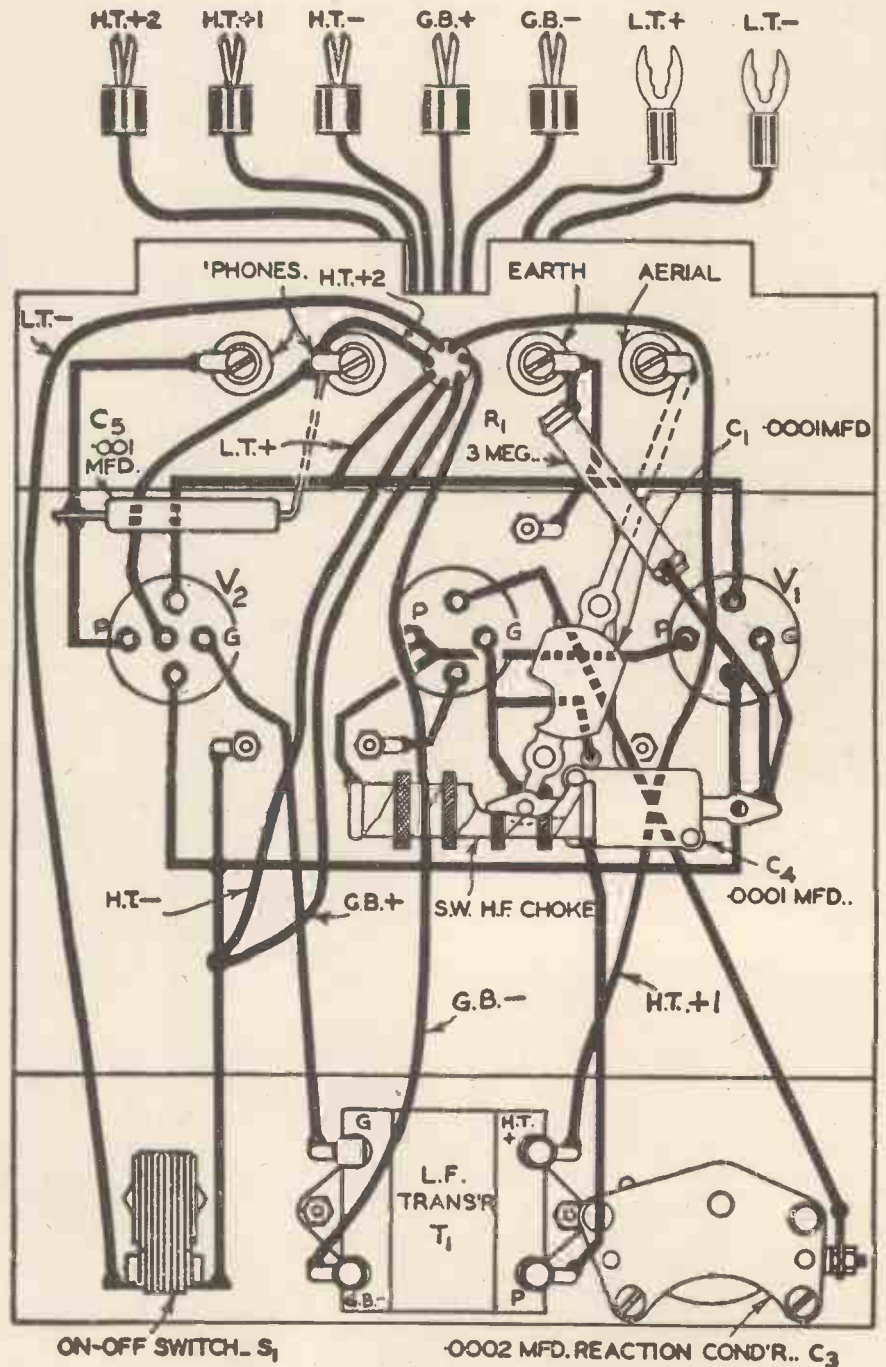
By arranging the components in the

positions indicated the length of each wiring run is kept to the barest minimum, so those readers building this set for themselves should follow the layout exactly if good results are desired. The performance of a short-wave set is dependent on layout and careful wiring far more than a broadcast receiver, so do not try alternatives on your own account.

As far as the actual wiring is concerned, this is very simple. Bare connecting wire can be used, but where there is a danger of wires sagging and touching, slip a length of insulating sleeving over the wire. The fixed condensers, grid leak, and high-frequency choke are carried in the wiring run. It is necessary therefore first to make the connections nearest to the underside of the chassis, making each joint a sound soldered one. If the constructor does not



Drilling details for the panel.



Wiring diagram of the Two-Pound Two Short-waver.

LIST OF COMPONENTS

- Three four-pin B.T.S. coils, types A.B.O.
- One Varley Niclet transformer, 3-5/1.
- One Ward and G. on/off switch.
- One 3-megohm Erie grid leak.
- One .0001 mfd. Eddystone microdenser.
- Three Clix chassis mounting five-pin valve-holders.
- One .0001 mfd. Dubilier condenser, type 665.
- One .001 mfd. Dubilier condenser, type 670.
- One B.T.S. S.W. H.F.C. 10/200 metres.
- One .0001 mfd. T.C.C. condenser, type M.
- One B.T.S. slow-motion dial.
- One .0002 mfd. slow-motion Eddystone reaction condenser.
- Four Clix small type terminals, A, E, and two phones.
- Five Clix wander plugs, H.T. + 2; H.T. + 1; H.T. -; G.B. +; and G.B. -; and two spade tags L.T. + and L.T. -.
- One Peto-Scott aluminium chassis, panel, and cabinet (sprayed black).
- Two Hivac valves, L210 and Z220.
- One Loudspeaker—Amplion "Harmona."
- One 100-volt H.T. battery—Drydex.
- One 9-volt G.B. battery—Drydex.
- One 2-volt L.T. accumulator—Exide.

# DR. N. W. McLACHLAN

D.Sc., M.I.E.E.

Dr. McLachlan, who is recognised as a leading authority on loudspeakers, stated in an article which was published in the July issue of the "Wireless Magazine" that "The performance of any particular loudspeaker depends largely upon a number of factors, some of which are the acoustical properties of the enclosure or room where the instrument is used."

Amplion Loudspeakers are designed to combat the adverse acoustic conditions associated with the average home of to-day, and this, coupled with their wonderful faithfulness in reproduction—their ability to handle large outputs without any signs of distortion—their great sensitivity and their suitability for use with all types of output valves, has resulted in their having gained and maintained a reputation for consistent quality performance.

Whether you want a loudspeaker for inclusion in your receiver cabinet or an extension loudspeaker for another room, you will undoubtedly find one of the Amplion range which will meet with your specific requirements.



Specified for the "TWO POUND TWO SHORT-WAVER."

The "HARMONA," 25/-  
Fitted with Universal Transformer.

**NOTE.**—The Editor, Mr. F. J. Camm, has specified and used the Amplion "Harmona" and "Dragon" loudspeakers as listed in this message to readers of "Practical Mechanics."

## AMPLION P.M. MOVING-COIL LOUDSPEAKERS :

The "HARMONA" .. .. .	25/-
The "DRAGON" .. .. .	29/6
MODEL "M.C.33" .. .. .	47/6

(In handsome Walnut Cabinet)

Literature giving details of the above Amplion Loudspeakers will be sent to all sending a postcard request to Dept. "P.M."

# AMPLION

AMPLION (1932) LTD.

82-84 ROSOMAN ST., LONDON, E.C.1



## "GOLTONE" 'MAGNOLUX' BAKELITE CYCLE LAMP.

Unaffected by rain or other atmospheric conditions, and will not rust or corrode. Superb finish with silver-plated parabolic reflector. 3 1/2 in. diameter front, and bracket attachment for cycle. Sliding back with spring retaining clip. Takes the Standard Large Twin Cell, Long Life Battery.

BC/3530, Ebony Black. Complete with Bulb and Refill 3/6  
BC/3930, Ivory White. Complete with Bulb and Refill 5/-

Full particulars on request.

Obtainable from first-class Cycle Stores. Refuse Substitutes. If your Cycle Store does not stock, write direct.



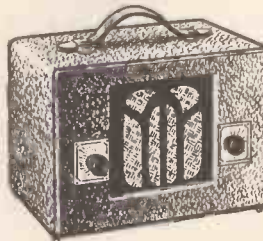
Television is the coming boom in wireless—it will bring even greater prosperity to the industry and create many more opportunities for a career. Men who foresaw the broadcasting boom made good—be trained and prepared for this television boom which must follow as surely as night follows day.

At the WIRELESS COLLEGE students receive training in all the latest developments in all branches of the Wireless profession. Marine, Aircraft, Manufacturing, Designing, Experimenting, Sales and Service, etc. College on sea front. Write for free prospectus.

STUDENTS ACCEPTED AS BOARDERS. TRAINING FEE CAN BE PAID AFTER APPOINTMENT SECURED

The WIRELESS COLLEGE COLWYN BAY N. WALES

## A Really Portable ALL MAINS Set!



A.C. and D.C. 110-250 Volt. 5 Valves—Moving Coil—No Earth required—Self-contained Aerial—Long and Short Wave.

The latest thing from America, fine tone and excellent range. Attractively covered in washable Fabrikoid Leather in several colours, or in Polished Walnut Cabinet.

MEASURES 10" x 7" x 6" SPECIAL PRICE £3.15

Large Selection of All Wave Radio Sets—7 to 16 Valves, from £10 10s.

Also 6 Valve Long and Short Wave CAR RADIO sets, complete with Suppressor - - - £7 10s.

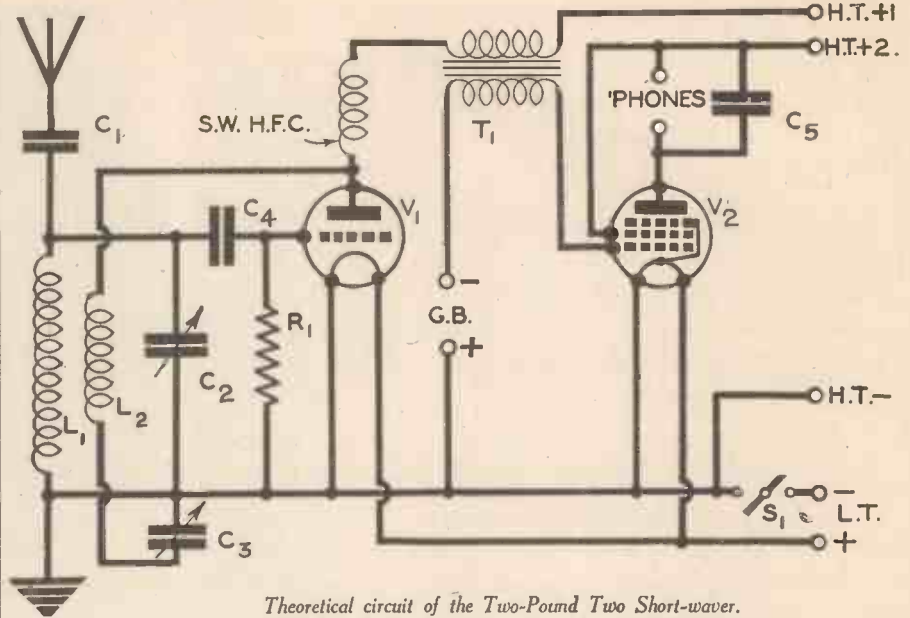
DOUGLAS HOLT 9 Little Turnstile, Holborn, W.C.1. (Car and Radio Accessories)

Estd 1919 Ltd.

desire to use a soldering iron, then take special pains in gripping each lead under the respective terminal heads. Bring out the battery leads through the centre hole at the chassis back, terminating each one in the appropriate marked plug or spade tag. The diagram on page 176 shows full details of the wiring. When complete, make a final check to see no wire has been omitted or that connections have worked loose.

Attach the slow-motion dial to the tuning condenser spindle according to the maker's instructions and then proceed to carry out a preliminary test. If an outdoor aerial is being employed or even an indoor one, it is better not to make a direct metallic connection to the terminal. Join a short length of rubber-covered flex, say one foot, to the set's aerial terminal, and twist the aerial lead-in about half a dozen times round this, as shown, so that the two leads are perfectly insulated from one another. This acts as a small series-capacity feed, being additional to the fixed condenser  $C_2$  included in the set itself.

Now connect the phones and earth lead together with the L.T., H.T. and G.B. batteries. Only 2-volt valves are used,



Theoretical circuit of the Two-Pound Two Short-waver.

of the three coils in the centrally positioned valve-holder.

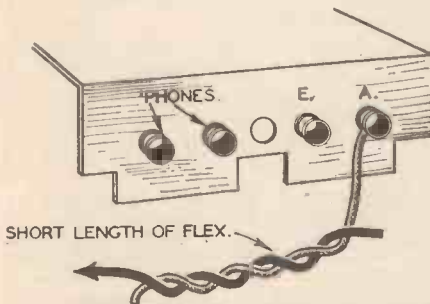
The first test is to make any adjustments that may be necessary to ensure a smooth reaction control over the whole of the tuning range. Switch on the set and, advancing the reaction control slowly, note whether the set "slides" smoothly into oscillation or "bursts" suddenly into a howl. If the former, see if there is any overlap between the reaction condenser setting for oscillation to start and stop.

A "ploppy" oscillation is useless for short-wave station-searching, and the detector high-tension voltage controlled by the H.T. +1 plug needs to be altered

of a short-wave set is tricky, in the case of the Two Pound Two this is certainly not true. First of all, from the three coils specified, choose the one to cover the waveband it is desired to receive for the first trials. Initially this should preferably be the 18 to 37-metre coil, for in this band there are a number of European stations which are on the air from as early as 8 a.m., the transmissions continuing until midnight. It is advisable for the reader to obtain details of the times and

wavelengths of these transmissions from published lists, for this will prove invaluable in aiding the search for stations.

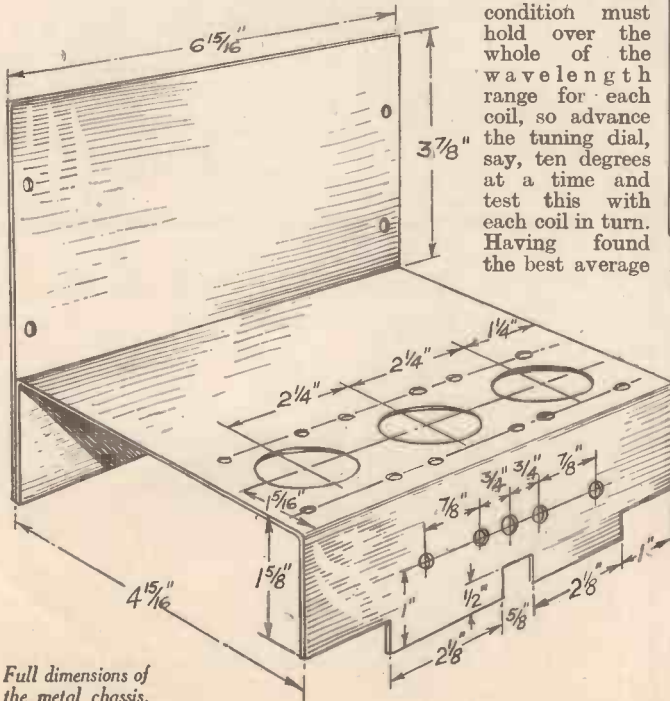
With the appropriate coil inserted in the centre valve



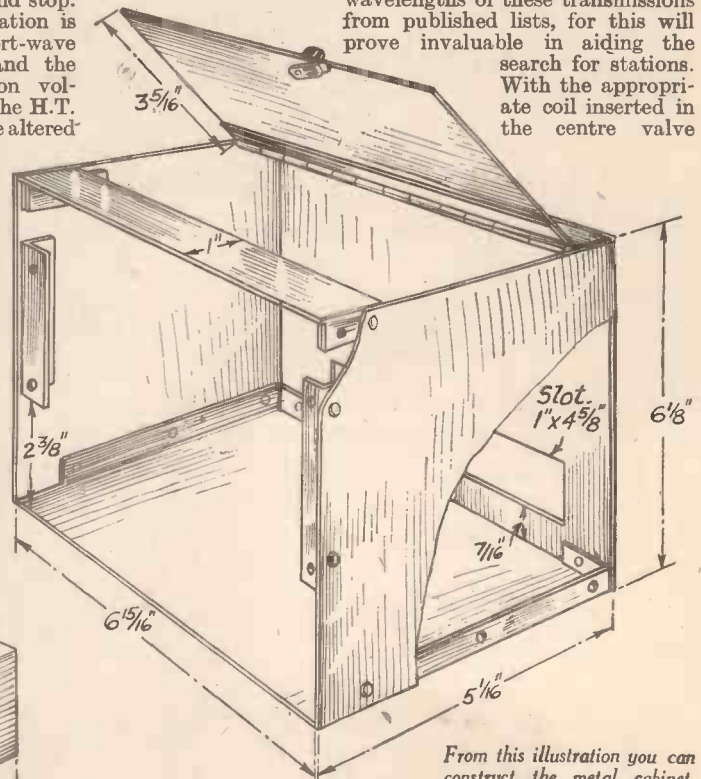
Method of using a short length of wire for aerial.

while for grid bias apply about  $7\frac{1}{2}$  to 9 volts (this can be further adjusted on site as desired), make H.T. +2 approximately 100 volts, and H.T. +1 between 30 to 40 volts. Insert the L210 in  $V_1$  position, the Z220 valve in  $V_2$  position, with any one

absence of overlap is obtained. This condition must hold over the whole of the wavelength range for each coil, so advance the tuning dial, say, ten degrees at a time and test this with each coil in turn. Having found the best average



Full dimensions of the metal chassis.



From this illustration you can construct the metal cabinet.

detector voltage, proceed to search for stations.

**Operating the Set**

Although it is always assumed that the operation

socket, and the detector and pentode output valves in the other two sockets, connect up the battery supplies, headphones, aerial, and earth to the appropriate terminals. Set the reaction and tuning condensers at minimum, switch on the set and turn the reaction control knob in a clockwise direction very slowly until the set oscillates.

**IF YOU are INTERESTED in**



**KITS and COMPONENTS Or Conversion of OLD RECEIVERS, Read attached matter.**



**KITS**

WRITE TO SOLE AGENT AND DISTRIBUTOR for the BRITISH ISLES and Colonies:



● APPLY for full particulars of the famous OSTAR-GANZ H.V. Valves—for you profit greatly by incorporating these *valves of the future* in your set. Their longer life, greater efficiency, cheaper consumption and a **guarantee for 6 months**, all tend to lower costs. A valve for every purpose. No Barretters, No Breaking Down Resistances, and No Main Transformers required. The amazing results and **NEW PRICES** will interest all.

● APPLY FOR **FREE BLUEPRINTS** of our KITS comprising All-Wave Models from 2-6 Valves, Radiograms, Amplifiers, and S.W. Adaptors. Now is the time for you to construct your receiver or radiogram. No previous experience necessary, for our **FREE Technical Advice** and Blueprints save you endless time, worry and expense. A few of our Popular Models are:—

**OSTAR-GANZ UNIVERSAL 3-VALVE "ALL-WAVE" RECEIVER KIT.** 19.65 m., 200-2,000 m., all wave changes on single switch. £7 10 0. **THREE PENTODE 4-VALVE ALL-WAVE RECEIVER.** Wave range 20.65 m., 200-2,000 m. £9 9 0. **6-VALVE "ALL-WAVE" SUPER KIT.** Wave ranges: 13-2,000 m., four wave bands on single switch, £14 14 0. **"OSTAR-GANZ COMPACT" AMPLIFIER** £5 10s. 0d. **UNIVERSAL AMPLIFIER KIT.** Push Pull Output £9 9 0. All Models complete with Ostar-Ganz H.V. Valves.

● APPLY for particulars of our Conversion Scheme—for **OLD SETS CAN BE REJUVENATED.** Give your present set a new lease of life; let us convert it into a 1936 UNIVERSAL All Wave Model for a very small outlay. (*All Makes and Models can be converted.*) **QUALITY RECEPTION ASSURED.**

**EUGEN J. FORBAT (Dept. A), 28-29 Southampton Street, Strand, W.C.2. Tel.: TEMple Bar 8608 and 4985**

★ **HYVOLTSTAR UNIVERSAL** ★

All Waves, All Mains, A.C., D.C. Receivers.

**OFFERS YOU DISTINCTIVE STYLE WITH REVOLUTIONARY RESULTS ON ALL WAVE BANDS FROM 13-2,000 METRES**

*Revolutionary Sound Diffusion by means of Sound Reflectors.* Working on 100-250 volts A.C. D.C. without alteration. HYVOLTSTAR is the only set which incorporates the famous OSTAR-GANZ UNIVERSAL High Voltage Valves. Not a mass-produced article, but an individual job, for every model is constructed throughout by our highly skilled technicians. All Models obtainable in chassis form. Send to-day for full details of our New Programme of Receivers, Radiograms and Amplifiers from Dept. P.M. **HAVE A SET ON APPROVAL** without obligation.

**UNIVERSAL HIGH VOLTAGE RADIO, LTD., 28-29 Southampton St., Strand, London, W.C.2. 'Phone: TEMple Bar 8608 and 4985**

**PRICES**

UNIVERSAL ALL WAVE SUPERHET four. Chassis 10½ Gns.	Table Model 13½ Gns.
UNIVERSAL ALL WAVE SUPERHET five. Chassis 13½ Gns.	Table Model 17 Gns.
UNIVERSAL ALL WAVE SUPERHET six. Chassis 14½ Gns.	Table Model 19 Gns.
UNIVERSAL ALL WAVE SUPERHET seven. Chassis 21 Gns.	Table Model 25 Gns.
UNIVERSAL ALL WAVE SUPERHET ten. Chassis 30 Gns.	Table Model 35 Gns.
	Radiogram 42 Gns.



**LOOK OUT FOR THE NEXT SLOGAN**



**S**CRUIT  
**C**ONNECTORS  
**R**AISE  
**U**NIFORM

Obtainable from all Electrical Wholesalers.  
Made by—V. G. Manufacturing Co. Ltd.  
Gorst Road, Park Royal, London, N.W.10.

**I**NSULATION  
**T**ESTS



**MIDGET & NORMAL CONNECTORS**

# DYESTUFFS IN YOUR GARDEN



*Woolen material after being mordanted with an iron salt, being entered into the cold dye bath.*

## How to utilise the Colouring-matter of Plants for the Home Dyeing of Fabrics

to what extent they can be adapted to modern requirements.

Only wool and, to a smaller extent, silk (not artificial silk) can be dyed with natural dyestuffs. It is usually very difficult to dye cotton or linen with such colours. It is true that cotton can be dyed blue with indigo and red with madder, both of which are natural dyestuffs. But then, indigo and madder do not grow in English gardens or in our fields or by the wayside. Consequently, such exceptional colouring-matters do not come within the scope of this article.

The beginner is recommended to confine his first attentions to the dyeing of wool with natural dyestuffs. Afterwards will be the time to see how far his process can be adapted to the dyeing of cottons and linen.

In all vegetable dyeing, what is known as a "mordant" has to be used. A mordant is a substance with which the fabric is impregnated previous to the actual dyeing. Its purpose is to fix the colouring matter firmly in the pores of the material.

There are three common mordants used in the vegetable dyeing processes. These

**B**EFORE the advent of synthetic aniline dyes about the middle of the last century, colouring-matters obtained from various plants were universally employed for most dyeing purposes. These were termed the "Vegetable" or "Natural" dyes.

The introduction of the huge class of synthetic dyestuffs, however, resulted in the majority of the older vegetable dyes being ousted from their former uses. The synthetic dyes, it was found, possessed not only a far greater colour and shade range than the natural dyestuffs, but, also, they were applied to the cloth more quickly. For reasons such as these, dyeing with natural or vegetable dyes quickly became a thing of the past. Nowadays, such dyes are seldom employed except for very special purposes or by individual craft-workers who make a speciality of vegetable dyeing.

The vegetable dyes possess several great advantages over the synthetic colours. In the first place, they are usually much faster to light and washing. Vegetable dyeing gives soft and lustrous colours, colours which, even when they are old and dirty, retain their beauty and charm. Aniline dyes, on the other hand, give bright colours which are well adapted to the requirements of modern commerce, but, usually, these colours are hard and metallic.

Chemical experimenters and other individuals may be interested to try their hands at the age-old art of vegetable dyeing. Anyone with a garden or having easy access to a field or a hedgerow can obtain the necessary material for the process. At the outset, however, it should be remarked that vegetable dyeing is not so easy as "chemical" dyeing with aniline dyestuffs. Usually, in the latter instance, the material is placed in the dye solution and heated up for a certain length of time, after which it is taken out, rinsed and dried.

In dealing with natural dyes, however, the process is more complicated. There is a good deal of individuality in it as well, it being an acknowledged fact that two workers can start out with the same materials and, using them in identical proportions, can obtain entirely different shades of colour.

In the olden days it used to be said that the successful dyer was born, not made. Such an assertion, however, will not preclude any interested worker from resurrecting these old dyeing methods on a small scale at home and from determining at first hand

LIST OF COMMON DYE PLANTS ADAPTED FOR HOME DYEING

Plant or Tree	Part Required	Mordant	Colour
Nettle	Root	Alum	Yellow
Parsley	Leaves, stem or root	Alum	Yellow
Ash	Fresh inner bark	Alum	Yellow
Agrimony	Leaves	Alum or chrome	Yellow
Birch	Leaves	Alum	Yellow
Bracken	Roots and young tops	Alum, chrome or iron	Yellow to Yellow-green
Dock	Root	Alum	Yellow-fawn
Gorse	Bark, flowers or leaves	Alum or chrome	Yellow-green
Bramble	Leaves	Chrome	Full yellow
Broom	Bark and leaves	Chrome	Pale yellow
Privet	Leaves	Alum, chrome or iron	Yellow
Teasel	Leaves and stem	Chrome	Yellow-brown
Willow	Leaves	Iron	Yellow-brown
St. John's Wort	Leaves and stem	Chrome	Yellow-brown
Pear	Leaves	Chrome	Yellow-green
Plum	Leaves	Chrome	Yellow-green
Hop	Leaves and stem	Chrome	Yellow-green
Marsh Marigold	Leaves and stem	Alum or chrome	Yellow-green
Elder	Leaves	Alum	Yellow-green
Ling	Leaves	Alum or chrome	Yellow-green
Saw-wort	Leaves	Alum	Lemon-yellow
Ragweed	Leaves	Alum	Lemon-yellow
Elder	Leaves	Chrome	Green-yellow
Larch	Bark	Alum	Green
Lily of the Valley	Leaves	Alum	Green
Heather	Leaves, twigs and flowering tops	Alum	Green-yellow
Dock	Root	Chrome or chrome-iron	Brown
Onion	Outer skin	Iron	Light brown
Walnut	Root or fresh leaves	Alum, chrome or iron	Brown
Alder	Bark	Iron	Brown
Larch	Pine needles	Iron	Brown
Oak	Bark or acorns	Iron	Brown-black
Blackberry	Young shoots	Iron	Black
Iris	Root	Iron	Black
Alder	Bark	Copper	Black
Bryony	Berries	Alum	Purple
Whortleberry	Fruit	Alum	Purple
Deadly Nightshade	Leaves and stem	Alum	Purple
Damson	Fruit	Alum	Purple
Dandelion	Root	Alum, chrome or iron	Grey-fawn
Sloe	Fruit	Alum	Blue
Yellow Iris	Root	Alum	Blue
Woad	Stem, leaves or root	Alum	Blue
Wild Madder	Leaves or stem	Alum	Red
Lady's Bedstraw	Roots	Alum	Orange-red
Dyer's Woodruff	Roots	Alum	Red-orange
Gromwell	Roots	Alum or chrome	Orange
Potentil	Roots	Chrome	Orange-yellow

When referring to the above list of plants (which is by no means exhaustive), it should be noted that the colours given are approximate ones only. The precise colour and shade depends enormously upon the conditions of mordanting and upon the exact composition and strength of the dye bath. Only practical experience can determine any definitely required shade.

are the alum, chrome and iron mordants.

**Alum mordant.**—This is a very commonly used mordant in vegetable dyeing and it gives very fast colours, the shades being on the light side. A good alum mordanting bath is made by dissolving in a convenient quantity of water 4 ounces of common alum to every pound of wool which is to be mordanted. The wool is steeped in this bath for an hour or two. Finally, the bath is brought to near the boiling-point for half an hour. The wool is then removed from the bath, wrung out (not rinsed) and, if desired, dried. It will then be ready for the dyeing operation.

**Iron mordant.**—This bath is prepared by dissolving in a convenient quantity of water  $\frac{1}{2}$  ounce of iron sulphate ("green vitriol") for every pound of wool to be mordanted. The wool is mordanted in the manner described in the previous paragraph.

**Chrome mordant.**—This is made up of about  $\frac{1}{2}$  ounce of potassium bichromate for every pound of wool to be mordanted.

In mordanting the material, it is essential to see that the fabric is turned over in the bath from time to time in order to ensure equal penetration of the mordant to all areas of the cloth. If this precaution is not taken, unequal dyeing will result.

Upon the nature of the mordant, the strength of the mordanting bath and the time during which the fabric is steeped in it will depend the finished colour of the dyed material. The stronger the mordanting bath, the heavier the shade of colour. Alum mordants give light shades. Iron mordants impart the darkest shades of all, whilst chrome mordants are noted for the bright colours which they produce.

Other mordants are tannic acid (in its various forms), copper sulphate, "Tin crystals" (stannous chloride) and Cream of Tartar. These can all be used separately or in conjunction with the three chief mordants mentioned above and by their aid an enormous variation of shades can be produced.

Having now disposed of the question of mordants, let us turn our attention to the actual plant dyes which can be used. Accompanying this article is a table showing a number of dye plants which can be employed in the home dyeing of woollen and silk fabrics. Most of them are very readily obtainable and, usually, at all times of the year.

The leaves, stems or roots of the dye plant should first of all be washed reasonably free from extraneous dirt and soil. They should then be shredded coarsely and boiled up in a small quantity of water in order to extract their contained dye. This extract, together with the leaves or roots, is then poured into a larger basin and diluted

with a convenient quantity of cold water. The cloth (which has previously been mordanted) is now passed slowly into the dye liquor. Heat is applied and the dye bath is brought up to the boil during the course of about one hour. It should be maintained at this temperature for a further half hour and then allowed to cool. To obtain the best and the fastest shades, the cloth should not be withdrawn from the dye bath until it has cooled down again.

Vegetable dye baths can be used over and over again until they become exhausted. When this occurs, the addition of fresh dye extract will restore them again.

The great secret of success in vegetable dyeing is to perform each operation slowly. The longer the processes of dyeing and of previous mordanting take, the better the resulting shades are likely to be. It is on account of the necessary slowness of the processes that vegetable dyeing is not a commercial proposition in modern times. In India, however, and, nearer still, in the north-west of Scotland and the western districts of Ireland, vegetable dyeing is still practised. The colours produced are exceedingly fine, but they take weeks to obtain.

Another practical point: do not commence your dyeing operations with large quantities of material or with made-up garments. A small scarf is the biggest thing you should attempt at first. Indeed, many country craft-workers dye nothing else than hanks of white wool. This is really the easiest and the most successful form of natural dyeing. The hanks or skeins are not unduly bulky. Owing to their physical formation, they take the mordant and the dye easily and evenly and they can be made up into many different forms of wearing apparel afterwards. It is, therefore, undoubtedly best to confine oneself to the dyeing of hanks and skeins until the technique of the process has been thoroughly mastered.

In reading through the table of dye-stuffs, it will be noticed that the commonest natural dye materials, as, for instance, privet leaves or dock leaves, dye wool yellow or yellow-green. The beginner would be advised to confine his attention to such vegetable dyes before proceeding to trials with others. By altering the composition of the mordant, a large number of shades may be obtained. The colour shades are all soft and homely ones. For brilliance, of course, they do not stand comparison with the artificial dyes, but for softness and beauty, as well as for the important practical criteria of light-fastness and stability to washing and wearing, these age-old and now almost forgotten colours and shades are still, for the most part, unexcelled.

## ITEMS OF NEWS

MISCELLANEOUS PARAGRAPHS FROM ALL SOURCES

### Petrol from Coal

THE new plant at Seaham Harbour is to be duplicated and the output doubled. The first unit is just commencing production, and will use over 500 tons of coal a day. It will yield about 4,000,000 gallons of motor spirit, 4,000,000 gallons of heavy oil, 100,000 tons of smokeless fuel, and hundreds of tons of valuable by-products every year.

### The Model of the "Queen Mary"

IN the November issue we described the construction of an interesting model of the *Queen Mary* built to the scale of  $\frac{1}{4}$  in. to the foot—the largest of its kind ever built in England. We should like to set on record the fact that this model was made by Messrs. Bassett-Lowke Ltd., the well-known makers, of Northampton.

### A Pedal Aeroplane

IT is reported that Herr Dunnbeil, a German, has made flights of over 250 yds. at a height of 15 ft. at Frankfurt aerodrome in a home-constructed pedal aeroplane.

### A Record Locomotive

AFTER running nearly 1 $\frac{1}{2}$  million miles, the L.N.E.R. locomotive No. 7930 has been broken up. This engine was built in 1891, and was assembled in the record time of 9 $\frac{1}{2}$  hours to show how quickly it could be done.

### The Passing of Another Liner

THE S.S. *Olympic* is now being dismantled and is in the hands of the ship-breakers, having been purchased for £100,000 from the Cunard Line. She was built 24 years ago and has crossed the Atlantic over five hundred times.

You'll need these

Exide

AND

Drydex

BATTERIES

for the

£2

TWO-VALVE  
SHORTWAVE

They are specified

For L.T.—Exide DTG, 2 volt,  
20 ampere hours 4/6

For H.T.—Drydex Super-Life,  
100 volts 9/-

For G.B.—Drydex HI001,  
9 volts 10d.

Obtainable from Exide Service Stations and all reputable dealers. Exide Service Stations give service on every make of battery.

Exide Batteries, Exide Works, Clifton Junction, near Manchester. Branches at London, Manchester, Birmingham, Bristol, Glasgow, Dublin and Belfast.



# PIANO- ACCORDION

Quickly Mastered  
by the

# Hohner Postal Course

As evidenced by the fact that within the last twelve months **OVER 2,000 PEOPLE** have obtained this mastery with the aid of the course.

Absolute proof that the Hohner School Course makes accordion playing extremely easy—that it is a fascinating and interesting study—that it is a genuine and thorough teaching method—and that it is the most complete and practical course of tuition ever written for any musical instrument.

**AL DAVISON, M.A.**  
Mus. Bac. (Cantab), F.R.C.O., Principal of the School and author of the Hohner Course, which is an authoritative Standard Work for all future Developments of the Piano-Accordion.

**NO PREVIOUS MUSICAL KNOWLEDGE REQUIRED**  
**MUSIC LEARNED WHILE PLAYING INSTRUMENT**

The course is so simple that anyone, without the slightest knowledge of music, can master the instrument, because reading music is learned as playing proficiency is acquired by progressive easy stages.

**MELODIES PLAYED FROM FIRST BOOK**

*Members of the School are unanimous in their praise of the course.*  
Mr. HENRY HALL, Mr. JACK PAYNE, Mr. QUENTIN MACLEAN, Mr. GEORGE SCOTT, Mr. FRED BAMBERGER (Mr. Jack Hylton's late pianist) and other leading professional musicians say that the Course is a clever and comprehensive educational work. They are impressed with its simplicity.

## Send for FREE BOOK

*"The Joy of Musical Expression"*

which gives a complete description of the course and of the unlimited possibilities of the Piano-Accordion for the player's pleasure—and profit.

.....**COUPON—POST TO-DAY!**.....

Hohner School of Piano-Accordion Playing,  
179 Tottenham Court Road, London, W.1

Please send me, post free, "The Joy of Musical Expression"

Name .....

Address .....

P.M. 12/35 .....

## The "GRAYSON" 3in. Centre Lathe



**SPECIFICATION.**—Length between Centres, 12½". Max. Swing over Saddle, 3½"; Max. Swing over Gap, 7½"; Dia. of Mandrel, ¾" Whit.; Mandrel and Tail-stock bored ¾" clearance; Centre No. 1 Morse; Dia. of Face Plate, 6½"; Dia. of Catch Plate, 2½". Lead Screw; Square Thread, ⅝" by 8 t.p.i.; 3-speed Cone Pulley, 2¼"-3"-3½"; Width of Belt, 1½".

**FULLY COMPOUND SLIDE REST**

Model as Illustrated, 20" between Centres £5 16 0

Short Bed Model, 12½" between Centres £5 5 0

FULL SPECIFICATION SENT ON APPLICATION

**EASY TERMS ARRANGED WITH PLEASURE**

### DRILL CHUCKS

Straight or No. 1 Morse Taper Shanks

Cap. ½" ⅝" ¾"  
1/16 2/3 3/- ea.



### SPECIAL OFFER



**ALL METAL TWO-SPEED HAND DRILL**

½" Cap. 3/6 Post 6d.

¾" Cap. Two-Speed Breast Drill 5/6 Post 9d.



### THE "IDEAL" POCKET MICROMETER

¾" Capacity - - - 4/- ea. Post Free  
1" " " " " " " 7/6 " " "

**E. GRAY & SON, Ltd.,** 18-20 CLERKENWELL RD. LONDON, E.C.1

Established 1822.

## The "UNICORN" Electric Drill

¼" CAPACITY. BRITISH MADE

Efficient, a model of accuracy and workmanship, and trouble-free qualities are the features of this drill. Its equipment comprises a powerful A.C. or D.C. Motor, voltages 100/120, 200/230, 230/250, with Armature Shaft in ground alloy steel. Hobbed gears in metal housing. Hoffman ball thrust. Keyless chuck, ¼-in. capacity. Aluminium die cast handle. Current consumption 175 watts, using ¼-in. drill on mild steel. 8-ft. Cab tyre flex with earth wire. Weight 5 lbs.

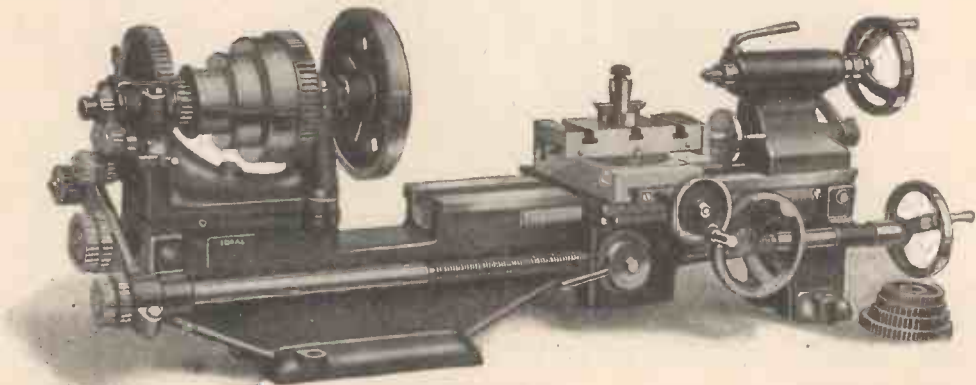


**PRICE £2 . 19 . 6**

Carriage Paid. Please state voltage.

Send for illustrated leaflet to:— Tele: GULLIVER 3739.

CORONA ENGINEERING CO., LEIGHTON PLACE, KENTISH TOWN, N.W.5



## "IDEAL— LATHES"

3 in. S.C. Lathes from £4  
3½ in. S.C.B.G. from £7/18/6

**THE IDEAL JUNIOR 3" LATHE.**  
S.C.B.G. Comp Rest. Quick return to Saddle. Full divided Nut to apron. Price £6/7/6.

**DEFERRED TERMS ARRANGED**  
LISTS—Stamp please

**J.WILLIMOTT & SON**  
Neville's Factory,  
Chilwell, Notts.



# SHEET-METAL WORK FOR THE AMATEUR

An Instructive Article Enabling the Amateur, with the Aid of a Few Tools, to become Efficient in Sheet-Metal Work

**B**EFORE attempting to construct anything in sheet metal, it is necessary to have a knowledge of the tools required, the properties of various metals, and the standard of thickness. The tools are fairly inexpensive, and for elementary work a kit comprising the following articles would be sufficient: *Snips* (these are small shears for cutting sheet metal), straight and round nosed; a *Rule*; a *Square*; *Dividers* or *Compasses*; a *Sandbag*; a *Wooden Block hollowed out*; *Metal Heads*, for shaping; several *Hammers*; several *Mallets*; some *Emery Cloth*; a *Soldering Outfit*; and a *Gauge*.

### The Sandbag

A sandbag is a bag of leather which need be only about 6 in. or 8 in. in diameter, stuffed or packed tightly with silver sand. This provides a yielding surface upon which the metal can be beaten and worked into various shapes. The method of making this is as follows: Take two circles of basile leather, say 10 in. in diameter, place the inner surfaces of the leather face to face, each disc upon the other, closely sew or machine the two edges together with the exception of about 3 in. This aperture will allow the sand to be poured in and rammed home tight with any wooden plunger. When closely packed and hard, the aperture should be sewn with a cobbler's needle and thread. The diagrams will more accurately show how this is made.

### The Hollow Block

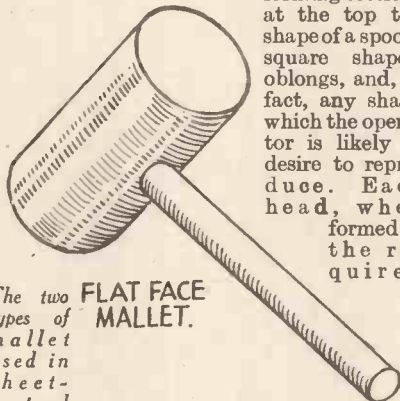
The hollow block is made very easily. Obtain a block of hard wood, preferably ingrained; a block of approximately 10 in. in diameter will serve this purpose. Mark out in the centre an oval 6 in. x 3 in.; take a carpenter's gouge, and gouge out where marked to a depth of about 1½ in. at the greatest depth, hollowing up the sides in proportion. The use of this is to enable the metal to be driven into the hollow (the edges of which will have been treated in the manner directed) become contracted, and enable the operator to beat out all wrinkles.

### Metal Heads

The metal heads are quite easily made

from odd pieces of iron or steel bar. Heads of various shapes are likely to be required, forming sections at the top the shape of a spoon, square shapes, oblongs, and, in fact, any shape which the operator is likely to desire to reproduce. Each head, when formed to the required

The two types of mallet used in sheet-metal work.



shape, should be filed bright and polished.

**Other Tools**  
The purpose of these tools is to have a proper surface upon which the

### BEATING MALLETS.

beaten metal can be hammered to form a bright and plain finish. Several hammers are required, with faces of various shapes. All tools for beaten-metal work should be kept bright. This especially applies to the hammers, as the face of the hammer imparts its



own imprint every time it is applied to the metal surface. These will have to be purchased from the local tool shop. At least two mallets will be required. One, a sheet-metal worker's mallet, round section with a flat face; and the other, a beater's mallet, with two round faces, one somewhat larger than the other. The majority of the beating and primary shaping is carried out by the mallet. For this reason, the selection of these requires to be done carefully. The other details require little explanation, and until the operator is advanced, the foregoing description of tool kit will be sufficient.

### Various Kinds of Metal

It will be found that aluminium is not only easy, but fascinating to work, as the metal is so ductile when annealed, and so effective when formed and cleaned, that it at once appeals to the amateur. Copper, brass and steel can be attempted after further experience. Aluminium can be purchased in various gauges from ½ in. or even less, up to any thickness. The most convenient gauge to commence on is No. 20 standard wire gauge. This will enable an experiment to be carried out inexpensively, and by working metal of this gauge the operator would gain considerable experience.

### Annealing Aluminium

To anneal this metal, it should be placed over any flame, keeping the whole surface moving so that the heat becomes general; drip oil on the surface from an oil can, and so soon as the whole of the surface becomes generally heated to cause the oil to congeal and blacken on the surface of the metal, plunge straight into cold water; it will be found then to be soft and pliable, and quite easy to work.

During working, the metal will gradually become hard, and if beaten or stretched indefinitely, will crack. So soon as the metal is found to be harsh and hard, it can be re-annealed in the same manner.

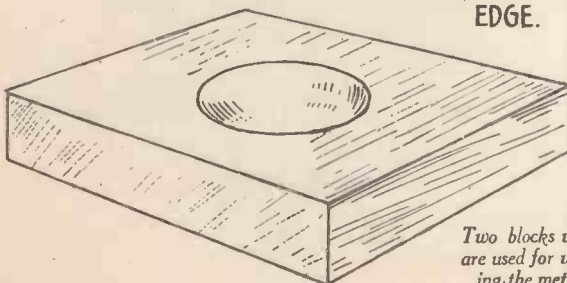
Care is needed when annealing, as aluminium, if subjected to excessive heat, becomes impoverished, when it will collapse entirely. To gain the necessary experience in anneal-

ing, experiments should be carried out on scrap pieces of metal.

Showing the beating mallet in use.

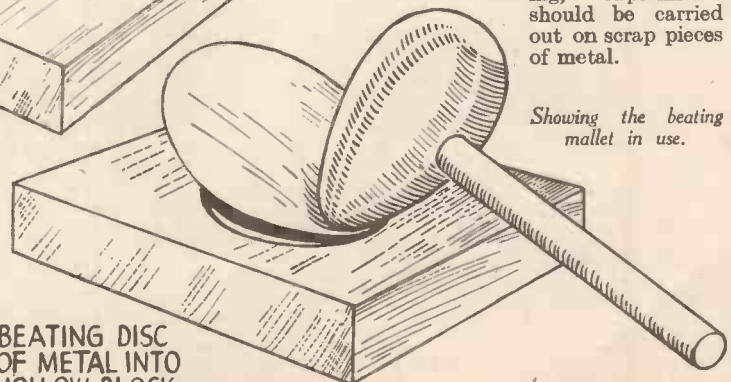
BEATING BLOCK OF HARD WOOD.

BLOCK HOLLOWED TO FORM FLUTED EDGE.



Two blocks which are used for working the metal.

BEATING DISC OF METAL INTO HOLLOW BLOCK.



**Annealing Brass and Copper**

Sheet brass is annealed in the same manner, and will stand considerably more heat than aluminium. Sheet brass can be placed in a flame until it becomes a very dull red, and plunged straight into water. This metal will also harden under working, and constantly requires re-annealing.

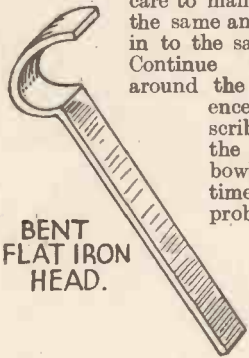
Copper is treated in the same way, except that copper will stand very much more heat than brass, and can be made really red hot before plunging. Before attempting to work in any of the three metals mentioned, experiments in annealing are very necessary, as it is quite impossible to work or beat these metals into any form unless they are properly annealed, and maintained in that condition by constant re-annealing.

**Making a Fancy Bowl**

Take a circular piece of either a aluminium brass, or copper, of 20 gauge, 11 in. in diameter.

The size of the required base should be marked with the dividers, in this instance, say, 4 in.; that is, a 2-in. radius struck from the centre, striking another circle 6 in. in diameter. The purpose of these circles is to provide a guide in working. We will presume that the operator has thoroughly annealed the circle.

Place the hollow block in the position shown in the diagram, beating in the metal to the hollow with the round-nosed mallet, gradually turning, and taking care to maintain the disc at the same angle, and to drive in to the same degree only. Continue this operation around the full circumference, between the two scribed lines, until the metal becomes bowl shaped. By this time it will, in all probability, require



**BENT FLAT IRON HEAD.**

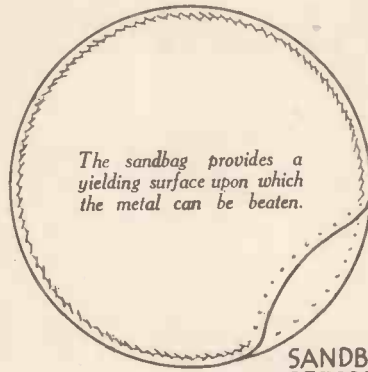
*This device is used for shaping metal.*

re-annealing. Place the bottom section of the shape now produced over the oval, or hollow, block, in such a manner that when beaten by the mallet the metal is driven into the hollow.

The purpose of this is, to a certain extent, to stretch the bottom section. It is plain that if this beating process of driving the bottom down was continued sufficiently to form the desired shape, the metal would become so thin that it would be useless. It is, therefore, necessary first to pucker the outer edges by working in the manner described before, and by a compromise thicken up certain parts, making thin other parts,

and gradually form the desired shape. By continuing this method, and constant annealing, a plain domed bowl can be obtained.

If it is desired to turn out the upper edge



*The sandbag provides a yielding surface upon which the metal can be beaten.*

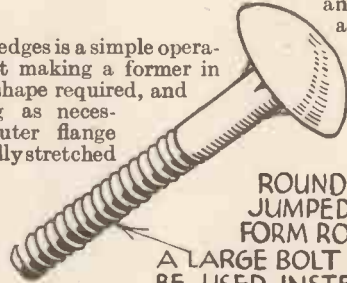
**SANDBAG BEFORE CLOSING UP.**

as in some types of bowl, the outer edge only should be annealed, and by placing on the block with the edge overhanging, it can be gradually stretched and driven over to form a flange, which can afterwards be fluted and given a decorative shape.

**Fluting**

Fluting the edges is a simple operation; by first making a former in wood to the shape required, and by annealing as necessary, the outer flange can be gradually stretched

*A further type of metal head used in sheet-metal work.*



**ROUND IRON JUMPED UP TO FORM ROUND HEAD**  
**A LARGE BOLT CAN BE USED INSTEAD.**

and driven into the former, and will by degrees become shaped as required. In order to harden the finished article and produce a clean surface, it should be planished. This is accomplished by placing the work on to a metal head of suitable shape, and hammering the whole of the surface with a bright-faced hammer, evenly and lightly, thus producing a flat surface that can be ground, filed, and polished bright.

Various useful articles can be made in flat sheet metal, without the necessity of beating. As an example, a serviceable and ornate inkstand can be produced in sheet brass, if the operator takes sufficient care and interest. For this purpose 22-gauge sheet brass is quite thick enough. The base can be formed in wood, the metal cut to the required size, and by completely covering the wood base, and inseting the metal sheet to the bottom, this will have the appearance of a heavy metal article. Various decorative designs can be cut from a slightly heavier gauge metal, for the pur-

pose of holding pens, and two ink-wells inserted into the base. These can be purchased from any stationer's.

**Soldering**

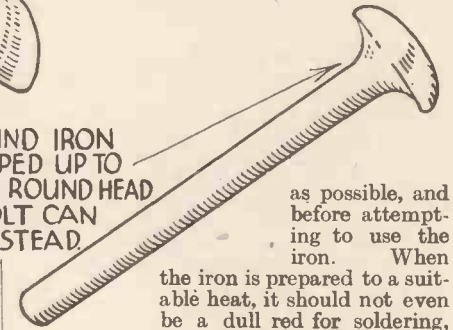
In the making of flat and beaten articles, a knowledge of soldering is very essential.

The copper bit used is known to most people, but many have difficulty in soldering owing to the lack of knowledge required for preparing the tools and the articles to be soldered.

The copper bit should first be faced with tin. This is accomplished by heating the bit to just below a dull red; thoroughly file the face to make it perfectly clean, insert or rub the face in soldering flux, apply the end of a high-grade stick of tinman's solder to the filed face, when some will adhere; again rub the face in the flux, which will distribute the tin over the whole of the filed surface. This is absolutely necessary before commencing to use the soldering iron.

A tin of solidified or liquid flux, a few sticks of solder, files, emery cloth or other means of cleaning the metal, and a gas stove, are all that are necessary for soldering.

The main point to remember in soldering is cleanliness. It is quite impossible to solder metal if any dirt or foreign matter is adhering to the surface. It should always be scraped or emery-clothed perfectly clean and bright, and a small quantity of the flux applied to the surface as soon after cleaning



as possible, and before attempting to use the iron. When

the iron is prepared to a suitable heat, it should not even be a dull red for soldering, but sufficiently heated to

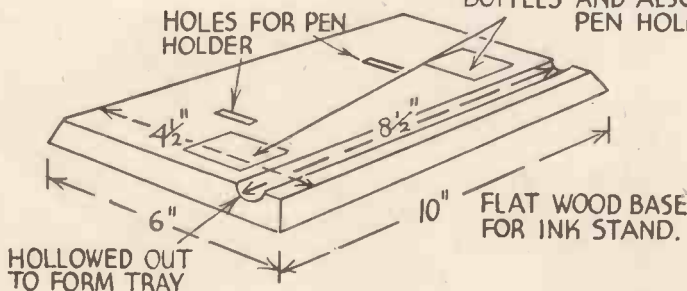
melt the solder.

The bit can be applied to the surface for soldering, and the soldering stick applied to the point of the bit. This will melt sufficient solder to adhere to the job.

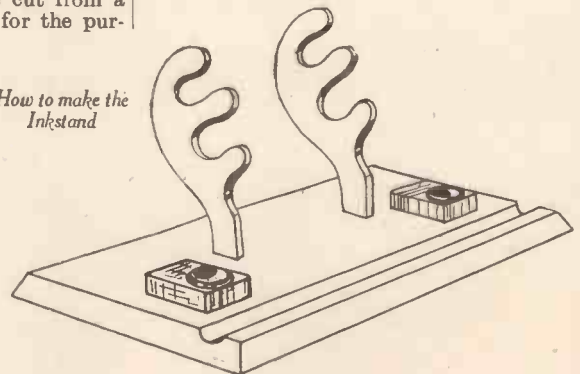
The soundest soldered joint is a sheet of solder between the two surfaces. Soldering in itself possesses no great strength except that of adhesion. A blob of solder imparts very little extra strength to any light sheet metal, and it must be remembered that it is the solder between the joint that produces the strength, and not that visible, or in lumps. A perfectly strong soldered joint can be made without any of the solder being visible on the outer surface of the metal.

**CUT HOLES TO FIT INK BOTTLES AND ALSO FOR PEN HOLDER.**

*How to make the Inkstand*



**HOLLOWED OUT TO FORM TRAY**



# A SUN-RAY LAMP

*The Ultra-violet Rays are Noted for the Health-giving Properties, and below we Describe a Simple Lamp for Producing Artificial Sunlight*

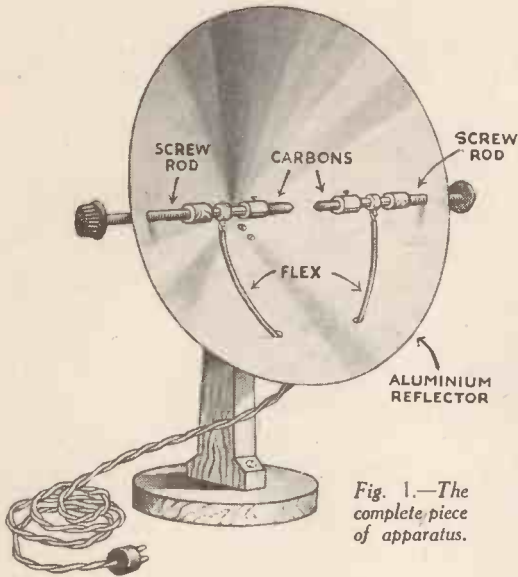


Fig. 1.—The complete piece of apparatus.

As is well known, ultra-violet light or artificial sunlight can be produced by striking an arc between two carbon electrodes. This is the principle used in the sun-ray lamp shown in Fig. 1. It consists of an aluminium reflector mounted on a wooden stand, the electrodes, which can be adjusted by means of two knobs, being fixed to the reflector.

When constructing the lamp it is advisable to make the reflector and the wooden stand first, and fit the electrodes and other accessories afterwards.

### The Carbons

As shown in Fig. 1 the carbons are attached to two screwed rods, one on the right side of the reflector, and the other on the left. Each screw rod passes through a hole in the aluminium (see Fig. 5) and also through a wood block attached to the back of the reflector (see Fig. 3).

In the wood block is a countersunk nut which makes it possible to screw the rod

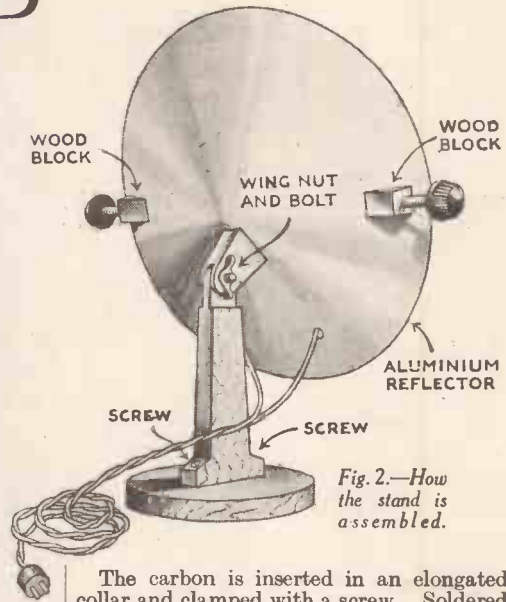


Fig. 2.—How the stand is assembled.

The carbon is inserted in an elongated collar and clamped with a screw. Soldered to the elongated collar is a brass rod which goes inside a loose collar. This loose collar has the flex attached to it.

Between the brass rod and the screw is a wood or ebonite insulator which, as shown in Fig. 7, is a cylindrical shaped piece of wood (or ebonite) with a hole at each end.

### The Insulator

The insulator is fixed in position by inserting the screwed rod in one hole and the brass rod in the other. It is advisable to cover the end of the brass rod with a piece of thin rubber before inserting it into the hole in the insulator. This not only helps to wedge it tightly, but also ensures a perfect insulation. The right-hand carbon is attached to the lamp in a similar manner. To work the lamp plug in and then screw the carbons to within 1/4 in. of each other, by turning the right- and left-hand knobs. A brilliant flame will result which gives out ultra-violet light.

The carbons will need renewing every second month or so. Dark tinted glasses should always be worn when using the lamp.

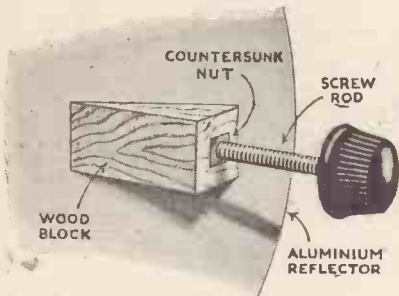


Fig. 3.—The carbons are attached to screwed rods as shown.

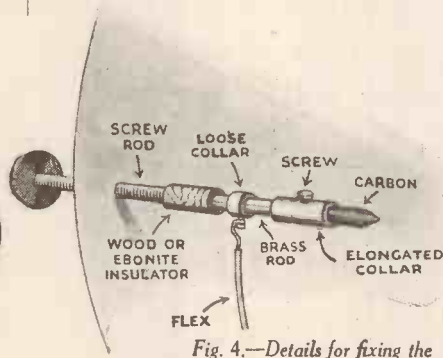


Fig. 4.—Details for fixing the left-hand carbon to the lamp.

backward and forward. A wireless tuning knob is attached to the end of the screwed rod for this purpose. Details for fixing the left-hand carbon to the lamp are illustrated in Fig. 4.

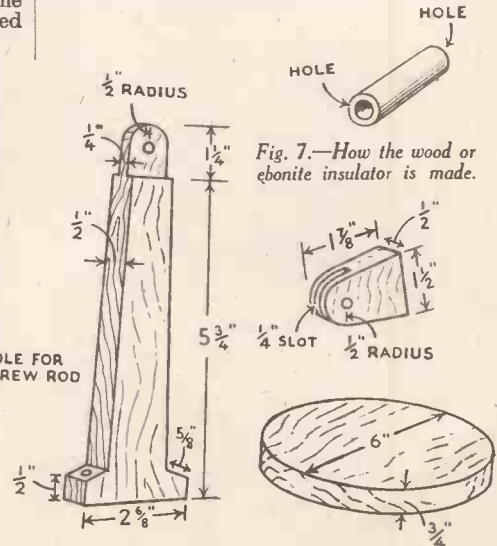
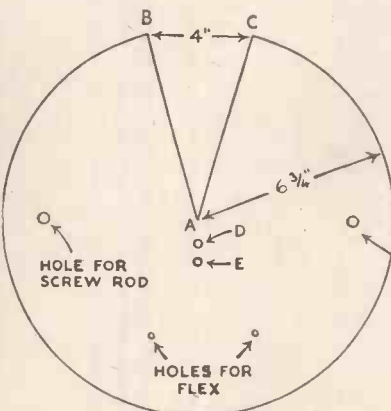
### The Stand

Parts for a simple stand are shown in Fig. 6, and a study of Fig. 2 will show how they should be assembled. The upright is attached to the base by means of two screws, whilst the smaller piece of wood is fixed to the top of the upright with a bolt and wing-nut.

The bolt acts as a pivot on which the reflector works, and by tightening the wing-nut, the reflector can be fixed at any desired angle. A flat piece of iron about 3 lb. in weight should be attached underneath the base.

The reflector is simply a shallow cone made from a single sheet of aluminium. To make it cut out the shape shown in Fig. 5 and join the edges AB and AC together. When made the reflector should be fixed to the small piece of wood at the top of the stand with two screws, the positions for which are indicated by D and E. The reflector and stand are now complete.

Before starting to fix the electrodes the reflector should be separated from the stand by removing the bolt and wing-nut.



Figs. 5 and 6.—(Above) Details of the reflector and (right) the various parts for making the stand.

Fig. 7.—How the wood or ebonite insulator is made.

**And here's  
— another!**

Send 1/6 Postal Order NOW for a genuine 'LINDBERG' Kit of this 13½-in. span FLYING SCALE MODEL "MONOCOUE."



All Kits contain full-sized plan, instructions, printed balsa wood, insignias, tissue, cement, rubber, propeller, etc., etc. You can't go wrong with a 'LINDBERG' Kit. They are the most authentic in design, methods of construction, and quality. Other types include: S.E.5, FAIRCHILD "24," U.S. NAVY RACER, FOKKER TRIPLANE, BOEING P.26A, CURTISS GOSHAWK. All 1/6 each, or any 3 for 4/-. Send your order NOW before any type is sold out!



**Make it a  
'LINDBERG'  
XMAS!  
Send for your  
KITS NOW!**

Photos of actual MODELS!

Above: FOKKER D-VII Bi-plane. Span 15 in., length 10½ in., weight ½ oz.  
On right: FOKKER D-VIII. Span 15 in., length 10½ in., weight ½ oz.  
Complete Kits for these fine models are obtainable for ONLY 3/- each, carriage paid. Other types are SPAD and NIEUPORT SCOUT.



If you want a Larger Super Detailed Model, send for one of these!

	Span	Price	
FAIRCHILD "22" Monoplane	15½ in.	3/9	Working controls from cockpit.
BEN HOWARD MIKE "	14 in.	5/-	Shock-absorbing landing gear.
CORBEN SUPER ACE "	17 in.	6/6	Guns, bombs, turned parts, etc., etc., etc.
BR-STOL FIGHTER Biplane	19½ in.	6/6	
RYAN S.T. Monoplane	18½ in.	9/9	Send 1½d. stamp for 4-page Illustrated Catalogues of Scale Models or Supplies List 3C.
HAWKER S. FURY	18½ in.	9/9	
DOUGLAS OBSERVATION	22½ in.	12/9	

**NORTHERN MODEL AIRCRAFT CO. (Dept. C)**  
37A FOUNTAIN STREET, MANCHESTER, 2.

**Scale Model Aircraft!**

Aeroplanes that you can make yourself and which are guaranteed to fly; here we illustrate only one of our large range of constructional models. Visit our Aeroplane Section on the Ground Floor and see the finest display of scale model aircraft in the country.



**THE MILES  
"HAWK-MAJOR"**

Wing span 16½ ins. A constructional Flying Model of the famous aeroplane record time holder for light aircraft—England—Australia and back. 2nd King's Cup, 1934-5. This wonderful kit includes all important parts blanked out, finished air-screw and step-up gear box, aluminium wheels and wind shield. Full working plan and "step-by-step" instruction sheet.

**PRICE 10/6**  
Post 6d.

**Hamleys**  
Est'd 1780  
**HAMLEY BROTHERS LTD**

200-202 REGENT STREET, LONDON, W.1  
TELE.: REGENT 3161. OUR ONLY ADDRESS

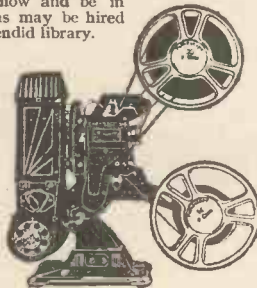


**HOME MOVIES  
WILL GIVE A "KICK" TO  
YOUR CHRISTMAS PARTY**

We have all the latest apparatus in stock from 8/- down. Get in touch with us now and be in time. Your films may be hired from our splendid library.

**PATHSCOPE 200B**  
With 200-watt lighting. Picture 10 ft. wide easily obtainable. Flickerless projection. Works off 110 volts. With lamp, plug, flex, adapter, and one empty 300-ft. super reel. **£15:0:0**

Nine monthly payments of 35/-.



**FIRST PAYMENT GETS YOUR HOME GINE.**



**THE "DEKKO" PROJECTOR**

Hand-driven projector for 9.5-mm. films. Well balanced. Silent projection. Base of solid cast metal. With resistance for any voltage from 100 to 250. Power-ful lamp, new type shutter. **70/-**

Nine monthly payments of 8/4.

**FREE LISTS**

of latest home cines and hundreds of guaranteed bargains. Free and post free.

**GENEROUS EXCHANGE ALLOWANCES.**

**CITY SALE & EXCHANGE**

(1929) LTD.

59 & 60 CHEAPSIDE, LONDON, E.C.2

**"COMET"  
RIGHT ON TOP!**

The "COMET" Petrol Engine Model 1935 Awards:—

- FIRST PRIZE: B.M.A.S. Power Competition at Cranborne.
- SECOND PRIZE: S.M.A.E. Sir John Shelley Competition at Fairey's Aerodrome.
- FIRST PRIZE: B.M.A.S. "Hallum" Competition at Cranborne. Mr. Brooks' Petrol Engine Model flew from Cranborne to the Isle of Wight, 35 miles as the crow flies!

Build one of these Models this winter, powered with the **18 c.c. COMET ENGINE**

**THE MODEL AIRCRAFT STORES**

133 RICHMOND PARK ROAD, BOURNEMOUTH

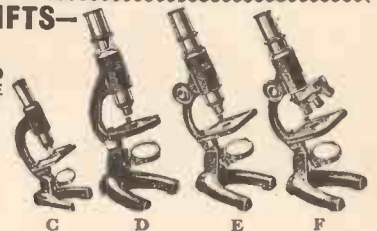
Please send 2d. stamps for price lists.

**IDEAL CHRISTMAS GIFTS—  
MICROSCOPES**

SPECIAL OFFER OF 1,700 BRAND NEW STUDENTS' PORTABLE MICROSCOPES, as illustrated.

Each model has inclinable body, swing mirror, stage clips, and is nicely finished in Black Crystalline Enamel and bright Nickel Plating.

**SHARP DEFINITION IS OBTAINABLE and GOOD WORK CAN BE DONE**



- Model C. Height 5½ in., sliding focus, magnification 25 x linear Price **5/-**
- Model D. Height 7 in., sliding focus, circular stage magnification 50 x linear... Price **9/6**
- Model E. Height 7 in., rack and pinion focusing, magnification 50 x linear, square stage... Price **12/6**
- Model F. Height 7 in., rack and pinion focusing, triple nose-piece. 3 lenses, magnifications 25 x, 50 x, 100 x, in wood case, with set of Dissecting Instruments. ... Price **30/-**

IMMEDIATE DELIVERY FROM STOCK.

**BROADHURST, CLARKSON & CO.**

Post Free in Great Britain.  
63 FARRINGTON ROAD, LONDON, E.C.1.



Figs. 1 and 2.—Two views of the "Bowden Mouse" petrol-driven biplane.

# A Petrol-Driven Model Biplane

By Capt. C. E. Bowden

The Model which Forms the Subject of this Article has been Designed Round a 10-c.c. Internal-combustion Engine

**T**HE general handiness and portability of a petrol-driven model aeroplane are very important features, perhaps next in importance to good flying qualities.

The advent of the small 10-c.c. petrol engines now being placed on the market, makes it possible to design models that are reasonably small and yet of sufficiently slow flying speed to be safe and moderately free from damage in the event of bad landings.

In viewing this latter point, I think consideration should be given to a happy combination of robust construction, lightness of total weight, good stability, and correct flying trim that will not be easily disarranged.

I have accordingly designed and produced a model that, I think, incorporates all these points, and at the same time allows for as small overall dimensions as the required robustness of construction and light wing-loading will permit. In order to ensure that flying trim will not be disarranged in the event of a hard knock, struts and bracing wires have been entirely eliminated, as in my experience reliable flying trim is very difficult to maintain with any type of wire bracing. The wires stretch and alter angles of plane settings after a hard landing when testing in the initial stages.

The model can be entirely dismantled or assembled ready for flying in a few minutes, and if a heavy landing is made the various component parts will be knocked off. To those who intend to copy the construction of this model, I would suggest that if they wish for success, they should copy the design in all details, otherwise the original intention behind the design may be lost.

On the other hand I intend to discuss in general terms the layout of biplane design suitable for model work, so that those interested may possibly be assisted in designing their own models, and those who are contemplating constructing the model to be described in this article will be able to do so intelligently and understand the reasons for the design.

I have chosen the biplane because it is easier to design a model in this form where overall dimensions must be small coupled with light wing-loading, and provided certain rules are adhered to in a biplane, it is no more difficult to construct a successful biplane than a monoplane.

It is popularly believed that a model biplane is a difficult proposition. My first petrol model "Kanga," which broke the then existing record, was a biplane, and

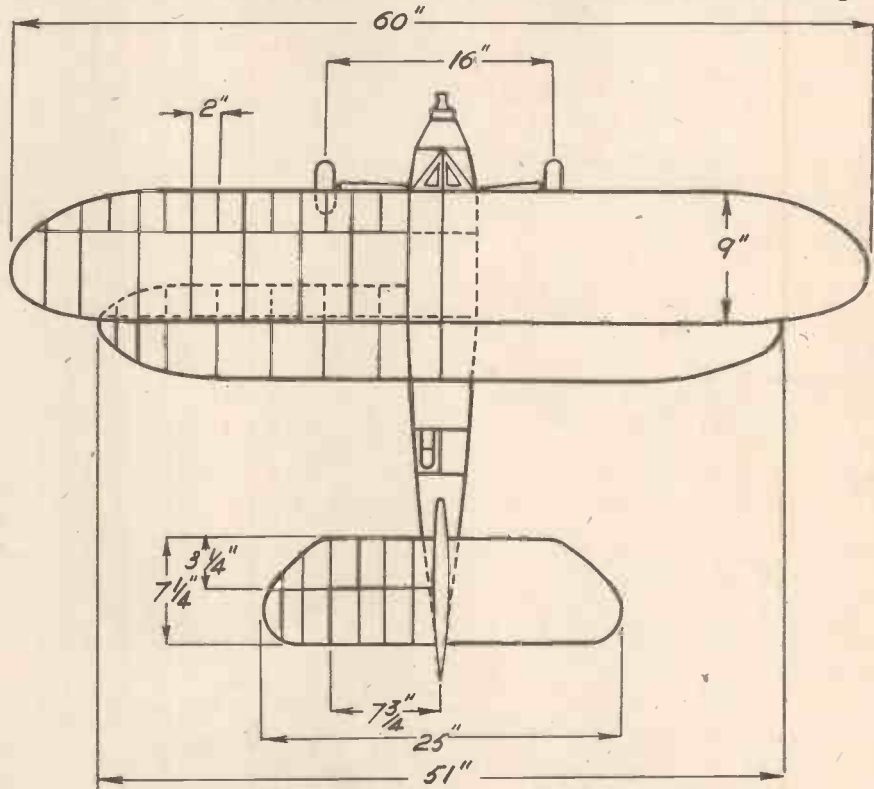
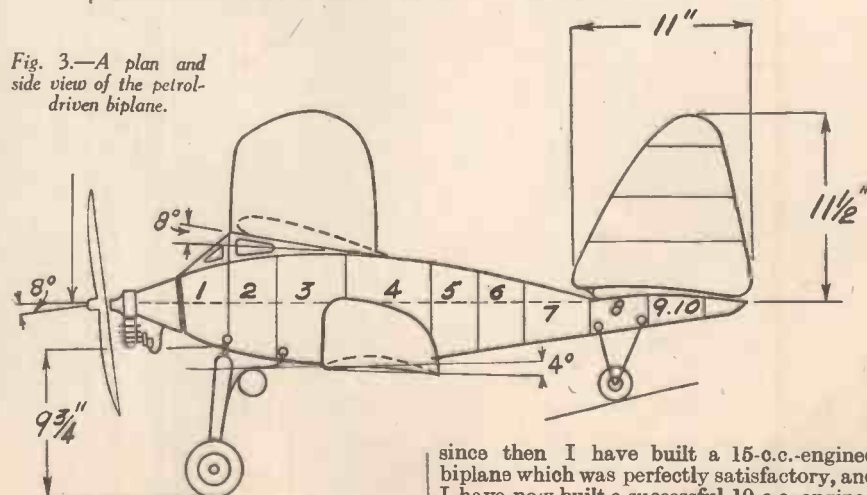


Fig. 3.—A plan and side view of the petrol-driven biplane.



since then I have built a 15-c.c.-engined biplane which was perfectly satisfactory, and I have now built a successful 10-c.c.-engined

biplane, including a number of very stable balsa model biplanes. The only reason I did not use a biplane model when I successfully attacked my own R.O.G. record in 1934 was that I happened to have my most efficient engine fitted to a monoplane at the time.

#### Stability in the Design of a Biplane

Firstly the thrust line should be in the correct position in relation to the combined centre of pressure of the two planes. That is to say that the thrust line should be located on the combined centre of pressure, but must be well above the centre of gravity. The centre of pressure point will of course vary in the case of wings of differ-

sized tail plane than is normally required on a model biplane.

That is to say I set my top plane at a considerable angle of incidence to the thrust line and my bottom plane I set at a very fine angle of incidence to the thrust line, but I heavily "stagger" my bottom plane (move it back to the rear). In this way I get a flying "V" and as soon as the top plane rises too much and commences to stall the bottom plane gains a better angle of lift and pushes the rear of the model up, just in the same way as a tail plane averts a stall on the main plane of a monoplane.

For the purposes of appearance I do not use an excessive positive "stagger" and dispense with a tail, but I use a smallish tail

lower pitched propeller of a lighter weight and symmetrical-shaped blades. This propeller gives a greater thrust at low speeds for the take-off and climb at steep angles. My own propellers are also cast in elektron and weigh about 2 oz.

The engine as delivered from America has a wooden base upon which the lugs on the side of the crank-case and the petrol tank are screwed. In my opinion this is the only disadvantage of this otherwise excellent little power unit. I consider that an engine in a petrol model should be so installed that it will knock off in a crash. [It can be fixed so that it knocks off, complete with its mounting.—Ed.]

It is difficult to design a fixing to do this with the system of attachment provided on the "Brown Junior."

I have two "Brown Juniors" and have tried two different engine mountings. I will briefly describe both so that the reader can use whichever he or she fancies.

Both these mountings fit the same forward bulkhead of the biplane fuselage. They are therefore interchangeable in a few minutes. Both mountings are kept in position on the forward bulkhead by rubber bands. They are thus easily knocked off in a crash, or removable for attention or changing of engines.

No. 1 engine mounting, as depicted in Fig. 4, is an elektron casting. A pattern was made up of wood to the desired shape and sent off to a firm of casting specialists. Several spare mountings were produced for a matter of only a few shillings. This mounting is rather heavy but very strong, and allows the existing petrol tank and mixing-valve type of carburettor to be used, as supplied with the engine.

The engine must be run in its upright position with cylinder uppermost. The back of the casting is bolted to a circular disc of three-ply wood  $\frac{1}{4}$  in. thick. At the rear of this disc is another piece of three-ply wood in the form of a square also  $\frac{1}{4}$  in. thick. This square fits into the forward bulkhead of the fuselage but is not fixed to the fuse-

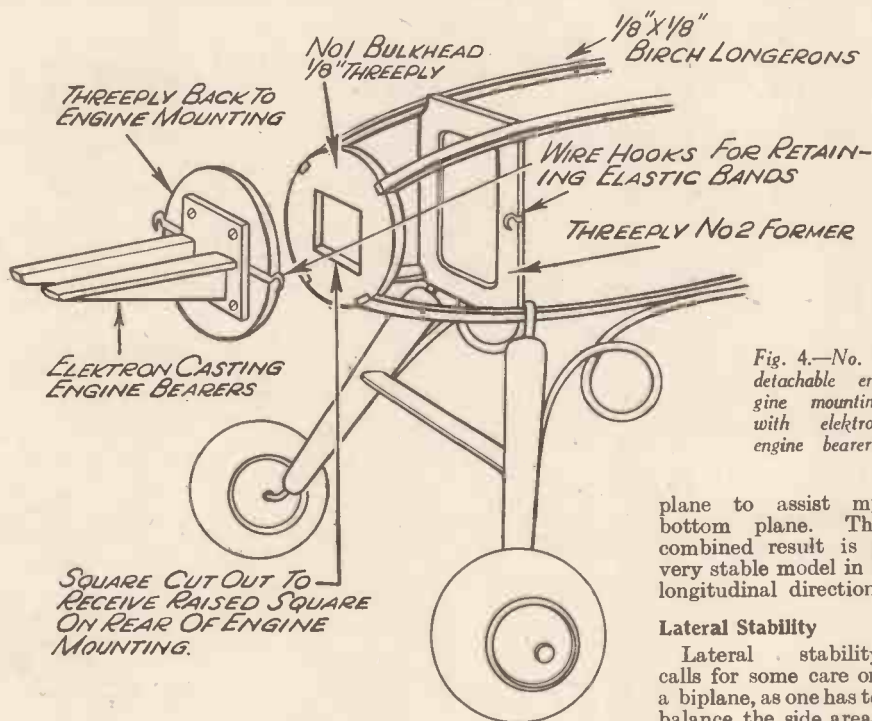


Fig. 4.—No. 1 detachable engine mounting with elektron engine bearers.

plane to assist my bottom plane. The combined result is a very stable model in a longitudinal direction.

#### Lateral Stability

Lateral stability calls for some care on a biplane, as one has to balance the side areas presented forward by

the dihedral angle chosen, with the correct sized fin at the rear. This fin must be large enough to prevent swinging of the model in its initial movement over the ground in the take-off, when the speed of the model is not very great.

In addition the side areas of the fuselage must be considered, and it must be remembered that it is very important to see that these side areas are much greater above the centre of gravity than below. In fact, the greater they are, provided they are balanced fore and aft, the greater the stability laterally.

If the reader will study the side elevation drawing of the biplane shown in Fig. 3, when reading the above remarks on stability, the matter will be more easily followed.

I have named the small biplane to be described, the "Bowden Mouse."

#### The Power Unit

The engine used in this little biplane is the American "Brown Junior" two-stroke, of 10 c.c. It can be obtained in this country complete with coil and condenser from Stuart Turner Ltd., of Henley-on-Thames. Its weight is  $6\frac{1}{2}$  oz., less propeller and mounting. Tank, coil, and condenser are  $5\frac{1}{2}$  oz. As received it is capable of between 4,000 and 5,000 r.p.m. with a suitably low-pitched propeller.

A standard propeller can be obtained for it cast in elektron. This is perfectly satisfactory, although I have made up a slightly

ent area top and bottom, and one must make the correct allowance for this. It will, therefore, be quite obvious that the exact midway position between the "gap" of the two wings will not be correct.

The next point to consider is the location of the tail plane and fin. They must not be blanked by the upward and backward column of disturbed air of the lower plane, and yet the tail plane should be set with its leading and trailing edge in line with a line drawn through the thrust line along the fuselage. This is to prevent any difference in effect on the tail plane whether the engine is running or off, and is a very important point if a good glide is to be obtained after the power has ceased.

It is a fact that a biplane can be made to fly successfully without a normal type tail plane if a very large positive "stagger" is given to the planes, and the bottom plane is given a lesser angle of incidence than the top plane to the thrust line. Actually the bottom plane acts as a large tail plane, and owing to its size is able to obtain sufficient leverage without being set at the end of a long fuselage. An excellent example of this is the little French "Pou-du-ciel" that is causing such a lot of interest both in England and France at the moment. By doing without a tail plane, etc., this little aeroplane is able to be produced very cheaply and in a very light form. I have already used this principle on my model biplanes, and also assisted it by a smaller



Fig. 5.—No. 2 detachable cone type mounting, with the engine inverted. The top wing platform in cabin form and the undercarriage details should be noted.

lage. Wire hooks are placed on the engine mounting and on each side of No. 2 bulkhead of the fuselage. Rubber bands keep the mounting up hard against No. 1 bulkhead of the fuselage, and the  $\frac{1}{4}$ -in. three-ply square prevents the mounting moving round in a circular direction. A glance at Fig. 4 will make the above clear.

(To be continued.)



**SKYBIRD LEAGUE**

# SKYBIRDS

**THE MOST MODERN OF ALL HOBBIES**  
**SCALE MODEL AEROPLANE CONSTRUCTION**  
 New Models and Accessories are always being added.

**NOW READY—**  
 The **HAWKER "HART."**  
 Constructive Set - - - 2/6  
 Assembled and Painted (as illustrated) 7/6

Join the **SKYBIRD LEAGUE**—the League of Aero-Modellers.



Don't fail to visit The **SKYBIRD LEAGUE STAND**—Schoolboys' Own Exhibition, Imperial Institute (S. Kensington). **JAN. 1st to 11th.**

A **SKYBIRD MODEL** of the World-famous **IRVIN AIRCHUTE**  
 Complete with Lines and Parachutist, price 1/-



## SHIPSERIES

A Sister Series to SKYBIRDS.  
 Constructive Waterline Models of Famous Ships and Accessories. Scale, 100 feet equals 1 inch.  
**SHIPS OF THE ROYAL NAVY.** Sets 1/6 to 3/- each.  
**SHIPS OF THE MERCHANT NAVY** Sets 4/6 to 5/- each.

Write for illustrated list and address of nearest agent to:  
**A. J. HOLLADAY & CO. LTD. (Desk P.M.)**  
 3 Aldermanbury Avenue, London, E.C.2.

## "WILCO" XMAS GIFTS



**12/6**  
 Cash or C.O.D. Carriage Paid.

**GEARED MOTORS** that work off 2-6v. Accumulator or 4'5 Battery and give various speed drives are an appreciated Xmas Gift. This latest model, as illustrated, will give lasting service and pleasure. A real precision engineering job. Self-lubricating. Powerful. Gear ratio, 1 to 15, r.p.m. 2,500. Excellent for driving models, etc. Price only 12/6. When used with A **"WILCO" TRANSFORMER**, it is ideal for driving cinemas. The "Wilco" Transformer with speed control reduces 200/250 volts A.C. to 2-8 volts. Capacity 3 amperes. Working costs are negligible. Ideal for driving "Wilco" Motors off the electric mains and lighting up bulbs for use with models, railways, etc. Price 15/6.



**7/9**  
 Post 6d.

**"WILCO" MOTODYNE**  
 Powerful, compact. Serves 3 purposes. As motor for driving models, etc. As dynamo for lighting supply. As power unit for model driving or driving motor boats, 7/9. Larger model at 11/6.

**"WILCO" UNIVERSAL (A.C.D.C.) MAINS MOTORS**  
 The "Wilco" range includes the following models which are supplied geared or not geared:—  
 1/100 h.p. 3-part commutator 21/8 (not geared 17/8)  
 1/50 h.p. 3-part commutator 29/6 (not geared 25/-)  
 1/30 h.p. 8-part commutator 35/- (not geared 30/-)  
 Full details of these Ironclad type motors are given in our New 40-page Catalogue, "P.M."



**2/6**  
 Post 3d.

**MORSE TAPPER**  
 A well-constructed and serviceable Transmitting Key. Adjustable to operator's touch. Terminal connections. Solid polished wood base. Price 2/6. Morse Tapper Set complete with Key, Buzzer, Lamp Bulb and Battery, 4/6.



**14/6**  
 Post Free.

**"WILCO" Super Dynamo.** Strong twin magnets. Lights 6 lamps of 3-5 v., 25 amp. Adjustable brushes. Generates D.C. current. Base 6 1/2 x 4 1/2 in.



**25/-**  
 Carr. Paid

**"WILCO" ELECTRIC GRINDER**  
 The "Wilco" Electric Grinder incorporates a fan-cooled 150 h.p. induction motor with switch and carries fine and coarse grinding wheels. For A.C. 200/230 or 230/250 v.

**NEW 40-PAGE CATALOGUE "P.M."**  
 Over 200 illustrations, many useful gifts and bargains in: Motors, Electric Drills, Meters, Transformers, Cycle Dynamo Sets, etc. 3d. Post Free.

**L. WILKINSON** 8 CITY ROAD LONDON E.C.1

# HOME MOVIES

Ideal Entertainment for Xmas

## SPECIAL OFFER

The "Ace" All-electric Projector for 9'5 mm. Mickey Mouse Films, complete, post free, 37/6  
 9'5-mm. Mickey Mouse Films, 3/9 & 6/6 each.

We also offer a wide range of re-conditioned Home Cine Equipment and Films, and invite your enquiry for our complete free lists.

**Post Free Mail Order Service by return**

No matter what your Movie requirements are, we can give prompt service and delivery of all new makes.

Complete 9'5-mm. and 16-mm. Film Libraries.

Specialists in { **MECCANO, HORNBY TRAINS and FROG AEROPLANES. PHOTOGRAPHIC.**

**EASIEST OF EASY PAYMENTS. PART EXCHANGES**

**THE AMATEUR CINE SERVICE LTD.**  
 P.M. Dept., 52 WIDMORE ROAD,  
 BROMLEY, Kent. Close Wednesdays 1 p.m.


Hours 9 a.m. to 8 p.m.

# FINEST VALUE in CHEMISTRY EQUIPMENT

**HERE ARE TWO EXAMPLES OF THE VALUE WE OFFER**

1 Flask, flat bottom, 150 c.c.; 1 Beaker, spouted, 100 c.c.; 3 Test Tubes, 4 in. x 1 in.; 1 Thistle Funnel, 20 cm.; 3 ft. Glass Tubing; 1 Rubber Cork, 2 holes; 4 Ins. Rubber Connection Tubing; 1 Glass Stirring Rod. **2/6** Post Free

1 Bunsen Burner; 2 ft. Rubber Tubing for Bunsen; 1 Tripod Stand; 1 Wire Gauze with Asbestos Centre; 1 Evaporating Basin, 85 c.c.; 1 Crucible and Lid; 1 Pipeclay Triangle; 1 Filter Funnel, 2 in. diam.; 100 Filter Papers, 11 cm.; 1 Thistle Funnel, 20 cm.; 1 Flask, flat bottom, 150 c.c.; 1 Beaker, spouted, 100 c.c.; 3 Test Tubes, 4 in. x 1 in.; 3 Test Tubes, 5 in. x 1 in.; 1 Test Tube Holder; 1 Test Tube Brush; 6 ft. Glass Tubing; 1 Bone Spatula; 1 Rubber Cork, 2 holes; 1 Glass Stirring Rod. **10/6** Post Free



**SAMPLE PARCELS**  
**2/6 & 10/6**  
 POST FREE

IF THESE SELECTIONS OF APPARATUS ARE NOT WHAT YOU REQUIRE, WRITE FOR OUR CATALOGUE CONTAINING FULL DETAILS OF OTHER SETS FROM 2/6 TO 105/- ALSO DETAILS OF:—

## INEXPENSIVE APPARATUS, CHEMICALS, MINERALS & TEXT BOOKS

A large range of Chemicals in bottles is available from 3d. each. An extensive selection of Laboratory Glass Ware, Stands, Basins, etc., and a new section on Minerals, the whole being supported by a complete section giving full details of up-to-date Text Books.

Write now to: **BECK** (Scientific Dept. A)  
 60 High Street, STOKE NEWINGTON, N.16

**WRITE FOR FREE CATALOGUE**

Also for Booklet of Tested Experiments 6d. (p.o.) post free

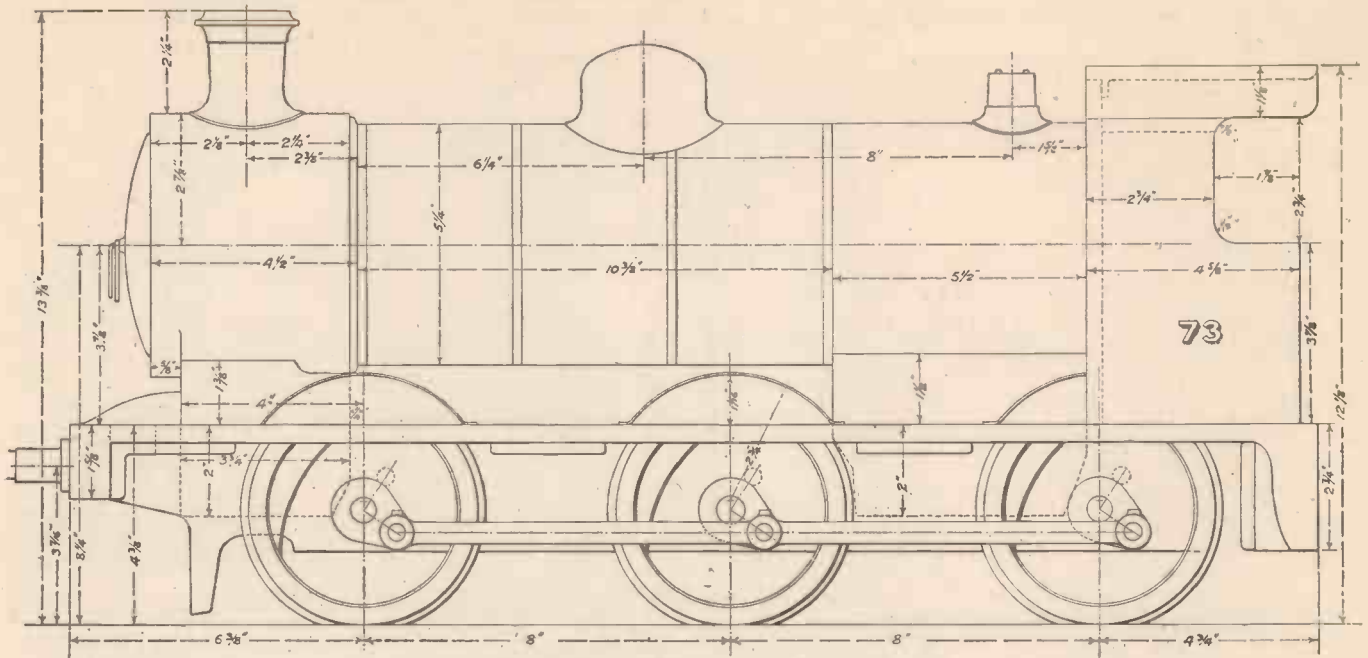


Fig. 4.—The L.N.E.R. engine No. 73.

# A Model Electric Garden Railway

As promised in my previous article of this series, I give here two further designs for the exterior outline of the 1-in.-scale electrically-driven locomotive. The first, Fig. 4, is engine No. 73 of the London and North Eastern Railway, and Fig. 5 the Southern Railway's goods engine No. 316. In all four models, without departing to any noticeable extent from scale, the wheel diameters, distance of axles apart and, in fact, everything below the footplate can be made the same, but the boilers and their mountings, the buffers, and the cabs will differ. No special remarks are called for in connection with the L.N.E.R., but in the Southern, because the boiler is pitched lower, it may be neces-

By E. W. Twining

The Concluding Article on this subject in which are given Two Further Designs for the Exterior Outline of 1-in.-scale Electrically-driven Locomotives

### The Electric Circuits

We now come to the important matter of arranging a place on which can be mounted the switches, etc., which control the operation of the engine. It is obvious that, as the cab space is occupied by the sprockets and chains of the power transmission, there is no room there for the controls, and it becomes a question as to whether these should be put in a tender with an auxiliary truck behind for the driver to ride upon, or the switches should be fixed on the front end of the truck between the feet of the driver.

The first is, of course, the better scheme from the point of view of appearance, but it involves making an additional vehicle.

sary to arrange the wooden platform on which the motor is bolted at a slightly lower level.

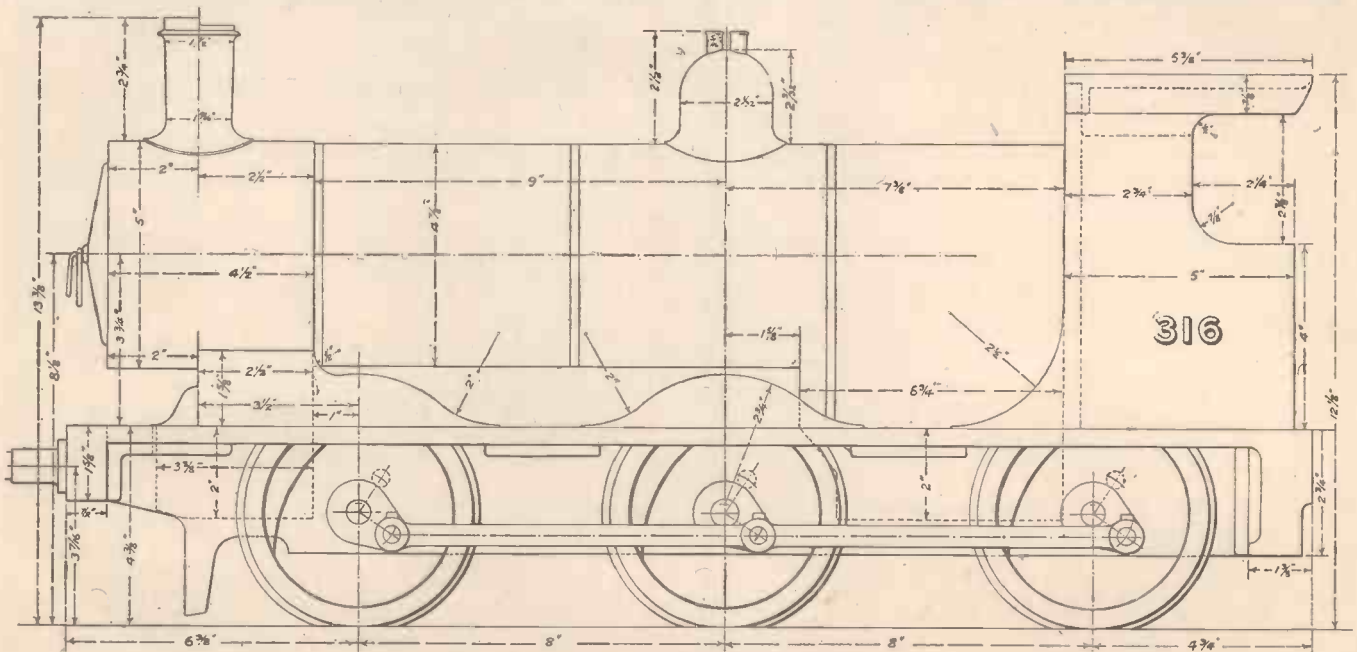


Fig. 5.—The S.R. engine No. 316.



If a tender is constructed the top of what is normally the tank may very well be hinged to give access to switches placed inside. These switches can be at the back of the tender next to the driver's truck. If this scheme is adopted it will be as well to mount the current pick-up brushes on the underneath side of the tender instead of on the engine, and to couple up the electric connections between the engine and tender with flex and two 5-amp. plugs and sockets. The reason why two of these will be required is that as the motor must be made reversible the armature and the field windings of the motor must be taken separately to the switches. The need for this will be explained by referring to Fig. 6, which is made up of two diagrams. In both of these *F* is the field winding, and *A* the armature with the carbon brushes *B, B* shown in contact with the commutator *C*. *D, D* are ordinary double-pole switches which are coupled together mechanically by a bar *b* and form a reversing switch lettered *RS*. These switches are of the ordinary electric-light kind. Besides these there is a single-pole main switch, marked *MS*, which is also of the ordinary 5 amp. pattern.

*VR* is a variable resistance. Such a resistance is quite easy to obtain, but it may be found less difficult to secure the straight sliding pattern than the other, which is fitted with a radial moving lever. It really does not matter which type is employed, except that the lever type is more compact and looks more correct. The Klaxon motors are quite capable of taking the full current load directly from the mains without a starting rheostat or resistance, but the effect on the train would be very sudden, lacking in realism, and would tend to jerk the driver backwards off his seat. Therefore a resistance is advisable so that the train starts up slowly and more naturally.

**Reversing the Motor**

It is, of course, well known that in order

to reverse the direction of rotation of a motor, in which the field winding and the armature are in series, it is necessary to change the direction in which the current flows either through the armature or through the fields. In the case of the locomotive we are going to make it possible to change the flow through the field winding. It is not necessary for me to put into writing the path taken by the current in effecting this as shown in the two diagrams of Fig. 6, but

it will be seen that, although the current is flowing in the same direction in both the diagrams, through the brushes and armature, in the upper one it is passing downwards through the field coil whilst, owing to the change effected by the reversing switch, in the lower one it is flowing upwards; thus the direction of rotation of the armature is altered.

If the current we are using were of a very much lower voltage a more simple switch for

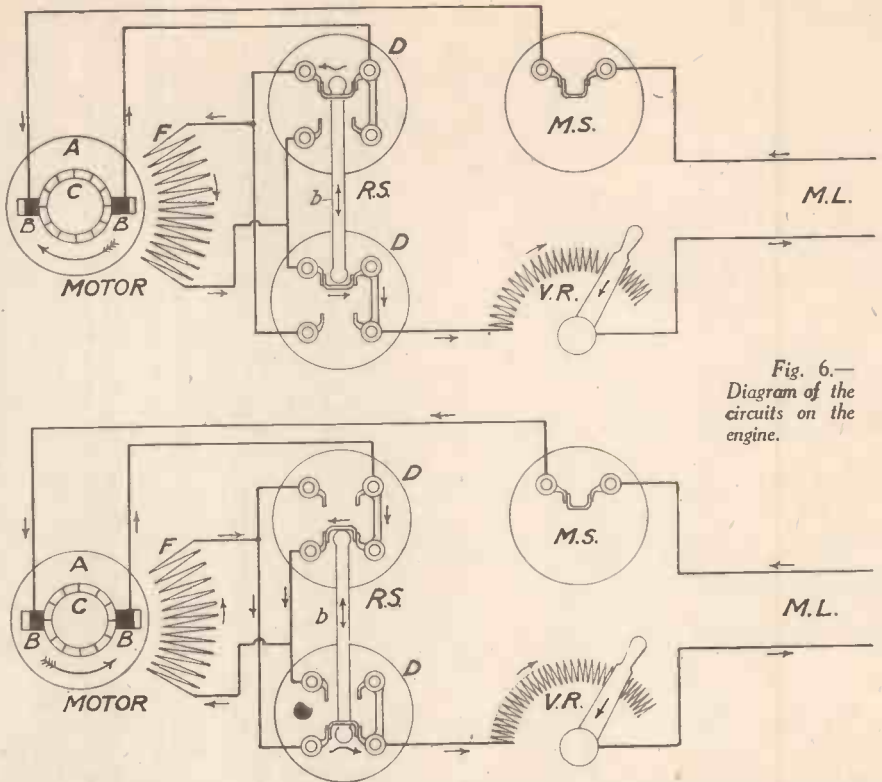
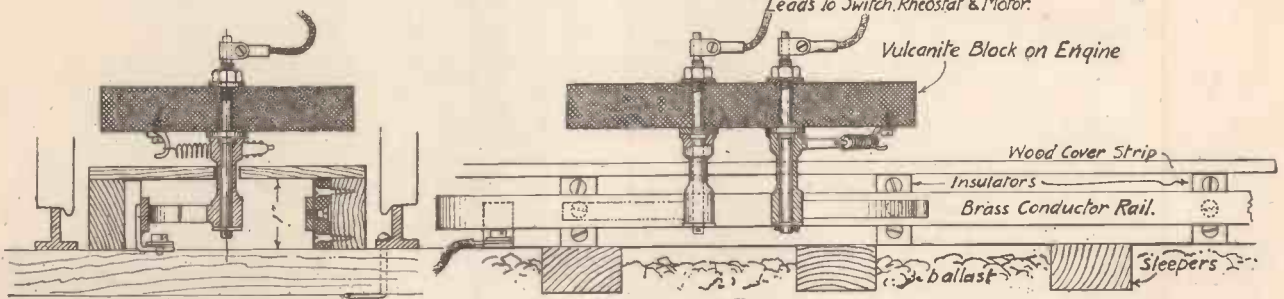


Fig. 6.—Diagram of the circuits on the engine.

**CROSS SECTION**

**LONGITUDINAL SECTION.**



**PLAN.**

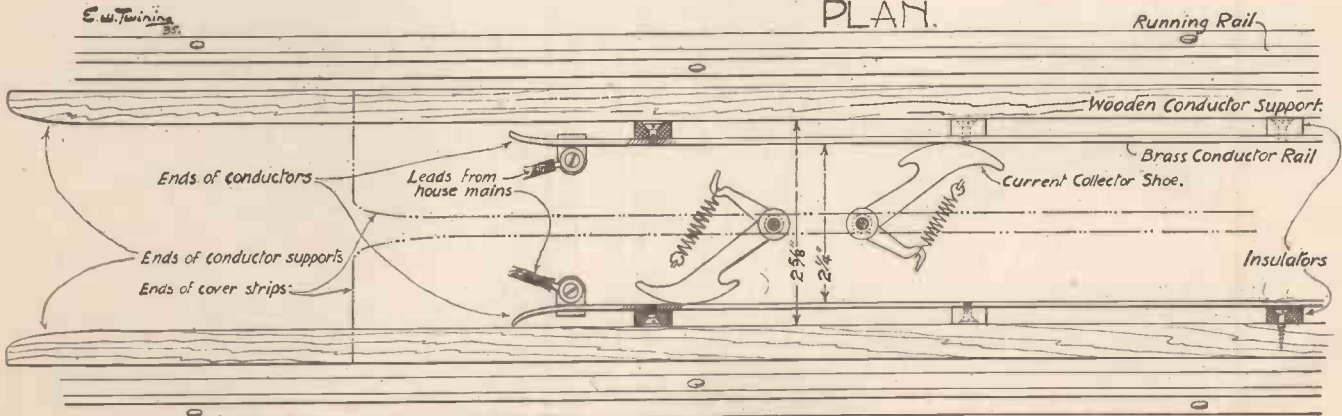


Fig. 7.—The layout for the current conductors and the pick-up brushes which rub upon them.

reversing than the two, which are shown coupled, could be made, but as reversing may perhaps be done whilst the main current is on, we must employ switches having a quick make-and-break. Actually, however, reversing should not be so done and in running the locomotive I strongly advise in every case that the main current be switched off before operating the reversing switch.

In the diagrams *ML* are the main leads which are connected to the terminals on the two current collectors, which rub upon the conductor rails on the track.

#### Permanent Way

For the form and arrangement as well as the method of constructing, and laying of permanent way, suitable for our electric locomotive I must refer the reader to the March 1935 issue of PRACTICAL MECHANICS, in which I showed complete drawings for such a track intended for an engine of the same gauge. The engine in this case, however, was a steam locomotive so that, for our present electric system, we shall need to add the conductor rails to an exactly similar track as that previously shown. As a matter of fact, two different kinds of sleeper for supporting the running rails were shown in the drawings, but either of these will be suitable for receiving the electric arrangement.

In Fig. 7 is shown the layout for the current conductors and the pick-up brushes which rub upon them. In the cross section and the longitudinal section will be seen a block of vulcanite. This is carried rigidly in some suitable manner upon either the engine, the tender, or the truck, as the case may be. Passing through the block are two hard-brass pins secured with nuts. On the lower ends of these pins are bell-crank levers with slender tubular shafts between them, fitting over and being capable of semi-rotary movement about the pins. The longer arms of these bell-cranks are provided with large curved shoes, which are caused to press against the brass strips forming the conductor rails by spiral springs on the shorter arms slipped over hooks, which are screwed into the vulcanite block. The shoes, and in fact the whole of the bell-crank levers,

should be made of hard gunmetal. The upper ends of the pins form terminals on which the leads to the switches are secured by clips, into which the lead flexes are soldered. The brass-strip conductors are carried on small insulators of either ebonite or bakelite. They can be cut from a sheet of this material with a hack saw. These insulators are, in turn, screwed to the upright faces of wooden strips 1 in. high, placed parallel with each other and parallel also with the running rails. The strips should be secured to the sleepers at a uniform distance apart of  $2\frac{1}{2}$  in. between their inner faces.

In order to render the system as safe as possible from electric leakage and absolutely safe as regards accessibility to the conductors by the fingers of children, and perhaps the feet of straying animal pets, it is most essential that the space between the wooden strips carrying the conductors be entirely covered, with the exception of a narrow slot through which the slender tubular portions of the bell-crank pick-ups can pass. The width of such slot is clearly shown in the cross section and plan in Fig. 7. The cover can be of any suitable material other than metal, but I suggest that it be built up with boards of hard wood about  $\frac{3}{8}$  in. thick.

#### The Ends of the Track

Now it is obvious that if the conductor rails were completely covered right up to the ends of the track, or if a complete circle of rail were laid without any break, it would be impossible to place the locomotive—or the truck fitted with the pick-up brushes—on the rails, and so we shall have to provide in the circle or at the ends of the track a space where the brushes can enter the slot. A reference to the plan view will show the arrangement I have devised for making the system safe at the track ends and yet rendering it possible for the brushes to engage with the conductors.

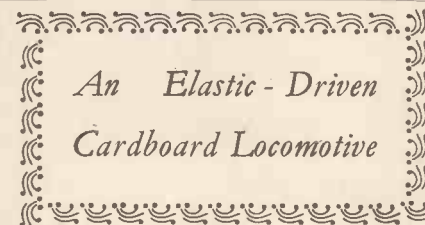
This is arranged by, first of all, terminating the conductor rails, and where they end they are made to splay outwards somewhat. About 3 in. beyond the conductor ends the covered strips terminate; then at about

6 in. beyond this, or perhaps a little more, the wooden supports for the cover also are made to finish and they, too, are cut away on their inner faces so as to give an outward curve. The running rails then continue alone for perhaps 3 ft. without anything on the sleepers between them. It will now be obvious what the procedure with the engine is. Engine, tender and truck are all placed upon the running rails at the track, each coupled together with the coupling links and the plug-and-socket electrical connections, then wheeled gently along the rails until the brushes engage first with the wooden support sides and then with the conductors.

It remains but to mention the connecting-up of the conductor rails with the house mains. To some extent, although this is a most important matter, I shall have to leave this to the reader, for much will depend upon circumstances, such as the situation of the railway in relation to the house. If the reader is not himself an electrician it would be as well to look around amongst one's friends to find out who is fairly well up in electric-lighting work. It is sufficient for me to suggest here that the actual connection to the conductor rails should be as shown in the illustration, Fig. 7, where I have indicated brass angles well soldered to the rail with a cheese-head screw and washer tapped into the angle to serve as a terminal for gripping a loop in the end of flex. This flex should be of the heavy rubber-covered type; twin flex is most convenient. If it is to pass any little distance to the house it should be enclosed in Simplex steel tubing under the ground. It may then be taken, also in steel tubing, up the wall and possibly in through a window frame where it can terminate in a socket. From that point connection can be taken to an ordinary lamp holder by means of a length of household flex with a plug and an adapter to fit into a lamp holder.

All outside woodwork, not only the sleepers but the wooden conductor supports and cover strips, should be thoroughly well coated, preferably two coats, with creosote. This will have to be done before the woodwork is fixed together.

WHEN making a cardboard model of this type it is best to build the engine and tender in one piece, so that we can get the same effect by length and small bulk. This means, of course, that the locomotive would not negotiate a curve, but that is not essential for a simple toy of this type. If the model is made with flanged wheels, which would possibly be adapted from some other broken engine, a straight track laid along the garden path would be quite satisfactory. The rubber mechanism is shown in the sketch below, and it will be seen that there are three skeins, one at the top and two below. Between these latter the propeller shaft will make an angle downwards to the rear coupled axle of the engine where brass bevel gears are fitted. The boiler will, of course, have to be hollow and provided



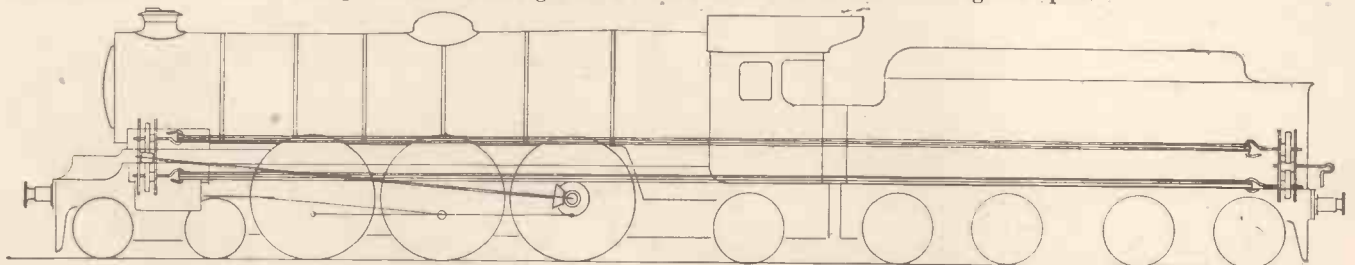
with a slot along the under side to allow of the passage of the rubber into place.

Obviously, the motor must be put in from underneath, although it would be an advantage if the boiler and cab were made to lift off, as also, perhaps, the tender top. In this case the motor can be fixed from above. The hook for winding is on the back of the tender and

may very well be made as shown, with an extension to drop between two pins soldered to the back of the tender tank.

#### Negotiating a Curve

If it is desired that the engine with its train should be capable of negotiating a curve it is suggested that instead of fitting the motor to the locomotive, the first coach next to the engine should be used for driving the train, in which case the locomotive would be a dummy and be pushed in front of the power-driven unit. Of course, the coaches of a train are longer over the buffers than the engine and tender which pulls them, except perhaps the big "Pacific" types, so that actually it is possible to get a larger power unit into a coach than into an engine; moreover, there is no restriction as regards space.



The finished model, showing details of the mechanism which carries the elastic motor.

# WOODWORKING FOR BEGINNERS

*The First Article of a Short Series*

**American Hammer.**—A hammer having a claw for withdrawing nails, etc. (See also Hammers.)  
**American Whitewood.**—A hardwood grown principally in Canada and the Eastern

gymnastic apparatus, and (when having a more wavy grain) for veneers. Ash is sometimes mistaken for oak, due to its being of similar density and having a

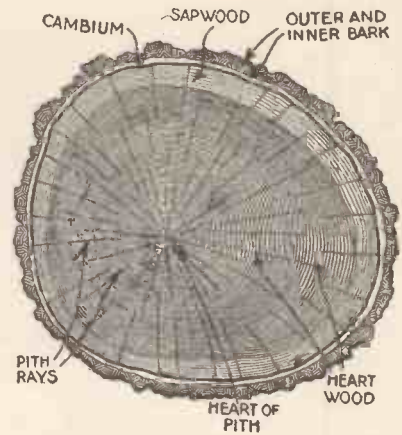


Fig. 1.—Cross-section through the trunk of a timber-bearing tree, showing its formation.

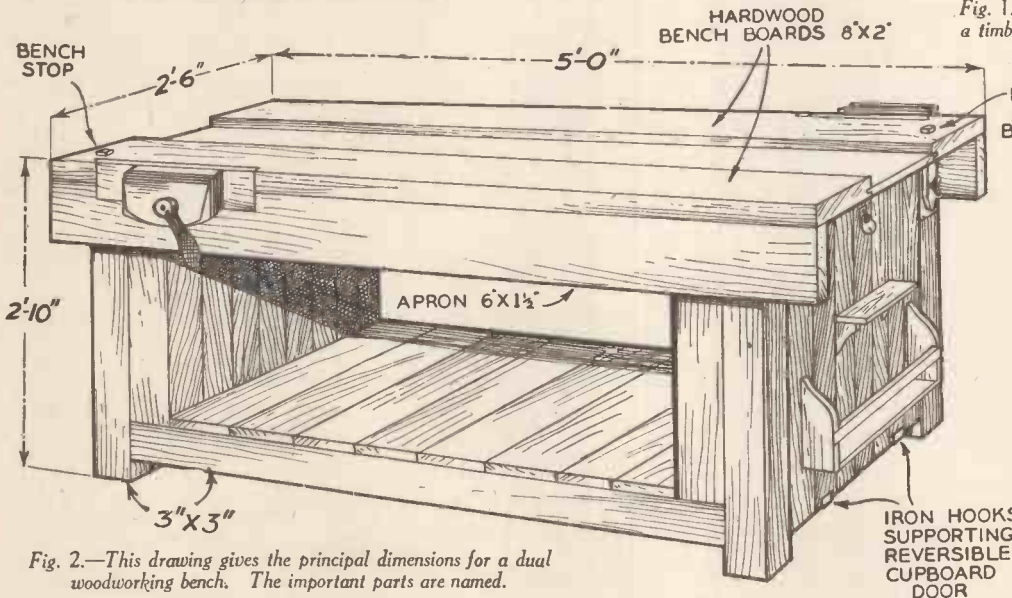


Fig. 2.—This drawing gives the principal dimensions for a dual woodworker's bench. The important parts are named.

Beech is very hard and heavy and takes a very high polish. It can be turned easily and is extensively used for turned objects like chair-legs. Although very durable when subject to either dry or wet conditions, rot very soon sets in if humidity is varied. An acid is contained in the wood which corrodes iron, and therefore fixings of the latter metal should never be used. The timber is often attacked by worms which bore holes into it. The beech tree is large, having a circumference up to 12 ft., and thus the wood can be obtained in wide boards.  
**Bench.**—Any woodworker's bench must essentially be rigidly constructed, and the most convenient height is one equal to approximately half

the height of the worker. (See Fig. 2.)  
**Bench Hook.**—Sometimes called a sawing board. Consists of a flat board of beech to which a lath is attached to each end on opposite sides. The hook thus fits on the edge of the bench and is used to hold boards of wood whilst sawing. (See Fig. 3.)  
**Bench Stop.**—A projection formed on the top of a bench and used to hold lengths of timber whilst planing. The simplest (and perhaps the best) form of bench stop consists of a slightly tapered length of hardwood some 2 in. square, which fits

States of America. Of yellowish brown colour and having a slightly green tinge, this wood is very widely used for cheap furniture and other articles not subject to exposure to the weather. It is close grained, takes on a good finish, and can be stained and varnished to produce an excellent appearance. Must be carefully seasoned to prevent warping and splitting at the ends of boards. Can be obtained in most widths up to 12 in. or so. Besides the above name it is variously referred to as canary wood, lime-tree, white lind, and yellow basswood.  
**Annual Rings.**—The rings to be seen on the cross section of a tree trunk. One is formed each year, and thus the age of the tree can be determined from the number of concentric rings. (See Fig. 1.)  
**Arkansas Stone.**—A natural stone used for sharpening tools. It cuts quickly, wears evenly, and produces a fine, keen edge. For the latter reasons it is especially suitable for sharpening surgical instruments. Arkansas stone is rather expensive, and for that reason is not used very widely now that "artificial stones" of almost equal quality can be obtained so much more cheaply. (See Oilstones.)  
**Artificial Seasoning.**—See Seasoning of Timber.  
**Ash.**—A British-grown hardwood having a particularly straight grain and being fairly flexible. It may be either pinkish white or light brown in colour, and is widely used for making tool handles, wooden wheels, agricultural implements,

rather similar grain; it is, however, somewhat lighter in colour, and the medullary rays are not so clearly marked on the cross section.  
**Auger Bit.**—A twist bit used for woodworking. Its point is screwed like the end of a gimlet. Suitable for drilling in every direction; that is, either with, across, or down the grain. (See Bits.)  
**Basswood.**—Also called American white-wood. (See under that heading.)  
**Beech.**—A British-grown hardwood, pale straw coloured, and very close grained. It has a particularly uniform texture and is therefore very suitable for the making of plane stocks, for which purpose it must wear away with perfect evenness.

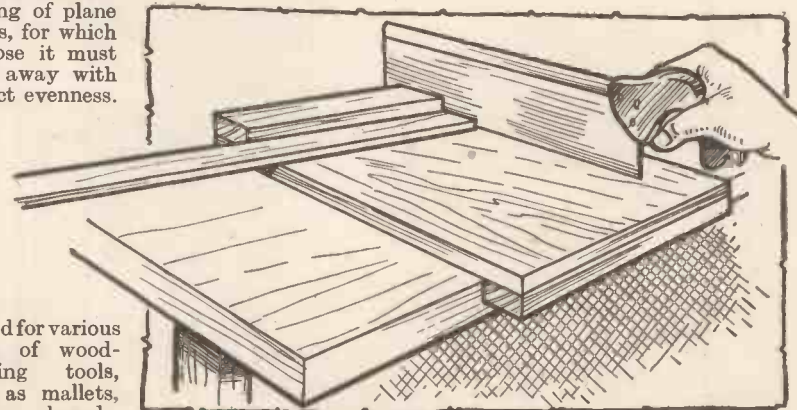


Fig. 3.—This sketch shows how a bench hook is used.

is used for various kinds of woodworking tools, such as mallets, sawing boards, bench stops, etc.

into a corresponding hole in the bench top. Other more elaborate, but less reliable, forms of benchstop are operated by means of a large

Fig. 4.—A slide bevel.

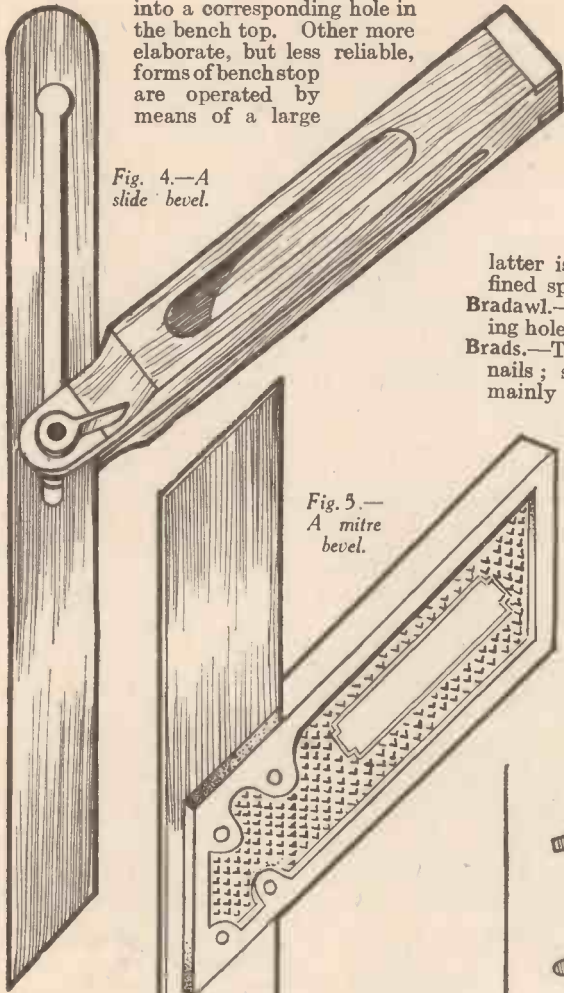
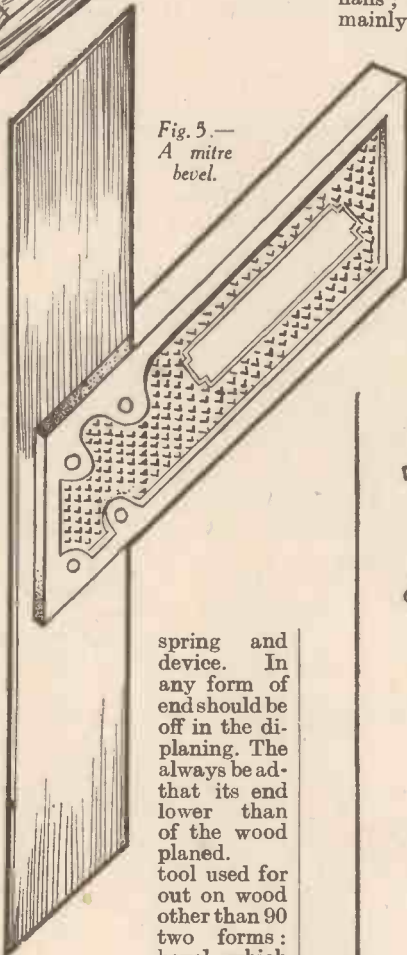


Fig. 5.—A mitre bevel.



cam or locking device making stop the bevelled rection of stop must justed so is slightly the surface being

**Bevel.**—A marking angles degrees. In the mitre has the 45 degrees to the stock, and the slide bevel, with which the blade may be adjusted to any angle.

The name is also used to describe a sloping surface formed on a piece of wood. (See Figs. 4 and 5.)

**Bevelled-Edge Chisel.**—Also called paring chisel. (See Chisels.)

**Birch.**—A straight-grained hardwood which is extremely tough and able to withstand hard wear and tear. Of light or reddish brown colour, the wood is used for various kinds of furniture and work-benches, whilst it is excellent material for the wood-turner.

**Bits.**—These are made in a wide variety of kinds, among which are: centre bits (used for boring across the grain), shell bits (for small diameter holes, either with or against the grain), auger bits (see under this heading), countersink or rose bits (for countersinking for screw heads, etc.), and reamers.

spring and device. In any form of end should be off in the displaning. The always be ad- that its end lower than of the wood planed.

tool used for out on wood other than 90 two forms: bevel which blade set at

(See Figs. 6 to 8 for various types.)

**Bow Saw.**—Consists of a wooden framework which holds a narrow blade. Is chiefly used for cutting exterior curves. (See Saws.)

**Brace.**—A tool for holding and turning a bit. Can be obtained with either plain or ratchet chuck. The

latter is useful when working in a confined space or in corners.

**Bradawl.**—An awl or pricker used for making holes for nails (or brads).

**Brads.**—The old-fashioned name for nails; still used for cut brads which are mainly employed for nailing down flooring boards, and for the usual kind of oval nails. (See Nails.)

**Bull-Nose Plane.**—A small plane, generally with metal stock, used for working in corners. The edge of the blade comes almost up to the front end of the plane, and there is no mouth as with most kinds of planes: (See Planes.)

fastening together two parts of a wooden framing at right angles. It may be considered as the opposite of a mortice and tenon joint. The proportions of the joint are the same as those for a mortice and tenon; that is, the thickness of the wood is divided into three equal parts. A bridle joint is useful when the horizontal member is subjected to the greater strain, but the upright one is very much weaker due to the fact that two-thirds of its thickness is cut away.

**Canary Wood.**—See American Whitewood and Basswood.

**Cap Iron.**—The iron which fits against the face of the cutting iron of a plane. It should always be adjusted so that its edge is the correct distance back from the edge of the cutting iron. This distance depends upon the hardness of the wood being planed and varies from  $\frac{1}{4}$  in. for pine and deal to under  $\frac{1}{2}$  in. for beech or English oak. (See Planes.)

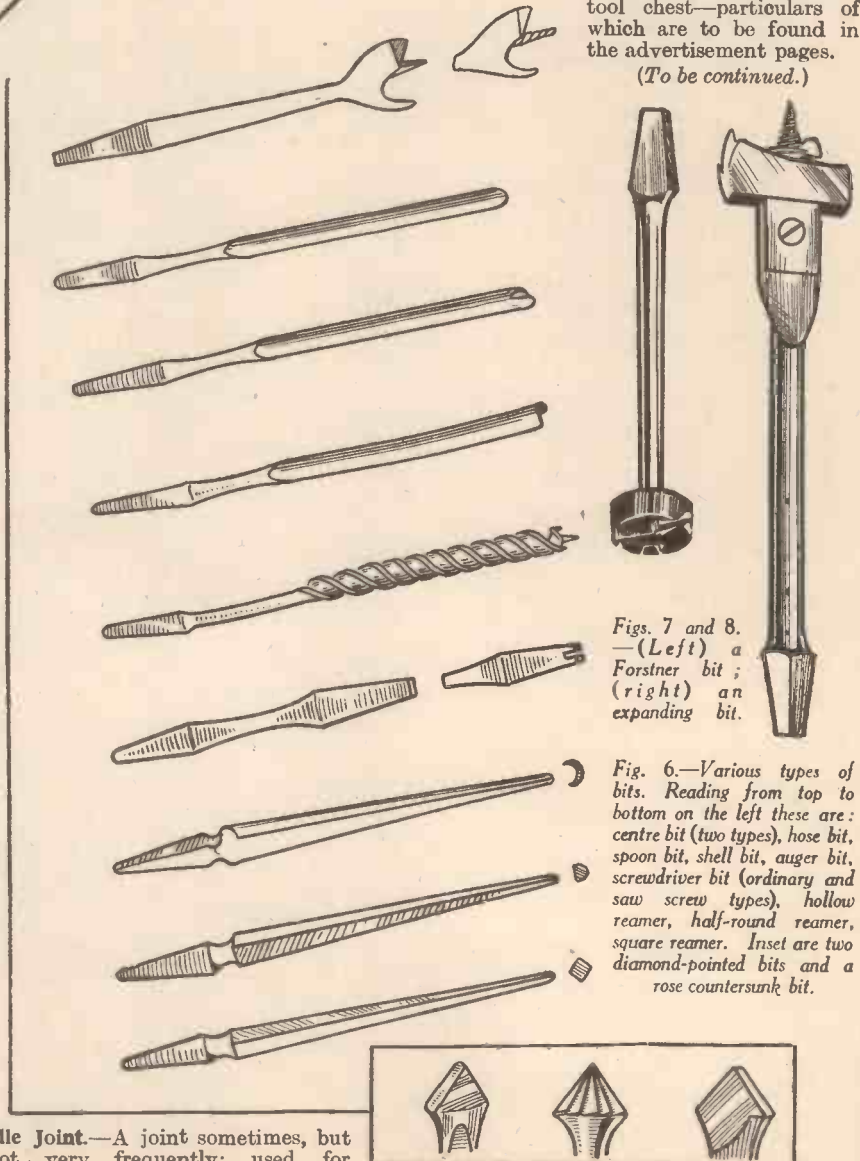
**Carborundum.**—An artificial oilstone obtainable in all grades at prices between sixpence and a shilling per pound. It is quick cutting and does not easily clog. (See Oilstones.)

**Centre Bit.**—See Bits.

Most of the tools described in this series of articles are to be found in Messrs.

Guaranteed Tools splendid tool chest—particulars of which are to be found in the advertisement pages.

(To be continued.)



Figs. 7 and 8.—(Left) a Forstner bit; (right) an expanding bit.

Fig. 6.—Various types of bits. Reading from top to bottom on the left these are: centre bit (two types), hose bit, spoon bit, shell bit, auger bit, screwdriver bit (ordinary and saw screw types), hollow reamer, half-round reamer, square reamer. Inset are two diamond-pointed bits and a rose countersunk bit.

**Bridle Joint.**—A joint sometimes, but not very frequently; used for

# MAKE EXTRA MONEY IN YOUR SPARE TIME!



**Finest Sheffield Tools**  
 ONLY are included in the New and Improved G.T.L. Tool Chest, making it better value than ever.  
**ALL BEST BRITISH**

## With the NEW AND IMPROVED **G.T.L. TOOL CHEST** and Home Repairing Outfit

**Y**OUR spare time, during the present long winter evenings, can be turned to good account if you've a G.T.L. Tool Chest and Home Repairing Outfit. With it you can make a thousand-and-one useful articles for your home and garden, and it opens up a new and inexpensive way of adding to the comfort, convenience and amenities of your property, while saving you literally pounds a year in repairs for which you would otherwise have to pay. Incidentally, it also affords a new, pleasurable way of adding to your income by making articles to sell. So that—with a G.T.L. Tool Chest—instead of spending money in your leisure hours, you will be making it, saving it and enjoying it!

### NO EXPERIENCE NEEDED

A valuable **FREE BOOK OF INSTRUCTION**, containing over 200 working illustrations, is included in the G.T.L. Tool Chest. If you have never handled a tool, you CAN be sure of immediate success because this book tells you what to make and shows you step-by-step how to make it.

### The New and Improved G.T.L. Tool Chest

The new G.T.L. Chest for 1935 has been vastly improved by the inclusion of additional Tools and improvements to existing ones. Now there are over fifty high-quality articles, all the finest Sheffield Tools, neatly fitted in steel clips, and they come to you direct from the manufacturers after being carefully tested. Everything for every purpose is here, and the G.T.L. Tool Chest stands alone in its quality, completeness and arrangement. This Chest is the original and only G.T.L. Guaranteed Tool Chest.

### A Few Shillings brings you the G.T.L. Tool Chest on 7 Days Approval at once

A first payment of a few shillings and the G.T.L. Tool Chest is sent at once to your Home CARRIAGE PAID and packing free. The balance can be paid by small monthly sums to suit your pocket; meanwhile the G.T.L. Tool Chest is making money for you.

**FREE** To Readers of "PRACTICAL MECHANICS"

A Beautiful 16-page BROCHURE describing the G.T.L. GUARANTEED TOOL CHEST and Home Repairing Outfit in detail, and telling how you can save and make money—as tens of thousands of others are already doing.

**POST THIS COUPON NOW**

To **GUARANTEED TOOLS (1933) LTD.**, 12-13 Chiswell St., London, E.C.1

Please send me by return, free of all cost and obligation, your beautifully illustrated booklet of the G.T.L. Guaranteed Tool Chest and Home Repairing Outfit, together with particulars of price, and how I can obtain it at once for a small first payment. (PLEASE WRITE CLEARLY.)

Name .....

Address .....

P.M. 2/35.

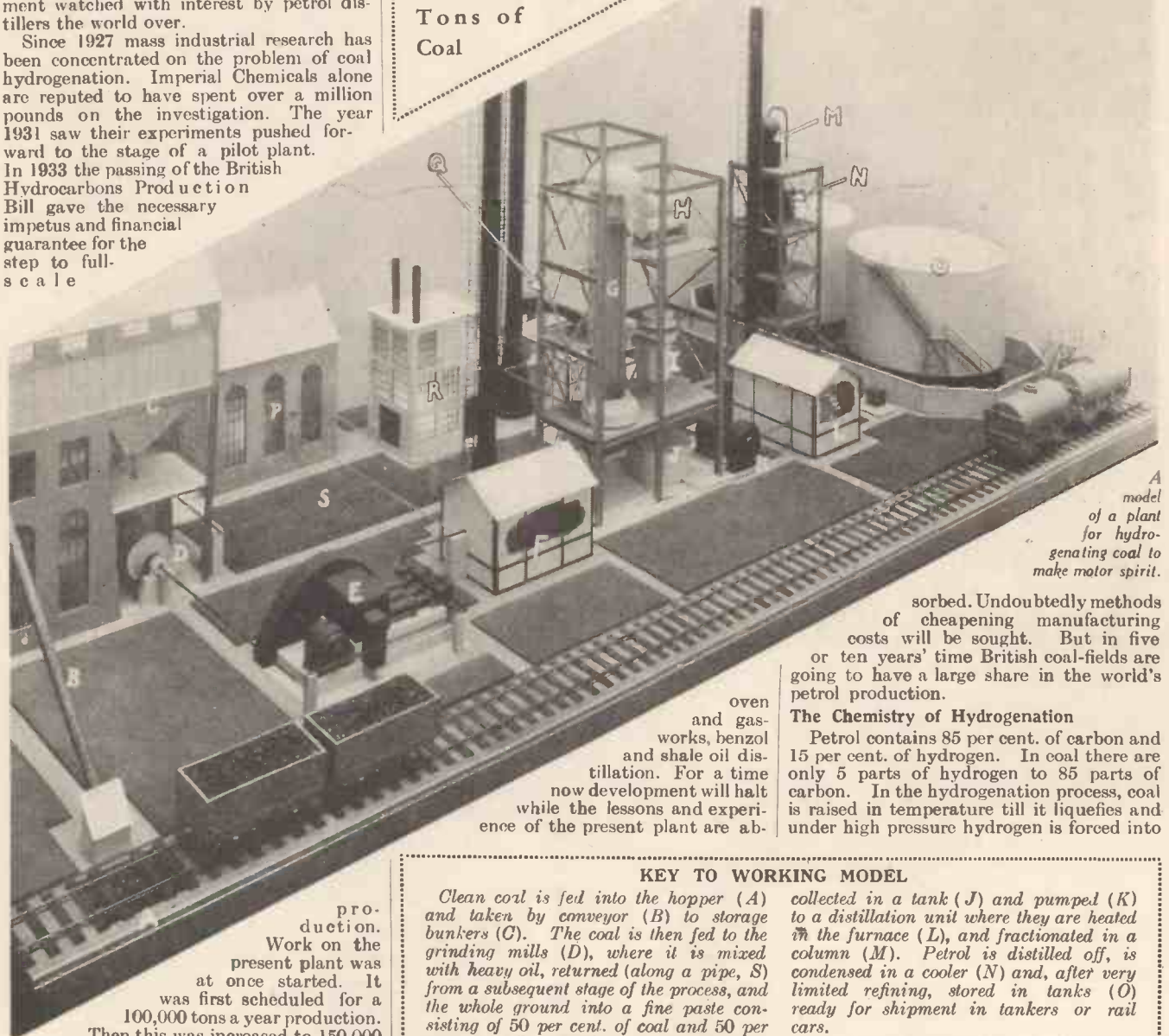
¼d. stamp is sufficient if in an unsealed envelope.

# PETROL FROM COAL

**T**HE official opening of the coal hydrogenation plant of Imperial Chemical Industries at Billingham-on-Tees, is an outstanding event in the industrial history of this country. It marks the beginning of an entirely new British industry. It is a vast commercial experiment watched with interest by petrol distillers the world over.

Since 1927 mass industrial research has been concentrated on the problem of coal hydrogenation. Imperial Chemicals alone are reputed to have spent over a million pounds on the investigation. The year 1931 saw their experiments pushed forward to the stage of a pilot plant. In 1933 the passing of the British Hydrocarbons Production Bill gave the necessary impetus and financial guarantee for the step to full-scale

The Present Output of Petrol from Coal is 123,000 Gallons a Day, Obtained from Over a Million Tons of Coal



A model of a plant for hydrogenating coal to make motor spirit.

sorbed. Undoubtedly methods of cheapening manufacturing costs will be sought. But in five or ten years' time British coal-fields are going to have a large share in the world's petrol production.

## The Chemistry of Hydrogenation

Petrol contains 85 per cent. of carbon and 15 per cent. of hydrogen. In coal there are only 5 parts of hydrogen to 85 parts of carbon. In the hydrogenation process, coal is raised in temperature till it liquefies and under high pressure hydrogen is forced into

oven and gas-works, benzene and shale oil distillation. For a time now development will halt while the lessons and experience of the present plant are ab-

production. Work on the present plant was at once started. It was first scheduled for a 100,000 tons a year production. Then this was increased to 150,000 tons taking in not only coal hydrogenation, but hydrogenation of low temperature tars and creosotes. On these latter materials it started up in February of this year. In two years from the start of work in June, the coal unit came into full production.

The present output is 123,000 gallons a day. That is 45 millions of gallons a year, using over a million tons of British coal, providing employment for 2,000 miners and 2,000 plant operatives.

The present figure is only 4 per cent. of our total annual production of petrol. But it equals in amount all home produced spirit from all other sources, including coke

## KEY TO WORKING MODEL

Clean coal is fed into the hopper (A) and taken by conveyor (B) to storage bunkers (C). The coal is then fed to the grinding mills (D), where it is mixed with heavy oil, returned (along a pipe, S) from a subsequent stage of the process, and the whole ground into a fine paste consisting of 50 per cent. of coal and 50 per cent. of oil. High-pressure paste injectors (E) force this paste against a pressure of 3,700 lb. per square inch (250 atmospheres) into the converter system, and at this point it joins the hydrogen, which has been manufactured, purified, and compressed in the plant (P). The two are heated together in the pre-heater (F) to the reaction temperature of 450° C. The reaction takes place in the special heavy steel forging, or converter (G). Most of the products and gas pass overhead from the converter, through a cooler (H) to a catchpot (I), where the condensed mixed oils separate from the uncondensed gases. The former are

collected in a tank (J) and pumped (K) to a distillation unit where they are heated in the furnace (L), and fractionated in a column (M). Petrol is distilled off, is condensed in a cooler (N) and, after very limited refining, stored in tanks (O) ready for shipment in tankers or rail cars.

The heavy fractions (S) are returned to the process, part being used as pasting oil in the coal mills (D) and the remainder hydrogenated further so that only petrol is finally produced. Going back to the converter (G), a heavy residual sludge including all the coal ash is purged off the bottom of the system and passed to a sludge plant (R), where as much oil is recovered as possible and the remainder made into solid fuel for burning under boilers. The uncondensed gases separated in the catchpot vessel (I) are treated to recover all the available hydrogen, and the balance, consisting chiefly of hydrocarbon gas, returned to the hydrogen plant (P).

combination. The yield of petrol is nearly 70 per cent. by weight. Low-temperature tar and creosote, intermediate products of the distillation of coal, hydrogenate in a similar way and give a 90 per cent. yield. Hydrogen for the process is made by the decomposition of steam over red-

hot coke. The coke originally comes from carbonisation of coal in coke-oven batteries. Petrol is therefore made from coal and water in a straight clean process without by-products.

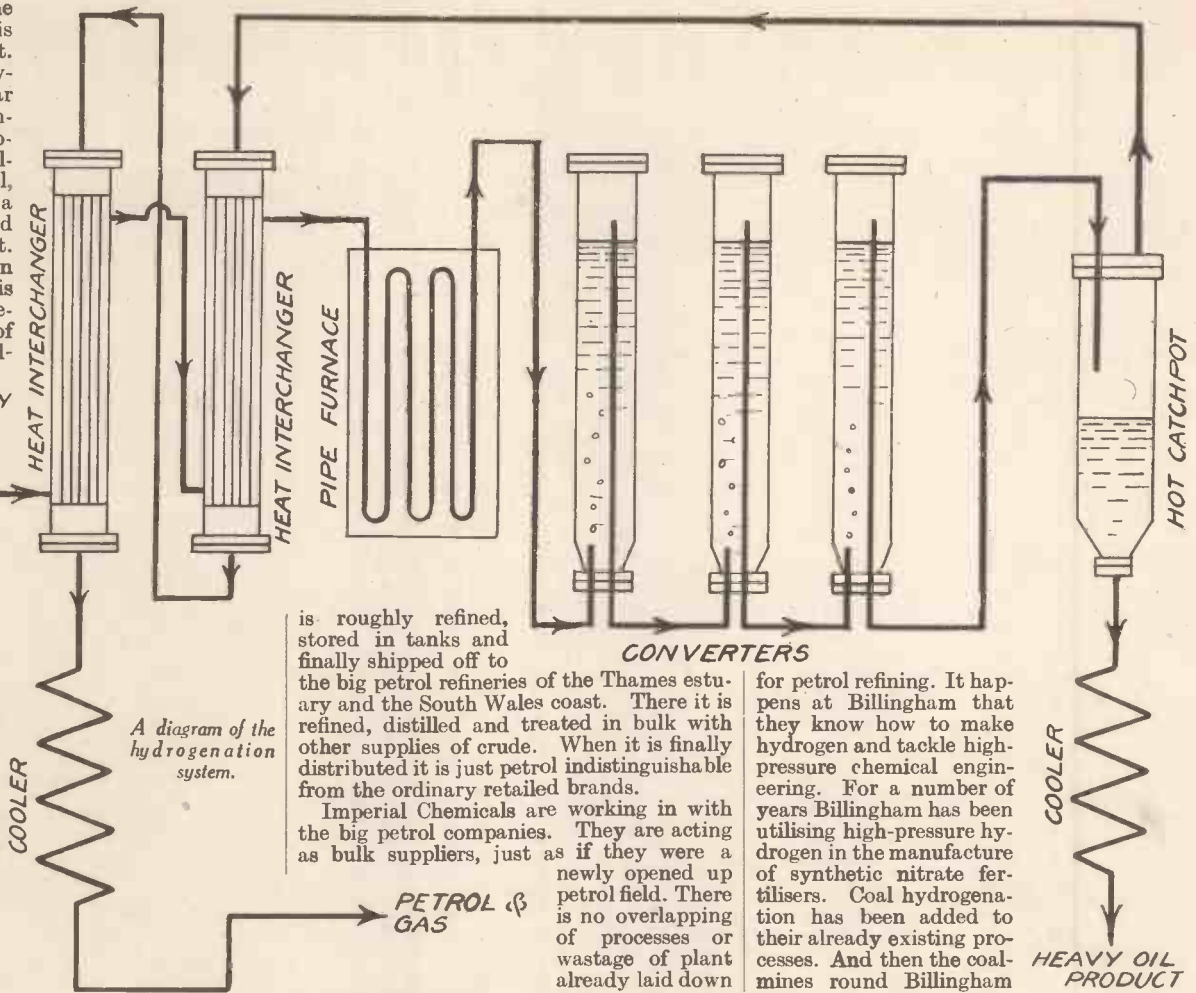
The Process Described  
Coal from the pits is first rigorously cleaned free from dirt and shaly inclusions. Dirt represents so much inert matter useless in the process. The final coal going to the plant is down to 2½ per cent. of ash. It is dried, rough crushed, then pulverised and ground up with oil. This gives a slurry which can be pumped and handled as a liquid. The oil for making up the slurry comes from the end stage of the process. The mixture is then injected with compressed hydrogen against the working pressure which amounts to nearly a ton and a half per square inch. The mastery of the high pressure technique required for the process has been one of the greatest engineering triumphs of the venture.

The mixture is then raised in temperature, first by heat interchange with products coming out of the converters, finally in gas-fired pipe furnaces. A temperature of 875° F. is reached and the coal liquefies. From the pipe stills the now liquid mass passes into the bottom of the converters, huge solid forged vessels 70 ft. or 80 ft. in height. As it flows up these hydrogenation goes rapidly forward, the coal mass undergoes the transformation to petrol and oil. Then follows the resolution of the mixture stage by stage. Heavy oil comes out first, followed by middle diesel oils, petrol and finally permanent gases. These gases are passed back as a further supply of hydrogen to effect more hydrogenation. Some heavy oil is passed back for making up fresh coal slurry. The rest of the heavy oil is hydrogenated and cracked down to petrol and middle oils. All middle oil fractions are gathered together and hydrogenated again to petrol. Thus by persistent reaction a final bulk yield of petrol is assembled which

is roughly refined, stored in tanks and finally shipped off to the big petrol refineries of the Thames estuary and the South Wales coast. There it is refined, distilled and treated in bulk with other supplies of crude. When it is finally distributed it is just petrol indistinguishable from the ordinary retailed brands.

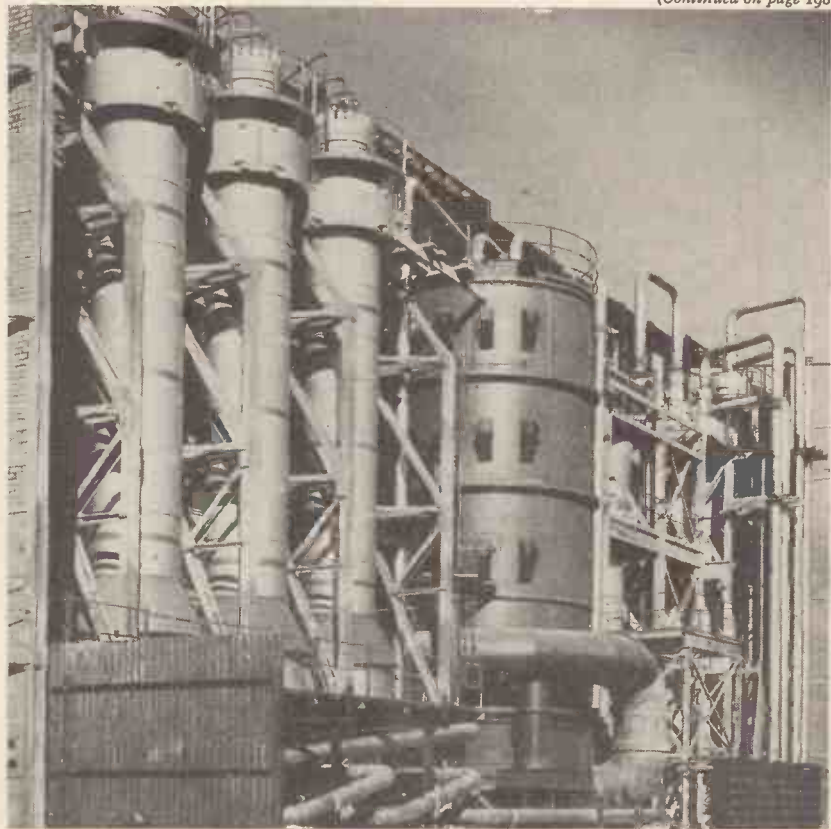
Imperial Chemicals are working in with the big petrol companies. They are acting as bulk suppliers, just as if they were a newly opened up petrol field. There is no overlapping of processes or wastage of plant already laid down

for petrol refining. It happens at Billingham that they know how to make hydrogen and tackle high-pressure chemical engineering. For a number of years Billingham has been utilising high-pressure hydrogen in the manufacture of synthetic nitrate fertilisers. Coal hydrogenation has been added to their already existing processes. And then the coal-mines round Billingham



A diagram of the hydrogenation system.

(Continued on page 198)



High-pressure vessels termed "converters," where the coal is hydrogenated.

## PETROL FROM COAL (Continued from page 197)

supply a type of coal which is perhaps the best in the world for hydrogenation.

## Other Plant

British coal hydrogenation is a subject of world-wide interest. Since the war the increase of motor transport, the extended use of liquid fuel at sea, the coming of the aeroplane, have required larger and larger supplies of petroleum. And there have been no really outstanding discoveries of petrol fields to balance up supply against

future demand. Petrol producers are already economising supplies by cracking down heavy oil and by utilising the casing head gas from the wells. In 1931 a combination of hydrogenating interests formed an international patents pool. Included were the I.G. in Germany, the Standard Oil Company of America, the Royal Dutch, Shell Mex and Imperial Chemicals. The I.G. at their Leuna works have been operating a thousand million gallons a year plant successfully making petrol from the brown

coal or lignite which makes up the bulk of German fuel supplies. The Standard Oil Company have been hydrogenating crude oil in America for some time. Now we have the development of British bituminous coals. Billingham is the first plant in the world to make petrol from bituminous coal. Petroleum interests watch the process closely.

In fifty years' time or less Britain instead of relying on foreign supplies of oil may be one of the bulk suppliers.

AMONGST all the various weapons or mechanical devices of savages, none has probably aroused greater interest than the boomerang. Simple as it looks it has had almost miraculous powers attributed to it. Why? Because it is able, so it is said, to describe the most wonderful figures and curves in the air; to hit the object aimed at (a bird, say) and return to the thrower, to circle round a tree or building and to return to the sender, or to circle round the thrower and fall back behind him. Now, whatever the boomerangs of the native Australians could do (and they are of very crude construction)

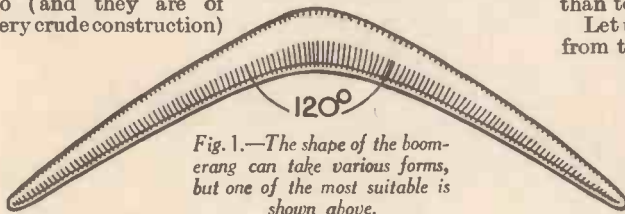


Fig. 1.—The shape of the boomerang can take various forms, but one of the most suitable is shown above.

there is no difficulty whatever in constructing boomerangs that will perform all the feats mentioned above, all save one, no boomerang has or ever will be made that can hit the quarry squarely and return to the sender.

The boomerang can take many forms, but one of the best is shown in Fig. 1. It is made of a thin piece of hard, tough wood, left flat on one side but rounded on the other, with sharpened edges and rounded ends, and bent in the middle in its own plane at an angle of about 120 degrees.

The greatest thickness should be about  $\frac{1}{4}$  in., length, 2 ft. to 2  $\frac{1}{2}$  ft., greatest breadth about 1  $\frac{1}{2}$  in. Instead of being steamed and bent to the required angle, two pieces neatly mortised together may be used or it may be cut out of plywood, but the first method is the best. Now in order to experiment with such a weapon, a large open space is necessary. Hurlled horizontally, or approximately so, through the air, in such a manner as to rotate rapidly, in calm air, not in a wind—its flights will fascinate you. It is an ideal boomerang.

## A Simple Boomerang

Let us begin, however, with something simpler. Cut from a piece of thinnish cardboard, such as an old postcard, the shape of a boomerang, as shown in Fig. 1, stick one end beneath your left thumb nail, flick or snap it with your right forefinger, and send it flying across the room. Choose a large room free from obstacles or an open space on a calm day.

When it has reached the end of its flight, what does it do? It starts to return. In order to do this successfully it must be spinning rapidly in its own plane; if it begins to wobble, the air resistance commences to stop it.

Once started it will keep on skimming through the air edge first until the energy put forth in sending it is used up.

But why does it return to the sender?

## The Boomerang Explained

By V. E. Johnson, M.A.

How it is used and why it circles in the air and returns to the thrower.

Simply because it is easier for it to do that than to do anything else.

Let us suppose it has flown out from the sender in the half of a

sweeping oval curve, at an angle of 20 degrees to the horizontal, and has duly arrived at the highest point of its flight. The force which has sent it so far, against gravity and air resistance has

been used up but it is still spinning. It is still a gyroscope or spinning-top.

Gravity or the attraction of the earth, which has never ceased to act on it, now has the upper hand and it commences to fall. It slides down the same plane by which it went up. To go in any other direction it would have to change its plane (of rotation), but its spin (following Newton's First Law of Motion) will prevent this; it therefore tends to return in the direction of the thrower. The curved or crescent shape greatly assists in producing that "spin" which is essential to success.

Any boomerang must, of course, be thrown from one end in order to give it "spin." Hold by the fingers underneath and the thumb on top, the greater the spin the more successful the flight. Some very interesting experiments can be made with a boomerang shaped like a cross (Fig. 2) and of dimensions shown. You can construct it of thick cardboard, or thin plywood is much better—preferably the edges should be sharpened, and one side "rounded" and the other kept flat—throw it with rounded side uppermost, but unless thrown vertically grasp it at A between the fingers and thumb of the right hand, holding it nearly horizontal with the arm extended across the body towards the left, and hurl it away towards the right, i.e. throw it forward across the body from left to right.

Note carefully which way it "curves away."

## Spin Essential

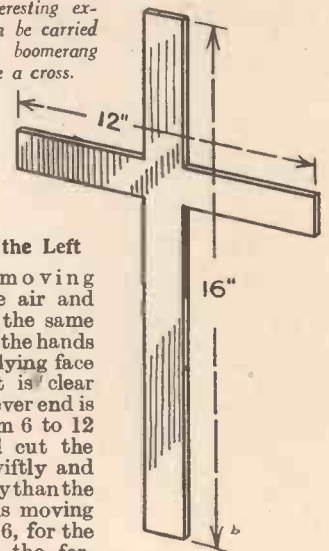
Hold it as before and, supposing you wish to send it in the same direction as before, turn the body through a semicircle and this time throw it across the body from right to left. When interesting flights are desired it should not be thrown too violently, a sharp jerk with the wrist at the end of the act of throwing has the effect of imparting a good spin and a good spin is essential for good flights. All experiments out of doors

should be made on a calm day. If there is a slight wind, throw the boomerang against it; in windy weather the flight is erratic and the boomerang is liable "to go anywhere and do anything."

Lastly, take the cross boomerang, but, instead of throwing it forward in a horizontal or slightly inclined plane, hold it above the head and throw it in a vertical plane at some imaginary object some 20 or 30 yards straight in front of you. The boomerang does not hit the ground but changes its plane of rotation and sails away to the left. If it be thrown in the same plane but rotating in the opposite direction, it will skim away towards the right.

Now let us take the first experiment with the cross boomerang when it was thrown across the body from left to right. When thrown correctly it will invariably curve towards the left. What is the explanation?

Fig. 2.—Interesting experiments can be carried out with a boomerang shaped like a cross.



## Curving to the Left

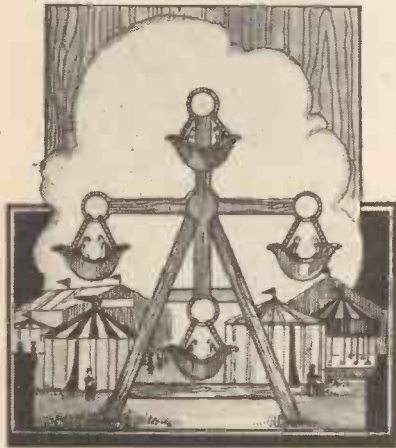
When moving through the air and rotating in the same direction as the hands of a watch lying face upwards, it is clear that whichever end is moving from 6 to 12 o'clock will cut the air more swiftly and more forcibly than the end which is moving from 12 to 6, for the former has the forward motion of the boomerang, considered as a whole, increased by the forward movement of the spin—just as the other has it diminished. In other words, it is the left-hand end for the time being, which is the more forcibly acted on, and therefore that end of the boomerang has the greater tendency to rise.

Bearing in mind that the boomerang is a gyroscope, the effect of this is to cause the front part of the gyroscopical boomerang to tilt up, and this tilting up effect will be the predominating one. Now, with its front edge higher than its back, and its left-hand quarter the highest, the boomerang will tend to turn upwards and towards the left. It may make one complete circuit or even more; the tilting can become so excessive that the boomerang may turn right over and a reverse curve be the result. Similar explanations can be given of its behaviour in the other experiments. So much for the "mystery" of the boomerang.



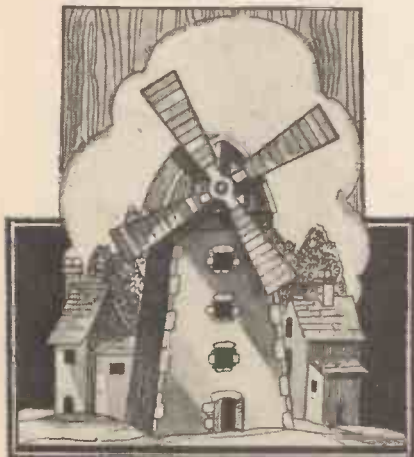
**SAND MECHANISM FOR MODELS**

**H**AVE you ever tried making working models, using sand as the motive power? By making the sand trickle through a hopper on to a suitable mechanism placed below, motive power is obtained which is quite sufficient for driving the models shown. This particular model has been so designed that two models are operated from the same mechanism. Figs. 1 and 2 are actually the back and front of the device. The completed model stands 7½ in. high



A swing-boat, as shown, should be fitted on the front of the box.

and 5½ in. wide, with a box-pattern centre 2 in. deep. The back and front of the box is made as shown in Figs. 1 and 2. When the sand is poured through the hole in the top into the hopper, it is



A windmill, which forms the back of the box.

released through the latter on to a series of buckets. The weight of the sand turns the buckets on a central spindle, and the sand is emptied into a drawer container beneath. As long as the sand runs from the hopper at the top into the buckets, so the rotating spindle will turn the sails and the swinging boat arms on the outside of the model.

**ORDER NEXT MONTH'S COPY NOW!**



**PIFCO TEST INSTRUMENTS ENSURE 100% EFFICIENCY FROM RADIO**

Buy to-day one 42/- Pifco Rotameter-de-Luxe (Moving-coil) or one 29/6 Rotameter (Moving-iron) and you will receive a complete set of 3 Pifco Valve Adaptors costing 15/-, in velvet-lined case for 7/6.

Either of these indispensable instruments, together with a set of Valve Adaptors, will form a complete test set which will ensure 100% efficiency from your radio set at all times.

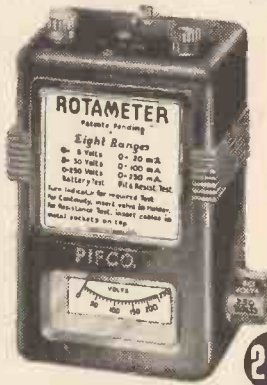


**PIFCO VALVE ADAPTORS**

Each adaptor has a 5-pin base with top sockets for "plug-in" testing of 5, 7 or 9-pin valves under working conditions without alteration to set wiring. Four nickel-plated terminals, complete with strapping links, are fitted to connect meter in either grid or anode circuit of valve.

Ask your dealer to-day to show you Rotameters and Adaptors, or write for Pifco Testmeter Folder, post free, from PIFCO, LTD., SHUDEHILL, MANCHESTER, or 150 Charing Cross Road, London, W.C.2.

**PIFCO**



29/6



**ROTAMETER-DE-LUXE**  
(9 Ranges including valve test)

Every conceivable test, including valves, can be made with this amazing instrument (400 volts—500 ohms per volt). Finished in black bakelite, complete with leads and fitted in handsome velvet-lined case. Price 42/-

**ROTAMETER**  
(9 Ranges including valve test)

Eight separate dials and valve test available at the turn of a knob. Size of each dial 1½ ins. by ½ in. Finished in black bakelite, complete with leads. Price 29/6.

**ROTAMETERS and RADIOMETERS**  
PIFCO ON THE SPOT WILL TRACE YOUR TROUBLES LIKE A SHOT

**NOVELTIES**  
OF INTEREST TO ALL PRACTICAL MECHANICS  
POST FREE | BARTON, GILLETTE  
103 NEW OXFORD STREET, W.C.1



**BE UPRIGHT**  
Look manly — be upright — wear the VITALITY Shoulder Support. Develops fine, graceful figure, expands chest 2-3 inches, keeps the shoulders broad and square, improves breathing, energy, health, looks. If short, appears to add 2 inches to the height. Increases poise. For both sexes. Alters the set of the figure, banishes and prevents stoop. Gives perfect freedom of movement, has no buckles. Undetectable. Try 7 days. If not delighted, your money back. Costs 3/9 only. Write— VITALITY APPLIANCES, Dept. M.P.1, 28 Dean Road, London, N.W.2.

**'WELCOM' Model Aircraft**

Obtainable from Stores, Toy Dealers, Stationers, etc., or in case of difficulty from the sole manufacturers:

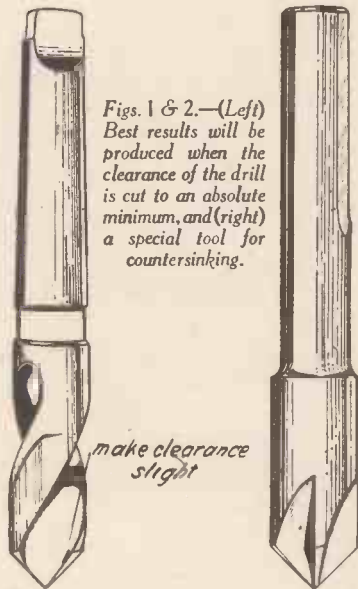
**Williams, Ellis & Co., Ltd.**  
82 Farringdon Street, E.C.4

LISTS ON APPLICATION

Have you seen the Special Christmas Bargains on the inside back cover?

# Small Tools and Cutters

FOR the purpose of providing a seating for a certain type of screw head or for lightly chamfering the mouth of a hole under a drilling machine some form of countersinking tool is necessary. Such operations require to be cleanly done, that is to say, free from "chatter marks" and scores. Where the countersink is to accommodate a screw head it is essential that the angle be correct to enable the cone to seat properly. It is quite possible to produce good work with an ordinary twist drill, modified by grinding the point to a suitable angle. In fact, this method is



Figs. 1 & 2.—(Left) Best results will be produced when the clearance of the drill is cut to an absolute minimum, and (right) a special tool for countersinking.

preferable where the screw head is recessed below the surface. There is, however, one very important point to be observed in the matter of grinding the clearance if satisfactory results are to be obtained. As a general rule the appearance of a hole that has been countersunk by means of a twist drill looks anything but pleasing. This is chiefly due to the amount of clearance on the drill, and the best results will be produced when the clearance is cut down to the absolute minimum (see Fig. 1). Further advantages on the matter of finish will be gained if the ground part of the drill is "stoned" up.

Objections may be raised against modifying full-length drills and keeping them for use as countersinks, although for a special job the drill can be altered temporarily; but there is nothing to prevent short ends of drills being ground in this manner and kept for the special purpose.

There is, however, a special type of tool made for countersinking. This is made in various forms; the most common is that shown in Fig. 2. The teeth may vary in number, but the four-tooth variety gives good results in steel. Resharpener is carried out by "stoning" or grinding, but where the latter course is adopted care must be taken to grind evenly, so that each cutting edge does an equal share of work. Precautions must also be taken to see that the clearance is not excessive, if "chattering" is to be avoided. Small rose countersinks do not lend themselves to resharpener except perhaps to a minor degree. In any case they are only intended to be used on

## The Fourth Article of a Series. This Month we Deal with Countersinking and Reaming Tools

the softer materials, like brass and aluminium alloy.

### Dee Bits

The type of countersink shown in Fig. 3 gives good results on soft brass and aluminium and produces a clean finish in what are really difficult mediums to machine. It can also be used for mild steel, gunmetal, hard brass, etc. An advantage possessed by such cutters is that they are easily made from silver steel of a suitable diameter. The only machining necessary is to turn the point on the end; the flat is filed slightly below centre, and the tool hardened and tempered. How simple is the making of such cutters may be gathered from the illustration. Where the countersink must be true with the hole it is advisable to make the cutter with a pilot (see Fig. 4), but where this is done the pilot is left solid, so as to prevent the hole from being reamed larger. It will be readily apparent that the sphere of usefulness of such cutters is not confined to countersinking operations,

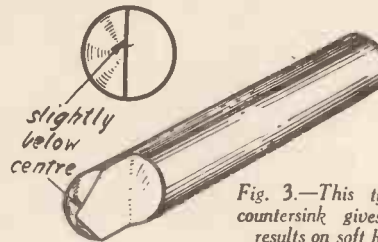


Fig. 3.—This type of countersink gives good results on soft brass.

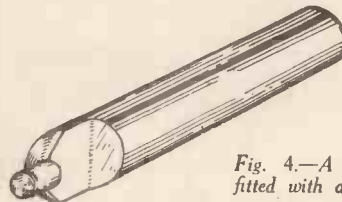


Fig. 4.—A cutter fitted with a pilot.

as by suitably shaping the blank, a hole can be mouthed out to almost any shape. Incidentally the small amount of trouble taken in making the cutter will reflect to advantage in the quality of the finished job.

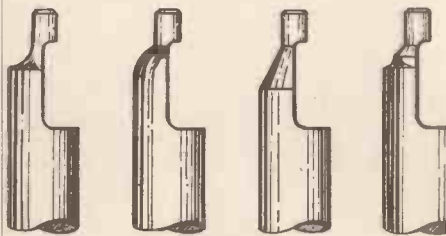


Fig. 5.—A group of special cutters.

A group of special cutters is shown in Fig. 5. The first is suitable for forming a radius on the mouth of a hole. The second produces a special seating, the third a special taper,

and the last is a combination countersinking and radiusing cutter. Thus it will be seen that these cutters when made to suitable contours have a wide range of application. It must be mentioned, however, that this style of cutter will not be satisfactory if the contour includes a shoulder at right-angles to the pilot, as when such a surface reaches the work the cutting action ceases. This can often be turned to advantage, where a number of countersinks or seatings have to be drilled exactly the same depth, by providing a shoulder on the cutter to act as a stop. The cutters shown are provided with pilots, but this feature is only essential when the operation must be performed true with the hole. It should be pointed out that all cutters of this description cut on one edge, and to restore when dulled, the flat surface only is stoned.

### Reamers

Before dealing with the various forms of toothed reamers, mention must be made of the fact that for certain classes of work, more particularly of brass and gunmetal, special reamers may be made in the form of Dee bits. Such a reamer is shown in Fig. 6. A reamer of this description will, when properly made, produce a beautifully-finished flat-bottomed hole in brass or gunmetal. It should be noted that for flat bottoming the end must be backed off at about 4 or 5 degrees as shown, and the flat surfaces require to be perfectly finished after hardening. The end may of course be modified within certain limits to produce a base of almost any shape, but where the end of the cutter must terminate in a point, the prior drilling operation must be carried out in such a manner that no appreciable amount of metal is removed by the extremity. Where the diameter of the hole is such that the corrected silver steel is not



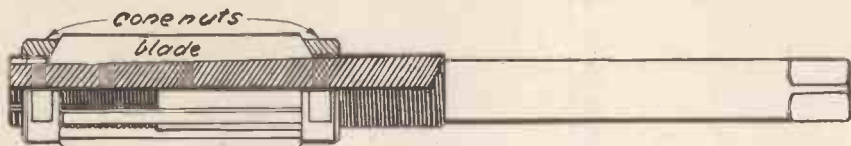
Figs. 6 & 7.—(Left) A reamer made in the form of a dee bit, and (right) a fluted reamer.

available or a hole other than parallel is required, care must be taken to see, when reducing the blank to the requisite diameter or taper, that a high degree of finish is obtained. This is most essential.

### Fluted Reamers

Fluted reamers are made in many different styles, and the first to be considered are what are known as parallel hand reamers. These are to be had with straight or spiral teeth, as in Fig. 7. In order to facilitate the entry into a hole the end of the toothed portion is tapered. This taper is

usually of the order of about 1 degree a side and extends to a distance equal to  $1\frac{1}{2}$  times the diameter. While suited to reaming out bushings or like objects, where the reamer can pass right through the job, a bottoming reamer having no lead must be used to follow up where a blind hole has to be dealt with.



Most straight-toothed reamers have the teeth unevenly spaced, the object of this being to prevent chattering. The teeth are relieved, but a narrow "land" is left along the parallel portion, and although the relief on the lead may be stoned up any attempt at sharpening generally should be confined to stoning the fronts of the teeth. Great care should be taken with the storage of reamers, as they will quickly become dull if allowed to rub together in a box. To secure the best results from a hand reamer leave as little metal as possible for it to remove, and also feed it into the work at an even rate per revolution. This is not always an easy matter, and some hand reamers have a threaded lead, which pulls the reamer into the hole at a definite rate of feed, a feature offering a marked advantage in use on phosphor bronze.

**Machine Reamers**

Reamers intended for machine use may differ from hand reamers only so far as the shank is concerned. There are, however, types which are widely different. Shell reamers may be regarded as the fluted portion of a short reamer. The lead is at an angle of approximately 45 degrees on the front of the teeth. A hole through the centre of the reamer accommodates a separate shank, the drive being taken by a flat cotter. Rose shell reamers differ only as regards the arrangement of the teeth. In this instance the cutting takes place on the front, the body being fluted to admit lubricant. The land between each flute is extremely wide and therefore no cutting action can take place. The purpose of this class of reamer is to remove a lot of metal, such as enlarging a cored hole. Once the reamer has started truly it must continue so on account of the guide afforded by the cylindrical portion. An ordinary reamer having narrow lands would tend to follow any irregularities in the cored hole.

**Expanding Reamers**

The reamers so far dealt with are only capable of producing holes equal in diameter to the nominal size. A solid reamer that is sharp can be made to cut a few thousandths oversize by inserting a strip of foil between one of the teeth and the work. As the reamer is fed in this has the effect of forcing the opposing teeth over to one side of the hole. This method cannot be relied upon with any degree of certainty, and the surest method is to use a reamer of correct diameter. Where the hole required happens to be an odd size, that is, not to a fraction of  $\frac{1}{16}$  in. or to an even millimetre, a special reamer will be required. This is quite a practical proposition where such a tool will be constantly required, but for occasional use, an adjustable reamer will suit the purpose better.

There is one type of reamer of American origin which is similar in appearance to a solid reamer with the exception that a short

portion of the blank is left unfluted at the bottom. This short portion is a few thousandths smaller than the body of the reamer and acts as a pilot. A hole is drilled up the body from the pilot extending beyond the end of the flutes, and a counter-bored hole terminates in a slow taper half-way up the flutes. Three equally-spaced

coned nuts. Equally spaced slots are milled in the body to receive the blades and the bottoms of these slots taper upwards towards the shank. The blades fit neatly into the slots, the ends being shaped to suit the conical faces in the nuts; incidentally they are all exactly the same length. When the nuts are locked the blades are forced on the bottom of the slots and held secure. When in the position shown in the sketch the reamer blades are at their minimum diameter. By slackening the back nut and tightening the front one the blades are forced upwards along the tapering slots, thus causing the cutting edges to increase in diameter. The smallest sizes are provided with four blades and the others with six. Thus it is an easy matter to set the blades with the aid of a micrometer. As an indication of the range of sizes covered it may be mentioned that 11 reamers cover all sizes from  $\frac{3}{16}$  in. to  $1\frac{1}{16}$  in. The total expansion on each of the three lesser sizes is  $\frac{1}{32}$  in., but as the diameter increases so does the amount of adjustment; the largest reamer mentioned expands from  $\frac{1}{16}$  in. to  $1\frac{1}{16}$  in. On account of the method of construction the maximum size can be conveniently increased by inserting a strip of foil or tin underneath each blade. Spare blades are obtainable when required, these being supplied in sets of 4 or 6 as the case may be. One drawback to this particular pattern is that it is unsuitable for use in blind holes. This objection is overcome by the design of the "Vickers" adjustable reamer illustrated in Fig. 9. Here the blades slide outwards and a micrometer adjustment is afforded by graduations on the head of the centre screw. Fig. 10 shows a longitudinal section; notice the shape of the blades. The locknut is first released and the cone bolt screwed in by means of a special key to effect adjustment. The cone nut holds the blades in position, bearing being taken on both ends of the central cone; again the blades are renewable.

narrow slots are cut at the roots of the teeth in the centre hole, the extent of the slots being confined to the toothed portion. The counterbored hole is tapped at the mouth and the adjustment is effected by means of a screwed taper plug. It will thus be apparent that the slots are opened, causing the reamer to become slightly barrel shaped and therefore on account of the liability of the reamer to break if the screw is forced in too far the range of adjustment is limited to a comparatively small amount. As recommended by the manufacturers the following limits of expansion should not be exceeded: For reamers  $\frac{1}{2}$  in. to  $\frac{5}{8}$  in. in diameter, plus '005 in.,  $\frac{3}{4}$  in. to  $\frac{7}{8}$  in., plus '008 in., and  $\frac{7}{8}$  to 1 in., plus '010 in.

Another similar type of reamer having a narrow range of adjustment is intended for machine use. In this the fluted portion is short and is expanded by means of a cone bolt operating on the front end. The slots

Fig. 8.—An adjustable reamer with both straight and helical blades.

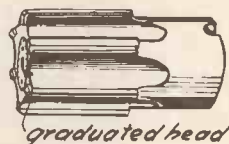
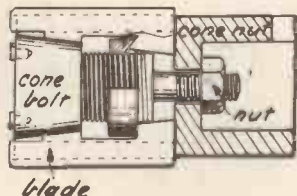


Fig. 9.—A "Vickers" adjustable reamer.

Fig. 10.—A longitudinal section of the adjustable reamer shown in Fig. 9.



in this instance are carried out to the end and therefore the greatest expansion takes place on the front end.

**Inserted Blade Types**

Adjustable reamers of this type have a much greater range of adjustment. That shown in Fig. 8 is made with both straight and helical blades. Reference to the part sectional view should make the construction clear, but briefly this is as follows: The body made of good-quality alloy steel is turned integral with the shank, and the screwed portions accommodate female

coned nuts. Equally spaced slots are milled in the body to receive the blades and the bottoms of these slots taper upwards towards the shank. The blades fit neatly into the slots, the ends being shaped to suit the conical faces in the nuts; incidentally they are all exactly the same length. When the nuts are locked the blades are forced on the bottom of the slots and held secure. When in the position shown in the sketch the reamer blades are at their minimum diameter. By slackening the back nut and tightening the front one the blades are forced upwards along the tapering slots, thus causing the cutting edges to increase in diameter. The smallest sizes are provided with four blades and the others with six. Thus it is an easy matter to set the blades with the aid of a micrometer. As an indication of the range of sizes covered it may be mentioned that 11 reamers cover all sizes from  $\frac{3}{16}$  in. to  $1\frac{1}{16}$  in. The total expansion on each of the three lesser sizes is  $\frac{1}{32}$  in., but as the diameter increases so does the amount of adjustment; the largest reamer mentioned expands from  $\frac{1}{16}$  in. to  $1\frac{1}{16}$  in. On account of the method of construction the maximum size can be conveniently increased by inserting a strip of foil or tin underneath each blade. Spare blades are obtainable when required, these being supplied in sets of 4 or 6 as the case may be. One drawback to this particular pattern is that it is unsuitable for use in blind holes. This objection is overcome by the design of the "Vickers" adjustable reamer illustrated in Fig. 9. Here the blades slide outwards and a micrometer adjustment is afforded by graduations on the head of the centre screw. Fig. 10 shows a longitudinal section; notice the shape of the blades. The locknut is first released and the cone bolt screwed in by means of a special key to effect adjustment. The cone nut holds the blades in position, bearing being taken on both ends of the central cone; again the blades are renewable.

These reamers run from  $\frac{3}{8}$  in. diameter upwards, this size being capable of expanding '014 in. A separate shank is required as with shell reamers, the drive between being taken by a cotter.

**Taper Reamers**

Solid taper reamers are available in Morse and Brown and Sharp tapers, as are also standard taper pin reamers, having a standard taper of  $\frac{1}{4}$  in. per foot and arranged in a series so that a continuous taper is formed, with a margin for overlap by the set of reamers. Thus the large end of the reamer is greater in diameter than the small end of the next size in the series. Such reamers may be marked in fractions of an inch to correspond with the nominal diameter of the taper pin, or 000, 00, 0, 1, 2, etc., from small to large. In use, taper-pin reamers require raising occasionally to break the chips in long holes. This prevents gapping the flutes.

**Fluxite For "Wiped Joints"**

WE have recently been handed by Fluxite, Ltd., an interesting pamphlet which describes the only successful method for making a wiped joint.

Rasp and tarnish the ends of the pipe in the usual way, and when the tarnish is dry, smear the end of the pipe and over the tarnish with "Fluxite." Then soak a piece of rag with "Fluxite." This rag should then be pressed close behind the cutting edge of the shavehook, following up immediately behind each stroke. This method prevents air from attacking and oxidising the cleaned end of the pipe.

# AROUND THE TRADE

Items and Topical Thoughts Concerning Manufacturers and their Products

## Hamblings "00" Railways

MODEL-RAILWAY enthusiasts who are interested in the 00-gauge accessories should write for a copy of the latest lists issued by Hamblings, of 26 Charing Cross Road, W.C.2. In addition to a complete range of locomotives and rolling stock, it is possible to obtain all the parts for the track, either ready assembled or in parts for home assembly. These include straight or curved sections, points, crossovers, etc., substantially made in brass, and the prices are quite low. Right- or left-hand points cost 3s. complete, and a 36-in. length of track, ready assembled with 67 sleepers to the yard costs only 2s. 6d. Scale parts for point or signal working are also obtainable, and a novel form of signal frame is also manufactured which enables the user to construct any desired size of signal box, simply by placing special units end to end. This type of frame costs approximately 8d. per lever. The railway may be improved by the addition of figures, and a large range of these is now obtainable including station staff, passengers, etc. It should be remembered that in the 00 gauge a human being is represented by a figure less than an inch in height. These figures cost 4½d. each, or in sets of 6 passengers 2s.; 12 station staff, with porter's trolley, 5s., and so on.



The most popular of the smaller type of Great Western locomotives, the "Pannier," stocked by Hamblings. This model measures 5 in. long, 2½ in. high, and 1½ in. wide.

If desired, Hamblings will make up any super-detail scale-model engine on request, and some interesting models are already included in the extensive range. Readers who live in London, and visitors to this town, should make a point of visiting the showrooms to see the marvellous layout and complete range of models and accessories.

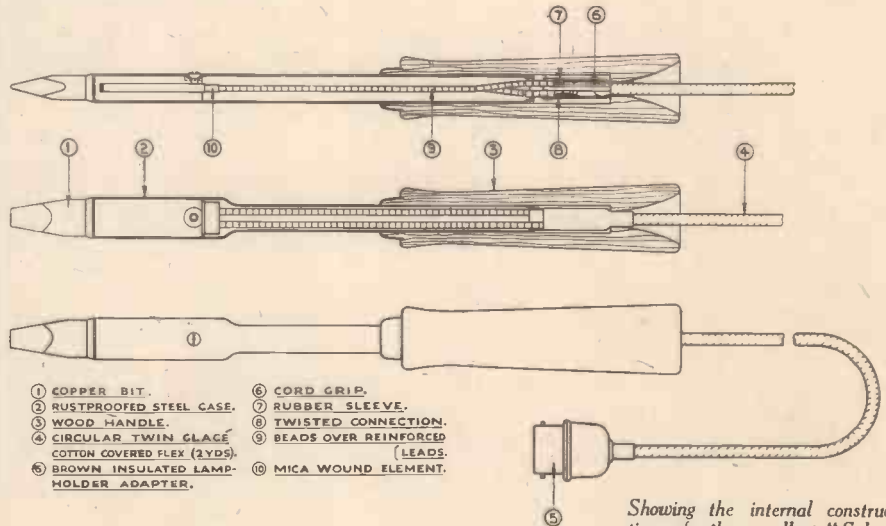
## A Special Offer

MODEL makers will no doubt like to avail themselves of a special offer made by the Micro Co., 26-31, Eyre Street Hill, Hatton Garden, E.C.1. They are selling ½ gross of turned screws with nuts and washers (assorted B.A. sizes) for the moderate price of 1s. 9d. post free.

## The "Webley" Air Pistol

THE "Webley" air pistols are designed on scientific lines, machined on the interchangeable system, and spare parts can be obtained at little expense. Obtainable at varying prices the "Mark I" air pistol, calibre .177 or .22, costs 30s., an extra

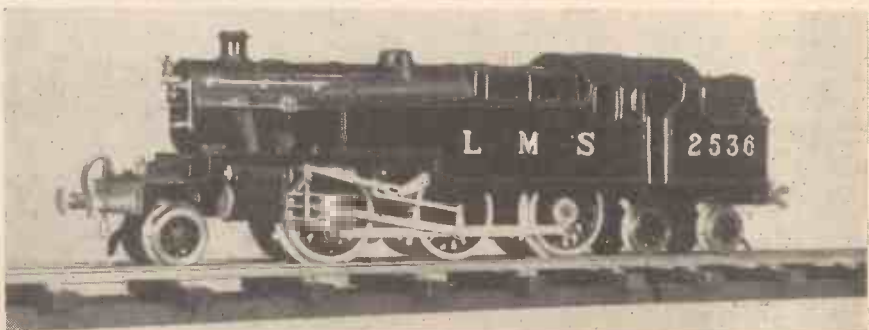
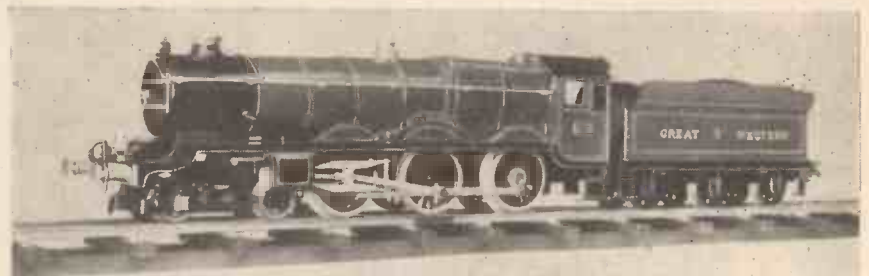
interchangeable barrel for same costing 10s. extra. The pistol weighs 30 oz., and its overall length is 8½ in. The "Senior" air pistol, calibre .177 or .22, costs 45s., weight 33 oz., and overall length 8½ in., and the "Junior," calibre .177 only, costs 20s., weight 24 oz., overall length 7½ in.



Showing the internal construction of the excellent "Solon" soldering iron. It is a most serviceable, durable, and reliable tool.

Extraordinary accuracy can be obtained with these pistols, and they will appeal to all classes of buyers both for individual practice and for friendly rivalry in competitions. The barrel being interchangeable, it is thus possible to possess both calibres in one pistol. Each pistol is supplied in a box containing "Webley" special pellets, spare washers, and cleaning brush.

as it has a coating of tin when supplied. The following spares are obtainable for the iron. A copper bit, ready tinned, 1s. 6d.; heating element with beaded tails, 3s.; 6 ft. flex, 1s. 6d.; and brown bakelite lamp-holder adapter, 6d.



(Above) G.W.R. King George V, replica of the locomotive that went to America, complete with bell, and (below) a 2-6-4 L.M.S. Stanier Tank. Both models are marketed by Messrs. Bassett-Lowke Ltd.

# DEFYING JACK FROST

## How to Prevent Burst Water Pipes During the Winter Months

**Y**OU drain the water from your radiator, country motorist, or fill up with glycerine or with one of the excellent advertised non-freezing liquids, but do you leave the garage pipe and tap to take care of themselves?



(Above) What to avoid and (right) how to avoid it.

Apart from not having any water for car washing when your tap has reached the condition shown in the photograph published here, there is always the risk of burst pipes. This is less likely, of course, where the pipes are of heavy gauge lead as specified by the majority of water companies. This is because the strength and elasticity of lead resists the pressure of ice better than other materials, but the precaution of bandaging with felt strips or straw bands is advisable.

### Defying Jack Frost

For a pipe fitted against a wall, which is the arrangement generally met with in a garage or stable yard, felt is easier than straw bands to thread through the narrow space between the pipe and the wall. The kind of felt which is laid under carpets is excellent, and an old piece should be cut into strips about 4 in. wide. Put the bandage on like puttees, but make a spiral up and down so that you have a double layer, and tie with string every 6 in. If, in addition, you turn off the water at the

main supply valve at night you can defy Jack Frost with impunity. In the event of a burst with the thaw, if the pipe is lead you can easily stop the flooding by knocking the pipe flat with a hammer.

### A Warm Bath for your Car

A Surrey motorist who saved his rose garden last summer by fitting a by-pass from the bath waste to store water for garden purposes writes me about the warm baths which he has been giving his car at the cold week-ends. As an owner-driver disinclined to pay for car washing, he reserved Saturday morning for work with clogs and the car hose, but found it painfully cold work.

How is this for an amateur plumber? "I thought of the by-pass I had fitted during the drought last summer to lead the bath water to the storage tank," he writes, "and wondered if I could add more pipes that would lead warm water from the bath to my car hose. I got a plumber to solder unions to the ends of a 20-ft. length of 1/2-in. lead pipe



and coupled this at one end to a branch from the bath waste, and at the other to my hose connection.

"I do not get a lot of pressure and the quantity is limited to the yield from three morning baths, but with a sponge and bucket I make a pretty fair job of a 12 h.p. saloon—and what is most important—without frostbite."

# The New Pelmanism

A letter from

**SIR HERBERT BARKER**

The World-Famous Specialist in Manipulative Surgery

"THE whole world is stirred and awakening to the clamant necessity of putting its mighty house in order.

"Eager hearts and ambitious minds are asking what they can do to help this great work for humanity. The answer is: Make yourselves more efficient—in body, mind and character.

"Can we do this? I say most emphatically, We can, and by that simple, alluringly pleasant, and marvellous system which the denizens of the entire earth now know as Pelmanism. No one who has investigated its methods can doubt this, and imposing and impressive testimony of many of our greatest men constitutes, I should say, a unique record of praise.

"I always thought it quite impossible that the old 'Little Grey Books' could be improved upon, but the new ones have—if I may say so—achieved the impossible and made the perfect more perfect.

"Take this Course—all of you—and life will have a new beginning whatever your age. You will, each day more and more deeply, realise the quiet but intense joy and satisfaction of knowing with certainty that your mind and character are steadily being built up, stone by stone; that your brain is being fortified and clarified; your will strengthened, and life becoming what it was surely intended to be, a glorious privilege—a blessing beyond all price."

Not only Sir Herbert Barker but the well-known journal *Truth* has been greatly impressed by the new enlarged Pelman Course. "It places Success on a scientific basis," says *Truth* in a report which, together with a copy of "The Science of Success" containing full particulars of the Pelman Course, every reader can obtain free by writing to the

### PELMAN INSTITUTE,

130 Pelman House, Bloomsbury Street, London, W.C.1

Readers who can call at the Institute will be welcomed. The Director of Instruction will have a talk with them, and no fee will be charged for his advice.

TO THE PELMAN INSTITUTE,  
130 Pelman House, Bloomsbury Street,  
London, W.C.1

Please send me a free copy of "The Science of Success," and a reprint of "Truth's" report.

NAME.....

ADDRESS.....

Occupation .....

All correspondence is confidential

PELMAN (OVERSEAS) INSTITUTES: PARIS, 80 Boulevard Haussmann. NEW YORK: 271 North Avenue, New Rochelle. MELBOURNE: 306 Flinders Lane. JOHANNESBURG: P.O. Box 4928. DURBAN: Natal Bank Chambers (P.O. Box 1480). CALCUTTA: 102 Clive Street. DELHI: 10 Alipore Road. AMSTERDAM: Damrak 68.

**SCIENTIFIC MICROPHONE BUTTON**

NOW 1/-

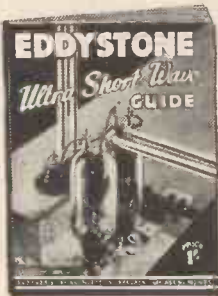
USEFUL—  
INSTRUCTIVE—  
ENTERTAINING—  
Over a Hundred uses  
\*Microphone  
\*Detectorphone  
\*Baby Alarm, etc.  
Reduced from 3/6 to 1/-  
Postage 2d.  
Every one fully tested and guaranteed

"THE WONDERS OF THE MICROPHONE."  
A comprehensive book containing over 25 diagrams and illustrations showing actual circuits and experiments. A source of endless education and amusement.  
Price 6d. Post free.



The SCIENTIFIC SUPPLY STORES (WIRELESS) LTD.  
Dept. "M" 126 Newington Causeway, Elephant & Castle LONDON, S.E.1.  
Phone: HOP. 4177

**EVERYONE INTERESTED in the Ultra Short WAVELENGTHS**



—will find this new EDDYSTONE GUIDE invaluable. Full of interesting information with many constructional articles and fully illustrated.

From your Radio Retailer, or W. H. Smith & Son. In difficulty send direct PRICE Stratton & Co., Ltd., Bromsgrove Street, Birmingham. 1/-

**KEEP YOUR CHIN UP**

DEVELOP AN UPRIGHT, GRACEFUL FIGURE. Breathe Better! Feel Better! LOOK BETTER! HARRISON'S ADJUSTABLE SHOULDER-BRACE



Keeps Your Chest Expanded, Head Up and Shoulders Squared. For Either Sex. State Size of Chest.  
2/6 From T. R. HARRISON  
6 Highfield Terrace,  
Art. Silk SALTAIRE, YORKS.  
at 3/6. Money-Back Guarantee.

**Make More Money**

£3 to £6 weekly can be earned at home in a wonderful business of your own. No matter where you live, you can commence to make money in your spare or whole time. No risk, canvassing or experience required. A wonderful opportunity for anyone wishing to add pounds to their income. Particulars, stamp.

**BALLARD, 71 Graces Rd., London, S.E.5**



**CASTING MOULDS**

Make your own lead soldiers, animals, Indians, etc.  
Illustrated Catalogue free.  
J. Toymoulds, 18 Kenyon St., Birmingham

**FREE ADVICE BUREAU COUPON**

This coupon is available until December 31st, 1935, and must be attached to all letters containing queries.  
PRACTICAL MECHANICS, DECEMBER, 1935

# Making A Small

This Simple Device is Suitable for 200-240-volt Mains

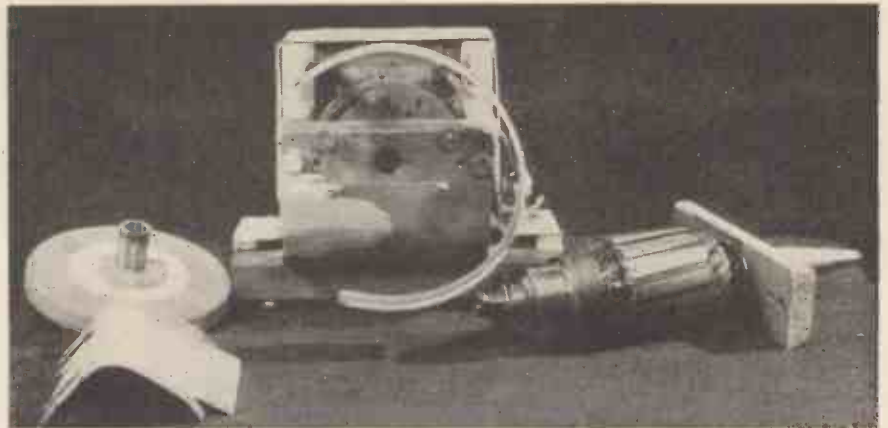


Fig. 1.—Showing the various parts of the grinder ready for assembly.

THIS small electric tool grinder has proved extremely useful. It runs off 200-240-volt mains, and the total cost of materials should not exceed 10s.

The only part of this tool which is not home-made is the armature of a 12-volt car dynamo, around which the rest is built. Figs. 2 and 4 clearly indicate the

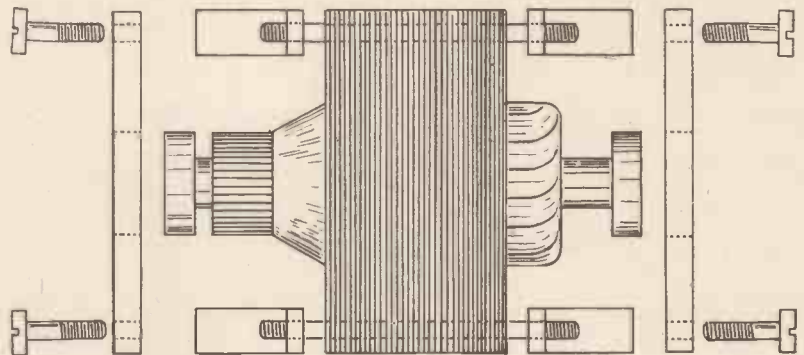


Fig. 2.—Constructional details of the armature.

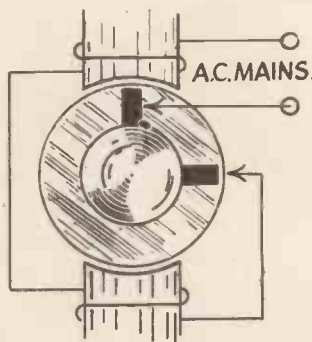


Fig. 3.—The coil connections.

method of construction.

**The Fields**

You should first measure the armature, i.e. the diameter and length of poles. Then cut from sheet iron of 18 or 20 gauge the shape of the field laminations (Fig. 6). There should be sufficient of these to build up to the length of the armature poles. They can be bored out—the bore should be approximately .02 in. longer than the diameter of the armature—and sawn to shape in clumps of about two dozen.

**Clamping Holes**

The clamping holes should be jig-drilled

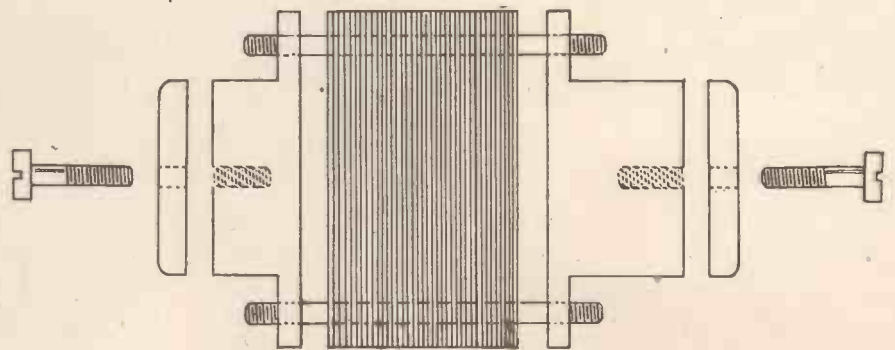


Fig. 4.—Further details of the armature.

# Tool Grinder

and Can be Made for the Nominal Sum of 10s.



Fig. 5.—The completed tool grinder.

so as to ensure that they are all in the same position in relation to the bore. If backed with metal, hard wood will be suitable for the drilling-jig; and it is as well to drill

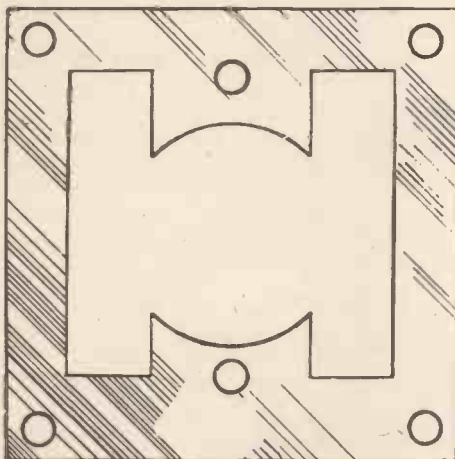


Fig. 6.—The shape of field laminations.

these holes .015 in. over the size of the clamping bolts.

We next come to the side and end plates. These are iron castings of very simple design. The side plates are turned on end; the end plates are faced on one side and bored to take the armature ball races, i.e. they are simply a push fit.

### The Coils

The coils are former-wound and consist of 400 turns of No. 24-gauge enamelled wire. Figs. 7 and 8 illustrate the former. This is held together by one central bolt and should fall apart easily when the winding is finished. The coils may be taped with insulating tape. The connections are shown in Fig. 3.

### The Brushes

Fig. 9 shows the brush holder, and it may

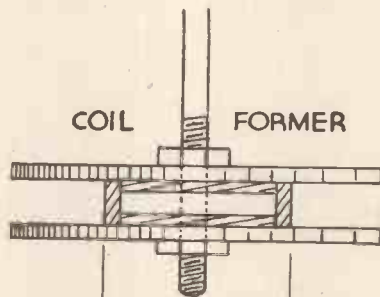


Fig. 7.—The method of making the coil former.

be possible to use parts of the dynamo for this.

Finally, when testing, rock the brushes about until you find the best running position.

It is also important to fit a guard round the wheel, the speed of which should reach about 5,000 revs. per minute.

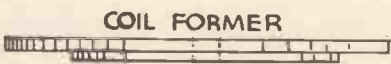
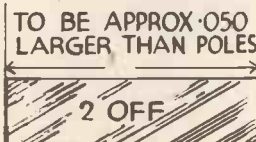


Fig. 8.—Further details of the coil former.

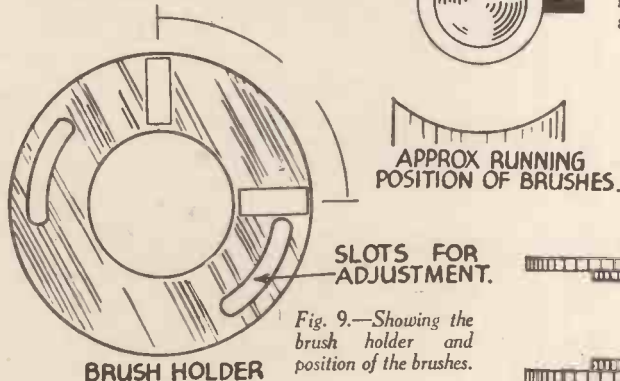
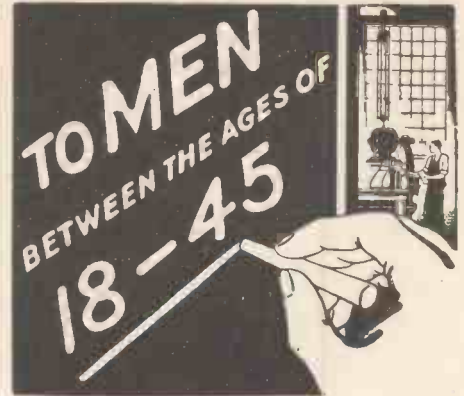


Fig. 9.—Showing the brush holder and position of the brushes.



Things are happening to-day which vitally affect you!

If you are about 18, perhaps you are getting settled in your chosen work and already feeling the strain of competition for a better position. If you are in the 40's, your family responsibilities are near the peak, the necessity for money is tense—and younger men are challenging your job. And men of the ages between 18 and 45 face similar problems, in one form or another.

The most valuable employment security to-day is the security a man creates for himself—in himself! Through training, he is able to adapt himself to new conditions, to utilise experience without being handicapped by habit! He masters jobs and makes new jobs. He meets emergencies—and is not overwhelmed by them. And this is an age of emergencies.

For 44 years the International Correspondence Schools have helped thoughtful and ambitious men to acquire the training they need. To-day, with this need more urgent than ever, this world-famous institution offers greater opportunities than ever. Why not permit us to show you the way to greater security and larger earnings? Our expert advice is free. Write to-day.

... COUPON FOR FREE BOOKLET ...

INTERNATIONAL CORRESPONDENCE SCHOOLS, LTD.  
Dept. 95, International Buildings, Kingsway, London, W.C.2.

Please send me your booklet containing full particulars of the Course of Correspondence Training before which I have marked X. I assume no obligation.

- |   |  |
|---|--|
| <input type="checkbox"/> Accountancy              | <input type="checkbox"/> Marine Engineering            |
| <input type="checkbox"/> Advertising              | <input type="checkbox"/> Mechanical Engineering        |
| <input type="checkbox"/> Aeronautical Engineering | <input type="checkbox"/> Mining Engineering            |
| <input type="checkbox"/> Architecture             | <input type="checkbox"/> Motor Engineering             |
| <input type="checkbox"/> Bookkeeping              | <input type="checkbox"/> Plumbing                      |
| <input type="checkbox"/> Building                 | <input type="checkbox"/> Radio                         |
| <input type="checkbox"/> Chemical Engineering     | <input type="checkbox"/> Railway Equipment and Running |
| <input type="checkbox"/> Civil Engineering        | <input type="checkbox"/> Salesmanship                  |
| <input type="checkbox"/> Draughtsmanship          | <input type="checkbox"/> Steam Engineering             |
| <input type="checkbox"/> Electrical Engineering   | <input type="checkbox"/> Textiles                      |
| <input type="checkbox"/> Engineering Design       | <input type="checkbox"/> Woodworking                   |

Examinations, state which.....


The I.C.S. teach wherever the post reaches and have a wide variety of courses of study. If, therefore, your subject is not in the above list, write it here.

Name..... Age.....

Address.....

# NOVELTIES FOR

*Some Practical Suggestions for Christmas*



*The modern way*  
**ELECTRIC SOLDERING**

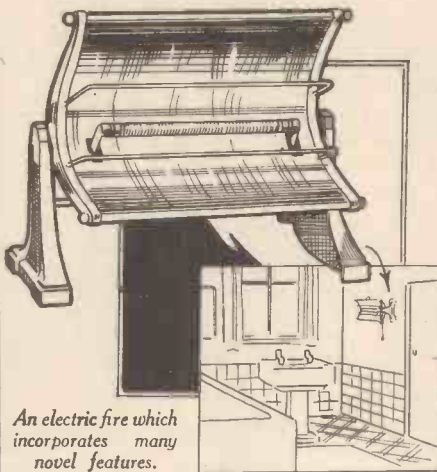
The Solon Electric Soldering Iron has the strongest heating element obtainable. Clamped in contact with the bit, it concentrates all heat. None is wasted. The Solon simplifies soldering. It is quicker, easier, more economical and more efficient. Plug in—solder in three minutes.

**7'6**  
65 Watts  
125 Watts 22/6  
240 Watts 37/6

Use a **SOLON** ELECTRIC SOLDERING IRON

W. T. Henley's Telegraph Works Co. Ltd.  
Dept. 25. YAC  
Holborn Viaduct, London, E.C.1.

NO doubt there are many readers who have friends interested in cycling, wireless, carpentry, etc. Therefore, when making up your shopping list for Christmas, why not give them something relative to their hobby? The following suggestions will undoubtedly prove helpful when making your final selection and at the same time has the advantage of suiting all pockets. They are extremely up-to-date and will make very acceptable presents.



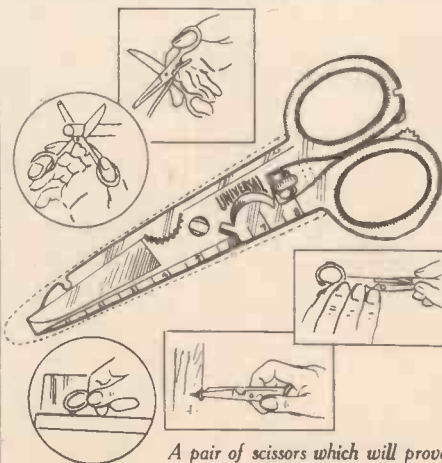
An electric fire which incorporates many novel features.

### A Handy Electric Fire

A NOVEL feature of this fire, which will make an ideal present, is the fact that the reflector may be tilted at almost any angle and thus direct the heat in the required direction. As is shown in the inset sketch, it may be fixed up high on the bathroom wall to supply warmth to the one room in the house which modern builders seem to ignore when designing their heating schemes. The white enamel finish makes it very suitable for this use, but it is also obtainable in antique copper or silver. Very economical to run (consuming only one unit per hour), it costs 27s. 6d. It is made by the Belling Electric Co., Enfield, Middlesex.

### Universal Scissors

SELDOM does one find one tool which is capable of being used for so many pur-



A pair of scissors which will prove an ideal tool for the handyman.

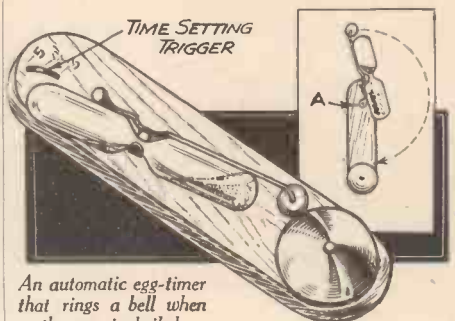
poses as the scissors illustrated on this page, and they should prove of interest to every practical mechanic. They may be used as ordinary or buttonhole scissors, pipe tongs, cigar-cutter, wire-cutter, ruler, measure, nail-file, screwdriver, box-opener, hammer, pen-knife, glass-cutter or breaker, marking wheel, and literally to cap the lot a covering sheath is supplied. They may be obtained for 4s. 3d. post free from Messrs. Barton Gillette Co., 103 New Oxford Street, W.C.1.

### The "Opalite" Torch

STATED to be the smallest flashlight in the world, the "Ever Ready" company have produced a small torch known as the "Opalite." Its smallness makes it extremely convenient to carry and it will slip easily into a lady's handbag or a man's waistcoat pocket. The tip of the "Opalite" is something entirely new, as it is semi-opaque except for an aperture through which the bulb throws a small concentrated spot of light. The result is a light completely free from glare which can be used very conveniently in theatres and cinemas where a more diffused light would be disturbing. It sells at the very reasonable price of 2s.

### An Automatic Egg-timer

INTRIGUING in operation, the mechanics of this gadget is well worthy of study. As will be seen by a glance at the small



An automatic egg-timer that rings a bell when the egg is boiled.

inset sketch the striking arm of the bell is pivoted at A and has the glass sand-container attached to it. We will assume that the time trigger is at the three-minute mark and the arm is swung up until it comes into contact with it. The sand, now in the upper compartment, commences to trickle into the lower one. When the sand has been running for three minutes the weight of sand in the lower compartment upsets the balance, swings the arm downwards, and the striker comes into contact with the bell. The position of the trigger at the four- and five-minute settings allows the arm to fall slightly farther back and thus a greater weight of sand is required to upset the balance. The price is 1s. 9d. post free.

### The Tilly Storm Lantern

A LANTERN that will serve a number of useful purposes is now obtainable for a moderate price. It gives a magnificent light of 300 c.p., and enables work to be continued after dark. A small reflector is provided to prevent rain falling on the globe, and when the lamp is used for suspension, the 12-in. diameter white

**FUN WITH YOUR RADIO**

BROADCAST your own Jokes, Songs and Plays, or learn to Croon with the "HOME MIKE." Only **5/-**

Just clip the "HOME MIKE" to your Set. Works on all Receivers. No Alterations. Complete with Transformer. Great Entertainment Novelty—the Rage of the Season. Order at once to avoid disappointment. No Set complete without one.

Complete with Instructions. Send P.O. or sent C.O.D. on receipt of p.c., or phone HOP 1800.

SCIENTIFIC SUPPLY STORES (Wireless) LTD., 126 Newington Causeway, Elephant and Castle (Dept. "M"), London, S.E.1.

**MAKE A MAN OF YOURSELF**

I positively GUARANTEE to give you Robust Health, Doubled Strength and 10-25" more muscle in 30 days or return your money in full. The famous STEBBING 4-in-1 Course consists of four great courses in one, yet costs only 3/- post free. It has been proved (1) The most effective HEALTH and ENERGY System ever devised; (2) It quickly builds NORMAL WEIGHT and VIRILE MANHOOD; (3) It develops a strong WILL, rigid SELF-CONTROL; and (4) It includes an amazing SUCCESS and PERSONAL MAGNETISM Course. Complete Course 5/- No extras, no appliances to purchase.

Pupil S. Devey (London)

Further details sent privately, under plain, sealed cover.

LIONEL STEBBING, STEBBING INSTITUTE, Dept. C.P., 28 Dean Road, London, N.W.2.



# CHRISTMAS

*Presents that will Suit all Pockets.*

enamelled reflector, which costs 4s. extra, should be fitted in addition. Sold in two types—the P.L.53 with glass globe and guard costs 36s, and the P.L.52 with mica globe (no guard necessary) costs 34s. 9d.

The lantern is strongly made in stout brass, and there are no parts which can rust, corrode, or get out of order. It will burn steadily anywhere, and is unaffected by weather, however severe.

### A Razor Blade Protector

DESIGNED to prolong the life of the safety-razor blade (the three-hole and slotted types) this protector automatically wipes and greases the blade and thus solves the cut-towel problem and at the same time prevents corrosion. After use the blade is placed on the sliding arm and pushed into the protector, the body of which is charged with an antiseptic compound.

The only attention required is a few drops of lubricating oil every six or twelve months. The case, which is a high-class synthetic moulding, is obtainable in a variety of colours. The price is 3s. 9d. post free. Barton Gillette Co., 103 New Oxford Street, W.C.1.

### A Pocket Hand-warmer

THOSE unfortunate people who suffer from cold hands will find this little gadget useful this winter. As the illustration shows, the burner is attractively finished

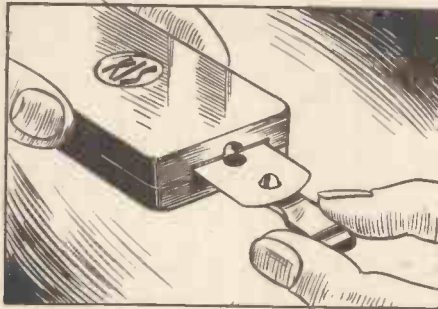


An ingenious hand-warmer that can be carried in the pocket.

and its compact size enables it to be used in cases of sickness where rapid heat is required. Once charged with petrol the warmer will give twenty-four hours' service without refilling, a platinum-asbestos burner being employed. It costs 4s. 9d. post free, and is supplied complete with a cloth case and full instructions for use.

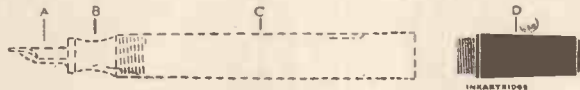
### A Novel Fountain Pen

KNOWN as the "Ink-makor" an ingenious fountain pen has appeared on the market which generates its own ink. The ink is obtained by screwing an "Ink-arteridge" D to the end of the pen as shown, and then filling the pen with water by means of a lever fitted in the side of the stem. Each replaceable "Ink-arteridge" lasts about a year, but for less frequent writers nearly two years. The "Ink-makor" is obtainable in different styles



A useful razor blade protector which wipes and greases the blade after use.

with various nib points. This remarkable writing instrument forms its own ink when you turn the point upward or downward in



A remarkable pen that generates its own ink.

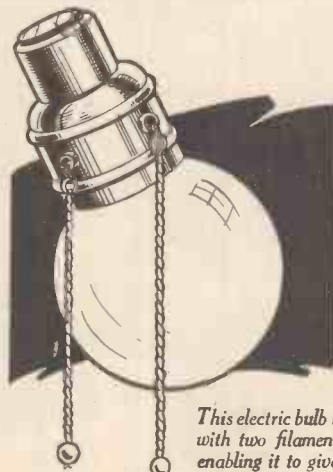
putting in or taking out of your pocket, and whilst you are writing. It costs 18s. 6d., but if supplied with a heavier type of nib, 27s. 6d. It is sold by Messrs. E. B. Meyrowitz, Ltd., Regent Street, London.

### Variable Electric Lighting

IN many cases it is very handy to be able to regulate the amount of light in a room, such as in the sickroom or bedroom. The novel bulb, illustrated on this page, contains two filaments and enables one to have either a bright or a dull light as the circumstances demand. No wiring alterations are necessary, as the bulb fits into a standard lamp holder, and the variations in light are obtained by simply pulling one or other of the switch cords. The bulbs are of opal finish and the voltage ranges are 100 to 130 and 200 to 260 volts. They cost 5s. each, and are obtainable from the General Electric Co., Magnet House, Aldwych, W.C.2.

### A Tool for Cyclists

If you are a keen cyclist, then you have no doubt experienced the tedious job of fitting



This electric bulb is fitted with two filaments, thus enabling it to give a dull or bright light as desired.

## RUN YOUR MODELS

FROM THE MAINS!!

To obtain the utmost satisfaction with miniature Locos, or similar working models, it is essential that the source of supply is constant. The Heyberd TRAIN TRANSFORMER has been designed to give constant power with low running costs. A variable control is incorporated, enabling the model to be stopped, started, or speed increased or decreased. THESE MODEL TRANSFORMERS CAN BE HANDLED WITH PERFECT SAFETY.

Model T101. Price 27/6  
Output: Maximum 22 volts 3 amps.



Send Now for Free descriptive lists, of Heyberd Train Transformers, Rectifier Units, etc.

F.C. HEYBERD & CO. 10 FINSBURY ST., LONDON E.C.2.

## WATERPROOF UNBREAKABLE

GUARANTEED 7 YEARS against breakages.

YOURS 5/- DOWN FOR

You can now own a watch world famous for its reliability under the most severe climatic conditions.

WATERPROOF—it can even be used whilst bathing! UNBREAKABLE—it can be worn without fear of accidental damage.

Incorporating a patented floating non-magnetic jewelled lever movement, shock, vibration, dust and sand proof.

Time tested under water, chromium patent gland case, 24-hour dial, Leather strap. Cash price 59/6 (instantaneous dial 2/8 extra), or yours for 5/- down.



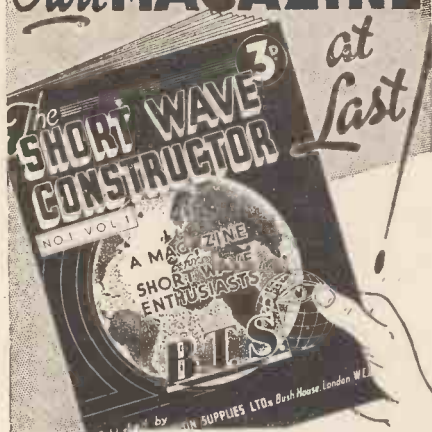
## THE ORIGINAL Aeroplane WATCH

Made by the Suppliers to IMPERIAL AIRWAYS, etc. YOUR OLD WATCH TAKEN IN PART EXCHANGE.

Other models from 25/- Write for FREE illustrated catalogue of watches from 5/- down or send your order to-day to:—

G. & M. LANE & CO. LTD. (Dept. P.M.8) 24/26 Ludgate Hill, London, E.C.4

# The SHORT WAVE FAN'S Own MAGAZINE



The demand for No. 1 of "THE SHORT WAVE CONSTRUCTOR" has been overwhelming... you should secure your copy while you may... Full of articles of absorbing interest. Describes in detail 3 entirely new Short- and Ultra-Short-Wave Circuits, etc., etc. ... the latest in short-wave technique. From branches of W. H. Smith & Sons, Radio dealers, or send 3d. direct to the Publishers, BRITISH TELEVISION SUPPLIES, LTD.

**SPECIFIED**  
TWO POUND TWO SHORT WAVE No. 1 Now On Sale

3 B.T.S. 4-pin Coils, A, B, C	12 6
1 B.T.S. S.W. Choke, 10-200 m.	2 9
1 B.T.S. Indigraph Slow-motion Dial	7 6



BRITISH TELEVISION SUPPLIES, LTD.,  
8-10 CHARING CROSS ROAD, LONDON, W.C.2

## BRILLIANT LIGHTING FOR WINTER WORK



Mechanics, amateur and professional, and owners of small workshops, lathe sheds, observatories, etc., should get the Tilley Lantern. It gives a magnificent light and enables work to continue after dark, either in or out of doors. Can be placed anywhere. Wind and Rain proof. British made throughout.

### TILLEY LANTERN

(Burns ordinary Paraffin)  
Light of 300 c.p. for 6 hours for 1d.

The Lantern is strongly made in stout brass, and there are no parts which can rust, corrode, or get out of order. Will burn steadily anywhere, unaffected by weather, however severe. Get rid of all antiquated devices and use this marvellously efficient Storm Lantern. You will then wonder how you did without it before!

Remit 36/- or can be sent C.O.D. Post and Charges Paid.

TILLEY LAMP CO. (Dept. P.M.) HENDON, N.W.4

## BE TALL

Your Height increased in 14 days or money back. The amazing Stebbing System soon brings 3-5 inches

increase and new energy. The first, original, and the one GENUINE GUARANTEED Height Increase System. Recommended by Health and Efficiency. Complete Course, 5/-, or Booklet free, privately.

STEBBING SYSTEM Dept. M.P. 28 Dean Rd., London, N.W.1

## DON'T BE BULLIED

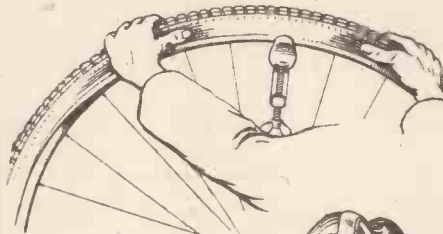


Learn to fear no man. The BEST self-defence ever invented, namely, JIJITSU. Easy to learn. Send 2 penny stamps for SPLENDID ILLUSTRATED LESSONS. Photo ARTICLE, Testimonials and particulars, or P.O. 1/- for FIRST PART of my course. You will be more than delighted. Dept. F., Blenheim House, Bedford Lane, Feltham, Middlesex.

new tyres to your bicycle. A new tool, which has recently been placed on the market, known as the "Jack-it-on Tyre Tool" will facilitate this task. With the aid of this tool any tyre, however stubborn, can be properly fitted in one minute without physical exertion. The device is all-metal, weighs only 3 oz., and will last a lifetime. The method of using the tool is shown in the sketch, which is self-explanatory. The gadget costs 1s. 6d., and will make an ideal Christmas present for your cycling friends. It is made by "Jack-it-on" Tyre Tools, Quorn, Leicestershire.

### Bakelite Electric Cycle Lamp

MESSRS. WARD & GOLDSTONE, the well-known wireless manufacturers, have recently introduced a bakelite electric cycle lamp as shown on this page. Whereas

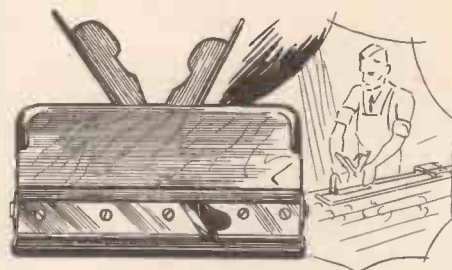


A tool for cyclists which facilitates the fitting of tyres to the wheels of the bicycle.

the cheap type of metal-cased cycle lamps are usually shabby and useless after one season, the bakelite types will retain their attractive appearance for years. They are unaffected by rain or other atmospheric conditions, and will not rust or corrode. The cases are of super-grade finish, and owing to the high insulating properties the full life of the battery is assured. The lamp is fitted with a silver-plated parabolic reflector, has a 3 1/4-in. diameter front, and a bracket attachment for the cycle. It is made in two finishes—ebony black, complete with bulb and refill, costing 3s. 6d., and ivory white, with bulb and refill, 5s. Spare 2 1/2-3-volt refill batteries are obtainable for 8d. each.



A bakelite electric cycle lamp which is unaffected by existing weather conditions.



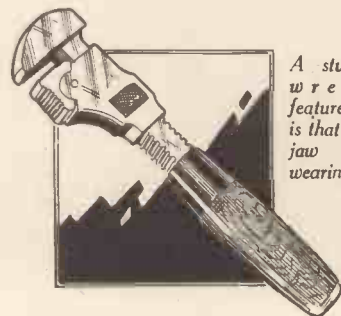
A multi-purpose plane that should appeal to all woodworkers.

### A Multi-purpose Plane

STRONGLY made and extremely well finished, this grooving, feathering, and checking plane should appeal to every woodworker. The grooving side has a metal plate and a 3/8 in. bit, while the fence may be extended to allow the bit to cut in the centre of 1 1/2 in. wood. The feathering and checking side is fitted with a cast steel skew iron, a metal depth stop, and the adjustable fence enables one to rebate from 1/4 in. to 3/4 in. wide. One indication of the thought which has been put into the design of this tool is the fact that the fixing screws of the fence and the stop operate in iron bushes bedded into the block, thus obviating any wear of the wood. The price is 11s. post free from Messrs. Chalwin Edwards, High Holborn, W.C.2.

### A Sturdy Pipe Wrench

FIRST-CLASS workmanship and material are combined in the production of this wrench. It is capable of quickly gripping and holding the pipe, and when required it may be instantaneously released. A note-

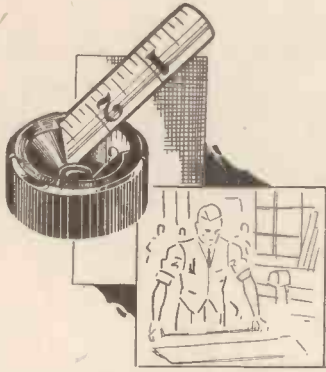


A sturdy pipe wrench, a feature of which is that the lower jaw has two wearing surfaces.

worthy feature is that the lower jaws have two wearing surfaces, so that when the tool is worn down it is only necessary to reverse it and the tool is as good as new. Made in six sizes, for pipes of 1/2 in., 3/4 in., 1 in., 1 1/2 in., 2 in., and 2 1/2 in. diameter, they cost 7s. 6d., 8s. 6d., 9s. 6d., 11s. 6d., 17s. 6d., and £1 1s. respectively, carriage paid. Obtainable from Messrs. Chalwin Edwards, High Holborn, W.C.1.

### A Useful Spring Rule

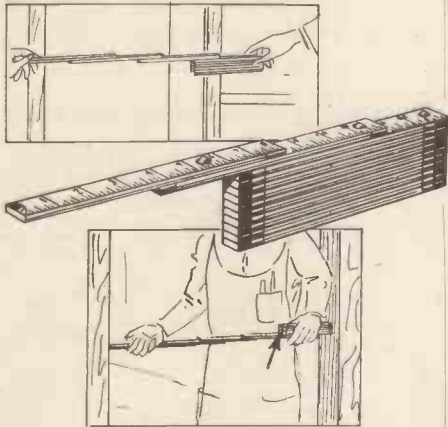
CONTAINED in a case measuring only 1 1/2 in. in diameter, this rule easily slips into the pocket and is always ready for use. The rule being made of flexible steel is useful for either longitudinal or cylindrical measurements and coils smoothly into the bakelite case. Costing 3s. 3d. post free, the rules are obtainable in various graduations. Marked in eighths of an inch.



A useful spring rule.

**Improved Wireless Reception**

TO obtain purity of reception and to reduce or remove interference, crackling and humming noises from your wireless receiver, due to radiation (usually picked up by the down lead) fit the new "Goltone" air-spaced metal-screened flexible down lead which effectively solves the problem. It is not essential that the entire length of the down lead be metal screened, although in severe cases of interference it is advisable to commence the screening within a few inches from the horizontal aerial span and complete it close to the receiver itself. In this case the screened lead will replace the lead-in tube and terminate near the receiver. A 10-ft. length with 3 ft. additional lead-in wire with 1 bracket costs 15s. It will make a useful present for your wireless friends.



A collapsible rule that can be extended to a length of 6 ft., but when closed measures only 8 in. by 2 1/2 in. by 1/2 in.

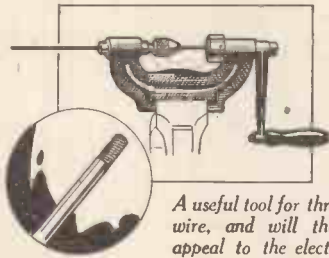
**A Handy Collapsible Rule**

ALTHOUGH capable of measuring up to 6 ft. this rule may easily be slipped into the pocket, as it measures, when closed, only 8 x 2 1/2 x 1/2 in. The sections, as will be seen from the main sketch, slide out and firmly interlock with one another, thus when the rule is fully extended a rigid 6-ft. measure is obtained. Another novel feature is that it is possible to measure inside dimensions, such as the width of a doorway or passage, quickly and accurately by simply reversing the rule and reading at the point indicated by the arrow in the lower sketch. The price is 7s. 6d. post free.

**A Useful Wire Threader**

WHERE long lengths or large numbers of wire rods are to be threaded this tool will be found to be a great advantage over the stock-and-die method. As will be

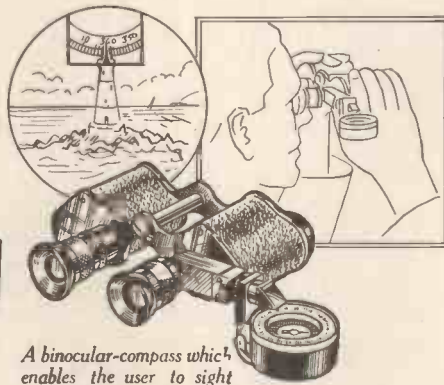
seen from the sketch the cast-iron frame is designed so that it may be clamped firmly in the vice, thus assuring rigidity in operation. The capacity of the chuck is from 0 in. to 3/8 in., and the hollow spindle, which slides backwards and forwards in a splined groove, enables any length of rod to be dealt with. The price is 7s. 6d. carriage paid.



A useful tool for threading wire, and will therefore appeal to the electrician.

**A Binocular-Compass**

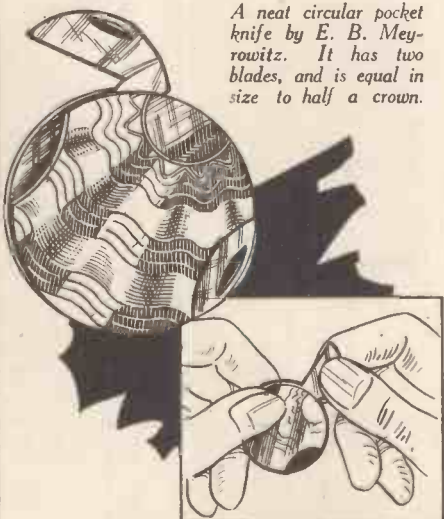
EXTREMELY useful to surveyors, sailors, explorers, yachtsmen, etc., this instrument enables the user to see the object and the compass dial at the same time, at all angles of elevation and depression and by both night and day. An object once sighted, its bearing may instantly be taken and even if it is moving it need not be lost sight of, but followed by the binoculars and



A binocular-compass which enables the user to sight an object and see the compass at the same time.

its change of bearing noted from time to time. The price complete is £18, but the manufacturers are willing to convert ordinary binoculars. It is obtainable from Messrs. Stanley, High Holborn, W.C.2.

A neat circular pocket knife by E. B. Meyerowitz. It has two blades, and is equal in size to half a crown.



A smart young mechanic named Sayers Said, "FLUXITE's the stuff for repairs! For work that is neat, Clean and quick, it's a treat, And no other method compares!"

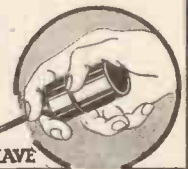
See that FLUXITE is always by you—in the house—garage—workshop—wherever speedy soldering is needed. Used for 30 years in government works and by leading engineers and manufacturers. Of Ironmongers—in tins, 4d., 8d., 1/4 and 2/8. Ask to see the FLUXITE SMALL-SPACE SOLDERING SET—compact but substantial—complete with full instructions, 7/6.

Write for Free Book on the ART OF "SOFT" SOLDERING and ask for Leaflet on CASE-HARDENING STEEL and TEMPERING TOOLS with FLUXITE.

TO CYCLISTS! Your wheels will NOT keep round and true unless the spokes are tied with fine wire at the crossings AND SOLDERED. This makes a much stronger wheel. It's simple—with FLUXITE—but IMPORTANT.

**THE FLUXITE GUN**

is always ready to put Fluxite on the soldering job instantly. A little pressure places the right quantity on the right spot and one charging lasts for ages. Price 1/6.



ALL MECHANICS WILL HAVE

**FLUXITE**

IT SIMPLIFIES ALL SOLDERING

FLUXITE Ltd., Dept. P.M., Dragon Works, Bermondsey St., S.E.1

**How to Stop Smoking**



Many men spend 10/- or more a week on tobacco and cigarettes; how much could you save if you gave up smoking? You will save not only the money you are now wasting, but your nerves and general health, giving you sounder sleep, a better appetite and altogether a brighter outlook on life.

Thousands have mastered the heavy smoking habit quickly, permanently, by help of the Stanley Treatment for Tobacco Habit. The Editor of "Health and Efficiency" says—"It is a pleasure to recommend such a method which brings freedom from the tyranny of tobacco." Think what it would mean to YOU in health and pocket to be done with Tobacco, and write to-day for Booklet and particulars of this genuine treatment.—The Stanley Institute (Dept. 22A), 21 Warwick Lane, London, E.C.4.

**Learn-To-Earn**  
MONEY-IN-SPARE-TIME

Melton Fancy Leather Work offers a splendid opportunity for ALL to earn money making useful saleable articles at home on the Unit System. Tuition Free. Choice of several lines, weekly payments made on production sent to our works.

Write for Illustrated Booklet.

Dept. 521, The Melton Manufacturing Co., 265 Melton Road, LEICESTER.

## REVEALS SECRET of DUAL PERSONALITY

### Astounding Sidelights Disclosed in New FREE Book

Why are most of us conscious of our superiority before inferiors, yet painfully aware of our inferiority when in the presence of superiors? Why have we confidence when left alone with a job we know, yet fumble and fluster when being watched? Why are we amusing to our intimates, yet shy before others?

"These Esoteric Mysteries were explained in a nutshell," affirms Shelley Castle, the author who has done so much to bring the benefits of Practical Psychology to the attention of the multitudes, when Dante said, "This is the body within which I cast a shadow, for each individual has an astounding dual personality." Within every man and woman is the invisible but real YOU, waiting, like the Genie of the Lamp, to help with Amazing Powers that will enable YOU to achieve any reasonable desire.



Photo by Howard Coster.

**1,000 Experts Are Agreed** that humanity is on the verge of realising its own vast potentialities. "The Great Discovery," which is FREE to all responsible people, lays bare the truth.

Mr. D. G. B. (Stewartstown) writes, "I read your most absorbing book entitled 'The Great Discovery' and must say that it has revealed to me many astounding things."

Its disclosures will amaze. Enquiries for this remarkable FREE Book will be dealt with in strict rotation and should be addressed to the Author, Mr. Shelley Castle, Suite (149B), 1 Jackson's Lane, London N.6.

## The DOSSBELL Studio

SPECIALISTS IN  
TECHNICAL  
ILLUSTRATIONS



Write or 'phone us at  
**HIGH HOLBORN HOUSE,  
HIGH HOLBORN, W.C.1.**

Hol. 9638.



## HUMATAGRAPH (Hygrometer)

Indicates the humidity of the air with scientific accuracy. Models for the home and industrial purposes. Matt. Black, 25/-; Chromium plated, 28/-; Pocket model in case, 14/6.

**C. L. BURDICK MFG. CO.**  
40-44 HOLBORN VIADUCT  
LONDON, E.C.1  
CVS-27

## REPLIES in BRIEF

**P. B. H. (Leek).**—The only diagrams available of the "Flying Flea" are those appearing in M. Mignet's book and published by Messrs. Sampson Low Marston & Co., 100, Southwark Street, S.E.1. Full-size drawings are not available.

**W. H. B. (Birmingham).**—See the article on Regulations in this issue. Casein glue is obtainable from the Central Chemicals Ltd., 24, Southwark Street, S.E.1.

**H. W. (Bedford).**—Without money, you cannot pursue the idea.

**H. M. E. (Newport).**—Without more details we cannot advise you. It is, of course, possible to stop a watch by compressed air, and the pressure required will depend on the method of application. A great deal of pressure will be needed for the mainspring end but very little for the escapement end.

It is impossible to design an amplifier to pick up a metallic click. It seems to me that you are in need of the services of an expert designer on the spot.

**E. L. P. (Southend).**—There is no satisfactory method of proofing the bag. You will have to obtain a new one.

**M. C. (Shetland).**—A good book on plating is that published by William Canning & Co. Ltd., 77 St. John Street, London, E.C.1. We are unaware of its price. Your notes regarding the electrical clock have been noted.

**J. F. (co. Leitrim).**—You omitted to place a stamp on your envelope. It will be quite in order for you to try the improvement to the sewing machine which you suggest.

**T. E. (Flint).**—Thanks for your suggestion, which will be kept in mind. We believe Osira lamps are obtainable for household purposes. Many thanks for appreciation.

**K. S. (North Finchley).**—Recommend you to get into touch with the publishers, E. and F. N. Spon, Ltd., 57 Haymarket, S.W.1.

**J. L. (Bristol).**—See article in this month's issue.

**T. L. D. (Winsford).**—It is unnecessary to hold a pilot's licence to fly the "Flying Flea." The regulations are published in this issue. For details of insurance, apply to the Air Ministry, Adastral House, Kingsway, W.C.2. I recommend you to buy M. Mignet's book on the "Flying Flea."

**F. R. (Hythe).**—Re Serpents' Eggs, apparently you have not mixed the ingredients thoroughly. Each should be powdered separately and the three mixed together very intimately. Beyond this we cannot offer any other explanation as the experiment in our experience is invariably successful.

**R. G. (Hounslow).**—Sorry we have no plans of the "Flying Flea" giving English measurements. It is easy to convert millimetres into inches bearing in mind that 1 mm. equals .03937 ins., that there are 2.5 cms. to an inch and 25.4 mm. to an inch.

**B. J. (St. Annes-on-Sea).**—Study the article given in this issue. There are no royalties nor patent rights to pay.

**G. W. H. (Wednesbury).**—Cannot trace any book giving the information you require.

# INCREASE YOUR HEIGHT



## for the New Year

Short people can be made taller with the aid of a box of Challoner's Famous Formula—

## H.T.N. TABLETS

and easy system: well tried: harmless and safe. No strenuous exercises or old-fashioned appliances. If one box is insufficient, we guarantee to supply a further box FREE of all charge. E.H. (Sutton) writes: "Results beyond expectations and I am as pleased as Punch." Act NOW! Send 1½d. stamp for full particulars in sealed envelope. Sample 7½d. Book on height improvement 3d. P.O. or stamps only. Colonial Return Air Mail 1/- extra.

**THE CHALLONER CO. (late of Bond St.)**  
Department H31, Laboratory and Works:  
**HYDE HEATH, AMERSHAM, BUCKS.**

## Engineers' Guide

Bright Prospects and Big Pay Opportunities for the trained man

Write to-day for this great Guide which contains world's widest choice of home-study engineering courses, and shows how to obtain a recognised Qualification such as A.M.I.Mech.E., A.M.I.E.E., A.F.R.A.S., etc. Mention branch, post or qualification that interests you, to THE TECHNOLOGICAL INSTITUTE OF GREAT BRITAIN, 123, Temple Bar House, London, E.C.4. (Founded 1917. 19,000 Successes.)



## To Success



## RE-SHAPE YOUR NOSE

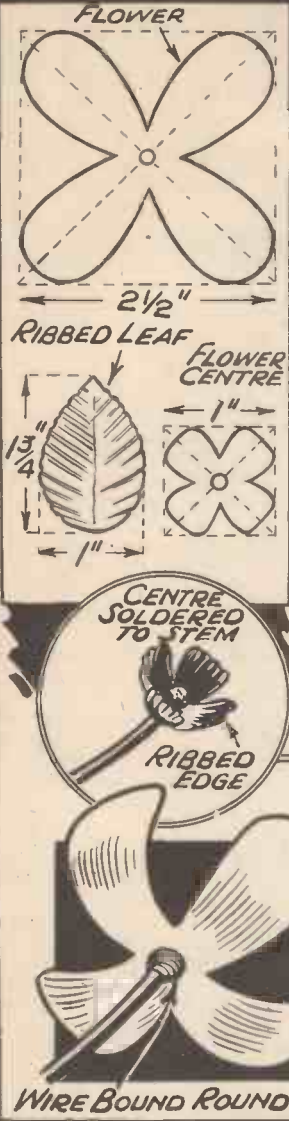
Nothing spoils your looks so much as an unattractive, odd-shaped Nose. This new scientific Guaranteed NOSE-MOLDER will re-shape your Nose as you wish, while you sleep. Improve your appearance. Create favourable first impressions. Ugly noses of every type corrected. Try 14 days. If not delighted, money refunded. No pain or operations. Complete NOSE-MOLDER, 5/6. EAR-MOLDER, 4/6. SHOULDER-BRACE, 3/6. STRENGTHENING INSULATOR, Dept. M.P.1, 28 Dean Road, London, N.W.2.

## HALF-PRICE MODELS

Railways, stationary engines, etc. Just like new. Suitable for presents. Xmas catalogue 4½d. Models bought.

MODEL EXCHANGE, 11 FRIARS STREET, IPSWICH

# Novel Decorations in Metal



**T**HE only tools needed to make these attractive metal flowers are a pair of pliers, tinsnips, and a soldering iron. The blossoms and leaves are cut from old cocoa tins and enamelled—green for the leaves and centres, white or pink for the petals. Copper wire forms the stems.

Draw out the shape of the petals, centres, and leaves on paper and use as templates for the tin. The number of blooms and leaves required is a matter of taste. The leaves are grouped in threes.

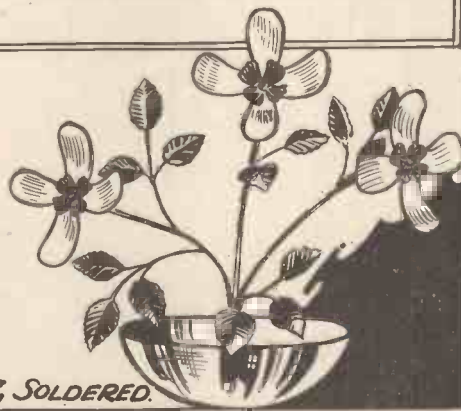
Fold the leaves down the centre and rib them with the side of the pliers. Crinkle the edges of the centres with the pliers and bend into a cup form. Solder lengths of 18 S.W.G. to the leaves and enamel green, leaving the stems bare.

Fix the centres to 12-inch lengths of No. 14 S.W.G. copper wire with a blob of solder, and enamel green, again leaving the stem. Enamel the petals pink or white and leave the various parts to dry.

To assemble, slip the petals on the stems behind the centres and bind a little thin wire round the stem to hold them in place. Make fast with a little solder.

Solder the leaves to the main stems, which are in turn soldered together at the base.

Bend the flowers and leaves about to give the most pleasing arrangement, and enamel the stems.



# TRUSSES ABOLISHED



A photo of Mr. T. Beasley, who healed himself after many years of suffering.

Send for Free Booklet of the Great British RUPTURE Treatment supported by MEDICAL PROFESSION.

Wonderful relief from Rupture. Not a truss, but a neat, washable inflated air cushion adjusted to your needs. It cannot slip, it is light and comfortable, and you will not know you have it on. Holds Hernia firmly, in most cases broken tissues

re-unite, and the Rupture is conquered for ever. Doctors recommend it, and *The Lancet* has endorsed it.

## OPERATIONS ARE UNSATISFACTORY

An eminent authority in "The Medical World" supports us thus: The rate of post-operative recurrence is high—too often more serious than the original Hernia. He says, "I definitely advise moderate and comfortable yet firm pressure," and states the pressure should be eased gradually as the case progresses. Only with the instantly adaptable BEASLEY AIR GUSHION is this possible.

Being medically approved the Beasley Appliance may be obtained through Approved Societies as an Additional Benefit. Write or call:

BEASLEY APPLIANCE COMPANY., Dept. 197,  
45 CONDUIT STREET, LONDON, W.1,  
or 270 DEANSGATE, MANCHESTER.  
Above and 34 Manchester Road, Bradford, are open until 6 p.m. Saturdays.

## BOOKS worth READING

### TWO SPLENDID HANDBOOKS.

"Everybody's Book of Aeroplanes, How They Fly and How to Know Them," by R. Barnard Way. Published by Percival Marshall & Co., Ltd. Price 1s. 6d., with numerous original drawings by the author. 100 pages.

**T**HIS is an excellent little handbook of particular practical value to the amateur. Ranging, as it does, from some description of the early pioneers of flying, through the various forms of aeroplane construction, up to a discussion of many modern types, it gives a splendid bird's-eye view of progress in the air. The chapters include: The early pioneers; How the aeroplane flies; How an aeroplane is made; Biplane or monoplane?; Gliding; Aeroplane engines; Monoplanes; Some biplanes; Seaplanes, flying boats and amphibians; Air-liners; Aeroplanes that are different; The Schneider Trophy;

Identifying aeroplanes; and Imperial Airway Liners.

"Small Alternating Current Motors," by Alfred H. Avery, A.M.I.E.E. Published by Percival Marshall & Co., Ltd. Price 1s. 6d., with numerous photographs and diagrams. 51 pages.

**T**HE object of this handbook, written by a well-known authority, is to put before the reader a clear exposition of the differing types of motors. As the author says in his Introduction: "... An attempt has been made to meet a want long experienced, by formulating a few simple rules for the calculation of windings to suit changed conditions of voltage, frequency or speed. Especial attention has been given to the important question of self-starting." The diagrams throughout considerably increase the value of the text.

The Contents are divided into paragraphs dealing with speed and torque characteristics, constructional differences, the repulsion induction, capacitor and universal motors, the centrifugal switch, combined voltage and frequency modifications, calculating wire sizes and value of magnetic flux, also speed calculations. Altogether a thoroughly helpful book.

## PLEASE SEND NOW FOR THE STUART CATALOGUE NO. 3 6d. POST FREE

describing in 72 profusely illustrated pages the full range of Stuart products—

**STEAM ENGINES and BOILER, PUMPS, PETROL ENGINES, FITTINGS, SCREWS, DRILLS, MATERIALS, ETC.**



The "METEOR"

A high-speed engine complete with lubricator and stop valve

Only 18/6. Boxbed 1/6 extra.

A most attractive Christmas present  
Other engines from 5/-

**STUART TURNER LTD., HENLEY-ON-THAMES**

**ASTOUNDING BARGAIN**  
**FITTED CHESTS OF GUARANTEED**  
**£6.60 TOOLS**  
 47 Strongly Made  
 Standard Size Tools  
 FOR  
**50/-**  
**EVERY TOOL FULLY GUARANTEED**  
 Offer cannot be repeated after present stock cleared.



- |                            |                         |
|----------------------------|-------------------------|
| 1 Hand Saw, 24" Blade.     | 3 Centre Bits.          |
| 1 Tenon Saw, 10" Blade.    | 1 set of 3 Gimlet Bits. |
| 1 Keyhole and Pad Saw.     | 1 Square.               |
| 1 Claw Hammer.             | 1 Axe.                  |
| 1 Pin Hammer.              | 1 Oilstone.             |
| 2 Files (Handled).         | 1 Pair Pincers.         |
| 1 Rule.                    | 1 Small Screwdriver.    |
| 1 Gouge (Handled).         | 1 Large Screwdriver.    |
| 3 Chisels (Handled).       | 1 Glass Cutter.         |
| 2 Brad Awls.               | 1 Spokeshave.           |
| 2 Gimlets.                 | 1 Punch.                |
| 1 pair Pipe Grips.         | 1 Level.                |
| 1 pair Construction Pliers | 1 Marking Gauge.        |
| and flat grip.             | 1 Cork Rubber.          |
| 1 Oil Can.                 | 2 Sheets Sand Paper.    |
| 2 Pencils.                 | 1 Rawplug Outfit.       |
| 1 Soldering Iron.          | 1 Instruction Book.     |
| 1 Tool Chest.              | 1 Croid Glue.           |
| 1 Smoothing Plane.         | 1 Tin Fluxite.          |
| 1 Brace.                   |                         |

**FREE** To every purchaser of the "Zyto" Guaranteed Tool Chest, a handsome 7,6 cloth-bound copy of "Home Repairs and Renovations."

**DON'T DELAY—ORDER NOW.**

\*List of special offers in wood and metal workers' tools free. Post 2d. Please state which you require.

**S. TYZACK & SON LTD.**

TOOL SPECIALISTS,  
 341, 343, 345 Old Street,  
 London, E.1.

*For Everyman*



**NUFIX**  
 TONIC DRESSING for the HAIR

1/3 & 1/9

Fixes without hardness or deposit. No gum. Does not soil Headwear or Linen. Contains emulsified vegetable oil. Prevents dryness. Eliminates Dandruff, and keeps the hair and scalp in perfect condition. Most economical in use. Trial Size 6d.

From Chemists, Hair-dressers, etc.

Manufacturers:  
**WALDEN & CO. (NUFIX), LTD., London, N.W.9.**



## PRACTICAL MECHANICS



# Replies to Queries and Enquiries

If a postal reply is desired, a stamped addressed envelope must be enclosed. Every query and drawing which is sent must bear the name and address of the sender and be accompanied by the coupon appearing on page III of cover. Send your queries to the Editor, PRACTICAL MECHANICS, Geo. Newnes Ltd., 8-11 Southampton Street, Strand, London, W.C.2.

### ORGANIC COMPOUNDS

"(1) CAN you describe an easy process by which I can estimate the amount of the carbon and hydrogen in organic compounds?"

"(2) How can alcohol be prepared from its inorganic materials?"

"(3) Describe some tests for alcohol."

(C. G., New Eltham.)

(1) THERE is no easy method whereby carbon and hydrogen can be estimated in organic compounds. The process is one which necessitates expensive apparatus and also much experience and manipulative skill. A detailed account of the process may be found in any textbook of organic chemistry.

(2) Alcohol (ethyl alcohol) is usually produced by fermentation, but it may be produced from purely inorganic materials in several ways, one of which is the following:

Water is allowed to act upon calcium carbide with the production of acetylene. This is purified and then, mixed with air, is led over surfaces impregnated with platinum black, nickel salts, or other catalytic agents. A portion of the acetylene is converted to acetaldehyde and the vapour of this compound is passed, with or without hydrogen gas, over heated copper powder, as a result of which a portion of it is transformed into ethyl alcohol.

(3) The best test for alcohol is to warm it with a little potassium dichromate and dilute sulphuric acid. If alcohol is present, the peculiar apple-like odour of acetaldehyde will be noticed. Another delicate test for alcohol consists of warming the test liquid with a single crystal of iodine and then adding, drop by drop, a weak solution of caustic potash until the colour of the iodine disappears. If alcohol is present in the liquid, iodoform will be produced and it will be transmuted into yellow crystals. If too small in amount for this, it will be noticed by its penetrating antiseptic smell.

### A FORMULA FOR WATER-GLASS

"(1) WHAT is the formula of the water-glass adhesive as mentioned in an article in the April issue?"

"(2) Having a fair idea of anatomy, I have made a human figure out of cardboard, boxes, prisms, etc., and have built a fairly accurate figure (about 3 to 4 ft. in height). Can you give me a suitable recipe for plaster that has a smooth finish with which I can cover the figure?" (A. A., Cornwall.)

(1) WATER-GLASS adhesive is easy to make. Merely dissolve water-glass in its own bulk of water. This adhesive, when allowed to dry, sticks strongly. If you wish, you may make the water-glass

solution weaker, say 1 part of water-glass to 3 parts of water, and add a little glue solution to it. Please note that material fastened with water-glass adhesive must be dried under fairly firm pressure.

(2) Plaster of Paris will be the best material for you to use. The figure should be given a base coat of plaster of Paris mixed with about 25 per cent. of fine sawdust or cork dust. When this has set, place over it the final layer of unadmixed plaster of Paris. If you find that the plaster dries too quickly, add to it a pinch or two of citric acid or a little gum arabic or glue solution. This will keep it from drying for a few hours and, in addition, will tend to increase the strength of the plaster. Make the final plaster layer as fine as possible in order that it will take the necessary subsequent coat of paint nicely.

### DEATH RAYS, ETC.

"(1) PREPARED colloidal sulphur by the action of concentrated sulphuric acid on strong hypo solution, and allowed a concentrated mixture to crystallise. After some hours I noticed a mass of long, whitish-coloured, needle-shaped crystals "growing" in the solution; these were not the same shape and colour as monoclinic sulphur. Could you tell me whether it is a new allotrope of sulphur, and if not, which allotrope is it?"

"(2) How could I make a scintilloscope for watching the emanations from pitchblende and uranium nitrate, and could I use a zincblende (polished) screen?"

"(3) Would you please supply me with the names and addresses of firms who supply good mineral specimens separately? (I already know of Beck's, Stoke Newington.)

"(4) Has a real death-ray been invented yet? (I mean a ray that causes death directly, not a ray to help the aiming of guns.) I heard of a ray that puts the electrical equipment of cars and aeroplanes out of order, and of another ray which killed rabbits at some distance. (The experiments with the latter ray were carried out at Steep Holm, off Penarth, in the Bristol Channel.) If there are such rays, what is the chief principle of their working?" (N. L. C., Nottingham.)

(1) THE crystals to which you refer are not sulphur crystals but crystals of hypo. In order to precipitate sulphur from hypo solution, the latter solution need not be concentrated, and if this precaution is taken, you will not be troubled with crystallisation.

(2) A convenient form of scintilloscope can be made by taking an ordinary 3 in. x 1 in. microscope slide having a central cavity or depression in it. Into the depression is placed a small quantity of the radioactive material, finely powdered and mixed with a little quick-drying varnish or gum to hold it in position. Over the depression

**PATENTS,  
TRADE MARKS  
AND DESIGNS**

**FREE!  
ADVICE, HANDBOOK  
AND CONSULTATIONS**

**KINGS PATENT AGENCY LTD.**

B. T. King, O.I.M.E., Patent Agent O.B., U.S.A. & Can.  
146a Queen Victoria Street, LONDON, E.C.4  
49 Years' GRAMS: GEOLGIC, LONDON.  
References. TELEPHONE: City 6181.

**PRACTICAL HINTS ON  
PATENTS**

Send free on application.

**THE IMPERIAL PATENT SERVICE**  
First Avenue House, High Holborn, W.C.1.

Preliminary Consultation Free.

**PATENTS, DESIGNS  
AND TRADE MARKS**


A VALUABLE GUIDE ON INTERNATIONAL  
PROTECTION OF INVENTIONS.

100 Pages - - Post Free, 6d.

**The TECHNICAL ADVERTISING AGENCY**  
253 (D) Gray's Inn Road, London, W.C.1

**The 'ADEPT' Bench Hand Shaper**

Price £2 - 17 - 6



Length of stroke of ram, 3 1/2 ins.; Length of cross travel of slide, 3 ins.; Size of Table, 4 1/2 ins. x 4 ins.; Rise and fall of Table, 2 ins.; Vertical feed of tool slide, 1 1/2 ins.; Maximum distance between tool and table, 3 ins.; Weight, 18 lb. Also the 'Adept' No. 2 B.H. Shaper, 6 1/2 in. stroke. Price £5 - 17 - 6.

Manufactured by  
**F. W. PORTASS**  
83a, Sellers Street, SHEFFIELD.

Machine Vice 10/-

**FOYLES**  
Booksellers to the World

New and second-hand books on all technical subjects. Catalogues free on mentioning interests.

119-125 CHARING CROSS RD., LONDON, W.C.2  
Telephone: Gerrard 5660 (12 lines).

**WEBLEY AIR PISTOLS**  
Marvellously accurate for target practice.



No license required to purchase.

Senior 45/-, Mark 1 30/-,  
Junior 20/-, Webley Air Rifle 80/-  
Write for List. WEBLEY & SCOTT LTD.,  
106 WEAMAN STREET, BIRMINGHAM, ENG.

**FROST & CO.**  
70 Old Compton St., London, W.1  
Engineers, Tool and Model Makers.

Models of all descriptions.  
Inventors, Scale and Advertising.  
Patterns, Castings, or Finished Parts, Small Stampings and Press Tools.  
Experimental and Repetition Work.

**MAKE MONEY PICTURE FRAMING**



Picture Framing, Tray-making, Craft Work, etc. Wonderful Wholesale Bargains in Mouldings, Beadings, Frets, Plys, Jacobean Legs, Table Tops, Corner and Tray Mouldings, Fine Art Pictures, New Chromium Beadings.  
Fully Illustrated Guide post free.

**WATKINS PROVIDER**  
EXCHANGE WORKS, NEWPOST, MON.

on the slide is now placed a circle of very thin glass or a piece of thin celluloid, on which is painted a varnish consisting of luminous zinc sulphide mixed with a little celluloid cement to hold the powder together. Another 3 in. x 1 in. microscope glass slide (this time, without the central depression) is laid on top of the zinc sulphide "screen" and the whole is then bound up tightly at the edges with gummed paper. Viewed under a hand lens or a small microscope, the scintillations due to the bombardment of the zinc sulphide screen with the  $\alpha$ -particles from the radioactive material will be plainly seen. For the best results it is necessary to use a single drop of a 1 per cent. solution of radium barium bromide, as the radioactive material is extremely costly. If you use a polished zincblende screen, the radioactive material will have to be brought close up against it, and the scintillations on the screen examined under a hand lens. Both zincblende and pitchblende vary very greatly in their scintillating and radioactive power.

(3) Single specimens of minerals may be obtained from Messrs. George H. Richards & Co., 48 Sydney Street, Fulham Road, South Kensington, London, S.W.

(4) No practical "death-ray" has yet been forthcoming. All reported "death-rays" have comprised either rays of concentrated radiant heat or else electromagnetic rays focused into a beam. It is true that the former can kill small animals at short distances and that the latter have the power to interfere with electrical equipment, yet the fact remains that such rays are not of sufficient practical importance to be utilised on a large scale.

**BY-PRODUCTS OF COAL**

"I AM interested in the by-products of coal. Could you give me a complete list of them and the method of making a few of the simple ones?" (C. F. G., Oldham.)

THE compilation of a complete list of materials obtainable from coal would be a very lengthy task. Here, however, is a comprehensive list of the better-known substances obtained by the distillation of coal:

Gases	Liquids	Solids
(Constituents of Coal Tar)		
Methane.	Benzene.	Coke.
Carbon monoxide.	Toluene.	Various mineral ashes.
Ethane.	Xylene.	
Ethylene.	Carbolic acid.	
Hydrogen sulphide.	Naphthalene.	
Carbon dioxide.	Anthracene.	
Ammonia.	Cresol.	
	Pyridine.	
	Thiophene.	
	Phenanthrene.	
	Also Pitch, a semi-solid.	

You can destructively distil coal for yourself at home by putting a few pieces in a can, luting the lid on with clay, and by providing a delivery pipe passing through the lid of the can. The can is placed in a hot fire. Very quickly, gases will be evolved and, escaping through the pipe, they will burn with a smoky flame at the end of it. In the can will remain coke and a little pitch.

**A NEW HANDBOOK!**

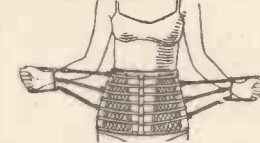
Power-Driven Model Aircraft.

**ABDOMINAL CULTURE**

**The Way to Health**

Nearly all human ills originate from the abdominal cavity, where most of the vital organs and glands are situated.

Writing in "New Health," edited by Sir W. Arbuthnot Lane, Bt., C.B., a Medical Representative of the New Health Society says:



The pulling strands contract and relax the Belt alternately, exercising abdominal muscles and massaging internal organs.

Health Belt is an extremely valuable aid to the maintenance of health through re-educating and strengthening the abdominal muscles. It will also, by its alternating pressures on the abdominal cavity, produce an internal massage of the contained organs."

The "Lancet" describes the 'Rallie' Health Belt as "an ingenious appliance" affording "gentle massage to the abdominal muscles."



The Rallie Health Belt shown with the pulling strands extended. The device is for men and women of all ages.

The "Medical Times" says: "We consider this belt will be very useful in a variety of conditions, such as obesity and weakness of the lumbar muscles. Doctors and others who take little or no exercise would benefit greatly from its regular use. It appears to us that this belt will be found a real boon. . . . The belt is well and strongly made, is beautifully finished, and very comfortable when adjusted to the body. We feel that we are warranted in giving it our cordial recommendation."

This new appliance is specially recommended for the treatment of Constipation, Lumbago, Backache, Kidney Weakness, Liver Disorders, Obesity, Dyspepsia, etc. It is also ideal for correcting Round Shoulders and developing Weak Chests. It is not a corset nor ordinary belt, but is specially designed for abdominal culture and equally suitable for men and women.

Illustrated Book free from

**RALLIE HEALTH APPLIANCES**  
(Dept. P.M.1), 172 Buckingham Palace Road,  
LONDON, S.W.1.

**RUPTURE**



**THIS APPLIANCE SCRAPS UNDERSTRAPS AND BALL OR OVAL FRONTED PADS.**

Greatest Discovery of Modern Times. Freedom at last! An amazing new invention that holds rupture firmly and securely WITHOUT UNDERSTRAPS. This new method invented by Mr. W. Blunden, A.M.A., L.S.M., the World's Foremost Rupture Specialist, supersedes old-fashioned trusses and appliances. The famous Blunden Scientifically shaped Pneumatic Pads give support at the LOWEST part where the rupture is always weakest. Comfort and security undreamed of. Write to-day and learn all about it and how you can TEST IT FOR SEVEN DAYS BEFORE PAYMENT. If insured obtain through your Approved Society. Write to-day **BLUNDEN SURGICAL APPLIANCE Co. Ltd.** (Dept. 243A), 9 Oxford St., London, W.1. **MANCHESTER: 6 John Dalton Street.**

**EXTRA**  
INCHES TO YOUR HEIGHT

Professor Carne is ready to send entirely free a copy of his famous books, 'How to Build Stature' and also 'Every Woman a Venus.' It costs you nothing to send for these books. They will be the means of greatly improving your height, your health and physique. They will give you an assurance you never thought possible. Enclose 2d. stamp. (Please mention Mr., Mrs., Miss, or Title, as there is a special book for ladies.) All books sent privately.

**P. CARNE, P.L., REIWIBINA, CARDIFF, S. WALES.**

# BUY, EXCHANGE OR SELL

Advertisements are accepted for these columns at 2d. per word (minimum 12 words at 2s.—advertisements of less than 12 words are charged at the minimum rate of 2s.), subject to a discount of 2½% for 6 consecutive monthly insertions or 5% for 12 consecutive monthly insertions. **TERMS:**—Cash with order. Cheques, Postal Orders, etc., should be made payable to George Newnes Ltd. *The Proprietors reserve the right to refuse or withdraw advertisements at their discretion.* All advertisements must be received on or before the 5th of the month preceding date of publication and should be addressed to the Advertisement Manager, "Practical Mechanics," George Newnes Ltd., 8-11 Southampton Street, Strand, W.C.2.

## BOATS

**BARGAINS (foreign).** As long as stock lasts: Cl.W. Boats, 12 in., listed 4/6 for 2/6; El. Boats, 21 in., listed 24/6 for 15/-; El. Boats, 28 in., listed 32/6 for 18/-; Cl.W. Boats, 28 in., Beam 6 in., listed 40/- for 15/-; Cl.W. Cruiser with 2 cabins and El. Lights listed 78/- for 25/-; El. Cruiser with 2 cabins and El. Lights listed 78/- for 25/-; Sailing Boats, 32 in., listed 35/- for 18/-; Sailing Boats, 40 in., listed 60/- for 30/-; All boats are new and made of best grade mahogany wood. Marine Steam Engines d.a. oscillating cylinders by Bassett-Lowke, complete with copper boiler, hard soldered, 12/- 4-volt Electric Motors, very powerful, listed 6/- for 2/6.—F. C. Reiser, 72 Twyford Avenue, London, W.3. Phone ACOrn 1783.

## CALENDARS

**PICTURES FOR CALENDARS,** Jigsaws, Framing. Twelve different, 9d.—Lees, Bentinck Road, Nottingham.

## CHEMISTRY

**A GARDEN IN A GLASS.** Lagoon Chemical Garden Outfits, price 104d. post free from Finch, 8 Brisbane St., Clayton-le-Moors, Accrington.

## CINEMATOGRAPHY

**ARTISTIC CINE FILMS.** Exclusive productions now available in 9.5 mm. and 16 mm. List Free. Projectors from 27/6. Pocket Cinema 25/-. P.M. Dane, 64 Stanley Street, Liverpool, 1.

**CINEMATOGRAPH FILMS.**—Standard size from 6d. 100 feet. Machines, Accessories. Sample Films, 1/- and 2/6 post free. Catalogues free.—"Filmaries," 67 Lancaster Road, Leytonstone, E.11.

**FILMS.**—30 ft., 9.5 mm., 1/3, others; 100 t., 35 mm., 1/-.—Hobbs, 20 Mansebrae, Glasgow, S.4.

**MOVIES AT HOME.** How to make your own Cinema Projector. Particulars free.—Moviescope (N), Pear Tree Green, Dodinghurst, Essex.

**"FILMCRRAFT."**—Here is a fascinating series of authoritative textbooks for everyone interested in the Cinema as the newest of the arts. The Filmcraft series, each 3s. 6d. net, includes volumes by Pudovkin, Adrien Brunel, G. E. Kendall, D. Charles Otley, Percy W. Harris. From all Booksellers and Newsagents.—George Newnes Ltd., 8-11 Southampton Street, Strand, London, W.C.2.

## ELECTRICAL

**SMALL GOOD-CLASS ELECTRICAL AND MECHANICAL MODELS,** Chemical and Scientific Apparatus, Tools, Measuring, Meteorological and other Instruments wanted.—Andrews, 27 New Bailey Street, Salford.

**INSTRUMENT MAKING,** Acoustic and Electrical, etc. Inventors' Models, Experimental Work, Machining, Gear Cutting, Turning, Screw Cutting, Milling, etc. Send requirements for quotation.—Gaydon & Co., Scientific Engineers, 42a Sydenham Road, Croydon.

## ELECTRICAL (continued)

**ELECTRIC MOTORS,** secondhand, guaranteed, all sizes, low prices.—Geeco Ltd., 47 Pitt Street, Glasgow, C.2.

**SURPLUS ELECTRICAL** and Engineering Materials, low prices.—The London Electric Firm, Croydon.

**ELECTRICAL APPARATUS.**—Microphones, etc. Catalogue—Stamp.—Smallpiece Electricity, 38 Walton Road, Woking.

**QUALITY BARGAINS.** Electric Drills, A.C. and D.C. motors, all sizes. Air compressors, Bandsaws, S.C. Lathes, Grinding heads. Details free, Large Catalogue 2/-.—John P. Steel, Bingley.

## ENGINEERING

**SMALL ENGINEERING.** 25 years' practical experience behind the job you want. Speciality, short orders.—Hunter Ross, 19 Greenham Road, London, N.10. Phone Tudor 1931.

## ENGINES

**ENGINES.** Build Butler's ¼-h.p. practical Model Petrol Engine. Set of Castings, 9/9. Interesting Catalogues 3d. TAPS. Your own stocks, dies, taps, ¼ in., ½ in., ¾ in. and 3 taps, 12/-.—Write Profit-Sharing Works, Littleover, Derby.

## ENGRAVING

**ENGRAVE ON METALS** with the Vibra Engraving Machine. Tallies, name plates, etc., speedily done. A.C. mains only. £3 complete. Particulars—Lycett's, Skinnergate, Darlington.

## FORMULAS

**MANUFACTURE YOUR OWN PRODUCTS.** Guaranteed Formulas, 1/-. Six for 5/- (lists—literature, 3d.). Make money from used motor-engine oil, instructions, 1/-.—"TECHNOCRAFT," 41 Longford Place, Manchester.

## MAGIC

**WORLD'S GREATEST "MENTAL-TELEPATHY"** Performance, £1. Easily learnt. "CAL-ASTRO"—"MIND READING" Performance, £1. Famous "X-RAY EYE" Performance, 6/-. ESCAPES from Handcuffs, Safes, Ropes, Mailbags, Trunks, Boxes, FULL INSTRUCTIONS, 5/-.—"DEVILLE," 41 Longford, V.P. Manchester.

**BE A HYPNOTIST.** Amazing secrets in manuscript form, 1/8 post free. Conjuring catalogue, 3d.—Gordon & Co., 65 Chancery Lane, London, W.C.2.

**PERPLEXITIES AND TANTALISERS.**—"The Strand Problems Book" is the finest collection of puzzles of all kinds ever assembled, mathematical, geographical, literary—acrostics and codes, by W. T. Williams (Tantalus) and G. H. Savage. Only 2s. 6d. net, from all Booksellers.—George Newnes, Ltd., 8-11 Southampton Street, Strand, London; W.C.2.

## METAL WORK

**"DIE-CASTING IN LEAD"** tells how to make lead Soldiers, Cowboys, Animals, etc., with complete catalogue of dies. 1/2.—Industries (below).

**"HOME TOYMAKING,"** just published, with 180 illustrations of practical amusing toys. 1/2.—Industries (below).

**DOLLS' HOUSE BRICKPAPER.** Roof, flooring, bedroom, kitchen and fancy papers. Six assorted sheets, 1/6; 12 sheets, 2/6.—Industries, 13 Gordon Avenue, Twickenham.

**MAKE METAL TOYS.** Easy, profitable with "SUCCESS" Moulds. List Free.—Lee's, Bentinck Road, Nottingham.

## MICROSCOPY

**MICROSCOPIC OBJECTS** unmounted prepared. Assorted packet 2/-. **MOUNTED SLIDES STOCKED.**—LENG, 183 MANCHESTER DRIVE, LEIGH-ON-SEA.

**MICROSCOPES** from 7/6. Accessories—Slides. Repairs to all optical instruments. Exchanges. Pullon, 128 Eastcombe Avenue, S.E.7.

## MISCELLANEOUS

**GENUINE BARGAIN.** Original 2 guineas Mind Training Course. 5/- only.—Leonard, 18 Ramwell Street, Bolton.

**STOP SMOKING.** Send 2/6 for complete treatment. Immediate results guaranteed. "Peacock," 752D Bury Road, Bolton.

**SPECIAL OFFER!** Free Vest-Pocket Safety Razor given with 2 dozen Finest Quality British Razor Blades, 3-hole type. 2/-, post free. P.M., 52 Amelia Street, Walworth, London.

## MODELS

**INVENTORS' and ENGINEERS' Drawings,** Models, Patterns.—Bland, 105a Crawford Street, London, W.1.

**TURNING AND FITTING** for Model Makers. Scientific Instrument Making and Repairs.—S. Bowles, 23 Beaumont Road, Hornsey Rise, N.19.

**SCREWS, NUTS, WASHERS** (special Model Engineers' sizes). Everything for Electrical Re-winds and Repairs. Lists Free.—Lumen Electric Co., 9 Scarisbrick Avenue, Litherland, Liverpool 21.

**MODEL BARGAINS.** Catalogue 44d. See page 210.—Model Exchange, 11, Friars Street, Ipswich.

**AN INVALUABLE Handbook.** ACCUMULATORS. Up to date, practical, dealing with every type of accumulator, methods of charging them at home, care and maintenance. This little book also explains how to erect a charging station. This is one of Newnes' Home Mechanic Books. Ask your Newsagent to show you other Titles in this Helpful Series. Obtainable at all Booksellers, 1s. each.—George Newnes Ltd., 8-11 Southampton Street, Strand, London, W.C.2.



# BUY, EXCHANGE OR SELL

## MODELS (continued)

**ARE YOU HANDY With Your Hands?**—If you like making and mending things you ought to know about the "Home Mechanic" Series of 1s. Handbooks. They cover a wide field, from model and toy-making to motor-car upkeep and radio construction. Each is complete in itself and fully illustrated. Price 1s. each from all Booksellers and Newsagents (from whom a list of subjects can also be obtained).—George Newnes Ltd., 8-11 Southampton Street, Strand, London, W.C.2.

**"WORKING MODELS and How to Make Them."** Edited by F. J. Camm, 3s. 6d.—This book will appeal to all who are handy with tools. Contains complete instructions for the making of every kind of working model. Each model has been actually constructed in accordance with the details given and subjected to stringent tests. The instructions and diagrams are so clear that even the most elaborate model can be built without fear of failure. Obtainable at all Booksellers and Newsagents.—George Newnes, Ltd., 8-11 Southampton Street, Strand, London, W.C.2.

## MONEY-MAKING

**MONEY-MAKING OPPORTUNITIES** constantly occurring; highly recommended; particulars free; send postage. Messrs. Green, 17 Church Lane, Hull.

**YOU WILL BE DELIGHTED** with our money-saving Catalogue. Endless variety. Postcard now. Green's, 323 Albert Street, Lytham.

## MONEY-MAKING BOOKS

**3,000 FORMULAS, RECIPES**, with "DIRECT-ORY," "WHERE TO BUY" chemicals, both 4/9. **SOAP-MAKING COURSE** (no machinery needed), 4/-. **MAIL-ORDER COURSE and TRADERS' "DIRECTORY,"** 3/-. **"TECHNOCRRAFT,"** 4/1 Longford Place, Manchester.

## OPTICAL

**ASTRONOMICAL TELESCOPES.** Microscopes, accessories, all Optical Instruments.—Mackett & Co., Manufacturing Opticians & Engineers, 51 Millers Road, Brighton.

## PATENTS

**REGINALD W. BARKER & CO.** (Established 1886), 56 Ludgate Hill, London, E.C.4. Patent and Trade Mark Booklets Gratis.

## PHOTOGRAPHY

**£500** worth good, cheap Photo Material, Film, Plates, Cards, Papers, Chemicals. Catalogue and 4 Samples Free.—Hackett's Works, July Road, Liverpool 6.

**POSTCARDS FROM ANY PHOTO.** Time to finish, four days. 25 1/9; 50 3/-; 100 5/-; 500 17/-; 1,000 30/-. Enlargements 1/- Samples and List Free.—Hackett's Works, July Road, Liverpool 6.

**DON'T TAKE RISKS.** Good developers mean good results. Our reliable stock developers keep twelve months after mixing. Satisfaction certain to amateurs and professionals. Best developer ever put on the market. Makes two pints strong developer. 6d. each. 6 for 2/3, 12 for 4/-. Post free.—Hackett's Works, July Road, Liverpool 6.

**4 DELIGHTFUL, ARTISTIC STEREOSCOPIC SLIDES,** 1/-. Lists free.—Smith, 31 Henley Street, Oxford.

## SITUATIONS VACANT

**YOU CAN USE YOUR SPARE TIME** to Start a Mail Order Business that quickly brings you a full-time income. Follow the lead of others who are averaging £12 per week net profits. Get away from a drudging routine job—join the big-money class. No previous experience necessary. Few pounds capital only needed. No samples or outfits to buy; no rent, rates or canvassing. New method makes success certain. Write to-day for FREE BOOKLET to Business Service Institute, Dept. (303c), 6 Carmelite Street, London, E.C.4.

**SANITARY AND WEIGHTS AND MEASURES INSPECTORS,** Relieving Officers, Handicraft Teachers, and Registrars are in constant demand. Permanent progressive positions. Full details of entry into these attractive careers from C.C., 335/3 High Holborn, W.C.1.

**POST OFFICE ENGINEERING.** Good positions open to youths and men age 17 to 40. For details of vacancies, salaries and prospects, write N.T.O. (Dept. 307), 335 High Holborn, W.C.1.

**PERSONS WANTED** (either sex); homework, addressing envelopes, circulars, etc.; materials supplied free. Write only—Somerville & Co., 49 Bow Lane, London, E.C.4.

**JUNIOR MECHANICS WANTED** to assist in manufacture of Transformers and Chokes. Main essentials Common Sense, Speed and ability to solder.—Apply, **SOUND SALES LIMITED, MARLBOROUGH ROAD, N.19.**

## STAMPS

**FREE !!** Twenty Unused Colonials, "Neurope," 1jd. Fifty for 9d.—G. H. Barnett, Lymington, Somerset.

**"RARE"** Mixed stamps, including Jubilees and high values 20/- per pound, sample 1/-. Just try them! **LIQUIFACTORS (P), 43 RECTORY ROAD, LONDON, S.W.6.**

**NINE DIFFERENT SILVER JUBILEE STAMPS** 2d. Request approvals, Sanders, 90 Newlands, Southampton.

## TOOLS

**TOOLS, MATERIALS.** Wonderful bargains for wood and metal workers. Fretworkers, Toymakers, Electricians.—**AGAN, 55 High Street, Battersea, S.W.11.**

**ELECTRIC DRILL** reconditioned new chucks, 1/2 in., 18/9, all voltages universal. General purpose motor, universal, over 1/2 h.p., 13/6 drives sewing machine, film projectors, etc., motor pulley, 1/8, 4-in. superior grindstone to fit motor, 2/3. Heavy duty treadle lathe with chuck, slide rest, 37/6. Chucks, lathe accessories, fretwork machines, 1/8 or 1/2 h.p. motors, etc., on application. Casting and machining in aluminium, brass, iron, models made list 2d.—Anel Cine Co., 7 Highbury Terrace Mews, N.5.

**GRAYSON'S** steel mouse threads flex through conduits. 5/- post free.—Below.

**GLASS-BORING** Outfits avoid risk.—Grayson & Company, 300 Campo Lane, Sheffield.

**UNDER COST!** 150 sets Highest Grade Lathe Tools.—Greenwood, Arnside Road, Southport.

**LATHES! LATHES! LATHES!**—New stock of 4-in. centre super bench lathes (Universal Machine Co.), full screw-cutting, tumbler reverse, ball thrust, 8-in. faceplate, back gear, turns 10 1/2 in. by 2 in. in gap, lever locked tailstock, tee slotted table and slide-rest, hollow mandrel, super finish, weight 130 lbs., worth £25, our price £7 15s. each, perfect tools. Send stamped envelope, or call after 6 p.m., close 4 Saturdays. P., 80 Ridgeview Road, Whetstone, N.20.

## TOOLS (continued)

**TOOLS** upon easy payments. Treadle Saw Benches, £8/10/0, power £3, Constructors' Saw Bench Fitments 12/6, Lathes 25/-. Compound Rests 15/-. Foot Treadles 35/-. Lists 2d.—Brown Bros., Accrington.

**ARE YOU THINKING OF PURCHASING A LATHE?** Then send for our list with illustration and full range of accessories. Quite the latest design. A really high-class machine at a most reasonable price.—Myford Engineering Co., Neville Works, Beeston, Notts.

## TURNED PARTS

**BRASS SCREWS AND TURNED PARTS** of any description, Experimental work and Model Making, Inventors' ideas developed in strictest confidence. Below.

**SPECIAL OFFER.** 1/2 Gross Turned Screws with Nuts and Washers, Assorted BA sizes; 1/9 post free. A genuine bargain.—**MICROCO, 26/31 Eyre St. Hill, E.C.1.**

## WIRELESS

**RADIO CONSTRUCTORS' BARGAIN PARCELS,** including valves, 5/9. Buckle, 60 Avenue Approach, Bury St. Edmunds.

**AN EXTRA GOOD ALLOWANCE** made on your old set or parts in part exchange for any new receiver for cash or easy terms. We take your goods as deposit. Peto-Scott kits and components supplied for cash only, or part exchange. Highest allowances; prompt attention.—R. Wigfield, Wireless Agent, Furlong Road, Goldthorpe, Yorks.

**A DICTIONARY OF WIRELESS TERMS,** by Ralph Stranger. A Wireless Work of Reference that should be on the bookshelf of every keen amateur. Compiled by a master of incidity, it gives the meanings of all Technical terms in general use. Price 2s. 6d. from all Booksellers and Newsagents.—George Newnes, Ltd., 8-11 Southampton Street, Strand, London, W.C.2.

**FOR THE RADIO ENTHUSIAST.**—"The Wireless Constructor's Encyclopedia," by F. J. Camm (Editor of "Practical and Amateur Wireless"), third edition. Compiled by one of the most accomplished designers and writers on the practical side of Wireless, it covers the whole field. A veritable Treasury of Wireless Knowledge. Price 5s., from all Booksellers and Newsagents.—George Newnes, Ltd., 8-11 Southampton Street, Strand, London, W.C.2.

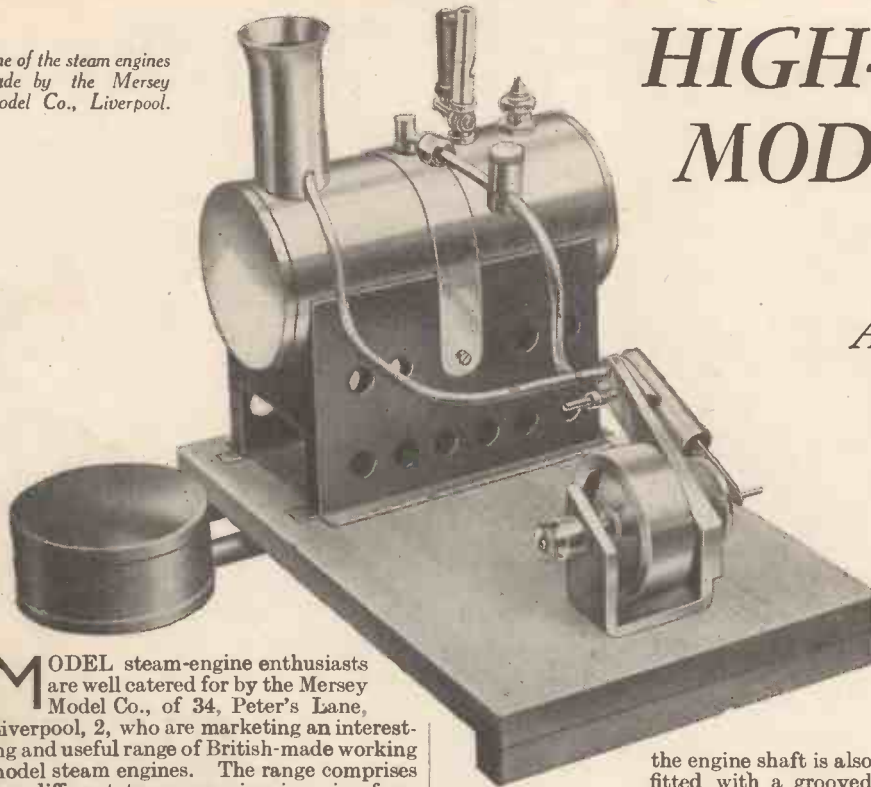
**FIFTY TESTED WIRELESS CIRCUITS,** by F. J. Camm, 2s. 6d.—This handbook contains every modern circuit, complete with instructions for assembling, component values, and notes on operation. Obtainable at all Booksellers and Newsagents.—George Newnes, Ltd., 8-11 Southampton Street, Strand, London, W.C.2.

**"THE MATHEMATICS OF WIRELESS,"** by Ralph Stranger.—This book is essential to the amateur who wants to gain a further knowledge of the subject without loss of time—or temper! Fully illustrated, 256 pages. Price 5s., from all Booksellers and Newsagents.—George Newnes, Ltd., 8-11 Southampton Street, Strand, London, W.C.2.

## WOODWORK

**CABINET HARDWOODS,** Oak, Mahogany, Ash, White-wood, Ply Woods, etc. Lowest Prices. Send Cutting lists. Planing free. Speciality prime Jap Oak, all thicknesses.—Wilfred Parr & Co., March Works, Lancaster Road, Leytonstone, E.11.

One of the steam engines made by the Mersey Model Co., Liverpool.



**M**ODEL steam-engine enthusiasts are well catered for by the Mersey Model Co., of 34, Peter's Lane, Liverpool, 2, who are marketing an interesting and useful range of British-made working model steam engines. The range comprises five different types, ranging in price from 10s. 6d. to 45s. 6d., each mounted on a polished wood baseboard.

#### High Quality Workmanship

The workmanship throughout is of a very high quality, and all models are tested before they leave the works. The first model, listed at 10s. 6d., has a lacquered brass boiler of solid drawn tube, fired by a two-wick methylated spirit lamp. The engine cylinder is of the single-acting oscillating type, having a stroke of  $\frac{3}{4}$ -in. and exhausting through the chimney. A heavy polished brass flywheel is provided, and

the engine shaft is also fitted with a grooved pulley to take a small driving band. The second model has a slightly larger boiler, an inclined single-acting cylinder, and a special crank disc. A three-wick spirit lamp is used for firing, and a displacement lubricator is fitted to the steam pipe. We recently tested one of these engines under steam, and noted its smooth and noiseless running. It worked at high speed and had quite a strong tongue at the engine shaft. This model is listed at 16s. 6d.

#### A Horizontal Boiler

The third model has a horizontal boiler

# HIGH-CLASS MODEL STEAM PLANTS

*A Useful Range of British-Made Working Model Steam Engines*

6 in. long and 2 in. diameter, which supplies steam for a single-cylinder engine of the same type as the previous model. This engine drives a countershaft which is provided with grooved pulleys for taking bands for driving small working models. The price of this model is 22s. 6d. The fourth model is a compact little steam plant, having twin oscillating cylinders, horizontally opposed, the engine driving a countershaft mounted on tall brackets. A four-wick spirit lamp is used for firing. At 37s. 6d. this is a very moderately priced and serviceable miniature steam plant. The last model of the series (54R) is of similar construction. In this case the twin-cylinder opposed engine is fitted with a specially designed combined reversing gear and speed control lever, which controls the running of the engine in either direction. This model is priced at 45s. 6d.

#### Spare Parts Obtainable

Spare parts for any of these engines are obtainable at reasonable prices, and an illustrated folder giving full particulars of the complete range can be obtained from the Mersey Model Co., at the above address.

## The Ostar Ganz "Ether Conqueror Minor"

**A**LTHOUGH this receiver employs only two valves it is designed on lines usually unassociated with such a modest receiver. The two valves are of the pentode type, the first being an H.F. pentode and the second an L.F. pentode rated to deliver an output of 2 watts. The circuit, so far as main details are concerned, is quite straightforward, and in the aerial circuit we find the usual tuning coils and condenser coupled to the first grid through a grid condenser with leak in parallel. Coupling between the two valves is carried out by means of a resistance-capacity circuit and the loud speaker is directly fed. The mains section follows the usual practice adopted with these all-mains valves and there is thus no mains transformer, the mains leads feeding direct to H.T. negative and the heater of the mains rectifier. A substantial smoothing choke is provided in the H.T. positive lead, and the field of the loud speaker may also be joined between H.T.— and the positive tapping.

#### The Tuning Circuits

It is in the tuning circuits that the novelty of this receiver lies, as it is designed to cover not only the usual medium- and long-wave broadcast bands, but also a short-wave band from 19 to 65 metres. A rather elaborate switch is incorporated to effect wave-

changing, and the coils are divided into three sections. The short-wave coil for use on the 19-65 metre band is mounted in an unscreened condition beneath the chassis, whilst on the upper side of the

chassis two separate coils are included in screening cans, and these are wired to produce a band-pass effect on the broadcast band, and to change the circuit as desired. To simplify tuning on the short-wave band a band-spread condenser is fitted and the main tuning condenser is employed in conjunction with this. Pick-up connections are provided.

## HOBBIES NEW ANNUAL

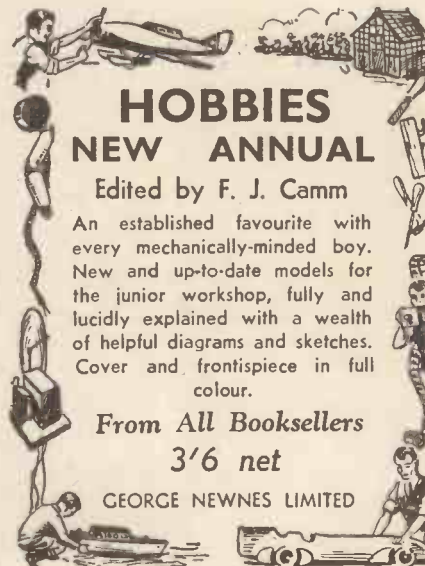
Edited by F. J. Camm

An established favourite with every mechanically-minded boy. New and up-to-date models for the junior workshop, fully and lucidly explained with a wealth of helpful diagrams and sketches. Cover and frontispiece in full colour.

From All Booksellers

3/6 net

GEORGE NEWNES LIMITED



#### Test Report

The selectivity is of a high order, due to the novel arrangement of the tuned circuits, and there is no serious loss of signal strength due to this arrangement. Reaction has little effect on tuning, but naturally makes a great deal of difference to the reception of foreign stations. It is delightfully simple to handle and the degree of selectivity is ample for all normal requirements, and is, in fact, superior to that usually found with a band-pass circuit. On the short-waves results are equally satisfactory, and in view of the fact that only two valves are employed the sensitivity is very good indeed.

This receiver is sold as a kit of parts for home construction and costs £7 10s. with valves. A suitable cabinet and loud speaker may be obtained separately from the same firm if desired. The makers are Eugen J. Forbat, 28-29 Southampton Street, Strand, London, W.C.2.

# Special Christmas Bargains

**SENT ON APPROVAL** **30<sup>l</sup> VALUE FOR 8<sup>9</sup>**



**FREE UKULELE BANJO TUTOR** with every order!

This beautiful Hawaiian Banjo, genuine, 30<sup>l</sup> value, is the public at ridiculous figure of 8/9 only, or sent for 6d. deposit and 6d. fortnightly until 9/9 is paid. Highly polished satin-walnut finish. Brass-fretted finger board. Amazingly sweet tone. Very little practice required to master it with speedy Tutor sent Free. Send now to avoid disappointment to:—

**Aircraft Products, Ltd., Dept. (P.M.U.1), 89 New Oxford Street, London, W.C.1.**

## A NEW ELECTRICAL WEEKLY

If you are interested in the manufacture, sale, or use of electrical plant or electrical power, you should certainly obtain a copy of a new weekly which was issued on November 22nd, and which is entitled *The Electrical Engineer*.

In the pages of the first issue will be found the names of many men of eminence in the Electrical profession: Sir. J. Ambrose Fleming, M.A., D.Sc., M.I.E.E., F.R.S.; Lieut.-Colonel R. E. Crompton, C.B., R.E., F.R.S., M.I.C.E., M.I.E.E.; Sir Noel Ashbridge, M.I.E.E.; W. J. H. Wood, M.I.Mech.E., M.I.E.E.; A. T. Dover, M.I.E.E.; Lord Hirst of Witton, Founder and Governing Director of the General Electric Co. Mr. Allan Monkhouse, M.I.E.E., who will be remembered by his recent experiences in Russia, contributes a weekly feature.

This new publication offers the best six-pennyworth of technical information now available to anyone in, or interested in, any branch of Electrical Engineering or its applications to industry.

**STUPENDOUS FACTORY CLEARANCE**



**PIANO ACCORDIONS**

The most amazing offer ever made to popularise this organ-toned instrument. Full scale piano keys. 8 repeating bass notes. Clear, music. Strong bellows. Well finished piano keys. Leather and shoulder straps at our name over the world. 6d. Money back if not at once Dispatch.

**8<sup>6</sup> POST 6<sup>o</sup>**

**AIRCRAFT PRODUCTS, LTD.**  
(Dept. Z.P.M.1)  
Street

## "DUPLIX TAILSTOCK" 3 1/4-in. B.G.S.C. LATHE

### POINTS OF SUPERIORITY:

Weight (bench model) 85 lbs. Concentric adjusted bronze bearings. Ground mandrel and tailstock barrel. Multi-purpose tailstock. Compare with any other make, and judge for yourself. List stamp please.

**WARD & POLLARD,**  
Engineers, Orchard Works,  
Plumstead High St., London, S.E.18

## The "RANDA"



Gap Bed, Back Gear and Surfacing. 12 1/2" Mandril. No. 1 Mandril. Bearings. Complete set of Change Wheels.

**ROSS & ALEXANDER**

## PLAY THE WORLD'S BEST PIANO ACCORDIONS



TONELLA, LA FLORENZA, PANGOTTI-VICKERS, VERDI, HOHNER, L'ORGANOLA, CARMEN, STUDENT, TANGO.

Beautiful Model Illustrated with 48 Basses and Octave Couplers, only 5/- per week. In case.

**"DON'T GAMBLE"** Insist upon a World's Best Accordion and save money. Also Concertinas, Drums and other band instruments.

★ **HAWAIIAN GUITAR** Offer. Complete outfit only 1/3 week.

Write for list of 1936 Models or ask your dealer.

FROM 1/- PER WEEK

**J. J. VICKERS & SONS, LTD.,** Dept. P.M. 80-82 Royal Hill, London, S.E.10.

## GENUINE AND ONLY SUPER CHROMATIC MOUTH ORGAN

CASH PRICE 10/6 POST FREE SPECIAL TUTOR  
SMALLER MODEL 6/6 POST FREE 1/- EXTRA

**LARRY ADLER**  
The world's greatest Harmonica Player.

This superb **HOHNER INSTRUMENT** can be played in ANY Key (all 12 Keys) including all



## JUBILEE WORM HOSE



The long-life the ever

The Best

For Radiators, Air, Oil, and Water Hose Joints.

Large sizes stop squeaking brakes.

Stocked by all Garages and Accessory Dealers

**L. ROBINSON & CO.,**  
25 London Chambers,  
GILLINGHAM, KENT.

OF CHEMICAL GLASSWARE  
25 c.c. BLUE GRADUATED BURETTES, 2/9.  
SECONDHAND CHEMICAL BALANCES from 15/-  
TEST TUBES from 6d. doz. BEAKERS, FUNNELS, etc.

OUR JUNIOR MICROSCOPE. MORE THAN A TOY. MAGNIFICATION x 25. 12/6 in case. Part postage 3d.

MOTORS. WIRE. PARTS OF ALL KINDS. LENSES. PRISMS. RACKS. PINIONS, etc. Call and be satisfied.

Every kind of scientific instruments bought, sold and exchanged. NO LISTS AVAILABLE.

**SOLD FLUX**

Sold in 6d. and 1/- tins at all Cycle Accessory Dealers, Tool Shops, Ironmongers, etc.

Write for your free copy "Joining of Metals" to

**SIR WM BURNETT & CO (CHEMICALS) LTD.**  
GREAT WEST ROAD, ISLEWORTH MIDDLESEX  
TELEPHONE: HOUNSLOW 0476

NEW IMPROVED 1936 ADANA HIGH SPEED AUTOMATIC PRINTING MACHINE

REG. TRADE MARK

COMPLETE 38'6" MACHINE



This new Improved 1936 Model possesses all the modern features that could possibly be required of a printing machine, including an excellent adjustable paper gripping device.

**CASH**  
OR  
**EASY**  
**TERMS**

MAKE

E'S

HOME

can be  
"ADANA"  
by

A Real Automatic Machine in every detail. Accurate Metal Diecastings (having a tensile strength of over 20 tons) from costly moulds have made it possible to market this fine piece of machinery at this remarkably low price. Nothing has been spared to produce a smooth-running, high-class, fast Printing Machine. The result is wonderful. No words can explain what fine adjustments can easily be made to produce a perfect print, and which, once set, is permanently maintained throughout the job, as the impression is entirely mechanical.

1,000 COPIES  
PER HOUR

ies per hour are easily  
of paper, card, or  
printed. It  
limited

**You Can Print**

**EVERYDAY NEEDS**

- |                          |                         |
|--------------------------|-------------------------|
| Private Noteheadings     | Commercial Noteheadings |
| Visiting Cards           | Billheads               |
| Business Cards           | Sports Printing         |
| Gummed Labels            | Competition Cards       |
| Showcards                | Correspondence Cards    |
| Greeting Cards           | Advertising Blotters    |
| Small Wrappers           | Wedding Cake Cards      |
| Price Tickets            | Wedding Invitations     |
| Entertainment Cards      | Hairdressers' Cards     |
| Sports Scoring Cards     | Admission Tickets       |
| Card Games Scoring Cards | Window Tickets          |
| Small Programmes         | Dance Invitations       |
| Tag Labels               | Calendars, etc.         |

**OFFICE PRINTING**

- |                         |                           |
|-------------------------|---------------------------|
| Commercial Noteheadings | Overprinting Ledger Cards |
| Business Cards          | Commercial Envelopes      |
| Overprinting Circulars  | Motto Desk Pads           |
| Card Index Slips        | Letter Reference Slips    |
| Price Tickets           | Account Remittance Slips  |
| Overprinting Cheques    | Cash Receipts             |
| Stationery Samples      | Exhibition Cards          |
| Proofing of Blocks      | Travellers' Cards         |
| Advertising Tickets     |                           |

**HOTEL PRINTING**

- |                         |                         |
|-------------------------|-------------------------|
| Menus and Wine Lists    | Forthcoming Attractions |
| Writing Room Stationery | Small Programmes        |
| Tariff Cards            | Receipt Slips           |
| Porters' Labels         | Tag Labels              |
| Room Notices            | Cloakroom Tickets       |
| Entertainment Cards     | Waiters' Pads           |
| Dance Cards             | Billheads, etc., etc.   |

**FACTORY AND SHOP**

- |                           |                           |
|---------------------------|---------------------------|
| Works Instructions        | Wrappers' Number Tickets  |
| Overprinting Carded Goods | Titles on Negatives       |
| Overprinting Cartons      | Snapshot Wallets          |
| Chemists' Labels          | Wage Envelopes            |
| Parcel Labels             | Jewellers' Envelopes      |
| Small Wrappers            | Seed Envelopes            |
| Printing Bags             | Hairdressers' Cards       |
| and Statements            | Window Tickets            |
| g Seals                   | Stores Labels, etc., etc. |

**FOR THE CHURCH**

- |      |                       |
|------|-----------------------|
| ts   | Small Programmes      |
| els  | Pew Seat Cards        |
| ents | Duplex Envelopes      |
|      | Wedding Hymn Sheets   |
|      | Admission Tickets     |
|      | Calendars, etc., etc. |

**BALL AND RACING PRINTING**

**XMAS CARDS**

There are only a few weeks left to Xmas, and during this time there will be a colossal demand for printed Private Xmas Cards. We supply cards in a variety of attractive designs at very low prices, all ready for you to just print names and addresses to sell to your friends and neighbours. Do not delay. The time is limited. The profit is enormous.

Write at once for  
Particulars and Samples of work

**D. A. ADANA**

(Dept. P.M.16)

17/18 Church St., TWICKENHAM

London Depot:

1 Ludgate House, Fleet Street, E.C.4

Manchester: 60 Oldham Street

**FREE WITH EVERY MACHINE**

**100-PAGE BOOK**

"85 Ways of Making Money with a Printing Machine"—value 2/6