

NEW PRACTICAL

February 1992 • £1.50

ELECTRONICS

SCIENCE AND TECHNOLOGY

Wanna Buy A Game Boy?

The lowdown on
Portable Electronic Games

Kodak Photo CD

Snap shots on compact disc

Industrial Espionage

Professional information hunting

What's New

- Active badges
- Improved audio CD
- Twin lens camcorder
- Digital camera
- Sharp palmtop
- Micro mice
- Video editors

Satellite salvage

Powering the Green Car

The flash gun revealed

A testing time for transistors

Barry Fox on BT's not so secret codes



IMPORTS **EASY PC FILES**
UPGRADE DISCOUNT AVAILABLE

Finally... an exceptional PCB and Schematic CAD system for every electronics engineer!

BoardMaker 1 is a powerful software tool which provides a convenient and professional method of drawing your schematics and designing your printed circuit boards, in one remarkably easy to use package. Engineers worldwide have discovered that it provides an unparalleled price performance advantage over other PC-based systems.

BoardMaker 1 is exceptionally easy to use - its sensible user interface allows you to use the cursor keys, mouse or direct keyboard commands to start designing a PCB or schematic within about half an hour of opening the box.

HIGHLIGHTS

Hardware:

- IBM PC, XT, AT or 100% compatible.
- MSDOS 3.x.
- 640K bytes system memory.
- HGA, CGA, MCGA, EGA or VGA display.
- Microsoft or compatible mouse recommended.

Capabilities :

- Integrated PCB and schematic editor.
- 8 tracking layers, 2 silk screen layers.
- Maximum board or schematic size - 17 x 17 inches.
- 2000 components per layout. Symbols can be moved, rotated, repeated and mirrored.
- User definable symbol and macro library facilities including a symbol library editor.
- Graphical library browse facility.
- Design rule checking (DRC)- checks the clearances between items on the board.
- Real-time DRC display - when placing tracks you can see a continuous graphical display of the design rules set.
- Placement grid - Separate visible and snap grid - 7 placement grids in the range 2 thou to 0.1 inch.
- Auto via - vias are automatically placed when you switch layers - layer pairs can be assigned by the user.
- Blocks - groups of tracks, pads, symbols and text can be block manipulated using repeat, move, rotate and mirroring commands. Connectivity can be maintained if required.
- SMD - full surface mount components and facilities are catered for, including the use of the same SMD library symbols on both sides of the board.
- Circles - Arcs and circles up to the maximum board size can be drawn. These can be used to generate rounded track corners.
- Ground plane support - areas of copper can be filled to provide a ground plane or large copper area. This will automatically flow around any existing tracks and pads respecting design rules.

Output drivers :

- Dot matrix printer.
- Compensated laser printer.
- PostScript output.
- Penplotter driver (HPGL or DMPL).
- Photoplot (Gerber) output.
- NC (ASCII Excellon) drill output.

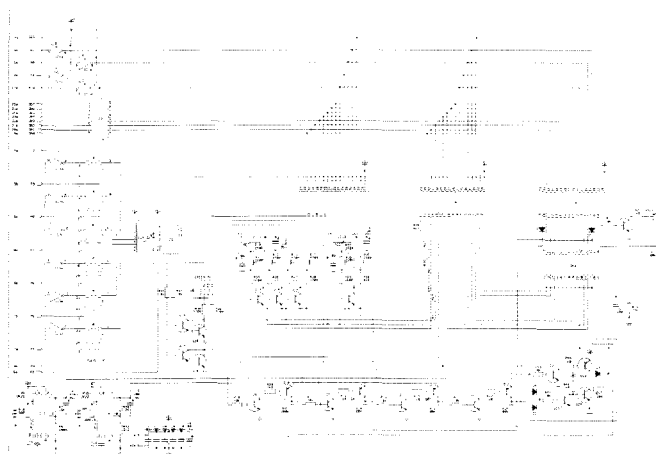

Produce clear, professional schematics for inclusion in your technical documentation.

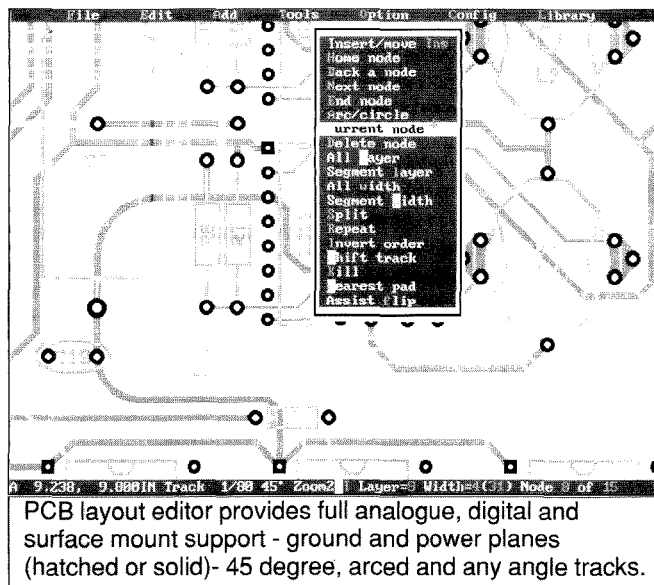

PCB layout editor provides full analogue, digital and surface mount support - ground and power planes (hatched or solid)- 45 degree, arced and any angle tracks.

£95

Despite its quality and performance, BoardMaker 1 only costs £95.00 + £5.00pp + VAT. Combine this with the 100% buy back discount if you upgrade to BoardMaker 2 or BoardRouter and your investment in Tsien products is assured.

Don't take our word for it. Call us today for a FREE demonstration disk and judge for yourself.

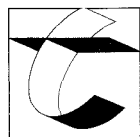

tsien

Tsien (UK) Limited
Cambridge Research Laboratories
181A Huntingdon Road
Cambridge CB3 0DJ
Tel 0223 277777
Fax 0223 277747

All trade marks acknowledged

This month...

In last month's issue I mentioned that I would rather like a laptop Macintosh computer. At the time, the machine was just a rumour and phoning Apple had produced a resounding "no comment". Days after the magazine was sent to be printed, a press release arrived on my desk from Apple announcing the launch of three new laptop computers – just in time to miss the deadline. Fortunately, Apple were kind enough to let me play with the new PowerBook 140 for a few days – the full review can be seen on page 10.

Also in last month's issue we featured the Joint European Torus. As everyone will know now, they achieved a fusion reaction that produced 2MW of power on 9th Nov 1991 and are looking forward to continuing their research up until 1996.

Here at PE we try to keep you in touch with all of the latest technology.
Kenn Garroch, Editor

Next month...

NEW PRACTICAL ELECTRONICS

SCIENCE AND TECHNOLOGY

Video Recorders

We look at which is best



PE looks at the best of the VCRs, CAD, 3D sound, games machines, how a camera flash works plus all of the regulars.
Out On 5 December

Features

- What A Year It Was.....14
Ian Burley Looks at what was new in 91.
- The Multimedia Myth.....20
A riot of buzzwords looking for a technology
- All That's New At Comdex Fall...25
Ian Burley takes a trip to the USA
- Future Technologies45
Atom sized switches and superconducting logic
- Look After Your Plants.....48
Build a greenhouse monitor

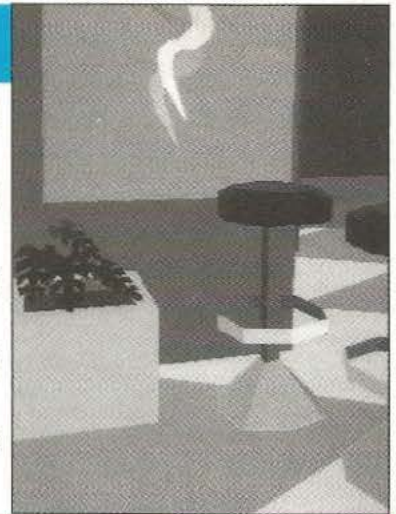

Reviews

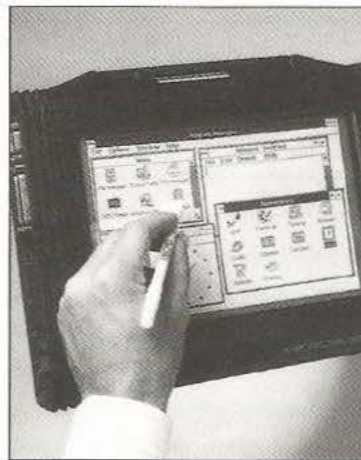

- The New Laptop Mac10
PE gets hold of one of the first machines
- Protect Your Car.....35
The Electronize car alarm system under scrutiny
- Analogue Circuit Analysis.....36
The latest CAD software
- Painting Pictures On A TV38
Laura Esterman looks at the Vtech Video Painter
- The Ideal Book For Mr. Fixit.....39
The WEKA Electronics Repair Manual
- Hunting The Snark43
We send Fiona Gammie to the theatre

Regulars

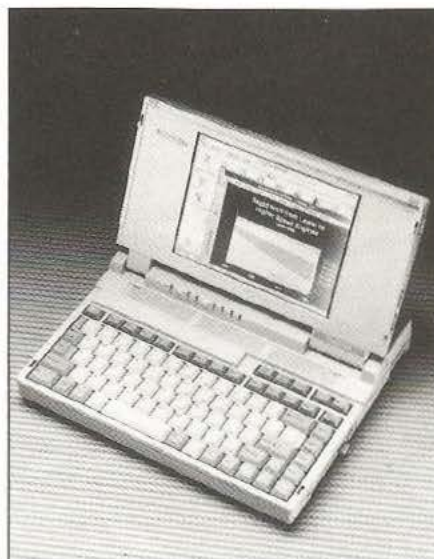

- Wavelengths5
- Innovations6
Price cuts from Toshiba & MT
- What's New9
Computers from Amstrad, Fujitsu & Apple
- Silicon Valley.....13
Introducing an 8-Bit Risc Microcontroller
- How It Works32
Telephone answering machine
- Practical Technology40
PC display cards for high quality graphics
- Techniques57
- Barry Fox62
Channel 5, who will start the bidding?

Editor: Kenn Garroch Editorial Assistant: Laura Esterman Advertisement Manager David Bonner Production Manager: Richard Milner Production Assistant: Dino DiGioacchino Publisher: Angelo Zgorelec
 • Practical Electronics Intra House 193 Uxbridge Road London W12 9RA Tel: 081-743 8888 Fax: 081-743 3062 Telecom Gold: 87: S00567 • Advertisements The Publishers of PE take reasonable precautions to ensure that advertisements published in the magazine are genuine, but cannot take any responsibility in respect of statements or claims made by advertisers. The Publishers also cannot accept any liability in respect of goods not being delivered or not working properly. • © Intra Press 1992. Copyright in all drawings, photographs and articles published in PRACTICAL ELECTRONICS is fully protected, and reproduction or imitations in whole or in part are expressly forbidden. All reasonable precautions are taken by PRACTICAL ELECTRONICS to ensure that the advice and data given to readers is reliable. We cannot, however, guarantee it, and we cannot accept legal responsibility for it. Prices quoted are those current as we go to press. All material is accepted for publication on the express understanding that the contributor has the authority to permit us to do so. • Practical Electronics is typeset at Intra Press on Macintosh computers using Quark Xpress. Reproduction by Circle Rule Ltd. Printing by Andover Press, St Ives plc. Distribution by Seymour Press • ISSN 0032-6372 •

WOULDN'T YOU LIKE TO KNOW WHERE YOU STAND ON FREQUENCY LISTENING?

Then rush out and order your copy of Radio Active Magazine now!

Radio Active is the number one magazine for the world of Active Radio, providing our members with interesting and campaigning editorial mixed with lots of colour. Radio Active will give you information on:

- * SCANNERS
- * CITIZEN'S BAND
- * MARINE RADIO
- * PACKET RADIO
- * AIR BANDS
- * AND LOTS LOTS MORE

Every month we guarantee you at least 68 pages of the best editorial to be found anywhere this side of Jupiter. Radio Active is the best value on the market at only £1.40.



RADIO ACTIVE

The Best for Active Radio

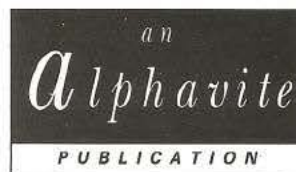

20 Potters Lane, Kiln Farm, Milton Keynes MK11 3HF
Tel: (0908) 569819
Fax: (0908) 260229

The Latest Micro Technology

- 1, **Micro-Emul Eprom Emulator** £ 69.95
1.5"X0.7"X0.7" The smallest Eprom Emulator in the world!
32 k bytes, No Batteries, 5 way micro connector.
- 2, **Infra-Red Link Micro-Emu2 Eprom Emulator** £ 99.95
No more ground problems, isolated with the host Computer.
32 k bytes, No more flying lead, size: 1.5"X0.7"X0.8".
- 3, **Flash Micro-Emu3 Eprom Emulator** £ 99.95
Download 32k bytes in just 0.3 seconds ...
2 wires instead of 28 way flying lead. With read & write facilities
- 4, **Micro 8031 in-circuit Emulator** £ POA
Size 2.1"X0.7"X0.8", 64 k break points, 64 k sampling points, 64 k I/O
sampling points. Real time emulation, Near Real Time sampling.
- 5, **High Performance Eprom Programmer** £ 39.95
For 2716 up to 27512, Auto select Serial or Parallel port, small & rigid.
with Static ram testing, & output for Micro-Em1.
- 6, **4000 series CMOS IC tester** £ 49.95
Tests most 4000 Cmos IC, including simulation and logic designs.
User defined configuration and optional upgrading facilities.
- 7, **74LS series TTL IC tester** £ 49.95
Tests most 74LS series TTL chips, including logic set ups, input
current, output current, with optional I/O delay facilities.
- 8, **74HC series CMOS IC tester** £ 49.95
Tests most 74HC series CMOS chips, including logic set ups,
input voltage and output loading, etc..
- 9, **8031 Marco Assembler** £ 49.95
Powerful macros with standard predefined symbols, optional maths
libraries and I/O libraries.

A Special Technical Help Line will be set up in Jan 1992 !

Free Technical Help for our customers who wish to learn about micro technology ...
Please add £2.50 P&P, credit card orders welcome. Delivery within 14 days upon receipt of payment.

For more information, write, phone, or fax :-

Computer Instruments U.K.

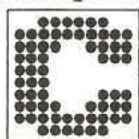

Tel: (0224) 210 368
Fax: (0224) 213 600
62-64 The Green,
Aberdeen AB1 2PE
Scotland, U.K.



MQP ELECTRONICS SYSTEM 200

UNIVERSAL DEVICE PROGRAMMING SYSTEM

- Fast and reliable programming
- Low cost
- Expandable system - buy only what you need
- Virtually all programmable devices covered
- Easy to upgrade
- Manufacturer approved algorithms
- Efficient and attractive software interface
- Special batch mode for production

System 200 is one of the most versatile programming systems available. At the heart of the system is the award-winning Model 200A programmer. Designed to quickly connect to the serial or parallel port of any PC compatible, the Model 200A is controlled by PROMDRIVER, widely acclaimed as the best driver software available for any programmer.

- EPROMs, EEPROMs and FLASH memories up to 4Mbit and beyond
- Microcontrollers from most manufacturers including
 - 8748 and Family
 - 8751 Family (including 87C751/2 and 87C552)
 - Z8 Family
 - PIC1 6C5x Family
- Emulators
- 8 pin Serial EEPROMs
- PALs, GALs, EPLDs etc
- Bipolar PROMs

Write or phone today for Free Information Pack:

Phone: (0666) 825146 Fax: (0666) 825141



MQP Electronics Ltd., Park Road Centre
Malmesbury, Wiltshire SN16 0BX UK

European Distributors: Digitron, Norway Tel: 071-17 890; Synatron, Germany Tel: 089/4602071; Logtech, Sweden Tel: 08 770 1470

Wavelengths

If you have any comments, suggestions, subjects you think should be aired, write to PE

After seeing yet another flashing light circuit for Christmas – in your December issue, I noticed that once again, only binary (ON-OFF) pulses were given. Though this is adequate – and on par with the average Japanese product available in the shops – it does not give the soothing, twinkly “peace on Earth” feel that is wanted at Christmas.

The circuit I made for my Christmas tree lights last year is relatively cheap, will work from a wide range of supply voltages (I have used it on supplies from 3 to 12V) and is much more Christmassy.

The circuit uses one half of an LM324 quad op-amp, and drives 4 (well, between 3 and 5) LED's. The speed of the “twinkle” is controlled

by R3-C1 and the difference between max and min brightness can be altered by the resistor R4. The output produced is of the form shown in Fig. 2.

The op-amp IC1a is used as a comparator. Resistors R1, R2 and R4 give the circuit hysteresis, C1 charges and discharges through the op-amp output, via R3 and as the mid-point of R3-C1 is connected to the inverting input of the op-amp, IC1a oscillates merrily (well, it is Christmas). IC1b is simply a buffer for the signal and provides the current required for the LEDs.

As a quad op-amp is used, two circuits can be made with a single chip. By using two slightly different time constants (values for R3-C1), two different flash speeds can be set and a pleasant effect (ask my girl-

friend, she agrees with me). For the board I made last year, 3 LM324s were used giving six phases of colours, red, green and tri-colour.

I realise your next issue will be dated January but the circuit does provide an elegant alternative to the Christmas tree lights featured annually in a certain electronic retailer's own magazine (for the past decade or so) and I think it may be worth squeezing it onto the bottom of a page, for those of us who buy your magazine as it comes out.

Richard B Sagar
Dewsbury
W Yorks

I'm afraid it was just too late for the Jan issue so it is “squeezed” in here instead – it may be that some people still have their Christmas trees still in place.

Noisy World

I am a regular listener to BBC Radio 4 as I drive around London and one thing that is most annoying is the amount of interference with the signal.

The particularly bad places are around the West End with all of the neon signs; I presume it is these signs since they seem to be the only common denominator.

I think that the trouble lies with the fact that Radio 4 is broadcast on long wave since I don't get the same trouble with Radio 1 on medium wave. Is there any easy solution to get rid of, or at least reduce, the noise?

James Higgins
Wimbledon
London

I think the only real solution is to get an FM radio which shouldn't suffer quite so much. Other possibilities, such as getting the sign makers to silence their signs or Radio 4 to broadcast on medium wave are unlikely to be practical – unless other readers have some ideas?

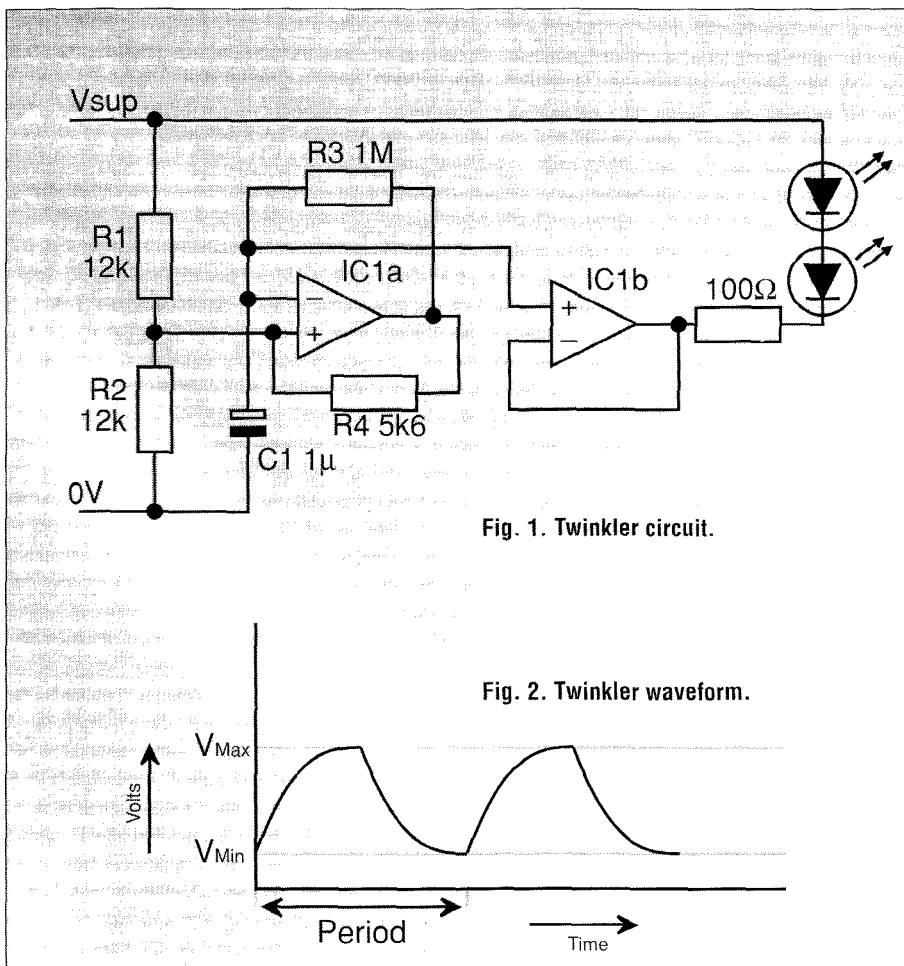

Innovations

This month, the world's smallest and fastest lasers and new moves from the BBC.



BBC World Service presenter John Tidmarsh with air hostesses from Cathay Pacific Airways.

Goodbye MW

Radio 3 says goodbye to Medium wave on 28th February 1992. Transmission will be confined to the higher quality FM waveband and the released frequencies will be used by a second national commercial radio station.

A number of listeners will have noticed that Radio 3 on 1215kHz and 1197kHz was of pretty poor quality when compared with the FM equivalent which is also in stereo. Only those who have very old radios will really notice the loss.

Hello Cathay

Passengers flying with Cathay Pacific Airlines will now be able to listen to the BBC World Service during the flight.

Using a special computerised aerial system that automatically keeps track of the best signal, the programmes will be fed to passengers via one of the many

headphone channels in all seating classes. The agreement between Cathay Pacific and the BBC is the first of its kind and the service will be available on the entire 747

fleet this spring, not just for Europe, but for the full network including flights to Australia, Canada, Japan, South Africa and the USA

Small And Fast

AT&T Bell Labs in San José California has announced the world's smallest lasers. Just 400 atoms thick (a thousandth the diameter of a human hair) and five microns in diameter, they are shaped like a tack when viewed through a scanning electron microscope.

Using a technique known as whispering gallery mode, named after the sound effect experienced in St Paul's Cathedral in London, the photons travel with low losses around the edge of the disc in much the same way as whispers travel around the whispering gallery.

Each disc is made from sandwiched layers of indium gallium arsenide and indium gallium arsenide phosphide semiconductors. Bell is hoping to find uses for their lasers in switching

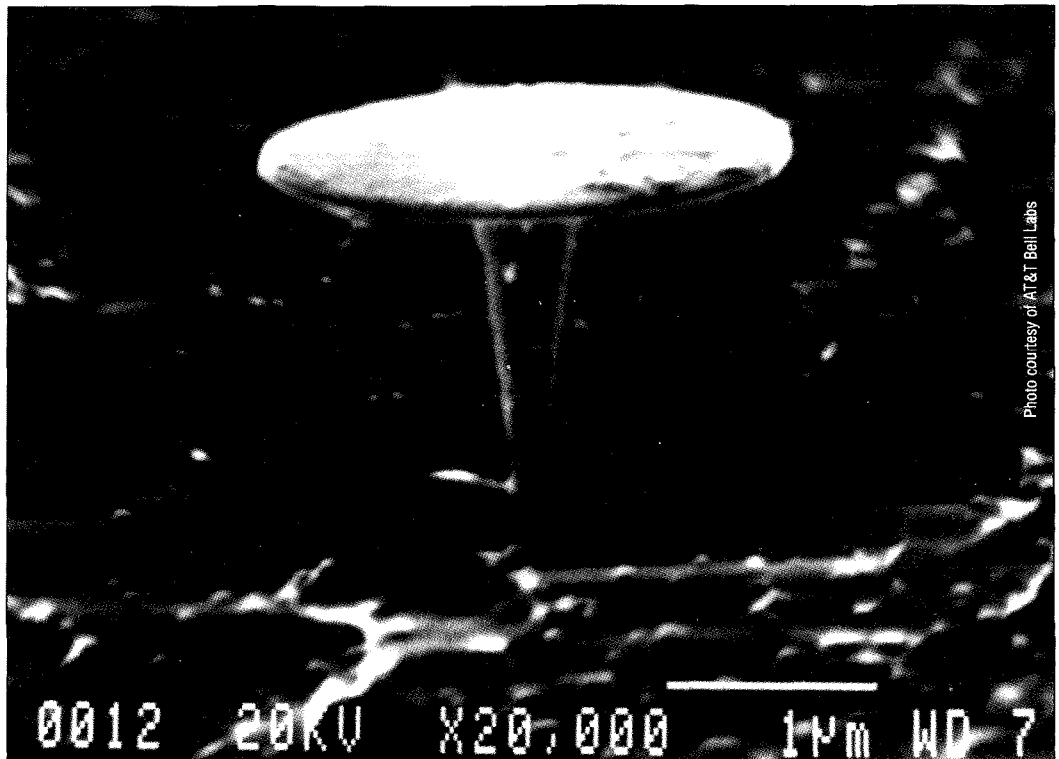
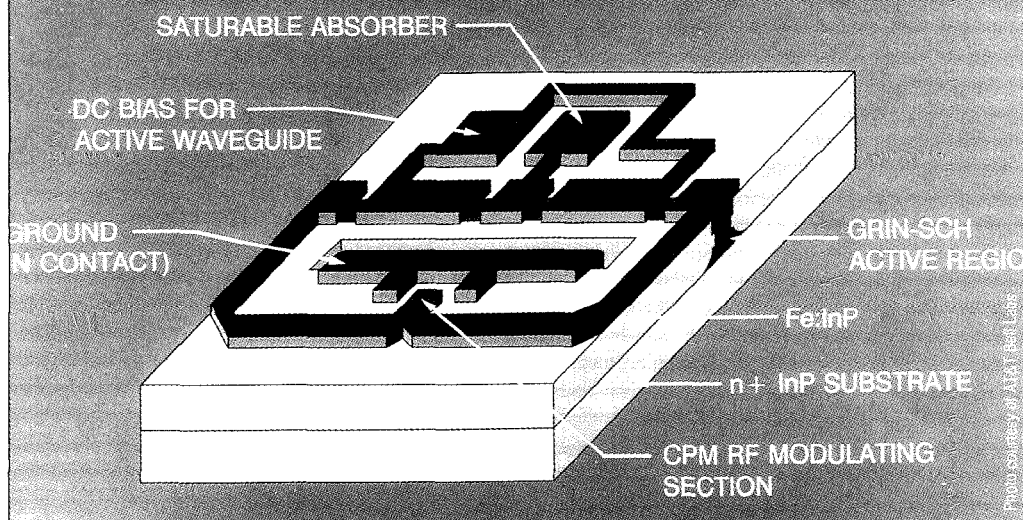

Photo courtesy of AT&T Bell Labs

The world's smallest laser.

MONOLITHIC ACTIVE CPM QUANTUM-WELL LASERS



and computing technology.

Another record breaking announcement from Bell concerns the world's shortest and fastest laser pulses using a monolithic semiconductor laser.

The colliding-pulse, mode-locked (CPM) laser is able to generate 350 billion light pulses per second, each one shorter than a trillionth of a second – the fastest before this had been able to launch pulses down a fibre at about two and a half billion pulses per second.

The new system sent pulses lasting 600

femtoseconds through 24 kilometres of optical fibre. In the 1980s, the best that could be achieved with a laser system was about 45 Mega-bits per second. With the new system, this has been increased to 350 Giga-bits per second. Bell predicts that it will be able to send 1000 Giga-bits per second or 1 Tera bit by the year 2000. This should lead to more efficient communications systems and allow more information to be squeezed into a fibre optic cable – handy for such bit hungry uses such as video-phones and multi-channel TV.

Computer Lab

The latest computer technology has been introduced at Leeds University School of Computer Studies to help students study complex mathematical problems visually.

The Silicon Graphics Visual Computing Laboratory uses over 60 Iris Indigo RISC computers to display and manipulate and move 3D colour graphic images. The University now claims to have the most advanced undergraduate teaching facility in England. It is able to cover a wide range of

subjects from graphics programming to multimedia software.

Multimedia Year

Anyone interested in the ongoing multimedia saga will be interested in the first European Multimedia Yearbook 1992 has just been published. It features 65 articles by leading practitioners of the art, plus profiles of 500 multimedia companies, descriptions of 470 products and contact information for nearly 200 additional distributors across Europe.

Published by IMI, this book covers a whole spectrum of information on multimedia from introductions to the software and hardware, interviews with leading industry figures to practical applications and comments on the industry.

The cost is £65 and more information can be obtained from Multimedia Ventures, 66 Derwent Road, London N13 4PX Tel. 081 886 6445.

Paper Mountains

Setting standards in the electrical and electronic industries allows systems from a variety of sources to work together. As well as setting standards, the International Electrical Commission has set something of a record. In its 85 years of existence, it has defined 2700 international standards, producing enough A4 pieces of paper so that, stacked end-to-end vertically, they would be 91.6 times higher than the Eiffel tower or 3.3 times higher than Mount Everest – laid out side by side the pages would cover 123.5 football pitches. The number of trees this represents doesn't bear thinking about.

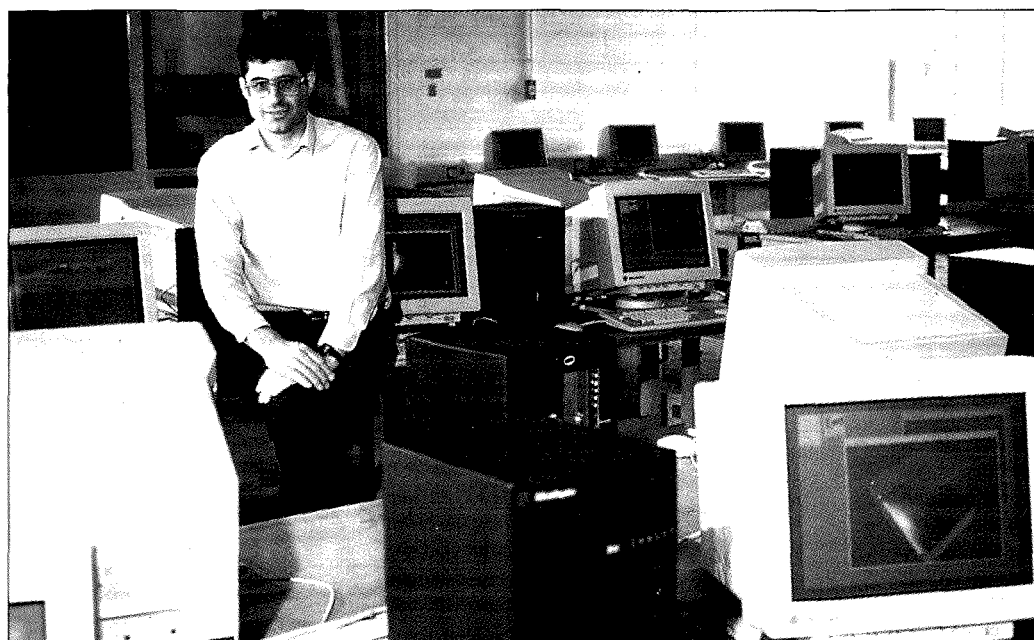

The new computer lab at Leeds University.

What's New

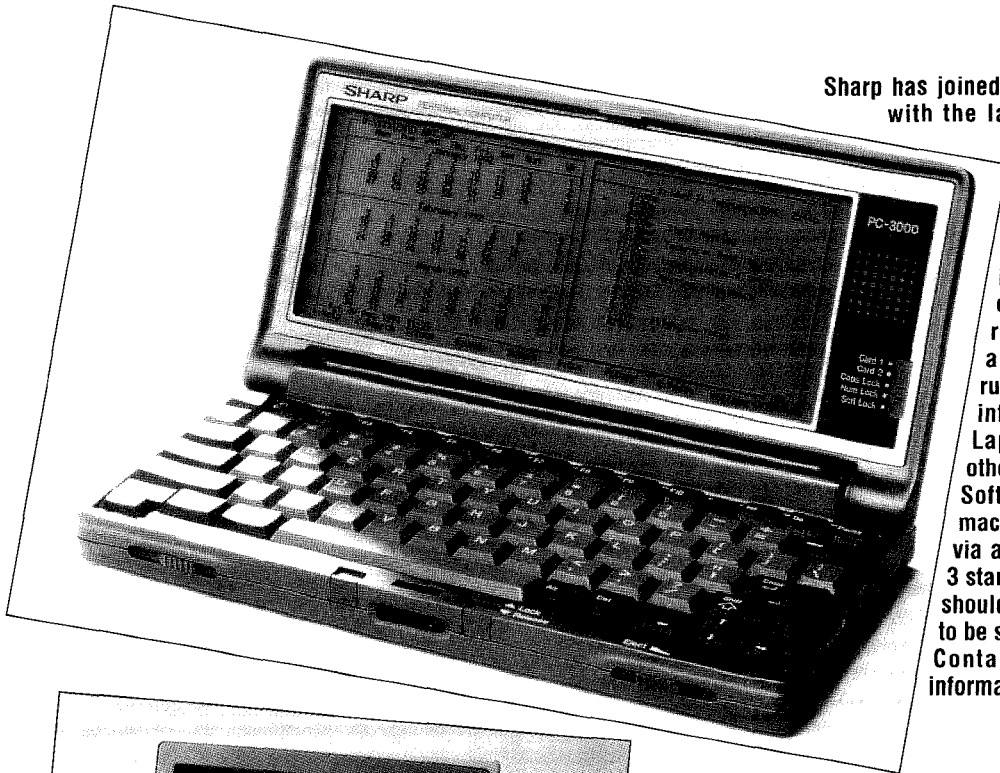

Sharp has joined the ranks of the palmtop PC producers with the launch of its PC-3000. Smaller than a standard video cassette and weighing less than 1lb, it features a 640x200 pixel LCD display with 4 grey levels, making it CGA compatible. MS DOS 3.3 is built in and the 77-key QWERTY keyboard should just about be "typeable" on. Using an 80C88A microprocessor running at 10MHz, the 1Mbyte of RAM allows most PC compatible software to run. It comes with a couple of utilities built into its 1Mbytes ROM – a database and Laplink software for serial connection to other PCs.

Software and data can be loaded into the machine via a standard RS232 serial link or via an optional extra floppy disk drive. Using 3 standard AA batteries for its power supply, it should run for about 35 hours. Prices have yet to be set but a figure of £800 seems likely. Contact Sharp on 061 205 2333 for more information.

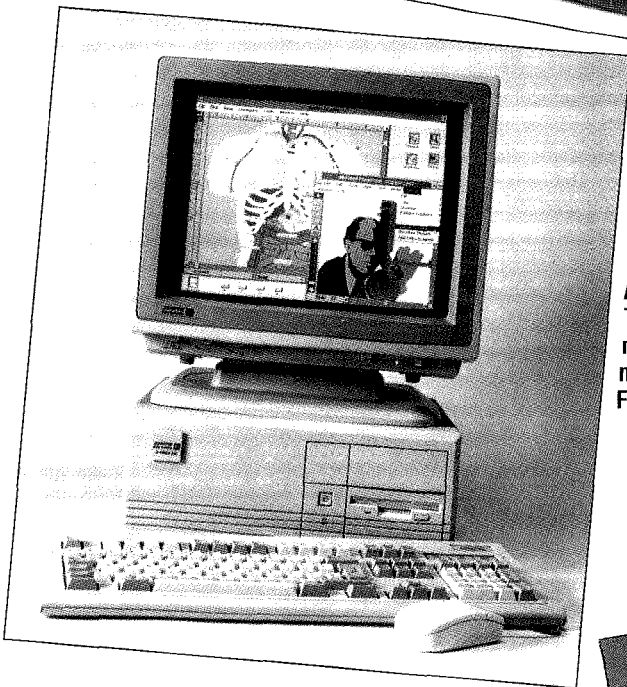

A collection of new machines has been announced recently by Zenith. At the top end is an Intel 486 based system running at 33MHz. Aimed at the user who requires lots of power to drive graphics applications (such as Windows 3) this machine is available in a number of different memory, speed and disk drive configurations.

Also announced was a new notebook style portable, the Mastersport 386SLe. This runs at 25MHz and should offer a 25% speed increase over other 386SX notebooks. It also features an 85Mbyte hard disk plus all the usual power management needed to operate a portable efficiently.

For more information, contact Zenith Data Systems Ltd on 0628 668588.

With the advent of portable computing and the increased use of graphical user interfaces (GUI), the need has arisen for a portable mouse. A solution has been offered by the US company Appoint. The Thumbelina miniature trackball an inch and a half square and three quarters of an inch high. The tiny size makes it possible to fit the device on the crowded keyboard of a laptop without having to remove other important keys. Alternatively, a portable system comes with a five foot cable and a drag-lock key – this saves the user from having to use an extra finger to hold down a button while trying to control the trackball. For more information, contact Appoint at 1332 Vendels Circle, Paso Robles, CA 93446, USA.



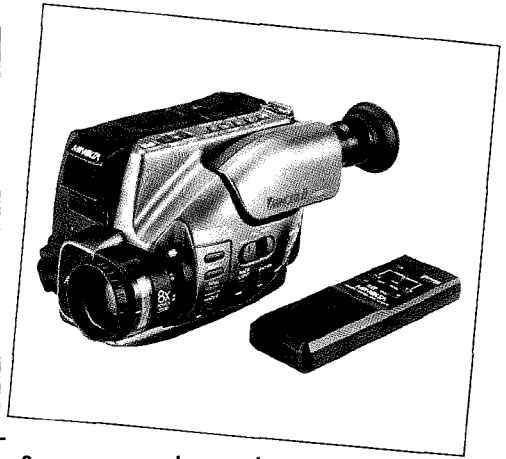

Left to right above are the Movie C-516E, the C-618E and the 8 418E, the latest camcorders from Minolta. The 516 features a 6x power zoom lens, auto-focus, low light capabilities, date and time insert, high speed shutter and full automation, all for £599.99. The next model, the 618E is priced at £799.99 and offers all of the features of the 516 but with a x8 zoom, titling facilities, wind noise reduction for the microphone and a 3W video light. Both of these models use the VHS-C cassette standard. The 8 418E model is an 8mm format camera with similar features to the 618 plus a digital signal processor and programmable auto exposure. The Movie 8 418 costs £799.99



A video can be turned into a film with the simple addition of titles. The VCR 4099 from Vivanco is an easy to use title generator for use with camcorders and video recorders. Connecting it between the two allows up to 10 pages of titles to be added using various character sizes and and colours. It is suitable for use in all video systems including Super VHS and Hi8. Priced at £459.99, it is available from Vivanco UK Ltd, Unit C, Boundary Way, Hemel Hempstead, Herts, HP2 7SS.

Also from Vivanco is the VCR 3088 video effect processor. This provides a variety of functions from 24 different special effect and wipe screens to automatic fading and control of colour saturation and video noise. A further enhancement is the ability to produce "digital art" allowing the creation of impressive visual effects.

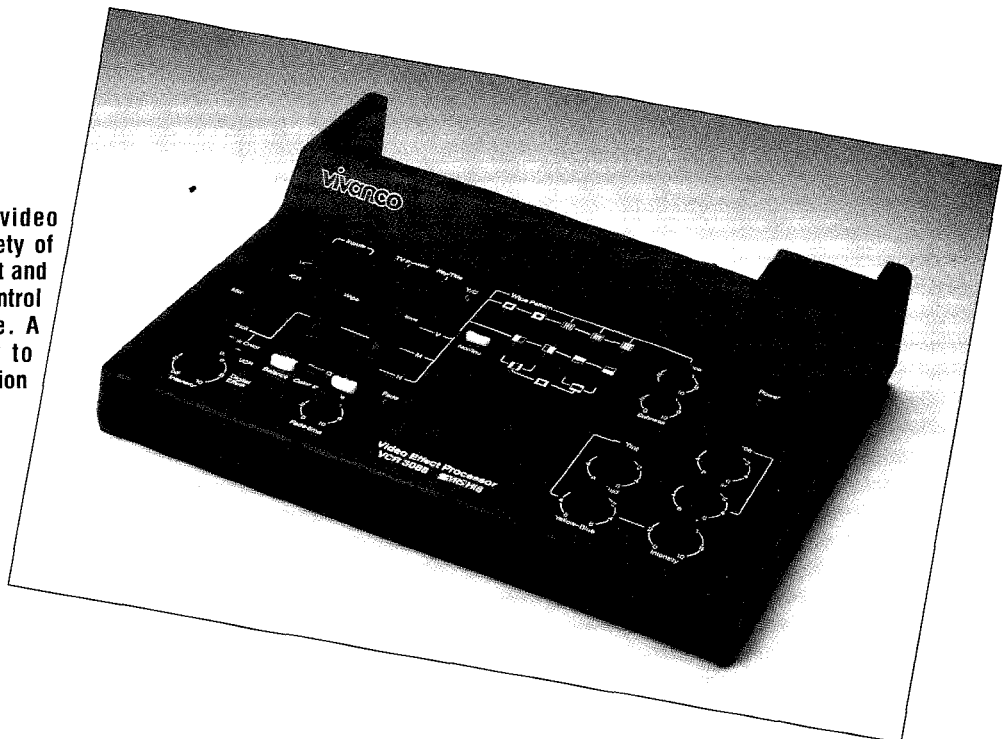

Setting The Scene...

This month's special feature is about the latest electronics craze sweeping the nation – hand held computer games. Kenn Garroch looks back to see where it all started.

Judging by the adverts plastered all over the TV, the toy of the year is the hand held video game. All of the main contenders have been pushing their machines heavily and obviously expect to make some large sales – even in an economy struggling to recover from a depression.

The development of the hand held game has not been a particularly long process and most people will remember the early space invaders and perhaps even electronic ping-pong or tennis.

Early games machines took advantage of the shrinkage in the size and price of electronic components that was happening in the mid to late 70s. As well as being fun, games soon became big business with well known names such as Atari getting in at the beginning – the early 8-bit Atari computers were specifically designed as games machines, their uses in programming, wordprocessing and other computer orientated pastimes was a side event.

In pubs, clubs and amusement arcades all over the world, computer games with bright flashing colours and gaudy sound effects were getting customers to spend their money. Almost all were games of skill and all depended on moving graphic images generated by microprocessors. Early systems were relatively simple and it wasn't long before the home computer market was providing the same games and offering equivalent sound and vision quality.

The two machines that made the running were the Sinclair Spectrum and the Commodore 64. The first was based upon the Z80 microprocessor and the second on the older 6502 – actually it was a slightly upgraded version known as the 6510 which gave access to the complete 64k RAM of the machine.

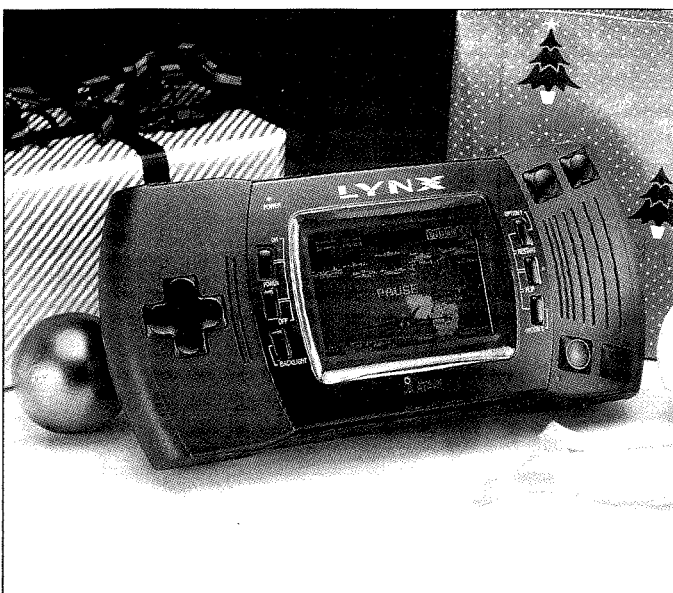

Games on both machines improved in leaps and bounds – the more ancient amongst us may remember being completely amazed by 3D Ant Attack on the Spectrum and as for Elite on the BBC, it was a revelation.

Software authors pushed their hardware to the limit and writing games became big business. Instead of one "spotty herbert" in a bedroom working all ours to turn out a masterpiece, games were produced by a team that included artists, musicians, programmers and story editors. Somewhere around this time, the electronics industry stepped in again and out came the 16-bit microprocessor. The market soon polarised into two or three main machines with the biggest sales going to the Atari ST and the Commodore Amiga.

The Amiga was revolutionary in that it had hardware graphics controllers and sampled sound. Previously, all graphics had been created and moved by a solitary microprocessor and sounds had been beeps or multiples of beeps. Commercial arcade games had been pioneering dedicated graphics chips to improve the speed of animation but they were expensive and required lots of hardware. With the Amiga, Commodore compressed a sophisticated graphics and sound system into three or four chips and put them under control of a 16/32-bit microprocessor – the same 68000 as used in the Apple Macintosh, a serious business machine. The technology of the computer game had expanded way beyond the bounds of the early 8-bit home computers.

Another idea that made games easy to get running was the plug in cartridge. This was used in the early Atari machines circa 1979, which also had rudimentary dedicated graphics chips but its time wasn't right and it never really took off. The Nintendo games console introduced in the mid 80s took this idea up and showed the way of the future. Featuring the totally addictive Super Mario Brothers it paved the way for a revolution in computer games. At about the same time, liquid crystal display (LCD) technology was developed to the extent where small screens, about twice the size of a watch face, were being produced featuring very simple games. The advent of the large LCD and eventually colour made hand held games a reality.

Nearly all current hand helds use quite old 8-bit microprocessors, the specialised graphics and sound hardware plus low power consumption chips seem to have created the perfect toy – when you get bored of playing one game, simply slot in another. The hand held games console is being marketed with a vengeance. Whether it is just a craze or a fad remains to be seen. ■

Hand Held Games Leading The Pack

Of the games machines available four are leading the way, Game Boy, Systema 2000, Game Gear and Lynx. Julian Musgrave has a go at selecting the winner.

If your memory of a hand held electronic game is of a monochrome, monotone, monotonous monogame then its time to look again. Colour LCD screens have dragged hand-helds out of the stone age and are worth taking time out to investigate.

Back in the good ol' days of 48K Speccys, Vic 20s and Commodore Pets hand held games either meant carrying around a box of Monopoly or playing Mario Bros on a pocket sized "Game and Watch". The surprising thing about these products were how playable a very basic specification game with as few as three moves could be. They sold by the lorryload and indeed still sell today but with a price tag of £20 or less we are looking at pocket money

products for pocket money buyers. These days real men (and women) pine for a Lynx or a Game Gear. So what's the big difference? Well size and price for a start. Hand-helds are now larger and heavier on the pocket. They start at £50 and go to around £120, but the most important difference is what they can do. Cartridge software is the key revolution, meaning that you buy a piece of hardware that can use many different games not just one. Following closely behind must be colour LCD screens and better sound both of which enhance game play considerably... but at a price as we shall see. Another thing worth mentioning is that they can be connected together so that players can play against one-another.

Currently there are three machines easily available, plus a fourth one with rather poor distribution. The big three are Game Boy, from Nintendo, Game Gear, from Sega, and Lynx, from Atari. The other one just launched is Systema 2000 from Systema with which I will start.

Systema 2000

This is a monochrome machine using a 4 x 4cm screen with a somewhat crude 55 x 55 pixels of grey on an olive green background. It has all the usual controls; sound, contrast, start, select, A & B buttons and four way pad, though this is set at an angle which makes control more difficult than it needs to be. Currently there is a limited range of



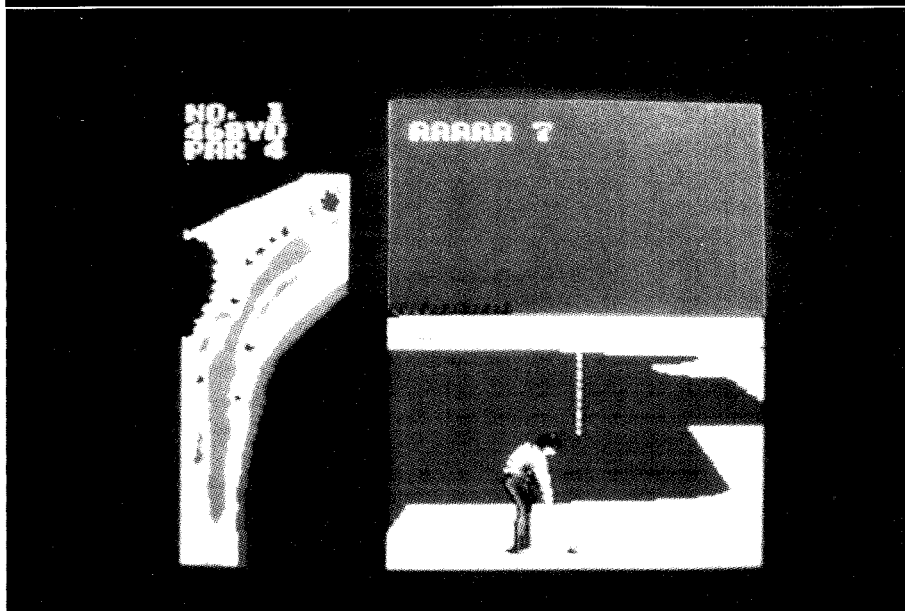
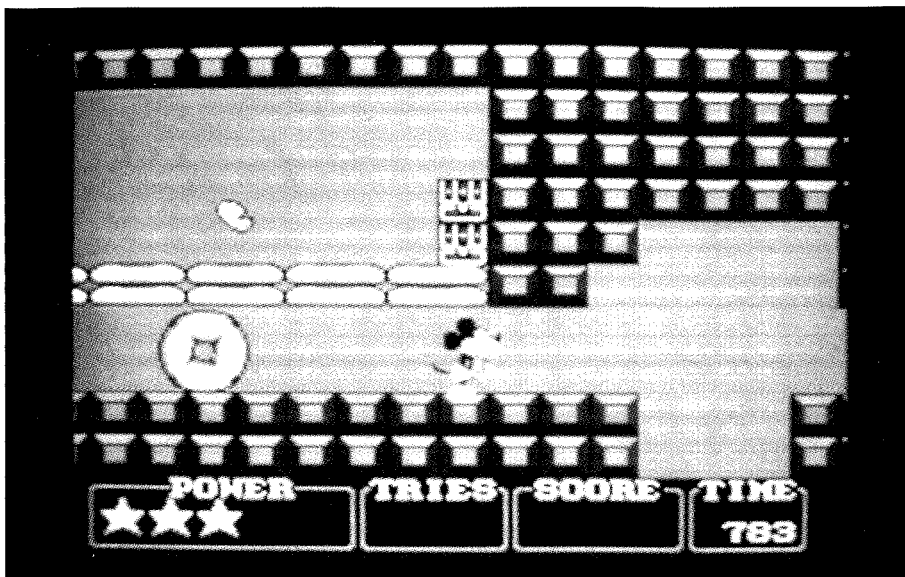

games but more are promised. The three sent for review, Falling Blocks (Tetris by another name), Go Bang and Hyperspace were frankly dreadful compared with say Game Boy games and the blocky screen in no way helped turgid game play. There are no extras for this system at present.

Game Boy

This is physically the smallest of the bunch and is the cheapest of the big 3 by a large margin. It has a 4.5 x 4.5 cm monochrome screen with grey tones overlaying a rather nauseating shade of yellow. Rotary controls vary contrast and volume with a four way game pad and four other push buttons on the front. The best thing about the Game Boy, apart from its price, is its large range of games. A specialist shop should have over thirty titles and even Dixons stock a dozen or so.

Titles range from the prosaic Tetris which is supplied with the machine, arcade games such as Double Dragon and Super Marioland, through to games with some

strategy in them such as Nobunaga's Ambition. Technically the machine works well, but note that the monochrome screen severely limits the level of enjoyment and it suffers from movement lag which makes fast games pretty difficult to follow. It is also impossible to see in poor lighting conditions without a lighting device; in fact the Game Boy's very obvious deficiencies have created a whole new industry in Game Lights, Amplifiers, magnifiers and the like as users struggle to overcome its in-built problems. Apart from these a rechargeable battery pack and various carry cases make up the extras range for the Game Boy.

Atari Lynx

Atari has a reputation for popping up with highly innovative products, some of which do very well, others of which bomb spectacularly for no very good reason. Sometimes, as in the case of the ST computer it can do both at the same time. Now that's a quality act! Technically the Lynx is the most advanced of the bunch. It uses a 4 MHz processor alongside two other custom chips feeding into a 160 x 102 pixel, 4.7 x 7 cm, 16 colour screen. There are the usual controls for brightness, volume, four way pad and two fire buttons, but in addition it has three programmable function buttons which can also pause games and flip the display through 180 degrees. The games for the Lynx are generally of a very high standard indeed with titles like Gauntlet 3,

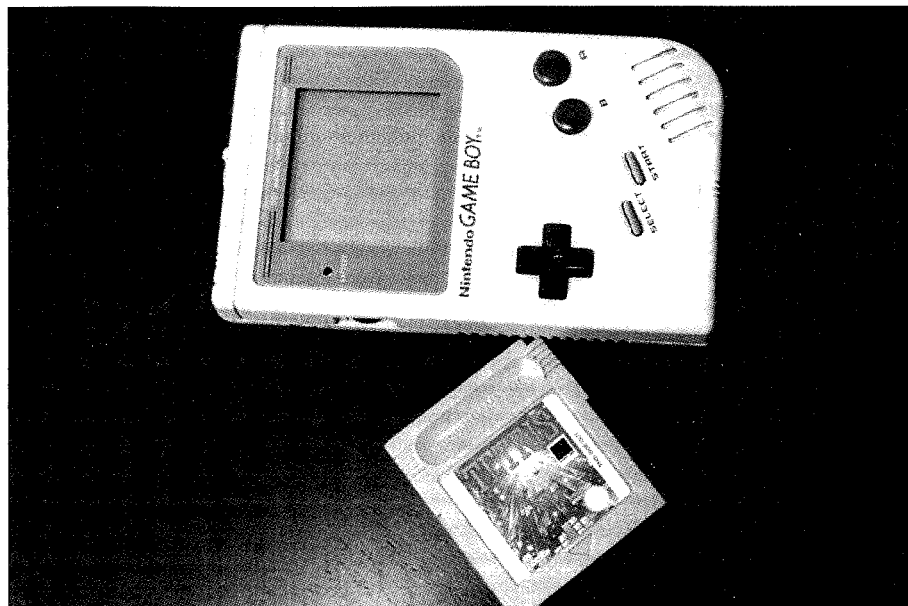



Blue Lightning, Warbirds, Ninja Gaiden and Chequered Flag setting standards that the Game Gear is struggling to follow. Extras for the Lynx include mains PSU, car adaptor and various carry cases.

Game Gear

The Game Gear has many of the characteristics of the Lynx. It is about the same size, about the same price and has a colour screen. Inside, however, it seems to be a different beast altogether. It uses the venerable Z80 processor feeding a 480 x 164 pixels, 5 x 6.5cm, 16 colour screen. It has all the usual controls but lacks the three function keys of the Lynx. Despite these differences it is difficult to tell Lynx and Game Gear apart on purely visual grounds, though on most

games the sound of the Lynx is markedly superior. It is when we get to the software that the Game Gear falls on its face. Not only does it have fewer titles at the time of writing but the quality of the games is markedly lower than those for the Lynx. Only Wonder Boy and Outrun impress, but do not stand up to comparison with the best of the Lynx games. Blue Lightning knocks the spots off G Loc, for instance, while Chequered Flag makes Super Monaco look pretty silly. The Game Gear boasts no less than three alternative power supplies; a mains adaptor, a car adaptor and a rechargeable pack. At this point we must mention the TV tuner, however. Any moment now Sega will release a TV tuner which can turn the Game Gear into a TV receiver. Although pricey at £74.99

it doesn't half make the Game Gear a sexy piece of kit. I expect many people have bought Game Gear for this reason alone, rightly or wrongly, and Sega have definitely stolen a march on Atari on this one.

Conclusion

You have two decisions to make when choosing a hand-held. Mono or colour? The People's Choice or the Dark Horse? If it's mono the Game Boy is not just the best, it's effectively the only one to buy. You'll get good value from it and with lots of software to choose from. The battle between the Game Gear and Lynx is more difficult. The Game Gear is the obvious choice as Sega will publish most of their existing titles on it while the Lynx has to create its software as it goes. Also the TV tuner is a very worthwhile addition which has yet to be announced for the Lynx. Nevertheless my own vote is for the Lynx for the very good reason that the games are better now and look likely to remain better in the future. I mean, just why are you buying this thing, to watch Coronation Street? ■

Specifications

	Game Boy	Game Gear	Lynx
Size	15 x 9cm	10 x 23cm	11 x 21cm
Power	4 x AA	6 x AA	6 x AA
Battery Life	15 hours	3 hours	3 hours
Screen	Mono	Colour	Colour
Colours	2	32	16
Software Titles	50+	12*	22*
Software price	£20-25	£20-25	£25-30
System +1 game	£70	£120	£115

MICRONTA®

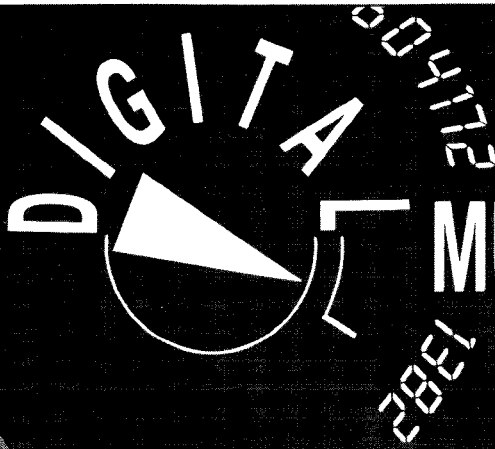

MULTIMETERS

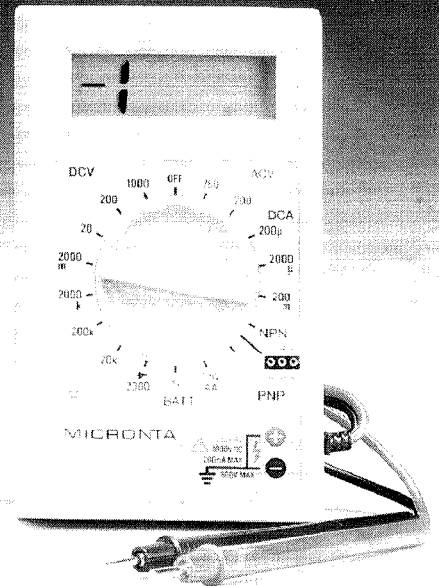
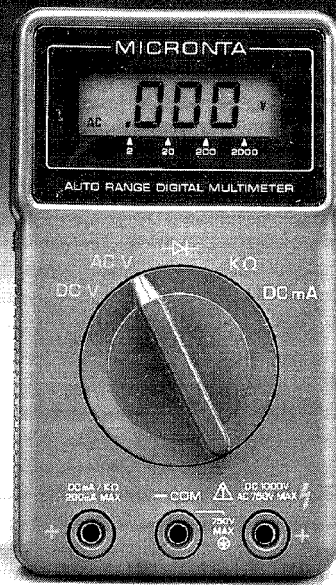

DUAL DISPLAY

£49⁹⁵

Autoranging. Large display plus 32-segment bargraph. Data hold, range control, diode and continuity check. Measures to 1000 VDC, 700 VAC, 10A AC/DC, resistance to 30 megohms. With moulded rubber holster. Requires 2 "AA" batteries. **22-167** **£49.95**

COMPACT AUTORANGE

£29⁹⁵

Autoranging. Features diode-check, auto polarity. Easy-to-read LCD display, low-battery indicator. Measures AC/DC volts, DC current and resistance. Fuse protected. Requires 2 "AA" batteries. **22-166** **£29.95**

MINI DMM

£22⁹⁵

Mini DMM. With built-in test leads. Measures 1000 VDC, 750V AC, 200mA DC current. Resistance to 2 megohms. Built-in transistor checker NPN/PNP hFE, 1.5 and 9v battery checker. Requires 9v battery. **22-9022** **£22.95**



ALL THE ACTION AS IT HAPPENS!

InterTAN U.K. Ltd., Tandy Centre,
Leamore Lane, Walsall, West Midlands WS2 7PS
Tel: 0922 710000

Silicon Valley...

IC Fax And Simple Chips

This month sees the inside of a combined data/fax/modem the size of a credit card, a three wire memory system and a boat power convertor.

Cirrus Logic has introduced an integrated circuit that provides data, facsimile (fax) and voice capabilities in only two chips. This allows a complete data/fax/modem to be built onto an area smaller than a credit card.

Known as the Communicator product family, the basic two chip system (coded as CL-MD1424AT) is aimed at integrated communications systems for computers – both desk-bound and portable. Its main components are a digital signal processor (DSuP) and a sigma-delta analogue front end (SAFE).

The DSuP is a programmable communications signal processor with on-board ROM featuring built in data/fax/modem and voice command firmware. The SAFE is used to filter the analogue signals and provide functions such as volume control and amplification.

An optional three chip set (CL-MD1424EC) offers V42/MNP 1 to 5 protocol to provide standard error correction and data compression of up to 4:1 and hence transmission speeds up to 9600bps. This will allow the system to connect to all other standard modem systems such as bulletin boards and on-line data services.

When used in fax mode the system supports the group 3

standard and can transmit or receive at all standard speeds from 300 to 14,400bps. It can also transmit and receive in background mode – where the computer's controlling software permits.

Voice mode provides the useful auto fax/voice recognition system so that both a fax and a normal voice operated telephone can be operated on the same line. Touch tone dialling is generated by this system so that the latest BT exchanges and systems can be accessed.

For more information, contact Cirrus Logic 1463 Centre Pointe Drive, Milpitas CA 95035 USA.

Time In A Can

Dallas Semiconductor has announced the launch of its DS1494 Time-in-a-can. This serves as a real time clock for a computer or as an add-on time meter that tracks the number of hours a system has been turned on. Simplicity is the order of the day since it has only three connections, one to ground, one to +5V and one to its packaging for data communications.

To get information out of the device, say the amount of time a system has been powered up, a connection to the lid of its case is used. A "one wire protocol" of long

and short pulses allows data to be transferred at 16kbytes per second. As well as knowing how long a system has been on, the number of times it has been turned on and off can be supplied and each unit has a unique 48-bit serial number. 4096 bytes of non-volatile RAM allow data, such as maintenance information, to be stored on-chip – also written via the single wire system.

For more information contact Dallas Semiconductor, 4401 South Beltwood Parkway, Dallas TX USA.

Boat Power

Anyone who does a lot of messing about on the river may also be interested in a power convertor that changes 24V from standard boat power systems to 13.8V for on-board equipment such as radios. Instead of using one half of a pair of batteries which will probably run one down but not the other, the system uses both.





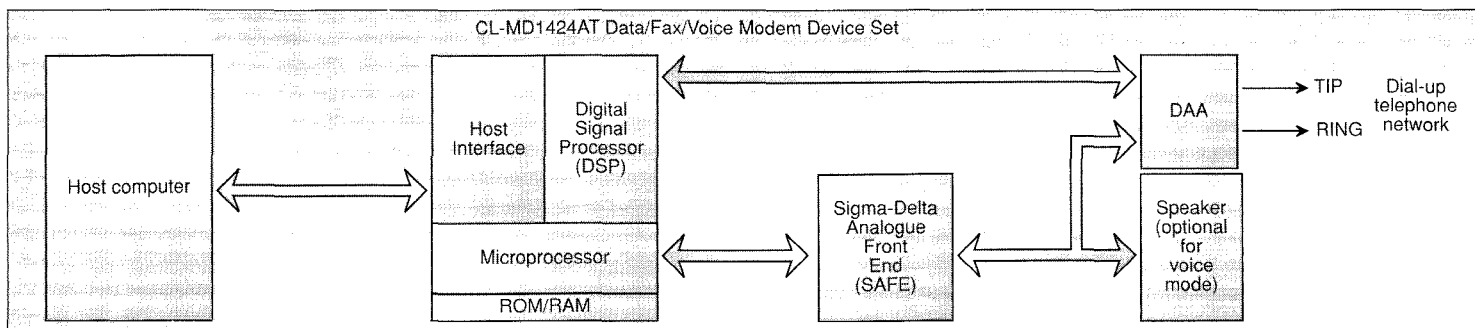

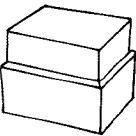

Built to the standard common negative format, up to 20A is supplied from a compact block that offers 4.5W per cubic inch.

For more information, contact Davtrend, Unit 7a, Fitzherbert Spur, Farlington, Portsmouth, PO6 1TT (Tel 0705 372004). ■

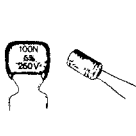
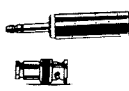

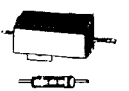
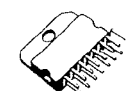
CRICKLEWOOD ELECTRONICS LTD

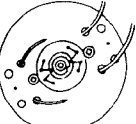
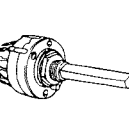
NEW 1992 CATALOGUE

 BOOKS	 BOXES & CASES	 CABLE & WIRE	 CAPACITORS
 CONNECTORS	 KITS	 RESISTORS	 SEMICONDUCTORS
 SPEAKERS	 VIDEO HEADS	 SWITCHES	 TOOLS & TEST GEAR

SEND NOW FOR THE

**CRICKLEWOOD
ELECTRONICS LTD**

COMPONENT CATALOGUE.
ONE OF THE BEST
RANGES AVAILABLE

NAME
ADDRESS

PLEASE SEND COPIES OF CRICKLEWOOD
ELECTRONICS CATALOGUE @ £2.00 EACH. PLEASE MAKE
CHEQUES OUT TO CRICKLEWOOD ELECTRONICS ETC.

CRICKLEWOOD ELECTRONICS LTD, 40 CRICKLEWOOD BROADWAY
LONDON NW2 3ET. TEL 081 450 0995, 081 452 0161 FAX 081 208 1441



DATING
ELECTRONICS LIMITED

Clayton Wood Close
West Park
Leeds LS16 6QE
Tel: 0532 744822
Fax: 0532 742872

For products you can rely upon to give amazing results

For information on **Active Antennas, RF Amplifiers, Converters, Audio Filters, the Morse Tutor and Speech Processors** send or telephone for a free catalogue and selective data sheets as required.

All our products are designed and made in Britain.

Orders can be despatched within 48 hours subject to availability.



VISA AND ACCESS WELCOME



HENRY'S

EXCITING

SPECIAL OFFERS!!

BIG, BIG SAVINGS

HURRY LIMITED STOCKS



32 Range 3 1/2 digit mm 12mm Display
FEATURES: 5 Capacitance ranges, 6 - resistance ranges to 20M ohm. Diode and transistor test. AC/DC volts ranges, 5 ranges AC/DC current to 10 amps. Also continuity buzzer. With leads, battery and instructions

£23.95 UK post etc £2.00 Post free when you Buy Two!

Instrument stockists for **Hameg Scopes**
Black Star ■ **Thurby** ■ **Thandar** ■ **Test Lab**
Always special offers for callers.



19 range 3 1/2 digit mm
FEATURES: Pocket Dmm with 12mm display. AC/DC volts, 6 ranges DC current to 10 amps, 5 resistance ranges, Diode test. With leads, battery and instructions

ONLY £10.95

UK post etc £2.00 Post free when you Buy Two!

Further Special Instruments Offers - while stocks last
S7300 AC Clamp meter with case 0/600v, 0/300A, 0-1K ohm **£29.95** M265 Add on Clamp meter for Ohm's 0/1000A **£12.95** DW6060, True power digital watt meter, 0/6kw, 1000 VDC, 750 VAC **£35.95**

SPEAKERS FOR PA, DISCO AND HIGH POWER CAR SYSTEMS

All models available 4 ohms or 8 ohms
Cant/pack/ins extra
10" 150watt H/D Bass Speakers
34Hz Res. Ideal Bass or Subwoofer. Huge magnet **£35.95**
8" 75 watt Bass/mid
vented coil **£15.95**
12" 90/120 watt **£21.95**
Bass/mid vented coil (400w max) H/D Bass. **15" 250 watt** (400w max) H/D Bass. **£81.95**
Huge magnet 28Hz Res. 102 dB

LARGE RANGE OF AMPLIFIERS, GRAPHICS, SPEAKERS AND SYSTEMS IN STOCK FOR PA - DISCO AND IN-CAR

OPEN 6 DAYS A WEEK FOR CALLERS OR TELEPHONE ORDERS

ALL PRICES INCLUDE UK VAT

Brand new ASTEC SW mode power supply



Three pin mains socket input on/off switch. Output +5 volt 3.75 amp, +12 volt 1.5 amp, -12 volt x 2.5 ins.

ONLY £12.95 (UK Carr etc £2.05)

**HENRY'S
AUDIO ELECTRONICS**

404 EDGWARE ROAD, LONDON W2 1ED
Tel: 071-724 3564/071-258 1831 Fax: 071-724 0322
DISCOUNTS FOR QUANTITY AND EDUCATIONAL

COLOUR CATALOGUE WITH SUPPLEMENTS SEND \$4 PO/CHO Callers £2.00 FREE to Trade/Education (Written Request)



NATIONAL COLLEGE OF TECHNOLOGY

DISTANCE LEARNING COURSES

The National College of Technology offer a range of packaged learning short courses for study at home or in an industrial training environment which carry national BTEC awards. Study can commence at any time and at any level, enabling you to create a study routine to fit around existing commitments.

Courses on offer include:

- Analogue Electronics
- Digital Electronics
- Fibre/Optoelectronics
- Programmable Logic Controllers

Tutor support and BTEC certification are available as options with no travelling or college attendance required. These very popular courses which are ideal for vocational training contain workbooks, audio cassette lectures, PCBs, instruments, tools, components and leads as necessary to support the theoretical and practical training. Whether you are a newcomer to electronics or have some experience and simply need an update or certifications, there is probably a distance learning course for you. Write or telephone for details to:

**National College of Technology
NCT Ltd. PO Box 11, Wendover, Bucks
Tel: (0296) 624270**

Kodakchrome On Compact Disc

Displaying your snaps on TV may sound like a technology of the 21st century but Kodak is about to introduce it in 1992 as Kenn Garroch explains.

A compact disc player with the logo "Kodak" on it is something of a surprise. Realising that Kodak is using CD technology to display pictures gives the idea more credibility. However, the system can also deliver high quality audio using the latest Bitstream technology – this gives some clue as to Kodak's partner in the enterprise.

Philips has been at the forefront of CD technology since its invention. It is pioneering the consumer multimedia field along with Commodore but with the more up-market CD interactive or CD-I.

As may be expected of a device bearing the name of Kodak, this new system is all about images; still images taken in the usual way with a 35mm camera onto normal film. The ability to then store these images on a CD and play them back through a standard colour TV is the heart of the photo-CD idea. Gone are the days of needing a blacked out room, a huge projection screen and a not too reliable slide projector. The modern equivalent allows up to 100 stills to be stored on a standard 12cm CD, played back in any order, zoomed, panned and rotated.

WORM Technology

Until fairly recently, CDs have only been known for their ability to hold data, whether it be in the form of text, images or music, in a mass produced way. Recording onto the medium was relegated to disc manufacturers and most people could only use the discs in playback mode. However, a technique known as Write Once, Read Many



The Kodak Photo CD displays pictures in high quality colour on a standard TV set.

times (WORM) was developed quite early on in the evolution of CDs. This was used mainly for computer backup purposes – the average CD can hold around 600 million bytes, roughly the capacity of 10 hard disk drives or 900 novels. Unfortunately, the discs were expensive and the drives even more so.

To allow CDs to be used economically in WORM mode, Kodak is relying on mass production and a special dye coating for the disc. To write data, a laser is beamed at the disc to heat the dye up. This changes its colour, a change which can be detected by

a read-back laser as used in normal compact disc players. The data is stored in digital form and can be written a little at a time – the discs can be sent in for updates at a later date. The colour change in the dye is permanent and is expected to have around the same working life as photographic film. Because the data is stored digitally, it can be retrieved with no loss of quality and transferred to new discs as the old ones begin to wear out.

Image Scanning

Converting a photographic image into digital form is performed with



A Photo CD disc and "jewel case".

a special image scanner. Kodak's system splits a 35mm slide into 3072 lines of 2048 dots or pixels (picture elements). Each pixel is scanned in the three primary colours, red, green and blue, and converted into one of 256 levels each. Adding all this data up gives 3072x2048x3 or

exactly 18 Mega bytes – 256 levels can be crammed into an 8-bit binary number or byte. Obviously, only about 33 images of this size will fit onto a CD. However, there is a lot of redundant information in a picture, mainly due to areas being the same colour, and this can be

compressed by a factor of about three to give the required storage capacity of 100 images per disc.

The high resolution at which the images are stored is better than most current reproduction systems are capable of. Standard UK television sets give 625 lines, high definition TV (HDTV) gives 1250, so the stored picture quality will always be better than the reproduction – a form of "future proofing".

Who Will Buy?

The main users of Photo CD are expected to be owners of 35mm cameras worldwide. However, Kodak is aiming its new image storage system at a number of markets. Anyone who currently has to store and manipulate photographs would do well to examine the system. Photographic libraries, publishers and people who have to give visual presentations, will all be targeted as potential customers.

The picture below was printed in colour on an XL 7700 digital continuous tone printer from an original image on a Kodak CD.



Printed on KODAK EKTATHERM Media using the KODAK XL7700 Digital Continuous Tone Printer from an original image on a KODAK PHOTO CD



EASY-PC, SCHEMATIC and PCB CAD

Over 9000 Installations
in 50 Countries Worldwide!

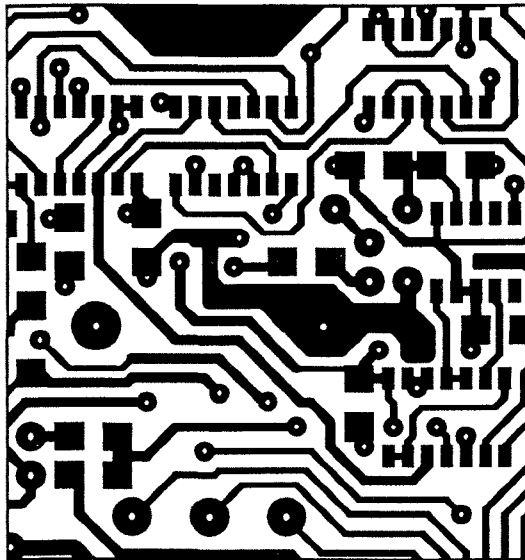

- Runs on:- PC/XT/AT/286/386/486 with Herc, CGA, EGA or VGA display.
- Design:- Single sided, Double sided and Multilayer boards.
- Provides Surface Mount support.
- Standard output includes Dot Matrix / Laser / Inkjet Printer, Pen Plotter, Photo-plotter and N.C. Drill.
- Superbly easy to use.
- Not copy protected.

Still
Only
£98.00!
Plus P&P+VAT

BRITISH
DESIGN
AWARD
1989

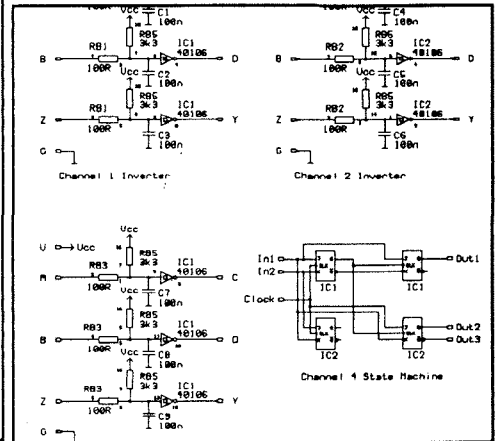

Options:-500 piece Surface Mount Symbol Library £48,
1000 piece Symbol Library £38, Gerber Import facility £98.

DIGITAL
SIMULATION £195

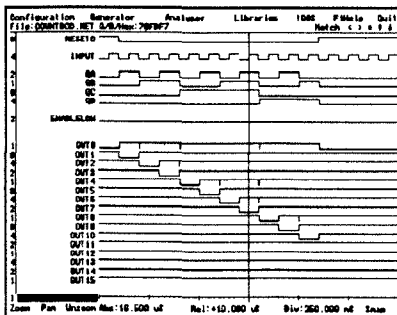

- At last! A full featured Digital Circuit Simulator for less than £1000!
- PULSAR allows you to test your designs without the need for expensive test equipment.
- Catch glitches down to a pico second per week!
- Includes 4000 Series CMOS and 74LS Libraries.
- Runs on PC/XT/AT/286/386/486 with EGA or VGA.
- Not Copy protected.

ANALOGUE
SIMULATION £195

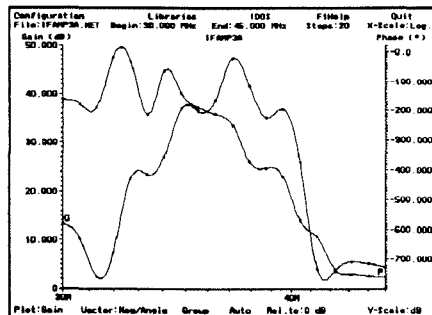

- NEW powerful ANALYSER III has full graphical output.
- Handles R's, L's, C's, BJT's, FET's, OP-amp's, Tapped and Untapped Transformers, and Microstrip and Co-axial Transmission Lines.
- Calculates Input and Output Impedance, Gain & Group Delay.
- Covers 0.001 Hz to > 10GHz
- Runs on PC/XT/AT/286/386/486 with EGA or VGA.
- Not Copy protected.

SMITH CHART CAD
£195

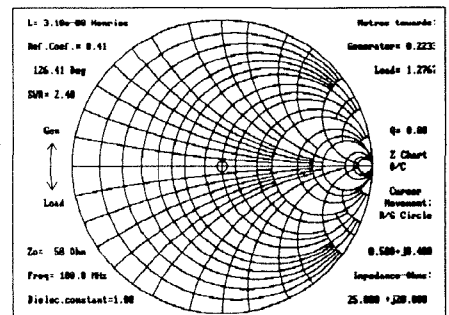

- Z-MATCH II simplifies RF matching and includes many more features than the standard Smith Chart.
- Handles transmission line transformers, stubs, discrete components, S Parameters etc.
- Supplied with many worked examples.
- Superbly easy to learn and use.
- Runs on IBM PC/XT/AT/386/486, CGA, EGA, VGA.
- Not Copy protected.

For full information, Write, Phone or Fax:-

• TECHNICAL SUPPORT FREE FOR LIFE!

Number One Systems Ltd.



REF: PE, HARDING WAY, ST. IVES, HUNTINGDON, CAMBS, ENGLAND, PE17 4WR.

Telephone: 0480 61778 (7 lines) Fax: 0480 494042

International: +44 -480-61778, Fax: +44-480-494042 ACCESS, AMEX, MASTERCARD, VISA Welcome.

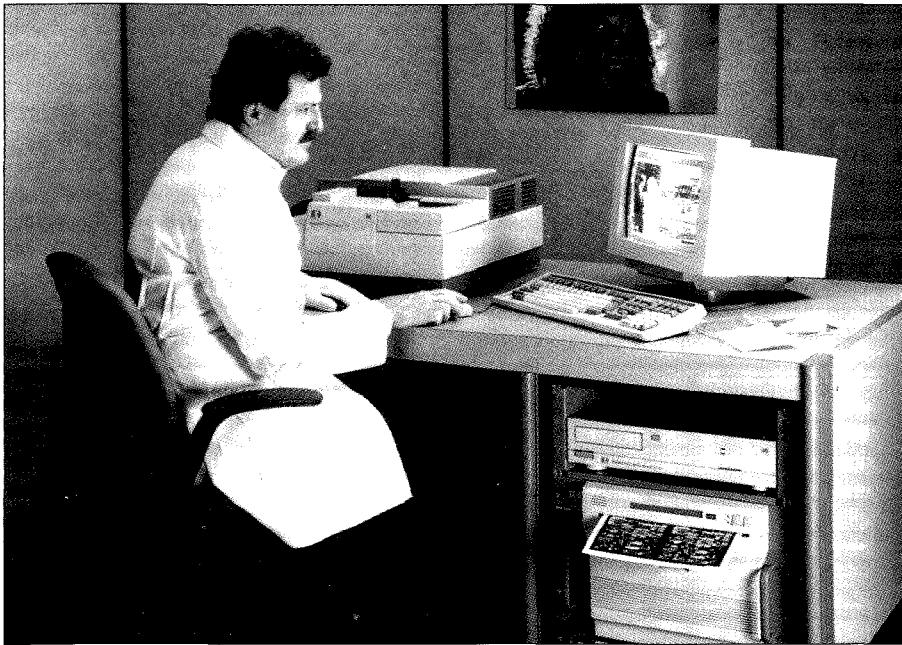

Kodak's scanner, computer system and colour printer in action.

The basic Photo CD player looks very much like a standard CD with the exception of having a Kodak badge rather than usual Sony, Philips, Panasonic, Toshiba or any one of a number of others in the audio industry. It hooks up to a HiFi system with the usual twin phono leads, the other main connection being to the TV. The video connection is via a composite video, Super VHS and Scart RGB for best quality. Although many older sets only have aerial sockets on the back, most of the new models have direct video connections in one form or another.

After switching the system on and inserting a disc, a remote control handset runs everything. To begin with, pictures are simply played back in the sequence they were recorded with a short, programmable delay between each one which can be set to three, five or eight seconds. A pause button plus backwards and forwards allow simple control. An on-screen programming function allows any of the pictures to be placed in any order and repeated or even left out entirely.

Because the shape of a TV screen is not the same as a 35mm slide, only a portion of the picture is available at any one time. Oddly, there was no way to zoom out to show the whole frame. Kodak says that it had to draw the line on the machine's capabilities at some point and this is something that may be put in at a later date in the top of

the range machines. However, all is not lost, the section of the picture seen on the TV screen can be moved by pressing buttons on the control pad – left, right, up and down. There is also a zoom-in facility that allows sections of the screen to be enlarged to twice their normal size. The image can also be rotated through 90° to cope with portrait and landscape (vertical or horizontally framed) shots as well as those "arty" pictures that don't have any particular orientation. Once an image has been selected, its position, zoom factor and rotation are stored in a memory in the CD player so that the next time it is shown, it comes out in the same way.

Operation of the player has deliberately been kept simple – Kodak is wary of the criticisms levelled at most video recorders: that they are too complicated to use and can put people off. In practice, it would have been nice to have seen a few extras, especially more zoom features, rotation in single degree amounts rather than just right angles, the ability to edit images and place them within other images, a simple facility to add captions and display the contents of the disc in a tiled format; to mention just a few. A less obvious drawback with the system is that playing a photo CD means that an audio CD cannot accompany it so there's no chance of that beautiful sequence of holiday photographs with specially chosen music on CD.

The Process

As far as customers are concerned, getting photos onto CD is simple and should be available at all Kodak processing labs. Pictures are taken in the usual way and then sent off to be processed. Either slide or print film can be used as the scanner can cope with negatives or positives. At the moment, only 35mm film can be scanned but if the demand is there, other popular formats such as 110, 120 and disc will be added.

The film is developed and printed in exactly the same way as before with the usual production of either slides or prints. At this stage, the whole film can be scanned and transferred to CD. If the customer only wants a few of the photographs transferred, the appropriate negatives can be sent back and transferred at a later date. After scanning, the processing company is able to adjust the images and colour content via a computer, based on a Sun Workstation, which displays the pictures and allows editing before transfer to CD. As the pictures are transferred, a composite of all of them is printed out onto a single sheet which is inserted in the CD "jewel case" and, since each picture is assigned a number, this provides a reference for later use.

Because the pictures are stored at a very high quality, they can be printed out using Kodak's 7700 digital continuous tone colour printing system – an example of the quality (although only in black and white) is shown on page 18. In practice, it is virtually impossible to tell a print produced from the digital data from a print produced in the normal way.

Another service that could be offered by independent processing companies is to take images from CDs and add computer text and graphics to produce high quality personalised greeting cards.

Because Kodak supports such a large photo-processing and finishing service, it will be able to ensure that a large number of them provide the Photo CD service.

The Commercial Angle

As well as appealing to home users, Kodak is aiming to supply the audio-visual presentation hardware

market. Replacing overhead and slide projectors will just be the start. By creating an open license on the technology, Kodak will allow anyone to build and manufacture products that use the hardware and software. The company will generally gain from this because it owns a good slice of the world photo-finishing industry and Photo CD depends upon this as an image source.

By going in with Philips, Kodak has created a CD-I compatible system and all Photo CD discs will be viewable on CD-I players as well as the CD-ROM XA (extended architecture) industry standard. Using this technology allows pictures stored on CDs can be incorporated into any system which supports it – desk top publishing,

computer aided graphics design, multimedia and so on. There is also the possibility of using the Kodak scanner at a lower resolution to store more pictures on a disc, though at an inferior quality. For newspaper publishing, this provides the perfect picture library since only low resolution images are needed – compare a newspaper photograph to one reproduced in a magazine to see the difference.

What Will It Cost?

At the moment, Kodak has yet to fix any prices. However, transferring a set of 24 photographs from negatives to CD should cost between £11 and £15 including the disc. Kodak Photo CD players will start from around £300 for the basic

model – not too bad considering that it offers Bitstream audio CD as well. By offering a higher quality audio system than many people currently have, Kodak is hoping to get buyers who are moving up from older systems as well as people who are new to CD and want the Photo system as well.

The whole thing, including processing labs and players is due to be launched in the summer of 1992 – by next Christmas, there should be quite a glut of personalised greeting cards as well as pre-recorded image discs featuring such goodies as “The complete Tate”, “Indonesia, A Photo Travelogue” and possibly even “Your Favourite Page 3 Stunners”.

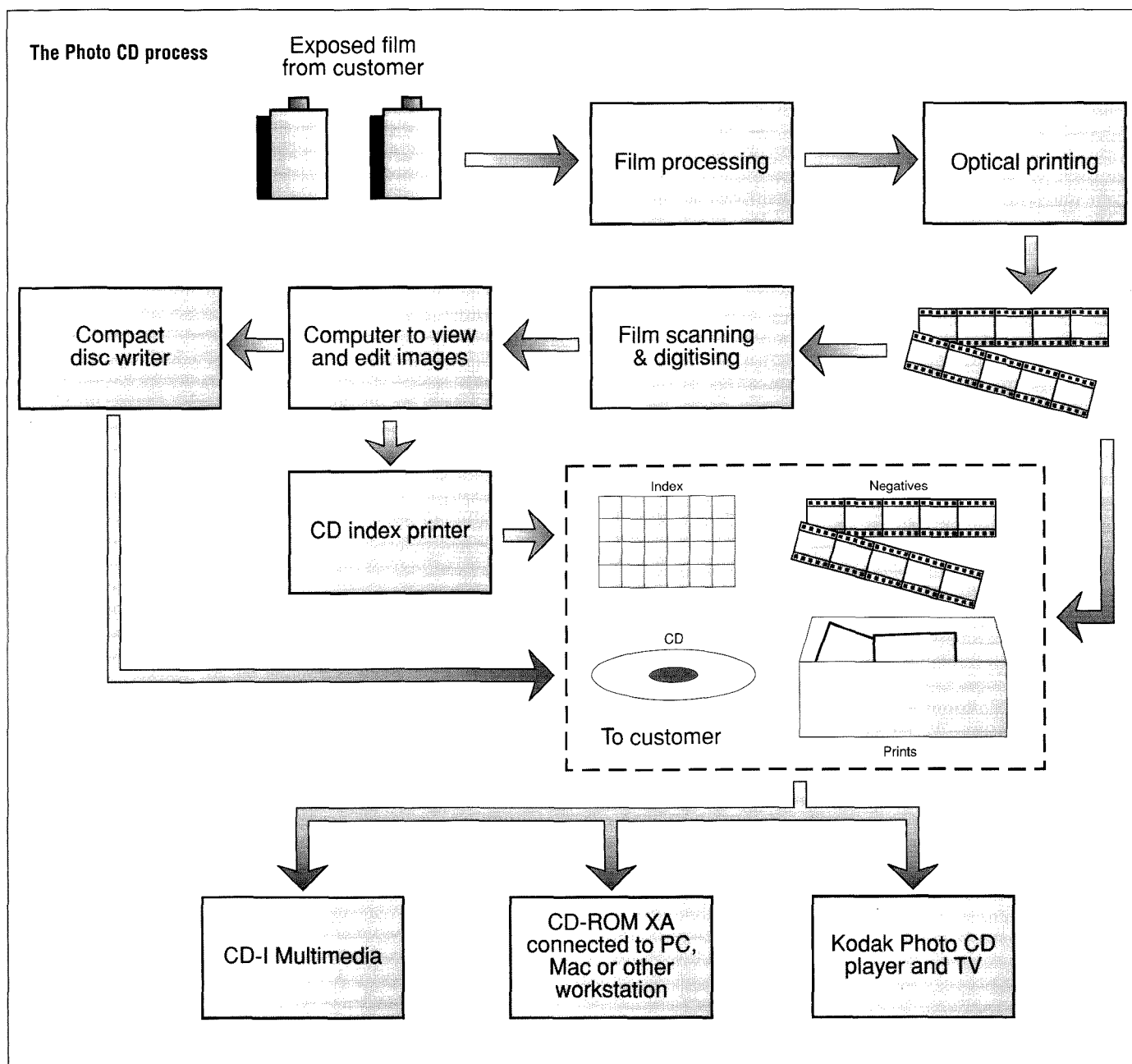

The Naming Of Names

Ashley Jones explains the Systeme International d'Unités and takes a brief look back over its history and the names that were made famous by it.

A large number of measurements have to be made in the field of electronics. The characteristics of a circuit can be defined in terms such as voltage, current, resistance, and so on. To make these comprehensible all over the world, a common system of units must be used – there's no point in measuring potential difference in volts in one place and measuring it in ab-volts in another and then having to convert backward and forward where necessary. A number of attempts have been made to set this up over the years, some successful, others confusing.

In 1791, the French revolution saw the formation of the metric system which was designed to get away from the older variable base systems such as imperial measures – this used 12s, 20s and 100s and performing calculations could be quite difficult with errors being quite common. By setting up everything to use base 10, all calculations became much easier. The basic unit of length was defined as the metre with others for area, volume, capacity and so on (see table 1). With the development of science and the need for more complex descriptions and measurements, other units evolved to describe new observations and were eventually rationalised into the cgs system. This used the centimetre, gram and second as its base units and attempted to derive everything else from them. There were also a number of sub-cgs systems for special cases such as stat-units and ab-units. These were used for special calculations such as those involving electrostatic systems. The main cgs units can be

Quantity	Unit	Symbol	Equivalent in imperial
length	metre	m	1.093613 yards
area	are	a	119.6 square yards
volume	stere	st	1.308 cubic yards
capacity	litre	l	1.057 quarts
mass	gram	g	0.035 ounces

Table 1 The metric system

seen in table 2 with their SI equivalents.

The next step towards a rational system was the creation of MKSA. This attempted to unify all measurements and remove any special cases. It was based on metres, kilograms, seconds and amperes and allowed virtually any of the more complex measurements such as those of magnetic fields to be defined in terms of these base units. The system in use today, the Systeme International d'Unités (SI), is based on the MKSA and was defined by the 11th General Conference on Weights and Measures in 1960. It has seven base units (table 3) that can be used to define all of the derived units shown in table 4.

Derivations

The idea of deriving units from a set of pre-defined base definitions

allows all observable phenomena to be described in a standard way. It would be possible to use just the base units. For example, the frequency of an event can be described as so many per second, in base units $1/s$ or s^{-1} . Describing a potential difference as square metres, kilograms, per second, per second, per second, per ampere is somewhat cumbersome and it is much easier to use the derived unit of the volt.

Finding Some Meaning

Because the units are derived from a standard set, all of their interrelationships can be seen and some understanding of what they really mean can be gained. For example, the newton is a measure of force and in base units is defined as $m.kg.s^{-2}$ or metres times kilograms per second per second. Metres per second is a

Quantity	Unit	Symbol	SI equivalent
energy	calorie	cal	4.1868 joule
force	dyne	dyn	10^{-5} newton
force	gram-force	gf	9.87×10^{-5} newton
length	centimetre	cm	0.01 metre
length	angstrom	Å	0.1 nanometre
mass	gram	g	0.001 kilogram
time	second	s	1 second
work energy	erg	erg	10^{-7} joule

Table 2. cgs to SI conversions

The Names That Made It

Getting an SI unit named after you ensures that you will never be forgotten. Most of the people who made the grade were great contributors to science. Many are household names others are not so well known.

André Marie Ampere (1775 – 1836) performed many experiments with electricity and magnetism and their interaction. A great deal of his work was based on experiments performed by Hans Christian Oersted (1777 – 1851) who discovered that an electric current would deflect a magnetic compass needle.

The coulomb is named after **Charles Augustine de Coulomb** (1736 – 1806) who defined Coulombs Law. This states that the force between two charges is proportional to their magnitudes and inversely proportional to the square of the distance between them. Whilst performing his experiments on electricity he showed that the charge of a body resides only at its surface.

Michael Faraday (1791 – 1867) was famous for his experiments and demonstrations at the Royal Institution in London. His contributions to science and engineering were numerous and included the discovery of Benzene, electromagnetic induction, electrolysis the connection between light and magnetism, the invention of the dynamo and the concept of magnetic lines of force.

Joseph Henry (1797 – 1978) was a contemporary of Michael Faraday and carried out many similar researches. He is mainly known for the discovery of electromagnetic induction and self induction though Faraday got the acclaim by publishing first. His other work covered the making of electromagnets and electric motors as well as studying sunspots and helping Samuel Morse design the telegraph – help which was, rather ungratefully, not acknowledged by Morse.

Heinrich Rudolf Hertz (1857 – 1894) was the first person to

transmit radio waves. His experiments showed that like light waves, radio waves could be reflected and refracted. Because of this and the fact that they travelled at the same speed, he surmised that light, radio waves and heat radiation were all electromagnetic in nature.

James Prescott Joule (1818 – 1889) defined Joule's Law which states that the heat evolved in a given time by the passage of electricity through a conductor is proportional to the resistance of the conductor times the square of the current – written $H \propto RI^2$ where H is the rate of heat generation in Watts, R is the resistance of the conductor in ohms and I is the current in amperes. During his experiments he showed that heat energy and mechanical energy were equivalent. Working with William Thompson (who was later to become Lord Kelvin) he derived the Joule-Thompson effect whereby the temperature falls when a gas is permitted to expand without an external energy source – this effect is now widely used in refrigerators and freezers.

William Thompson, later Lord Kelvin, (1824 – 1907) made many important contributions to the world of physics. Amongst his many fields of study were heat engines, the formulation of the second law of thermodynamics, the introduction of the absolute temperature scale (named after him), electromagnetic theory and long distance telecommunications.

Sir Isaac Newton (1642 – 1726) is one of the most famous mathematicians of the modern age. He invented calculus – a system of mathematics whereby continuous functions could be dealt with in a logical and systematic way – and is probably best known for his formulation of the theory of universal gravitation. He also defined the three laws of motion: that a body continuous in its state of motion unless acted on by an outside force; that the rate of change of motion, or acceleration, is proportional to the applied force; that every action is opposed by an equal and opposite reaction.

measurement of speed and metres per second per second is a change in speed or acceleration. Multiplying the mass into this gives the idea that force is to do with accelerating masses – from Newton's laws of motion, a force is the physical quantity which, when it acts upon a mass, causes it to change its current motion or accelerate which is implicit in the SI definition.

The Big And The Small

Multiples and sub-multiples of SI units are shown in table 5 and are used as single prefixes to define larger and smaller quantities – multiple prefixes for example, milli kilo seconds are not allowed. For large numbers, table 6 shows the definitions of numbers greater than

one million and the confusion between the US and European systems.

In the US method, the numbers are named after the number of groups of three zeros which follow 1000, so 1 000 000 000 000 is a trillion. However, the European system names them after the powers of 1000 which they represent, so 1 000 000 000 000 is a billion. Most people these days tend to use the US system but mixing them up can cause a great deal of confusion.

Most countries now use SI Units and older terminology such as dynes and ergs has fallen from use. However, the changeover is still taking place in some areas; the angstrom is quite common in physics and chemistry and it is unlikely that the hour and minute

Name	Symbol	Multiplier
atto	a	10^{-18}
femto	f	10^{-15}
pico	p	10^{-12}
nano	n	10^{-9}
micro	μ	10^{-6}
milli	m	10^{-3}
centi	c	10^{-2}
deci	d	10^{-1}
deka	da	10^1
hecto	h	10^2
kilo	k	10^3
Mega	M	10^6
Giga	G	10^9
Tera	T	10^{12}

Table 5 Multiples and sub-multiples

Power of 10	Power of 1,000,000	US name	European name
10^6	$10^{(3+3)}$	1,000,000 ¹	million
10^9	$10^{(3+2 \times 3)}$		million
10^{12}	$10^{(3+3 \times 3)}$	1,000,000 ²	milliard
10^{15}	$10^{(3+4 \times 3)}$		billion
10^{18}	$10^{(3+5 \times 3)}$	1,000,000 ³	quadrillion
10^{33}	$10^{(3+10 \times 3)}$		quintillion
10^{60}		1,000,000 ¹⁰	decillion
10^{303}	$10^{(3+100 \times 3)}$		centillion
10^{600}		1,000,000 ¹⁰⁰	centillion

Table 6. Numbers over 1,000,000

engineering. He invented the induction motor and started the transmission of electric power by alternating current rather than the direct current system favoured by Edison at the time. As well as helping to tap the power of the Niagara Falls he performed many experiments on transformers and gave his name to the tesla coil – a device used to generate high voltages.

Georg Simon Ohm (1789 – 1854) is well known for his definition of Ohm's Law: that the electrical potential difference across a conductor is proportional to the current flowing through it. The constant of proportionality is the resistance of the conductor giving rise to the well known formula $V=RI$ where V is the potential difference or voltage across the conductor, R is its resistance in ohms and I is the current in amps flowing through the wire.

and giving his name to a computer language. He also studied hydrodynamics and hydrostatics and discovered that atmospheric air actually had weight. Pascal's Law states that the pressure in an enclosed body of fluid arising from forces applied to its boundaries is transmitted equally in all directions with unchanged intensity – it also acts at right angles to the surface of the container and is the reason why balloons are round in shape.

Alessandro Giuseppe Antonio Anastasio Volta (1745 – 1827) invented the first battery by making a pile of alternating metal discs and paper soaked in salt water. Up until this point it had been thought that electricity was closely allied to life and was a special property of animal matter. Volta's battery proved that electrical power could be generated from inanimate substances and settle the matter once and for all.

Blaise Pascal (1623 – 1662) is, perhaps, better known for his triangle

Ernst Werner Von Siemens (1816 – 1892) was one of a family of engineers and along with his brothers Friedrich (1826 – 1904) and Karl Wilhelm (1823 – 1883) invented an electroplating process, a regenerative steam engine, an open hearth steel manufacturing process and the laying of an Atlantic telegraph cable in 1874.

James Watt's (1736 – 1819) main work was inventing steam engines and their associated technology. He coined the term horsepower so it is unsurprising that the SI unit named after him replaced this outdated term.

Unit	Symbol	Quantity
ampere	A	electric current
candela	cd	luminous intensity
kelvin	K	temperature
kilogram	kg	mass
metre	m	length
mole	mol	amount of substance
second	s	time

Nikola Tesla (1856 – 1943) was born in Croatia and is one of the many unsung heroes of electrical

William Eduard Weber (1804 – 1891) is most famous for his work on the Earth's magnetic field in association with Johann Karl Friedrich Gauss.

Table 3. SI base units

Table 4 SI derived units

Name	Symbol	Quantity	Equivalent in other units	In base units
coulomb	C	quantity of electricity		A.s
farad	F	capacitance	C/V	$m^{-2}.kg^{-1}.s^4.A^2$
henry	H	inductance	Wb/A	$m^2.kg.s^{-2}.A^{-2}$
hertz	Hz	frequency		s^{-1}
joule	J	energy, work	Nm	$m^2.kg.s^{-2}$
lumen	lm	luminous flux		cd.sr
lux	lx	luminance	lm/m ²	$m^{-2}.cd.sr$
newton	N	force		$m.kg.s^{-2}$
ohm	Ω	electrical resistance	V/A	$m^2.kg.s^{-3}.A^{-2}$
pascal	Pa	pressure	N/m ²	$m^{-1}.kg.s^{-2}$
siemens	S	conductance	A/V	$m^{-2}.kg^{-1}.s^3.A^2$
tesla	T	flux density	Wb/m ²	$kg.s^{-2}.A^{-1}$
volt	V	potential difference	W/A	$m^2.kg.s^{-3}.A^{-1}$
watt	W	power	J/s	$m^2.kg.s^{-3}$
weber	Wb	magnetic flux	V s	$m^2.kg.s^{-2}.A^{-1}$

Angles are measured in radians (rad) and solid angles in steradian (sr)

Keeping Track Of The Workers

Active badges, pioneering high frequencies, fractal floppies and still cameras all feature in Ian Burley's roundup of the latest technology.

This month we have news of how we could be soon imitating the Star Trek crew at the office with some exciting new gadgets called Active Badges. Sharp has produced the world's first twin lens camcorder, Pioneer is set to add a bit of sparkle to the high notes on digitally recorded music and we look at a system which dramatically boosts the data capacity of an ordinary PC floppy disc by using fractal compression.

Finally, there's a look at Logitech's all-digital still camera.

Active Badges

Have you ever wondered how the Star Ship Enterprise's intercom always knows where to page Captain Kirk (or Picard)? He obviously wears an Active Badge. Seriously, Olivetti Research in Cambridge has developed a compact electronic device, patented as the Active Badge, designed to keep track of office staff and visitors inside a building. The research project was so successful that it has now been permanently adopted at Olivetti Research Labs and all staff and visitors to the building are issued with the badges.

OK, so office security badges and swipe cards aren't new and some are sophisticated enough to use the same magnetic field principle of security tags used in clothes shops to activate and unlock doors remotely. However, unlike these passive badges, Olivetti Research has packed a light sensor, an infra-red transmitter/receiver and a radio field sensor into the compact dimensions of its badge to provide a relatively detailed and

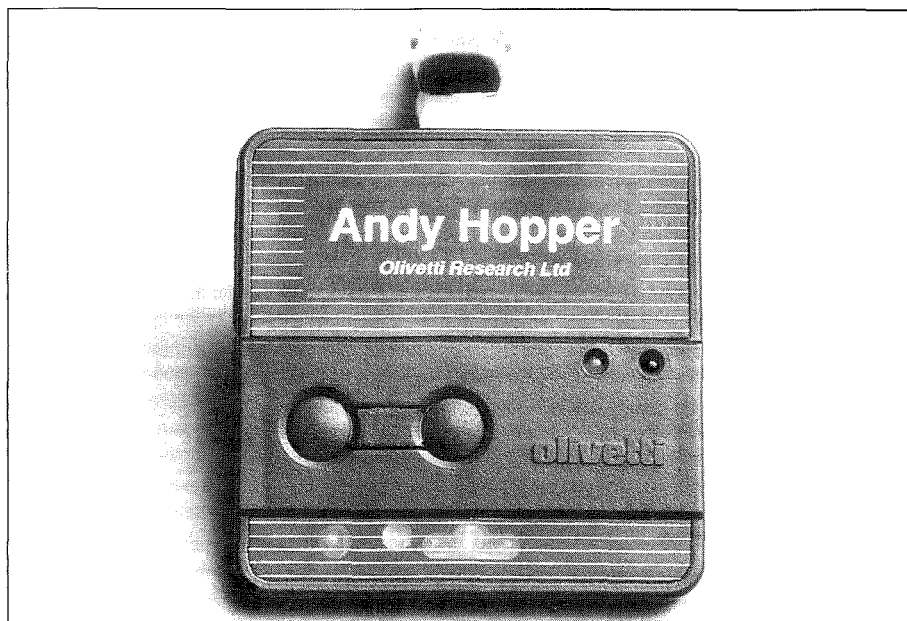

Olivetti's Active Badge.

dynamic tracking system.

Wall-mounted infra-red sensors detect an automatic unique code signal transmitted by the badge every 15 or so seconds. The signal is bright enough to be reflected off a wall and on to the sensor reliably even though it only lasts one tenth of a second. The wall-mounted sensor is networked to a central monitoring unit which can provide a status list of badge-wearers. If there has been no interruption in badge to room-sensor signalling for a couple of minutes, status is deemed to be 100% for that person in a particular location.

If contact is lost, in other words signals begin to be missed, the percentage status begins to drop and its a good bet the badge-wearer is on the move – but at least you know where he or she has just been. Contact which has been lost for over a couple of minutes results in a status indication of the time of that

day the badge was last detected and in which location. If contact was a previous day, that day of the week will be returned.

Most of the Olivetti Research staff think the badges are great because the problem of knowing quickly and accurately where their colleague are in the building has been largely solved. Status lists are instantly accessible on network terminals and workstations all around the building.

The light sensor, in the form of a simple light dependent resistor, has a couple of functions. Frequency of signalling depends on ambient light. If no light is detected at all, the resistor acts as an off switch to save battery power – for example if the badge has been stowed away in a drawer for the night or it's being deliberately hidden in a pocket or by being placed face-down on flat surface. Yes, you have the option to 'hide' from the system if you really

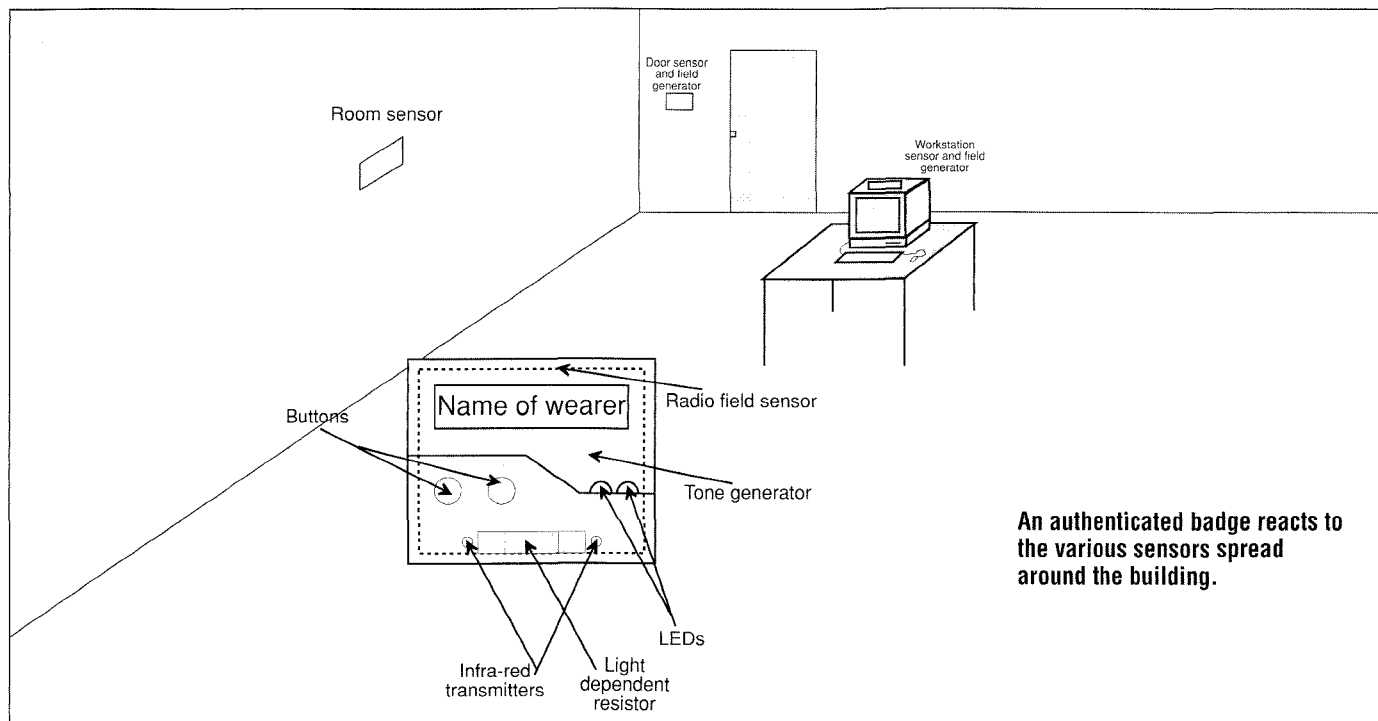

An authenticated badge reacts to the various sensors spread around the building.

need to. A manual on/off switch could have been implemented, but it was thought that users would frequently forget to turn their badges on. Varying ambient light changes the frequency of signalling, introducing an element of randomness which helps avoid a signalling clash with other badge wearers in the same room.

Current prototype badges have programmable buttons, although the example I was issued when I went to visit Olivetti Research recently only used the buttons for manual signalling. The radio field sensor is a recent addition. It works in conjunction with the infra-red system, which only signals, on average, once every 15 seconds in order to preserve power. The radio sensing is only short range, so the system can detect the proximity of a badge wearer to a specific field generator. One of these might be by a security door or in a workstation. Badges can be challenged via the infra-red system once they have been instantly detected by the radio sensor trigger.

The idea is that in a futuristic office a badge wearer would no longer need to mess about with on/off switches, booting his or her PC, and so on. Just by approaching the machine, the badge will trigger the PC into life, even resuming some applications which had been frozen, much in the way laptop computers already do now.

There's no reason why, with suitably networked PC workstations, badge wearers couldn't waltz up to any conveniently free station and instantly have their work ready to go; private offices could make way for multi-user work-rooms to improve office-space efficiency. Of course, phone calls could be automatically routed to where the desired badge-wearer is in the building. I'm sure a good few readers would pay a pretty penny for that facility, though probably just as many others might wince at the idea. Olivetti Research has actually taken this concept a bit further

Active badges are beginning to excite a lot of people. Xerox in Palo Alto has decided to develop its own systems under licence from Olivetti Research. Roy Want, who co-invented the Active Badge principle at Olivetti Research, is now working with Xerox full time on the project.

With such distinguished names as Olivetti, Xerox and Digital Research (which helps finance Olivetti Research) to back Active Badges, I'm sure we'll be hearing about these new gadgets a lot more in the not so distant future. Now all we need is for somebody to develop a decent Star-Trek style personal communicator – and little birds tell me Olivetti Research has come to a similar conclusion!

Sounds We Can't Hear

A rather longer time ago than I can care to remember, there used to be a HiFi advert for a cassette recorder which boasted that its frequency response at the top end extended to as high as 16KHz; the limit of human hearing sensitivity, the ad proclaimed. This was before the widespread availability of digitally recorded music. When digital compact disc was introduced, its frequency response was limited artificially at 20KHz, well above the supposed sensitivity threshold of human hearing – or was it?

There is now a fair amount of evidence which suggests that though we can't consciously hear sounds above 20KHz, our ear drums do register very high frequency sounds and these are shown to induce brain wave responses similar to those which represent forms of "well feeling" or a relaxed state. It is now suggested that chopping the frequency response of CDs at 20KHz is, in retrospect, an error which blocks out important high-frequency harmonics. This information adds another string to the bows of some extreme HiFi purists who continue to reject CD in favour of analogue recordings.

The 20KHz frequency response limit was partly imposed because it would keep component costs in CD players down. All music CD software is limited to 20KHz, but the Pioneer HiFi company has come

SURVEILLANCE PROFESSIONAL QUALITY KITS

No. 1 for Kits

Whether your requirement for surveillance equipment is amateur, professional or you are just fascinated by this unique area of electronics SUMA DESIGNS has a kit to fit the bill. We have been designing electronic surveillance equipment for over 12 years and you can be sure that all of our kits are very well tried, tested and proven and come complete with full instructions, circuit diagrams, assembly details and all high quality components including fibreglass PCB. Unless otherwise stated all transmitters are tuneable and can be received on an ordinary VHF FM radio.

UTX Ultra-miniature Room Transmitter

Smallest room transmitter kit in the world! Incredible 10mm x 20mm including mic. 3-12V operation. 500m range£16.45

MTX Micro-miniature Room Transmitter

Best-selling micro-miniature Room Transmitter
Just 17mm x 17mm including mic. 3-12V operation. 1000m range.....£13.45

STX High-performance Room Transmitter

Hi performance transmitter with a buffered output stage for greater stability and range. Measures 22mm x 22mm including mic. 6-12V operation, 1500m range.....£15.45

VT500 High-power Room Transmitter

Powerful 250mW output providing excellent range and performance. Size 20mm x 40mm. 9-12V operation. 3000m range.....£16.45

VXT Voice Activated Transmitter

Triggers only when sounds are detected. Very low standby current. Variable sensitivity and delay with LED indicator. Size 20mm x 67mm. 9V operation. 1000m range...£19.45

HVX400 Mains Powered Room Transmitter

Connects directly to 240V AC supply for long-term monitoring. Size 30mm x 35mm. 500m range£19.45

SCRX Subcarrier Scrambled Room Transmitter

Scrambled output from this transmitter cannot be monitored without the SCDM decoder connected to the receiver. Size 20mm x 67mm. 9V operation. 1000m range.....£22.95

SCLX Subcarrier Telephone Transmitter

Connects to telephone line anywhere, requires no batteries. Output scrambled so requires SCDM connected to receiver. Size 32mm x 37mm. 1000m range.....£23.95

SCDM Subcarrier Decoder Unit for SCRX

Connects to receiver earphone socket and provides decoded audio output to headphones. Size 32mm x 70mm. 9-12V operation£22.95

ATR2 Micro Size Telephone Recording Interface

Connects between telephone line (anywhere) and cassette recorder. Switches tape automatically as phone is used. All conversations recorded. Size 16mm x 32mm. Powered from line£13.45

UTLX Ultra-miniature Telephone Transmitter

Smallest telephone transmitter kit available. Incredible size of 1mm x 20mm! Connects to line (anywhere) and switches on and off with phone use. All conversation transmitted. Powered from line. 500m range£15.95

TLX700 Micro-miniature Telephone Transmitter

Best-selling telephone transmitter. Being 20mm x 20mm it is easier to assemble than UTLX. Connects to line (anywhere) and switches on and off with phone use. All conversations transmitted. Powered from line. 1000m range£13.45

STLX High-performance Telephone Transmitter

High performance transmitter with buffered output stage providing excellent stability and performance. Connects to line (anywhere) and switches on and off with phone use. All conversations transmitted. Powered from line. Size 22mm x 22mm. 1500m range£16.45

TKX900 Signalling/Tracking Transmitter

Transmits a continuous stream of audio pulses with variable tone and rate. Ideal for signalling or tracking purposes. High power output giving range up to 3000m. Size 25mm x 63mm. 9V operation£22.95

CD400 Pocket Bug Detector/Locator

LED and piezo bleeper pulse slowly, rate of pulse and pitch of tone increase as you approach signal. Gain control allows pinpointing of source. Size 45mm x 54mm. 9V operation£30.95

CD600 Professional Bug Detector/Locator

Multicolour readout of signal strength with variable rate bleeper and variable sensitivity used to detect and locate hidden transmitters. Switch to AUDIO CONFORM mode to distinguish between localised bug transmission and normal legitimate signals such as pagers, cellular, taxis etc. Size 70mm x 100mm. 9V operation£50.95

QTX180 Crystal Controlled Room Transmitter

Narrow band FM transmitter for the ultimate in privacy. Operates on 180 MHz and requires the use of a scanner receiver or our QRX180 kit (see catalogue). Size 20mm x 67mm. 9V operation. 1000m range.....£40.95

QLX180 Crystal Controlled Telephone Transmitter

As per QTX180 but connects to telephone line to monitor both sides of conversations. 20mm x 67mm. 9V operation. 1000m range.....£40.95

QSX180 Line Powered Crystal Controlled Phone Transmitter

As per QLX180 but draws power requirements from line. No batteries required. Size 32mm x 37mm. Range 500m£35.95

QRX180 Crystal Controlled FM Receiver

For monitoring any of the 'Q' range transmitters. High sensitivity unit. All RF section supplied as a pre-built and aligned module ready to connect on board so no difficulty setting up. Outpt to headphones. 60mm x 75mm. 9V operation£60.95

A build-up service is available on all our kits if required.

UK customers please send cheques, POs or registered cash. Please add £1.50 per order for P&P. Goods despatched ASAP allowing for cheque clearance. Overseas customers send sterling bank draft and add £5.00 per order for shipment. Credit card orders welcomed on 0827 714476.

OUR LATEST CATALOGUE CONTAINING MANY MORE NEW SURVEILLANCE KITS NOW AVAILABLE. SEND TWO FIRST CLASS STAMPS OR OVERSEAS SEND TWO IRCS.

★★★ Specials ★★★

DLTX/DLRX Radio Control Switch

Remote control anything around your home or garden, outside lights, alarms, paging system etc. System consists of a small VHF transmitter with digital encoder and receiver unit with decoder and relay output, momentary or alternate, 8-way di1 switches on both boards set your own unique security code. TX size 45mm x 45mm. RX size 35mm x 90mm. Both 9V operation. Range up to 200m.

Complete System (2 kits)£50.95
Individual Transmitter DLTX£19.95
Individual Receiver DLRX£37.95

MBX-1 Hi-Fi Micro Broadcaster

Not technically a surveillance device but a great idea! Connects to the headphone output of your Hi-Fi, tape or CD and transmits Hi-Fi quality to a nearby radio. Listen to your favourite music anywhere around the house, garden, in the bath or in the garage and you don't have to put up with the DJ's choice and boring waffle. Size 27mm x 60mm. 9V operation. 250m range£20.95

**SUMA
DESIGNS**

THE WORKSHOPS, UNIT PE, 95 MAIN ROAD,
BAXTERLEY, NEAR ATHERSTONE,
WARWICKSHIRE CV9 2LE
VISITORS BY APPOINTMENT ONLY



0827 714476

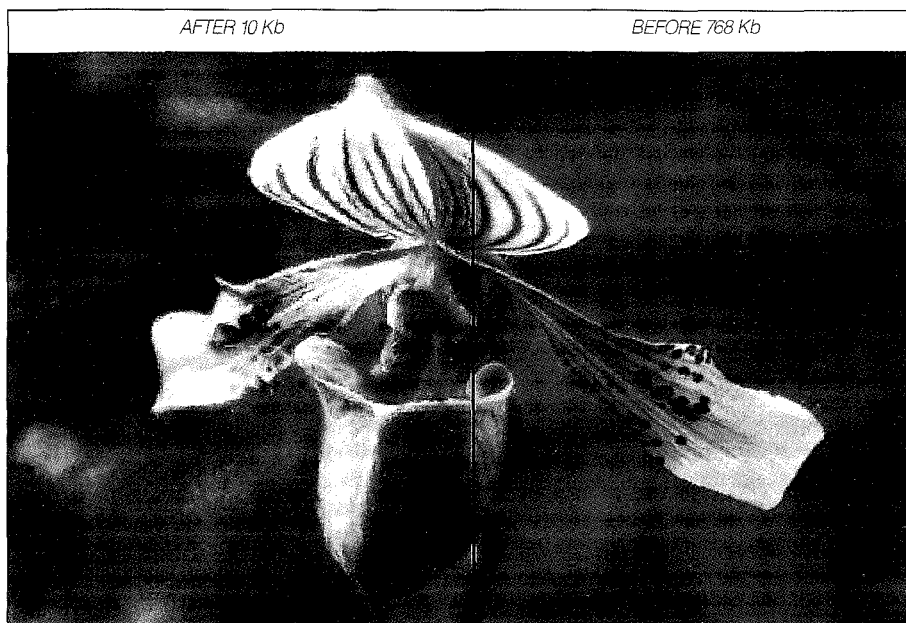

On the left, the result of compressing the image using fractals.

up with a gadget which, it's hoped, will restore some of the sought after effects of lost high-frequency harmonics. Something called a Legato Link conversion is performed on high frequencies reproduced by the CD. Normally these sounds simply get chopped at 20KHz, but the Pioneer process artificially extends the response across the 20KHz barrier to a around 30KHz. In effect the frequency response is faded out smoothly rather than being decapitated. Of course, the result is totally artificial, but those who have heard the Pioneer system report definite differences in the subtlety of the music. Pioneer will introduce an enhanced top-end CD deck featuring Legato Link conversion processing later in the year. However, it's not expected to be very affordable at £1500+. What with multi-bit, Bitstream and MASH digital sound-shaping, the once shining purity of digital sound is now looking a sight tarnished.

The Fractal Floppy

You just might have heard of fractals. This is a fairly trendy area of modern mathematics. Crudely, the theory says that very simple mathematical formulæ can describe complex shapes. By using fractals you can convert the bulky complexity of real-world graphics into a stream of very compact fractal codes. It's thought that fractal transformations could contribute a major breakthrough in

real-time video transmission and storage. The problem is that the coding requires a lot of very hard work. It's still early days, but a firm set up by a British pioneer of fractal transform technology, Dr. Michael Barnsley, has now produced a fractal-based system aimed at PC users which can store, typically over a hundred 640x400 pixel full colour images on an ordinary 1.44 Mb floppy disk still leaving space for a hundred or so pages of text. Barnsley's firm is called Iterated Systems and is based in Atlanta, Georgia, where he was a professor of mathematics at the Georgia Institute of Technology.

Let's put things into perspective; a 24-bit colour image at

640x400 resolution occupies 768k in an uncompressed state. You couldn't even get two uncompressed pictures on a single 1.44Mb floppy. Using typical compression utilities like Arc or PkZip you might get a compression of around 10:1. If you are lucky, you might get twenty compressed images on the disk without any spare space. Iterated Systems' process can compress some 768K pictures down to an incredible 10K. If the image was generated using fractals in the first place, the compression ratio becomes incredible. A favourite example is that of a quite beautiful fern plant entirely generated from a fractal formula just 100 bytes long. There is a small catch, however, as real-world images compressed using fractals cannot be re-created bit-perfect as with Arc or Zip methods. In fact, stills which have been decompressed from their fractal state look slightly different; some might say slightly degraded. But there is another advantage to help restore the balance; fractal images are independent of resolution limiting factors. Like vector drawings, fractal images will make full use of the display resolution available.

Iterated Systems is offering both compression hardware and utilities to create what it calls Floppy Books. Essentially, these are generously illustrated and quite substantial documents on a single floppy disk which might otherwise require a whole box full of disks. The

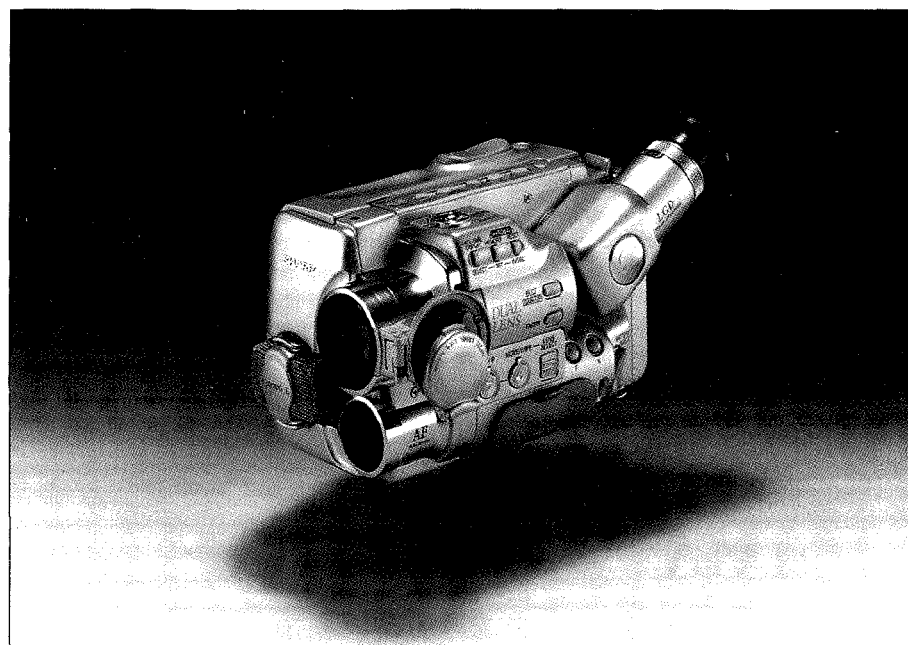

The Sharp 8mm camcorder with twin lens system.

SUBSCRIBE TO ProgramNOW

EUROPE'S LEADING PROGRAMMING MAGAZINE

C, C++, Pascal, Assembler, dBase, Fortran, Windows, Unix and a spectrum of software development issues.

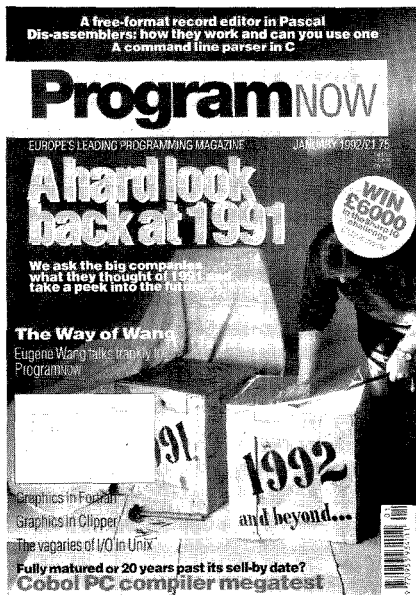

Return this coupon with your payment to PN Subs, Intra House, 193 Uxbridge Road, London W12 9RA

Name	
Job Title	
Dept/Division	
Organisation	
Address	
Town	
Country	
Post/Zipcode	
Telephone	

Overseas subscriptions are sent surface mail - air mail rates available on request

YES!

Please send me the next 12 issues of ProgramNOW
I enclose a cheque made payable to INTRA PRESS for:
 £21 (UK) Airmail rates on request

Or, please debit my Access Visa Card

Card Number.....

Expiry date.....

Signature.....

PE2/92

COMPONENTS for TV * Video Audio * Computer

VIDEO BELT KITS	
AMSTRAD VCR4600/4700/5200	£3.19
FISHER FVHP905/906/908	£2.93
JVC HR3300/3330/3660	£2.93
SANYO VT5500/5150/5500	£1.49
SANYO VT55500	£2.49
THORN 8900 to 8922	£2.79
VIDEO PINCH ROLLERS	
AMSTRAD VCR4500/4600 Mod Kit	£8.17
HITACHI VT11V/133	£5.17
JVC Above models	£5.17
SHARP VC381/386/388/390	£5.67
THORN 3V00/06/16/22/23/24	£5.17
SERVICE MANUALS	
BHANTONE 01/8771	£6.99
PHILIPS 22DC570/670-00	£3.25
PHILIPS KT4/K40 Chassis	£10.00
OTHER SPARES	
FERGUSON 3V23/29/30/32 Reel Idler	£3.55
HITACHI VT11/14/33/34/61/62/63	
Video Head	£26.10
SHARP RG281/4 Main belt	£1.40
TOSHIBA STU2 Mains transformer	£9.99

LEADS & CONNECTORS	
'Universal' Video Lead Kit	£7.40
9 piece 'Scart' Video Lead Kit	£8.59
AC Mains Lead - 2 pin fig. 8	£0.61
INTEGRATED CIRCUITS	
LM733CN	£2.27
TBA530	£1.14
TBA810P	£1.40
TDA1001B	£2.66
AERIALS & EQUIPMENT	
FM Omnidirectional Aerial	£18.24
UHF TV Aerial (10 element - Band A)	£6.89
Loft Mast/Bracket	£1.99
75Ω CO-ax Cable	per m/£0.23
Cable clips	per 10/£0.21
* (Brown or White)	
TELEPHONE ACCESSORIES	
BT Plug-in Tone Ringer	£6.95
Socket Doubler	£3.68
IDC Junction Box	£3.95
5m Extension Lead	£4.20
LUJ2 Secondary Skt. & Box	£3.20
LUJ3 Secondary Skt. (Flush)	£2.67
4 core cable	per m/£0.15
Cable clips	per 10/£0.20

TOOLS & EQUIPMENT	
UNIROSS Plug-in 'Fast' Charger for AAA/AA Ni-CADs	£5.49
UNIROSS 'C' Ni-Cad Battery	£2.09
WELLER WM12D Micropoint Soldering Iron	£8.25
12W/240Vac	£2.45
'Universal' Crimping Tool	£0.80
Junior Hacksaw	£0.80
Craft Knife & Spare Blade	£0.58

This is just a small sample of stock. Our latest price list is free on request with first order - alternatively please send 50p Stamps/Cheq./3 x IRCs towards P&P for a copy by return.

WE CAN SUPPLY A VAST RANGE OF SPARES for many makes of TV, Video, Computer & Audio Equipment. Write (Encl. SAE please) or PHONE FOR A 'PRICE AND AVAILABILITY' on your requirements. **0452 526883**

COMPUTER SPARES

AMSTRAD/SINCLAIR		EPSON	
IC 40007 G Array	£19.86	C78010B0031 CPU	£30.24
IC 40010 G Array	£18.86	HA13007 T. Array	£4.86
IC AY389 12A	£6.92	SINCLAIR	
IC HA13408	£7.87	40054 ROM (+2)	£16.99
IC LA4140	£1.70	40056(128K/4)	£17.99
IC PEGA1A	£30.85	ROM (48K/4)	£7.99
IC UPC1378H	£2.45	ZX8302 (OL)	£10.48
IC Protector N75	£1.55	ZX6401 (Spec)	£7.94
Transistor 2SD1397	£4.99	ZTX213 Transistor	£0.28
Jack Skt. (CPC I/O)	£2.07	ZTX650 Transistor	£0.49
Joystick (CPC)	£6.71	UM1233 Modulator	£6.56
Service Manual		Membrane (OL)	£7.95
CPC 464 (early)	£8.49	Membrane (+/128K)	£7.99
Service Manual		Bubble Mat (+/128K)	£1.18
PCW8256/8512	£13.89	Speaker (+/48K)	£1.55
User Manual CPC464	£10.95	Power Skt. (Spec)	£0.65
User Manual CPC6128	£14.25	28 Way Edge Conn.	£3.49
ATARI		COMMODORE	
IC CO14806 (KE1)	£11.409	IC 6510 CPU	£10.03
IC CO29847 (KE1)	£4.49	IC 6526 CIA	£11.11
IC YM7149F (ST)	£10.02	IC 6569 VIC	£25.63
SWITCH 'Reset' (ST)	£1.25	IC 6581 SID	£16.35
THERMISTOR (ST-PSU)	£1.34	IC 8501 CPU	£10.80
TL431 (ST-PSU)	£1.20	IC 8520 CIA	£11.22
CNY65 (ST-PSU)	£4.42	IC 251641-02 PLA	£3.98
PC101 (ST-PSU)	£4.73	IC 906114-01 PLA	£9.24
PC7 13V (STE-PSU)	£2.94	IC 901225-01 ROM	£6.55
We can supply most ST-PSU Transistors		IC 901226-01	£9.21
PHILIPS		IC 901227-03 ROM	£12.33
Serv. Manual BM7513	£2.99	Modulator 251916-02	£18.76
Serv. Manual CM8833	£3.80	User Manual (C64)	£4.25
		TV Lead (Also Spec.)	£1.49

All above are manufacturer's original spares. We can also supply a range of manuals and parts for some other makes - including Acorn, Olivetti and Panasonic.

OTHER COMPUTER CHIPS

6502 CPU	£5.05	AM26LS31PC	£1.63
6522 VIA	£4.49	75154PC 4 x line driver	£1.85
6818 RT Clock	£7.24	64K x 1 DRAM (120ns)	£1.99
8255A PPI	£2.82	64K x 1 DRAM (150ns)	£1.69
8272A FDC	£14.09	64K x 4 DRAM (100ns)	£2.99

SPECIAL OFFERS

SONY High Speed CPU (8MHz) - Same as NEC V30 Direct replacement for 8086 CPU (Approx 25% faster) £9.99	74LS00 TTL IC	18p ea. (1+)
While stocks last.		15p ea. (5+)
SED9420CAC	TEXAS DRAM (TMS4532-15N14) - For Spectrum 48K	£1.72 ea. (1+)
		£1.22 ea. (5+)

MAIL ORDER ONLY. Please add 95p (UK) P&P but not VAT. All items subject to availability - Prices can change without notice.

Marapet (PEB)
1 Hornbeam Mews
Gloucester GL2 0UE

Interak 1 BUILD YOUR OWN COMPUTER

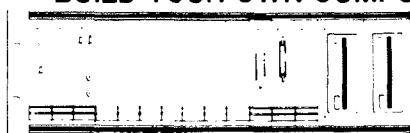

INTERAK can be commenced with the minimum of outlay. Bare boards from £10.95, beg borrow or steal the components or buy from us - all parts available separately. No special or custom chips like PALs, ULAs, ASICs etc. used - no secrets.

Go as fast or as slowly as your funds and enthusiasm permit

Made for those who must know what goes inside. Full circuit diagrams and descriptions are provided. And honestly can you really use a computer effectively if you don't know what's inside and nobody will tell you?

Solid engineering construction - something to be proud of. 19" 3U rack mounting, plug-in circuit boards and modular construction keeps obsolescence at bay.

Flourishing Independent Users Group and newsletter. Hundreds of programs on disk at little or no cost from the Users Group.

Program in machine code (Assembler), Basic, C, Forth etc. Database, Word Processing, Scientific applications.

Cassette tape operation or disk (up to 4 drives, 1 Megabyte 3.5" available from us, but you can add 3" 5.25" 8" if you want). Disk operating system CP/M Plus.

64K RAM, Z80 based at present with potential for expansion to a 16 Megabytes address space and Zilog's latest Z80280 in the future.

Needs no specialised knowledge to construct, and we will happily get you out of a jam if you get into one.

Availability of personal and individual after sales service, impossible to obtain from large companies who are only after your money.

Security of supply - from Greenbank Electronics, established in 1970.

Greenbank

For more details write or phone us:
Greenbank Electronics, Dept PE02, 460 New Chester Road,
Rock Ferry, Birkenhead, Merseyside, L42 2AE. Tel: 051-645 3391



The picture within picture facility of the Sharp VL-MX7.

software is Microsoft Windows compatible. Hardware-assisted processing is required at the compression stage and the PC card is not exactly inexpensive, but if you can't afford to buy one, Iterated Systems can do the compilation for you for a fee and a royalty. While the initial compression process is a heavy-duty operation, decompression is software driven and very quick.

Before long, we are going to enjoy the benefits of fractal transform technology on all sorts of imaging from stills and multimedia through to broadcast and possibly high definition TV. Until then, I'm content to wonder at the fact that

Floppy Book technology can stuff 70-odd megabytes of images onto a single 1.44 megabyte floppy...

Iterated Systems (UK) Ltd - Tel.0734 880 261

Sharp's Twin-Lens

The Video 8 camcorder lobby has gained a considerable boost with the news that Sharp has produced its first 8mm camcorder, the stereo sound VL-MX7. Previously the Japanese consumer electronics giant was a faithful VHS-C club member. If that wasn't enough, Sharp's new ultra-compact palmcorder is unique in that it has two built in lenses and a colour finder. Supplementing the

standard 8x zoom lines is a 'super wide' fixed focal length lens offering a 62 degree field of view compared to the normal wide angle view of 45 degrees. If you're not yet satisfied, this camera has enough gadgets to keep you occupied. You might like to know that that the zoom and wide angle views can be digitally mixed picture-in-picture style. The idea is that you can have a close-up of, say a child, in a window, with the rest of the scene in the overall background. Finally there's an instantaneous 12x 'zoom' switch between the fixed wide angle lens and the 8x zoom. The camera, which will be available in a striking all-silver option, will be available from March. No price had been set at press-time. Sharp UK: Tel.061-205 2333.

The All-Digital PhotoMan

In past issues of PE we have enthused over Canon's cute little Ion (or Xap-Shot in the US) still-video camera. This has been interfaced to PCs and colour printers though some have argued that the camera isn't ideal for these applications as its pictures are stored in analogue form on a 2.5in micro-floppy disc. If you think about it, the picture is first digitised by the camera's CCD imaging chip, then stored in analogue on the disc. To send it to a PC or a printer you have to re-digitise it. All these transformations gradually erode picture quality.

Logitech, a Swiss firm better known for its computer mice and handscanners, has brought out an all-digital still camera called PhotoMan. The camera has on-board chip memory which can store up to 32 monochrome 256-grey level pictures. Picture data is transferred digitally from the camera to a PC via a serial communications interface. There can be no degradation due to repeated analogue/digital or vice-versa transformations. I haven't seen the camera's results first hand, but they ought to be first class. PhotoMan comes with PhotoTouch, an image editing and re-touching utility which runs under Microsoft Windows. PhotoMan should be available soon priced "under £600" according to Logi UK. For more information, contact Logi UK on 0344 891 313. ■

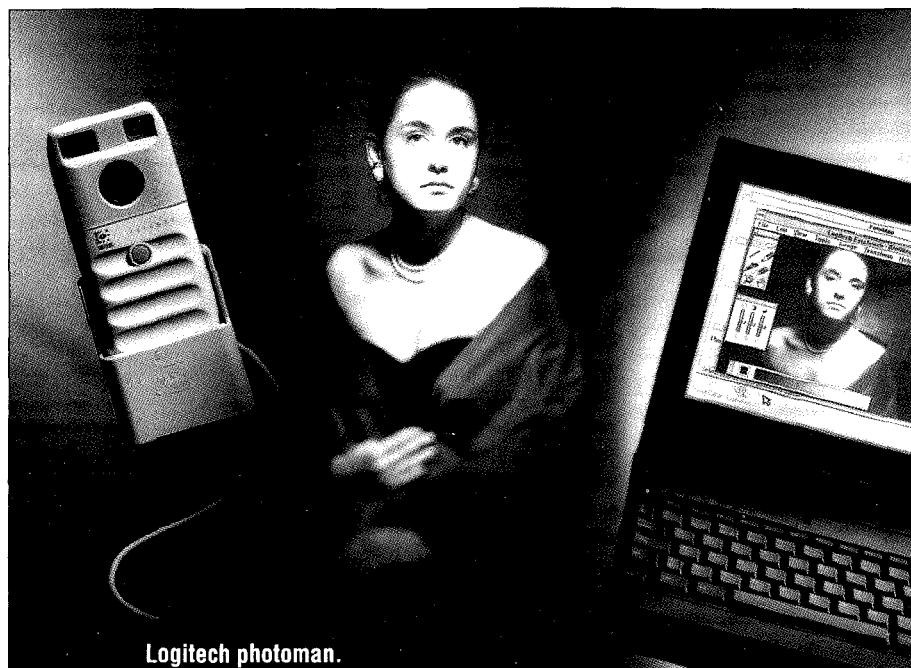

Logitech photoman.

Techniques

Andrew Armstrong discusses the switching of lamps and Cuk Convertors.

Mr T Spearritt, an ophthalmic optician, writes to ask for help with a visual field screening device. He wishes to select eighteen different combinations of low voltage lamps by means of a rotary switch, and would like a design for an electronic indicator to show the switch positions. He writes: "Since the positions are selected at random and are not always consecutive, a counter type drive would not suffice."

He subsequently explained that the test apparatus, which is used in a darkened room, incorporates a timer to illuminate up to four 6V 400mA lamps for a brief period. The rotary switch selects one of eighteen combinations of lamps, and the subject has to say how many are illuminated.

There are many approaches to this problem. If a design were required for manufacture, then a microprocessor would constitute

the best way to do the job. It is probably not worth the work of programming for a one-off, where a circuit using standard logic chips is easier to debug.

Switching

First of all, on looking through my electronics catalogues, I did not find any 18-way rotary switches. In any event, a conventional rotary switch may not stand up to the wear required if the instrument is in regular use. While a counter which simply selects the sequences in order might not be acceptable, there is nothing against an electronic control to replace the mechanical switch. I first considered using up and down buttons to select the next lamp sequence, but decided against it because this would be inconveniently fiddly. Far better is the system used on some electronically tuned radios: a rotary encoder which will clock a counter

up or down.

Such encoders may be mechanical or optical, but the optical ones are less prone to wearing out than ordinary rotary switches. An example of a suitable encoder would be Farnell part no. 109112 (costing £2.01).

If one of the quadrature outputs is used to clock a counter, while the other is used to set whether it counts up or down, then the direction of counting will be controlled by the direction of rotation of the encoder. With this simple system, it is possible to make the counter count in the wrong direction by turning the switch half a position round and then back again, but in a manually controlled system this does not matter.

The Circuit

The circuit of the counter indicator and lamp-drive system is shown in

GO TO PAGE 57.

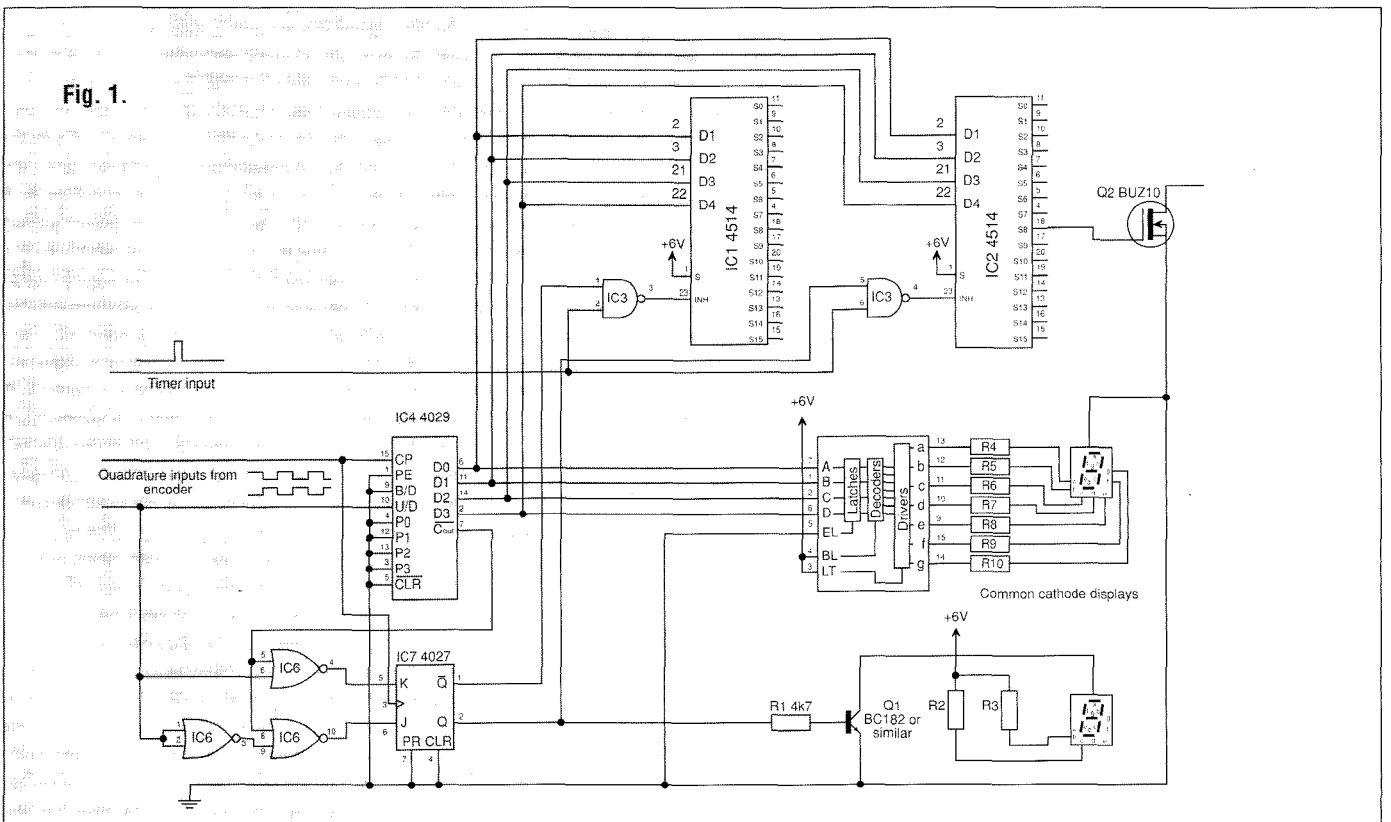

How It Works...

The Flash Gun

Kevin Garway explains the hows, whys and wherefores behind the electronic flash gun with illustrations by Derek Gooding.

Producing a photograph requires a number of essential items, a camera, film and, most important of all, light. The correct amount of illumination of the subject in a photograph generally determines whether or not the picture comes out at all. Using different films and adjusting the exposure time to allow more light into the camera provides a wide range of lighting levels in which pictures can be taken. For low light conditions, the only solution is a flash unit.

Disposable

Most people will remember having seen old movies of the 1930s where the "press corps" huddles around the starlet and flash bulbs go pop. This old style disposable method of providing instantaneous light was wasteful and lacked the sophistication and accuracy available to modern units. With the falling cost of Xenon flash bulbs and the increased use of higher quality 35mm cameras, a demand was created for re-usable units powered from easily obtainable batteries.

In the latest flash guns, electronic circuitry is used to ensure that the flash provides exactly the right amount of light for exactly the right length of time.

Sensors

A flash gun can either be built in, attached to the camera by an electric lead, or fitted to a "hot shoe". The latter method is perhaps the most common as it allows a number of different flash units to be used with one camera - various

qualities and capabilities are available at different prices. The illustration opposite is a of the latest hot-shoe type. It fits onto a special slot on top of the camera which also provides an electrical connection to the shutter trigger circuitry.

When the camera shutter is tripped, a switch closes in the camera mechanism which closes a circuit in the trigger circuit board of the flash gun. From here, a switch connects the storage capacitor to the xenon flash tube causing it to light up. The trigger circuitry then monitors the output of a sensor on the front of the flash. This receives reflected light from the subject of the photograph and enables the trigger circuit to keep the flash operated until enough light has been provided to complete the photograph. At this point the trigger switches off the flash and the power circuitry begins to recharge the storage capacitor. Settings on the back of the gun allow it to be set up to match the camera and determine how much

light should be given to the subjects - this depends mainly on the distance of the main subject, the speed setting of the camera and the setting of the aperture. A more sophisticated system uses a sensor built into the camera itself to determine when the flash should be turned off allowing fully automatic and highly accurate operation. The operating speed of the electronics is so much faster than the shutter mechanics that quite intelligent monitoring of the light levels can be done to produce the perfect exposure.

After the flash has been fired, its capacitor must be recharged. Depending on the model, this may take a minute or so, or happen almost instantaneously. A sounder and LED indicator are usually provided to show the user the current status - the pitch of the tone from the sounder rises as the flash recharges and the LED lights up when it is complete. The top range systems have separate power packs that improve performance to the stage where a the flash can be used

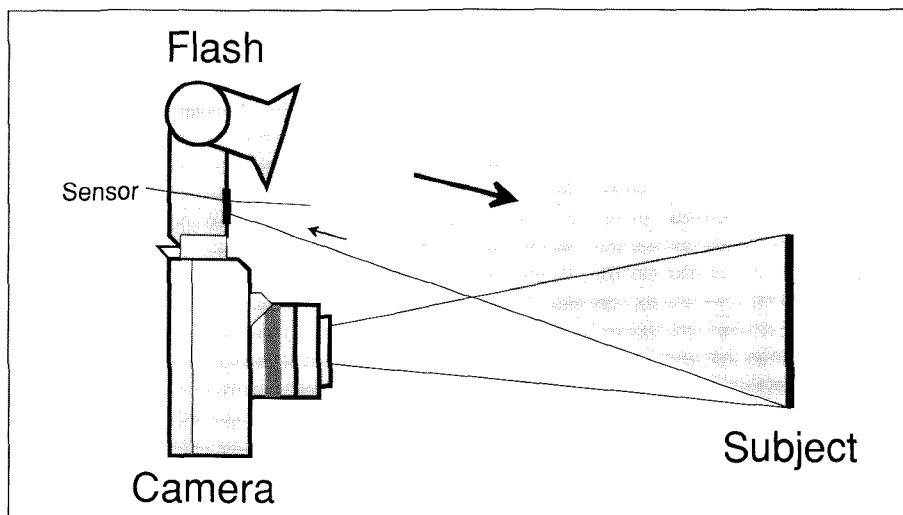

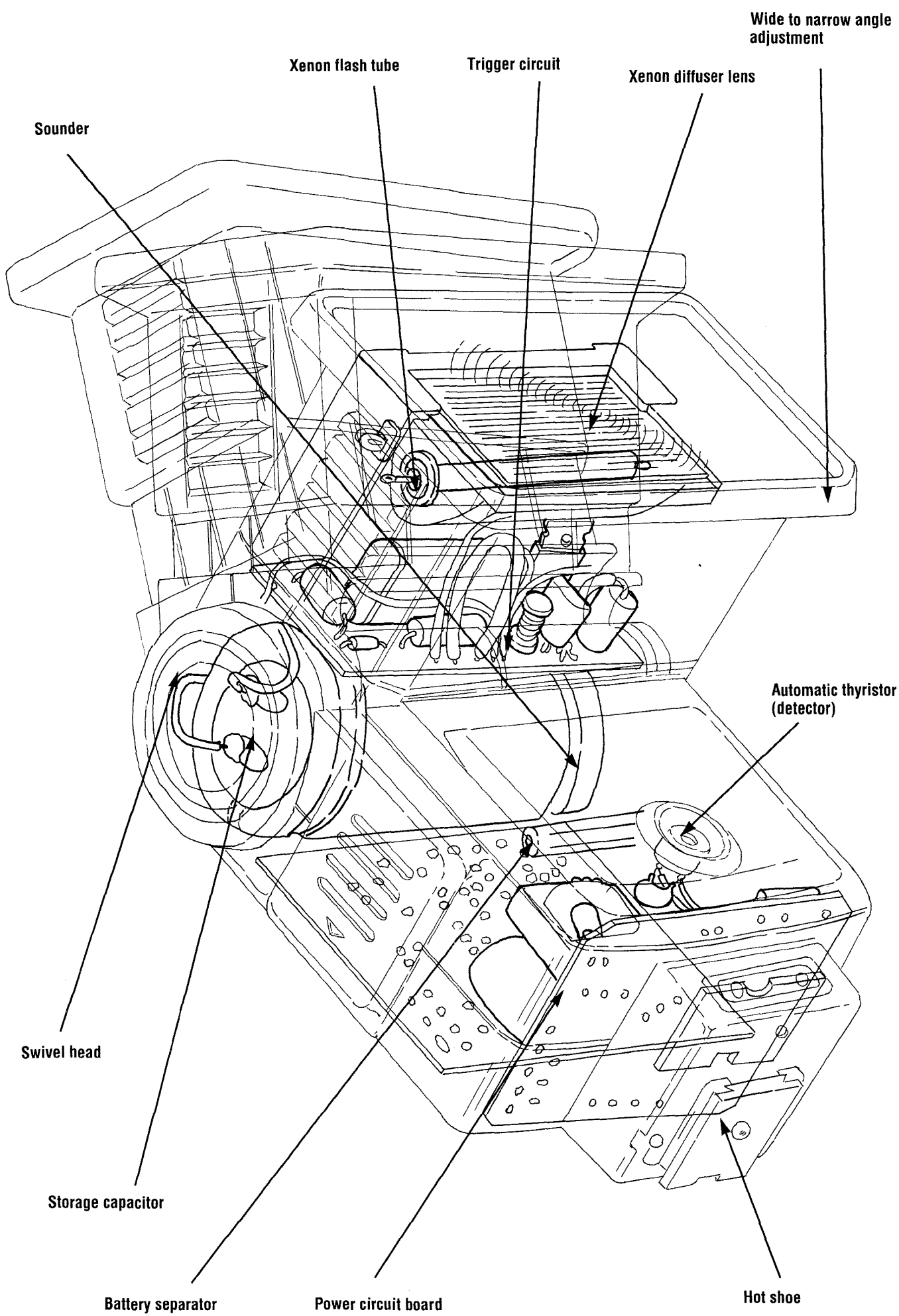

The Pollution Free Power Source

Alan Breck describes a development in fuel cells by a US company that is leading the way to environmentally friendly cars.

Since its invention, the automobile has done more to promote human freedom than almost any other machine. With it, people can go wherever they like, whenever they like, in relative comfort and safety. Unfortunately, like all good things there is a drawback. The internal combustion engine used as the main power source emits a whole range of smelly and dangerous gases and chemicals that not only pollute the local environment, but also the atmosphere and the world as a whole. It is noisy and relatively inefficient – it converts only about 25% of the available energy in petrol or diesel into useable power. The problems it causes are now becoming so bad that many governments are beginning to take seriously legislation to curb its use. The solution to the problem is to change the main power source from the mechanically complex internal

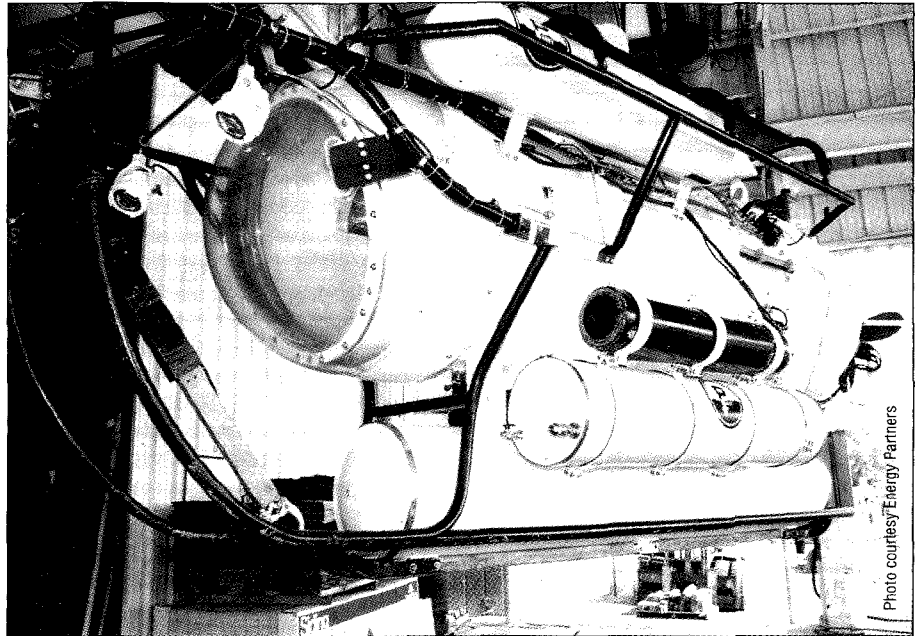

Fig. 1. A fuel cell system installed on the PC14 submersible.

combustion engine to something simpler, quieter and more efficient.

A prime candidate is the fuel cell. This uses plain hydrogen and

oxygen as its fuels and produces heat, electricity and pure water. The technology has been around for at least 25 years – it was used in the Apollo space program – but, until recently has not been compact and efficient enough to be taken seriously.

A recent development by the US firm, Energy Partners, could see a change to the current way of thinking and make electric cars commonplace.

What Is The Trick?

Compared to the 25% efficiency of an internal combustion engine, fuel cells operate at around 60%. The by-products of the reaction that produces electricity are absolutely pure water and heat. The process is completely silent and uses a process known as cold oxidation.

Internal combustion engines are

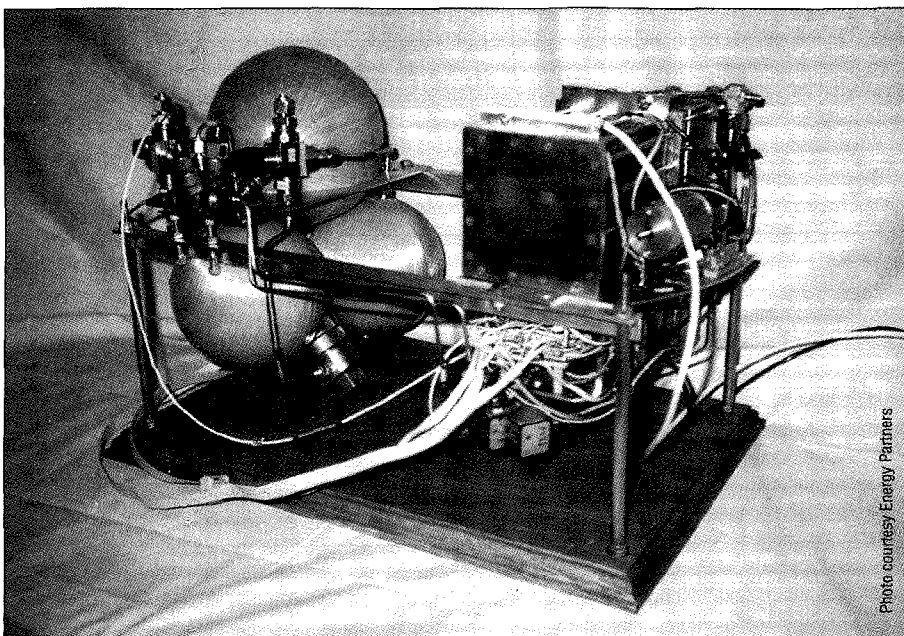

Prototype fuel cell.

limited by the Carnot cycle, a theorem developed by N Carnot in 1824.

The efficiency of a heat engine working at maximum thermal efficiency depends upon the temperatures at which it accepts and discards heat.

This is the basis for the second law of thermodynamics which, basically, says that "there ain't no such thing as a free lunch" and you don't get something for nothing – perpetual motions machines are impossible. The efficiency of a heat engine such as the internal combustion engine is defined as $(T1-T2)/T2$ where T1 and T2 are the temperatures of the heat source – the incoming heat – and the heat sink – the out going heat. Since these are set by the fuel and the surrounding air temperature there is an inherent limitation in the efficiency. Fuel cells, on the other hand, do not depend on the Carnot cycle and offer a much higher efficiency.

How It Works

A fuel cell operates in a similar way to a battery. A chemical reaction causes electrons to flow between two electrodes, allowing a current to be drawn off. Unlike a battery, however, a fuel cell does not need

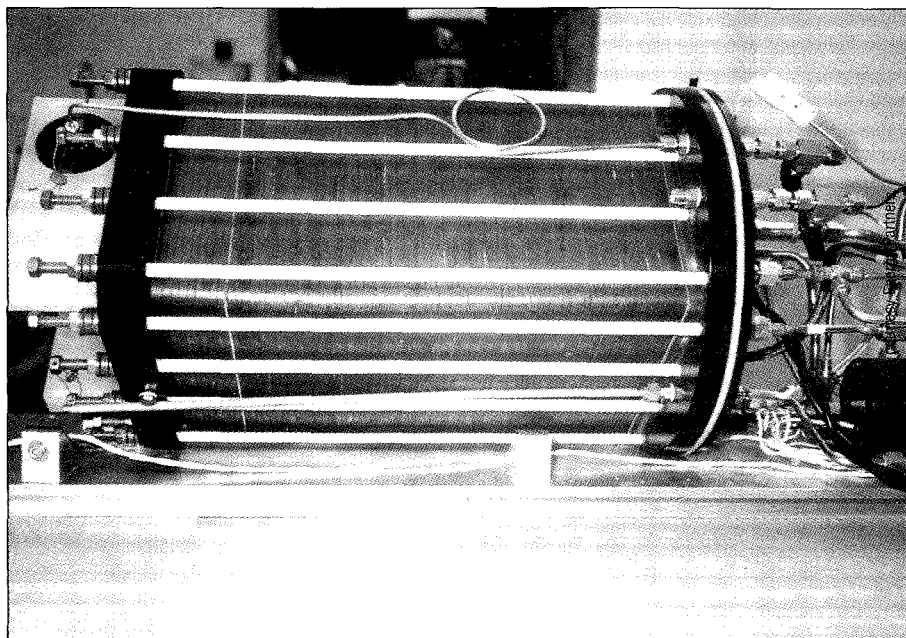

Fig. 2. The fuel cell stack.

recharging. It consumes chemical fuels in a process that frees electrons at the anode (the positive terminal) and creates a demand for them at the cathode (the negative terminal). This potential current flow can be tapped to produce useable electric power.

The most common fuels used in fuel cells are hydrogen and oxygen. They have a number of advantages, the most obvious being that 21% of the Earth's atmosphere is oxygen which can be extracted and used

relatively easily. Hydrogen, although abundant in the Universe (it is made up from 90% hydrogen atoms), does not exist in quantity in the atmosphere. However, it has a variety of uses and is made industrially in large quantities. Its major drawback is that it is very flammable and when mixed in the right quantities with oxygen, is highly explosive. However, there are now a number of solutions to this problem and a tank of hydrogen is no more dangerous than a tank of petrol – this is also highly explosive when mixed in the correct quantities with oxygen.

A number of different techniques can be used to build practical fuel cells. Some of these are available commercially while others are still experimental (see table 1). The system used by Energy Partners is a Proton Exchange Membrane Fuel Cell or PEMFC that uses pure hydrogen as the fuel and pure oxygen as the oxidant. The individual cells are grouped into a stack (Fig 2) to give a long service life and a large amount of power in a relatively small volume.

There are two basic versions of the PEMFC stack. The first is an open loop (Fig. 3.) where an excess of fuel and oxidant gases are delivered to the stack. The molecules not used up in the reaction are able to carry away the water generated by the reaction and are vented to the surrounding area. Before the gases are allowed to enter the fuel cell membranes, they pass through a series of humidifiers so that they

Fig. 3. Open loop fuel cell system.

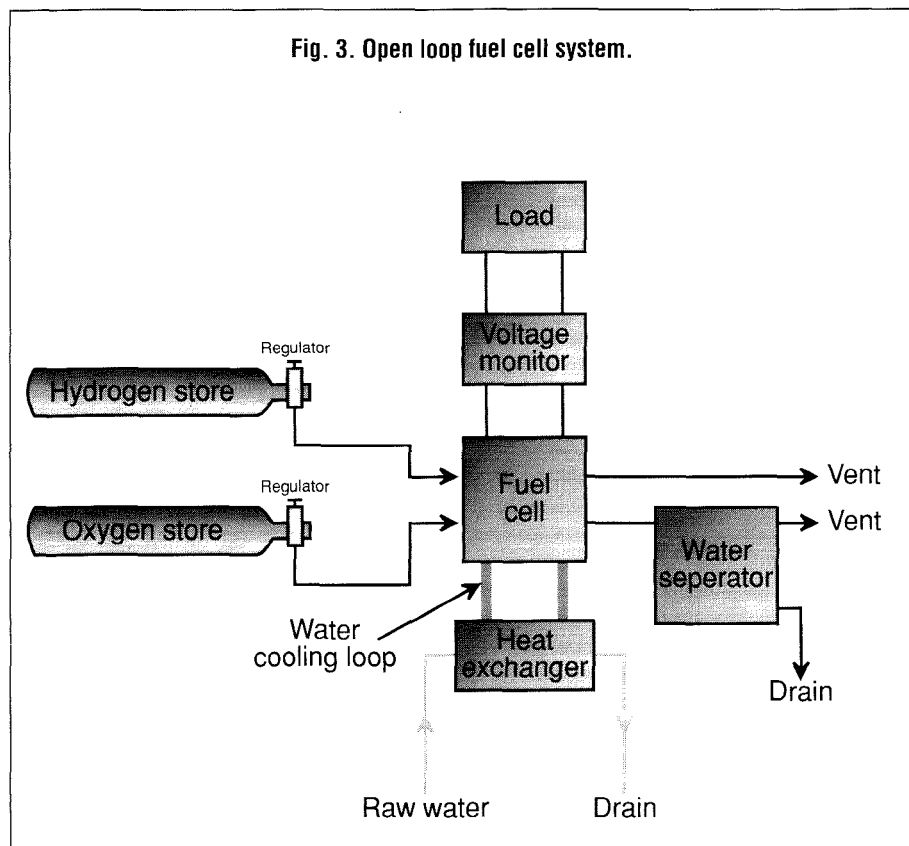

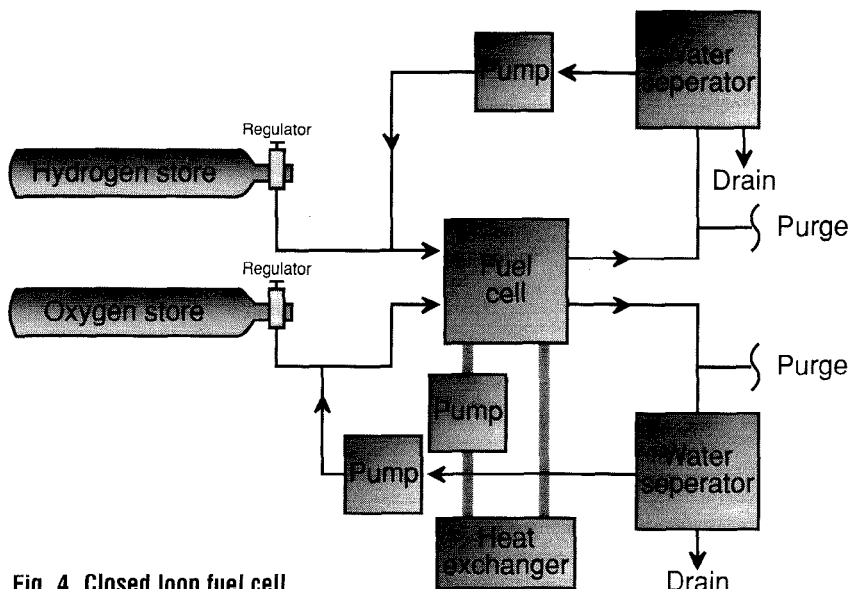

Fig. 4. Closed loop fuel cell.

become saturated with de-ionised water and stop the membrane assemblies from dehydrating. After flowing through the stack where electricity, in the form of direct current, and water are produced, the oxygen stream passes through a system to remove the water before it is vented. The hydrogen side of the reaction tends not to generate

very much water (see **The Chemical Reaction**). The heat is removed via a heat exchanger which passes it to the de-ionised water, a system linked to the humidifiers.

Because an excess of gas is used to carry away the generated water, the open loop system is somewhat wasteful. Energy Partners latest

system is a closed loop (Fig. 4.) which feeds the gasses back to be used again. This allows the cell to be used for prolonged periods without re-fueling and improves the efficiency. The drawback is that extra equipment is needed to recirculate the gases and remove the water from them. This adds to the load in the cell but with the right choice of pumps and good design, these extras can be kept to a minimum.

Areas Of Use

As well as being used as a power source for a car, the fuel cell is ideal for other transportation systems. An example of this is the test performed on a two man submersible – the PC14. This used a closed loop fuel cell offering 3.5kW of power (5kW peak) as a replacement for the standard battery system.

Strapped onto the outside of the submarine (Fig. 1), the two tanks and the fuel cell unit had an air weight of 750lb and were neutrally buoyant in the water. The existing battery system which was removed for the tests weighed in at 1850lb

The Chemical Reaction

One way to build a fuel cell is to use a hot alkaline electrolyte such as potassium hydroxide and bi-porous sintered nickel electrodes. At the hydrogen electrode (the cathode), hydrogen reacts with hydroxyl ions to give water and electrons:

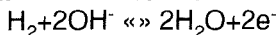

At the oxygen end of the system, the oxygen reacts with water removing electrons from the electrode (the anode), producing hydroxyl ions.

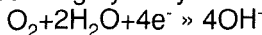

The reaction requires a catalyst such as platinum or nickel which is used to form the electrodes. These are porous to the gases allowing them to enter the electrolyte and react but keep the liquid in the centre compartment.

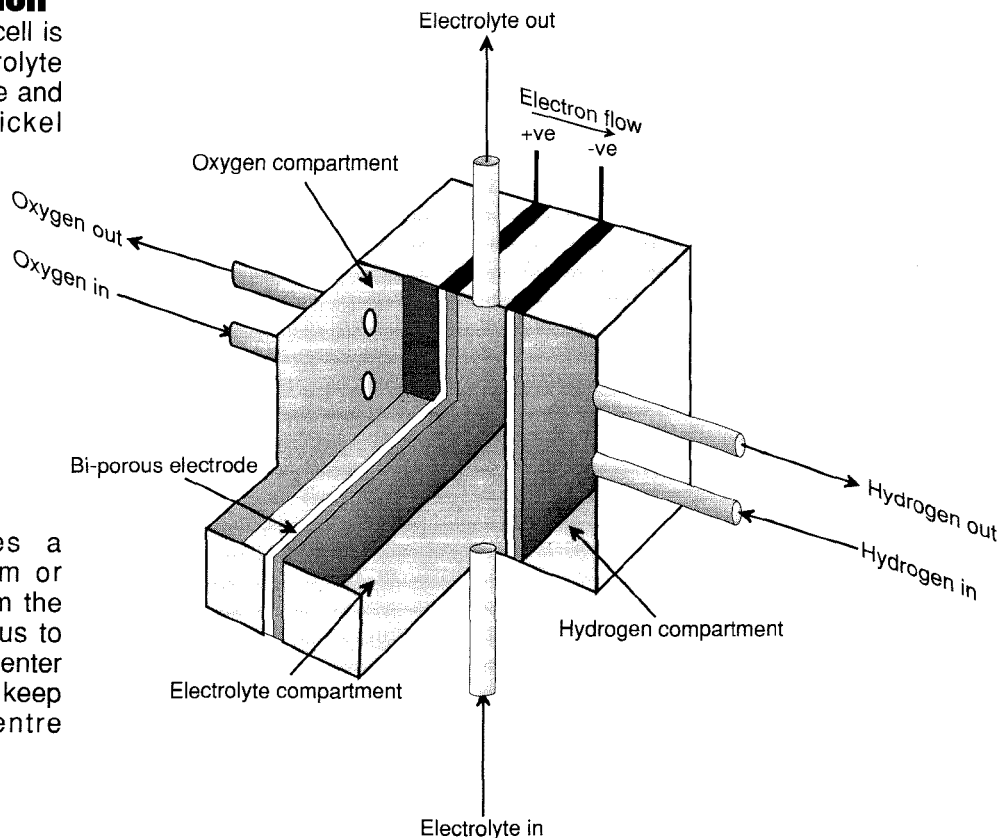

and had a negative buoyancy weight of 400lb. The fuel cell system was also some 66% smaller than the volume of the submersible's standard battery pod. An extra advantage was that replacing empty gas cylinders took around 30 minutes. Recharging the battery system required between eight and twelve hours.

When used in a car, the fuel cell system would be even lighter since the oxygen would be drawn from the atmosphere leaving only the hydrogen fuel tank and membrane stack to add weight. Compared to an equivalent battery system, the power to weight ratio is significantly better. Whether the green car will be a success depends upon a number of factors. At the moment it is still cheaper to manufacture internal combustion engine vehicles – it is also relatively cheap to clean them up using catalytic converters, non-leaded petrol and so on. Unfortunately the petrol engine car has a limited life because it requires oil and there is only so much available – it is also rather wasteful to burn it in this fashion. In the long run, the petrol engine is doomed but changes have to take place in the short term. Only legislation can force this change and the pressure on governments will have to be pretty serious to make this happen. By providing a cheap and workable alternative, the fuel cell should help ease the automobile into a new age. ■

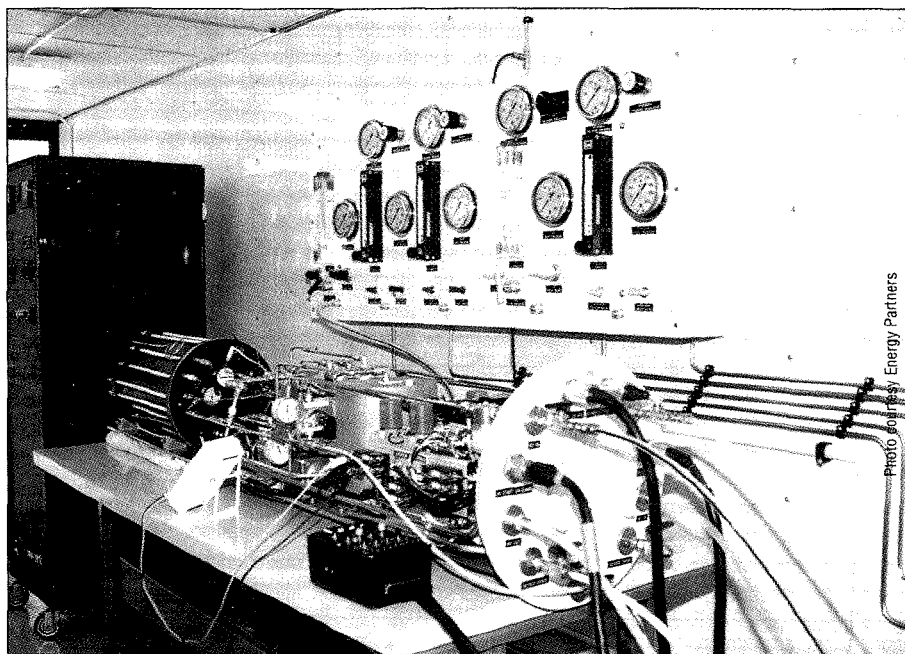

Fig. 5. The complete fuel cell system under test.

Major fuel cell types available

Alkaline fuel cell (AFC)
 Molten carbonate fuel cell (MCFC)
 Phosphoric acid fuel cell (PAFC)
 Proton exchange membrane fuel cell (PEMFC)
 Solid oxide fuel cell (SOFC)

The aspects of importance in a fuel cell design

Exhaust products

Most fuel cells produce water and heat only. Other emissions are of importance where possible pollution is a problem.

Method of load following

The amount of power required by a system will generally increase or decrease – say when a car starts to go uphill – and the amount of power that the fuel cell can provide must follow this as closely as possible.

Operating temperature and pressure

The ability to operate under extreme conditions is an obvious advantage.

Preferred fuel and oxidant

Readily available fuels will make fuel cells easier to use.

Preferred power level and range

Sustaining a particular voltage output over a long period of time as well as providing a wide range of power capabilities is also important.

Required support systems

Portable fuel cell systems need to be small and compact with the minimum of parts to keep the cost down.

Response to cold starts

If a fuel cell system is to be used in a car, it must be able to start up first thing in the morning with no delays.

Response to large and rapid load changes

Taking load following to its extreme, a fuel cell should be able cope with surges in power requirement without power loss.

Tolerance to impurities

The quality of widely available fuels and oxidants necessarily means that their quality cannot be guaranteed. A good fuel cell system must be able to cope with this.

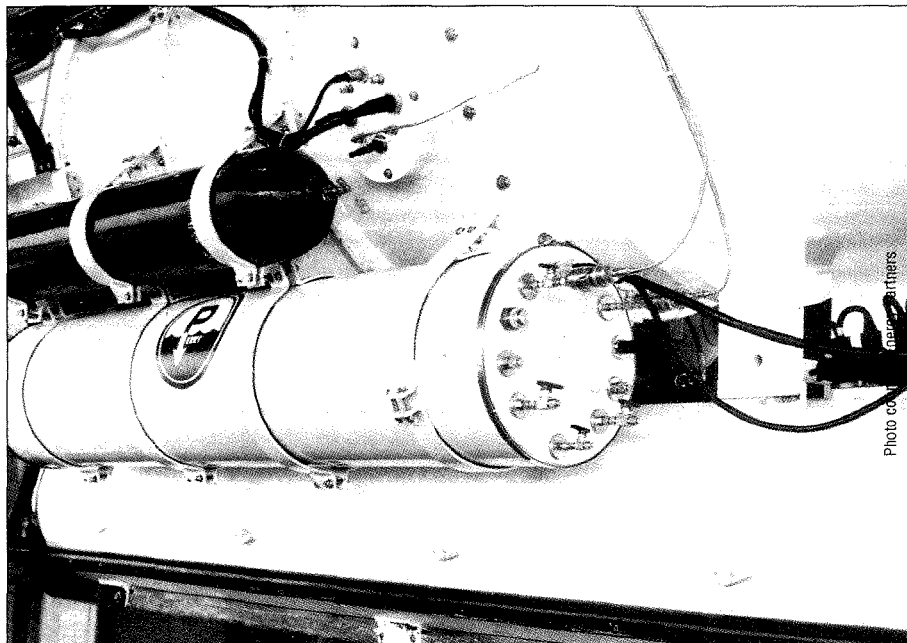

Close-up of the closed loop fuel cell power system attached to the PC 14.

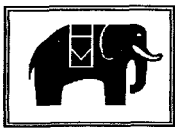

Happy Memories

Memories

4164	100ns	1.45
41256	80ns	1.65
41464	80ns	2.20
414256	80ns	3.95
411000	80ns	3.95
256 x 9 SIMM	80ns	11.50
256 x 9 SIPP	80ns	12.00
1Meg x 9 SIMM	80ns	32.50
1Meg x 9 SIPP	80ns	34.50
4Meg x 9 SIMM	80ns	126.50
36 bit SIMMs and Laser memory in stock as well		
6264	100ns LP	1.95
62256	100ns LP	2.95
2764	250ns	1.85
27128	250ns	2.25
27256	250ns	2.45
27C256	250ns	2.45
27512	250ns	3.45
27C512	250ns	3.75

Motherboards

80286 12MHz	Up to 4Mb RAM
80286 16MHz	
80286 20MHz	
80386SX 20MHz	Up to 8Mb RAM
80386DX 25MHz	Up to 16Mb RAM
80386DX 33Mhz	128K Cache

Diskdrives

5¼" 1.2Mb Floppy	£47	3½" 1.44Mb Floppy	£44
40Mb 25Ms IDE 3½"	£144	90Mb 19Ms IDE 3½"	£225
105Mb 19Ms IDE 3½"	£254	180Mb 19Ms IDE 3½"	£399
IDE Controller for 16 bit bus.	2 x FDD & 2 x HDD		£18
Ditto with 2 Serial, Par & games ports on board			£29

Video

Mono/Parallel Printer card.	Hercules compatible.	£12.95
VGA card, 16 bit 256K RAM, upto 800 x 600 resolution		£29.95
VGA card, 16 bit 512K RAM, upto 1024 x 768		£59.50
VGA card, 16 bit 1Meg RAM, 1024 x 768 in 256 colours		£79.50
TTL Paper white 14" tilt & swivel monitor		£84.50
VGA Paper white 14" tilt & swivel 1yr on site warranty		£97.50
Panasonic VGA col 1024 x 768 14" 2yr on site warranty		£275

Miscellaneous

120Mb internal tape streamer (uses floppy controller)	£215
102 Key Enhanced Keyboards	£29.50
MS compatible Serial Mouse, 9/25 adaptor, software	£13.95
16bit NE2000 compatible Ethernet card	£89.50
2 Serial, Parallel & Games port card	£12.95

Cases

£59	Fliptop 4 drive capacity	£75
£77	Desktop, LED speed display	
£95	with 5 drive capacity	£87.50
£180	Floor-standing tower with 7 drive capacity	£169
£295	All cases include 200W power supply and fittings	Others available.
£425		

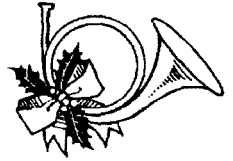

Now the puff's gone out of Xmas have a Happy New Year with some gifts for yourself!



Carriage on Motherboards, Floppy drives & Keyboards £5, Mouse & Controller cards £3, Cases, Hard disks & monitors £10, IC's free if over £20 nett, otherwise add 75p. VAT to be added to the total. Full list of other IC's and computer parts on request.

Send orders to: HAPPY MEMORIES, FREEPOST, KINGTON, HEREFORDSHIRE HR5 3BR

TEL: (054 422) 618 FAX: (054 422) 628

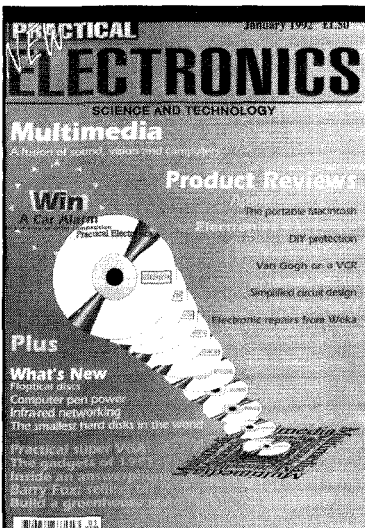

Missing a Practical Electronics back issue?

Don't despair!

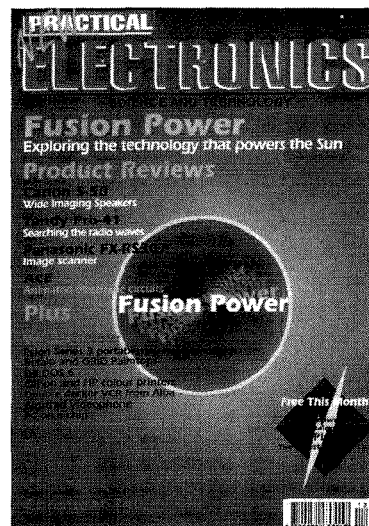

Back copies of Practical Electronics are available by post from PE Back Issues, Intra Press, Intra House, 193 Uxbridge Road, London W12 9RA. Write enclosing your requirements and a cheque or postal order payable to Intra Press. All back issues cost £2 each, including postage and packing. If the issue you require is not available, individual articles can be reprinted at a cost of £2 each.

Orders for more than £5 can be accepted by phone with Access or Visa cards on 081 743 8888.



Screen play
Modem madness
Radio rules
CAD for real
How it works
Data sheet
New tech roundup

Rescue Drama In Orbit

John Brook relates how one of the European Space Agency's satellites was brought back into action after going missing, presumed dead.

On the 12th July 1989, an Ariane-3 launch vehicle rose into the sky above the island of Kourou in French Guiana. On top of it was Europe's largest telecommunications satellite, Olympus. Destined to provide two direct broadcast television (DBTV) channels plus a number of specialised communications systems, Olympus was the world's largest three-axis stabilised telecommunications satellite and for almost two years it performed its duties, including broadcasting the BBC to the gulf forces, almost without a hitch.

The two main problems that had cropped up with the satellite were with the infra-red (IR) imaging sensors used to orient the satellite towards Earth and the solar arrays used to provide power, one of which had stopped working altogether.

Disaster Strikes

On the morning of 29th May 1991 the faulty IR system lost its lock on Earth and the on-board control systems forced the satellite into the safety mode of European Sun acquisition. This orientated one of Olympus' axes to the Sun – the most easily found object in the solar system – and transferred operation to an emergency communications mode awaiting new commands from the ground station.

Unfortunately, the standard recovery procedure did not have the desired effect and by nine o'clock that morning it was clear that something had gone drastically wrong. The satellite was completely out of control and not responding to ground based commands. Something had caused Olympus to start tumbling and move out of its orbit. The on-board power systems had become discharged and only a

variable voltage was available to the on-board computers and control systems. To all intents and purposes, Olympus was beyond recovery and 600 million ECU plus a great deal of manpower looked as though it had been totally wasted. To get a replacement satellite into orbit would cost a further 200 million ECU and take at least two years.

Decision Time

On 3rd June, the Director General of ESA, Jean-Marie Luton put together a team of engineers headed by David Wilkins, head of satellite operations at ESOC who had previous experience on 10 Gemini and 7 Apollo missions, and instructed them to try to recover Olympus. At the same time, he set up a board of inquiry to look into the cause of the incident and make recommendations to prevent

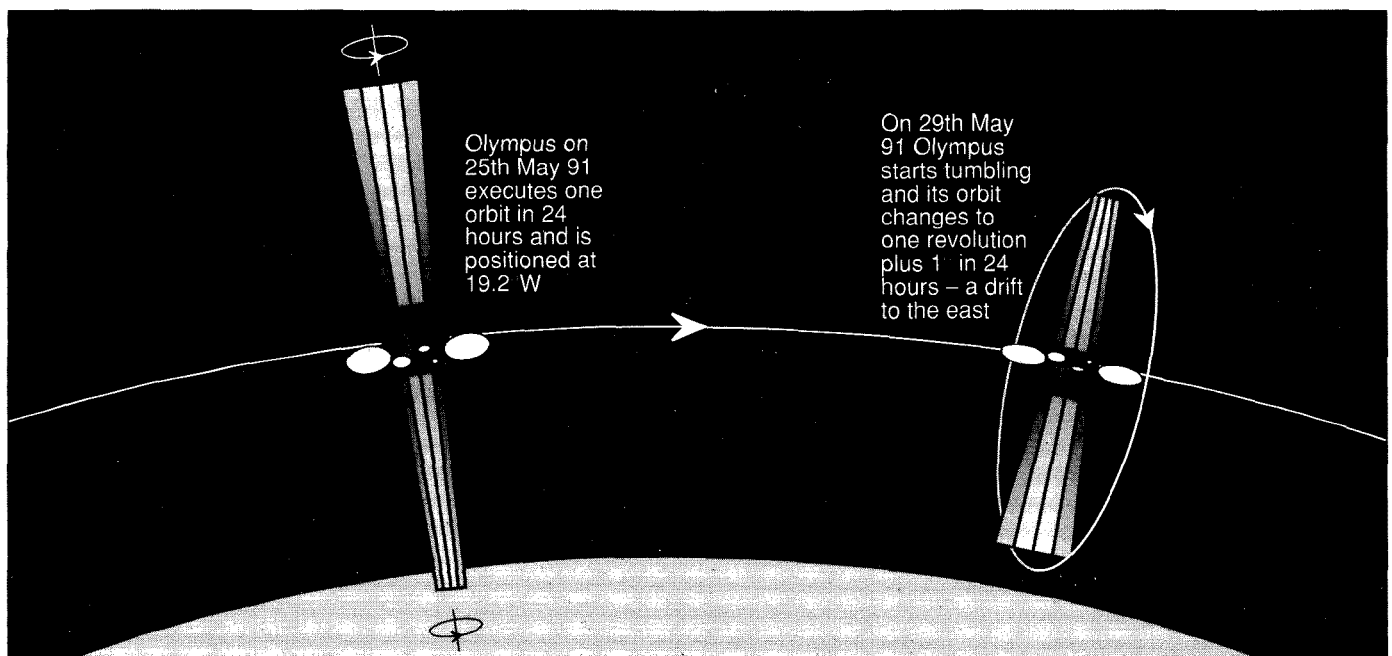

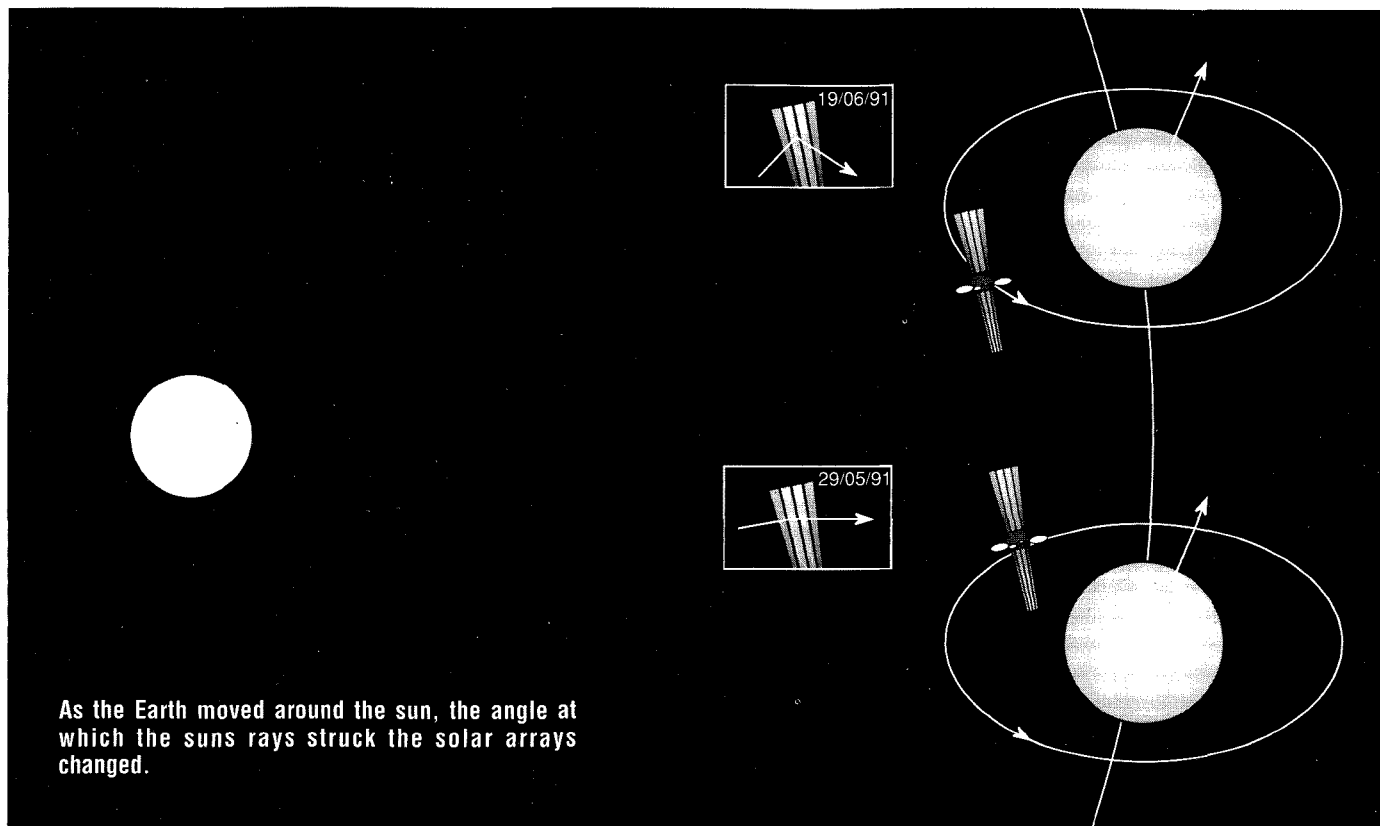

similar problems occurring in the future.

During the next ten days, a plan of action was pieced together by the ESA team and the main contractor for Olympus, British Aerospace. After deciding what could have happened to cause the loss of control, a detailed plan of action was set up to recover it.

Meanwhile In Orbit

After going into its Sun acquisition mode, Olympus received a number of commands from ground control that eventually resulted in it spinning out of its orbit. During the first few days of June, it was rotating once every 90 seconds or so and the solar array was pointing away from the sun where it had no hope of getting any power. In addition to this it was drifting eastwards at about five degrees a day. To add to its troubles, the lack of power meant that the internal heating control systems had shut down and the temperature inside the craft had dropped to around -50 to -60 Celsius.

The only hopeful sign was that the rotation would cause sunlight to illuminate the one working solar array for a few seconds every turn. This allowed sporadic bursts of telemetry to be emitted from the antenna which could be picked up

by ground stations. These were eventually pieced together by the recovery team and gave them some idea of what conditions were like on-board the spinning satellite.

The Plan

The only way in which Olympus could be recovered was if commands could be sent to its control systems to stop it from spinning and aim its on-board

Making It Pay

Olympus carries four separate communications payloads. These are devoted to direct broadcast TV, pan-european business communications and a radio research package.

The systems are split into four main areas, the first of which is used to provide two television channels. One is jointly used by the BBC and Eurostep, an association formed to promote educational TV, offering up to nine hours of programming every day. The BBC uses the channel during the evening to broadcast to Europe.

The second TV channel is used by the Italian company RAI for use in experimental broadcasts including high definition television (HDTV). Both channels are very high power and 30cm receiving dishes are all that are required to receive them throughout central Europe.

The second main payload is a specialised communications

package offering services in the 12 to 14 GHz band. A large number of groups can use the five narrow spot beams and four transmitters giving satellite access to a wide range of people from universities to private companies.

The third payload uses a very small aperture antenna (VSAT) system in the 20 to 30GHz frequency range offering two steerable spot beams. Earth stations need only have dishes of around one metre diameter to both send and receive data to and from the satellite and, hence, to anywhere in Europe and even North America. So far, this system has been used for video-conferencing and mini-computer link-ups.

The final payload is being used to do research into the propagation of radio waves in the 20 to 30GHz band. The results from this should allow future satellite systems to make even better use of this frequency range.

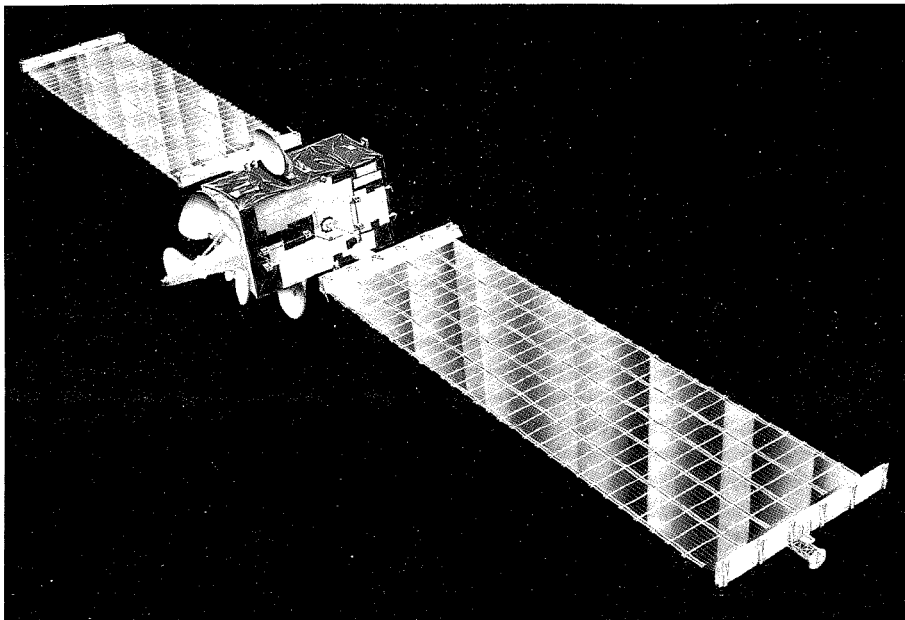

Artists impression of Olympus in orbit.

antenna at Earth. Unfortunately, this required action from the propulsion systems and at -50 Celsius, the fuel and pipelines were frozen solid. To enable the on-board heaters to thaw the system out, power was needed and this could only be obtained from one source, the Sun.

Because the satellite was spinning on its axis, sunlight only fell on the solar array for a few seconds at a time. To begin with, this did not raise the power levels sufficiently to send any control commands at all. However, as the Earth rotated around the Sun, the angle at which the sunlight struck the panels decreased and the power levels available on each turn increased. This allowed the recovery team to start sending commands to shut down all non-essential systems. Eventually, as much power as possible from the solar array was diverted to the batteries and their heaters, allowing them to be charged.

Once enough energy was available, the solar array was tilted more towards the sun and the battery charge increased allowing more heaters to be turned on. By 8th July, the batteries were showing full charge and the next phase of the recovery was undertaken. Due to the very low temperatures experienced by the fuel and propellant system, warming had to be done slowly and carefully – like water pipes frozen in winter, quick thawing could cause the fuel system to burst, ruining the whole operation. By 26th July, no pipes

appeared to have broken and the thawing proved to be so successful that the thrusters were fired. This allowed the rotation of the satellite to be stopped and its antenna pointed stably at the ground station. When full control had been achieved Olympus was finally manoeuvred back onto its station, 19.2 degrees West, on 13th August. The final phase of the recovery involved re-initialising all of the payloads and getting them back up to fully operational status.

Final Report

Two months after it had been set up, the inquiry found that the causes of Olympus' loss of control had been due to a number of factors, both human and mechanical. The direct cause was the use of an incompletely tested operating procedure. In addition to this, when the satellite had entered Sun acquisition mode, the commands sent to revive it had been incorrect and one had been missed out completely. The inquiry also concluded that the loss of one solar array and the malfunctioning of the IR Earth sensor had contributed to the situation. In a fully operational satellite, the new procedure would not have had to be used and the craft would have been able to reposition itself automatically.

The recovery of Olympus was due almost entirely to the team of engineers led by David Wilkins. The odds were very much against success but luck and ingenuity helped them succeed. ■

Timetable To Recovery

12th July 1989 Olympus launched into space on top of an Ariane-3 from Kourou, French Guiana

28th January 1991 Loss of operation of one of the two solar arrays.

29th May First signs of trouble as the on-board control system loses its lock on the signal controlling the satellite's orientation with respect to Earth. The satellite automatically enters emergency European Sun acquisition mode. By 9 o'clock the same day, Olympus has started tumbling and drifts out of its orbit.

3rd June The recovery team meets and plans to obtain telemetry and recharge the batteries from the solar power system. The satellite is spinning around its X axis with one revolution every 89 seconds and drifting five degrees per day eastward. Only the dual decoder is available to receive commands from the ground.

19th June An uplink is achieved from an Australian ground station in Perth. It is now possible to control some of the heating and telemetry systems.

27th June The main power voltage reaches a level whereby the battery charger and altitude control systems can be started up.

28th June Battery charging starts.

1st July The North solar array is positioned to allow more power to be channelled to the battery charger. The main power system becomes fully regulated in both sunlight and shadow

2nd July Batteries become fully charged and the positioning of the solar array is fine tuned. The heaters are slowly turned on to thaw out the propulsion system.

5th July NASA allows ESA to make use of its deep space antenna network until 20th July enabling continuous monitoring of the telemetry to be undertaken during the critical phases of the recovery.

12th July The temperature and pressure in the propulsion system is monitored as it warms up.

19th July Olympus has now thawed out to the point where the liquid propellant tanks and associated pipework are no longer frozen.

24th July Thawing continues until the propellant system is in full working order.

26th July The thrusters are tested and the spin is reduced from once every 100 seconds to once every 104 seconds.

29th July The on-board systems are now able to go into Sun acquisition mode.

31st July Earth acquisition is obtained.

2nd August The eastward drift is reduced from five to three degrees per day.

13th August Olympus is finally back on station at 19.2 degrees west.

14th August The switch-on of the 12GHz propagation package is accomplished and payload commissioning commences.

15th August The 12GHz direct broadcast television system is switch on and channel 25, the RAI channel is activated.

16th August The 20/30GHz communications payload is switched on.

23rd August All payloads in full working order.

AMSTRAD PORTABLE PC'S FROM £149 (PPC1512SD), £179 (PPC1512DD), £179 (PPC1640SD), £209 (PPC1640DD), MODEMS £30 EXTRA. NO MANUALS OR PSU.

HIGH POWER CAR SPEAKERS. Stereo pair output 100w each. 4ohm impedance and consisting of 6 1/2" woofer 2" mid range and 1" tweeter. Ideal to work with the amplifier described above. Price per pair £30.00 Order ref 30P7R.

2KV 500 WATT TRANSFORMERS Suitable for high voltage experiments or as a spare for a microwave oven etc. 250V AC input. £10.00 ref 10P93R

MICROWAVE CONTROL PANEL. Mains operated, with touch switches. Complete with 4 digit display, digital clock, and 2 relay outputs one for power and one for pulsed power (programmable). Ideal for all sorts of precision timer applications etc. £6.00 ref 6P18R

FIBRE OPTIC CABLE. Stranded optical fibres sheathed in black PVC. Five metre length £7.00 ref 7P29R

12V SOLAR CELL. 200mA output ideal for trickle charging etc. 300 mm square. Our price £15.00 ref 15P42R

PASSIVE INFRA-RED MOTION SENSOR. Complete with daylight sensor, adjustable lights on timer (8 secs - 15 mins), 50' range with a 90 deg coverage. Manual override facility. Complete with wall brackets, bulb holders etc. Brand new and guaranteed. £25.00 ref 25P24R.

Pack of two PAR38 bulbs for above unit £12.00 ref 12P43R

VIDEO SENDER UNIT Transmit both audio and video signals from either a video camera, video recorder or computer to any standard TV set within a 100' range! (tune TV to a spare channel). 12V DC op. £15.00 ref 15P39R Suitable mains adaptor £5.00 ref 5P19R

FM TRANSMITTER housed in a standard working 13A adapter (bug in mains driven). £26.00 ref 26P2R

MINIATURE RADIO TRANSCEIVERS A pair of walkie talkies with a range of up to 2 kilometres. Units measure 22x52x155mm. Complete with cases. £30.00 ref 30P12R

FM CORDLESS MICROPHONE. Small hand held unit with a 500' range! 2 transmit power levels reqs PP3 battery. Tuneable to any FM receiver. Our price £15 ref 15P42AR

12 BAND COMMUNICATIONS RECEIVER. 9 short bands. FM, AM and LW/DX/local switch, tuning 'eye' mains or battery. Complete with shoulder strap and mains lead. **NOW ONLY £19.00!! REF 19P14R.**

WHISPER 2000 LISTENING AID. Enables you to hear sounds that would otherwise be inaudible! Complete with headphones. Cased. £5.00 ref 5P170R.

CAR STEREO AND FM RADIO. Low cost stereo system giving 5 watts per channel. Signal to noise ratio better than 45db, wow and flutter less than .35%. Neg earth. £25.00 ref 25P21R.

LOW COST WALKIE TALKIES. Pair of battery operated units with a range of about 200'. Our price £8.00 a pair ref 8P50R

7 CHANNEL GRAPHIC EQUALIZER plus a 60 watt power amp! 20-21KHZ 4-8R 12-14V DC negative earth. Cased. £25 ref 25P14R.

NICAD BATTERIES. Brand new top quality. 4 x AA's £4.00 ref 4P44R. 2 x C's £4.00 ref 4P73R. 4 x D's £9.00 ref 9P12R. 1 x PP3 £6.00 ref 6P35R

TOWERS INTERNATIONAL TRANSISTOR SELECTOR GUIDE. The ultimate equivalents book. Latest edition £20.00 ref 20P32R.

CABLE TIES. 142mm x 3.2mm white nylon pack of 100 £3.00 ref 3P104R. Bumper pack of 1,000 ties £14.00 ref 14P6R

1992 CATALOGUE AVAILABLE NOW
IF YOU DO NOT HAVE A COPY PLEASE REQUEST ONE
WHEN ORDERING OR SEND US A 5"X9" SAE FOR A FREE COPY.

GEIGER COUNTER KIT. Complete with tube, PCB and all components to build a battery operated geiger counter. £39.00 ref 39P1R

FM BUG KIT. New design with PCB embedded coil. Transmits to any FM radio. 9v battery req'd. £5.00 ref 5P158R

FM BUG Built and tested superior 9v operation £14.00 ref 14P3R

COMPOSITE VIDEO KITS. These convert composite video into separate H sync, V sync and video. 12V DC. £8.00 ref 8P39R.

SINCLAIR C5 MOTORS 12v 29A (full load) 3300 rpm 6"X4" 1/4" O/P shaft. New. £20.00 ref 20P22R.

As above but with fitted 4 to 1 inline reduction box (800rpm) and toothed nylon belt drive cog £40.00 ref 40P8R.

SINCLAIR C5 WHEELS 13" or 16" dia including treaded tyre and inner tube. Wheels are black, spoked one piece poly carbonate. 13" wheel £6.00 ref 6P20R. 16" wheel £6.00 ref 6P21R.

ELECTRONIC SPEED CONTROL KIT for c5 motor. PCB and all components to build a speed controller (0-95% of speed). Uses pulse width modulation. £17.00 ref 17P3R.

SOLAR POWERED NICAD CHARGER. Charges 4 AA nicads in 8 hours. Brand new and cased £6.00 ref 6P3R.

12 VOLT BRUSHLESS FAN 1/2" square brand new ideal for boat, car, caravan etc. £5.00 ref 5P206.

ACORN DATA RECORDER ALF503 Made for BBC computer but suitable for others. Includes mains adaptor, leads and book. £15.00 ref 15P43R

VIDEO TAPES. Three hour superior quality tapes made under licence from the famous JVC company. Pack of 10 tapes £20.00 ref 20P20R.

PHILIPS LASER. 2MW HELIUM NEON LASER TUBE. BRAND NEW FULL SPEC £40.00 REF 40P10R. MAINS POWER SUPPLY KIT £20.00 REF 20P33R READY BUILT AND TESTED LASER IN ONE CASE £75.00 REF 75P4R.

6V 10AH LEAD ACID sealed battery by yuasha ex equipment but in excellent condition now only 2 for £10.00 ref 10P95R.

12 TO 220V INVERTER KIT As supplied it will handle up to about 15 w at 220v but with a larger transformer it will handle 80 watts. Basic kit £12.00 ref 12P17R. Larger transformer £12.00 ref 12P41R.

VERO EASI WIRE PROTOTYPING SYSTEM ideal for designing projects on etc. Complete with tools, wire and reusable board. Our price £6.00 ref 6P33R.

MICROWAVE TURNTABLE MOTORS. Ideal for window displays etc. £5.00 ref 5P165R.

STC SWITCHED MODE POWER SUPPLY 220v or 110v input giving 5v at 2A, +24v at 0.25A, +12v at 0.15A and +9v at 0.4A. £6.00 ref 6P59R

HIGH RESOLUTION 12" AMBER MONITOR 2v 1.5A Hercules compatible (TTL input) new and cased £22.00 ref 22P2R

VGA PAPER WHITE MONO monitors new and cased 240v AC. £59.00 ref 59P4R

25 WATT STEREO AMPLIFIER. c. STK043. With the addition of a handful of components you can build a 25 watt amplifier. £4.00 ref 4P69R (Circuit dia included).

LINEAR POWER SUPPLY. Brand new 220v input +5 at 3A, +12 at 1A, -12 at 1A. Short circuit protected. £12.00 ref 12P21R.

MINI RADIO MODULE Only 2" square with ferrite aerial and tuner. Superhet. Req's PP3 battery. £1.00 ref BD716R.

BARGAIN NICADS AAA SIZE 200MAH 1.2V PACK OF 10 £4.00 REF 4P92R, PACK OF 100 £30.00 REF 30P16R

FRESNEL MAGNIFYING LENS 83 x 52mm £1.00 ref BD827R.

ALARM TRANSMITTERS. No data available but nicely made complex transmitters 9v operation. £4.00 each ref 4P81R.

UNIVERSAL BATTERY CHARGER. Takes AA's, C's, D's and PP3 nicads. Holds up to 5 batteries at once. New and cased, mains operated. £6.00 ref 6P36R.

COLOUR MONITORS

AMSTRAD CTM644

RGB INPUT

£75.00 REF A75P1

RESISTOR PACK. 10 x 50 values (500 resistors) all 1/4 watt 2% metal film. £5.00 ref 5P170R.

CAPACITOR PACK 1. 100 assorted non electrolytic capacitors £2.00 ref 2P286R.

CAPACITOR PACK 2. 40 assorted electrolytic capacitors £2.00 ref 2P287R.

QUICK CUPPA? 12v immersion heater with lead and cigar lighter plug £3.00 ref 3P92R.

LED PACK. 50 red leds, 50 green leds and 50 yellow leds all 5mm £8.00 ref 8P52R

FERRARI TESTAROSSA. A true 2 channel radio controlled car with forward, reverse, 2 gears plus turbo. Working headlights. £22.00 ref 22P6R.

MIRACOM WS4000 MODEMS

V21/23

AT COMAND SET

AUTODIAL/AUTOANSWER

FULL SOFTWARE CONTROL

tone AND PULSE DIALLING

£29

PIR LIGHT SWITCH Replaces a standard light switch in seconds light operates when anybody comes within detection range (4m) and stays on for an adjustable time (15 secs to 15 mins). Complete with daylight sensor. Unit also functions as a dimmer switch! 200 watt max. Not suitable for fluorescents. £14.00 ref 14P10R

CUSTOMER RETURNED 2 channel full function radio controlled cars only £8.00 ref 8P200R

WINDUP SOLAR POWERED RADIO! FM/AM radio takes rechargeable batteries complete with hand charger and solar panel 14P200R

240 WATT RMS AMP KIT Stereo 30-0-30 psu required £40.00 ref 40P200R

300 WATT RMS MONO AMP KIT £55.00 Psu required ref 55P200

ALARM PIR SENSORS Standard 12v alarm type sensor will interface to most alarm panels. £16.00 ref 16P200

ALARM PANELS 2 zone cased keypad entry, entry exit time delay etc. £18.00 ref 18P200

MODEMS FOR THREE POUNDS!! Fully cased UK modems designed for dial up system (PSTN) no data or info but only £3.00 ref 3P145R

TELEPHONE HANDSETS Bargain pack of 10 brand new handsets with mic and speaker only £3.00 ref 3P146R

BARGAIN STRIPPERS Computer keyboards. Loads of switches and components excellent value at £1.00 ref CD40R

PC POWER SUPPLIES These units are new but need attention complete with case, fan IEC

BULL ELECTRICAL
250 PORTLAND ROAD HOVE SUSSEX
BN3 5QT TELEPHONE 0273 203500
MAIL ORDER TERMS: CASH PO OR CHEQUE
WITH ORDER PLUS £2.50 POST PLUS VAT.
PLEASE ALLOW 7 - 10 DAYS FOR DELIVERY

NEXT DAY DELIVERY £5.00

FAX 0273 23077



input plug disc drive and mother board fly leads. Our price is £5.00 (less than the fan alone would cost!) ref 5P208R

HIGH VOLTAGE CAPACITORS A pack of 20 500PF 10KV capacitors ideal for ionizers TV repairs and high voltage experiments etc. Price is £2.00 ref 2P378R

DATA RECORDERS Customer returned mains battery units built in mic ideal for Computer or general purpose audio use. Price is £4.00 ref 4P100R

SPECTRUM JOYSTICK INTERFACE Plugs into 48K Spectrum to provide a standard Atari type joystick port. Our price £4.00 ref 4P101R

ATARI JOYSTICKS Ok for use with the above interface, our price £4.00 ref 4P102R

BENCH POWER SUPPLIES Superbly made fully cased (metal) giving 12v at 2A plus a 6V supply. Fused and short circuit protected. For sale at less than the cost of the case! Our price is £4.00 ref 4P103R

SPEAKER WIRE Brown twin core insulated cable 100 feet for £2.00 REF 2P79R

MAINS FANS Brand new 5" x 3" complete with mounting plate quite powerful and quite. Our price £1.00 ref CD41R

DISC DRIVES Customer returned units mixed capacities (up to 1.44M) We have not sorted these so you just get the next one on the shelf. Price is only £7.00 ref 7P1R (worth it even as a stripper)

HEX KEYBOARDS Brand new units approx 5" x 3" only £1.00 each ref CD42R

PROJECT BOX 5 1/2" x 3 1/2" x 1" black ABS with screw on lid. £1.00 ref CD43R

SCART TO SCART LEADS Bargain price leads at 2 for £3.00 ref 3P147R

SCART TO D TYPE LEADS Standard Scart on one end, Hi density D type on the other. Pack of ten leads only £7.00 ref 7P2R

OZONE FRIENDLY LATEX 250ml bottle of liquid rubber sets in 2 hours. Ideal for mounting PCB's fixing wires etc. £2.00 each ref 2P379R

QUICK SHOTS Standard Atari compatible hand controller (same as joysticks) our price is 2 for £2.00 ref 2P380R

VIEWDATA SYSTEMS Brand new units made by TANDATA complete with 1200/75 built in modem infra red remote controlled qwerty keyboard BT approved Prestel compatible, Centronics printer port RGB colour and composite output (works with ordinary television) complete with power supply and fully cased. Our price is only £20.00 ref 20P1R

3 INCH DISCS Ideal for Amstrad PCW and Spectrum +3 machines pack of 10 discs is £12.00 ref 12P1R

AC STEPDOWN CONVERTOR Cased units that convert 240v to 110v 3" x 2" with mains input lead and 2 pin American output socket (suitable for resistive loads only) our price £2.00 ref 2P381R

SPECTRUM +3 LIGHT GUN PACK complete with software and instructions £8.00 ref 8P58R

CURLY CABLE Extends from 8" to 6 feet! D connector on one end, spade connectors on the other ideal for joysticks etc (6 core) £1.00 each ref CD44R

COMPUTER JOYSTICK BARGAIN Pack of 2 joysticks only £2.00 ref 2P382R

MINI MONO AMPLIFIER PACK 4 amplifiers for £2.00! 3 watt units 9-12v operation ideal for experiments etc £2.00 ref 2P383R

BUGGING TAPE RECORDER Small hand held cassette recorders that only operate when there is sound then turn off 6 seconds after so you could leave it in a room all day and just record anything that was said. Price is £20.00 ref 20P3R

IEC MAINS LEADS Complete with 13A plug our price is only £3.00 for TWO! ref 3P148R

COMPUTER SOFTWARE BARGAIN 10 cassettes with games for commodore 64, Spectrum etc. Our bargain price one pound! ref CD44R

NEW SOLAR ENERGY KIT Contains 8 solar cells, motor, tools, fan etc plus educational booklet. Ideal for the budding enthusiast! Price is £12.00 ref 12P2R

FUSE PACK NO 1 Fifty fuses 1 1/4" long (glass) quick blow 10 popular values £2.00 ref 2P384R

FUSE PACK NO 2 Fifty fuses 20mm long (glass) quick blow 10 popular values £2.00 ref 2P385R

POTENTIOMETER PACK NO 1 30 pots for £3.00! ideal for projects etc. Ref CD45R

286 AT PC
286 MOTHER BOARD WITH 640K RAM FULL SIZE METAL CASE, TECHNICAL MANUAL, KEYBOARD AND POWER SUPPLY £139 REF 139P1 (no i/o cards or drives included)

35MM CAMERAS Customer returned units with built in flash and 1/28mm lens 2 for £8.00 ref 8P200

STEAM ENGINE Standard Mamod 1332 engine complete with boiler piston etc £30 ref 30P200

TALKING CLOCK LCD display, alarm, battery operated. Clock will announce the time at the push of a button and when the alarm is due. The alarm is switchable from voice to a cock crowing! £14.00 ref 14P200R

HANDHELD TONE DIALERS Small units that are designed to hold over the mouth piece of a telephone to send MF dialling tones. Ideal for the remote control of answer machines. £5.00 ref 5P209R

COMMODORE 64 MICRODRIVE SYSTEM Complete cased brand new drives with disc and software 10 times faster than tape machines works with any Commodore 64 setup. The original price for these was £49.00 but we can offer them to you at only £25.00! ref 25P1R

USED SCART PLUGS Pack of 10 plugs suitable for making up leads only £5.00 ref 5P209R

C CELL SOLAR CHARGER Same style as our 4 x AA charger but holds 2 C cells. Fully cased with flip top lid. Our price £6.00 Ref 6P79R

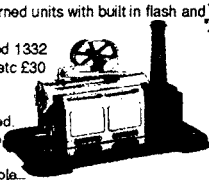

Finding The Anecdotal Evidence

Among the books this month is a probable best seller from the author of the *Hacker's Handbook* Hugo Cornwall's latest work is a hoot.

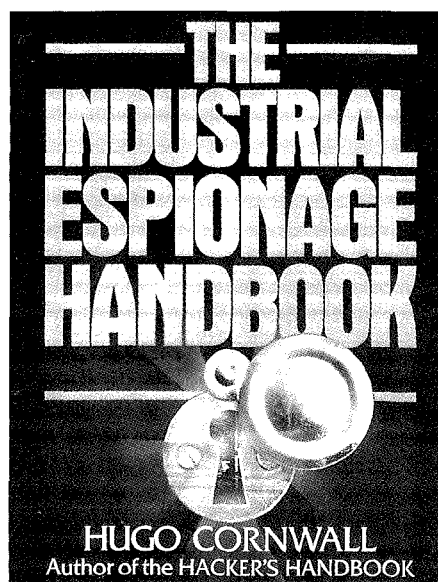

The Industrial Espionage Handbook

Hugo Cornwall
£9.99

Publisher: Random Century
ISBN 07126 3634 X

On the face of it, Industrial Espionage would appear to be a pretty dull business. Hugo Cornwall takes the basic subject matter and brings it to life with a wash of anecdotes. He covers espionage from every angle, looking at the international scene—“the Russian effort is easily the world’s most extensive and professional industrial spying operation”—and describing the basic workings of British Intelligence and also at what the amateurs get up to. There is a lot of practical advice in here too – did you know that it is cheaper for someone in the UK to search the on-line version of the FT via California than it is from London?

In the end, espionage is mainly legwork, research and more

research will probably gain more information than a little light burglary or tapping someone's video monitor – he describes how to do things like this in detail as well.

This is the perfect book for the devourer of anecdotes and popular myths. It is full to the brim with fascinating snippets of information and comes high on the list of unput-downables.

KPG

A Concise Introduction to QuarkXPress

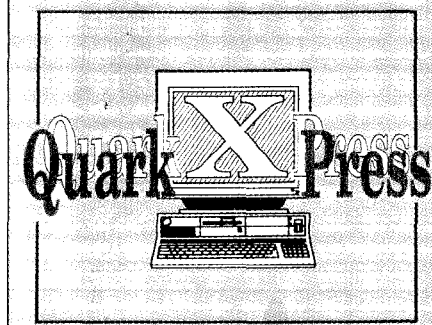

A Concise Introduction to Quark Xpress

J Glenwright
Price £4.95

Publisher Bernard Babani
ISBN: 0-85934-252-2

The best way to learn Quark Xpress is to use it; practice is much more valuable than any manual could ever be. Having said that, however, *A Concise Introduction to*

Quark Xpress patiently explains the ins and outs of this Desk-Top Publishing system in clear, easy-to-follow language. Ideally it is suited to someone already familiar with the basic functions of a Macintosh computer. Every function is explained, along with instructions for use, though at times these methods are a bit more complicated than necessary. Still, getting started is the hardest part and after incorporating this manual, the beginning DTPer should feel confident enough to fiddle around and discover what works best for him or her.

LE

Understanding PC Software

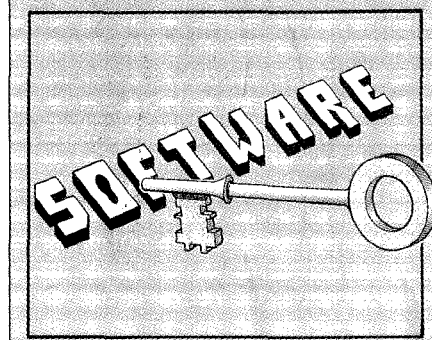

Understanding PC Software

R A Penfold

Price £4.95

Publisher Bernard Babani

ISBN: 0-85934-248-4

Quite why this book has been

published is not clear, anyone who uses a PC at work will know more than this book lets on and anyone who doesn't probably isn't interested and certainly wouldn't want to plough through this lot – they'd be better off (and much more likely to be) watching one of the many TV programs on the subject.

The author splits software into three main areas, wordprocessors (mainly WordPerfect), Graphics in the form of pixel and object orientated programs, desk top publishing and dBase IV. A few mentions are given at the end to spreadsheets, WIMPs, or GUIs as they are now known, and various utilities. It whizzes through brief descriptions of the basic concepts involved and does nothing to inspire the reader to go out and try them. The only way to learn about computers is to use them, reading descriptions of the things simply creates confusion.

PM

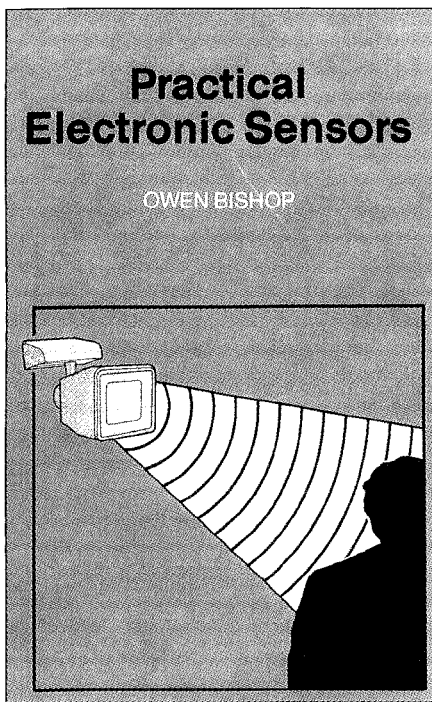

Practical Electronic Sensors

Owen Bishop
 Price £4.95
 Publisher: Babani
 ISBN 0 85934 218 2

Owen is well known for his projects, many of which have been published in PE. If you want to know about and make electrical sensors then this book is a good place to start. Radiation, thermal, sound and magnetic sensors are covered as well as devices for

humidity, pH, gas, and nuclear radiation. The projects include alarms, switches and indicators for the various measurements. If you are experienced in building electronic projects then you will have no trouble – construction details for the electronics are left to the minimum and although parts lists are given, there are no board layouts, either strip or PCB.

SB

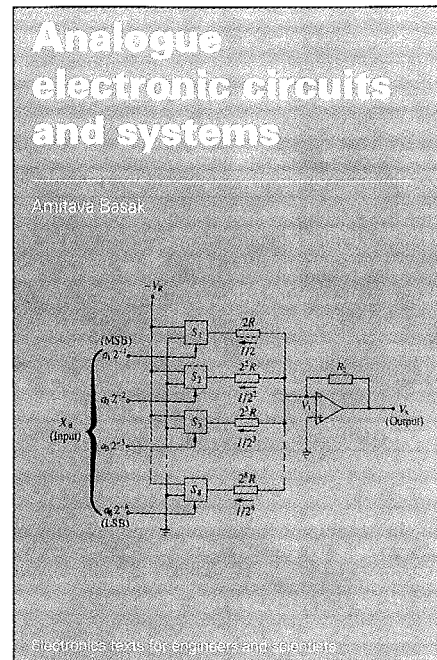

Analogue electronic circuits and systems

Amitava Basak
 Price £50 HB, £17.95 PB
 Publisher: Cambridge University Press
 ISBN 0 521 36046 3 (HB)
 ISBN 0 521 36913 4 (SB)

This is definitely a textbook for the undergraduate electronic engineer. A good solid grounding in maths is vital to understand even the first few pages.

Each chapter begins with a series of objectives that the reader should understand by the end. Starting off with multi-stage transistor circuits and their implementation in linear ICs, the book moves on through power amplifiers, operational amplifiers, some applications and then moves on to cover oscillator circuits and phase locked loops. After a quick look at modulation, the author takes a quick tour through data acquisition systems, and finishes up with computer aided design and circuit analysis.

Unfortunately, this book doesn't

introduce the reader to subjects in a nice easy descriptive way, it throws you in at the deep end with formulæ and complex circuit analysis. A number of problems are set at the end of each chapter with answers given at the end.

Analogue electronic circuits and analysis covers quite a lot of ground and should prove useful to anyone studying electronics at degree level.

JL

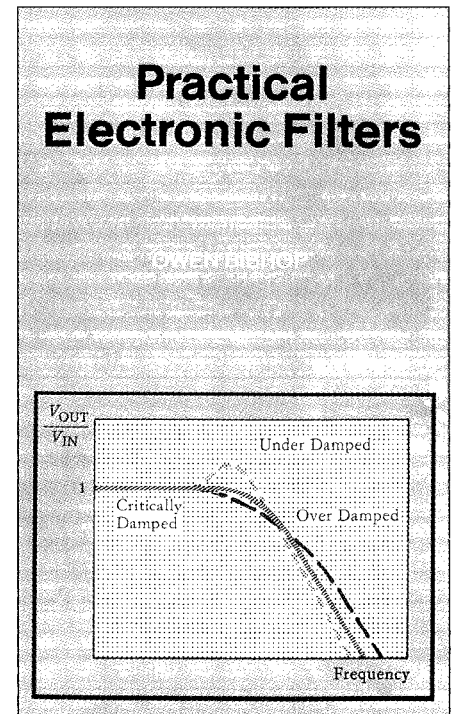

Practical Electronic Filters

Owen Bishop
 Price £4.95
 Publisher: Babani
 ISBN 0 85934 244 1

Filtering and how it works is one of the foundation blocks of electronics. This book deals with them in a non-mathematical way and introduces the basics in a form that is reasonably readable – almost no equations. The basic principles described in early chapters lead on to more complex filtering techniques and at each stage practical applications and circuits are given. The circuits given can be built as all of the component details are given. However, there is no information about actual construction so a little experience in this department is required if any of the designs are to be made up.

WK

The End Of The Phone As We Know It...

The latest chip from National Semiconductor looks set to revolutionise the way in which we use the telephone as James McHann explains.

The next area to be "siliconised" could well be the voice communications market. Almost all of the big silicon suppliers, National Semiconductor and Cirrus Logic to name but two are producing sophisticated devices that deal directly with telephone lines. At one end of the scale are integrated modem/fax systems built to enable all computers to talk directly with each other – every personal computer should have communications hardware and software built in as standard in the next few years – and at the other are systems that can digitise human speech for storage, further processing and even speech recognition.

It has been possible for quite a while to have computerised

systems that answer the telephone and respond to simple commands. Even more common are gadgets that understand the DTMF (touch-tone) frequencies – when phoning companies in the US, it is now common to come across recorded messages that say "Please press one for the accounts department, two for our main office..." and so on. Some UK telephones still use the old pulse dialling system and are unable to operate these new systems, however, all new phones have touch-tone and are opening up a new world.

An example of the technology behind this revolution is the National Semiconductor AM160. This is a single chip that incorporates a digital signal processor (DSP) a micro-controller

unit (MCU) plus all of the RAM, ROM, timers and interface controllers needed to run a telephone and interface with a computer.

Converting the analogue voice signals to and from digital form is performed by an external chip called a CODEC (coder-decoder) which houses an analogue to digital converter (ADC) and digital to analogue convertor (DAC). Sounds are converted to moving electrical signals by a microphone so that they become analogues of the moving air waves – hence the term analogue signals. These are then measured, or sampled, at discreet intervals and the voltages converted into numbers by an ADC. Once in this form they can be subjected to the whole range of

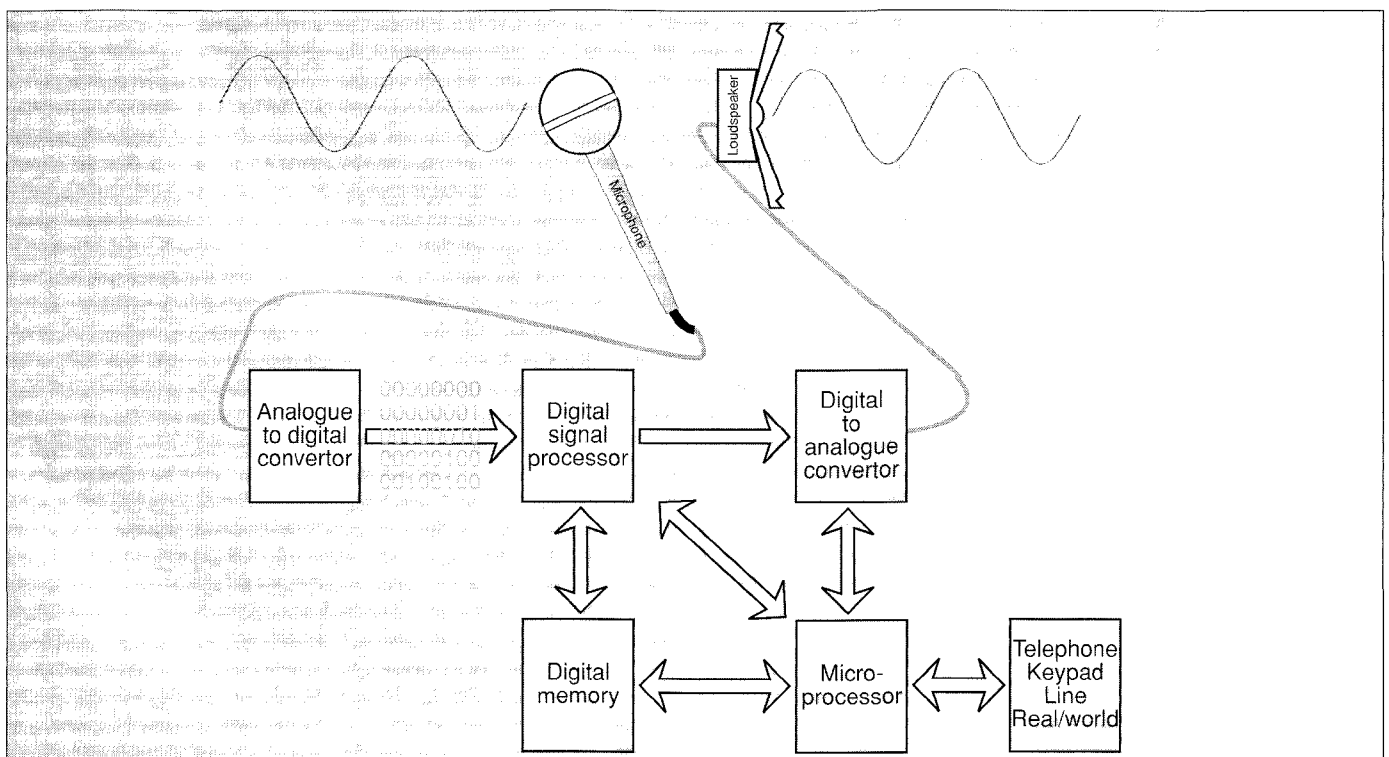

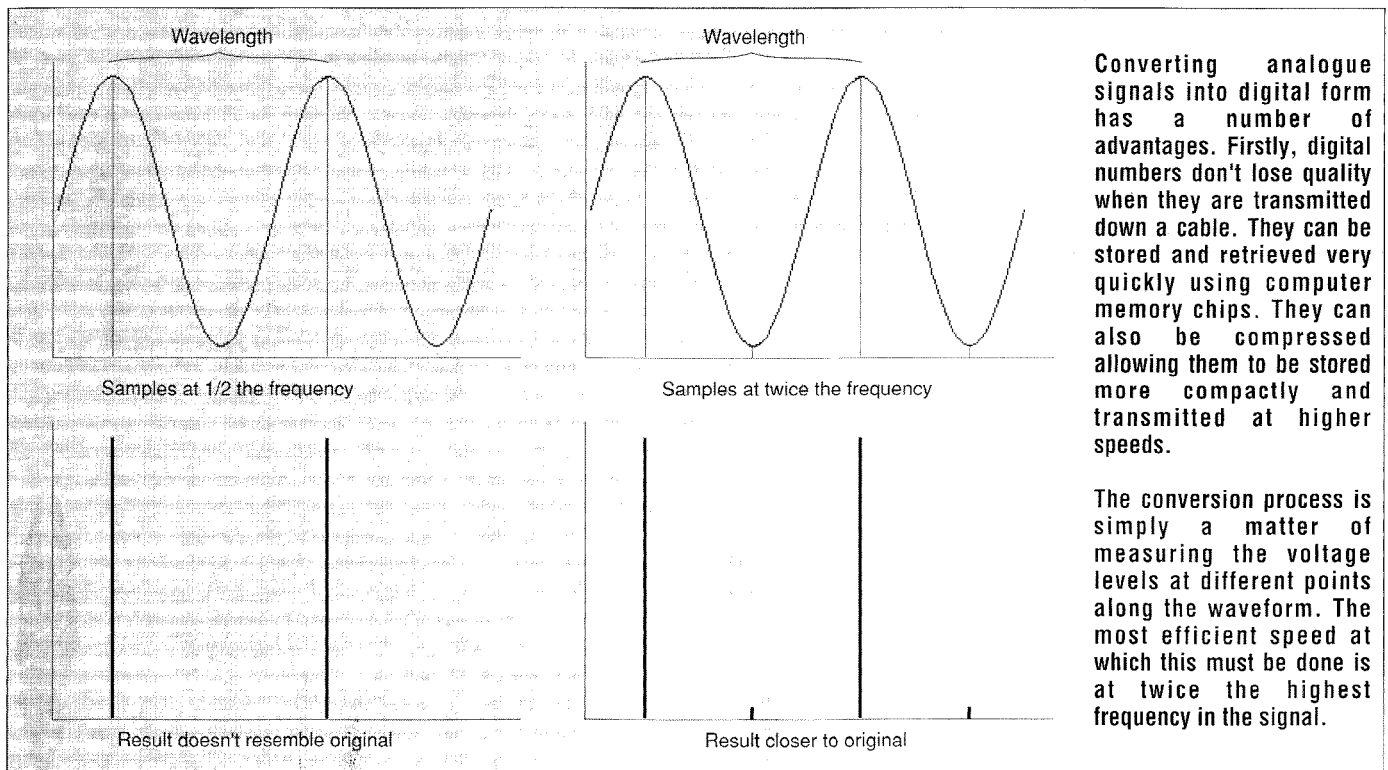

Converting analogue signals into digital form has a number of advantages. Firstly, digital numbers don't lose quality when they are transmitted down a cable. They can be stored and retrieved very quickly using computer memory chips. They can also be compressed allowing them to be stored more compactly and transmitted at higher speeds.

The conversion process is simply a matter of measuring the voltage levels at different points along the waveform. The most efficient speed at which this must be done is at twice the highest frequency in the signal.

processing techniques available to digital computers.

The frequency at which the samples are taken is quite critical. If it is too low, information is lost (see above) since the resulting numbers don't represent the analogue waveform accurately. If too many samples are taken then redundant information is recorded and the load on the processing system is increased. The voice telephone network has a limited frequency bandwidth of about 4kHz and studies in information theory have shown that the minimum frequency at which samples can be taken to give accurate reproduction is twice the maximum frequency of the signal being monitored. In the telephone network, this is 8kHz or one sample every 125 μ s.

The sample numbers are fed directly to a digital signal processor which, for real time processing, must be able to perform operations on the numbers at a greater rate than the information is flowing in. The greater the processing power of the DSP, the more complex are the operations that can be performed on the incoming data. In the past, processing has mainly been for data compression – there is quite a lot of redundant information in speech and removing it can save a lot of memory space. Having operated on the data, the DSP can either feed it out to a memory for storage and

later use, or it can send it down a telephone line to another DSP, or transfer it back out to a loudspeaker via the CODEC and its DAC.

The other major part of the AM160 is a 32-bit micro-controller used by National Semiconductor in a variety of office automation applications such as photocopiers and laser printers. By integrating it onto the same chip as the DSP, the AM160 can be used to control sophisticated telephone systems and interface to computers.

One of the main applications envisaged for the AM160 is the tapeless answering machine where both outgoing and incoming voice messages are stored digitally in RAM chips. Messages can be compressed, given date and time stamps and forwarded to other telephone numbers where and when necessary. The voice-mail facilities allow messages to be passed on to people who enter the right password on their touch-tone keypad and messages can be speeded up without increasing their

frequency. Speeding up using a tape system results in a "Pinky and Perky" effect. Using a bit of digital processing allows the speed up but reduces the pitch so that messages can be scanned quickly. Other possible functions are voice synthesis and basic recognition so that callers can answer questions and give replies to get further information. The telephone will never be the same again. ■

NS32AM160 Specifications

Manufacture: 1-micro double-metal CMOS technology
NS32CG 32-bit core

2.1kbyte internal ROM

4-level interrupt controller

CODEC clock generator and interface

2ms real time timer

Watchdog timer

Pulse width modulator module

Dynamic RAM controller for 4 and 16-bit devices
(bit/nibble/byte organised)

On-chip DSP module

Internal RAM with CPU address space

Complex 16x16-bit multiplier-accumulator

Two-stage pipeline for vector operators

Three operating modes

Internal ROM of 25kbytes

External ROM of 128kbytes

Evaluation mode with 512kbyte addressing

Clock speed: 20.48MHz

Power: 140mA at 5V

Power down mode: 1.5mA

60-pin PLCC package

MAC speed 80ns

A Testing Time For Transistors

Owen Bishop describes how to build a couple of simple test circuits to monitor the operation of all types of transistors, from bipolar to MOSFET.

This pair of instruments can be built as one versatile unit or you may construct each separately. One is for testing NPN and PNP transistors (more about transistor types later) and the other for field effect transistors (more about these later too). The NPN/PNP tester is also useful for testing other components such as diodes as well as for some additional checks on FETs. The NPN/PNP tester makes a simple project for the beginner so, if you want to get started the easy way, build this first and, perhaps, the FET tester later. If you are the sort of person who likes to learn as you build, these projects will teach you about transistors and what they do. There is also a bit about operational amplifiers and a few logic ICs as well so there is something to be learned about these topics as well.

The cost of the project has been kept low by using a display of light emitting diodes (LEDs) instead of a moving coil meter. Maybe the results will not be precise enough to suit the professional but will well

satisfy the average hobbyist. Since the two testers are separate circuits, apart from sharing the same power supply and a few switches, they are dealt with separately.

Bipolar Tester

NPN/PNP transistors are collectively known as bipolar junction transistors, though to most people they are just ordinary transistors. The description bipolar refers to the fact that conduction through the transistor is effected by two types of charge carrier, electrons and holes. An electron is a unit of negative charge. A hole is easy to understand if you think of it as a vacancy, where there ought to be an electron but isn't. It is a location in the atom where an electron is missing and at any time, this can be filled by an electron coming along from somewhere else.

The description junction transistor refers to the fact that the action of the transistor depends upon the behaviour of the electrons and holes at the junction between

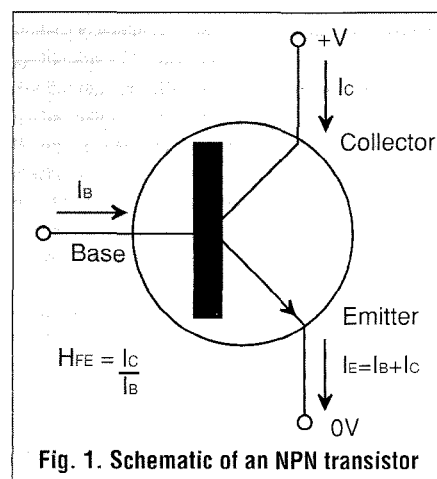

Fig. 1. Schematic of an NPN transistor

two different types of semiconductor material. These two types are referred to as N-type and P-type. The essential difference between the types is that conduction of electric current is by electrons in N-type material and holes in P-type material. Since NPN transistors consist of a very thin layer of P-type material sandwiched between two layers of N-type, there are two P-N junctions and both types of charge carrier are present. This explains why they are called bipolar junction transistors.

It is usual to represent an NPN transistor by the schematic symbol in Fig. 1. The N-type layers are known as the collector and emitters, the P-type layer between them is the base. Normally current can flow only from P-type to N-type as in a diode. Thus the NPN transistor has the same configuration as two diodes connected back to back. Current can flow from base to emitter but not from emitter to base or from base to collector or, of course, from collector to emitter.

One might, however, wonder how it is possible for a transistor to work at all with so many

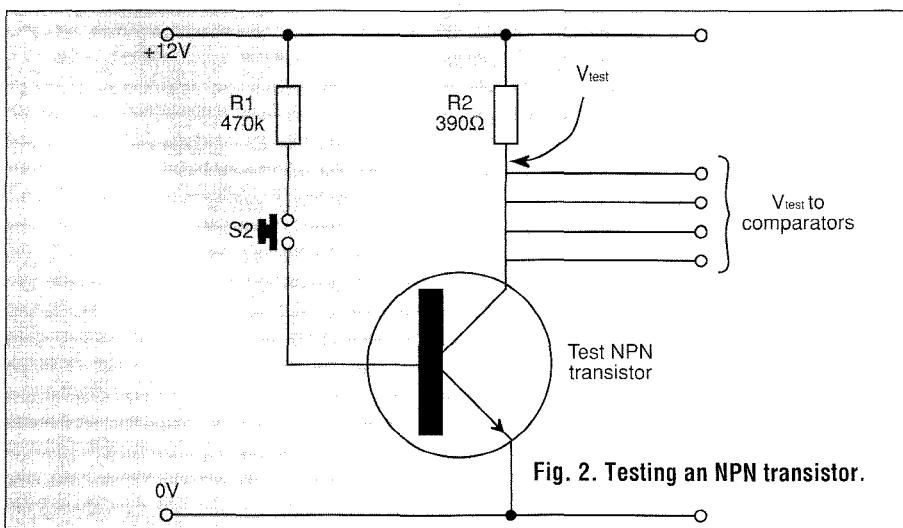

Fig. 2. Testing an NPN transistor.

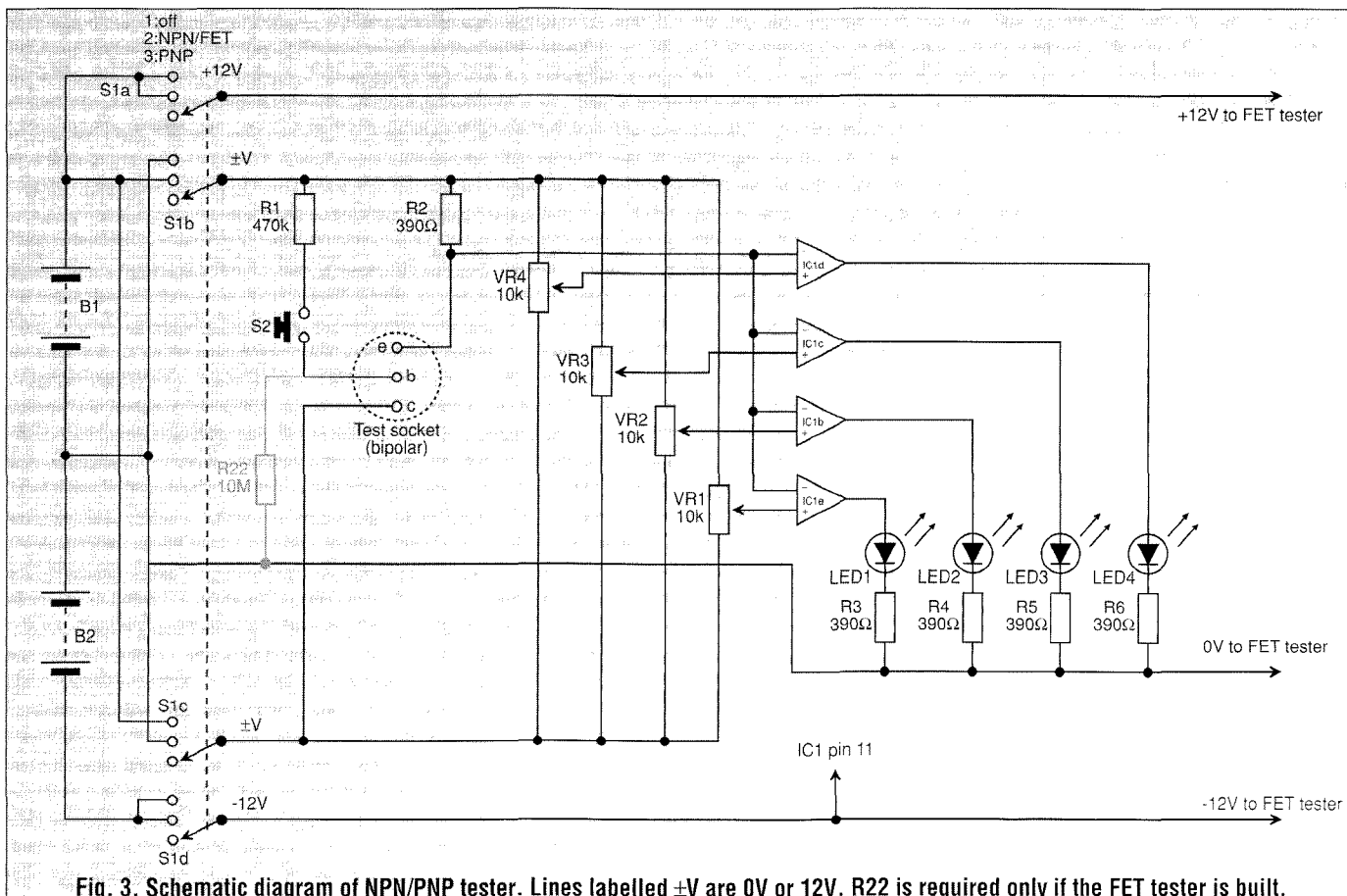

Fig. 3. Schematic diagram of NPN/PNP tester. Lines labelled ±V are 0V or 12V. R22 is required only if the FET tester is built.

Table 1

Gain (H_{FE})	I_C (mA)	Voltage across R3	V_{test}	Variable resistor
5	0.12	0.05	11.95	VR1
50	1.2	0.5	11.5	VR2
200	4.85	1.9	10.1	VR3
500	12	4.7	7.3	VR4

NPN Test Circuit

The essentials of the circuit for testing NPN transistors is shown in Fig. 2. When the button-switch S2 is open, there is no base current and there should be no collector current. When S2 is pressed a small current flows through R1 and S2 into the base. If the transistor is functioning correctly, the collector current flows. This current passes through R2 on its way to the transistor generating a potential difference across it. The size of this is determined by Ohm's Law: the potential difference, or voltage, equals current times resistance or:

$V=RI$ where V is in volts, R in ohms and I in amps. For example, when 20mA is flowing the voltage is:

$$V=0.02 \times 390 = 0.78V$$

The voltage at the transistor is

restrictions on the flow of current. An NPN transistor is connected with its collector several volts positive with respect to its emitter. No current flows apart from a very small leakage current, until the base is made a fraction of a volt (about 0.6V) positive compared to the emitter. When the base-emitter voltage is 0.6V or more, a current, known as the base current I_B , flows into the base layer. Immediately after this happens, a current begins to flow from the collector to the base and through to the emitter. The in-built diode action between the base and the collector is overcome because of the thinness of the base layer. The whole point about transistor action is that, over a wide range of collector-emitter voltages, collector current I_C , is many times greater than the base current. I_C and I_B combine together and leave the emitter as the emitter current I_E . In summary:

If there is no base current, there

is no collector current.

A small base current causes a much larger collector current to flow. The ratio between the base and collector currents, I_C/I_B is known as the gain of the transistor.

The aim of a transistor tester is to establish that a given transistor behaves as described as above and to estimate the value of the gain. This is more precisely known as the direct current gain, symbolically H_{FE} - note that because this is a ratio between two currents, it has no units.

Table 2

LEDs lit	Gain
None	less than 5
1	5 to 50
1+2	50 to 200
1+2+3	200 to 500
1+2+3+4	over 500

Diagnosis
 Transistor faulty
 Low-gain transistor: most power transistors come in this range
 Medium gain transistor
 High gain transistor
 Super-high gain transistor or darlington pair

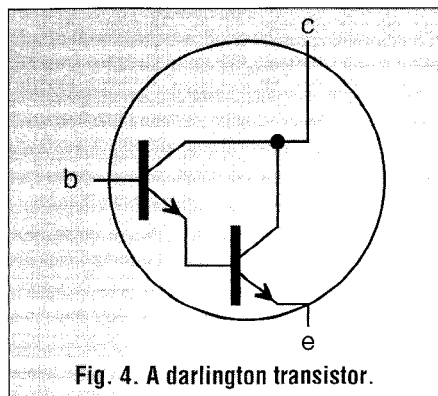

Fig. 4. A darlington transistor.

therefore 12V minus the voltage generated by the resistor. This is referred to as V_{test} . A collector current of 20mA gives a V_{test} of $12 - 0.78 = 11.22V$. This is measured by a series of operational amplifiers as shown in Fig. 3. Each op-amp is wired as a comparator and compares V_{test} with the voltage set by the variable resistors. Each amplifier has its own test level giving four in all. The op-amps work as high gain amplifiers and if the voltage at the - input is greater than the voltage at the + input, the output becomes -10.5V. If the opposite is true then the output goes to +10.5V. The amplifying action ensures that only a small voltage difference at the inputs causes a very large output difference. The comparison voltage for V_{test} is set up using variable resistor as a potential divider that allows voltage coming out of the wiper to be set anywhere between the supply voltage.

The output from an op-amp goes to an LED and when the voltage is less than the comparison voltage, the output goes high and the LED lights up.

Threshold Levels

When S2 is pressed, a current flows from the +12V supply line to the base of the test transistor. The voltage between the base and emitter of a conducting transistor is approximately 0.6V, which means that the voltage across R1 is $12 - 0.6 = 11.4V$. The current through R1 is $\text{voltage/resistance} = 11.4/470,000 = 24\mu A$. We can now work out what the collector current will be for a number of different values of the gain - see table 1.

As the table shows, the higher the gain, the lower the V_{test} and the more LEDs light up.

When S2 is not pressed, there is

zero voltage across R2 and V_{test} is 12V and no LEDs light up. If any LED lights at this stage, there is a serious leakage of current through the transistor which must be faulty. When S1 is pressed, the display is interpreted as shown in table 2.

The Other Variety

A PNP transistor consists of a layer of N-type material (the base) sandwiched between two layers of P-type (collector and emitter). As might be expected, the action and testing of these devices is the reverse of the NPN transistors (Fig. 5). S1 (Fig. 3.) is switched to position 2 to reverse the polarity of the supply to the test circuit. When S2 is not pressed, V_{test} is 0V and all the LEDs are lit. When S2 is pressed one or more of the LEDs go out. A gain of 50 to 200 is indicated by LED1 and LED2 going off but LED3 and LED4 remaining on.

The darlington transistor has two transistors in the same package (Fig. 4.) connected so that the gain of the pair is the product of the individual gains. Darlington's have gains in the region of 1000.

Power Supplies

The schematic in Fig. 3 shows the circuit operating with a $\pm 12V$ supply. Most of the circuit is powered by the +12V side, the negative supply being used only by the op-amps. A supply of $\pm 12V$ is

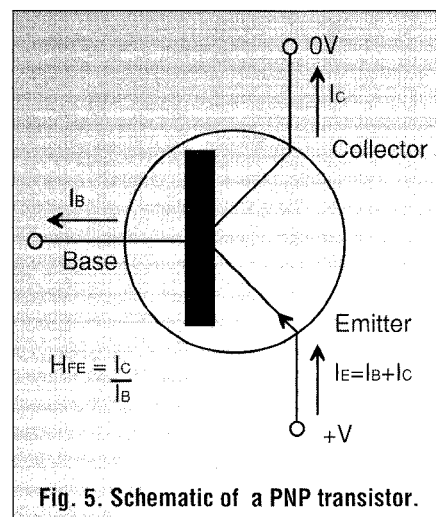

Fig. 5. Schematic of a PNP transistor.

more or less essential for the FET tester so if both are being built, it makes sense to set up a $\pm 12V$ system. If only the NPN/PNP tester is constructed, it is possible to run this from $\pm 6V$ or $\pm 9V$.

Because all of the test currents and voltages are proportional to the supply voltages, no change in the circuit is needed to run it on a lower power supply.

FET Tester

Field effect transistors work on an entirely different principle to bipolar transistors. This is illustrated in Fig. 6 which shows a diagram of one type of FET. The body of the transistor consists of a bar of P-type silicon with two small N-type regions (source and drain) at each end. To one side of the bar is

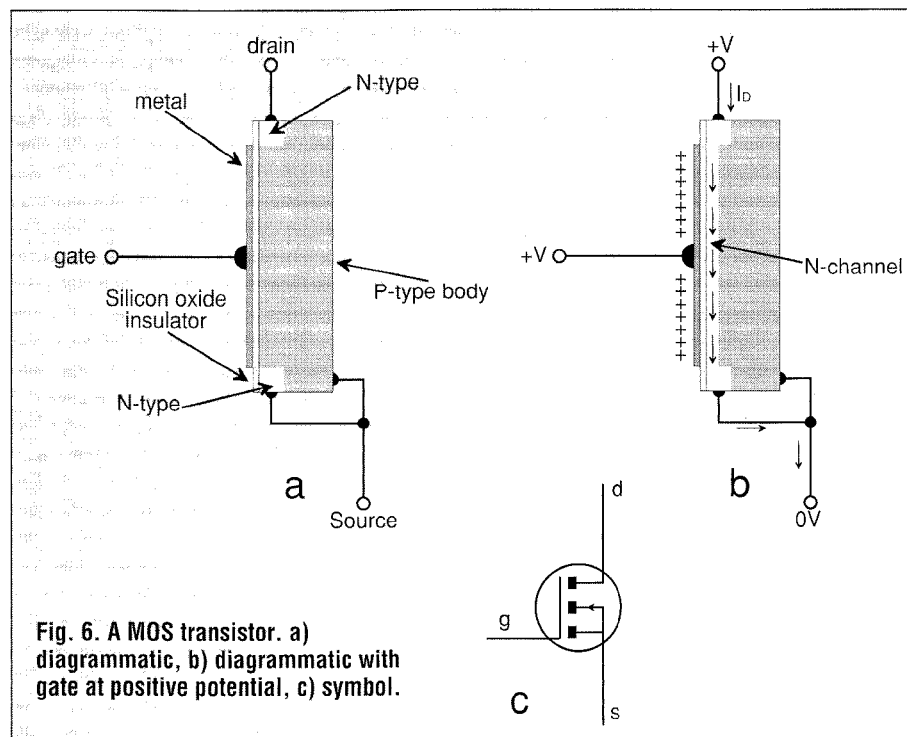

Fig. 6. A MOS transistor. a) diagrammatic, b) diagrammatic with gate at positive potential, c) symbol.

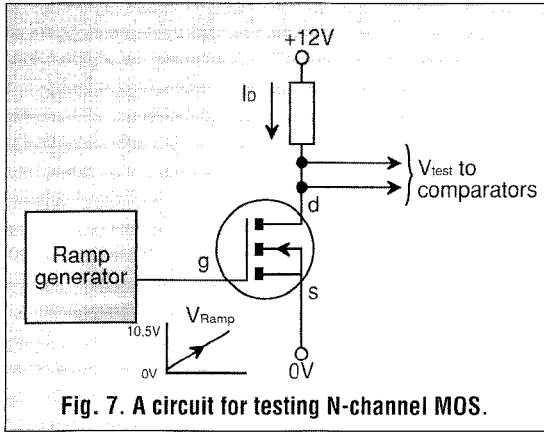

Fig. 7. A circuit for testing N-channel MOS.

a layer of silicon oxide which is a good insulator. Outside of this is a thin metal layer called the gate. The fact that the transistor consists of a metal gate, an oxide layer and a silicon bar gives their name, metal-oxide-silicon transistors, usually shortened to MOS.

Although the bar is conductive and contains a plentiful supply of holes, no current can flow through it as the PN junctions at each end act as back-to-back diodes. But, if a positive charge is applied to the gate (Fig. 6b), the holes are repelled by the electrostatic field. This leaves the material near the gate with an excess of electrons – it becomes N-type silicon. Now there is a continuous path of N-type silicon between the source and drain terminals and a current flows.

The action of this type of transistor depends upon the effect of the field produced by the charge on the gate, which is why it is called a field effect transistor. The transistor described above conducts when a channel of N-type silicon is produced so it is referred to as N-channel MOSFET. Because there is no channel in the absence of a charge on the gate and a positive charge increases the width of the channel, it is called an enhancement MOSFET.

Although the gate of the MOSFET has a similar function to the base of a bipolar transistor, the essential difference is that the gate is totally insulated from the body of the transistor. No current flows into the gate which means that ratio of

the gate current to the source drain current cannot be used to define the gain. Instead it is described in terms of transconductance. This is represented by a variety of symbols including Y_{FS} , G_{FS} and g_m – the latter is the most common and will be used in this article. The g_m is calculated by measuring the change in drain current I_D produced by a given change in the gate voltage V_Q :

$$\text{transconductance} = \Delta I_D / \Delta V_Q$$

This is expressed in siemens or amps per volt with the unit symbol S. For most FETs, g_m is far less than 1s so the most frequently used is the millisiemens (mS) or milliamps per volt.

MOSFET Testing

Measuring transconductance involves measuring changes in voltages and current. We require a circuit that produces a voltage change at a definite rate and measures the resultant change in the drain current. Fig. 7. shows the principle. The gate voltage is swept up from 0V to +10.5V at a precisely known rate by a sub-circuit known as a ramp generator. At lower levels, below the threshold of the transistor, no drain current flows. At high levels, an increasing current flows. What the circuit measures is the length of time taken for the current to increase from one fixed level to another higher fixed level. As in the NPN circuit, the current is not measured as such but an op-amp comparator senses the voltage produced across a resistor. This technique requires two op-amps, one to detect when the voltage crosses the level corresponding to, say 3mA, and another to detect when it crosses, say 7mA. The increase in current is 4mA and the average current during that time is 5mA. Knowing the average current is important since g_m is proportional to its square root. For example, the g_m at 9mA is three times the g_m at 1mA and the g_m at

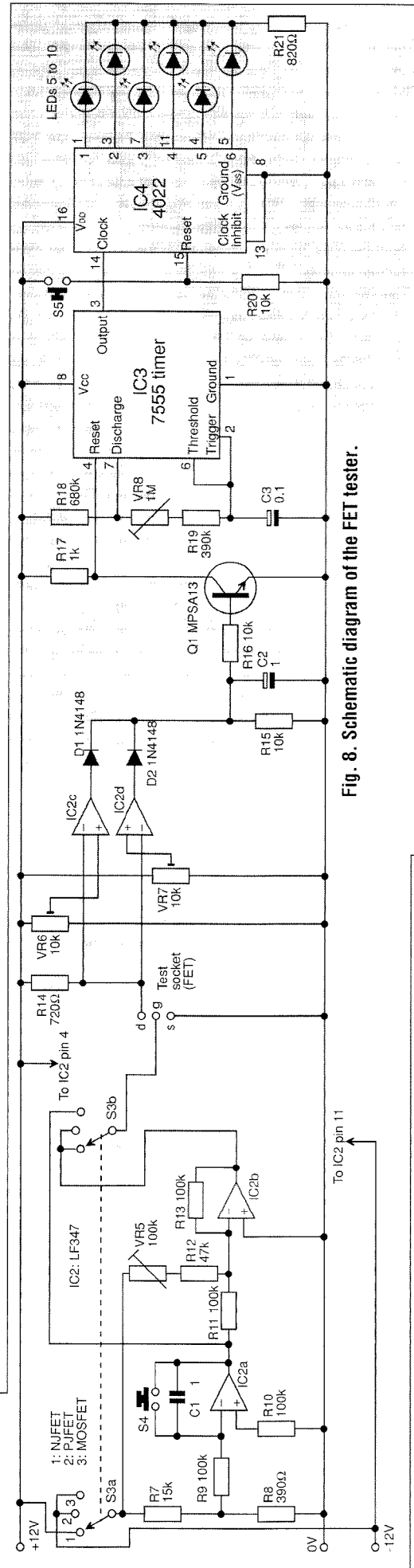

Fig. 8. Schematic diagram of the FET tester.

Table 3

Ramp	VR5 to	Vramp from	Ramp	For testing
1	+12V	IC2b	-10.5 up to 0	N-channel JFETs
2	-12V	IC2b	+10.5 down to 0V	P-channel JFETs
3	-12V	IC2a	0 up to 10.5	MOSFETs
4	+12V	IC2a	0 down to -10.5	not used

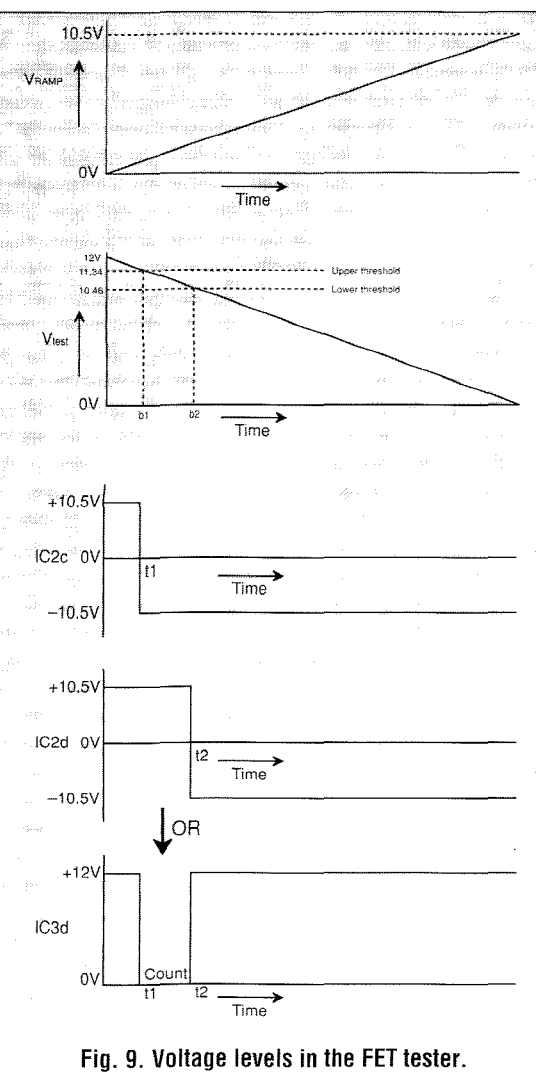

Fig. 9. Voltage levels in the FET tester.

100mA is 10 times the g_m at 1mA. This relationship is used to calculate the g_m for any required current level given a value measured at some other level.

The remainder of the sub-circuit is concerned with measuring the time taken for current to increase by 4mA. The lower current (that is, the higher threshold voltage) detector is wired as in the NPN/PNP tester so that its output goes high when the current rises above 3mA (Fig. 8. IC2c). The higher detector is wired in the opposite way so that its output is high to start with and goes low when current rises above 7mA (Fig. 9.).

Logic

During the test period, the current first reaches 3mA and then 7mA. Fig. 9 shows the outputs of the comparators both of which are low at the critical time. Detecting this condition is achieved by the logical OR operation. Since only one such gate is required, it is more

economical to construct it from two diodes (D1, D2) and a resistor (R15). The voltage at the upper end of R3 is low only when the outputs of both op-amps are low. The diodes also have the function of blocking negative voltages from the section of the circuit beyond them. When the op-amp outputs go low, they drop to -10.5V. The diodes prevent the levels falling below 0V.

The action of this OR gate is not fast enough or sufficiently free from noise to operate the counter circuit reliably. C2 serves to reduce short term voltage spikes and the high-gain darlington transistor Q1 produces a rapid voltage swing between logic high and logic low. This transistor also acts as an inverter so that the logic level at the reset input of IC3 is held low during the counting period. A high level at the reset enables counting and a series of pulses goes from IC3 to the counter IC4.

The counter has eight outputs, one of which is high at any one instant. When reset by pressing S5, output 0 goes high and all other outputs go low. Output 0 is not used but the next six outputs are each connected to an LED. Resetting causes all of the LEDs to go off. During the time that IC3 is enabled, the counter increments as it receives each pulse. The outputs go high and the LEDs 5 to 10 light up in order.

Going Up

The ramp generator is based on a pair of op-amps. The first (IC2a) is the generator, producing an output which begins at 0V and increases at a fixed rate. The second op-amp (IC2b) is used to invert the output of the first op-amp as required for certain types of FET. The action of the generator is initiated by pressing and releasing S4. This discharges C1, which is then gradually charged by the current from the amplifier. The rate of change of the output is given by:

$$V_{\text{ramp}} = V_{\text{in}} \times t / RC$$

V_{in} is the voltage at the junction of R7 and R8. If R7 is connected through S3a to -12V line, V_{in} is $(-12 \times 390) / 15390 = -0.3V$. If R and C have the values 100kΩ and 1μF shown in the schematic, the equation reduces to:

$$V_{\text{ramp}} = 3t$$

V_{ramp} increases from 0V at a steady rate of 3V per second until it reaches the limit imposed by the amplifier, about +10.5V. This takes about 3.5s.

If R7 is connected to the positive supply rail, the reverse action occurs. V_{ramp} decreases from 0V at 3V/s until it has fallen to -10.5V.

The second op-amp is connected as an inverter amplifier with a gain of 1 (because $R_{11} = R_{13}$). With the rising ramp described above, it would give a ramp falling from 0V to -10.5V, but this is already available. The minus (-) input of IC2b is also connected to the positive or negative supply by means of R12 and VR5. This provides an extra input which is added to the input from the first op-amp. IC2b is being used as a summer. Because this is an inverting amplifier, connecting R12 and VR5 to the negative supply means that the range of the ramp can be changed so that, instead of falling from 0V to -10.5V, it begins at +10.5V and falls to 0V. Four different ramps are, therefore, available as shown in table 3.

Counting Down

The timer runs at 5Hz and each count corresponds to a V_{ramp} change of 0.6V. The timer is enabled when the logic output is low, during which period, the voltage is changing by 3V/s and the current is changing by 4mA. This gives the transconductance as:

$$g_m = \Delta I_C / \Delta V_{\text{ramp}} = 1 / \text{count} \times 0.15 \text{ mS}$$

The higher the transconductance, the smaller the count since a high g_m means that current increases rapidly and therefore takes less time to increase by a given amount. Table 4 relates count to g_m .

This range of values is suitable for the majority of FETs which have g_m in the range 0.5 to 3mS for a current flow of a few mA. The

Count	g_m in mS
0	more than 7
1	7
2	3.3
3	2.2
4	1.7
5	1.3
6	less than 1.1

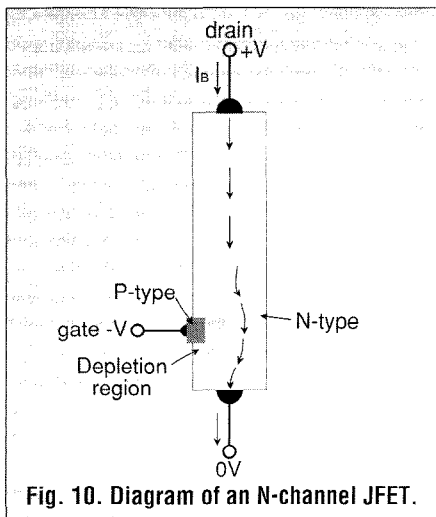

Fig. 10. Diagram of an N-channel JFET.

data published for some FETs, particularly power FETs are usually measured for much larger currents, perhaps several amps, at which g_m is higher.

Other FETs

The complementary type to the N-channel enhancement MOSFET described above is the P-channel enhancement MOSFET. It has a body of N-type material with P-type source and drain. It conducts when the gate is negative with respect to the source, repelling the electrons and creating a continuous P-type channel.

The other category of MOSFET is the depletion MOSFET in which the channel is normally restricted in width when a charge is applied to the gate. These types are rarely used so we have not provided facilities for testing them. A much commoner depletion FET is the junction FET or JFET. In this, the insulation between the gate and the body is provided not by an insulating layer of oxide but by removing all charge carriers from the region. Fig. 10 shows how this is done in an N-channel JFET. The gate consists of a region of P-type material. A negative voltage is applied to the gate, forming a PN junction with the N-type body. This creates a depletion region, as in a reverse biased diode, through which current cannot pass. Electrons flow from from source to drain along the N-type bar, but their flow is restricted when the gate is strongly negative and the depletion region becomes wider. In testing this type of transistor, the connections are as in Fig 11,

and the gate voltage is ramped up from -10.5V to 0V. If it were to exceed about +0.5V the PN junction at the gate would become forward biased and current would flow from the gate to the body of the transistor. The transistor is never operated in this conduction.

The remaining FET type is the P-channel JFET, the compliment to the N-channel. This is operated with a positive gate voltage, which is ramped down from +10.5V to 0V for testing.

Testing FETs

Rotary switch S3 is used to select the required test conditions:

- 1 N-channel JFETs
- 2 P-channel JFETs
- 3 N-channel and P-channel enhancement MOSFETs

Set S3 according to the type of FET and insert the test FET in the socket. For N-channel JFETs and MOSFETs, the terminals are as marked in Fig. 8, but P-channel JFETs and MOSFETs are inserted with opposite polarity, the source in socket d and the drain in socket s.

If the LEDs of the display change in rapid sequence at this stage, the FET is probably faulty.

It is possible that one LED may come on owing to glitches produced by the transistor being inserted in the socket, but this does not indicated a fault.

Press and release the reset button, S5. The display clears.

Press the test button S5, holding it for a second and then releasing it. After a pause, LEDs come on in sequence, for a fraction of a second. The displayed count indicates the transconductance as given in table 4.

If no LED comes on, or the display flickers erratically, it is likely that the transistor is faulty. One of the problems with FETs is

that they cannot be manufactured to such close tolerances as bipolar transistors. It is possible that some FETs will have characteristics outside the range covered by the test circuit and other types are designed to be intermediate between enhancement and depletion. These will appear to be faulty when they are not. If in doubt, consult the manufacturer's data sheets to see what the gate and source voltage ranges should be.

Further FET Tests

It is also possible to use the bipolar tester circuit to test FETs – the optional resistor R22 should be wired in for this. It makes virtually no difference to the operation of the circuit and with the highly insulated gates of the FETs it has the effect of bringing the gate within a few millivolts of the source voltage. This enables I_{DSS} , the current through the FET when the gate source voltage is zero, to be measured. The button S2 is not pressed for this test. With JFETs, I_{DSS} is in the region of 1-50mA and is close to the maximum that the transistor can pass. For enhancement MOSFETs, I_{DSS} is only a few microamps since there is practically no conduction channel when the gate and source are at the same potential.

If S2 is pressed, the gate potential is raised to that of the drain. This must not be done with JFETs as the gate junction becomes forward biased and the normal action of the transistor does not occur with MOSFETs. The result is to cause the maximum I_D to flow – usually several hundred milliamps.

The testing procedures are as follows, all with S1 set to position 2 (NPN/FET) and using the bipolar test socket:

N-channel JFET – insert drain at c, gate at b and source at e. Some or all of the LEDs come on indicating the value of I_{DSS} . The second column of table 1 shows the corresponding currents. If none light, the transistor is faulty.

P-channel JFET – test as above. Interpret the display by noting which LEDs are not lit. For example, if D1 and D2 are off but D3 and D4 are on, I_{DSS} is in the range 1.20 to 4.85mA.

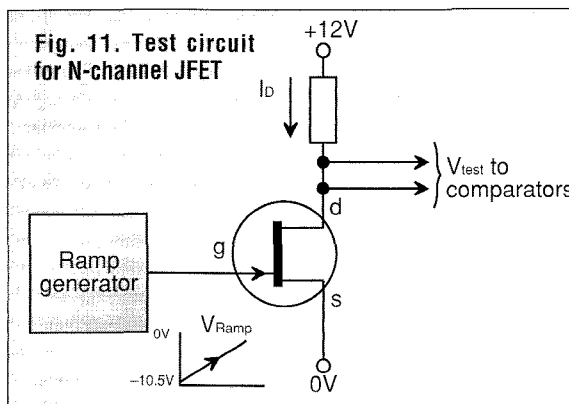

Fig. 11. Test circuit for N-channel JFET

Parts List

For bipolar tester

Resistors

carbon or metal film, 0,25W, 5%

- R1 470k
- R2-R6 390Ω
- VR1-4 10k miniature horizontal presets

Semiconductors

- LED1-4 light emitting diodes, individual LEDs or part of a bargraph display.
- IC1 LF347 quad JFET operational amplifier

Miscellaneous

- S1 4-pole 3-way rotary switch
- S2 push to make push button
- 14 way dual in line (DIL) socket
- Transistor sockets
- Snap on battery connectors
- Enclosure

FET tester

Resistors

- R7 15k
- R8 390Ω
- R9, R10
- R11, R13 100Ω
- E12 47k
- R14 220Ω
- R15, R16 10k
- R17, R20 1k
- R18 680k
- R19 390k
- R21 820Ω
- R22 1M
- VR5 100k min horz preset
- VR6, VR7 10k min horz preset
- VR8 1M min horz preset

Capacitors

- C1, C2 1μF polyester
- C3 0.1μF polyester

Semiconductors

- D1, D2 1N4148 silicon small signal diodes
- LED5-10 light emitting diodes, individual or part of bargraph
- Q1 MP5A13 NPN darlington transistor
- IC2 LF347 quad JFET op-amp
- IC3 7555 CMOS timer
- IC4 4022 CMOS divide-by-8 counter with one-of-8 inputs

Miscellaneous

- S3 2-pole (or 4-pole) 3-way rotary switch
- S4, S5 push-to-make push-button
- 8-way DIL socket
- 14-way DIL socket
- 16-way DIL socket
- transistor sockets

N-channel MOSFET – insert the drain at e, gate at b and source at c. All LEDs come on. Indicating minute I_{DSS} . Press S2. Usually all the LEDs light, showing an I_D in excess of 12mA. If none light, the transistor is faulty.

P-channel MOSFET – insert the drain at e, gate at b and source at c. All LEDs come on, indicating minute I_{DSS} . Press S2. All LEDs go out, showing I_D is greater than 12mA. If they do not go out, the transistor is faulty.

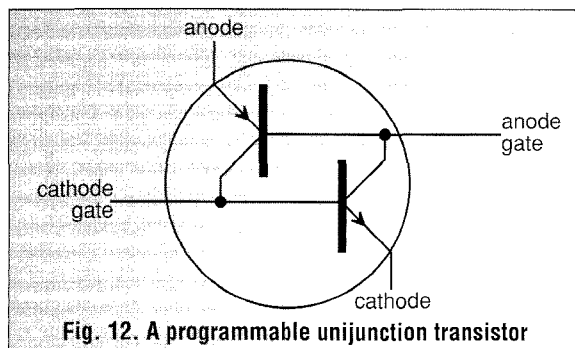

Fig. 12. A programmable unijunction transistor

Construction

The first thing to decide is the supply voltage. As already mentioned, the bipolar tester operates on ±6V, ±9V or ±12V. The FET tester is better on a ±12V supply though it can be made to run on ±9V if it is accepted that this will make it impossible to test certain type of FET that have uncommonly high or low threshold voltages. The combined testers require only 60mA on the positive supply and 15mA on the negative. If the tester is only to be used occasionally then a pair of 9V PP3 alkaline batteries are good enough.

Having decided what batteries to use, the size of the enclosure can be determined. For combined testers, this needs to have a lid or panel large enough to to mount two rotary switches, the three push-buttons, the LED display and the transistor sockets.

Construction presents no particular problems but attention must be given to setting the critical voltage levels. For the bipolar tester, the most precise way to do this is to connect the positive probe of a voltmeter to the +12V line and the negative probe to the wiper of the variable resistor being set. Adjust the resistor to give the voltage as shown in table 1.

In the FET tester, VR6 and VR7 are set to voltages of 0.06V and 1.54V respectively, below the positive line. For example, with a ±12V supply, they are set to 11.34V and 10.46V. VR5 adjusts the amount that is to be added to the ramp voltage. Connect a voltmeter between the g terminal of the transistor socket and the 0V line.

Turn S3 to position 1 and press and release S4. The voltage goes to approximately -10.54V and then ramps slowly up to 0V. It may finish fraction of a volt above or below 0V. Adjust VR5 to bring it to 0V. Then switch S3 to position 2 and repeat. This time the ramp voltage falls from +10.5V to 0V. If it does not come to 0V exactly, adjust VR5 to bring it nearer. Owing to resistor tolerance, it may be impossible to bring it to exactly 0V. This does not matter. The main point is to repeat the procedure a few times with S3 at positions 1 and 2 until the final values of V_{ramp} are equally placed on either side of 0V. To complete the setting up of the circuit, adjust VR8 until the timer runs at 5Hz. This is made easier if the link between R17 and pin 4 of IC3 is removed. IC3 is then connected to +12V. The timer runs continuously. If a frequency meter is not available, let the timer run and measure how long it takes for LED5 to come on 10 times. If the timer is running at 5Hz this takes exactly 16 seconds.

Higher Range

As an option, the range may be increased by switching a smaller capacitor into the timing circuit. This additional capacitor C4 has a value of 0.01μF, so increasing the clock rate by ten times. This allows for measurement of g_m in the range 10 to 70.

HFE	500	LED4	NPN & PNP	
	200	LED3		
	50	LED2		
	5	LED1		
FETs		LED5		7
		LED6		3.3
		LED7		2.2
		LED8		1.7
		LED9		1.3
		LED10		<1.3 g_m

Fig. 12. Using a bargraph LED display.

Practical Electronics Classified Ads

Reach thousands of serious electronic and computer enthusiasts – advertise in PE Classified pages:
 Rates 20p (plus 4p VAT) per word or £8.50 (plus £1.49 VAT) per column cm. All classified advertisements must be pre-paid. Send your copy, with remittance payable to Intra Press, (Payment by Visa or Access accepted – ads may be phoned in) to:

Practical Electronics, Intra House, 193 Uxbridge Road, London W12 9RA.
Tel: 081-743-8888. Fax: 081-743-3062

Education

Start training now for the following courses.

- Telecomms Tech C&G 271
- Radio Amateur Licence C&G
- Microprocessor
- Introduction to Television

Send for our brochure - without obligation or telephone us on 06267 79398 (Ref: PE2/92)
 Name.....

Radio & Telecommunications
 Correspondence School,
 12 Moor View Drive, Teignmouth,
 Devon TQ14 9UN

Retailers

Project your retail image here!



Phone David Bonner
 for details on
 081-743-8888

LONDON N WEST

CRICKLEWOOD ELECTRONICS

One of the largest ranges of components in the UK!

40 Cricklewood Broadway,
 LONDON NW2 3ET

Tel: 081-450 0995/452 0161

**Modernising your workshop?
 Sell your old equipment
 through PE Classifieds pages.**

FOR SALE

Practical Electronics
 in Binders volumes one
 (1965) to ten (1974) and
 later loose copies. Offers
 for lot (0905) 54318.

Computer Parts

CAMBRIDGE COMPUTER SCIENCE LIMITED

3.5" 720K Diskette Drives	£29.00 each
10MByte Winchester, used, 3 months Wty	£35.00 each
5.25" Disk Drives, 80Tk, DSDD	£25.00 each
5.25" Disk Drives, 80 Tk, DSDD Used, No Wty	£15.00 each
<small>(The £15.00 drives are sold on a strictly "as is" basis)</small>	
5.25" Disks, DSDD, 48tpi, boxes of 10	£3.00 box
Lockable diskette boxes for 80*3.5" or 100*5.25" (state which)	£5.99 each
Small sized diskette boxes (lockable)	40*3.5" £4.75, 50*5.25" £4.99 each
Printer stands (suit 9" x 13.25" coils) Basic £2.99, or with paper catcher	£1.99 each
Digital multimeter, 14 ranges, inc leads & manual	£15.00 each
Apricot Disk drive PSU	£10.00 each
5V @ 6A PSU	£4.80 each
5V @ 10A PSU	£5.40 each
Nicads AA £0.89, C £1.99, D £2.09, PP3 £4.99, Universal charger	£5.99 each
74LS TTL, pick and mix, buy 10 or more for	£0.12 each
<small>Types available: 00 02 04 08 10 11 12 13 14 15 20 21 26 27 30 32 33 37 38 42 74 85 85 86 99 107 109 122 125 132 136 139 145 151 153 157 158 160 162 163 164 165 174 191 193 240 253 257 260 298 353 365 366 373 385 390 399 670 682</small>	
27128 EPROMS (Ex equipment)	£1.20 each or £5.00 5
256K Byte DRAM Modules, removed from equipment	£6.00 each
62256-10 NV 32KByte SRAM	£5.00
8K Byte NV RAM chips £3.00 each	£10.00 four
<small>Range of Aluminium and plastic project boxes (ask for list)</small>	
Prices include postage. Add 50p (plus VAT) to orders below £5.00	
All items new unless stated. Add 17.5% VAT to all prices.	
Send an SAE for our latest list or for more info.	
Dept PE, 374 Milton Road, Cambridge, CB4 1SU	
Tel: 0223 424602, 0831 430496 or 0831 430552 (Mail order only)	

Components

CATALOGUE £1.00 + 25 P&P

LEDs 3mm or 5mm red/green	6p each.	Yellow 11p each.
High intensity red/green or yellow 5mm 30p each		
Cable ties 1p each	£5.95/1,000	£49.50 per 10,000
Stepping motor 4 phase 12V 7.5 step 50 ohms	£8.95	
SAAI027 stepping motor driver chip	£3.95	
FM Transmitter kit good quality sound	£8.60	
High quality photo resist: copper clad epoxy glass boards		
Dimensions	single sided	double sided
3x4 inches	£ 0.95	£1.07
4x8 inches	£ 2.40	£2.68
6x12 inches	£ 5.37	-
12x12 inches	£10.66	-
Special Offers		
Computer Grade Capacitors with screw terminals 35000uf 20V	£2.50	
87,000uf 10V £1.95, 68,000uf 15V £2.95, 10,000uf 16V	£1.50	
7 segment Common anode led display 12mm	£0.45	
LM2931ATS.0 Low drop out 5V regulator T0220 package	£0.85	
BS250 P channel MOSFET £0.45, BC559 transistor	£3.95 per 100	
74LS05 hex inverter £10.00 per 100, used 8748 Microcontroller	£3.50	
TV Main switch 4A double pole with momentary contacts for remote control pack of 10 £3.95 box of 60 £19.95		
DC-DC converter Reliability model V12P5 12v in 5v 200ma out 300v input to output Isolation with data \$4.95 each or pack of 10	£39.95	
Hour counter (used) 7 digit mains 240V AC 50Hz	£1.45	
Resistor pack 2500 resistors 1/8-2W 50 different values	£8.95	
Qwerty keyboard 58 key good quality switches new	£5.00	
Qwerty keyboard with serial output, no data	£5.00	

Wide range of CMOS TTL 74HC 74F Linear transistors kits
 Rechargeable batteries, capacitor tools etc always in stock.
 Please add 95p towards P&P - VAT included

JPG Electronics 276 - 278 Chatsworth Road
 Chesterfield S40 2BH
 Access/Visa orders (0246) 211202. Callers welcome

**Practical Electronics Classifieds
 list the best sources for unusual or
 back catalogue components**

Surplus

TURN YOUR SURPLUS

ICS transistors etc into cash, immediate settlement. WE welcome the opportunity to quote for complete factory clearance.

Contact:

COLES-HARDING & CO.,
 103 South Brink, Wisbech, Cambs.
 ESTABLISHED 15 YEARS
 Tel: 0945 584188 - Fax: 0945 588844

Recycle your old projects and generate useful cash from spare components

Miscellaneous

UNIVERSAL PROGRAMMER Hi-Lo ALL-03 £295

Take advantage of Asian low labour cost!

- ★ Texas Instrument approved. Good quality.
- ★ PC based, programs stored into 5 diskettes.
- ★ Program most MPU, PLD, EPROM, EEPROM, BPPROM.
- ★ Adaptors for PLCC devices are available.
- ★ 1 year guarantee. Money back if not satisfied.
- ★ Price includes postage but not VAT.

Write for free catalogue and price list.

Active Action Industrial Ltd
Rm 1307, Wing Tuck Coml Ctr.
177-183 Wing Lok Street
Hong Kong

SPACEWATCHERS

European AstroFest 92

Europe's largest astronomical
show and lecture programme

14th to 15th February 1992
Kensington Town Hall
London W8

Full details and booking form from:

AstroFest 1992 Tickets
Intra House
193 Uxbridge Road
London W12 9RA

73 AMATEUR RADIO TODAY

**Broaden your
horizons.
Subscribe to the
world's leading Radio
Ham magazine.
European rates for
surface and air mail
available on request
from:**

**73 Amateur Radio
Today
PO Box 50330
Boulder
CO.
80321-0330
USA**

Components

High Stability Resistors

Carbon Film Resistors 0.56R to 10MΩ E24 series 1/4W - 1p
100 off per value - 75p. 1000 off in even hundreds per value - £6.00
Metal Film 1/4W 10R0 to 1MΩ E12 series 5% - 2p. 1% E24 series - 3p

Mixed metal-carbon film 1/2W E24 series 1R0 to 10MΩ - 1 1/2p
Mixed metal-carbon film 1W 4R7 to 10MΩ E12 series - 5p

BC107/8/9 - 12p. BC182/BC183. BC184/BC121/3/4 versions - 10p

BFY50.51 & 52 - 20p. 2N3055 - 50p. TIP31A/32A - 25p. TIP. 41.42 - 40p

Tantalum bead electrolytics subminiature (Mfds/Volts)

0-135. 0.2235. 0.4735. 1.035. 2.235. 3.315. 3.320. 4.715 - 14p. 3.335. 4.725.
4.735 - 15p. 6.815. 6.835 - 15p. 10.15. 20.25 - 20p. 10.35. 22.15. 33.10. 47.10 - 30p.
100.6 - 30p. 100.16 - 50p. 220.6 - 60p

Aluminium Electrolytics (Mfds/Volts)

150. 2.250. 4.750. 10.16. 10.25. 10.50 - 5p. 22.16. 22.25. 22.50. 47.16. 47.25. 47.50 -
6p. 100.16. 100.25 - 7p. 100.50 - 12p. 220.16 - 8p. 220.25. 220.50 - 10p. 470.16.
470.25 - 11p. 1000.16 - 15p. 1000.25 - 16p. 2200.25 - 22p

Miniature Polyester Capacitors 250V Wkg. Vertical Mounting

.01. .015. .022. .033. .047. .068 - 4p. 0.1 - 5p. 0.15. 0.22 - 6p

Mylar Capacitors 100V Wkg. Vertical Mounting E12 Series

1000p to 8200p - 3p. 0.01 to .068 - 4p. 0.1 - 5p. 0.15. 0.22 - 6p

Subm. Ceramic Plate 100V Wkg. E12 Series Vertical Mounting

2%. IP8 to 47P - 3p. 56P to 330P - 4p. 10%. 390P to 4700P - 4p

Plate/disc ceramic 50V. Wkg. Vertical Mount. E12 series 1P0 to 1000P &

E6 series 1500P to 47000P - 2p. 0.1 - 3p

Polystyrene Capacitors 63V Wkg. E12 Series Axial Mounting

10P to 820P - 4p. 1000P to 10.000 - 5p. 12.000P - 6p.

Diodes

Zener diodes E24 series 3V3 to 33V 400mW - 8p. 1 watt - 12p. 1N4148 - 2p. 1N4001 -

3p. 1N4002 - 3.5p. 1N4007 - 5p. 1N5404 - 14p. OA91 - 8p. AA143 - 10p. W005 - 20p.

W01 - 25p. BYX10 - 6p.

L.E.D's Red. Green & Yellow 3mm & 5mm - 10p. 8mm - 35p

20mm fuses 0.15A to 10A quick blow - 5p. 0.1A to 5A Anti Surge - 8p

High Speed drills 0.8mm. 1.0mm. 1.3mm. 1.5mm. 2mm - 30p

*Expo "Reliant" drilling machines 12V d.c. with improved 3-jaw chuck - £7.00

Nicads AA - 90p. HP11 - £2. HP2 - £2.20. PPS - £5 Universal chargers for all above

batteries - £6.50

Glass reed switches with single pole make contacts - 8p. Magnets - 12p. 0.1" stripboard

2.5" X 1" 9 rows 27 holes - 25p. 3.75" X 2.5" 24 rows 37 holes - 70p. Isolators list price

£18.95 7 year guarantee - £12.00. Jack plugs 2.5mm 1.5mm - 14p. Sockets panel

mtg - 10p

All prices VAT inclusive. Postage 30P (free over £5).

THE C.R. SUPPLY CO.
127 Chesterfield Road,
Sheffield S8 0RN.
Tel: 0742 557771

Classifieds can be a TIGHT SQUEEZE

Give your ad room to
breathe
in our

DISPLAY PAGES

Contact David Bonner
on

081-743 8888

Large selection of interesting
components at very competitive prices.

Large S.A.E. for lists to AGS
Electronics, Unit 2, Haxter Close,
Bellver Ind. Estate, Plymouth, Devon
PL6 7DD. Tel: 0752-767738.

SURPLUS/REDUNDANT ELECTRONICS COMPONENTS WANTED

ICs - Tuners - Transistors - Valves - Diodes etc - any quantity
considered - immediate payment.

ADM ELECTRONICS SUPPLIES

Tel 0827 873311

Fax: 0827 874835

Surveillance

Suma Designs

sell top quality
surveillance equipment
in kit form or as ready
built units.

See our full page
display ad in this issue

Kits, Plans, Assembled Units,
Surveillance Microtransmitters,
Phone Recording Switches, Trackers,
Defence /Protection Circuits, Plus
much more. Send 2 x 22p stamps for
lists, or tel. 05436 76477 24hrs.
Everything for the budding 007.
ACE(PE). 53 Woodland Way,
Burntwood, Staffs. WS7 8UP.

Surveillance devices, lasers, Tesla
coils, scramblers, ultrasonic and
many more, over 150 designs. Send
SAE to: Plancentre, Old Wharf,
Dynock Road, Ledbury HR8 2HS for
free list.

NEW VHF MICROTRANSMITTER KIT,
tuneable 80-135 MHz, 500 metre
range, sensitive electret microphone,
high quality PCB. SPECIAL OFFER
complete kit ONLY £5.95, assembled
and ready to use £9.95 post free.
Access orders telephone 021 411 1821.
Cheques/ P.O.'s to: Quantek
Electronics Ltd, (Dept P.E.), 3
Houldey Road, West Heath,
Birmingham, B31 3HL

Super VHF Microtransmitters.
Long range, high sensitivity.
Tuneable 75-115 MHz. Listen on any
FM radio. Assembled, ready to use.
High quality, fully encased. Full
instructions, guaranteed. Ideal Xmas
presents as baby monitors etc. £9.50
post free. Cheques/POs; Mr B.
Hicks, 24 Brewster Road, Boston,
Lincs, PE21 0DY. Tel: 0205 362003

EPROM PROGRAMMING
SERVICES. All sizes all makes up to
512kb. Data can be sent as written text
or as data file on 3.5" or 5.25"/disk,
PC or AMIGA compatible. For details
contact: W.Vincent, 159 Askew
Road, London, W12 9AU, Tel. 081 749
7304

Miscellaneous

SERVICE MANUALS

Available for most equipment. T.V. Video, Audio, Test, Amateur Radio, Military Surplus, Kitchen, Etc. Any Video Recorder, Video Camera or Oscilloscope

Manual £15.00 (subject to stock). All Others Manuals £10.00 (subject to stock). Over 100,000 manuals available for equipment from 1930's to the present. Circuit sections supplied on full size sheets

up to A1 size (33" X 24") if applicable. Originals or photostats supplied as available. FREE Repair and Data Guide Catalogue with all orders or send SAE for your copy today.

Mauritron (PE)

8 Cherry Tree Road, Chinnor, Oxfordshire, OX9 4QY.

Tel:(0844)51694 Fax:(0844) 52554

IBM PC Public Domain Shareware sg: EE Draw 2.2, PCB CAD; PC Route 2. On 3.5 inch disk, £2.50. What's more, ham radio, loud speaker cross assembler. J.D. Soft. Tel: 061 430 5208

Oscilloscope 25MHz Gould (054040) with four separate digital storage facility and GPIB interface all boxed as new cost £2000 sell for £500 service manual included. Tel: 081 472 9545.

ATM Filmnet Recorder Kit. PCB, parts and diagrams. Only £29.95. Auto switch-over type capable of decoding the scrambled Filmnet video signal. Send an addressed

Miscellaneous

Missing a vital Practical Electronics back issue? Don't despair!

Reprints of articles and software listings are available for £2 each from Intra Press, Intra House, 193 Uxbridge Road, London W12 9RA, or by phone on 081 743 8888. We cannot accept credit card orders below £5 total value.

envelope and two International Reply Coupons for free information. T-F Electronics, Box 1219, Hilversum, 1200BE, The Netherlands.

Open University course PT501 'Microprocessor design for engineers' looks at software /hardware design, includes microcomputer and input/output devices. Mint condition over £450, accept £175 ono. Tel 0727 834279

Miscellaneous

Writing Classified Advertisements That Work

- ① Start by mentioning the product or service you are selling. By doing so, you make it easier for the reader to see what you are offering.
- ② Always include the price of whatever it is you are selling. Research has shown that 52% of people who read classified ads will not respond to advertisements that fail to include the price.
- ③ Keep abbreviations to a minimum. It makes whatever you have to say more easily understood.
- ④ Pretend to be your prospective customer. Ask yourself what it is you would like to know about the product or service that you are selling that would make you want to buy it. For example, you could include information such as brand names, colours and specifications.

NASDA, Japan's National Space Development Agency Exhibition is on show at the Science Museum, Exhibition Road, London, until the 28th February 1992. The exhibition is located on the Ground Floor in the Exploration of Space Gallery.

General Enquiries:
Telephone 071 938 8008

CLASSIFIED COUPON

							£3.36
							£5.04
							£6.72
							£8.40
							£10.08
							£11.76

Rates are 20p per word plus 4p VAT (lineage, for semi-display advertisements contact our Ad. Dept.). All classified advertisements must be pre-paid. Please send your copy with the remittance (payable to Intra Press or payments by Visa or Access accepted) to: Practical Electronics Classified Dept., Intra House, 193 Uxbridge Road, London W12 9RA. Tel: 081-743 8888, Fax: 081-743 3062

FROM PAGE 31.

Fig. 1. The timing circuit is not shown here because this part of the instrument has already been built by Mr. Spearritt, and requires no further design work.

The starting point of the design was to use a BCD up/down counter to provide the data for the least significant digit. The most significant digit can only be 1 or 0, so a simple flipflop will do this function. A JK flipflop is shown here, but a circuit could equally be designed around a D-type.

Assuming that the rotation of the knob provides the waveform shown appearing at the two inputs to the circuit, IC4 will count up until, when it reaches 9, the carry-out pin will go to logic 0 enabling IC7 to be clocked. The queue output of IC7 will switch to logic 1, switching on segments B and C of the most significant digit to show a 1. This sophisticated circuit incorporates leading-zero blanking - the first digit doesn't switch on at all if a 1 is not required.

The least significant digit is driven in the conventional manner by a BCD to seven-segment decoder/driver. This drives a common cathode display, whose brightness is set by the value of the resistors R4 to R10 (and R2 and R3 in the case of the most significant digit). All these resistors have the same value, which you should choose according to the brightness you want. Start with 2k2 and experiment until you find the illumination you want.

To drive the lamps, 18 mutually-exclusive outputs are required. To provide this, two four line to sixteen line decoders are both fed with the least significant digit data. Only one of the decoders is enabled, according to the state of IC7. The decoder selected by IC7 is uninhibited while the timer input is at logic 1. The outputs of the decoders are active high, and control the 6-volt lamps via power mosfets. Any MOSFET with an on-resistance low enough to not to reduce the lamp voltage significantly will do. The suggested type, the BUZ10, is available from Maplin at a reasonable price. Only one output drive transistor is shown, but of course 18 are needed.

Not all the outputs of each decoder are used. 18 lamp sequences are required, while the counter has 20 states counting 0 and

19. It makes sense to treat these two states as dead positions, and operate on positions 1 to 18. To do this, outputs S1 to S9 on IC1 and S0 to S8 on IC2 would be used.

Perhaps, if Mr. Spearritt discovers anything of relevance to the design of electronic displays - VDU screens, for example - he would write to PE and tell us about it.

Alright Cuk?

During the last year there have been several references in the technical press to the Cuk (pronounced chook) converter, a novel switched mode power supply topology devised by Slobodan Cuk at the California Institute of Technology.

The claims for this converter seem almost too good to be true, and very valuable if they do work out, so I decided to investigate further. Here is a potted version of what I have learned so far. It would not be possible to encapsulate all I have found of interest in this short article, and I still have more to learn, but here are the highlights:

The Principles

The first part of the converter viewed on its own looks like a flyback converter, which would provide voltage step up in this configuration. The second part of the circuit looks like a buck regulator. The Cuk converter partakes of some of the properties of each type of regulator; it can both increase and decrease voltage according to the mark/space ratio with which the switch is operated, unlike a flyback converter whose output is always equal to or greater than its input voltage, or a buck regulator which can only regulate down from the input voltage.

The way in which the converter functions may not be obvious so I have run a computer simulation to produce some idealised waveforms. Real life waveforms do look like these theoretical ones, except that they have extra rings and overshoots due to leakage reactance, stray capacitances and the like. Fig. 1 shows the circuit which was simulated. The components shown are idealised, that is, pure inductance and capacitance, so extra resistors have been added to the circuit to simulate the resistance of the component. R3 and R4 simulate the resistances associated with L1 and L2 respectively, and R2 simulates the on-resistance of the FET. The FET model does include figures for gain and a normal FET response curve, so that saturation can occur in this simulation. This also corresponds with effects I have observed in practice.

Fig. 2 shows a typical set of waveforms obtained after the converter has been running for some time. The FET is driven with a 1:1 mark/space ratio, in which mode the output voltage should be of the same value as the input voltage but negative, if there were no losses in the circuit. As can be seen, the output voltage is slightly reduced due to the losses, the diode forward drop, and so on.

The sequence of events is as follows: while the FET is on, energy is fed into L1 from the input power source, and the current in L1 ramps up approximately linearly. In continuous operation, C1 will charge so that its left-hand end is on average in excess of 30 volts more positive than its right-hand end. While the fet is on, the left-hand end of the capacitor is at zero volts, so the right-hand end starts at whatever negative potential the

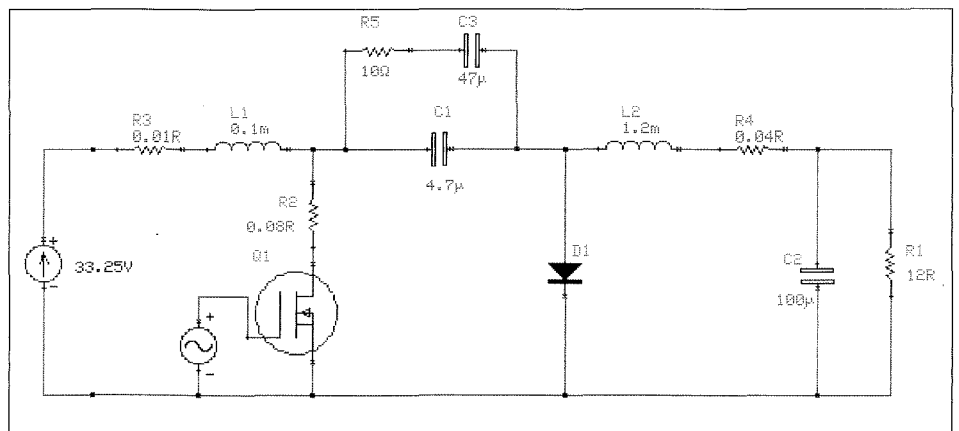

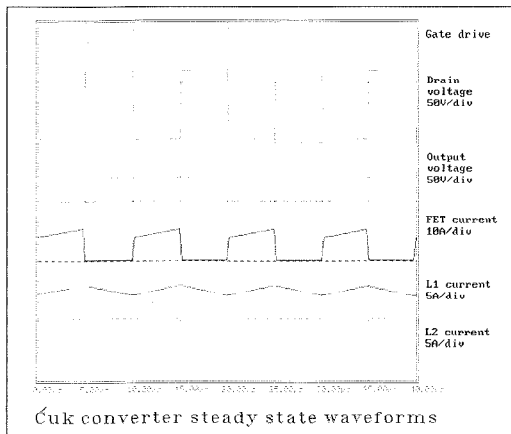

capacitor had charged to during the other part of the operating cycle. This transfers energy to L2, partially discharging the capacitor. Therefore, the current in both inductors ramps up while the FET is switched on.

When the FET is switched off, energy from L1 is transferred to C1. The right hand end of C1 is prevented from rising more than one diode drop above 0V, while the left hand end is charged to a voltage dependent upon the current in L1. During this part of the cycle, the current in L1 ramps down, as does the current in L2, which continues to supply energy to the output.

All this is clearly shown in the waveform diagram. The amplitude of the drain voltage waveform is equal to the voltage across C1, while the slope on the top of the waveform is due to the capacitor charging. The output voltage, on the scale shown here, is completely constant, though on a magnified scale ripple would obviously be visible.

Ripple Current

Note that the positive current in L1 and the negative current in L2 are of almost exactly equal amplitude and have very similar waveforms. Note also that the FET current while the FET is switched on is equal to the sum of the currents in the two inductors, so that one potential disadvantage of this type of converter is that high peak currents must be switched.

The great advantage is that both input and output currents are continuous. In a flyback converter, continuous current may be drawn from the supply, but the output load is supplied in discontinuous pulses. This makes the job of filtering the output much more

difficult. A buck regulator, on the other hand, can supply continuous load current but it draws current from its supply in sharp pulses. It follows therefore that filtering and preventing the radiation of interference is likely to be much easier with a Cuk converter than with other topologies.

A further refinement is possible: if L1 and L2 are wound on the same inductor core, it is possible to arrange that the AC component of the input current, the ripple, is coupled to the output in such a way as to cancel the output ripple. (It is equally possible to reduce the input ripple current to zero, at the expense of increasing the output current ripple, but it is less likely that anybody would wish to do this.)

The down side of this is that the inductor core must store both the input and the output energy. In many practical designs, the necessary turns ratio between input and output inductors will make one of the inductors unusually high. The total energy storage required from the core is then also high – in a design I am currently working on, I need to store up to 35 millijoules.

Stability

There is another snag associated with the Cuk converter, and it is to combat this that R5 and C3 are included in the simulation circuit. A practical switched mode power supply must include control circuitry to regulate the output voltage. Careful consideration is normally required to make sure that the control loop does not oscillate. It is much more difficult to avoid oscillation when controlling a Cuk converter. Inherent instability is not visible in a steady state operation, so in Fig. 3 are the simulated waveforms at switch-on. I can attest that these are also true to life.

Notice how the peak drain voltage is different on subsequent cycles. The apparent frequency one would get by drawing a waveform across the tips of the drain voltage waveform would correspond to a resonance which will tend to upset any voltage control loop which is applied to the system. C3 and R5 damp this ring; it

would be much more severe without those two components. The resonance is deliberately under-damped in order to demonstrate its effect.

To make the converter controllable damping components are absolutely essential. It is also vital to ensure that the resonant frequency due to L1 and C1 is not too close to that due to L2 and C2. Since in most cases an undetermined amount of extra load capacitance may be connected to the power supply, and partly to reduce the output ripple, it is sensible to make the L2/C2 frequency the lower one.

The FET current waveform shows the effects of saturation in the fet. When the fet is switched on it conducts the maximum current which it can conduct given its gate voltage. The effect of this is visible in the drain voltage waveform, when at switch-on the drain voltage momentarily falls close to zero, and then rises as saturation takes effect. As the demanded FET current decreases, saturation takes place for less and less of the switching cycle, until by 250µs it is no longer occurring. Note also that while the FET is operating in saturation, the inductor currents do not show their normal characteristic triangular ripple.

There is more that can be said about the Cuk converter. I hope this outline has explained the basic principles. I suspect that this topology will see increasing use as it becomes more widely known and its advantages are appreciated. In particular, it may prove to be valuable to help meet European EMC (electromagnetic compatibility) requirements in reducing interference from power supplies. ■

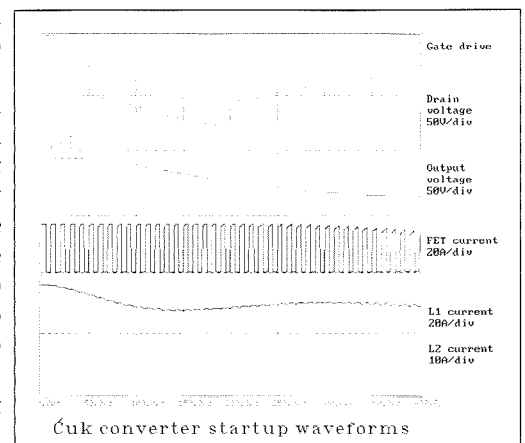

Subscribe to

PRACTICAL

ELECTRONICS

SCIENCE AND TECHNOLOGY

Every month we bring you the best coverage of the modern technical world.

Innovations has all the news of the latest developments, technical features explain the detail behind the glittering facade of technology, while writers such as Barry Fox, Technology Journalist of the Year and Ian Burley, Editor of BT's Prestel Micronet consumer section, analyse the growing role of electronics in everyday life. Finally, for those of you who want personal hands-on experience of design and construction, our projects offer entry level designs and advanced challenges.

A 12-month subscription is only £18 (UK), £22 (surface mail) or £39 (air mail). Concessionary rates also available. Order by credit card on 081 743 8888.

Subscribe today and book your place in the electronic future.

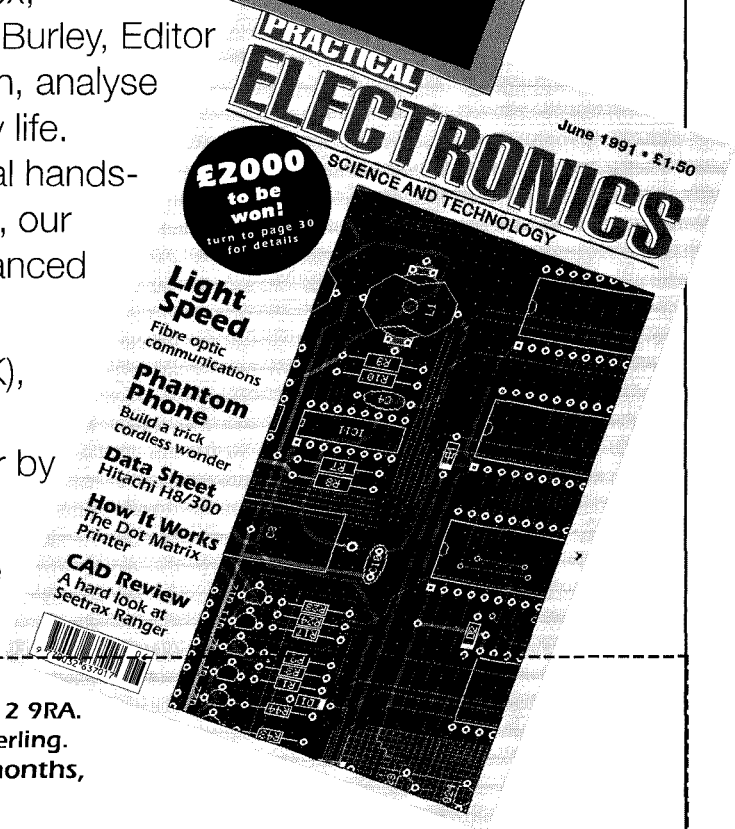

Send to:
Intra Press, Intra House, 193 Uxbridge Road, London W12 9RA.
Make cheques/postal orders payable to Intra Press in £ sterling.
Please subscribe me to Practical Electronics for 12 months,
starting with the issue.
I enclose a cheque/postal order/banker's draft for £.....

Name
Address
Town
County
Post Code.....
Or: Please charge my VISA/Mastercard
Number
Expiry date.....

Subscription rates:

UK post – £18, Overseas surface mail – £22, overseas airmail – £39.

Discount rates:

UK BAEC/Educational concession– £16.20, Overseas BAEC/Educational concession – £19.80 (surface mail only available)

Please enclose proof of BAEC membership or educational status.

Barry Fox continued from page 62

authorisation code, including the PIN, in addition to the telephone number called after the code. Quirke used his chargecard in a small hotel in the North of England and an alert desk clerk queried the long strings of numbers which appeared on the printout used by the hotel to calculate Quirke's bill.

Unseen Problem

In many hotels the guest would not see the logger printout. People making calls from an office phone would never see the switchboard printout. But any opportunist with access to the logger can make a note of any chargecard numbers and either use them to make free calls, or sell the number to third parties.

A month after TRR had alerted BT to the problem, BT was still sending out literature to prospective card users and giving advice over the phone which made no mention of the security risks.

Safe Credit Limit

BT argues that cards are subject to a daily credit limit and holders can set a low limit. Also BT says its fraud managers look for abnormal patterns of use. But setting a low limit to protect against fraud would prevent the legitimate owner using the card from making a flurry of expensive calls in an emergency.

BT admits that the full number and PIN will show up on a call logger. A spokesman says: "We are looking into it. We are planning to make the public aware now that the subject has come up. We will build warnings into our literature to educate customers. We will also be talking to hotels and will warn them on security."

"This is not a huge problem at present" reassures BT.

BT says it is now talking with telephone service providers AT&T in the US, and KDD in Japan, about adopting a new card system.

In the US and Japan "calling card" calls are made by calling an operator and then keying in or speaking the authorisation codes. So only the codes needed to reach the operator are logged by a switchboard. To adopt these safer systems, BT would have to completely restructure its Chargecard system.

Why, I wonder, did BT not take such obvious security issues into account before launching the system? Coming hard on the heels of technical messes like Electronic Yellow Pages and Phone Base, I wonder whether anyone at the top of BT understands technology. ■

Solder Competition Winners

The following 10 readers will each be receiving a solder station

- John Proctor, East Budleigh, Devon
- Brian Sayer, Tolworth, Surrey
- D Riseborough, Norwich
- I D Scott, Reading, Berks
- N S Wesson Orpington Kent
- R H Birkett, Redditch Worcs
- D de Garis, Guernsey, Channel Islands
- Paul Alan Wiles, Rugby, Warwickshire
- C P Konis, Oxford, Oxon
- G Headland, Lindford, Bordon, Hants

OMNI ELECTRONICS

stock a wide range of electronic components at

**174 Dalkeith Road
Edinburgh EH16 5DX
Tel: 031 667 2611**

Open Mon–Thu 9.15am–6.00pm
Fri 9.15am–5.00pm
Sat 9.30am–5.00pm



1990/91 catalogue costs £1.50
contains vouchers to use against purchases
Do you have your copy yet?

MAKE YOUR INTERESTS PAY!

Over the past 100 years more than 9 million students throughout the world have found it worth their while! An ICS home-study course can help you get a better job, make more money and have more fun out of life! ICS has over 90 years experience in home-study courses and is the largest correspondence school in the world. You learn at your own pace, when and where you want under the guidance of expert 'personal' tutors. Find out how we can help YOU. Post or phone today for your **FREE INFORMATION PACK** on the course of your choice. (Tick one box only!)

Electronics	<input type="checkbox"/>	TV, Video & Hi-Fi Servicing	<input type="checkbox"/>
Basic Electronic Engineering (City & Guilds)	<input type="checkbox"/>	Refrigeration & Air Conditioning	<input type="checkbox"/>
Electrical Engineering	<input type="checkbox"/>	Car Mechanics	<input type="checkbox"/>
Electrical Contracting/Installation	<input type="checkbox"/>	Computer Programming	<input type="checkbox"/>
GCSE/GCE/SCE over 40 examination subjects to choose from <input type="checkbox"/>			

Name _____ Address _____



International Correspondence Schools, EDS22 312/314 High Street, Sutton, Surrey SM1 1PR. Telephone: 081-643 9568 or 041-221 2926 (24 hours)

Advertising Index

ADM	5	JPG Electronics	54
AGS	55	London Elec. Coll.....	54
Alphavite Publications ..	4	Maplin.....	OBC
BK Electronics.....	IBC	Marapet	29
Bull Electrical.....	42	Mauritron.....	56
Cambridge Computer		MQP Electronics	4
Science	54	NCT.....	16
Coles Harding	54	Number One Systems.	19
CR Supply Company...55		Omni Electronics	60
Cricklewood.....	16	Program Now	29
Datong Electronics.....	16	Radio & Tel. Corr. Schl	54
Greenbank	29	Suma Designs	27
Happy Memories	38	Tandy	14
Henry's Audio	16	Tsien.....	IFC
Intl. Corr. Schl.....	60		

The Universe comes to London

A Two Day Conference and Exhibition

Speakers Include:

Doctor Patrick Moore,

CBE, Editor-in-Chief, Astronomy Now

Professor Arnold Wolfendale,

Astronomer Royal

Professor Sir Bernard Lovell,

Jodrell Bank, University of Manchester

Professor Malcolm Longair,

Cavendish Laboratory, Cambridge University

Professor Peter Willmore,

Department of Space Sciences, Birmingham University

Professor Tony McDonnell,

Head of Unit for Space Sciences, University of Kent at Canterbury

Professor Andrew Lyne,

University of Manchester

Doctor Heather Couper

Leif Robinson,

Editor, Sky & Telescope

Doctor John Mason,

Deputy Editor, Astronomy Now

The Venue:

Royal Borough of Kensington Town Hall
Hornton Street, London W8 7NX ENGLAND
Friday 14th - Saturday 15th February 1992

Sponsored by:

Astronomy Now

**SKY
& TELESCOPE**

For details of how to exhibit contact the organisers:
Peter Hall & Associates Limited
Suite 75, 49 Hallam Street, London,
W1N 5LN ENGLAND
Telephone: 071-580 2104
Fax: 071-323 3891

For a copy of the Conference Programme, details
of special accommodation packages,
and how to apply for tickets, write to:
The 1992 European AstroFest (Tickets)
Intra House, 193 Uxbridge Road,
London W12 9RA ENGLAND

Barry Fox Examines BT's Chargecard Fiasco

Barry examines BT's telephone chargecards and finds that their security is not only lax, it is almost non-existent.

If you use one of British Telecom's Chargecards, be warned. If you know anyone who uses one, warn them. There is a very serious flaw in their security.

A Chargecard lets the owner make telephone calls from over 30 million phones throughout the UK, and from 120 countries, with the call billed to the cardholder's home or office account. BT warns cardholders that they must pay for any unauthorised calls. Nearly a million have been issued over two years. Recently BT stepped up promotion.

Widely Available

Anyone can apply for a Chargecard, although BT admits that there have been delays of up to 8 weeks in issuing them. BT variously blames this on a virus in the Chargecard control computer and unprecedented demand for



cards. BT also admits to "malfunction" of the control system which has left some people with new or renewed cards which do not work because the code numbers on the cards do not match the numbers in BT's system.

But these problems pale into insignificance when compared with the security loopholes.

Security Risk

The Chargecard looks like a credit card and carries an account number. When making a call through an operator, the card holder simply reads out the number to the operator. So there is no security. If the card falls into the wrong hands, or someone sees it and notes the number, or overhears the number when spoken to the operator, they can make calls which are billed to the rightful cardholder's account. The cardholder will not find out about the fraud until the itemised bill comes through. In applying for the

card the subscriber must sign a declaration accepting responsibility for use of the card "whether the use is authorised or unauthorised".

"It's like credit cards, if someone gets a credit card they can book tickets with it," says BT.

But with credit cards the party must sign on collection, or have goods sent to the address registered for the card. The alternative way of using the Chargecard is, in theory, more secure when used to make direct dial calls from a payphone, hotel phone or private home or office phone. The cardholder is given a secret personal identification number or PIN. The cardholder dials 144, then keys in the account number printed on the card, then the PIN and then the telephone number being called. If the call connects, the charge is billed to the cardholder's account.

The fatal flaw in the direct dial system is that many private switchboards in hotels and offices now have an electronic call logger which registers, records and prints out all numbers called from all extensions. Offices use loggers to stop staff making private calls and hotels use them to bill guests for calls made.

Problem Revealed

Unfortunately for BT, and fortunately for cardholders, Dermot Quirke, editor of the telecommunications trade newsletter Telecomms Regulation Review, has discovered that these loggers will also faithfully record and print out the full Chargecard

Continued on page 60

"I wonder whether anyone at the top of BT understands technology."

OMP MOS-FET POWER AMPLIFIERS HIGH POWER, TWO CHANNEL 19 INCH RACK

THOUSANDS PURCHASED BY PROFESSIONAL USERS

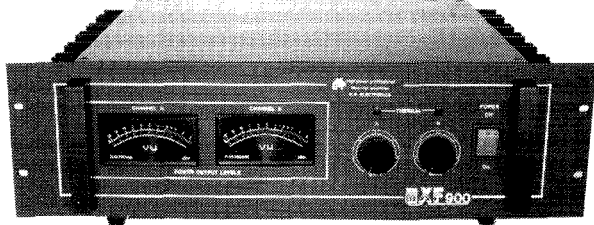

THE RENOWNED MXF SERIES OF POWER AMPLIFIERS

FOUR MODELS:- MXF200 (100W + 100W) MXF400 (200W + 200W) MXF600 (300W + 300W) MXF900 (450W + 450W)
ALL POWER RATINGS R.M.S. INTO 4 OHMS, BOTH CHANNELS DRIVEN

FEATURES: ★Independent power supplies with two toroidal transformers ★ Twin L.E.D. Vu meters ★ Level controls ★ Illuminated on/off switch ★ XLR connectors ★ Standard 775mV inputs ★ Open and short circuit proof ★ Latest Mos-Fets for stress free power delivery into virtually any load ★ High slew rate ★ Very low distortion ★ Aluminium cases ★ MXF600 & MXF900 fan cooled with D.C. loudspeaker and thermal protection.

USED THE WORLD OVER IN CLUBS, PUBS, CINEMAS, DISCOS ETC.

SIZES:- MXF200 W19" x H3 1/2" (2U) x D11"
 MXF400 W19" x H5 1/4" (3U) x D12"
 MXF600 W19" x H5 1/4" (3U) x D13"
 MXF900 W19" x H5 1/4" (3U) x D14 1/2"

PRICES:- MXF200 £175.00 MXF400 £233.85
 MXF600 £329.00 MXF900 £449.15
 SPECIALIST CARRIER DEL. £12.50 EACH

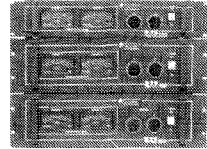

OMP VARISPEED TURNTABLE CHASSIS

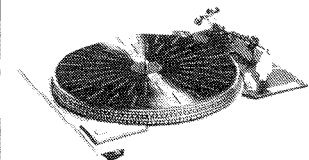

★ Manual arm ★ Steel chassis ★ Electronic speed control 33 & 45 R.P.M. ★ Vari pitch control ★ High torque servo driven DC motor ★ Transit screws ★ 12" die cast platter ★ Neon strobe ★ Calibrated balance weight ★ Removable head shell ★ 1/2" cartridge fixings ★ Cue lever ★ 220/240V 50/60Hz ★ 390x305mm ★ Supplied with mounting cut-out template.

PRICE £61.30 + £3.70 P&P

OPTIONAL MAGNETIC CARTRIDGES STANTON AL500mkII GOLDRING G950
 PRICE £16.95 + 50p P&P PRICE £7.15 + 50p P&P

STEREO DISCO MIXER DJ6500

★ WITH ECHO ★

STEREO DISCO MIXER with 2 x 7 band L & R graphic equalisers with bar graph LED Vu meters. **MANY OUTSTANDING FEATURES:-** including Echo with repeat & speed control, DJ Mic with tone control & talk-over switch, 7 Channels with individual faders plus cross fade, Cue Headphone Monitor. Useful combination of the following inputs:- 3 turntables (mag), 3 mics, 5 Line for CD, Tape, Video etc.

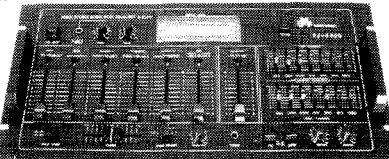

Price £134.99 + £5.00 P&P

SIZE: 482 x 240 x 120mm

PIEZO ELECTRIC TWEETERS - MOTOROLA

Join the Piezo revolution! The low dynamic mass (no voice coil) of a Piezo tweeter produces an improved transient response with a lower distortion level than ordinary dynamic tweeters. As a crossover is not required these units can be added to existing speaker systems of up to 100 Watts (more if two are put in series). **FREE EXPLANATORY LEAFLETS ARE SUPPLIED WITH EACH TWEETER.**

TYPE 'A' (KSN1036A) 3" round with protective wire mesh. Ideal for bookshelf and medium sized Hi-Fi speakers. **Price £4.90 + 50p P&P.**

TYPE 'B' (KSN1005A) 3 1/2" super horn for general purpose speakers, disco and P.A. systems etc. **Price £5.99 + 50p P&P.**

TYPE 'C' (KSN1016A) 2" x 5" wide dispersion horn for quality Hi-Fi systems and quality discos etc. **Price £6.99 + 50p P&P.**

TYPE 'D' (KSN1025A) 2" x 6" wide dispersion horn. Upper frequency response retained extending down to mid-range (2KHz). Suitable for high quality Hi-Fi systems and quality discos. **Price £9.99 + 50p P&P.**

TYPE 'E' (KSN1038A) 3 3/4" horn tweeter with attractive finish trim. Suitable for Hi-Fi monitor systems etc. **Price £5.99 + 50p P&P.**

LEVEL CONTROL Combines, on a recessed mounting plate, level control and cabinet input jack socket. 85x85mm. **Price £4.10 + 50p P&P.**

OMP LINNET LOUDSPEAKERS

THE VERY BEST IN QUALITY AND VALUE

Made especially to suit today's need for compactness with high output sound levels, finished in hard wearing black vinylite with protective corners, grille and carrying handle. Each unit incorporates a 12" driver plus high frequency horn for a full frequency range of 45Hz-20KHz. Both models are 8 Ohm impedance. Size: H20" x W15" x D12".

CHOICE OF TWO MODELS

POWER RATINGS QUOTED IN WATTS RMS FOR EACH CABINET

OMP 12-100WATTS (100dB) PRICE £163.50 PER PAIR
OMP 12-200WATTS (200dB) PRICE £214.55 PER PAIR

SPECIALIST CARRIER DEL. £12.50 PER PAIR



IN-CAR STEREO BOOSTER AMPS

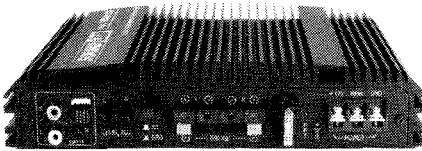

PRICES: 150W £49.99 250W £99.99
400W £109.95 P&P £2.00 EACH

THREE SUPERB HIGH POWER CAR STEREO BOOSTER AMPLIFIERS

150 WATTS (75 + 75) Stereo, 150W Bridged Mono
 250 WATTS (125 + 125) Stereo, 250W Bridged Mono
 400 WATTS (200 + 200) Stereo, 400W Bridged Mono
ALL POWERS INTO 4 OHMS

Features:
 ★ Stereo, bridgable mono ★ Choice of high & low level inputs ★ L & R level controls ★ Remote on-off ★ Speaker & thermal protection.

OMP MOS-FET POWER AMPLIFIER MODULES

SUPPLIED READY BUILT AND TESTED.

These modules now enjoy a world-wide reputation for quality, reliability and performance at a realistic price. Four models are available to suit the needs of the professional and hobby market i.e. Industry, Leisure, Instrumental and Hi-Fi etc. When comparing prices. NOTE that all models include toroidal power supply, integral heat sink, glass fibre P.C.B. and drive circuits to power a compatible Vu meter. All models are open and short circuit proof.

THOUSANDS OF MODULES PURCHASED BY PROFESSIONAL USERS



OMP/MF 100 Mos-Fet Output power 110 watts R.M.S. into 4 ohms, frequency response 1Hz - 100KHz -3dB, Damping Factor >300, Slew Rate 45V/uS, T.H.D. typical 0.002%, Input Sensitivity 500mV, S.N.R. -110 dB. Size 300 x 123 x 60mm.
PRICE £40.85 + £3.50 P&P



OMP/MF 200 Mos-Fet Output power 200 watts R.M.S. into 4 ohms, frequency response 1Hz - 100KHz -3dB, Damping Factor >300, Slew Rate 50V/uS, T.H.D. typical 0.001%, Input Sensitivity 500mV, S.N.R. -110 dB. Size 300 x 155 x 100mm.
PRICE £64.35 + £4.00 P&P



OMP/MF 300 Mos-Fet Output power 300 watts R.M.S. into 4 ohms, frequency response 1Hz - 100KHz -3dB, Damping Factor >300, Slew Rate 60V/uS, T.H.D. typical 0.001%, Input Sensitivity 500mV, S.N.R. -110 dB, Fan Cooled, D.C. Loudspeaker Protection, 2 Second Anti-Thump Delay. Size 385 x 210 x 105mm.
PRICE £81.75 + £5.00 P&P



OMP/MF 450 Mos-Fet Output power 450 watts R.M.S. into 4 ohms, frequency response 1Hz - 100KHz -3dB, Damping Factor >300, Slew Rate 75V/uS, T.H.D. typical 0.001%, Input Sensitivity 500mV, S.N.R. -110 dB, Fan Cooled, D.C. Loudspeaker Protection, 2 Second Anti-Thump Delay. Size 385 x 210 x 105mm.
PRICE £132.85 + £5.00 P&P

NOTE: MOS-FET MODULES ARE AVAILABLE IN TWO VERSIONS: STANDARD - INPUT SENS 500mV, BAND WIDTH 100KHz. PEC (PROFESSIONAL EQUIPMENT COMPATIBLE) - INPUT SENS 775mV, BAND WIDTH 50KHz. ORDER STANDARD OR PEC.

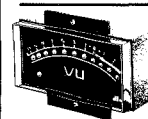

Vu METER Compatible with our four amplifiers detailed above. A very accurate visual display employing 11 L.E.D.s (7 green, 4 red) plus an additional on/off indicator. Sophisticated logic control for very fast rise and decay times. Tough moulded plastic case, with acrylic tinted front. Size 84 x 27 x 45mm.
PRICE £8.70 + 50p P&P

LOUDSPEAKERS

LARGE SELECTION OF SPECIALIST LOUDSPEAKERS AVAILABLE, INCLUDING CABINET FITTINGS, SPEAKER GRILLES, CROSS-OVERS AND HIGH POWER, HIGH FREQUENCY BULLETS AND HORNS, LARGE (A4) S.A.E. (50p STAMPED) FOR COMPLETE LIST.

Ⓜ - From McKenzie Professional Series
 Ⓝ - From McKenzie Studio Series

McKENZIE - INSTRUMENTS, P.A., DISCO, ETC

ALL McKENZIE UNITS 8 OHMS IMPEDANCE

- 8" 100 WATT Ⓜ C8-100GP GEN. PURPOSE, LEAD GUITAR, EXCELLENT MID, DISCO. RES. FREQ. 80Hz, FREQ. RESP. TO 7KHz, SENS 96dB. **PRICE £31.45 + £2.00 P&P**
- 10" 100WATT Ⓝ C10-100GP GUITAR, VOICE, KEYBOARD, DISCO, EXCELLENT MID. RES. FREQ. 80Hz, FREQ. RESP. TO 6KHz, SENS 97dB. **PRICE £38.89 + £2.50 P&P**
- 10" 200WATT Ⓜ C10-200GP GUITAR, KEYB'D, DISCO, EXCELLENT HIGH POWER MID. RES. FREQ. 59Hz, FREQ. RESP. TO 5KHz, SENS 97dB. **PRICE £53.21 + £2.50 P&P**
- 12" 100WATT Ⓜ C12-100GP HIGH POWER GEN. PURPOSE, LEAD GUITAR, DISCO. RES. FREQ. 49Hz, FREQ. RESP. TO 7KHz, SENS 98dB. **PRICE £40.35 + £3.50 P&P**
- 12" 100WATT Ⓜ C12-100TC (TWIN CONE) HIGH POWER, WIDE RESPONSE, P.A., VOICE, DISCO. RES. FREQ. 45Hz, FREQ. RESP. TO 12KHz, SENS 97dB. **PRICE £41.39 + £3.50 P&P**
- 12" 200WATT Ⓜ C12-200B HIGH POWER BASS, KEYBOARDS, DISCO, P.A. RES. FREQ. 45Hz, FREQ. RESP. TO 5KHz, SENS 99dB. **PRICE £71.91 + £3.50 P&P**
- 12" 300WATT Ⓜ C12-300GP HIGH POWER BASS, LEAD GUITAR, KEYBOARDS, DISCO ETC. RES. FREQ. 49Hz, FREQ. RESP. TO 7KHz, SENS 100dB. **PRICE £95.66 + £3.50 P&P**
- 15" 100WATT Ⓜ C15-100BS BASS GUITAR, LOW FREQUENCY, P.A., DISCO. RES. FREQ. 40Hz, FREQ. RESP. TO 5KHz, SENS 98dB. **PRICE £59.05 + £4.00 P&P**
- 15" 200WATT Ⓜ C15-200BS VERY HIGH POWER BASS. RES. FREQ. 40Hz, FREQ. RESP. TO 3KHz, SENS 98dB. **PRICE £80.57 + £4.00 P&P**
- 15" 250WATT Ⓜ C15-250BS VERY HIGH POWER BASS. RES. FREQ. 39Hz, FREQ. RESP. TO 4KHz, SENS 99dB. **PRICE £90.23 + £4.50 P&P**
- 15" 400WATT Ⓜ C15-400BS VERY HIGH POWER, LOW FREQUENCY BASS. RES. FREQ. 40Hz, FREQ. RESP. TO 4 KHz, SENS 100dB. **PRICE £105.46 - £4.50 P&P**
- 18" 500WATT Ⓜ C18-500BS EXTREMELY HIGH POWER, LOW FREQUENCY BASS. RES. FREQ. 27Hz, FREQ. RESP. TO 2KHz, SENS. 98dB. **PRICE £174.97 - £5.00 P&P**

EARBENDERS- HI-FI, STUDIO, IN-CAR, ETC

- ALL EARBENDER UNITS 8 OHMS** (Except EB8-50 & EB10-50 which are dual impedance tapped @ 4 & 8 ohm)
- BASS, SINGLE CONE, HIGH COMPLIANCE, ROLLED SURROUND**
- 8" 50watt EB8-50 DUAL IMPEDANCE, TAPPED 4/8 OHM BASS, HI-FI, IN-CAR. RES. FREQ. 40Hz, FREQ. RESP. TO 7KHz SENS 97dB. **PRICE £8.90 + £2.00 P&P**
- 10" 50WATT EB10-50 DUAL IMPEDANCE, TAPPED 4/8 OHM BASS, HI-FI, IN-CAR. RES. FREQ. 40Hz, FREQ. RESP. TO 5KHz, SENS. 99dB. **PRICE £13.65 - £2.50 P&P**
- 10" 100WATT EB10-100 BASS, HI-FI, STUDIO. RES. FREQ. 35Hz, FREQ. RESP. TO 3KHz, SENS 96dB. **PRICE £30.39 - £3.50 P&P**
- 12" 100WATT EB12-100 BASS, STUDIO, HI-FI, EXCELLENT DISCO. RES. FREQ. 26Hz, FREQ. RESP. TO 3 KHz, SENS 93dB. **PRICE £42.12 + £3.50 P&P**
- FULL RANGE TWIN CONE, HIGH COMPLIANCE, ROLLED SURROUND**
- 5" 60WATT EB5-60TC (TWIN CONE) HI-FI, MULTI-ARRAY DISCO ETC. RES. FREQ. 63Hz, FREQ. RESP. TO 20KHz, SENS 92dB. **PRICE £9.99 + £1.50 P&P**
- 6" 60WATT EB6-60TC (TWIN CONE) HI-FI, MULTI-ARRAY DISCO ETC. RES. FREQ. 38Hz, FREQ. RESP. TO 20KHz, SENS 94dB. **PRICE £10.99 - 1.50 P&P**
- 8" 60WATT EB8-60TC (TWIN CONE) HI-FI, MULTI-ARRAY DISCO ETC. RES. FREQ. 40Hz, FREQ. RESP. TO 18KHz, SENS 99dB. **PRICE £12.99 - £1.50 P&P**
- 10" 60WATT EB10-60TC (TWIN CONE) HI-FI, MULTI ARRAY DISCO ETC. RES. FREQ. 35Hz, FREQ. RESP. TO 12KHz, SENS 98dB. **PRICE £16.49 + £2.00 P&P**

TRANSMITTER HOBBY KITS

PROVEN TRANSMITTER DESIGNS INCLUDING GLASS FIBRE PRINTED CIRCUIT BOARD AND HIGH QUALITY COMPONENTS COMPLETE WITH CIRCUIT AND INSTRUCTIONS

3W TRANSMITTER 80-108MHz, VARICAP CONTROLLED PROFESSIONAL PERFORMANCE, RANGE UP TO 3 MILES, SIZE 38 x 123mm, SUPPLY 12V @ 0.5AMP. **PRICE £14.85 - £1.00 P&P**

FM MICRO TRANSMITTER 100-108MHz, VARICAP TUNED, COMPLETE WITH VERY SENS FET MIC, RANGE 100-300m, SIZE 56 x 46mm, SUPPLY 9V BATTERY. **PRICE £8.80 + £1.00 P&P**

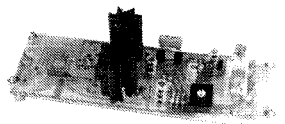

PHOTO: 3W FM TRANSMITTER

B.K. ELECTRONICS

UNITS 1 & 5 COMET WAY, SOUTHEND-ON-SEA, ESSEX, S92 6TR.
Tel.: 0702 - 527572 Fax.: 0702 - 420243



POSTAL CHARGES PER ORDER £1.00 MINIMUM. OFFICIAL ORDERS FROM SCHOOLS, COLLEGES, GOVT. BODIES, PLCs ETC. PRICES INCLUSIVE OF V.A.T. SALES COUNTER, VISA AND ACCESS ACCEPTED BY POST, PHONE OR FAX.



1992 BUYER'S GUIDE TO ELECTRONIC COMPONENTS

Maplin

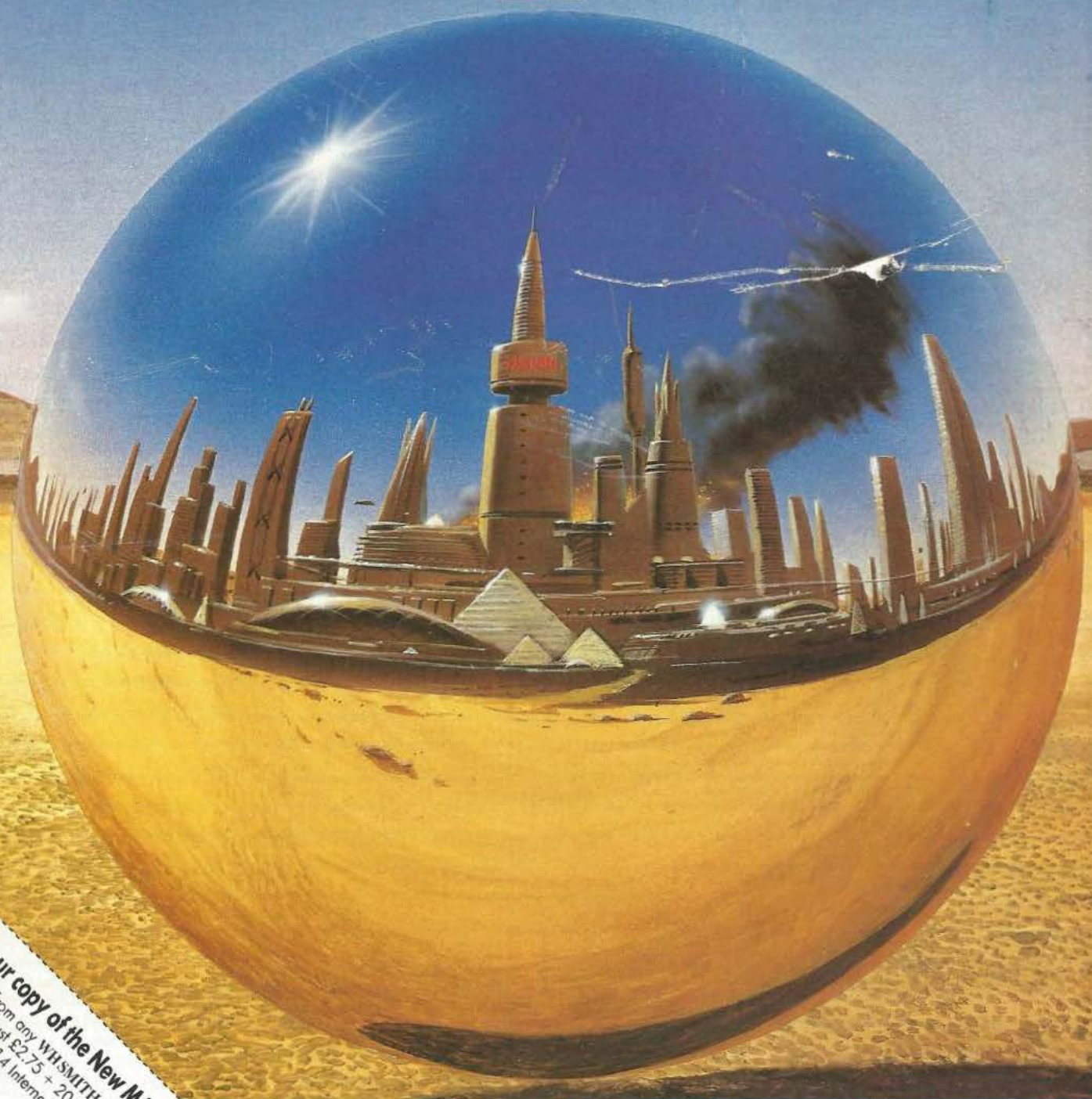

Order your copy of the New MAPLIN Catalogue on sale NOW!
Pick up a copy from any WHSMITH for just £2.75 or post this coupon now to receive your copy for just £2.75 + 20p p&p. If you live outside the U.K. send £4.85 or £4.85 + 14 International Reply Coupons. I enclose £2.95.

Name

Address

Post Code

Send to Maplin Electronics,
P.O. Box 3, Rayleigh,
Essex SS6 8LR

Over 600 product packed pages with
more than 600 brand new products.
On sale now, only £2.75

Available from all branches of WHSMITH and
Maplin shops nationwide. Hundreds of new products
at super low prices!