

PRACTICAL

July 1991 • £1.50

ELECTRONICS

SCIENCE AND TECHNOLOGY

£2000
to be
won!
turn to page 53
for details

A Global Village

Satellites come down to Earth

Neural Networks

Electronics with intelligence

Low Herz Metering

Simple designs for beginners

Practical Components
Everything about transistors

Data Sheet
The New Hitachi H8/330

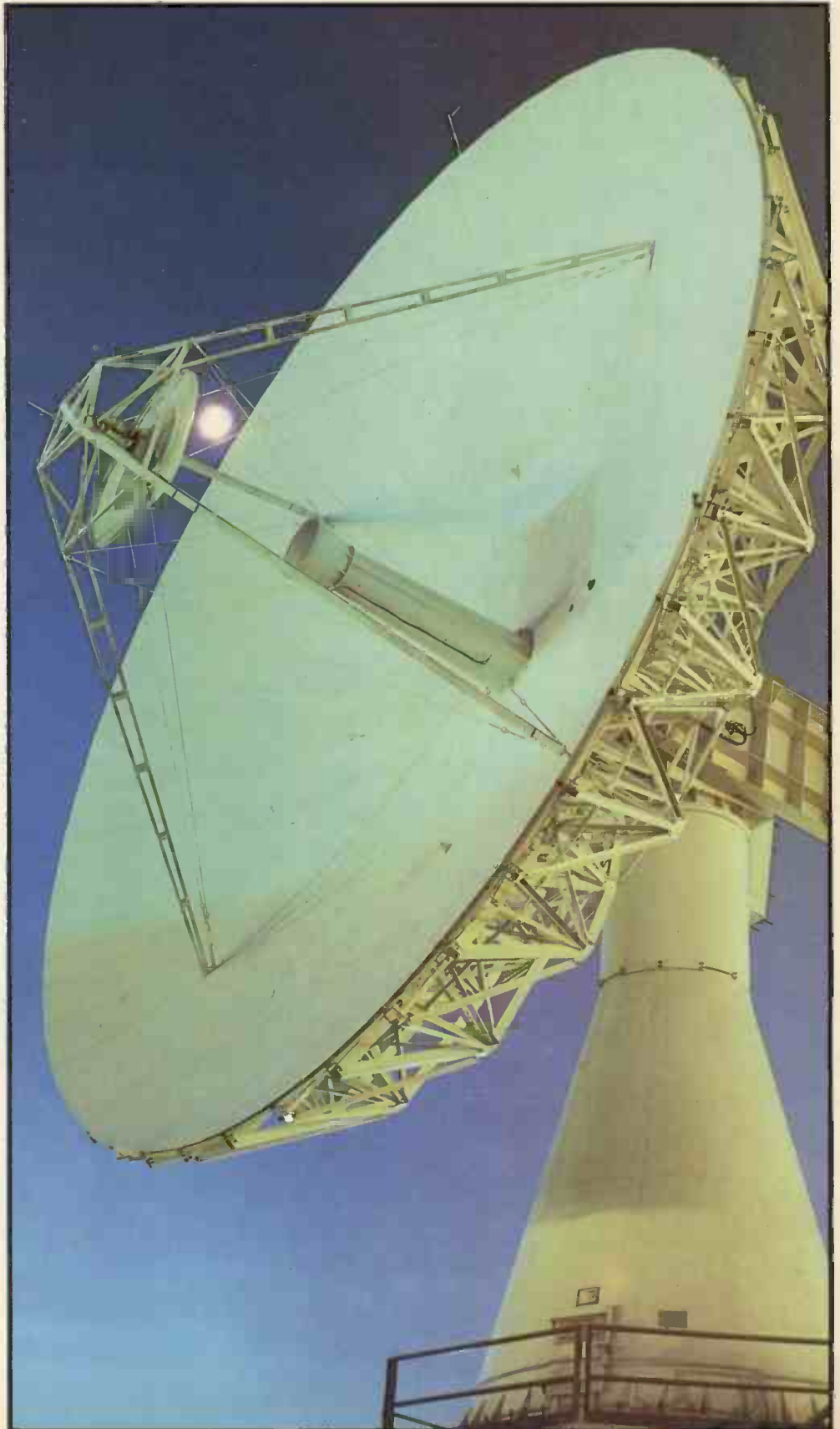

Take the Sensible Route!

BoardMaker is a powerful software tool which provides a convenient and fast method of designing printed circuit boards. Engineers worldwide have discovered that it provides an unparalleled price performance advantage over other PC-based and dedicated design systems by integrating sophisticated graphical editors and CAM outputs at an affordable price.

NEW VERSION

In the new version V2.40, full consideration has been given to allow designers to continue using their existing schematic capture package as a front end to BoardMaker. Even powerful facilities such as Top Down Modification, Component renumber and Back Annotation have been accommodated to provide overall design integrity between your schematic package and BoardMaker. Equally, powerful features are included to ensure that users who do not have schematic capture software can still take full advantage of BoardMaker's net capabilities.

BoardMaker V2.40 is a remarkable £295.00 (ex. carriage & VAT) and includes 3 months FREE software updates and full telephone technical support.

AUTOROUTER

BoardRouter is a new integrated gridless autoroute module which overcomes the limitations normally associated with autorouting. **YOU** specify the track width, via size and design rules for individual nets, BoardRouter then routes the board based on these settings in the same way you would route it yourself manually.

This ability allows you to autoroute mixed technology designs (SMD, analogue, digital, power switching etc) in **ONE PASS** while respecting **ALL** design rules.

GRIDLESS ROUTING

No worrying about whether tracks will fit between pins. If the track widths and clearances allow, BoardRouter will automatically place 1, 2 or even 3 tracks between pins.

FULLY RE-ENTRANT

You can freely pre-route any tracks manually using BoardMaker prior to autorouting. Whilst autorouting you can pan and zoom to inspect the routes placed, interrupt it, manually modify the layout and resume autorouting.

BoardRouter is priced at £295.00, which includes 3 months FREE software updates and full telephone technical support. BoardMaker and BoardRouter can be bought together for only £495.00. (ex. carriage & VAT)



tsien

Tsien (UK) Limited
Cambridge Research Laboratories
181A Huntingdon Road
Cambridge CB3 0DJ UK
Tel 0223 277777
Fax 0223 277747

All trademarks acknowledged

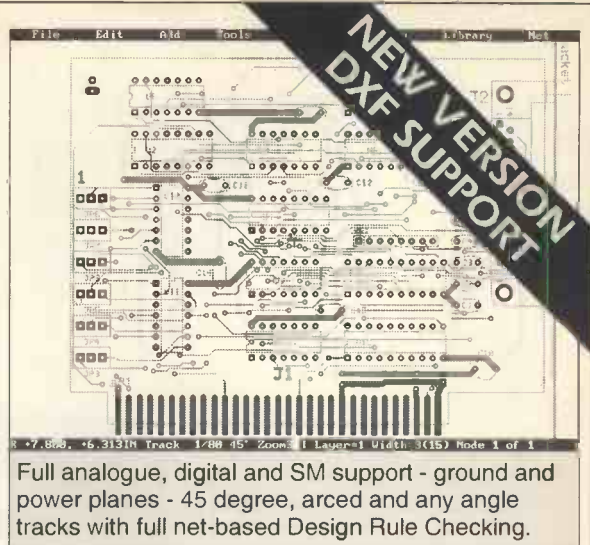

Full analogue, digital and SM support - ground and power planes - 45 degree, arced and any angle tracks with full net-based Design Rule Checking.

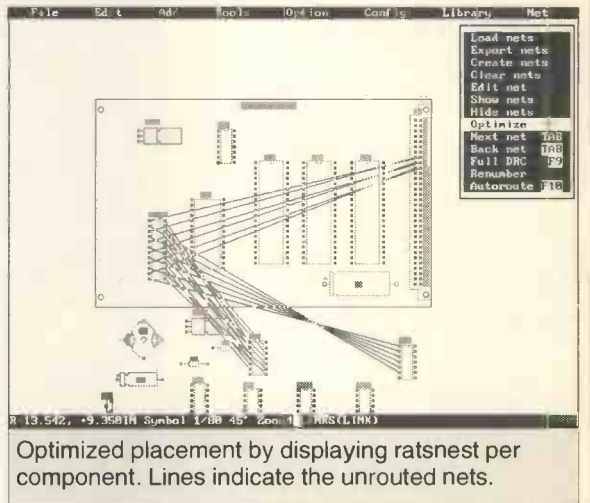

Optimized placement by displaying ratsnest per component. Lines indicate the unrouted nets.

HIGHLIGHTS

- Net list import from OrCAD, Schema etc.
- Graphical and manual netlist entry
- Top down modification for ECOs
- Forward and back annotation
- Component renumber
- Effortless manual routing
- Fully re-entrant gridless autorouting
- Simultaneously routes up to eight layers
- Powerful component placement tools
- Copper fill
- Curved tracks
- Extensive Design Rule Checking
- Full complement of CAM outputs
- Support and update service
- Reports generator
- Gerber, PostScript & DXF output
- Full SMD support

Don't just take our word for it. Call us today for a FREE Evaluation Pack and judge for yourself.



This month...

Due to a lack of communication between myself and Hitachi, the H8/330 did not get published as advertised on the cover last month. Fortunately, the situation has been sorted out and the chip is featured in the Data Sheet section this month.

Judging by the number of phone calls to PE's offices, many readers are missing the PCB service.

Unfortunately, this had to be withdrawn for economic reasons – it has since been farmed out to a third party.

As anyone who has done it will tell you, it is quite easy to build your own PCBs and the materials are widely available. To prove the point I set about making a board the results of which can be seen on page 43 – to my shame, I have to admit that this is the first PCB I have ever made (degree level electronics courses are heavy on the theory but can be light on the practice).

Kenn Garroch, Editor

Next month...



Remote sensing... Charge-Coupled Devices have enormously extended the reach of modern telescopes. IRIS, the latest IR device, has probed structures millions of light years away.

Build It

- A Low Hertz Meter25
More essential test equipment to build and use.
- PE Chronos.....37
The final part of the Universal Counter Timer.
- Logic Analyser47
A digital code convertor for the workshop.

Features

- The Satellite Story10
The Earth is caught up in an invisible web of telecommunications. Since the launch of TelStar, satellites have played an important role.
- Neural Networking16
Computers modelled on the human brain may offer startling new processing capabilities.
- Innovation and Alienation22
Technology affects our values in subtle ways.
- Printed Circuit Construction43
Almost all designs use PCBs. Learn how to build them yourself.

Regulars

- Wavelength.....5
The great debate over resistor symbols rumbles on plus modifications to the PE Tele-Snap.
- Innovations.....6
Microcircuitry, macroeconomics, meters and much more.
- Data Sheet31
Full specifications and diagrams of the new Hitachi H8/330 super powered microcontroller.
- Practical Components.....34
The transistor is the key component in modern logic circuit technology.
- Techniques58
A variety of problems solved by our technical expert, including temperature sensors and guitar pickups.
- Barry Fox63
Once again the hydra-like problem of radio spectrum bandwidth allocation rears its ugly heads.

Editor: Kenn Garroch Technical Editor: Andrew Armstrong Technical Illustrator: Derek Gooding Advertisement Manager David Bonner Production Manager: Richard Milner Production Assistant: Michael Sullivan Office Manager: Laura Esterman Office Secretary: Wendy Rhodes Publisher: Angelo Zgorelec • Practical Electronics Intra House 193 Uxbridge Road London W12 9RA Tel: 081-743 8888 Fax: 081-743 3062 Telecom Gold: 87: SQ0567 • Advertisements The Publishers of PE take reasonable precautions to ensure that advertisements published in the magazine are genuine, but cannot take any responsibility in respect of statements or claims made by advertisers. The Publishers also cannot accept any liability in respect of goods not being delivered or not working properly. • © Intra Press 1991. Copyright in all drawings, photographs and articles published in PRACTICAL ELECTRONICS is fully protected, and reproduction or imitations in whole or in part are expressly forbidden. All reasonable precautions are taken by PRACTICAL ELECTRONICS to ensure that the advice and data given to readers is reliable. We cannot, however, guarantee it, and we cannot accept legal responsibility for it. Prices quoted are those current as we go to press. All material is accepted for publication on the express understanding that the contributor has the authority to permit us to do so. • Practical Electronics is typeset at Intra Press on Macintosh computers using Quark Xpress. Reproduction by Tetracolour Ltd. Printing by Andover Press, St Ives plc. Distribution by Seymour Press • ISSN 0032-6372 •

Wavelengths

If you have any comments, suggestions, subjects you think should be aired, write to PE

I found the Tele-Snap project in the May issue of PE interesting until the software part came into view.

It seems a pity that GW-Basic was used as there are so many good versions of Basic available for the PC these days. However, once I saw Locomotive Basic 2 mentioned, this signalled the Amstrad PC1512 computer.

If Mr. Becker was using a PC1512 he is correct when he says he cannot use 16 colours from GW-Basic, but if he was using an IBM compatible with EGA graphics then my version of GW-Basic will allow the use of 16 colours.

I was an Amstrad PC1512 owner and I quickly got fed up with Basic 2 so I taught myself to program in C, Borland Turbo C in fact, the effort being well worth it I would say.

Now to the best part; because I wanted to use the unique 16 colour mode of the Amstrad PC1512 I wrote a graphics library in C which allows the programmer to access the 16 colours just as easily as if using a proper EGA card – the library is available from me at the fully inclusive price of £10.95 and is compatible with Turbo C v1.5 and Turbo C v2.0.

Not content with this I then rewrote the library in Turbo Pascal and this is also available from me for £10.95 and is compatible with Turbo Pascal v4.0, v5.0 and v5.5.

Both disks contain a demo program and several example programs and are available on 5.25in or 3.5in disks, please state size when ordering.

If, like me, you already have an expansion card fitted to your PC which uses address space at 300H then the following modification may be of use.

The PC allocates I/O memory space to a prototype card from 300H to 31FH, its official title is "prototype card I/O map" but this really means the area has not been reserved by IBM for its own use and is available for the user safe in

the knowledge that the computer will not try to access it for any internal use.

As the card already installed in my computer uses I/O addresses 300H to 303H I would need to change the Tele-Snap I/O address to 310H using the following method.

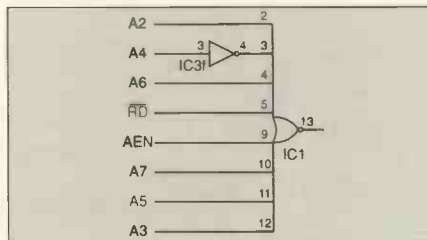

By cutting a few tracks on the PCB and soldering a few links on, the unused gate in IC3 can be used to invert A4 which now makes the base address of the Tele-Snap 310H

If a clearer modification is required then an IC socket can be used for IC1 and a small board made up which plugs into this using a header plug – an extra 74HC04 would then be required.

Douglas Fisher
Highfield
Braithwaite
Workingham
Cumbria
CA14 4TG

More Squiggles

In May 1991, John Bilson commented that he thought that the 'squiggle' resistor was the standard symbol. However, I understand from my GCSE and A level studies that the rectangle was now standard. I remember in the second year I wrote down a squiggle and was told not to do it again!

On the subject of the new design of Practical Electronics, I would like to ask what has become of Space Watch? I have been an intermittent read of the magazine over the past twelve months and the main reason that made me decide to start reading it regularly was the space item that set it apart from other

magazines. I read with interest the so called 'science feature' on superconductors in the May edition. Is this going to be a regular feature, perhaps taking in some of the items from space watch?

Your series named 'How It Works' is very good. I like the cut away pictures that have been included. Talking of 'How It Works', are you going to publish follow up articles on Nicam Stereo. It seems a pity that, after showing technical details, this is not backed up with a practical project to show the system, perhaps a small project that would fit into an existing TV?

The article on computer interfacing (April 1991) was illuminating. Here I am typing this letter into my QL with all its slots and plug holes and not a mention in the articles. Am I the only reader with such a computer? I doubt it as it has been described by some people as a good hacking machine or good for experimenting with add on electronics. In addition to having 256k put aside for add-ons, the computer can automatically check for such devices and link in any required extensions to the operating system, if the hardware is accompanied by a small ROM.

Overall I very much like your magazine. I nearly entered the loyalty bonus contest last month but, to my consternation, I find for this and other months that the slip we have to send in is on the other side of some pretty informative articles. Is it not possible to arrange that the slip is with the other adverts, or even on a page of its own?

James Gibson
Newbury
Berks

Alas, Space Watch is no more but there will be other articles covering similar ground in the future. I'll have to look into the Nicam question – nothing is planned at the moment. As for the QL, I'm afraid that there wasn't space, perhaps in a future issue. Turn to page 53 for the solution to your tearing problem. ■

Telepoint Tax Peril

The new tax on mobile telephones may apply to telepoint phones as well, because the Treasury is apparently unaware of the difference between telepoint and cellular phones. Telepoint phones are cheaper but can only make outgoing calls and must be in range of a base station, thus cannot be used to annoy customers in restaurants. With only about 5000 subscribers the system is struggling to stay alive. Telepoint operators are keeping their heads down hoping the tax will not be levied on their service.

TV interference

The proposed Channel 5 TV service is liable to clash with the frequencies used by millions of home video units in the UK. The new service will use two UHF frequencies called channels 35 and 37 – these are currently used by radio microphones and airport radar. The channels will be freed for TV use by moving radio mics off the TV waveband and by transferring radar to channel 36.

Unfortunately a lot of domestic video equipment already uses these frequencies, albeit at low power, to connect to the aerial sockets of TV sets, and often suffers from interference as a result. For instance in the area around Heathrow airport, which uses channel 36 radar, many video recorders must be retuned to channel 37 from the usual channel 36 setting.

Under the terms of the

Intelligent Isolation

Using 2 way radios, cellular phones, computers or even fax machines in a car is becoming quite common, and so too is the possibility of overvoltage and reverse polarity damage caused by a battery change or a misconnection. The RP2 works as an intelligent relay which can completely isolate the 12 volt radio or computer should the supply voltage exceed 16 volts or if the polarity is reversed in vehicles. A pair of light emitting diodes give instant indication of the problem.

Conventional 'crow bar' diode protection against reverse power connections is designed to blow the supply fuse, but becomes completely

useless should the equipment in question still have a metal to metal contact to the vehicle chassis. Reverse polarity in this situation will often vaporise power plugs or PCB tracks. Fusing of the negative supply cable is one solution, but if that blows, then it's absence when correct polarity is restored will not be obvious and can be dangerous.

The RP2 is designed to prevent such potential damage and can be connected in series with the supply cable close to the radio or other equipment and the car. It is available for £3 direct from Stewart Harding at Communication Development Specialists Ltd on 02956 83656

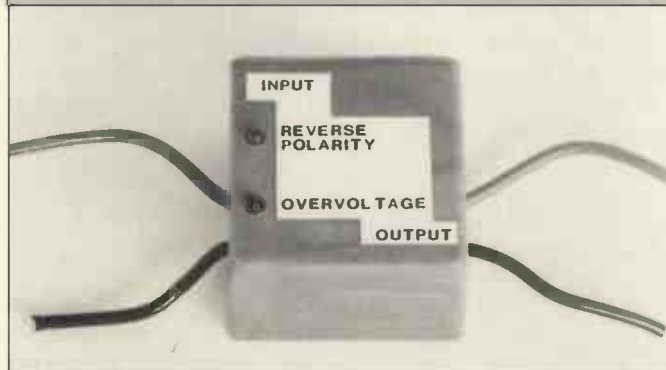

broadcasting Act 1990, franchisees of Channel 5 TV must pay for any modifications to equipment necessary because of interference. Taking into account the numbers of video sets, satellite receivers and game machines involved, the cost is likely to run into many millions of pounds.

Funding Doom?

The annual State of the Universities report from the

Committee of Vice-Chancellors and Principals suggests that increases in research grants from industry and medical charities have more than made up for a relative lack of government funding over the past decade. The cash available for each tenured researcher has increased by 35% since 1984, and there are now more researchers doing more research. But since the new funds are often applied to short-term, applied research with a quick payoff – rather

than basic science, which is regarded as the government's responsibility – long-term research projects have suffered.

Protectionism

European Community policy on support for the home electronics industry may be in disarray after a recent move by France. When the European Commission, which controls Brussels-based aid to electronics companies, announced a reorientation of funding away from basic research and towards market-lead developments, the French called for an agency modelled on the ESA to support electronics without interference from Brussels and announced £1 billion of support for Bull and Thomson, the computer giants which made record losses last year. The Commission replied that the last attempt at such an agency, the French-sponsored Eureka plan, failed to gain significant support from industry. Furthermore the Commission has promised to investigate the French aid as an unfair subsidy and a distortion of free trade.

A report in The Economist (20-26 April) claims that state subsidies for European computer companies, in the form of grants and large government contracts, have merely enabled manufacturers to survive in the face of superior international competition, and are thus counter-productive.

CD Tester

Instruments

PCB failures can now be tracked down to component level without powering up the boards and without circuit documentation using T3000, a new trouble-shooting instrument for fault-finding on analog or digital printed circuit boards. Designed by Polar and distributed in the UK by Whingate, this portable instrument uses the powerful impedance signature technique to address PCB repair issues.

The T3000 tests a PCB on a component by component basis. It works by applying an AC signal which is both voltage and current limited to the component under test and displaying the resulting dynamic "impedance signature" on its built in screen. Different types of component present different forms of signature and it is easy to spot when one has failed. This technique easily identifies the vast majority of service-related problems; catastrophic component failures and open or shorts. In its "compare" mode it allows the signature of a good board to be displayed alongside that of the faulty board under test and it is also possible to spot a large proportion of complex parametric failure modes.

The T3000 checks any kind of device technology from discrete resistors, capacitors, inductors, diodes and transistors to analog or digital ICs. It is also possible for non-electronics specialists to operate as it has built in easy to use features such as the autoranger which auto selects the best drive

Studios and radio stations may find this new CDQC-2 Compact CD Test System useful for controlling all CD parameters. It can be used to archive CDs, monitor CD tracks prior to broadcast, and diagnose

even inaudible CD faults.

Using an attached printer, the CD tester can report faults in a number of different ways. The cost is a mere £5,240 plus VAT and it is available from FWO Bauch Ltd on 081 953-0091.



for the device under test. The cost is £2,450 and it is available from Whingate Test Services Ltd 0202 605239.

When measuring far away from any mains power, the new HP 8590B rugged spectrum analyser run from the Hewlett Packard 85901A AC power source could prove useful. It covers a frequency of 9kHz to 1.8GHz and an amplitude range from -115dBm to +30dBm. The new spectrum analyser also has 32 kbytes of nonvolatile program memory and a built in clock/calendar which can be used to stamp time and date information onto test results. Rates are £281 + VAT for one week's rental which can be obtained from Hewlett Packard Rental Department on 0753 580000.

Allied Meters

Philips in conjunction with Fluke, the famous US instrumentation firm, has brought out a new range of multimeters, the Fluke 70 series II. A key feature of the range, which starts at £59, is the Automatic Touch Hold facility which allows the user to take readings in hard to reach places while keeping their eyes on the circuit. Models at the top end of the range, priced at £155, can check capacitance from 10pf to 9,999µF and are designed to test large

electrolytics, saving the need for a dedicated capacitance tester. They use a digital display to show both Hz Frequency and AC voltage at the same time and so allow the technician to see how much potentially hazardous voltage is present when making frequency measurements.

The new alliance between the two companies means that the meters will be sold in the UK by Philips and in the US and Canada by Fluke.

Testing TVs can sometimes be confusing since it is important to know whether it's the box or the remote control which is to blame. A remote control tester, now available from Maplin in kit form, checks whether



the remote control unit is transmitting an infra-red carrier or data stream. This tester ignores any ambient infra-red energy, so it can be used in full sunlight. It works by detecting changes in the ambient infra-red level

and converts these into visible light by means of an amplifier and red LED. The kit costs £7.10 inc. VAT and is available from Maplin on 0702 554155.

Logic Probes designed for use with TTL, DTL and CMOS IC's are now available from Maplin for £15.28 (plus postage). Using its memory function to detect the occurrence of single pulses or logic level, the probe can recognise pulses from 30ms up to 500ms. It has 3 coloured LRDs showing high logic level (red), low logic level (green) and pulse (yellow).

Radio buffs are set for an exciting time as with the deregulation of the airwaves as 200 or more new independent local radio stations are planned. To enable listeners to take advantage of the variety of stations, the Maplin Radio Rod has been launched. This rod is omni-directional and designed to receive national and local transmissions from any direction in the range 88-108 MHz. It can be fitted in the loft or on the outside of the house together with a coax plug or coupler. Cost £14.25 inc. VAT (plus postage).

General

Miniature lamps designed for building into electronic and electrical equipment are now available at quite reasonable prices. The range consists of 3 basic types: signal filament 6-70V current ratings 20-200mA; signal neon and green fluorescent lamps 60-220V and current rating 0.3-3.5mA; multi LED lamps in red, green

Packing Them In

Housing gadgets such as personal alarms, pagers or calculators can require specialised casing. A new range of enclosures from OK Industries could fulfill the need. Called PacTec pockets, the basic models come in a choice of 4 colours and 3 sizes with variations such

as sloped display panels and battery compartments. EMI/RFI shieldings, belt clips, wrist straps and UL94V-O fire retardant rating are additional options. One off prototypes can be bought directly from OK industries in Eastleigh Hants, Tel: 0703 619841.

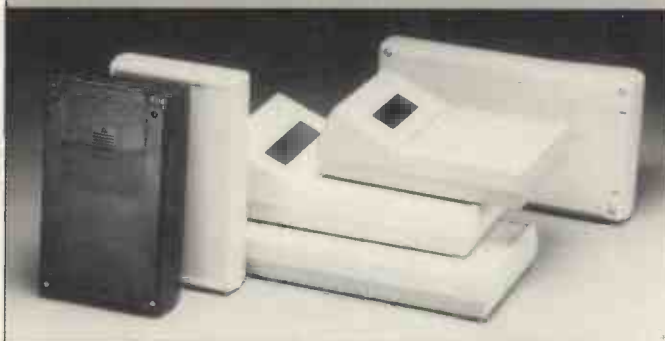

or yellow 6-48 VDC current rating 10-35mA. The lamps have a life expectancy of between 3000 and 100,000 hours and are available from Electroustic Ltd on 0254 333664.

Ion imbalances in the home can be restored using the new ioniser kit from Maplin. The ioniser called Breeze, produces negative ions electronically to counteract the excessive positive ions generated by electronic apparatus such as TVs. The kit costs £33.67 inc. VAT and is aimed at the experienced constructor as the ioniser generates very high internal voltage and needs to be built with care. For more information contact Vic Sutton of Maplin on 0702 554155.

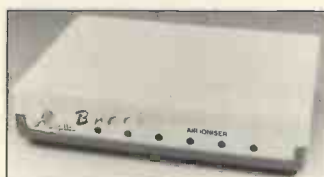

Computers

The Oak VGA card from Southern Peripherals, keenly priced at £42, enables users to get graphics display on IBM PC's AT's and XT's at a low cost. It claims to have more functions than a standard IBM VGA and as it is fully compatible with the IBM Bios, it is also downwards compatible with MDA, monochrome Hercules, CGA and EGA standards. One of the other key features is that the Oak VGA can be used with a variety of packages including Windows 3.0, Lotus 1-2-3 version 2, Framework II and III, Wordperfect 5.0 and 5.1, Ventura VI.I and Autocad. The card also supports 132 column text mode applications such as Wordstar version 3.3 and 4.2 and Wordperfect version 4.2. The card has a single ship VGA graphics controller which provides fast host access to video memory, allowing 32bit access to the video RAM.

It operates with a memory configuration of 256kbyte. It can be bought from Southern Peripherals in Hampshire 0256 819 221.

Bigger Bytes are in from Mitsumi with their 3.5 inch floppy disk drives in anticipation of the move to higher capacity 4Mbyte design as the next market standard. This 1 inc high drive is compatible with 1Mbyte, 2DD, 2Mbyte and 2HD media and is powered from signal 5V supplies. It is distributed by Southern Peripherals and enquiries should be directed to their sales office on 0256 819221.

Events

Sussex Amateur Radio and Computer Fair is on 14th July at the Brighton Racecourse, Brighton. It starts at 10.30 and purports to bring together the best of computer, amateur radio and component specialists under one roof. Contact: Ron Bray (0273) 415654.

Fourth International 16-Bit Computer Show, 12th-14th July, The Novotel, London W6. Forum for the latest products and services for the Atari ST, Commodore Amiga and PC. Contact: Tim Collins (081) 549 3444.

Reference

Readers may find the Crydom Solid State Relay Handbook at £11.87 a usefully comprehensive reference book. It covers over 233 pages detailing the use and application of devices in the range 0.7A to 90A; 120 to 480 AC 4 to 15V DC. Sales enquiries to Alan Coulling, Unitel 0438 321393. ■

MICRONTA®

VISION
P
R
E
S
E
N
T

Multitesters

A Talking Multitester. Press a button on the probe and the meter will call out it's reading in clear English. The reading is also shown on the units large, easy to read LCD display. Features autoranging, autopolarity, continuity sounder, diode-check and over-range indicators. Measures to 1000 VDC, 750 VAC, 300mA AC/DC, 30 megohms resistance. Requires 4 "AA" batteries.

B Digital Multimeter. Full autorange or manual range control, selectable by a switch. Easy to read LCD display. Ideal for use in the field, lab, shop, bench or home. Fold-out stand allows you to adjust position for better visibility or to hang unit. Features continuity check, autopolarity, diode-check and low battery indicator. Measures to 1000 VDC, 750 VAC, 200 mA AC/DC, 20 megohms resistance. Requires 2 "AA" batteries.

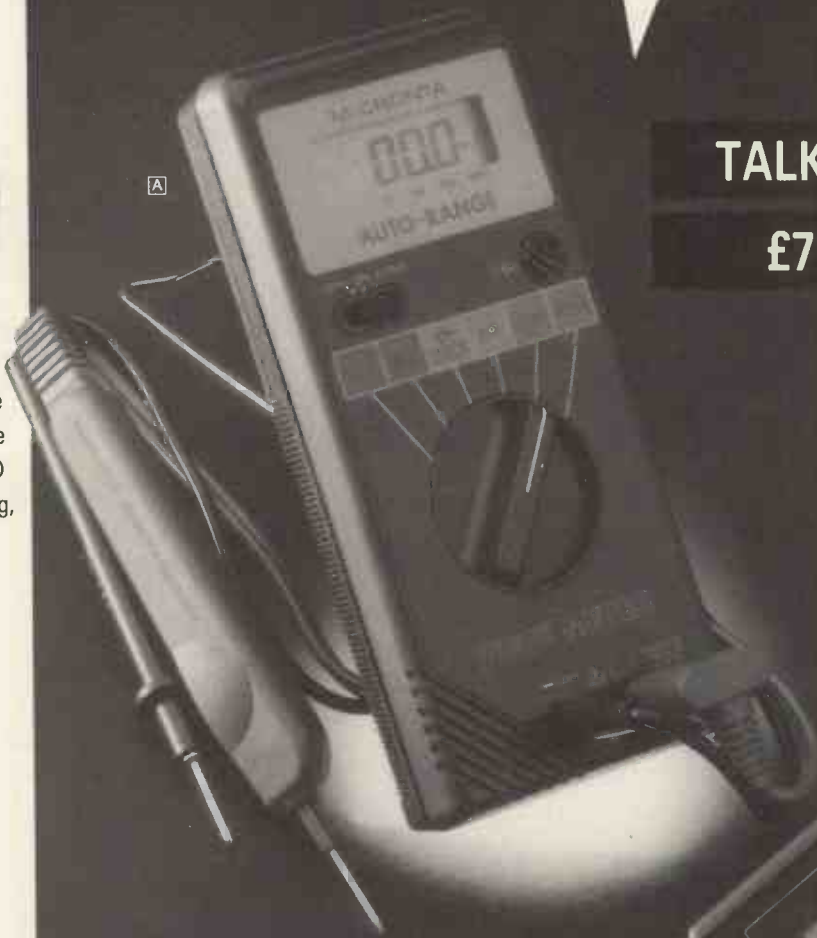

TALKING METER

£79.95 22-164

DIGITAL METER

£39.95 22-184

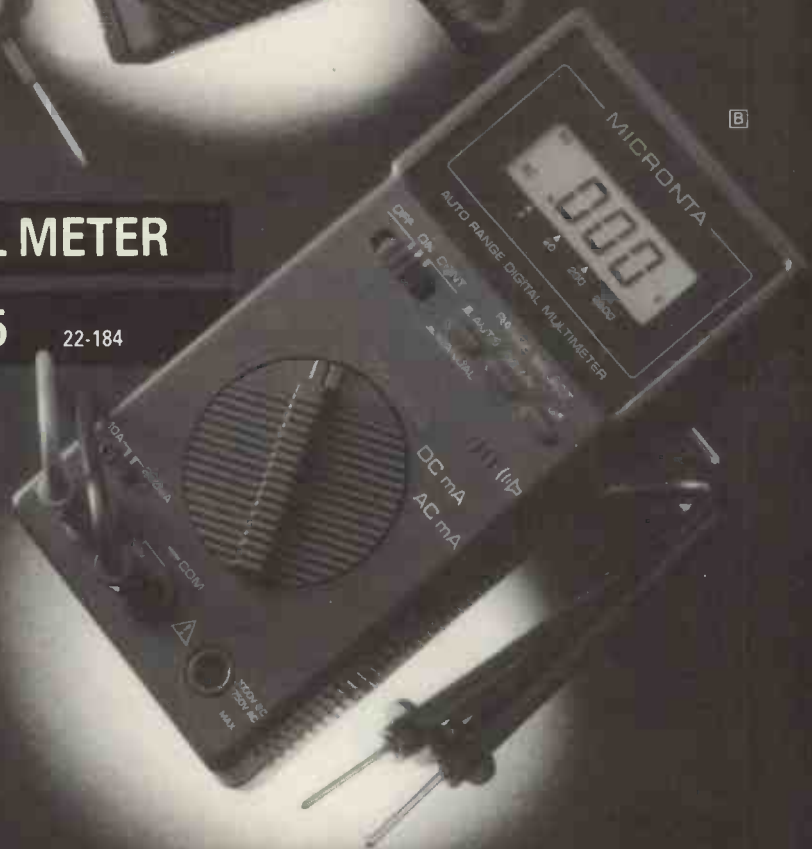

Tandy®

ALL THE ACTION
AS IT HAPPENS!

InterTAN U.K. Ltd.,
Tandy Centre,
Leamore Lane, Walsall,
West Midlands. WS2 7PS
Tel: 0922 710000

Talking To The Skies

Satellite TV, once a dream, is now an accepted part of everyday entertainment. John Brook switches on tunes in and wigs out to find out what it is all about.

As well as being useful for navigational purposes (they always point south), TV satellite dishes are bringing more and more news and entertainment into our homes. After getting off on a fairly rocky start, satellite TV is now an established part of the UK entertainment scene.

There are 16 major satellites in geosynchronous or Clarke orbits, visible from the UK. All transmit TV signals in one form or another and represent a colossal investment in the future of communications and direct broadcast TV. Unfortunately, there are a number of different standards in use for encoding the picture as well as a few systems that use scramblers as well.

By far the most common formats are PAL as used in the majority of TV sets in the UK and Germany and SECAM, used by French TV. The other system used in satellite broadcasting in MAC (Multiplexed

Analogue Components) in two formats – D MAC and D2 MAC.

D MAC is an amplitude modulated form of the FM MAC standard and in its normal format, as used in the UK, it can accommodate eight data or digital audio channels alongside the video. The European format, D2 MAC only supports four channels and, consequently, has a narrower bandwidth. Both have to be converted into PAL or SECAM by a decoder before being fed into "normal" TV sets and have been adopted by the European Commission as the standard for all new direct TV broadcasting systems.

The future of MAC lies with high definition TV (HD MAC) with its proposed 1250 lines and aspect ratio of 16:9 – much better than the current 4:3 used on standard 625 line TV. The drawback is the need for complicated video displays and cameras that can cope with the

greater number of lines and the increased screen width. On the plus side, however, the signals will still be compatible with 625 line TVs and D MAC decoders allowing the technology to be introduced before any demand actually exists.

Moving The Data

The majority of UK direct broadcast services operate in cooperation with British Telecom's London Teleport situated in the Docklands. Data is beamed up to orbit from the 13m antennae to the various satellites, Eutelsat II F1, Intelsat VA F11 and Astra and, as well as providing transmissions for such popular programs as CNN and Sky, it also serves the nearby business community with high speed data links and teleconferencing.

Communicating with a satellite uses two main channels, the up-link which transmits all of the control and data information and the



Intelsat III in a Clarke orbit covers one face of the globe – I M Postmaster General.

Satellites from the UK

Name	position	TV channels
Intelsat VB F15	60°E	5
DFS 1 Kopernicus	23.5°E	8
Astra 1A	19.2°E	17
Eutelsat II F1	13°E	9
Eutelsat 1 F5	10°E	5
Eutelsat 1 F2	7°E	5
Tele X	5°E	2
Intelsat VA F12	1°W	5
Telecom 1C	5°W	6
Telecom 1A	8°W	1
Olympus 1	18.8°W	3
TDF 1A	19°W	3
TV Sat 2	19.2°W	4
Intelsat VA F11	27.5°W	7
Marcopolo 1	31°W	5
Panamsat 1 F1	45°W	1

Getting Into Orbit

Getting an object into earth orbit is a simple enough idea as can be seen in the illustration on the right. The basic task is to give the object enough speed away from the surface so that it doesn't fall back down to Earth. The top picture shows the object fired of at a relatively slow speed at a tangent to the surface. After moving away for a short distance, it is eventually attracted back due to the force of gravity. Giving the object more speed allows it to travel further but it is still attracted back toward the ground. The centre diagram shows that the attraction causes the object to curve around with the surface for some way until it hits again. The next obvious step from this situation is to give it more speed enabling it to go into orbit – lower diagram. The velocity required to get an object into an orbit is called escape velocity and for the earth it is 3075m/s (around 17000mph).

Unfortunately, the pictures don't take into account atmospheric drag, and perturbations in the earth's gravity field. The solution to the atmospheric problem is to lift the object out of the atmosphere before giving it orbital speed. The minimum height at which drag is zero is around 240km. Once there it will stay in orbit long enough to allow ground control to manoeuvre it so that gravitic irregularities can be compensated for.

At 240km the satellite circles the earth

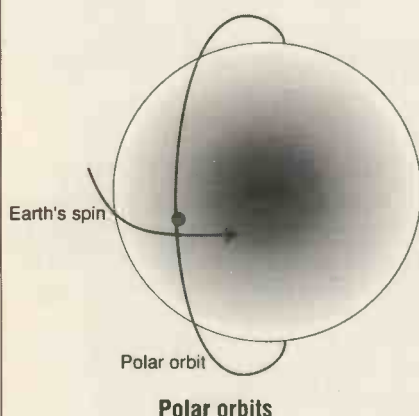

every 1.5 hours or so. This is fine for some uses – spy satellites are placed at this height to get good pictures (it is just about possible to photograph a car number plate) – but for others, such as communications, it makes life very difficult. The ground based antennas would have to track across the sky at quite a speed to keep up with the satellite and it would only be in view for a short while. Since satellites in low orbits circle faster than the earth's day, moving them further away, although increasing their speed, causes them to be overhead for longer periods. Eventually a point is reached where the satellite is moving around the earth at the same rate at which the earth is spinning – every 24 hours. This makes it appear to be stationary above a single spot and is ideal for communications since any antennae can be pointed at the same spot all of the time.

For satellites that are used for Earth sensing, meteorology, crop analysis and so on, another type of orbit can be used. Once above the atmosphere they are given a velocity at right angles to the earth's rotation. This puts them into a polar orbit allowing virtually every spot on the planet to be observed (lower left). The problem with this is that it takes a lot more fuel to get the satellite in position. Normal orbits travel in the same direction as the Earth spins since even before the rocket takes off it is travelling at 1667 km/h (along with everything else at the surface of the Earth). Trying to cancel out this speed would take a lot more fuel as would manoeuvring to different orbits – the Space Shuttle is launched from Cape Canaveral which is 28° north of the equator and since it must go into a circular orbit before it launches any satellites it is more expensive in terms of fuel than the European launch vehicle, Ariane, which takes off from Kourou which is only 5° north of the equator.

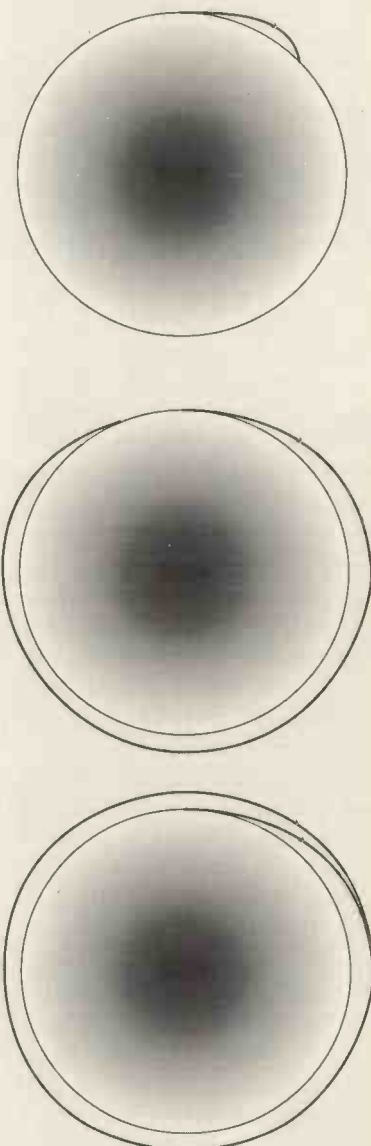

Getting there.

satellite is able to broadcast. Low power systems require larger receiving dishes whereas higher power systems can beam images directly into the home. Low power TWTs are generally capable of transmitting up to 25W and need a dish of around 3m in diameter on the ground. They are used for intercontinental telephone traffic and cable TV programs. In the medium range are the TWTs used in Astra running at about 55W. These produce enough power to transmit directly into 60cm dishes. At the top end are the high power TWTs used in Marcopolo 1. These are able to produce enough power

down-link. In the Astra system, used, among other things, to transmit Sky TV, there are two down-link antennae, one using horizontal polarisation and the other vertical. A total of 16 channels are available ranging from 11200MHz to 11450MHz. and the

system is designed mainly to operate with direct broadcast TV.

The two technological developments that make direct broadcasting of TV into homes are the travelling wave tube (TWT) and the low noise block (LNB). The first determines the power that the

Gravity

The force F between two bodies, one having mass M_1 and the other M_2 , is given by the following formula:

$$F = GM_1M_2/d^2$$

G is the universal constant of gravity ($6.670 \times 10^{-11} \text{ Nm}^2 \text{ kg}^{-2}$) and d is the distance between the bodies. In the case of the earth and according to Newton (who defined force to be equal

to mass times acceleration), this gives the acceleration g with which bodies will fall to Earth:

$$g = GM/R^2$$

where M is the mass of the earth ($5.98 \times 10^{24} \text{ kg}$) and R is the radius (6367.5 km) and results in a figure of 9.83 ms^{-2} which corresponds closely to experimental results.

for dishes of 30cm and, in particular, the squarial.

To develop more power from a medium sized satellite, a number of TWTs can be operated in parallel. Two 55W transmitters can produce a signal in the region of 110W which is about the same as a high power system.

It may appear that the signal from a direct broadcast satellite can be received at any point on the face of the Earth where the satellite is in direct sight. In practice, only a predetermined area or footprint is available. At its centre the dishes used to receive the signal would be the smallest. Moving away from this area, larger antennae are needed. For example, the Astra V1 beam is centred on the south of England and most of France. In these areas the conventional 60cm dish can be used. By the time the signal reaches Norway, mid Italy, south Spain and Iceland, a large 1.5m dish is needed.



Earth Remote Sensing

By the time you read this there should be (at least) one new satellite in orbit around the earth. ERS-1 or European Remote Sensing Satellite number 1 is set to be launched from Kourou in French Guyana on the 3rd May 1991. As its name suggests it will be used to gather more information about the state of the planet and its environment.

Placed in a near polar orbit at an altitude of 785km ERS-1 has on board a number of sophisticated instruments able to make detailed height measurements, resolve images down to 25m, measure the temperature of the sea and the speed of the winds. All of this information is transmitted back to

Earth for analysis that will lead to a clearer understanding of the way in which the planet operates and the effects we are having on it.

By far the most sophisticated piece of equipment on ERS-1 is the Synthetic Aperture Radar or SAR. This is part of the active microwave instrument and is able to obtain high resolution pictures of strips of the earth's surface 100km wide. Its 10m long antenna is aligned parallel to the orbital path of the satellite and directs a narrow radar beam onto the surface of the earth, using the delay and strength of the returned signals to build up an image. The transmitted signal is phase coded with a linear chirp

(frequency change) and the received echo compressed to generate high resolution pictures which depend upon the roughness, dielectric properties and range of the target. Due to power limitations, the SAR can only be operated in image mode for 10 minutes per orbit and because of the large amount of information generated, it can only be used when in sight of a ground station which can record the data. The second operating mode for the SAR is wave mode. This allows 5kmx5km pictures every 200km covered and can measure the direction and length of sea waves from 100 to 1000m.

Yes, it's true, the new
LOW COST BANGER
 from SEETRAX offers you

SCHEMATIC - PCB DESIGN - AUTOROUTING
 at prices you won't believe.

For £200.00 you get
SCHEMATIC CAPTURE and PCB LAYOUT

featuring

- Auto Net List Generation • Net List Input • Manual Routing
- Full Design Rule Checking • Gerber • HPGL • Dot Matrix

For £100.00 you get
AUTOROUTING

- Power • Memory • Signal



Call now for a free Demo Disk

Seetrax Limited, Hinton Dauney House, Broadway Lane,
 Lovedean, Hampshire, PO8 6SC • Tel: 0705 599017 • Fax: 0705 599036

★ ★ 8031 ★ ★
LOW COST DEVELOPMENT & TARGET SYSTEM

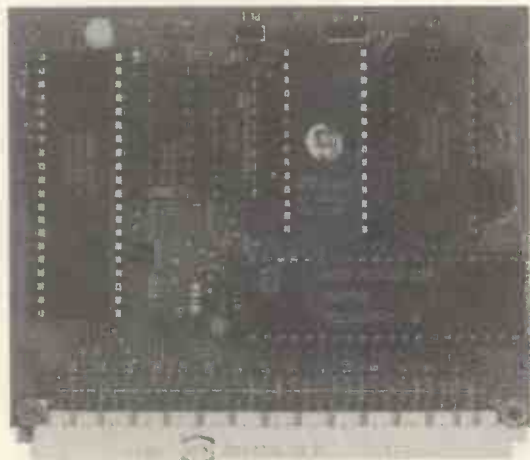

★ ★ £99.95 ★ ★ + £5.00 Carriage + VAT
 Includes 32K RAM, 8K EPROM, 38 I/O Lines, IBM
 PC/XT/AT Hosted SB51 Cross Assembler, Manual
 and Full Technical Support.

8031 Module only £59.95. 80188 & 64180 modules available

GNC ELECTRONICS

Units 2B-2C Gilray Road
 Diss, Norfolk IP22 3EU
 TEL: 0379 644285



THE SATELLITE BOOK

THE DEFINITIVE GUIDE!

John Breeds

Following the phenomenal success of his book
 'Satellite TV Installation Guide', Europe's best and
 most authoritative author for the satellite
 industry has put together the most
 comprehensive and informative book ever
 published on satellite television.

Every possible technical and practical
 related subject is covered – right from
 simple dish installation through to how
 to wire up a block of flats or even a large
 town!

There are also detailed analyses of customer care, how to
 work safely on ladders, and how to kit out a van with the tools of the trade.
 Scrambling/descrambling techniques are also included. Get real practical help
 from this 280 A4 page definitive guide. Supplemented by more than 300
 illustrations and invaluable tips and triacks of the trade – all in the familiar
 easy-to-read style of John Breeds' books

Only £27.95

(Postage FREE UK, Europe add £5, ROW add £15)

Easily the best value satellite book today!
(Total satisfaction or your money back!)

Swift Television Publications

17 Pittsfield, Cricklade, Swindon SN6 6AN

Tel or Fax on 0793 750620 or send the coupon now!

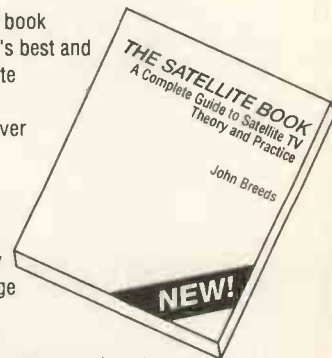

I enclose cheque/PO or please debit my Access/Visa card £27.95

Number..... Exp.....

Name.....

Address.....

Postcode..... Tick for FREE satellite booklist!

The First Communications Satellites

The idea of putting an object into orbit was first put forward in the 1920s but, unfortunately, the technology was inadequate and it was not until after World War II that practical rockets became available. The development of the A4 or V2 by the Germans was taken up by the USA and USSR and the first satellite was placed into orbit in October 1957. Sputnik I put the Soviet Union into the lead in what soon became known as the space race. Other countries quickly became involved with France, the UK, West Germany, Japan, China and Italy all getting devices into orbit at some stage of the game.

To begin with, satellites were used purely for research purposes with experiments to see what "outer space" was actually like. However, in 1945 one A C Clarke published an article which described how artificial satellites could be used to transmit radio waves over the horizon and, by selecting the correct orbit, the

satellite could be kept over the same spot on earth all the time. This geostationary orbit was calculated to be at 36000km (22300 miles) and is now known as a Clarke Orbit.

In 1955 a paper was published by Dr John Robinson Peirce who was the director of electronics research at Bell labs and, incidentally came up with the name "transistor". Entitled *Orbital Radio Relays* it started off with the Clarke Orbit idea and went on to describe all of the technical details needed to actually build a communications satellite. A few years later he persuaded NASA to launch Echo, a large passive metalised balloon, which was used to test and prove the basic principles – it was also a very bright sky object and was seen by a large number of people. In 1962 the same team launched the world's first real telecommunications satellite, Telstar, and the age of global communications had begun.

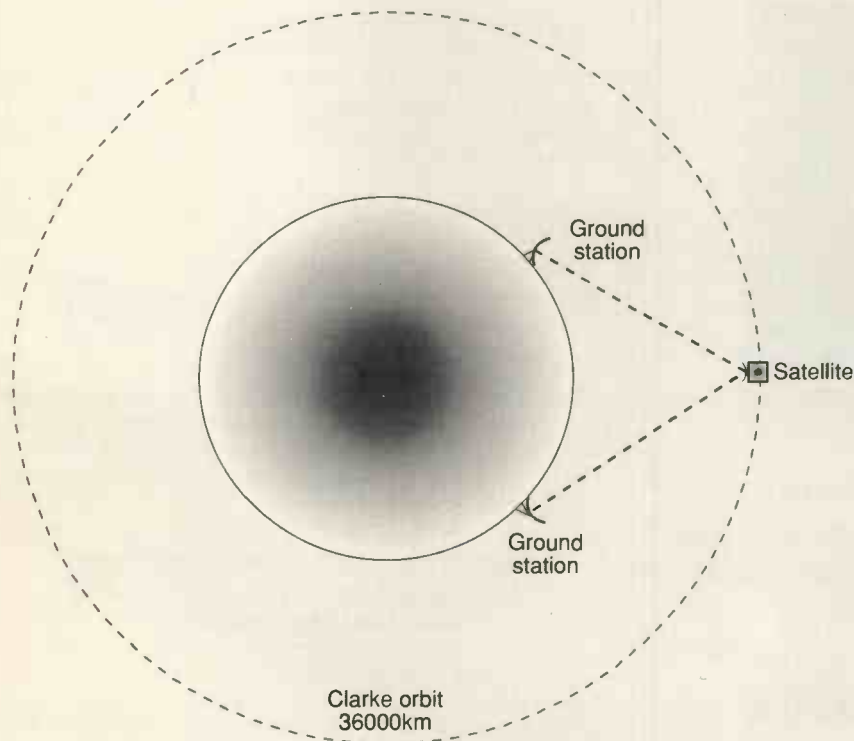

The Down Side

At the other end of the link, the LNB down converter forms a low noise amplifier that boosts the signal as it is received. It is positioned at the focus of the dish and is the most important item in the receiving system.

The LNB receives the weak signals directly from the satellite transmitter 36000km away and amplifies them. It also converts them to lower frequencies which can then be fed down a waveguide to the rest of the decoding equipment by the TV set. Without modern electronic advances in very low noise high frequency amplifiers, the LNB and satellite TV would be impossible.

At The TV

When the signal has been put through the LNB, it is fed into the satellite receiver. Here it may be either in plain (clear) format or scrambled. In the first case, the signal is converted into a UHF signal which can be fed directly into a TV aerial socket in a similar way to a VCR. If the signal is encrypted, the user must supply some sort of identification in the form of a password before the picture can be seen.

The Videocrypt system operated by Sky TV uses Public Key cryptography to code up the pictures. As the image lines are transmitted, they are cut at randomly selected points and transposed using rotation to produce a jumbled result. Without a descrambling key, it is impossible for the user to watch the program.

The encryption algorithm is transmitted as part of the TV picture during the vertical blanking period. Decoding the signal requires a smart card with a microprocessor and memory built onto it. When this is placed in the decoder it provides the key for the algorithm and the picture becomes clear. In the event of a security breach, the data sent with the program can easily be changed and new cards dispatched to the users by post. An interesting aspect of the system is that the audio signal is not scrambled, presumably to tempt people to buy decoders and smart cards for the channels that sound good. ■

Practical Electronic Neural Networks

The average human brain has 10^{11} neurons (the same as the number of stars in the galaxy) and 10^{14} interconnections. Douglas Clarkson examines the latest electronics substitutes.

After five decades of rapid improvement in the capabilities of digital computers, neural network developers are now able to utilise these powerful systems to develop both their theoretical models and working ideas. There has been an awareness since the early 1940's of the potentialities of networks of interconnected logical units or neurons. Unfortunately, a lack of understanding of how to configure them to perform useful work has

forced them to the academic sidelines.

The general level of interest in neural networks ebbed considerably when in 1969 Minsky and Papert published 'Perceptrons' showing that useful tasks could only be undertaken by neural networks with architectures which, at the time, could not be usefully trained.

Fortunately for the science, a publication by Rosenberg around 1985 of a 'back propagation'

method for training networks to perform useful tasks provided a new avenue for research. This changed the emphasis from finding out how to make neural networks perform useful tasks to using them to solve problems. Almost every department of Computer Science has by now have spawned a neural network group.

The simple arithmetic operations which neural networks tend to utilise can readily be implemented by conventional electronic components such as operational amplifiers, potentiometers and so on. However, before looking at the details, it is a good idea to look at such networks are designed.

Structure

Figure 1 shows a simple neural unit with three inputs I_1 , I_2 and I_3 each with relative weighting W_1 , W_2 and W_3 . The neural unit can be described as having a threshold value T . Assuming the inputs I_1 , I_2 and I_3 can assume either a logical 1 or 0, the summed value of the inputs modified by the respective weighting values is $I_1 \cdot W_1 + I_2 \cdot W_2 + I_3 \cdot W_3$. If this value is greater than the value T , then the neural unit will 'fire' and its output will be 1. The weights W_1 , W_2 and W_3 can be both positive or negative values.

Figure 2 shows how such a circuit can be implemented from conventional analogue circuitry. The weighting components of each input are determined by adjusting analogue potentiometers between reference voltages $+V$ and $-V$. When an input is logic 0, the input value is set to 0 volts by, for example, a CMOS analogue switch. When the

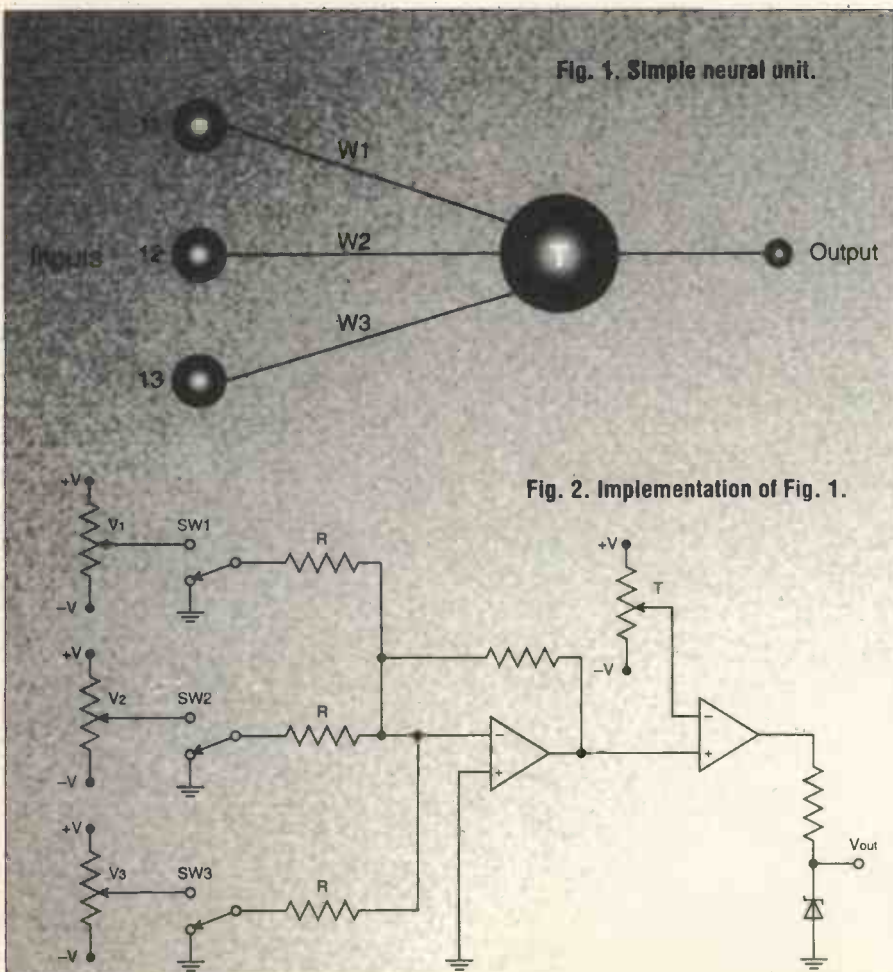

NT404 NISP

The world's first dedicated neural instruction set processor or NISP was recently announced by Neural Technologies in conjunction with Micro Circuit Engineering and Recognition Research.

Based upon a novel RISC (Reduced Instruction Set Computer) architecture and optimised for high performance neural network tasks, the NT404 is aimed at applications where real time intelligent processing is required – pattern recognition such as speech, graphics, finger prints and optical character recognition should all be possible.

The chip is designed to overcome the limitations and deficiencies inherent in software simulated solutions; conventional processor based hardware and existing neural network chips. It operates in real time and unlike many current systems can be configured for virtually any network size or topology. Its flexible I/O architecture and standard microprocessor interface ensure ease of integration for the system designer. An advanced neural development environment (NDEV) is also available.

The NDEV runs on an IBM-PC system and comes complete with software and plug in expansion card containing the NT404, NISP I/O

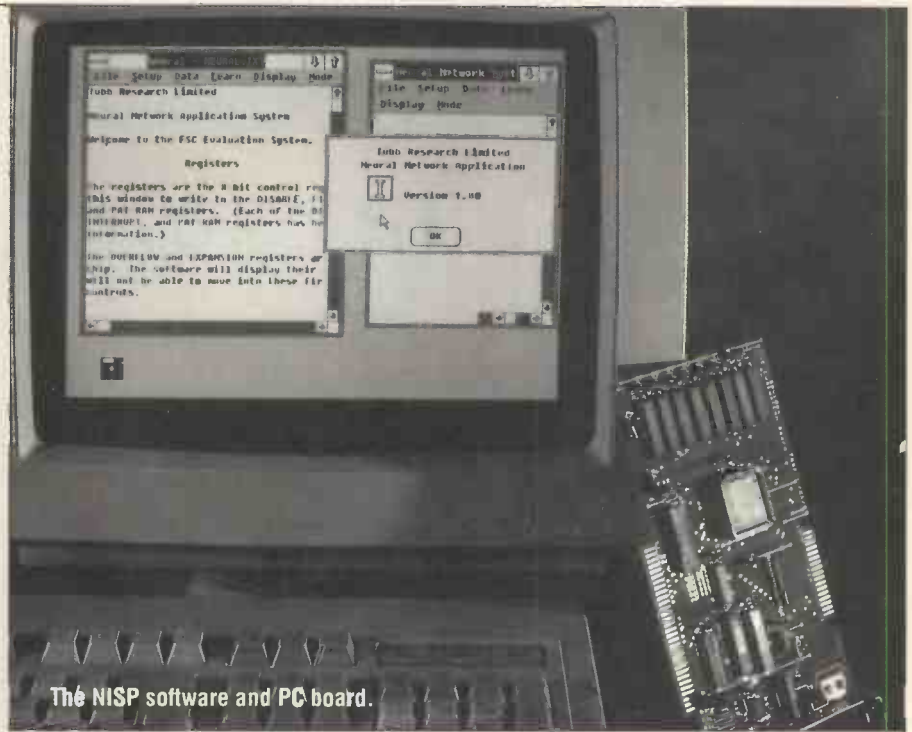

The NISP software and PC board.

interface and bread-board area for prototyping.

The software suite comprises a powerful design system software package, the DSS, and a comprehensive run time system. Based upon Recognition Research's Autonet, it accepts a variety of data formats and automatically generates trained NT404 compatible network files with no programming or prior neural network knowledge.

Operating at 40MHz the NT404 supports up to 8000 neurons, 57,000 synapses and any number of layers. It has 16-bit data I/O and a simple handshaking system for real time data transfer up to 20MHz. Neuron transfer or threshold functions are fully programmable and operation through the network is maintained with 16-bit accuracy. Both 8 and 16-bit interfaces are supported.

input is set to logic 1, the input weighting voltage is input directly to the current summing amplifier. The output of the summing amplifier is connected to a comparator with threshold voltage T . Where a positive weighting value is required, for example $+V_1$, then this is in fact implemented by establishing a voltage $-V_1$ due to the inverting nature of the amplifier.

When the threshold value V_{ref} is exceeded, the output of the voltage comparator will rise close to its positive power rail and a logical 1 output will be available at the zener diode output. This output can in turn be fed to the input stages of other neural units.

The network will need to be trained using a simulated computer model and the resulting solution parameters incorporated into the hardware. The weighting voltages and the voltage reference could, however, be implemented using A/D converters though this would

be a costly option.

While demonstration neural network elements can be constructed using building block units such as discrete operational amplifiers, practical implementations are being developed which utilise VLSI fabrication techniques in order to implement the function of hundreds or even thousands of neuron elements in a single silicon

device.

Even the very simple network shown in Fig. 3 where four inputs are fed forward to a middle layer and then to the single output, would require a relatively large number of components to implement using conventional analogue circuitry, assuming that relevant training values for the voltage weight values could be determined.

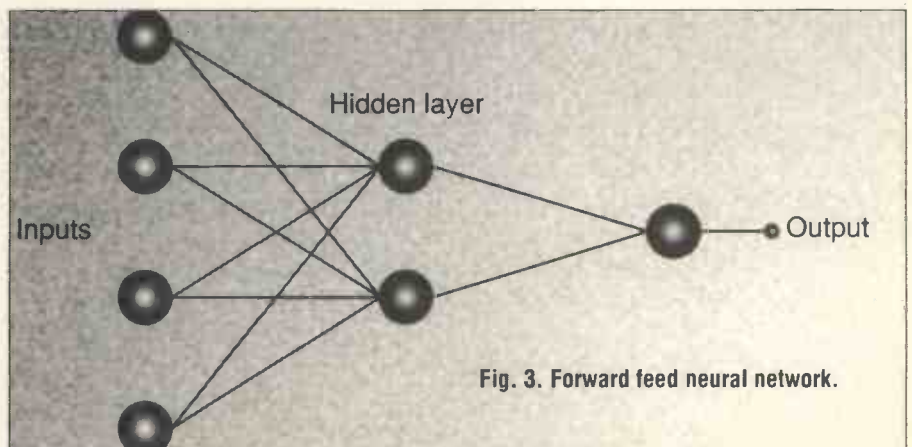

Fig. 3. Forward feed neural network.

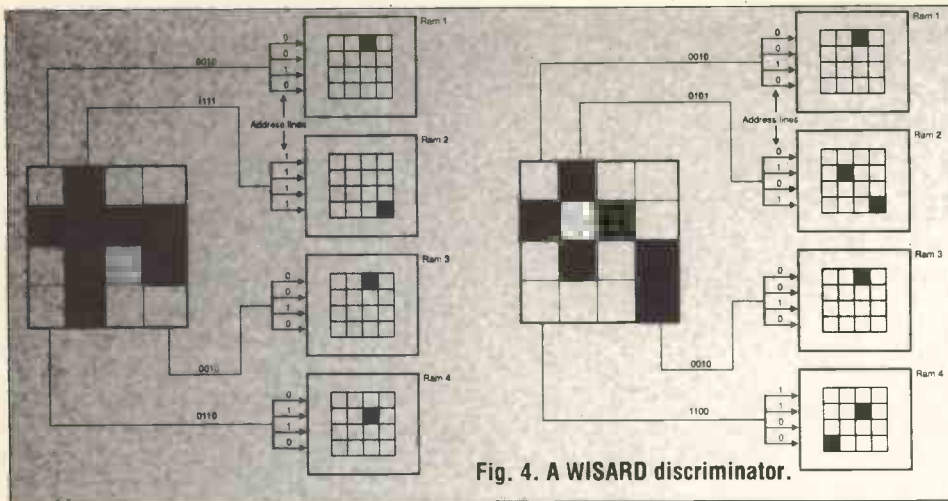

Fig. 4. A WISARD discriminator.

The weights in a network are usually initially established as a series of random values distributed about zero. A training set of data consists usually of a series of inputs to the network and a corresponding set of expected outputs. The process of training operates by adjusting the values of individual weight values until there is minimum error between the expected and observed output for a specific input pattern. Even relatively small neural networks can require many hours of computer time to implement a training process.

While much of the use of neural networks gives the appearance of a 'turn the handle' approach, a significant amount of skill lies in matching a specific problem and training set to an appropriate network topology. A poorly designed network may always perform poorly no matter the extent of the training data available.

The training of neural networks using such back propagation methods is essentially a software process. Once, however, the weight spread of a specific problem has been determined, that solution can be embedded into hardware which will then undertake the function of the network trained previously.

Solutions in Silicon

While it is certainly easier to design, train and simulate neural networks using conventional computer systems, applications increasingly require a 'black box' approach where the network is implemented in hardware. A range of methods are being utilised in order to build neural networks onto chips.

It is of course possible to

download weight values into an EPROM which can be read by a conventional digital processor and numerous systems have been developed which demonstrate this facility. Interest in hardware implementations of neural networks has been directed at a more fundamental level in order to develop systems which have networks directly built on silicon.

In the search for hardware solutions, the options available are for analogue, digital or hybrid.

Specific implementations using conventional analogue VLSI circuitry have been implemented. These have incorporated fixed weight values and cannot be adapted to cope with new training scenarios. One approach to increase the flexibility is to use digital switches to select various weight values. The high overhead of such digital switches limits the usefulness of such designs.

Chipping In

AT&T is developing a neural computing chip with 256 neurons and more than 100,000 synapses using fixed resistor values. Such devices could be used to compress the bandwidth of video images so that they can be sent down phone lines in real time.

With all the families of silicon technology available, it is not surprising that a broad range of researchers are using a range of approaches to achieve neural networks. While digital systems offer the advantage of speed and arbitrary accuracy, natural neural network systems cope very well with much poorer levels of accuracy. This argument is often used by researchers implementing neural networks using analogue devices.

Often systems which are described as being digital VLSI neural networks are not strictly so. This could be argued for the WISARD (Wilkie, Stoneham and Aleksander's Recognition Device) system. This functions by implementing a series of discriminator units are shown in Fig. 4.

Specific address lines based on data bits set in the sampled pattern relate to specific bits set in associated RAM. Thus 0000 maps to top left bit in the figure and 1111 maps to bottom right. The presentation of multiple training patterns writes or overwrites a logical 1 in the appropriate RAM element. The system functions by

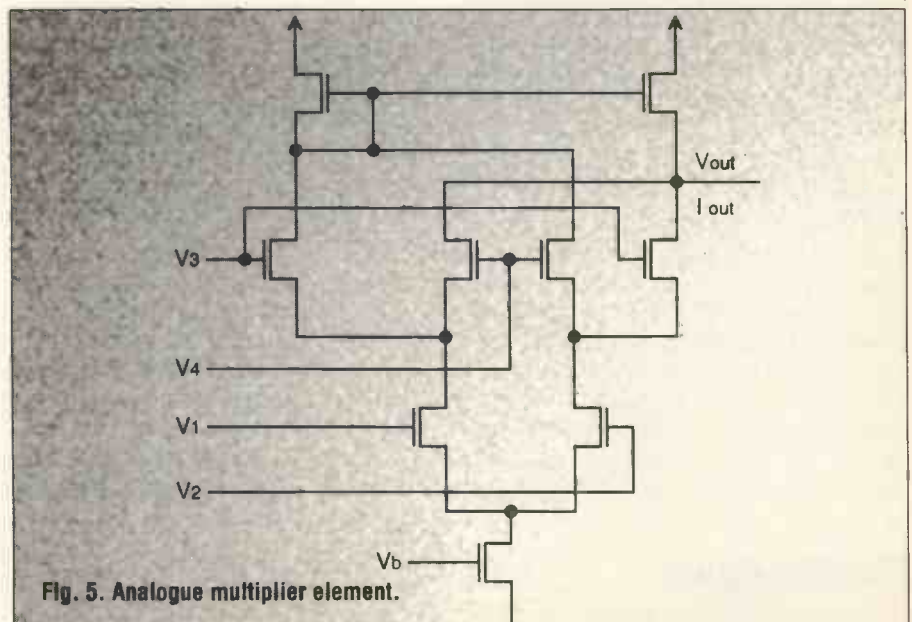

Fig. 5. Analogue multiplier element.

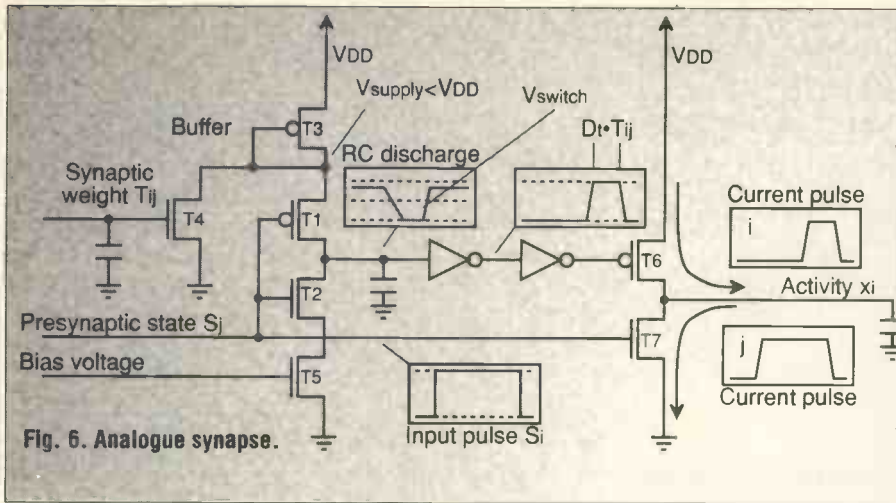

Fig. 6. Analogue synapse.

learning on a training set during which RAM space is updated and then compared against specific problem cases. A real system would consist of a series of such discriminator units, each of which seeks to pattern match against a previous training set. The system is perhaps closer to a nearest neighbour classifier than a conventional multilayer perceptron.

The advantage of the WISARD system in common with that of an orthodox neural network, is that the result of a comparison of a test pattern against a store of trained information takes place rapidly without the need for conventional software programming.

A significant amount of work in hardware implementations of neural networks has been undertaken by Carver Mead at Caltech in the USA. Extensive use has been made of analogue MOSFET technology to build systems for investigation of sensory processing systems such as an artificial eyes and ears. In general the senses are by no means as simple as they would appear. Even the most basic sensory systems use complex natural neural preprocessing networks to unscramble data before passing it on to the brain for processing at a higher level. The key feature of such processes is that they are undertaken locally, close to the site of the initial sensory stimuli. Thus these sensory systems are a valuable source of information of how to use artificial neural networks to copy nature's example.

Scaling Down

Figure 5 shows a typical circuit

used by Mead in the form of a four quadrant Gilbert Multiplier circuit where the output current I_{out} is proportional to $(V_1 - V_2) * (V_3 - V_4)$. This allows neural networks to be implemented using compact analogue multiplier units, allowing higher densities of on-chip neurons than could be implemented using digital systems.

The technique of the so called pulse stream arithmetic is being developed in the UK, primarily at Edinburgh University, to use analogue circuit elements for neural network implementations. Fig. 6 indicates a pulse stream synapse circuit. The weight of the synapse T_{ij} is stored as a voltage on a capacitance. An input voltage pulse V_j of width D_t at a specific frequency is input into the synapse. This causes an RC discharge as shown where the fall time during discharge is much longer than the rise time at the end of the input pulse. The inverter has a switching threshold V_{switch} which determines the width of the subsequent pulse, so that this is the stage where multiplication is taking place. V_{switch} is in fact proportional to the initial synaptic weight T_{ij} . The transistors T6/T7 are designed to either sink or source current respectively depending on the value of T_{ij} .

For $T_{ij} > 2V$, an increase in potential proportional to $(T_{ij} - 2V)$ will occur and for $T_{ij} < 2V$, a decrease in potential proportional to $(2V - T_{ij})$ will occur.

Thus for synaptic weight values close to 2V, the synapse will be relatively insensitive to input clock pulses. The greater the deviation the more rapidly will the synapse be driven to saturation voltages,

either positive or negative. Such circuits require typically around 11 MOSFET transistors per synapse.

MOSFET circuits can be designed which utilise so called transconductance multiplier effects, where the drain/source current is proportional to the term $V_{gs} * V_{ds}$ (g_s is gate to source and d_s , drain to source). Such circuits can more directly implement current pulse switching at the output to simulate synaptic multiplication. Such a design which utilises 4 MOSFET elements is shown in Fig. 7. It is estimated, however, that using such a transconductance approach around 15,000 synapses could be implemented on an 8 mm by 8 mm die of Silicon using 3 μ m CMOS fabrication technology.

While digital systems offer options for both precision and accuracy, there is the anticipation in some quarters that it will be analogue systems which will allow high density hardware implementations of neural networks.

The Neural Bit Slice

One approach of implementing digital neural networks in silicon has been the development of the Neural Bit Slice (NBS) computing element by Micro Devices in the USA. The device is constructed in CMOS technology and packaged in a 68 pin PLCC. It comprises eight independent neurons, each of which can have eight external digital inputs. In addition, there is the facility for routing back to a specific neuron the outputs from the other seven neural units. The block diagram of the MD1220 is shown in Fig. 8.

Sets of 16-bit wide synaptic weights are held in external weight memory. Each computational cycle is called a frame and consists of calculating a bit wise multiplied

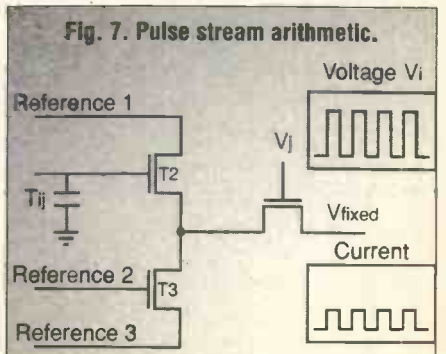

Fig. 7. Pulse stream arithmetic.

product from the input data and the appropriate weight data. The dot product register exists as two separate 8-bit registers. An extra register can be accessed to check for accumulator overflows. The digital nature of the implementation avoids errors of drift and offset which may be present with an analogue implementation.

Each neuron has reserved weight space for 15 synaptic weight values, eight for external inputs and seven for internal inputs derived from outputs of other seven neuron elements.

In calculating the value of the output in the serial mode, time multiplexed inputs unique for each neuron are applied and multiplexed with the appropriate weight value. In the parallel mode, each of the synaptic inputs $SI(j)$ is applied to each of the neurons during each weight cycle.

The calculated value can be compared against a threshold selection function as outlined in Fig.9. In the single threshold case, for example, the output of the neuron will be 1 when the summed value is greater than 0 and zero otherwise.

Some Real Uses

The MD1220 neural bit slice device is designed for use as a building block in real time neural network systems. The design of the device allows expansion along rows and columns. The processing time through a single NBS is 7.2 μ S, which is claimed to be equivalent to a 55 MIPS processor. The 16-bit weight space provides excellent resolution. It would be undesirable, for example, to have too coarse a resolution (say 8-bit) since this would lead to difficulties in successful training of the network.

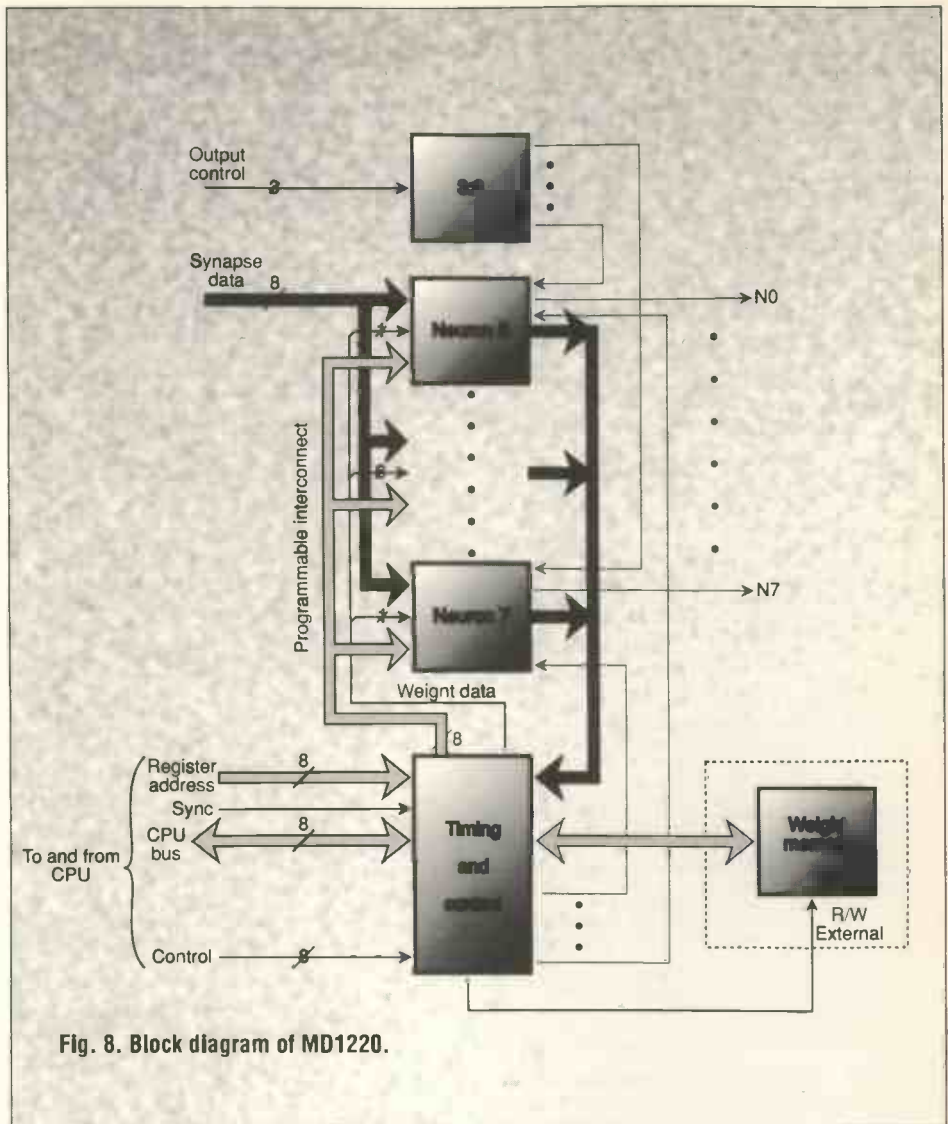
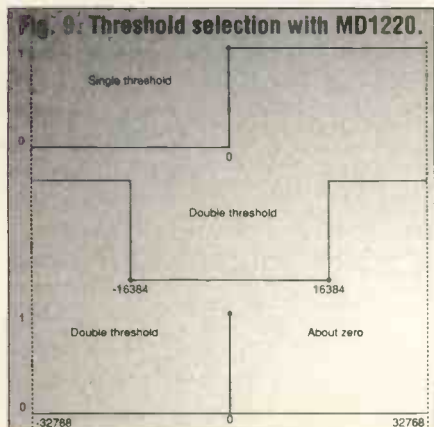

Fig. 8. Block diagram of MD1220.

Chips such as the MD1220 are used with a development system which can configure a specific network topology and determine the weight values necessary to perform specific functions. The MD1220 is supplied in the UK by Neural Technologies of Petersfield as an evaluation board which can be operated with the BRAINMAKER neural network software package on an IBM PC. Using such a development system, designs can be implemented to provide high performance real time neural network systems.

While the MD1220 device does not provide a hardware solution for neural networks with hundreds of neurons, it does allow for less demanding tasks in embedded control to be implemented cost effectively.

Neural Technologies have recently announced a dedicated Neural Instruction Set Processor (NiSP - see box) and National

Semiconductor is offering the NU32, a device with 32 neurons which connects to a weight chip which can implement 1024 weight values. Intel is providing the N64, a neural network chip with 3 layers, each with up to 64 neurons. Weight values are stored in programmable, read only memory.

Often however, it is the availability of support systems such as that available for the MD1220 which allow such hardware devices to be evaluated effectively for specific applications. Thus the systems which tend to be the most popular need tend to be those for which the most technical support is provided.

Neural networks are destined to play an important part in future smart interfaces simulating sensory functions. The role of hardware implementations will be important to provide both the speed of response and the sophistication of function required.

Does office automation mean alienation?

Technology is changing our lives, but is it also destroying our values? – Tom Ivall ponders the effect of technology on life as we know it.

The fact that some consumer technologies fail to make the intended mass markets – like the video disc and the Prestel viewdata system – tells us something about the relationship between technology and human beings. Without such failures it might seem that consumers are mere functional components of the market mechanism, permanently open mouths for whatever goodies designers, manufacturers and marketers decide to push into them. In fact, of course, consumers are individuals with particular wishes, interests, tastes and values.

In relation to consumer technologies our wishes, interests and tastes are often transitory and subject to the whims of fashion. But values – such as truth, beauty,

justice, charity, respect for life – though still subject to modification, are more enduring in the way they affect our actions. So it seems to me important that we should try to understand the interaction between values and technology as well as we can.

This interaction is important to the people in industry who design the technology and its products because the success of their work may well depend on these transcendental factors. It's important to all of us who live in industrialised societies because the technology of our world, by affecting the material way we live, may be changing the values we hold, even though we may be largely unconscious of them.

"Technology is changing our

lives" is a familiar platitude that doesn't get us very far and is only part of the truth. In conducting our lives we are also changing the technology – by what we choose to accept or reject. To consider technology either simply as a cause or simply as an effect is a sterile exercise. This is crude determinism, appropriate to machines but not human affairs.

In one direction it would assume that technical innovation is free to act autonomously, which it is not, and in the other direction that there is some immutable human essence – human nature – controlling everything, which also is not true.

The reality is much more complex. When you study what actually happens you find there is a continuous loop of action linking technology and human values, within which causes and effects can't be distinguished from each other – rather as in an electronic feedback system. Certainly you can't pin down a primary cause and an ultimate effect in this loop.

Let's break into the loop arbitrarily at, say, the technology point and assume for the moment it's computer-based automation. You find that this particular technology changes values connected with labour, skill and the formal relationships between managers and workers. In turn the modified values influence the social forces which control long-term research and industrial planning. Social forces are in turn influenced by political and economic change and human values are therefore subject to the combined impact of political, economic, social and technological change. In the end the modified research and planning

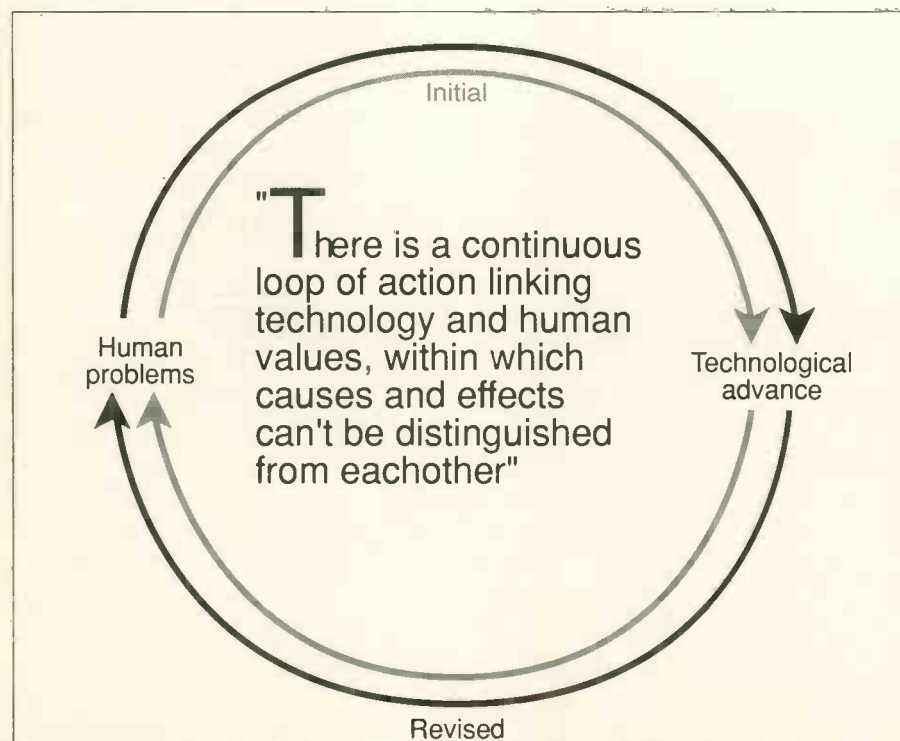

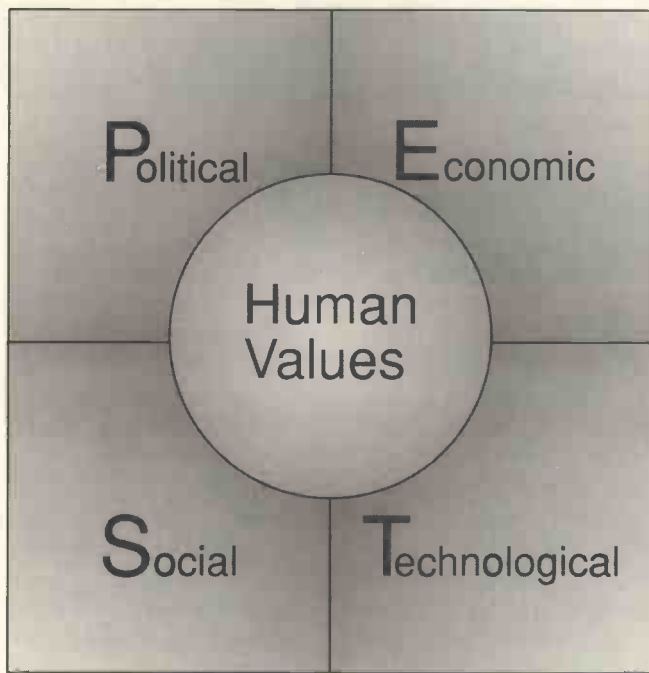

PEST – the pressures on human values.

goals have their effect on the future direction of the technology – completing the cycle.

This continuous interaction produces a social pattern, but not through a single force. It results from a complex interplay of economic and political power, historical accident, ownership, size of organisations and so on. These factors don't control anything directly but exert various pressures and apply various limits which combine to shape the emerging social pattern.

The values involved are extremely complex in themselves. We know them to be abstract principles which we hold in high regard. But where do they come from? How do they get into our minds? Sciences like anthropology and sociology can describe in detail what is actually valued in various societies but can't explain why. For example, is something valued because it is desired? Or is it desired because it is valued? Some values are considered intrinsic, like those listed above, while others are instrumental values – means to an end – like thrift or diligence.

Electronics is contributing to at least three main areas where technology is interacting strongly with values. One is transport and communications. Here, private transport, the telephone/telecoms systems and electronic home entertainment are tending to

promote the instrumental values of flexibility and mobility over the traditional ones of security and stability.

In the area of medicine and pharmacology, technology has influenced society by offering greater control over life; prolonging it, supporting it when it would otherwise cease, and preventing it altogether through contraception. Suffering and misfortune are being subtly revalued as technical problems which can be fixed. Together with genetic engineering, these perceptions are tending to diminish our sense of the uniqueness of human life.

The third main area is office

automation and computing. Here the interaction occurs mainly through the value systems of the workers involved. The benefits of greater productivity and easier, cleaner working conditions have to be paid for by loss of direct sensory experience and physical contact with the work, a feeling of remoteness or alienation. The work, whether in a factory or an office, becomes more abstract and intellectualised, experienced largely through the medium of symbols on VDU screens or computer print-outs.

When these conditions are accepted as inevitable they become the basis of new instrumental values; order, uniformity, precision, efficiency. Some social critics find this a worrying trend. They feel that man is becoming preoccupied with his own tool-making, that efficiency and technique are being worshiped for their own sake and getting higher in the scale of values than the supposed object of all this striving – man himself. There is a fear that we may be devaluing the principle that life is an end in itself.

However, it's not fair to blame automation and computing alone for this distortion, if in fact it is occurring. They are just one component of industrialisation which has concentrated populations in towns and changed living habits, thereby modifying the culture and its values. One sad result is a narrowing of our ideas of what constitutes normal human behaviour. We are in danger of losing our mystics, eccentrics and originals. ■

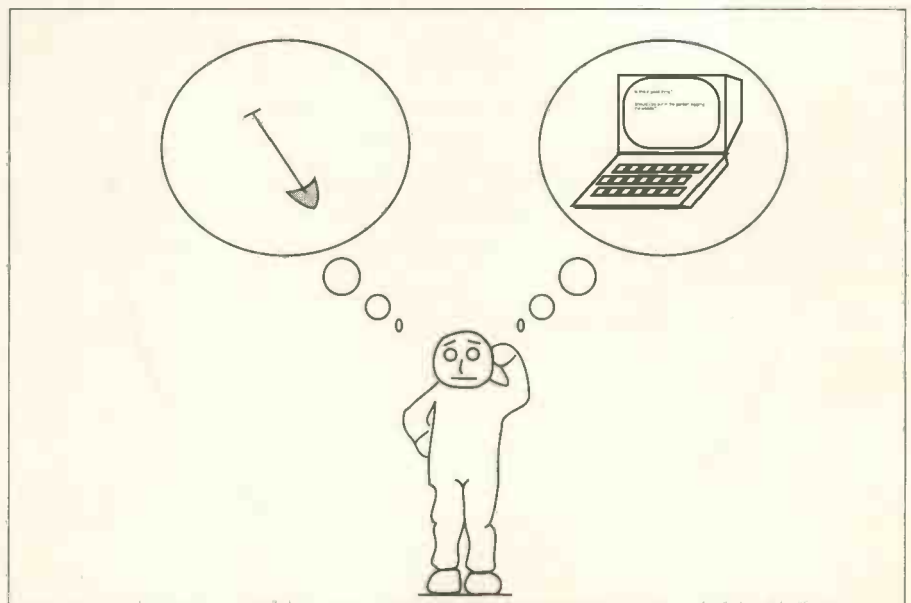

OUT NOW!

SUMMER 1991 CATALOGUE

- 192 pages
- £££'s discount vouchers
- 100s new products
- New range kits
- Over 3000 lines
- Fast same day despatch

Available from most large newsagents or directly from **Cirkit**



£1.70
plus 30p
postage

Cirkit

CIRKIT DISTRIBUTION LTD

Park Lane · Broxbourne · Hertfordshire · EN10 7NQ

Telephone (0992) 444111 · Fax (0992) 464457



One of the fastest EPROM programmers on the market! Model 200 – £295 (other models from £195)

New adapters now available for Model 200

87C751 87C752
87C054 87C451 87C552
87C51FB 87C51FC
In both DIL & PLCC packages.

8 Pin serial EEPROM adapter for Model 200

- Read & programs over 50 devices
 - PC (M8571, X2402), 9306, 2506 etc.
- As used for security devices in many car radios, mobile radios, cellular phones & security systems

Z8 & PIC 16C5x Family Adapters for Model 200

- All security functions programmable
 - Manufacturers approved algorithms
- From £75

Adapters available also include

- 8748/41 family £75
- 8751 family from £75
- (including Intel, Philips & AMD parts)
- 40 pin EPROMS up to 4 Mbit £75
- 63701/5 from £95
- 32 pin PLCC EPROMS £100

The Model 200 now has a parallel interface option

- Includes MS-DOS driver software, parallel or serial lead, comprehensive manual, 32 pin ZIF socket and universal object file editor/converter.
- Programs virtually all EPROM devices currently available including micro controllers (over 700!).
- Easy to set up – not a plug-in board.
- Compatible with our EPROM Emulator.
- 12 Month Guarantee. Money back if not completely satisfied.
- Designed, manufactured and supported in the UK.

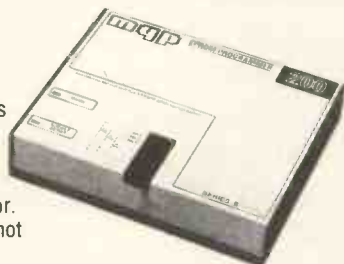

We also sell Bipolar and Gang Programmers, EPROM Emulators and Erasers and a universal cross-assembler for IBM PCs and compatibles

Write or phone today for Free Information Pack:
Phone: (0666) 825146 Fax: (0666) 825141



**MQP Electronics Ltd., Park Road Centre
Malmesbury, Wiltshire SN16 0BX UK**



Scandinavian customers please contact:	Digitron A/S, Ålesund, Norway	Phone 071-45 890 Fax 071 45 453
German customers please contact:	Synatron GmbH, Graßbrunn B. München, Germany	Phone 089/4602071 Fax 089/4605661

A DOT MATRIX PRINTER for only £19.95?

Yes! I have obtained the remaining production line parts for the amazing **AMBER 4000** printer and can supply them to you as a kit complete with assembly instructions.

A few small parts will have to be supplied from your own spares box, but all the major items including the case are included. Send me a SAE for full details.

This superb 40 column printer boasts many features and can be driven from both parallel and serial signals. The SAE will tell all, or send a cheque for £22.95 (includes £3 P&P) for immediate dispatch.

I only have 150 kits so to avoid disappointment contact me now at:

CHIPLINK
10 Hardys Field
Kingsclere
Newbury
Berkshire RG15 8EU

Practical Electronics Subscriptions

Book your place in the technological future with a subscription to Practical Electronics. Our combination of in-depth features, innovation updates and electronic projects you can build yourself is available in regular monthly doses for only £18 a year. Subscribe or renew now and get a free gift, either a 12-issue binder or the 300-page International Transistor Equivalents Guide. Concessionary rate (-10%) available to students and teachers upon proof of status.

Fill in and return this form (or a photocopy) to:

**Practical Electronics Subscriptions
Intra House
193 Uxbridge Road
London W12 9RA**

UK Readers

One Year Subscription at £18
BAEC/Educational Rate £16.20

Overseas Readers

Surface Mail at £22
BAEC/Educational Concession Rate £19.80
Air Mail at £39
BAEC/Educational Concession Rate
I enclose proof of BAEC membership
I enclose proof of Educational status (e.g. Headed paper)

I wish to start/renew my subscription from the issue.
As my free gift I would like to receive (tick one)
The Practical Electronics Binder
The Transistor Equivalents Guide

Please send my monthly copy of PE to:

Name

Address

.....

Town

Post Code

I enclose a cheque/postal order for

Or: Please charge my VISA/MasterCard
Number

Expiry date

Signature (for credit card orders)

(N.B. Cheques/Postal Orders or Banker's Drafts must be made out in £ Sterling, payable to Intra Press.)

Electroparts

T.V. Video · Electronic Spares · Import & Export
342 Pinner Road, North Harrow
Middlesex HA14 LB

Tel: 081-472 5778 / 081-861 4286 · Fax: 081-861 4271

Super Service
Competitive Prices
Speedy Delivery

Credit Card
Orders Welcome



Integrated circuits

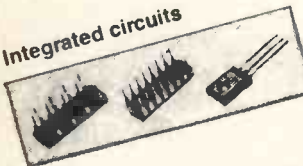

Transistors



Crystals



Valves

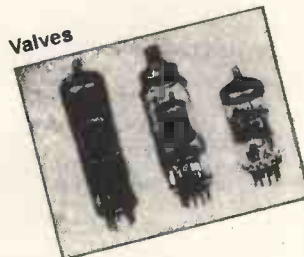

Varicap tuners

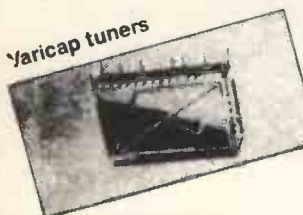

For
Quality Components
&
Fast Service

Please phone or write for catalogue. Enclosing 30p A4 SAE.

Advertisers Index

ADM	55	Laser Alarms	56
BK Electronics	4	London Electronics Coll	54
Cambridge Computer		Lys Electronics	46
Science	55	Maplin	OBC
Chiplink	23	Marapet	55
Cirkit	23	Mauritron	56
Coles Harding	55	Morrison Micros	46
Cooke International	54	MQP	23
CR Supply Co	55	NR Bardwell	55
Cricklewood	29	Number One Systems	IBC
Electronics Shop	54	Omni Electronics	54
Electroparts	24	Panrix	29
Fraser Electronics	54	Radio & Telecom Schl	54
GNC Electronics	13	Seetrax	13
Greenbank	46	Service Trading Co.	30
Greenweld	57	Stewart of Reading	46
Happy Memories	30	Suma Designs	60
Intl. Corr. School	46	Swift TV	13
J&N Bull	20	Tandy	9
JPG Electronics	55	Tsien	IFC
Labcenter	29		

At The Lower End Of The Range

Making measurements of low frequencies is not as straightforward as it may seem. This easy to build meter from Owen Bishop provides a simple way to measure from 0.5Hz to 20Hz.

The two most commonly used instruments for measuring frequency are the oscilloscope and the frequency counter. With the oscilloscope, you display the waveform and use the grid on the screen to measure the time for one complete oscillation. The reciprocal of this gives the frequency. Those who have a frequency counter can measure frequency with much more precision but, for most amateurs, the expense of a frequency counter is rarely warranted.

For very low frequencies a simple technique is to arrange for the signal to flash an LED and count the number of flashes observed during a given period of time, say 30 seconds. You then calculate the frequency. A related technique is to display the signal on an oscilloscope and count the rises and falls of the horizontal trace in a given time.

A difficulty arises when you try to measure a frequency in the range

0.5Hz to 10Hz. It is too fast for the LED flashing technique and too slow for the oscilloscope or frequency counter. As a consequence of Murphy's Law, I often find myself with a signal in this range and no means of measuring it.

The Requirements

The low frequency meter (LFM) is sensitive to an input signal with an amplitude of about 1mV peak-to-peak or greater. The input impedance is relatively high, being approximately 1M Ω , input is protected up to +100V. The display is a moving-coil meter and although a digital panel meter could be used with this circuit, a much more comprehensible readout is obtained with a pointer moving over a scale. There are two switched ranges, 0-2Hz and 0-20Hz. The circuit also provides an output signal running at 100 times the frequency of the input signal. If you

already have a frequency counter, this output can be fed to it and you simply divide the reading on the frequency counter by 100.

Circuit Operation

There are two main ways of determining frequency, measuring the period or counting the number of waves in a given time. Neither of these methods gives a rapid result with signals of low frequency. When measuring the period it is necessary to average out readings taken for a number of consecutive waves. With wave-counting, if the timing period is 10s and the frequency is 1Hz, for example, only 10 waves are counted. The precision is only 10% and even less for lower frequencies.

This circuit uses a technique that involves generating a signal with a frequency which is 100 times greater than the input signal frequency. This simplifies the measurement process and also

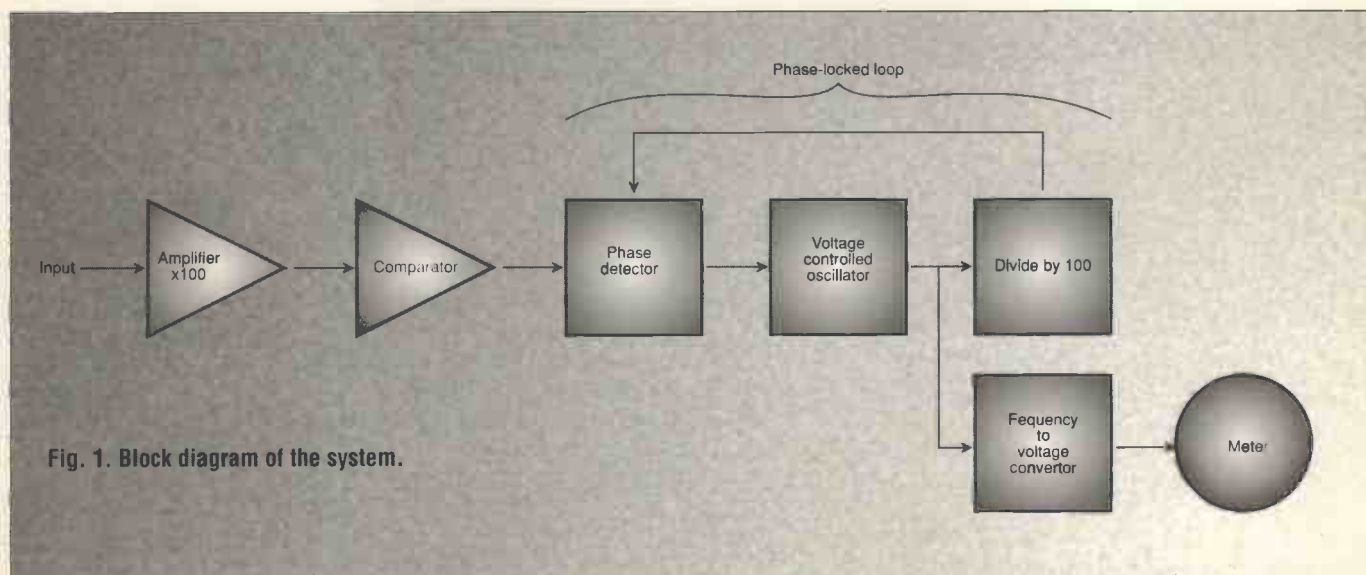

Fig. 1. Block diagram of the system.

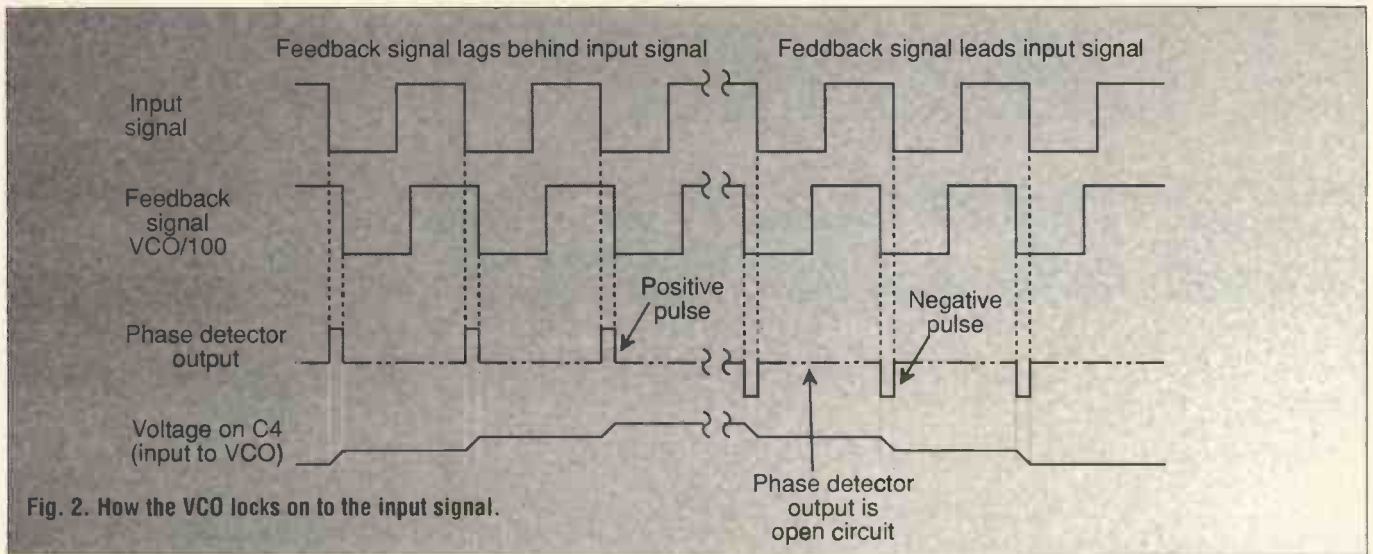

Fig. 2. How the VCO locks on to the input signal.

(provided that the frequency is not changing too rapidly) allows a more rapid measurement to be taken.

Phase Locked Loop

The initial stage (Fig.1) is an amplifier for detecting small signals. This is followed by a comparator to convert the waveform into a square wave with rapid rise and fall times suitable for driving to the next stage.

Frequency multiplication is achieved by making use of a phase-locked loop (PLL). As Fig 1 shows this consists of 3 parts, a phase detector, a voltage-controlled oscillator (VCO) and a divider. The detector receives the low-frequency signal (call this the input signal) and compares it with another low-frequency signal (call this the

feedback signal) coming from the divider. The output of the detector depends on to what extent the two signals are in phase with each other. For them to be in phase and to remain in phase also implies that they are identical in frequency.

If the frequency of the input signal is higher than that of the feedback signal the voltage at the output of the detector is high (+12V) causing the VCO frequency to rise to its maximum. If the frequency of the input signal is lower than that of the feedback signal, the voltage falls to zero, VCO frequency falls to its minimum value – in this circuit, to zero. If the two frequencies are equal and in phase, the output from the phase detector is open-circuit and the loop is broken. However, the phase detector produces a pulse at any

time the signals begin to go out of phase (Fig.2). The pulse may be positive or negative. If the feedback signal starts to lag behind the input signal, the pulse is positive. This adds a little extra charge to a capacitor in the loop, causing the voltage supplied to the VCO to increase. This tends to increase its frequency, so that its output (or rather, the output of the divider) catches up with the input signal. The length of the pulse depends on how far out of phase the two signals are, so the rate of catching up is greater if there is a larger phase difference.

Conversely, if the feedback signal goes ahead of the input signal, a negative pulse from the phase detector reduces the charge of the capacitor, causing the VCO to oscillate more slowly, until the

Fig. 3. Circuit diagram.

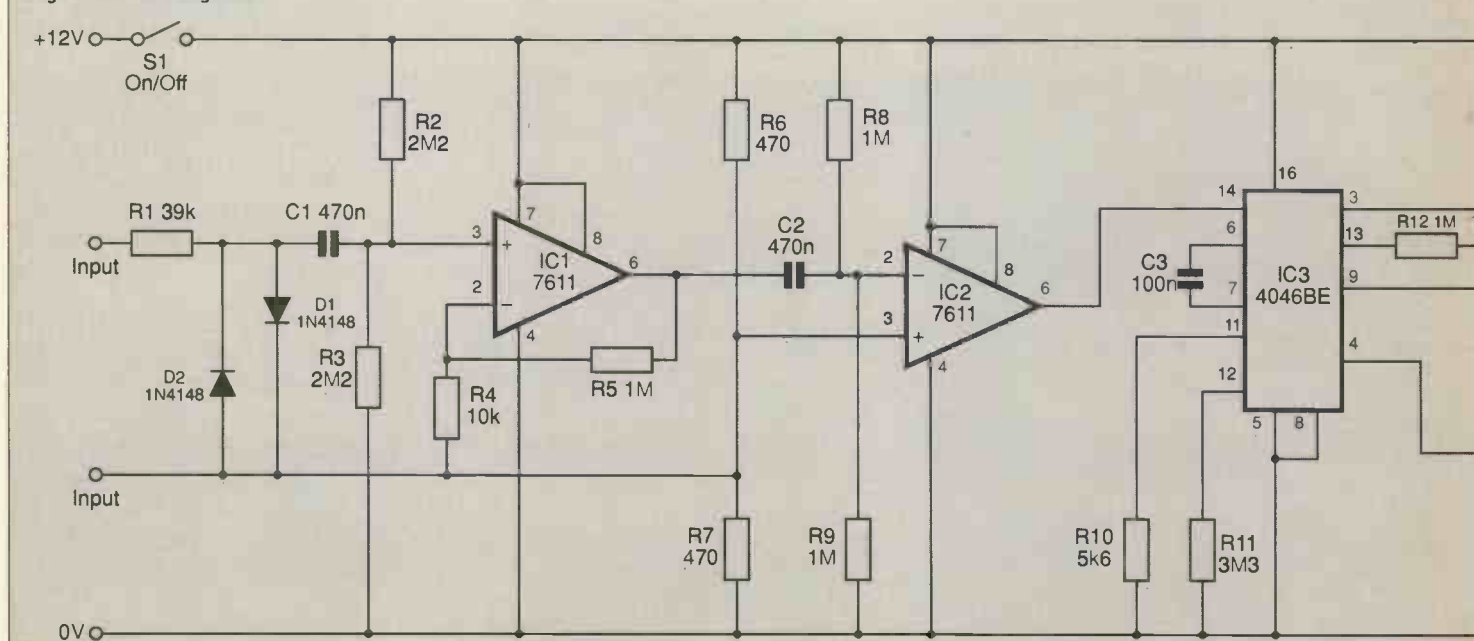

feedback signal has fallen into step with the input signal.

If the signals are both the same frequency and both exactly in phase, the charge on the capacitor is constant. The VCO oscillates at a constant frequency and the loop is stable. In practice, any capacitor has a small leakage current, so the VCO rate falls very slowly until the phase detector detects the phase discrepancy and emits a further positive pulse to replenish the charge.

The system becomes stable when the input and feedback signal match – the system has locked on to the input signal. The feedback signal is the VCO frequency divided by 100 and so the system locks on when the VCO frequency is 100 times that of the input signal. If the input signal subsequently changes in frequency the phase difference is detected immediately, the VCO frequency is altered accordingly and the system remains locked on.

The output from the VCO is suitable for driving a conventional frequency counter so, if such an instrument is available, no further stages are required. For a self-contained frequency meter a stage is needed to measure the frequency of the VCO signal. In the LFM this is a tachometer IC specially designed for converting frequency to voltage.

The signal arriving at the tachometer goes to a sub-circuit known as a charge pump. As each pulse arrives, a unit of charge is

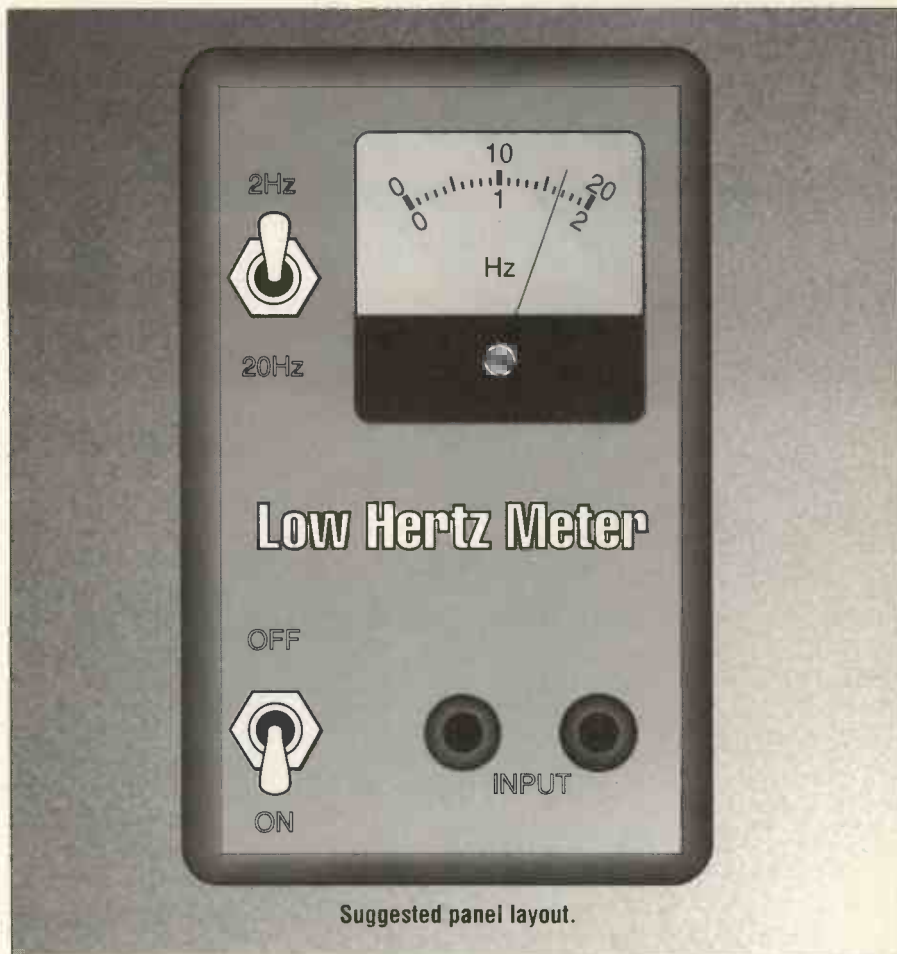

transferred to a capacitor. This is another storage capacitor, not the capacitor referred to in the description of the PLL. The higher the frequency, the more pulses arrive in a given time and the more rapidly the charge accumulates on the capacitor. The charge leaks away slowly through a resistor and

thus the voltage across the capacitor varies with the frequency of the signal. This voltage is fed to a voltmeter which is calibrated to display the frequency of the incoming signal.

Practical Considerations

Input protection is provided by D1 and D2 (Fig.3). When the input voltage exceeds $\pm 0.6V$ one or other of the diodes conducts. The diodes are rated to withstand a peak inverse voltage of 100V. R1 limits the current passing through the diodes to a safe value. The diodes are rated to withstand a peak inverse voltage of 100V so limiting the maximum allowable input swing to $\pm 100V$.

The signal passes through C1 to the amplifier (IC1), an operational amplifier connected in the non-inverting mode. R4 and R5 set the gain of the amplifier to 100. The amplifier signal goes to IC2, another operational amplifier but connected as a comparator. R6 and R7 hold the (+) input close to 6V and one signal input terminal is connected to this line. R8 and R9 hold the (-) input at 6V too, but signals arriving from

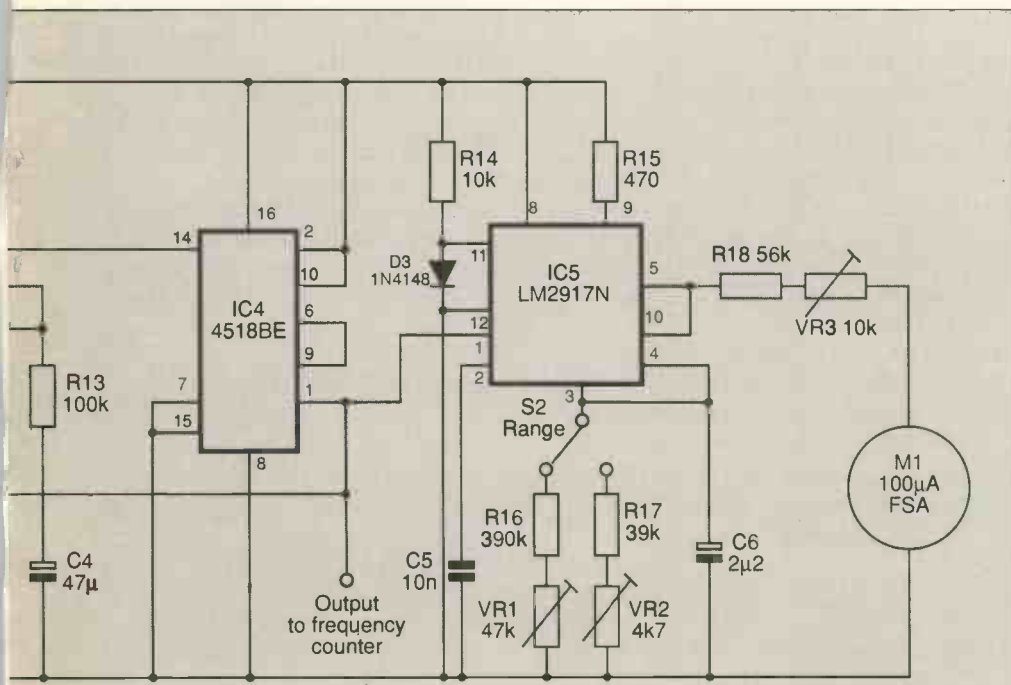

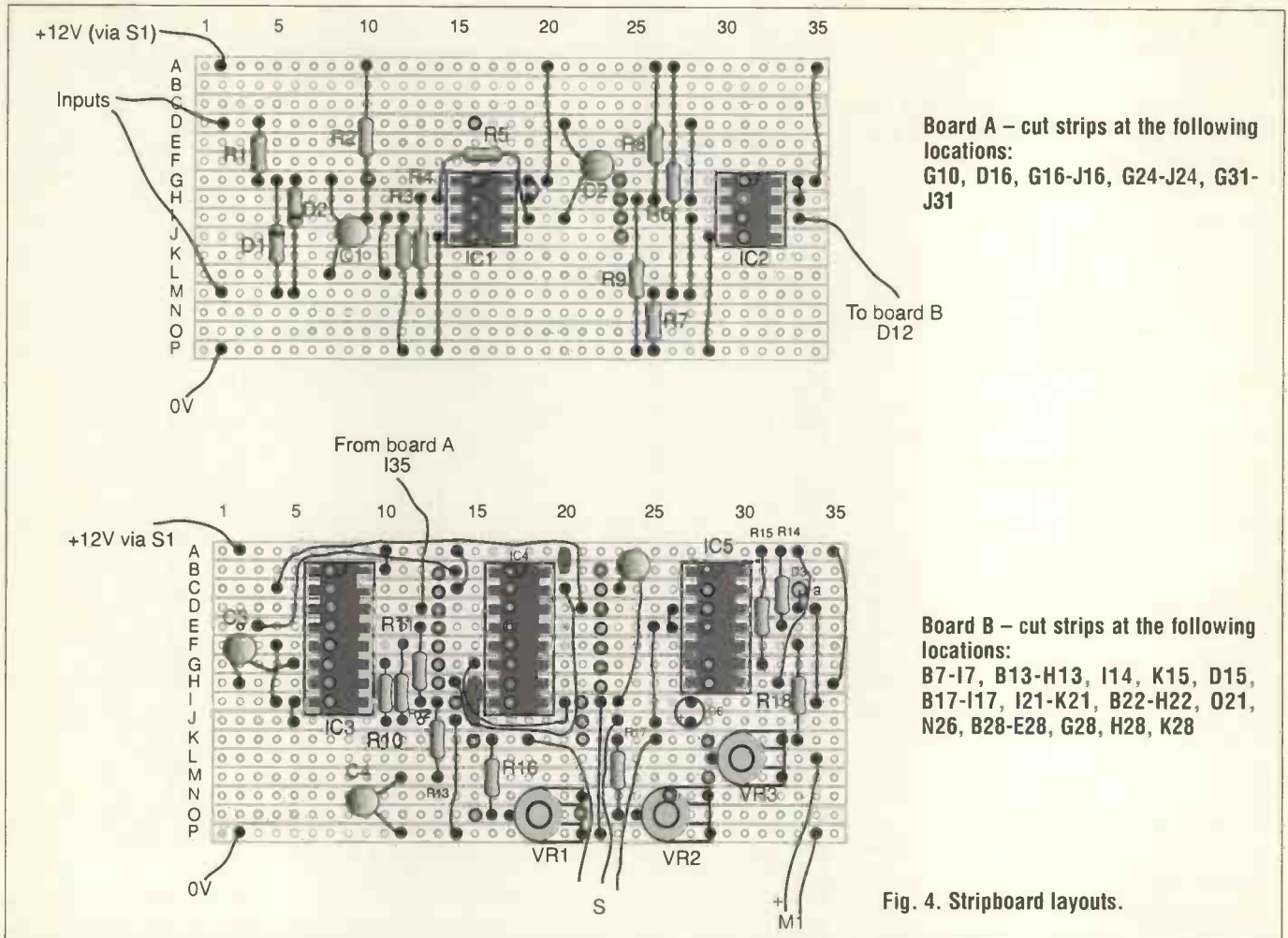

Fig. 4. Stripboard layouts.

IC1 through C2 cause the voltage at the (-) input to rise and fall, producing sharp upward and downward sweeps of the output of IC2. The signal is thus converted into a square wave ready for the PLL.

The phase comparator and VCO are contained in a single IC, IC3. R10 and C3 set the maximum frequency of the VCO to a little more than 2kHz, – just over 100 times the maximum signal frequency. The signal goes to one input of the phase comparator at pin 14.

R12, R13 and C4 comprise the loop filter. It is on C4 that the output pulses from the phase detector are stored, pin 13 being the control input of the VCO. The values have been selected so as to make the loop lock on reliably to low-frequency signals, though this is to a certain extent at the expense of inability to follow rapid changes of frequency. C4 is a tantalum bead capacitor; an electrolytic capacitor has too high a leakage current to be satisfactory for charge storage in a PLL.

The output of the VCO (pin 4) goes to the input of a divide-by-10 counter in IC4. The output of this counter at pin 6 goes to a second divide-by-10 counter in the same IC. The final frequency, being the VCO frequency, divided by 100 appears at pin 14. This is fed back to the phase comparator at pin 3 of IC3. The VCO output also goes to the tachometer, IC5.

The charge pump circuit of the tachometer delivers a unit of charge to C6 as each pulse arrives from the VCO. The amount of charge delivered, and hence the voltage across C4 for any given frequency, depends on the values of C5 and the resistance between pin 3 and the 0V rail. It also depends on the standard voltage used within the IC, which is set to 7.56V by an internal reference. The voltage reference makes the output independent of battery level above about 10V. Thus the output voltage at pin 5 is given by:

$$V_{out} = 7.56 \times fRC$$

R is the total value of the fixed

resistor (R16 or R17) and the variable resistor (VR1 or VR2) selected by the range switch S2. To obtain a maximum output of 6.2V at 2Hz, R16 and VR1 must total 410k. For the 20Hz range the total of R17 and VR2 must be 41K.

We use a moving-coil meter with a series resistor to measure the output voltage. The resistance required is made up of R18 and VR3, and is calculated from:

$$R = V_{max} / I - r$$

where I is the full-scale current of the meter and r is the resistance of its coil. In the prototype we used a 100µA meter with coil resistance 940 Ω, so:

$$R = 6.2 / (100 \times 10^{-6}) - 940 = 61k$$

This is obtained by using the fixed and variable resistors shown.

Putting It In The Box

The circuit requires only 30mA, so it is conveniently powered by two

Continued on page 61

Psst... Powerful Software Saves Time

ISIS - Intelligent Schematics

ISIS SUPERSKETCH - our highly popular schematic drafting package. Still only £69 (basic library).

ISIS DESIGNER - no nonsense schematic capture with Netlist, Bill of materials and ERC reports. Excellent value at £275.

ISIS DESIGNER+ - Design Management Tool with Hierarchical Design, Auto Annotation and ASCII data import. Unrivalled features for just £475.

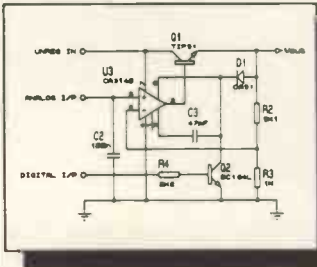

- Auto wire router.
- Auto dot placement.
- Auto label generator.
- Auto component finder.
- Object oriented 2D drawing.
- Comprehensive libraries.
- Integral Device Editor.
- Output to dot matrix, pen plotters, lasers, POSTSCRIPT.
- Export to DTP in IMG, DXF.
- Runs on any PC compatible with mouse.

ARES - Advanced Routing

PCB II - an exceptionally easy to learn PCB drafting package - ideal for the computer-phobic and only £69.

ARES - advanced PCB design with netlist integration, 10 routing layers, EMS memory support, DRC, auto power planes and more. Attractively priced at £275.

ARES AUTOROUTE - our new autorouter uses an advanced multi-strategy algorithm to achieve very high completion rates. £475 price tag includes ARES.

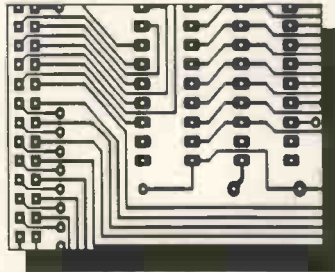

- Topological Route Editor
- Unlimited user configurable pad, track and via styles.
- Surface mount & metric support..
- 1 thou resolution.
- 30x30 inch max board size.
- Object oriented 2D drawing for silk screen graphics.
- Drivers for dot matrix, pen plotters, lasers, POSTSCRIPT, gerber, NC drill.

Labcenter
Electronics

COMBINATION PRICES

SUPERSKETCH & EXT LIB & PCB II £149
 DESIGNER & ARES £495
 DESIGNER & ARES AUTOROUTE ... £675
 DESIGNER+ & ARES £675
 DESIGNER+ & ARES AUTOROUTE .£850
 Prices inc UK delivery, exc VAT.

Call for demo packs
 Tel: 0274 542868
 Fax: 0274 481078

See us at
 Leetronex 91
 Stand No 1

14 Marriner's Drive, Bradford. BD9 4JT

The ONE STOP Component Shop

▶ Massive Stocks

▶ Old & New Technology

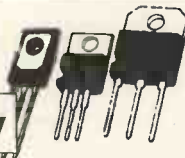

▶ Latest Japanese Semi-conductors & Transistors Available

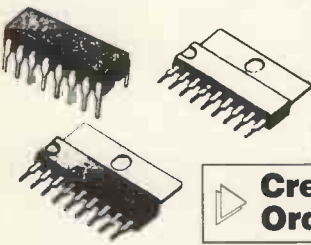

▶ Credit Card Telephone Orders a Speciality

CRICKLEWOOD ELECTRONICS



Tel: 081 4520161 & 081 4500995
 40 Cricklewood Broadway, London NW2 3ET
 Fax: 081 2081441 - Telex: 914977 CRICKEL G

UPGRADE OR BUILD YOUR OWN IBM COMPATIBLE



MOTHERBOARDS

CPU	RAM	L/SPEED	PRICE
286-12	Ok	16Mhz	£105
286-12	1Mb	16Mhz	£165
386 SX	Ok	19Mhz	£285
386-25	Ok	33Mhz	£485
386-33	64k cache	54Mhz	£850

GRAPHIC CARDS

VGA	256k	16 BIT	£75
SUPER VGA	512K	16BIT	£95

ADD-IN CARDS

Floppy Hard Disc Controller	£59
I/O Card for XT/AT	£28

BOOKS

Build your own 80286 IBM Comp-Pilgrim	£16.30
PC Upgrade Book Smith	£11.85

KEYBOARDS

(ENHANCED 102 KEY)	PRICE
IBM + COMPATIBLE	£35
AMSTRAD 1640/1512	£59
PS2 + COMPAQ	£75

FLOPPY DRIVES

360k	5.25	£55
1.2M	5.25	£59
720k	3.5	£55
1.44	3.5	£59

HARD DISC DRIVES

ST 225 20Mb 68MS 5.25"	Half Height	£145
ST 251 40Mb 28MS 5.25"	Half Height	£240
IDE hard disc 40Mb 28MS 3.5"	Half Height	£219
Dual Drive Cable Set		£10

Write, Phone or Fax for a FREE Catalogue
 All prices exclude 15% VAT (Carriage by Post)

MANY OTHER PERIPHERALS AVAILABLE

PANRIX ELECTRONICS

93 KENTMERE APPROACH,
 LEEDS LS14 1JW.
 Tel: 0532 650214
 Fax: 0532 300 488



Rewarding Loyalty

You can be a winner with our Reader Loyalty Bonus.

This month's top ten readers:

P. Jones of London NW6 has £173.96 of the money spent with Maplin Electronic Components refunded.

D. Moore of Marton who bought £120.73 worth of goods from Number One Systems.

J. Shah of Birmingham receives £119.95 for buying goods from Greenweld.

G.L. Marshall of Southport has the £99.95 spent with Maplin refunded.

M. Smith of Edinburgh traded with Maplin and has £91.99 refunded.

J. Thomas of London W11 gets back the £44.95 he spent with Tandy.

S.N. Burn of Whitley Bay claims his £28.37 which he spent with Bull Electrical.

H. Levin of Brighton secures his £21.35 for purchasing goods from Greenweld.

A. Reekie from Liverpool is reimbursed £14.95 for trading with Cambridge Computer Science.

Leon Volauseh of Pontypridd has £14.25 repaid for his purchase from Maplin.

See page 53 for entry details!

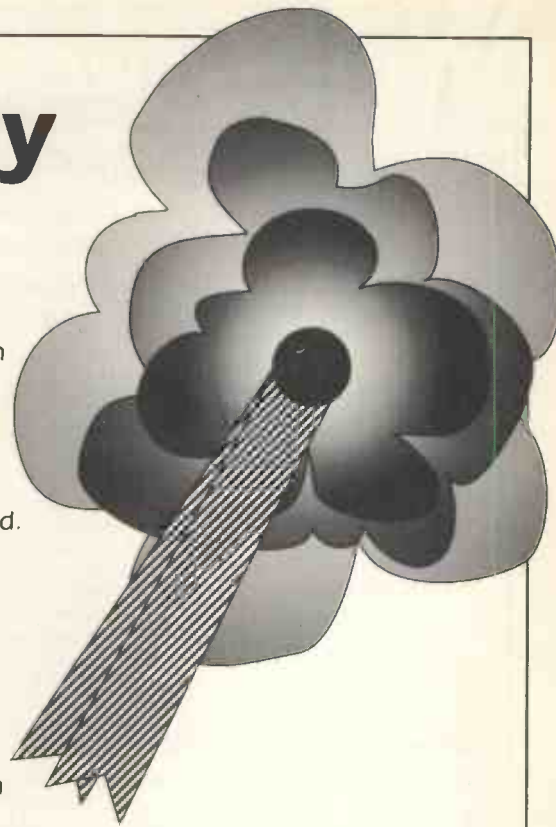

HAPPY MEMORIES

4116	150ns pulls	1.00	256x9 SIMM	80ns	11.50
4164	100ns	1.45	256x9 SIPP	80ns	12.00
41256	120ns	1.40	6264	100ns LP	2.45
41256	100ns	1.55	62256	100ns LP	3.45
41256	80ns	1.65	2764	250ns	1.85
41464	100ns	2.20	27128	250ns	2.25
414256	80ns	4.45	27256	250ns	2.45
411000	80ns	4.45	27C256	250ns	2.45
1Megx9 SIMM	80ns	37.50	27512	250ns	3.45
1Megx9 SIPP	80ns	39.50	27C512	250ns	3.75

Motherboards

80286 Up to 4Mb RAM EMS on board
 12MHz £79 16MHz £95 20MHz £112
 80386SX 16MHz £255 20MHz £290
 80386DX 25MHz £390
 80386DX 33Hz Cache £675

Odds

120Mb Internal Tape Streamer £215
 102 Key Tactile Keyboard £35

Video

8 Bit VGA card 256K 800x600 £37.50
 16 Bit VGA 512K 1024x768 £69
 16 Bit VGA 1Mb 1024x768x256 £85
 Hercules/Printer card £9.95
 Amber TTL 14" Monitor £79.50
 VGA Paper White £110
 VGA Colour 1024x768 £259

Carriage on Motherboards, Floppy drives & Keyboards £5, Video & Controller cards £3, Hard disks, Cases & Monitors £10, ICs free if over £15 nett, otherwise add 50p. VAT to be added to total. Full list of ICs, computers and computer parts on request.

Disk drives

5.25" 1.2Mb Floppy £47
 3.5" 1.44Mb Floppy £44
 5.25" Frame for floppy £5
 40Mb 28Ms 3.5" IDE £140
 80Mb 19Ms 3.5" IDE £265
 106Mb 19Ms 3.5" IDE £325
 177Mb 15Ms 3.5" IDE £475

Cards

16 Bit controller 2xFDD and 2 x IDE HDD £12
 With serial, Parallel & Games port on board £29
 8 Bit Ser. Par. & Games £12

Cases

Smart Desktop 200W £87.50
 Tower Case 220W £169

Happy Memories, FREEPOST,
 Kington, Herefordshire HR5 3BR
 Tel: (054 422) 618 Fax: (054 422) 628



VARIABLE VOLTAGE TRANSFORMERS

INPUT 220/240V AC 50/60 OUTPUT 0-260V
 Price P & P
 0.5KVA 2.5 amp max £29.00 £3.75 (£37.65 inc VAT)
 1KVA 5 amp max £37.40 £4.25 (£41.65 inc VAT)
 2KVA 10 amp max £54.00 £5.48 (£59.48 inc VAT)
 3KVA 15 amp max £71.50 £6.24 (£77.74 inc VAT)
 5KVA 25 amp max £126.50 (Carriage on request)

VOLTAGE CHANGING TRANSFORMER

1250 Watt auto. Tapped 0-90V, 100, 110, 115, 120, twice to obtain voltages between 90 and 240V. Fitted in heavy duty louvered metal case. Fused input. Price incl VAT & p&p £39.50.

COMPREHENSIVE RANGE OF TRANSFORMERS-LT-ISOLATION & AUTO (110-240V Auto transfer either cased with American socket and mains lead or open frame type. Available for immediate delivery.

ULTRA VIOLET BLACK LIGHT FLUORESCENT TUBES

4ft 40 watt £10.44 (£12.00 inc VAT) Caller only
 2ft 20 watt £7.44 + £1.25 p&p (£8.69 inc VAT)
 13in 10 watt £5.80 + 75p p&p (£6.55 inc VAT)
 12in 8 watt £4.80 + 75p p&p (£5.38 inc VAT)
 9in 6 watt £3.96 + 50p p&p (£4.46 inc VAT)
 6in 4 watt £3.96 + 50p p&p (£4.46 inc VAT)

230V AC BALLAST KIT for either 6in, 9in or 12in tubes £5.50 + 55p p&p (£6.05 inc VAT)
 For 13in tubes £6.00 + 75p p&p (£6.75 inc VAT)

400 WATT UV LAMP

Only £34.00 + £2.50 p&p (£36.50 inc VAT)
175 WATT SELF BALLASTED BLACK LIGHT MERCURY BULBS Available with BC or ES fitting. Price incl VAT & p&p £19.84.

12 VOLT BILGE PUMPS

Buy direct from the importers
 500 GPH 15ft head 3 amp
 £16.00 inc
 1750 GPH 15ft head 9 amp
 £20.18 + £2.00 p&p (£22.18 inc VAT)

EPROM ERASURE KIT

Build your own EPROM ERASURE for a fraction of the price of a made up unit kit of parts less case includes 12in 8 watt 2537 Angst Tube Ballast unit pair of bl-pin leads neon indicator on/off switch safety microswitch and circuit £14.00 + £2.00 p&p (£16.00 inc VAT)

SUPER HY-LIGHT STROBE KIT

Designed for Disco, Theatrical users etc. Approx 16 joules. Adjustable speed £48.00 + £2.00 p&p (£50.00 inc VAT)

Case and reflector £22.00 + £2.00 p&p (£24.00 inc VAT)
 See for further details including Hy-Light and industrial Strobe Kits.

WIDE RANGE OF XENON FLASHTUBES

Write/Phone your enquiries
EXTENSIVE RANGE OF DIFFERENT TYPES OF GEARED MOTORS AVAILABLE FROM STOCK

WASHING MACHINE WATER PUMP

Brand new 240V AC fan cooled can be used for a variety of purposes. Inlets 1 1/2 ins. Outlet 1 inch. Price including p&p and VAT — £10.95 or 2 for £20 including p&p and VAT.

12V DC 20 RPM REVERSIBLE MOTOR

Swiss precision built. Ideal for robotics. Size: length inc. shaft 90mm. Diameter from fixing 38mm square. Currently advertised by well known supplier at £27.00 plus p&p & VAT. Our Price £14.95 inc. p&p & VAT

GIANT BLOWER EXTRACTOR UNIT

Twin output centrifugal blower 1 HP 240V AC motor, output approx. 3800 c.f.m. Size: Length 100cm; Height 27cm; Depth 26cm; Fixing plate 106 x 33cm. Price £125 + VAT. Ex warehouse

TORIN CENTRIFUGAL BLOWER

230V inc 2,800 RPM 0.5amp 130mm diameter impeller outlet 63 x 37mm overall size 195 x 160 x 150mm long. Price £1750 + £2.50 p&p (£23 Inc. VAT)

SHADED POLE GEAR MOTORS

In the following sizes:
 9 RPM 12 RPM 80 RPM 160 RPM 110V AC or 240V AC with capacitors (supplied). Price incl VAT & p&p £12.65

GEARED MOTORS

71 RPM 20lb inch torque reversible 115V AC input including capacitor and transformer for 240V AC operation. Price incl VAT & p&p £23.00

SOLID STATE EHT UNIT

Input 230/240V AC. Output approx 15KV. Producing 10mm spark. Built-in 10 sec timer. Easily modified for 20 sec. 30 sec to continuous. Designed for boiler ignition. Dozens of uses in the field of physics and electronics. eg supplying neon or argon tubes etc. Price less case £8.50 + £1.00 p&p (£10.50 inc VAT) NMS

HEAVY DUTY MOTOR

Crouzet 115V/230V A.C. heavy duty 1RPM motor. Anticlockwise type £2015. Size 68mm diameter x 55mm long. Shaft 6mm diameter x 20mm long. Price inc. VAT & p&p £18.40.

RHEOSTAT

50W 2ohm 5amp ceramic power rheostat. Price incl VAT & p&p £10.35.

MICROSWITCH

Pye 15 amp changeover lever microswitch, type 5171 Brand new. Price 5 for £6.90 inc. VAT & p&p.

NMS = NEW MANUF SURPLUS
 R&T = RECONDITIONED AND TESTED

SERVICE TRADING CO

57 BRIDGMAN ROAD, CHISWICK, LONDON W4 5BB



Showroom open Monday/Friday

081-995 1560
 ACCOUNT CUSTOMERS MIN. ORDER £10



Ample Parking Space

Hitachi H8/330

Perhaps the most sophisticated micro-controller available, this chip has everything built in, from 57 I/O pins and ADC to DPRAM and EPROM.

The new Hitachi H8/330 is a micro-controller with an exceptionally large number of features. It is able to operate at up to 10MHz from an internal clock and offers 16k bytes of EPROM or one time programmable (OTP) ROM, 512 bytes of RAM, 15 bytes of dual port RAM (DPRAM), eight channels of 8-bit resolution analogue to digital conversion (ADC), full duplex synchronous and asynchronous serial communications interfaces, a 16-bit free running timer, two 8-bit multi-function timers, two 8-bit PWM modules, 57 parallel input/output lines and 9 input only lines. It has a low power consumption, being fabricated using CMOS technology and consumes only 12mA when operating at 6MHz. Further power savings can be made by putting internal modules to 'sleep' when they are not needed.

The central processing unit (CPU) section of the chip is based around eight 16-bit registers, each of which can be divided into two. There is no distinction between data and address registers except that when they are being used for addresses, all of the 16-bits are used. Additional control registers are the 16-bit program counter and the condition code register (CCR) which holds all of the status flags – interrupt, half carry, negative, zero, overflow, carry and two flags for the user status. The stack pointer uses register R7 as a 16-bit pointer to the current stack position.

A number of data formats are catered for, one bit, 8-bit bytes, 16-bit words and packed BCD. The arrangement of the working registers (R0-R7) is such that data sizes less than 16-bits can occupy either the low or high portion with no overhead such as extra instructions.

The H8/330 instruction set supports eight addressing modes and has 150 instructions made up from seven basic instruction types.

A large number of these are devoted to bit manipulations and allow data being moved to and from the I/O ports to be dealt with efficiently.

The CPU is able to communicate with the facilities available on the chip via direct addressing. Most of the devices are able to contribute to the system's 30 interrupt vectors, nine of which are externa. How the internal and external memory are accessed depends on the operating mode selected. There are three of these allowing various memory and I/O configurations. Programs can be either from external ROM, a mix of external and internal or just from 16k bytes of internal – the external memory could also be RAM. The on chip registers are placed at the top end of the

memory occupying 112 bytes, just above the 512 bytes of internal RAM.

An interesting feature of the H8/330 is the dual port RAM. This consists of 15 bytes of memory which can be accessed by the on chip CPU or by an external device. An interrupt is available so that the on board CPU can be notified of external accesses.

Other on-board systems are the 16-bit free running timer (FRT) which provides a host of useful timing facilities. Counting can be derived from the internal clock divided by 4, 8 or 32, or from an external source. Two comparators allow the output of independent waveforms and interrupts can be generated for seven different situations.

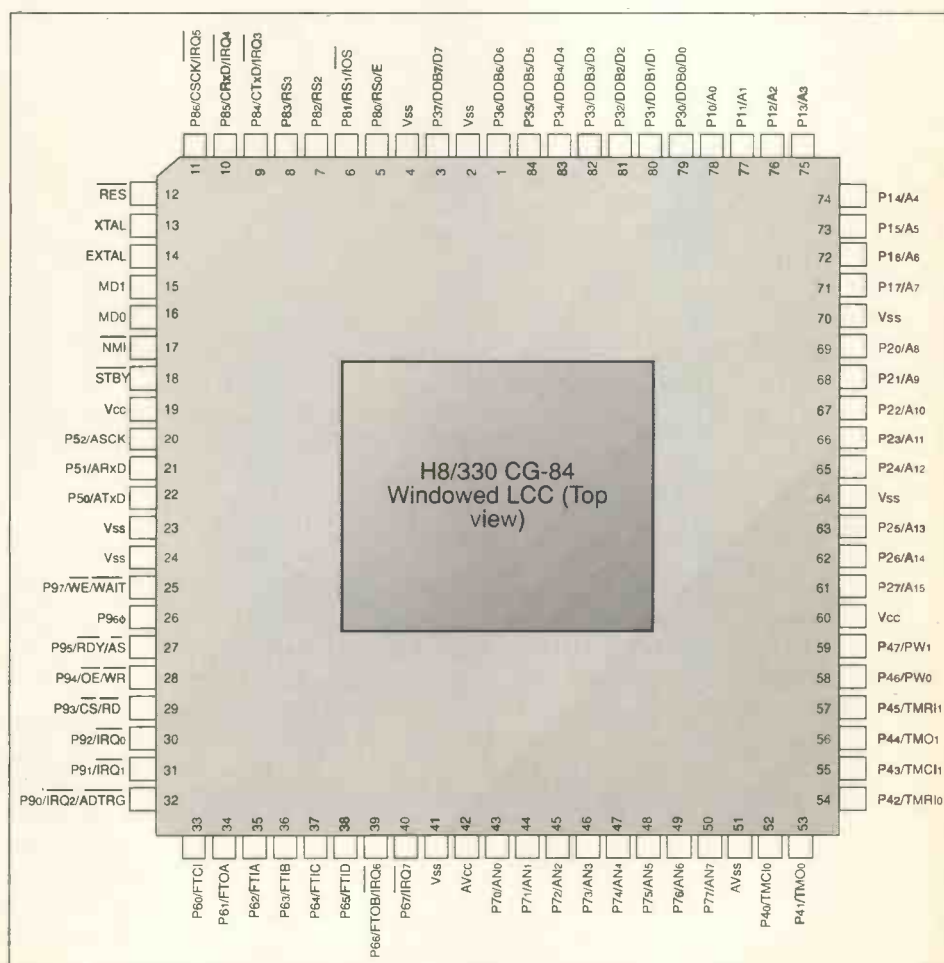

Pin Usage

Vcc	Power supply	In
Vss	Ground	In
XTAL	Crystal	In
EXTAL	External crystal	In
ϕ	System clock	Out
\bar{E}	Enable clock	Out
\bar{IOS}	Input/output select	Out
\bar{RES}	Reset	In
STBY	Standby	In
A ₀ -A ₁₅	Address bus	Out
D ₀ -D ₇	Data bus	In and out
WAIT	Wait	In
\bar{RD}	Read	Out
\bar{WR}	Write	Out
\bar{AS}	Address strobe	Out
\bar{NMI}	Non-maskable interrupt	In
IRQ ₀₋₇	Interrupt request 0 to 7	In
MD ₀₋₁	Operating mode select	In
FTCI	Free run timer clock	In
FTOA	Free run timer compare A	Out
FTOB	Free run timer compare B	Out
FTIA	Free run timer capture A	In
FTIB	Free run timer capture B	In
FTIC	Free run timer capture C	In
FTID	Free run timer capture D	In
TM ₀₋₁	8-bit timer clock	Out
TMCI ₀₋₁	8-bit timer clock	In
TMRI ₀₋₁	8-bit timer counter reset	In
PWM ₀₋₁	PWM timer	Out
ATxD	Asynchronous transmit data	Out
ARxD	Receive data	In
ASCK	Serial clock	In and out
CTxD	Synchronous transmit data	Out
CRxD	Receive data	In
CSCK	Serial clock	In and out
AN ₀₋₇	ADC analogue in	In
ADTRG	ADC start conversion ext	In
AVcc	Analogue power supply	In
AVss	Analogue ground	In
DDB ₀₋₇	Dual port RAM (DPRAM) bus	In and out
\bar{CS}	Chip select	In
RS ₀₋₃	DPRAM register select	In
\bar{OE}	Output enable	In
\bar{WE}	Write enable	In
\bar{RDY}	Ready	Out
P1 ₀₋₇	Port 1	In and out
P2 ₀₋₇	Port 2	In and out
P3 ₀₋₇	Port 3	In and out
P4 ₀₋₇	Port 4	In and out
P5 ₀₋₂	Port 5	In and out
P6 ₀₋₇	Port 6	In and out
P7 ₀₋₇	Port 7	In and out
P8 ₀₋₆	Port 8	In and out
P9 ₀₋₇	Port 9	In and out

Other timing facilities are provided by the 8-bit timer which has two independent channels. These can be derived from the system clock divided by 8, 64, 1024 or an external source. As with the 16-bit timer, compare and interrupts are provided.

The third system is the pulse width modulation (PWM) module which, again, has two independent channels. Each includes an 8-bit duty register which can be used to give pulses with any duty ratio from 0 to 100%.

Serial communications are supported in both synchronous and asynchronous format. Data rates are

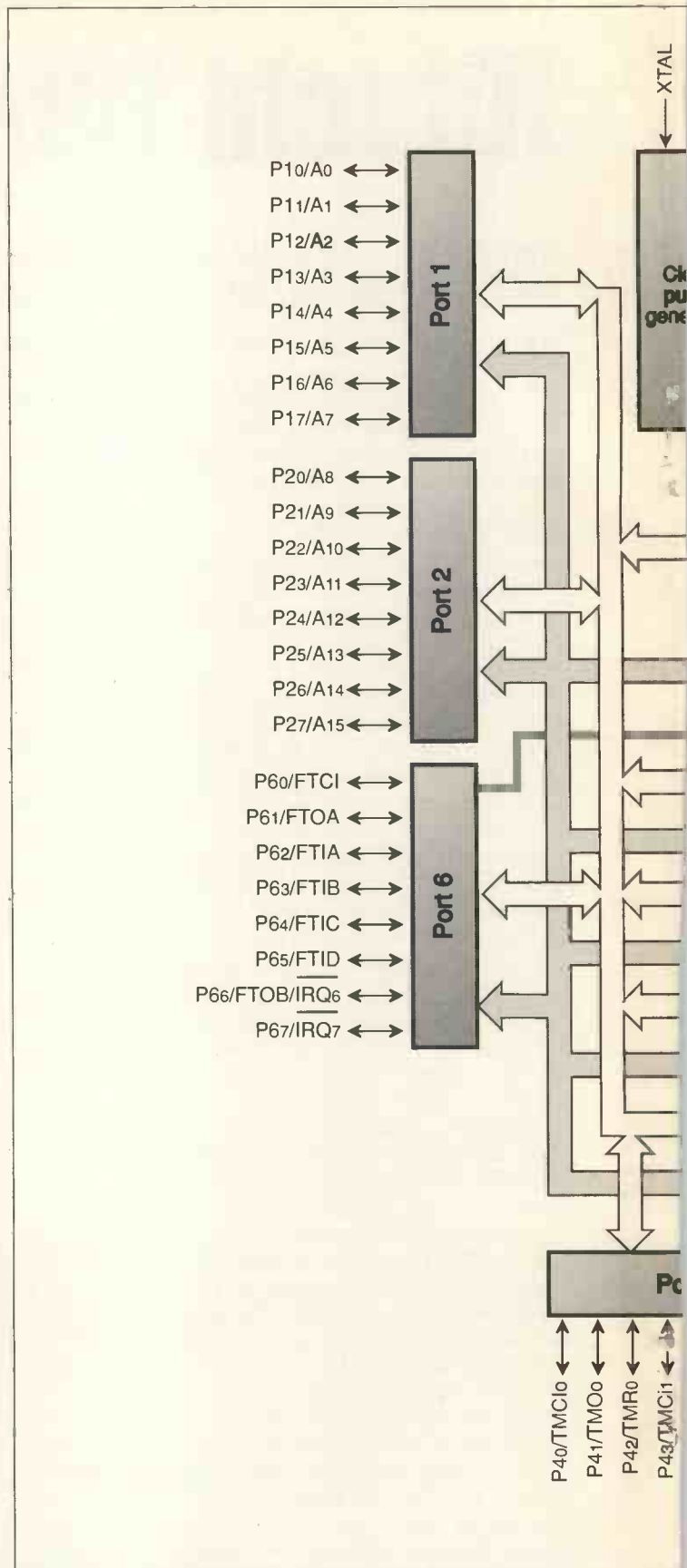

determined by a built in baud rate generator or an external source. Double buffering allows data to be sent and received continuously and overrun, frame and parity errors are automatically detected.

A single ADC (analogue to digital convertor) can be programmed to sample up to eight channels with 8-bit resolution at 10MHz. Conversions can be triggered either internally or externally and the results transferred to data

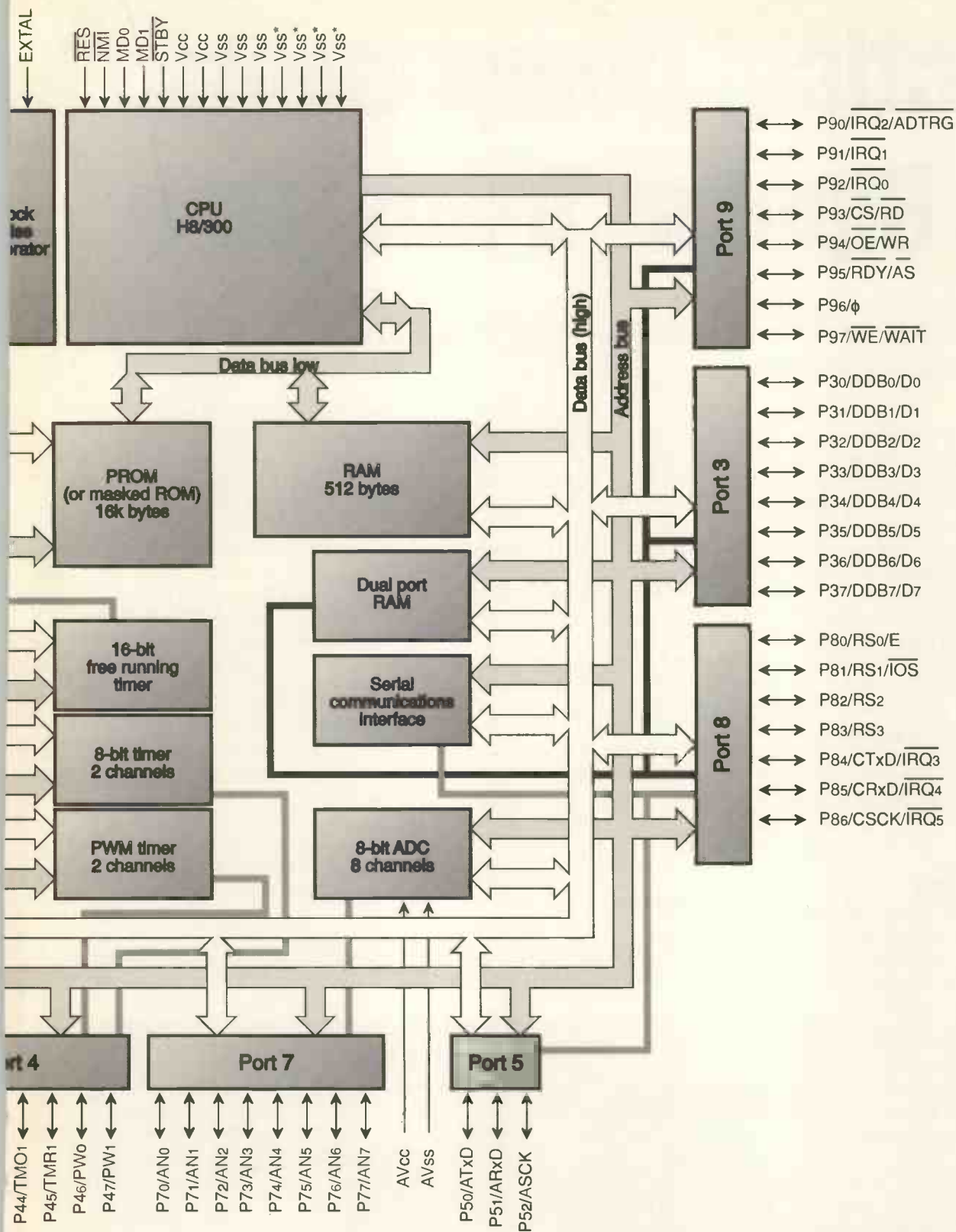

registers corresponding to each channel. The most important part of the chip is its input/output capabilities. There are 57 I/O pins, each of which can be programmed for input or output, and nine input only pins. Depending upon the operating mode, some of the pins will be used for external addressing and data bus functions. Others provide interrupt functions and register selection for the DPRAM.

Instruction types	
Data transfer	MOV
Arithmetic	ADD, INC, DAA, NEG, SUB, DEC, DAS, CMP, MUL, DIV
Logic/Shift	AND, OR, XOR, NOT/SHA, ROT
Bit manipulation	BSET, BCLR, BNOT, BTST, BLD, BLD, BST, BST, BAND, BOR, BXOR
Branch	BR on flag status, JMP, BSR, JSR
System control	RTS, RTE, SLEEP, LDC, STC, ANDC, ORC, XORC, NOP

Practical Components: The Bipolar Transistor

Following on from last month's examination of diodes, Steve Knight BSc., looks at the most famous semiconductor of them all.

The name transistor is a combination of two words, 'transfer' and 'resistor'. This is because transistor action depends upon the fact that a current generated in a circuit of low resistance can be transferred to a circuit of high resistance, so enabling a power gain to be acquired. The precise, detailed behaviour of a transistor will be found in advanced textbooks dealing with the mathematics of solid state physics and quantum theory. A simple explanation can, however, be made using the basic facts already obtained about diode operation.

At The Junction

Junction transistors consist of two PN diodes formed close together in one single crystal of germanium or silicon, so that either a PNP or an NPN configuration is produced.

Fig.1 shows what is known as a diffused alloy junction construction. Here, two N-type regions are alloyed under heat to a thin P-type wafer and cooled sufficiently slowly for the P-type crystal lattice to grow out into the N-regions. There are then two PN junctions separating three distinct regions. Connecting leads are taken from each of these regions. There are then two PN junctions separating three distinct regions. Connecting leads are taken from each of these regions and the transistor is suitably encapsulated. It is an NPN device since it is formed of a sandwich in that order. A PNP transistor can be fabricated in exactly the same way. Modern transistors are made by a more sophisticated technique than the

alloying method and much closer control of the transistor characteristics is possible, but the basic principle is unchanged.

It follows from the above that a transistor is two junction diodes connected back to back. Fig. 2 shows the situation for both NPN and PNP transistors, and for each of these arrangements the external connections are known as the emitter, base and collector terminals. The arrowheads on the emitters indicate for both types of device the flow of conventional current in the base-emitter diode – this symbolism immediately identifies the type of transistor concerned.

Starting Up

To get the transistor operational, sources of DC voltage are now applied to the terminals as shown in Fig. 2. A steady bias voltage V_C is applied between the collector and base with a polarity such that the

diode is reverse biased and appears as a very large resistance. A second steady bias voltage V_B is then applied across the emitter and base such that this diode is forward biased and appears as a very low resistance. As a consequence, the emitter injects its majority carriers into the base region. Notice that the polarity of these carriers is opposite to the polarity of the collector region. The carriers accordingly find themselves in a narrow region faced with an attractive field.

Looking at this from the point of view of an NPN device, Fig.3 illustrates what happens: the majority carriers in the N-type emitter are electrons and these are injected into the P-type base under the influence of the forward bias V_B . Since the base is P-type and electrons exist there only as minority carriers, once they reach the depletion layer existing between the base and collector regions, they have an unrestricted run through the potential barrier

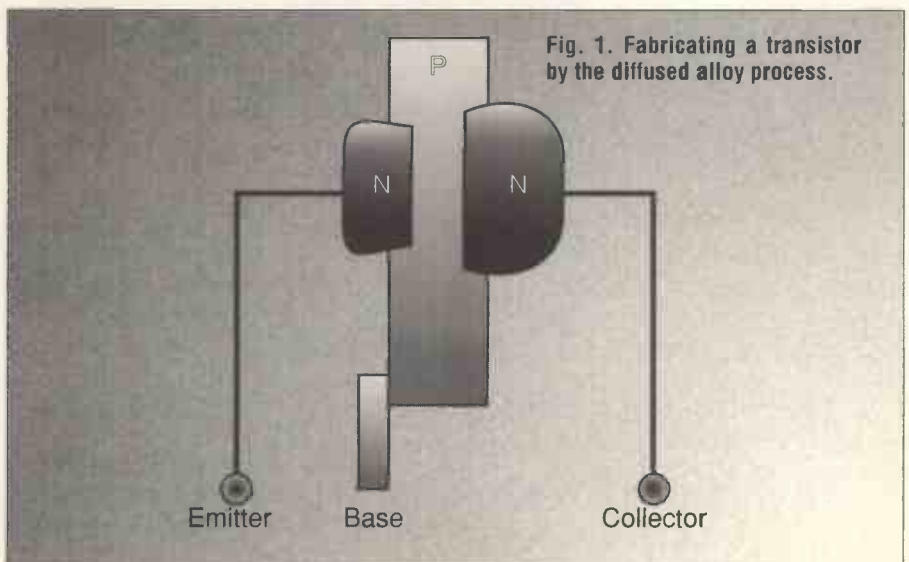
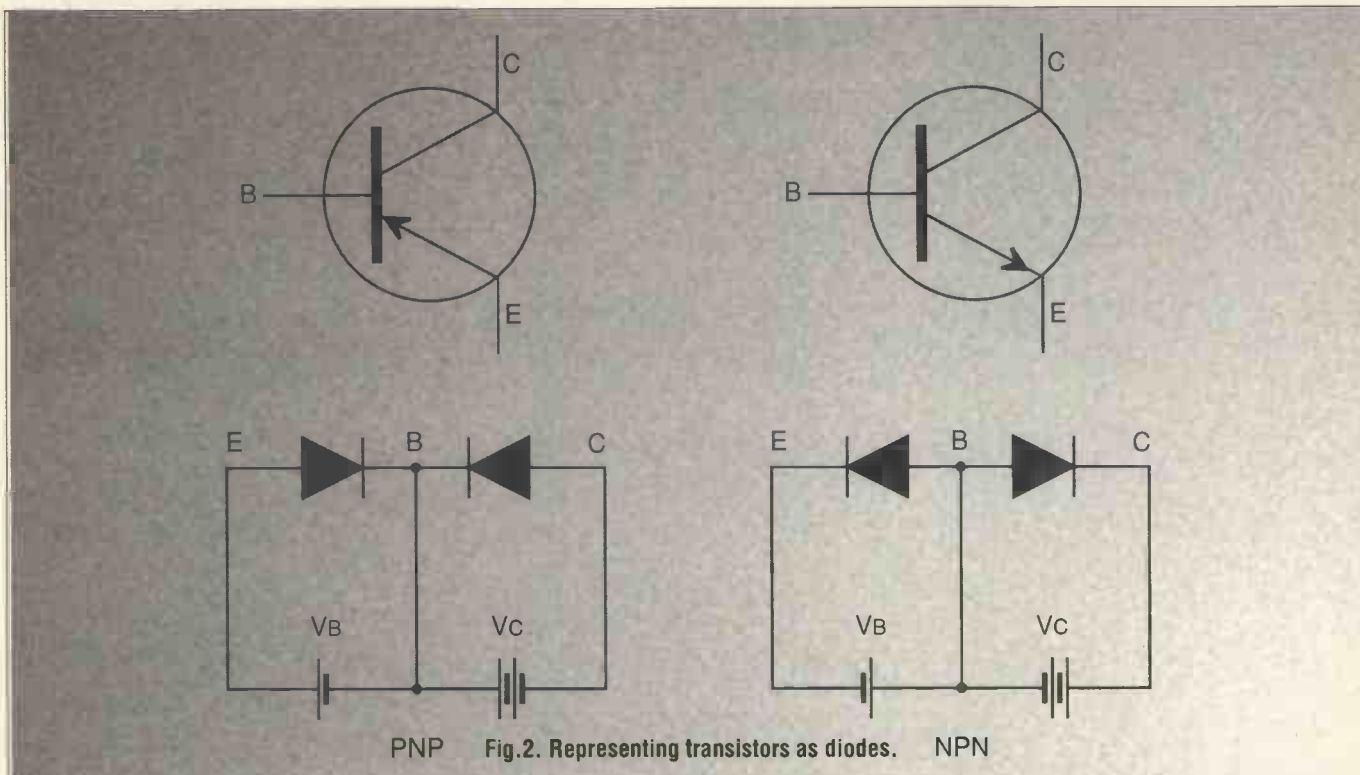

Fig. 1. Fabricating a transistor by the diffused alloy process.



PNP Fig. 2. Representing transistors as diodes. NPN

and are rapidly swept into the collector region. Those electrons arriving at the collector, then, are derived almost entirely from the emitter.

Almost? Yes, because in the base region a small proportion of the electrons recombine with holes and so effectually disappear from the active process. This loss of charge upsets the charge equilibrium because the base has captured a number of negative charges; this unbalance is corrected by the base battery supplying holes to the base region, which it does by an outward flow of electrons. Thus a small base current I_B is established. The base region is made very narrow to reduce this loss of majority carriers, since the time spent by the electrons crossing the base is then short and the chance of recombination correspondingly reduced.

As a result some 99.5% or more of the carriers reach the collector where they provide the collector current I_C . This process is the fundamental, though simplified, mechanism whereby current amplification takes place in a transistor.

Seen from the point of view of the external circuit, a relatively large current flows into the emitter terminal (I_E), a small flow of electrons leave the base (I_B), and from the collector a current (I_C) flows which is almost equal to the

emitter current flowing in. Clearly, the sum of the base and collector currents must equal the emitter current, so $I_E = I_B + I_C$. For a small general purpose transistor we might find such typical values as $I_E = 2\text{mA}$, $I_B = 50\mu\text{A}$, so that I_C would be 1.95mA . For power transistors, emitter currents can be a matter of several amperes.

The physical behaviour of a PNP transistor can be deduced in the same way: the majority carriers in the emitter are now holes and these flow into the base when the base is biased negatively. Again, a small proportion of these holes will recombine with the majority electrons in the base and give rise to a small inward flow of current into the base to restore the charge equilibrium. Relative to the NPN

transistor, the PNP circuit simply reverses the battery connections and the external currents direction of flow.

Hooking Up

A transistor may be connected in any one of three possible ways into a practical circuit, and its amplifying or control characteristics depend upon which of these configurations is used. In Fig. 4a the common-base connection is shown; here the input signal is applied between emitter and base and the output signal is taken between collector and base, that is, the base is the common electrode. Fig. 4b shows the common-emitter (the most usual of the configurations) where the input is applied between

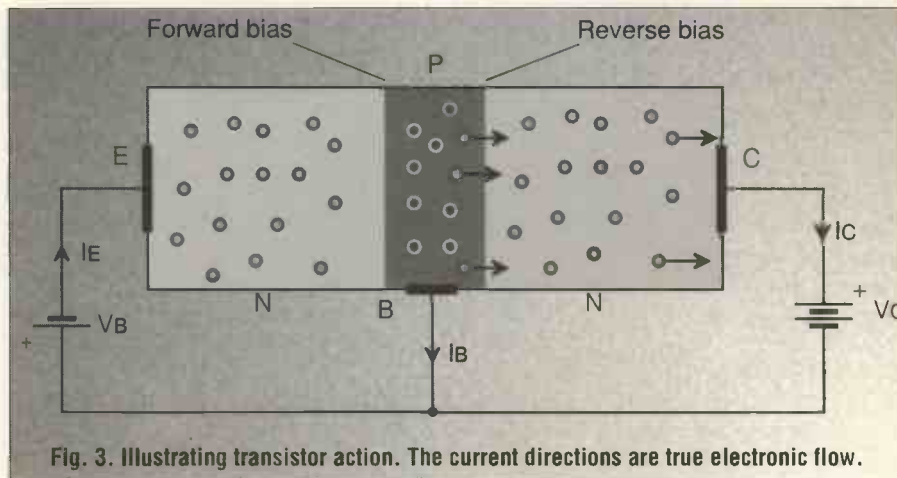

Fig. 3. Illustrating transistor action. The current directions are true electronic flow.

It's All In The Gain

Because both electrons and holes are carriers, the form of transistor described above is known as 'bipolar'. Field-effect transistors operate with only one type of carrier, electrons or holes and these are known as 'unipolar'.

The gain of a bipolar transistor used in a practical circuit where AC signals are superimposed on the static DC conditions is known as the dynamic gain. In general terms, this dynamic gain is always rather less than the static gain figure but not greatly so. Apart from their purpose of establishing the static conditions, the battery supplies are fundamentally irrelevant.

A typical basic amplifier stage, considering an NPN common-emitter connection, is shown in Fig.5. This differs from the static circuit in that a load resistor R_L is included in the collector circuit, and the base-bias voltage (formerly the battery V_B) is derived from the single source by way of base resistor R_B .

If this circuit is properly to amplify an AC signal (supposing this to be a small sine wave for simplicity) then the base-emitter diode must be forward biased even when there is no signal input. If it is not, then the negative half cycles of the input will produce no response. Hence the value of R_B is chosen so that a mean or quiescent base current flows which can be varied in a linear fashion on either side by the positive and negative alternations of the base signal. Typically, for a small signal transistor, the quiescent current would be, say, 10 - 100 μ A.

When an input signal voltage is applied to the base, it varies the base current alternately above and

below the mean value and then changes the collector current and so the voltage developed across R_L . We then have a device which is a current amplifier, but when used in the manner shown amplifies a voltage. Suppose, by way of an illustrative example, the h_{FE} of the transistor shown to be 75, R_L to be 1K Ω , and the mean I_B to be 100 μ A. Since 100 μ A (= 0.1mA) is the steady base current, the collector current will be $h_{FE}I_B = 75 \times 0.1 = 7.5$ mA. This current flows through R_L and develops a voltage across R_L equal to $7.5 \times 10^{-3} \times 10^3 = 7.5$ V. Hence, for the 12V supply, 5.5V is the quiescent voltage at the collector.

In any amplifier it is necessary first to establish, both at the base and at the collector, these quiescent conditions before the AC signal is applied. Unless these values are correct (though they are not usually extremely critical) the amplifier will produce a distorted output. The relevant point is that, when the signal is zero, the transistor must draw sufficient collector current to ensure that the collector voltage stands closely to the midway value between the supply level and the common earth rail, ready to swing in either direction relative to the polarity of the input signal. From the example, the collector can swing upwards from 5.5V towards the supply rail voltage (+12V) when the input goes fully negative, and downwards towards the earth rail (0V) for a positive-going input cycle. In practice, neither of these extremes (known respectively as 'saturation' and 'cut-off') should be reached if the signal is to remain undistorted. Notice that there is a 180° phase reversal in the output voltage relevant to the input voltage. ■

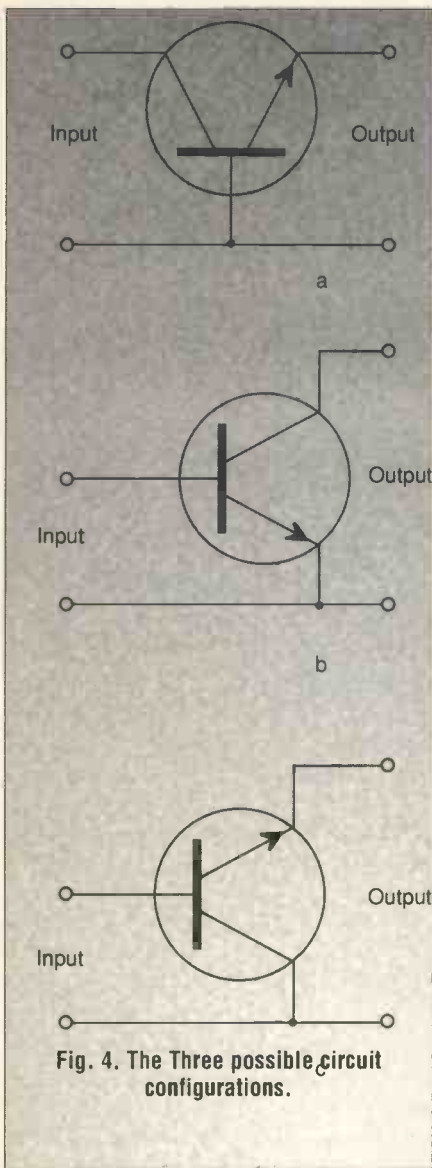

Fig. 4. The Three possible circuit configurations.

base and emitter and the output is obtained between collector and emitter. Fig.4c shows the common-collector circuit (also known as the emitter-follower) where the input goes between base and collector and the output comes between emitter and collector.

Since the internal operation of a transistor is independent of the configuration used, the relationship between the input and output currents is readily deduced. Taking the static gain off a circuit as the ratio: output current/input current, for the common base connection the gain (designated h_{FB}) is I_C/I_E and this must always be less than 1. For the common-emitter the gain (designated h_{FE}) is expressed as I_C/I_B and this is always much greater than 1. h_{FB} can lie typically within the range 0.950 to 0.998, with h_{FE} in the range 50 to 500. The gain of the emitter-follower, h_{FC} , is for all intents and purposes equal to h_{FE} .

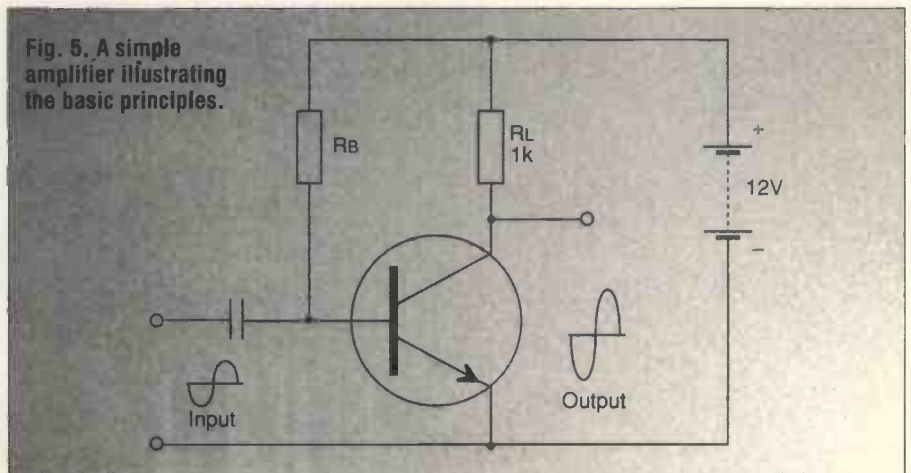

Fig. 5. A simple amplifier illustrating the basic principles.

PE Chronos: Putting On Weight

This month the Anthony H. Smith gets down to some real hardware and describes the input circuitry complete with capacitive compensation and ODR detection.

No matter how stable and accurate a universal counter timer's frequency reference may be, the performance of the instrument is often dictated by the quality of the input circuits. The reasoning is simple. If the instrument can't handle a particular input signal and gives no reading, or - even worse - if it mistriggers and gives an erroneous reading, the frequency reference might just as well be a grandfather clock.

Consequently, to justify the use of a high accuracy standard, and to facilitate truly universal measurements, the Chronos has two, fully comprehensive input conditioning channels. Channel A is identical to channel B, and is shown in the schematic of Fig.1 (overleaf).

Frequency Breaks

The position of Sw1 determines whether the input signal at Skt1 is DC or AC coupled via C1. Note that C1 effectively forms a high pass filter with the input resistance of the channel, namely 1M. The break frequency of this filter is:

$$\begin{aligned} f_o &= 1/(2\pi CR) \\ &= 1/(2 \times 0.1 \times 10^{-6} \times 1 \times 10^6) \\ &= 1.6\text{Hz.} \end{aligned}$$

Sw2 is three-position slide switch mounted on the PCB (to minimise interconnections and noise), and is used to select either all pass (AP), high pass (HP), or low pass (LP) filtering.

Selecting either LP or HP feeds the input signal through a first-order RC filter. The LP has a 3dB break at $f_o = 55.6\text{kHz}$ and the HP at $f_o = 1.2\text{kHz}$. Note that the input resistance of the circuitry following

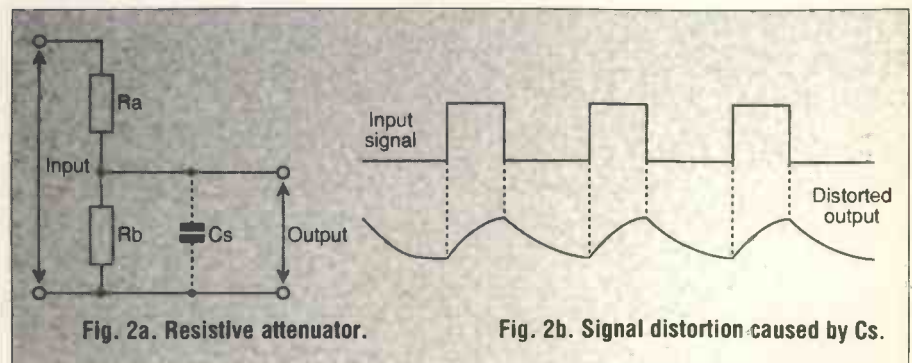

the filters is 1M and is included in the calculation to take account of its shunting effect when determining the HP break frequency.

The precision of the filters' break frequencies depends mainly on the values of R1, C3 and R2, C2 so close tolerance components are used. Note, also, that being at the very input to the channel, the filters must be capable of withstanding overload so C2 and C3 are high voltage capacitors.

Cutting Down The Signal

Sw3 is used to select either x1, x10, or x100 attenuation of the input signal. In the x1 position, the signal is fed directly from the filters to the amplifier and undergoes no attenuation. In positions x10 and x100 the signal amplitude must be reduced by a factor of ten and a hundred, respectively, before reaching the amplifier.

Unfortunately, there is an added complication, Fig.2a shows an attenuator formed from a simple resistive potential divider. At its output, there will always be some shunt capacitance Cs, due to strays and to the capacitance of the following circuitry. At low frequencies, Cs has negligible effect

on the attenuator's operation. At high frequencies, however, the low reactance of Cs adds unwanted attenuation to sinusoidal signals, and severely distorts pulse and rectangular inputs - Fig.2b.

Neutralisation of the effect of Cs is provided by the 'compensated attenuator' of Fig.3. This can be regarded in two ways. Firstly, assume Cb represents the stray capacitance whose reactance grows smaller at higher frequencies. Normally, this would cause unwanted attenuation. However, the presence of Ca - whose reactance also, of course, reduces at high frequencies - has a balancing effect, cancelling out the attenuation introduced by Cb.

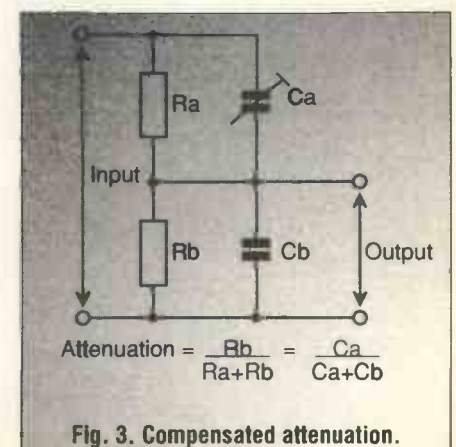

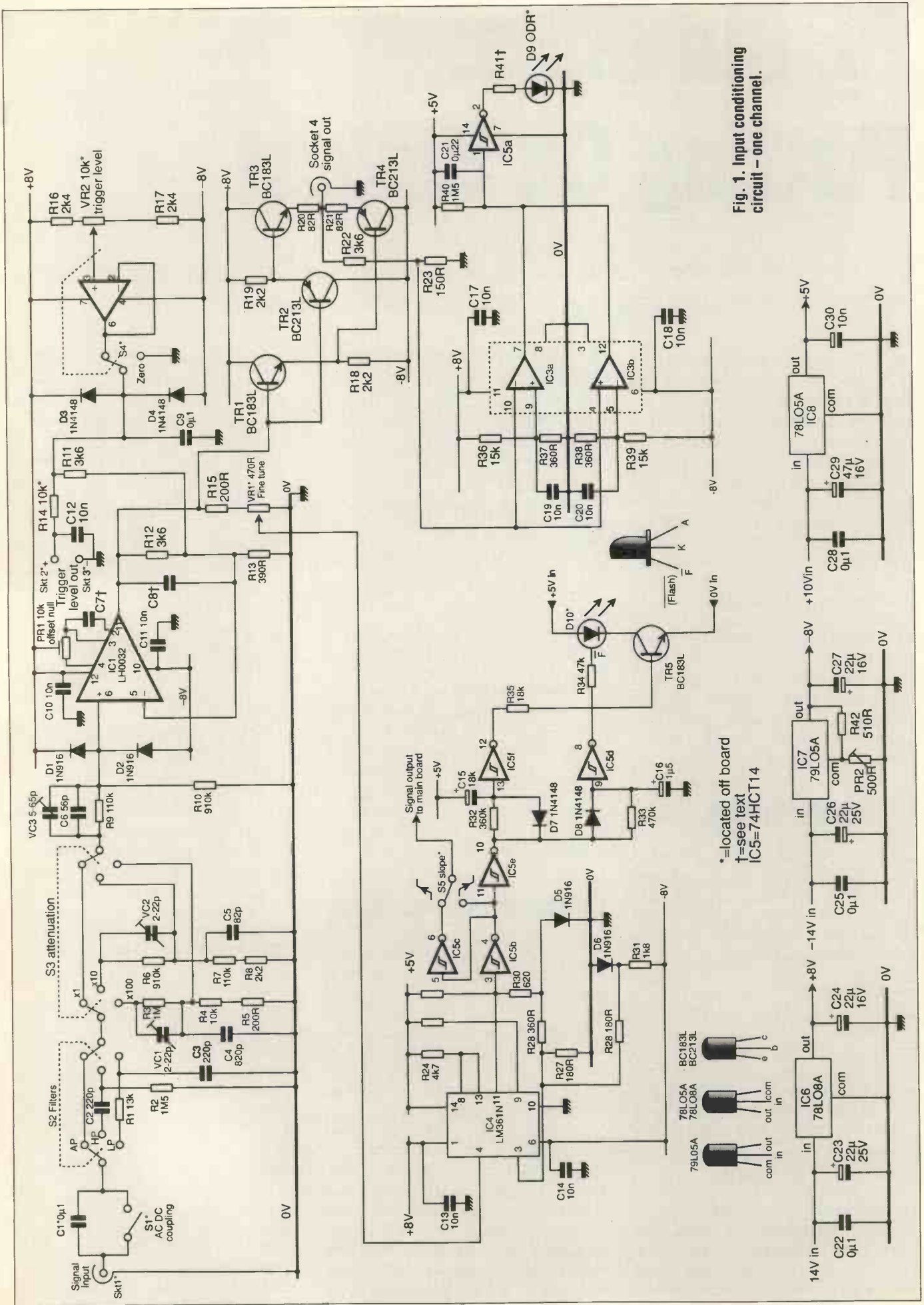

Fig. 1. Input conditioning circuit - one channel.

Alternatively, the compensated attenuator can be viewed as a resistive divider in parallel with a capacitive divider. If the attenuation due to each divider is the same:

$$\frac{R_b}{R_a + R_b} = \frac{XC_b}{XC_a + XC_b} = \frac{C_a}{C_a + C_b}$$

then there will be no frequency-dependent attenuation and no pulse distortion. In practice, C_a is made variable such that it can be trimmed to balance out exactly the effects of stray capacitance.

Consider, for example, the x10 attenuator:

$$\text{ATTEN} = \frac{R_b}{R_a + R_b} = \frac{C_a}{C_a + C_b} = 0.1$$

thus, $C_a = 0.111C_b$.

If C_b is due to stray and unwanted shunt capacitance it will have a typical value of about 10pF. But since $C_a = 0.111C_b$, C_a must be a variable capacitor with a mid-range value of about 1pF - obviously not very practical.

The solution, ridiculous as it may seem, is to increase the stray capacitance. For example say $C_b = 82\text{pF}$, then $C_a = 0.111 \times (82\text{pF} + \text{STRAYS})$ which equals approximately 10pF. Thus, a 2-22pF trimmer will do perfectly for C_a . This is then adjusted to give optimum pulse shape at the attenuator output for a given input pulse. Typical output pulse shapes obtained during the trimming procedure are shown in Fig.4.

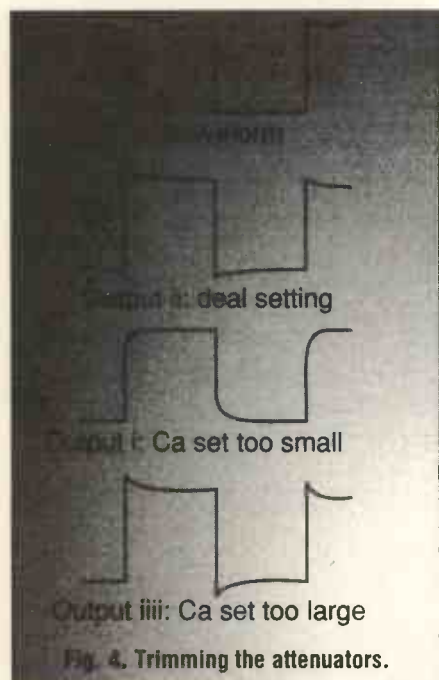

As well as getting the capacitance ratio just right the resistances values must also be correct. This is not as simple as it may seem. Not only must the attenuator's total resistance equal 1M, but account must be taken of the shunting effect caused by the protection circuitry on the attenuator output. In other words, R_b will be shunted by 1M.

Resistors with 1% tolerance are used in the attenuators and although even closer approximations could be made by using, say, 0.1% resistors, these are usually expensive, hard to come by, and yield little significant improvement in performance.

Amplifier Protection

All of the circuitry preceding the amplifier is protected simply by using components rated to withstand the specified overload voltage (250V RMS). The amplifier, however, is a low voltage device which, on its own, cannot tolerate high voltages. An LH0032 op-amp (IC1) is used - this is a specialised device superior to most op-amps, and is one of the most expensive items used in the Chronos. Consequently, adequate overload protection is absolutely essential.

The amplifier is operated on +8V supply rails (this allows the output to swing to $\pm 7\text{V}$ maximum, ensuring a dynamic range of $\pm 5\text{V}$). Unfortunately, the LH0032 will be damaged if the input voltage exceeds the supply rail voltage so the diodes D1 and D2 are used to clamp excessive inputs. Normally, these diodes are reverse biased and have no effect on circuit operation. However, should the voltage at IC1 input (pin 6) rise above +8V or fall below -8V, either D1 or D2, respectively, will conduct, preventing the input voltage increasing any further.

As well as the clamp diodes, some current limiting is required. R_9 limits the input current to a safe 2.3mA RMS when the input is overloaded by 250V RMS. Under these circumstances, practically the entire 250V is dropped across R_9 . This means that it has to have a wattage rating of at least 0.57 watts - a 0.6W type is ideal.

The LH0032 has an extremely high input resistance, typically $10^{12}\Omega$ (This high resistance is one of

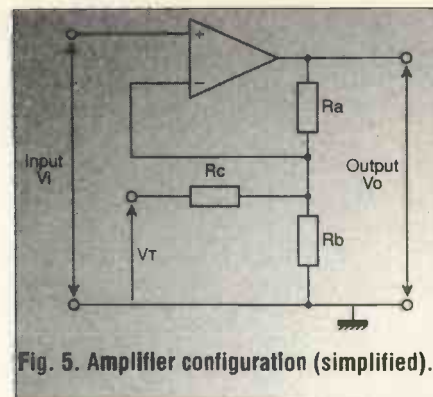

Fig. 5. Amplifier configuration (simplified).

the things that makes the LH0032 so suitable for use in any application requiring a high resistance, low bias-current amplifier). However, since the Chronos must have an input resistance of 1M, it is necessary to shunt the op-amp input by R_{10} (910k), such that the resistance looking into the protection network is $R_9 + R_{10} = 110\text{k} + 910\text{k}$, approximately 1M.

Compensation

Unfortunately, R_9 and R_{10} form a potential divider, which, just like the attenuators, has unwanted capacitance at its output. This capacitance is comprised of the input capacitance of the LH0032 (typically 5pF), and the parallel combination of D1 and D2. It is minimised by using low capacitance devices for D1 and D2, but cannot totally be eliminated.

Because of this the presence of C_6 in parallel with VC3 across R_9 is required to compensate the protection network. VC3 must be adjusted in the same way as VC1 and VC2 to obtain optimum pulse response.

High Performance

In addition to its high input impedance, the LH0032 has several other features which are essential for optimum performance of the Chronos's input circuits. In particular, its wide bandwidth (70MHz at unity gain) and high slew rate (typically 500V/ μs) allow it to cope with high frequency signals, even those having large amplitude and fast rise times.

The device is configured as a non-inverting amplifier with a nominal gain of ten (the actual gain is slightly higher to compensate for the attenuation caused by R_9 and R_{10}).

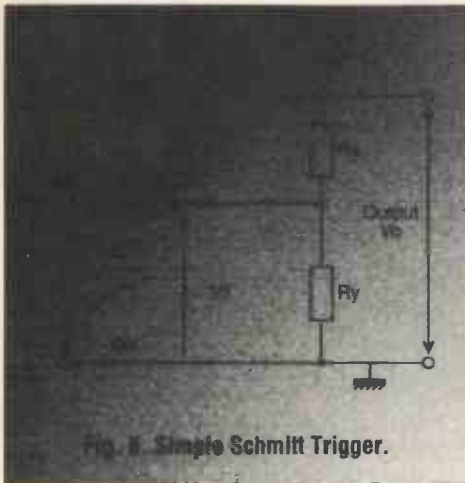

As well as providing amplification, the op-amp must also be configured to allow a variable, DC trigger level voltage to be added to the output: the arrangement used is shown, simplified, in FIG.22.

The output voltage is given by:

$$V_o = V_i \left(\frac{R_a + R_c}{R_c} + \frac{R_a}{R_b} + 1 \right) - \frac{R_a}{R_c} V_T$$

For simplicity, let $R_a = R_c$ such that:

$$V_o = V_i \left(2 + \frac{R_a}{R_b} \right) - V_T$$

This is the arrangement we require; V_o contains the input voltage V_i , multiplied by the factor $(2 + R_a/R_b)$, along with the DC trigger offset V_T .

V_T can be any value in the range -5V to +5V, and is derived from potentiometer VR2 buffered by unity gain voltage follower IC2 (buffering is required to reduce the loading on VR2 so that it has a linear span, and also ensure that the set trigger level remains constant with changes in the amplifier input voltage).

VR2 has an integral switch (Sw4) which provides a simple means of rapidly and precisely setting V_T to zero such that the trigger level offset is removed from the op-amp output: thus, the output will swing symmetrically about zero volts, which is usually the optimum setting for most frequency measurements.

Note that V_T can be read on a voltmeter connected to Skt2 and Skt3. R14 is provided to safeguard against damage caused either by a short circuit between Skt2 and Skt3, or by an accidental overload which will be clamped by D3 and D4. C9

and C12 decouple any noise from the trigger voltage: if C12 is rated at 100V, and R14 at 0.6W, an overload voltage up to 100V can be tolerated at the trigger level output. Note, however, that the presence of R14 means that the trigger voltage must be read using a voltmeter with high input resistance (at least 1M Ω); a low resistance meter will attenuate the output voltage, causing errors.

Gain And Nulling

By relating Fig.5 to Fig.6, Ra corresponds to R12, Rb to R13, and Rc to R11. Consequently, the closed loop op-amp gain is:

$$V_o/V_i = (2 + 3600/390) = 11.23$$

the overall gain of the amplifier stage is

$$\text{GAIN} = 11.23 \times R_{10} / (R_9 + R_{10}) = 11.23 \times 0.89 = 9.995,$$

which is as close an approximation to the required gain of ten as we are likely to get.

The LH0032 has provision to zero its input offset voltage which would otherwise appear as an undesirable offset at the output. This is achieved using PR1, a 10k Ω multi-turn trimmer.

Like many other op-amps of its kind, the LH0032 requires 'external compensation'. This simply means the addition of one or two external capacitors (C7 and C8) which tailor the frequency response of the device. Without compensation, the op-amp would be likely to burst into parasitic oscillation under no-input conditions.

Signal Monitoring

The output of IC1 is fed to a signal buffer built around TR1, TR2, TR3 and TR4. These transistors constitute a pair of complementary emitter followers, combined to create a unity-gain follower whose output at Skt4 is a replica of the op-amp output signal.

The circuit's input impedance at the bases of TR1 and TR2 is very high (around 350k Ω) so as not to load IC1 excessively. The output is a low impedance source, with R20 and R21 providing short circuit protection.

Tests on the prototype buffer showed that it has excellent fidelity and almost ideal gain. The output does, however, have a slight DC offset, and so the buffer should not be used to establish trigger levels (always use the trigger level voltage output at Skt2 and Skt3).

Schmitt Trigger

Hysteresis is essential when converting a noisy input signal to a clean digital waveform. In the Chronos input circuitry, this is accomplished by the Schmitt trigger built around IC4. The LM361 comparator was chosen for its fast response time (20ns max.), and low input offset voltage (typically 1mV). It features complementary TTL outputs at pins 9 and 11 but, unfortunately, has the disadvantage that it cannot tolerate input voltages greater than +5V. Since the LH0032 output can swing to +7V when saturated, it must be attenuated by 5/7 in order to protect the LM361. this attenuation is provided by R15 and VR1.

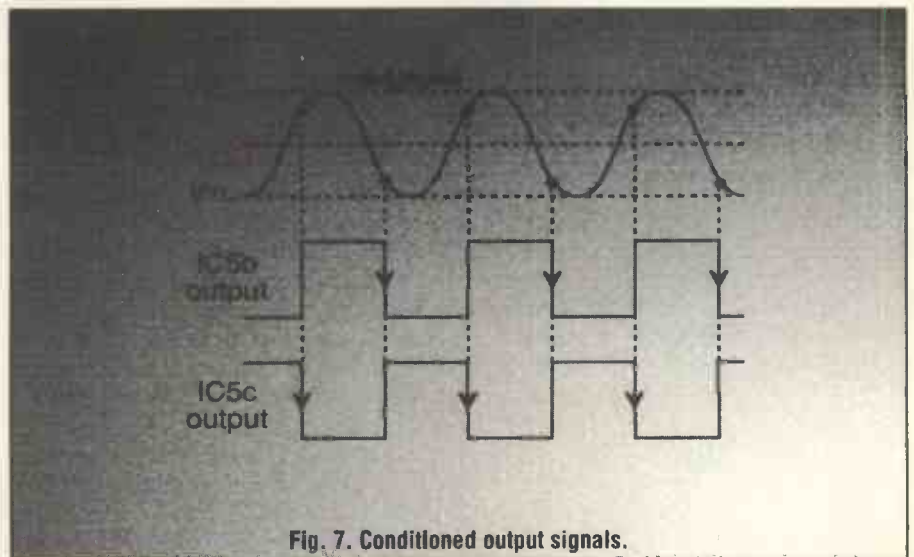

Fig. 7. Conditioned output signals.

VR1 itself is provided to act as a variable, fine attenuation control. The use of variable attenuation will usually only be required when making frequency measurements and some period measurements. For the majority of time measurements it will usually be best to introduce no variable attenuation at all.

The principles underlying Schmitt trigger operation are illustrated in the basic circuit of Fig.23. Assume, initially, that the input voltage V_i is zero, and that the comparator output is in positive saturation V_+ .

The voltage fed back to the non-inverting input of the comparator will also be positive:

$$V_F = V^+ \times \frac{R_y}{R_x + R_y}$$

If V_i now starts to rise above zero, there will come a point when the inverting input is more positive than the non-inverting input, at this point, the output will fall rapidly from positive saturation into negative saturation. As it does so, V_F will also go more negative, reinforcing the voltage difference between the inputs.

When V_o is fully in negative saturation, V_- , V_F will also be at its maximum negative value given by:

$$V_F = V^- \times \frac{R_y}{R_x + R_y}$$

Consequently, it will be necessary for V_i to fall and go more negative than the above value of V_F before the non-inverting input becomes more positive than the inverting input, at which point the output will change stage again, and go into positive saturation.

The actual transition at the output only takes an instant, and is enhanced by the positive feedback typical to all Schmitt triggers. The positive and negative values of V_F given above correspond to the upper and lower threshold voltages V_{TU} and V_{TL} , respectively, which define the limits of the trigger window as described last month. Also, if the positive and negative saturation levels have equal magnitude, then V_{TU} and V_{TL} will also be equal in magnitude such that the trigger window is symmetrical about zero volts.

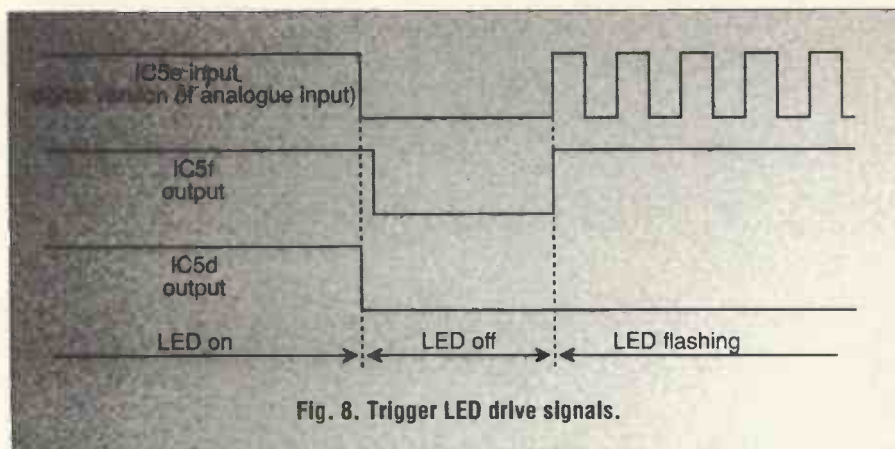

Fig. 8. Trigger LED drive signals.

This is exactly what we require for the Chronos Schmitt trigger. However, as the LM361 output(s) does not swing between positive and negative saturation levels, but instead has only positive logic levels, how do we obtain the required threshold levels? The solution is provided by the level shifting network formed around diodes D5 and D6 (Fig.1).

Level Shifting

The LM361 output at pin 11, "+ out", corresponds to the output of the comparator in the example circuit of Fig.6. Thus, when the inverting input ("-in", pin 4) is more positive than the non-inverting input ("+" in", pin 3), pin 11 goes low (typically to about 0.3V). On the other hand, when the inverting input is more negative than the non-inverting input, pin 11 goes high (to around 3.3V).

Now, in order to obtain the required positive and negative threshold levels, V_{TU} and V_{TL} , we make use of the level shifting network comprising D5, D6, R27, R28, R29, R30 and R31.

Diodes are used as low-capacitance voltage references and the nominal potential at the junction of D6 and R31 is always -0.65V. The values of R27, R28 and

R29 are chosen such that when pin 11 is high, the voltage at pin 3 of the comparator is nominally +70mV; when pin 11 goes low, however, the potential at pin 3 is pulled down to -70mV. Thus, the hysteresis levels are set at $V_{TU} = +70mV$ and $V_{TL} = -70mV$. Note that the relatively constant voltage drops across D5 and D6 ensure that the threshold voltages are little affected by variations in supply rail voltages.

The result of the Schmitt trigger action is that the signal at pin 11 of IC4 is an "inverted", digital version of the analogue input at pin 4. The output signal is then processed by the digital Schmitt triggers of IC5. This device is a 74HCT14, whose inputs are directly compatible with TTL voltage levels, such as those output by the IM361 (a 74HC14 should not be used).

Indications

The digital outputs of IC5b and IC5c are the required conditioned signals fed to the main board via Sw5 which determines whether the Chronos triggers on the positive or negative signal slope.

The output of IC5b is further inverted by IC5e whose output is thus an inverted, digital version of the input signal. This is input to the trigger LED drive circuit.

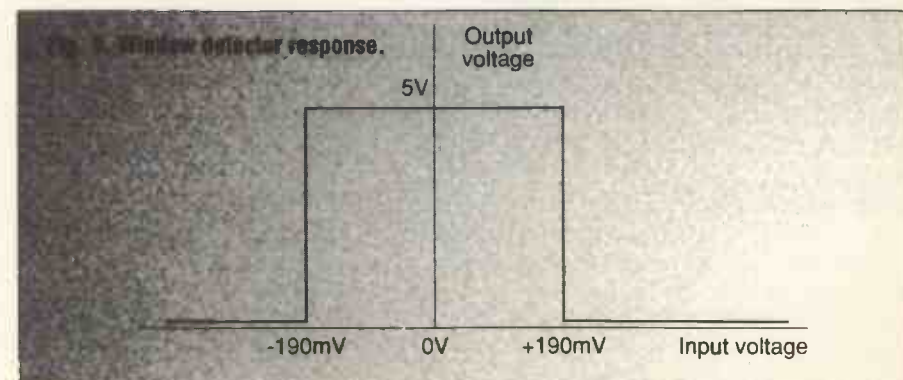

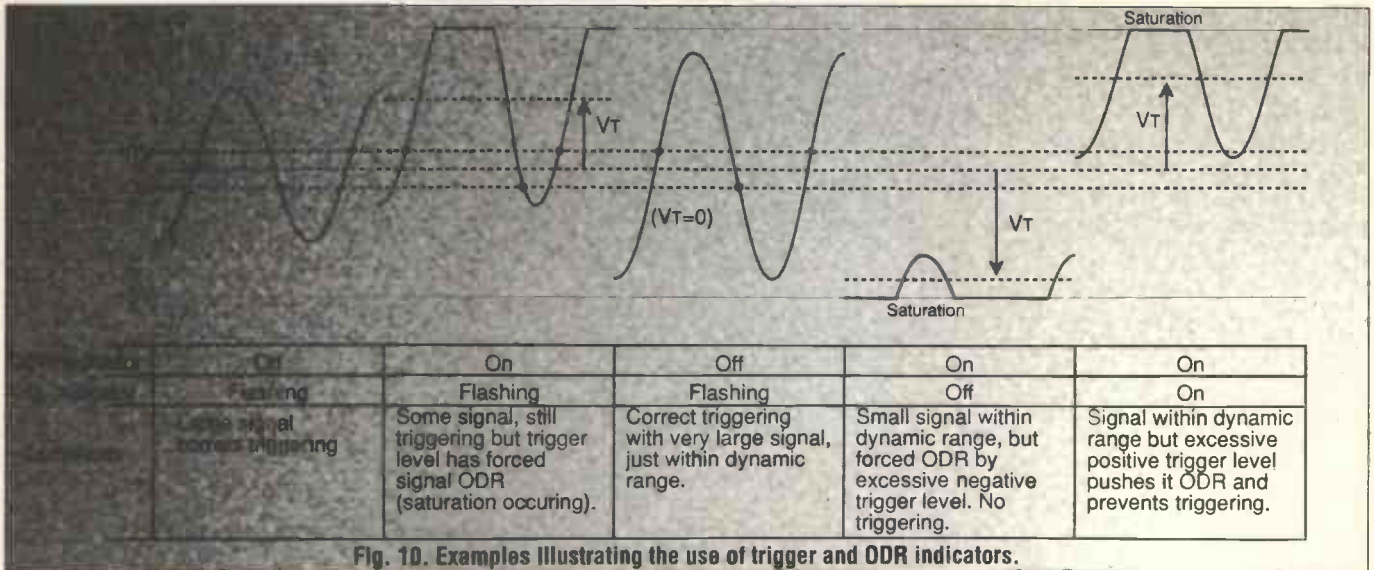

Fig. 10. Examples illustrating the use of trigger and ODR indicators.

D10 is a tri-state LED. With its \bar{F} (Flash) input high, it remains continuously illuminated; take \bar{F} low and the LED blinks at a constant rate (about 3 flashes per second). When the input voltage remains continuously below the lower Schmitt threshold V_{TL} , or when the trigger level has been set so positive that the entire input signal is below the trigger window, the LED must be extinguished.

When the input is continuously above the upper Schmitt threshold V_{TU} , or when the trigger level has been set so negative that the entire signal is above the trigger window, the LED must be continuously on.

Finally, when the input signal is crossing both hysteresis thresholds and correctly triggering the Schmitt, the LED must flash.

The required driving signals are derived from IC5d and IC5f. Using the input signal to IC5e as a reference the way in which outputs of IC5d and IC5f respond to changes in the input signal can be seen - Fig.8.

The time constants of R32-C15 and R33-C16 have been set long enough to ensure correct flashing operation when the input is pulsing, but not so long as to result in sluggish response of the trigger LED when the input signal reverts to a non-pulsing, high or low state.

ODR Detection

The circuitry built around IC3 constantly monitors the nature of the signal output from the op-amp, and warns the user whenever this signal has exceeded the +5V dynamic range. The two

comparators of IC3 are configured as a "window detector" with the boundaries of the window corresponding to the +5V limits of the dynamic range.

Each comparator is fast and has an open collector output allowing both outputs to be tied together.

The input to the window detector is actually derived from the signal monitor buffer - this is simply to reduce loading on the op-amp's output. R22 and R23 attenuate the output signal by a factor of 25. Thus, whenever the potential at the junction of R22 and R23 exceeds +200mV, the amplifier output is outside the $\pm 5V$ dynamic range. ($+5V/25 = +200mV$). The overall response of the circuit is shown in Fig.9. Under ODR conditions, the low voltage applied to the input of IC5a causes its output to go high, illuminating the ODR LED, D9. The value of R41 depends on the type of LED used, and should be chosen to limit the LED current to 10mA, or less: a value in the region of 200 to 300 will probably suffice.

The ODR circuit operates very well over the entire DC to 10MHz frequency range. When dealing with alternating signals outside the dynamic range (as opposed to just static voltage levels), the window detector output will, of course, be pulsed: hence, C21 is required to integrate these pulses. Without this capacitor, the LED would appear to flicker when indicating pulsed ODR conditions, rather than glowing continuously.

The ODR feature is unique to the Chronos and both it and the trigger indicators are useful and reliable

aids in setting up the input controls for the best triggering conditions.

In certain cases, it is possible to get away with a measurement, even though conditions have forced the signal outside the dynamic range - the second waveform of Fig.10 is a typical example.

Power Sources

The +8V, -8V and +5V rails are provided by three on-board regulators (IC6, IC7 and IC8, respectively) fed by unregulated voltages from the PSU section of the main board. Each channel has its own three regulators (there are six on the board in total) - necessary in order to isolate the two channels from each other.

Without this power supply isolation, excessive crosstalk between channels was found to occur under certain conditions. Fortunately, providing each channel with its own regulator drastically reduces the interference. Even under worst case conditions, the channel separation is a minimum of 50dB.

In order to allow for precise matching of the +8V rails, a variable voltage circuit is built around IC7 (79L05A). By adjusting the preset variable resistor PR2, the magnitude of the negative rail voltage can be made to equal the magnitude of the +8V rail.

Matching the positive and negative 8V rails in this way ensures that the trigger level control (VR2) has a perfectly balanced span and also ensures that the threshold levels for the ODR circuit have precisely the same magnitude. ■

D.I.Y. Printed Circuit Boards

Shamefully the editor had to admit to never having made a PCB, until now. After a little encouragement he rolled up his sleeves and gave it a go – what follows is the result.

Some may think that making printed circuit boards is a difficult, messy, expensive and complicated process. I certainly suspected so before doing the practical parts of this article. The reality is somewhat different however. The basic principles are very straightforward and all of the materials needed are easily available.

There are two main approaches to PCBs, 'draw your own' or lift a pattern from a magazine. PE publishes a number of board designs every month so it seems natural to use this approach. I used the Frost Alarm design by John Becker published in the February issue of PE.

Getting The Right Image

At first sight, the most difficult part of making up a PCB is getting the track pattern from magazine into a form which can be transferred to the board. The first step is to get



The materials needed to make a PCB.

hold of a can of transparentiser. This is a useful chemical which makes paper virtually transparent. Spraying a cut-out of a photocopy of the page makes the white parts of the paper resemble tracing paper while the black parts remain opaque. This can be used as a

positive image which can be impressed onto the board.

Copper clad board comes in a number of sizes and there are two main types, SRBP and fibre glass. Of the two, the first is cheaper and the second is tougher. Which is used depends on the environmental conditions in which the board must operate.

After cutting the board to size, cleaning it to remove any grease and stains – the best way to do this is with a pan scrub and some scouring powder (Vim or Flash or whatever) – it is dried and then sprayed with photo-resist. After cleaning it is a good idea handle the board with kitchen paper so that it doesn't acquire any accidental thumbprints. Kitchen towel also comes in useful for wiping implements, catching unwanted spray and cleaning up any nasty messes – have plenty on hand.

A photographic process is used to transfer the track pattern (also known as the foil pattern) to the

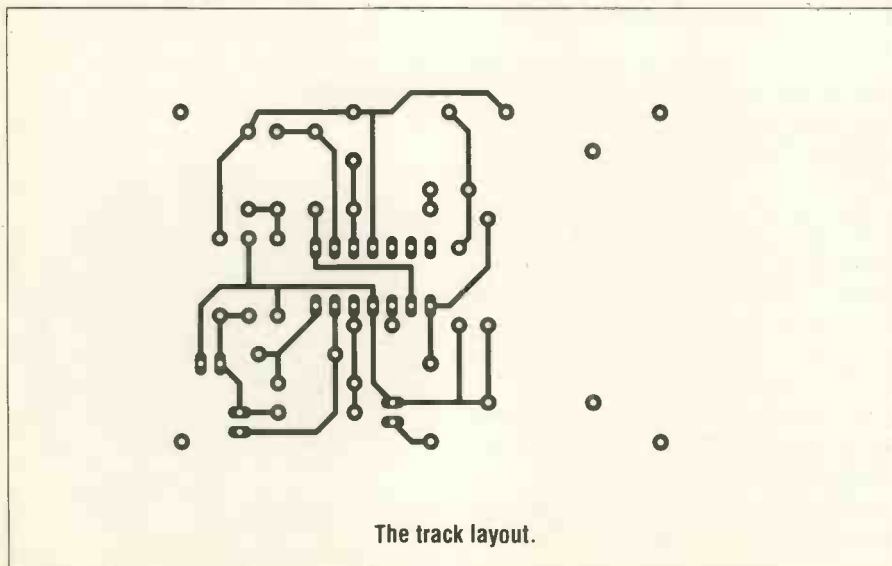

The track layout.

Step By Step

- ◆ Get design from mag and photocopy (a few times just to make sure).
- ◆ Coat photocopy with transparentiser.
- ◆ Cut board to size.
- ◆ Polish copper board with Vim or other scourer and then rinse thoroughly and dry.
- ◆ Spray board with photo resist and dry – either by leaving it for 24 hours or placing it in front of a fan heater or in an electric oven at 80° C for 15 minutes
- ◆ While waiting for board and paper to dry make up the developer and etching solutions according to the manufacturer's instructions.
- ◆ Place design on board making sure it is the right way around and hold in place with a piece of glass.
- ◆ Expose under a UV, sun-ray lamp or in sunlight for the correct time – around 10 mins seems to do the trick.
- ◆ Place in developer and wait for pattern to emerge, green on a copper coloured background.
- ◆ Once the pattern is clear, wash the board in cold water to stop the development and then dry it.
- ◆ Check the design to make sure it is correct. If not, make corrections either by cleaning the board, respraying, re-exposing and redeveloping. Alternatively use an etch resist pen to make the correction marks.
- ◆ Place board in the etchant and wait

- for the copper to clear away from the tracks – if all is going well the copper goes a rather pretty pink colour and the resist covered tracks appear bright green (depending on the type of photo-resist used). Swirl the mixture around to allow the precipitate to move off the board. The process takes around 45 minutes.
- ◆ Wash the board to clear away the etchant and then scrub the tracks with scouring powder until they are a bright shiny copper colour.
- ◆ With a fine drill (1mm) make all of the holes from the copper side using the pad holes as markers.
- ◆ Insert the components and solder into place

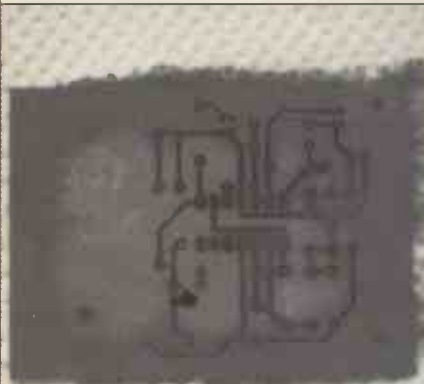

After exposure and development.

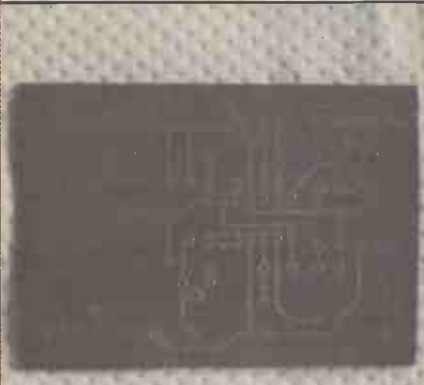

The start of the etching process.



The final etched and cleaned board.

board. The copper layer is coated in UV sensitive paint (photo-resist) which, when exposed and developed, resists the etching fluid leaving the copper tracks behind. It is possible to buy pre-coated board but this has the disadvantage that any mistakes that occur up to the etching stage cannot be easily rectified. Buying a spray can of photo-resist, although very smelly, does give the option of scrubbing it off and starting again from scratch.

After spraying the board it should normally be left for 24 hours in a dark dust free area to dry. For those who don't have the patience for this, an electric fan heater will do the job in around 15 minutes – just spray the board, wait until it goes touch dry and then place in front of the heater for a while. Bear in mind that the photo-resist is light sensitive so exposing it to bright lights before necessary is not a good idea.

The next step is to place the transparentised track pattern onto the photo-resist covered board. Placing a piece of glass over it will allow the UV light through and keep the pattern in close contact with the photo-resist and copper. One thing to make sure of at this point is that the pattern is the right way around. Remember that the copper tracks go on the underside (copper side) of the PCB with the component leads coming through from the top. From the non-copper side of the board, this means that the tracks should be reversed. In practice, magazines usually print

the copper track pattern in reversed form just to make sure.

The exposure time for the photo-resist depends upon where the UV light comes from. A specially made exposure box can cost around £50 or more, so alternatives are useful. The next best method is a sun-ray lamp since this emits UV light at the right wavelengths (350 to 400nm). Placing the board, pattern and glass cover about 10 inches from the lamp and leaving it on for 10 minutes or so gives a perfect result. Shorter exposure times mean that large areas of photo-resist are left where they shouldn't be and over exposure will give no resist at all. The next step down from a sun-ray lamp is to use the sun itself. Exposure time will need to be a little longer and will depend upon the brightness of the sun – a little experimentation may be needed to obtain good results but using spray-on photo-resist means that the same piece of board can be used repeatedly.



Etching the board

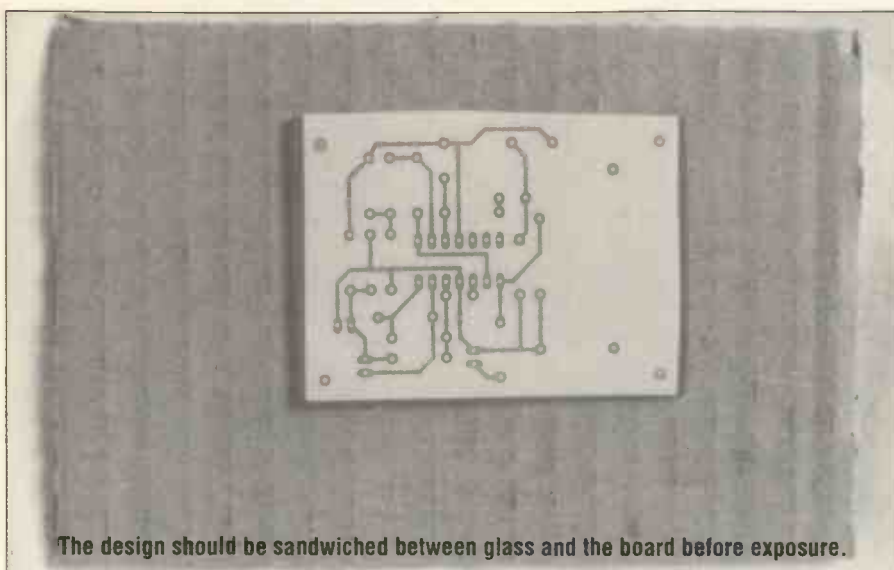

The design should be sandwiched between glass and the board before exposure.

Once the photo-resist has been exposed it is developed to remove the unwanted areas that need to be etched. This is normally done with a weak solution of sodium hydroxide in water. It can either be bought in concentrated liquid form or as solid crystals which are dissolved in water before use. The only real difference between the two methods is that, generally, the crystals must all be made up in one go. The concentrated liquid is easier to measure out so small quantities can be made as required.

Placing the exposed board into the developer starts the process and a small black cloud can be seen to form over the board as the photo-resist comes away. The development is finished when the tracks and the copper are markedly different colours. The board is then washed and placed into the etching fluid.

Ferric chloride is the chemical

used to remove unwanted copper from PCBs. The iron in the solution is replaced by the copper to form copper chloride with the iron being precipitated. Fresh Ferric chloride is a yellowish colour with a tinge of deep red. Copper chloride is blue so when the etching solution becomes blue, it is used up and should be disposed of – be sure to add developer to it to make it liquid before pouring it down the drain.

Either plastic or glass bowls can be used for the developing and etching – metal bowls will probably corrode with the ferric chloride.

Etching takes 45 minutes to an hour and the liquid should be agitated from time to time to dislodge any debris that collects on the board surface. When finished, washing and scrubbing removes the rest of the etch resist and leaves the finished product. All that remains is to drill the holes and tidy up. A sharp 1mm bit is usually good

enough to fit most components; placed in the centre of a pad where the copper has been etched away, it soon goes through SRBP – fibre glass is a little tougher.

Care should be taken when using the developing and etching chemicals. Although the developer is dilute enough not to be corrosive, this is not the case when it is in concentrated form. If any is spilled on the skin it should be washed off with copious amounts of cold water. The same applied to ferric chloride which has the added disadvantage of leaving very yellow stains when spilled.

The whole process from cutting the board to finished product takes a few hours, most of which is spent waiting for developments. The costs are relatively low since the chemicals will make quite a number of boards. ■

Component list

Copper clad board – approx £0.75 for 75x100mm

Positive photo-resist spray – £2.95 can covers 2.5m²

Photo-resist developer – £2.75 bottle gives 1lt

Ferric chloride crystals – £2.25 enough to etch .23m²

Etch resist pen – £1.98 useful for correcting mistakes or making modifications

Drill 1mm – £1.50

All of the above are available from good component suppliers

Transparentiser – £9.95

This is available from a number of office supply retailers or by mail order from

Cannon and Wrinn,

68 High St,

Chislehurst,

Kent

081 467 0935

Miscellaneous

UV exposure box or sun lamp or sunshine

Fan heater for those in a hurry

Roll of kitchen paper

Two glass bowls

Access to a photocopier

Hacksaw

Drill

Pan scrub and scouring powder

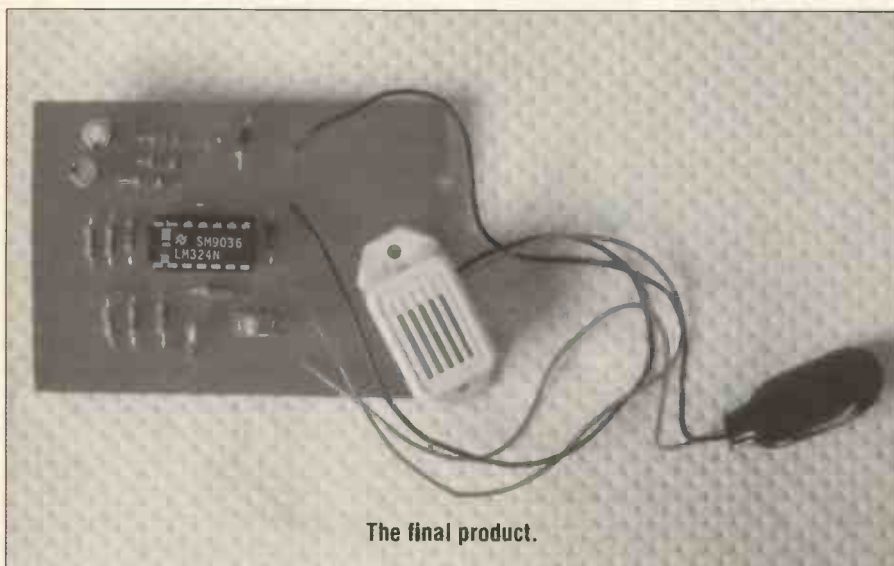

The final product.

Looking At It Logically

Complex digital circuit construction can be a difficult proposition. Simplify things with John Becker's versatile visual data code converter.

This project has been designed to assist in the testing and development of digital electronic circuits. It provides a visual readout of monitored logic codes, displaying them in a choice of binary, hex or decimal formats. Data may be input as 8-bit parallel or serial blocks. Frequency and pulse counting modes are also included. Binary codes are displayed on eight light emitting diodes (LEDs). A 4-digit liquid crystal device (LCD) displays hex and decimal codes. The text also takes a closer look at the functions of the 4534 multiplexed BCD (binary coded decimal) counter. The block diagram for the Logic Reader is shown in Fig.1. Most of the functions are performed by single dedicated chips, as detailed in the main circuit diagram of Fig.2.

One After The Other

8-bit parallel data is input to the octal tri-state non-inverting transparent latch gate IC7. Latching may be triggered either synchronously from an external clock, or asynchronously from the internal clock generator around IC1d. S3 selects the sync source. The internal clock rate is set by C4 and varied by the panel-mounted control VR2, with D3 forcing a rapid reset from the positive phase. IC7 inputs data to its register when the clock pulse is high. Data remains latched during low clock pulse phases.

The latch output is enabled by an active low logic on IC7 pin 1 and is controlled by S5 and R8. With S5 open-circuit to IC7, R8 holds pin 1 high, setting the latch output into a high impedance state.

Serial data is input to the 8-bit SIPO (serial in, parallel out) register IC3. Data bits presented to pin 14 are shifted in on the positive-going edges of pulses received on pin 11. As with the parallel register, clocking may be triggered synchronously from an external source or asynchronously from the generator around IC1d.

Data latching occurs on the negative-going edges of pulses received on IC3 pin 12. S4 provides for latching pulses to be sourced internally or externally. Since IC3 is an 8-bit register, latching is required following receipt of the eighth bit of any data block. Internal latching is controlled by the 7-stage binary ripple counter IC5. The counter is clocked by the same source as IC3 and its Q2 output goes high on receipt of the eighth pulse following a previous reset. This transition is first delayed fractionally by the action of R6 and C5. When C5 has charged

sufficiently, it resets IC5. The resulting negative-going change of Q2 causes C5 to discharge and thus latch data into IC3.

Converted serial-to-parallel data is available on IC3's QA-QH outputs when output enable pin 13 is held low via S5. With the opposite setting of S5, pin 13 is held high via R7, forcing the outputs into a high impedance state.

As selected by S5, the eight outputs of the serial and parallel registers are taken to a common data bus. The binary code of the data on the bus is displayed by eight LEDs, one on each data line. Current through the LEDs is limited by their respective resistors R9-R16. For compactness, the printed circuit board has been designed to accept LEDs and resistors in modular packages, LM1 and RM1 respectively. Individual components may be substituted if preferred.

For subsequent readout in a hex

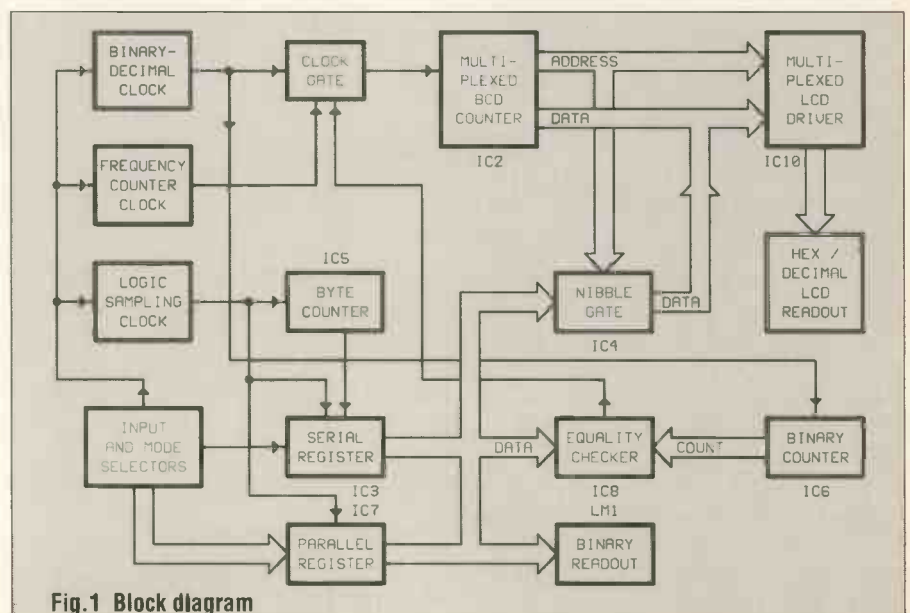

Fig.1 Block diagram

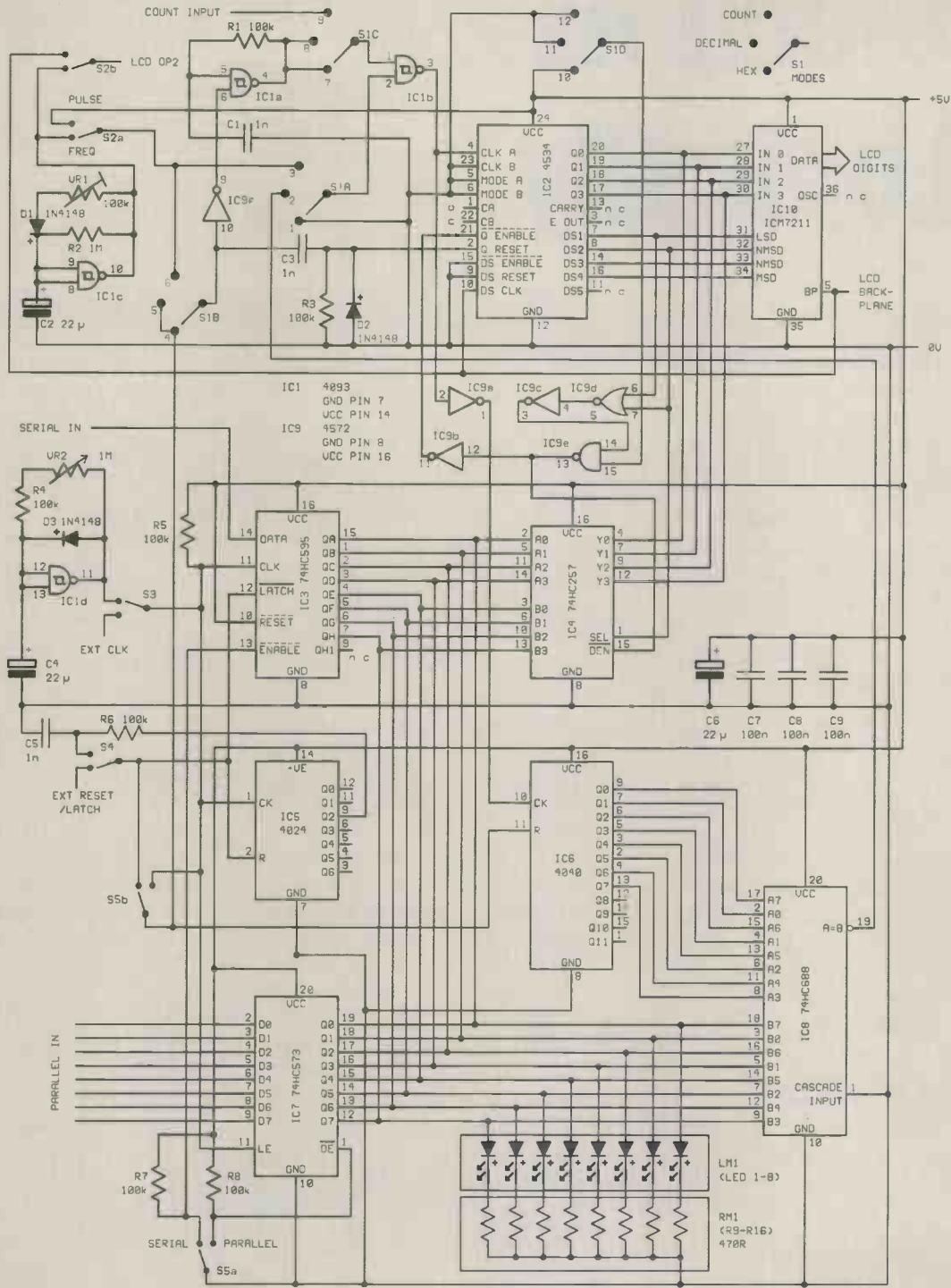

Fig.2 Control circuit diagram.

format, the register's 8-bit output data byte is first split by IC4 into two nibbles each of four bits. IC4 is a quad 2-input data selector with tri-state outputs. Under control of the logic level on pin 1, data from either inputs A0-A3 or B0-B3 is routed to outputs Y0-Y3. A low level on pin 1 selects the A-Y block path. The outputs are only enabled when a low logic level is on pin 15, they are otherwise in a high

impedance state. When selected by mode switch S1 in position 1, control of IC4's routing and enabling is derived from IC2, the function of which will be described shortly.

Right Reading

From IC4, the nibbles of output data are fed to the data inputs of the multiplexed 4-digit LCD driver

IC10. Full details of the connections between IC10 and the LCD are shown in Fig.3. Data is latched into IC10 and routed to the required LCD digit in response to the logic on pins 31-34, a high level selecting the respective digit register. Reading the LCD from left to right, the digits are controlled in order of pins 34-31, designated as MSD (most significant digit), NMSD (next MSD), NMSD, and LSD (least

SD). IC10 decodes the 4-bit input data into a 7-segment alphanumeric output, i.e. 0-9, A, b, C, d, E, F (note that b and d are displayed in the equivalent of lower case). The chip is designed specifically to drive LCDs, toggling the output segment lines up and down in the correct phase against the LCD's backplane drive clock. The backplane frequency is preset within the chip and, although this could be slowed by the connection of a capacitor between the OSC pin and 0V, free-runs at about 125 Hz.

When input data to IC10 is routed as alternating 4-bit nibbles from IC4, the LCD displays the equivalent hex codes in the two right hand digits. The full representation of all 256 hex codes implicit in an 8-bit data byte, from 00 to FF, is available.

Base Converter

Conversion of the serial and parallel input data from binary to its equivalent 0-255 decimal readout is done using a count-and-compare technique. This involves the synchronous clocking of binary and BCD counters, IC6 and IC2, and the use of an 8-bit equality comparator, IC8. Although the conversion could be achieved using arithmetic techniques, the count comparison method requires fewer components. Position 2 of switch S1 selects this mode.

IC8 has two sets of 8-bit inputs. It compares the data on both inputs, and if they are found to be equal, output pin 19 goes low. If non-equality is detected, the output remains high. Data from the serial or parallel registers is routed to IC8's B0-B7 inputs. Comparison data to the A0-A7 inputs is supplied by eight outputs of the 12-stage binary ripple counter IC6. The counter is clocked by a signal originating from the oscillator around IC1a, gated via IC1b and inverted by IC9a. Resetting of IC6 is dependent upon the immediate level of the control signal selected by S5b. IC2 is reset by a pulse generated across C3, R3 and D2 by the transition of the selected control signal from low to high.

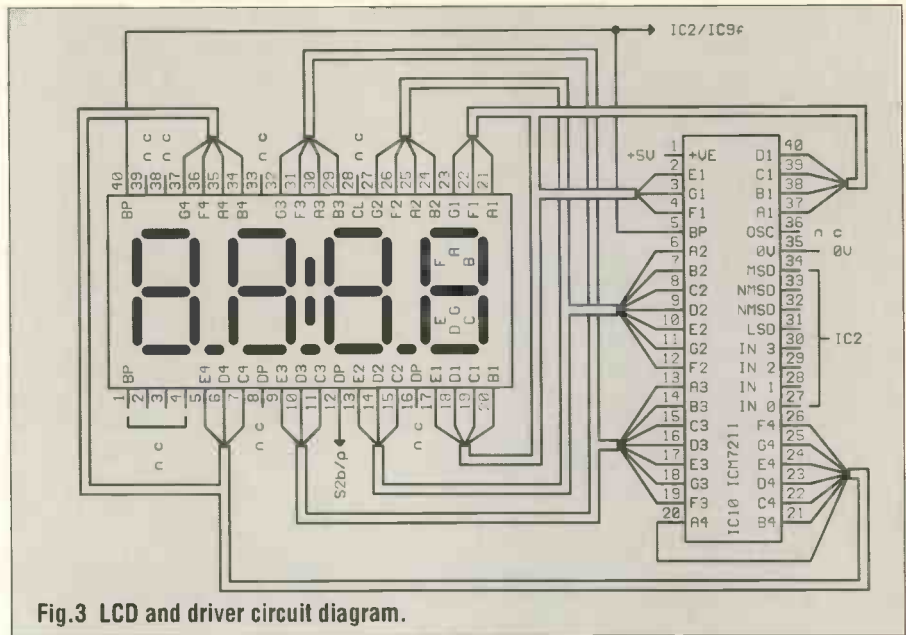

Fig.3 LCD and driver circuit diagram.

the point at which the two data blocks are equal, IC8 pin 19 goes low, so closing gate IC1b and stopping the pulse count. The clock output of IC1a is gated and synchronised by the register latching pulses inverted by IC9f.

Synchronously with IC6, counter IC2 is reset, clocked and stopped by the same signal sources. This chip comprises five cascaded BCD counters and multiplexed control logic. The functional block diagram in Fig.4 clarifies its operation. Whereas the output of counter IC6 is in binary format, the Q0-Q3 outputs of IC2 are in the BCD format required for producing a decimal readout on the LCD. With both counters under common control, binary codes from IC3 and IC7 are thus indirectly translated into decimal.

There are two slight differences in the reset and clock controls for the two counters. IC2 is clocked on positive-going pulse edges, whereas IC6 is clocked on the negative edges, hence the inclusion of IC9a to invert the clock phase for IC6. Resetting of IC6 is dependent upon the immediate level of the control signal selected by S5b. IC2 is reset by a pulse generated across C3, R3 and D2 by the transition of the selected control signal from low to high.

The clocking rate generated by IC1a has been set to allow the decimal conversion to be carried out almost instantaneously following the registering of fresh serial or parallel input data.

On The Bus

The internal decade counters within IC2 have their contents presented to the common outputs Q0-Q3 under control of a digit select (DS) clock. In this circuit, the LCD backplane clock from IC10 is used as the DS clock. This triggers a five-stage counter, each stage of which selects the relevant decade of the main counter, routing it onto the output bus. The DS counter also has its own outputs, DS1-DS5, the first four of which are used to simultaneously select the LCD digit to which the count data is routed. Output DS5, although active, is not used.

Outputs DS1 and DS2 also control the enabling of the outputs of both IC2 and IC4. When hex display mode is selected, DS1 alternates IC4's path switching between A-Y and B-Y. However, on its own, this simple control would cause the 2-digit hex data to be displayed as two identical pairs on the four LCD digits. The circuit around IC9b-e restricts the hex data pair to display only on digits one and two. DS1 and DS2 are taken to the NOR gate IC9d, the output of which is inverted by IC9c to become one input control for the NAND gate IC9e. In hex mode, the second input of IC9e is held high via S1d. If either DS1 or DS2 is high, controlling digits one and two, the output of IC9a will be taken low, enabling the output of IC4 and, inverted by IC9b, disabling the Q0-Q3 outputs of IC2. If either DS2 or DS3 is high, the opposite enabling

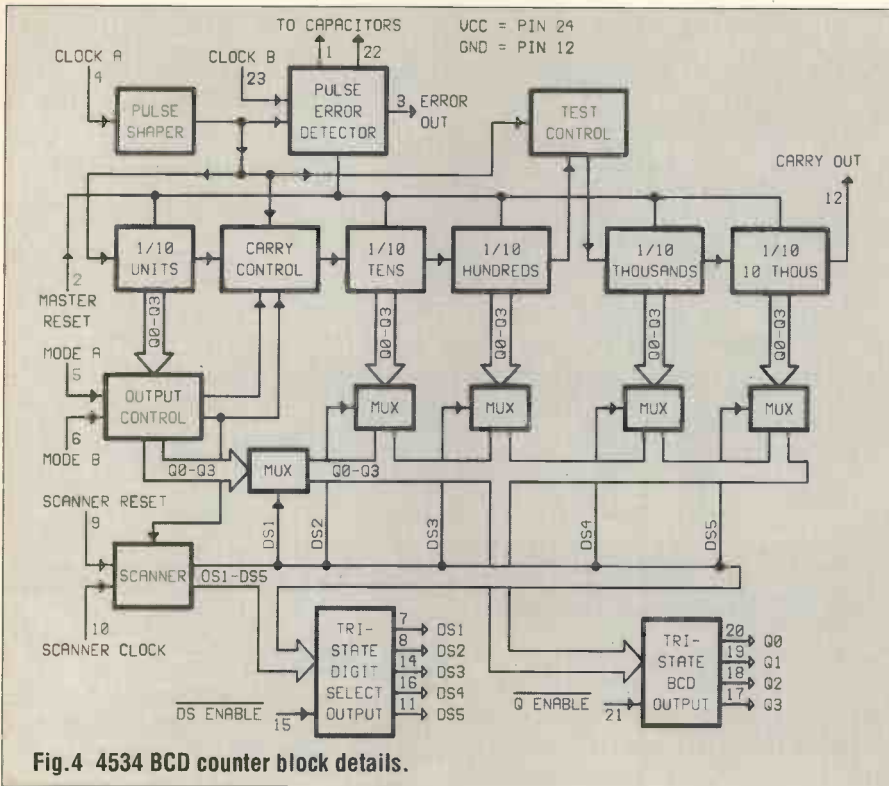

Fig. 4 4534 BCD counter block details.

condition occurs, routing IC2's Q0-Q3 outputs to LCD digits three and four. Since the Q clock to IC2 via IC1b (driving the CLK A input) is disabled in this mode and the Q counter is reset by each data register latch pulse, LCD digits three and four are forced to display zeroes. The hex display will thus be in the range 0000-00FF.

Through The Gate

In mode three as selected by S1, frequency and pulse counting facilities are available, with the resulting 4-digit displays in decimal format. The source signal to be counted is switched via S1 and IC1b to the Q input of IC2. IC1b can now be held permanently open for pulse counting, or opened and closed at a fixed rate for frequency counting purposes. The control clock for the latter is generated by the circuit around IC1c. This is configured as a wide mark-space ratio pulse generator, in which C2 sets the basic clocking rate. Between them, VR1 and D1 set the relative duration of the positive pulse. The negative period is lengthened by the relatively high value of R2. On the positive-going transition of the output from IC1c, IC2 is reset by the pulse generated across C3. For the remainder of the positive phase of IC1c, gate IC1b is held open, allowing external pulses to be

counted. When IC1c's output goes low, the gate closes and the LCD displays the number of pulses counted during the period.

VR1 is adjusted to produce a timing period of 0.1 seconds following the end of the reset pulse. Conversion of the count to kHz is simply performed by activating the second decimal point of the LCD readout. The point is switched on by S2b which routes the IC1c signal to it as its active clock. With S2 switched to pulse count mode, the decimal point is triggered in phase with the backplane frequency, so turning it off. The usable frequency display range is 00.01 kHz to 99.99 kHz. Greater accuracy in the timing of frequencies below 10kHz can be achieved by lengthening the sampling period to exactly one second and disabling the decimal point. This produces a display range of 0001 Hz to 9999 Hz. Reversing the polarity of D1 will

extend the duration of the on phase whilst shortening the off phase. The value of C2 may need increasing to achieve the slower sampling rate.

To allow pulse counting for an unspecified period, gate IC1b is held permanently open by taking its input pin 2 high via S2a. The LCD decimal point is inactive in this mode. Briefly switching S2 back to run-mode resets the pulse count to zero.

COUNTER OPTIONS

Readers wishing to explore the merits of the multiplexed counter type 4534 in other situations will be interested by brief details of other facilities the chip offers.

Fig.5 shows the mode control truth table for different selections of the Mode A and Mode B inputs.

Capable of operating from a power supply up to 18V DC, the maximum clock input frequency is determined by the supply voltage. The figures are typically 1MHz at 5V to 5MHz at 15V.

On reset of the DS counter, output DS5 and its Q-count multiplexer are selected. The DS counter is decremented by each DS clock pulse, stepping immediately back to 5 following 1.

Fig.6 shows how detection of Q-counter clocking errors can be achieved by jointly clocking inputs CLK A and CLK B. In this mode, capacitors are connected to ground from both pin 1 and pin 22 providing a clock slew rate comparison. The skew is the time difference between the low to high transition of CLK A to the high to low transition of CLK B, and vice-versa. The minimum useful capacitor value is around 100pF. A pulse error detection facility is especially useful when the primary clock source is generated, for example, by a manually operated keypad.

MODE A	MODE B	FIRST STAGE OUTPUT	CARRY TO SECOND STAGE	APPLICATION
0	0	NORMAL COUNT AND DISPLAY	AT 9 TO 0 TRANSITION OF FIRST STAGE	5-DIGIT COUNTER
0	1	INHIBITED	INPUT CLOCK	TEST MODE CLOCK DIRECTLY INTO STAGES 1, 2 AND 4
1	1	INHIBITED	AT 4 TO 5 TRANSITION OF FIRST STAGE	4-DIGIT COUNTER WITH 1/10 AND ROUNDOFF AT FRONT END
1	0	COUNTS 3 TO 7 = 5 0 TO 2, 8, 9 = 0	AT 7 TO 8 TRANSITION OF FIRST STAGE	4-DIGIT COUNTER WITH 1/2 PENCE CAPABILITY

Fig. 5. Mode truth table for 4534 BCD counter.

Board Building

There are two printed circuit boards, one for the main circuit, the other for the LCD and its driver IC10, Figs.7 and 8 show their details, including the control wiring schematics.

The LCD is mounted above IC10, increasing its height by plugging it into a second IC socket above the first, board-mounted, socket. 40-pin sockets of the width required for the LCD seem unobtainable but an alternative is to cut standard 40-pin sockets in half lengthwise to become two 20-pin SIL (single in line) strips.

Terminations to the external input data and control leads are left to the reader's discretion. In a practical workshop situation, soldering them as flying leads to test points of the circuit under examination is probably one of the most useful of options. Alternatively, they may be terminated in miniature probe clips suitable for attaching to individual component leads or IC pins. Also for practical reasons, the controls and PCBs of the prototype were mounted in a lidless box with integral front panel, so allowing direct access to all signal points. This housing method additionally removed the need to provide specific viewing slots for the LED and LCD displays.

The unit requires a regulated +5V power supply. The circuit draws less than 1mA with the LEDs off, rising to 50mA with eight of them on. (Two of the LEDs in the 10-way display are not used.)

Take care that, with the inputs wired as shown, no external control or data signal level exceeds +5V, or falls below -0.5V. The unit may, however, be easily modified to accept signal levels above +5V by the inclusion of resistors in series with each input line. In most normal workshop situations, where perhaps CMOS logic circuits powered by 9V supplies may be under test, resistor values of between 1k and 10k should provide adequate protection for the chip inputs.

Other than adjusting the frequency counter clock control preset VR1, no setting up is required. To adjust the clock pulse length, connect the unit to a digital signal source of a known frequency,

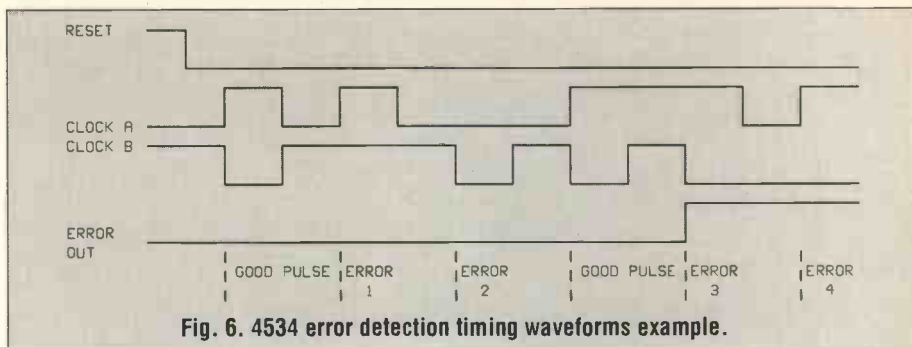

Fig. 6. 4534 error detection timing waveforms example.

15kHz for example, switch S1 to mode three and adjust VR1 until the LCD shows the right answer, in this instance 15.00.

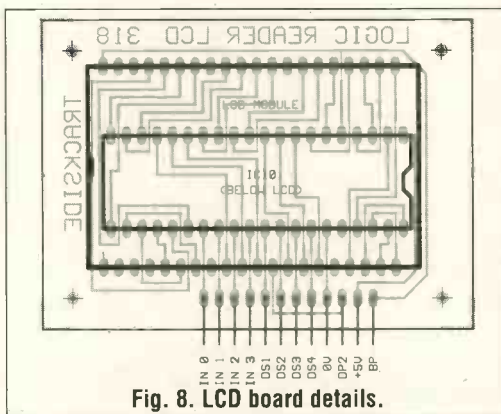

Fig. 8. LCD board details.

Checking the correct operation of serial and parallel, hex and decimal readouts can be assisted using a computer with a parallel output port. The listing in Fig.9

shows two example routines written in Basic. They were written for a Commodore 3032 computer but are readily translatable for other machines having 8-bit parallel data ports with associated handshake lines. In particular, it will probably be necessary to change the register address codings seen in Lines 110 and 120. DRT and AT are the variables holding the address codes for data direction and ATN (attention) registers respectively. The variables labelled OUT, UP and DN are self explanatory. As listed, the serial input and reset lines are controlled via computer lines D0 and D7, and clocking is triggered via the ATN line.

To access the unit via a PC-compatible computer, an address-decoding interface board will be needed. Examples of typical decoding circuits, sections of which can be suitably modified, have been

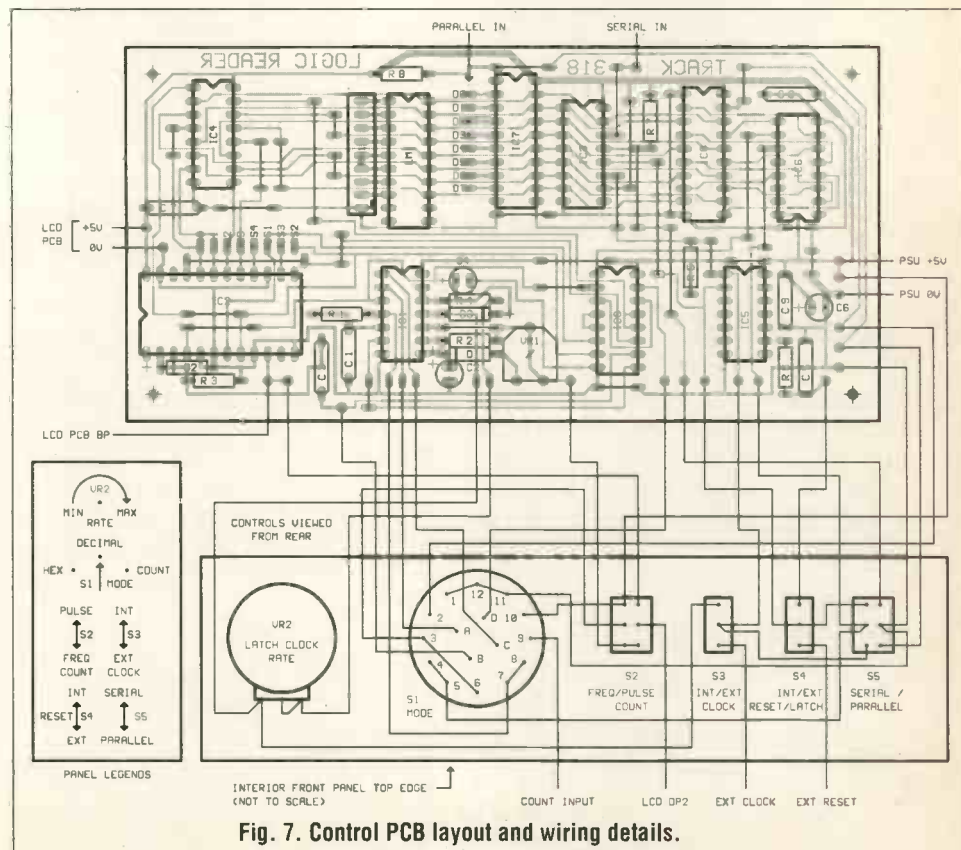
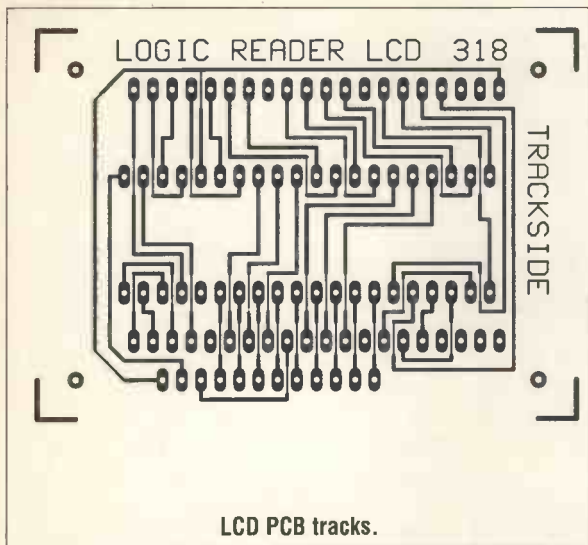

Fig. 7. Control PCB layout and wiring details.



LCD PCB tracks.

rate. In the serial output section, decimal numbers incrementing from 0 to 255 are each decoded into their eight separate binary bits. Each bit is sent and clocked individually. The latching/reset command is sent after each eighth bit. A keyboard pause command is included in line 260.

If the computer used for testing the circuit is fast enough with its output commands, the frequency counter can

can be suitably modified, have been published in recent issues of PE.

The first section of the listing outputs decimal numbers incrementing from 0 to 255 as 8-bit parallel binary codes. The loop in line 170 slows down the output

be checked via looped triggering of the ATN line coupled to S1 position 9. For example:

```
280 POKE AT,UP:POKE
AT, DN:GOTO 280
```

Repetitive pulse counting can also be checked out in this way. ■

```
100 REM LOGIC READER TEST
110 DRT=59459:AT=59468:
    OUT=59471
120 UP=237:DN=205:POKE
    DRT,255
130 REM GOTO 190
140 REM PARALLEL OUTPUT
150 FOR Z=1 TO 255:POKE
    OUT,Z:PRINT Z;
160 POKE AT,UP:POKE AT, DN
170 FOR X=1 TO 1000:NEXT
180 NEXT:PRINT:GOTO 150
190 REM SERIAL OUTPUT
200 FOR Z=0 TO
    255:PRINTZ;:D=Z
210 FOR T=7 TO 0 STEP-
    1:A=2^T:W=D/A
220 B=0:IF W>=1 THEN D=D-
    A:B=1
230 POKE OUT,B:POKE
    AT,UP:POKE AT, DN
240 PRINT B;:NEXT:PRINT
250 POKE OUT,128:POKE OUT,0
260 GET Z$:IF Z$="" THEN
    260
270 NEXT:GOTO 200
```

Fig. 9. Basic test listing.

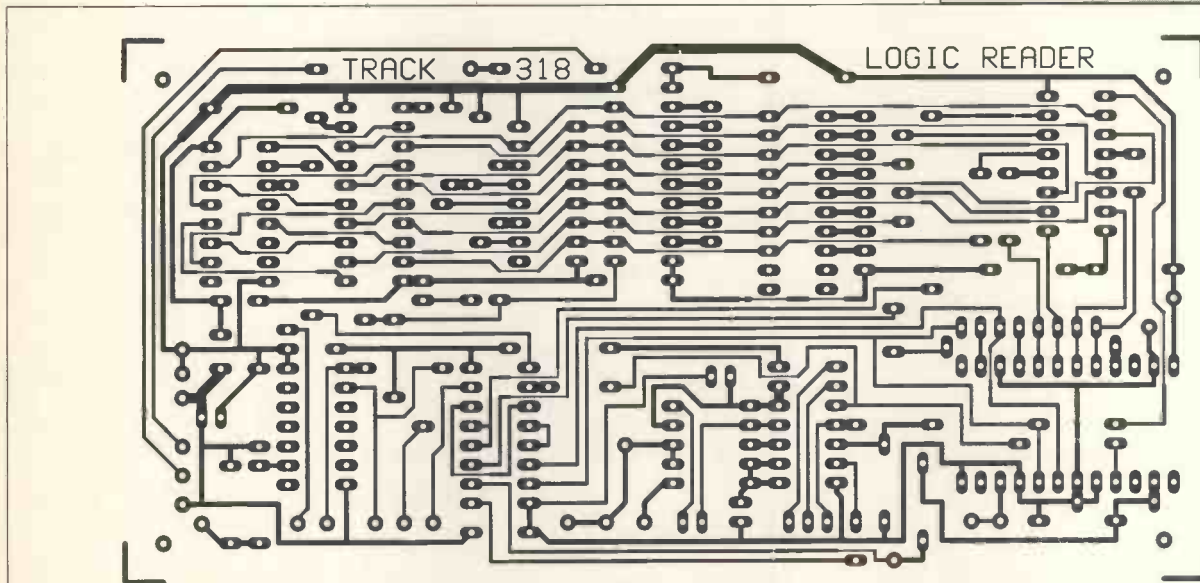

Control board.

COMPONENTS

Resistors

- R1, R3-R8 100k
- R2 1M
- R9-R16 470R (module of 8 commoned resistors)
- All 0.25W 5% carbon film or better.

Capacitors

- C1, C3, C5 1n polystyrene
- C2, C4, C6 22µ 16V electrolytic
- C7-C9 100n polyester

Potentiometers

- VR1 100k horiz skel preset
- VR2 1M lin rotary

Semiconductors

- D1-D3 1N4148 (3 off)
- IC1 4093
- IC2 4534
- IC3 74HC595
- IC4 74HC257
- IC5 4024
- IC6 4040
- IC7 74HC573
- IC8 74HC688
- IC9 4572
- IC10 ICM7211

Switches

- S1 4P3W rotary
- S2, S5 DPDT min toggle

- S3, S4 SPDT min toggle

DIL sockets

- 14-pin (2 off), 16-pin (4 off), 20-pin (3 off), 40-pin (3 off, see text).

Miscellaneous

- 10-way LED DIL module, 4-digit LCD, knobs (2 off), printed circuit boards, PCB supports (8 off), box to suit (see text).

Constructors note

- The components used in the Author's unit were all purchased from RS/Electromail.

Practical Electronics is giving away up to £2,000 Pounds to its readers!



If it's a wet summer you'd be better off indoors with a kit paid for by PRACTICAL Electronics

We're offering to refund 10 readers of Practical Electronics up to £200.00 for purchases made from advertisers in this issue (including all products from our advertisers' catalogues like Maplin, Greenweld etc.)

The rules are simple:

Buy any product from any advertiser and we will refund you all or part of the cost, up to a maximum value of £150, or £200 if you are a subscriber.

All you have to do is complete and cut out the coupon below and send it to us with proof of purchase. Then if you are one of the lucky readers drawn out of the bag, we will refund your money.

Needless to say, this is one offer you really can't afford to refuse!

Buy any product from any of our advertisers!

Send to: PE Reader Loyalty Bonus, July 1991
Intra Press, 193 Uxbridge Road, London W12 9RA

I purchased price.....

as advertised by

Name

Address.....

Town..... Postcode.....

I am a Subscriber Complete and return this coupon by July 31st. The winners will be announced in the October issue of PE.

Practical Electronics Classified Ads

Reach thousands of serious electronic and computer enthusiasts – advertise in PE Classified pages:
 Rates 20p (plus 4p VAT) per word or £8.50 (plus £1.49 VAT) per column cm. All classified advertisements must be pre-paid. Send your copy, with remittance payable to Intra Press, (Payment by Visa or Access accepted – ads may be phoned in) to:

**Practical Electronics, Intra House, 193 Uxbridge Road, London W12 9RA.
 Tel: 081-743-8888. Fax: 081-743-3062**

Education

FULL-TIME TRAINING COURSES

**2 YEAR
 BTEC NATIONAL DIPLOMA**
 Electronics and
 Communications
 Engineering

(TV, Computers, Programming, IT)

**1 YEAR
 BTEC NATIONAL CERTIFICATE**
 1. Electronic Equipment Servicing

(TV, Video, CCTV)

2. Computing Technology

(Microprocessors, DataComms, Interfacing)

3. Information Technology

(Telecomms, Satellite TV, Networks)

4. Software Engineering

(Assembler, BASIC, Pascal, CAD/CAM)

★ Those eligible can apply for E.T. grant support ★

★ An equal opportunities programme ★

COURSES COMMENCE

Monday 16th September

LONDON ELECTRONICS COLLEGE

Dept: AA, 20 Penywern Road,
 London SW5 9SU. Tel: 071-373 8721

Start training now for the following courses.

- Telecomms Tech C&G 271
- Radio Amateur Licence C&G
- Microprocessor
- Introduction to Television

Send for our brochure - without obligation or telephone us on 06267 79398 (Ref: PE7/91)

Name.....

.....

.....

Radio & Telecommunications
 Correspondence School,
 12 Moor View Drive, Teignmouth,
 Devon TQ14 9UN

Retailers

**Project your
 retail image
 here!**

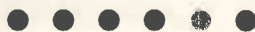

Phone David Bonner
 for details on
 081-743-8888

EDINBURGH

OMNI ELECTRONICS

stock a wide range of
 electronic components at
**174 Dalkeith Road
 Edinburgh EH16 5DX**
 Tel: 031 667 2611

Open Mon-Fri 9am-6pm
 Sat. 9am-5am

NEW CATALOGUE OUT NOW

Price is just £1.50

Contact Omni Electronics
 now for details

LONDON N WEST

CRICKLEWOOD ELECTRONICS

*One of the largest ranges
 of components in the UK!*

**40 Cricklewood Broadway,
 LONDON NW2 3ET
 Tel: 081-450 0995/452 0161**

Retailers

MANCHESTER

THE ELECTRONICS SHOP

We stock a large range of electronic components, test equipment, telephone accessories, computer accessories, microphones, speakers, discolorighting, mixers, meters, stylus, so call in and have a look around.

29 Hanging Ditch, Manchester M4 3ES
 Telephone: 061-834-1185
 Fax: 061-833-2969

SOUTHSEA

ELECTRONIC COMPONENTS

EVERYTHING FOR YOUR NEXT PROJECT
 THE BIGGEST DISPLAY IN THE SOUTH
 IS AT

FRASER ELECTRONICS

42 ELM GROVE ★ SOUTHSEA ★ HANTS
 Telephone: 0705-815584



SOUTH COAST



Cooke International

"We stock used scopes, signal generators, power supplies, power meters, DVMS, oscillators, attenuators, test equipment. Much more available, visit our s/room and bargain store. Prices from £5 upwards!"

Contact: Cooke International, Unit Four,
 Fordingbridge Site, Main Road, Barnham, Bognor
 Regis, West Sussex PO22 0EB.
 Tel: 0243 545111 Fax: 0243 542457
 "Open: Mon - Fri 9am - 5pm or phone"

**Support
 your local
 electronics
 specialist!**

Surveillance

Surveillance devices, lasers, Tesla coils, scramblers, ultrasonic and many more, over 150 designs. Send SAE to: Plancentre, Old Wharf, Dynock Road, Ledbury HR8 2HS for free list.

NEW VHF MICROTRANSMITTER KIT, tuneable 80-135 MHz, 500 metre range, sensitive electret microphone, high quality PCB. **SPECIAL OFFER** complete kit ONLY £5.95, assembled and ready to use £9.95 post free. Access orders telephone 021 411 1821. Cheques/ P.O.'s to: Quantek Electronics Ltd, (Dept P.E.), 45a Station Road, Northfield, Birmingham, B31 3TE

Kits, Plans, Assembled Units, Surveillance Microtransmitters, Phone Recording Switches, Trackers, Defence /Protection Circuits, Plus much more. Send 2 x 22p stamps for lists, or tel. 05436 76477 24hrs. Everything for the budding 007. ACE(PE). 53 Woodland Way, Burntwood, Staffs. WS7 8UP.

PROFESSIONAL INTRUDER ALARM EQUIPMENT

One x 1 Coded Keypad Microprocessor Control Panel, One Rechargeable Battery, Two x 12mts Passive Infra Red Detectors, One self Actuating Siren Bell Box and flashing Strobe Light, Four Magnetic Door Contacts, two Panic Buttons, 100 mts Cable and one box of Cable Clips. Only £189.00 + VAT inclusive of delivery. Allow 28 days for delivery.

Please make cheques payable to:
Laser Alarms Limited,
 Laser House,
 Newton Avenue,
 Gloucester GL4 7LT

Miscellaneous

Oscilloscope double beam 10MHz. Portable (tequipment) £120, AVO 8 Mk5 cased £100, both excellent, geiger counter £50. Wanted: Transistorized 20-60 MHz oscilloscope not working/"cheap!" 0803-882572.

Pro Alarm Panels, value £44, £65, unused, sale £5,£10. 999 Dialler £10, Bells, Ultrasonics, Strobes, Sensors, CR Components, Tx, New Bench Drill £150, Lucky Bags £5. All must go. Sorry no mail order, callers only. Please phone first. Hockley, 61 Disraeli Terrace, Leeds LS11 6NT. Phone Leeds 778444 (Private).

For Sale, 80C39 Microprocessors, £2.75p, TL094 opamps 75p, TL066 30p, Reusable cable clips stick or scxrew down 5p, send orders and cheq/PO to: P.I. Ridge, 5 Conway Groce, Great Barr, B'Ham B43 5HD

Oscilloscope TekTronix 455, Delay Time Base, 0.05µs time base, VGC, £350 ono. Romsey (Hants) 517101

Enthusiast wishes to swap/sell electronics related P.D. software. PC, ST and Amiga. Non profit making. LUI. 56 Leamington Terrac, Edinburgh EH10 4JL.

Missing that vital PE back issue? Don't despair!

Reprints of articles and software listings are available for £2 from the editorial address. We cannot accept credit card orders below £5 value.

Miscellaneous

FOR SALE

Practical Electronics in Binders volumes one (1965) to ten (1974) and later loose copies. Offers for lot (0905) 54318.

SERVICE MANUALS

Available for most equipment. TVs, Videos, Test, Amateur Radio etc. Write or phone for quote.
Mauritron (PE), 8 Cherry Tree Road, Chinnor, Oxon OX9 4QY
Tel: (0844) 51694. Fax: (0844) 52554

Writing Classified Advertisements That Work

- ① Start by mentioning the product or service you are selling. By doing so, you make it easier for the reader to see what you are offering.
- ② Always include the price of whatever it is you are selling. Research has shown that 52% of people who read classified ads will not respond to advertisements that fail to include the price.
- ③ Keep abbreviations to a minimum. It makes whatever you have to say more easily understood.
- ④ Pretend to be your prospective customer. Ask yourself what it is you would like to know about the product or service that you are selling that would make you want to buy it. For example, you could include information such as brand names, colours and specifications.

CLASSIFIED COUPON

									£3.36
									£5.04
									£6.72
									£8.40
									£10.08
									£11.76

Rates are 20p per word plus 4p VAT (Ilnage, for semi-display advertisements contact our Ad. Dept.). All classified advertisements must be pre-paid. Please send your copy with the remittance (payable to Intra Press or payments by Visa or Access accepted) to: Practical Electronics Classified Dept., Intra House, 193 Uxbridge Road, London W12 9RA. Tel: 081-743 8888, Fax: 081-743 3062

Techniques

From solar heating temperature sensors to guitar string pickups, Andrew Armstrong has electronic solutions for everything.

Two readers have a similar request this month. Mr S D Craft of Deal in Kent writes "I wish to construct a digital temperature indicator to show the temperature in six different positions in a solar heating installation". Mr P Anslow of Wakefield in Yorkshire writes "I need a circuit to measure the temperature of my solar panels at several different points. Preferably it should use a 9V battery supply, and have thermistor sensors wired back to a rotary switch".

These requirements are sufficiently similar that one design can satisfy both of them. The only alteration I have made in designing this unit is that I have used semiconductor temperature-sensors instead of thermistors. This avoids the use of complicated and difficult to calibrate thermistor linearisation circuitry.

The circuit shown in Fig. 1 illustrates the basis of a digital thermometer operating with a number of switched remote sensors. The ICL7116 DPM (digital panel meter) is chosen because it has sufficient accuracy for the job, is easily available, has a low current consumption, and drives a liquid crystal display. If it were not necessary to run the unit on battery power, then the ICL7117 (a similar chip but using an LED display) would be equally suitable. Display connection details are not shown because they are simply a matter of following the pin connections in the data sheet.

At first sight, the circuit may not appear to make sense, so an explanation is in order: the A to D (analogue to digital) conversion used in the chip cannot measure relative to the negative power-supply rail. Both input and reference voltages are measured internally relative to the common terminal, which maintains a constant voltage below the positive supply rail. It is for this reason that

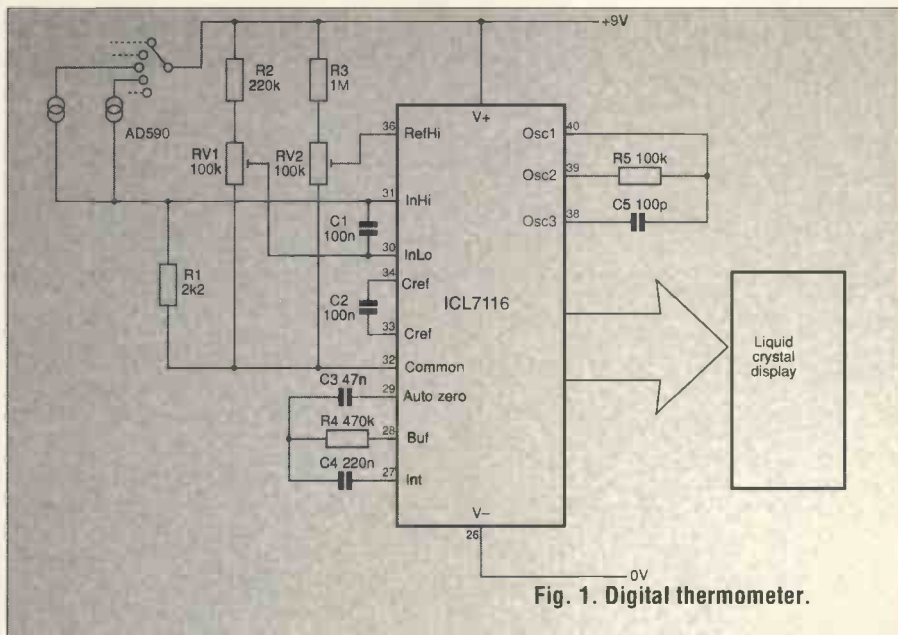

Fig. 1. Digital thermometer.

the reference voltage is adjusted using a potentiometer chain between positive and common.

Temperature Sensors

The AD590 temperature sensor passes a current of $1\mu\text{A}$ per Kelvin. Thus, at normal room temperatures, a current of between 290 and $300\mu\text{A}$ will flow. This gives approximately 600mV across R1 at 0°C . To make the meter read zero at freezing point, an offset of 600mV is fed to the low input terminal. Temperatures of above freezing feed a positive voltage to the high input relative to the low input, and give a positive output reading.

AD590 temperature sensors have different tolerances, so the meter can only give a completely accurate reading from one of them. To calibrate the unit, first adjust RV1 to give 600mV between the low input and the common terminals. Then, set the reading switch to the temperature sensor whose accuracy is most important, and adjust RV2 until the correct temperature is displayed, as verified by some dependable temperature reading instrument.

Calibration accuracy on the other sensors should be accurate enough for most requirements. If absolute accuracy is required, a second gang could be added to the selector switch to switch preset potentiometers in series with R1 (whose value should be lowered to $1\text{k}\Omega$), to trim each sensor to work accurately.

On The Pickup

Mr J M Alsoop writes to ask about guitar electrics. He wants information about pickups and control circuits, the difference between solid bar and individual string pickups and the effect of using more than one pickup.

Though superficially simple, this is a big subject. Among guitar buffs, many aspects of electric guitar design are considered important, even the colour of the knobs! But seriously, it is true that some points which would normally be considered electrically insignificant can affect the sound enough to matter, while other things which would be considered important in other fields do not concern many electric guitar players.

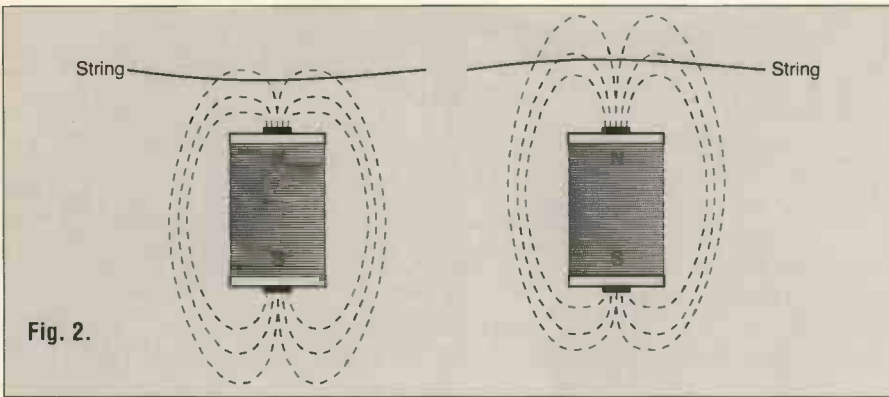

minimum harmonic signal, but the harmonic output tends to increase as the pickup is moved nearer to the end of the string. This effect accounts in part for the reason that the same note played by fretting a different string can sound different: if a bass string is fretted to produce a high note, then the pickup is likely to be more or less in the middle of the vibrating area of string. If the same note is played on a high string, most of the length of the string will be in use, so the pickup will be towards one end of the vibrating portion, and so will receive a different tonal balance.

In principle, a guitar pickup consists of a coil of wire wound round a magnet, and positioned so that the vibration of the string disturbs the magnetic field and so generates a voltage in the coil. To disturb the magnetic field, the string must of course be made of steel so that it will interact with the field. Fig 2 illustrates this effect.

A typical single-coil guitar pickup is illustrated in Fig. 3. In this type of pickup, the coil runs round a series of pole-pieces, one per string. The magnet is behind the entire assembly, so that one magnet can provide the magnetic field for

which amplifies the hum more.

"Humbucking" pickups can almost eliminate hum from the guitar pickup output. Here, two identical coils pick up the hum and their outputs are added in antiphase so that the hum is cancelled. The antiphase connection can be either series or parallel: series connection tends to accentuate bass at the expense of treble, while parallel connection does the opposite. The second coil on the pickup only picks up hum; it doesn't get any signal from the guitar strings, because there is no magnet behind the coil.

Controls on most electric guitars are passive in nature: a selector switch will select one, the other or both pickups, the volume control connected across the pickups will adjust the output level, and a simple treble cut control, illustrated in Fig. 6 will adjust the tone. Passive

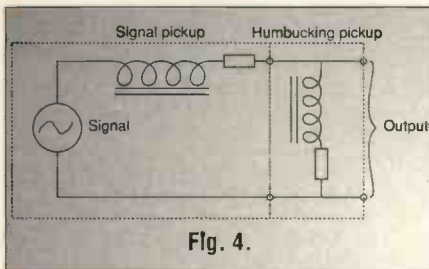

To understand why the tone is affected by series or parallel connection, it is necessary to consider the equivalent circuit of a pickup, containing inductance, resistance and a source of voltage (hum or hum-plus-string signal). Figs. 4 and 5 show the effects of series and parallel pickup connection using these equivalent circuits. Working from the fact that inductors have a series impedance proportional to frequency, it is clear that in Fig. 5 the extra inductance in series with the pickup reduces the treble more than the bass, while the parallel inductor shown in Fig. 4 tends to short out the bass more than the treble.

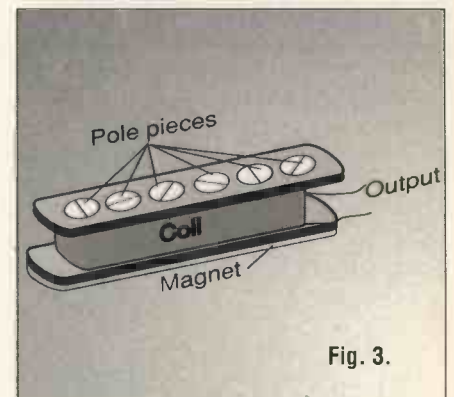

all the strings. The advantage of this is that it is simple, reliable and economical, and works well. Some pickups of this general type use adjustable pole-pieces so that the output from each string can be set individually.

A major drawback of this simple design is that it will also pick up any hum field present around the guitar. Modern guitars often use very light strings, which give a lower output from the pickup. To achieve the required volume, the amplifier gain is turned up further,

treble and bass tone controls generally attenuate the signal to be of great value, but some designs have used inductors as well as capacitors in the tone control circuit, to achieve passive control without too much loss.

Some guitars, and especially optional extras for guitars, use active circuitry which can include anything up to a full graphic equaliser, and goes beyond the scope of this article. ■

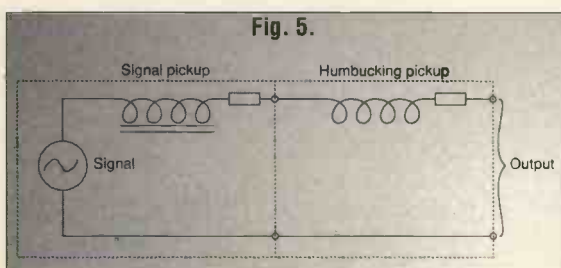

Positioning

The position of the pickup has a substantial effect upon the sound. This is because the guitar string does not vibrate purely sinusoidally and the amplitude of harmonic vibration varies relative to the fundamental along the length of the string. A pickup exactly in the middle of the string would receive maximum fundamental and

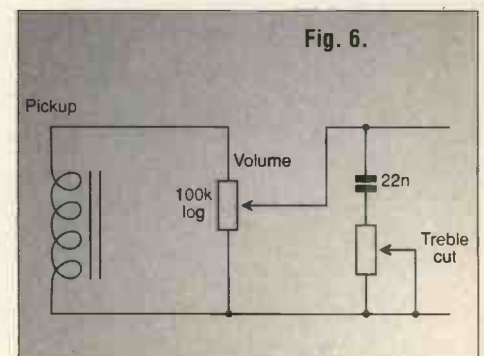

PRACTICAL ELECTRONICS

SCIENCE AND TECHNOLOGY

The more things change, the more they stay the same. Especially, it seems, in PE.

July 1966

Back in the early days of PE the lack of PCBs must have been quite a limitation to what circuits could be built. Components were usually fixed to wooden panels with the leads poking through specially drilled holes. These were then connected together by soldering wires to them. The projects this month 25 years ago have a familiar ring to them; fuzz box, stabilised power supply, bug locator and microphone mixer – they have appeared again and again over the years, always in improved forms of course. For all that electronics hardware has improved beyond recognition in 25 years, the basic ideas and projects don't seem to have changed at all.

1976

The cover story this month was the PE digiscope. This was an amazingly simple idea that was, perhaps, before its time. It comprised a portable hand-held box with a probe on one end and a matrix of LEDs on the other. The signal fed into the probe could be viewed on the LEDs and although not an entirely accurate representation, gave some idea of what was going on. The main problem was the resolution of the image but with modern LCD displays, chips and general improvements in technology, it seems likely that the time is right for a more modern version.

1981

Mike Kenward's editorial 10 years ago started off by saying that there had been "one or two comments recently that the light at the end of the depression is just beginning to show". A familiar sentiment 10 years on when nothing appears to be any different. Perhaps talking the economy back into shape does work – it's nice to think that if you wish hard enough, its bound to come true – only time will tell.

1986

An interesting article appeared in this issue. It covered the recharging of dry cell batteries. According to the author "propaganda" had been put out in the UK saying that this was a dangerous process. He actually tried overcharging some batteries, just to see what would happen. The result seemed to be nothing-at-all. With the possibility of getting 20 recharges per cell, it's a wonder that the idea didn't catch on. On the other hand, NiCd batteries and chargers are now so easily available that no one would want to buy normal dry cells and recharge them would they? ■



Whether your requirement for surveillance equipment is amateur, professional or you are just fascinated by this unique area of electronics SUMA DESIGNS has a kit to fit the bill. We have been designing electronic surveillance equipment for over 12 years and you can be sure that all of our kits are very well tried, tested and proven and come complete with full instructions, circuit diagrams, assembly details and all high quality components including fibreglass PCB. Unless otherwise stated all transmitters are tuneable and can be received on an ordinary VHF FM radio.

UTX Ultra-miniature Room Transmitter. Smallest room transmitter kit in the world! Incredible 10mm x 20mm including mic. 3-12V operation. 500m range.....£16.45

MTX Micro-miniature Room Transmitter. Best-selling micro-miniature room transmitter. Just 17mm x 17mm including mic. 3-12V operation. 1000m range.....£13.45

STX High Performance Room Transmitter. High performance transmitter with a buffered output stage for greater stability and range. 22mm x 22mm including mic. 6-12V operation, 1500m range.....£15.45

VT500 High-Power Room Transmitter. Powerful 250mW output providing excellent range and performance. Size 20mm x 40mm. 9-12V operation. 3000m range.....£16.45

VXT Voice Activated Room Transmitter. Triggers only when sounds are detected. Very low standby current, variable sensitivity and delay with led indicator. Size 20mm x 67mm, 9V operation, 1000m range.....£19.45

QTX180 Crystal Controlled Room Transmitter. Narrow band FM transmitter for the ultimate in privacy. Operates on 180 MHz and requires the use of a scanner receiver or our QRX180 kit (see catalogue), Size 20mm x 67mm. 9V operation. 1000m range.....£40.95

SCRX Subcarrier Scrambled Room Transmitter. Scrambled output from this transmitter cannot be monitored without the SCDM decoder connected to receiver. Size 20mm x 67mm, 9V operation, 1000m range.....£22.95

SCDM Subcarrier Decoder Unit for SCRX. Connects to receiver earphone socket and provides decoded audio output to headphones. Size 32mm x 70mm. 9-12V operation.....£22.95

HVX400 Mains Powered Room Transmitter. Connects directly to 240V AC supply for long term monitoring. Size 30mm x 35mm. 500m range.....£19.95

ATR2 Micro Size Telephone Recording Interface. Connects between telephone line (anywhere) and cassette recorder. Switches tape automatically as phone is used. All conversations recorded. Size 16mm x 32mm. Powered from line.....£13.45

UTLX Ultra-Miniature Telephone Transmitter. Smallest telephone transmitter kit available. Incredible size of 10mm x 20mm! Connects to line (anywhere) and switches on and off with phone use. All conversation transmitted. Powered from line. 500m range.....£15.95

TLX700 Micro-Miniature Telephone Transmitter. Best-selling telephone transmitter. Being 20mm x 20mm it is easier to assemble than UTLX. Connects to line (anywhere) and switches on and off with phone use. All conversations transmitted. Powered from line. 1000m range.....£13.45

STLX High-Performance Telephone Transmitter. High power transmitter with buffered output stage providing excellent stability and performance. Connects to line (anywhere) and switches on and off with phone use. All conversations transmitted. Powered from line. 1500m range.....£16.45

TKX900 Signalling/Tracking Transmitter. Transmits a continuous stream of audio pulses with variable tone and rate. Ideal for signalling or tracking purposes. High power output giving range up to 3000m. Size 25mm x 63mm. 9V operation.....£22.95

CD600 Professional Bug Detector/Locator. Multicolour readout of signal strength with variable rate bleeper and variable sensitivity used to detect and locate hidden transmitters. Switch to AUDIO CONFIRM mode to distinguish between localised bug transmission and normal legitimate signals such as pagers, cellular, taxis etc. Size 70mm x 100mm. 9V operation....£50.95

★★★ SPECIAL ★★★

DLTX/DLRX Radio Control Switch. Remote control anything around your home or garden, outside lights, alarms, paging system etc. System consists of a small VHF transmitter with digital encoder and receiver unit with decoder and relay output, momentary or alternate, 8-way dil switches on both boards set your unique security code. TX size 45mm x 45mm, RX size 35mm x 90mm. Both 9V operation. Range up to 200m. Complete System (2 kits).....£50.95
Individual Transmitter DLTX.....£19.95
Individual Receiver DLRX.....£37.95

A build-up service is available on all our kits if required.

UK customers please send cheques, POs or registered cash. Please add £1.50 per order for P&P. Goods despatched ASAP allowing for cheque clearance. Overseas customers send sterling bank draft and add £5.00 per order for shipment. Credit card orders welcomed on 0827 714476.

OUR LATEST CATALOGUE CONTAINING MANY MORE NEW SURVEILLANCE KITS NOW AVAILABLE. SEND TWO 22P STAMPS OR OVERSEAS SEND TWO IRC'S.

SUMA DESIGNS

The Workshops

95 Main Road, Baxterley,

Nr. Atherstone, Warwickshire CV9 2LE



Tel: 0827 714476

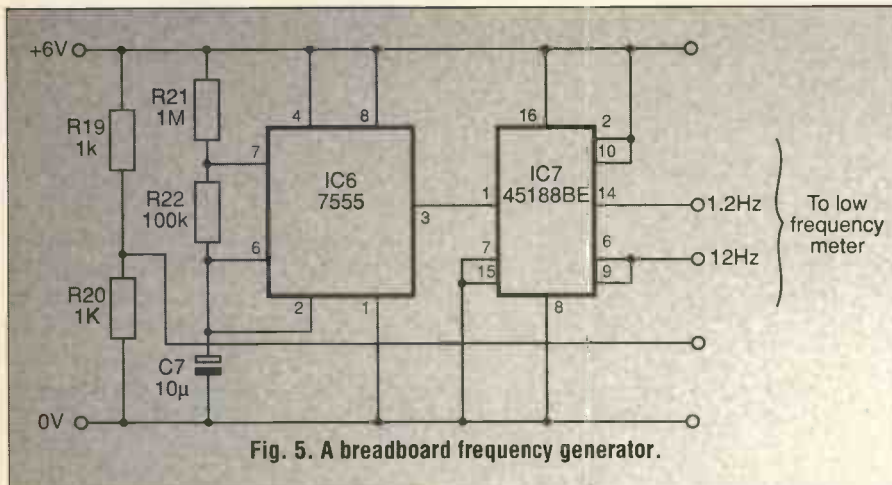

Fig. 5. A breadboard frequency generator.

continued from page 28

PP1 6V batteries or two battery holders each with 4 type AA cells. The circuit for the prototype is on two boards (Fig.4) which slot into grooves moulded in the sides of the case. if the case you are using has different dimensions, cut your boards to fit. It is possible also to combine the layouts of Fig.4 on to a single board and fit this at the bottom of the case, using plastic self-adhesive pcb mounting strip or double-sides self-adhesive pads.

The power switch, range selector switch, input terminals and meter are mounted on the lid or front panel of the case.

For testing the circuit, you will need a oscillator capable of generating signals in the range 0 to 20Hz. The best is a calibrated signal generate but it is possible to make do with an astable multivibrator based on a 7555 time ic. Fig.5 shows a suitable circuit, which can be breadboarded for the occasion. Using 1% tolerance capacitor and resistors gives frequencies close enough for calibration.

Build Board A first and, if you have an oscilloscope, check that the output from pin 6 of IC2 is a square wave. Otherwise connect an LED and 180 resistor in series between pin 6 and the OV rail and see that the LED flashes strongly at the correct rate (as near as you can tell).

Next, assemble the sub-circuits associated with IC3 and IC4 on Board B and make the wired connections to board A. Monitor the signal at pin 1 of IC4. With a 1.2 Hz input, this has a frequency of 120Hz; with a 12Hz input, the frequency is 1.2kHz.

Finally, assemble the tachometer sub-circuit (IC5). Before placing the

ic in its socket, use a multimeter to adjust the combined resistances of R16/VR1 and R17/VR2 to 410k and 41k respectively.

Also calculate the series resistor required for the meter and adjust VR3 accordingly.

When finally tested with a 12Hz signal, and with S2 switched to the 20Hz range, the meter takes a few seconds to come up to its final reading. This is while the charge is accumulating on C4. Its progress is unsteady as the VCO gradually locks on to the correct frequency. The needle finishes a little to the right of the centre of the scale. For example, if the full-scale reading is 100µA, the needle reads 60µA. After settling, the needle readily follows slow changes of frequency, but needs a few seconds to catch up with a rapidly-changing frequency. The same meter reading is obtained with a 1.2Hz signal on the 2Hz range. There is more tendency for the needle to hover around the true reading on this range as there is more likelihood of the PLL occasionally losing its lock at such low frequencies. ■

Components

Resistors

(0.6W metal film, 1% tolerance)

R1	39k
R2,R3	2M2
R4,R14	10k
R5,R8,R9,R12	1M0
R6,R7,R15	470
R10	5k6
R11	3M3
R13	100k
R16	390k
R17	39k
R18	56k

(depending on meter coil, see text)

Variable resistors

(sub-miniature horizontal presets)

VR1	47k
VR2	4k7
VR3	10k

(depending on meter coil, see text)

Capacitors

C1, C2	470n polyester
C3	100n polyester
C4	47u tantalum bead
C5	10n polyester
C6	2u electrolytic

(radial leads) or tantalum bead

Semiconductors

D1-D3	1N4148 signal diode
-------	---------------------

Integrated circuits

IC1, IC2	ICL7611 CMOS operational amplifier
IC3	4046BE CMOS phase-locked loop

IC4 4518BE CMOS dual decade counter/divider

IC5 LM2917N tachometer (8-pin or 14-pin version)

Miscellaneous

M1 moving-coil microammeter (e.g. 0-100uA).

S1 single-pole single-throw toggle switch

S2 single-pole double-throw toggle switch

Pair input sockets or terminals

8-pin dil sockets (2 off)

14-pin dil socket

16-pin dil sockets (2 off)

2.5mm matrix stripboard, 90mm x 42mm (16 strips x 32 holes)(2 off)

1mm terminal pins (10 off)

Components for breadboarded frequency generator

Resistors

(0.6W metal film, 1% tolerance)

R19, R20	1k (2 off)
R21	1M0
R22	100k

Capacitor

C7	10n (10000pF) polystyrene 1% tolerance
----	----------------------------------------

Integrated circuits

IC6	7555 CMOS timer
IC7	4518BE CMOS dual decade counter/divider

All We Need Is Radio Gaga

This month Barry tunes into Britain's crowded radio waves to see where all of the programs fit into the great scheme of things.

It seems like only yesterday that there were only a few radio stations in Britain and no frequencies for any more. Then, suddenly, there were enough frequencies for dozens of new commercial stations and the BBC started Radio 5.

In 1979 a World Administrative Radio Conference of the International Telecommunications Union decreed that the whole of the VHF radio band (Band II) had to be released for entertainment broadcasting. In 1984 a Regional Administrative Conference in Geneva set a timescale - the band must be cleared by 1995.

Pirate radio put the British government under pressure to act on the WARC ruling and make room for more legitimate stations. It also set about ending the wasteful practice of simulcasting, whereby one station broadcasts the same programme on two different frequencies at the same time.

On The Right Path

Frequency allocations in the UK are now like footpaths. Those with rights risk losing them if they do not use them. This has led to disputes between the Radio Authority and BBC. The BBC says it needs all its allocated frequencies, to build relay stations. The Radio Authority sees any unused frequency as a new local station.

The Home Office asked the BBC to stop simulcasting its national stations. Radio 2 moved off the MW wave last August and its MW frequencies were taken over by Radio 5. Radio 3 will stop MW broadcasting in 1992 and Radio 1 a year or so later. This will release



frequencies for independent national radio.

The main changes are in the VHF-FM band which, in Britain, stretches from 87.5MHz to 108MHz. Inside this band there is a complex jigsaw of allocations which will baffle all but the most dedicated listener. The BBC national, BBC local, commercial local and future commercial national stations stack in a multi-layer sandwich.

No More Police

Until the end of 1989 the police used a large chunk of frequencies (97.6 - 102 MHz) smack dab in the middle of the VHF band - a ludicrous situation when you bear in mind how touchy the police are about crime reporters eavesdropping on their radio conversations. This chunk is now used by Radio One and Independent Radio. Although they do not seem to use them much, utility services (gas and rail for example) will still hold a large

chunk (105 - 108 MHz) of frequencies at the top of the band until 1996. After that there will be no more VHF frequencies to allocate.

Who's Got What

The current situation is that the BBC uses the low end of the band (88 - 94.6 MHz) for national and regional radio, Radios 2, 3 and 4. The next chunk (94.6 - 96.1 MHz) is used for BBC local radio and Radio 4 in some areas. The next up (96.1 - 97.6 MHz) is used by Independent Local Radio. BBC Radio 1 has 97.6 - 99.8 MHz and a mix of new independent national and local radio stations, mainly yet to come, has 99.8 - 102 MHz. Further up a slice (102 - 103.5) goes to ILR and the highest slice (103.5 - 105) goes to BBC local radio.

But there are even odd exceptions to the general rule where, for instance, ILR station Melody uses a frequency once allocated to the BBC and ILR Kiss uses a national allocation. Melody got its frequency because the BBC did not go through with its plan to build a new local station in Berkshire.

Using a continuous tuning dial or frequency display is now a turn off for listeners. The short term answer to the worsening muddle is a radio with pre-set tuning buttons. The long term answer is RDS, the BBC's Radio Data System. Digital code in a sub-carrier identifies each station. So an RDS receiver can have pre-set buttons marked only by station name. The listener need know nothing about frequencies. The pity of it is that so far only car radios have RDS. ■

EASY-PC, SCHEMATIC and PCB CAD

Over 7500 Installations
in 50 Countries Worldwide!

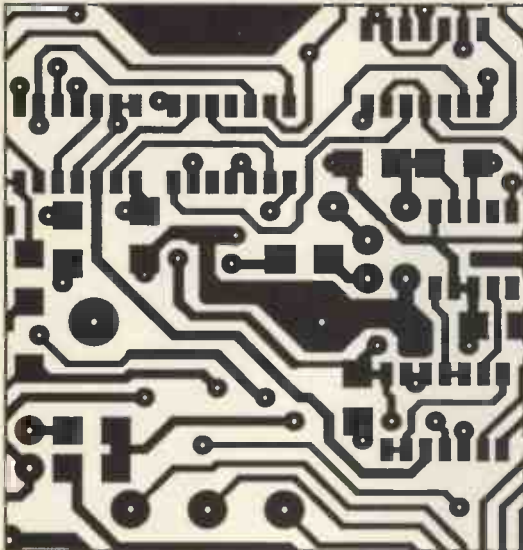

- Runs on:- PC/XT/AT/286/386/486 Herc, CGA, EGA, VGA.
- Design:-Single sided, Double sided and Multilayer boards.
- Provides Surface Mount support.
- Standard output includes Dot Matrix / Laser / Inkjet Printer, Pen Plotter, Photo-plotter and N.C. Drill.
- Superbly easy to use.
- Not copy protected.

Still Only £98.00!
Plus P&P+VAT

BRITISH DESIGN AWARD 1989

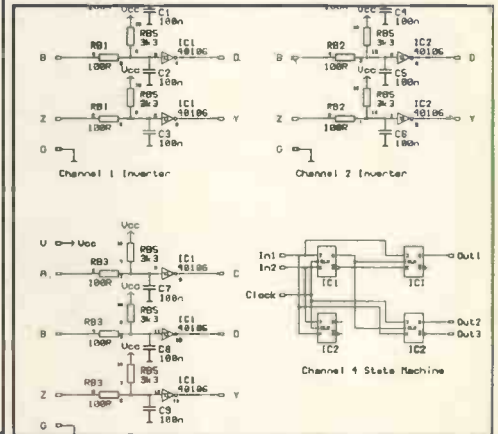

Options:

1000 piece Symbol Library £38, Gerber Import facility £98

DIGITAL SIMULATION PULSAR £195

SMITH CHART CAD Z-MATCH II £195

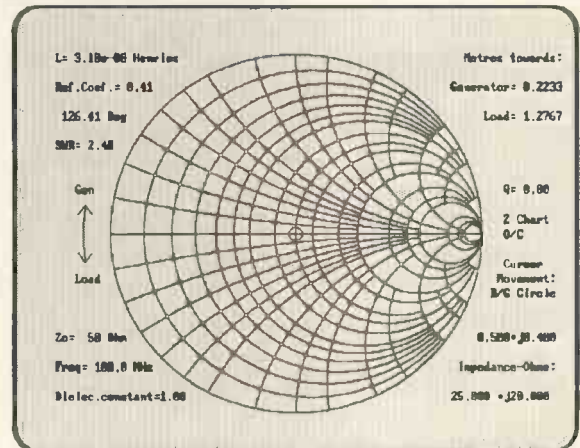
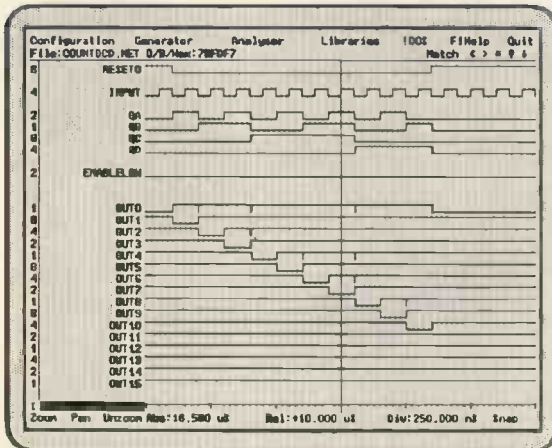

- At last! A full featured Digital Circuit Simulator for less than £1000!
- Pulsar allows you to test your designs without the need for expensive test equipment.
- Catch glitches down to a pico second per week!
- Superbly easy to learn and use.
- Runs on PC/XT/AT/286/386/486 with EGA or VGA.

- Z-MATCH II simplifies RF matching and includes many more features than the standard Smith Chart.
- Handles transmission line transformers, stubs, discrete components, S Parameters etc.etc..
- Supplied with many worked examples.
- Superbly easy to learn and use.
- Runs on IBM PC/XT/AT/386/486, CGA, EGA, VGA.

For full information, Write, Phone or Fax:-

Number One Systems Ltd. I

REF: PE, HARDING WAY, ST.IVES, HUNTINGDON, CAMBS, ENGLAND, PE17 4WR.

Telephone: 0480 61778 (7 lines) Fax: 0480 494042

International: +44-480-61778, l'Fax: +44-480-494042 ACCESS, AMEX, MASTERCARD, VISA Welcome.

The CAD Specialists

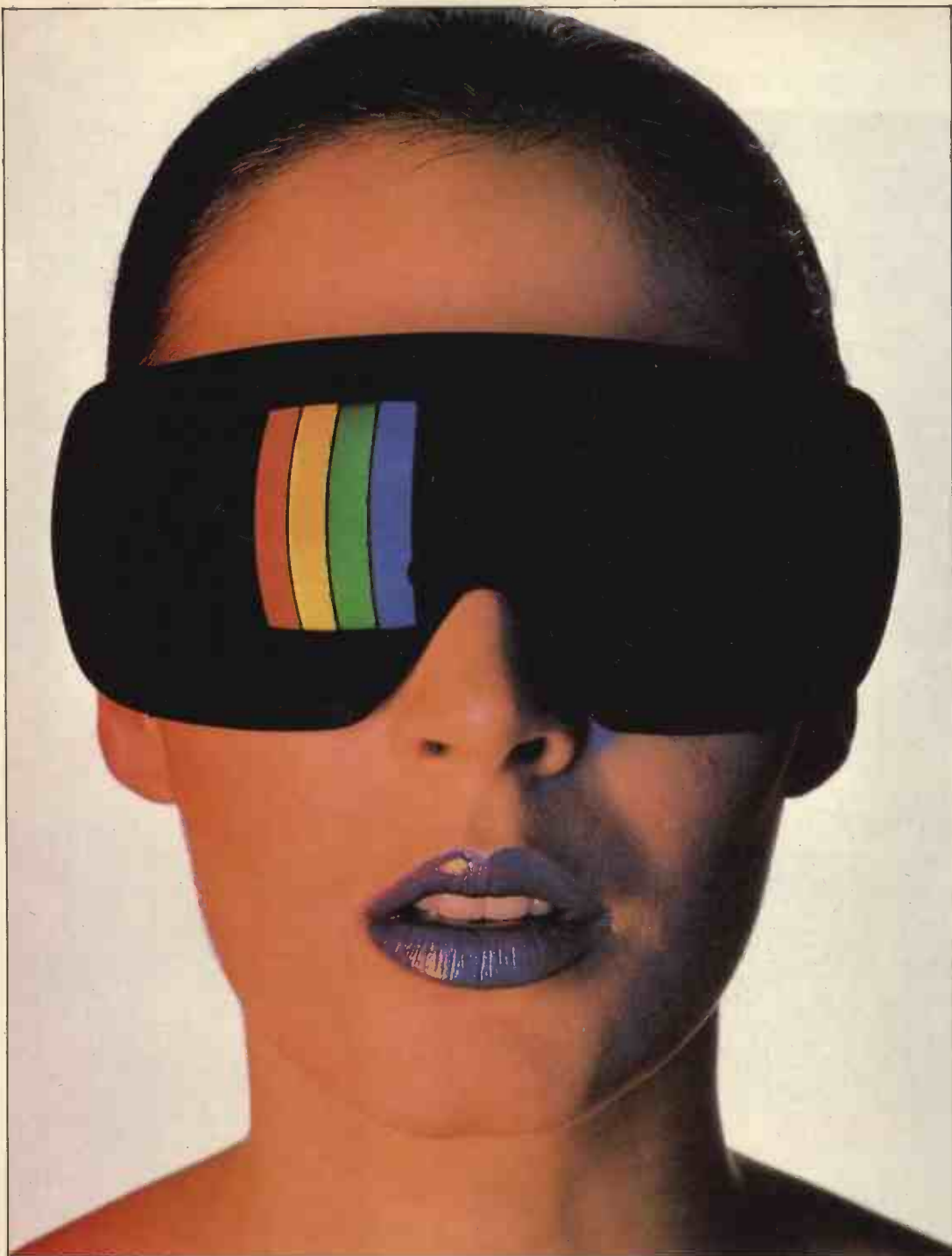

NICAM!

...set your sights on a better sound!

Experience a new sensation. An experience that opens up a whole new spectrum of sound.

Put yourself on stage at the Albert Hall, surrounded by a great orchestra. Imagine the sound you will hear, every nuance, every note; or travel up the Nile with an intrepid explorer, a journey not only full of breathtaking beauty and colour, but rich in the sounds of another continent; or capture the hidden gasps of 100,000 hardened fans at Wembley for the F.A. Cup Final, when the ball skims the crossbar with the last kick of the match; follow with your ears as well as your eyes, dodging the bullets, as your favourite hero battles out of yet another tight corner, it's just like being in a cinema!

Nicam hi-fi stereo will turn your living-room into a living room of

sound! You don't settle for second best with television picture quality, why settle for second best in television sound quality? Nicam sound is the new high quality digital stereo sound system, pioneered by BBC, ITV and TV/video manufacturers. In fact so good is Nicam it is comparable to the superb sound reproduction of the compact disc, when played through your existing hi-fi arrangement. If your television hasn't got a built-in Nicam decoder, you will need the Maplin Nicam Tuner System. Ultimately almost all of your favourite programmes will be broadcast in superb hi-fi quality stereo-sound. Without a Maplin Nicam Tuner you won't be able to capture every sound to its full.

Nicam hi-fi stereo. Catch your breath, open your eyes, and pin back your ears! It's what your hi-fi system was made for... It's what your ears are made for!

DIGITAL STEREO TV SOUND FROM YOUR HI-FI

The complete kit contains all the components required to build the unit. However you will also need: a power supply, 12V at 600mA regulated e.g. YZ21X at £9.95; a co-ax Y adaptor e.g. FS23A at £1.20; a co-ax lead to connect to your TV or video; RW36P 2m long at £1.36, JW39N 5m long at £1.98, or JW40T 10m long at £2.95; a phono lead to connect to your hi-fi e.g. RW50E at £1.06 or a SCART/Peritel lead JW36P at £5.95. An infra-red remote control kit is also available LP20W at £29.95. Complete kit LP19V only £149.95 incl. VAT + £1 mail-order handling charge.

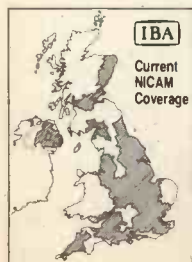

IBA
Current
NICAM
Coverage

Maplin ELECTRONICS
CREDIT CARD HOTLINE
0702 554161

For a friendly welcome and the very best of service why not visit our shops in Birmingham, Brighton, Bristol, Leeds, London (Edgware and Hammersmith), Manchester, Newcastle-upon-Tyne, Nottingham, Reading, Southampton and Southend-on-Sea.
Subject to availability. Prices subject to change.



Digital stereo sound companion for your TV set.