

**PRACTICAL**

OCTOBER 1990 • £1.50

# ELECTRONICS

SCIENCE AND TECHNOLOGY

## CHIP TESTER

Check out the health  
of your chips

## SOUND OPERATED SWITCH

Verbally throwing  
light on night-time  
security

## POLYLINE METERING

Can imaginative  
technology help pay  
the piper?

## TELE-SCOPE

Finding out more  
about using your tv  
as an oscilloscope



Anyone can win with our  
**READER LOYALTY**  
**BONUS**  
See page 35



# REALISTIC®

# Walkie talkies

49 MHz FM  
Fully Approved To  
DTI Specs MPT-1336

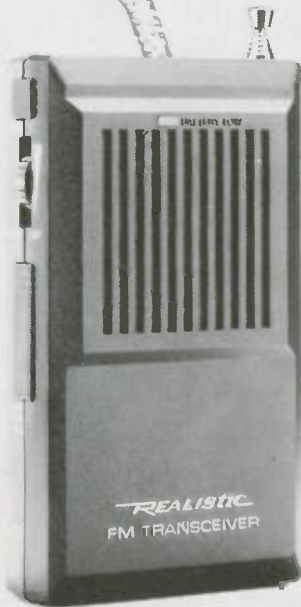

21-401

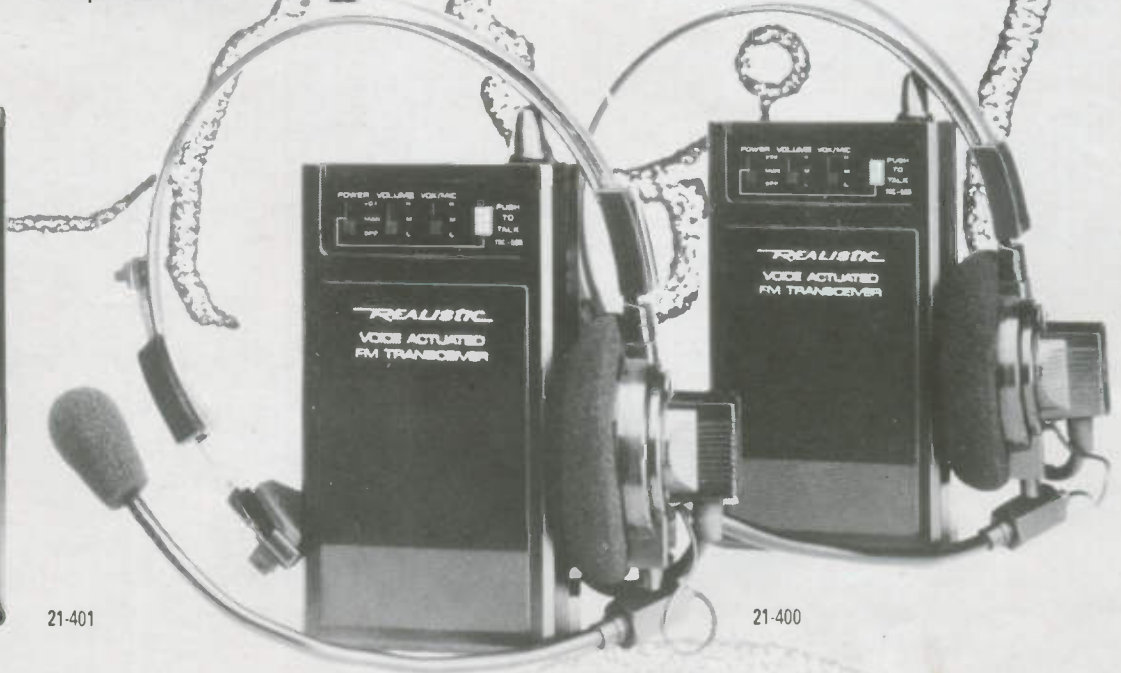

21-400

£24<sup>EACH</sup><sub>95</sub>

• Licence Not Required

Realistic TRC-501. Only 25.4mm thick and five ounces light! Call button transmits a tone signal. Low-battery indicator, push-to-talk button, telescopic aerial. Includes belt clip. Requires one 9v battery.

£59<sup>PAIR</sup><sub>95</sub>

• Licence Not Required

Realistic TRC-500. Voice-actuation gives you hands free communication. Dual-conversion superhets for high sensitivity and clear 2-way communication. Volume switch. With belt clips. Each headset requires 9v battery.

# Tandy®

Over 400 Tandy Stores And  
Dealerships Nationwide. See  
Yellow Pages For Address Of  
Store Nearest You.

InterTAN U.K. Ltd., Tandy Centre, Leamore Lane, Walsall, West Midlands. WS2 7PS  
Tel: 0922 710000

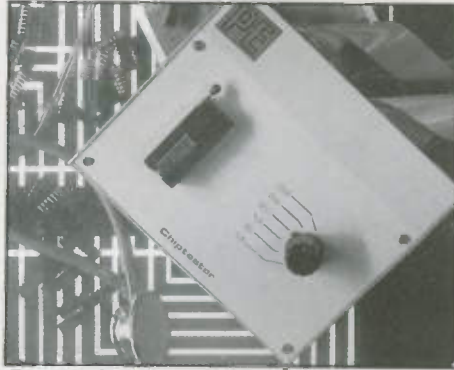

Page 12 ▲

## NEXT MONTH

### A BIKE COMPUTER!

What with Middle-East oil crises and increasing green and health issues, it's not surprising many people are buying push-bikes. We're featuring next month an ideal constructional project for anyone who wants to know the facts and figures of their pedalling - a bike computer. It's simple to build and is microprocessor controlled. It uses an alphanumeric led to display at the touch of a keypad numerous parameters: current speed; distance travelled since start of trip; peak speed reached; average speed; time since start of trip in hours, mins and seconds, and in decimal hours; total distance travelled since computer first installed; number of wheel revs since trip. And there is a keypad controlled coded security alarm option. All speeds and distances are expressed in both mph and kph. Suitable for bikes (and other vehicles) of any wheel diameter.



★ THOUSANDS OF YOU WILL WANT TO BUILD ONE

★ SO DON'T MISS YOUR COPY OF OUR NOVEMBER 1990 ISSUE

★ ON SALE FROM FRIDAY OCTOBER 5TH

**PE TAKES TECHNOLOGY FURTHER - BE PART OF IT!**

★ ★ ★

# PRACTICAL ELECTRONICS

VOL 26 NO 10

OCTOBER 1990

## CONTENTS

### READER LOYALTY BONUS!

GET YOUR GOODS FREE from our advertisers. ....35

### CONSTRUCTIONAL PROJECTS

**CHIPTESTER** by Dave Raynor.....12

Be sure your chips are in good health by letting this professional quality chip tester analyse their capabilities with the assistance of a Beeb computer.

**PE TELE-SCOPE - PART 2** by John Becker .....19

Discussing timing circuit details, turning theory into practice, and carrying out the simple alignment to the interface which turns your tv into a 2MHz oscilloscope.

**AF OCTAVE MEASURER - PART 3** by Joe Chamberlain ...37

Putting the finishing touches to our sophisticated multi-octave frequency analyser. It's an excellent item of audio-workshop test equipment.

**SOUND OPERATED SWITCH** by Paul Benton .....41

Let the voice of a caller at your door light up his features for night-time recognition as friend or foe. An ideal project for the security conscious.

### SPECIAL FEATURES

**POLYLINE METERING** by Robert Redding .....19

Does it really make sense for inspectors to personally visit households in order to read the gas and electricity meters?

**HISTORY OF TECHNOLOGY - OHM** by Ian Poole .....30

Ohm's Law defines the inter-relationships of resistance, current and voltage, but did you know that Ohm's work was largely ignored by the scientific community?

**HOME-BASE** by Ian Burley .....32

Continuing our perusal of the new products on display at the Summer Consumer Electronics Show in Chicago, and which are likely soon to be on sale in Britain.

**BASIC ELECTRONICS - PART TEN** by Owen Bishop .....48

Increase your understanding of electronics by knowing more about devices which control current and voltage. And gain more experience by building the modules.

### REGULAR FEATURES

**EDITORIAL** by John Becker - Viewing philosophy .....9

**LEADING EDGE** by Barry Fox - Radio data systems .....8

**SPACEWATCH** by Dr Patrick Moore - Another solar mystery .....46

**INDUSTRY NOTEBOOK** by Tom Ivall - A boost from the ERM .....57

**POINTS ARISING** .....40

### PRODUCT FEATURES

**NEWS AND MARKETPLACE** - what's new in electronics .....4

**SPECIAL SUBS OFFER** - FREE binders for PE Subscribers.....10

**BOOKMARK** - the Editor's browse through some new books ....52

**ARMCHAIR BOOKSHOP** - haven for practical bookworms .....58

**PCB SERVICE** - professional PCBs for PE Projects .....60

**HOW TO DO IT** - the route to better board building .....61

**ADVERTISERS' INDEX** - locating favourite stockists .....62



## QUILLER METERS

Six new multimeters have been introduced by British company Quiller. The QI range comprises low-cost, quality instruments with 'realistic specifications' to meet today's standards.

From a modest 10A dmm, at around £15 retail, the range progresses through analogue units to two high spec dmm's. The first of three analogue meters is a 500V insulation tester, also offering a 300Vac measurement scale. The other two offer large displays, dB ranges, semiconductor test, and are

ideal for general purpose and desk instrument work.

The range's penultimate dmm is compact, autoranging, and features a bargraph display. Top of the range is powerful and rugged dmm with a comprehensive selection of facilities including temperature, capacitance, frequency ranges and semiconductor test.

For more information contact Quiller Ltd, 2 Paisley Road, Bournemouth, Hants, BH6 5EU. Tel: 0202 417744.

## HANDY THERMOMETERS

The CP Instrument Company have provided a solution to their belief that insufficient features are to be found on some instruments. The company have carefully selected the popular functions that most users of hand-held thermometers require and neatly packaged them into a single unit. They go so far as to say that it "can only be termed the ultimate hand-held thermometer".

Although we are reluctant to consider anything as being "the ultimate", the thermometer certainly appears to be remarkably simple to use and has a lot of features. Apart from reading either 0.1° or 1° resolution in both °C and °F it will store peak and valley temperatures with one probe, thereby eliminating probe error. It will accept type JKT and E thermocouples, will "hold" on all functions, and most importantly, can be field calibrated against known temperatures.

The non-volatile memory function takes this thermometer into a field of its own (!) storing up to eight readings indefinitely.

Externally the meter is housed in an abs plastic case with a sealed



positive response membrane keypad and shatterproof display window.

Simon Thomas, marketing manager of CP instruments says. "At £149.50, no other thermometer can even come close to offering these combined functions in such an easy to use package at such a low price. It's so reliable that we even offer a three-year guarantee!"

For further information contact The CP Instrument Co Ltd, PO Box 22, Bishops Stortford, Herts, CM23 3DH. Tel: 0279 757711.

## TICK TOSH

Toshiba is looking to increase its share of the clock radio market this year with the introduction of two new models, the RC1061L and RC1079L.

Both models feature dimmer switch, sleep function, snooze facility, led display, battery back-up and fm/mw/lw 3-band radio. The RC1079L also includes a dual alarm, and is priced at around £23. The other model costs around £15.



## CATALOGUE

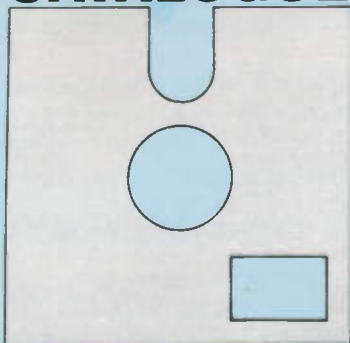

## DATABASE

Adcola are a household name when it comes to soldering equipment and accessories. Their latest brochure has come in and is well worth browsing through. It does not cover soldering irons themselves but is devoted to desoldering and assembly products. Included are a desoldering/rework static-free station, anti-static desoldering braid, desoldering pumps, inspection lamp lenses, soldering iron tip cleaning, fume hoods and a selection of low cost cutters, nippers and pliers. Adcola Products Ltd, Adcola House, Gauden Road, London SW4 6LH. Tel: 071-622 0291.

Velleman's High-Q kit catalogue is a well illustrated source of commercially manufactured electronic kits for a wide selection of functions. It's an A5 sized catalogue of 32 pages, in which each kit is shown as a colour photo of its finished form, and they really do look appetising. The contents include: alarm, audio, car accessories, housings, communications, computer interfaces, dimmers, gadgets, household applications, light-effects, measuring, membrane keyboards, sensors, counters, timers and power supplies. The prices look very reasonable and set-by-step instructions are provided with each kit. Velleman are an international company whose kits are widely distributed across Europe, Canada and the USA. The sole UK distributors for Velleman are High-Q Electronics Ltd, PO Box 1481, London NW7 4RF. Tel: 0707 263562.

Mega Electronics have established an excellent reputation as manufacturers and suppliers of equipment and materials for all your pcb, front panel and label requirements. Their latest catalogue illustrates the very large variety of products available for these areas and should be obtained by any hobbyist seriously into making pcbs and doing general electronic assembly. The 56-page A4 catalogue is liberally illustrated and covers pcb processing equipment, pcb laminates, pcb chemicals, pcb prototyping systems, cad software, front panel/label production, lightboxes, soldering equipment, tools and uv exposure units. Newly introduced is a selection of electronics components. Mega Electronics, Mega House, Grip Industrial Estate, Linton, Cambridge, CB1 6NR. Tel: 0223 893900.

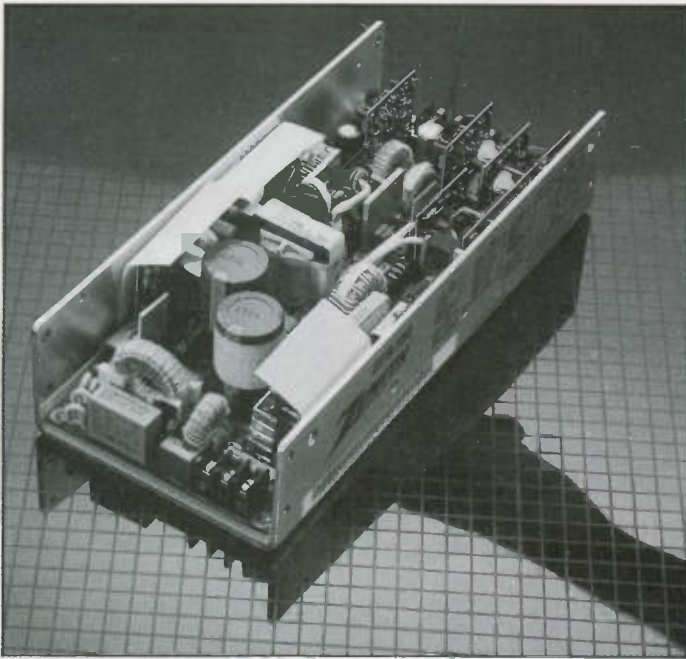

## ADJUSTABLE SMPS

Several new models of adjustable switched mode power supplies have been added to Zenith's range. They are rated from 150W's to 200W's total load capacity and will operate from any mains supply, with autoranging for 115/230V ac inputs.

The main feature of these smps is the wide range of output voltages available from four outputs, varying from 5V dc to 26V dc. If higher voltages are required, any two output

channels can be combined in series. Line, load and cross regulation for all outputs on each new model are tightly regulated at 0.2%. A patented electronic start up circuit increases reliability and efficiency of the units.

For further information contact **Bernadette Collins, Zenith Electronics, Virginia Road, Kells, Co Meath, Ireland. Alternatively, ring Allan Swift, Zeniths' UK Sales Manager on 0306 76730.**



## PCB TOROIDS

An extensive range of high quality encapsulated pcb toroidal power transformers is now being manufactured by Toroid Technology Ltd. The toroids have been designed for high efficiency, low weight, and for use where space is at a premium.

This low cost range has a standard selection of power ratings from 15VA to 120VA, with two primary windings of 120V for series or parallel connection. All models are encapsulated in a thermally conductive resin within a nylon enclosure.

For more information contact **Paul Richards, Toroid Technology Ltd, 175a Brigstock Road, Thornton Heath, Surrey, CR7 7JP. Tel : 081-689 8002.**

## ENGINEERING A CAREER

The new IEEIE, the professional Institution for Incorporated Engineers and Engineering Technicians in Electronic and Electrical Engineering, has published a careers brochure aimed at attracting more young people into the profession. The brochure contains comprehensive information on the profession and also defines the qualifications required for membership of an engineering institution such as the IEEIE.

IEEIE Secretary, Alan Gingell, says "Engineering needs to attract the brightest youngsters, not only for careers as Chartered Engineers but also as Incorporated Engineers and Engineering Technicians.

Another publication is also newly available from the IEEIE. Entitled "Tales of 12 Women - who are glad they chose Engineering", the booklet contains information on winners and finalists of the prestigious Young Woman Engineer of the Year Award. It is freely available to schools and colleges in an aim to motivate more female students to pursue a rewarding and exciting career as an Incorporated Engineer.

For more information contact **Jenny Poulton, IEEIE, Savoy Hill House, Savoy Hill, London WC2R 0BS. Tel: 071-836 3357.**



If you are organising any event to do with electronics, big or small, drop us a line, we shall be glad to include it here.

Please note : Some events listed here may be trade or restricted category only. Also, we cannot guarantee information accuracy, so check details with the organisers before setting out.

**Sep 18-21.** EFTPOS 90. Exhibition and conference on electronic retailing. Alexandra Palace, London. 0273 722687.

**Sep 25-27.** British Laboratory Week. Olympia, London. 0799 26699.

**Oct 2-4.** Eurostat 90. Barbican Red Hall, London. 0799 26699.

**Oct 18-19.** Direct to Home Broadcast by Satellite. IEEIE conference - registration £105 per day. IBA Conference Hall, Brompton Road, London SW3. 071-836 3357

**Nov 6-8.** Total Solutions. NEC Birmingham. 0799 26699.

1991

**Mar 19-21.** Nepcon Europe and Electronics International (formerly British Electronics Week). NEC, Birmingham. 0799 26699.

**April 17-18.** Laboratory Manchester. Windsor Hall, G-Mex Centre, Manchester. 0799 26699.

**May 15-16.** Laboratory Scotland. Scottish Exhibition Centre, Glasgow. 0799 26699.

### IEE FARADAY LECTURES 1990-91

Presented by the Universities of Bath and Sussex.

**1990:** Oct 17 Brighton. Oct 30 Edinburgh. Nov 7 Liverpool. Nov 13 Middlesborough. Nov 21 Manchester. Nov 27 Reading. Dec 4 Coventry. Dec 12 Ipswich.

**1991:** Jan 15 Exeter. Jan 22 Swansea. Jan 29 Southampton. Feb 5-7 London. Feb 12 Hanley, Stoke-on-Trent. Feb 27 Nottingham. Mar 6 Sheffield. Mar 13-14 Bath.

For free tickets and further information contact (enclosing SAE) The Faraday Officer, IEE, Michael Faraday House, Six Hills Way, Stevenage, Herts, SG1 2AY.

### MICROPROCESSOR TRAINING COURSES

In conjunction with Colchester Institute, Flight Electronics is offering a range of intensive four-day microprocessor courses. Contact: Suzanne Kittow, Flight Electronics Ltd, Flight House, Ascupart Street, Southampton SO1 1LU. Tel: 0703 22721.



## IC TESTER-PROGRAMMER

Connect Alpha's latest tester to any IBM compatible system and you have a commercial chip tester programmer at your command. The ICT10 recognises and tests all major ttl 74 and cmos 4000 series, tests drams and srams and has a sophisticated multi-eprom programmer. Supplied ready for use with user-friendly software and programmed instructions, this test set is a powerful tool for serious hobbyists as well as engineers and technicians.

The tester will instantly recognise any supported ttl or cmos chip by quoting its industry standard part number. Testing suspect components together with general soak testing can aid long term circuit reliability. Equipped with a versatile eprom programming capability it will read an existing eprom, compare it with a reference, program up to four eproms, verify blanks, and give the check sum. Files can be read from assemblers in binary or hex formats, and the data can be edited and saved back. The price of the unit is £295 plus vat.

For further information contact Alpha Electronics Ltd, Unit 5, Linstock Trading Estate, Wigan Road, Atherton, Manchester, M29 0QA. Tel: 0942 873434.

## POCKETING SATELLITES

Inmarsat and Motorola are to study the feasibility of a low-orbiting satellite system concept that could support pocket mobile telephone services worldwide.

The Iridium Satellite Communications System proposed by Motorola could revolutionise mobile comms with its constellation of 77 small low-orbit satellites. Customers would be able to communicate globally using small

pocket telephones. Calls could be interconnected directly using on-board satellite switching and inter-satellite links.

"The Iridium concept promises higher capacity and lower user costs for personal communications than is possible through geostationary satellites", said Olof Lundberg, Director General of Inmarsat. "This capacity may be needed towards the end of the century as demand continues to grow."

For further information contact Elizabeth Hess, Inmarsat, 40 Melton Street, London NW1 2EQ. Tel: 071-387 9089.

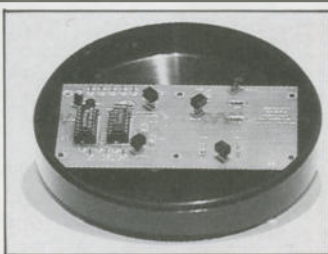

## WEATHER CENTRE

Maplin's new weather monitoring system allows you to measure wind direction and speed from the comfort of your home. The project is in two halves, an outside unit which gathers data on wind speed and direction, and an indoor unit which displays the weather data gathered.

An analogue meter shows the speed in mph and knots, and a 16 point led compass display shows the direction. An optional digital temperature module gives a readout of inside and outside temperatures.

The kits are available from Maplin's nationwide shops, or from their mail order offices at PO Box 3, Rayleigh, Essex, SS6 8LR. Tel: 0702 552911.

## AMSTRAD STORY

Alan Sugar is arguably one of the most extraordinary businessmen to have emerged in Britain since the war. He is the man who developed Amstrad, and who symbolised many of the dramatic social and business developments which transformed Britain in the 1980s.

Published to coincide with the 10th anniversary of the floatation of Amstrad, a commemorative book has been published. *Alan Sugar - The Amstrad Story* tells of Alan Sugar's rise from selling car aerials from the back of a van in the East End of London at the modest age of 19, to become, according to Rupert Murdoch, "Probably Britain's greatest entrepreneur", and one of the richest men in the country. Alan Sugar's personal philosophy of "aggression,

energy, realism and instinct", combined with a flair for design, marketing and packaging have made him Britain's most innovative and pioneering businessman.

The key to his success was his ability to demystify computers and technology, and to market his products developing electronic goods that people wanted at affordable prices. In doing so he brought technology out of the lab and into the home and small business, and helped develop the first computer-literate generation in the UK.

The book is published by Century, Random Century House, 20 Vauxhall Bridge Road, London SW1V 2SA. Tel: 071-973 9670.

## 3-D TVS

A British company claim to have achieved a major breakthrough in 3-D tv and cinema viewing. Delta Systems Design Ltd has produced Deep Vision, an internationally patented 3-D system applicable to tv, cinema, video, live action, animation and computer graphics.

It is a unique 3D system and the viewer is not required to wear any form of spectacles. (Remember the red and green specs in the era of 3D cinema?) What is more, the system can convert *all* existing films into 3-D.

Deep Vision is a digital process which specially encodes the image. When the image is viewed through a tv, or in a cinema, equipped with a digital decoder the viewer experiences the impression of 3-D. Success has been achieved where other systems have failed, partly because Deep Vision does not attempt to mechanically create the 3-D image. Instead it activates the brain's powers of depth perception, allowing the viewer to perceive 3-D with natural perspectives and depth.

James Ashby is the inventor of the system. His Delta Group is currently negotiating the formation of a joint venture company with RCA-Columbia and Brent Walker for the global marketing of Deep Vision.

For further information contact Karin Cambrai, Delta Systems Design Ltd, 71 Endell Street, London WC2. Tel: 071 497 8004.

## CABLE FRANCHISES

The Cable Authority has announced the last three franchise awards to be made, bringing the total number to 135.

By the end of 1990, 40 to 50 of the broadband franchises should be operating. Around the middle of next year the vast majority of the other franchises should also have been switched on. It is expected that two-thirds of the homes in Britain will have access to cable tv facilities.

With the review of the BT/Mercury telecoms duopoly expected in

November, the Authority has reported that cable operators will be hoping for greater freedom to develop their own business with the right to interconnect with BT or Mercury.

Incidentally, the Authority has received a flood of complaints about programme substance following the banning of the German-language RTL Plus for breaching the Authority's codes and guidelines (reported in PE News May 90). However, that ban could be the last of its kind due to the effect of the Council of Europe Convention, and the European Community Directive on Broadcasting. These state that any service regarded as acceptable by the European country from which it originates must also be treated as acceptable in other European countries. Unless the government decides to take special action under those instruments, the banning of the RTL Plus channel here is only temporary.

## DIGITAL BT

Britain has become the first major country in the world with a long distance telecoms network which is entirely digital. British Telecom proudly announced this fact when they recently closed the last of the old style electro-mechanical exchanges, at Thurso in Scotland, transferring their customers' phone lines to the new digital system.

The network, part of a massive BT investment programme now running at £3 billion a year, gives customers in the most remote parts of the Highlands and Islands access to the same high quality connections as those in the City of London.

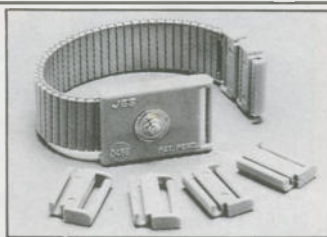

## ANTI-STATIC WRIST BAND

If you are a frequent user of static-prone devices, such as cmos chips, you could benefit from the convenient protection offered by OK's new wrist band. It is an adjustable watch strap type of anti-static wrist band named the Ergoband. Made from jewellery quality stainless steel, it features a patented linking system enabling the band to be adjusted to fit all sizes of wrist. Supplied as a basic single-size band, it comes with four expansion links, plus a cord set with a 1M resistor incorporated.

For further information contact OK Industries UK Ltd, Barton Farm Industrial Estate, Chickenhall Lane, Eastleigh, Hants, SO5 5RR. Tel: 0703 619841.

## CUSTOMISED LCDS

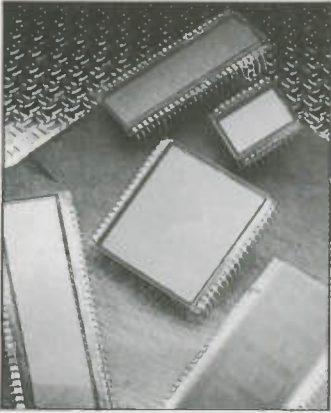

A new custom super-twist nematic (S-TN) lcd production service from Varitronix has been announced by Trident Microsystems. The service will help those who have the need for quantities of lcds produced to meet their own specifications.

Turn-around time for prototypes is around five to eight weeks, with production runs taking around nine to twelve weeks.

S-TN lcds are the ideal solution for displays requiring acceptable viewing angles when multiplexed more than eight ways.

For further information contact John Turney, Displays Division, Trident Microsystems Ltd, Trident House, 55 Ormside Wat, Redhill, Surrey, RH12 2LS. Tel: 0737 7659000.

## CHIP COUNT

### FASTEST 1 MBIT EEPROM

The world's fastest 1Mbit eeprom has been launched by Seeq Technology. The 28C010 has a maximum access time of 120ns, and has the lowest active and standby current requirements of any available 1Mbit eeprom, of 80mA and 350µA respectively.

Features on the chip include an extended chip-select facility which eliminates the x4 decoder required for multi-part system applications. A reverse bias generator provides improved latch-up protection as well as protection from voltage drops and surges. Software write protection, incorporating a disable option is also provided, together with false write and erase protection.

The biggest drawback of the 28C010 from a hobbyist point of view is the horrendous price, of around £380.

### 64 MBIT DRAMS

Siemens and IBM have signed an agreement to jointly develop 64Mbit memory chips. The goal of the project is to have a world-standard 64Mbit dram ready for commercial introduction in the mid 1990s. Work will concentrate primarily on the chip design and the process technology, using some of the most sophisticated tools and materials available.

### 16-BIT RISC CONTROLLER

Siemens's SAB 80C166 risc-type single chip 16-bit cmos microcontroller is up to 20 times more powerful than competitive 16-bit microcontrollers. It boasts a 100ns machine-cycle time with a 20MHz clock, with most instructions executed in one cycle. Furthermore, there's a large memory space ranging from 256Kbytes to 16Mbytes depending on the package size.

### COOLER POWER OPTOTRIAC

Siemens has introduced the world's first optocoupled triac capable of delivering two amps at 55°C without any requirement for additional cooling.

The IL428 contains a Gallium Arsenide infrared led optically coupled to a 2A phototriac, both chips being encapsulated within a 4-pin single-in-line package. The device is sensitive enough to directly interface loads to logic, a maximum input current of only 8mA being required to switch 2A efficiently.

Insulation is rated at 7.5kV and repetitive peak forward off-state voltage at 600V. The triac is thus ideal for use on 240Vac systems.

### 2K SERIAL EEPROM

The XL93C56 2K serial cmos eeprom has been introduced by Exel. The device holds 2048 bits of non-volatile memory in an 8-pin dil package and offers exceptionally low power consumption. It can continue functioning in read mode if the power supply weakens to a mere 2.0V, making the chip ideal for battery-powered applications. The memory is organised as 128 registers of 16 bits each. Six instructions provide control for read, write and enable functions. Data is transferred using in and out data pins and a serial clock to shift bits in and out.

The device offers a 10-year, 10,000 non-volatile write cycle guarantee. It operates on a single 5V supply and consumes 2mA in active mode and 4µA in standby mode.

### SOURCE DATA

Excel Microelectronics Inc. 2150 Commerce Drive. PO Box 49007. San Jose, CA95161-9007, USA.

Seeq International Ltd, Dammas House, Dammas Lane. Old Town, Swindon SN1 3EF. Tel: 0793 694999.

Siemens plc, Siemens House, Windmill Road, Sunbury on Thames, Middx TW16 7HS. Tel: 0982 785691.



## MICRO-PROCESSED FREQUENCIES

A new dual-channel microprocessor controlled frequency counter from Beckman has the exceptionally wide measurement range of 0.01Hz to 1.3GHz. The FC130A is intended for applications ranging from general audio to amateur and business radio cordless and cellular telephone repairs, and computer servicing. Monitoring of transmitter outputs can be made with

a simple chip antenna.

Periods from 8ns to 100 secs, and rate per minute (rpm) from 0.6 to 7200 million rpm can be measured with high accuracy and resolution on an 8-digit plus exponent led display.

For full details contact Beckman Industrial Ltd, Astec Building, High Street, Wollaston, Stourbridge, West Midlands, DY8 4PG. Tel: 0384 442394.

## USER-UNFRIENDLY

These days practically every manufacturer and distributor is falling over themselves to produce everything from computer programs to spray cans that are user-friendly, ozone-friendly or just friendly-friendly. Well, TK Electronics have spotted that not everything ought to be user-friendly. They've introduced a new digital electronic lock kit which is decidedly user-unfriendly. The only time it will behave benignly is if you enter the correct unlocking code. The first time you enter the wrong code, it will take note of your human fallibility but not

actually do anything. But, if you make any more mistakes it will show its displeasure by sounding a loud alarm. It will resolutely then deny any access to the door it controls, ignoring further keyboard entries for an unspecified snooze period. This should be a good deterrent to any malignant-minded burglar.

The price of only £19.95, including vat, should be a good friendly incentive to you to buy this unfriendly lock, from TK Electronics, 13 Boston Road, London W7 3SJ. Tel: 081-567 8910.

**U**S company Sage Alerting Systems wants to create a non-profit industry group in North America to try and make the European radio data systems, RDS, a new standard for broadcasting in the US and Canada.

The "RDS North America" group would work like the industry group which promoted the general concept of compact disc in the early 80s. But it may prove far harder to break the "no software - no hardware" vicious circle in North America than in Europe. Whereas most European countries rely on a national radio network (like the BBC in Britain), in North America the radio system is fragmented.

### SLOW ROARING

Those pushing RDS across the Atlantic like to paint the picture of RDS already being a roaring success in Europe. Although things are picking up, and the BBC has done sterling work in breaking that software/hardware vicious circle, RDS has been slow to get off the ground. Here's how and why.

In 1985, after nearly ten years research, the

## LEADING

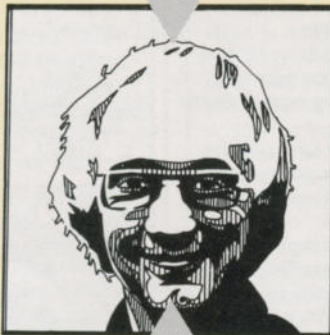

## EDGE

1989. EON code transmission has been phased in (starting from London) from July 1989. But manufacturing lag means that there are still no car radios with EON facilities.

There is also still no sign of the BBC's dream, a portable self-tuning radio. The BBC's long-term ambition is to use RDS as a way of making radio a real competitor to television - with push button tuning. The data signal does the tuning, once the user has selected a programme by name.

In April 1988 the BBC published a "Yellow Book" on "functional requirements for the BBC portable receiver". The BBC said it planned to sell a badged BBC RDS radio, just as it had previously sold the BBC Micro. The BBC would draw up the specification and an outside contractor would be licensed to make and sell it, with royalties paid to the BBC. Learning from some unhappy experiences with the BBC Micro, the BBC did not want to license just one company to make the badged radio. Instead the BBC planned to deal with a consortium of several design and manufacturing companies. The aim was to have sets on sale by 1989.

Although the document is brief, just eight

# RADIO DATA SYSTEMS

BBC promised a "radio of the future" and proposed RDS as a European standard. In March 1984 the European Broadcasting Union accepted and published the BBC's proposal (Technical Document Number 3244). Subsequently the CCIR gave RDS its blessing as an official standard (Recommendation 643).

An extra carrier conveys the codes needed to control the receiver. FM radio broadcasts already, of course, have an extra carrier at 38 kHz for stereo. In the US they already use a carrier at 57 kHz for background music, eg for supermarkets, but European broadcasters decided long ago to keep this frequency clear for information.

### EUROPEAN RDS

Radio stations in West Germany, Austria and Switzerland have for many years been broadcasting traffic information with a primitive channel-switching system called ARI (Autofahrer Rundfunk Information). ARI transmits analogue signals on a 57 kHz carrier wave. Sweden tried another system called Public Information, which broadcast digital codes on a 57 kHz carrier. Attempts at selling ARI into the US were not successful.

RDS builds on the Swedish PI system and uses a digital code on a 57 kHz carrier. The signal on the 57 kHz carrier is digital data running at 1187.5 bits/second - closely equivalent to 1200 baud electronic mail.

One carrier can take both ARI and RDS signals, making it possible for Continental countries to phase in RDS and later phase out ARI.

In March 1986 the BBC promised to spend £0.4 million, 1% of the annual engineering investment in radio, on converting transmitters to RDS. By January 1988, all the BBC's

BY BARRY FOX  
Winner of the UK  
Technology Press Award

## There's dithering and dicking over the introduction of RDS. Will eons pass before EON solves some of the problems?

Network and Local Radio vhf-fm transmitters were converted. The IBA has now converted half its network of local commercial radio stations.

### BBC LAUNCH

The official launch of RDS was set for the BBC's Radio Show at Olympia on 30 September 1988. But there were few receivers, and only for cars. A Volvo radio, made by Mitsubishi and costing around £500, was the only system available promised off-the-shelf.

There was then post-launch confusion over the RDS standard. It was found that the Other Network (ON) code, which lets a car radio switch from a national network station to local radio when there is a traffic flash, needed modification to ensure error-free reception. The BBC developed an enhanced and more robust ON code format and the European Broadcasting Union accepted the proposal for Enhanced Other Network (EON) in March

pages, it is tied to eleven EBU, IEC, CCIR and BSI standards. Whereas the RDS requirements were relatively straightforward - circuitry capable of decoding the RDS signal, twelve pre-set buttons for stored stations and a display to read out the frequency and service name, indicate whether the service is mono or stereo and tell the quality of reception - the Yellow Book tied the RDS licence to general performance of the receiver. Tests conducted by the BBC, suggest that very few portable radios on sale today would meet the Yellow Book standard. So the BBC radio would by definition be a high quality radio, as well as an RDS receiver.

### JOINT VENTURES

The BBC could not find any solo manufacturer willing and/or able to meet the spec and pay a royalty to sell under licence at an attractive price. The next idea was a joint venture between pairs of manufacturers, with the BBC helping to fund production of RDS radios to be sold under the BBC name. So far there has been no joy there either.

Most car radio makers now offer at least one RDS receiver in their range, but this has until recently been more a show of capability than genuine commercial interest. Things now seem to be changing, with a groundswell of interest building up and prices falling from around £500 to below £200.

As EON codes are already being transmitted it can only be a question of time before we get receivers with the EON facility to switch automatically from national to local station for news flashes. Is it any wonder that those in the know are waiting for a receiver with EON before buying?

PE



**R**ecently, the stability of my philosophical outlook suffered a severe shaking. One of the foundations upon which my life is built is the solid belief that I am totally free from being influenced by salesmen. Normally, the ritual chant dogmatically intoned to any uninvited doorstep rep can be summed up in the four-word verse: "Thanks, but no thanks!". I'm neither rude nor brusque, just polite and adamant. But that short incantation is the outward expression of the unspoken chorus: "Up till now I've done without it, I'll continue doing without it, until I'm ready to want it. Don't call me, I'll call you".

Now of course being "ready to want it" is in itself a condition which is heavily influenced by sales talk, whether across the doorstep, or by adverts on tv and bill-boards. I guess that when I fell for the satellite tv pitch on the doorstep my 'wanting' had been thoroughly ripened subconsciously by expert advertisers. A sense of euphoria the night of the sales call probably also helped the ripening and my fall from self-grace. I had just finished another design and was feeling on top of the world. What was more natural, then, than to show extra goodwill to the smart young clip-board carrying satellite tv rep out working late on a balmy mid-summer's evening?

He was invited in and, to my later amazement, I found myself signing on the dotted line. So much for dogmatic amateur philosophy!

And yet, when next day I reconsid-

## PRACTICAL ELECTRONICS



### VIEWING PHILOSOPHY

ered yester-evening's signing ceremony, it became apparent that although I could probably live with the cultural shock of more tv channels, the technology was still not ready for me. It's still necessary to have separate aerial dishes and associated set-top black boxes for each of the two main contenders of Sky/Astra and BSB. Nor am I aware of the imminence of tv sets which incorporate satellite reception and decoding circuits within their cabinets.

Then I received the Cable Authority's report on their National Survey. It reminded me that both Sky and BSB channels are carried on cable. Moreover, it showed that it's significantly cheaper to view by cable than to dou-

ble-rent satellite equipment. From the figures quoted, if both Sky and BSB facilities are directly rented from their respective companies, complete with the movie channels, it would cost around £42 per month. Yet if Sky and BSB are brought in cable, the channels can be viewed for around £24 per month.

It appears from the Authority's report that nearly two out of three people in Britain are as yet unaware that Sky and BSB are carried by cable. The report goes on to state that over eight million households say they would subscribe to cable when it passes their homes. Other findings reveal that 60 per cent of the public have heard of cable tv, but over 90 per cent are aware of dish reception (so who's got the better sale's pitch, then?). Over a third of dish owners say they would prefer cable if it was available. Greater choice and a dislike of dishes were given as the main reasons for opting for cable.

As you have read from periodic reports in PE, cable facilities are in the process of becoming widely available across Britain. Although the Authority's franchisees have not yet dug up my road, I'm sure they will soon. And when they do they probably won't need to try coaxing me into having their co-ax linked to my teaset. To me it's a better access route to the new channels than via dishes. I regret I've cancelled my direct satellite trial option.

Philosophy needs tempering by experience.

THE EDITOR

Editor:

**John Becker**

Sub-Editor:

**Helen Armstrong**

Technical Illustrator:

**Derek Gooding**

Group Advertisement Manager:

**Jacqueline Barlow**

Advertisement Executive:

**David Bonner**

Production Editor:

**Richard Milner**

Office Manager:

**Wendy Cooper**

Office Secretary:

**Wendy Rhodes**

Publisher:

**Angelo Zgorelec**

Practical Electronics,  
Intra House, 193 Uxbridge Road,  
London W12 9RA  
Tel: 081-743 8888  
Telecom Gold: 87: SQQ567  
Fax: 081-743 3062

#### Readers' Enquiries

All editorial correspondence should be addressed to the editor and any letters requiring a reply should be accompanied by a stamped addressed envelope, or equivalent payment.

We regret that lengthy technical enquiries cannot be answered over the phone.

#### Advertisements

The Publishers of PE take reasonable precautions to ensure that advertisements published in the magazine are genuine, but we cannot take any responsibility in respect of statements or claims made by advertisers. The Publishers also cannot accept any liability in respect of goods not being delivered or not working properly.

© Intra Press 1990. Copyright in all drawings, photographs and articles published in PRACTICAL ELECTRONICS is fully protected, and reproduction or imitations in whole or in part are expressly forbidden. All reasonable precautions are taken by PRACTICAL ELECTRONICS to ensure that the advice and data given to readers is reliable. We cannot, however, guarantee it, and we cannot accept legal responsibility for it. Prices quoted are those current as we go to press. All material is accepted for publication on the express understanding that the contributor has the authority to permit us to do so. ISSN 0032-6372

#### PE Services

**SUBSCRIPTIONS** - Annual subscription rates are £18.00 for the U.K. or £21.00 overseas (Air mail overseas is £39.00). Please send your cheques (payable to Intra Press), payment by Visa or Access also accepted, to: Practical Electronics, Subscription Dept., P.O. Box 500, Leicester LE99 0AA. Telephone: 0858 410510 (ask for Practical Electronics Subscriptions).

**BACK ISSUES** - We still have a limited number of the back issues from the last three years available (Certain issues from earlier years are also available, but check before ordering). Price £1.75 - overseas £2.25 (inclusive of postage). Orders should be sent to our editorial address.

**BINDERS** - to hold 12 issues of PE are also available from our editorial address. Price £5.95 (overseas £6.95 - surface mail). Post included.

**BOOK SERVICE** - see the Book Service advertisement in the magazine.

**PCB SERVICE** - details inside.

Cover Photo:  
Ed Davis

# SPECIAL SUBS OFFER!

## SUBSCRIBE AND BE GIFTED!

TAKE OUT 12 MONTHS' SUBSCRIPTION TO PE AND CHOOSE A GIFT:

★ A FREE BINDER TO HOLD 12 COPIES OF PE WORTH £5.95

OR

★ A FREE 300 PAGE BOOK "INTERNATIONAL TRANSISTOR EQUIVALENTS GUIDE" WORTH £3.95

EXTRA SPECIAL OFFER TO STUDENTS, TEACHERS AND BAEC\* MEMBERS SAVE 10% AND RECEIVE THE GIFT OF YOUR CHOICE!

(\*British Amateur Electronics Club)



If you already subscribe to PE you can take advantage of this special offer by extending your existing subscription - please advise your current subscription number or say from which month you want your subs to run.

Yes please PE, put me on course to a hi-tech future: Enrol me on your priority subscription list and send me 12 issues and my free gift for the following special price:

### UK readers

£18 .....

£16.20 (student/teacher/BAEC) .....

### Overseas Readers

£22 .....

£19.80 (student/teacher/BAEC) .....

Proof of my student/teacher/BAEC status is attached (e.g. headed notepaper etc.). .....

I wish my subs to start from the earliest possible issue .....

I wish to extend my existing subscription for a further 12 months commencing with the issue dated .....

As my free gift I would like to receive:

The Binder .....

The Transistor Equivalents Guide .....

Please send my monthly copy of PE to:

Name and address .....

.....

.....

Post Code .....

I enclose a cheque / postal order .....

Please charge to my Access / Visa card number

Send this form (or a photocopy of it) to:  
Practical Electronics Subscriptions, 193  
Uxbridge Road, London W12 9RA

## COMPUTER ICs

80C31 MICRO	£2
P8749H MICRO	£5
BBC MICRO PARTS	
SN76489AN	£3
VIDEO ULA 201647	£10 ea 10+ £8
6845 CRT	£5
6522 PIA	£3
DM88LS120	£4.50
AY3-1015D UART	£2.50
8086 processor ex equipment	£2
USED 41256-15	£1.50
USED 4164-15 ex-equipment	£1
9 x 41256-15 SIMM MODULE NEW	£10
8 x 4164 SIP MODULE NEW	£8
HD 146818 CLOCK IC	£2
2864 EEPROM	£3
27128A 250nS EPROM USED	£2 NEW £2.30
FLOPPY DISC CONTROLLER CHIPS 1772	£16 ea
68000 8 PROCESSOR NEW	£5
HD63484-8	£5
ALL USED EPROMS ERASED AND BLANK CHECKED CAN BE PROGRAMMED IF DESIRED.	
2716-45 USED	£2 100/£1
2732-45 USED	£2 100/£1
2764-30 USED	£2 100/£1.60
27C256-30 USED	£2
27C512 USED (ALSO 27512)	£3.00
1702 EPROM EX EOPT	£5
2114 EX EOPT 60p 4116 EX EOPT	70p
6264-128k static ram	£3.00
62256-12 32K static Ram	£7.00
2532 EPROM USED	£2
4416 RAM	£3.00
USED 4416-15 RAM	£2
USED 41464-15	£5

## REGULATORS

LM317T PLASTIC TO220 variable	£1
LM317 METAL	£2.20
7812 METAL 12V 1A	£1
7805/12/15/24V plastic	35p 100+20p 1000+ 18p
7905/12/15/24V plastic	35p 100+20p 1000+ 18p
CA3085 7099 variable reg	2/£1
LM338 5A VARIABLE	£8

## CRYSTAL OSCILLATOR

1.8342 £1 each 1M, 1.8432M, 4M, 16M	£1.50 each
-------------------------------------	------------

## CRYSTALS

2.77 MHz 200 MHz 24.9152MHz 20MHz 49.504MHz, 8M, 16.588M	£1 each
--	---------

## TRANSISTORS

BC107, BCY70 PREFORMED LEADS	
full spec	£1 £4/100 £30/1000
BC557, BC548B, BC238C, BC308B	30/£1 £3.50/100

## POWER TRANSISTORS

N POWER FET IRF531	3/£1
P POWER FET IRF531	2/£1
2SC1520 sim 8F259	3/£1 100/£22
TIP141/2 £1 ea TIP112/125/42B	2/£1
TIP35B TIP35C	£1.50
SE9301 100V 10A DARL SIM TIP121	2/£1
2N3055 EX EOPT TESTED	4/£1
PLASTIC 3055 OR 2955 equiv 50p	100/£35
2N3773 NPN 25A 160V £1.80	10/£16

## QUARTZ HALOGEN LAMPS

A1/216 24V 150 WATTS	£2.25
H1 12V 50W (CAR SPOT)	£1.50
14 WAY ZIF 9KT	£1
TEXTTOOL single in line 32 way. Can be ganged (coupling supplied) for use with any dual in line devices.	2/£2
28 WAY TEXTTOOL ZIF SOCKET EX NEW EQUIPMENT	£2.50

## CAPACITORS COMPUTER GRADE

3300uF 350V SIC SAFCO FELSIC 037	£6(£1.50)
2200uF 160V SIC SAFCO FELSIC CO38	£4(£1.20)
24,000uF 50V	£3 (1.30)

## TURNS COUNTING DIALS

10 turn dial 21 mm dia. fits 3mm spindle	£2
10 turn digital dial (3 digits) for 3mm or 6mm shaft	£3.50
10 turn clock face dial for 6mm spindle	£4

## MISCELLANEOUS

MAINS ADAPTOR 9V DC 200mA	£1.25
SLOPING FRONT PLASTIC CASE 225 x 215 x 76mm	£3.30
76mm WITH ALI FRONT PANEL 200 x 130mm	£3.30
HUMIDITY SWITCH ADJUSTABLE	£2
WIRE ENDED FUSES 0.25A	30/£1
NEW ULTRASONIC TRANSDUCERS 40kHz	£2/pair
12 CORE CABLE 7.02mm OVERALL SCREEN	70p/METRE
OP AMP LM10CLN	£2.90
BNC 50 OHM SCREENED CHASSIS SOCKET	3/£1
BNC TO CROC CLIPS LEAD 1 metre	£1
LEMAG EARTH LEAKAGE TRIP 35A 30mA trip	£9.00
AMERICAN CHASSIS 2/3 pin SOCKET	2/£1
USED 3 1/2" FLOPPY DISCS D/S 720K	50p/10/£4
TO-220 HEAT SINK sim RS 403-162	10/£2.50
SMALL MICROWAVE DIODES AEI DC1028A	2/£1

## D.I.L. SWITCHES 10 WAY £1 8 WAY 80p 4/5/6 WAY 50p

180 volt 1 watt ZENERS also 12v & 75v	20/£1
VN10LM 60v 1/2A Sohm TO-92 mostlet	4/£1 100/£20
MIN GLASS NEONS	10/£1
MINIATURE CO-AX FREE PLUG RS 456-071	2/£1
MINIATURE CO-AX FREE SKT RS 456-273	2/£1.50
DIL REED RELAY 2 POLE n/o CONTACTS	£1
PCB WITH 2N2646 UNIJUNCTION with 12v 4 POLE RELAY	£1
400m 0.5w thick film resistors (yes four hundred megohms)	4/£1
STRAIN GAUGES 40 uhm foil type polyester backed balco grid alloy	£1.50 ea 10+ £1
ELECTRET MICROPHONE INSERT	£0.90
Linear Hall effect IC Micro Switch no 613 SS4 sim RS 304-267	£2.50 100+ £1.50
HALL EFFECT IC UGS3040 + MAGNET	£1
OSCILLOSCOPE PROBE SWITCHED X1 X10	£10
CHEAP PHONO PLUGS	100/£2 1000/£18
1 pole 12 way rotary switch	4/£1
AUDIO ICS LM380 LM386	£1 ea LM324 4/£1
555 TIMER 5/£1 741 OP AMP	5/£1
ZN414 AM RADIO CHIP	80p
COAX PLUGS nice ones	4/£1
COAX BACK TO BACK JOINERS	3/£1
4 x 4 MEMBRANE KEYBOARD	£1.50
15 000uF 40V	£2.50 (£1.25)
INDUCTOR 20uH 1.5A	5/£1
1.25" PANEL FUSEHOLDERS	3/£1
CHROMED STEEL HINGES 14.5 x 1" OPEN	£1 each
12v 1.2w small wire ended lamps fit AUDI VW TR7 SAAB VOLVO	10/£1
12V MES LAMPS	10/£1
STEREO CASSETTE HEAD	10/£1
MONO CASS HEAD £1 ERASE HEAD	50p
THERMAL CUT OUTS 50 77 85 120°C	£1 ea
THERMAL FUSE 121°C 240V 15A 220°C	5/£1
TRANSISTOR MOUNTING PADS TO-5/TO-18	£3/1000
TO-3 TRANSISTOR COVERS	10/£1
STICK ON CABINET FEET	30/£1
PCB PINS FIT 0.1" VERO	200/£1
TO-220 mcas + bushes	10/50p 100/£2
TO-3 mcas + bushes	15/£1
PTFE min screened cable	10m/£1
Large heat shrink sleeving pack	£2
CERAMIC FILTERS 6M/9M/10.7M	50p 100/£20
1/2C chassis plug ri filter 10A	£3
Potentiometers short spindles values 2k5 10k 25k 1m	
2M5 lin	5/£1
500k lin 500k log	4/£1
40kHz ULTRASONIC TRANSDUCERS EX-EOPT NO DATA	
ONRON 12V GZV DIL RELAY 2 POLE CHANGEOVER	2/£1
SCART CONNECTOR	£1
BZV48C12 WIRE ENDED 12V 7WATT ZENER 17K STOCK	5/£1
3M/SCOTCHFLEX 50 WAY ROUND JACKETED FLAT CABLE 3659/50	
(50 WAY IDC RIBBON WITH FOIL AND BRAID SCREENS, ROUND SECTION WITH BLACK PVC OUTER) £1. METRE, 100' REEL	£65
FANS 240V 120mm	£6 (1.50)
(OTHER VOLTAGES/SIZES USUALLY AVAILABLE)	
MOULDED INDUCTOR 470UH SIZE OF 1W RES	8/£1

## DIODES AND RECTIFIERS

1N4148	100/£1.50
1N4004/SD4 1A 300V	100/£3
1N5401 3A 100V	100/£3
BA158 1A 400V fast recovery	100/£3
BA159 1A 1000V fast recovery	100/£4
120V 35A STUD	85p
BY127 1200V 1.2A	10/£1
BY254 800V 3A	8/£1
BY255 1300V 3A	6/£1
6A 100V SIMILAR MR751	4/£1
1A 800V BRIDGE RECTIFIER	4/£1
4A 100V BRIDGE	3/£1
6A 100V BRIDGE	2/£1
8A 200V BRIDGE	2/£1.35
10A 200V BRIDGE	£1.50
25A 200V BRIDGE £2	10/£10
25A 400V BRIDGE £2.50	10/£22

## SCRs

PULSE TRANSFORMERS 1 1+1	£1.25
2P4M EQUIV C106D	3/£1
MCR72-6 10A 600V SCR	£1
35A 600V STUD SCR	£2
TICV106D 800mA 400V SCR	3/£1 100/£15
MEU21 PROG. UNIJUNCTION	£1.50

## TRIACS

BT 137-600 8A TO-220	2/£1
BT138-600 12A TO-220	70p
MEU21 PROG. UNIJUNCTION	3/£1
NEC TRIAC AC08F 8A 600V TO220	5/£2 100/£30
TXAL225 8A 400V 5mA GATE 2/	£1 100/£35
3TA08-400 8A 400V 5mA GATE ISOL TAB	£1
CA3059 0 VOLTAGE SWITCH	£1 each

## DIACS 4/£1

## CONNECTORS

D25 IDC SOCKET FUJITSU	£2
34 way card edge IDC CONNECTOR (disk drive type)	£1.25
CENTRONICS 36 WAY IDC PLUG	£2.50
CENTRONICS 36 WAY IDC SKT	£4.00
BBC TO CENTRONICS PRINTER LEAD 1.5M	£3.00
CENTRONICS 36 WAY PLUG SOLDER TYPE	£4
USED CENTRONICS 36W PLUG+SKT	£3

## USED D CONNECTORS price per pair

D9 60p, D15 £1.50, D25 £2, D37 £2, D50 £3.50 covers 80p ea.	
---	--

## WIRE WOUND RESISTORS

W21 or sim 2.5W 10 of one value	£1
R10 OR15 OR22 2R0 4R7 5R0 5R6 8R2 10R 12R 15R 18R 20R	
22R 27R 33R 47R 56R 62R 91R 120R 180R 390R 430R 470R	
680R 820R 910R 1K15 1K2 1K5 1K8 2K4 2K7 3K3 3K0 5K0	
4 FOR £1	
W22 or sim 6W 7 OF ONE VALUE	£1
R47 R62 1R0 1R5 1R8 3R3 6R8 9R1 12R 20R 24R 27R 33R 51R	
56R 62R 68R 100R 120R 180R 220R 390R 560R 620R 910R 1K0	
1K2 1K5 1K8 2K2 2K7 3K3 3K9 4K7 8K2 10k 15K 16K 20K	
W23 or sim 9W 6 of one value	£1
R22 R47 1R0 1R1 56R 62R 100R 120R 180R 220R 300R 390R	
680R 1K0 1K5 5K1 10K	
W24 or sim 12W 4 OF ONE VALUE	£1
R50 2R0 9R1 18R 22R 27R 56R 68R 75R 82R 100R 150R 180R	
200R 220R 270R 400R 620R 1K0 6K8 8K2 10K 15K	

## PHOTO DEVICES

SLOTTED OPTO-SWITCH OPCOA OPB815	£1.30
2N5777	50p
TIL81 PHOTO TRANSISTOR	£1
TIL38 INFRA RED LED	5/£1
4N25 OP12252 OPTO ISOLATOR	50p
PHOTO DIODE 50P	6/£2
MEL12 (PHOTO DARLINGTON BASE n/c)	50p
4 DIGIT LED 7 SEG. DL4770	£1
LEDs RED 3 or 5mm 12/£1	100/£8
LEDs GREEN OR YELLOW 10/£1	100/£6.50
LEDs ASSORTED RED/GN/YW + INFRA/RED	200/£5
FLASHING RED OR GREEN LED 5mm 50p	100/£40
HI BRIGHTNESS LEDS COX24 RED	5/£1

## STC NTC BEAD THERMISTORS

G22 220R, G13 1K, G23 2K, G24 20K, G54 50K, G25 200K, RES	
@ 20°C DIRECTLY HEATED TYPE	£1 ea
FS22BW NTC BEAD INSIDE END OF 1" GLASS PROBE	
@ 20°C 200R	£1 ea
A13 DIRECTLY HEATED BEAD THERMISTOR 1k res. Ideal for audio Wien Bridge Oscillator	£2 ea

## CERMET MULTI TURN PRESETS 3/4"

10R 20R 100R 200R 250R 500R 2K 2K2 2K5 5K 10K 47K	
50K 100K 200K 500K 2M2	50p each

## IC SOCKETS

6 pin 15/£1 8 pin 12/£1 14/16 pin 10/£1 18/20 pin 7/£1, 22/24/28 pin 4/£1 40 pin 30p	
--	--

## SOLID STATE RELAYS

40A 250V AC SOLID STATE RELAYS	£16
--------------------------------	-----

## POLYESTER/POLYCARB CAPS

100n, 220n, 63v 5mm	20/£1 100/£3
1n/3n/5n/6n/8n/2/10n 1% 63v 10mm	100/£6
10n/15n/22n/33n/47n/68n 10mm rad	100/£3.50
100n 250v radial 10mm	100/£3
100n 600v sprague axial 10/£1	100/£6 (£11)
2u2 160v RAD 22mm, 2u2 100v RAD 15mm	100/£10
10n/33n/47n 250v ac x rated 15mm	10/£1
470n 250v ac x rated rad	4/£1
1U 600V MIXED DIELECTRIC	50p ea.
1u0 100v RAD 15mm, 1u0 22mm RAD	£8/100
2U2 250V PMT CAPS. STOCK 6K	£20/100

## RF BITS

MINIATURE CO-AX 50Q URM95	100m/£12
TRIMMER CAPS ALL	4/50p
SMALL 5p 2 pin mounting 5mm centres	
SMALL MULLARD 2 to 22pF	4/50p
SMALL MULLARD 5 to 50pF	4/50p
larger type grey 2 to 25pF black 15 to 90pF	
TRANSISTORS 2N4427	60p
FEED THRU CERAMIC CAPS 1000pF	10/£1
MICROWAVE X BAND GUNN OSCILLATOR 9 TO 11GHz EX-EQUIPMENT (DOPPLER SHIFT MICROWAVE MODULE)	£9.50

## MINIATURE RELAYS Suitable for RF

5 volt coil 1 pole changeover	£1
5 volt coil 2 pole changeover	3/£1
12 volt coil 1 pole changeover	£1

## MONOLITHIC CERAMIC CAPACITORS

10n 50v 2.5mm	100/£4.50
100n 50v 2.5mm or 5mm	100/£6
100n ax short leads	100/£3
100n ax long leads	100/£8
100n 50v oil package 0.3" rad	£10/100

## STEPPER MOTORS

7.5 DEGREES PER STEP 2 12 volt windings	£4
---	----

# KEYTRONICS

TEL. 0279-505543

FAX. 0279-757656

P O BOX 634

BISHOPS STORTFORD

HERTFORDSHIRE CM23 2RX

## MAIL ORDER ONLY

MIN CASH ORDER £3.00 OFFICIAL ORDERS WELCOME  
UNIVERSITIES COLLEGES SCHOOLS GOVT. DEPARTMENTS

MIN. ACCOUNT ORDER £10.00  
P&P AS SHOWN IN BRACKETS (HEAVY) ITEMS  
65p OTHERWISE (LIGHT) ITEMS

ADD 15% VAT TO TOTAL  
ELECTRONIC COMPONENTS  
BOUGHT FOR CASH



Is there a dud ic in that set of parts you are collecting together for your latest project? There are many occasions when this question arises: when parts are being re-used, when they were bought as a 'job lot', in colleges and schools after a project or experiment is finished, or simply to eliminate a suspect component in a non-working project at home or at work.

## OBJECTIVES

Chiptester was designed to functionally test digital ics quickly and easily. It had to be low cost to make, and be flexible so that new chip data could be incorporated at will. It had to test a wide range of chip sizes and be able to determine the function of an unmarked chip. A design based upon the use of a home computer was indicated and, after some experimentation, the prototype was made and the software written. A number of Chiptesters have now been made to the same design and are in good service.

Using a home computer to form part of the

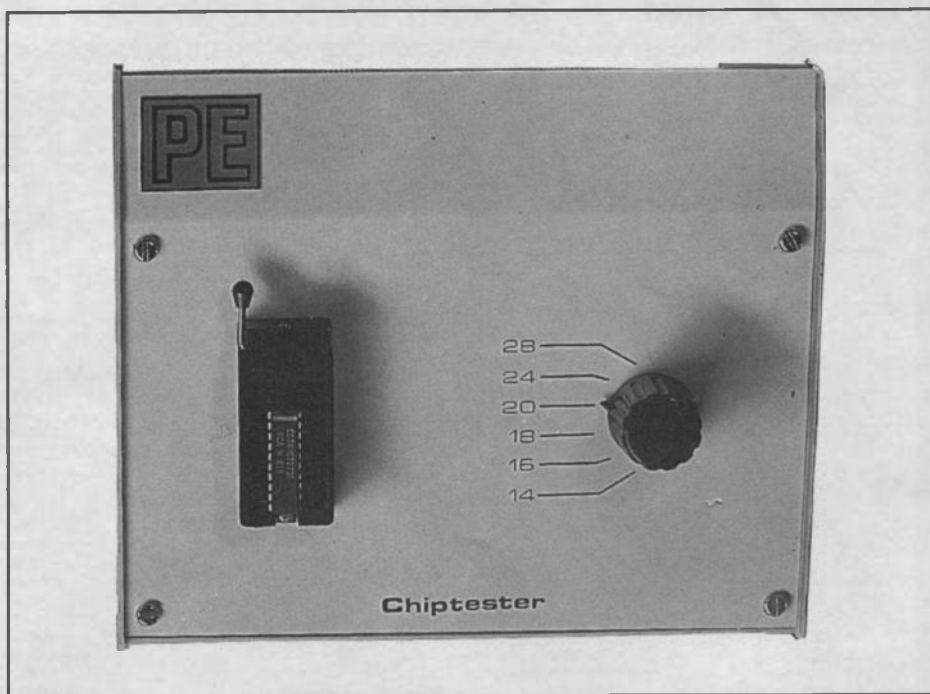

# PE CHIPTESTER

tester allows display of the device waveforms for fault analysis or device demonstration in colleges or schools and provides a great simplification of the circuit design and construction. The tests carried out may be more extensive, and the device files may be stored on disc file for easy use, and in search mode to discover the type number of unmarked devices. If one has a printer then the displayed waveforms may be printed out for reference.

Chiptester will functionally test a wide range of 5V logic chips including popular ttl, cmos, hct and similar families. It was designed to work with any disc based BBC microcomputer including the Master, and most variants have been tested, all successfully. It requires the 1MHz BUS and USER port connections and is powered from the computer. An interesting feature of the chiptester is the novel zero insertion force connector which will allow all chip sizes up to 28 pin with 0.3, 0.4 or 0.5 inch centres to be inserted in the one type of socket. An on-screen display shows the correct position for inserting the ic, which is normally the bottom position, but for devices with non-standard supply pins an offset may be introduced.

## OPERATION

In its most often used and simplest mode, the test specifications of the ic to be tested are first called up from disc file. This is simply a matter of entering the device part number. The next stage is the testing of the device itself. A display is given showing the chip position in the socket and advising where to set the switch for the power supply pins. The device is then tested and a pass or fail indication is given.

## Dave Rayner presents you with a versatile and inexpensive digital integrated circuit tester for use with BBC microcomputers

Many variations on this simple procedure are made possible by the software. During the test phase for example, the display may be made to show the waveform on any desired chip pins as the test progresses.

The display is colour coded to show the difference between input and output pins and is highlighted where any faulty output occurs. Another useful pair of commands are the loop-until-pass and loop-until-fail tests. With these, one can trace intermittent failures or temperature-related failure modes. There is also a search mode where all the device files on disc are searched for a match against the device under test. If desired, new test files may be created easily by the user and saved to disc, thus Chiptester can also be used for testing PAL's and other user programmed devices.

The software is very comprehensive, being in total about 30K of overlaid basic files, some machine code and about 37K of ic data files. Because of the size the listings are not

reprinted in these pages and the software is available on disc from the author directly, (see later).

## CIRCUIT DESCRIPTION

The circuit diagram for Chiptester appears in Fig.1. The heart of the circuit is a versatile interface adaptor (VIA) chip type 6522 connected to the 1MHz bus of the Beeb via connector J7. This is not the place for full technical details of how the 1MHz bus works but basically it is a buffered, high speed interface into the Beeb's internal data and address buses. IC2a,b and c are used to clean up the page select line FRED which suffers from glitches produced by the Beeb's internal circuitry. Most of the address decoding is done by the Beeb while producing FRED but IC2d provides a little bit of additional address decoding.

The VIA is a large scale integration (lsi) interface chip. It contains latches, buffers and other logic circuits needed for handshaking and simple interfacing techniques. The internal logic connections are alterable by the software and for our purposes the attractive feature is that by appropriate software commands, it allows many of its pins to be configured as either output or input pins individually. This is just what we want since we don't know in advance which pins of our socket will need to be inputs or outputs.

There is another VIA inside the Beeb which gives us a few more input/output lines available at the USER port, J6. The 5V supply is also taken from the user port and since we don't need much power to test one chip this is well within the capabilities of the Beeb's supplies. A 500mA fuse, F1, is fitted just in

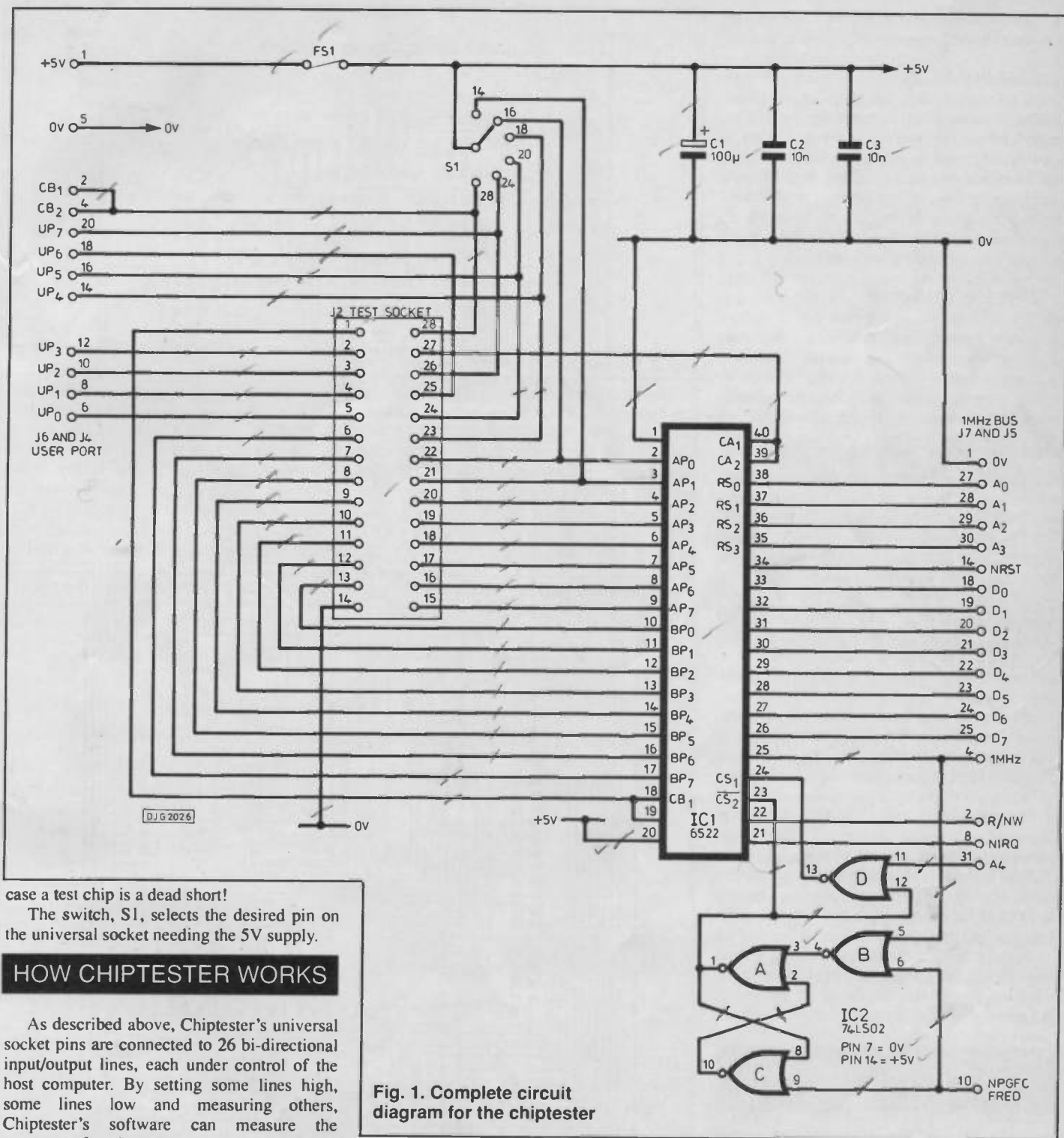

Fig. 1. Complete circuit diagram for the chiptester

case a test chip is a dead short!  
 The switch, S1, selects the desired pin on the universal socket needing the 5V supply.

**HOW CHIPTESTER WORKS**

As described above, Chiptester's universal socket pins are connected to 26 bi-directional input/output lines, each under control of the host computer. By setting some lines high, some lines low and measuring others, Chiptester's software can measure the response of an ic and compare this against a file describing the correct response for the ic under test. A sequence of such tests confirms whether the device is working or not. In addition, pins may be defined as clock pins and after specified cycles of the clock, the output pins are measured and confirmed against the file as above.

Each stage of the test is initiated by setting input pin conditions and/or clock pin(s) count values. The outputs are then verified for that stage. Most devices can be fully functionally tested within ten or fifteen such stages, although a few may be only spot tested, such as memories and processors. Chiptester files allow twenty-eight measurement stages with

up to twelve clock count stages each with up to 1024 cycles.

Certain definitions are required to be understood if you are going to make the best use of Chiptester or if you are going to create your own test files. These are described next.

**Output Pins**

Outpins Pins are defined as those pins of the device under test that can always be relied upon to exhibit particular voltage levels at any stage in a series of input pin stimuli. Chiptester measures only those pins that are defined as output pins. There is no "don't care" possibility for output pins.

**Input Pins**

These are defined as all those pins that are not output pins. These include supply pins, NC pins, etc. Chiptester sets voltage levels at all input pins even if pins are known to be in a "don't care" state.

**Supply Pins**

These are a special form of input pin which allow many cycles of signal changes to be applied to the ic under test within one test measurement period. Up to five pins may be defined as clock pins. Pins defined as clock



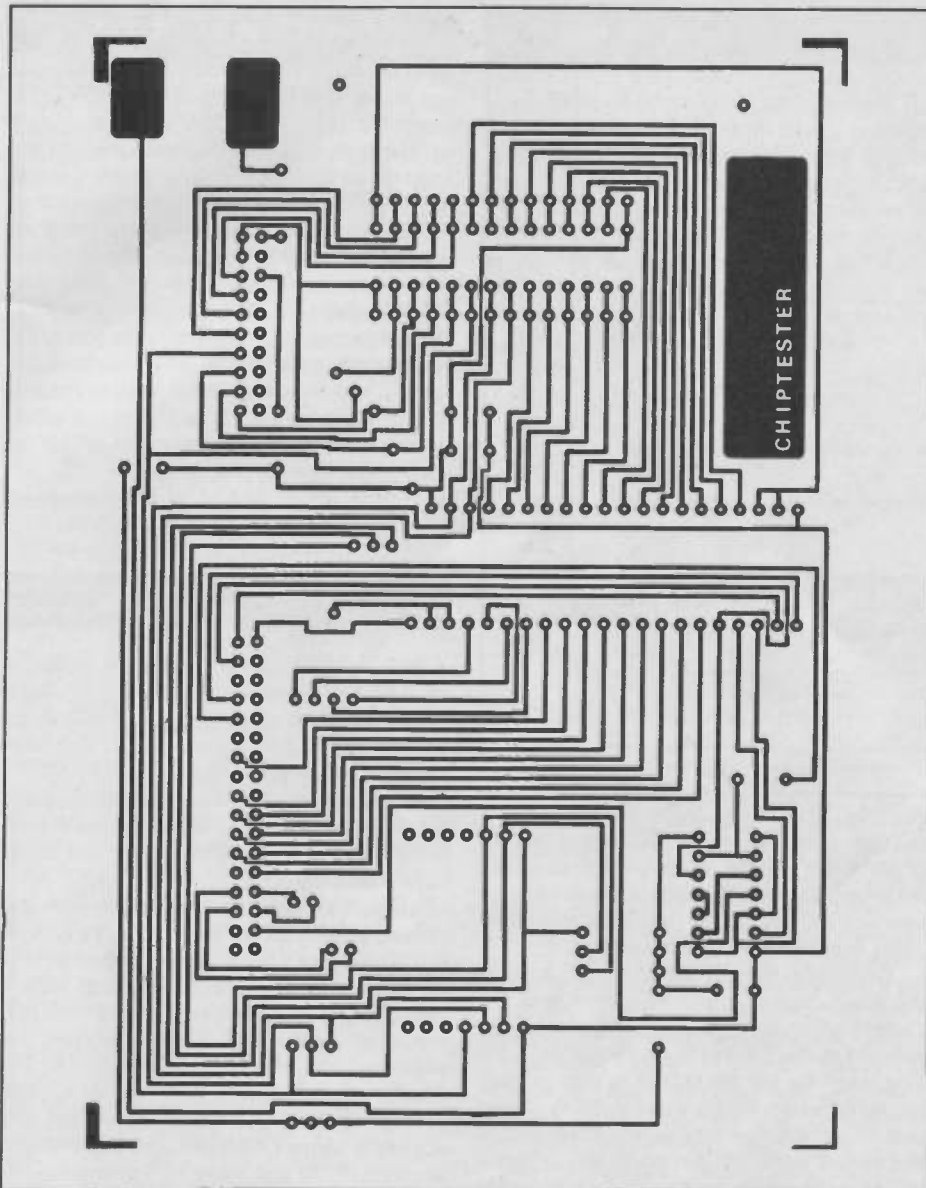

Fig. 4. PCB Track layout.

since, although it has input protection circuitry on its pins, in common with all lsi devices, it can be damaged by high static voltages. Only insert it after all other wiring is completed. Note that there are six resistor positions on the pcb and that nothing should be fitted in these spaces. Originally, I intended to write a software routine to monitor the position of the front panel switch but in the event, the pull-down resistors required for this conflicted with the ic testing requirements and so the routine and the resistors were abandoned. Such was the over-confidence in my design that I had already committed the pcb artwork before I found out my error!

On the reverse side of the pcb are the fuse clips and 500mA fuse. Mounting holes are not drilled for the fuse clips and they are fitted by bending the solder tags outwards by 90 degrees and flat soldering them to the pcb directly on to the track pad area. Fit a fuse to the clips before soldering them up and this will ensure that they are positioned the correct distance apart. The reason for designing the fuse on the reverse side of the pcb is so that it can be easily changed should it ever blow.

## VICE SQUAD

Many constructors will not have the special tools required to assemble the Insulation Displacement Connectors (IDCs) but do not despair! a small workshop vice will come to the aid, and the procedure is quite simple provided a little care is taken. First trim the cable off square at both ends with a very sharp heavy duty trimming knife. Check that no strands of wire are left protruding as these could short out later. About 1 metre is enough for each cable and although the parts list calls for both 20-way and 34-way cable, in fact the 20-way may be stripped down from a length of 34-way. The next step is to familiarise oneself with the correct orientation of the connectors at each end of one cable. Note that there is no strain relief at the transition connector end (pcb end) so that the cable exits from the side of the connector facing out from the edge of the pcb. However, at the cable socket end there should be a strain relief clip fitted which reverses the direction of the cable after the assembly is squeezed together (this can be confusing if not

appreciated). Fig. 5 shows the correct orientation for the computer end of the cable.

In assembly, the red strand of wire is mated with pin one of both connectors (usually marked with a little indented triangle), and the end of the cable lined up square with the surface of the connector. If the pins of the transition connector are temporarily mated into the sockets of the cable socket connector, then the whole cable assembly can be squeezed up in the vice in one action and the pins of the transition connector are protected at the same time. While you are squeezing the parts together keep a close eye on how the compression is going and if you see that one part is fully assembled while another is not then move the whole stack of parts in the vice to compensate. Do not overtighten the vice, it is sufficient for the ends of the two halves of each connector to be just touching. Ideally, by this time the total width of the cable will also be level and touching although sometimes there may be a little bow left in the centre which can just be pinched down separately. Repeat the procedure for the other cable and carefully solder the transition connectors into the pcb. IC1 may now be fitted and the assembly is then ready for fitting to the front panel, assuming that you have already done the panelwork in advance.

## ZIF SOCKET

The zif socket is mounted to, and from the top of the front panel, and is connected to its mating socket J2, in the pcb by an extra two low profile ic sockets which make up the height needed to clear the components on the pcb and to match the mounting shoulder of the pcb mounted switch. It's best to fit one ic socket to the zif socket before assembly of the pcb to the front panel as the pins may be better observed for correct mating if there is one socket placed on each half first. I used ic sockets measuring 5mm high and found that three of them, including the one soldered into the pcb, produced just the right height to make the pcb parallel with the front panel. Actually, the switch shoulder is only 12.5mm high from the pcb but the last socket goes through the front panel cut-out to mate with the zif socket. Originally, the design was intended to have two adhesive pcb stand-off pillars fitted near the zif socket and the pilot holes for these are still to be found on the pcb. However, I've built a number of these now and on all of them I've found that the sockets are so strong and the switch pressure forces the sockets together so well that no extra

Fig. 5. Cable orientation at computer end

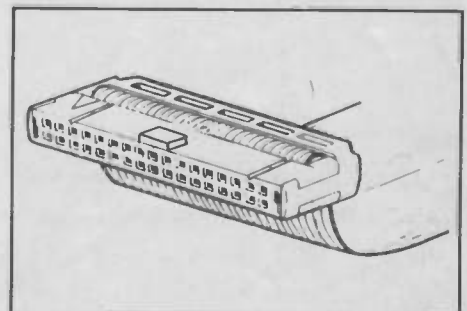

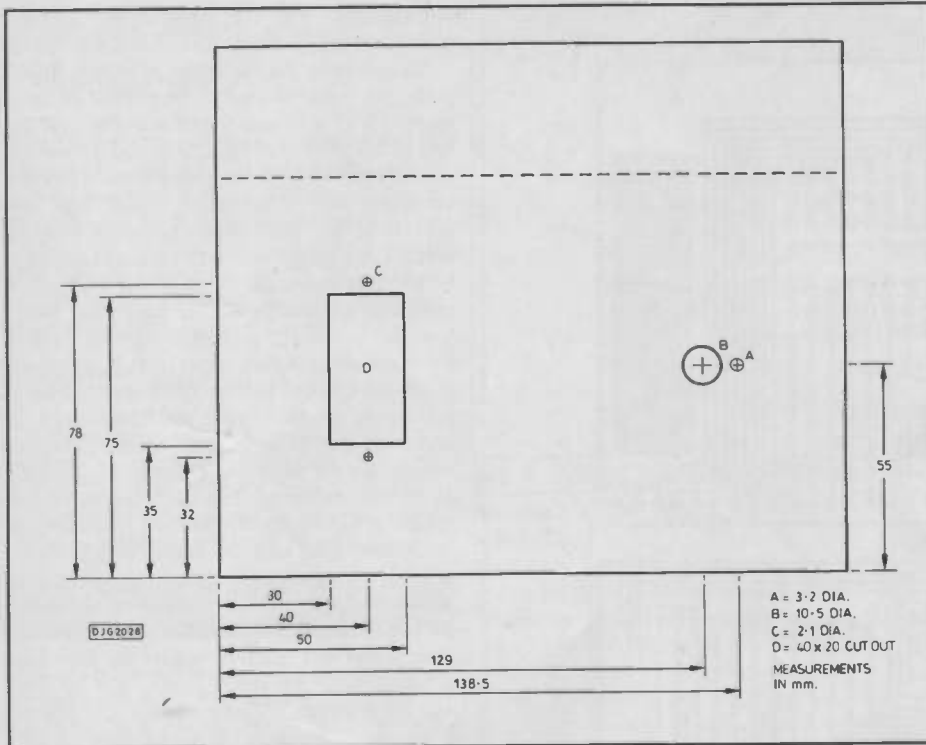

Fig. 6. Metal-work dimension details.

support is required.

Fit the two adhesive ribbon cable clips to the front panel in a comfortable position for the cables to exit from the box and fold the end of the clips down on the cables. See the photograph showing the assembled front panel.

## PANELWORK

Fig. 6 shows the machining details for the front panel. The thin aluminium is very soft and should not present any difficulty to the constructor. One warning though, because the metal is so soft you will need to use sharp tools otherwise you will risk distorting the surface of the panel. If you are using a different case from the one recommended, be sure to maintain the same relationship between the rectangular cut-out and the switch mounting hole otherwise the pcb will not match up to the panel.

When the holes have been cut out of the panel you may mark the switch positions as shown in Fig. 7 using panel lettering transfers and a light coat of spray varnish to protect them from wear.

The base of the case requires a little attention to enable the ribbon cables to pass out unhindered. Take a sharp file to the rear edge of the case and remove about 2mm of the plastic for a width of 110mm, centrally positioned. This will allow the cables to exit tidily. Stick on self adhesive rubber feet to finish the job.

## TESTING

It's only possible to do a minimum of tests before using the software, but there is so little to go wrong except poor assembly,

that the few tests given below will be enough. Later we will be describing the use of all of the features of Chiptester using ic's 7400 and 7414 as demonstration devices so you will need to obtain one of each of these chips to get the best appreciation.

With the computer switched off, connect the Chiptester to the USER port and the 1MHz bus, making sure the connectors are inserted correctly. Pin 1 on the cable is the side with the red tracer and is also marked on the computer with a triangle, these should match one another when connected. Rotate the switch to the 28-pin position. This puts the +5 volts supply on the top right hand pin of the socket and so will ensure that whatever chip is inserted, the supply won't

be accidentally connected to a signal pin.

Using a voltmeter between pins 14 and 28 of the test socket, switch on the computer and check that pin 28 is about 4.75V with respect to pin 14. (At this point other pins will be high too). Check the display on the monitor or tv to see that it is the normal Acorn prompt. If either are not correct turn off the computer straight away and check all connections, soldering and ribbon cable assemblies for faults. Check the 6522 and 74LS02 chips for correct insertion against the component overlay drawing. Since the only supply used comes from the computer itself, only the most gross and prolonged fault will be able to damage the computer, but to be sure, don't leave the computer turned on if there is any fault suspected.

Further testing needs the software to be loaded into the computer.

## SOFTWARE

Before using your software, make a back-up copy and put the original away in a safe place. The working disc will need to have its write-protect notch uncovered, so that new device files can be saved onto it.

Insert the disc into drive 0 and press shift-break to auto-boot. The disc contains both the software to control Chiptester and the ic device files.

Once the main menu appears on the screen, some machine code has already been run and this causes all the test socket pins to be cleared down except the selected supply pin. Using your voltmeter again, check that this is so. Rotate the switch to the other pin positions and check that the +5V supply moves correctly to each in turn. All preliminary testing is now complete and you are ready to try Chiptester with the two test ic chips, 7400 and 7414. A full description of all the software features will be found below.

Fig. 7. Front panel legends. This drawing may be photocopied enlarged and mounted on your unit.

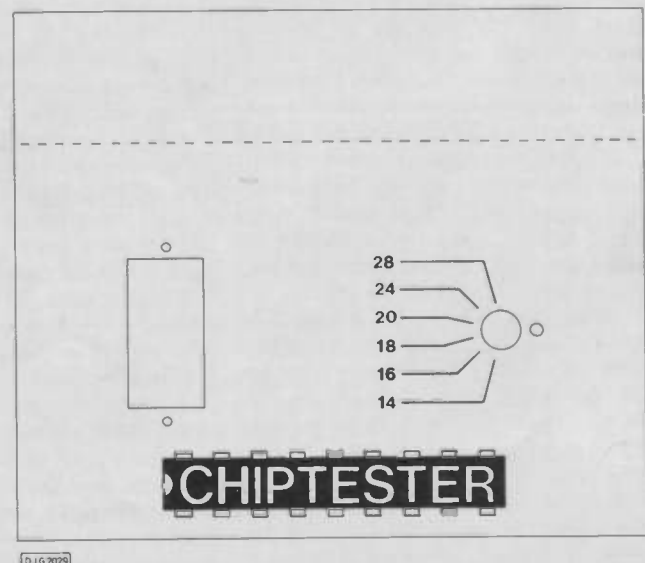





## SOME TECHNICAL NOTES

As will be noted from the foregoing, Chiptester is powered from the host computer via a connection cable and an internal fuse. The 5 volt supply is thus nominal and typically will be about 4.75 volts.

Although pins 1, 27 and 28 of the test socket may be defined as chip output pins the voltages on them are not measured by the software and these pins should not be used as outputs in test specifications. There is no restriction on their use as device input pins. Naturally, this only affects the testing of chip sizes greater than 24 pins. Pin 14 of the chip test socket is always at ground potential.

Note that not all pins of the Chiptester change logic states at exactly the same time. Quite apart from the small differences between individual pins, there are three separate groups of pins and also three separate pins that are all programmed at distinctly different times because the software can only operate on one byte at a time.

Normally, this is of no consequence as no measurements are taken from the chip until after all the input pins have been set to the desired levels. Where the order of setting input pins could be important, it is best to use two separate tests to ensure that the desired sequence is maintained. For completeness, however, I list the order of setting and reading pins on the Chiptester socket:

### OUTPUT TO SOCKET (setting pin levels)

- 1st pin 28
- 2nd pins 1 & 27
- 3rd pins 2 - 5 & pins 23 - 26
- 4th pins 15 - 22
- 5th pins 6 - 13

### INPUT FROM SOCKET (read pin levels)

- 1st pins 2 - 5 & pins 23 - 26
- 2nd pins 15 - 22
- 3rd pins 6 - 13

Pins 1, 27 and 28 are not read in from the socket.

## PROBLEMS

If you get some very odd results, check that both connectors are plugged in properly. Also check with a voltmeter that the correct supplies are getting to the ic under test. If there is no +5V supply, it's possible that the fuse has blown.

Sometimes on old chips the pins are tarnished and this prevents good contact in the socket - just push the chip up and down a few times in the socket to scrape the pins a little.

## DATA FILE STRUCTURE

Approximately 400 device files may be stored on an 80 track disc along with the operating software, and about 180 on a 40 track disc. As well as the operating software. My disc contains a data file of just over 100 popular ic types and option 5 in the menu allows the easy creation of many more. The only knowledge required for this is the expected operation of the chip, however, for those interested, each record consists of 349 bytes made up as follows:

- 12 bytes - 10 character string - chip type number
- 5 bytes - integer variable - no. of pins on device
- 5 bytes - integer variable - offset of socket
- 5 bytes - integer variable - clock pin(s) definition
- 5 bytes - integer variable - No. of tests in this specification
- 5 bytes - integer variable - output pin(s) definition

Then follows, 28 times the next two items, in pairs:

- 5 bytes - integer variable - input levels definition (or clock count value)
- 5 bytes - integer variable - output levels definition

Lastly:

- 32 bytes - 30 character string - user message

Definitions of clock pins, output pins, input levels and output levels are stored as binary values in 4-byte integer variables with bit zero corresponding to pin 1 on the chip socket. The most significant 4 bits are used for control purposes, such as defining a clock cycle instead of an input level definition.

My 80 track disc contains three data files: DATA, CMOS & TTL. The file called DATA is the one used by the program and contains a compilation of various devices. If you wish to make several discs, each with a particular family of ic types, you could start by using one of the other two files. It will need to be re-named DATA and it must be the last file recorded to the new disc to allow room for continued expansion of the file length as more chips are added.

## NON-STANDARD SUPPLY PINS

Some types of chips do not have their supply pins in the normal diagonally opposite positions. As Chiptester always expects them this way, a little trick is used to solve the problem. As an example, we'll take the 74LS90 which is a 14 pin chip with supplies on pins 5 for VCC and 10 for ground.

Because the chip socket's bottom left hand pin is at ground potential the chip will have to be positioned with an offset in the socket. The +5 volt pin also needs to be dealt with and the most convenient way to do this is to call the chip an 18 pin size and use two wire links for ground and VCC.

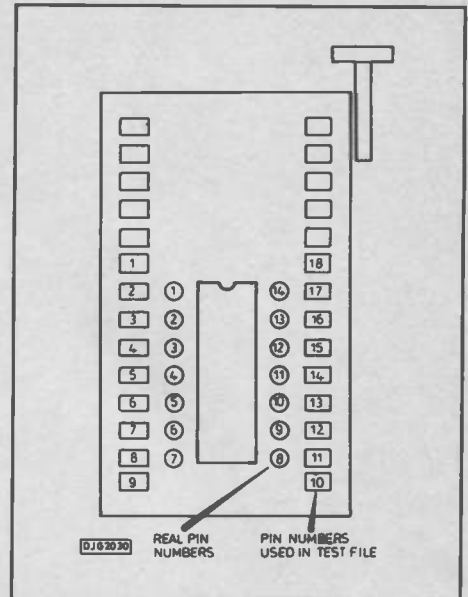

Fig. 8. Pin number relationship when using non-standard chip.

The pin numbering will be wrong and the chip will look bigger on the screen than is actually the case. Look at the file for the 7490 and see what I mean. Fig. 8 shows how the real chip pins relate to the imaginary chip pins.

Since real pin 5 is VCC the display shows a link between 6 and 18. Similarly a link is used between 9 and 13. In the files all the chip numbers are also imaginary, ie the output pins are specified as 11, 12, 14 and 15, corresponding to real pins of 8, 9, 11 and 12.

If you've got a 74LS90 you can try the test for yourself, once the principle is understood it's quite easy to create files for all sorts of oddball chips.

## MAIN MENU

The main menu gives options on the following functions:

1. Load device from disc
2. Edit test parameters
3. Test device
4. Search for unknown device
5. Enter/edit test data
6. Save test data to disc
7. List devices on disc
8. Batch test

Next month we'll look at these in turn, and give you the components list.

PE

## SOFTWARE

The Author, David Rayner, has kindly offered to supply readers with a copy of his software disc for the nominal price of £6. This includes postage in the UK, but overseas readers should add an extra £1 to cover the additional postage. Please write to him at 10 Hardys Field, Kingsclere, Newbury, Berks. RG15 8EU. A listing of the software is available from the PE Editorial Office. Please enclose a large stamped addressed envelope.

Please mention **Practical Electronics** when contacting advertisers

Main catalog table with columns: TTL'S, 74LS SERIES, LINEAR IC'S, CPUs, RAMS, CRYSTALS, INTERFACES IC'S. Includes various IC part numbers and prices.

4000 SERIES

Table listing 4000 Series TTL and CMOS parts with prices. Includes sub-sections for 'SPECIAL OFFER', 'DISCOUNT', 'TTL / CMOS 4000 SERIES REGULATOR', 'ZIF sockets', and 'TTL & ECL'.

VOLTAGE REGULATORS

Table listing Voltage Regulators with specifications like input/output voltage and current.

OPTO ISOLATORS

Table listing Opto Isolators with part numbers and prices.

DISPLAYS

Table listing various Displays including LED and LCD types.

DISPLAY DRIVERS

Table listing Display Drivers with part numbers and prices.

\*ATTENTION\* ALL PRICES ARE SUBJECT TO CHANGE WITHOUT NOTICE

SCRS LOW PROFILE DIL SOCKETS BY TEXAS

TUNED PIN LOW PROFILE SOCKETS

ZENERS

TRIACS

DISCRETE DISPLAYS

LED'S

REDFIL 209 GREEN

TRELI 015 YELLOW TL2120

RECI LED'S (R.G.Y)

CARBIL (COLOUR) 10 LED

Bargraph Red Green 0.2 1.90 TL220 0.18 TL222 0.22 TL226 0.35 TL232 0.55 TL238 1.20 TL241 1.30 TL240 0.75

SUPPORT DEVICES

Table listing Support Devices like buffers and inverters.

ROMS PROMS

Table listing ROMs and PROMs with various capacities.

DISCOUNT

ON 30% DISCOUNT

TTL & CMOS

4000 SERIES & REGULATORS

CRT CONTROL

Table listing CRT Control parts.

KEYBOARD ENCODER

Table listing Keyboard Encoders.

UHF MODULATORS

Table listing UHF Modulators.

UARTS

Table listing UARTs.

SPECIAL OFFER

30% DISCOUNT

ON 30% DISCOUNT

TTL & CMOS

4000 SERIES & REGULATORS

CRT CONTROL

KEYBOARD ENCODER

UHF MODULATORS

UARTS

TELE TEXT DECODER

WIRE WRAP SOCKETS BY TEXAS

\* SPECIAL OFFER \*

30% DISCOUNT

ON TTL/CMOS 4000 SERIES/REGULATORS

DRAMS

4164 - 12 1.75

4164 - 15 1.50

41256 - 10 3.00

41256 - 12 2.70

41256 - 15 2.80

41464 - 12 4.00

1MB RAM - 8 12.00

1MB RAM - 10 11.00

256K x 4 12.00

SIMMS

1M x 9 - 10 124.00

1M x 9 - 8 129.00

SIPS

256K x 9 - 10 37.00

256K x 9 - 8 50.00

SRAMS

6264LP - 12 4.00

62256 - 12 10.00

2732 3.50

2764 2.80

27128 - 12.5V 3.50

27128 - 21V 4.50

27256 5.00

27512 7.00

27512 7.00

27512 7.00

27512 7.00

Right side of the catalog table containing parts like CRYSTALS, INTERFACES IC'S, CPUs, RAMS, CRYSTALS, INTERFACES IC'S, etc.

TECHNO HOUSE LTD

TECHNO HOUSE, 468 CHURCH LANE, LONDON NW9 8TQ

(Tel 01 205 9558, Fax 01 205 0190, Telex 922800)

PLEASE ADD £1 p&p & 15% VAT (Export: no VAT, p&p at cost)

Orders from government depts. & colleges etc. welcome

Stock items are normally by return of post

Detailed Price List on request



**W**e left off last month just as the first mode change takes place. This is what happens next:

**FIRST MODE CHANGE**

Several changes occur at this point. IC10 pin 3 goes low, putting IC1 into its high impedance 'off' state. IC2's data input pin 12 is taken low (logic 0), and gate IC3 is opened, putting its outputs onto IC2's A8-A13 address lines, so allowing a different set of address codes to be sent to them from a separate counter, IC7. For the duration of IC10 pin 3 being high IC3 has been in a high impedance state and so the second counter has been isolated from IC2.

IC10 pin 3 also controls the multiplex gate IC13 and provides clock signals to the latch IC8b. When IC10 pin 3 is high, IC13 links input 10 to output 9, and input 13 to output 12. Now that IC10 pin 3 has gone low, IC13's above inputs are closed, and instead input pins 11 and 14 are linked respectively to outputs 9 and 12. IC4's clock signal now



# PE TELE-SCOPE

comes via IC13, not from S1/S2, but direct from the 4MHz oscillator.

Latch IC8b controls the reset pins of the counters IC4 and IC8c, and the enable pin of IC13. On receipt of the negative-going signal from IC10 pin 3, IC8b is clocked and its Qa output pin 3 goes high. This resets IC4 and IC8c back to zero, and holds them there for as long as output Qa remains high. IC13 is disabled by the same change, via D7, and will allow no further signals through any of its sections until re-enabled. This condition remains until a sync signal is received. On receipt of the signal, Qa will go low opening IC13 and removing the forced reset from IC4 and IC8c, allowing them to resume counting.

When IC10 pin 3 goes low, its pin 2 goes high. The output is inverted by IC11b, which inhibits gate IC12a, forcing its output high, and thus putting IC2 into read (playback) mode. In this state, IC12 cannot allow the clock signals to get to IC2's read/write pin 9. IC10 pin 2 has the opposite effect for the second memory chip, IC6. The high level now allows the gate IC12b to pass clock signals to IC6's read/write pin 9.

**MEMORY TRANSFER**

Up until now, IC6 has been merrily cycling through all its memory cells in an order set by counters IC5 and IC7, which are under 4MHz clock control from IC11e. During this time IC6 has been in read mode, placing its memory contents at its output pin 8. It is now called upon to play a less passive role, by recording the entire contents of IC2. It has a moment of reprieve, though, for it has to wait for a synchronisation signal. This

## Part Two: in which John Becker draws the test line on the goggle-box.

signal is derived from the state of counter IC7, as detected by the quad-input AND gate IC9a. We shall see presently how IC9a is responsible for sending a sync signal to the tv, placing the notorious dot back at the start of screen line one. The same signal resets IC8b through an internal connection to IC8a, so enabling IC13 and allowing IC4 and IC8c to restart. It also resets counters IC5, IC7 and IC8a back to zero.

Upon receipt of the sync pulse from IC9a, the system now synchronously cycles both memories through all address codes. The data contents from IC2 go from its pin 8 to the data input pin of IC6. With the read/write pin 9 of IC6 now under clock control, the memory records IC2's contents. It will continue to do so until counter IC7 steps its output pin 3 low following a previous clocked high. The level change is passed through IC13 from pin 11 to pin 9 and so once more IC10 is clocked on by one place.

**SECOND MODE CHANGE**

The third output of IC10 is not used directly. Rather, it is the duration between which IC10 pin 2 goes low, and IC10's fourth output, pin 7, goes high that is important.

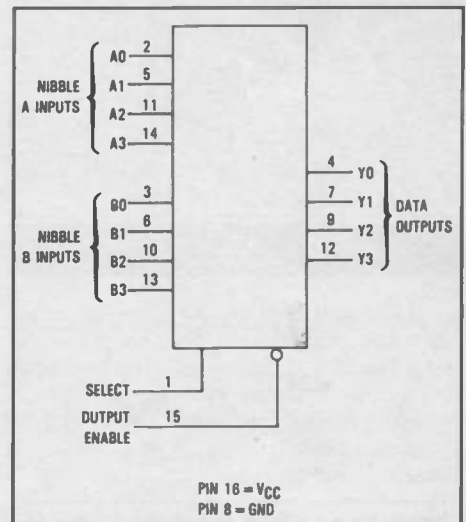

Fig. 6. Logic diagram of the 74HC157 used for IC13.

When IC10 pin 2 goes low it puts IC6 back into read mode, but IC2 reverts back to write mode. Both memories are still under control from the same clock source, but IC6 now sends its data off to the circuit which drives the tv, while IC2 again cycles through its contents, this time erasing them! Since IC10 pin 3 still remains low (IC10 is a sequential counter, not a binary one), IC2's data input pin 12 is also low, so zeros are written into each location as it comes to the fore.

**THIRD MODE CHANGE**

The erasing condition continues until IC7 pin 7 is again taken low following a preceding

high. This again steps IC10 on by one place, sending its fourth output pin 7 high. Memory IC6 takes no notice of IC10's step to output 4, and will continue to play back its data until IC10 pin 2 again goes high, at some as-yet unknown time in the future.

Memory IC2 is again subject to change though. IC10 pin 7 sends its high level via D1 to once more disable IC13. Counter IC7 is brought to a standstill and IC10 is prevented from seeing any further clock pulses until after it and IC13 have been reset.

## WAITING FOR SYNC

Resetting of IC10 is basically under control of the input signal under investigation. As you will see when we look at the input signal conditioning circuit, there are a number of options available by which the input signal, or some other source, can be used to reset IC10. We need these options in order to synchronise the input signal to the start of each sample recording run.

The signal sync pulse, from whatever chosen source, is applied to one input of the AND gate IC9b. For convenience, it's a 4-input AND but two of its inputs are unused apart from being tied high to the positive line. For the gate's output to change state we need the simultaneous occurrence of two high level signals, one from IC10 pin 7, the other from the signal sync source. Until this combination is received, IC9b's output pin 1 will remain low. On detection of the dual-high condition, IC9b pin 1 will go high, so resetting IC10, whose output pin 7 goes low, but with its pin 3 going high. We are now back to the start of the cycle, at which point IC2 begins to record the next batch of data.

## VIDEO SIGNAL

Later on I shall discuss tv screen control signals at greater length. Take for granted for the moment that the control circuitry shown in Fig.2 must provide three signals to the tv interface module: the video signal, and the horizontal and vertical screen deflection synchronisation pulses.

Fig. 7. Logic diagram for the 74HC541 as used for IC3.

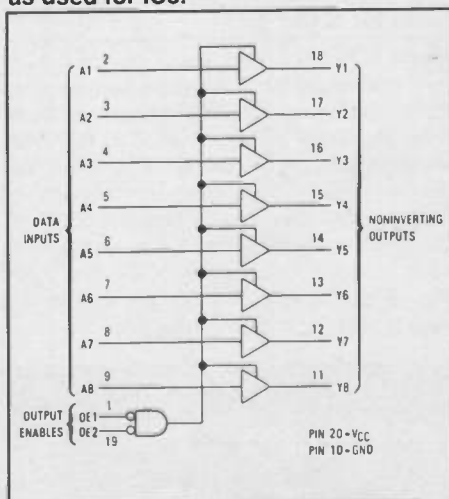

The video signal is basically that which comes out from memory chip IC6, at its pin 8. However, it needs inverting, and it also needs to be blanked off during some parts of the record/playback cycle. IC12c is used both as an inverter and as a video shut-off gate.

In conjunction with the status of counter IC8a's Qb output, IC12c is opened twice during each full frame cycle of the tv screen. It is closed at the start of the screen cycle, during which time IC2 is transferring its data to IC6. It is opened immediately following the end of the data transfer, allowing the contents of IC6 to be displayed on the screen as an appropriate waveform. It is closed again when IC6 has cycled through its entire contents, so preventing the same contents from being displayed a second time lower down the tv screen. However, at the end of that second cycling, the gate reopens so again the memory contents are available for viewing even further down the screen. Following that cycle the gate closes again, by which time the sync pulse which triggers the tv screen back to the top line is only milliseconds away, at which point IC8a is reset to zero, along with many other functions discussed earlier.

## SECONDARY BLANKING

Although there is no basic reason why you shouldn't view the same data at various levels down the screen, I found it disconcerting, which is the reason why I included the gate. With the single gate alone, though, two traces would still be displayed, except for the secondary shut-off condition I've built in. This uses IC6's own enable/disable control, accessible at pin 11, and is placed under control from IC8a pin 6. Pin 6 toggles high and low at half the rate of IC8a pin 5. It is low during the time that data is being transferred from IC2 to IC6, and during the playback period immediately following the transfer. This is a convenient fact since IC6 pin 11 needs to be low in order to enable the output, a situation matching the preference to view IC6's contents immediately after transfer. During the second period that IC12c is open, IC6 is now being held closed by IC8a pin 6. You thus only see the full data display once on the screen.

## PICTURE SYNC

In the UK, we have adopted the 50Hz standard for the vertical screen line movement, and a horizontal shift rate at 15625Hz. Synchronisation for both these rates needs to be sent to the tv mixed in with the video signal. The mixing will be described later. The 50Hz and 15625Hz signals are both derived from the master clock oscillator in conjunction with the counted outputs of IC5, IC7 and IC8a.

Most conveniently, 15625Hz is a binary sub-multiple of 4MHz; we only need to divide 4MHz 256 times to get this rate. All that's necessary is to take the eighth output of the binary dividing counter chain of IC5 and IC7,

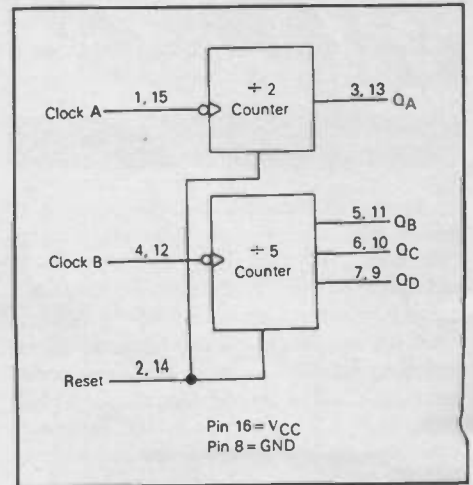

Fig. 8. Logic diagram for the 74HC390 as used for IC8. (Figs 6-8 are from the Motorola high speed CMOS logic data book.)

which is at IC7's pin 12 output. This is simply inverted by IC11f for sending to the tv driver module.

While still making use of the binary counters already in circuit, deriving a 50Hz signal is less simple since 50Hz is not a binary sub-multiple of 4MHz. A close approximation to 50Hz, though, can be obtained by ANDing five of the outputs of the counter chain. Four outputs are ANDed into IC9a, which as we saw earlier is the sync control source which also resets IC8a. By then NANDing IC8a pin 7 with IC7 pin 3 at IC12d, a vertical sync signal of very close to 50Hz, and of a suitable duration, is produced. Precision timing of the 50Hz is not necessary since tvs have a vertical hold control accessible on the tv set. Slight adjustment of that control will lock the tv onto the unit's sync pulse. In many cases even minor adjustment may not be necessary.

## DIGITAL SAMPLING

When sampling analogue signals we ideally need as many samples as possible to build up a smooth representation of the signal. For sampling digital signals we don't really need to take any more than two samples. We already know that a digital signal is going to be either high or low. Knowing this, we can totally bypass the analogue to digital converter IC1 when recording digital signals. (There are instances when the analogue shape of a digital signal is important, but if you need to know that sort of detail then you really need a more sophisticated unit than this one.)

Bypassing IC1 is accomplished by using its second enabling control, pin 6. Switch S3b in the signal conditioning circuit can be switched to place a low or high level onto pin 6, respectively enabling or disabling the chip's outputs. This control polarity is the opposite of that required by IC1 pin 5, but the effect is the same, the outputs are put into high impedance in the disable mode.

Now, instead of taking our input signal into IC1, we take it, via R8, to the msb (most



significant bit) address line controlling the memory block code. The remaining block code address lines are held high via R3-R7. The inclusion of the resistors prevents address line interference when IC1 is in analogue sampling mode.

When the signal via R8 toggles up and down, the memory sees the block address code swing between the equivalent of address 63 and address 31. It is then only into the line cells of those two address blocks that the data is written. The operation of the rest of the circuit remains as described above and the tv screen will display a digital waveform.

Originally, I used the digital input to swing the block addresses between 0 and 63, but found the screen height too great. In the configuration now shown, the digital swing is half the height of the maximum that an analogue swing can produce.

It is not necessary to only use the digital sampling mode in order to view digital signals. They can be passed through IC1 as though they are analogue signals. Using that method, though, you will not only see the minimum and maximum sample heights, but also one or more intermediate steps. These additional steps will vary in position depending on the relative phases of the sampled signal and that of the sampling clock.

### COUNTER CHIPS

It is important to note that the counter chips have an HC coding in their number. It may occur to some of you that you could save a few pence on the unit by using the standard cmos 4024 or standard ttl 74390 instead of the HC versions. Don't!

The circuit is operating at a very high speed, up to 4MHz in some parts. The

standard counter chips cannot keep up with these speeds. Although you would find that each output would toggle in response to input clock signals, you would find that the delay between the clock trigger and the time at which the outputs changed would be too long to be satisfactory. This unit depends very heavily on its synchronisation capabilities; using slow response counters would result in disappointing screen displays. In particular, you would find that a lot of white dots appeared at random points around the waveform you were displaying. These would be due to the failure of the counters to keep up with recording events.

IC11 also needs to be an HC device in order to allow the oscillator to generate 4MHz.

Decade counter IC10 does not need to be an HC device since it is not called upon to react at a critical sync rate. Gates IC9 and IC12 were also found to be happy as standard cmos versions.

### SIGNAL CONDITIONING

Two functions are performed by the signal conditioning circuit. The necessary synchronisation signal is extracted and set to the required phase, and the signal itself is set to a suitable amplitude.

The sync control circuit is formed around IC15a-d. S3a selects whether the sync source is digital, or an analogue derivative. The signal is inverted by IC15a, from where it is routed via R8 for use as the block address controller when in digital mode. It also goes to S4 which selects between IC15a and an external sync source. The latter source, if used, should not be allowed to exceed +5V or be lower than 0V.

IC15b is an inverter, giving S5 the choice of selecting between inverted and non-inverted sync signals. This allows you to synchronise the sampling to either the positive or negative-going edges of the signal being sampled.

Following S5, the circuit around IC15c and IC15d is configured as a pulse length standardiser. A positive-going signal into IC15c pin 13 causes the gate output to fall, generating a negative pulse across C10. This causes IC15d's output to go high. It will remain high until C10 has recharged via R21, at which point IC15d pin 10 will revert low again.

Via the sync on-off switch S7, the positive-going signal goes to IC9b in the sampling circuit. If, by this time, IC10 pin 7 is high, IC9b will be triggered and so reset the sampling cycle back to its first mode. If IC10 pin 7 is not high, the signal from S7 will be ignored.

There are times when we don't wish the sampling to be synchronised to the input signal. For example, when examining dc or slow moving ac signals it is usually preferable to let the screen trace idle as it wants. In these instances, S7 can be switched away from IC15d, allowing a high level via S6 to be constantly applied to IC9b. This enables the sampling to restart immediately IC10 pin 7 has gone high.

S6 allows us to stop sampling and simply view the contents of memory IC6 for as long as we want. With sampling no longer taking place, IC6 will continually display on screen the last waveform received. It will continue to do so until S6 is set to the run mode again.

So that 'hold' can be applied in both sync and free-run modes, S6 is also coupled to

Fig. 8. Signal conditioning circuit.

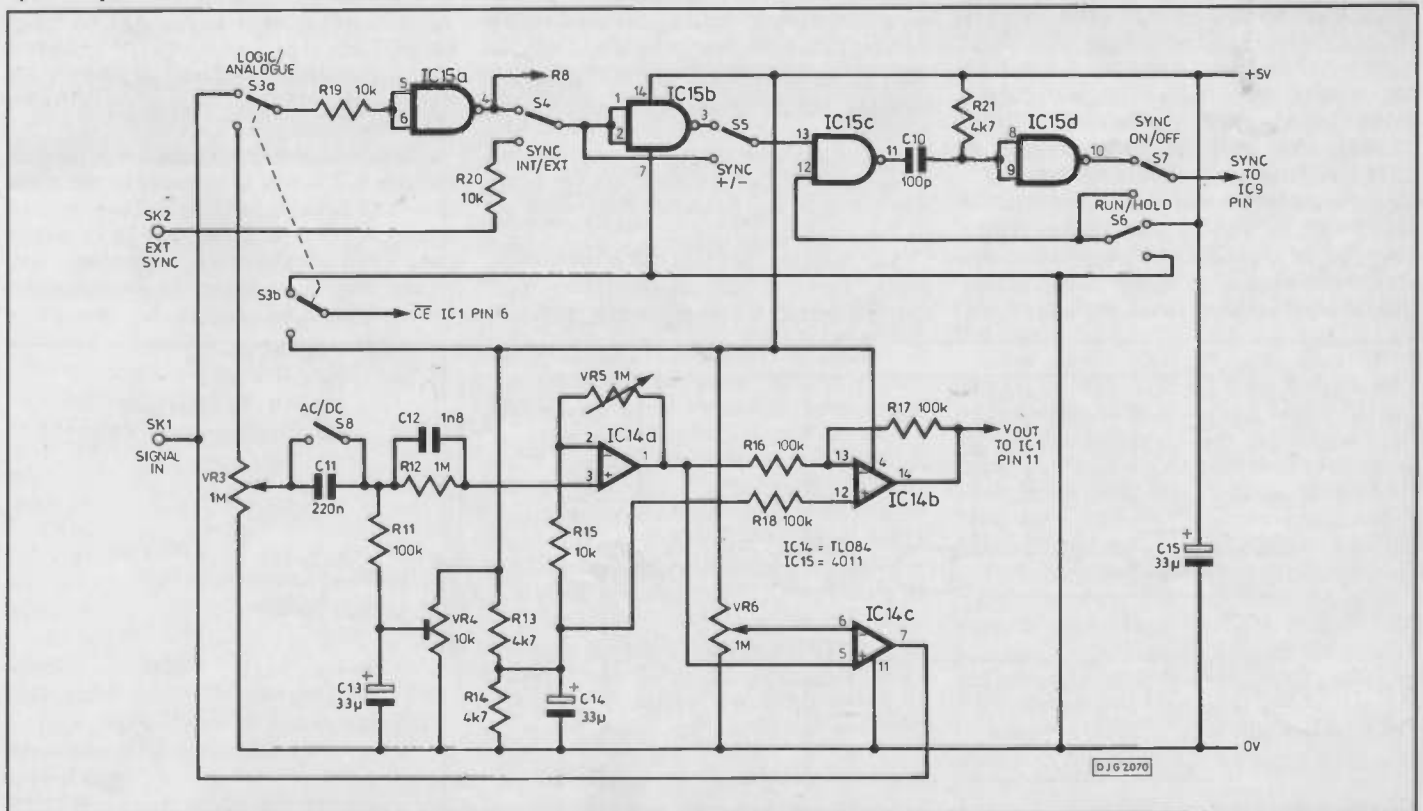

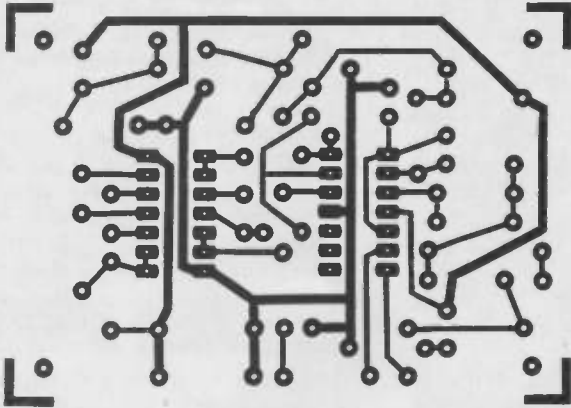
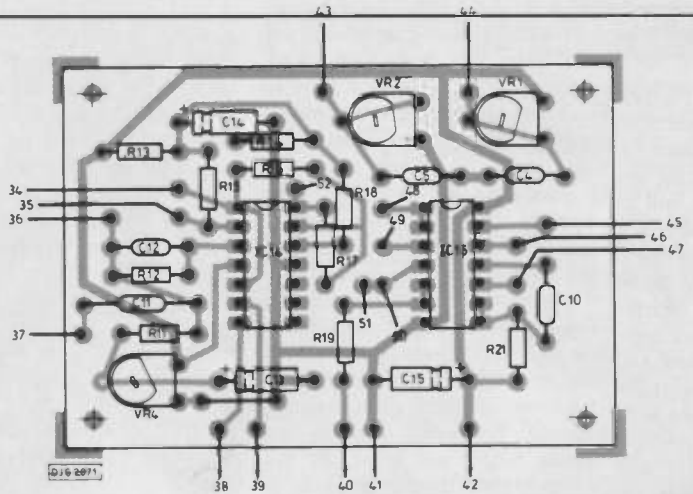

Fig. 9. Track and component layouts for the signal conditioning pcb.



IC15c pin 12, preventing the gate from passing sync signals.

## SIGNAL AMPLITUDE

Analogue signals may be too high or too low for the screen to display the waveform across the best screen area. In a true oscilloscope, signal attenuation and amplification would be controlled by a complex network of components. In this less sophisticated visual display unit, the signal level controls have been made equally less sophisticated, using two panel-mounted pots to vary attenuation and gain.

Signals are brought into VR3, which allows you to reduce their level. S8 allows you to switch the signal directly through as a dc level, or through C11 as an ac waveform. Via C12 and R12 the signals go to the opamp IC14a. Here their amplitude can be held to the same level, or amplified by use of VR5, which varies the gain from nil to around 100 times.

From IC14a the signals are inverted by IC14b, but given no further gain, and go direct to the signal input of the a-d converter IC1.

Additionally, the signals are routed to IC14c, which is the sync pulse extractor. It is simply a comparator, the trip level of which is set by VR6. By varying VR6, you can set the point on the signal waveform at which the comparator changes its output state. You can thus choose whether, for example, you trip

towards the top of the waveform, part way down, or right towards the bottom. IC14c's output is fed to the other side of the sync source selector S3a.

Back on the input to IC14b, VR4 is used to make minor adjustments to the dc bias level applied to the opamp, so enabling you to set the final output at IC14b to a midway point in the absence of signals, at maximum gain of VR5. There is nothing critical about this pot, which can be adjusted while viewing the screen. It should initially be set to a midway point before making corrections.

S3b is wired so that in the analogue mode IC1 pin 6 has a low level on it, so enabling the chip. In the digital mode, S3b applies a high level to IC1 pin 6, so disabling the chip.

## SAMPLING RATE

Earlier in the text I referred to S1 and S2 as being the selectors for the source of sample clocking pulses. We need to be able to vary the sampling rate so that we can always show a reasonable cross section of a waveform irrespective of its frequency. If we were to keep a fixed sampling frequency, we would find that some signal frequencies would fill the screen with too much data, whereas others would not provide enough.

The sampling routine is independent of the display memory read out during the entire sampling period. It does not matter, then, how

long the sampling period takes. We could let it take a week or more if we wanted and had a slow enough clock source.

If you wanted to take a really long time with the sampling, you would plug an external clock generator into the external clock socket SK3, switching S2 to its external setting. R22 provides a certain amount of protection against adverse clock signal levels, but you should still take care that they do not exceed +5V or fall below 0V.

It's more likely, though, that you will wish to use the unit's internal clock. You have a choice of 15 different sampling frequencies, 12 selectable by S1, the other three by S2. Starting off with the highest frequency of 4MHz direct from the oscillator around IC11e, S1 selects in turn successive outputs of the binary counter chain IC5 and IC7. Each output selected runs at half the rate of the preceding one. The lowest three counter outputs are selected by switching S2 away from S1 bringing in the signals from IC7 pins 3-5 (marked as A11-A13 on S2 in Fig.2). Each time you divide the sampling clock rate by two you enable a signal twice the previous frequency to cover the same span across the screen.

Whatever the sampling clock source, once memory IC2 is full, as indicated by the status of counter IC8c, the sampling will end and high speed transfer to IC6 take place at the 4MHz rate. Following which sampling can recommence, depending on the settings of the various sync control switches.

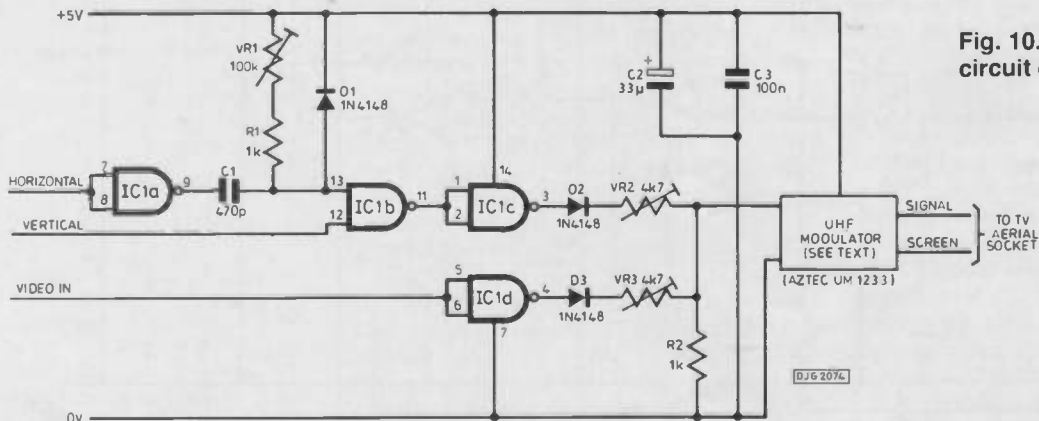

Fig. 10. TV interface circuit diagram



## TV INTERFACE

The tv interface module used by this unit is identical to the one I built to let my semi-defunct Commodore 3032 drive a tv screen. Circuit-wise there is barely anything to it, but you will be interested to know a bit about the theory once I've described the functional practicalities. (Owners of 3032 machines who have the book *The Pet Revealed* should view the interface circuit given there with caution. There appear to be errors in the pin numbering shown. My version is simpler, and I've proved its workability!)

Basically, the circuit shown in Fig.7 is simply a mixer which combines the video signal with the horizontal and vertical sync signals, sending them as a single signal to a uhf (ultra high frequency) modulator. The modulator's output is fed direct to the tv aerial socket, where it is seen by the tv as just another signal, though without sound and colour data.

The video signal from memory IC6 via gate IC12c is inverted by IC1d. D3 ensures that only the positive aspect of IC1d's output has any affect on the remaining circuit. Between them, VR3 and R2 attenuate the level to suit the tv video detection circuit.

The horizontal sync signal, running at 15625Hz, needs a bit of minor modification. It's taken via the inverter IC1a to have its pulse length changed. The length of the pulse tells the tv at which point across the screen the lines should begin (see later). C1 and VR1 plus R1 set the pulse length in a manner similar to that used with IC15b in the sync extractor circuit, except that here we can change the pulse length by using VR1. D1 is included keep the pulse height to within acceptable logic levels. The re-timed pulse is inverted by IC1c, after which D2 performs a similar function to D1. VR2 sets the level to suit the tv's sync circuit. As you see, both

signals are combined at the input to the modulator.

Vertical syncing does not require the addition of another pulse. Rather, it is achieved by stopping the horizontal pulses from reaching the modulator. The vertical signal simply opens and closes IC1b, so controlling the flow of horizontal signals through the gate.

The uhf modulator is bought as a ready-made component. It is manufactured and preset to generate a uhf signal which is then modulated by the combined video and sync signals. You do not need to adjust the modulator. It is pre-tuned to tv channel 36, all you need to do is plug it in to the tv aerial socket and then tune your tv controls to that channel.

## POWER SUPPLY

The entire circuitry of main unit, signal conditioner and video interface need to be run from a stabilised 5V power supply. Provision has been made on the main pcb for a 7805 5V regulator (IC16) to be mounted on it. With this in place, a non-regulated dc supply of around 9V can be brought into the regulator's input via pcb point 33, with the 0V line going into point 32 or 53. If you want to run the unit from the mains you could use a battery eliminating adaptor to supply the 9V to IC16, in which case a largish-value capacitor of 470µF or 1000µF, at 16V to 25V rating, should be connected across the adaptor's output ripple voltage. Alternatively, a mains power supply may be used, of which many examples have been published in PE. DO NOT apply mains power or any other ac power source directly to IC16, or allow any voltage other than +5V dc to reach the subsequent circuits.

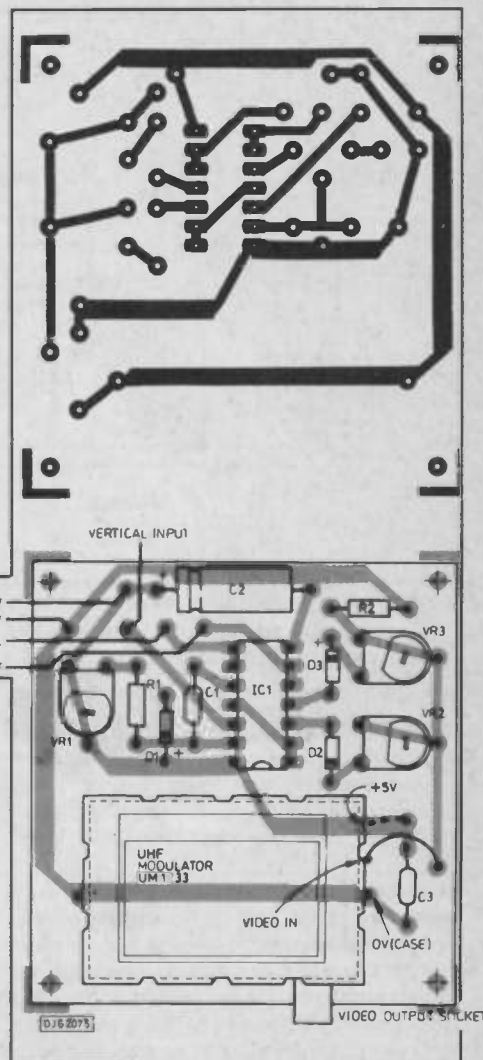

Fig. 11. Trace and component layouts for the TV interface pcb.

## SYNC AND VIDEO SETTING

The setting of the sync and video controls requires that you have satisfactorily completed the main circuit. That completion, though, requires that you have completed the video alignment. A 'lift yourself up by your boot laces' situation! The two sets of checking really go hand in hand, but I'll detail the video completion first, and then look at the main circuit finalities.

Turn down VR3 to stop the video coming through. Turn up VR1. If the blank picture appears to be rolling, adjust the tv vertical hold (frame hold) control until it stops. Now adjust VR1 until the left or right hand screen sides show a discoloured area. Now turn VR1 the other way until the picture is uniform and has no jagged edges.

Assuming that the main unit is sampling signals, turn up VR3 allowing the video signal to pass through to the tv. You should now see a representation of the waveform on screen, though probably not yet in a fully recognisable form.

You are likely to find that the relative settings of VR1-3 may need adjusting to get

## TV INTERFACE COMPONENTS

### RESISTOR

R1 1k 0.25W 5% carbon film

### CAPACITORS

C1 470p polysterene  
C2 33µ 6.3V electrolytic  
C3 100n polyester

### SEMICONDUCTORS

D1-D3 1N4148 (3 off)  
IC1 4011

### POTENTIOMETERS

VR1 100k preset  
VR2, VR3 4k7 preset (2 off)

### MISCELLANEOUS

UHF modulator UM1233, 14-pin dil ic socket, aerial lead with plugs to suit, printed circuit board, pcb supports (4 off)

## UHF MODULE CHECKING

You can check out the modulator and tv tuning without the sampling circuitry in operation. Connect the module to the tv and switch on the tv and the power to the module.

Unless your tv is already tuned to channel 36, you will probably either see a poor picture of a regular tv broadcast channel, or a lot of 'snow' on screen. Turn the tv tuning control slowly across its range. Once you get close to channel 36 the tv screen should start clearing, showing a uniform brilliance. Continue tuning until the screen is as clean as possible. Switch off the modulator and the tv screen should show 'snow' again. Switch back on and once more a clear screen should result. If the screen does not show 'snow' when switching off the modulator, you could by chance have tuned to another channel responding to another broadcast signal. If so, switch the module on again and continue tuning.

Fig. 13. Wiring diagram.

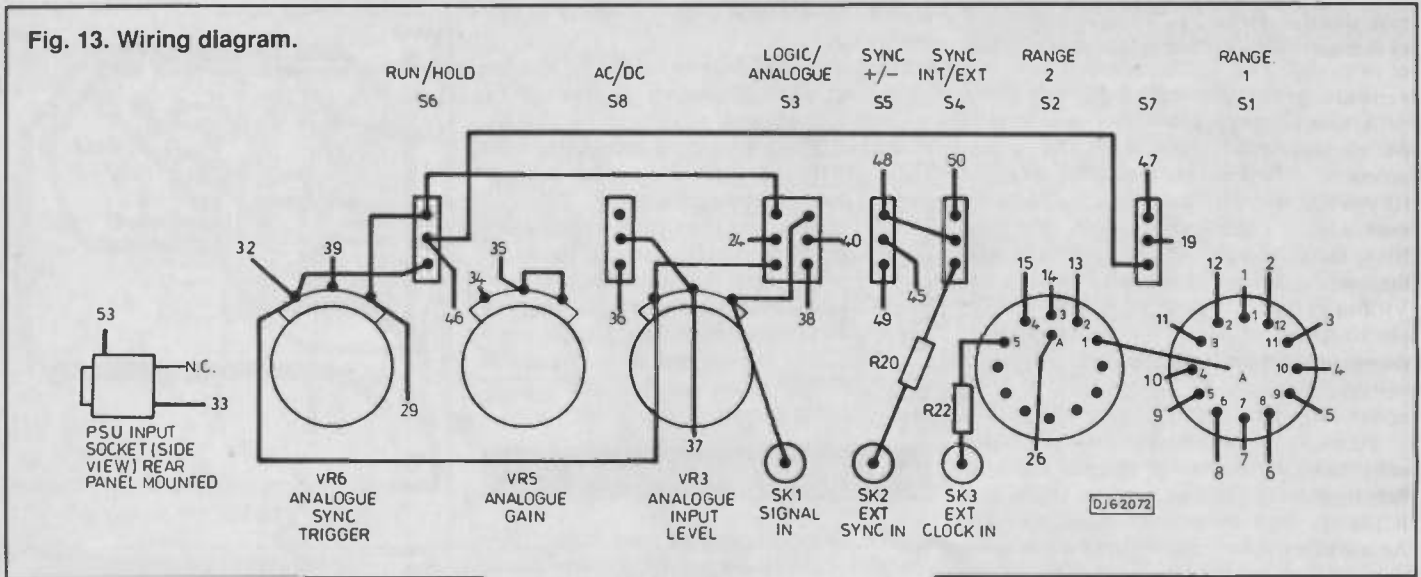

the best picture, and that the tv frame hold may need slight readjustment. You will not damage the tv by incorrect settings of VR1-3.

**MAIN UNIT CHECK OUT**

Assuming you have assembled the boards and controls correctly, the full unit should work first time. Check the digital sampling aspect first.

Switch both S1 and S2 to positions 1, so routing the 4MHz clock to the sampling circuits. Temporarily remove the wires to pcb points 19 and 25. Connect a lead from S1 position 3 or 4 to R8 at pcb point 25, and connect another lead from point 25 to point 19. These connections send a square wave signal to memory IC2 and to the sync point of IC9b. Switch on and view the tv screen. You should see several ups and downs of the waveform displayed.

**TEST POINTS**

I have allowed two test points on the board to enable you to check the video aspect at earlier stages should you need to. Test point 1 (pcb point 20) and test point 2 (pcb point 54) are connected to the outputs from memories IC2 and IC6, respectively. Either of these points may be

**ADDITIONAL PCB LINKS**

- PCB PIN 16 video output
- PCB PIN 17 vertical output
- PCB PIN 18 horizontal output
- PCB PIN 30 0V output
- The above pins go to the equivalent pins on the video pcb.
- PCB PIN 20 test point 1
- PCB PIN 54 test point 2 (see text for test point info)
- PCB PIN 21 link to PCB PIN 52
- PCB PIN 22 link to PCB PIN 43
- PCB PIN 23 link to PCB PIN 44
- PCB PIN 25 link to PCB PIN 51
- PCB PIN 28 link to PCB PIN 42
- PCB PIN 31 link to PCB PIN 41
- The right hand column of pcb pins is on the Signal PCB.

connect to the video input of the video interface board instead the lead from IC12c (pcb point 16).

IC2's output will produce a random display of dots and lines while recording the sample and while resetting back to zero. During transfer of data from IC2 to IC6 the waveform should be clearly displayed on screen, though as a dark trace on a light background (since the signal is bypassing the inverter gate IC12c).

IC6's output should cause several copies of the waveform to be displayed following each

other on screen, leaving some screen areas blank. The image will again be a darker trace on a lighter background.

Should you not see satisfactory results on screen it is likely that you have made an error during assembly. It is unlikely (though vaguely possible) that the chips are at fault. Recheck all your work, paying special attention to looking for bad joins or solder shorts across tracks.

**DIGITAL SYNC CHECK**

Having established that the digital signal is being displayed, switch off and remake the proper connections to pcb points 19 and 25. Take the temporary connection from S1 now to the signal input socket. Switch S3 to digital mode and switch back on. Experiment with all settings of S4-S7 observing the screen and noting what they do.

**ANALOGUE CHECK**

Still using the digital signal the analogue circuits can be checked, though not aligned. Switch S3 to analogue, turn VR3 fully up (max input level), and VR5 to minimum (nil gain). Set VR1, VR2 and VR6 midway and S8 to ac mode. You should again see a digital-

Fig. 13. Suggested front panel legends which may be photocopy enlarged and fixed to the front of the unit's case.

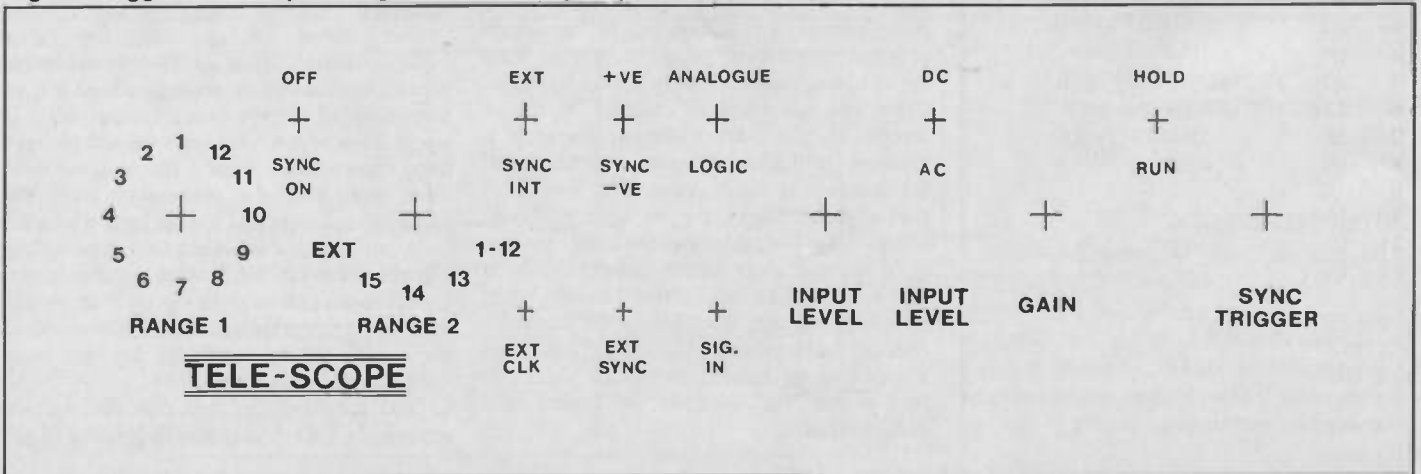





type signal on screen, but at a different height to that seen in digital mode, and with addition of extra sample bits moving up and down the vertical edges of the trace.

A sine or triangular waveform is needed for aligning IC1 and hopefully you've got access to a signal generator for producing it. (If you haven't a sig-gen the alignment can be done when any other sort of known signal is being fed in.) Bring in the signal in place of the temporary connection to S1. Set VR1 and VR2 to put 5V on IC1 pin 9 and 0V on IC1 pin 10. These levels set IC1 for its maximum reference range in which only a full input voltage swing will produce a maximum output count swing.

Turn up or turn down the signal input level until the screen shows the waveform to have flat tops and bottoms. This indicates that IC14a is just beginning to clip the signal. Adjust bias control VR4 until the clipping is symmetrical. Slightly reduce the input level until the waveform is no longer flattened. Progressively reduce the settings of VR1 and VR2 in turn until once more the signal is flattened uniformly. You will also notice the height of the waveform increases as VR1 and VR2 are reduced, due to the reference voltage span being reduced.

Now very slightly turn both presets the other way until the signal resumes its better shape. The circuit is now aligned, though you may find you need to make slight adjustments once you've put the unit into prolonged use and are more familiar with it.

### VARIABLE SYNC AND CLOCK

You've probably already been playing around with the sync control VR6 and seen how the screen waveform shifts backwards and forwards depending on the point at which the sync signal trips. And you probably had to switch S1 to a different setting in order to display a usable waveform on screen when plugging in the signal generator, so you'll know how that works too. If you haven't, try both actions now!

#### SWITCH S1 RANGE POSITIONS

1	f (clock)	4MHz	0.25µs
2	f/2	2MHz	0.5µs
3	f/4	1MHz	1µs
4	f/8	500kHz	2µs
5	f/16	250kHz	4µs
6	f/32	125kHz	8µs
7	f/64	62.5kHz	16µs
8	f/128	31.25kHz	32µs
9	f/256	15.625kHz	64µs
10	f/512	7.8125kHz	128µs
11	f/1024	3.90625kHz	256µs
12	f/2048	1.953125kHz	512µs

#### SWITCH S2 RANGE POSITIONS

1	to S1	(f to f/2048)	
2	f/4096	976.5625Hz	1.24ms
3	f/8192	488.5625Hz	2.48ms
4	f/16384	244.140625Hz	4.096ms
5	external clock		

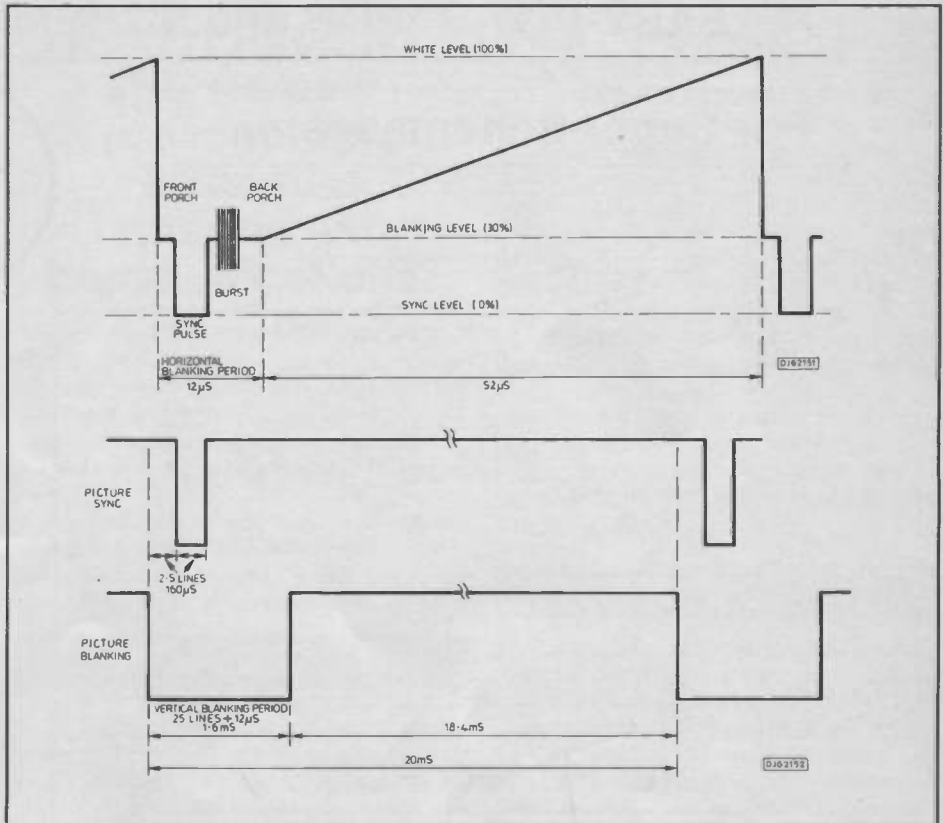

Fig. 14. TV sync and timing waveform data.

### TV POSTSCRIPT

Purely for interest, a diagram (Fig. 14) and a few notes on the nature of the tv signal normally received by your set (this data may not be appropriate for overseas readers):

Although it has been said earlier that the vertical sync frequency is 50Hz, a more complex situation exists. The normal 625 lines which form a picture are not transmitted as a single sequence. Instead, the data is sent as two groups each of 312.5 lines. Each group is known as a field (once upon a time referred to as a frame, the term probably having its origins in film making). The two fields are placed in slightly different positions on the screen, the lines of one group being 'interlaced' between those of the other. The transmission rate for each field is 25Hz, but the total time to transmit both fields before the cycle recommences gives a repetition frequency rate of 50Hz. It is the field frequency rate that determines the line frequency of 15625Hz, ie 25 x 625. Each line period corresponds to 1/15625Hz, which is 64µs in duration. 12µs of this contains the line sync information.

The vertical repetition rate of 50Hz can be otherwise defined by saying that each picture lasts for 20ms. About 1.6ms of this is used for the field pulses. This 1.6ms corresponds to 25 lines plus one horizontal blanking interval, during which the tv video signal is also blanked. (Blanking of the video signal in the module described above was found to be unnecessary in this application.) The interval includes 2.5 line periods, a total of 160µs followed by a field pulse chain, also lasting for 160µs.

In the UK, the video bandwidth is nominally

5.5MHz and only 575 of the total 625 lines are actually seen on screen. The remaining 50 lines occur during the vertical 'flyback' period when the dot flies back from the bottom of the screen to the top. During this time the screen is blanked so the flyback is not seen.

Readers who want to know more about tv and video are referred to the *Video Handbook - 2nd Edition* by Ru Van Wezel. All aspects of the subject are covered, including tv technical facts and standards, video cameras, transmission and reception, picture recording, audio, production techniques, and much more. It is published by Heinemann Newnes as ISBN 0-434-92189-0.

### EYE OPENING

Much has been said about the theoretical and practical aspects of this circuit. I hope you have found it interesting and informative. I also hope that you will build the circuit, either for any of the reasons I gave at the start of the article, or just for the sheer enjoyment of building a circuit the likes of which you probably haven't come across before. For me, designing it has fulfilled a challenge I recognised years back, and I have had a great deal of enjoyment from doing it. May it open your eyes to wider appreciation of the fascinating world of electronics. PE

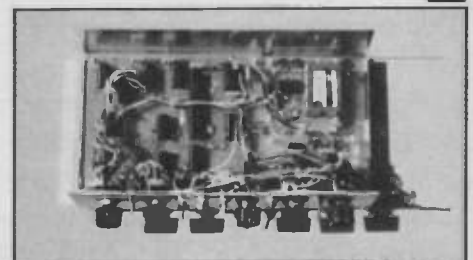





**E**lectricity and gas meters are unique instruments which differ profoundly from the fast changing area of instrumentation for measurement and control. For process control, the aim is to obtain information very quickly in a form that can be fed back for control or as a precise figure for accountancy and record purposes. House meters get read every few months and the accuracy only determines the fairness of one bill against another.

One aspect of domestic metering which is more difficult is due to the highly variable nature of the demand. For long periods, say overnight, the load may be virtually zero and then suddenly change to its maximum without warning. It is therefore the rangeability of measurement which is more important in its accuracy at any one value. Thus the main criterion from the supplier's point of view is the minimum reading that is reliable. This led some 50 years ago to much work on meter bearings and starting torque, since unless the pilot consumption is registered, the loss to the company is significant.

Because such meters are mechanical in principle, the limiting factor is friction, and this varies with time. While improved bearings and materials can reduce the effects, the elimination requires an entirely different principle. The most obvious is electronic operation and of course such electricity meters are now available.

## Robert Redding offers a new prospect for residential metering and communications.

research, some 12 companies responded and after six months' evaluation, it was announced that they would sponsor four schemes. One was fluidic and three were electronic; two of these were based on ultrasound, and resulting contracts were due to be assessed at the end of 1989.

The decision surprised some traditionalists, and led to headlines such as "Revolution in the Meter Cupboard" (1) and "British Gas Goes Electric: as long as it runs on batteries". (2)

### READING COSTS

If, however, one looks basically at the business of domestic supplies or accountancy, then it becomes quite clear that the cost of reading the meter far exceeds the cost of the meter itself, and until the bills have been issued, the measurement is virtually useless. What is required is an automatic billing

procedure, and we need the meter's information as an electrical digital signal which can print the bill! The major problem is how to get the information to the right place, and though the telephone line is the obvious answer, previous attempts at using this and combining forces with other services, seem to have failed (3).

Personally, I would go further and suggest that the function of the residential meter is to ensure the safe delivery of the service at the house in an easily controlled manner. If we have a digital gas flow measurement system, then the storage and recovery of information, and its processing and use for all sorts of purposes, is inherent as well as the ability to print out the bill automatically. The main problem is how to get the information from the gas main to the point where it can be used; how we measure it is secondary.

### ORIGINS

It may help to explain such a radical proposal if I outline how I arrived at it. About 1946 I was involved in the telemetry of gas stocks as shown by the height of gas holders. The "transmitter" had evolved from work on electricity meters by George Shoter of NorthMet and was intrinsically safe from explosion. The information was transmitted on a telephone line to head office, so the hazards of the problem are not new!

# POLYLINE METERING

## FLUID TRENDS

The trends in fluid flow measurement generally have been towards electronic operation, either by detecting the movement of a turbine blade or vortices in the stream, or directly by magnetic field effects and ultrasound. Obviously, the "non-invasive" or electronic type are inherently attractive, even if less easily accepted for such an important measurement, where the differential pressure across an orifice has ruled for a century. Recent interest in a fresh gasmeter may change the outlook.

The traditional domestic gas meter works by counting the number of times a bellows fills and empties, and has been virtually unchanged for a century. In the last decade there have been attempts to make a smaller version and locate it outside the premises. Soon after British Gas became a PLC, it called a meeting to promote "The Gas Meter for the 21st Century".

Some of the 100 manufacturers expressed apprehension about disclosing new ideas against yet another specification for a gas meter costing about £30, but it was insisted that the PLC's job was to supply gas, not compete with the instrument industry.

Given five months to come up with proposals for further development and

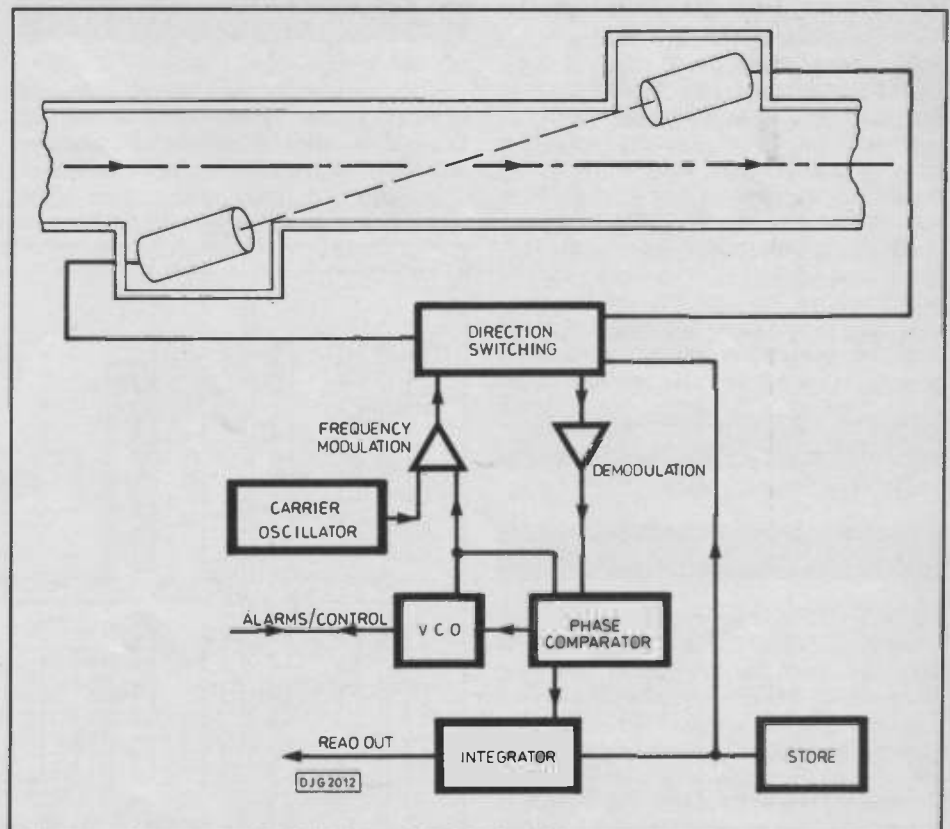
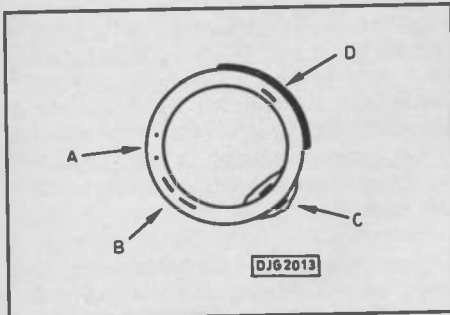

Fig. 1. Simple basic principles of continuous-wave ultrasonic flowmeters.



**Fig. 2. Various configurations for conductors in polythene pipe walls.**

However, the buzz term in 1950 was Automatic Control, with the accent on pneumatic devices of American origin. I joined the company which made the first electronic process controller in 1951, and there followed ten halycon years for the instrument industry. We had the right ideas, but unfortunately it was not soundly based commercially, and the initiative moved to the USA in the early 60s. I tried my hand at computer-aided design of process plants in the hopes of making them controllable, but that was way ahead of its time too.

## SAFETY

Intrinsic safety had been pioneered in mining in the UK, but there was a new context. A large petrochemical complex might have a lot of individual 'safe circuits', but there were severe doubts about the safety of control systems as a whole, and this was where the zener 'safety barrier' came to the rescue. Many new areas adopted electronics for duties such as remote control, security and fire alarms, and new headaches arose on North Sea oil rigs.

Such work caused me to try to evolve a gas detector to measure the amount of gas in the atmosphere long before it reached the explosive limit, that is, a pattern recognition early warning system, and an ultrasound system was evolved for this purpose. Most ultrasonic sensing uses the pulse techniques of emitting a pulse and measuring the time period until a reflection is received. This was problematic in the open air, and led to an ultrasonic carrier beam, on which a lower frequency modulation was phase-locked. It gave an extremely sensitive measure of the transit time as a frequency, but was not popular. Its eventual slow evolution as a transducer and particularly as a flowmeter was described recently (4).

## FREQUENCY KEY

The key to solving the problem is that the information signal takes the form of a frequency. Since the 1950s there have been advocates of transmitting information as a frequency but the analogue 4-20mA which replaced the earlier 3-15 psi of pneumatics, has ruled the petro-chemical industry so that a turbine or vortex flowmeter has its natural frequency output invariably turned into a dc

analogue in order "to conform with industry standards". Such ironies are now beginning to show in digital control system and data highways.

The special property of a frequency in carrying information is that the fundamental frequency can be recovered in spite of severe distortion and attenuation in the transmission path.

Using a frequency also neatly kills the analogue to digital controversy and any need for conversion, because a frequency signal can be both at the same time, as will be seen in principle in the ultrasonic gasflowmeter of Fig.1.

The phase-locked loop frequency that settles between two transducers across a pipe will be the same, whether the sound travels from A-B or B-A. If, however, the fluid in the pipe moves, the apparent frequency will change, ie the doppler shift will add in one direction and subtract in the other. This difference is a direct translation of fluid motion into Hertz. Numerically it is 2Hz per metre per second of velocity. Notice that all other effects, such as the temperature and the nature of the fluid itself affect the actual frequency values equally, but the difference is a fundamental measure of motion alone.

Whether one uses a carrier and modulation and in what form depends on the size and duty required but in principle all that is known about frequency modulation on radio applies, and seems to work better on sound waves which are many times slower, perhaps because the attenuation varies as the square of the frequency.

## CORRECTION OF VARIABLES

Once we have the fluid velocity expressed in Hertz, we can correct for any variable we know about, such as pressure, temperature, density, to give mass or energy as required. The important point about the prime measurement is that it is linear, continuous

and can be scaled to suit large and small conduits.

The time between reversals can be made one second, several minutes or even one hour if the temperature is stable, and this is the reason for saying that the best location for the meter is buried underground with the pipe before it enters the premises. The limit of performance is set by the need to keep the ambient temperature steady during the whole cycle of reversal while counting the frequency up and down, to leave a digital remainder, which, related to the test period, is a difference frequency whose period is an analogue value of the flow, and the number of cycles is the total volume.

The digital frequency signal is of course just right for communications on the public telephone line, were it not so overloaded! and even more so on the fibre optic cables when we get them to each house, but this is currently in considerable doubt. (3)

## COPPER INSERTS

However, if we bury the meter underground we shall need connections alongside the pipe (and indeed it is quite usual to put a telephone cable alongside plastic water and gas pipes) in order to find where they are before making excavations. The nub, though, of my proposal is that we can incorporate two small strips of copper in the wall of the gas (or water) pipes and so make a connection from each house and its meters, and on to the end of the street where a local sub-station can connect with the trunk telephone and fibre optics network.

The implications of this proposal, referred to for short as "Polyline", are profound. The regular material for new underground water and gas pipework is polyethylene in long continuous lengths jointed by fittings with inbuilt electric heaters. The wall is thus an ideal electrical insulator for a broad band communication circuit, and Fig.2 shows a number of possible configurations for wires or striplines.

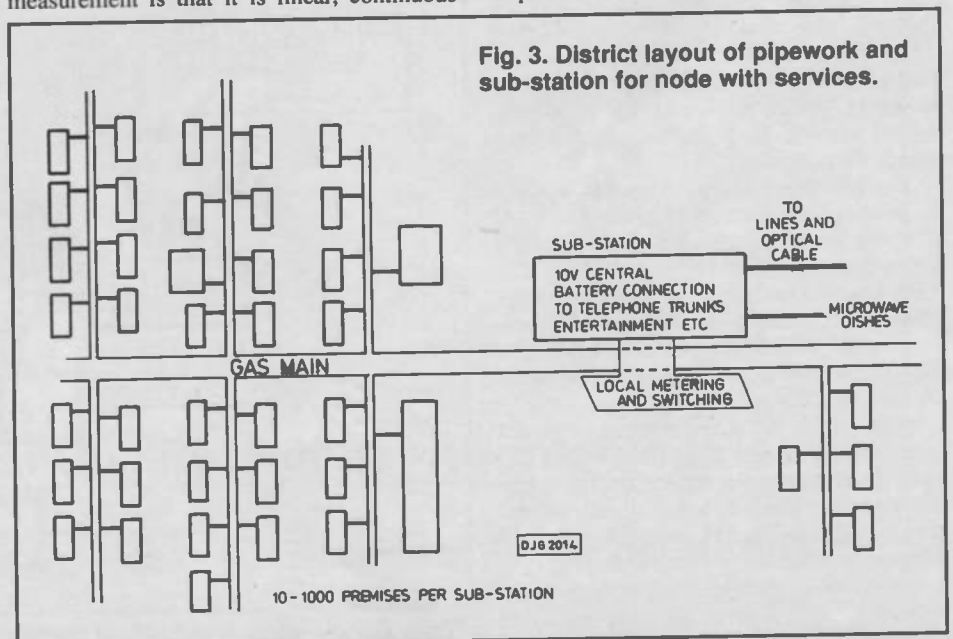

**Fig. 3. District layout of pipework and sub-station for node with services.**





**O**hm is a name which is synonymous with the most basic electrical and electrical theory. In fact every school boy who studies physics will have heard of Ohm's Law and will be familiar with the ohm as the unit of resistance. Yet behind the unit and the law was a very real man. Someone who performed experiments with phenomena which were at the fore front of the science of the time. He was someone who had to take the criticism and ridicule of others of the time who did not agree with his findings. He was also a person who had a great insight, he was able to develop his theories with only the most basic measuring techniques and equipment.

## EARLY YEARS

Georg Simon Ohm was born on the 16th March 1789 in a town called Erlangen in Bavaria which is now part of West Germany. He was the eldest of three children born to Wolfgang and Maria.

His father was a locksmith who had a keen interest in the science of the day. He taught his children a lot of what he had learned and this was to pay off for some of them in the years to come.

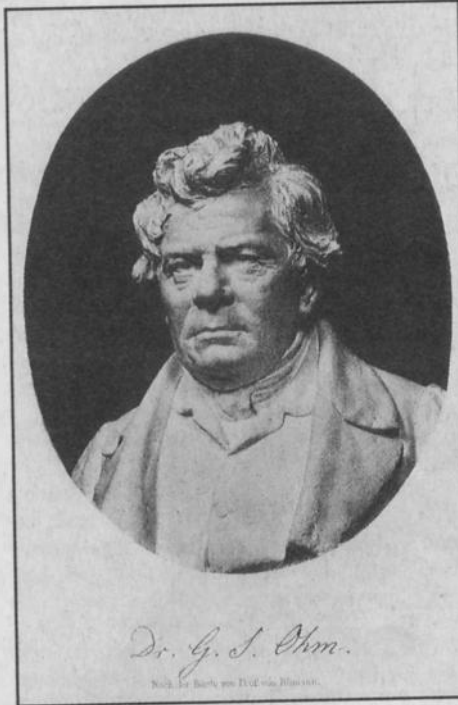

The Institute of Electrical Engineers kindly supplied this photo of von Rumann's bust of Georg Ohm.

this set up he was able to derive a new relationship and this turned out very much like the form which well all know now.

When he was certain of his findings he published a paper, hoping to gain further recognition. However, there were inevitably some of the established scientific community who treated his findings with a great deal of scepticism. They even ridiculed him in the scientific press. A few people, though, recognised his work, and he was able to move on to Berlin to proceed with further research.

## CAREER IMPROVEMENT

Much of Ohm's time was now devoted to his research. He also wanted to become a professor at a leading university and he accordingly set out to do this.

The first step which Ohm took was to publish a book summarising his work. This he did in 1827 in a book called "*Die Galvanische Kette Mathematisch Bearbeitet*", (The Galvanic Circuit Investigated Mathematically). He also invited offers of a job from the academic institutions but as his work was received so indifferently none were forthcoming. As a result of this Ohm decided to resign from his post as teacher at Cologne

# GEORG OHM

The young Georg entered secondary school at the age of 11 years and he showed he was a bright student. He went on from the secondary school to University at Erlangen in Bavaria in 1805. Ohm made a good start there, but like for so many young people today the social life seemed to have far greater attractions and his studies took second place. After just over a year he had to leave and bear the anger of his father who had so many hopes for his eldest son.

At this point Ohm took up teaching as he had a firm grounding in the subject from his earlier years. He started in Switzerland and remained here for five years.

## FOUNDATIONS LAID

Ohm returned to Erlangen having learnt some of the hard truths about life. This time he set to work and soon obtained a PhD. Now he decided that he wanted to make something of his career. He took up teaching with the idea of becoming a university professor. He spent a few years moving from one post to another without any real degree of success. He decided to publish a book on geometry to gain more recognition. This he did and fortunately it worked for he soon became a teacher in Cologne at the Jesuit's College which was very well respected.

## THE LAW DERIVED

It was 1820 and the phenomenon of electromagnetism had only just been

**Ian Poole reveals that Ohm, although an early researcher into electromagnetism, only received widespread recognition post-humously.**

discovered. Ohm was fascinated by it and started to experiment. He performed many experiments and measured the various effects associated with it. The science was a very different one to that of today. Even the most basic measurements were quite difficult to make with any degree of accuracy.

There were no meters as we know them today. Instead the magnetic force around the conductor was measured. By doing this Ohm noticed that the type of conductor had an effect on the magnetic flux. He performed many experiments to try to determine any relationships that might exist. Despite many difficulties because the science was at its very foundation Ohm came up with a relationship between the current, voltage and the properties of the wire. Unfortunately it was not Ohm's Law as we know it today because it even included logarithms.

Ohm continued his work and refined his results. He managed to improve the batteries which were a major source of error in high results and he also used several pieces of similar wire, but of different lengths. Using

and take up temporary teaching. This would enable him to take up any appointments if they did arise. During this time he found that his work was just beginning to be accepted, but even so nobody wanted to offer him a job.

Then in 1833 Ohm did manage to secure a better post. It was as professor of physics in Nurnberg at what we would call a polytechnic today.

## LAST YEARS

The true importance of Ohm's work slowly began to be recognised, and with this came a number of honours. In 1839 he became a member of the Berlin Academy. Then in 1841 the Royal Society in London awarded him the Copley Medal and a year later he was made a foreign member.

Finally, in 1852 he was appointed professor of physics at Berlin University. Unfortunately he was not able to enjoy this for long as he died shortly afterwards on July 16th 1854 in Munich.

After Ohm's death his work achieved more acceptance. Many societies and organisations saw the need for units of resistance. In fact it was the British who saw fit to name their unit of resistance after the great Ohm himself. Then in 1881 this unit was adopted by international agreement at a conference and Ohm's name was made immortal. Finally he had achieved the recognition he wanted during his life time.

# A HANDY NEW ADDITION TO OUR VERSATILE MULTIMETER RANGE

**£38<sup>98</sup>** inc. VAT  
please add £1.00  
for p + p

## DIGITAL CAPACITANCE METER

An extremely useful hand-held capacitance meter measuring from 1pF to 20,000µF in nine ranges.

### Features include:

- 13mm, 3.5 digit LCD
- Zero adjustment
- Low battery indicator
- One year warranty
- Supplied with battery (PP3), manual and test leads
- Just one of our many low cost Digital Multimeters - send for full details

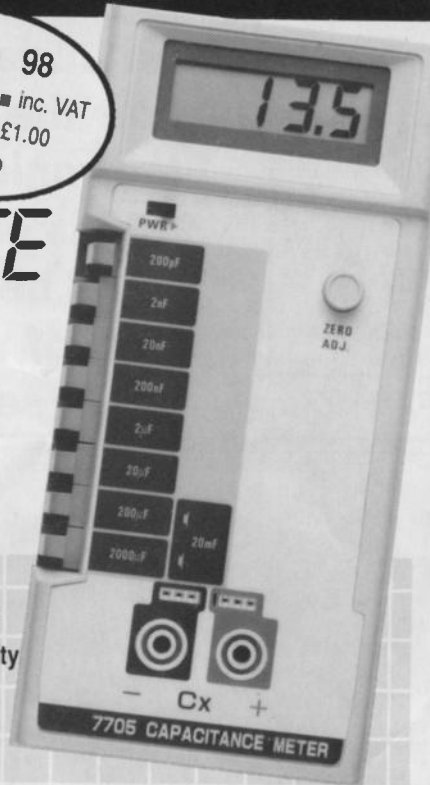

### Specification

ranges	res.	accuracy
200pF	0.1pF	+ (0.5% + 1 digit + 0.5pF)
2nF	1.0pF	+ (0.5% + 1 digit)
20nF	10pF	+ (0.5% + 1 digit)
200nF	100pF	+ (0.5% + 1 digit)
2µF	1.0nF	+ (0.5% + 1 digit)
20µF	10nF	+ (0.5% + 1 digit)
200µF	100nF	+ (0.5% + 1 digit)
2000µF	1µF	± (1.0% + 1 digit)
20,000µF	10µF	+ (2.0% + 1 digit)

Overload protection	0.25A 250V fuse
Excitation voltage	3.2V, all ranges
Dimensions	180 x 85 x 38mm

## OUT NOW!

- The new Cirkit Catalogue
- 184 pages
- Discount vouchers
- 1,000's of products



# Cirkit

£1.60 inc.

**SAME DAY DESPATCH - 0992 444111**

Cirkit Distribution Ltd.

Park Lane, Broxbourne, Herts. EN10 7NQ

Tel. Enquiries (0992) 441306 Fax. (0992) 464457

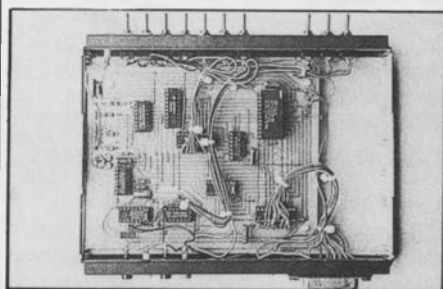

## ALL KITS INCLUDE PCBs

## THIS MONTH'S GREAT PE FEATURE!

**TELE-SCOPE (PE SEP-OCT 90)** Interface for turning any tv into an oscilloscope. Plugs into aerial socket. It can save you hundreds of pounds!  
Comps & case: SET 303 £89.95

### FREQUENCY COUNTER-GEN (PE SEP 89)

Great value & highly versatile test gear. 2 freq gens produce analogue (over 20kHz) & digital (over 2MHz) waveforms. Lcd counter displays freq of int & ext sigs to 4MHz. Components & case (excl lcd): SET 296 £33.50 (LCD counter module PCIM300 available from Cirkit).

### MONO-STEREO ECHO STATION (PE OCT 89)

Lengthy echo, reverb, multi-tracking, phasing, flanging, chorus & vibrato effects with mono & stereo signals. Echo to 25ms on std unit. Echo to 166ms & multiple range choice on long unit. Infinite reverb on both units. Extended delay version: SET 294L £65.00. Standard delay version: SET 294S £33.50.

# PHONOSONICS

## LEADING SUPPLIERS OF KITS FOR PE PROJECTS SINCE 1972

### MESSAGE MAKER (PE MAY-JUN 90)

Give sophistication to your displays: put moving messages of your choosing on a semi-intelligent alphanumeric lcd screen. Computer or eeprom operation. Logic comps & case (excl eeprom): KIT 299.1 £32.50. LCD module extra: £29.50.

### MORSE DECODER (PE JUL 90)

Semi-intelligent module decodes morse from radio, cassette, etc, displaying on alphanumeric lcd screen. No prior knowledge of morse reqd, but unit will help you learn it! Logic components & case: KIT 300.1 £30.95. Programmed eeprom extra: £15.00. LCD module extra: £29.50.

### EEPROM PROGRAMMERS (PE JAN-FEB 90)

Eeproms are re-programmable without the need for erasing with uv light. Here's a choice of programmers! 16-digit keypad data entry unit: KIT 297.1 £67.50. Hex-switch data entry unit: KIT 297.2 £29.95.

### RADIO CLOCK (PE MAR-MAY 90)

Decodes Rugby signals & displays time and calendar data on led screen. Needs no batteries, resetting or winding up - you need never be late again! Receiver logic comps: KIT 298.1 £13.00. Decoding logic comps: KIT 298.2 £36.50. Programmed eeprom extra: £15.00. LED module extra: £11.00

### DUAL BEAM SCOPE (PE NOV 88-JAN 89)

Ideal for the enterprising constructor - a diy twin-trace 1MHz scope with all the usual features for variable time-base, sync & input on both channels. Set of circuit components: KIT 290 £57.50. CRT, transformer & case excluded - catalist states purchase sources

### SCOPE EXPANDER (PE AUG-SEP 90)

Multiply your test viewing - give your scope 8 digital traces on 1 chan. Also acts as logic analyser. Comps & case: SET 302 £45.95.

### VOICE SCRAMBLER (PE JUN 88)

Retain your communications privacy with 32 switch-selectable coded chans. Transmitted signal incomprehensible to unauthorised listeners without equivalent unit. Unit doubles as coder and decoder, switchable. Comps & case: SET 287 £49.50.

### GEIGER COUNTER (PE AUG 86)

High level radiation detector with speaker, meter and computer output. Upgraded version of orig PE project as demonstrated 3 times on BBC tv. Battery operated, very portable. Components & case: SET 264 £65.50.

## CATALIST

Many more PE projects in our Catalist! Send medium sized SAE for your copy and with all enquiries. (Overseas send £1.00 to cover postage.)

## ORDERING

Add 15% VAT on all UK orders. Add P&P - kits over £50 add £3.50. others add £2.50. Photocopies £1.00 per monthly part plus 50p post. Insurance 50p per £50. (Overseas: double UK P&P & ins rates.) Payment CWO, CHQ, PO, ACCESS, VISA. Order by post or via answering machine.

**PHONOSONICS, UNIT P, DEPT PE99,  
8 FINUCANE DRIVE, ORPINGTON,  
KENT, BR5 4ED.**

Tel: 0689 37821 (answering machine).



The world's smallest VHS camcorder, the JVC GR-AX70

# HOME-BASE

**Ian Burley may be foot-sore after the Summer Consumer Electronics Show in Chicago, but his enthusiasm for what could be coming our way is full of vitality. Here's his second report.**

## TINY CAMCORDERS

Since Sony introduced the almost vestigial 8mm HandyCam video camcorder last year, which is still the smallest camcorder on the market incidentally, a rash of tiny new camcorders from other manufacturers have appeared and some of them utilise some pretty smart technology. Olympus has resorted to artificial intelligence "fuzzy" logic in an effort to make the autofocus mechanism of its VX81 camera work more sensibly in conditions where the subject can't be held firmly in the sight of the focus sensor, in action photography for example. Panasonic's PV-40 VHS-C Palmcorder also uses fuzzy logic to provide an electronic picture stabilisation feature. This attempts to damp out the problem of camera wobble, a common problem with the new generation of lightweight cameras. JVC doesn't claim any clever AI technology for its GR-AX70 camera, though it is the smallest VHS-C camera in the world.

*You will recall that Barry Fox looked at fuzzy logic focussing in PE Sept 90. Ed.*

**AI and fuzzy logic maintain optimum focus and exposure in the Olympus VX-81 8mm camcorder.**



Panasonic's PV-4066 Talking VCR

## TALKING AND WIRELESS VIDEOS

JVC may not use AI technology in its camcorders but AI does creep into the specifications of its televisions. For example, if you can't decide which soap to watch, your JVC tv will help you by informing you how popular programmes are in your household.

The tv actually remembers which programmes are watched and can produce a sort of domestic ratings list on-screen. The set will also remember a particular viewer's preferred volume setting. Naturally, picture in picture, video freeze, split screen and multi-channel indexing are all standard as well.

If you're never sure that you've programmed your video correctly, how about a video which tells you? Voice confirmation of video programming is now featured on Panasonic's new PV-4016 and PV-4066 video recorders. The videos will also say "start, stop, rewind," etc to confirm the command.

The newest craze to hit the American tv/video market looks like being wireless video. Several companies demonstrated prototype wireless adaptors, basically compact short range transmitters and receivers which plug into tvs, videos and even video cameras. The range is limited to about 120 feet. This means you can take your portable tv out by the pool and watch your favourite video, for example. And of course any number of tvs will be able to show the recording being played back by one vcr without any cable spaghetti.

Another use would be for security and, perhaps, keeping an eye on your creche. New Jersey-based Gemini managed to gain FCC approval for its videocaster system before the show and announced a \$99 (£60) for a starter pack of one transmitter and receiver. Extra receiver boxes are priced \$60 (£35).





A golf caddy with a difference.

CADDY-CAM

How about the problem of not having anybody handy to do a bit of filming while you're doing something memorable like practising your golf swing or even playing basket ball? Visionary Products in Massachusetts has come up with what it calls an Auto-Cameraman. This is a patented motorised adaptation to a tripod fitting which locates the camera. A position sensor keeps track of a transmitter worn by the subject and the result is that the camera follows you about.

POCKET ENCYCLOPAEDIA

After cramming the Holy Bible into a pocket sized electronic book last year, Franklin Electronic Publishers Inc. now claims to have produced the first pocket electronic encyclopaedia. It's an electronic edition of the Concise Columbia Encyclopaedia. Franklin doesn't say how much memory is hidden away inside the \$299 (£180) unit, but apparently you can search information from anything between the life of Picasso and the progress of the French Revolution. A small calculator-like qwerty

You need never be at a loss for facts with Franklin's pocket encyclopaedia.



keyboard enables you to type in search parameters. A spelling checker is built in, as is a cross referencing ability.

POCKET VIDEOGAME

NEC has produced a hand held version of its TurboGrafx 16-bit computer game console which uses a 2.5 inch colour lcd tv screen, called the TurboExpress. Atari was the first company, last year, to bring out a colour hand held video game with the Lynx. NEC improves on the Lynx by giving it a more powerful microprocessor, a really superb TFT (thin film transistor) active matrix display and the option of a plug-in tv tuner. You can even plug your video camera into the TurboExpress, making it into a colour video monitor.

Talking of active matrix colour lcd displays, Sharp exhibited a 14 inch prototype television using a TFT flat panel lcd screen. It was difficult to judge the quality as the signal source appeared to be very noisy, but I'm convinced we shall see decent sized lcd slimline televisions appearing in the shops some time next year.

Casio's new organiser is the BOSS (Business Organiser Schedule System) model SF-9500. At \$300 (£177), the SF 9500 will have to compete with Sharp's impressive new Signature OZ models. You get 64K ram expandable to over 128K with optional ram cards and a variety of built in applications. The main BOSS advantage over the Signature OZ is that it has a much more useful 32 column six line display. Accessories also allow you to link your BOSS with a PC or Apple Macintosh to exchange data.

HOME AUTOMATION STANDARD

The US Electronic Industries Association had a stand to promote their work in defining a broad set of home automation industry standards. The project is expected to be finalised early in 1991 and consumer electronics products adhering to the standards set are expected some time towards the end of that year.



More new products that are determined to organise your pocket into a portable office.

NEW ORGANISERS

Both Sharp and Casio have added new models to their electronic organiser line ups. The Sharp IQ is called the Wizard in the States and a completely new range of Wizards has been introduced; the ZQ and the OZ. The ZQ is a cut down, cheaper version of the IQ and it can't accept slot-in software application cards. The ZQ also opens up clam-shell style rather than the book-folding action of the original. There is an advantage in this; the keyboard is now in a proper qwerty layout. Two basic models were announced; the ZQ2000 and 5000. The former has 16 or 32K ram and the latter 32 or 64K ram plus extra built in applications and a more detailed display. US prices start at \$110 (£65) and \$210 (£124) respectively.

For what Sharp refers to as 'Power users' you can opt for the OZ Signature series. These offer between 64K and 128K ram, retain the new qwerty style keyboard and also accept IQ software cards - including a 3D spreadsheet. Prices start at \$360 (£212).

And if your pocket's too full, use your wrist!





Mug-shots take on a new meaning when Canon demonstrate their Xap-Shot video still camera, transferring images to coffee mugs.

The hub of a home automation system is communications links to enable the user and controlled appliances to talk to each other. The EIA standard will embrace radio frequency (rf), infrared (ir), mains power cable, fibre optic and telephone line media. A simulated home environment fitted with various home automated appliances was exhibited at the show to demonstrate a bedside panel enabling a householder to lock the doors, switch off lights, adjust the heating and turn off the tv conveniently just before retiring at night. You will also be able to phone into the household control system from the office, for example, and use touch tone number codes to control appliances, like heating or air

conditioning. A number of specialised control chips will have to be developed and incorporated into new products or adapters for older ones. Home automations products displayed in the EIA stand included remotely controlled light switches, a 'smart' remote control phone, remotely controlled drapery and door locks, a home automated video recorder and laser disc player, a system controller, personal computer and data bridges which convert signals from one medium to another. We'll bring you more news of the EIA standards once they're finalised.

*(We gave you another insight into home automation in PE May/June 89. Ed.)*

The new Gemini wireless videocaster scoops industry as the world's first product to transmit quality audio and video from any domestic video source without wires.



## TALKING TRANSLATOR

A number of electronic language translation aids were exhibited at the show but the one which caught my eye came from Matrix Design. Called the Interpreter, this is a walk-man sized unit with a single line lcd display and a small qwerty keyboard. On one side is a speaker and you can also use an earphone, for this translator actually speaks. A dictionary of 10,000 words and 67,000 phrases in five languages (English, French, Italian, German and Spanish) is stored inside this remarkable package. You can either type in single words or search for a required phrase in English and then you can read and hear the foreign language version. Look out for the Interpreter in those Innovations type catalogues which fall out of the Sunday supplements every now and again.

## CALLER ID

AT&T, one of the biggest phone companies in the world, has added its weight behind the Caller ID lobby. This is the controversial option available in some States which enables the receiver of a phone call to identify the phone number of the caller before deciding whether or not to answer. Last January Northern Telecom launched a special Maestro phone to take advantage of Caller ID and now AT&T has unveiled its own add-on box, the Call Display 64. Connecting between a conventional phone and the wall socket, the unit has a simple lcd display and stores the numbers of the last 64 callers and the time/date of each call. Buttons let the user search the call number list and numbers can be selectively erased. The \$90 (£53) unit doesn't offer an automatic call screener, in other words a facility to bar previously selected callers.



To round off this report, a few other items of interest. Blaupunkt demonstrated an in-car cd auto-changer player which links to the dashboard mounted amplifier via optical fibre. Usually the auto-changer player is located in the boot, so long cables are required and these are prone to electrical interference and impedance. Optical fibre instantly bypasses these problems.

That's all we could fit in to this Summer CES report! Home Base gets back to normal next month.

PE

*Ian Burley is the News and Features editor for BT Micronet, an on-line computer and technology magazine published on Prestel by British Telecom.*

# Reader Loyalty Bonus

**REALISTIC Walkie talkies**

Only 24.95

59.95

**Tandy**

Buy any product advertised in this issue of Practical Electronics, and we will refund you all or part of the cost, up to a maximum value of £150 or £200 if you are a subscriber.

**MCP SERIES II NOW PROGRAMS MORE DEVICES**

- STILL from only £250
- 12 bit and memory in memory
- High speed algorithms
- Low cost software
- 12 Month Guarantee
- 25 I/O devices
- Expanded EPROMS (256K, 512K, 1024K)
- Programs for 256K, 512K, 1024K per EPROMS, EPROMS, and Micro controllers
- Adapters for other devices scheduled for shipment include 256K, 512K, 1024K, the 8078 family and 7817CSD
- Easy to use menu driven software for MS DOS installed in the area with each improved pip up help facility in either the Serial port or network no separate user - cable included in price
- Memory from 64K to 1024K in 16K increments
- Designed, manufactured and supported in the UK

We also sell **Assembler and Comp Programmers, EPROM Emulators and Erasers, and a widespread cross-assembler for IBM PCs and compatibles.**

Write to: **MCP ELECTRONICS**, PARK ROAD CENTRE, MILLS BRIDGE, WILTS, SN16 8BA.

TEL: 0885 874 147 Fax: 0885 874 141

**mcp**



Buy any product advertised in this issue of Practical Electronics, and we will refund you all or part of the cost, up to a maximum value of £150 or £200 if you are a subscriber.

Buy from **ANY** of our advertisers

All you have to do is complete and cut out the coupon send it to us, together with a copy of the goods you purchased. Then, if you are one of the five lucky readers drawn out of the bag on November 7th, we will refund you your money.

Needless to say, this is one offer you really can't afford to refuse. And, as you will have realised, it will also pay you to become a subscriber. We intend to keep on repeating the Practical Electronics Reader Loyalty Bonus for many months to come.

**B. K. ELECTRONICS**

CRYSTALS

TRANSISTORS

POWER TRANSISTORS

DIODES AND TRIACs

IC SOCKETS

SOLID STATE RELAYS

POLYESTER/POLYCARB CAPS

STEPPER MOTORS

**A HANDY NEW ADDITION TO OUR VERSATILE MULTIMETER RANGE**

**DIGITAL CAPACITANCE METER**

£38.00

OUT NOW!

**Cirkit**

Same Day Despatch - 0982 22 111

**IT WILL PAY YOU TO SUBSCRIBE NOW**

Send to: PE Reader Loyalty Bonus, October 1990, Intra Press, 193 Uxbridge Road, London W12 9RA

I purchased..... as advertised by..... on page..... of the October issue of PE.

Name:.....

Address:.....

Town:..... Postcode:.....

I AM A SUBSCRIBER

Make sure you complete and return this coupon as soon as you make your purchase, together with a copy of your receipt.



## AUTOMATION ORIGINS

Dear Mr Becker,

I was interested to read Robert Hill's letter (PE Aug 90) about automation in the electronics industry. Mr Hill's work at Pye TVT was predated by that of John Sargrove in the early to mid 1940s.

Sargrove invented, constructed and put into operation a machine which produced complete panels for radio receivers. On these panels the inductors and the majority of the capacitors and resistors were actually 'printed' onto the boards. Necessary contacts were inserted and connected automatically. The machine also tested the boards.

I have a video tape made from a film, first shown in 1947, which shows the machine in operation producing the pair of boards required for a simple two valve regenerative receiver. Sargrove also designed the special valve needed for the set. In my possession are his films of various automation projects together with some lantern slides and one of the valve used on the radio receiver project.

Sargrove's work, which is insufficiently recognised and appreciated, led him to being awarded the first Clerk Maxwell Premium of the British Institution of Radio Engineers. (This institution is now part of the Institution of Electrical Engineers.)

If you are interested, I could write an article on Sargrove and his work. Incidentally, I am not related to your correspondent Robert Hill!

Joe Hill B Sc, C Eng, MIEE,  
Gerrards Cross, Bucks.

*I contacted Joe Hill by phone and discussed Sargrove's work with him. It is indeed a story which should interest you all, and hope to publish in due course.*  
Ed.

## SOURCE AND CHIPS

Dear Sir,

I want to ask a big favour. I want to build the *Mono-Stereo Echo Station* in PE Oct and Dec 89, but the ics are not available in South Africa. I have already built your *Vodalek* and it's working like a dream. Is it possible for you to send me a price for the MN3011, MN3101 and MN3004 chips and for me to buy them from you?

I am also urgently looking for a capacitor tester with various

# TRACK FEEDBACK

testing values and digital displays. A project also fascinating me is your *Frequency Counter and Dual Generator* in PE Sep 90, the sourcing the chips is also a problem.

L.U. Janse van Rensburg,  
Cape Province, South Africa.

*We regret that PE cannot offer to obtain components for readers, we would never get PE to press if we did! We have a lot of excellent advertisers who will be only too delighted to let you have their catalogues, and it is through those pages, or the adverts, that you will need to turn to locate parts for projects.*

*With the particular parts you mention, I happen to know that the author bought his chips from RS Components. Although RS will only supply to the trade, they have a separate division, Electromail, who will supply to non-trade customers. They are at PO Box 33, Corby, Northants, NN17 9EL, tel 0536 204555.*

Ed.

## CREDIT THAT CAT

Dear Ed,

I have belatedly read the letter from W.R. Peach in PE March 90 concerning his problems in controlling a Cat Flap. Your reply was also quite interesting!

I have been puzzling myself with a similar idea but without weighting the cat down with a 2lb magnet, it is quite difficult to make the flap open every time.

A way to fix this problem may lie in a method I have seen used by security companies. I have seen for some years now, security systems that use a credit card sized card that has an active antenna in it. The card is placed in a changing magnetic field and generates its own power from some internal circuit, and then sends a signal back to a small receiver. I do not pretend to understand exactly how this works, but I thought it might be possible to build a simple version of this for your errant cats! It may even solve your own personal problem as you could open the flap when the cat is still two feet away from the door. I have read somewhere that it is possible to design an antenna that

sends back double the frequency that it receives, with almost no hardware at all.

Maybe a timer should be built in (long at first, until the cat gets used to it) so that if 'Pussy' decided to sleep near the door, either inside or out, your heating would not be departing at the same time as the local moggies invite themselves in for tea and a quick warm up! The cat would have to leave the vicinity and return to re-activate the opener.

Another method, but not so secure, would be to build a metal detector under a mat. The coil would be large and as a small piece of aluminium foil gives the strongest signals (ask any detector user!), a part of the cat's collar could be wound with foil and then taped over. The system must be designed so that the normal amount of metal in collar and maybe a bell, do not produce a large enough effect.

If you do decide to design something, do not forget a disable switch for when the door is open, to stop it causing damage to walls or itself!

A Mathison, West Germany.

*Moggy's not sure she should thank you, but I am!*

Ed.

## BASIC ISSUES

Dear Sir,

I have just purchased my first issue of PE and am really enjoying the read and would like to try and learn some more.

The articles by Owen Bishop on *Basic Electronics* with the experimental circuits are super. Is there any way I could get photocopies of the previous articles by him? I am a disabled pensioner so I cannot afford to buy the entire set of back issues. I shall be purchasing future issues from my local newsagent.

R.A. Pyatt, Orpington, Kent.

*When we still have back issues available we naturally would prefer to sell the issues themselves rather than photocopies of individual articles. However, in this instance we would be pleased to sell photocopies of Owen's*

articles, at £1.00 each including post (the standard price for article photocopies). However, the back issues are only £1.75 each including post, and there's a lot more interesting information you could have for just another 75p a time!

Ed.

## SOLDERING TIPS

Dear John,

With reference to your article on *How To Do It*, page 61 of several PE issues, under the heading *Assembling the PCB*, I must point out that you are wrong to say, and I quote, "clip off the excess component leads after you have soldered them. If this method is adopted it will lead to oxidation of the component leads and possible fracture of the soldered joints."

The following is a list of the proper procedures to adopt when soldering components to pcbs and which ought to be of use to your readers. This technique of soldering is widely accepted by private manufacturers, H.M. forces etc.

Clean the pcb; clean the leads of components; form the leads; clean the leads again; tin the leads if necessary; insert the component; cut the leads; solder the component; clean the soldered joints; inspect the work carefully, especially for blow holes and de-wetting.

I have been an avid reader of PE for a good many years - keep up the good work.

P.G. Frazer-Ward, Redcar, Cleveland.

*You are absolutely right, this is the best technique and one which should be adopted if assembly-work is to stand up to the rigours of time.*

*One problem readers should be aware of when cutting leads prior to soldering is the danger of component leads slipping partly out of the pcb when it is inverted for soldering. The use of pcb assembly frame with a foam clamp lid minimises the risk. In the absence of a frame, slight bending the leads sideways to stop the component moving also helps get round the problem. However, the latter method makes component removal less easy should the occasion arise.*

*If readers are concerned about long term oxidation and have problems with cutting leads before soldering, a compromise solution is to solder and cut, and then resolder each joint to fully coat the bare lead.*

Ed.

PE

The power unit is a conventional design using integrated circuit stabilisers for the four supply rails of +12V, -12V, +5V and -5V. Zener diodes may be substituted for the two 5V stabilisers if the analogue version of the filters is used since the 5V supplies are then only required for the driver board. The circuit for this modification is shown as an inset on the power unit diagram Fig.26. No circuit board design is provided for the power unit because of the variety of mains transformers and capacitors available from different suppliers. I used separate transformers for the 12V and 6V supplies as shown in the diagram but there is no objection to using a combined transformer if one is available. The diodes connected across the various stabilisers protect the unit against inadvertent short circuits in the load. If you are sure that there won't be any short circuits during testing these diodes can be omitted. The 100nF capacitors on the input and output of each stabiliser should be wired close to the integrated circuit pins. They are provided to prevent high frequency oscillation within the stabilisers.

Care should also be taken in construction of the power unit for safety reasons. The mains connections to the fuse, switch and transformer should be covered by sleeves to prevent accidental contact if the unit is being tested outside its case. To improve the overall screening it is best to mount the whole assembly in a metal box. Several companies supply inexpensive cases which are suitable. My own unit was built in a box measuring

## Part Three. Joe Chamberlain concludes the project with final constructional, alignment and use details.

380mm x 95mm x 210mm deep. It may be worth noting that the two types of filter can be mixed (the same drive frequencies are used for both) provided that the switched capacitor driver circuit is used. There is certainly some advantage in using the analogue filter for the 12.8kHz channel. Of course you do not need to construct the full range of channels if, as in my own case, only a limited frequency coverage is required for a specific application.

### ALIGNMENT

There is very little alignment to undertake if the filter components have been correctly made up. It is helpful, but not essential, to have access to a millivoltmeter, frequency counter and oscilloscope to follow the procedure described.

**Analogue driver.** Adjust the frequency of the multivibrator to 25.6kHz, either by using a frequency counter or by comparing the 50Hz output from the divider chain with the mains frequency.

**Analogue filters.** Switch on only the output required to drive the filter to be aligned and adjust VR2 and VR5 to produce maximum output. Connect the output of the transmitter to the input of the receiver and similarly adjust the receiver filters. Signal levels can be monitored with either an oscilloscope or a millivoltmeter. Repeat this sequence for all the filters in turn, remembering to turn off all unused signals.

**Amplifier unit.** The output level of each signal source can now be separately adjusted to produce an output level of 0dB when the output is terminated in 600 ohms. Gain control VR21 should be set for maximum output and the attenuator set to minimum loss. Adjustment of the output level is achieved by changing the value of the input resistors R1 to R10 to set the output to the nearest 2dB. Fine adjustment may be made by slightly detuning the transmit filters but the range of adjustment should be limited to 1dB for each filter section otherwise the filter response will suffer. Again, only one channel should be switched on at a time.

**Display.** The display module should light all segments when the transmitter and receiver are connected back to back, the terminating resistor is connected and the controls are set as follows:

# AF OCTAVE MEASURING

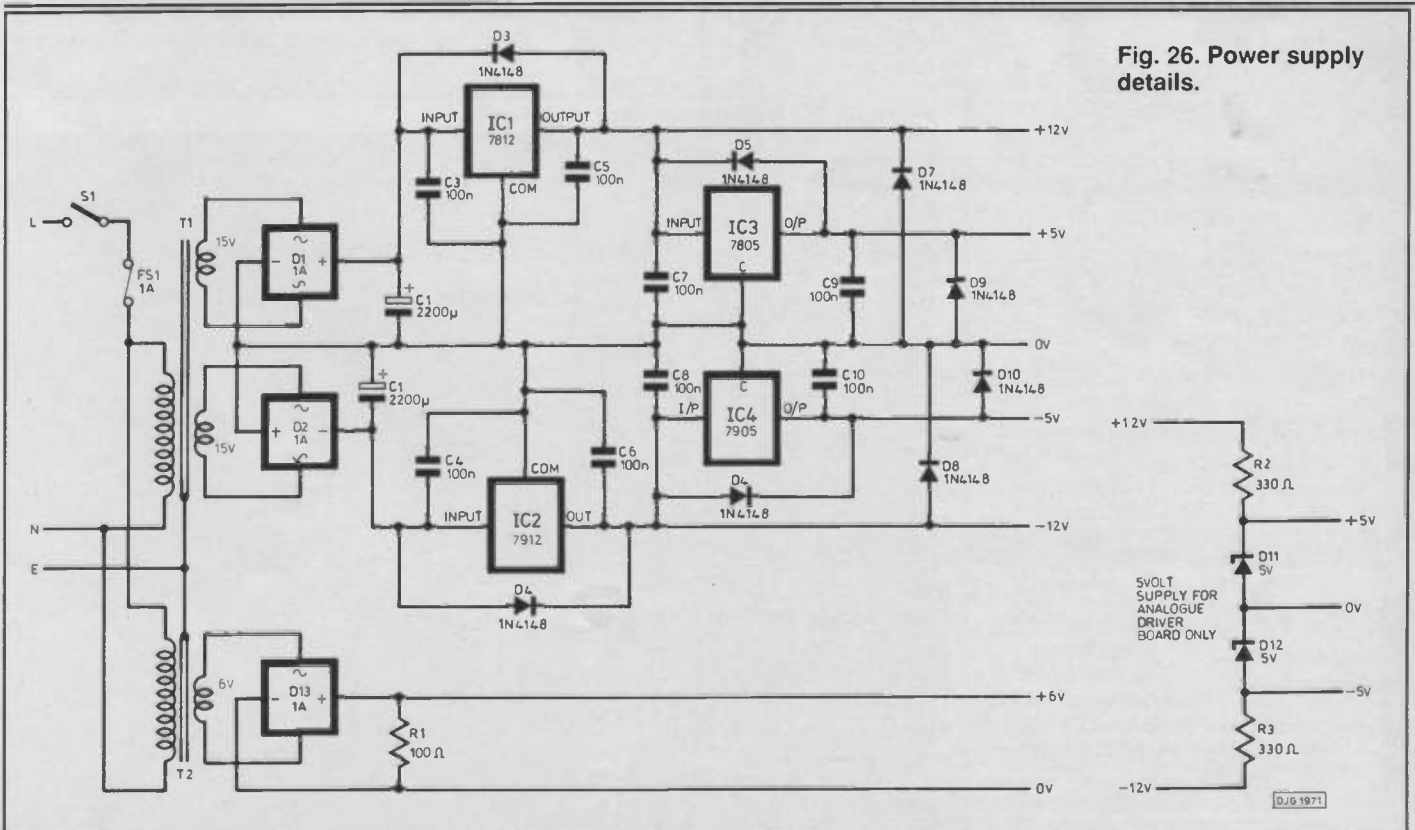

Fig. 26. Power supply details.

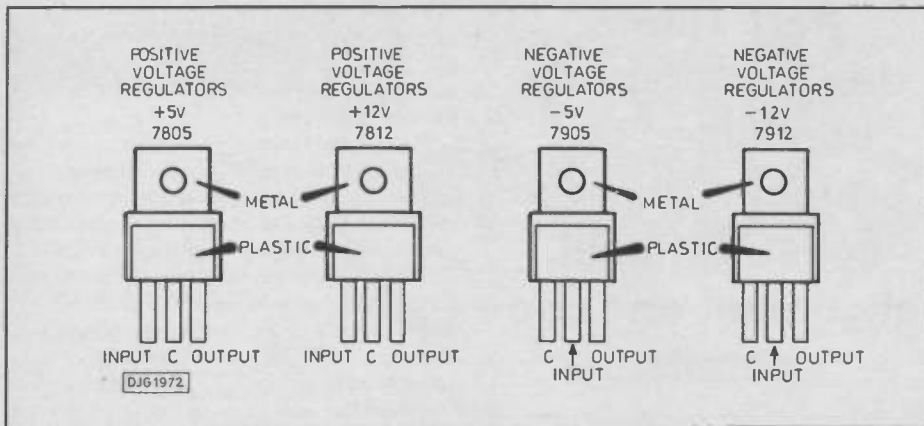

Fig. 27. Connections for 1A regulators.

Transmit attenuator 0dB (minimum loss)

Transmit variable gain control (R21)  
maximum output

Termination in circuit

Receiver input level control near minimum loss  
Receiver gain control minimum (position S)

Three segments should extinguish when 10dB is inserted in the transmit attenuator. This test should again be done for each channel in turn. If the receive sensitivity varies between channels, R13 on the analogue filter board may be adjusted. The corresponding resistor on the switched capacitor filter board is R16. The resistors should only need trimming if the loss through the different filters varies. There are no other adjustments to be made on the switched capacitor filters.

## POWER SUPPLY COMPONENTS

### RESISTORS

R1 100 ohms 20% 0.5W  
R2, R3 330 ohms 20% 0.5W  
(2 off)

### CAPACITORS

C1, C2 2200µ 25V electrolytic  
(2 off)  
C3-C10 100n polycarbonate or polyester (8 off)

### SEMICONDUCTORS

D1, D2, D3 1 bridge rectifier (3 off)  
D3-D10 1N4148 (8 off)  
D11, D12 5V zener diodes 0.5W  
(2 off)  
IC1 7812 +12V regulator  
IC2 7912 -12V regulator  
IC3 7805 +5V regulator  
IC4 7905 -5V regulator

### TRANSFORMERS

T1 240V primary  
2 x 15V secondaries,  
12VA  
T2 240V primary  
6V secondary 6VA

## USING THE TEST SET

The display modules have 10 leds with 3dB increments so that the range of levels that can be displayed between one led being on and all 10 being on is 27dB. This should be made clear by looking at the calibration scale for the display shown in Fig.28.

With the item under test connected between the transmitter and receiver turn on the channels covering the frequency band of interest. The receiver input level control is then adjusted until the highest signal level just lights the highest level led. The shape of the frequency response can then be observed by noting the readings on the displays. If the dynamic range of the unit under test is greater than 27dB the highest level signals should first be switched off and the receiver switched gain control increased by one step (10dB) and 10dB should be subtracted from the displayed level reading. The object of turning off the higher level signals is to prevent the receiver being overloaded.

Photo of the boxed interior of the project.

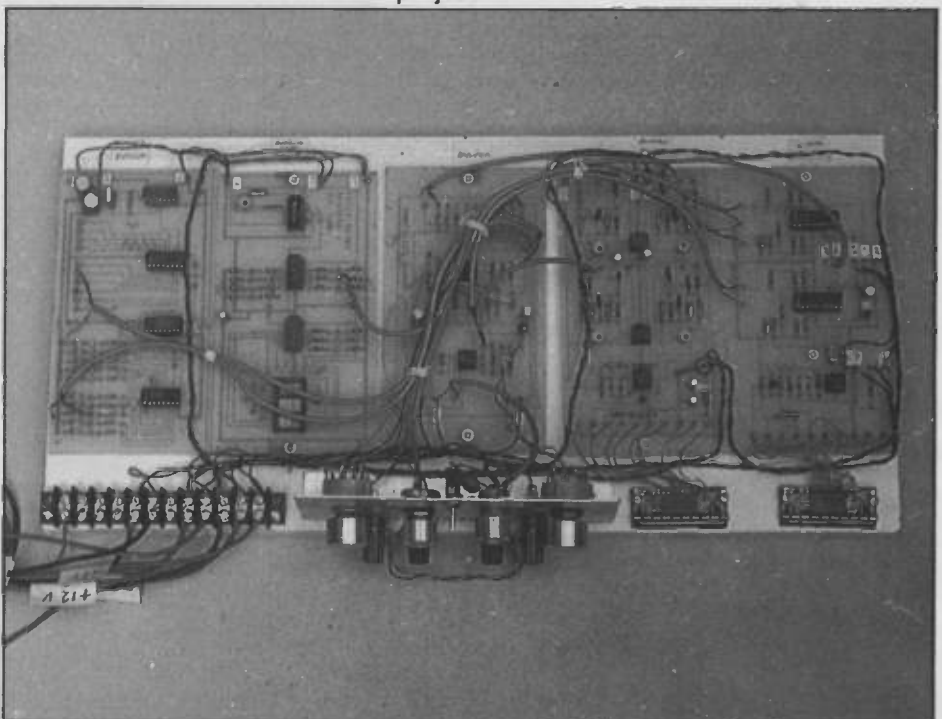

H J K L

Receive Amplifier Gain

	-0dB	-10	-20	-30
	-3dB	-13	-23	-33
	-6dB	-16	-26	-36
	-9dB	-19	-29	-39
	-12dB	-22	-32	-42
	-15dB	-25	-35	-45
	-18dB	-28	-38	-48
	-21dB	-31	-41	-51
	-24dB	-34	-44	-54
	-27dB	-37	-47	-57

Fig. 28. Display module. Calibration of the led bargraph.

If for example the performance of a tone control circuit with both lift and cut controls was being tested the controls should first be set to maximum lift and the receiver input control set as above. A range of 20dB can then easily be observed. Now to examine the performance of the cut controls it will be necessary to increase the receiver sensitivity by 20dB using the switched gain control in order to examine the lower level signals.

All this may seem complicated in writing but a short period of familiarisation with the controls will enable you to quickly make a wide range of measurements. The important things to remember are firstly do not overload the receiver and secondly to make sure that the lowest led is lighted if you want to measure the minimum signal level.

PE



NATIONAL  
COLLEGE OF  
TECHNOLOGY

## Packaged Short Courses

The National College of Technology (NCT Ltd) offers a range of packaged short courses in analogue electronics, digital electronics & fibres, optoelectronics & programmable logic controllers for study at home or at work. The advantages are that you may,

- commence at any time
- work at your own pace
- have a tutor (optional)

and there is no travelling involved. BTEC certificates are available subject to the conditions of the award. These highly popular packed courses contain workbooks, a cassette tape, circuit board and components necessary to provide both theoretical and practical training.

Whether you are a newcomer to electronics or have some experience and simply need updating, there is probably a packaged short course ready for you. Write or telephone for details, quoting Practical Electronics, to:

**NCT Ltd, Bicester Hall**  
5 London Road, Bicester  
Oxon OX6 7BU  
or telephone (0296) 613067 Ext. 202

## BTEC Electronic & Computer Engineering

For a practical course blending computing, electronics and engineering relevant to industry:

Join us in September 1990 for the BTEC National Diploma or Certificate. *Two Years, full or part-time.*

This course is highly relevant to industry and emphasises practical experience. For further details, please contact:

The Faculty of Science & Technology  
School of Scientific Technology  
North East Surrey College of Technology  
Reigate Road, Ewell, Epsom  
Surrey KT17 3DS  
Telephone: 081-394 3096/98/99

**nescot**  
North East Surrey College of Technology

## PROGRAMMABLE ELECTRONIC LOCK KIT

Keys could be a thing of the past with this new high security lock. Secure doors to sheds, garages, even your home or prevent the unauthorised use of computers, burglar alarms or cars. One 4-digit sequence will open the lock while incorrect entries will sound an alarm. The number of incorrect entries allowed before the alarm is triggered is selected by you. Further entries will be ignored for a time also set by you. Only the correct sequence will open the lock and switch off the alarm. The sequence may easily be changed by entering a special number and code on the supplied keyboard. Kit includes: keyboard, alarm buzzer, high quality PCB and all electronic components. Supply: 5-15V d.c. Will drive our Latch Mechanism (701 150 @ £16.50) or relay directly.

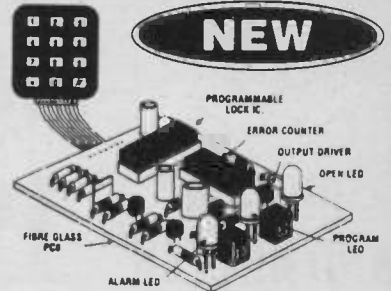

**XK131 ..... £19.95**

## DISCO LIGHTING KITS

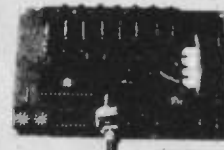

DL8000K 8-way sequencer kit with built-in opto-isolated sound to light input. Only requires a box and control knob to complete. **£39.95**

DL1000K 4-way chaser features bi-directional sequence and dimming 1kW per channel. **£23.95**

XK139 Uni-directional version of the above. Zero switching to reduce interference. **£12.95**

DLA/1 (for DL & DLZ1000K) Optional opto input allowing audio 'beat' / light response. **95p**

DL3000K 3-channel sound to light kit, zero voltage switching, automatic level control and built-in mic. 1kW per channel. **£19.55**

## POWER STROBE KIT

Produces an intense light pulse at a variable frequency of 1 to 15Hz. Includes high quality PCB, components, connectors. 5Ws strobe tube and assembly instructions. Supply: 240V ac. Size: 80 x 50 x 45. **XK124 STROBOSCOPE KIT... £17.25**

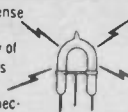

## REMOTE CONTROL DIMMER KIT

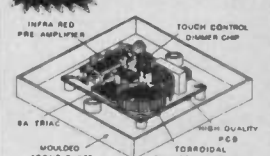

Imagine controlling the brightness of your lights or switching them on or off from the comfort of your armchair! This kit contains all the components from front panel to the last screw to enable you to do just that and fit the shallowest wall boxes. Max power 300W (not fluorescent). **XK132 ..... £19.95**

## IR TRANSMITTER KIT

Designed for use with the XK132 and comes complete with a pre drilled box. A PP3 9 volt battery is required. **MK8 ..... £4.95**



**WK138 TOUCH DIMMER KIT..... £12.95**

## VERSATILE REMOTE CONTROL SYSTEM

These kits can switch up to 16 pieces of equipment on and off or control 16 functions depending on the keyboard selected for the MK12 transmitter. MK12 receiver has 16 logic outputs and operates from 12 to 24V dc. or 240V ac. via the transformer supplied. The MK18 requires a 9V battery and keyboard. Great for controlling lights, TVs, garage door etc. **MK12 IR Receiver..... £19.95**  
**MK18 Transmitter..... £8.95**  
**MK8 4-Way Keyboard..... £2.75**  
**MK10 16-Way Keyboard..... £7.95**  
**901 132 Box for transmitter..... £2.95**

## VOICE RECORD/PLAYBACK KIT

This simple to construct and even simpler to operate kit will record and playback short messages or tunes. It has many uses - seatbelt or lights reminder in the car, welcome messages to visitors at home or at work, warning messages in factories and public places, in fact anywhere where a spoken message is announced and which needs to be changed from time to time. Also suitable for toys - why not convert your daughter's £8 doll to an £80 talking doll!!

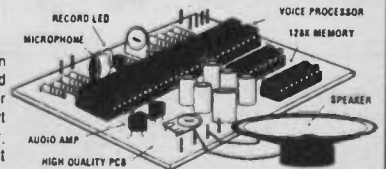

Size ..... 76 x 60 x 15mm  
Message time ..... 1 - 5 secs normal speed, 2 - 10 secs slow speed  
**XK129 ..... £25.95**

**TR ELECTRONICS**  
13 BOSTON RD. LONDON W7 3SJ  
TEL: 01-567 8910.  
FAX: 01-566 1916



### ORDERING INFORMATION:

All prices include VAT. Free P & P on orders over £60 (UK only) otherwise add £1.15. Overseas P & P: Europe £3.50, Elsewhere £10. Send cheque/PO/Visa/Access No. with order. Giro No. 529314002

LOCAL AUTHORITY AND EXPORT ORDERS WELCOME  
GOODS BY RETURN SUBJECT TO AVAILABILITY

Remember the new  
Component Catalogue  
available from  
early 1990

# CRICKLEWOOD ELECTRONICS

**BIGGER  
AND BETTER**

**1990 COMPONENT  
CATALOGUE**



- ONE OF THE LARGEST RANGES OF COMPONENTS IN THE UK
- FAST AND EFFICIENT SAME DAY PERSONAL SERVICE
- VERY COMPETITIVE PRICE; QUANTITY DISCOUNTS AVAILABLE
- DISCOUNT VOUCHERS INCLUDED
- NO MINIMUM ORDER

CRICKLEWOOD SUPPLY MOST OF THE COMPONENTS FOR P.E. PROJECTS. 13,000 STOCKLINES (MANY UNOBTAINABLE ELSEWHERE) PLEASE PHONE US FOR YOUR SPECIFIC NEEDS.

FILL IN THE COUPON AND POST IT WITH YOUR CHEQUE, PO ETC FOR £1.50 TO RECEIVE YOUR 1990 CRICKLEWOOD ELECTRONICS CATALOGUE AND VOUCHERS WHICH YOU CAN USE AGAINST YOUR NEXT PURCHASE

**Cricklewood Electronics Ltd**  
40 CRICKLEWOOD BROADWAY, LONDON, NW2 3ET  
Tel: 081-450 0995/452 0161  
Fax: 081-208 1441 Telex: 914977



TELEPHONE ORDERS OUR SPECIALITY

## CRICKLEWOOD ELECTRONICS 1990 COMPONENTS CATALOGUE

PLEASE SEND ..... COPIES OF THE 1990  
CRICKLEWOOD ELECTRONICS CATALOGUE AT  
£1.50 TO:

NAME .....

ADDRESS .....

Remittance enclosed £.....

## Newsagent Order Form

Dear Newsagent, I like reading Practical Electronics magazine. Please deliver/save one copy each month until further notice.

My name is .....

Address .....

**Don't miss a single issue of PE! Make a firm order with your Newsagent!**

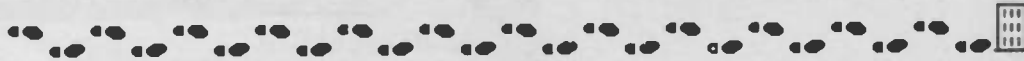

Newsagent

## POINTS ARISING

**EPROM POLY PROGRAMMER** (May-Jun 90)

The author has kindly offered to supply ready-programmed eproms for the project at £18.50 including post etc. Alternatively, you may send your own 8748 chip which he will program for £5.50 including post. Since the project was published he has written further software versions to cater for 12.0 Baud (V2.0), 2400 Baud (V2.1), 4800 Baud (V2.2). Please state Baud rate required and send a cheque direct to the author, and payable to him: Kevin Browne, 59 Pledwick Lane, Sandal, Wakefield, West Yorks, WF2 6EA.

Details of using the Poly Programmer to

program 8748 microcontrollers will be published as a separate article in the near future.

The use of ports P10-P12 (control lines C0-C2) is not required for programming ordinary eproms. These were provided for programming more exotic devices (such as the 8748) which require more than one control line. The ports can be controlled using the command 'k' (chr 107) followed by data byte, whose binary bit pattern of bits 0-2 corresponds to the required states of the three outputs C0-C2 (eg, set C1 and C2 to high: data=3).

The input port can be read in the same way, using command 'C' (chr 67) or 'K' (chr 75). The response from the programmer is either chr ) or chr 255 depending on the state of the input. Fig. 21 in the article details all the commands available in the programmer.

The article was written in 1988. Since then

manufacture of the pot core quoted has ceased. Other pot cores, of approximately the same size (18mm diameter), should work equally well since the inductance of 11 seems far from critical. Try Electrovalue B65819 (RM7).

In PE June, the 'Top' pcb was shown as a reversed image of the track (Fig. 14). If you have already acquired this pcb, it will be necessary to mount the chip sockets on the track side of the board. The sockets should be mounted so that they rest just above the pcb enabling soldering to be carried out to the legs and tracks simultaneously. With the pcb in this orientation it is not practical to paint the surface as suggested by the author. However, legends may be applied to a card which may then be cut to size and mounted on the pcb.





The circuit described here is basically a sound operated mains relay. When triggered, it has the capability of operating lights, etc, for a predetermined time before switching them off.

The device was originally intended to help an old-timer who, during the winter months was frightened to open the door at night to callers. This device will pick up the sound of the doorbell and turn on one or more outside lights as required. They stay on for a set time, after which the unit turns them off. In all probability, any no-gooder will think twice about evil deeds if, when the doorbell is pushed, or the door is knocked, he is zapped by a floodlight. It is also possible to run a cable to the rear of the premises to operate other lights to illuminate another area which might be chosen by accomplices who endeavour to gain entry at the rear while their friends keep the occupier busy at the front!

The device may also be incorporated into your diy alarm system, by placing the sensor

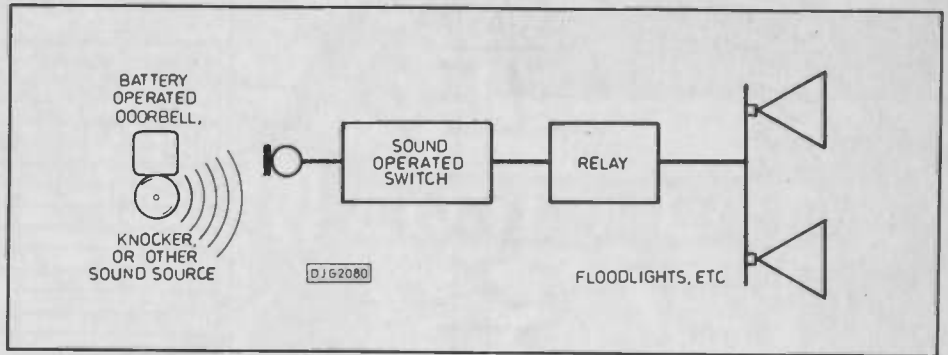

Fig. 2. System diagram of the sound operated switch.

## Paul Benton enlightens you with an evocative security system

design incorporates a current amplifier transistor, TR5. This gives readers greater flexibility in choosing this driver transistor to suit their own particular requirements.

When the output of the 555 goes high, it supplies current to the base of TR5. This turns on the transistor and so energises the relay. The normally-open relay contacts now close feeding power to the mains lamp. To

# SOUND OPERATED SWITCH

microphone in an area where, if there is a noise, there could be problems!

### THE CIRCUIT

The circuit used is relatively straight forward. ICI, a 555 timer device, is biased by VR1 to be just on the edge of triggering. Sounds are picked up by the microphone, and are amplified by TR1 and TR2. The amplified signal is used to trigger pin 2 of the 555, causing the output of the timer, pin 3, to go

high, for a time determined by R8 and C4. Any other large signal picked up by the microphone during the recharging of the timing capacitor will cause TR4 to conduct, discharging C4 by this path. In the event of no further sound being picked up by the unit, C4 will keep on charging until it reaches about two-thirds of the supply voltage, at which point the output of the timer will now go low.

Although the standard 555 timer is capable of sourcing (or sinking) up to 200mA, the

work out the contact rating required for the wattage of lighting that you want to control, use the equation:

$$I \text{ current} = P \text{ watts} / V \text{ voltage}$$

For example, if you just wish to illuminate a standard 60 watts enclosed bulkhead fitting:

$$I = 60/240 = 0.25 \text{ amps (per fitting)}$$

However, if you wish to illuminate like Blackpool, using a 1kW flood,

$$I = 1000/240 = 4.7 \text{ amps (per fitting).}$$

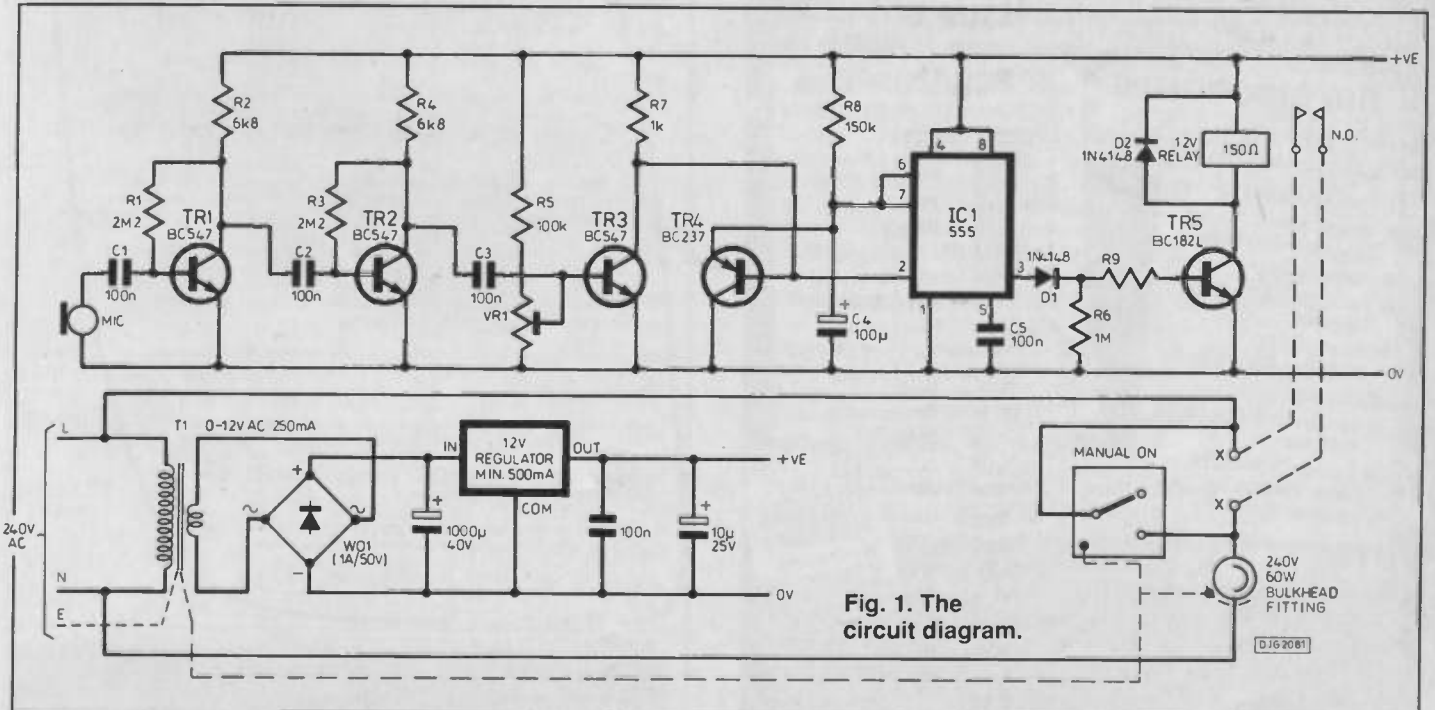

Fig. 1. The circuit diagram.

## COMPONENTS FOR MAIN UNIT

### RESISTORS

R1,R3	2M2 (2off)
R2,R4	6k8 (2off)
R5	100k
R6	1M
R7,R9	1k (2off)
R8	150k
VR1	10k preset

### CAPACITORS

C1,C3,C5	100n polyester (4 off)
C4	100µF 16V electrolytic

### SEMICONDUCTORS

TR1-TR3	BC547 (3 off)
TR4	BC327
TR5	BC182L
D1,D2	1N4148 (2 off)
IC1	555

### MISCELLANEOUS

Hookup wire, stripboard, tinned wire, crystal microphone insert, relay 12V 200ohm spco.

### PSU COMPONENTS

12V transformer	1000µF 40V
WOI bridge rectifier	10µF 25V
12 volt regulator 7812.	100n

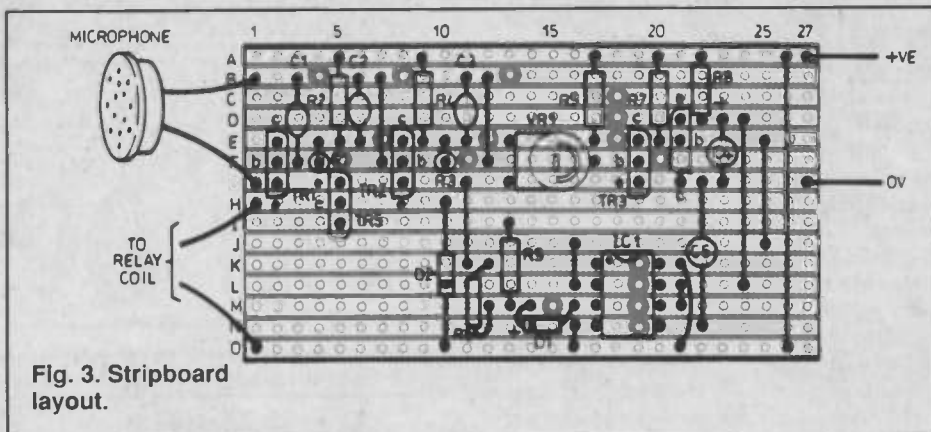

Fig. 3. Stripboard layout.

It is important that an adequately-rated relay is used, or overheating will occur. Also ensure that the cable used is rated sufficiently.

The controller layout is shown in Fig.3. No layout is offered for the power supply, which may be constructed to suit your needs.

On a note on safety, keep mains wiring away from everything else. Use insulating sleeving on any length of bare wire that is evident. Ensure that every part of the installation is earthed, etc. IF IN DOUBT, SEEK THE ADVICE OF A COMPETENT PERSON. The novelty of this circuit is that there is no connection between the bell-push and the mains voltage, since audio coupling is used, so keep it that way!

The test procedure is as follows:

Using a PP3 battery as a temporary supply,

turn VR1 so that the slider is at ground. Temporarily disconnect one leg of C4. Using a voltmeter on pin 3 of IC1, very gently turn the pot until the timer fires, then back off a touch. Reconnect C4, and tap the microphone. (My sub-editor, Helen says a mic should never be hit. She's right, of course, but we've all done it from time-to-time! Ed.). The 555 should give an output for about 25 seconds, ie the relay should stay energised for this period. To increase the sensitivity, turn the slider of the pot towards R5, or for less sensitivity, towards ground. If a longer on-period is required, increase the value of either R8 or C4, the latter being preferred.

PE

# HENRY'S

## ELECTRONICS

## DISTRIBUTORS

ELECTRONICS DISTRIBUTORS FOR TRADE, INDUSTRY, EXPORT, EDUCATION AND HOBBYISTS

**BIG DISCOUNTS FOR EDUCATION AND QUANTITY**

- Tools/Service Aids
- Test Instruments (UK's largest in-stock Range)
- Communications
- Public Address/Disco Equipment
- Security/CCTV/Doorphones/Alarm Systems
- TV, Video Distribution
- Speakers for Hi-Fi, in car, PA and Disco
- Components, Audio, TV, Video, Telephone and Computer Accessories

### SPECIAL OFFERS

Dmm was (£18.95) **£13.95** (30 models stocked)  
 1 kw outdoor PIR Lights controller was (£32.95) **£19.95**  
 VHF/UHF TV/FM Amplifier was (£11.95) **£9.95**  
 Analogue MM 27 Ranges CAP/Hfe/Temp/10A AC/DC etc. was (£39.95) **£29.95**  
 ALL PRICES INCLUDE VAT

### FREE CAR PARKING

Two Car Parks (Bell and Church Streets). Present your ticket when purchasing and get one hour as discount.

OPEN 6 DAYS A WEEK FOR CALLERS AND TELEPHONED ORDERS



### CATALOGUES IN COLOUR

- Instruments
- Security
- Supplements
- Components
- Ask Henry's first
- £1 for callers: large SAE £2 stamp UK by post. (Export £5.00) Free to Education with Trade Prices

## HENRY'S AUDIO ELECTRONICS

404 Edgware Road, London W2 1ED  
 Instruments/Audio 071-724 3564  
 Security/Communications/CCTV 071-724 0323  
 Components 071-723 1008 Fax: 071-724 0322  
 Trade/Education/Export 071-258 1831  
 Account facilities available.

## Interak 1 BUILD YOUR OWN COMPUTER

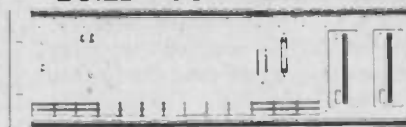

INTERAK can be commenced with the minimum of outlay. Bare boards from £10.95, beg borrow or steal the components, or buy from us - all parts available separately. No special or custom chips (ie. PALs, ULAs, ASICs etc) used - no secrets.

Go as fast or as slowly as your funds and enthusiasm permit.

Made for those who must know what goes inside. Full circuit diagrams and descriptions are provided. And honestly, can you really use a computer effectively if you don't know what's inside and nobody will tell you?

Solid engineering construction - something to be proud of. 19" 3U rack mounting, plug-in circuit boards and modular construction keeps obsolescence at bay.

Flourishing Independent Users Group and newsletter. Hundreds of programs on disk at little or no cost from the Users Group.

Program in machine code (Assembler) Basic C Forth etc Database Word Processing Scientific applications.

Cassette tape operation or disk (up to 4 drives, 1 Megabyte 3.5" available from us, but you can add 3" 5.25" 8" if you want). Disk operating system CP/M Plus.

64K RAM Z80 based at present with potential for expansion to a 16 Megabyte address space and Zilog's latest Z80280 in the future.

Needs no specialised knowledge to construct, and we will happily get you out of a jam if you get into one.

Availability of personal and individual after sales service, impossible to obtain from large companies, who are only after your money.  
 Security of supply - from Greenbank Electronics, established in 1970.

**Greenbank**

For more details write or phone us:  
 Greenbank Electronics, Dept. E10P, 460 New Chester Road, Rock Ferry, Birkenhead, Merseyside, L42 2AE. Tel: 051-645 3391



# AG E & G ELECTRONICS

ELECTRONIC COMPONENTS MAIL ORDER COMPANY.

1990 COMPONENTS CATALOGUE IS AVAILABLE NOW.

**FREE** entry to win an ultraviolet exposure Unit Value £ 200.

Have you send for your copy yet ?

Electronic Components at the right prices.

- FAST SERVICE
- LOW PRICES
- LARGE DISCOUNTS

Competition ends

31 Dec 1990.



0.5" ORANGE DUAL LED DISPLAY  
Value £ 2.00 absolutely free !!!

Simply complete and return the order form below and we will send your free gift.

PLEASE SEND A COPY OF THE A & G ELECTRONICS CATALOGUE AT £1.00 (REFUNDABLE WITH MY FIRST ORDER) AND MY FREE GIFT TO:

NAME .....

ADDRESS .....

I HAVE ENCLOSED £ .... Tick box to enter the competition.

A & G ELECTRONICS LTD.

Free Post ,100 Park Avenue ,

London E 6 2BR. (No Stamp Required)

TEL : 081-552 2386 Fax : 081 - 519 3419.

## TWO GREAT HOBBIES

ONLY  
£129.00  
INC VAT



## ...IN ONE GREAT KIT!

The K5000 Metal Detector Kit combines the challenge of DIY Electronics assembly with the reward and excitement of discovering Britain's buried past.

**THE KIT** — simplified assembly techniques require little technical knowledge and no complex electronic test equipment. All stages of assembly covered in a detailed 36 page manual.

**THE DETECTOR** — features Analytical Discrimination & Ground Exclusion, backed by the proven pedigree of C-Scope, Europe's leading detector manufacturer.

Ask at your local Hobby/Electronics shop or contact:—

**CSCOPE**

C-Scope International Ltd., Dept. PE  
Wotton Road, Ashford, Kent TN23 2LN.  
Telephone: 0233 629181.

PROGRAM NOW  
SOFTWARE APPLICATIONS AND DEVELOPMENT

# CALL FOR PAPERS

## Program Now wants writers!

We're looking for software developers and programmers to write for what is the Uk's *only* newsstand magazine for software developers.

We are looking for well-written articles on the following subjects to appear in future issues.

- *Managing interrupts in C*
- *C++ linked lists*
- *Developing a C library*
- *Concurrency In Pascal*
- *Fast floating point routines in Assembler*
- *Programming in Protected Mode on the 286*

Alternatively, we are interested in viewing abstracts, articles and programs in C, Pascal, Fortran or Assembler. We especially welcome TSRs, Vanilla C or Pascal programming routines, and articles on programming and design methodology.

Send your abstracts and outlines to:

Clive Grace,  
The Editor,  
Program Now,  
193 Uxbridge Road,  
London. W12 9RA.

*If you are interested in writing for Program Now, but the above articles are not within your field of expertise, please contact us with your ideas anyway. We always consider new scripts and welcome quality writing and good programming!*

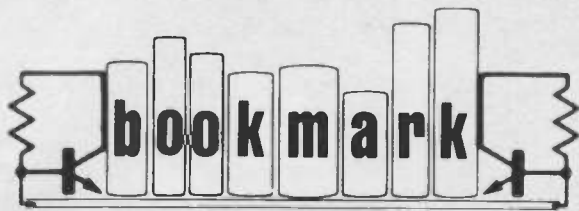

Your Ed looks at some of the new books recently received.

**A Beginners' Guide to Modern Electronic Components. R. A. Penfold. Babani BP285. £3.95. ISBN 0-85934-230-1.**

The expertise of my good friend Robert has again come to the fore. He's a mine of electronic information, and is able to tell its story in a very readable and instructive style. As many of you already know, he is a frequent contributor to PE. In this book he gets down to the very basics of electronics from a hardware point of view. As he points out in his preface, there have been vast changes in electronics over the last couple of decades, particularly in the semiconductor areas. Through this book, Robert helps to clarify for those not yet fully conversant with electronics, the nature of the component families, and to sort out what may appear to some as a bewildering array of types. His main aim has been to explain the difference between components of the same basic type so that the right component can be selected for a given application. In over 160 pages he discusses passive components in 19 sections of the first chapter, semiconductors in two lengthy chapters, and a variety of miscellaneous products in a fourth chapter. The latter looks at such items as switches, relays, meters, connectors and so on. The book does not claim to cover every possible variant, but it goes a long way to help you understand more about what components are and can do.

**Programming in QuickBASIC. N. Kantaris. Babani BP 284. £4.95. ISBN 0-85934-229-8.**

Noel Kantaris is a frequent author of Babani's computer-orientated books and has many publications to his credit. In this latest book of his, he presents a guide to help those unfamiliar with QuickBasic to achieve a working knowledge of this programming language. QuickBasic is one of the two most popular structured and compiled dialects in use today on IBM and compatible computers (the other being TurboBasic). Unlike standard Basic and its variants, QuickBasic is a compiled language. A separate program, called the compiler is used to check the whole program for errors and then compile it into the machine-specific code that will actually be executed by the computer. This makes a compiled program far more efficient than an interpreted one. In this book, QuickBasic statements are introduced and explained with the help of simple programs. This enables the user to build up a considerable library of programs and procedures which become the building blocks of advanced programming techniques. There are over 140 pages containing seven chapters. In the first chapter a 'package overview' is given, looking at menus, statements, variables and arithmetic operators, plus entering, running and saving programs. Chapter two looks at input and output control, and the third discusses program flow including loops and conditional statements. Strings and arrays are in chapter four, while functions and procedures are discussed in chapter five. Disc filing and handling are considered in the next chapter. The final chapter consists of appendices, covering such things as reserved words, error messages, and solutions to the exercise problems given in the preceding chapters.

**An Introduction to VHF/UHF for Radio Amateurs. I.D. Poole. Babani BP281. £3.50.**

Ian Poole is another contributor to PE whose knowledge is also available in book form. In PE he regularly gives a thumb nail history of some of the famous personalities who have left their mark on the world of technology. Ian is also knowledgeable about radio and in this book he shares with you his interest in amateur radio (his call sign is G3YWX). Although the interest in cb radio was short lived, the more serious discipline of amateur radio is very much alive and transmitting. One of the largest growth areas

in amateur radio is the increased use of the vhf and uhf portions of the frequency spectrum. In this book, Ian discusses the essentials required to gain the most from these two bands, and as such will be of use to both newcomers and experienced operators. Topics included in the book are propagation, aerials, receivers and transmitters. Descriptions of the bands are given, with outlines of the bandplans and channels. There is a special chapter on scanners. In addition, repeater and mobile operation are included as well as DXing and data modes, plus a section on packet radio.

**How to Expand, Modernise and Repair PCs and Compatibles. R.A. Penfold. Babani BP271. £4.95. ISBN 0-85934-216-6.**

You'll recall that Robert outlined some of the thinking involved with making your own PC-compatible in PE July 90. This book looks at another aspect of computer dishing which should interest you and help you fulfil an ambition or two. Recognising that PC upgrading might be a bit confusing to the uninitiated, Roberts has written this book to provide you with advice and guidance on the popular forms of internal PC expansion. He believes it should help to make things reasonably straightforward and painless for you. Little knowledge of computing is assumed, although it is expected that you have, and can operate, a standard desktop PC of some kind, such as the PC, PC XT, PC AT, or an 80386-based PC. The subjects covered in the book include an overview of the PC, memory upgrades, adding hard and floppy disc drives, display adapters and monitors, fitting a maths co-processor, keyboards, ports, mice and digitisers. The final two chapters cover maintenance, repairs, and diy pcs. Since these subjects are covered from a practical point of view, the book will appeal to any like-minded person.

**Passive Components - A User's Guide. I.R. Sinclair. Heinemann Newnes. £14.95. ISBN 0-434-91856-3.**

This authoritative book will be of interest to the more advanced electronics hobbyist, and those who are practising technicians and students in industry and education. In the context of this book, passive components have been taken to include any component which is incapable of power amplification, rather than the narrower definition of resistors and capacitors only. Ian Sinclair observes that the intensive use of semiconductors, notably ics, has increased the importance of the part that passives have to play. This is partly due to the use of passives in feedback circuits, which thus affects the overall performance of the circuits. The book discusses the main passive components, their fundamental actions, parameters, variations with temperature, tolerances, stability, reliability and manufacturing methods and standards. This is a useful reference work.

**Optoelectronic Line Transmission - An Introduction to Fibre Optics. R.L. Tricker. Heinemann Newnes. £12.95. ISBN 0-434-91978-0.**

Practising electronic and telecoms students, technicians and engineers will find most appeal from this book. Lt Col Ray Tricker is a serving officer in the Royal Corps of Signals, currently stationed in Hong Kong as the Communications Equipment Manager and Maintenance Adviser. He is thus in an advantageous position to know the ins and outs of fibre optics used in both commercial and military environments. His book is an informative, non-mathematical and eminently readable introduction to fibre optic transmission, and includes a chapter on the often overlooked subject of testing. The other chapters cover a basic introduction to fibre optics, the theory, the nature of fibres and cables, transmitters, receivers, waveguides, connectors and repeaters, communications systems. The final chapter looks to the future, discussing development trends with regard to both industry and military expectations.

## PUBLISHERS' ADDRESSES

**Bernard Babani (Publishing) Ltd, The Grampians, Shepherds Bush Road, London W6 7NF. Tel 081-603 2581.**

**Heinemann Professional Publishing, Halley Court, Jordan Hill, Oxford, OX2 8EJ. Tel : 0865 311366.**

**T**he Sun is in some ways a variable star; this has been known ever since the discovery of the eleven-year solar cycle, more than a century ago. But the more we find out about the Sun, the greater the problems we have to face. Of these, perhaps the most baffling is that of the lack of solar neutrinos.

Neutrinos have no charge and (virtually) no mass, so that they are very difficult to detect. For many years now Dr. John Davies and his colleagues at Homestake Mine, in South Dakota - operating a mile below ground, as a screen against cosmic rays - have recorded far fewer neutrinos than theory predicts. A Japanese experiment in the late 1980s gave similar results. Now there has been added evidence from SAGE, the Soviet-American Gallium Experiment located in the North Caucasus. According to theory, SAGE should detect about 14 solar neutrinos per day over a 60-day period. In fact it has found none at all.

It is not likely that the experiment itself is faulty; the fault lies either with theory (perhaps the Sun's core is cooler than expected?) or with the properties of neutrinos themselves. We must await new results, but certainly the lack of solar neutrinos is giving theorists a severe headache.

## HALLEY'S COMET

Halley's Comet, which we remember so well, is still under observation - and in February this year it was imaged with the 1.5-metre Danish telescope at the European Southern Observatory at La Silla, in Chile. A year earlier, images had shown a definite coma - that is to say, a dust-cloud round the icy nucleus. This has now vanished, and it may be said that Halley's Comet has now entered its period of 'hibernation', which is likely to last until mid-2061 when it again comes within five astronomical units of the Sun.

# SPACE

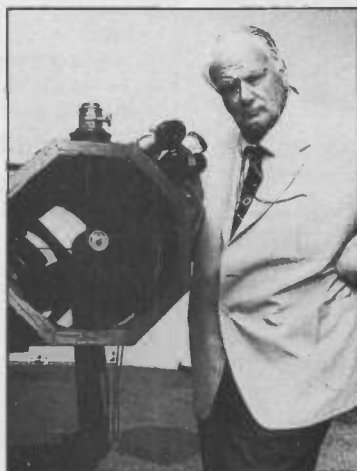

# WATCH

BY DR PATRICK MOORE CBE

**Does the lack of solar neutrinos mean the sun is cooler than we think, or is theory incorrect?**

## NEW GALAXY

From Cambridge, Dr. M.J. Irwin and his colleagues have found a new member of the Local Group of galaxies. It is, predictably, a dwarf; it lies in the constellation of Sextans, and it is about 280,000 light-years away,

rather further than the two famous Clouds of Magellan. It contains at least a quarter of a million stars, but its low surface brightness has meant that it has not been identified until now. Its position in the sky is: RA 10h 13m,0, dec.  $-1^{\circ}37'$  (epoch 2000.0).

## HST UPDATE

Obviously there is great concern about the state of the HST or Hubble Space Telescope. I wrote about it last month, but I make no apology for returning to it now. After all, HST was meant to be the supreme scientific optical achievement of the twentieth century, and it is heartbreaking to find that so much has gone wrong.

Moreover, there is no doubt at all that the errors in the telescope were avoidable. Ten years or so ago, when the main mirror and the secondary were being made by the Perkin-Elmer Corporation, there was a mistake. The wavefront error from the two mirrors was supposed to be less than  $1/20$  of a wavelength of red light. In fact it is half of a wavelength, which for many fields of research is totally unacceptable. Worse is the admission that to save time and money, Perkin-Elmer never tested the two mirrors together - which shows, yet again, that in a major scientific project it is foolish to try to 'cut corners'.

The main mirror cannot be put right, because the pistons controlling its figure are too weak and are in the wrong positions. Neither can the HST be brought back to Earth for repair, as had been hoped. So all that can be done is to make the best of it - and in the ultra-violet, at least, the HST will still out-perform any Earth-based telescope - and to see what are the prospects of sending up modified instruments to compensate for the faults in the main mirror system.

This may well be possible, though the

# THE SEPTEMBER SKY

**T**his is a reasonably good month for planets. Mercury is a morning object for the whole of the second half of September, and is at its best; it should be easily visible with the naked eye before sunrise - though on no account sweep for it with binoculars or a telescope unless the Sun is completely out of view. Of course, no surface markings will be seen, but it is always worth finding this elusive little world and noting its phase. Around September 16, Mercury is not far from Venus, which is of course so brilliant that it cannot be mistaken - though, like Mercury but for different reasons, it too lacks surface detail; the present phase is over 90 per cent.

Mars is now visible from late evening, and is becoming steadily brighter; it is in the Aries-Taurus area, and by the end of September the magnitude has risen to  $-0.8$ , superior to any star apart from Sirius. Of the other two bright planets, Jupiter is in the east before dawn, while Saturn is still visible well after sunset, in the south-west, very low down in Sagittarius.

The Moon is full on September 5, and new on the 19th. There are no solar or lunar eclipses this month. Nether are there any

major meteor showers, though the Piscids, reaching their maximum about September 10, can produce a ZHR of over 9.

Much had been expected of Levy's Comet, though as I write these words (early August) the magnitude seems to be well below the predicted value - we seem to be unlucky with comets this year! In any case, the comet moves south during September; the predicted position for September 5 is RA 17h 53, dec.  $-17^{\circ}56'$ , with a magnitude of just above 4. By the law of averages we are certainly due for a bright comet, but when the next brilliant visitor will appear is anybody's guess.

Meanwhile, the Sun has been active, with some major spot-groups, and during August there was some fairly obvious auroral activity even from South England. Whether the Sun has now passed its peak for this cycle, as had been expected, remains to be seen. There are continuing efforts to correlate sunspot activity with radio reception - of course there is a definite link, but details remain rather obscure - but the association of sunspots with British heat-waves, such as that of early August 1990, is much more dubious.



earliest date is 1993. Meanwhile, there will be some results which will be of real value, and the view I expressed last month, that the HST cannot be dismissed as a total failure, still holds good. But we do have to admit that it is a disappointment - and let us hope that in any future ambitious programme, any temptation to cut costs will be firmly resisted.

One can only be awestruck by the evolution of solar prominences. The two photos on the right were taken three and a half hours apart, on July 30 1990. Below is Comet Levy, seen against a stunning backdrop of stars on July 31st. J. Dragesco and P. Tosi of France kindly supplied the photos.

PE

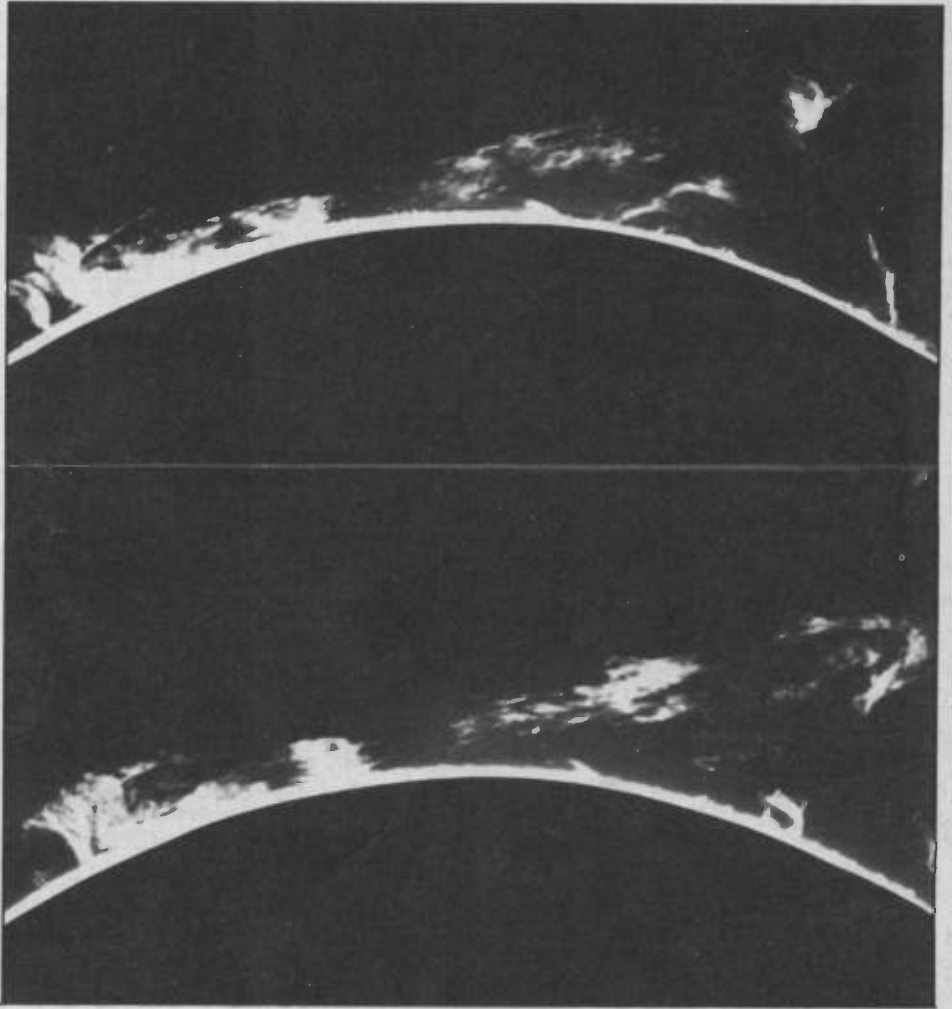

# Astronomy Now

Britain's leading astronomical magazine

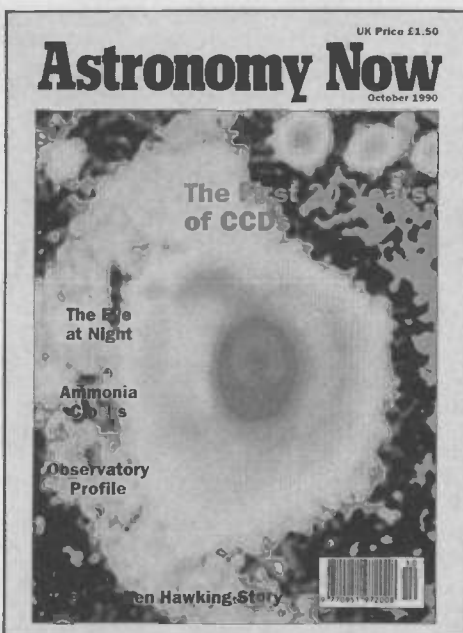

## In the October issue:

- CCDs – The First Generation ○
- The Eye at Night ○
- The Stephen Hawking Story ○
- Time Telling Ammonia Clouds ○
- Observatory Special ○
- ○ ○

plus: News Update - The Night Sky - Sky Watch Down Under and more...

**October issue on sale now - price  
£1.50!**

## ONE POUND PACKS

All packs are £1 each Note the figure on the extreme left of the pack ref number and the next figure is the quantity of items in the pack, finally a short description.

- BD2 5 13A spurs provide a fused outlet to a ring main where devices such as a clock must not be switched off.
- BD9 2 6V 1A mains transformers upright mounting with fixing clamps.
- BD13 12 30 watt reed switches, it's surprising what you can make with these - burglar alarms, secret switches, relay, etc., etc.
- BD22 2 25 watt loudspeaker two unit crossovers.
- BD30 2 Nical constant current chargers adapt to charge almost any nicad battery.
- BD32 2 Humidity switches, as the air becomes damper the membrane stretches and operates a microswitch.
- BD42 5 13A rocker switch three tags so on/off, or change over with centre off.
- BD45 1 24hr time switch, ex-Electricity Board, automatically adjust for lengthening and shortening day, original cost £40 each.
- BD49 5 Neon valves, with series resistor, these make good night lights.
- BD56 1 Mini uniselector, one use is for an electric jigsaw puzzle, we give circuit diagram for this. One pulse into motor, moves switch through one pole.
- BD67 1 Suck or blow operated pressure switch, or it can be operated by any low pressure variation such as water level in water tanks.
- BD103A 1 6V 750mA power supply, nicely cased with mains input and 6V output leads.
- BD120 2 Stripper boards, each contains a 400V 2A bridge rectifier and 14 other diodes and rectifiers as well as dozens of condensers, etc.
- BD128 10 Very fine drills for pcb boards etc. Normal cost about 80p each.
- BD132 2 Plastic boxes approx 3in cube with square hole through top so ideal for interrupted beam switch.
- BD134 10 Motors for model aeroplanes, spin to start so needs no switch.
- BD137 6.5" 4 Ohm speaker, 10 Watt rating
- BD139 6 Microphone inserts - magnetic 400 ohm also act as speakers.
- BD148 4 Reed relay kits, you get 16 reed switches and 4 coil sets with notes on making  $\omega$  relays and other gadgets.
- BD149 6 Safety cover for 13A sockets - prevent those inquisitive little fingers getting nasty shocks.
- BD180 6 Neon indicators in panel mounting holders with lens.
- BD193 6 5 amp 3 pin flush mounting sockets make a low cost disco panel.
- BD199 1 Mains solenoid, very powerful, has 1in pull or could push if modified.
- BD201 8 Keyboard switches - made for computers but have many other applications.
- BD211 1 Electric clock, mains operated, put this in a box and you need never be late.
- BD221 5 12V alarms, make a noise about as loud as a car horn. Slightly soiled but OK.
- BD252 1 Panostat, controls output of boiling ring from simmer up boil.
- BD259 50 Leads with push-on 1/4in tags - a must for hook-ups - maintains connections etc.
- BD263 2 Oblong push switches for bell or chimes, these can mains up to 5 amps so could be foot switch if fitted into pattress.
- BD268 1 Mini 1 watt amp for record player. Will also change speed of record player motor.
- BD305 1 Tubular dynamic mic with optional table rest.
- BD653 2 Miniature driver transformers. Ref. LT44, 20k to 1k centre tapped.
- BD548 2 3.5V relays each with 2 pairs changeover contacts.
- BD667 2 4.7uf non-polarised block capacitors, pcb mounting.

There are over 1,000 items in our One Pound Pack List. If you want a complete copy please request this when ordering.

**GEIGER COUNTER KIT** includes tube, PCB and all components to make a 9V counter £34. Ref 39p1

**PERSONAL STEREOS** Again customer returns but complete and with stereo head phones a bargain at only £3.00 each. Our ref 3P83.

**MAINS OPERATED MICROWAVE CONTROL PANEL** with Touch switches. This unit has a 4 digit display with a built in clock and 2 relay outputs - one for power and 1 for pulsed power level. Could be used for all sorts of timer control applications. Only £6.00. Our ref 6P18.

**EQUIPMENT WALL MOUNT** Multiangle for speakers etc. £3 each ref 3P72.

**SUB-MIN TOGGLE SWITCH** Body size 8mm x 4mm x 7mm SBDT with chrome dolly fixing nuts. 3 for £1. Order ref BD649.

**COPPER CLAD PANEL** for making PCB. Size approx 12in long x 8.5in wide. Double-sided on fibreglass middle which is quite thick (about 1/16in) so this would support quite heavy components and could even form a chassis to hold a mains transformer, etc. Price £1 each. Our ref BD683.

**MAINS FANS** Brand new, small type. Approx. 6" x 4" approx. 70W only £5.00. Ref. 5P166.

**REAL POWER AMPLIFIER** for your car, it has 150 watts output. Frequency response 20hz to 20Khz and signal to noise ratio better than 60dB. Has built in short circuit protection and adjustable input level to suit your existing car stereo, so needs no pre-amp. Works into speakers ref. 30P7 described below. A real bargain at only £57.50. Order ref: 57P1.

## POWERFUL IONISER

Generates approx. 10 times more IONS than the ET1 and similar circuits. Will refresh your home, office, workroom etc. Makes you feel better and work harder - a complete mains operated kit, case included £18.00 + £2 p&p. Our ref 18P2.

**REAL POWER CAR SPEAKERS** Stereo pair output 100W each. 4-Ohm impedance and consisting of 6.5in woofer, 2in mid range and 1in tweeter. Ideal to work with the amplifier described above. Price per pair £30.00. Order ref: 30P7.

**VIDEO TAPES** These are three hour tapes of superior quality, made under licence from the famous JVC Company. Offered at only £3 each. Our ref 3P63. Or 5 for £11. Our ref 11P3. Or for the really big user 10 for £20. Our ref 20P20.

**ELECTRONIC SPACESHIP** Sound and impact controlled, responds to claps and shouts and reverses when it hits anything. Kits with really detailed instructions. Ideal present for budding young electrician. A youngster should be able to assemble but you may have to help with the soldering of the components on the pcb. Complete kit £10. Our ref. 10P81.



**COMPOSITE VIDEO KITS** These convert composite video into separate H sync, Vsync and video. Price £8.00. Our ref 8P39.

**12" HIGH RESOLUTION MONITOR** Amber screen, beautifully cased for free standing, needs only a 12v 1.5 amp supply. Technical data is on its way but we understand these are TTL input. Brand new in makers cartons. Price: £22.00. Order ref: 22P2.

**BUSH RADIO MIDI SPEAKERS** Stereo pair. BASS reflex system, using a full range 4in driver of 4 ohms impedance. Mounted in very nicely made black fronted walnut finish cabinets. Cabinet size approx 8.5in wide, 14in high and 3.5in deep. Fitted with a good length of speaker flex and terminating with a normal audio plug. Price £5 the pair plus £1 post. Our ref 5P141.

**3.5in FLOPPY DRIVES** We still have two models in stock: Single sided, 80 track, by Chicon. This is in the manufacturers metal case with leads and IDC connectors. Price £40, reference 40P1. Also a double sided, 80 track, by NEC. This is uncased. Price £60, reference 60P2. Both are brand new. Insured delivery £3 on each or both.

**YUASHA LEAD ACID BATTERIES 6V 10A**. Superb Value at only £9.00 REF 9PRH or 2 for £15.00 ref 15P37. Also some 12V 1.9AH £7.00 REF 7P19.

**VERY POWERFUL 12 VOLT MOTORS**. 1/3rd Horsepower. Made to drive the Sinclair C5 electric car but adaptable to power a go-kart, a mower, a rail car, model railway, etc. Brand new. Price £20 + £2 postage. Our ref. 20P22.

**SINCLAIR CS WHEELS**. Set of 4 wheels with inner tubes and tyres. 2 13" dia. front wheels and 2 16" dia. rear wheels. Brand new, £6 each, 13" Ref 6P10, 16" Ref 16P11.

**C5 GEARED MOTOR**, phone for price and availability.

**ELECTRONIC SPEED CONTROL KIT** Suitable for controlling our powerful 12v motors. Price £17.00. Ref. 17P3 (heatsink required).

**ORGAN MASTER** Is a three octave musical keyboard. It is beautifully made, has full size (piano size) keys, has gold plated contacts and is complete with ribbon cable and edge connector. Can be used with many computers, request information sheet. Brand new, only £15 plus £3 postage. Our ref 15P15.

## PHILIPS LASER

This is helium-neon and has a power rating of 2mW. Completely safe as long as you do not look directly into the beam when eye damage could result. Brand new, full spec. £35 plus £3 insured delivery. Mains operated power supply for this tube gives 8kv striking and 1.25kv at 5mA running. Complete kit with case £15.

**HIGH RESOLUTION MONITOR**. 9in black and white, used Philips tube M24/306W. Made up in a lacquered frame and has open sides. Made for use with OPD computer but suitable for most others. Brand new. £20 plus £5 post. Our ref 20P26.

**12 VOLT BRUSHLESS FAN**. Japanese made. The popular square shape (4.5in x 4.5in x 1.75in). The electronically run fans not only consume very little current but also they do not cause interference as the brush type motors do. Ideal for cooling computers, etc., or for a caravan. £8 each. Our ref 8P26.

**MINI MONO AMP** on p.c.b. size 4in x 2in (app.) Fitted Volume control and a hole for a tone control should you require it. The amplifier has three transistors and we estimate the output to be 3W rms. More technical data will be included with amp. Brand new, perfect condition, offered at the very low price of £1.15 each, or 13 for £12.00.

**JOYSTICKS** for BBC, Atan, Dragon Commodore, etc. All £5.00 each. All brand new, state which required.

**SUB-MIN PUSH SWITCHES** Not much bigger than a plastic transistor but double pole PCB mounting. 3 for £1.00. Our ref BD688.

**AA CELLS** Probably the most popular of the rechargeable NICAD types. 4 for £4.00. Our ref. 4P44.

**20 WATT 4 OHM SPEAKER** With built in tweeter. Really well made unit which has the power and the quality for hifi 6.5in dia. Price £5.00. Our ref. 5P155 or 10 for £40.00 ref. 40P7.

**MINI RADIO MODULE** Only 2in square with ferrite aerial and solid dia. tuner with own knob. It is superhet and operates from a PP3 battery and would drive a crystal headphone. Price £1.00. Our ref. BD716.

**BULGIN MAINS PLUG AND SOCKET** The old and faithful 3 pin with screw terminals. The plug is panel mounted and the socket is cable mounted. 2 pairs for £1.00 or 4 plugs or 4 sockets for £1.00. Our ref. BD715, BD715P or BD715S.



**MICROPHONE** Low cost hand held dynamic microphone with on/off switch in handle. Lead terminates in 1 3.5mm and 1.25mm plug. Only £1.00. Ref. BD711.

**MOSFETS FOR POWER AMPLIFIERS AND HIGH CURRENT DEVICES** 140v 100watt pair made by Hitachi. Also available in H pack Ref 2SJ99 and 2SK343 £4.00 a pair. Ref 4P51.

**TIME AND TEMPERATURE LCD MODULE** A 12 hour clock a Celsius and Fahrenheit thermometer a too hot alarm and a too cold alarm. Approx 50x20mm with 12.7mm digits. Requires 1AA battery and a few switches. Comes with full data and diagram. Price £9.00. Our ref. 9P5.

**REMOTE TEMPERATURE PROBE FOR ABOVE** £3.00. Our ref. 3P60.

**25 WATT STEREO AMPLIFIER IC STK043**. With the addition of a handful of components you can build a 25 watt stereo amplifier. Supplied with a circuit diagram. £4.00 REF 4P69.

**600 WATT AIR OR LIQUID MAINS HEATER** Small coil heater made for heating air or liquids. Will not corrode, lasts for years. Coil size 3in x 2in mounted on a metal plate for easy fixing. 4in dia. Price £3.00. Ref. 3P78 or 4 for £10.00. Our ref. 10P76.

**EX-EQUIPMENT SWITCHED MODE POWER SUPPLIES** Various makes and specs but generally +5, +12V ideal bench supply. Only £8.00. Our ref 8P36.

**ACORN DATA RECORDER** Made for the Electron or BBC computer but suitable for others. Includes mains adaptor, leads and book. £12.00. Ref. 12P15.

**PTFE COATED SILVER PLATED CABLE** 19 strands of .45mm copper will carry up to 30A and is virtually indestructible. Available in red or black. Regular price is over £120 per reel. Our price only £20.00 for 100m reel. Ref. 20P21 or 1 of each for £35.00. Ref. 35P2. Makes absolutely superb speaker cable!

**NEW PIR SENSORS** Infra red movement sensors will switch up to 1000w mains, UK made, 12 month manufacturers warranty, 15-20m range with a 0-10min timer, adjustable wall bracket. Only £25.00. Ref 25P16.

**MAINS FANS** 80mm square silent mains fans ideal for equipment cooling where space is at a premium. They give quite a good draught and use about 12 watts. £9.00 ref 9P10.

**10 MEMORY PUSHBUTTON TELEPHONES** These are customer returns and sold as seen. They are complete and may need slight attention. Price £6.00 Ref 6P16 or 2 for £10.00 Ref 10P77 BT approved.

**MINIATURE DOT MATRIX PRINTERS**. These are 24 column 5v and similar to the one sold by Radio Spares for £46.00. You can have one for £10 ref 10P92.

**MYLAR CONE SPEAKERS**. These 85mm square 35ohm 2 watt speakers are ideal for outside use as they are virtually waterproof. £1.00 each ref BD903.

**BBC JOYSTICK INTERFACE** Converts a BBC joystick port to an Atan type port. Price £2.00. Our ref. 2P261.

**TELEPHONE EXTENSION LEAD** 5m phone extension lead with plug on one end, socket on the other. White. Price £3.00. Our ref. 3P70 or 10 leads for only £19.00 Ref. 19P2.

**LCD DISPLAY** 4.5in digits supplied with connection data £3.00. Ref. 3P77 or 5 for £10. Ref. 10P78.

**CROSS OVER NETWORK** 8 Ohm 3 way for tweeter midrange and woofer nicely cased with connections marked. Only £2.00. Our ref. 2P255 or 10 for £15.00. Ref. 15P32.

**BASE STATION MICROPHONE** Top quality uni-directional electret condenser mic 600r impedance sensitivity 16-18KHz - 68db built in chime complete with mic stand bracket. £15.00. Ref. 15P28.

**MICROPHONE STAND** Very heavy chromed mic stand, magnetic base 4in high. £3.00 if ordered with above mic. Our ref. 3P80.

**SOLAR POWERED NICAD CHARGER** 4 Nicad AA battery charger. Charges 4 batteries in 8 hours. Price £6.00. Our ref. 6P3.

**MAINS SOLDERING IRON** Price £3.00. Our ref. 3P65.

**SOLDERING IRON STAND** Price £3.00. Our ref. 3P66.

**CAR IONIZER KIT** Improve the air in your car, clears smoke and helps prevent fatigue. Case req. Price £12.00. Our ref. 12P8.

**NEW FM BUG KIT** New design with PCB embedded coil 9v operation. Priced at £5.00. Our ref. 5P158.

**NEW PANEL METERS** 50UA movement with three different scales that are brought into view with a lever. Price only £3.00. Ref. 3P81.

**STROBE LIGHTS** Fit a standard edison screw light fitting 240V 40/min. flash rate available in yellow, green. Complete with socket. Price £10 each. Ref. 10P80 (state colour required).

**WHITE EXTENSION CABLE WITH A DIFFERENCE** It is flat on one side making it easy to fix and lock tidy. 4 core, suitable for alarms, phones etc. Our price only £5.00 for 50m reel. Ref. 5P153.

**METAL PROJECT BOX** Ideal for battery charger, power supply etc. Sprayed grey size 8in x 4in x 4.5in. Louvered for ventilation. Price £3.00. Ref. 3P75.

**TV SOUND DECODER** Nicely cased, mains powered with 8 channels. Will drive a small speaker directly or could be fed into HiFi system etc. £12.00 each. Ref 12P22.

**2KV 500 WATT MAINS TRANSFORMER** Suitable for high voltage experiments or as a spare for a microwave oven etc. £10.00 Ref 10P93.

**STC SWITCHED MODE POWER SUPPLY** 220V or 110V operation giving 5V at 2A+24 at 0.25A +12 at 0.15A and +90V at 0.4A. £12.00 each. Ref 12P27.

**PC STYLE CASES** 18" x 18" x 6" Complete with fan and grill illuminated power switch and IEC filtered power input plug. Priced at only £15.00. Ref 15P38.

**PC POWER SUPPLIES** Brand new with in-built fan and power switch on the back +5 -5 +12 -12 150 Watt made by Aztec £25.00 each, Ref 25P18.

**BOSCHERT SWITCHED MODE POWER SUPPLIES** +5 at 15A, +12 at 2A +24 at 2A 220V or 110V input. Brand new and guaranteed. Retail price is £180! Ours £20. Ref 20P30.

## BULL ELECTRICAL Dept. PE 250 PORTLAND ROAD, HOVE, BRIGHTON, SUSSEX BN3 5QT.

**MAIL ORDER TERMS:** Cash, PO or cheque with order. Please add £2.50 service charge. Monthly account orders accepted from schools and public companies. Access and B/Card orders accepted - minimum £5. Phone (0273) 203500. Fax: (0273) 20377.

**POPULAR ITEMS - MANY NEW THIS MONTH**

**1990 CATALOGUE NOW AVAILABLE. PLEASE SEND 6" x 9" SAE FOR FREE COPY!**



Last month's miscellany included phototransistors, thyristors and jfets, from which point we continue by looking at current and voltage control.

### JFET CURRENT SOURCE

The jfet provides a self-adjusting current source when its gate is connected to its source (Fig. 17). If the external load is reduced, causing an increased current to flow, the voltage drop between the source terminal and the region of the bar adjacent to the gate region increases. The potential difference across the gate increases, making the depletion zone wider. This increases the effective source-drain resistance, reducing the flow of current through the transistor and load. Thus we have negative feedback, which maintains a steady current.

The jfet makes a very simple current source but has the disadvantage that we can not predict what the current will be for any given transistor. This contrasts with the current source of Fig. 15, last month, in which we can decide on the current we want and obtain it by selecting suitable values for the resistors. With jfets, we either have to find one that gives the current we need, or else use a series resistor (Fig. 18) of suitable value to adjust the current. Devices sold as

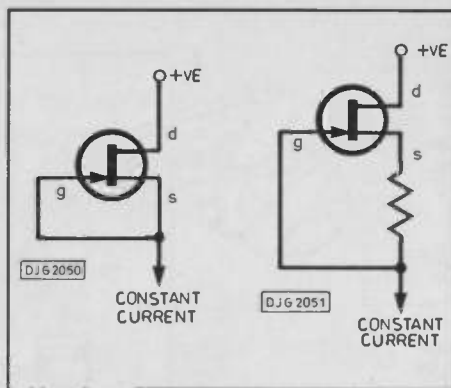

Fig. 17. (left) Jfet as a current source, and Fig. 18. (right) as a programmed current source.

biased; no current flows, except a small leakage current which can be ignored. This is the situation in Fig. 20a. A small steady current flows through the bar. If the inter-base resistance is 6 kilohm, for example, and the inter-base voltage is 6V, the current is 1mA.

The emitter potential is raised until it is the same as that at X; this is the *peak point*. As the emitter potential is raised above 3.6V, part of the junction becomes forward-biased and current begins to flow (Fig. 20b). Because of the holes now present in the lower part of the bar, the resistance of that

part (R2) falls. This has the same effect as if a low-value resistor was suddenly put into the potential divider; the potential at X falls very rapidly and soon the whole junction is forward-biased (Fig. 20c). A very large current flows.

In Fig. 21 the rising potential at the emitter is provided by charging a capacitor, C1. Let us see what happens by trying it out in practice.

#### Investigation 4 - a ujt oscillator

Fig. 22 shows how to set up the circuit. An analogue voltmeter is better for this demonstration, but a digital meter can be used. Set VR1 to about the middle of its range. Apply the power and watch the needle of the meter. It moves up the scale as the capacitor charges and down again as it discharges. What do you notice about the movement up? What do you notice about the movement down? What is the effect of increasing the resistance of VR1? What is the effect of decreasing it?

Remove the plain wire at point A and replace it with an led. Explain what happens to the led. An oscillator in which a current is switched on and off regularly is called a *relaxation oscillator*. We shall describe oscillators of the other type, *harmonic oscillators* in a later issue.

# BASIC ELECTRONICS

constant current diodes are simply jfets with their gate and source connected. After manufacture, they are sorted according to the constant current they produce and given a corresponding type number.

### UNIUNCTIONS

A unijunction transistor, as its name implies, has only one pn junction (Fig. 19). Glancing at the drawing, one might think that this is just the same as a jfet. However, the n-type material is only slightly doped, so the resistance of the transistor is relatively high. The terminals at either end are known as *base 1* and *base 2* and the b1-b2 resistance is several kilohms. The p-type material, nearer to b1 than to b2, is known as the *emitter*.

The transistor is used with b2 positive of b1, so there is a drop in potential down the bar from b2 to b1. Think of the bar as a potential divider consisting of two resistors R1 and R2 (Fig. 20a), joined at point X. The potential at X is given by the ratio  $R2/(R1 + R2)$ . This ratio is known as the *stand-off ratio*,  $\eta$ . In a typical ujt,  $\eta$  is about 0.6. So, if b1 is at 0V and b2 is at 6V, then X is at  $0.6 \times 6 = 3.6V$ .

Imagine that we gradually increase the emitter potential from 0V. If the emitter potential is less than that of X (ie, between 0V and 3.6V) the pn junction is reverse-

By Owen Bishop  
Part 10 - More assorted devices and circuits to add to your versatile repertoire, from current sources to voltage regulators.

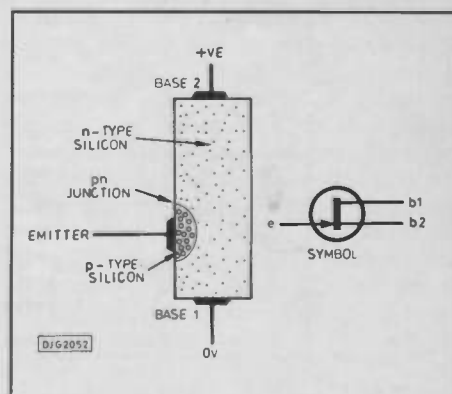
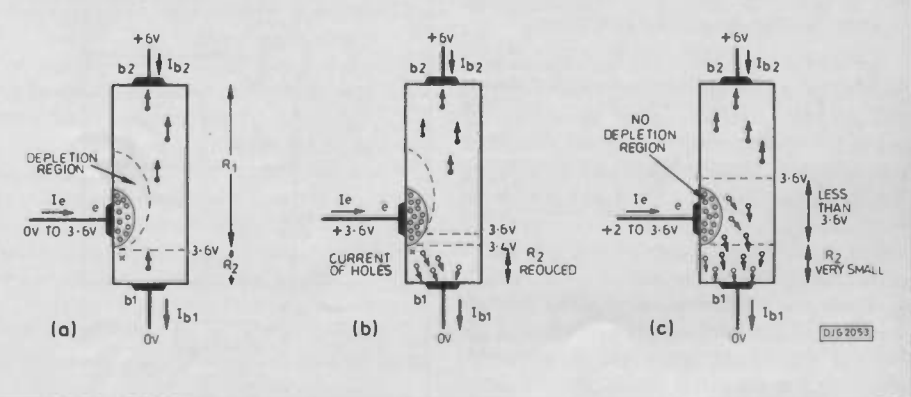
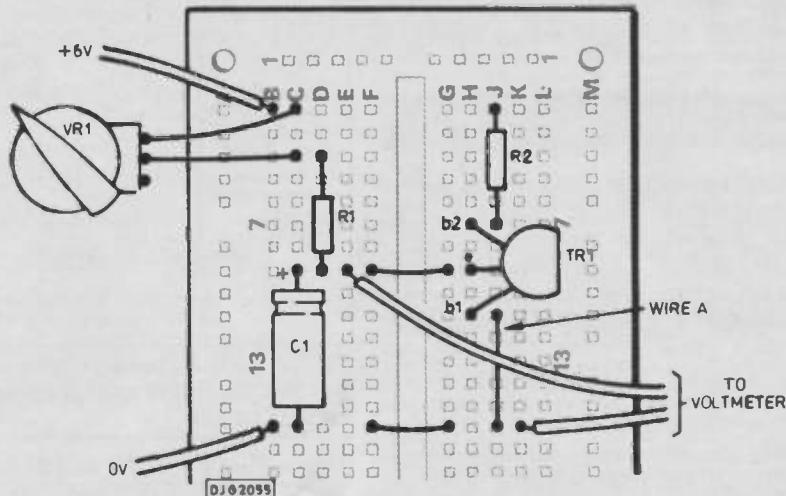
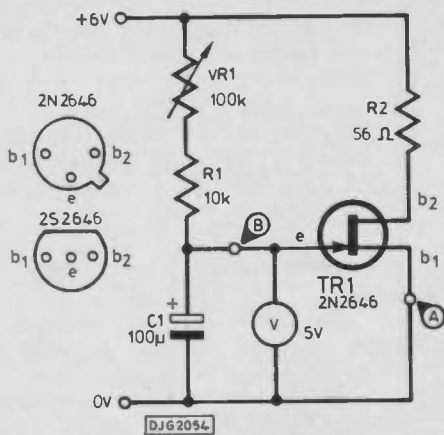

Fig. 19. (Above right). Unijunction transistor and its symbol. Fig. 20. (Below). Action of a UJT: (a) emitter voltage below  $V_{peak}$ ; (b) emitter voltage equal to  $V_{peak}$ , discharge beginning (negative resistance). Potentials shown are typical with a 6V supply.





**Figs. 21 and 22. Relaxation oscillator using a UJT and its breadboard layout as for Investigation 4.**

**Investigation 5 - a UJT audio oscillator**

Fig. 23 shows the circuit, which is very similar to that of Fig. 21. Build the circuit on a breadboard and listen to the audio signal. What is the effect of varying the setting of VR1? Why has C1 a smaller value than in Fig. 21? What is the function of R3?

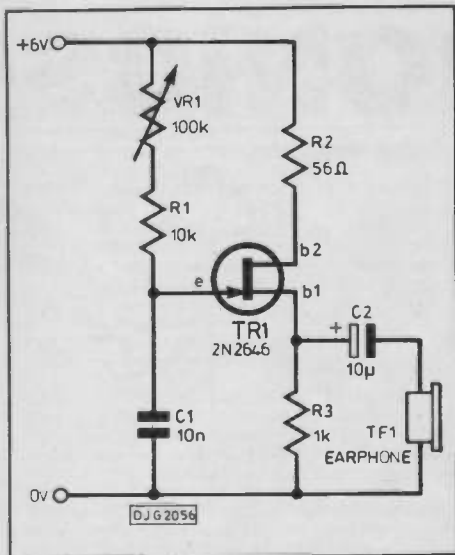

**Fig 5. Thyristor (a) structure, (b) shown as two transistors, (c) transistor connections.**

**Investigation 6 - a ramp generator**

In this circuit (Fig. 24) the capacitor is charged by the current flowing from a current source. Since the source is to supply (or source) current rather than draw current, a pnp transistor is used. The base of TR1 is biased by a potential divider (R2 and the interbase resistance of TR2); it is not as stable as the zener-biased source of Fig. 15, but is good enough for this purpose.

There is a confusing use of terms to clear up here. When referring to the transistor of Fig. 15 we should really call it a *current drain*, as the transistor drains current away

from the load. The circuit in Fig. 24 has a different action because it supplies current to the load. However, most people refer to both types of constant current circuit as sources, whether in fact they are sources or drains.

Set up the circuit and watch the needle. How does the motion of the needle differ from that in Investigation 4?

**VOLTAGE REFERENCES**

It is often useful to be able to produce a stable voltage in a circuit. For example, we may want to measure an unknown voltage from an external source (perhaps a sensor) by comparing it with a stable and accurately known reference voltage. Another major use for a reference voltage is in a power supply, as will be described later.

The zener diode has already been quoted as a device for obtaining a stable voltage, but a better device is the *band-gap reference*. This is an integrated circuit which gives much higher precision than a zener. It has

**Fig. 24. UJT ramp generator with current current source (Investigation 6)**

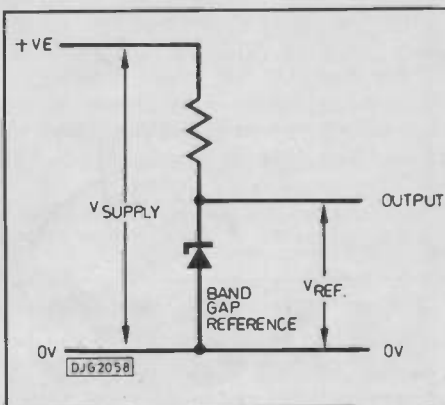
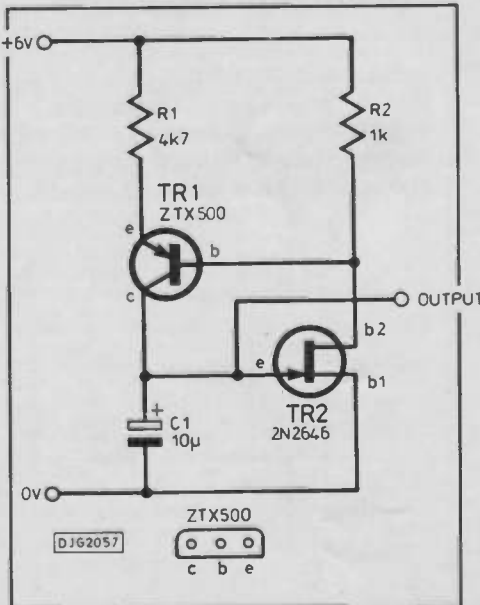

**Fig. 25. Circuit for using a 2-terminal band-gap reference device.**

temperature compensation built in, giving it greater accuracy under varying working conditions. Some of these devices have several terminals to which external components may be connected to set the voltage very precisely. Many of the more recently produced references are in a transistor package with only two terminal wires. These are connected to a circuit in the same way as a zener diode (Fig. 25). The operating current of band-gap references is extremely small (often less than 1mA).

Another class of device for controlling voltage is the *voltage regulator*. The purpose of this is to produce a reasonably steady voltage that is independent of the supply voltage and the current load over a wide range. Regulators are the basis of many designs of power supply units. A typical voltage regulator is the 7805 (Fig. 26). This is a 3-terminal integrated circuit that incorporates everything needed to produce a regulated supply of 5V usually at up to 1A. It requires a minimum input voltage of 7V and most types can accept up to 30V or 40V. There are related versions rated to produce current up to 100mA, 1A, or 2A. The device incorporates current limiting, so that there is a dramatic drop in output voltage if excess current is drawn. This protects the device against short-circuits on its output side, as

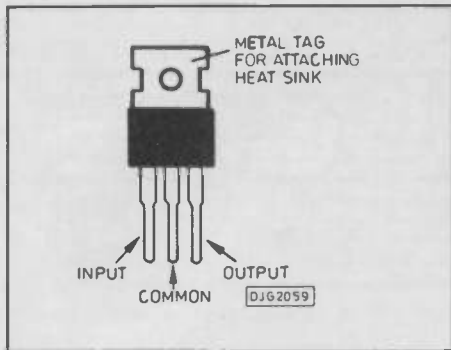

Fig. 26. 7805 voltage regulator ic.

well as protecting the circuit being supplied. There is also protection which cuts-out the ic if it becomes over-heated.

Nowadays there is a wide range of voltage regulators rated for various maximum currents and for various voltages, including negative voltages and variable voltages. More recently, 'low drop-out' regulators have been added to the range. These operate with the input voltage only about 1V higher than the required output voltage.

## POWER SUPPLY CIRCUITS

Apart from battery-powered circuits most electronics circuits are powered from the mains, using a low-voltage direct current power supply unit. Although a few may operate at a higher voltage, most operate between 5V and 18V. In particular, most computer circuits operate on 5V, the standard voltage required for transistor-transistor logic (ttl) ics, memory chips and microprocessors.

The first step in power supply is to use a transformer to reduce the voltage from that of the mains (usually 240V) to a voltage a little more than that required by the circuit. Transformers work only with alternating current, but most electronic circuits require direct current, so the next step is to *rectify* it. The principles of transforming and rectifying current have already been explained in an earlier issue.

With less critical circuits, fluctuations in the supply voltage are of little concern. The rectified supply may be used directly. If a steadier voltage is required, a zener diode gives a reasonable degree of regulation, provided that the current drawn does not vary over too wide a range. The way to use a zener diode as regulator was described in an earlier issue. However, one of the disadvantages of the simple zener circuit is that, when the load is drawing less than its maximum current, the surplus current has to flow through the zener. Not only is this wasteful of power, but it necessitates using a high-power zener and having to take measures to dissipate the excess heat produced.

One way around this problem is to let the zener operate with a small current but to amplify the current for use by the load. The type of amplifier most suited for this

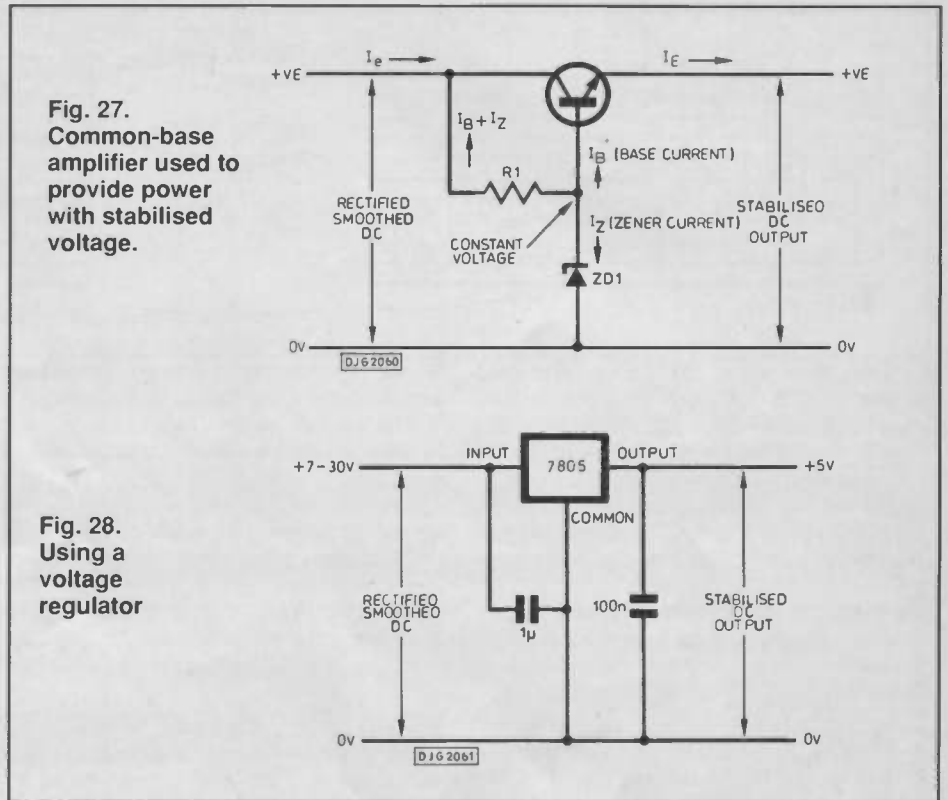

Fig. 27. Common-base amplifier used to provide power with stabilised voltage.

Fig. 28. Using a voltage regulator

purpose is the common-base amplifier described recently (Fig. 27). As explained then, this has high output impedance. That is to say the output voltage does not fall significantly when a high current is drawn - a essential feature for a power supply.

In Fig. 27 the transistor is a power transistor capable of carrying a current of the order of several amps. Its base is held at a stable voltage by the zener diode. Current flows through R1, then goes partly through the zener (IZ) and partly to the base of TR1. The zener current must be at least 5mA to bring the diode into conduction. The amount of base current determines the collector and emitter currents. Under steady conditions the forward voltage drop between the base and emitter is about 0.6V. If extra current is being drawn from the circuit, the potential at the emitter begins to fall. The base potential is being held steady so the base-emitter voltage drop increases. This increases the base current slightly. This makes the collector and emitter currents increase, and so provides the extra current that the load requires. The reverse happens if the load draws a reduced current. Whatever the change in current required by the load, the circuit operates to accommodate this. At all times the output voltage of the circuit remains steady at 0.6V below the zener voltage.

The advantage of this circuit is that the current through the zener is very low, but the output current can be several amps. Of course, if high current output is required the transistor must be rated to carry this, and a substantial heat-sink may be needed.

The circuit of Fig. 28 shows how a voltage regulator ic is used to obtain a stabilised supply. Although it has no more

components than the common-base amplifier of Fig.27, its performance is considerably better.

## SWITCHED POWER SUPPLIES

Before leaving the subject of power supplies, mention must be made of switched power supplies. These are used to provide a high current at low voltage, as might be required in a microcomputer, for example. The principle is to keep a capacitor charged to a given voltage by switching the rectified supply current on and off at high frequency (several kilohertz). The supply current is drawn from this capacitor. A transistor is used as the power switch and is turned on for a longer or shorter proportion of the cycle to keep the capacitor charged to the required voltage. The more current being drawn, the greater portion of the cycle the transistor is on. Very little power is wasted since the transistor is either off or fully on. The current drawn by the unit may in fact be less than the current being supplied to the load. The main disadvantage of switching regulators is that they generate high-frequency interference which must be very carefully filtered out if it is not to lead to trouble. It may also produce an irritating screeching sound. (SMPSUs were discussed in PE April and Aug 87. Ed.)

## MODULES OF THE MONTH

### 13. JFET amplifier (Fig. 29)

This is the common-source amplifier of Fig. 11 (last month) without the input and output capacitors and the gate resistor.

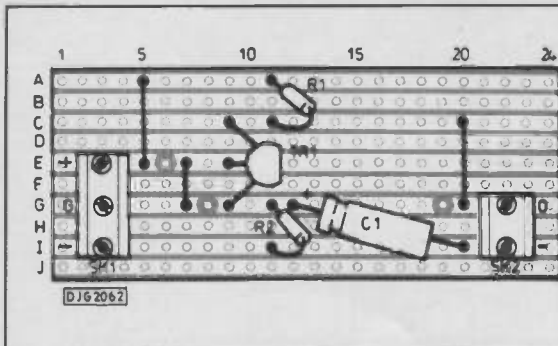

Fig. 29. (left)  
Module 13

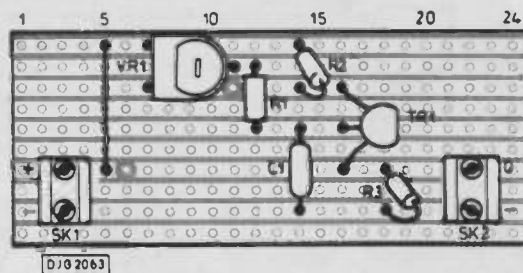

Fig. 30. (right)  
Module 14

Omitting these allows the module to be used in touch-switch circuits. If you need the gate resistor, bend the wires of a 1M resistor so that they fit into terminals 'G' and '-' of SKT1. Input and output capacitors can be mounted by inserting one of their wires into the 'G' and 'O' terminals of SKT1 and SKT2, respectively. If you are joining this module to the bipolar transistor amplifier (Module 10) or the loudspeaker module (Module 11), these already have input capacitors, so only a wire link is needed between the output of this module and the inputs of the others.

**Parts required:**

R1 5k6, R2 1k8, C1 100 µF electrolytic, TR1 2N3819 n-channel jfet, SKT1 3-way pc socket, SKT2 2-way pc socket, stripboard 63mm x 25mm.

**14. UJT audio oscillator (Fig. 30)**

This is a simple audio oscillator with variable pitch, based on the circuit of Fig. 23. It has no output capacitor, since the other modules to which it might be connected (Modules 10 and 11) already have input capacitors. If you want to join this to the jfet amplifier above, use a 100nF capacitor to join the 'O' terminal of this module to the 'G' terminal. The gate resistor is required.

**Parts required:**

R1 10k, R2 56-ohm, R3 1k, VR1 100k miniature horizontal preset resistor, C1 10n polyester, TR1 2N2646 unijunction transistor, SKT1/SKT2 2-way PC sockets (2 off), stripboard 63mm x 25mm.

**SYSTEMS OF THE MONTH**

There are now 14 modules in this series so, if you have built them all (or perhaps not quite all!), there is plenty of scope for designing and assembling your own systems. Here are two systems incorporating this month's modules. The first (Fig. 31a) is a buzzer system that can be used for a variety of purposes, including a door alert and a morse code practice set. The output from the ujt oscillator goes to the common-collector amplifier of the loudspeaker module. You could try connecting another amplifier, perhaps the jfet amplifier or the bipolar transistor amplifier (Module 10), between the oscillator and the loudspeaker module, with the idea of obtaining greater volume. However, do not expect any great improvement. The ujt oscillator already produces a waveform of reasonably high voltage amplitude. What is needed now is

current amplification, but the loudspeaker module is only a low-current circuit.

The second system (Fig.28b) is a touch switch that controls a buzzer, lamp or relay. A metal plate is wired to the gate ('G') terminal of Module 13. There is a direct wire connection between the output of this module and the input of the Schmitt trigger. The load of the Schmitt trigger may be a solid-state buzzer, as shown, or a lamp or relay (Module 7). The relay module may be used for switching any device for which its contact ratings are suitable.

**DISCUSSION**

**Investigation 1.** The voltage gain of a 1-transistor jfet amplifier is usually not as high as that of a comparable amplifier using a bipolar transistor. Its main advantage is its high input impedance. The amount of voltage amplification depends on the value of the source resistor. Within limits, the greater the value of Rg, the larger the output voltage. C3 acts to hold the potential of the source terminal steady when an audio signal is present. As in the bipolar transistor amplifier described in an earlier issue, it prevents feedback causing a reduction in amplification. It is known as a *by-pass capacitor*.

**Investigation 2.** The action may be influenced by various factors but usually the voltage falls when a charged polythene strip is brought near the plate. With acetate, there is a slight rise in voltage and a sharp fall as the strip is *taken away*. The two strips appear to be charged in the opposite sense, one positively, the other negatively. This confirms the results of Investigation 1 of Part 1 of this series. The fact that the voltage falls with polythene shows that current through the transistor is reduced; therefore the depletion region must have become wider; therefore the polythene must carry negative charge (electrons). The acetate must be positively

charged (some of its atoms lacking electrons). The effect demonstrated here illustrates the use of a jfet as the first stage in an *electrometer* - an instrument for measuring electric charge.

The voltage usually falls when the plate is touched, less if the body is earthed, more if the body has become highly charged by walking on a nylon carpet. This effect indicates a use for the jfet as the first stage in a *touch switch*, or in a *proximity switch*.

**Investigation 3.** The current stays close to about 10mA whatever the value of the load, up to about 220-ohm. There is a slight fall if voltage is reduced, but the drop is not nearly as much as 25%.

The voltage across R1 is 6-3.9 = 2.1V. Vbc = 0.6V, so the voltage across R2 = 3.9 - 0.6 = 3.3V. Current through R2 = 3.3/330 = 0.01A, or 10mA. Maximum load for 10mA = voltage across R1/current = 2.1/0.002 = 210 ohms.

**Investigation 4.** The needle moves slowly up, gradually moving more slowly up to the peak value (about 4V), corresponding to the *peak point*. Then it flicks rapidly down to about 2V, the *valley point*. The movement of the needle indicates the waveform at point B, Fig. 21, as illustrated in Fig. 32b. Increasing VR1 makes the circuit oscillate more slowly, because the reduced charging current takes longer to charge the capacitor; decreasing VR1 makes it oscillate faster.

The led glows steadily, owing to the continuous current passing through R2 and TR1, but flashes every time the capacitor is discharged. This corresponds with the waveform at point A, Fig. 21, illustrated in Fig. 32a.

**Investigation 5.** The frequency of oscillation and hence the pitch of the note increases as VR1 is reduced. C1 is smaller so that it will charge more rapidly and thus produce a note of higher (ie, audio) frequency. R3 is needed to 'turn a current into a voltage'. Every time a pulse of current flows from b1, a

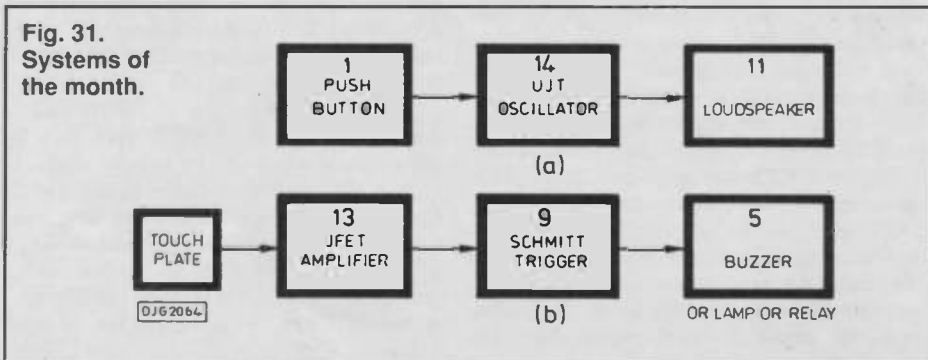

pd is generated across R3. Thus the potential of b1 is briefly raised. The positive-going edge is transmitted through the capacitor, causing a pulse of current to flow through the earphone.

**Investigation 6.** The needle moves up the scale at a *constant* rate. This shows that the capacitor is charging at a constant rate owing to the constant charging current. The waveform at A is a *sawtooth* waveform, as in Fig. 33. The steadily increasing voltage is called a *ramp* and has many uses, particularly in measuring and timing circuits.

**NEXT MONTH** We introduce the workhouse of the analogue world, the operational amplifier. PE

**Fig. 32. Waveform of the UJT oscillator.**

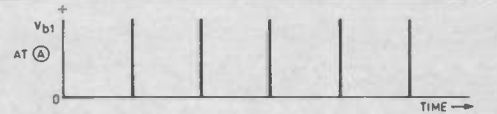

**Fig. 33. Output of the UJT oscillator with constant current source (ramp generator).**

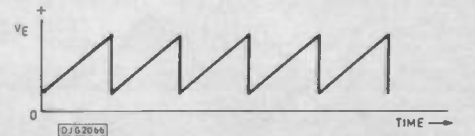
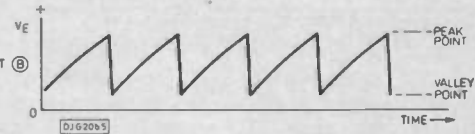

# TUTORKIT MICROELECTRONICS TUTORS

Logic Tutors  
OP Amp Tutors  
I.C. Patchboards  
GCSE Units  
Computer Interfaces

Prices from



Including instruction manual and patch leads

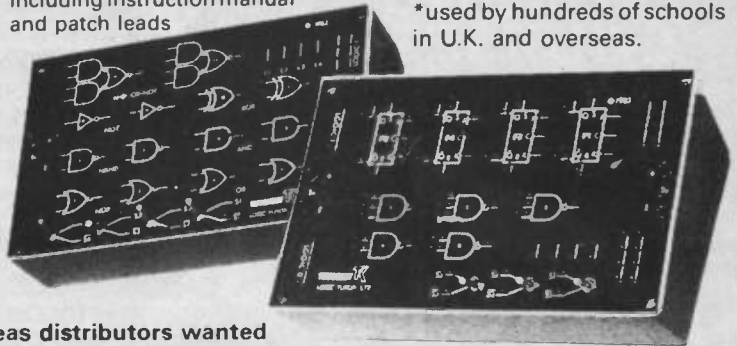

\*used by hundreds of schools in U.K. and overseas.



**TUTORKIT PRODUCTS**  
(Div of Limrose Electronics Ltd)  
Llay Industrial Estate  
Wrexham, Clwyd, U.K.  
LL12 0TU. Tel 097 883 2285

Overseas distributors wanted

# BINDERS

Binders for Practical Electronics are available for £5.95. Send your cheques or postal orders (payable to Intra Press) to:  
**Practical Electronics Binders**  
193 Uxbridge Road  
London W12 9RA



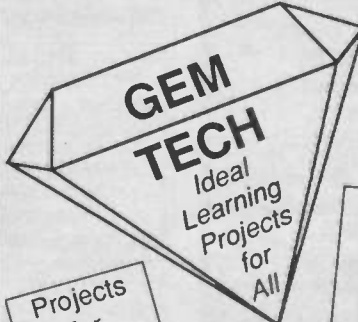

**GEM TECH**  
Ideal Learning Projects for All

Projects for Motoring  
Audio  
Lighting  
Metering  
Effects  
etc.

Kits for all abilities  
Step-by-Step Instructions

plus Assembly Tools

plus PCB Making Materials and equipment

plus Tutorials Books and Features

Learn at your own pace!

**Catalogue**  
only  
**50p**

plus Test Gear

plus this month's Special Offers!

**GEM-TECH**  
Dept PE10, Unit J,  
8 Finucane Drive,  
Orpington,  
Kent, BR5 4ED

**MAIL ORDER**

# PRACTICAL ELECTRONICS CLASSIFIED

Reach thousands of serious electronic and computer enthusiasts. Advertise in PE Classified pages: Rates 20p per word or £8.50 per single column cm (plus VAT). All classified advertisements must be pre-paid. Send your copy with the remittance (payable to Intra Press or payment by Visa or Access accepted) to: **Practical Electronics, Intra House, 193 Uxbridge Road, London W12 9RA. Tel: 081-743-8888. Fax: 081-743-3062**  
**LET PE WORK FOR YOU!**

## EDUCATION

### FULL-TIME TRAINING COURSES

**2 YEAR**  
**BTEC NATIONAL DIPLOMA**  
 Electronics and  
 Communications  
 Engineering  
 (TV, Computers, Programming, IT)

**1 YEAR**  
**BTEC NATIONAL CERTIFICATE**  
 1. Electronic Equipment Servicing

(TV, Video, CCTV)  
 2. Computing Technology  
 (Microprocessors, DataComms, Interfacing)

3. Information Technology  
 (Telecomms, Satellite TV, Networks)

4. Software Engineering  
 (Assembler, BASIC, Pascal, CAD/CAM)  
 ★ Those eligible can apply for E.T. grant support ★  
 ★ An equal opportunities programme ★

**COURSES COMMENCE**  
 Monday 17th September 1990

### LONDON ELECTRONICS COLLEGE

Dept: AA, 20 Penywern Road,  
 London SW5 9SU. Tel: 071-373 8721

### Start training now for the following courses.

- Telecomms Tech C&G 271
- Radio Amateur Licence C&G
- Microprocessor
- Introduction to Television

Send for our brochure - without obligation or telephone us on 06267 79398 (Ref: PE8/90)  
 Name.....

Radio & Telecommunications  
 Correspondence School,  
 12 Moor View Drive, Teignmouth,  
 Devon TQ14 9UN

## RETAILERS

### EDINBURGH

### OMNI ELECTRONICS

stock a wide range of  
 electronic components at  
**174 Dalkeith Road**  
**Edinburgh EH16 5DX**  
**Tel: 031 667 2611**  
 Open Mon-Fri 9am-6pm  
 Sat. 9am-5am

**NEW CATALOGUE OUT SOON**  
 Price is just £1.50  
 Contact Omni Electronics  
 now for details

### MANCHESTER

### THE ELECTRONICS SHOP

We stock a large range of electronic components, test equipment, telephone accessories, computer accessories, microphones, speakers, discolorighting, mixers, meters, styllif, so call in and have a look around.

29 Hanging Ditch, Manchester M4 3ES  
 Telephone: 061-834 -1185  
 Fax: 061-833-2969

### SOUTHSEA

### ELECTRONIC COMPONENTS

EVERYTHING FOR YOUR NEXT PROJECT  
 THE BIGGEST DISPLAY IN THE SOUTH  
 IS AT

### FRASER ELECTRONICS

42 ELM GROVE ★ SOUTHSEA ★ HANTS

Telephone: 0705-815584

Barclaycard

Access

### STAFFORDSHIRE

### COMPONENT SOLUTIONS Ltd.

"answering your component problems"

Unit 62, Enterprise Centre, Bedford Road,  
 Stoke-on-Trent, Staffs., Tel: 0782 287038

## SURVEILLANCE

**SURVEILLANCE DEVICES**, lasers, Tesla coils, scramblers, ultrasonic and many more, over 150 designs. Send SAE to: Plancentre, Old Wharf, Dynock Road, Ledbury HR8 2HS

## MISCELLANEOUS

**NEW VHF MICROTRANSMITTER KIT**, tuneable 80-135 MHz, 500 metre range, sensitive electret microphone, high quality PCB. **SPECIAL OFFER** complete kit **ONLY £5.95 assembled and ready to use** £9.95 post free. Access orders telephone 021 411 1821. Cheques/P.O.'s to: **Quantek Electronics Ltd, (Dept P.E.), 45a Station Road, Northfield, Birmingham, B31 3TE.** SAE for details of this and other kits

**DATAMAN S3 EPROM PROGRAMMER.** Many professional features. Will program hundreds of PROM types. In-circuit RAM evaluation up to 64 kbytes. Mint condition. Full documentation. Offers around £450. (0737) 76482)

**VOICE/SOUND ACTIVATED SWITCHES** easy to follow diagrams and uses, only £1.00. Components and PCBs available from Herrington, 63 Home Farm Road, Hanwell, London W7 1NL

## KITS

### VELLEMAN KITS

Over 100 Project kits in stock. Send 50p for 1990 Catalogue plus price list.

Electronic Retailers wanted throughout the country with a view to stocking our product.

**High Q Electronics**  
**PO Box 14810**  
**London NW7 4RF**  
**Tel: 0707-263562**

**COMPONENTS**

**III C.E.S. N.W.**  
FOR ELECTRONIC COMPONENTS

TEST EQUIPMENT REPAIRS  
IBM PC ACCESSORIES  
AT DISCOUNT PRICES

Let us source that difficult to find component for your kit or project. Send for details of all our services.  
Appt. 2, No. 8 Merlon Gardens, Colwyn Bay, Clwyd North Wales LL29 7PR

Tel:0492 533083 Fax: 0492 534716

C.S. COMPONENTS (Est. 4 years). Suppliers & stockist of electronic components, electronic valves, military equipment and spares. Obsolete and hard to find products are our speciality. C.S. Components, Southfield House, 11 Liverpool Gardens, Worthing, West Sussex BN11 1R

- Carbon Film Resistors 1/4W E24 series 0.51R to 10MΩ - 1p
- 100 ohm per value - 75p 1000 off in even hundreds per value - £7
- Metal Film 1/4W 10R0 to 1MΩ 5% E12 series - 2p 1% E24 series - 3p
- Whatt metal/carbon film E24 series 1R0 to 10MΩ - 11p
- 1 Watt metal/carbon film E12 series 4R7 to 10MΩ - 5p
- BC107/B/9 - 12p BC547/B/9 - 8p BC182L 184L - 10p
- BFY50/S1/52 - 20p 2N3055 - 50p TIP31A,32A - 25p TIP,41,42 - 40p
- Tantalum bead subminiature electrolytics (Mkds/Volts)
- 0.1/35, 0.2/35, 0.4/35, 3.3/16, 4.7/16 - 14p 4.7/35 - 15p
- 2.2/35, 4.7/25, 10/5 - 15p 4.7/35, 6/9/16 - 16p .10/16, 22/16 - 20p
- 22/16 - 20p 33/10 - 30p 47/10 - 35p 100/6 - 40p
- Aluminium Electrolytics (Mkds/Volts)
- 1/50, 2.2/50, 4.7/25, 4.7/50, 10/16, 10/25, 10/50 - 5p 22/16, 22/25 - 6p
- 22/50, 47/16, 47/25, 47/50 - 6p 100/16, 100/25 - 7p 100/50 - 12p
- 100/100 - 14p 220/16 - 8p 220/25, 220/50 - 10p 470/16, 470/25 - 11p
- 1000/25 - 18p 1000/35, 220/25 - 22p 4700/25 - 70p
- Miniature Polyester Capacitors 250V Wtg. Vertical Mounting
- 01, 015, 022, 033, 047, 068 - 4p 0.1 - 5p 0.15, 22 - 6p 0.47 - 8p
- Mylar Capacitors 100V Wtg. Vertical Mounting E12 Series
- 1000p to 8200p - 3p 01 to 068 - 4p 0.1 - 5p 0.15, 0.22 - 6p
- Subminiature Ceramic Plate 100V Wtg. E12 Series Vertical Mounting
- 2% 1P8 to 47P - 3p 56P to 330P - 4p 10% 390P to 4700P - 4p
- Ceramic plate/disc E8 Series 50V 22P to .047 - 2p
- Polyethylene Capacitors 63V Wtg. E12 Series Axial Mounting
- 10P to 820P - 3p 1000P to 10,000 - 4p 12,000P - 5p
- 1N4148 - 2p 1N4002 - 4p 1N5404 - 14p W01 bridge - 25p
- 0A91 - 8p AA143 - 8p W005 - 20p 1N4006 - 8p
- Zener diodes E24 series 3V3 to 33V 400mW - 8p 1 watt - 12p
- L.E.D's Red, Green & Yellow 3mm & 5mm - 10p 8mm - 26p
- 20mm fuse 0.1A to 5A quick blow - 8p Anti Surge - 8p
- High Speed drills 0.8mm, 1.0mm, 1.3mm, 1.5mm, 2mm - 30p
- Expo Reliant drilling machines 12Vd.c. with improved 3-jaw chuck £7.00
- Nicads AA - 80p HP11 - £2 PPS - £4.20 Universal Chargers - £8.50
- Glass reed switches single pole make contacts - 8p Magnets - 12p

VAT inclusive. Return postage 25p (free over £5). Lists free.  
**THE C.R. SUPPLY CO.,**  
127 Chesterfield Road,  
Sheffield S8 0RN. Tel. 557771.

**PE WORKS FOR YOU!**

**Cooke International**

DO YOU WANT USED  
SCOPES, SIGNAL GENERATORS, POWER  
SUPPLIES, POWER METERS, DVM'S,  
OSCILLATORS, ATTENUATORS.  
TEST EQUIPMENT.

Contact: Cooke International, Unit Four, Fordingbridge Site, Main Road, Barnham, Bognor Regis, West Sussex PO22 0EB.  
Tel: 0243 545111, Fax: 0243 542457  
Wide range of items available. Send for lists.

**COMPONENTS**

**30 DAYS GUARANTEE. PLEASE ADD VAT. CHECK AVAILABILITY & CARRIAGE COSTS.**

- AUDIO GENERATOR 10HZ TO 120 KHZ SINE £15
- SIGNAL GENERATOR 144H - 10 KHZ TO 72 MHZ £22.50
- MARCONI 2015 AM/FM 10-520MHZ SIG GEN £150
- MARCONI 2002AS 10KHZ - 72MHZ SIG GEN £80
- COMPUTER FIELD**
- CALCOMP DIGITIZERS JUST IN MODEL 2000 12 INCH X 12 INCH TABLE ONLY. SPECIAL PURCHASE SO £80
- CGA, EGA, AND VGA STOCK AND PRICES CHANGE FAST SO TELEPHONE. £10
- PRINTERS WIDE RANGE FROM £45

**Try Our Bumper Component Pack!**  
ICs - Capacitors - Diodes - Leds  
Bridge Rectifiers, and other components etc.

**REPAIRS AND SORT OUTS**

WE REPAIR IBM & COMPATIBLES - ANY PRINTERS - ANY MONITORS - ANY TEST EQUIPMENT. CAN'T GET IT TO WORK CALL US - NO SILLY PRICES

**A. WOOD. NORTH WEST.**  
**94 WORSLEY ROAD, FARNWORTH**  
**TEL: BOLTON (0204) 71795**  
**OPEN 7 DAYS A WEEK**

**SURPLUS/REDUNDANT ELECTRONICS COMPONENTS WANTED**

ICs - Tuners - Transistors - Valves - Diodes etc - any quantity considered - immediate payment.

**ADM ELECTRONICS SUPPLIES**  
Tel 0827 873311 Fax: 0827 874835

**FOR SALE**

100 new resistors assorted £1.00.  
Buy £5.00 worth and receive other type components free!  
Contact: Ray, 71 Tothale Turn, Liverpool 27 L27 4Y0

**N.R. BARDWELL LTD**

- 10 - 4p 3w MBB Rotary Switches .....£1.00
- 200 - Signal Diodes 1N4148 .....£1.00
- 100 - Rectifier Diodes 1N4001 .....£1.00
- 100 - Zener diodes 6V8 400mW .....£1.00
- 30 - Assorted DIL sockets up to 40 pin .....£1.00
- 30 - Assorted sockets/conn's. DIL, Edge, IDC, Header etc. ....£1.00
- 30 - Transistors BC478 .....£1.00
- 25 - Assorted High Brightness Leds .....£1.00
- 20 - Miniature SPST Slide Switches .....£1.00
- 20 - Magnetic ear pipes + lead and plug .....£1.00
- 75 - Electrolytics 4.7µf 63V .....£1.00
- 1 - Pelizzor effect Heal Pump .....£1.00
- 1 - 10 watt Stereo Amplifier 4 controls + data .....£2.95

Prices include VAT, postage 85p. All items new.  
Many other lines in stock. Lists free.  
Shop open Mon/Sat 9.30-5.30. Lists S.A.E.  
**288 ABBEYDALE ROAD, SHEFFIELD S7 1FL**  
TEL: (0742) 552886 FAX: (0742) 500689

**TURN YOUR SURPLUS**

ICS transistors etc into cash, immediate settlement. WE welcome the opportunity to quote for complete factory clearance.

Contact:  
**COLES-HARDING & CO.,**  
103 South Brink, Wisbech, Cambs.  
ESTABLISHED 15 YEARS  
Tel: 0945 584188 - Fax: 0945 588844

**COMPONENTS**

**ELECTRONIC COMPONENTS**

Send for our 1991 Catalogue!  
Contains 000's of product lines including SMD components.  
Send cheque or P.O. for £1.80 to:

**SARM DIGITAL**

13, Pearl Street, Macclesfield, Cheshire SK10 2AL

Mail Order Only.  
Prop. N. Farrar

**Switch Mode P.B.U. Mains Operated. Brand New. Outputs +5V/3.5A, +12V/1.3A, -5V/0.3A. Fully tested £6.00 each**

**Capacitors High Value. (Mkds/Volts)**  
9000/50V £1.00, 10000/30 £1.00, 22000/20 £1.50  
47000/48 £3.50, 68000/16 £2.00

**Relays:** 3.5V, 12V, 24V, 50V DC Coils, 2PCO, 4PCC 3 for £1.00  
115V AC, 240VAC Coils £1.00 each

**Fuses 1" & 1+1/4" Antisurge, 62mA, 1A, 1.5A, 3A. 10 for £1.00**

**Second User Tek Scope, Type 475 Dual Channel, 200Mhz £395.00**  
**H.P. Storage Scope with 2 Vertical Plugs-ins, Type 141B £345.00**

**Carriage Components 0.75p**

Cheque or Postal Order to  
**MULTI SOURCES, Unit 2, Stable Yard, Downs Barn, Milton Keynes, MK14 7RZ**

- Resistors 1/4 W 5% carbon (E12) 1p metal film 1% .....3p
- Resistor Pack 85 different E12 values + zero ohm link total content
- 1000 resistors .....£8.95
- L.E.Ds red/green 3/5mm .....6p each. Yellow 11p
- Cable ties 75mm .....1p each £5.95/1,000 £49.50 per 10,000
- Stepping motor 4 phase 12v 7.5' step 50 ohms .....£8.95
- SAA1027 stepping motor driver chip .....£3.95
- FM transmitter Kit good quality sound .....£7.94
- High quality photo resist copier clad epoxy glass boards
- Dimensions single sided double sided
- 3x4 inches .....£0.95
- 1x1.07
- 4x8 inches .....£2.40
- £2.68
- 6x12 inches .....£5.37
- 12x12 inches .....£10.66

**Special Offers**  
Computer Grade Capacitors with screw terminals 38000uf 20v £2.50  
8700uf 10v £1.95, 68000uf 15v £2.95, 10000uf 16v £1.50  
7 segment Common anode led display 12mm .....£0.45  
LM2931ATS.0 Low drop out 5V regulator T0220 package .....£0.85  
BS250 P channel MOSFET £0.45, BC559 transistor .....£3.95 per 100  
74LS05 hex inverter £10.00 per 100, used 8748 Microcontroller .....£3.50  
Stereo LW/MW/FM Tuner pre-amp assembly complete with volume/tone controls and tuning scale Brand new in makers carton .....£5.95, faulty £2.50  
Circuit diagram description and setting up procedure for tuner assembly described above £0.50. 5 digit 6v electromagnetic counter .....£1.95  
Hour counter (used) 7 digit mains 240V AC 50Hz .....£0.95  
LCD display 16 digit 7x5 dots dot matrix .....£2.50  
Querty keyboard 58 key good quality switches .....£5.50  
95p for P&P per order (VAT incl.)  
wide range of CMOS TTL 74HC 74F Linear transistors kits capacitors, resistors tools etc always in stock  
JPG Electronics 276 Chatsworth Road Chesterfield S40 2BH  
Access orders (0246) 211202. Callers welcome

**CLASSIFIED COUPON**

						£3.22
						£4.83
						£6.44
						£8.05
						£9.66
						£11.27
						£12.88
						£14.49

Rates are 20p per word plus 3p VAT (lineage, for semi-display advertisements contact our Ad. Dept.). All classified advertisements must be pre-paid. Please send your copy with the remittance (payable to Intra Press or payments by Visa or Access accepted) to: Practical Electronics Classified Dept., Intra House, 193 Uxbridge Road, London W12 9RA. Tel: 081-743-8888, Fax: 081-743-3062



Established since 1973 Hills Components can offer the trade a selection of nearly 4,000 product lines covering the following ranges

- Aerials & Accessories
- Batteries & Accessories
- Cables & Accessories
- Computer Accessories
- Connectors (all types)
- Electronic kits/Modules
- Filters/Fuses
- Hardware/Fixings
- Headphones/Intercoms
- Connecting leads (all types)
- Microphones
- Multimeters
- Passive Components
- P.C. Boards
- Relays
- Speakers
- Switches
- Service Aids
- Soldering Equipment
- Telephones & Accessories
- Transformers

**TRADE ENQUIRIES ONLY**

Please phone or write quoting your company name & address for a copy of our 1990 catalogue

**TRADE ONLY**

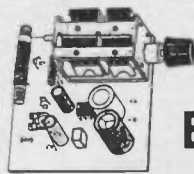

**ELECTRONIC KITS & MODULES**

FOR HOBBYISTS ELECTRONICS ENTHUSIASTS  
EDUCATIONAL ESTABLISHMENTS ETC.

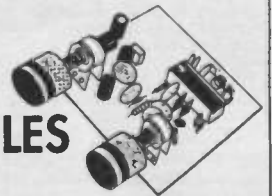

Build your own:  
Geiger-Mueller Indicator, Metal Detector,  
Stereo Amplifier Digital Combination Lock, or  
any of the many other kits available for numerous applications

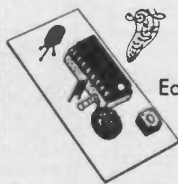

Each kit comes in component form with easy to follow instructions for assembly

**OVER 100 KITS TO CHOOSE FROM**

Some of the popular kits include

- \* Antenna Amplifiers
  - \* Lie Detectors
  - \* Alarm Systems & Monitors
  - \* Infra-Red Light Barriers
  - \* Sirens - Kojak-Warship-FBI-Ships-Space
  - \* Micro-Wave Indicators
  - \* Radios & Receivers
  - \* Electronic Barking Dog
  - \* Lighting Consoles
  - \* Amplifiers (up to 200w)
  - \* Car Aerial Amplifiers
- PLUS MANY MANY MORE

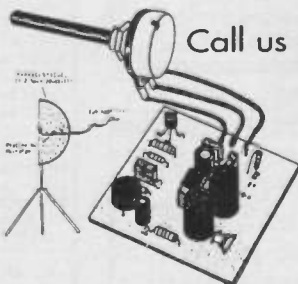

Call us now for details of your local Stockist

**HILLS COMPONENTS LTD**

Units 5 & 6  
Melinite Industrial Estate  
Brixton Road, Watford  
Herts WD2 5SL.  
0923 52000

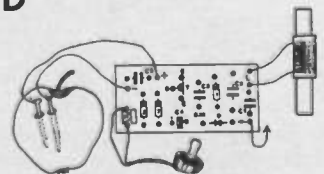



It's nice to see that the ancient art of lens grinding is keeping right up to date. When I went to get a new pair of spectacles recently I discovered that my local opticians use data communications to send their lens prescriptions directly to an automatic lens grinding and polishing machine in their main factory. Here the coded data electronically sets up the machine to produce the specified lenses from optical blanks. The system almost eliminates paper-work.

## EXCHANGES

There's likely to be more of this kind of thing in all branches of industry when the UK goes into the exchange rate mechanism (ERM) of the European Monetary System. It now seems probable that we shall in fact join the ERM, despite the Prime Minister's worries about sovereignty. The economic arguments in favour look pretty strong. At the time of writing Britain is one of only three EC

## INDUSTRY



## NOTEBOOK

## DEMANDING IT

There's another reason why the UK electronics industry should benefit from Britain's entry into the ERM. It's likely that ERM participation will bring an increased demand from all sectors of British industry for more automation and IT systems - which will include electronic products for measurement, control, information processing and data communications.

Experience from France shows that entry into the ERM imposes a discipline on manufacturing industry to make it operate more efficiently. With a floating exchange rate, as in the UK at present, there is a tendency for manufacturing inefficiency to be masked by compensatory adjustments in the exchange rate.

Inadequacies such as poor organization, low productivity and high labour costs result in increased unit costs and higher prices for products. These inflationary economic conditions tend to devalue the currency and

# A BOOST FROM THE ERM?

countries which have not yet joined. The currencies of the other nine are all participating in it.

How, then, could the ERM benefit the UK's electronics industry? And what has industrial automation got to do with it?

In the ERM, which was started in 1979, the EC member countries agree to keep their currencies in almost fixed relationship to each other. Each currency has a central fixed rate defined in terms of the European Currency Unit (ECU). In practice the rate is allowed to fluctuate slightly by up to 2.25% either side of this central ECU reference (except for Spain's peseta, which has a tolerance of  $\pm 6\%$ ).

Control is achieved by the central banks buying and selling currencies. This results in what is called a parity grid - a set of bilateral exchange relationships - so that all the currencies move together as a bloc. They vary very little among themselves or against the ECU.

## ELECTRONIC BENEFITS

First, the UK electronics industry should benefit from this system because companies would be able to plan their EEC export/import trading with much greater confidence. The return on long-term investment and the results of decisions - say on product development or marketing - would be much more predictable.

The prices at which firms could expect to sell products in the EEC, and the cost of the materials, components, machines, etc, they import from EEC suppliers, would be known in advance with considerably greater accuracy. These prices would not be subject to unpredictable variations as they are with the present floating exchange rate of the pound sterling relative to other EC currencies. As things stand, UK electronics manufacturers are

By Tom Ival

## Entry into the ERM should enable the UK electronics industry to be more competitive and efficient.

tending to set artificially high prices as a hedge against unexpected swings in the exchange rate, and this of course makes the products uncompetitive in EEC markets.

So overall the electronics industry should benefit by becoming more efficient - through better management decisions based on predictable and consistent trading conditions - and more competitive in selling its products in EEC countries. Its trade deficit might be reduced.

Of course, the electronics industry also trades with other parts of the world. But, in common with UK industry generally, it is doing more and more business with the EC as time goes on. Gordon Gaddes, the director general of the trade association BEAMA (British Electrical & Allied Manufacturers' Association) recently told me that approximately a half of the total exports from his member companies now go to West European countries and over a half of these firms' imports come from the same area. In UK world trade generally, British exports to EEC countries have risen from 37% in 1978 to 50% in 1989.

So, with Britain's economy getting increasingly locked into the EEC, it becomes more and more important that we should get rid of the disadvantages resulting from a floating exchange rate.

lower the exchange rate. Consequently the products, although manufactured inefficiently, become cheaper to other countries and therefore more competitive in these markets.

Although this compensatory process keeps Britain's trade going, the domestic penalty we have to pay for it is a large trade deficit, high inflation and high interest rates.

## EFFICIENCY

Entry into the ERM will prevent the exchange rate of the pound sterling from falling relative to EEC currencies and the compensatory price adjustment described above won't happen. Consequently the export prices of British products will reflect the relatively high true cost of production and they will no longer be competitive in EEC markets.

So, to keep their product prices down and still maintain their profit margins, the only recourse of British manufacturers will be to operate more efficiently and reduce production costs. There are various ways of doing this but one of them is a greater investment in automation.

In general automation increases the productivity (output : input ratio) of labour, capital equipment, or materials consumption. For decades its techniques have been going more electronic. In terms of equipment this means a greater demand for measuring instruments and machines, process controllers, numerically-controlled machine-tools, robots with vision systems, on-line computers and microcontrollers, local-area networks and the kind of computer integrated manufacturing systems (outlined in the August 1989 issues, p.57) that save time and materials.

The social problem with automation is that it undermines certain traditional human skills in industry while demanding new skills to ensure that it works properly.

PE



# PRACTICAL ELECTRONICS BOOK SERVICE

*Here is your Editor's choice of books he thinks will be of interest to electronics and computer enthusiasts*

## BEGINNERS AND EARLY STARTERS

**Mini-Matrix Board Projects.**  
R.A.Penfold. 112 pages. £2.50. Order Code BP99

Shows a selection of 20 useful and interesting circuits that can be built on a mini-matrix board of 24 holes by 10 copper strips in size - an ideal book for early experimenters.

**From Atoms to Amperes.**  
F.A.Wilson. 160 pages. £3.50. Order Code BP254.

For the absolute beginner, clearly explaining the fundamentals behind the whole subject of electricity and electronics.

**Electronic Projects for Beginners.**  
F.G.Rayer. 128 pages. £1.95. Order Code BP48

Specially for the newcomer to electronics who is looking for a book containing a wide range of easily made projects. Some circuits need no soldering and many others show actual component and wiring layouts.

**Electronics Build and Learn**  
R.A.Penfold. 128 Pages. £5.95. Order Code PC 101

Combining theory and practice, the book describes a circuit demonstrator unit that is used in subsequent chapters to introduce common electronic components and circuit concepts, complete with practical experiments.

**Practical Electronic Building Blocks**  
R.A.Penfold. There are two books -  
Book 1 : 128 pages. £1.95.  
Order Code BP117  
Book 2 : 112 pages. £1.95.  
Order Code BP118

Book 1 is about oscillators and gives circuits for a wide range, including sine, triangle, square, sawtooth and pulse waveforms and numerous others from voltage controlled to customised ic types.

Book 2 looks at amplifiers, ranging from low level discrete and opamp types to ic power amps. A selection of mixers, filters and regulators is included.

**30 Solderless Breadboard Projects**  
R.A.Penfold. Two books each of 160 pages. Book 1 : £2.95. Order Code BP107. Book 2 : £2.25. Order Code BP113.

Each project is designed for building on a Verobloc breadboard and is accompanied by a description, circuit and layout diagrams and relevant constructional notes. Many of the components are common to several projects. Book 1 covers linear devices, and Book 2 covers cmos logic chips.

**Beginners Guide to Building Electronic Projects**  
R.A.Penfold. 112 pages. £1.95. Order Code BP 227

Shows the complete beginner how to tackle the practical side of electronics and includes simple constructional projects.

## SATELLITE TV

**Satellite TV Installation Guide - 2nd edition** John Breeds. £11.95. Order Code STV1

Full of vital information for any competent diyer who wishes to install a satellite tv antenna and obtain optimum reception quality.

**An Introduction to Satellite Television**  
F.A.Wilson. 112 pages. £5.95. Order Code BP195

Informative answers to many of the questions about this communications revolution. The information is presented on two levels, one aimed at the complete beginner, the other at professional engineers and serious amateur enthusiasts.

## TEST AND MEASUREMENT

**Getting the Most from Your Multimeter**  
R.A.Penfold. 112 pages. £2.95. Order Code BP239

There's more to what you can do with a meter than meets the casual eye. The book covers the basics of what you can do with analogue and digital meters and discusses component and circuit testing.

**Test Equipment Construction**  
R.A. Penfold £2.95.  
Order Code BP248

Describes in detail how to construct some simple and inexpensive, but extremely useful, pieces of test equipment.

**Oscilloscopes 2nd Edition**  
I.Hickman. £12.95. Order Code NT3

Subtitled 'How to Use Them, How They Work' the book is illustrated with diagrams and photographs and is essential reading for anyone who wants to know about scopes, from first principles to practical applications.

**How to Get Your Electronic Projects Working.**  
R.A.Penfold. 96 pages. £2.50.  
Order Code BP110.

Essential reading for anyone who wants first-time success in project assembly. Covers tracing mechanical faults as well as testing for failures of active and passive components of most types.

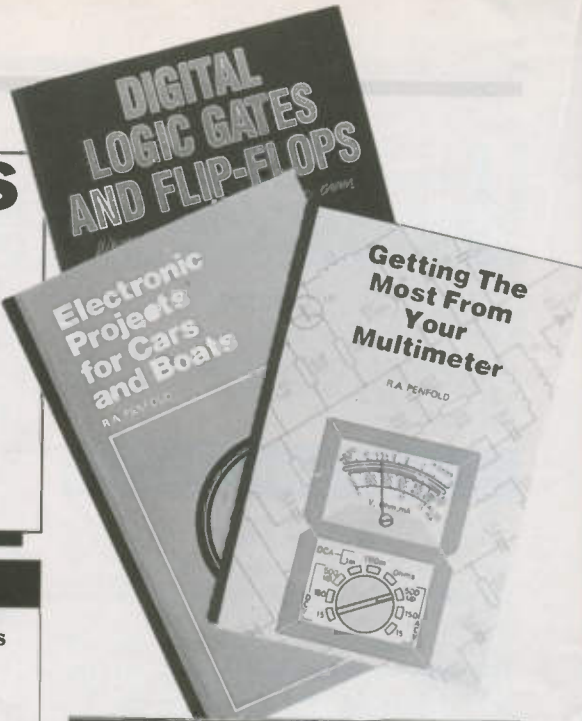

## AUDIO AND MUSIC

**Introducing Digital Audio**  
I.Sinclair. 112 pages. £5.95.  
Order Code PC102

A non-mathematical introduction to the new digital technology, discussing the principles and methods involved in devices such as cd, dat and sampling.

**Electronic Music Projects**  
R.A.Penfold. 112 pages. £2.50. Order Code BP74

24 practical constructional projects covering fuzz, wah, sustain, reverb, phasing, tremolo etc. The text is split into four sections covering guitar, general, sound generation and accessory projects.

**More Advanced Electronic Music Projects**  
R.A.Penfold. 96 pages. £2.95.  
Order Code BP174

Complementing BP74 by covering more advanced and complex projects including flanging, chorus, ring modulation, plus a selection of drum, cymbal and gong circuits.

**Computer Music Projects**  
R.A.Penfold. 112 pages. £2.95. Order Code BP173

Shows how home computers can produce electronic music and covers sequencing, analogue and Midi interfacing, digital delay lines and sound generators.

**Practical Midi Handbook**  
R.A.Penfold. 160 pages. £5.95.  
Order Code PC103

A practical how-to-do-it book for musicians and enthusiasts who want to exploit the capabilities of Midi. Covers keyboards, drums, sequencers, effects, mixers, guitars, and computer music software.

**Midi Projects**  
R.A.Penfold. 112 pages. £2.95. Order Code BP182

Practical details of interfacing many popular home computers with Midi systems, and also covering Midi interfacing to analogue and percussion synths.

**Electronic Synthesiser Construction.**  
R.A.Penfold. 112 pages. £2.95. Order Code BP185.

Even relative beginners should find the monophonic synthesiser described here within their capabilities if the book is thoroughly read. Individual aspects of the synth are dealt with separately and pcb designs are shown for the main modules.

## DIGITAL AND COMPUTING

**A Concise Introduction to MS-DOS.**  
N. Kantaris. 64 pages. £2.95.  
Order Code BP232

A ready-reference guide for those who need a quick insight into the essential command functions of this operating system, but who don't have the time to learn it fully.

**An Introduction to Computer Peripherals**

R.A. and J.W. Penfold. 80 pages.  
£2.50. Order Code BP170

Covers such items as monitors, printers, disc drives, cassettes, modems, etc. explaining what they are and how to use them with your computer and with each other.

**Digital Logic Gates and Flip-Flops.** Ian R. Sinclair. 192 pages. £8.95. Order Code PC 105

Intelligently looks at the basic building blocks of all digital circuits and is intended for enthusiasts, students and technicians who seek to establish a firm grasp of fundamental principles.

**Introduction to 6800/6802 Microprocessor Systems**

R.J. Simpson and T.J. Terrell. 238 pages. £10.95. Order Code NT9

The book covers systems hardware, programming concepts and practical experimental work that will assist in understanding the 6800/6802 microprocessor, with additional information on the 6802D5E evaluation system.

**An Introduction to 68000 Assembly Language.**

R.A. and J.W. Penfold. 112 pages.  
£2.95. Order Code BP184

Covers the fundamentals of writing programs that will vastly increase the speed of 68000 based machines such as the Commodore Amiga, Atari ST range, Apple Macintosh, etc.

**Getting the Most from Your Printer**  
J.W. Penfold. 96 pages. £2.95.  
Order Code BP181

How to use the features found on most dot-matrix printers from programs and popular wordprocessors, showing examples of what must be typed to achieve a given effect.

**Micro Interfacing Circuits**

R.A. Penfold. Two books, each of 112 pages.

Book 1 : £2.25. Order Code BP130.

Book 2 : £2.75. Order Code BP131

Both books include practical circuits and useful background information though pcb layouts are not included. Book 1 mainly covers computer input-output techniques. Book 2 deals primarily with practical application circuits.

**An Introduction to 6502 Machine Code.**

R.A. and R.W. Penfold. 112 pages.  
£2.95. Order Code BP147

Covers the main principles of machine code programming on 6502-based machines such as the Vic-20, Oric-1/Atmos, Electron, BBC and Commodore 64. It assumes no previous knowledge of microprocessors or machine code and gives illustrative programming examples.

**A Z-80 Workshop Manual.**

E.A. Parr. 192 pages. £3.95.  
Order Code BP112

A book for those who already know Basic but wish to explore machine code and assembly language programming on Z80 based computers.

**Practical Digital Electronics Handbook**

M. Tooley. 208 pages. £6.95.  
Order Code PC 104

Nine constructional projects introduce digital circuits, logic gates, timers, microprocessors, memory and interface circuits - an essential book for anyone interested in digital devices.

## DATA AND INFORMATION BOOKS

**NEW! Radio and Electronics Engineer's Pocket Book - 18th Edition.** Keith Brindley. 325 pages. £9.95. Order Code NT 11

An invaluable compendium of facts, figures and formulae and is indispensable to the designer, student, service engineer and all others interested in radio and electronics.

**NEW! Microprocessor Pocket Book.** Steve Money. 252 pages. £9.95. Order Code NT 12

Provides a wide selection of information which will be of general use to anyone involved in developing, designing or servicing, or who just wants to learn more about microprocessor systems.

**NEW! Computer Engineer's Pocket Book - 2nd Edition.** Michael Tooley. 224 pages. £9.95. Order Code NT 13

An invaluable compendium of facts, figures, circuits and data indispensable to designers, students, service engineers and all others interested in computer and microcomputer systems.

**Op Amps**

B. Dance. £7.95.

Order Code NT2

Subtitled 'Their Principles and Applications' this interesting book is written in a simple non-mathematical style and provides a source of practical circuits that use both commonplace and more sophisticated opamps.

**Electronic Hobbyists Handbook**

R.A. Penfold. 96 pages. £4.95. Order Code BP233

Provides a source of useful information that the amateur enthusiast is likely to need for day-to-day pursuance of hobby electronics.

**Newnes Electronics Pocket Book**

I.E. Parr. £9.95.

Order Code NT10

Presents all aspects of modern electronics in a readable and largely non-mathematical style, and is a good source of valuable information for enthusiasts and professional engineers alike.

**Key Techniques for Circuit Design**

G.C. Loveday. £6.95.

Order Code BM 101

Tackles the problems of designing circuits from scratch, introducing the concept of target specifications, the design sequence, device selection, rules of thumb, and useful equivalent circuits.

## GENERAL CONSTRUCTIONAL

**Electronic Science Projects.**

Owen Bishop. 144 pages. £2.95. Order Code BP104

A bumper bundle of experimental projects ranging in complexity and including a colour temperature meter, electronic clock, a solid state (led display) scope, an infra-red laser, a fascinating circuit for measuring the earth's electrical field strength, and many more.

**Electronic Security Devices**

R.A. Penfold. 112 pages. £2.50. BP56

Full of ideas for keeping your valuables safe. The circuits include designs for light, infra-red, ultrasonic, gas, smoke, flood, door and baby sensors.

**More Advanced Electronic Security Projects.** R.A. Penfold. 112 pages. £2.95. Order Code BP190

Follows on from where BP56 leaves off and describes a number of more up-to-date and sophisticated projects, such as pyro-sensors, infra-red and doppler-shift detection, fibre-optic loops, and many others.

**Electronic Projects for Cars and Boats.**

R.A. Penfold. 96 pages. £1.95.

Order Code BP94

15 fairly simple projects that can be used with a car and/or boat. Stripboard constructional details are included, as are explanations of the circuit theory.

**Power Supply Projects**

R.A. Penfold. 96 pages. £2.50.

Order Code BP76

A selection of power supply designs, including simple unregulated, fixed voltage regulated and variable voltage stabilised, ni-cad charger, voltage step-up, and inverter.

**More Advanced Power Supply Projects**

R.A. Penfold. 96 pages. £2.95.

Order Code BP192

Covers more advanced topics than BP76 and includes precision supplies, switch mode and computer controlled supplies, plus a selection of miscellaneous circuits.

**Popular Electronic Circuits.**

R.A. Penfold. 160 pages. £2.95. Order Code BP80

Containing a wide range of circuit designs for experienced constructors who are capable of producing working projects direct from a circuit diagram without specific constructional details.

## HOW TO ORDER

State your order code and your name and address clearly. Enclose a cheque, PO or international money order (add 50p postage per book - £1.00 for overseas surface mail), and send to:

**PE Book Service**

**Intra House**

**193 Uxbridge Road**

**London W12 9RA**

Books are normally delivered within 10 days but please allow 28 days for delivery.

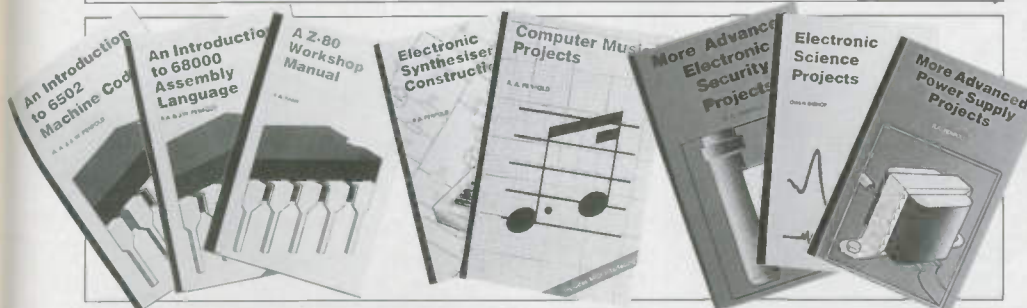

# PE PCB SERVICE

## IT IS EASY TO BUILD PRACTICAL ELECTRONICS PROJECTS!

Simplify your project assembly - use a ready-made printed circuit board. All are fully drilled and roller tinned. Just slot in the components as shown in the project texts, and solder them. PCBs are the professional route to project perfection.

### MAIL ORDERING

Select the boards you want, and send your order to: PE PCB SERVICE, PRACTICAL ELECTRONICS, 193 UXBRIDGE ROAD, LONDON W12 9RA.

Prices include VAT and postage and packing. Add £2 per board for overseas airmail. Cheques should be made payable to Intra Press (Payments by Access and Visa also accepted). Quote the project name and PCB Code Number, and print your name and address in Block Capitals. Do not send any other correspondence with your order.

### TELEPHONE ORDERS

Use your Access or Visa card and phone your order to **081-743-8888** clearly stating your name and address, card number and order details. All orders receive priority attention. Many PCBs are held in stock, so they are dispatched within a few days, but please still allow 28 days for delivery in case a PCB is temporarily out of stock.

**We can only supply the PCBs listed here! Please always check the latest issue of PE before ordering.**

We can also supply the photocopies of the text at £1.50 for each project part inclusive of postage and packing (overseas £2.00).

Please note that we do not supply components - they can be ordered from our advertisers!

<b>NOV 87</b>			
MIDI EXPANDER - Music Interface	159	£5.04	
<b>DEC 87</b>			
RS 232C TO MIDI	160	£6.43	
<b>FEB 88</b>			
DC MOTOR SERVO	165	£7.53	
<b>MAR 88</b>			
APPLIANCE TIMER	166A/B	£9.38	
LOGIC ANALYSER - Double-sided	168	£20.65	
<b>APR 88</b>			
LIGHT METAL EFFECTS	169	£7.10	
<b>JUNE 88</b>			
AMSTRAD ROM EXPANSION	173	£12.60	
MAINS MODEM	174	£4.90	
<b>AUG 88</b>			
SPEAKING CLOCK	176	£16.75	
<b>SEPT 88</b>			
BBC MULTIPLEXER	177	£4.50	
<b>OCT 88</b>			
METAL DETECTOR	178	£6.50	
<b>DEC 88</b>			
PANNING MIXER	181	£7.80	
<b>MAR 89</b>			
CAMERA SHUTTER TIMER	187	£9.95	
<b>APR 89</b>			
PC MULTIPOINT	188A/B	£20.55	
<b>MAY 89</b>			
KIRLIAN CAMERA	189A/C	£10.50	
<b>JUNE 89</b>			
DELUXE METRONOME	198	£10.95	
<b>JULY 89</b>			
PROJECTOR SYNCHRONISER	190A	£9.50	

<b>SEP 89</b>			
FREQUENCY COUNTER-GENERATOR	194A/B	£12.50	
<b>OCT 89</b>			
HOME SECURITY CONTROLLER	196A/C	£19.50	
<b>DEC 89</b>			
VIDEO AGC STABILISER	199	£6.50	
ECHO STATION	200A/B	£11.50	
MINI METRONOME	201	£5.90	
<b>JAN 90</b>			
BARGRAPH TACHOMETER	202	£5.90	
EEPROM PROGRAMMER (KEYBOARD VER)	203	£14.50	
<b>FEB 90</b>			
EEPROM PROGRAMMER (SWITCH VERSION)	204	£4.90	
MODEM	205	£11.50	
MOCK STEREO	206	£4.90	
<b>MAR 90</b>			
RADIO CLOCK (TUNER AND PULSE)	207	£6.50	
<b>APR 90</b>			
RADIO CLOCK (DISPLAY DECODER)	208	£13.50	
PC/INTERFACE	209	£5.90	
<b>MAY 90</b>			
EPROM POLY-PROG (MAIN PCB)	210	£8.50	
<b>JUNE 90</b>			
EPROM POLY-PROG (TOP PCB)	211	£7.50	
MESSAGE MAKER	212	£9.50	
BAUD RATE CONVERTER	213	£4.90	
INTERMITTENT WIPER	214	£3.90	
CIRCUIT BREAKER	215	£4.90	
<b>JULY 90</b>			
MORSE DECODER	216	£9.50	
<b>AUG 90</b>			
SCOPE EXPANDER	217	£9.50	
VOLTAGE PROBE	218	£5.80	
AF OCTAVE MEASURER:			
FILTER DRIVE	219	£6.60	
ANALOGUE FILTER	220	£7.35	
<b>SEP 90</b>			
AF OCTAVE MEASURER			
AMPLIFIER	221	£7.35	
SWITCHED FILTER	222	£7.35	
SWITCHED FILTER DRIVE	223	£7.35	
TELE-SCOPE - MAIN PCB	224	£11.50	
<b>OCT 90</b>			
TELE-SCOPE - SIGNAL PCB	225	£4.90	
TV INTERFACE	226	£4.90	
CHIPTESTER	227	£11.50	

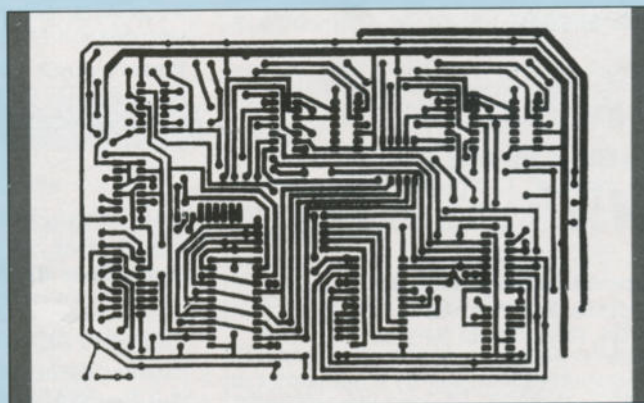

**PE PCBs are the professional route  
to project perfection!**

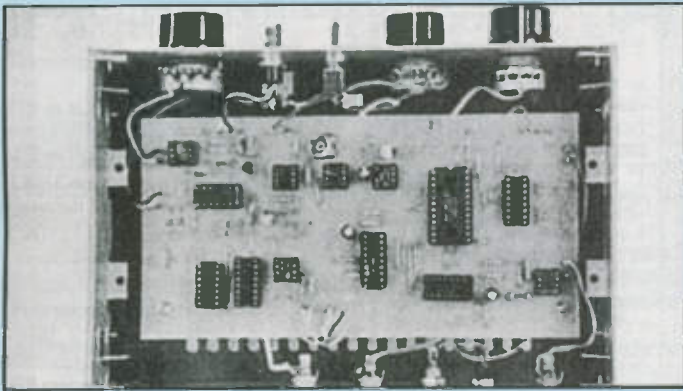

## NICE AND EASY DOES IT

**B**uilding the projects published in PE is a lot easier than some of you perhaps might think. Especially when you use one of our professionally made printed circuit boards.

It's almost like painting by numbers. All the pcbs are fully drilled, and basically all you need to do is slot in the components and carefully solder them to the pcb track pads. Their places are shown in the drawings published with the project.

## IDENTITIES

Component identities are usually clearly marked on them. Even if they are colour coded, like some resistors and capacitors, their values are easily worked out from component colour code charts. From time to time we publish these charts, but if you don't already have one, send a 9in x 4in stamped and self-addressed envelope to the Editorial office asking for one.

## TOOLS

For many projects you only need a few simple tools - Soldering iron between 15W and 25W, with a bevelled tip. Damp sponge for keeping the tip clean. Good multicore solder of 18swg or 22swg grade. Fine nose pliers for wire shaping. Adjustable spanner or heavy pliers for tightening nuts. Miniature screwdriver for adjusting preset controls. Small wire cutters for trimming component leads. Drill and selection of bits for drilling holes in boxes. Strong magnifying glass for checking joins in close up. It's also preferable to have a multimeter for setting and checking voltages. There are some very good low cost ones available through many of our advertisers, but get one that is rated at a minimum of 20,000 ohms per volt. Many projects do not require you to have a meter, but if you are serious about electronics, you really should have one.

## ASSEMBLING THE PCB

Authors will sometimes offer their own advice on the order of assembly, but as a general guide, it is usually easier to assemble parts in order of size. Start though with the integrated circuit sockets. Please use them where possible, they make life much easier than if you solder the ics themselves - with sockets you can just lift out an ic if you want.

Then insert and solder in order of resistors, diodes, presets, small capacitors, other capacitors, and finally transistors. Clip off the excess component wires before soldering, then make sure the solder covers the pads and the wires. Now use a magnifying glass, ideally one that you can hold to your eye, and take a good look at the joints, checking that they are satisfactorily soldered, and that no solder has spread between the pcb tracks and other joints. Be really thorough with visual checking since errors like this are the most likely reason for a circuit not working first time.

## SOLDERING

Bring the tip of the iron into contact with the component lead and the pcb solder pad, then bring the end of the solder into contact with all three, feeding it in as it melts. Once sufficient solder has melted to fully surround the pad and the lead, remove the solder, and then the iron. Now allow the join to cool before touching it, otherwise the solder may set unsatisfactorily. If it does move, just reheat the join once more.

## WIRING

Connecting the pcb to the various panel controls is the final assembly stage. Do this just as methodically, following the published wiring diagram. You can connect the wires to the pcb in one of three ways. The best is to insert terminal pins into the connecting holes on the pcb, and then solder wires direct to them. Or, pass the end of the wire through the pcb hole, soldering it on the other side. Alternatively, the wire can be carefully soldered direct to the pcb tracking. In all cases first strip the plastic covering off the wire, twist the strands together, and apply solder to them to keep them secure.

## TESTING

Now you are ready to test and use the project as described by the author. Components can occasionally fail, but these days it is extremely uncommon, and if you have followed the instructions, been careful with your joins, and bought the parts from a good supplier, you will have the enormous satisfaction of having built an interesting and working unit. It really can be easy if you do it with care.

## CHOOSE ONE NOW!

The PE PCB Service list shows all the pcbs available through PE. Look down the list and see which title takes your fancy - there must be at least one that will interest you! You will probably already have the relevant issue of PE, but even if you don't we can still help you.

## BACK ISSUES

We can usually supply copies of back issues of PE up to three years old. These are £1.75 each including postage (£2.25 for overseas readers). If we no longer have the issue needed, we will be pleased to send a photocopy of the article for the project that you want to build. These are £1.00 each per issue, including postage (£1.50 to overseas readers).

## OBTAINING PARTS

Some projects are available from advertising suppliers as complete kits. Otherwise, all the components listed in the text will be available from suppliers who specialise in individual components.

Occasionally a specific part may only be available from a particular supplier, if so the source will be given in the parts list. Otherwise there should be no difficulty in buying the parts. We have many good suppliers advertising in PE so have a look through their adverts - that's why they're here! Even though a part may not be listed in the adverts, a phone call or two should find a supplier who will be pleased to help. Like us, they too are in the business of encouraging you to enjoy electronics!

PE

# TRANSFORMERS

# EX STOCK

12/24V or 12-0-12V	2 x 12V Secs	2 x 25V Tapped Secs to give 5,7,8,10,13,17, 20,25,33,40, 50V or 20-0-20V or 25-0-25V	60/30V or 30-0-30V
24V	12V	£ P&P	2 x 30V Tapped Secs
0.15	0.05	3.44 1.87	Volts available: 16, 18, 36, 40, 60V or 24-0-24V or 30-0-30V
0.25	0.5	3.64 1.87	60V 30V
0.5	1	4.36 1.87	£ P&P
1	2	6.08 2.09	0.5 1 6.72 2.09
2 A	4	7.01 2.20	1 A 2 10.25 2.20
3 M	6	12.08 2.36	2 M 4 13.17 2.53
4 P	8	12.87 2.42	3 P 6 19.05 2.64
6 S	12	15.62 2.64	4 S 8 21.72 2.75
8	16	18.59 3.08	5 10 27.48 3.19
10	20	25.02 3.52	6 12 31.32 3.41
15	30	31.10 3.63	8 16 44.04 4.12
20	40	44.40 4.12	10 20 51.28 4.40
30	60	63.75 4.89	12 24 59.09 4.89
41	83	73.41 6.32	

MAINS ISOLATORS	30/15V or 15-0-15V	2 x 15V Tapped Secs to give: 3,4,5,6,8,9,10,15, 18,20,27,30V or 15-0-15V	96/48V or 36-0-36V
Pri 120V x 2 or 220/240V or 415/440V. Sec 440V or 240V or 110V Centre Tapped	30V 15V	£ P&P	2 x 36-48V Secs to give 60, 72, 84, 96V or 36-0-36V or 48-0-48V
20VA	0.5 1	4.55 1.81	96V 36/48V
60	1 2	6.19 1.98	0.5 1 7.16 1.76
100	2 A 4	10.01 2.20	1 2 12.80 2.31
200	3 M 6	11.60 2.42	2 A 4 21.05 2.91
250	4 P 8	13.84 2.53	3 M 6 25.49 3.02
500	5 S 10	17.72 2.64	4 P 8 32.54 3.32
1000	6 12	19.41 2.91	5 S 10 48.21 4.18
1500	8 16	25.74 3.02	6 12 57.87 4.40
2000	10 20	29.94 3.24	8 16 63.12 5.28
3000	12 24	33.42 3.35	
6000VA	15 30	37.43 4.01	
	20 40	51.10 6.54	

CASED AUTOS 240-115V	CONSTANT VOLTAGE TRANSFORMERS	TRANSFORMERS WOUND TO SPEC	TOROIDALS
105,115,220,230,240V	For Spike-free Stable Mains	Batch Winding 3VA to 15KVA	Batches Wound to Order
For step-up or down	Reversed Cased Auto 110V	AVO's & MEGGERS	30VA to 15KVA
80VA	Cable 1/7240V	Full range	
150	13A SK1 O/P 250VA £35.66	Send SAE for lists	
250	p+p £3.57		
350			
500			
1000			
1500			
2000			
3000			
4000			
5000			
7500			
10KVA			
20KVA			
30KVA			
40KVA			
50KVA			
60KVA			
80KVA			
100KVA			
150KVA			
200KVA			
300KVA			
400KVA			
500KVA			
600KVA			
800KVA			
1000KVA			

PO BOX 70, ILFORD ESSEX, IG5 0AP

**BARRIE ELECTRONICS LTD**  
TELEPHONE: 081-551 8454



# Happy Memories

4164	100ns	64K x 1	£1.65	2716	450ns	5 volt	£3.20
41256	80ns	256K x 1	£2.25	2532	450ns	Only pulls	£3.50
41256	100ns	256K x 1	£1.95	2732	450ns		£2.15
41464	100ns	64K x 4	£2.45	2764	250ns		£1.85
44256	80ns	256K x 4	£5.95	27128	250ns		£2.25
411000	80ns	1 Meg x 1	£5.50	27256	250ns		£2.56
6116	150ns	Low power	£1.45	27C256	250ns		£2.45
6264	120ns	Low power	£2.45	27512	250ns		£3.45
62256	100ns	Low power	£4.95	27C512	250ns		£3.75
SIMMS	80ns	1 Meg x 9	£57.50	SIPPS	80ns	1 Meg x 9	£59.00

Please call for prices of other chips, same chips but different speeds, quantity discounts etc. Second-hand (Pulled) chips available for many of the above devices at substantially lower cost. Call for availability and price of these and other items. Full list upon request.

Low profile IC sockets: Pins 8 14 16 18 20 24 28 40  
5 9 10 11 12 15 17 24

We always have a large quantity of both new and second-hand computer equipment in stock and will be pleased to quote on your requirements for hardware and software. If you would like to receive our (infrequently!) published lists please write your name and address down and post it to us. Thank you.

Please add 50p post & packing to orders under £15. VAT to be added to total. Credit card orders by phone or mail welcome. Plc, Government & Educational orders welcome for minimum invoice value of £15 net.

Happy Memories (PE), Freepost, Kington, Herefordshire. HR5 3BR.

Tel: (054 422) 618 Sales, 628 Fax  
(No stamp needed unless first class required)



# INDEX TO ADVERTISERS

A & G Electronics Ltd	44	Gem-Tech	53
ADM Electronics	55	Keytronics	11
Astronomy Now	47	Limrose Electronics	53
N.R. Bardwell	55	London Electronics College	54
Barrie Electronics	62	Maplin Electronics	OBC
BK Electronics	IBC	MQP Electronics	62
J&N Bull Electrical	48	Multilode Electronics	43
C-Scope	44	Multisources	55
C.E.S. NW	55	National College of Tech	39
Circuit Distribution Ltd	31	Nescot	39
Cricklewood Electronics Ltd	40	Number One Systems	26
C.R. Supply	55	Omni Electronics	54
Coles-Harding & Co	55	Phonosonics	31
Component Solutions Ltd	43	Program Now	44
Cooke International	55	Radio & Telecom School	54
JPG Electronics	55	Sarm Digital	55
Fraser Electronics	54	Suma Designs	43
Greenbank Electronics	42	Tandy	IFC
Happy Memories	62	The Electronics Shop	54
Henry's	42	Technomatic Ltd	18
High Q Electronics	54	TK Electronics	39
Hills Components	56	A. Wood	55

**PLEASE MENTION PRACTICAL ELECTRONICS WHEN REPLYING TO ADVERTS**

# MQP SERIES II NOW PROGRAMS MORE DEVICES

- STILL from only £195!
- Up and running in minutes
- High speed algorithms
- Low cost upgrades
- 12 Month Guarantee
- 2 & 4Mb devices
- 8-pin serial EEPROMs (X2402, 9306 families)
- Programs 24/28/32/40 pin EPROMs, EEPROMs and Micro-controllers
- Adapters for other devices scheduled for imminent release include Z8 (both Zilog and SGS), the 68705 family and TI 77C82
- Easy to use menu driven software for MS-DOS included in the price with much improved pop up help facility in colour
- Uses Serial port so requires no expansion slots - cable included in price
- Money Back Guarantee if not completely satisfied
- Designed, manufactured and supported in the UK

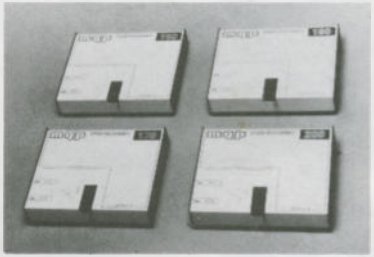

**We also sell Bipolar and Gang Programmers, EPROM Emulators and Erasers, and a universal cross-assembler for IBM PCs and compatibles.**

Write or phone today for Free Information Pack  
Tel: (0666) 825146 Fax: (0666) 825141



**MQP ELECTRONICS**  
PARK ROAD CENTRE  
MALMESBURY  
WILTS  
SN16 0BX

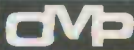

**POWER AMPLIFIER MODULES-TURNABLES-DIMMERS-LOUDSPEAKERS-19 INCH STEREO RACK AMPLIFIERS**

**OMP POWER AMPLIFIER MODULES**

Supplied ready built and tested.

**OMP POWER AMPLIFIER MODULES** Now enjoy a world-wide reputation for quality reliability and performance at a realistic price. Four models available to suit the needs of the professional and hobby market i.e. Industry Leisure Instrumental and Hi-Fi etc. When comparing prices NOTE all models include Toroidal power supply Integral heat sink Glass fibre P.C.B. and Drive circuits to power compatible Vu meter Open and short circuit proof

**THOUSANDS OF MODULES PURCHASED BY PROFESSIONAL USERS**



**OMP100 Mk 11 Bi-Polar** Output power 110 watts R.M.S. into 4 ohms. Frequency Response 15Hz - 30KHz - 3dB. T.H.D. 0.01%. S.N.R. - 118dB. Sens for Max. output 500mV at 10K. Size 355 x 115x65mm. PRICE £33.99 + £3.00 P&P.



**NEW SERIES II MOS-FET MODULES**

**OMP/MF 100 Mos-Fet** Output power 110 watts R.M.S. into 4 ohms. Frequency Response 1Hz - 100KHz - 3dB. Damping Factor >300. Slew Rate 45V uS. T.H.D. Typical 0.002%. Input Sensitivity 500mV. S.N.R. - 125dB. Size 300 x 123 x 60mm. PRICE £39.99 + £3.00 P&P.



**OMP/MF200 Mos-Fet** Output power 200 watts R.M.S. into 4 ohms. Frequency Response 1Hz - 100KHz - 3dB. Damping Factor >300. Slew Rate 60V uS. T.H.D. Typical 0.001%. Input Sensitivity 500mV. S.N.R. - 130dB. Size 300 x 155 x 100mm. PRICE £62.99 + £3.50 P&P.



**OMP/MF300 Mos-Fet** Output power 300 watts R.M.S. into 4 ohms. Frequency Response 1Hz - 100KHz - 3dB. Damping Factor >300. Slew Rate 60V uS. T.H.D. Typical 0.0008%. Input Sensitivity 500mV. S.N.R. - 130dB. Size 330 x 175 x 100mm. PRICE £79.99 + £4.50 P&P.

**NOTE - MOS-FET MODULES ARE AVAILABLE IN TWO VERSIONS STANDARD INPUT SENS 500mV BAND WIDTH 100KHz. PROFESSIONAL EQUIPMENT COMPATIBLE INPUT SENS 775mV BAND WIDTH 50KHz. ORDER STANDARD OR PEC.**

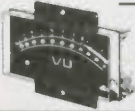

**Vu METER** Compatible with our four amplifiers detailed above. A very accurate visual display employing 11 LED diodes (7 green, 4 red) plus an additional on/off indicator. Sophisticated logic control circuits for very fast rise and decay times. Tough moulded plastic case with tinted acrylic front. Size 84 x 27 x 45mm. PRICE £8.50 + 50p P&P.

**LOUDSPEAKERS**



**LARGE SELECTION OF SPECIALIST LOUDSPEAKERS AVAILABLE, INCLUDING CABINET FITTINGS, SPEAKER GRILLES, CROSS-OVERS AND HIGH POWER, HIGH FREQUENCY BULLETS AND HORNS, LARGE S.A.E. (30p STAMPED) FOR COMPLETE LIST.**

**McKENZIE:- INSTRUMENTS, P.A., DISCO, ETC.**

- ALL MCKENZIE UNITS 8 OHMS IMPEDENCE**
- 8" 100 WATT C8100GPM GEN PURPOSE LEAD GUITAR. EXCELLENT MID. DISCO RES. FREQ. 80Hz FREQ. RESP. TO 14KHz SENS. 99dB. PRICE £28.99 + £2.00 P&P.
  - 10" 100 WATT C10100GP GUITAR VOICE ORGAN. KEYBOARD DISCO. EXCELLENT MID. RES. FREQ. 70Hz FREQ. RESP. TO 6KHz SENS. 100dB. PRICE £34.70 + £2.50 P&P.
  - 10" 200 WATT C10200GP GUITAR. KEYBOARD DISCO. EXCELLENT HIGH POWER MID. RES. FREQ. 45Hz FREQ. RESP. TO 7KHz SENS. 103dB. PRICE £47.48 + £2.50 P&P.
  - 12" 100 WATT C12100GP HIGH POWER GEN. PURPOSE LEAD GUITAR. DISCO. RES. FREQ. 45Hz FREQ. RESP. TO 7KHz SENS. 98dB. PRICE £36.66 + £3.50 P&P.
  - 12" 100 WATT C12100TC TWIN CONE. HIGH POWER WIDE RESPONSE. P.A. VOICE DISCO. RES. FREQ. 45Hz FREQ. RESP. TO 14KHz SENS. 100dB. PRICE £37.63 + £3.50 P&P.
  - 12" 200 WATT C12200H HIGH POWER BASS. KEYBOARDS DISCO. P.A. RES. FREQ. 40Hz FREQ. RESP. TO 7KHz SENS. 100dB. PRICE £64.17 + £3.50 P&P.
  - 12" 300 WATT C12300GP HIGH POWER BASS. LEAD GUITAR. KEYBOARDS. DISCO. ETC. RES. FREQ. 45Hz FREQ. RESP. TO 5KHz SENS. 100dB. PRICE £85.79 + £3.50 P&P.
  - 15" 100 WATT C15100B BASS GUITAR. LOW FREQUENCY. P.A. DISCO. RES. FREQ. 40Hz FREQ. RESP. TO 5KHz SENS. 98dB. PRICE £53.70 + £4.00 P&P.
  - 15" 200 WATT C15200B VERY HIGH POWER BASS. RES. FREQ. 40Hz FREQ. RESP. TO 4KHz SENS. 99dB. PRICE £73.26 + £4.00 P&P.
  - 15" 250 WATT C15250B VERY HIGH POWER BASS. RES. FREQ. 40Hz FREQ. RESP. TO 4KHz SENS. 99dB. PRICE £80.53 + £4.50 P&P.
  - 15" 400 WATT C15400B VERY HIGH POWER. LOW FREQUENCY BASS. RES. FREQ. 40Hz FREQ. RESP. TO 4KHz SENS. 102dB. PRICE £94.12 + £4.50 P&P.
  - 18" 400 WATT C18404B EXTREMELY HIGH POWER. LOW FREQUENCY BASS. RES. FREQ. 27Hz FREQ. RESP. TO 3KHz SENS. 99dB. PRICE £167.85 + £5.00 P&P.

**EARBENDERS:- HI-FI, STUDIO, IN-CAR, ETC.**

- ALL EARBENDER UNITS 8 OHMS EXCEPT E88-50 AND E810-50 DUAL 4 AND 8 OHM. BASS, SINGLE CONE, HIGH COMPLIANCE, ROLLED FOAM SURROUND**
- 8" 50 WATT E88-50 DUAL IMPEDENCE. TAPPED 4 & 8 OHM BASS. HI-FI, IN-CAR. RES. FREQ. 40Hz FREQ. RESP. TO 7KHz SENS. 97dB. PRICE £8.90 + £2.00 P&P.
  - 10" 50 WATT E810-50 DUAL IMPEDENCE. TAPPED 4 & 8 OHM BASS. HI-FI, IN-CAR. RES. FREQ. 40Hz FREQ. RESP. TO 5KHz SENS. 99dB. PRICE £12.00 + £2.50 P&P.
  - 10" 100 WATT E810-100 BASS. HI-FI, STUDIO. RES. FREQ. 35Hz FREQ. RESP. TO 3KHz SENS. 96dB. PRICE £27.50 + £3.50 P&P.
  - 12" 60 WATT E812-60 BASS. HI-FI, STUDIO. RES. FREQ. 28Hz FREQ. RESP. TO 3KHz SENS. 92dB. PRICE £21.00 + £3.00 P&P.
  - 12" 100 WATT E812-100 BASS. STUDIO. HI-FI. EXCELLENT DISCO. RES. FREQ. 26Hz FREQ. RESP. TO 3KHz SENS. 93dB. PRICE £32.00 + £3.50 P&P.
  - FULL RANGE TWIN CONE, HIGH COMPLIANCE, ROLLED SURROUND**
  - 5 1/2" 60 WATT E85-60TC (TWIN CONE) HI-FI. MULTI-ARRAY DISCO ETC. RES. FREQ. 63Hz FREQ. RESP. TO 20KHz SENS. 92dB. PRICE £9.99 + £1.50 P&P.
  - 6 1/2" 60 WATT E86-60TC (TWIN CONE) HI-FI. MULTI-ARRAY DISCO ETC. RES. FREQ. 38Hz FREQ. RESP. TO 20KHz SENS. 94dB. PRICE £10.99 + £1.50 P&P.
  - 8" 60 WATT E88-60TC (TWIN CONE) HI-FI. MULTI-ARRAY DISCO ETC. RES. FREQ. 40Hz FREQ. RESP. TO 18KHz SENS. 89dB. PRICE £12.99 + £1.50 P&P.
  - 10" 60 WATT E810-60TC (TWIN CONE) HI-FI. MULTI-ARRAY DISCO ETC. RES. FREQ. 35Hz FREQ. RESP. TO 12KHz SENS. 86dB. PRICE £16.49 + £2.00 P&P.

**TRANSMITTER HOBBY KITS**

**PROVEN TRANSMITTER DESIGNS INCLUDING GLASS FIBRE PRINTED CIRCUIT BOARD AND HIGH QUALITY COMPONENTS COMPLETE WITH CIRCUIT AND INSTRUCTIONS**

- 3W FM TRANSMITTER** 80-108MHz. VARICAP CONTROLLED PROFESSIONAL PERFORMANCE. RANGE UP TO 3 MILES. SIZE 38 x 123mm. SUPPLY 12V @ 0.5AMP. PRICE £14.49 + £1.00 P&P.
- FM MICRO TRANSMITTER** (BU) 100-108MHz. VARICAP TUNED COMPLETE WITH VERY SENS. FET MIC. RANGE 100-300m. SIZE 56 x 46mm. SUPPLY 9V BATT. PRICE £8.62 + £1.00 P&P.



3 watt FM Transmitter

\* PRICES INCLUDE V.A.T. \* PROMPT DELIVERIES \* FRIENDLY SERVICE \* LARGE S.A.E., 30p STAMPED FOR CURRENT LIST.

**OMP VARISPEED TURNTABLE CHASSIS**

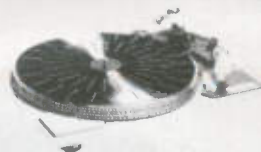

- ★ MANUAL ARM
- ★ STEEL CHASSIS
- ★ ELECTRONIC SPEED CONTROL 33 & 45
- ★ VARI PITCH CONTROL
- ★ HIGH TORQUE SERVO DRIVEN DC MOTOR
- ★ TRANSIT SCREWS
- ★ 12 DIE CAST PLATTER
- ★ NEON STROBE
- ★ CALIBRATED BAL WEIGHT
- ★ REMOVABLE HEAD SHELL
- ★ CARTRIDGE FIXINGS
- ★ CUE LEVER
- ★ POWER 230 240V 50 60Hz
- ★ 390 x 305mm
- ★ SUPPLIED WITH MOUNTING CUT OUT TEMPLATE

PRICE £59.99 + £3.50 P&P.

**OPTIONAL MAGNETIC CARTRIDGES**

**STANTON AL500**  
PRICE £16.99 + 50p P&P

**GOLDRING G850**  
PRICE £6.99 + 50p P&P

**OMP MOS-FET POWER AMPLIFIERS, HIGH POWER, TWO CHANNEL 19 INCH RACK**

**THOUSANDS PURCHASED BY PROFESSIONAL USERS**



**NEW MXF SERIES OF POWER AMPLIFIERS**

**THREE MODELS:- MXF200 (100w + 100w) MXF400 (200w + 200w) MXF600 (300w + 300w)**

All power ratings RMS into 4 ohms

**FEATURES:** ★ Independent power supplies with two Toroidal Transformers ★ Twin L.E.D. Vu meters ★ Rotary interlocked level controls ★ Illuminated on/off switch ★ XLR connectors ★ Standard 775mV inputs ★ Open and short circuit proof ★ Latest Mos-Fets for stress free power delivery into virtually any load ★ High slew rate ★ Very low distortion ★ Aluminum cases ★ MXF600 Fan Cooled with D.C. Loudspeaker and Thermal Protection

**USED THE WORLD OVER IN CLUBS, PUBS, CINEMAS, DISCOS ETC.**

**SIZES:-** MXF 200 W19 - H3 1/2 (2U) - D11  
MXF 400 W19 - H5 1/4 (3U) - D12  
MXF 600 W19 - H5 1/4 (3U) - D13

MXF200 £171.35

MXF400 £228.85

MXF600 £322.00

SECURICOR DELIVERY £12.00 EACH

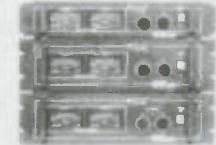

**OMP LINNET LOUDSPEAKERS**

THE VERY BEST IN QUALITY AND VALUE



**MADE ESPECIALLY TO SUIT TODAY'S NEED FOR COMPACTNESS WITH HIGH OUTPUT SOUND LEVELS FINISHED IN HARDWEARING BLACK VINYL WITH PROTECTIVE CORNERS GRILLE AND CARRYING HANDLE INCORPORATES 12 DRIVER PLUS HIGH FREQ HORN FOR FULL FREQ RANGE 45Hz-20KHz BOTH MODELS 8 OHM SIZE H18 - W15 - D12**

CHOICE OF TWO MODELS

POWER RATINGS QUOTED IN WATTS RMS FOR EACH CABINET

OMP 12-100 (100W 100dB) PRICE £159.99 PER PAIR

OMP 12-200 (200W 102dB) PRICE £209.99 PER PAIR

SECURICOR DEL. - £12.00 PER PAIR

**OMP SLIDE DIMMER 1K WATT & 2.5K WATT**

**CONTROLS LOADS UP TO 1KW & 2.5KW SUITABLE FOR RESISTIVE AND INDUCTIVE LOADS BLACK ANODISED CASE REAR VENT FLUSH MOUNTED THROUGH PANEL CABINET CUT OUTS. ADVANCED FEATURES INCLUDE -**

- Full 60/100mV S.I.D.F. TRAFFIC
- NFON MONITOR INDICATOR
- FLASH OFF/FRONT BUTTON
- HIGH & LOW LEVEL PRESETS
- FULLY SUPPRESSED 10 IS 800

**SIZES:-** 1KW H128 - W45 - D55mm  
2.5K WATT H128 - W76 - D79mm

PRICES:- 1K WATT £15.99  
2.5K WATT £24.99 + 60p P&P



**PIEZO ELECTRIC TWEETERS-MOTOROLA**

**PIEZO ELECTRIC TWEETERS - MOTOROLA**  
Join the Piezo revolution. The low dynamic mass (no voice coil) of a Piezo tweeter produces an improved transient response with a lower distortion level than ordinary dynamic tweeters. As a crossover is not required these units can be added to existing speaker systems of up to 100 watts (more if 2 put in series) **FREE EXPLANATORY LEAFLETS SUPPLIED WITH EACH TWEETER.**

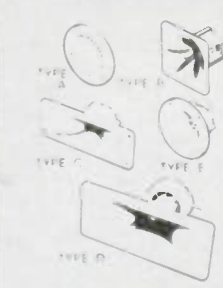

- TYPE 'A' (KSN2036A)** 3" round with protective wire mesh. Ideal for bookshelf and medium sized Hi-Fi speakers. Price £4.90 each + 50p P&P
  - TYPE 'B' (KSN1005A)** 3" super horn. For general purpose speakers, disco and P.A. systems etc. Price £5.00 each + 50p P&P
  - TYPE 'C' (KSN6016A)** 2" x 5" wide dispersion horn. For quality Hi-Fi systems and quality discos etc. Price £6.99 each + 50p P&P
  - TYPE 'D' (KSN1025A)** 2" x 6" wide dispersion horn. Upper frequency response retained extending down to mid range (2KHz). Suitable for high quality Hi-Fi systems and quality discos. Price £9.99 each + 50p P&P
  - TYPE 'E' (KSN1038A)** 3" horn tweeter with attractive silver finish trim. Suitable for Hi-Fi monitor systems etc. Price £5.99 each + 50p P&P
- LEVEL CONTROL** Combines on a recessed mounting plate, level control and cabinet input jack socket. 85 x 85mm. Price £3.99 + 50p P&P

**STEREO DISCO MIXER**

**STEREO DISCO MIXER** with 2 x 5 band L & R graphic equalisers and twin 10 segment L E D Vu Meters. Many outstanding features. 5 Inputs with individual faders providing a useful combination of the following -  
3 Turntables (Mag) 3 Mics. 4 Line including CD plus Mic with talk over switch Headphone Monitor Pan Pot L & R Master Output controls Output 775mV. Size 360 x 280 x 90mm. Supply 220-240V.  
Price £134.99 - £4.00 P&P

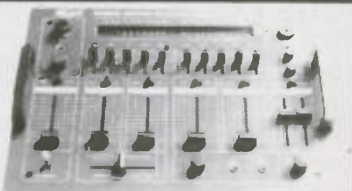

**B. K. ELECTRONICS** Dept PE  
UNIT 5, COMET WAY, SOUTHEND-ON-SEA, ESSEX. SS2 6TR  
TEL: 0702-527572 FAX: 0702-420243

1991 BUYER'S GUIDE TO ELECTRONIC COMPONENTS

# Maplin

FEATURING:  
AN ELECTRONICS  
CAST OF  
THOUSANDS!

POWER-PACKED  
WITH OVER  
600 PAGES!!

STARRING  
HUNDREDS OF  
NEW PRODUCTS  
AT SUPER  
LOW PRICES!

**SHOWING  
NOW!**  
at your local  
WHSMITH



ROD BROWN

**Order you copy of the New MAPLIN Catalogue on sale NOW**  
Pick up a copy from any WHSMITH for just £2.45 or post this coupon now to receive  
copy for just £2.45 + 50p p&p. If you live outside the U.K. send £4.85  
20 International Reply Coupons. I enclose £2.95.

Name \_\_\_\_\_  
Address \_\_\_\_\_  
Post Code \_\_\_\_\_  
Send to Maplin Electronics  
P.O. Box 3, Rayleigh  
Essex SS6 8LR.

PERFORMANCES DAILY  
your local branch  
of WHSMITH  
**ONLY £2.45**