

NEW

PRACTICAL

May 1992 • £1.50

ELECTRONICS

SCIENCE AND TECHNOLOGY

Musical Technology

This month's special feature looks at the world of High Fidelity

New Products

Sir Clive's Zike

64-bit Alpha Microprocessor

Toshiba's Colour Laptop

Canon Reflex Camcorder

A One Handed Computer

The Weather Watch

Rap Goes Portable

Reviews

Technics Surround Sound

FM Stereo Sound TX

Canon Super Speakers

Plus

How It Works: The Loudspeaker

Infra-Red Headphone Extension

Ceramic Batteries

Barry Fox Has The CD-ROM Blues

Feel The Bass With Our Sub-Woofer Project



SURVEILLANCE PROFESSIONAL QUALITY KITS

No. 1 for Kits

Whether your requirement for surveillance equipment is amateur, professional or you are just fascinated by this unique area of electronics SUMA DESIGNS has a kit to fit the bill. We have been designing electronic surveillance equipment for over 12 years and you can be sure that all of our kits are very well tried, tested and proven and come complete with full instructions, circuit diagrams, assembly details and all high quality components including fibreglass PCB. Unless otherwise stated all transmitters are tuneable and can be received on an ordinary VHF FM radio.

UTX Ultra-miniature Room Transmitter

Smallest room transmitter kit in the world! Incredible 10mm x 20mm including mic. 3-12V operation. 500m range.....£16.45

MTX Micro-miniature Room Transmitter

Best-selling micro-miniature Room Transmitter
Just 17mm x 17mm including mic. 3-12V operation. 1000m range.....£13.45

STX High-performance Room Transmitter

Hi performance transmitter with a buffered output stage for greater stability and range. Measures 22mm x 22mm including mic. 6-12V operation, 1500m range.....£15.45

VT500 High-power Room Transmitter

Powerful 250mW output providing excellent range and performance. Size 20mm x 40mm. 9-12V operation. 3000m range.....£16.45

VXT Voice Activated Transmitter

Triggers only when sounds are detected. Very low standby current. Variable sensitivity and delay with LED indicator. Size 20mm x 67mm. 9V operation. 1000m range...£19.45

HVX400 Mains Powered Room Transmitter

Connects directly to 240V AC supply for long-term monitoring. Size 30mm x 35mm. 500m range.....£19.45

SCRX Subcarrier Scrambled Room Transmitter

Scrambled output from this transmitter cannot be monitored without the SCDM decoder connected to the receiver. Size 20mm x 67mm. 9V operation, 1000m range.....£22.95

SC LX Subcarrier Telephone Transmitter

Connects to telephone line anywhere, requires no batteries. Output scrambled so requires SCDM connected to receiver. Size 32mm x 37mm. 1000m range.....£23.95

SCDM Subcarrier Decoder Unit for SC RX

Connects to receiver earphone socket and provides decoded audio output to headphones. Size 32mm x 70mm. 9-12V operation.....£22.95

ATR2 Micro Size Telephone Recording Interface

Connects between telephone line (anywhere) and cassette recorder. Switches tape automatically as phone is used. All conversations recorded. Size 16mm x 32mm. Powered from line.....£13.45

UTLX Ultra-miniature Telephone Transmitter

Smallest telephone transmitter kit available. Incredible size of 1mm x 20mm! Connects to line (anywhere) and switches on and off with phone use. All conversation transmitted. Powered from line. 500m range.....£15.95

TLX700 Micro-miniature Telephone Transmitter

Best-selling telephone transmitter. Being 20mm x 20mm it is easier to assemble than UTLX. Connects to line (anywhere) and switches on and off with phone use. All conversations transmitted. Powered from line. 1000m range.....£13.45

STLX High-performance Telephone Transmitter

High performance transmitter with buffered output stage providing excellent stability and performance. Connects to line (anywhere) and switches on and off with phone use. All conversations transmitted. Powered from line. Size 22mm x 22mm. 1500m range.....£16.45

TKX900 Signalling/Tracking Transmitter

Transmits a continuous stream of audio pulses with variable tone and rate. Ideal for signalling or tracking purposes. High power output giving range up to 3000m. Size 25mm x 63mm. 9V operation.....£22.95

CD400 Pocket Bug Detector/Locator

LED and piezo bleeper pulse slowly, rate of pulse and pitch of tone increase as you approach signal. Gain control allows pinpointing of source. Size 45mm x 54mm. 9V operation.....£30.95

CD600 Professional Bug Detector/Locator

Multicolour readout of signal strength with variable rate bleeper and variable sensitivity used to detect and locate hidden transmitters. Switch to AUDIO CONFORM mode to distinguish between localised bug transmission and normal legitimate signals such as pagers, cellular, taxis etc. Size 70mm x 100mm. 9V operation.....£50.95

QTX180 Crystal Controlled Room Transmitter

Narrow band FM transmitter for the ultimate in privacy. Operates on 180 MHz and requires the use of a scanner receiver or our QRX180 kit (see catalogue). Size 20mm x 67mm. 9V operation. 1000m range.....£40.95

QLX180 Crystal Controlled Telephone Transmitter

As per QTX180 but connects to telephone line to monitor both sides of conversations. 20mm x 67mm. 9V operation. 1000m range.....£40.95

QSX180 Line Powered Crystal Controlled Phone Transmitter

As per QLX180 but draws power requirements from line. No batteries required. Size 32mm x 37mm. Range 500m.....£35.95

QRX180 Crystal Controlled FM Receiver

For monitoring any of the 'Q' range transmitters. High sensitivity unit. All RF section supplied as a pre-built and aligned module ready to connect on board so no difficulty setting up. Outpt to headphones. 60mm x 75mm. 9V operation.....£60.95

A build-up service is available on all our kits if required.

UK customers please send cheques, POs or registered cash. Please add £1.50 per order for P&P. Goods despatched ASAP allowing for cheque clearance. Overseas customers send sterling bank draft and add £5.00 per order for shipment. Credit card orders welcomed on 0827 714476.

OUR LATEST CATALOGUE CONTAINING MANY MORE NEW SURVEILLANCE KITS NOW AVAILABLE. SEND TWO FIRST CLASS STAMPS OR OVERSEAS SEND TWO IRCS.

★★★ Specials ★★★

DLTX/DL RX Radio Control Switch

Remote control anything around your home or garden, outside lights, alarms, paging system etc. System consists of a small VHF transmitter with digital encoder and receiver unit with decoder and relay output, momentary or alternate, 8-way diode switches on both boards set your own unique security code. TX size 45mm x 45mm. RX size 35mm x 90mm. Both 9V operation. Range up to 200m.

Complete System (2 kits).....£50.95
Individual Transmitter DLTX.....£19.95
Individual Receiver DLRX.....£37.95

MBX-1 HI-FI Micro Broadcaster

Not technically a surveillance device but a great idea! Connects to the headphone output of your Hi-Fi, tape or CD and transmits Hi-Fi quality to a nearby radio. Listen to your favourite music anywhere around the house, garden, in the bath or in the garage and you don't have to put up with the DJ's choice and boring waffle. Size 27mm x 60mm. 9V operation. 250m range.....£20.95

**SUMA
DESIGNS**

THE WORKSHOPS, UNIT PE, 95 MAIN ROAD,
BAXTERLEY, NEAR AATHERSTONE,
WARWICKSHIRE CV9 2LE
VISITORS BY APPOINTMENT ONLY

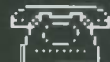

0827 714476

This month...

Sir Clive Sinclair is well known for his inventions. At PE we have seen them come and go, some have been successful like the ZX Spectrum and the black watch. Others were not so well received – the QL and the C5 to name but two. With the launch of the Zike Sir Clive is trying again to make a success of the transport marketplace. We take a look at the attempt on page 6.

The project this month is a unique design for a sub-woofer. This speaker system takes over where most others leave off and aims to produce sounds you can feel in a box that will not take over your home.

Kenn Garroch, Editor



Canon's Camcorder – page 22



Technics New AV system – page 20

Next month...

TV and Satellite – the latest TVs, flat, wide screens and 100Hz technology, satellite receivers, dishes and how they work.

Out On 7 May

Cover illustration: Kenn Garroch

Features

- Microprocessor Power**9
We take a look at the new 64-bit Alpha from Digital
- The Digital Revolution**11
The music industry is set to go digital this year
- The Perfect Power Source**17
Ian Poole takes a look at ceramic batteries
- Semiconductors Part II**32
Etching, implanting and ion blasting
- At The Bottom End Of The Range** ..40
Build the latest in sub-woofer designs



The Zike – page 6

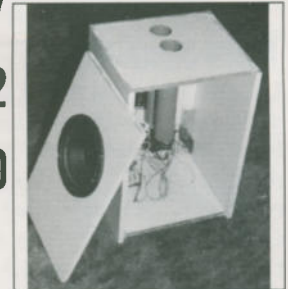

Sub-woofer – page 40

Reviews

- Canon S-50 Speakers** .19
The domes take over the home
- Technics AV**20
Ian Burley looks at the latest in surround sound
- Stereo Sound Sender**..21
An FM station for the home
- On The Bookshelf**30
Interfacing PCs, a reference work and transducers



FM Sound Sender – page 21

Regulars

- Wavelengths**4
Decimal time and April fools
- Innovations**6
The new Zike from Sir Clive and breaking out in colour
- What's New**8
It's tough but is it a one-armed-bandit?
- New Product Developments**.....22
Camcorders, watches and rap machines
- How It Works**32
A look inside a loudspeaker
- Techniques**.....57
Build an infra-red link for your headphones
- Barry Fox**.....62
Barry is having real problems with his CD-ROMs

A Husky In The Hand – page 8



Editor: Kenn Garroch Advertisement Manager David Bonner Production Manager: Richard Milner Publisher: Angelo Zgorelec • **Practical Electronics Intra House 193 Uxbridge Road London W12 9RA Tel: 081-743 8888 Fax: 081-743 3062 Telecom Gold: 87: SQQ567 • Advertisements** The Publishers of PE take reasonable precautions to ensure that advertisements published in the magazine are genuine, but cannot take any responsibility in respect of statements or claims made by advertisers. The Publishers also cannot accept any liability in respect of goods not being delivered or not working properly. • © Intra Press 1991. Copyright in all drawings, photographs and articles published in PRACTICAL ELECTRONICS is fully protected, and reproduction or imitations in whole or in part are expressly forbidden. All reasonable precautions are taken by PRACTICAL ELECTRONICS to ensure that the advice and data given to readers is reliable. We cannot, however, guarantee it, and we cannot accept legal responsibility for it. Prices quoted are those current as we go to press. All material is accepted for publication on the express understanding that the contributor has the authority to permit us to do so. • Practical Electronics is typeset at Intra Press on Macintosh computers using Quark Xpress. Reproduction by Circle Rule Ltd. Printing by Andover Press, St Ives plc. Distribution by Seymour Press • ISSN 0032-6372 •

Wavelengths

If you have any comments, suggestions, subjects you think should be aired, write to PE

Time And Again

Last month (the April edition of PE) you devoted a whole page to Eamon Fitzpatrick's rant about decimal time. Was this an April fool or is this guy serious? The idea of changing the way the whole world tells the time just to satisfy the digital imagination of a few is ridiculous. With calculators being so common these days, there is no real need to worry about decimals, converting between various systems is simple.

A J Kahn
London N22

Mr Fitzpatrick's ideas for a decimal time system have my wholehearted support. How we got saddled with the crazy 60, 60, 24 system is beyond me. The big problem is that no-one has ever had the opportunity to change it - perhaps the French should have tried it when they revolted. Alas, it is probably too late now, the whole world ticks to the same clock.

L Hanson
Liverpool

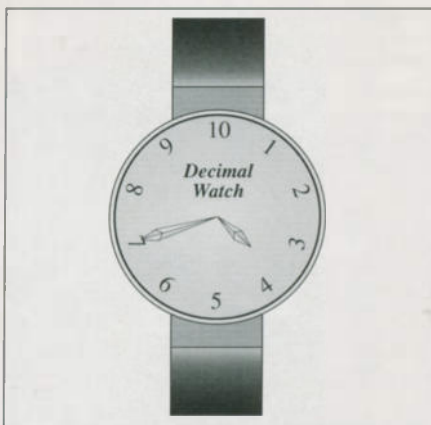

Caught In The Act

I think I spotted the April fool in the your April edition. The 3DTV article may read well but it is a little impractical. First of all, the scanning system is a little awry. Of the three beams, each would have to scan a large number of times

faster than the others to cover all of the positions in the 'tank'. For example, if a cube of dots 10x10x10 were to be created, as the first beam scans across the second would have to scan across it 10 times in the time it takes to make one scan. The third would then have to scan across the second ten times during its scan. The result is that the second beam must scan at a frequency ten times the first and the third 10 times the second or 100 times the first. For a large box of dots, this exponential scanning could create a few problems if not be impossible.

The second obvious error is in the gas that emits light when struck by three but not one or two beams. There is, as far as I am aware, no gas that would do this.

The most obvious giveaway to anyone who has read any children's science fiction (Tom Swift and his 3D telejector to be exact) is the caption on the first illustration.

Its a pity that such a 3D TV system probably won't work, if it did, someone would make a mint of money licensing it.

P Jones
Woodbridge
Suffolk

Your article about 3DTV in the April issue of PE was nice but it won't work. April fool I presume.

L Allen
Bebington
Wirral
Merseyside

OK we admit it, it was all pure fantasy.

Correction

I was attempting to build the video fader in the March issue of PE and after studying the article for a while, I noticed a few errors. Could you possibly print the corrections and let me know if there is anything else wrong?

T Larch
Nottingham

Sorry about the errors, here are the corrections:

C6 and C7 are both 10µF tantalum beads rated at 16V.

VR1 is a 1k linear potentiometer

VR2 is a 250Ω linear panel mounting potentiometer

C5 is shown with its polarity reversed on the schematic but is correct on the PCB layout.

Some readers wrote in to ask where they could get some of the components.

The CD4052 and NE592 are both available from RS Components - also known as Electromail Tel. 0536 204555. Maplin do similar components called the 4052BE and LM592 as do Cricklewood Electronics with the NE592 and Verospeed the CD4052.

Another question that cropped up about this project was whether two faders could be used to join two video signals. Unfortunately, to be joined together, two video signals must be "genlocked". That is, all sync pulses and the phase of the sub-carrier must be identical.

Cyberspace... More Info

Back in January you ran a feature on Multimedia and virtual reality. While I enjoyed this article, I think there could have been more information. Can you tell me where I can find out more about virtual reality systems?

K Macnally
St Helens
Merseyside

There is magazine called Cyberedge which may give you the information you need. It has been running for about a year but is only available from the US (as far as I know). For more information, write to:

*Cyberedge Journal
928 Greenhill Road, Mill Valley, CA 94941, USA. Fax 0101 415389 0251 - far more useful than a telephone number due to the time difference* ■

PROGRAMMING FLEXIBILITY FOR PROFESSIONALS

HARDWARE FEATURES

- PC-BASED PROGRAMMERS
- UK DESIGN, MANUFACTURE AND SUPPORT
- NO MESSY INTERNAL CARD
- PLUGS DIRECTLY INTO PARALLEL PORT (LPT1-3)
- EASILY TRANSPORTABLE BETWEEN MACHINES
- WORKS WITH XT, AT, 386, & 486. EVEN LAPTOPS!
- INCREDIBLY FAST PROGRAMMING TIMES
- FLEXIBLE DESIGN MEANS NO ADAPTORS NEEDED FOR MOST DIP PACKAGES
- UPGRADES BY FLOPPY

SOFTWARE FEATURES

- MENU DRIVEN
- FLEXIBLE FILE LOADING (HEX, BINARY, JEDEC)
- READS, VERIFIES, BLANK CHECKS, BIT TESTS, OVER-PROGRAMMES AND AUTO-PROGRAMMES
- CAN MODIFY PARAMETERS OF EXISTING MEMORY DEVICES AND STORE IN USER DATABASE
- HANDLES SECURITY FEATURES OF ALL DEVICES
- AUTOMATIC PAL TO GAL CONVERSIONS
- FULL BUFFER EDITING CAPABILITIES
- TEST VECTOR SUPPORT



SPEEDMASTER 1000

- LOW COST, UNIVERSAL PROGRAMMER
- EPROMS, EEPROMS, FLASH EPROMS, NVRAMS, SERIAL EEPROMS, PALS, GALS, PEELS, EPLDS
- SUPER FAST PROGRAMMING e.g. 27C256 (32Kx8) IN 4.5 Seconds
- JEDEC TEST VECTOR SUPPORT FOR PALS
- INCLUDES PAL DEVELOPMENT SOFTWARE
- UP TO 40 PIN DIPS WITHOUT ADAPTORS

£445

MICROMASTER 1000

- ALL FUNCTIONS OF SPEEDMASTER 1000
- MICROCONTROLLERS FROM T.I. (including TMS370 SERIES, TMS77C82), INTEL, ZILOG, MICROCHIP (PICS), MOTOROLA, PHILIPS AND OTHERS

£575

SPEEDMASTER 8000

- 8 WAY GANG/SET PROGRAMMER
- MASTER SOCKET
- EPROMS, EEPROMS, FLASH EPROMS
- UP TO 32 PIN
- PC OR STAND ALONE MODE
- SUPER FAST PROGRAMMING e.g. 8x27c256 (32Kx8) IN 6 Seconds

£645

Prices exclude VAT & delivery

ICE TECHNOLOGY LTD

UNIT 4, PENISTONE COURT, STATION BUILDINGS, PENISTONE, SOUTH YORKSHIRE S30 6HG

TEL (+44) 0226 767404 FAX (+44) 0226 370434

Prototypes manufactured directly in your own Lab in only a few hours.

LPKF offers a complete solution: Professional periphery for every CAD System.

Time spec sheet

of a 4 layer multilayer
milling inner layer: 45 min
pressing: 120 min
drilling: 10 min
through plating: 105 min
milling outer layer: 60 min
operating time: 5 hrs. 40 min

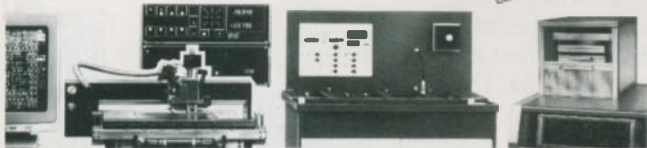
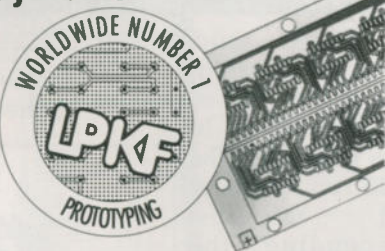

CAD > Milling/Drilling Prototypes > Through Plating > MULTIPRESS

For prototype production LPKF Mill/Drilling machines have proven its merits in thousands of installations all over the world. CAD data can be downloaded from any CAD system and prototypes are manufactured automatically either through the mill/drilling machine or by means of our latest laser technology.

The CONTACT through plating system and the MULTIPRESS completes the system. Suitable for any CAD system!

Request info material or call:



GH Systems 12 Coningsby
Bracknell Berkshire RG12 4BE U.K.
Tel 0344 860420/55046 Fax 0344 411346
Telex 849462 TELFAC G



New for 1992

- ★ **New MOSFET Amplifiers**
improved range of SMOS modules
30W, 30+30W, 60W, 120W
- ★ **20 watt Class A Amplifier**
- ★ **Low profile PCB Transformers**
a range of encapsulated transformers
4VA, 6VA, 10VA, 18VA, 24VA, 30VA

Write or phone for data and prices...
which include details of standard range of
toroidal transformers and audio modules.

No price increase for 1992

Jaytee Electronic Services

143 Reculver Road, Beltinge, Herne Bay, Kent CT6 6PL
Telephone: (0227) 375254. Fax: (0227) 365104

Innovations

This month, Sir Clive's new electric bike a break-out box and Toshiba's new colour laptop.



Better Than C5?

Called the Zike, it's the latest thing in personal transportation from Sir Clive Sinclair – the well known inventor of the ZX series of computers and the infamous C5. Also known as the Zero emission bicycle, the Zike is a bike with an electric motor.

The idea of a powered bike is not new but, until now, most attempts have usually been either cumbersome or impractical – in the UK at least. New technologies in the form of high capacity, low weight batteries, a neodymium-iron-boron electric motor, an

electronic controller and low weight frame make Zike a first in its class.

The power for the motor comes from a fairly standard 24V nickel cadmium (NiCd) battery system which, compared with the alternative lead-acid batteries available, is lighter and a lot more rugged. The electronic controller converts the voltage from the batteries to that required by the motor under any specific conditions. Charging can be either from the regenerative braking system or the external mains charger – this offers a recharge from empty to full in one hour and is said to cost about 1p.

Three modes of operation are possible selected from a switch on the handlebars. In the first, the Zike will run for about 30 minutes, depending the wind and terrain, with no effort on the part of the rider. The second mode expects a little pedal power from the rider to assist the motor and extends the range to about one and a half hours. The third mode is similar but requires even more pedal power to give two to

three hours of motor power. In all cases, any braking will recharge the battery, extending the range and saving on the brake blocks.

The Zike takes advantage of government legislation passed in 1983 which allows a special class of electrically power-assisted bicycles to be used on the road. Riders must be over 14 years of age and the machine must not exceed 15mph – the Zike's top speed is said to be about 12mph.

The most obvious problem that could arise for riders of the Zike is when encountering bumps in the road. Anyone who has ridden around London on a normal bicycle, or even driven in a car, will have noticed the rather numerous pot-holes, some of them up to 6in deep. The small size of the Zike's wheels and the vertical positioning of the steering above the front wheel could cause a few



tumbles – other towns in the UK may not have the same problems.

Able to cope with riders from 5ft to 6ft 6in and up to 17 stones, the Zike weighs a mere 11kg, is 115cm in length and 100cm high. It costs £499 (inc VAT) and has a large carrier basket available as an optional extra at £25 (inc VAT).

For more information contact Sinclair Research Ltd on 071 636 4488, or Vector Services Ltd on 0933 279300.

Break Out

The trouble with serial connections between computers is that they can be very hard to wire up. They will usually work with just three wires but may need up to 20 or so connections. To help get around the problem, Maplin has introduced a break-out box which allows all 25 connections on the link to be individually isolated and tested. The relevant signals can then be cross patched with jumper cables to make the right

connections. In addition to all this, the 50 lines can all be visually monitored via LEDs. The only drawback is that it only supplied with one male and one female connector. A gender changer (male to female convertor) is all that it needed to make the unit a complete package for serial linkers.

Priced at £29.95, the break out box is available from Maplin Electronic Supplies Tel. 0702 554161.

Teaser

The set of pictures on the right were sent to PE over the course of a week, starting at the top and eventually getting to the bottom. Only the pictures were sent, no text, compliments slips or anything else. Obviously it was a teaser campaign for the new Toshiba laptop a 25MHz 486SX TFT colour LCD screened machine costing £5550 for the 80Mbyte hard disk version and £5750 for the 120Mbyte. Very nice but very expensive. ■



Blue Segment, Vasily Kandinsky, 1921

The purest ...



The Red Room, Hsien Mustoe, 1908

the purest and most thoughtful minds.

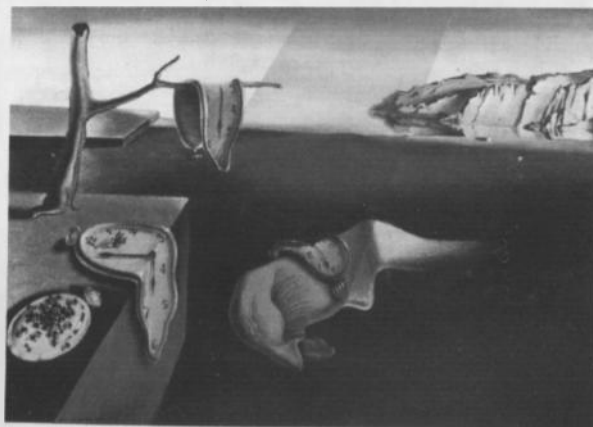

The Persistence of Memory, Salvador Dali, 1931

The purest and most thoughtful minds are those which love...



Starry Night, Vincent Van Gogh, Toshiba, 1992

The purest and most thoughtful minds are those which love colour the most.

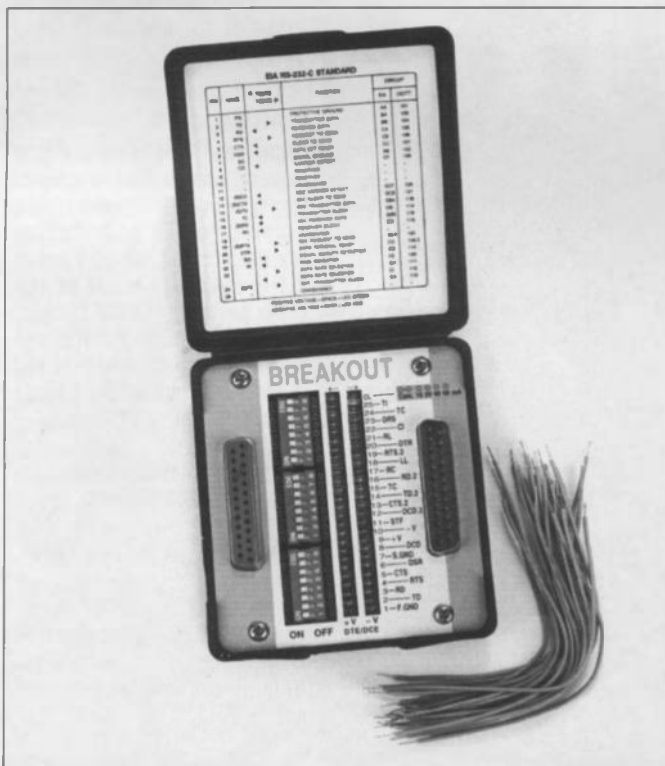

What's New

Computers have always needed two hands until now. Husky, known for making some of the toughest computers in the world, has introduced the FS/2 to be used in situations where one hand must be elsewhere.

Running MSDOS 3.3, the FS/2 is a fully functional IBM PC compatible with a 240x64 pixel resolution screen (40 characters by 8 lines). Built from lightweight magnesium alloy the unit weighs 750g and is fully shock, dust and shower proof.

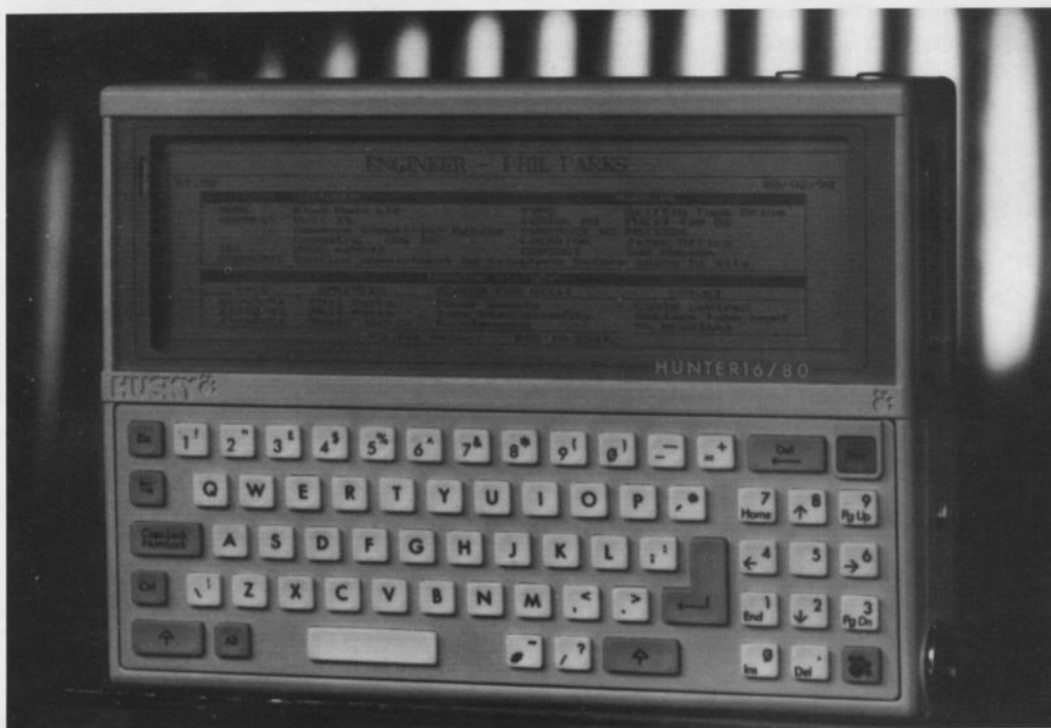

Also from Husky is a more conventional laptop machine. Featuring CGA compatible graphics on an LCD display the machine is not very much different from most of the other portables in the market, apart from the fact that it will withstand much more in the way of shocks and general maltreatment.

For more information contact Husky on 0203 668181

The Ultimate Microprocessor

The new Alpha from Digital Equipment Corp has a specification that makes major mainframes look puny.

The launch of the Alpha microprocessor from the Digital Equipment Corp looks set to revolutionise the size and power of computers. Claimed to offer the power of a Cray-1 – one of the world's fastest super-computers – the single chip microprocessor can be built into systems ranging from palmtops to super mainframes.

The incredible power of the 21064 should give rise to computer systems able to understand speech as well as being able to answer back – all in a device the size of a wallet. In slightly larger machines, the high speed processing capabilities will allow graphics and computer animation currently only available in large, expensive mainframes. By using a number of alpha microprocessors in parallel, super computers approximately 100 times faster than the current best and eventually a thousand times faster will be possible. Cray, a major manufacturer of super-computers had already expressed an interest in the device and is looking at a Multiple Instructions, Multiple Data system with a speed of over 100GFLOPs (Giga FLOPs)

The 21064 chip uses a 64-bit

RISC architecture able to address up to 1.8×10^{19} memory locations – 4 billion times the address space of current systems. It can execute up to 400 million instructions per second (MIPs) and 200 million floating point operations per second (MFLOPs) with an internal clock frequency of 200MHz. It has a built in floating point unit (FPU) which is fully IEEE 64-bit compatible as well as an 8kbyte cache and pipelined parallel instruction processing system.

The units will be manufactured in the US and Scotland to begin with but Digital is hoping that a number of other chip manufacturers will provide second sources. As with the alliance between IBM and Intel which worked so well in the IBM PC range of machines, Digital wants the chip to become an industry standard. To help with this, the architecture of the chip has been designed not to have a bias toward any particular operating system hopefully making it attractive to all manufacturers.

To ensure that the design does not go quickly out of date, Digital aims to increase the clock speed, allow it to execute more instructions in parallel and enable it

to operate along side other processors to form a massively parallel processor (MPP). The design is claimed to have a 25 year lifetime and over this period its performance should improve by a factor of 1000. ■

Glossary

Cache – on-chip fast memory used to store repeatedly needed instructions – accessing data in the main memory is relatively slow in comparison

CISC – complex instruction set computer requires a number of clock cycles per complex instruction

FPU – floating point unit off-loads floating point calculations onto a separate piece of hardware which performs them much more quickly

IEEE – institute of electrical and electronic engineers (in the US)

MFLOP – a million floating point operations per second

MIMD – Multiple instructions multiple data, effectively a parallel processing computer

MIP – million instructions per second

MPP – massively parallel processing

Pipelining – a system which queues instructions by fetching more while the current ones are being executed

RISC – a reduced instruction set computer aims to execute one simple instruction per clock cycle

VMS – an operating system used in DEC minis and mainframes

Vendor Device	Digital 21064	MIPS R4000	Sun/TI Viking	IBM RIOS	HP PA-4	Intel i860XP	Motorola 88110
Max internal frequency	200MHz	100MHz	50MHz	50MHz	66MHz	50MHz	50MHz
No. Chips required	1	1	1	7-9	2	1	1
Peak MIPs	400	100	150	200	132	150	150
Peak MFLOPs	200	50	50	100*	132*	100*	100
Architecture	64-bit	64-bit	32-bit	32-bit	32-bit	32-bit	32-bit
Available	now	now				now	mid 92

* combined floating point multiplication and addition

EASY-PC, SCHEMATIC and PCB CAD

Over 11,000 Installations
in 70 Countries Worldwide!

**Still
Only
£98.00!**
Plus P&P+VAT

**BRITISH
DESIGN
AWARD
1989**

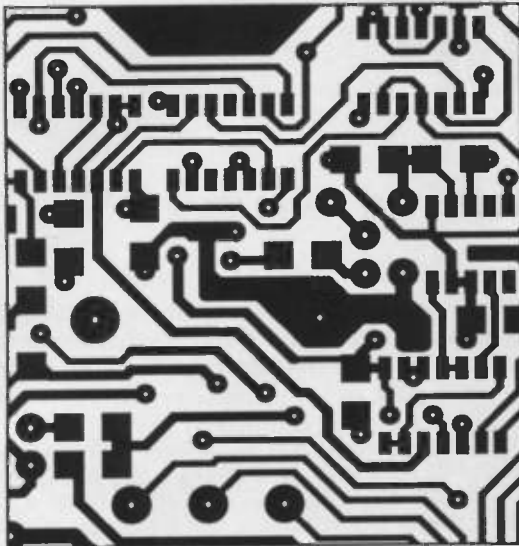

- Runs on:- PC/XT/AT/286/386/486 with Hercules, CGA, EGA or VGA display.
- Design:- Single sided, Double sided and Multilayer (8) boards.
- Provides full Surface Mount support.
- Standard output includes Dot Matrix / Laser / Inkjet Printer, Pen Plotter, Photo-plotter and N.C. Drill.
- Tech Support - free.
- Superbly easy to use.

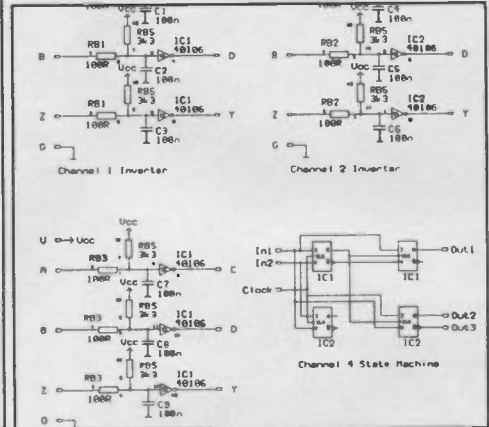

Options:-500 piece Surface Mount Symbol Library £48,
1000 piece Symbol Library £38, Gerber Import facility £98.

**DIGITAL
SIMULATION £195**

**ANALOGUE
SIMULATION £195**

**SMITH CHART CAD
£195**

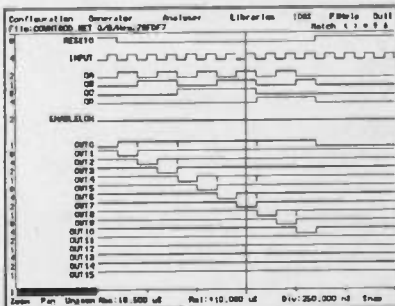

- At last! A full featured Digital Circuit Simulator for less than £1000!
- PULSAR allows you to test your designs without the need for expensive test equipment.
- Catch glitches down to a pico second per week!
- Includes 4000 Series CMOS and 74LS Libraries. 74HC/HCT libraries only £48.00 each.
- Runs on PC/XT/AT/286/386/486 with EGA or VGA.

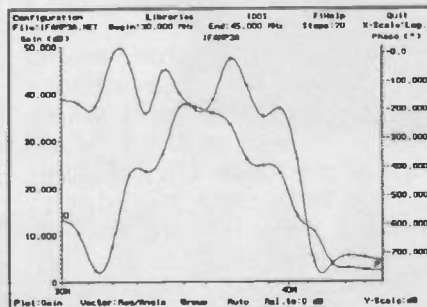

- NEW powerful ANALYSER III has full graphical output.
- Handles R's, L's, C's, Bipolar Transistors, FET's, OP-amp's, Tapped and Untapped Transformers, and Microstrip and Co-axial Transmission Lines.
- Plots Input / Output Impedance, Gain, Phase & Group Delay.
- Covers 0.001 Hz to > 10GHz
- For PC/XT/AT/286/386/486 with EGA or VGA.
- Very fast computation.

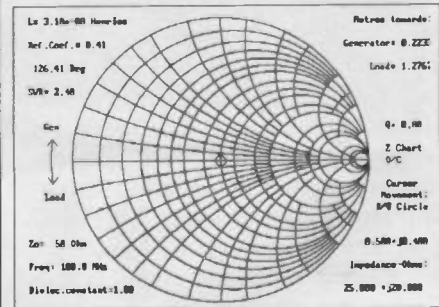

- Z-MATCH II simplifies RF matching and includes many more features than the standard Smith Chart.
- Handles transmission line transformers, stubs, discrete components, S Parameters etc.
- Supplied with many worked examples.
- Superbly easy to learn and use.
- Runs on IBM PC/XT/AT/386/486, CGA, EGA, VGA.
- Ideal for Education and Industry.

For full information, Write, Phone or Fax:-

Number One Systems Ltd.



REF: PE, HARDING WAY, ST. IVES, HUNTINGDON, CAMBS, ENGLAND, PE17 4WR.

Telephone: 0480 61778 (7 lines) Fax: 0480 494042

International: + 44 -480-61778, Fax: + 44-480-494042 ACCESS, AMEX, MASTERCARD, VISA Welcome.

TECHNICAL SUPPORT FREE FOR LIFE!
PROGRAMS NOT COPY PROTECTED.
SPECIAL PRICES FOR EDUCATION.

Music Reproduction Goes Digital

Kenn Garroch surveys the HiFi scene and finds that LPs and 45s are no longer in the groove. Everything is going digital.

Music has become an integral part of modern society. Few people have access to no music at all and radios, record, CD and cassette players are ubiquitous household items.

A multi-million pound international industry caters to the tremendous buying power of the 'thirty somethings' reproducing the hits from their youth in more readily accessible and easier to use formats than ever before.

Golden Oldies

The technology for recording sound has been around for a long long time. There are recordings of Queen Victoria and even Chopin in existence and the recitation of *Mary Had A Little Lamb* by Thomas Edison is legendary.

The first sound recording machines used cylinders of wax onto which a spiral groove could be cut. As the cylinder turned, a diaphragm picked up sounds and transferred them to the cutting needle. This movement was recorded in the wax and could be played back by reversing the process and allowing the wax to move the needle and hence the diaphragm. Although the sound may not have been very good, it served as a model for recording techniques that have been used ever since.

The development of the gramophone with its rotating disc, needle and horn gave rise to the early music industry with commercial production of large quantities of 78s – the number referred to the speed which which the disc rotated, 78 revs per minute.

Improvements in materials and

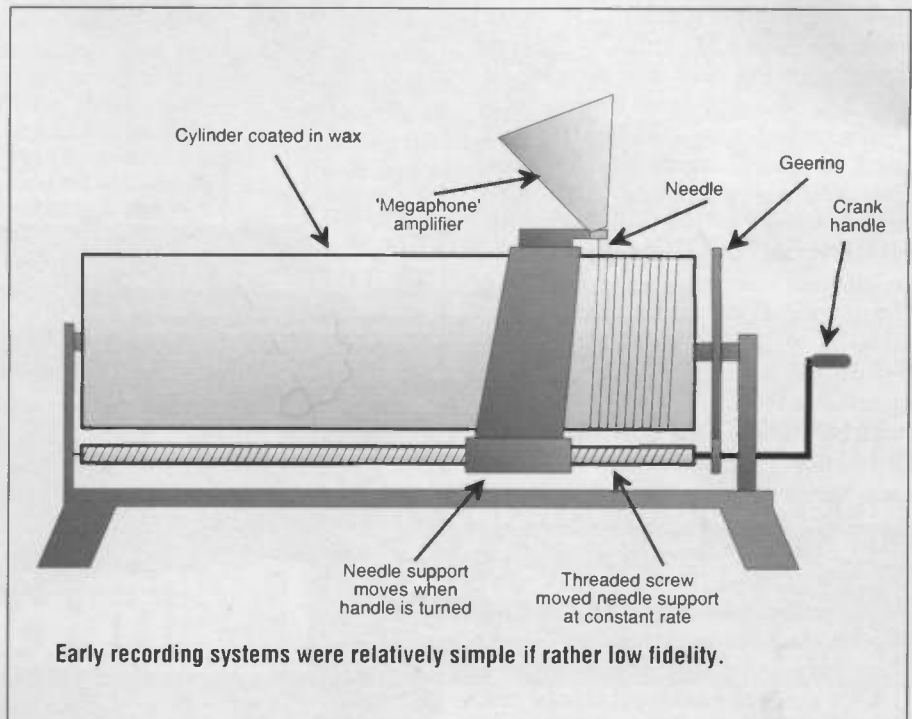

the development of the valve amplifier saw the introduction of the 45 and 33 – the single and long play (LP) formats. The use of a microgroove in a piece of vinyl plastic gave rise to improved quality and eventually to high fidelity or HiFi and stereo.

Using Both Ears

Until the introduction of stereo sound, all record players, tape recorders and radios used one speaker and produced fairly low quality sound – just like listening to a concert through a small hole in the wall of the theatre. The idea of stereo is based on the fact that most human beings have two ears and perceive sound across a stage in front of them. In practice, human hearing is a good deal more flexible

than this and is able to discern height as well as whether sounds come from behind. Consequently, conventional two speaker stereo is something of a trade off. It gives a horizontal sound stage image similar to that heard in a concert hall. However, it can't easily reproduce reflections from the rear, ceilings and floor – mainly because most listening rooms are much smaller than the original hall and therefore have very different acoustics.

Stereo is a good deal better than mono and has become the standard method of reproducing sound and music. Quadraphonic and surround sound systems are available but the need for at least four speakers and extra musical information has kept them in the background – apart from in the

world of cinema where it is worthwhile installing all the extra speakers in a theatre to get the desired effect.

In The Groove

Until recently, there were only two practical ways to record and reproduce sound: with a vibrating needle in a groove or on magnetic tape. Records, be they single (45) or LP (33), and cassettes were the only ways to buy music recordings. The invention of cheap lasers and super miniaturisation lead to the development of the laser disc and then the compact disc (CD). Mass production of CDs and CD players along with the dramatic increase in quality has given a boost to a floundering music industry and lead to the demise of the now obsolete vinyl records. Although many shops still stock LPs and singles, a number of music publishers have stopped producing them and gone over entirely to CDs. It will only be a few years before the old style LP becomes a specialist item used only by HiFi buffs who can hear and prefer the difference.

On The Wire

Compact cassette tapes are still going strong but they will soon be headed for the museum if Philips' new Digital Compact Cassette (DCC) system takes off. Until the invention of the Sony Walkman and its miniature brethren, cassettes had not been competing well with LPs. Their quality was not as good and they had the drawback of having their tracks recorded sequentially. It is impossible to skip from one to another very quickly. However, they found wide use in in car entertainment (ICE) systems since the bouncing of a car would not affect them and the general background noise covered up any lack of quality.

DCCs are the same size as ordinary compact cassettes but are digital and offer much better quality. The clincher as far as Philips is concerned should be the ability of DCC systems to play the older compact cassettes as well.



Sony's Magneto optical disc.



A DCC Player

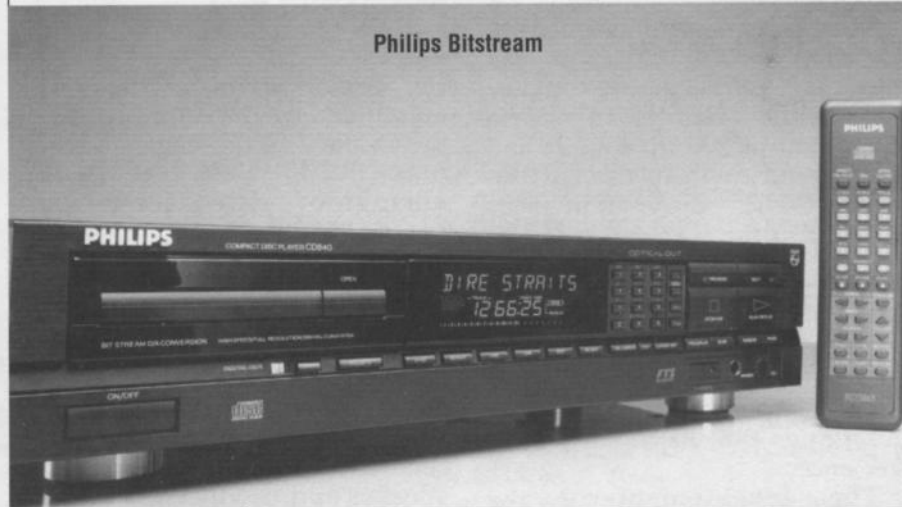

Philips Bitstream

Anyone with a large collection of cassettes need not worry about being able to play them on the new system and will be able to replace worn cassettes with their digital

counterparts when necessary.

Doing Things Digitally

What makes digital recording better than the older analogue (so



NATIONAL
COLLEGE OF
TECHNOLOGY

DISTANCE LEARNING COURSES

The National College of Technology offer a range of packaged learning short courses for study at home or in an industrial training environment which carry national BTEC awards. Study can commence at any time and at any level, enabling you to create a study routine to fit around existing commitments.

Courses on offer include:









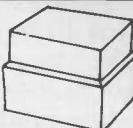

- Analogue Electronics
- Digital Electronics
- Fibre/Optoelectronics
- Programmable Logic Controllers

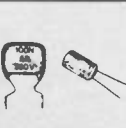
Tutor support and BTEC certification are available as options with no travelling or college attendance required. These very popular courses which are ideal for vocational training contain workbooks, audio cassette lectures, PCBs, instruments, tools, components and leads as necessary to support the theoretical and practical training. Whether you are a newcomer to electronics or have some experience and simply need an update or certifications, there is probably a distance learning course for you. Write or telephone for details to:

National College of Technology
NCT Ltd. PO Box 11, Wendover, Bucks
Tel: (0296) 624270

CRICKLEWOOD ELECTRONICS LTD

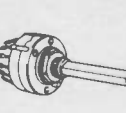
NEW 1992 CATALOGUE

 BOOKS	 BOXES & CASES	 CABLE & WIRE	 CAPACITORS
 CONNECTORS	 KITS	 RESISTORS	 SEMICONDUCTORS
 SPEAKERS	 VIDEO HEADS	 SWITCHES	 TOOLS & TEST GEAR

SEND NOW FOR THE

**CRICKLEWOOD
ELECTRONICS LTD**

COMPONENT CATALOGUE.
ONE OF THE BEST
RANGES AVAILABLE

NAME
ADDRESS.....
.....
PLEASE SEND COPIES OF CRICKLEWOOD
ELECTRONICS CATALOGUE @ £2.00 EACH. PLEASE MAKE
CHEQUES OUT TO CRICKLEWOOD ELECTRONICS ETC.

**CRICKLEWOOD ELECTRONICS LTD, 40 CRICKLEWOOD BROADWAY
LONDON NW2 3ET. TEL 081 450 0995, 081 452 0161 FAX 081 208 1441**



**SLASH YOUR PHONE BILLS!!!
100% FREE DIALLING!!!**



“CREDITCALL”

AFTER MONTHS OF LEGAL BATTLES
WE CAN NOW OFFER YOU THE
CREDITCALL FROM THE
INVENTORS OF THE
ORIGINAL ‘BLACK BOX’!!!

This ingenious little marvel is a Plug-in Adaptor designed to work on all the very latest systems.

**COMPLETELY
UNDETECTABLE!!!**

Simply plug the remarkable ‘creditcall’ into any authorised socket, then plug your telephone into the ‘Creditcall’. This amazing little gizmo can save you a fortune! ‘Creditcall’ works by blocking the metering pulses on the line and suppressing the charge signals.

**TAKE ADVANTAGE OF A LOOPHOLE IN THE
LAW ALLOWING US TO SELL THIS UNIQUE
UNIT; BUT ACT NOW!**

‘Creditcall’ comes complete with a Universal Adaptor plus full instructions of how you can start slashing your bills. Before ordering, please read the warning below.

YOU COULD SAVE £££'S!!!

**24HR CREDIT CARD ORDER LINE
ALL MAJOR CREDIT CARDS ACCEPTED**



09442 8887



**PRIORITY TELEPHONE ORDERING SERVICE
PLEASE ALLOW UP TO 7 DAYS FOR DELIVERY**

**BEWARE OF INFERIOR COPIES
BEING SOLD IN LONDON FOR WELL
OVER £200!**

**Top Secret Electronics (UK)
(Callers by appointment only)
26 Woodlands Road, Rillington,
Malton, YO17 8LD**

Please rush me the remarkable ‘Creditcall’. I enclose cheque/P.O. for £..... made payable to ‘Top Secret Electronics (UK)’. I have read the warning & fully understand that the use of this unit in the UK is illegal. I sign to state that I am purchasing this unit as a novelty only, further I will not connect direct/indirect to any telephone system without the prior consent of the system provider.

Signed.....
Date.....
Name.....
Address.....

Postcode.....
All orders are in strictest confidence – tick for no mailings

* Please note that the coupon must be signed & dated else we are unable to supply this unit in the UK. This unit is supplied as a novelty only. We will not be liable in the event of any illegal UK use. The slogan ‘Slash your phone bills’ applies to our advice with the supplied unit.



**SAVE A FORTUNE!
JUST
34.95**
Plus £2.50 Postage & Packing

**CREDIT
CALL**

WARNING
The use of this unit on any UK telecommunications system is strictly prohibited. Action may be taken under the various ‘Post Office’ Acts of criminal proceedings under the Theft Acts. This unit must not be used on any telecommunications system without the full consent of the system provider. The unauthorised obtaining of free telephone call(s) is a criminal offence.

GUARANTEE
If you are not entirely delighted with the remarkable ‘Creditcall’ simply return in the received condition for a full no quibble money-back refund.

**Top Secret Electronics (UK)
26 Woodlands Road,
Rillington, Malton, YO17 8LD**



called because it stores air pressure waves as either waves of plastic or variously rotated magnetic areas) is that once a sound has been coded up as a series of numbers it can be stored and manipulated without any loss of quality. The numbers need never change so they always represent the original exactly.

Converting sounds into digital form is simply a matter of sampling them. A sound is a continuously varying air pressure wave and is converted to its electrical analogue by a microphone. Taking repeated measurements of its amplitude and converting them to numbers results in a digital representation of the signal. Two main things are important in this process, the number of levels that can be measured and the speed at which the measurements take place. The usual format for digitising sound is to use 16-bit numbers to give 2^{16} or 65536 levels. The speed of measurement or sample rate must be at least twice the highest frequency being recorded and is usually around 44kHz (human hearing generally ranges from 20Hz to 20kHz). Once in numerical or digital form, the information is stored either on a CD with a laser which cuts tiny pits in the surface, or on a magnetic tape as in DAT (Digital Audio Tape).

To convert the numbers back to sound, a digital to analogue convertor is used. This transforms each number into a voltage resulting in a stream of voltages that represent the original samples. These can then be put through the usual amplification system and loudspeakers resulting in the original sound.

There are both advantages and disadvantages to this process. One big plus is that the dynamic range is very good – the loud sounds remain earsplitting and the quiet ones soft. A disadvantage is that frequencies over about 20kHz are removed at the original sampling stage. It has been found recently that although human ears cannot actually hear sounds above 20kHz, they do sense them and their presence affects the overall feeling of the music – frequencies up to 90kHz have this effect. This may be one reason why some purists say that they prefer old style LPs to CDs. A recent CD system from

Pioneer tries to replace the lost frequencies by interpolating them from the existing sound although it requires a very good set of loudspeakers and amplification to hear the difference.

Technologies In Sight

Apart from the appearance of DCCs later this year, Sony has developed a magnetic disk technology which provides a CD like format but with the ability to re-record. A problem with CDs is that they cannot be recorded in the home. Only DAT systems could provide the high quality digital recording capabilities on a home based unit and DAT has not been available in the UK for very long – it is also quite expensive. The Sony system uses small 2.5in disks which can hold 70 minutes or so of music. Recording is by means of a hot laser which loosens the magnetic material in the disks and allows an overall field to be set. After cooling the new information can be read with a cooler laser which detects the different magnetic areas. In other respects it is like CD with the ability to skip from track to track at random and reproduce high quality digital sound.

Other new technologies are enhancements on what is already available. Bitstream is a new method of reproducing the digital information from a CD. Instead of using a 16-bit DAC, single bits are used and the results averaged to get the sound signal. This offers quite an improvement over older methods and looks set to take over in the second generation of CD players.

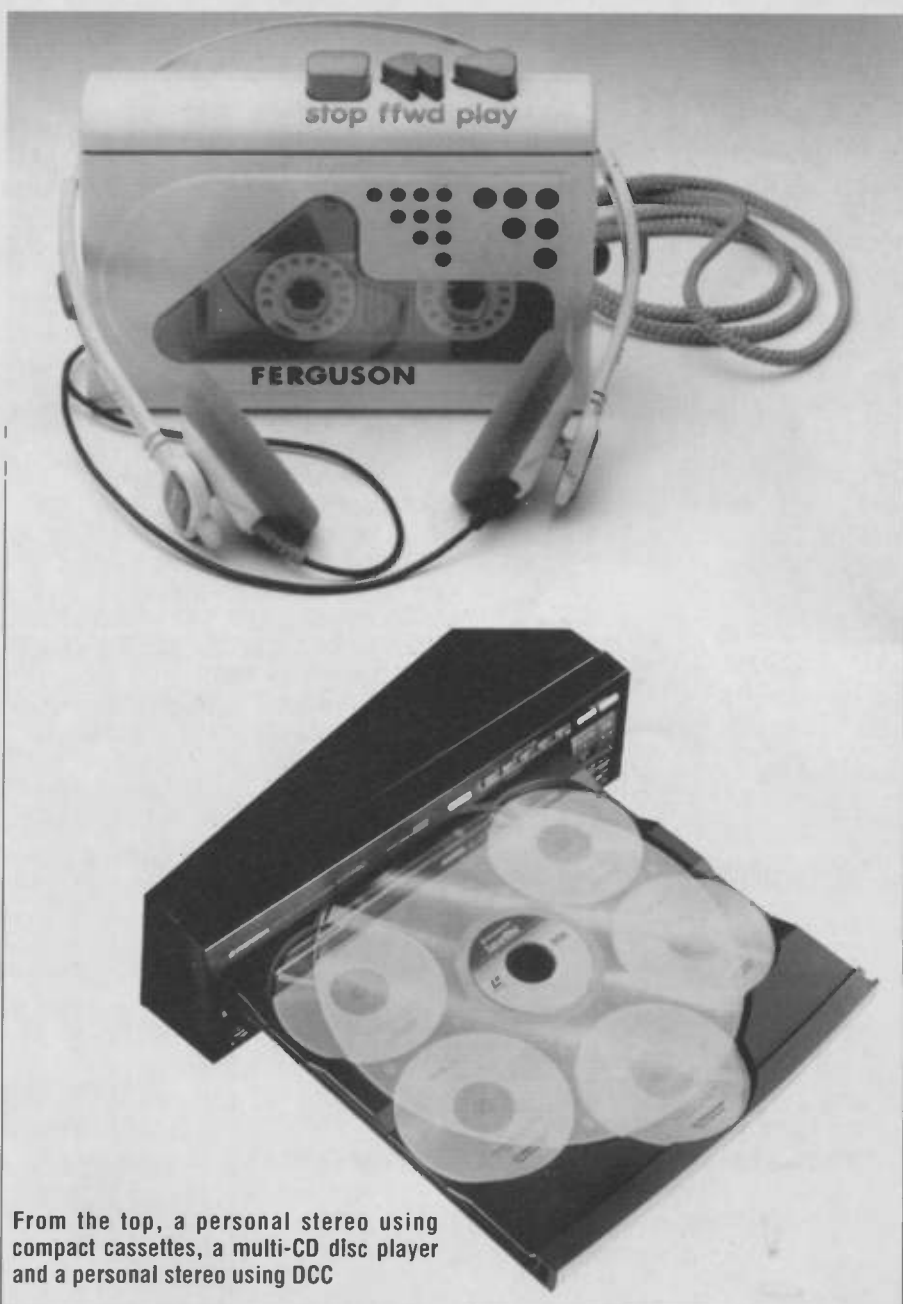

From the top, a personal stereo using compact cassettes, a multi-CD disc player and a personal stereo using DCC

Technologies Out Of Sight

After the market has become used to DCC, Sony Magneto Optical Disks and CDs have become rather old-fashioned, something will come along to take over. What this might be no-one really knows yet but a few guesses can be made by looking at the way in which the computer industry is moving. Ten years ago, personal computers had memories of around 64k. Now 1M is commonplace and many machines come with 4 to 8M as standard. This is an increase of between 16 and 64 times. Current CD technology supports around

600M per disk so it would appear that cramming 70 minutes of music onto a memory chip will take more than a few years advance in electronics. However, DCC systems reckon to increase the storage capacity of ordinary magnetic tape by a factor of four. This compression means that 70 minutes of audio should fit into 150M of memory, only an increase of about 40 times the current technology. It seems that an album on a chip should be with us in the next ten years making players the size of credit cards or smaller. Perhaps a personal stereo will consist of two ear-pieces connected by a small radio transmitter, only one of which actually has the album chip on it. ■





Happy Memories

Memories

4116	150ns (Pulls)	1.00
4164	100ns	1.45
41256	80ns	1.65
41464	80ns	2.25
414256	80ns	3.95
411000	80ns	3.95
256 x 9	SIMM 80ns	11.50
256 x 9	SIPP 80ns	12.00
1Meg x 9	SIMM 80ns	29.50
1Meg x 9	SIPP 80ns	30.50
4Meg x 9	SIMM 80ns	110.00
36 bit (72 pin)	SIMMs	Call
6264	100nsLP	1.95
62256	100nsLP	2.95
2764	250ns	2.50
27128	250ns	2.25
27256	250ns	2.45
27C256	250ns	2.45
27512	250ns	3.45
27C512	250ns	3.75

Motherboards

80286 12MHz EMS on board , Up to 4Mb RAM	£55
80286 16MHz " "	£72
80286 20MHz " "	£89
80386SX 25MHz Up to 8Mb RAM	£150
80386DX 25MHz Up to 32Mb RAM	£255
80386DX 33MHz 128K Cache "	£295
80486SX 20MHz £275	80486DX 33MHz 64K Cache £495

Diskdrives

5¼" 1.2Mb Floppy	£43	3.½" 1.4Mb Floppy	£36
40Mb 25Ms IDE 3½"	£149	85Mb 19Ms IDE 3½"	£215
104Mb 19Ms IDE 3½"	£240	180Mb 19Ms IDE 3½"	£375
IDE Controller for 16 bit bus. 2 x FDD & 2 x HDD			£14
Ditto with Serial, Parallel and games ports on board			£18

Video

TTL Mono/Parallel Printer card. Hercules compatible.	£12.95
VGA card, 16 bit 256K RAM, upto 800 x 600 resolution	£29.95
VGA card, 16 bit 512K RAM, upto 1024 x 768	£49.00
VGA card, 16 bit 1Meg RAM, 1024 x 768 in 256 colours	£65.00
Amber TTL 12" monitor	£85.00
VGA paper white 14" inc. on-site warranty	£89.50
VGA colour monitor 1024 x 768 14" inc. on site warranty	£260

I/O, plug-ins etc:

120Mb internal tape streamer (uses floppy controller)	£199
102 Key Tactile Keyboards	£29.50
MS compatible serial mouse, 9/25 pin adapter, software	£13.95
2 serial, 1 parallel & games port I/O card	£12.95
Desktop case with 200W power supply and all fittings	£75.00



Carriage on Motherboards, Floppy drives & Keyboards £5, Mice, Video & Controller cards £3, Cases, Hard disks & Monitors £10, IC's free if over £20 nett, else add 75p. VAT to be added to the total. List of other IC's and computer parts on request.

Send orders to: HAPPY MEMORIES, FREEPOST, KINGTON, HEREFORDSHIRE HR5 3BR

TEL: (054 422) 618 FAX: (054 422) 628



THE NAME IN INNOVATIVE
COMMUNICATION PRODUCTS

STOP NUISANCE CALLS
PROTECT YOURSELF AGAINST UNWANTED
TELEPHONE CALLS
DL20 TELEPHONE CALL
FILTER-MONITOR-ANSAPHONE

- ★ Call-Screen: Displays the number of incoming calls before the telephone is answered
- ★ Call-filter: No more unwanted calls
- ★ Call-Counter: Check number of calls on return
- ★ Call-Register: Stores 40 incoming call numbers and the time of call
- ★ Call-Monitor: Listen to any noise in your home/office by a secret code when calling
- ★ Normal time display
- ★ Memory back-up during power cut
- ★ Can connect both tone or pulse telephone systems
- ★ 20 phone number memories can be stored and recalled
- ★ OGM: To record a personalised outgoing message



£118.29

all prices are exclusive of VAT £3pp cut

NORTHERN MARKETING CONCEPTS



24 HOUR ORDER
HOTLINE



TEL (09442) 8887

Also suppliers of -

SCANNERS • TELEPHONE RECORDERS • COMPUTER-AIDED
SURVEILLANCE SOFTWARE

Please note that certain equipment may need approval before connection or use

Service Manuals

We can supply Service Manuals for almost any type of equipment. Televisions, Video Recorders, Amateur Radio, Test Equipment, Vintage Valve, Any type of Audio Equipment, Military Surplus, etc. etc.

All Makes and Models supplied, from the 1930s to the present.

Originals or photostats supplied as available.

FREE Repair and Data Guide with all orders or SAE for your copy.

Mauritron Services (PE)

8 Cherry Tree Road

Chinnor

Oxfordshire

OX9 4QY

Tel: (0844) 51694

Fax: (0844) 52554



Technology Update

Ian Poole takes a quick tour around some of the latest inventions and techniques in the world of electronics and semiconductor engineering.

The pressure for ever decreasing sizes of integrated circuit (IC) has given dynamic RAM designers significant problems. One of the major ones arises because these RAMs store their information in individual cells as a charge in capacitors. For these to be reliable each capacitor must have a certain minimum capacitance. To a large extent this is dependent upon the physical size of the capacitor.

One solution to this problem was to design capacitors using a trench or V in the structure. This gave a larger area for the capacitor whilst taking no more space in the horizontal plane. Although this method was reasonably successful and used in some 4M bit DRAMs, it only gave a limited increase in capacitance.

To help fully overcome the problem researchers at Siemens AG in Munich have been able to produce very thin and pure layers of titanium oxide. This is ideal for use as a dielectric material for capacitors in ICs because it has a very high dielectric constant – about 20 times that of silicon dioxide/silicon nitride which is normally used for the purpose. This means that the size of the capacitors can be reduced by almost the same ratio.

Not only does the titanium dioxide give an improvement in size but it has also been found not to suffer from the same loss of charge which has plagued designers for some time. Most silicon dioxide/silicon nitride capacitors lose their charge by currents due to quantum mechanical tunnelling. As this does not occur with titanium dioxide

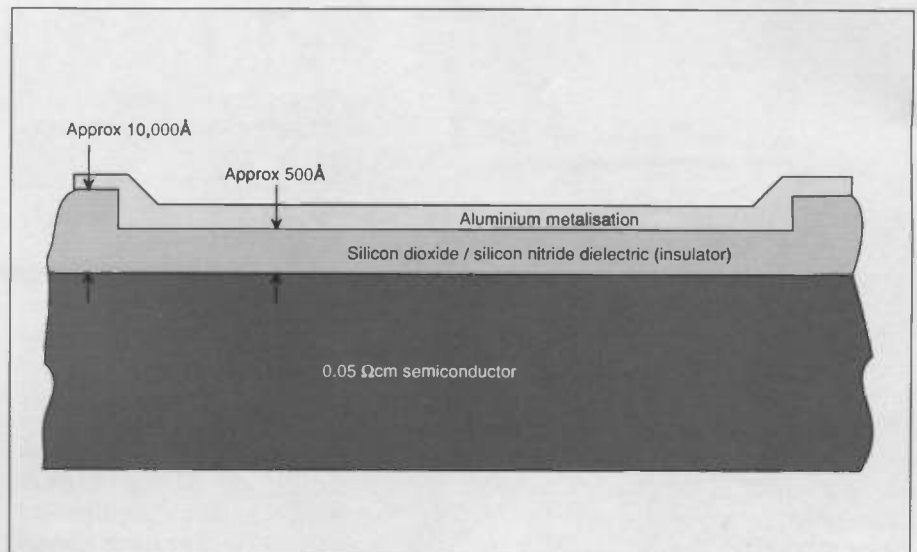

new ICs using it are expected to be more reliable.

Although there are many advantages to using titanium dioxide the processes which are needed to handle it have to meet stringent requirements. Even so the processes are now well advanced and it is hoped that Siemens will be able to launch a 256 M bit DRAM using the new capacitors

Ceramic Batteries

Batteries are being used increasingly as sources of power. This is partly due to the fact that there is more portable electronic equipment available than there was a few years ago. In view of this increase in battery usage any improvements which can be made could pay very large dividends on the investment spent in any development.

The existing technologies which are used have many drawbacks. Primary or non-rechargeable cells are expensive and cannot be

recharged despite the fact that they remain basically intact. In addition to this their disposal gives rise to environmental problems, a factor which is becoming increasingly important.

Rechargeable cells offer a sensible alternative and of those available, NiCds currently hold a virtual monopoly, but they are not ideal. In the first instance they only give 1.2 volts in comparison with the 1.5 volts of a standard cell and they are also very expensive. In addition to this they have a finite number of charge / discharge cycles because the mechanical stresses setup in the cathode by normal use eventually leads to failure.

A lot of work is currently being undertaken to overcome these problems. One investigation has discovered that a form of ceramic called a ternary oxide could be the key to a whole new generation of batteries.

Ternary ceramics can produce a wide variety of voltages by

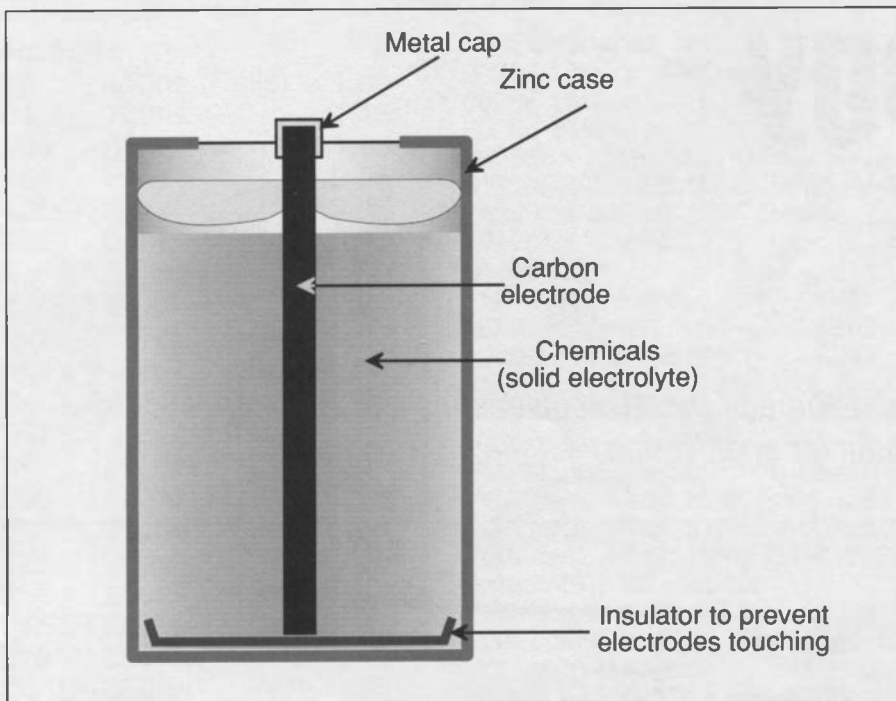

selecting the make up of the ceramic. This means that a voltage of 1.5 volts can be used. In addition to this the number of charge / discharge cycles is almost unlimited because there are no internal stresses set up in the cell during normal use.

Results so far have been very encouraging. A laboratory made cell using the anode from a commercially made NiCd, an electrolyte of sodium hydroxide and a ternary oxide cathode has shown no noticeable reduction in efficiency after several thousand charge / discharge cycles and the cell voltage has remained stable at 1.45 volts.

Investigations of the cell using X rays have proved that none of the stresses of NiCds were exhibited by this cell. Another advantage of ternary oxide cells is that they have a much greater energy storage capability than ordinary NiCds. This will mean that the cells will need charging less frequently.

Although the experimental cells have used liquid electrolytes there is no reason why a solid one could not be used. This could be done by firing three layers of ceramic together to give a completely solid state cell.

Once the technique has been perfected it should give a much more reliable cell and at a much reduced cost. It will also not have the same environmental problems after the cell has exceeded its useful

life and needs disposing. The only bad news is that there is still a considerable amount of development to be completed and these cells are unlikely to be available for at least five years.

New Photoresist

The ongoing quest for higher performance electronic equipment has meant that IC operating speeds and frequencies have had to rise. To achieve this IC dimensions have had to be reduced. However, many of the processes which were perfectly adequate some years ago are reaching their limits unless new ways of increasing their performance can be found.

One of the main processes in IC manufacture is called photolithography. Although there are other processes which can be

used instead they are much more costly. Unfortunately for many of the new breeds of ICs which are currently being produced the limit of resolution for photolithography is being reached. Generally it can produce structures with dimensions down to about 1 μm . If anything less than this is required then X-ray lithography is used.

The limitations behind photolithography arise from basic physics. To get sufficient resolution of the image onto the IC very short wavelengths have to be used. This means that a wider aperture is required in the optics and in turn this results in a very small depth of focus. As the light has to act on a sufficient thickness of photoresist to resist the chemical attack a limit is reached.

To overcome this problem researchers at Siemens have produced a new technique which has enabled them to achieve resolutions of better than 0.3 μm . The process involves using a two layer resist. The top layer is very thin and is sensitive to light. Once this has been exposed the resist pattern is transferred to the lower and thicker layer of resist by a chemical process called dry etching. This bottom layer forms two functions. The first is to give a sufficiently flat surface and ideal exposure conditions for the top layer. Secondly it is thick enough to act as a mask in the chemical etching process.

This process is currently used on an experimental basis. However when it is at a sufficiently advanced stage in development it could be a key process in the production of future Gigabit memory ICs which are just over the horizon. ■

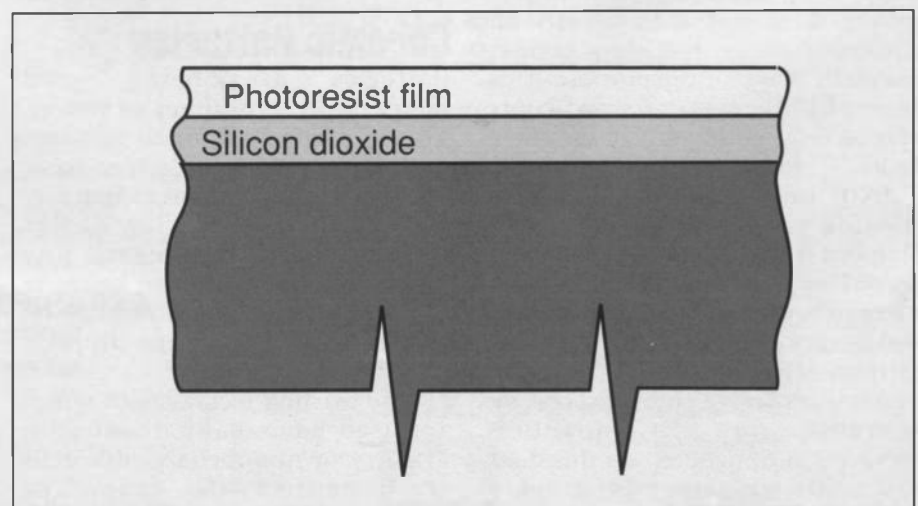

Review...

Canon S-50 Speakers

Domestic loudspeakers have not changed a great deal in design over the years until now. James Smith examines a completely new concept in sound and finds he likes it.

Possibly the most unusual loudspeakers ever produced, in appearance at least, the Canon S-50s are an attempt to usher in a new era of sound.

Unlike normal loudspeakers, which are housed in large square cabinets – usually made of wood but sometimes of concrete or plastic – the most striking thing about the S-50s are their round domes mounted on cone shaped pedestals. This is not an attempt at modern art or even post modern art, it is all functional. The sound is produced from normal speakers mounted facing down inside the domes. It is then reflected into the room by the cones to give a wide spread of sound known as 'wide image stereo'.

The S-50 speakers can be used with any HiFi sound system and have been especially designed for use with the latest HiFi television sets and Nicam digital stereo. Special shielding has been incorporated into the design to allow them to be placed relatively close to the TV set without affecting the electron beams inside the tube – anyone who has accidentally, or otherwise, placed a magnet close to a TV will have noticed the disastrous effect on the image.

Wide Image

The concept of wide image stereo stems from the idea that a normal pair of stereo loudspeakers have a definite hot spot where they give a perfect stereo image. All of the instruments, singers, band and so on, appear in their correct places and the sound from one speaker does not drown that from the other. Sitting with your head in this position results in the best listening.



Unfortunately, it is not practical for a number of people to sit with their head in the same location so those on the outside edges of the 'hot spot' will not get the best stereo effect. The Canon S-50s produce a much wider 'hot' area allowing a number of people to get, more or less, the same stereo effect. The area is also not just a straight line a certain distance from the speakers, it is an oval or circle so no special listening positions are necessary. So much for the theory, what about the practice.

After quite a lot of listening and demonstrating to amazed friends, the general opinion of the S-50s was a definite thumbs up. The only real problem with the speakers is that they tend to have their best effect at one position vertically. Sitting with them at head height produces much better effects than if they are much higher or lower. It is probably worth spending the extra money on the stands as this brings the units up to the correct height.

Aesthetically the S-50s go with

fairly modern decor – with other styles such as victorian or farmhouse, they look rather out of place. Quite apart from anything else, the speakers provide a very good talking point being variously described as ornaments, wig stands and even vases (though they are the wrong way up)

Specifications

Product: Canon S-50 Wide Imaging Stereo Speakers

Anechoic frequency response: 70Hz to 18kHz ± 3 db

Nominal impedance: 8 Ω

Power handling: 50W but can be used with any amplifier with an output from 15W to 100W per channel.

Price: £349.99 (inc VAT) £399.99 with stands

Availability:

Canon Audio Tel. 0483 740005 ■

Review...

Technics Surround Sound

Ian Burley connects up a Technics SA-GX505 and likes the video inputs, Dolby surround sound but thinks it is a little heavy on the gimmicks.

Is your stereo image keeping up with the Joneses or is it just a bit two dimensional? Surround sound was born in the cinema and now, along with the video age, it's a big growth market for customers in America who hanker after their own private movie theatre at home. Surround sound decoders have been available in the UK for a little while now and most of the big HiFi brand names offer the hardware.

This month we look at the Technics SA-GX505 receiver. A bit of a monster this unit provides a digital tuner, a 100 watts per channel amplifier sections, a fancy 'parametric' tone equalising system and bar-chart display, video input for video edits, a versatile infra-red remote control unit capable of controlling tape and CD decks, a motorised volume control knob and an optional remote control link with audio and video tape decks for synchronised operation. The knobs and buttons on this beast will either terrify you or keep you happy for months.

In many ways the SA-GX505 is typical of the latest generation of high-tech tuner-amplifiers, mainly from Japanese stables, but it's the Dolby Pro Logic decoder which makes this receiver stand out. Pro Logic is used in most cinema film sound tracks these days and has been for some time. It is also compatible with earlier Dolby Surround systems. The latter requires a minimum of four speakers, two behind and two in front of the viewer in order to construct the three dimensional sound stage. Pro Logic adds a central speaker at the front which is usually designed for focusing key sounds like dialogue. In addition there is a 'phantom' or wide mode



for ordinary stereo sound tracks plus Dolby 3 which is designed to reduce a stereo 'hot-spot' in the sound stage.

How does it perform? Unfortunately the review machine arrived late and we only had a limited time to play with it. We had mixed results. Some Dolby Surround movies we played through the SA-GX505 were disappointing compared with others. Hunt for Red October was an example of the former while Steven Spielberg's Always, which has lots of noisy planes zooming around the sound stage, was amazing. Both sound spectacular in a good cinema. Playing back ordinary stereo tracks from music CDs produced some interesting effects with phantom mode on. Some pop music videos were certainly enhanced by the surround sound trickery.

The conclusion one comes to is that a surround system needs careful choice of speakers and lots of trial and error experimentation when setting up. You really can't

just bung the speakers anywhere you like, hence the US trend for family home to incorporate a special room for home theatre.

Personally, I'm sold on it. My ten year old HiFi system is well overdue for replacement and I could do with the video input facilities. Surround coded tracks are beginning to appear on CDs as well as videos and laser discs. It's something we will be taking for granted in future years. I'm not sure I'd necessarily go for the Technics. It's big, the controls are very confusing and the remote control didn't always do what you expected it to. I can report, however, that the tuner section was very strong - grabbing stations in stereo which my old system easily gave up on and overall the sound was very clean. I'll need to look at the competition before finally making up my mind.

Technics SA-GX505 Stereo Receiver with Dolby Pro Logic Surround Sound Decoder.
Price: £349.95

Review...

Stereo Sound Sender

Julianne Christian plugs her personal stereo into a gadget that turns it into a private radio station giving perfect stereo at home and on the move.

The idea of a stereo sender is actually quite simple and although, at first sight it might appear to have limited uses, in practice it is a very handy gadget indeed.

The basic concept of the device is to take a standard high quality stereo sound signal, say from a CD, cassette or Nicam Stereo decoder, and convert it into a standard format FM stereo radio signal. This can then be picked up by any FM radio and replayed. The transmission power is very small and the signal can only be picked up within a small area – much like having an FM radio station just for your house.

Virtually any HiFi output can be connected to the device via its two phono sockets. The input circuitry is flexible enough to take signals from a variety of impedances and voltages, even the headphone output of a personal stereo. It is completely portable and powered by a single PP3 battery so it can be used in a wide range of situations.

On The Move

The most obvious use for the stereo sender is to connect up a personal stereo, say a Sony Walkman, to a standard HiFi via the tuner. Another use it to be able to connect portable sound systems to a car stereo. This has the great advantage that portable CDs and cassette players can be used in a car with no loss of portability removing the need for expensive removable In Car Entertainment (ICE) systems and leaving only a cheap stereo receiver for any prospective thieves.

Possibly the most flexible use of



the sender is to connect it to an unused output of a standard stereo system. This allows any music playing on it to be heard on any radio throughout the house – no messy wiring needed. One CD, tape or turntable serves every radio receiver in the building.

Other uses include remote TV, and general HiFi listening via radio headphones and connecting computer game sound cards to the HiFi. Since the system basically serves as a very sophisticated connection cable, it will find a multitude of uses – just like any other piece of connecting cable.

Not So Legal

The most obvious problem with the sender is that it is not strictly legal to operate an unlicensed radio transmitter on the necessary frequencies. The device puts out a signal that can be picked up at the

top end of the FM dial where there are few stations and consequently very little to interfere with. If, by any chance, a neighbour is using the same frequency then a small adjustable screw on the device allows the channel to be changed to remove any interference. Apart from this, the quality is as good as that from any FM station with perfect stereo and a good dynamic range. It is easy to install and use and its portability and the international FM stereo format allow it to be used anywhere in the world – licences permitting of course.

Specifications

Product:

Lazerline Stereo Sound Sender

Price: £64.95

Availability

Lazerline, Unit 2, Castle Commerce, Leighton Buzzard, Beds, LU7 7RG, Tel. 0525 377916

A Look At The Latest Gadgets And Gizmos

lan's bag of goodies this month includes a weather station on a watch, portable rap machines and a selection of camcorders.

This month in addition to the usual news from the consumer electronics arena, I continue my look at what was new from this year's Winter Consumer Electronics Show (CES) earlier this year in Las Vegas.

Wide Screen TV In Gear

CES shows have often been used by companies to showcase high definition TV (HDTV) prototypes in recent years, but all the HDTV hype appears to be obscuring what will probably be the next stage in domestic audio/visual development – namely wide-screen TV. Last month we brought news that RCA/Thomson showed a 16:9 aspect ratio wide-screen TV at CES. Also in the pipeline from RCA is a VHS (full-size cassette) camcorder which can be switched between 16:9 wide and ordinary 4:3 recording modes. Video 8 and Compact VHS versions are also under development. Laserdisc, which commands generous popularity in the US compared to the UK, already counts nearly 500 wide-screen or 'letterbox' titles and to accommodate this growing library we can expect switchable letterbox mode laserdisc players in the second half of this year. Video publishers are even bringing out special edition letterbox versions of earlier movie releases. For example the whole Star Trek the Movie series up to Star Trek V is now available in a wide-screen box-set. With wide-screen epics like Dances with Wolves, for example, which don't translate to conventional video format acceptably, public demand for wide-screen TV, which is relatively inexpensive compared

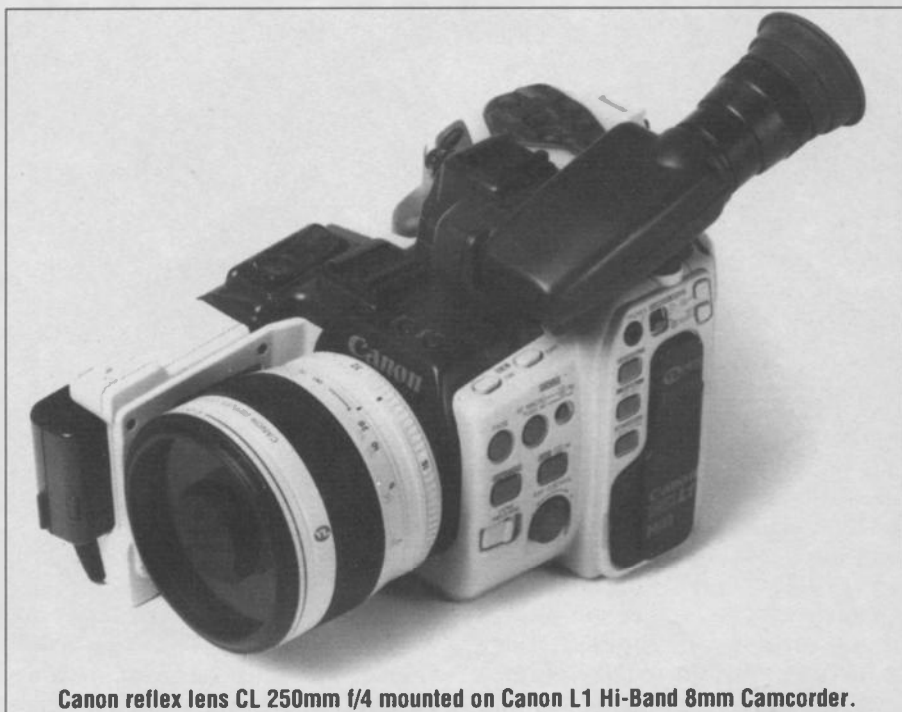

Canon reflex lens CL 250mm f/4 mounted on Canon L1 Hi-Band 8mm Camcorder.

with HDTV, could kick-start the market before HDTV broadcasts start in earnest, probably 2-3 years from now. There will also be no wasted investment as standard resolution widescreen TV sets will probably be designed to accept HDTV upgrade modules.

Canon at CES

With the US firm Honeywell successfully forcing Minolta into submission over a patent dispute regarding autofocus technology used by most of the Japanese still and video camera manufacturers, brave faces were the order of the day at CES.

Canon's video division had a number of interesting models on show at CES. Attracting the most attention was an ultra-telephoto

mirror lens for the top of the range L1 Hi8 camcorder (called the A1 here in the UK). This camera uses a special interchangeable lens mount system – you can even attach Canon still-camera lenses. The extremely compact 250mm lens is equivalent to a 3000mm telephoto in terms of your traditional 35mm SLR camera. And this is a video camera system aimed at the keen amateur!

A bit more down to earth is the new hi-band version of the Canon UC20 palmcorder, the UCS1. This effectively steals the limelight from Sony's TR705 Hi8 camcorder, which was the first Hi8 palmcorder. Canon claims the UCS1 takes over as the smallest and lightest hi-band camcorder on the market. The distinctive Canon UC range of camcorders incorporates a design

“Missing a copy of Practical Electronics?...”

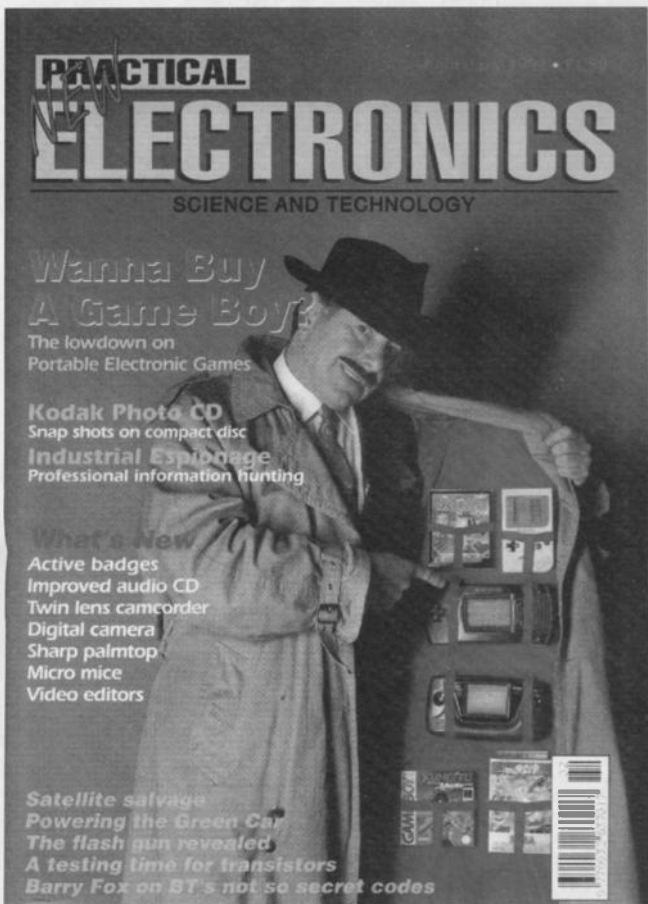

Back copies of Practical Electronics going back over a year are still available, so if you're missing issues from your collection you can still make up the difference!

Ordering is simple. Fill in the order form below or phone 081 743 8888 to order using your Access or Visa credit card. We regret that phone orders can only be accepted for amounts of £5 or more.

All back copies cost only £2 each including packing and postage to UK addresses. Overseas orders – please write or phone for details of air mail and surface mail costs.

If we haven't got the issue you want, we can photocopy individual articles for only £2!

“I may have what you're looking for!”

Back issues order form

Please tick the issues you require and send to PE Back Issues, Intra Press, Intra House, 193 Uxbridge Road, London W12 9RA.

- | | |
|---|--|
| <input type="checkbox"/> May 1991 | <input type="checkbox"/> June 1991 |
| <input type="checkbox"/> July 1991 | <input type="checkbox"/> August 1991 |
| <input type="checkbox"/> September 1991 | <input type="checkbox"/> October 1991 |
| <input type="checkbox"/> November 1991 | <input type="checkbox"/> December 1991 |
| <input type="checkbox"/> January 1992 | <input type="checkbox"/> February 1992 |
| <input type="checkbox"/> March 1992 | <input type="checkbox"/> April 1992 |

Please send my issues to:

Name

Address

.....

Town

Postcode.....

I enclose a cheque/postal order for £..... (£2 per back issue inc. postage and packing)

Cut coupon along dotted line or photocopy if you prefer to save your magazine intact.

Casio's RAP-10 portable rap machine.



Casio's RAP-2 with built in cassette recorder and headset microphone

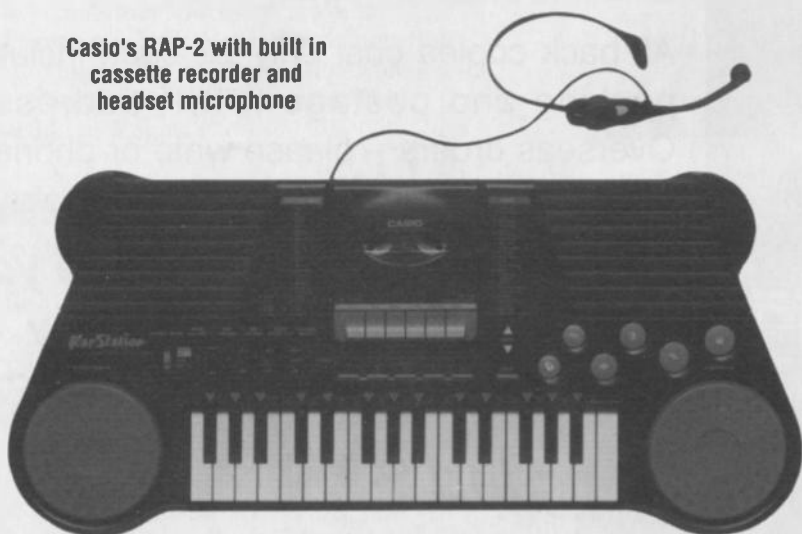

the year.

From the company which brought us the watch which could monitor your pulse and blood pressure (PE - last year), Casio launched its 'personal weather station' watch at CES. The ALT-6100-IV, which is priced \$150 (£86) is a chunky LCD wrist watch with built in altimeter, barometer and thermometer. The altimeter can measure up to 19,680 feet while a tiny bar graph can show either the change in altitude or barometric pressure over the last few hours. The thermometer ranges between -4 and 122 degrees Fahrenheit. A Celsius scale is optional. Rumour has it the watch also tells the time.

Another innovative Casio time-piece is the IA-1000L-9A. It's a databank watch, useful for storing things like Casio model numbers. However, you wouldn't think it was anything other than a conventional analogue watch at first glance. To get at the databank bits you need to flip the analogue time-face disguise to reveal a keypad and an LCD display. Included are basic calculator functions, a password protected 'tele-memo' database and diary/scheduling functions. I fully expect Casio to be the first company to produce a Thunderbirds-style TV/communicator wrist watch...

Sharp At CES

Those wall-mounted LCD TVs from Sharp were at CES once again not as prototype technology demonstrations, but this time as pukka products which domestic

whereby the obligatory infra-red remote control clips onto the camera's case and folds neatly out of the way. Internally, Canon claims it has taken camcorder chip integration to new limits with as many as 13 chips used previously now incorporated in just four chips for the UC series. The new UCS1 makes my nine month old Canon A10 palmcorder look distinctly obsolete!

Do The Casio Rap

Casio showed an electronic Rap machine at CES. If you've read this far and haven't the foggiest, rap is one of the current pop music crazes where performers sort of talk rather than sing in time to a rhythmic musical beat. The Casio Rap provides the rhythm and beat and combines the performer's amplified voice to boot via a built in

microphone. Two versions are offered: the portable \$70 (£40) RAP-10, which is small enough to wear on a belt and the RAP-2 (\$220 or £125). The latter has a built in cassette recorder and head-set mike. A three-note polyphonic synth is built in. Both models offer electronic record 'scratching' and selectable rap drum patterns. It would seem ghetto-blasting has finally reached the 90s.

Other Casio bits include the KL-2000, a pocket sized electronic label printer complete with LCD display and QWERTY keyboard. Besides typing in the wording for your label and using the built-in selectable fonts, there is a PC link option enabling you design custom graphics on your IBM compatible or Apple Mac and then squirt them across to the KL-2000. Costing \$300 (£170), the KL-2000 could well be in gadgets catalogues by the end of



The Casio "Flip top" DataBank watch.

**NEW
FROM LAZERLINE**

1st in the U.K

STEREO STEREO

audio Sender

AS REVIEWED
IN THIS
MONTH'S
ISSUE

- * NO TRAILING WIRES
- * USE ANYWHERE
(Battery powered)
- * VERY COMPACT, ONLY
2.5" x 1.5" x 4.75"
- * FM BROADCAST FOR CRYSTAL
CLEAR SOUND
- * TUNEABLE FOR BEST RECEPTION
- * AUTOMATIC GAIN CONTROL
- * INCORPORATES "STATE OF THE ART"
SURFACE MOUNT TECHNOLOGY

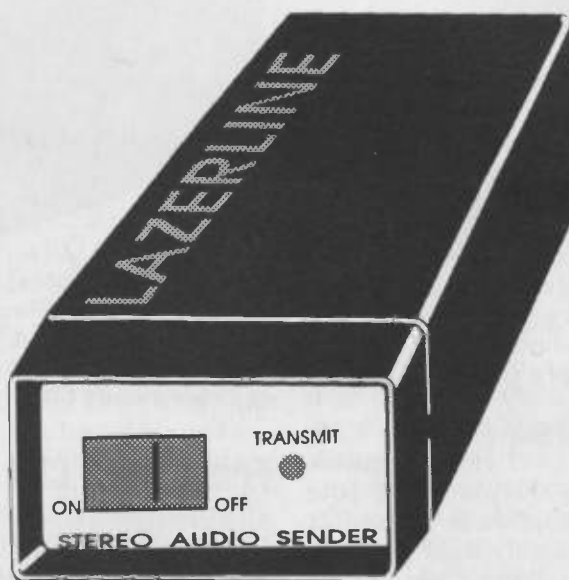

Not approved for use in the UK

ONLY
£64.95 inclusive

TRADE & EXPORT ENQUIRIES WELCOME

Would you like to listen to your CD walkman in your car? But you cannot use the headphone, and it is difficult to connect to the in-car loudspeaker. Or, may be you would like to listen to your hifi in the bedroom, or in the kitchen, or even in the garage..... What do you do?

Lazerline Audio Sender is a powerful mini broadcast station relaying any audio signal (mono or stereo) from your Compact Disc Player - Television - VCR - or other sound source to any FM receiver up to 60 yards away.

In conjunction with a personal radio with headphone the Audio Sender can be a "Cordless FM Amplifier". As well as normal private listening, this is particularly useful when one of the family is hard of hearing; he or she can listen to the television at higher volume level without disturbing other listeners.

Connected to a microphone the Audio Sender becomes a versatile monitoring device for, baby - elderly person - convalescent, or..... just for fun.



Direct Hotline Number
0525 377916

HOW TO ORDER

TO: Lazerline, Unit2, Castle Commerce, Leighton Buzzard, Beds, LU7 7RG

Please supply.....Audio Senders at £64.95 each inclusive.
I enclose cheque for.....payable to Lazerline.

I wish to pay by Visa - MasterCard, please debit my account. My card number is:

VISA MasterCard

Signature Expiry date

Name (on card)

Address

Postcode



The Casio weather station watch.

Japanese customers can now buy. Eight styles of 'frame' can be selected to match your 8.6" active matrix LCD screen. The range will be marked as the Liquid Crystal Museum series. Unfortunately pricing wasn't available at press-time. The controversially styled wall TVs have generated much heated discussion in PE's usually tranquil letters pages in recent months.

Also on the Sharp stand at CES: a new colour LCD video projector offering 650,000 pixel 400 line horizontal resolution in a compact and relatively lightweight package, a re-launch of Sharp's diminutive camcorder which takes full-size VHS tape, the SlimCam, and a

Digital Diary with computer link



Business organiser



A handful of casios

Label printer



Graphic display calculator



newly developed 5.6" colour LCD panel which uses comb filtering to enhance picture quality.

Franklin At CES

Finally from CES, Franklin, which produced the first ever pocket-sized electronic bible, unveiled an enhanced version of its Language Master electronic pocket dictionary

and thesaurus, the 6000-SE. This one speaks, not only to people with normal hearing but to the deaf as well. The device contains a 110,000 word spelling dictionary, 300,000 definitions and 500,000 thesaurus synonyms. If you can't take advantage of the headphone socket, you can see the pronunciation of words on the 6000-SE's LCD screen instead. The audible output can be speeded up or slowed down to suit your needs. The 6000-SE is priced \$495 (£283). Currently it has an American accent, but if there is demand over here the 6000-SE could end up speaking the Queen's English.

Canon 8mm UCS1 Camcorder.

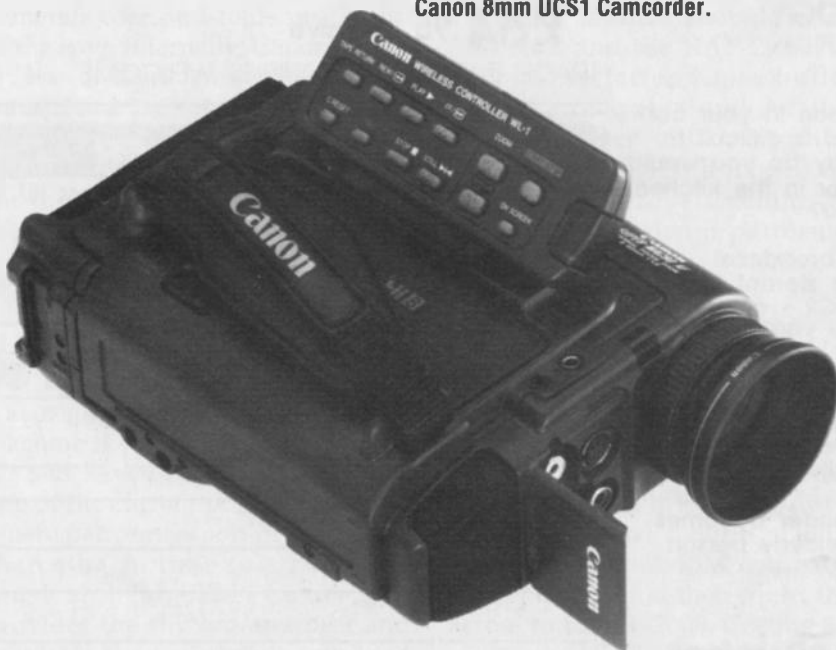

Computers Out Of Step

A new development in microprocessor architecture could save processor chip technology from an evolutionary dead end and as well as breed a new generation of ultra-low power-consumption processors. What's more, the increasingly rare phenomenon of a British-lead microchip engineering development could develop the first commercially viable example of such chips.

Modern microprocessor architectures are clock driven. Each clock tick steps the processor

Sharp high resolution projector.

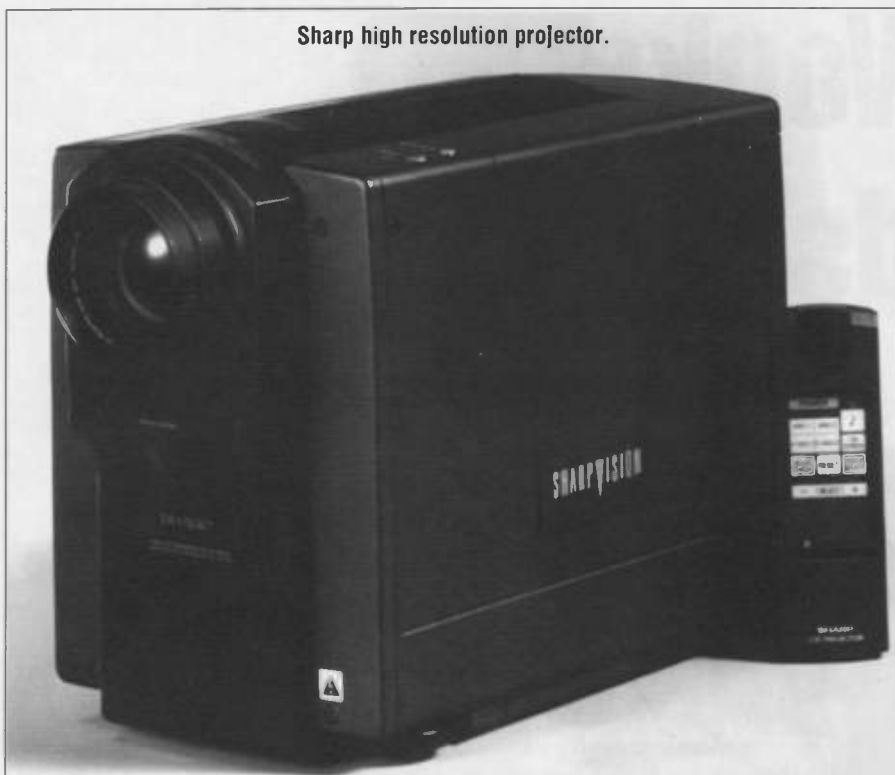

through its instruction processing cycle and RISC (reduced instructions set computer) processors can complete one or even 'cycles' in a single clock tick, sometimes up to 200 million times a second. The theory goes that there is a physical limit to the potential development of single-chip clock-driven architectures as chips get bigger and faster. All the transistors, perhaps several million, on the chip have to be switched in unison – this is a synchronous mode of operation. One day a chip will be made where that just isn't physically reliable any more.

UK researchers are therefore looking into asynchronous processor architectures. Put crudely, this means that parts of the chip will only communicate with other parts as and when necessary and there is no overall external clock driving it all along. In other words the processor cycle drives itself along and only the parts of the silicon relevant to the task dictated by the program it is running will be 'active'. This will save power – a goal of one-tenth power consumption has been set. This could enable a battery powered super-computer to be a reality. The technology shouldn't compromise performance as parts of the chip can be optimised. The first example of a general purpose asynchronous microprocessor could be an adapted

version of the ARM RISC processor originally designed by Acorn Computers in Cambridge and it's predicted it will run marginally faster than an equivalent synchronous chip. Chief computer engineer at Manchester University, Professor Steve Furber, leads the Eureka-funded project and he co-designed the original synchronous ARM architecture.

One by-product of asynchronous technology is that chip performance will be directly related to silicon quality rather than a set external clock speed. It's quite conceivable that asynchronous chips from different silicon production batches could differ in performance by several tens of percent, though in

many applications this won't be noticeable by the average user. An asynchronous ARM chip would be able to run existing synchronous ARM coded programs but a question mark hangs over time-critical routines.

As the demand for very low power-consumption chips accelerates in line with the development of compact portable battery-powered devices, asynchronous chips could be a key resource in the not too distant future. Meanwhile, it so happens that the very first valve-powered digital computers were also asynchronous. History does have this habit of repeating itself!

Thought For The Month

To end this month's scribbles I'll leave you with this snippet of news to ponder on. IBM has developed an experimental switching chip which can handle data transmission at the rate of 5 billion bits per second over 16 channels simultaneously. That's 80 billion bytes per second, or ten gigabytes per second (10x1024x1024x1024 bytes or 10,2400 megabytes). IBM suggests that this system could empty the contents of 16 60Mb PC hard discs in less than a tenth of a second – the only problem being that the drives can't work that fast! or think of it another way, the chip could transfer 18,000 average-sized novels in a second. It's technology like this which should make pipedreams like global high definition videophone systems connected into vast multimedia databases a reality, one day. ■

Franklin's Language Master



How It Works...

The Loudspeaker

There is more than one way of making a noise. Alan Jones explains how it is done by the average HiFi system.

In many ways, a loudspeaker is like an electric motor. It uses the interaction between a coil of wire carrying a current and a magnet. Following Fleming's left hand rule where the thumb, first and second fingers are extended at right angles to each other. The thumb points in the direction of wire motion for the first finger representing the lines of magnetic force and the second finger the direction of current flow – this is the opposite of the electron flow. A current flowing through the coil of the loudspeaker creates a magnetic field which interacts with the field of the magnet. This forces the coil to move in and out of the magnetic field depending on the amount and direction of current flow.

The output from an amplifier is connected to the coil of the loudspeaker to generate the required current. This coil is wound around a card or plastic cylinder and glued in place. Any movement of the coil results in a movement of the cylinder which is attached to a cone. In early days, this was simply card supported at its edges by corrugations that allowed it to move in and out without hinderance. Modern speakers use all sorts of different materials such as special polymer plastics to give a better frequency response.

Although the moving coil loudspeaker is probably the most common type, there are other ways of converting electrical signals into sounds. One method used extensively for high frequency work is the piezo sounder.

When an electric voltage is applied across certain types of crystal or ceramic it causes a change in size. By placing the piezo

material onto a metal plate and applying a voltage across it, the plate flexes. Changing the voltage at high speed causes the plate to flex at the same rate which creates a sound. When used in a tweeter or high frequency speaker, the frequency response usually ranges from 4kHz to 20kHz. This combines with the mid-range response of a magnetic coil loudspeaker to increase the overall frequency range of a loudspeaker system.

Another way of producing sound from an electrical signal is with a ribbon or film. This is a large flat area of material placed between two plates which can be charged electrostatically. Changing the charge moves the film and produces sound. The disadvantage of this type of system is that it requires special high voltage drivers and transformers. However, it avoids many of the resonances inherent in traditional cone speaker

designs and provides a higher quality signal.

One way to get around problems that crop up with limitations in particular speaker designs is to use combinations of different methods. A large cone speaker (woofer) could be used to get the low frequencies but, due to its mass, not be very good at producing mid and high frequency sounds. A smaller cone may be used in the mid range area and a piezo system (tweeter) for the high frequencies. To stop all signals being sent to all three speakers, a crossover circuit is used. This consists of a low pass filter for the woofer, a band-pass for the mid range and a high pass for the tweeter. The correct settings of the cut-off frequencies of the crossover can result in a good overall linear response from 70Hz to 20kHz. ■

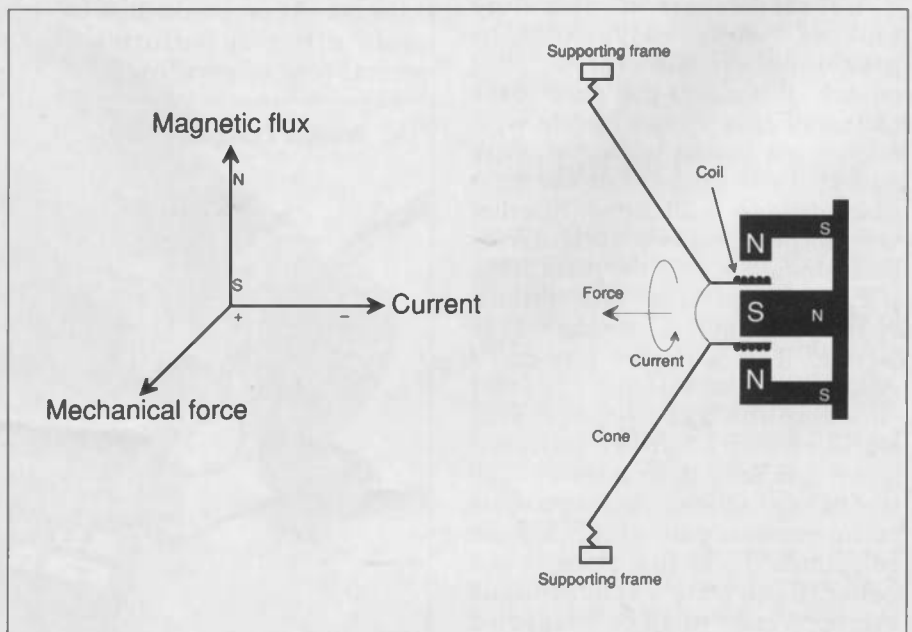

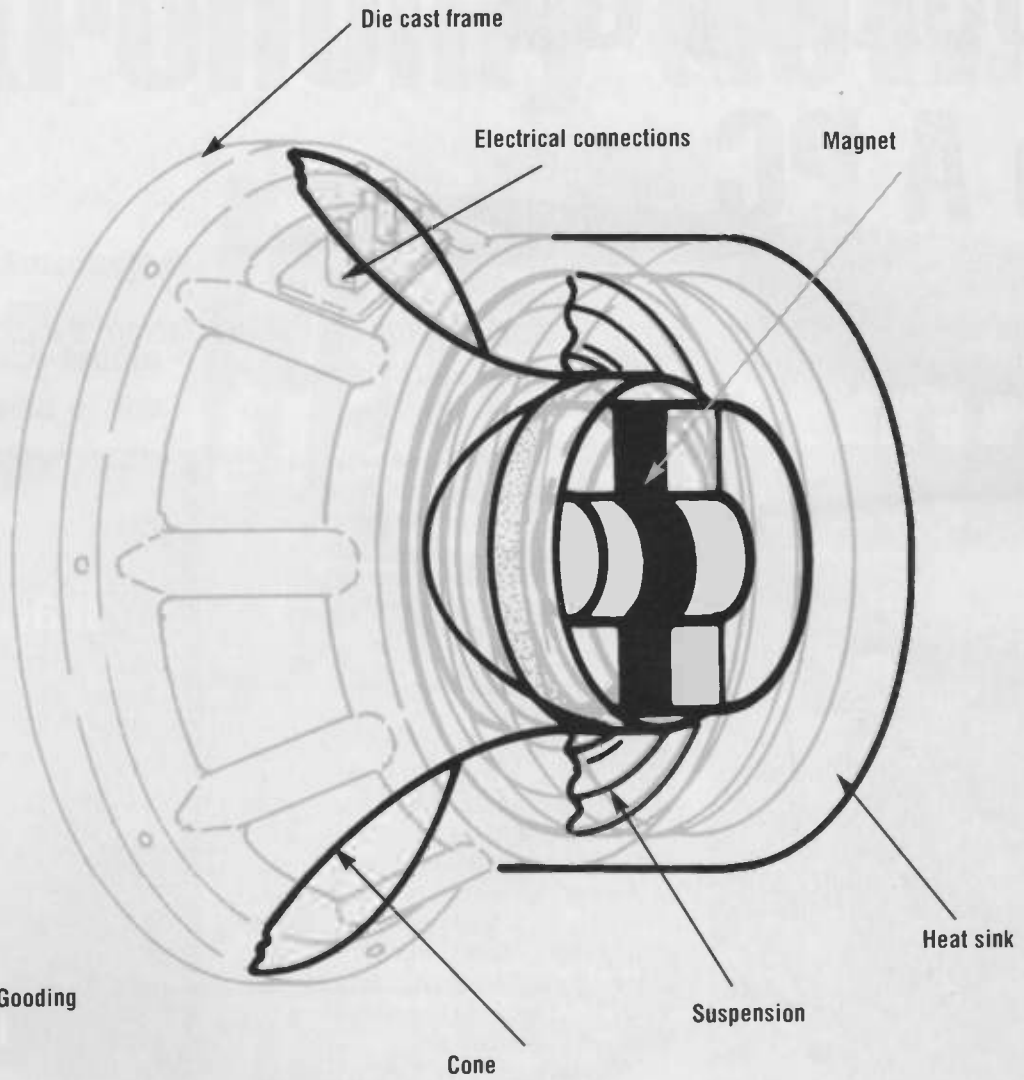
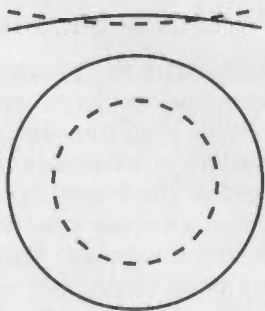
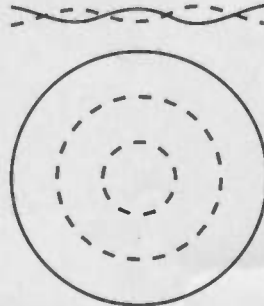

Illustration: Derek Gooding



Resonance



First overtone

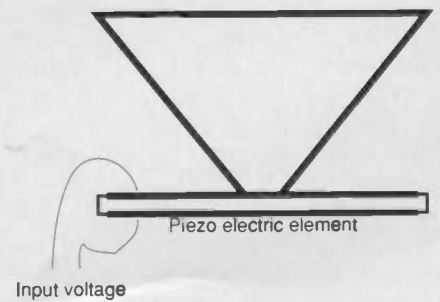

The piezo electric crystal sounder makes use of the fact that certain crystals deform when an electric voltage is applied to them.

Hooking Up To A PC

Three book reviews starting off with a short volume on PC interfacing, a look at a new electronics reference book and the complete work on sensors.

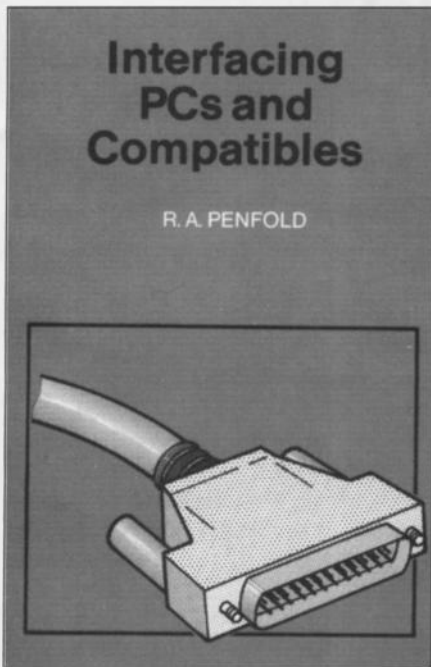

This book takes the reader from knowing very little about PC interfacing up to the point of putting theory into practice is possible. It starts off with a quick look at the various PC interfacing systems around and makes the comment "this is not something we will pursue further here" about most of them. What this comes down to is that the book covers the ISA (Industry Standard Architecture) slot and not much else.

Unusually for a Babani book from R A Penfold, there are no actual projects. All of the information is purely factual, nothing is really put into practice. Having said this, there is information about getting at the I/O card from GWBASIC and slot numbers, memory positions and so on. For the relatively experienced constructor this book could prove

quite useful. Anyone who hasn't built something of this type before would probably be better off with a PE project.

Book: Interfacing PCs and Compatibles
By R A Penfold
Published by Bernard Babani
Price £3.95
ISBN 0-85934-217-4

From absolute temperature to Zener diode, the reference guide to electronics terms is an alphabetical list of all you ever wanted to know about electronics. It covers most of its topics in some detail with quite a selection of diagrams and maths where necessary. The explanations are both lucid and logical and there is a mass of information.

Because of the way it is written, the guide can be used either as a straight reference book or as something to browse through – some of the topics are fascinatingly put, I found myself quite engrossed

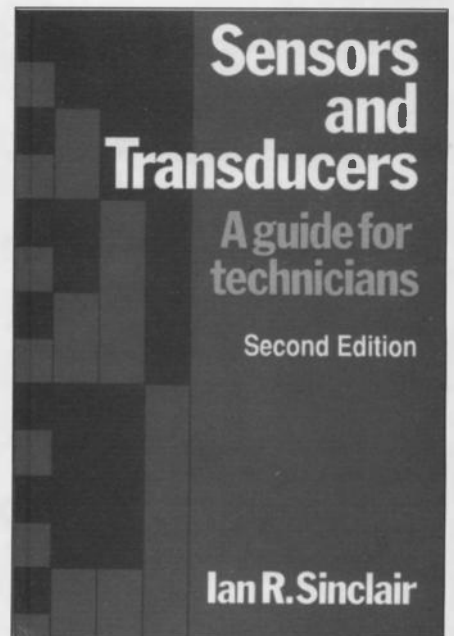
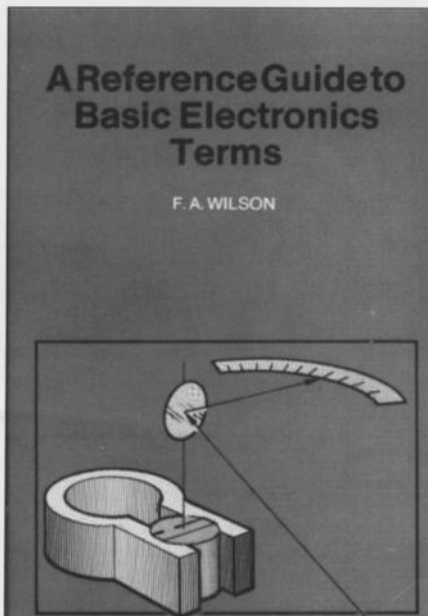

by the explanation of deBroglie waves.

Overall, this is a book well worth looking at if you need a reference guide to electronics.

Book: Reference Guide To Basic Electronic Terms
By F A Wilson
Published by Bernard Babani
Price £5.95
ISBN 0-85934-231-X

Covering a wide range of devices and environments, this book explains how to convert a variety of information to electrical signals. The theory is kept to a minimum and the practical explanation to a maximum. This is a fascinating book for people who like to know how things work.

Book: Sensors and Transducers
By Ian R Sinclair
Published by Newnes
Price £19.95
ISBN 0-7506-0415-8

Astronomy Now...

This month, **Astronomy Now** looks at the cosmic distance ladder and how the size of the universe is calculated. From the Moon to the furthest quasar – let **Astronomy Now** be your guide.

Next month, **AN** focusses on Professional amateurs – how amateur astronomers use a vast array of instrumentation to pursue their hobby. CCD cameras, videos recorders, photometers, computer controlled telescopes and more! Out on April 9th.

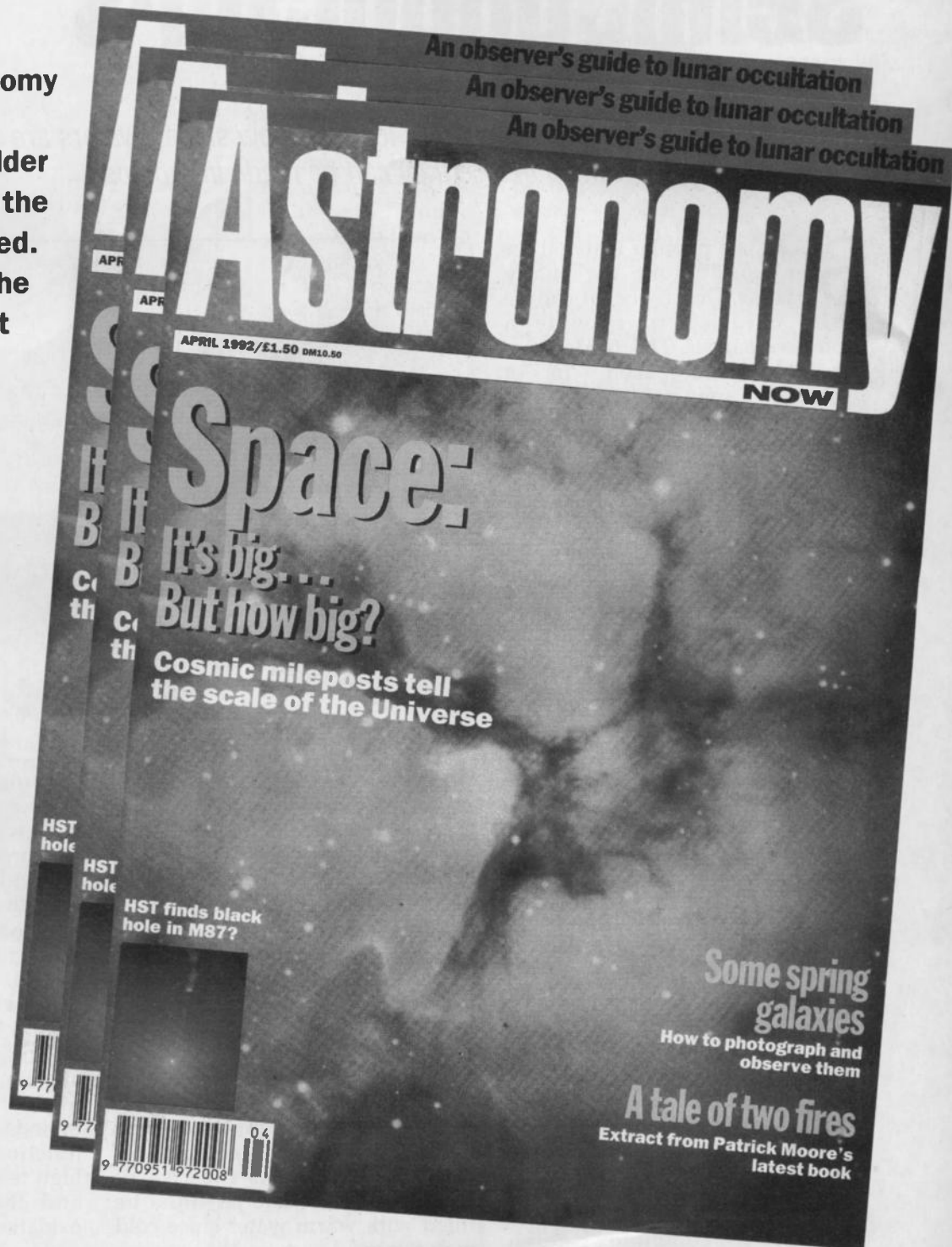

Bringing the night sky to life.

On The Making Of Semiconductors

The second of Mike Sanders' articles looks at how silicon wafers are oxidised, etched and implanted with impurities before they can be made into chips.

Silicon is a popular material for semiconductors for many reasons. One is that it can be easily oxidised to provide a protective barrier. This oxide layer can also be used in a photolithography process to make patterns and shapes to form electronic components.

The oxidation source is either oxygen or water vapour at temperatures between 900C and 1300C. The reactions are:

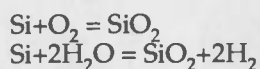

The furnace is usually a stack of three or four heating systems each with its own control where the temperature is kept within $\pm 0.5\text{C}$ of the required temperature.

Before oxidation the surfaces are cleaned thoroughly and not touched by human hand. Contamination by sodium can cause surface leakage and failure of the device – human hands are a source of sodium.

The wafers are dried and loaded onto the quartz holder called a boat before the oxidising process takes place. Sometimes, in order to decrease cost, a nitrogen-oxygen mixture is used as it is more readily available than pure oxygen.

There are two processes which use water vapour. One uses a hydrogen and oxygen mixture to create water. This is a pyrogenic (hot) process, commonly a torch system of burnt hydrogen. Its drawbacks are that it requires extreme precautions against explosion and the combustion of the oxygen-hydrogen mixture at the entrance to the reactor causes a non-uniform temperature over the

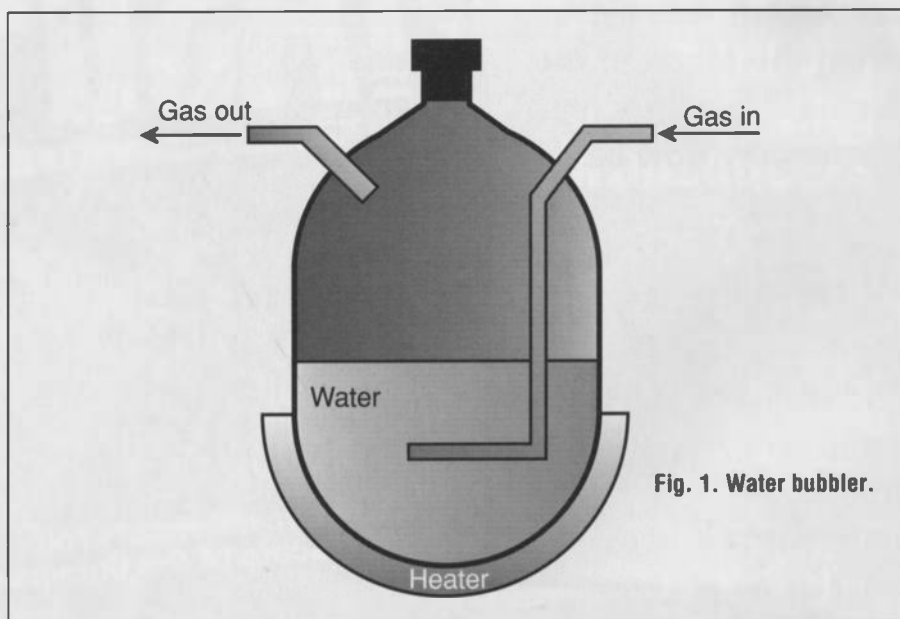

Fig. 1. Water bubbler.

chamber.

Another method uses a chamber called a bubbler (Fig. 1). Water in this is maintained at a constant temperature below its boiling point of 100C – since a constant pressure is required and the pressure varies greatly over the temperature range – Fig. 2.

Oxygen or nitrogen is used as a carrier gas and bubbled through the water to pick up water vapour. The exit is close to the oxidation furnace so that the vapour doesn't cool. One of the disadvantages of the bubbler is that when refilling the container with water there is the risk of contamination. The jar must be filled with warm water since cold water would reduce the vapour pressure.

The amount of contamination can be decreased if hydrochloric acid is also fed into the vapour. The chlorine combines with the impurities and prevents them from

moving. For the same time and temperature, the oxide layer grown with water vapour is thicker than that produced by the burnt oxygen method. Fig. 3 shows the rate of growth of the oxide layer for both methods over 10 minutes at different temperatures. The table is for (III) silicon, the thicknesses for (100) silicon being in general slightly less.

To grow thick layers of oxide at atmospheric pressures requires high temperatures and long periods. Devices requiring shallow junctions cannot be subjected to high temperatures for long periods and therefore a high-pressure oxidation process is used instead.

If a thin layer of oxide up to 500Å thick is required, electrolytic oxidation is employed as shown in Fig. 4. The wafer is connected to the anode and a voltage is applied between it and the cathode. The thickness of the oxide will depend

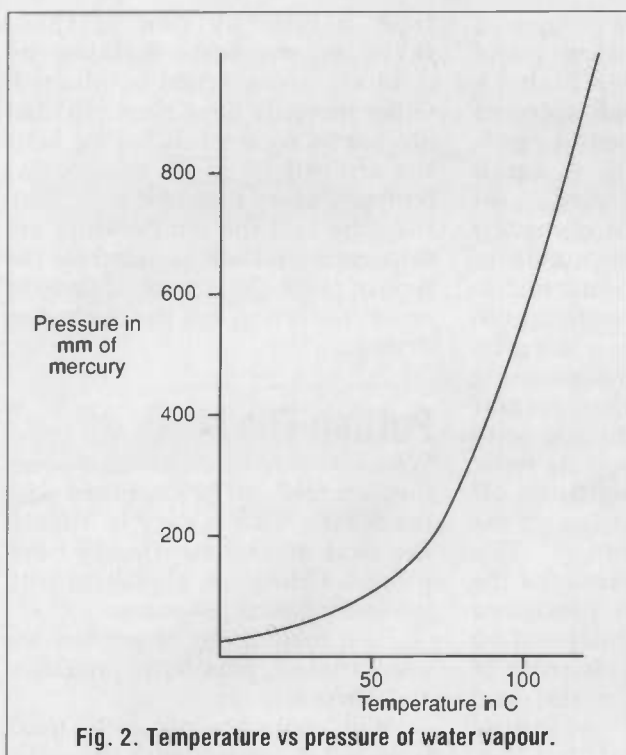

Fig. 2. Temperature vs pressure of water vapour.

on the voltage applied and although, electrically, the oxide layer is not very sound, the process does not interfere with the doping profiles of the layers underneath.

Creating A Mask

A simple definition of photolithography is printing with light. Several templates or masks are used in the process with oxidation or introduction of impurities after each masking step. This allows the necessary circuits to be built up.

The image of the mask is transferred to the wafer by the use of photoresist, a light sensitive material held in suspension in a

solvent. This is sensitive to the blue light from a mercury arc lamp but immune to the red and yellow lights used in dark rooms.

Photoresist comes in two types, positive and negative. In the first, the light increases the solubility of the resist in the solution whereas in the negative resist, the light causes polymerisation or hardening.

Both types can be used as etch resistant masks but whereas the negative photoresist could be used more often in the early days of photolithography,

positive photoresist is gaining importance as line widths and spacings become smaller than $5\mu\text{m}$.

A resist is a complex organic material made up from carbon, hydrogen, oxygen and nitrogen molecules. Its performance is assessed on the grounds of:

- The resolution or size of the lines to be produced
- Sensitivity to various light sources
- Adhesion to the wafer surface
- Resistance to etching

Before looking at the detailed process it may be as well to look at the basic principles of photolithography. There are two main steps, transfer of the image

from the mask to the photoresist and then from the photoresist to the silicon dioxide.

Fig 5a shows a substrate of silicon covered with a layer of silicon dioxide and then photoresist. The mask is lowered and light is shone over it to transfer the image to the photoresist - Fig 5b. The second property of the photoresist, the resistance to etching can now be used and the silicon etched wherever it is not protected by photoresist - Fig 5c. When the etching is complete, the remaining photoresist is removed from the surface - Fig 5d.

This viscosity of photoresist depends on the amount of solvent and is measured in centipoise. Most photoresist material is as sluggish as syrup and in the 14-60 centipoise range.

Before any masks are manufactured, the circuit is built and tested. It may also be simulated on a computer to check for variations in temperature, humidity, voltage variation and so on. When the engineer is happy with the performance, the drawing office sets about converting the circuit into a three dimensional drawing and turning this into a series of masks (photolithographic plates) to represent the layers of the circuit.

Each layer of the circuit is photographed and transferred to a glass plate called a master. From this a submaster is produced. This is then used to provide a number of working plates. A photosensitive glass plate which has an image transferred to it has clear and dark patches - Fig. 6.

A glass plate covered with photosensitive emulsion is liable to be scratched and other materials are sometimes used such as iron oxide or chromium oxide. The iron has the advantage that yellow light may be used to align the mask without affecting the exposure.

Revealing The Details

After the substrate of silicon has been prepared by oxidation, diffusion or metalisation, its top surface is cleaned and blown with nitrogen to dry it. The resist is then put on and dried.

Photoresist may be applied by brushing or spraying but the best method is by spinning. The wafer is

	Oxide thickness in μm				
	800C	900C	1000C	1100C	1200C
In dry oxygen	0.008	0.01	0.02	0.05	0.08
In pyrogenic steam	0.01	0.04	0.15	0.2	0.35

Fig. 3. Growth rate of oxide layer over 10 minutes for (III) silicon.

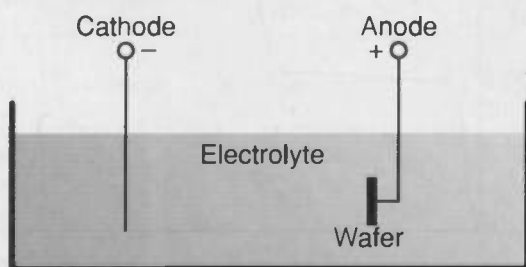

Fig. 4. Electrolytic oxidation.

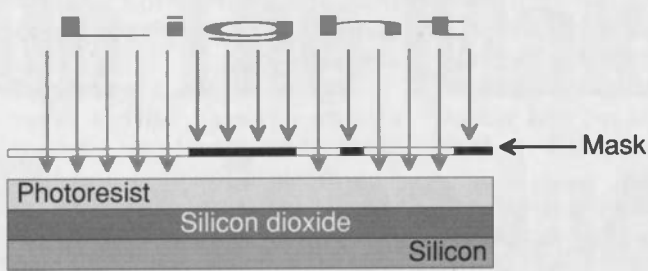

Fig. 5a. Exposure of photoresist to mask.

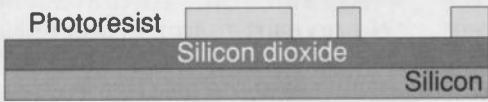

Fig. 5b. Development of photoresist.



Fig. 5c. Silicon dioxide etched.



Fig. 5d. Photoresist removed.

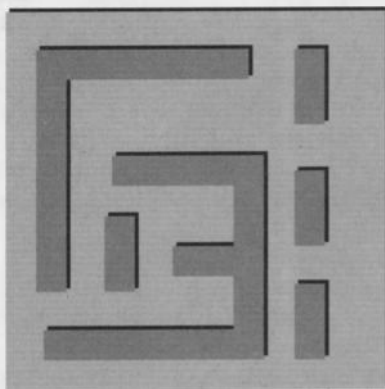

Fig. 6. Photosensitive glass plate.

held by a vacuum wand in a chuck which spins as shown in Fig. 7. A small quantity of resist is applied to the middle of the wafer and as the wafer spins, the resist spreads coating the wafer uniformly with the excess resist being flung off the edge of the wafer. The thickness of the film produced will depend on the viscosity of the resist and the spinning speed.

The spin lasts for about 30 seconds and goes up to about 5000 revs per second – it is quite an art form to get this absolutely right. Fig. 8 shows the five identifiable parts to the process. First, the resist is applied and the wafer spun up to 2000 revs/sec. It is held at this speed for about eight seconds and then accelerated to 5000 rev/sec where the speed is maintained for about 18 seconds. It is then decelerated rapidly, the wafer removed and the next one started.

The resist is dried moderately

(soft baked) by one of three favoured methods, heating by conduction, convection or infra-red. Other methods have been tried but are not as successful. Baking lasts for around 10 to 20 minutes at temperatures of around 80C. Both the time and the temperature are important and will depend on the type of resist, the type of surface the resist is covering and the method of drying.

Putting The Mask On

When the wafers have cooled down they are ready to be imprinted with the masks. This is easy to align if the first mask has already been printed. Otherwise, alignment with the wafer flats is necessary.

Four main types of printers are used: contact, proximity, projection and direct step on.

With contact printing, the mask is placed in contact with the wafer as shown in Fig. 9. This means that the mask wears out and the print quality deteriorates. It is a cheap method and is used where the print detail is not fine and slight deterioration can be tolerated.

Proximity printing (Fig. 10) does not allow contact between the mask and the wafer and so the mask lasts a bit longer. Apart from that, it has the same drawbacks as the contact printer and is used to produce only low density chips or discrete components.

The idea of the proximity printer can be extended to provide a projection printer (Fig. 11).

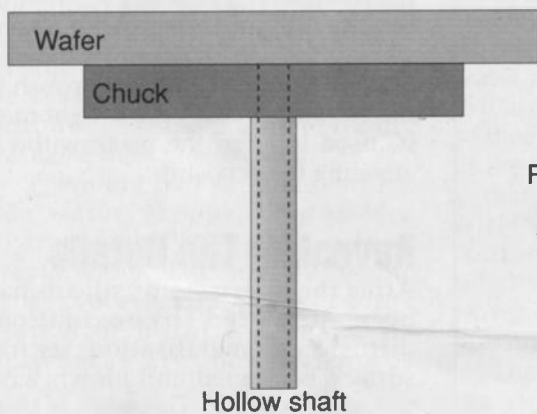
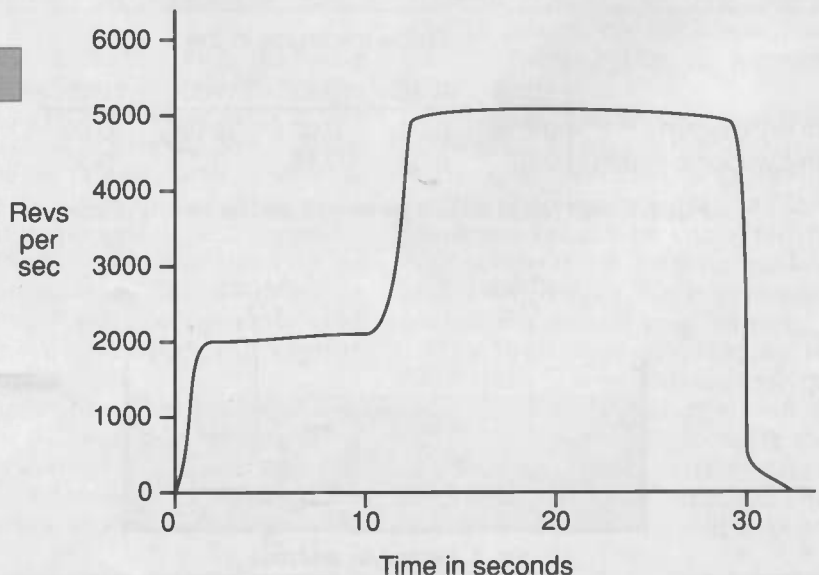

Fig. 7. Wafer clamped to spinner.

Fig. 8. Spin cycle for photoresist application.



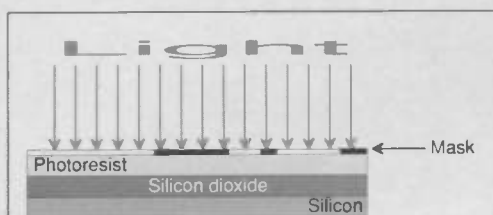

Fig. 9. Contact printing.

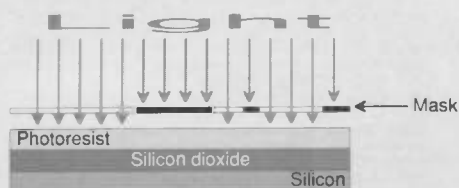

Fig. 10. Proximity printing.

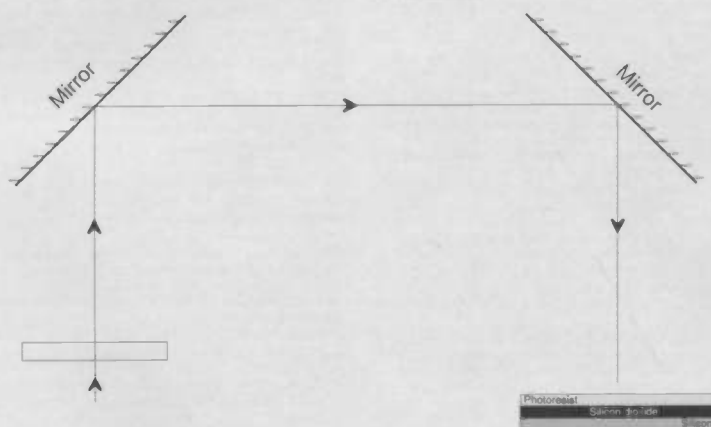

Fig. 11. Projection printer.

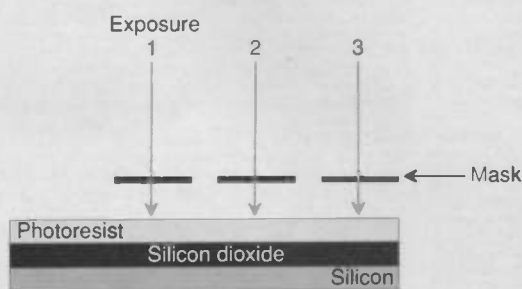

Fig. 12. Direct step-on printing.

magnification at all, the main feature being the step-on process shown in Fig. 12. Only part of the wafer is exposed each time and the circuit is built up in steps in the horizontal plane according to a grid marked out on the mask.

Xenon flash and the mercury arc lamps give out enough energy to affect most negative photoresists. These would normally react with oxygen so the process is blanketed in nitrogen. Fig. 13 compares the printing processes showing that the direct step-on can print the

smallest pattern but also handles the smallest number of wafers per hour.

After printing, the resist is developed by etching the exposed areas, if positive resist has been used, or on the unexposed areas, if the negative resist has been used. The developer can be applied

by spraying or dipping. Spraying atomises the developer in the same process as that used in aerosol cans and is less wasteful than dipping.

Once it has finished its work, the developer is rinsed off and if the process has been successful, the edges of the mask will be sharp

rather than ragged or blurred. If the develop and rinse processes have been automated then the two cycles overlap slightly so that the developer does not dry out.

Checking It Out

After processing, the wafer is examined either visually or automatically for accuracy of image transfer. Poor specimens are rejected and good ones hard baked to dry any remaining solvent. The temperatures used range from 110C to 130C for 10 to 20 minutes – similar to soft baking but at a slightly higher temperature.

Etching It In

Liquid etching was widely used in the early days of photolithography but these days the need for narrower tracks has seen dry etchants take over. An etchant must be selective in removing only the exposed area and not attacking the photoresist. This selectivity is expressed as a ratio of the etching of the exposed area to the unexposed area and 10:1 is the minimum acceptable.

Of the two main types available, the isotropic etchant removes material equally in all directions – Fig. 14, whereas an etchant that is anisotropic etches downwards more rapidly than sideways leaving vertical side walls – Fig 15.

Fig. 16 shows some liquid etchants, the materials they are capable of etching, the required temperature and the rate of etching. After the etching, the wafer is rinsed in de-ionised water to stop any further action.

One of the drawbacks of wet etching is the formation of bubbles. Also, dry etching is more suited to anisotropic etching in addition to achieving smaller line widths. Three main types of dry etching are used: plasma, physical and reactive.

In the plasma system, a wafer coated with resist is placed in a chamber. This is then evacuated and the reactive gas allowed in. The type of gas depends on the material being etched – for aluminium it would be a chlorine compound and for silicon, silicon nitride and silicon dioxide, a fluorine compound. An electromagnetic field is applied to

However, the projection optics is unable to expose the whole wafer at once so instead an arc shape has to be scanned.

With direct step-on printing, the mask is a magnification of the final pattern. Typical magnifications are five times and ten times though it can be done without any

Printing method	Mask to pattern ratio	Minimum pattern produced (μm)	Wafers per hour
Contact	1	5	60
Proximity	1	4	60
Projection	1	2.5	40
Direct step on	1 to 10	1.25	20

Fig. 13. Comparison of printing processes.

£1 bargain packs

In fact, cheaper than £1 because if you buy 10 you can choose one other and receive it free

5-13A SPURS provide a fused outlet to a ring main where devices such as a clock must not be switched off. Order ref. 2.

4-IN FLEX SWITCHES with neon on/off lights, saves leaving things switched on Order ref. 7.

2-6V 1A MAINS TRANSFORMERS upright mounting with fixing clamps Order ref. 9.

1-6 1/2" SPEAKER CABINET ideal for extensions, takes our 6 1/2" speaker. Order ref. 11.

12-30 WATT REED SWITCHES, it's surprising what you can make with these - burglar alarms, secret switches, relay, etc. Order ref. 13.

2-25 WATT LOUDSPEAKERS two unit crossovers. Order ref. 22.

2-NICAD CONSTANT CURRENT CHARGERS adapt to charge almost any nicad battery. Order ref. 30.

2-HUMIDITY SWITCHES, as the air becomes damper the membrane stretches and operates a microswitch. Order ref. 32.

5-13A ROCKER SWITCH three tags so on/off, or change over with centre off. Order ref. 42.

1-24HR TIME SWITCH, ex-electricity board, automatically adjust for lengthening and shortening day. Original cost £40 each. Order ref. 45.

1-MINI UNISELECTOR, one use is for an electric jigsaw puzzle, we give circuit diagram for this. One pulse into motor moves switch through one pole, Order ref. 56.

2-FLAT SOLENOIDS - you could make your multi-tester read AC amps with this. Order ref. 79.

1-SUCK OR BLOW OPERATED PRESSURE SWITCH, or it can be operated by any low pressure variation such as water level in water tanks. Order ref. 67.

1-MAINS OPERATED MOTORS with gearbox. Final speed 16 rpm, 2 watt rated. Order ref. 91.

1-6V 750MA POWER SUPPLY, nicely cased with mains input and 6V output leads. Order ref. 103A.

2-STRIPPER BOARDS, each contains a 400V 2A bridge rectifier and 14 other diodes and rectifiers as well as dozens of condensers, etc. Order ref. 120.

10M TWIN SCREENED FLEX with white pvc cover. Order ref. 122.

12-VERY FINE DRILLS for pcb boards etc. Normal cost about 80p each. Order ref. 128.

2-PLASTIC BOXES approx 3in cube with square hole through top so ideal for interrupted beam switch etc. Order ref. 132.

5-MOTORS FOR MODEL AEROPLANES, spin to start so needs no switch. Order ref. 134.

6-MICROPHONE INSERTS - magnetic 400 ohm also act as speakers. Order ref. 139.

4-REED RELAY KITS, you get 16 reed switches and 4 coil sets with notes on making c/o relays and other gadgets. Order ref. 148.

6-SAFETY COVER FOR 13A SOCKETS - prevent those inquisitive little fingers from getting nasty shocks. Order ref. 149.

6-NEON INDICATORS in panel mounting holders with lens. Order ref. 180.

1-IN FLEX SIMMERSTAT - keeps your soldering iron etc. always at the ready. Order ref. 196.

1-MAINS SOLENOID, very powerful as 1/2" pull or could push if modified. Order ref. 199.

10 KEYBOARD SWITCHES - made for computers but have many other applications. Order ref. 201.

1-ELECTRIC CLOCK, mains operated, put this in a box and you need never be late. Order ref. 221.

4-12V ALARMS, makes a noise about as loud as a car horn. All brand new. Order ref. 221.

2-6" X 4" SPEAKERS 4 ohm made for radiomobile so very good quality. Order ref. 242.

2-6" X 4" SPEAKERS 16 ohm 5 watts so can be joined in parallel to make a high wattage column. Order ref. 243.

1-PANOSTAT, controls output of boiling ring from simmer up to boil. Order ref. 252.

50-LEADS WITH PUSH-ON 1/4" TAGS - a must for hook ups - mains connections etc. Order ref. 259.

2-OBLONG PUSH SWITCHES for bells or chimes, these can switch mains up to 5 amps so could be foot switch if fitted into pattress. Order ref. 263.

1-MINI 1 WATT AMP for record player attached to unit that will also change speed of record player motor. Order ref. 268.

3-MILD STEEL BOXES approx 3" x 3" x 1" deep - standard electrical. Order ref. 283.

50-MIXED SILICON DIODES. Order ref. 293.

1-6 DIGIT MAINS OPERATED COUNTER, standard size but counts in even numbers. Order ref. 28.

1-IN-FIGHT STEREO UNIT. Has 2 most useful mini moving coil speakers. Ex BOAC. Order ref. 29.

2-6V OPERATED REED RELAYS, one normally on, other normally closed. Order ref. 48.

2-PLUG IN RELAYS with 3 changeover contacts. Coil operated by 12V DC or 24V AC. Order ref. 50.

4-CABINET LOCK with 2 keys. Order ref. 55.

1-DOLLS HOUSE SWITCHES or use them for any other low voltage application. Order ref. 57.

1-MAGNETIC BRAKE for stopping a motor or rotating tool. Order ref. 66.

1-TIMER REMINDER. Set it for anything up to 60 minutes. Order ref. 77.

1-SHADED POLE MAINS MOTOR. 3/4" stack so quite powerful. Order ref. 85.

2-5" ALUMINIUM BLADES. Could be fitted to the above motor. Order ref. 86.

AMSTRAD 25W POWER SUPPLY UNIT - This has a smoothed DC output 13.5V at 1.9A DC. However, a more popular rating for it is 12V at 2A DC. This is a useful voltage for many projects and one non-electronic use is to power garden lighting halogen lamps. The unit is in a plastic case with input and output leads and it has an internal fuse. A really robust unit, built for continuous operation, price £6. Order ref. 6P13B, reasonable reduction for quantity.

ARE YOU BUILDING A SPECIAL VOLTAGE POWER SUPPLY? - If so the Mullard 9003 unit might be just what you need. This is a plastic encased unit with a double wound mains transformer, the low voltage windings of which is on separate sections and is easy to modify. Very easy to take off turns until you get to the voltage you require. This can be anything from 3V to 18V. Contained within the 9003 are 4 rectifiers and 4 smoothing capacitors and plenty of room to add a voltage rectifier if you need it. Price of the 9003 is £2. Order ref.

- BARGAINS GALORE -

2P80B.

POP IN THE SEEDS AND STAND CLEAR! - It's surprising what heat under seed boxes will do to the germination time. You don't require a lot of heat and you could make a warm bed which would take up to 6 seed boxes with our Ref 5P109 which is 15m of waterproof heating wire. Only consumes 40W so won't add much to your electricity bill and you can almost see the seeds germinating. The price of 5P109 is £5 with instructions.

KEEP THE AIR MOVING - the greenhouse experts say this will considerably reduce leaf mould and other problems. It is a double outlet extractor blower, powered by a mains motor, approx 15" by 4". Installed through one of the windows it will extract or blow in depending on which way you mount it. Regular price probably £25, yours for £10. Order ref. 10P84B

CLEAR THAT SMOKE - according to a "Which" report, many ionisers available from chemists and similar have such a poor output that they are next to useless. Our ioniser kit, however, uses mains transformers and is so powerful you can feel the ion output on the back of your hand and it will clear smoke in seconds. Complete cased kit, price £16. Order ref. 16P5.

DON'T LOSE YOUR LICENSE - our electronic breathalyser gives a clear and accurate measurement. Blow into it and the meter records the alcohol content of the exhaled breath. Completely made up, and operates from internal batteries or from car cigarette lighter socket. Price £9.95. Order ref. 10P83B.

MAINS RELAY. 4-pole changeover, gold plated, 8A contacts, price £2. Order ref. 2P144.

WHITE CEILING SWITCH. Crabtree. 5A 2-way surface mounting, complete with cord and tassel. £1. Order ref. 52B.

ELECTRICAL PROGRAMMER. Learn in your sleep, have radio playing and kettle boiling as you wake, or switch on lights to ward off intruders, or have a warm house to come home to without leaving the heating on all day. Will handle up to 25A as well as being a clock. Beautiful Unit, only £2.50. Order ref. 2P5/1.

TELEPHONE BELLS. These will work off the standard mains, through a transformer, reduced to 50V, 2 for £1 Order ref. 600.

SUPER STRIPPER CASSETTE DRIVE UNIT, mounted on a metal chassis. Main items are: a high efficiency, battery operated motor, 1/2V to 9V, able to reverse; a solenoid, 9V operated cassette record and erase head; heavy brass fly wheel to give additional speed control; a magnetic sensor which, working with the semiconductor, would operate a tape counter. All this for £1 Order ref. 803B.

POWER CONTROL UNIT. Mounted on a heavy gauge panel are two 10A trip switches, a pilot light to indicate mains on, a contactor with two sets of contacts for heavy duty switching and two other sets of changeover contacts. This power unit was part of a 230V computer power supply system but all of the parts are easily removable and it is a really super stripper. Yours for £5. Order ref. 5P180B.

AUDAX 8 INCH PM SPEAKER. 5 Watt loading 15 ohm coil, so four in parallel would be suitable for a 20W column. Only £1 each. Order ref. 504.

LITHIUM BATTERIES 3.5V PENLIGHT SIZE, 2 mounted on p.c.b. with diodes, other bits. Lithium batteries as you may know are virtually everlasting (until they are put in circuit of course) so they are ideal or alarms and similar devices that do not draw current but rely on it always being available. 4 panels, that is 8 batteries altogether £2. Order ref. 2P258B.

POWER SUPPLY WITH EXTRAS output 12V 1A, mains input is fused and filtered and 12V output is voltage regulated, very well made on p.c.b. and also mounted on the board but easily removed are two 12V relays and a Piezosounder. Made for expensive equipment but never installed, Price £3. Order ref. 3P80B.

12 VOLT 1.9 AMP-HOUR RECHARGEABLE BATTERY by Jap YUASA brand new, charged ready for use £6.50 each. Solar charger to house this and keep it ready £29.50.

100 WATT MAINS TRANSFORMERS all normal primaries: 20-0-20V 2 1/2A, 30V 3 1/2A, 40V 2 1/2A and 50V 2A secondaries all upright mounting, all £4 each, good quantities in stock.

PHILIPS 9" HIGH RESOLUTION MONITOR black and white in metal frame for easy mounting, brand new still in maker's packing, offered at less than price of tube alone, only £15 plus £5 delivery - good discount for quantities.

16 CHARACTER 2 LINE DISPLAY screen size 85mm x 36mm, alpha numeric LCD dot matrix module with integral microprocessor made by Epson their ref 16027AR brand £8 each, 10 for £70, 100 for £500.

INSULATION TESTER WITH MULTIMETER internally generates voltages which enable you to read insulation directly in megohms. The multimeter has 4 ranges, AC/DC Volts, 3 ranges resistance and 5 amp range. These instruments are EX British Telecom, but in very good condition, tested and gnd. OK, probably cost at least £50 each, yours for only £7.50 with leads, carrying case £2 extra.

BRUSHLESS DC 12V FAN tiny, only 60mm square, goodair mover but causes no interference £8.00.

2mW LASER HELIUM NEON by PHILIPS, full spec, £30, power supply for this in kit form with case is £15.00, or in larger case to house tube as well £17.00. The larger unit, made up, tested and ready to use, complete with laser tube £69 plus £5 insured delivery.

MAINS 230V FAN best make "PABST" 4 1/2" square, metal blades £8.

SOLAR CHARGER HOLDS 4AA NICADS and recharges these in 8 hours., very neat plastic case £6.

SOLAR CELLS WITH TERMINALS for joining in series for higher volts or parallel for extra current: 100 mA £1, 400mA £2, 700mA £2.75, 1A £3.50.

AIR SPACED TRIMMER CAPS 2-20pf ideal for precision tuning uhf circuits 25p each, 10 for £2, 100 for £15.

MINI MONO AMP ON PCB SIZE 4" BY 2" with front panel holding volume control and with spare hole for switcher tone control. Output is 4 watt into 4 ohm speaker using 12V or 1 watt into 8 ohm using 9V. Brand new and perfect only £1 each or 12 for £10.

POWER SUPPLY UNITS mains in, DC out, based 4.5V 100mA regulated £1, 6V 700mA £1, 9V 500mA £2, 12V 400mA £2, 12V 2A £5, 24V 200mA £2.

AMSTRAD POWER UNIT 13.5V at 1.9A encased and with leads and output plug, normal mains input £5 each, 10 for £45.

AMSTRAD 3.5 FLOPPY DRIVE reference FD9 brand new and perfect, £35.

ATARI 64XE COMPUTER at 64K this is quite powerful and so suitable for home or business, unused and in perfect order but less PSU, only £19.50. Handbook £5 extra.

9" CATHODE RAY TUBE Philips M24/306W, which is not only high resolution but is also X-ray and implosion protected, regular price over £30, you can have them at £12 each. Tubes are guaranteed used.

80 WATT MAINS TRANSFORMERS two available in good quality, both with normal primaries and upright mounting, one is 20V 4A the other 40V 2A only £3 each or 10 for £27 carriage paid.

PROJECT BOX size approx 8" x 4" x 4 1/2" metal, sprayed grey, loured ends for ventilation otherwise undrilled made for GPO so best quality, only £3 each or 10 for £9.

12V SOLENOID has good 1/2" pull or could push if modified, size approx. 1 1/2" long by 1" square, £1 each or 10 for £9.

WATER VALVE 230V OPERATED with hose connections, ideal for auto plant spray or would control air or gas into tanks etc., £1 each or 10 for £9.

HANG UP PHONE won't clutter up your desk or workbench, current model, has push button dialling, last number recall, Internal alarm etc., Ex B.T. in good condition and fully working ready to plug In £5.

HIGH VOLTAGE CAPS if you use these ask for our 1-20kV Capacitor list, we have over 1/4 million In stock and might save you a lot of money.

ELECTRONIC BUMP AND GO SPACESHIP sound and impact controlled responds to claps and shouts and reverses or diverts should it hit anything! Kit with really detailed instructions, will make ideal present for budding electrician. Should be able to assemble but you may need to help with the soldering of the components on the PCB. Complete kit £8.95.

500V BRIDGE MEGGER developed for G.P.O. technicians the Ohmster 18B is the modern equivalent of the bridge megger. 9V battery operated and it incorporates a 500V generation for insulation testing and a null balance bridge for very accurate resistance measurement. Ex B.T. in quite good condition with data & tested. Yours for a fraction of original cost £45 + £5 insured delivery.

EXPERIMENTING WITH VALVES don't spend a fortune on a mains transformer we can supply one with standard mains input and secs. of 250-0-250V at 75mA and 6.3V at 3A. Price £5.

15 WATT 8 OHM 8" SPEAKER & 3" tweeter made for a discontinued high quality music centre, give real h.f. and for only £4 pair.

ULTRASONIC TRANSMITTER/RECEIVER with Piezo alarm, built into preformed case, is triggered by movement disturbing reflected signal, intended for burglar alarm, car alarm, etc. has many extras, time delay, auto reset, secret off device etc. A £40 instrument yours for £10.

MOVEMENT ALARM goes off with slightest touch, ideal to protect car cycle, doorway, stairway etc. Complete with piezo shrieker, ready to use. Only £2 (PP3 battery not supplied).

STEREO HEADPHONE extra lightweight with plug £2 each or 10 pairs for £18.

B.T. TELEPHONE LEAD 3m long with a B.T. flat plug ideal to make extension for 'phone, Fax, etc. 50p each, £40 per 100, £300 per 1,000.

WATER PUMP very powerful and with twin outlets, mains operated, £10.

STUDIO 100 BY AMSTRAD, the ultimate disco control panel, has four separately controlled and metered channels, twin cassettes, AM/FM radio, stereo audio amplifier, phone & CD inputs, etc. regular price over £400, we still have a few in the maker's packing, brand new and guaranteed, yours for £99.

ROTARY POSITION CONTROLLER for aeriels, ventilators, dampers, or applications requiring 180 degrees clockwise and anti-clockwise movement. We have the Sauter MVE4 154 servo motor drive ref AR30W3S regular price over £70 brand new, £15 each.

12 VOLT 8 AMP MAINS TRANSFORMER £4. Waterproof metal box for same, £4.

110 WATT SWITCHMODE POWER SUPPLY 230V mains operated, outputs of 38V 2 1/2 A and 5V 3A, we have a lot and need the space so you can have these at a fraction of their cost. Our price is £6.

10VA MAINS TRANSFORMERS all p.c.b. mounting, all £1 each, 10 for £9, 100 for £75, for output 12-0-12V Order ref WA1, 20-0-20V order ref WA3, 18-0-18V not p.c.b. mounting but fully shrouded same price order for WA4.

0-1MA FULL VISION PANEL METERS 2 3/4" square, scaled 0-100 but scale easily removed for re-writing £1 each, 10 for £9, 100 for £75.

5 AMP PANEL METER 80 x 70mm beautiful instruments £5 each. Order ref WA7.

VU METER illuminate this from behind becomes on/off indicator as well 1 1/2" square 75p each, 10 for £6, 100 for £50.

EDGE-WISE PANEL METER ideal when short of panel space only 40 x 14mm, also have built-in f.s.d., 500µA f.s.d., scaled 0-5, £1 each 10 for £9, 100 for £75.

VIBRATING REED FREQUENCY PANEL METER 4" square, 55-65Hz, only £9 each.

LOW PRICED FIELD TELEPHONES. Ex-GPO models, not quite so nice-looking but quite efficient, and have the big advantage that the ringing is done by means of a hand operated internal generator. This saves a lot of batteries. These 'phones have the normal type of rotary dial and can still be connected into a normal B.T. system. Tested, guaranteed in good order, price only £9.50 each. Order ref 9P5.

HAND GENERATORS as fitted in the above field telephones, this hand generator is a permanent magnet type and has an AC output of approximately 50V depending on how quickly you wind it. If you want a higher voltage then simply connect the output to a transformer. We have lit a 60W bulb quite successfully. The hand generator, complete with handle, £4. Order ref 4P51.

DRY BATTERIES CAN BE RECHARGED, but not with a normal d.c. charger, it must be a periodic current reversal type. We can supply the kit, with data. £9. Order ref 9P10.

SUPER MULTI-METER Ex British Telecom, this is a 19-range 20K o.p.v. top grade instrument, covers AC & DC voltages, current and resistance, very good condition, fully working and complete with leads £9.50, leather carrying case £2 extra (batteries not included but readily available).

SOLAR ENERGY EDUCATIONAL KIT. An ideal present for electronics students. It shows how to make solar circuits and electrical circuits, how to increase the voltage or current, how to use solar power to work a radio, calculator, cassette player and to charge nicad batteries. The kit comprises 8 solar cells, one solar motor, fan blades to fit motor and metal frame to hold it to complete a free-standing electric fan. A really well written instruction manual makes this a lovely little present. Price £8. Order ref. 8PA2B.

WANT TO KNOW HOW FAST IT'S TURNING? made by the famous Muirhead Company, we have DC tachometer generators which have an output voltage depending upon it's speed. At 1000rpm for instance, the output voltage is 3. Ex-equipment, price only 2 for £1. Order ref 246.

Prices include V.A.T.. Send cheque/postal order or ring and quote credit card number. Add £3 post and packing. Orders over @25 post free, unless postage quoted separately.

M & B Electrical Supplies Ltd
12 Boundary Road, Hove, Sussex BN3 4EH
Telephone (0273) 43038
Fax (0273) 41042



Fig. 14. Isotropic etchant



Fig. 15. Anisotropic etchant

electromagnetic field is applied to activate the gas and etch away the unprotected parts of the wafer.

Physical etching uses only the physical energy of the gas particles and is also called ion milling. Reactive etching combines chemical etching with physical etching.

Moving On

When the etching process is complete, the resist must be removed completely and, once again, either wet or dry methods can be used. Whatever the method, the aim is to remove the resist completely without damaging the wafer.

Wet processes use solvents like acetone, or sulphuric acid and ammonium sulphate or hydrogen peroxide and sulphuric acid.

Dry techniques use oxygen so that the resist turns into carbon dioxide, nitrogen and water vapour. Once complete, a final inspection is made under a microscope.

Not So Pure

Impurities are introduced into wafers to give them different properties and two main methods are used, diffusion and ion implantation. The first is a process whereby liquids and gases move slowly from an area of high concentration to an area of low concentration. An example is a

spoonful of dye colouring a glass of water. The rate of diffusion is called the diffusion coefficient and depends on the temperature of the fluids; since hotter particles have more energy, they move faster.

There are two main stages to diffusion, predeposition and drive-in. In the first case a small amount of impurity is introduced into the wafer after which it is "driven in".

During predeposition, a concentrate of the dopant is placed near the wafer surface and the wafer is heated. The concentrate is absorbed into the wafer until the solid solubility is reached – this is the maximum concentration of dopant possible at a given temperature and is achieved only if there is an excess of dopant at the surface of the wafer.

A typical solid solubility for boron in a silicon wafer is 2×10^{20} atoms per cubic centimetre and for phosphorous in silicon, as high as 9×10^{20} atoms per cubic centimetre at

1000C.

Another important factor in predeposition is the time taken and the thickness of the oxide mask where doping is not required. Fig 17 compares the thickness of silicon dioxide mask required to guard against boron compared to phosphorous. For instance, if the time required is 10 mins then at 1000C an oxide layer of just over $0.02 \mu\text{m}$ is required for guarding against boron whereas a layer greater than $0.1 \mu\text{m}$ is necessary to guard against phosphorous. This follows since phosphorous penetrates much more readily than boron.

Predeposition is carried out in a reactor similar to that used for oxidation. The wafers are cleaned and placed in a boat and then loaded into the reactor. The dopant may be used in solid, liquid or gaseous form. The powder is heated either at one end of the reactor or in a separate reactor – Fig 18. A carrier gas such as nitrogen may be used but a nitrogen-oxygen mixture is often used since oxides of the dopant produce better

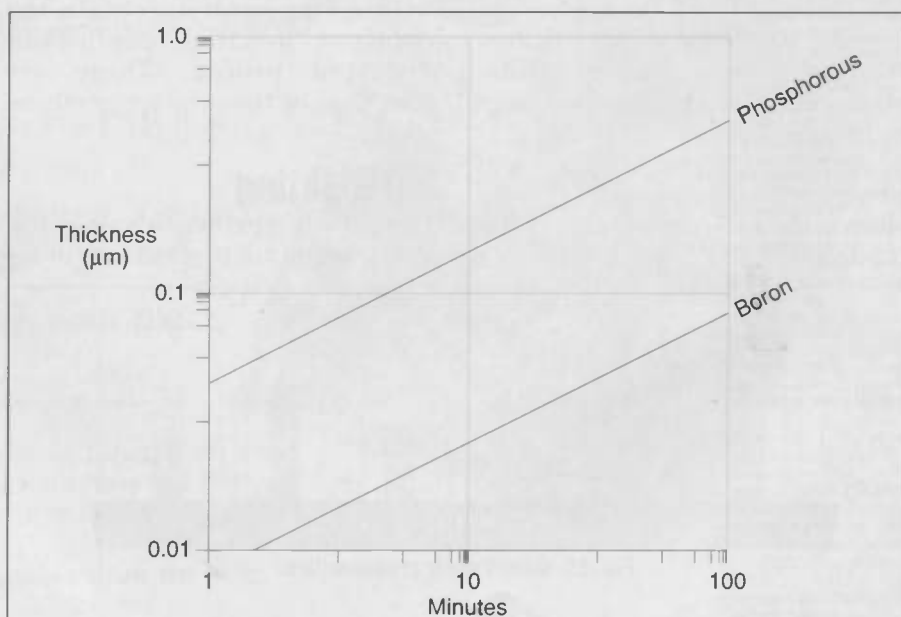

Fig. 17. Silicon dioxide thickness to guard against boron and phosphorous deposition.

Material to be etched	Etchant (ratio)	Temperature in C	Rate of etch in Å/min
Aluminium	Phosphoric acid, acetic acid, nitric acid, water (50:10:2:3)	20-40	2000-6000
Polycrystalline silicon	Potassium hydroxide or HF, HNO ₃ , H ₂ O (1:50:20)	20-30	3500-5000
Silicon nitride	Phosphoric acid	160-175	50-75
Silicon dioxide	NH ₄ F, acetic acid, water (3:3:2)	20-30	1800-2200

Fig. 16. Wet etchants.

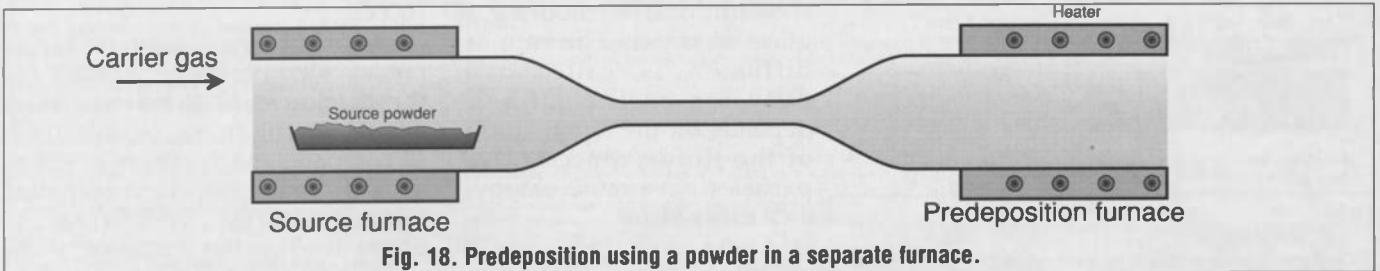

Fig. 18. Predeposition using a powder in a separate furnace.

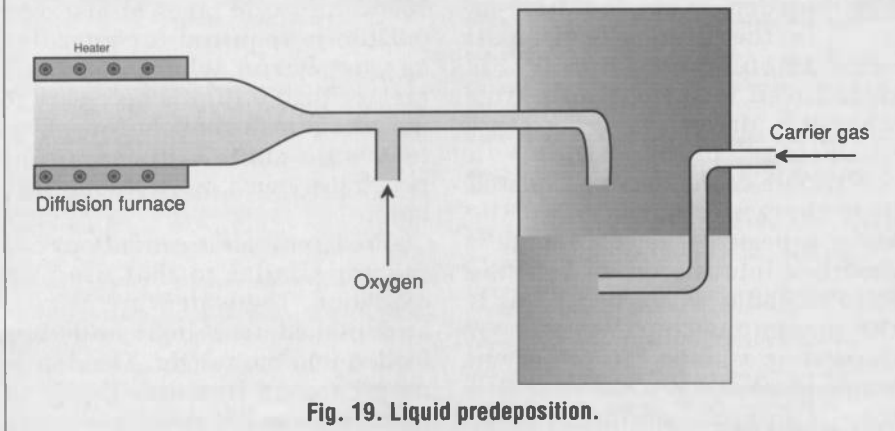

Fig. 19. Liquid predeposition.

predeposition.

Similarly, when a liquid dopant is used, nitrogen is bubbled through it but oxygen is also introduced – Fig 19. It may appear that using a gas dopant would be the simplest of the three choices but some gas dopants could decompose during storage. Also, some of them are toxic and therefore a gas leak could be lethal.

Another method of predeposition employs the layout shown in Fig. 20 where a wafer made of the dopant is used as a

source wafer. The recipient wafer is placed a fixed distance away and every source wafer has two recipient wafers facing it.

The next step in diffusion is drive-in to disperse the dopants within the wafer to obtain the required junction depth and diffusion profile. These are controlled by time and temperature.

Ion Blasting

The basic principles of ion implantation are to select ions of the

required impurity and impart sufficient energy to them to fire them into the wafer. In order to generate ions of the required type, a gas of the dopant is heated with an electric filament and the ions are separated by bending their paths with a magnetic field – the same method as in a mass spectrometer.

The change in the path depends on the charge and mass of the ions. After separation, the ions are accelerated to strike the target. Two parameters are important here, the energy of the ions and the number of them hitting the target.

The energy is controlled by the electric field and the number of ions by an ion counter. Since both the quantity of the dopant as well as the depth of implantation can be controlled ion implantation is valuable experimental tool as well as a commercial production process. It is used for such things as defining the threshold voltage of field effect transistors, manufacturing more exact resistors and so on.

A big advantage of ion implantation is that it is a low temperature process and so, low temperature photo resists can be used. One of the disadvantages is that ion bombardment can damage the crystal lattice. Fortunately, any damage can be repaired by heat annealing since the wafer can be completely re crystallised above 600C. ■

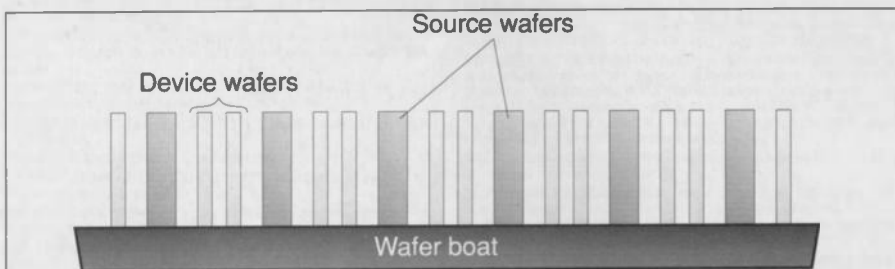

Fig. 20. Doped wafer predeposition.

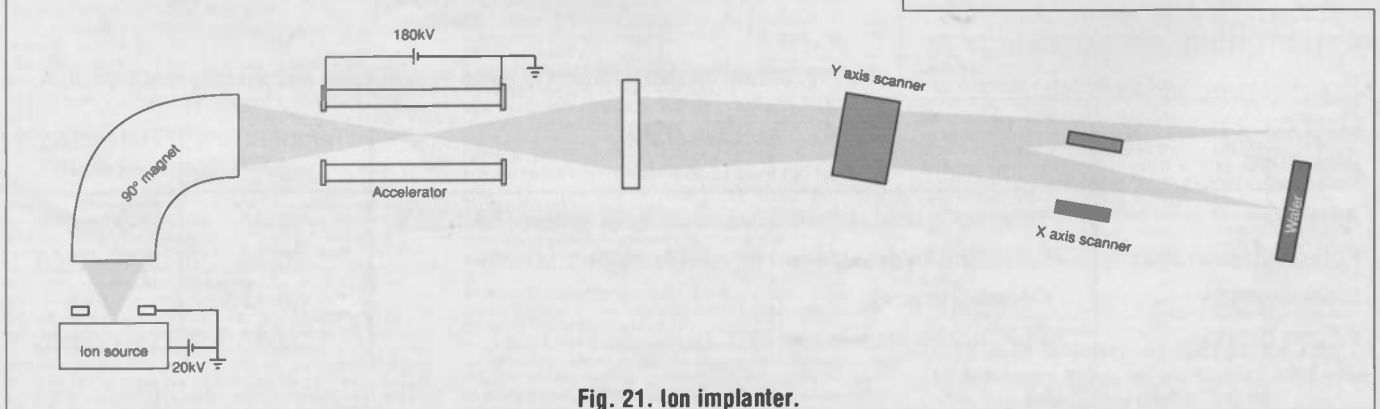

Fig. 21. Ion implanter.

Subscribe to

PRACTICAL

ELECTRONICS

SCIENCE AND TECHNOLOGY

Every month we bring you the best coverage of the modern technical world.

Innovations has all the news of the latest developments, technical features explain the detail behind the glittering facade of technology, while writers such as Barry Fox, Technology Journalist of the Year and Ian Burley, Editor of BT's Prestel Micronet consumer section, analyse the growing role of electronics in everyday life. Finally, for those of you who want personal hands-on experience of design and construction, our projects offer entry level designs and advanced challenges.

A 12-month subscription is only £18 (UK), £22 (surface mail) or £39 (air mail). Concessionary rates also available. Order by credit card on 081 743 8888.

Subscribe today and book your place in the electronic future.

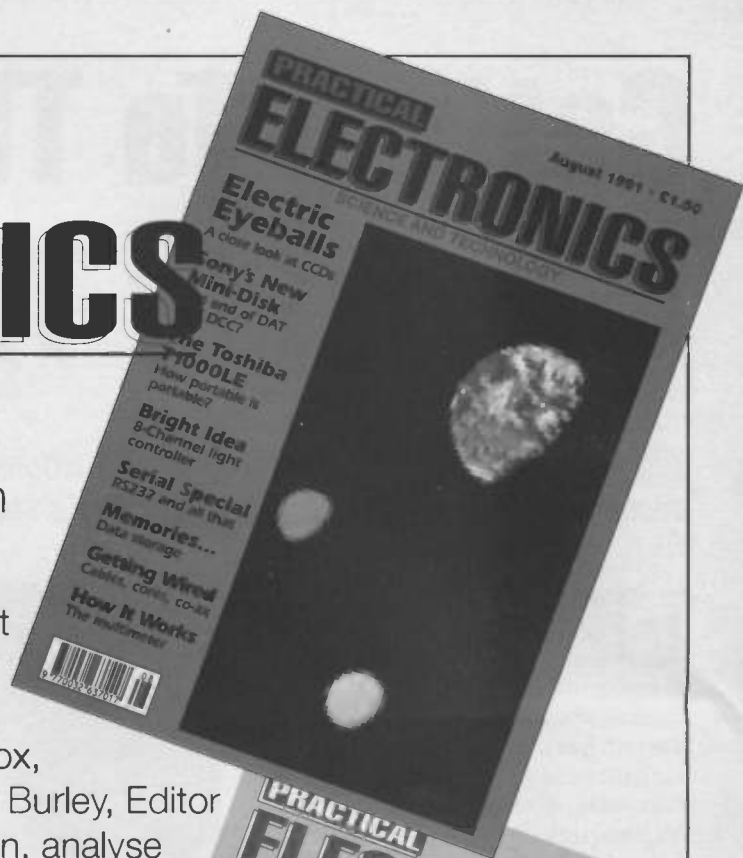

Send to:
Intra Press, Intra House, 193 Uxbridge Road, London W12 9RA.
Make cheques/postal orders payable to Intra Press in £ sterling.
Please subscribe me to Practical Electronics for 12 months,
starting with the issue.
I enclose a cheque/postal order/banker's draft for £.....

Name
Address
Town
County
Post Code.....
Or: Please charge my VISA/Mastercard
Number
Expiry date.....

Subscription rates:

UK post - £18, Overseas surface mail - £22, overseas airmail - £39.

Discount rates:

UK BAEC/Educational concession- £16.20, Overseas BAEC/Educational concession - £19.80 (surface mail only available)

Please enclose proof of BAEC membership or educational status.

Getting To The Bottom Of Things

Jeff Macauley's latest invention is a sub-woofer that will blow your socks off. Unlike other designs, however, this one fits neatly into a standard speaker case.

Undoubtedly the quality of sound reproduction equipment has improved greatly over the last couple of decades – except in one respect, decent bass response. One of the main reasons for this must be domestic. Using standard design techniques, the cabinet size required to reproduce real deep bass just cannot be accommodated in the average sitting room.

This size problem is probably why most subwoofer designs that have been published either are transmission lines disguised as window seats or simply don't go down far enough. I have probably been spoiled in this respect. I built my first subwoofer in 1978 and have used one ever since. Once the bass response of a system is extended to 30Hz or so, a whole new world of music opens up which is a simply out of reach of 90% of the systems you can buy. The cost however, used to be a 4 cubic foot enclosure dominating the listening room.

What is really required is a small unit which will extend the response of existing speakers down to low frequencies. If you feel your bass is lacking or simply want to feel the music as well as hear it, this project is definitely for you.

Before getting down to the nuts and bolts of the circuit it's probably as well to get some background information into the problems associated with bass reproduction. If the average speaker unit (driver) acted as a massless piston all that would be required to secure good bass would be to mount it into a sealed cabinet. Unfortunately, because the speaker cone has mass and the surround compliance, the

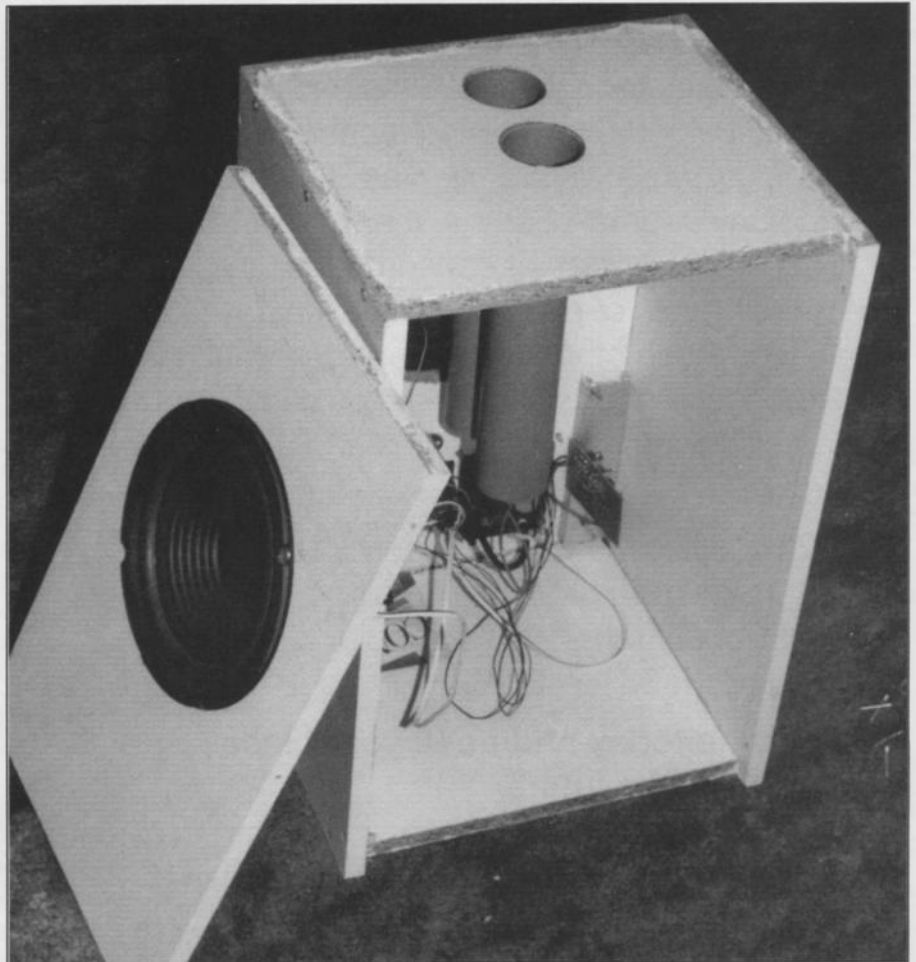

mechanical equivalent to electrical capacitance or the inverse of stiffness (the ability to flex), there is a bass resonance with all drivers.

It's bass resonance that ultimately determines the response of the driver and to damp it out properly, the system, driver and box has to be carefully calculated to operate properly. You might ask why the driver needs to be mounted in an enclosure anyway. The reason is that the radiation from the front of the cone is 180° out of phase with that emanating

from the back. The result is an acoustic short circuit because the bass from the rear cancels out that produced at the front. This is a natural consequence of the long wavelengths of bass signals, the result being that the speaker is not large enough to cause an obstruction at low frequencies.

Until relatively recently, the design of speaker enclosures was a bit of a hit and miss affair. This has now changed due to the pioneering work of Theile and Small. Given the driver's basic parameters, resonant

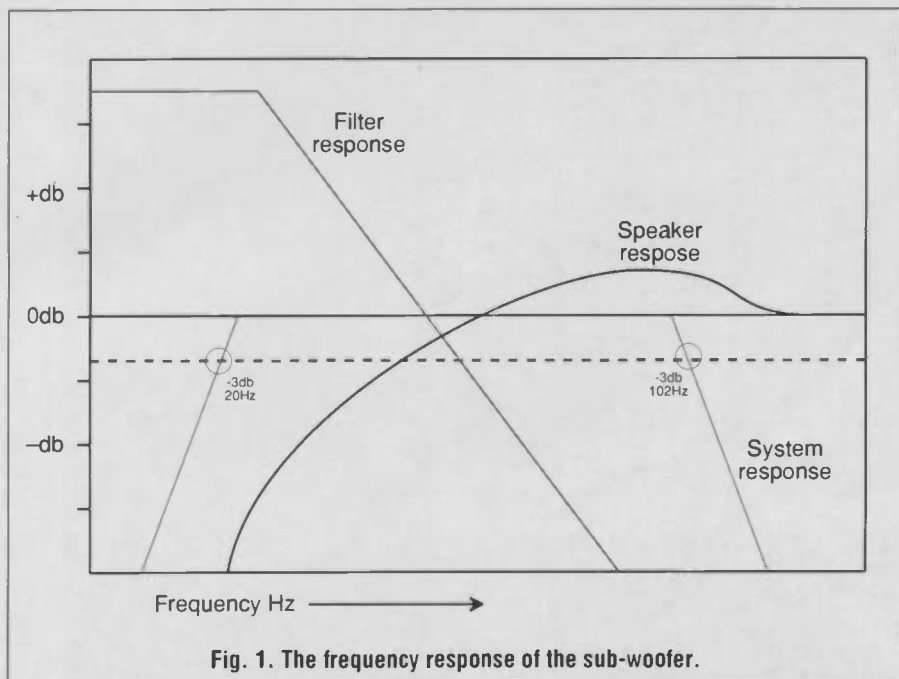

Fig. 1. The frequency response of the sub-woofer.

frequency f_s , the Q of this resonance, Q_{ts} , and the equivalent air volume to the compliance of the surround, V_{as} , the response of a speaker in the bass region can be accurately calculated. The basis of this is the similarity of the bass response of a speaker to that of high pass electrical filters. The behaviour of which has been well understood for decades.

When a driver is fitted into a small airtight case, the resonant frequency rises because of the extra stiffness of the enclosed air. Below the resonant frequency, the response looks like that of a second order high pass filter with an ultimate 12db/octave roll-off.

Therein lies the rub for domestic audio systems. Most speakers comply with the above description and suffer from compromised bass as a result.

Less common is the bass reflex enclosure. Here a vent or duct is inserted into the case and acts as a Helmholtz resonator. That is, the stiffness of the air in the enclosure resonates with the mass of the air in the vent to produce a mechanical tuned circuit. The result is that over a small range of frequencies, the bass radiated from the rear of the cone is phase inverted and radiates from the port. This is an efficient system which, when properly designed, can extend the bass

response of the driver. However, it suffers from some disadvantages. The enclosure size, vent length and diameter as well as the speaker parameters already mentioned must be considered in the design.

In addition, the reflex enclosure operates as a fourth order filter below resonance which compromises transient response. The result is that for any given driver, there is one and only one optimum sized enclosure. Usually prohibitively large. Another solution is to use a sealed enclosure together with a low pass filter. Again, if properly designed, the filter and enclosure combined operate as a bandpass filter in the bass region. The main difficulty with this is that below resonance the driver's motion is dominated by the cone surround resulting in large amounts of second harmonic distortion.

In practice, this is less of a problem than it appears. The ear can just detect 40% total harmonic distortion (thd) at 40Hz in the presence of program material. In this necessarily brief tour de force of speaker design, two other types of enclosure need mentioning. First, the active, filter assisted reflex enclosure. Here an auxiliary filter is added to a bass reflex enclosure to extend the bass response and reduce the required cabinet size. This works very well but, again, there is only one viable solution if optimum results are to be obtained.

Lastly there's the now venerable transmission line speaker. These are

Fig. 2. The circuit diagram.

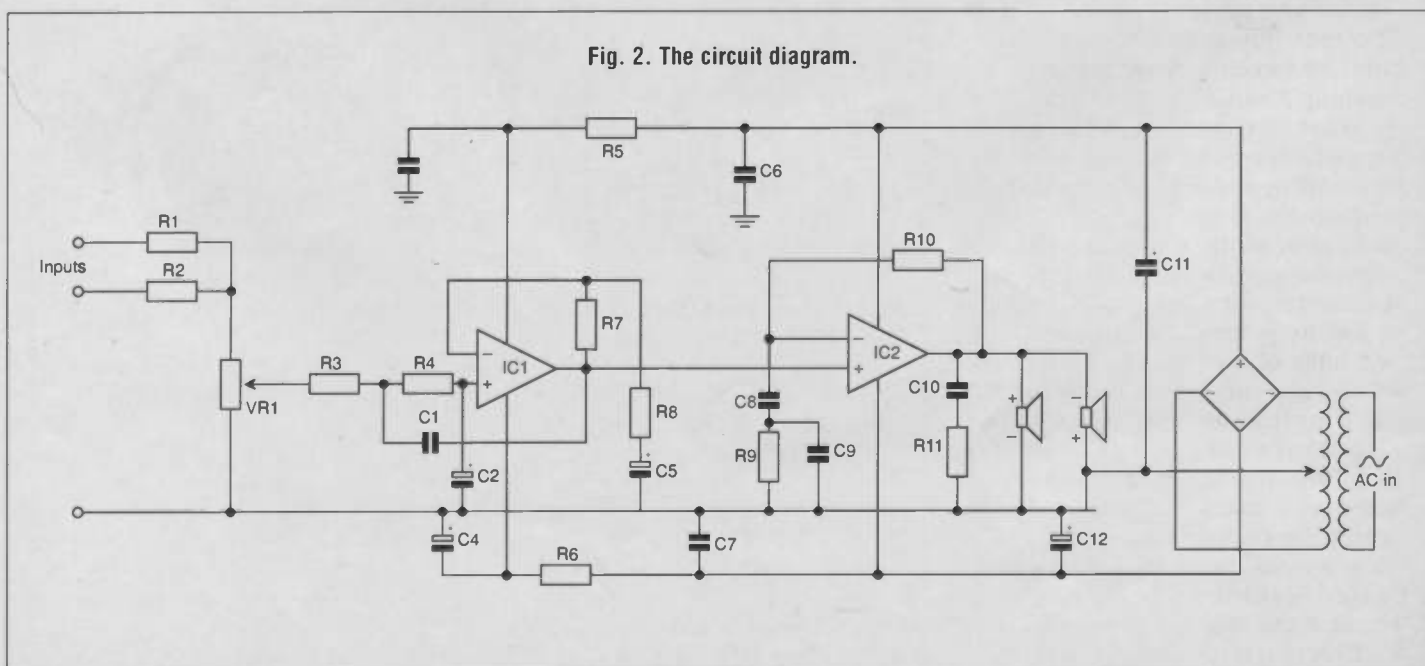

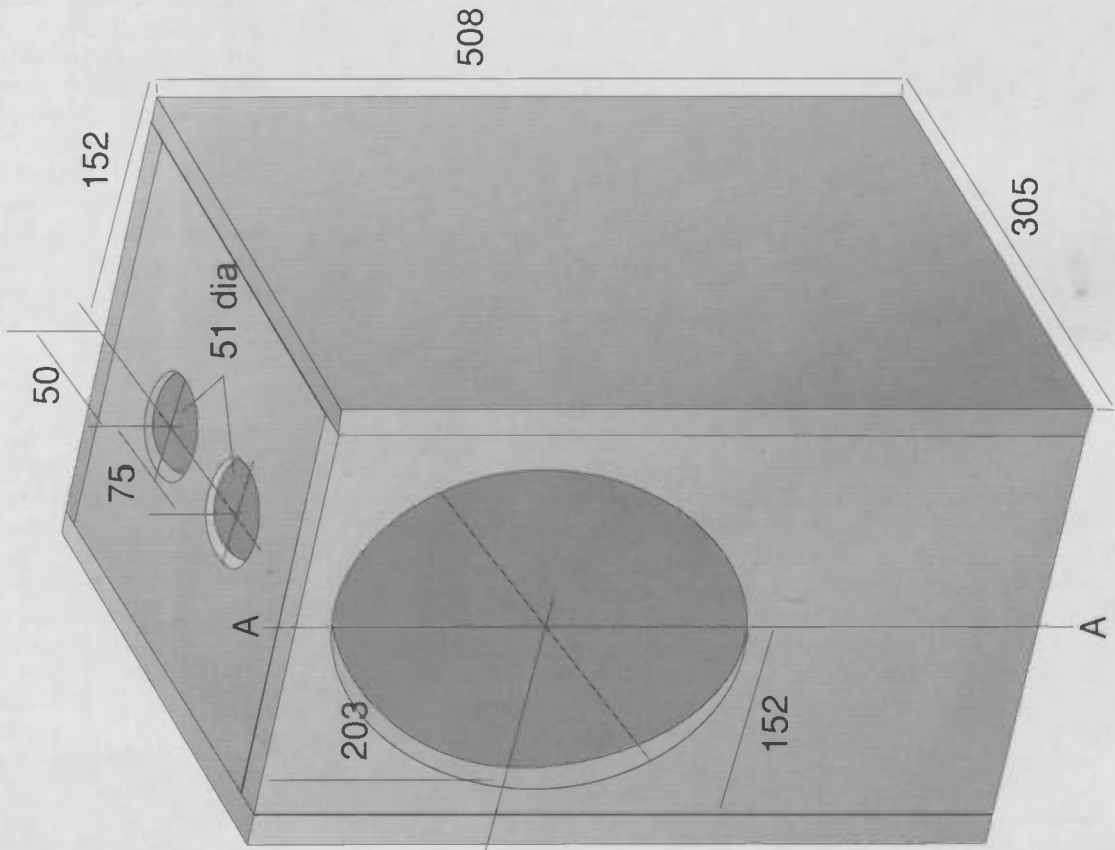
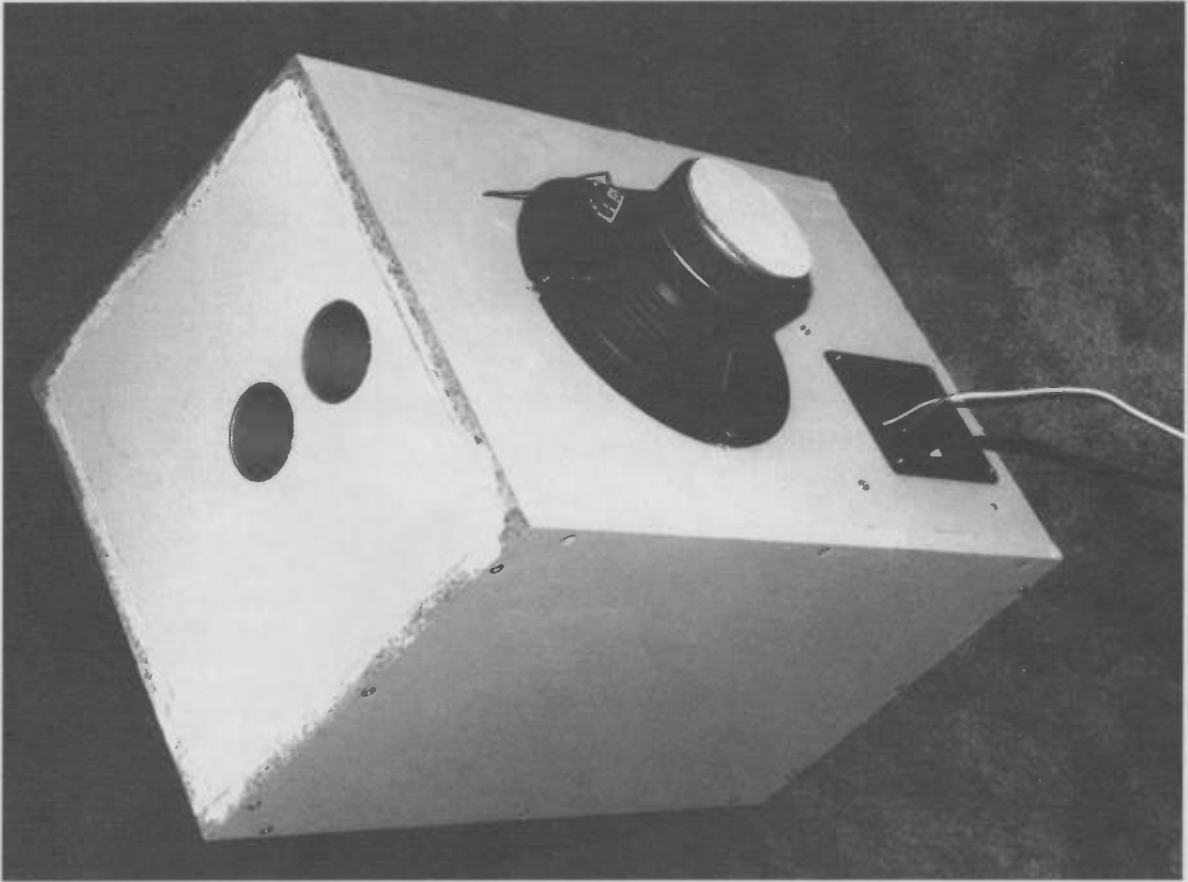

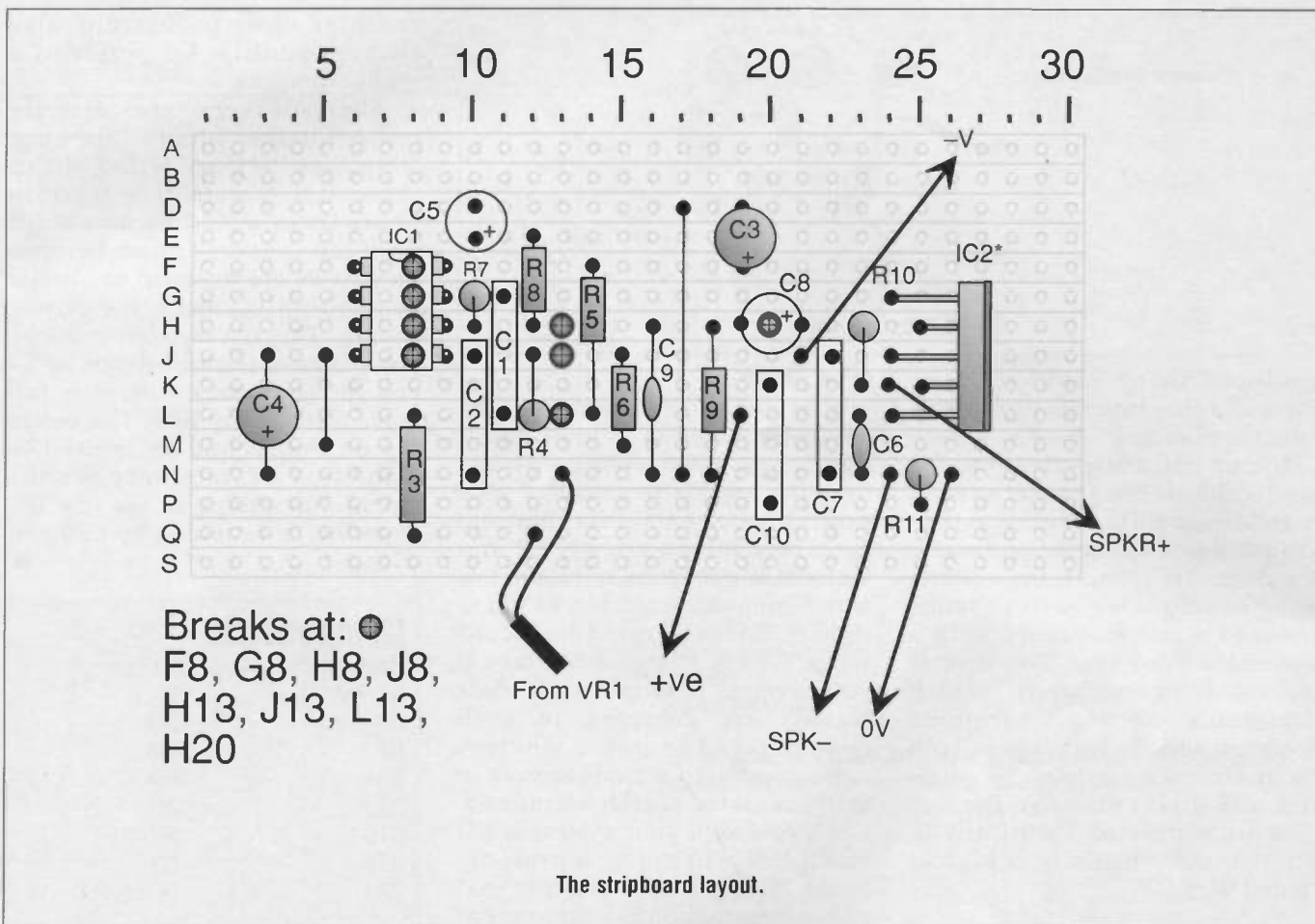

extremely good at reproducing deep bass but are large and unwieldy. Essentially, the bass from the rear of the driver is fed into a stuffed pipe. The stuffing both damps the speaker's natural resonance and slows the sound wave down making the pipe appear to be longer than it actually is.

However, most designs have pipes at least seven feet long, folded to make them more manageable. The system acts as a highly damped organ pipe.

Where does this leave us? At first sight more or less where we started except that there is another method which I discovered more or

less by accident. If you design a reflex enclosure with a cabinet much smaller than the optimum predicted by theory, a surprising thing happens. The phase relationship between the vent radiation and the speaker's direct output is altered so that the vent operates over a wide range of frequencies. The system response becomes that of a second order filter, that is, a closed box.

The small cabinet reflex has the advantage of superior transient response compared with a standard reflex design due to the slower rate of roll-off. The problem remains though that the response is falling but it's a simpler matter to design a suitable equalisation to render the system response flat. Here I've use a low-pass filter which produces a bandpass filter response in conjunction with the speaker system's high-pass effect.

This is illustrated in the graphs in Fig. 1 which show that the vent is still augmenting the drivers output down to around 10Hz before the characteristic rapid roll-off expected from a reflex system occurs. Full range systems have also been

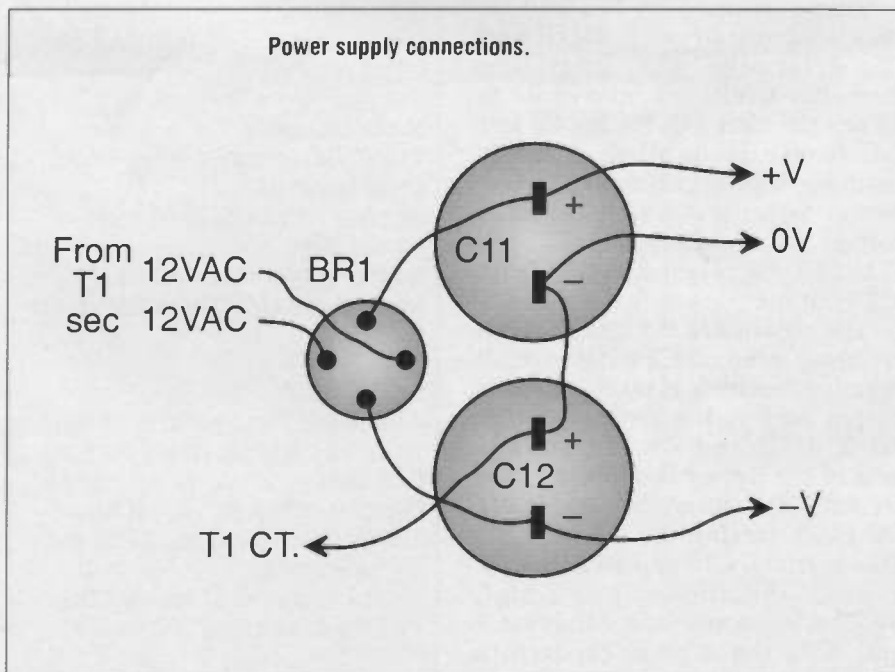

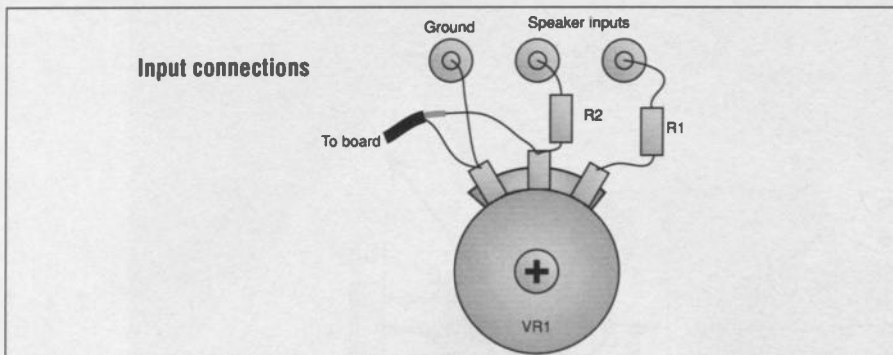

produced using Linkwitz type filters and the system is subject to a patent application.

In our particular situation, the bandwidth of the speaker system extends from 20Hz to 102Hz at the -3db points. The case, or enclosure, is a domestic 1.4cu.ft, the volume being based on the need to reflex down to a low frequency with a reasonable sized vent. Two drivers are used in push-pull which eliminates second harmonic distortion and the two drivers, both 8in in diameter, operate as a single unit with a 12in diameter. Because both are connected electrically in parallel, the sensitivity is high at around 94db/W.

Circuit

The full circuit diagram is shown in Fig. 2. Before discussing this in detail a word is in order about the devices chosen. The audio amplifier is a TDA2030 chip. This is capable of delivering 21W into the speakers at full tilt and is enough to drive the speakers to their safe excursion limit – contrary to popular belief, the power required to take the speaker to maximum excursion gets smaller as the frequency is decreased and this has to be taken into account in the design. In its operating range, total harmonic distortion (thd) is less than 0.1%, the signal to noise ratio (SNR) is good and generally the device does a competent job. What more could you sensibly ask? The transient response of a moscode amp would be wasted where the frequency range is so restricted.

The required equalisation demands a low-pass filter with a second order roll-off and a Q of 0.6. A TL072 dual op-amp has been utilised in this design. Only one half has been used but the pin out of the device makes for much simpler layout than if a single op-amp were

to be used.

Looking at the schematic, the device operates as follows. Input signals for the sub-woofer are taken from the speaker terminals of your existing stereo amplifier. These are passively mixed via R1, R2 and VR1. Mixing the bass signals in this way eliminates large out of phase signals that are caused by record warp. This is a large advantage if your system is vinyl based. Bass signals are common to both channels and in phase whereas these unwanted signals appear in antiphase at the cartridge terminals.

Of course, if your system is CD based this will not be a problem. Some HiFi pundits suggest that phase information is important at low frequencies. However, unless your ears are a couple of metres apart, it's unlikely that you will hear any. On the other hand, if the thought of missing something bothers you, why not make two subwoofers, one for each channel? Anyway, I digress. The signal from the slider VR1, the gain control, is fed into the low pass filter.

This is formed by IC1 and its associated circuitry. R3, R4, C1 and C2 determine the operating frequency whilst the ratio of R7 to R8 sets the filter's Q. R5, R6, C3 and C4 form decoupling circuits ensuring stability. Because a dual power supply is used, the bias voltage and input signal for IC2, the TDA2030, is taken directly from IC1's output.

The signals are fed into the non-inverting input of IC2 whilst overall negative feedback is taken from the output back to the inverting input via R10, C8 and R9. The voltage gain of the device is defined as the ratio of R10 to R9 whilst C8 acts as a DC block forcing the device's DC gain to unity. C10 and R11 provide a load for the amp at high frequencies to maintain stability. C6 and C7, the 100nF capacitors

mounted close to the chip, also ensure stability. C9 performs a similar function.

The speakers are directly coupled to the output of the amp. Note that they are wired out of phase. If they were to be wired in phase there would be no output from the speaker system because the drivers are mounted to operate in push-pull. Lastly, the power supply. This is very conventional. The mains is stepped down by T1 and the secondary voltage is full wave rectified by BR1. The centre tap on the secondary is used to provide a 0V reference for the circuit. Smoothing of the raw DC from BR1 is provided by C10 and C11. ■

Components

Resistors 1% Metal Film

R1, R2, R5, R6	1k
R3, R4	56k
R7	3k3
R8	10k
R9	2k7
R10	100k
R11	1Ω
VR1	1k log pot

Capacitors

C1, C2, C7, C10	100nF polyester
C3, C4, C5, C8	100μF 25V elect
C6	100nF ceramic
C9	1nF ceramic
C11, C12	4700μF 16V elect

Semiconductors

IC1	TL072
IC2	TDA2030
BR1	200PIV, 1.5A bridge rectifier

Miscellaneous

T1 240VAC primary, 0-12, 0-12VAC secondary at 2A
Stripboard 15 strips by 30 holes
Recess plate
4mm or similar input sockets
Matched pair of 200mm Woofers, see text

Cutting list

4 lengths of 20in by 12in by 15mm veneered chipboard (sides, front and back panels)
2 lengths of 12in by 10.75in by 15mm veneered chipboard (top and bottom panels)
Vents 2 lengths of 51mm diameter PVC drainpipe tubing 290mm long

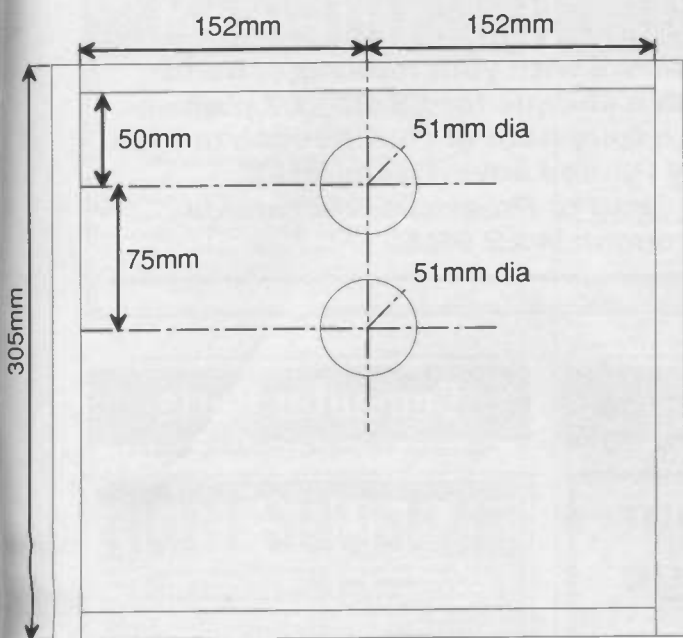

Design: Sub-woofer
 Scale: 1:4
 19th March 1992
 Author: Jeff Macauley
 Drawn by: K Garroch

A full designer approved kit for this project (minus wood panels) is available from:
Hobtek
The Cottage
8 Bartholomews
Brighton
Sussex BN1 1HG

The kit price is £89.99 inclusive. Matched pairs of speakers can be obtained from the same source for £59.99 inclusive.

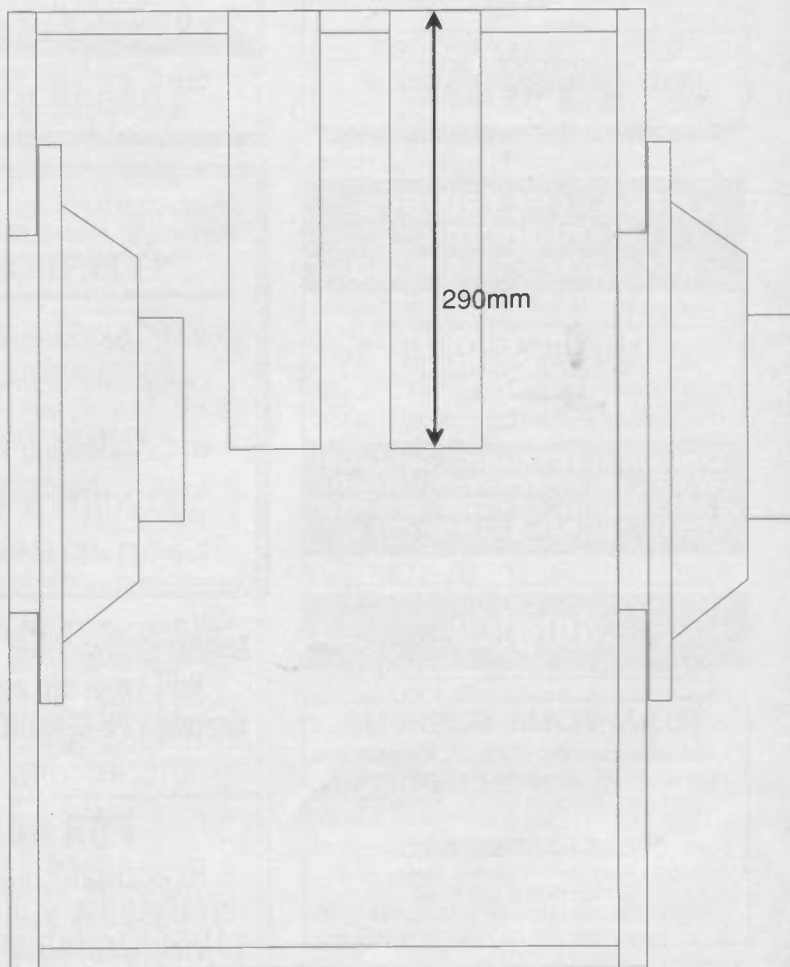
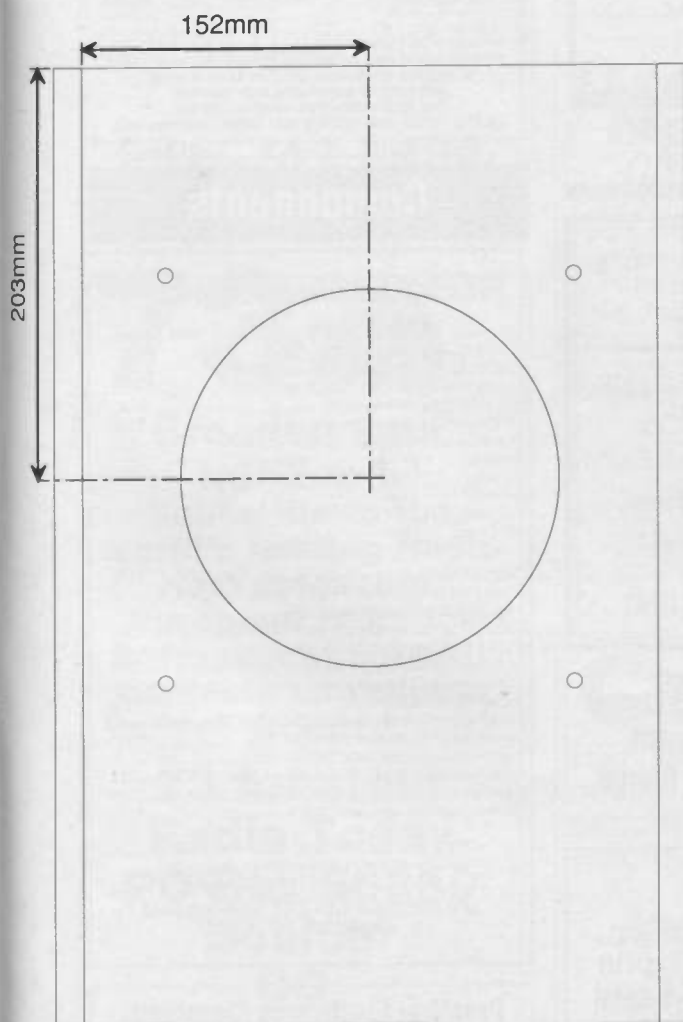

Practical Electronics Classifieds

Reach thousands of serious electronics enthusiasts with your message. Send your advertisement of up to 30 words along with a cheque for £8.23 (£7 plus VAT). Alternatively write down the number and expiry date of your Access or Visa card. For longer advertisements or semi-display (boxed advertisements), contact our ad. department on 081-743 8888. Send to *Practical Electronics Classifieds, Intra House, 193 Uxbridge Road, London W12 9RA*

Education

Start training now for the following courses.

- Telecomms Tech C&G 271
- Radio Amateur Licence C&G
- Microprocessor
- Introduction to Television

Send for our brochure - without obligation or telephone us on 06267 79398 (Ref: PE5/92)

Name.....
.....

Radio & Telecommunications
Correspondence School,
12 Moor View Drive, Teignmouth,
Devon TQ14 9UN

BTEC ELECTRONICS TECHNICIAN FULL-TIME TRAINING

THOSE ELIGIBLE CAN APPLY FOR E.T. GRANT SUPPORT
AN EQUAL OPPORTUNITIES PROGRAMME

O.N.C. H.N.C. O.N.D.

Next Course Commences
6th June 1992

FULL PROSPECTUS FROM

LONDON ELECTRONICS COLLEGE
(DEPT. EE) 20 PENYERN ROAD
EARLS COURT, LONDON SW5 9SU
TEL 071-373 8721

Surplus

TURN YOUR SURPLUS

ICS transistors etc into cash, immediate settlement. WE welcome the opportunity to quote for complete factory clearance.

Contact:

COLES-HARDING & CO.,

103 South Brink, Wisbech, Cambs.

ESTABLISHED 15 YEARS

Tel: 0945 584188 - Fax: 0945 588844

Recycle your old projects and generate useful cash from spare components

Retailers

**Project your
retail image
here!**



Phone David Bonner
for details on
081-743-8888

LONDON N WEST

CRICKLEWOOD ELECTRONICS

*One of the largest ranges of
components in the UK!*

40 Cricklewood Broadway,
LONDON NW2 3ET

Tel: 081-450 0995/452 0161

Modernising your workshop?

**Sell your old equipment
through PE Classifieds pages.**

FOR SALE

Practical Electronics
in Binders volumes one
(1965) to ten (1974) and
later loose copies. Offers
for lot (0905) 54318.

Computer Parts

CAMBRIDGE COMPUTER SCIENCE LIMITED

LCD modules.....16 char by 1: £4.00, 20 char by 2: £6.00, 40 char by 1: £8.00	
3.5" 720K Diskette Drives	£29.00 each
10MByte Winchester, used, 3 months Wty	£35.00 each
5.25" Disk Drives, 80 Tk, D5DD	£25.00 each
5.25" Disk, D5DD, 48K, boxes of 10 (free disk cleaner with 5 boxes) £3.00/box	
PC (AT style) power supplies 200W (Used)	£25.00 each
Nicads AA £0.89, C £1.99, D £2.09, PP3 £4.99, Universal charger	£5.90 each
88008 CPUs (Ex Equipment)	£1.40 each
88020 CPUs (Ex Equipment)	£3.50 each
88020 CPUs (Ex Equipment)	£20.00 each
74LS TTL, pick and mix, buy 10 or more for	£1.12 each
Types available: '00 '02 '04 '06 '10 '11 '12 '13 '14 '15 '20 '21 '26 '27 '30 '32 '33	
'37 '38 '42 '74 '83 '85 '86 '98 '107 '109 '122 '125 '132 '136 '138 '139 '145 '151	
'153 '157 '158 '160 '162 '163 '164 '165 '174 '191 '193 '240 '253 '257 '280 '298	
'353 '365 '366 '373 '385 '390 '399 '870 '882	
.....	£1.20 each or £5.00/5
27128 EPROMS (Ex equipment)	£1.40 each
27C256 EPROMS (Ex equipment)	£1.40 each
27C512 EPROMS (Ex equipment)	£1.40 each
1MBit-10 DRAM (Ex equipment)	£1.40 each
256K Byte DRAM Modules, removed from equipment	£6.00 each
6116 2K Byte SRAM	£1.10 each
6264-12 8K Byte SRAM	£3.80 each
62256-10 32K Byte SRAM	£5.00 each
65256 32K Byte rams	£4.00 each
8K Byte NV ram chips £3.00 each	£10.00/40

Prices include postage. Add 50p (plus VAT) to orders below £5.00

All items new unless stated. Add 17.5% VAT to all prices.

Send an SAE for our latest list or for more info.

Dept PE, 374 Milton Road, Cambridge, CB4 1SU

Tel: 0223 424882, 0631 430488 or 0631 430652 (Mail order only)

Components

CATALOGUE £1.00 + 25 P&P

LEDs 3mm or 5mm red/green6p each. Yellow 11p each.	
High intensity red/green or yellow 5mm 30p each		
Cable ties 1p each £5.95/1,000 £49.50 per 10,000		
Stepping motor 4 phase 12V 7.5' step 50 ohms	£8.95	
SAA1027 stepping motor driver chip	£3.95	
FM Transmitter kit good quality sound	£8.60	
High quality photo resist copper clad epoxy glass boards		
Dimensions	single sided	double sided
3x4 inches	£ 0.95	£1.07
4x8 inches	£ 2.40	£2.68
6x12 inches	£ 5.37	-
12x12 inches	£10.66	-

Special Offers

Computer Grade Capacitors with screw terminals 38000uf 20V	£2.50
87,000uf 10V £1.95, 68,000uf 15V £2.95, 10,000uf 16V	£1.50
7 segment Common anode led display 12mm	£0.45
LM2931A T5.0 Low drop out 5V regulator T0220 package	£0.85
BS250 P channel MOSFET £0.45, BC559 transistor	£3.95 per 100
74LS05 hex inverter £10.00 per 100, used 8748 Microcontroller	£3.50
TV Main switch 4A double pole with momentary contacts for remote control pack of 10 £3.95 box of 60 £19.95.	
DC-DC converter Reliability model V12P5 12v in 5v 200ma out 300v input to output Isolation with data \$4.95 each or pack of 10	£39.95
Hour counter (used) 7 digit mains 240V AC 50Hz	£1.45
Resistor pack 2500 resistors 1/8-2W 50 different values	£8.95
Qwerty keyboard 58 key good quality switches new	£5.00
Qwerty keyboard with serial output, no data	£5.00

Wide range of CMOS TTL 74HC 74F Linear transistors kits

Rechargeable batteries, capacitor tools etc always in stock.

Please add 95p towards P&P - VAT Included

**JPG Electronics 276 - 278 Chatsworth Road
Chesterfield S40 2BH**

**Practical Electronics Classifieds
list the best sources for unusual or
back catalogue components**

Miscellaneous

UNIVERSAL PROGRAMMER Hi-Lo ALL-03 £295

Take advantage of Asian low labour cost!

- ★ Texas Instrument approved. Good quality.
- ★ PC based, programs stored into 5 diskettes.
- ★ Program most MPU, PLD, EPROM, EEPROM, BPROM.
- ★ Adaptors for PLCC devices are available.
- ★ 1 year guarantee. Money back if not satisfied.
- ★ Price includes postage but not VAT.

Write for free catalogue and price list.

Active Action Industrial Ltd
Rm 1307, Wing Tuck Coml Ctr.
177-183 Wing Lok Street
Hong Kong

Components

High Stability Resistors

Carbon Film Resistors 0.56R to 10MΩ E24 series 1/4W - 1p
100 off per value - 75p. 1000 off in even hundreds per value - £5.00
Metal Film 1/4W 10R0 to 1MΩ E12 series 5% - 2p. 1% E24 series - 3p
Mixed metal/carbon film 1/2W E24 series 1R0 to 10MΩ - 1 1/2p

Tantalum bead electrolytics subminiature (Mids/Volts)
0-135, 0.22/25, 0.47/35, 1.0/25, 2.2/25, 3.3/16, 3.3/20, 4.7/16 - 14p. 3.3/25, 4.7/25,
4.7/25 - 15p. 6.8/16, 6.8/35 - 16p. 10/16, 20/25 - 20p. 10/35, 22/16, 33/10, 47/10 - 30p.
100/6 - 30p. 100/16 - 50p. 220/6 - 60p.

Aluminium Electrolytics (Mids/Volts)

150, 2.2/50, 4.7/50, 10/16, 10/25, 10/50 - 5p. 22/16, 22/25, 22/50, 47/16, 47/25, 47/50 -
6p. 100/16, 100/25 - 7p. 100/50 - 12p. 220/16 - 8p. 220/25, 220/50 - 10p. 470/16,
470/25 - 11p. 1000/16 - 15p. 1000/25 - 18p. 2200/25 - 22p.

Miniature Polyester Capacitors 250V Wkg. Vertical Mounting

.01, .015, .022, .033, .047, .068 - 4p. 0.1 - 5p. 0.15, 22 - 6p.

Mylar Capacitors 100V Wkg. Vertical Mounting E12 Series

1000p to 8200p - 3p. 0.01 to .068 - 4p. 0.1 - 5p. 0.15, 22 - 6p.

Subm. Ceramic Plate 100V Wkg. E12 Series Vertical Mounting

2% IP8 to 47P - 3p. 56P to 330P - 4p. 10% 390P to 4700P - 4p.

Plate/disc ceramic 50V. Wkg. Vertical Mount. E12 series 1P0 to 1000P & E6 series 1500P to 47000P - 2p. 0.1 - 3p.

Polystyrene Capacitors 63V Wkg. E12 Series Axial Mounting

10P to 820P - 4p. 1000P to 10,000 - 5p. 12,000P - 6p.

Diodes

Zener diodes E24 series 3V3 to 33V 400mW - 8p. 1 watt - 12p. 1N4148 - 2p. 1N4001 -
3p. 1N4002 - 3.5p. 1N4007 - 5p. 1N5404 - 14p. OA91 - 8p. AA143 - 10p. W005 - 20p.
W01 - 25p. BYX10 - 6p.

L.E.'s Red, Green & Yellow 3mm & 5mm - 10p. 8mm - 35p.

20mm fuses 0.15A to 10A quick blow - 5p. 0.1A to 5A Anti Surge - 8p.

High Speed drills 0.8mm, 1.0mm, 1.3mm, 1.5mm, 2mm - 30p.

"Expo" Reliant drilling machines 12V d.c. with improved 3-jaw chuck - £7.00

Nicads AA - 90p. HP11 - £2. HP2 - £2.20. PP3 - £5 Universal chargers for all above

batteries - £8.50

Glass reed switches with single pole make contacts - 8p. Magnets - 12p. 0.1" stripboard
2.5" X 1" 9 rows 27 holes - 25p. 3.75" X 2.5" 24 rows 37 holes - 70p. Ionisers list price
£16.95 7 year guarantee - £12.00. Jack plugs 2.5mm & 3.5mm - 14p. Sockets panel
mg - 10p.

All prices VAT inclusive. Postage 30P (free over £5).

THE C.R. SUPPLY CO.
127 Chesterfield Road,
Sheffield S8 0RN.
Tel: 0742 557771

Greenweld Newslines 0891 505 121

Calls charged at 36p/min cheap rate, 48p/min other times

For a weekly update on our latest surplus bargains - call now!! Our latest list FREE from GREENWELD, 27 Park Road, Southampton SO1 3TB

SURPLUS/REDUNDANT ELECTRONICS COMPONENTS WANTED

ICs - Tuners - Transistors - Valves - Diodes etc - any quantity considered - immediate payment.

ADM ELECTRONICS SUPPLIES

Tel 0827 873311

Fax: 0827 874835

Contact

HST for all your component needs. Send for your free catalogue and details of special offers.

HST Ltd,
Technology House,
Prospect Road,
Carlton, Nottingham
NG4 6LA
Tel: 0602-587225
Fax: 0602-484530

Surveillance

Suma Designs
sell top quality
surveillance equipment
in kit form or as ready
built units.
See our full page
display ad in this issue





Cooke International

FOR SALE

Scopes, signal generators, power supplies, power meters, DVMs, oscillators, attenuators, used test equipment.

Contact: Cooke International, Unit Four Fordingbridge Site, Main Road, Barnham Bognor Regis, West Sussex PO22 0EB
Tel: 0243 545111 Fax: 0243 542457
Wide range of items available, send SAE for lists

SCOPES

Repaired and recalibrated. All makes, all models. Nationwide collection and delivery. Copies of handbooks and spares for most popular models, including golden oldies.

Phone Mendascope Ltd
069-172 597

Kits, Plans, Assembled Units, Surveillance Microtransmitters, Phone Recording Switches, Trackers, Defence /Protection Circuits, Plus much more. Send 2 x 24p stamps for lists, or tel. 05436 76477 24hrs. Everything for the budding 007. ACE(PE). 53 Woodland Way, Burntwood, Staffs. WS7 8UP.

Surveillance devices, lasers, Tesla coils, scramblers, ultrasonic and many more, over 150 designs. Send SAE to: Placentre, Old Wharf, Dynock Road, Ledbury HR8 2HS for free list.

NEW VHF MICROTRANSMITTER KIT, tuneable 80-135 MHz, 500 metre range, sensitive electret microphone, high quality PCB. SPECIAL OFFER complete kit ONLY £5.95, assembled and ready to use £9.95 post free. Access orders telephone 021 411 1821. Cheques/ P.O.'s to: Quantek Electronics Ltd, (Dept P.E.), 3

Classifieds can be a TIGHT SQUEEZE

Give your ad room to
breathe
in our

DISPLAY PAGES

Contact David Bonner
on
081-743 8888

73 AMATEUR RADIO TODAY

Broaden your
horizons.
Subscribe to the
world's leading Radio
Ham magazine.
European rates for
surface and air mail
available on request
from:

73 Amateur
Radio Today
PO Box 50330
Boulder
CO.
80321-0330
USA

Miscellaneous

VERY INTERESTING DESIGNS

FOR ALL REASONS AND ALL SEASONS

WIDE SELECTION OF EXTREMELY USEFUL KITS AND
READY-MADE PRODUCTS FOR HOME, WORKSHOP AND
OUTDOORS, AT REASONABLE PRICES

RING OR WRITE FOR FREE LITERATURE

BECKER SYSTEMS, DEPT PE25, 8 FINUCANE
DRIVE, ORPINGTON, KENT BR5 4ED.
TEL: 0689 837821 (24 HRS)

Houldey Road, West Heath,
Birmingham, B31 3HL

Super VHF Microtransmitters. Long range, high sensitivity. Tuneable 75-115 MHz. Listen on any FM radio. Assembled, ready to use. High quality, fully encased. Full instructions, guaranteed. Ideal Xmas presents as baby monitors etc. £9.50 post free. Cheques/POs; Mr B. Hicks, 24 Brewster Road, Boston, Lincs, PE21 0DY. Tel: 0205 362003

EPROM PROGRAMMING SERVICES. All sizes all makes up to 512kb. Data can be sent as written text or as data file on 3.5" or 5.25" f/disk, PC or AMIGA compatible. For details contact: W. Vincent, 159 Askew Road, London, W12 9AU, Tel. 081 749 7304

Oscilloscope 535A with two 1A1 plug-ins plus spares and manuals. Offers J.M. Wilson. Tel: 0532 505364

Amstrad 2086 PC. 30Mb hard disk, 3.5-inch floppy, mono VGA, mouse, manuals. VGC. £350 ovno. Some electronics books, rather old, £3 each. Phone Richard, 0895 810680 (Uxbridge)

IBM PC Public Domain Shareware sg: EE Draw 2.2, PCB CAD; PC Route 2. On 3.5 inch disk, £2.50. What's more, ham radio, loud speaker cross assembler. J.D. Soft. Tel: 061 430 5208

Wanted: Electronics engineer to make up small electrical component for a novice. Good fee paid. Surrey area. 0428 683733 after 6:30pm.

IBM PC PD/shareware, electronic and others. JD Soft. Tel: 061 4305208

Wanted: Does anyone have a software listing for Amstrad EPROM programmer published in PE April 1987, author Stephen Burkitt. Davies, 42 Seaview Park, Murcar, Bridge of Don, Aberdeen AB23 8BR

Miscellaneous

Missing a vital Practical Electronics back issue? Don't despair!

Reprints of articles and software listings are available for £2 each from Intra Press, Intra House, 193 Uxbridge Road, London W12 9RA, or by phone on 081 743 8888. We cannot accept credit card orders below £5 total value.

Babani Books: Diodes BP36 £1.95. LEDs BP42 and BP87 £1.95. Digital ICs BP58 £2.50.

Miscellaneous

Writing Classified Advertisements That Work

- ① Start by mentioning the product or service you are selling. By doing so, you make it easier for the reader to see what you are offering.
- ② Always include the price of whatever it is you are selling. Research has shown that 52% of people who read classified ads will not respond to advertisements that fail to include the price.
- ③ Keep abbreviations to a minimum. It makes whatever you have to say more easily understood.
- ④ Pretend to be your prospective customer. Ask yourself what it is you would like to know about the product or service that you are selling that would make you want to buy it. For example, you could include information such as brand names, colours and specifications.

Advertising Index

BK Electronics	IBC
Bull Electrical	51
Cricklewood Electronics	13
GH Systems	5
Happy Memories	16
Ice Technology	5
ICS	53
Jaytee Electronic Services	5
Lazerline	25
M&B Electrical	36
Mauritron	16
NCT	13
Northern Marketing Concepts	14,23
Number One Systems	10
Omni Electronics	53
Service Trading Company	53
Silica Systems	OBC
Stewart of Reading	53
Suma Designs	IFC
Top Secret Electronics	13

Techniques

Need an infra-red headphone link? Andrew Armstrong describes how it's done.

This month's query comes from reader David Williams in Monmouth who says: "I have seen the advertisements for infra-red cordless headphones. Is it difficult to build this kind of thing? Have you any suggestions how I should start?"

Infra-red cordless headphones normally work with a frequency-modulated squarewave infra-red signal. Most of those advertised seem to be monophonic and they use a single frequency, normally in the range 50 to 100kHz.

If stereo signals are to be transmitted, two modulating frequencies would be used, rather than one, but a single receiver diode would still be adequate.

Starting at the beginning, the circuit shown in Fig. 1 generates a frequency-modulated squarewave

which is used to switch three infra-red leds in order to generate an adequate amount of power for a reasonable range.

The audio input signal, assumed to be at approximately line level, is AC-coupled to a volume control and then fed to an op-amp giving a voltage gain of approximately four. The output signal from the op-amp is fed via a (possibly superfluous) protection resistor to the frequency control input of the VCO (Voltage Controlled Oscillator) section of a 4046 phase-locked loop chip. This is set to a centre-frequency of approximately 70kHz.

The squarewave output is used to drive a small power FET which switches the current to the infra-red emitters. Three are shown in this circuit, but more may be used if

more output signal is required. Almost any small power FET will do the job: VN46, VN66, most HEXFETs will all be suitable. If only two or three LEDs are required in the circuit, then a VN10 may be powerful enough.

This circuit should present few problems. The only point requiring special attention is that the earthing and decoupling must be commensurate with the sharp pulse currents drawn by the output stage. The decoupling capacitor should be near to the 4046 and it may be found necessary to add a small resistor, say 10Ω, in series with the power connection to the 4046, and then to add extra decoupling across its supply pins. Ground-plane construction would be ideal for this circuit.

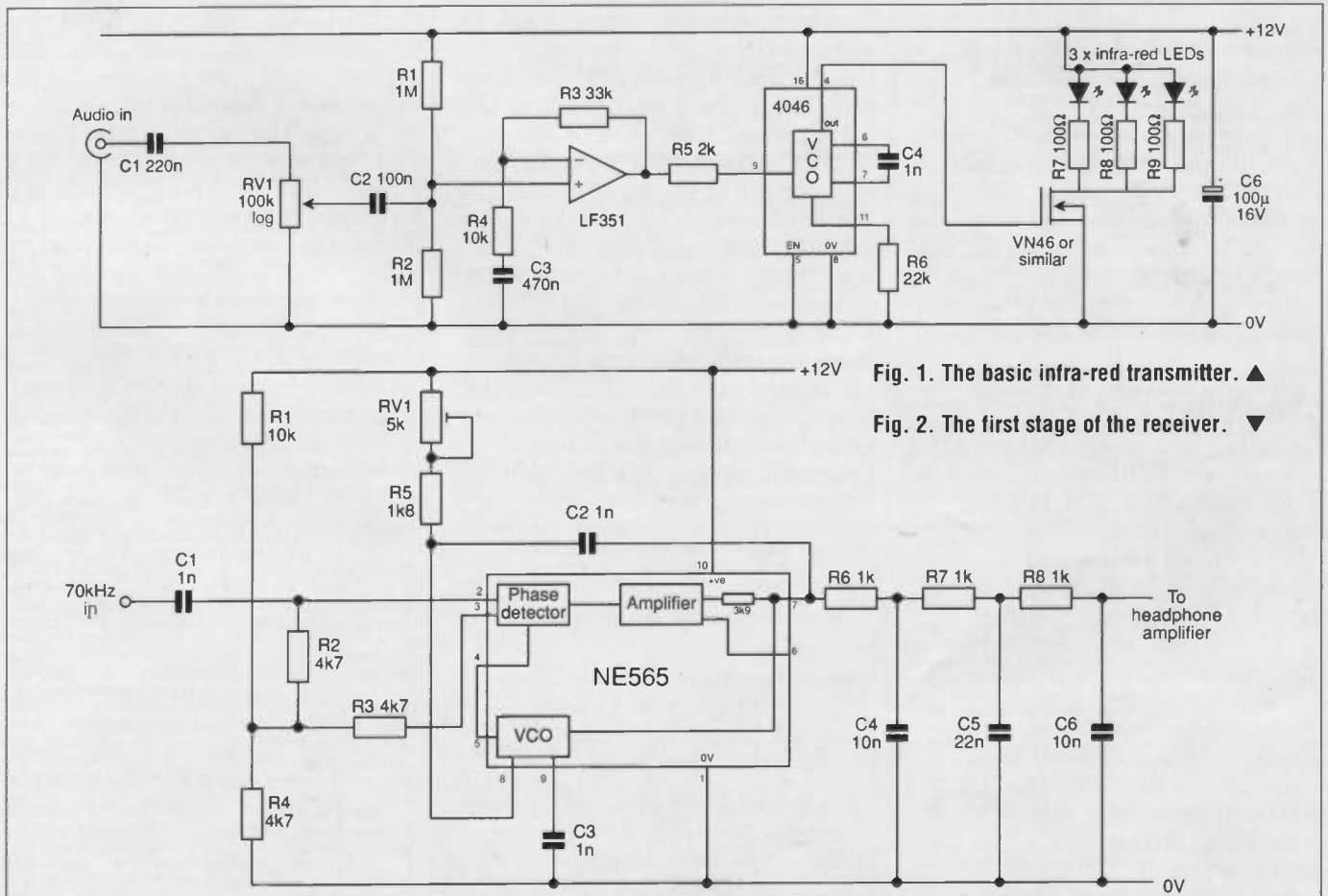

Fig. 1. The basic infra-red transmitter. ▲

Fig. 2. The first stage of the receiver. ▼

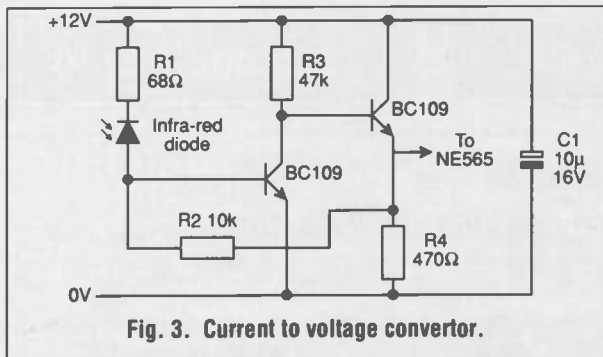

Fig. 3. Current to voltage convertor.

Demodulation

To demodulate the FM signal, another phase-locked loop is used. A 4046 could have been used for this job, but the NE565 is specifically intended for the task and is more linear. The demodulator circuit is shown in Fig 2.

The input signal is fed to the phase detector via a low-value capacitor to filter out any low-frequency noise that may be present. The phase detector inputs are biased by R1, R2, R3 and R4. Note that the signal inputs of the phase detector are differential, but only one half is used in this design.

The VCO is fed straight to the other half of the phase detector. The control signal for the VCO is connected internal to the chip. The frequency is set by RV1, R5 and C3. The demodulated audio output is filtered to remove unwanted high frequencies and is then fed to a headphone amplifier. Any conventional low-power amplifier design can be used as the headphone amplifier. For example, the LM386 power amp IC is ideal for the purpose, and readers can follow the application note normally provided with the chip.

Receiving

Reception and amplification of the modulated 70kHz infra-red is slightly more tricky, because the signal from the photo-diode will be of a low amplitude, and because most low-cost op-amps will not give usable gain at that frequency. For this reason, discrete transistor designs are required. Figs. 3 and 4 show two possible alternatives to serve as a starting point for experimentation. It is emphasised that these

circuits, in common with all Techniques designs, have not been prototyped, and may require some experimentation to make them work as intended. This is more true of analogue circuits than of digital ones.

The circuit of Fig. 3

is effectively a current-to-voltage converter, working on the current in the photo-diode. The bias point of the circuit is stabilised by the feedback resistor which also sets the gain, in this case 10 V/mA. It may be found by experiment that extra gain is required to achieve the desired range, in which case the amplification part of the circuit of Fig.4 might be suitable. If this is to be used as a second amplifier stage, the signal should be fed in via the 1nF capacitor C2.

The circuit of Fig. 4 converts the output of the infra-red photodiode to a voltage directly and then amplifies the voltage. The diode is biased to approximately half the supply voltage by Q1. The collector voltage is set by the base-emitter voltage, and the ratio of R1 and R2. In order to allow the voltage to vary at the signal frequency, the base is decoupled via C1, so that the gain of the circuit starts to fall off at around 10kHz.

The signal from the photodiode is amplified by a fairly conventional two-transistor amplifier, whose voltage gain is set by the feedback network comprising R7, R6, R8 and C3. The DC gain is approximately 6, while the AC gain is increased by R8 and C3 to approximately 30 at the signal frequency. The resistor values are calculated to bias the output to approximately half the supply

voltage, but the value of R3 may need to be altered by experiment if the correct output voltage is not at first achieved. In any event, a 12 V supply is shown for this circuit, and if another voltage is considered more convenient, then values must definitely be recalculated.

Setting Up

If an oscilloscope is available, the first thing to check is that the circuit of Fig. 1 is providing a squarewave somewhere in the range 50 to 100kHz, whose frequency is varied by the input signal. Failing this, an AC voltmeter coupled via a capacitor can indicate the presence of a signal, even if the voltmeter is not efficient at 70kHz.

Assuming that the frequency modulated signal is being generated correctly, the next step is to test the demodulator by joining the 0V lines of the transmitter and the demodulator together, and coupling the output signal from the VCO to the NE565 via a 10 to 1 resistive attenuator. Measure the voltage on pin 7 of the NE565 while adjusting RV1, and set RV1 so that the voltage is in the middle of its range of variation. Then, apply a signal to the audio input of the transmitter, and check that the demodulated audio is present on the output of the demodulator.

When the transmitter and demodulator are working, the photodiode and receiver preamplifier should be connected to the receiver, and tests carried out to optimise the preamplifier performance to achieve a reasonable range. Even if the circuit is working badly, a very short range should be attainable, and component values can be adjusted to improve this.

If a stereo headphone unit is required, two transmitters and two demodulators are required, but the preamplifier and detector diode can be common. Widely differing and non-harmonically related frequencies should be chosen to avoid cross-channel interference.

The sound quality from this design should be very good, though it will probably fall short of strict hifi quality. ■

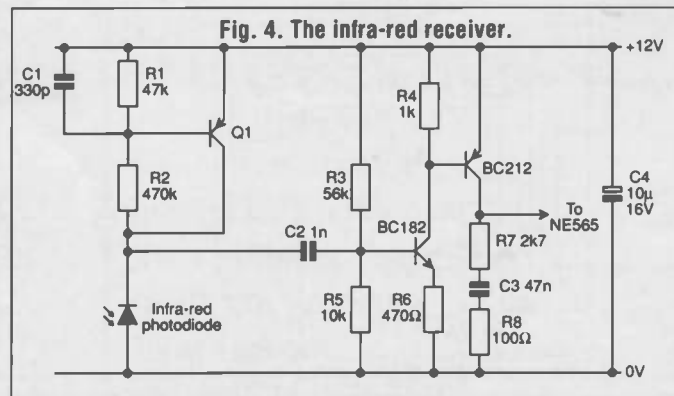

Fig. 4. The infra-red receiver.

AMSTRAD PORTABLE PC'S FROM £149 (PPC1512SD), £179 (PPC1512DD), £179 (PPC1640SD), £209 (PPC1640DD). MODEMS £30 EXTRA. NO MANUALS OR PSU.

HIGH POWER CAR SPEAKERS. Stereo pair output 100w each, 4ohm impedance and consisting of 6 1/2" woofer 2" mid range and 1" tweeter. Ideal to work with the amplifier described above. Price per pair £30.00 Order ref 30P7R.

2KV 500 WATT TRANSFORMERS Suitable for high voltage experiments or as a spare for a microwave oven etc. 250v AC input. Now only £4.00 ref 4P157

MICROWAVE CONTROL PANEL. Mains operated, with touch switches. Complete with 4 digit display, digital clock, and 2 relay outputs one for power and one for pulsed power (programmable). Ideal for all sorts of precision timer applications etc. Now only £4.00 ref 4P151.

FIBRE OPTIC CABLE. Stranded optical fibres sheathed in black PVC. Five metre length £7.00 ref 7P29R

12V SOLAR CELL. 200mA output ideal for trickle charging etc. 300 mm square. Our price £15.00 ref 15P42R

PASSIVE INFRA-RED MOTION SENSOR. Complete with daylight sensor, adjustable lights on timer (8 secs -15 mins), 50' range with a 90 deg coverage. Manual override facility. Complete with wall brackets, bulb holders etc. Brand new and guaranteed. Now only £19.00 ref 19P29

Pack of two PAR38 bulbs for above unit £12.00 ref 12P43R

VIDEO SENDER UNIT Transmits both audio and video signals from either a video camera, video recorder or computer to any standard TV set within a 100' range (tune TV to a spare channel). 12V DC op. £15.00 ref 15P39R Suitable mains adaptor £5.00 ref 5P19R

FM TRANSMITTER housed in a standard working 13A adapter (bug is mains driven). £26.00 ref 26P2R

MINIATURE RADIO TRANSCEIVERS A pair of walkie talkies with a range of up to 2 kilometres. Units measure 22x52x155mm. Complete with cases. £30.00 ref 30P12R

FM CORDLESS MICROPHONE. Small hand held unit with a 500' range/2 transmit power levels reqs PP3 battery. Tuneable to any FM receiver. Our price £15 ref 15P42AR

12 BAND COMMUNICATIONS RECEIVER. 9 short bands, FM, AM and LW DX/local switch, tuning 'eye' mains or battery. Complete with shoulder strap and mains lead NOW ONLY £19.00 REF 19P14R.

CAR STEREO AND FM RADIO. Low cost stereo system giving 5 watts per channel. Signal to noise ratio better than wow and flutter less than .35%. Neg earth. £25.00 ref 25P21R

LOW COST WALKIE TALKIES. Pair of battery operated units with a range of about 200'. Our price £8.00 a pair ref 8P50R

7 CHANNEL GRAPHIC EQUALIZER. plus a 60 watt power amp 20-21KHz 4-8R 12-14V DC negative earth. Cased. £25 ref 25P14R.

NICAD BATTERIES. Brand new top quality. 4 x AA's £4.00 ref 4P44R. 2 x C's £4.00 ref 4P73R. 4 x D's £9.00 ref 9P12R. 1 x PP3 £6.00 ref 6P35R

TOWERS INTERNATIONAL TRANSISTOR SELECTOR GUIDE. The ultimate equivalents book. Latest edition £20.00 ref 20P32R.

CABLE TIES. 142mm x 3.2mm white nylon pack of 100 £3.00 ref 3P104R. Bumper pack of 1,000 ties £14.00 ref 14P6R

1992 CATALOGUE AVAILABLE NOW
IF YOU DO NOT HAVE A COPY PLEASE REQUEST ONE
WHEN ORDERING OR SEND US A 6"x9" SAE FOR A FREE COPY.

GEIGER COUNTER KIT. Complete with tube, PCB and all components to build a battery operated geiger counter. £39.00 ref 39P1R

FM BUG KIT. New design with PCB embedded coil. Transmits to any FM radio. 9v battery req'd. £5.00 ref 5P158R

FM BUG Built and tested superior 9v operation £14.00 ref 14P3R

COMPOSITE VIDEO KITS. These convert composite video into separate H sync, V sync and video. 12v DC. £8.00 ref 8P39R

SINCLAIR C5 MOTORS 12v 29A (full load) 3300 rpm 6"x4" 1/4" O/P shaft. New. £20.00 ref 20P22R.

As above but with fitted 4 to 1 inline reduction box (800rpm) and toothed nylon belt drive cog £40.00 ref 40P8R.

SINCLAIR C5 WHEELS 13" or 16" dia including treaded tyre and inner tube. Wheels are black, spoked one piece poly carbonate. 13" wheel £6.00 ref 6P20R. 16" wheel £6.00 ref 6P21R.

ELECTRONIC SPEED CONTROL KIT for C5 motor. PCB and all components to build a speed controller (0-95% of speed). Uses pulse width modulation. £17.00 ref 17P3R.

SOLAR POWERED NICAD CHARGER. Charges 4 AA nicads in 8 hours. Brand new and cased £6.00 ref 6P3R

12 VOLT BRUSHLESS FAN. 1/2" square brand new ideal for boat, car, caravan etc. £5.00 ref 5P206.

ACORN DATA RECORDER ALF503. Made for BBC computer but suitable for others. Includes mains adaptor, leads and book. £15.00 ref 15P43R

VIDEO TAPES. Three hour superior quality tapes made under licence from the famous JVC company. Pack of 5 tapes New low price £8.00 ref 8P161

PHILIPS LASER. 2MW HELIUM NEON LASER TUBE. BRAND NEW FULL SPEC £40.00 REF 40P10R. MAINS POWER SUPPLY KIT £20.00 REF 20P33R READY BUILT AND TESTED LASER IN ONE CASE £75.00 REF 75P4R.

VGA PAPER WHITE MONO monitors new and cased 240v AC. £59.00 ref 59P4R

25 WATT STEREO AMPLIFIER. c. STK043. With the addition of a handful of components you can build a 25 watt amplifier. £4.00 ref 4P69R (Circuit dia included).

BARGAIN NICADS AAA SIZE 200MAH 1.2V PACK OF 10 £4.00 REF 4P92R, PACK OF 100 £30.00 REF 30P16R

FRESNEL MAGNIFYING LENS 83 x 52mm £1.00 ref BD827R.

ALARM TRANSMITTERS. No data available but nicely made complex radio transmitters 9v operation. £4.00 each ref 4P81R.

12V 19A TRANSFORMER. Ex equipment but otherwise ok. Our price £20.00

GX4000 COMPUTERS. Customer returned games machines complete with plug in game, joysticks and power supply. Retail price is almost £100. Ours is £12.00 ref B12P1

ULTRASONIC ALARM SYSTEM. Once again in stock these units consist of a detector that plugs into a 13A socket in the area to protect. The receiver plugs into a 13A socket anywhere else on the same supply. Ideal for protecting garages, sheds etc. Complete system £25.00 ref B25P1 additional detectors £11.00 ref B11P1

IBM XT KEYBOARDS. Brand new 86 key keyboards £5.00 ref 5P612

IBM AT KEYBOARDS Brand new 86 key keyboards £15.00 ref 15P612

386 MOTHER BOARDS. Customer returned units without a cpu fitted. £22.00 ref A22P1

COLOUR MONITORS

AMSTRAD CTM644

RGB INPUT

£75.00 REF A75P1

286 MOTHER BOARDS. Brand new but customer returns so may need attention. Complete with technical manual £20.00 ref A20P2

286 MOTHER BOARDS. Brand new and tested complete with technical manual. £49.00 ref A49P1

UNIVERSAL BATTERY CHARGER Takes AA's, C's, D's and PP3 nicads. Holds up to 5 batteries at once. New and cased, mains operated. £6.00 ref 6P36R.

IN CAR POWER SUPPLY. Plugs into cigar socket and gives 3,4,5,6,7,9, and 12v outputs at 800mA. Complete with universal spider plug. £5.00 ref 5P167R.

RESISTOR PACK. 10 x 50 values (500 resistors) all 1/4 watt 2% metal film. £5.00 ref 5P170R.

CAPACITOR PACK 10 x 1000

MIRACOM WS4000 MODEMS

V21/23

AT COMAND SET

AUTODIAL/AUTOANSWER

FULL SOFTWARE CONTROL

TONE AND PULSE DIALLING

£29

WASHING MACHINE PUMP. Mains operated new pump. Not self priming. £5.00 ref 5P18R.

IBM PRINTER LEAD. (D25 to centronics plug) 2 metre parallel. £5.00 ref 5P186R.

COPPER CLAD STRIP BOARD 17"x4" of 1" pitch "vero" board. £4.00 a sheet ref 4P62R 2 sheets for £7.00 ref 7P22R.

STRIP BOARD CUTTING TOOL £2.00 ref 2P352R.

50 METRES OF MAINS CABLE £3.00 2 core black precut in convenient 2 m lengths. Ideal for repairs and projects. ref 3P91R

4 CORE SCREENED AUDIO CABLE 24 METRES £2.00 Pre-cut into convenient 1.2 m lengths. Ref 2P365R

TWEETERS 2 1/4" DIA 8 ohm mounted on a smart metal plate for easy fixing £2.00 ref 2P366R

COMPUTER MICE Originally made for Future PC's but can be adapted for other machines. Swiss made £8.00 ref 8P57R. Atari ST conversion kit £2.00 ref 2P362R.

6 1/2" 20 WATT SPEAKER Built in tweeter 4 ohm £5.00 ref 5P205R

ADJUSTABLE SPEAKER BRACKETS Ideal for mounting speakers on internal or external corners, uneven surfaces etc. 2 for £5.00 ref 5P207R

WINDUP SOLAR POWERED RADIO FM/AM radio takes rechargeable batteries complete with hand charger and solar panel 14P200R

240 WATT RMS AMP KIT Stereo 30-0-30 psu required £40.00 ref 40P200R

300 WATT RMS MONO AMP KIT £55.00 Psu required ref 55P200

BULL ELECTRICAL

250 PORTLAND ROAD HOVE SUSSEX
BN3 5QT TELEPHONE 0273 203500
MAIL ORDER TERMS: CASH PO OR CHEQUE
WITH ORDER PLUS £3.00 POST PLUS VAT.

PLEASE ALLOW 7 - 10 DAYS FOR DELIVERY

NEXT DAY DELIVERY £8.00

FAX 0273 23077



ALARM PIR SENSORS Standard 12v alarm type sensor will interface to most alarm panels. £16.00 ref 16P200

ALARM PANELS 2 zone cased keypad entry, entry exit time delay etc. £18.00 ref 18P200

MODEMS FOR THREE POUNDS!!
Fully cased UK modems designed for dial up system (PSTN) no data or info but only £3.00 ref 3P145R

TELEPHONE HANDSETS
Bargain pack of 10 brand new handsets with mic and speaker only £3.00 ref 3P146R

BARGAIN STRIPPERS
Computer keyboards. Loads of switches and components excellent value at £1.00 ref CD40R

DATA RECORDERS
Customer returned mains battery units built in mic ideal for Computer or general purpose audio use. Price is £4.00 ref 4P100R

SPECTRUM JOYSTICK INTERFACE
Plugs into 48K Spectrum to provide a standard Atari type joystick port. Our price £4.00 ref 4P101R

ATARI JOYSTICKS
Ok for use with the above interface, our price £4.00 ref 4P102R

BENCH POWER SUPPLIES
Superbly made fully cased (metal) giving 12v at 2A plus a 6V supply. Fused and short circuit protected. For sale at less than the cost of the case! Our price is £4.00 ref 4P103R

SPEAKER WIRE
Brown twin core insulated cable 100 feet for £2.00 REF 2P79R

MAINS FANS
Brand new 5" x 3" complete with mounting plate quite powerful and quiet. Our price £1.00 ref CD41R

DISC DRIVES
Customer returned units mixed capacities (up to 1.44M) We have not sorted these so you just get the next one on the shelf. Price is only £7.00 ref 7P1R (worth it even as a stripper)

HEX KEYBOARDS
Brand new units approx 5" x 3" only £1.00 each ref CD42R

PROJECT BOX
5 1/2" x 3 1/2" x 1" black ABS with screw on lid. £1.00 ref CD43R

SCART TO SCART LEADS
Bargain price leads at 2 for £3.00 ref 3P147R

SCART TO D TYPE LEADS
Standard Scart on one end, Hi density D type on the other. Pack of ten leads only £7.00 ref 7P2R

OZONE FRIENDLY LATEX
250ml bottle of liquid rubber sets in 2 hours. Ideal for mounting PCB's fixing wires etc. £2.00 each ref 2P379R

QUICK SHOTS
Standard Atari compatible hand controller (same as joysticks) our price is 2 for £2.00 ref 2P380R

VIEWDATA SYSTEMS
Brand new units made by TANDATA complete with 1200/75 built in modem infra red remote controlled qwerty keyboard BT approved Prestel compatible, Centronics printer port RGB colour and composite output (works with ordinary television) complete with power supply and fully cased. Our price is only £20.00 ref 20P1R

AC STEPDOWN CONVERTOR
Cased units that convert 240v to 110v 3" x 2" with mains input lead and 2 pin American output socket (suitable for resistive loads only) our price £2.00 ref 2P381R

SPECTRUM +3 LIGHT GUN PACK
complete with software and instructions £8.00 ref 8P58R

CURLY CABLE
Extends from 8" to 6 feet! D connector on one end, spade connectors on the other ideal for joysticks etc (6 core) £1.00 each ref CD44R

COMPUTER JOYSTICK BARGAIN
Pack of 2 joysticks only £2.00 ref 2P382R

BUGGING TAPE RECORDER
Small hand held cassette recorder that only operate when there is sound then turn off 6 seconds after so you could leave it in a room all day and just record any thing that was said. Price is £20.00 ref 20P3R

IEC MAINS LEADS
Complete with 13A plug our price is only £3.00 for TWO! ref 3P148R

COMPUTER SOFTWARE BARGAIN
10 cassettes with games for commodore 64, Spectrum etc. Our bargain price one pound! ref CD44R

NEW SOLAR ENERGY KIT
Contains 8 solar cells, motor, tools, fan etc plus educational booklet. Ideal for the budding enthusiasts! Price is £12.00 ref 12P2R

POTENTIOMETER PACK NO 1
30 pots for £3.00! ideal for projects etc. Ref CD45R

286 AT PC
286 MOTHER BOARD WITH 640K RAM FULL SIZE METAL CASE, TECHNICAL MANUAL, KEYBOARD AND POWER SUPPLY £139 REF 139P1 (no i/o cards or drives included) Some metal work req'd phone for details.

35MM CAMERAS Customer returned units with built in flash and 28mm lens 2 for £8.00 ref 8P200

STEAM ENGINE Standard Mamod 1332 engine complete with boiler piston etc £30 ref 30P200

TALKING CLOCK
LCD display, alarm, battery operated. Clock will announce the time at the push of a button and when the alarm is due. The alarm is switchable from voice to a cack crowing! £14.00 ref 14P200R

HANDHELD TONE DIALLERS
Small units that are designed to hold over the mouth piece of a telephone to send MF dialling tones. Ideal for the remote control of answer machines. £5.00 ref 5P209R

COMMODORE 64 MICRODRIVE SYSTEM
Complete cased brand new drives with cartridge and software 10 times faster than tape machines works with any Commodore 64 setup. The original price for these was £49.00 but we can offer them to you at only £25.00! REF 25P1R

USED SCART PLUGS
Pack of 10 plugs suitable for making up leads only £5.00 ref 5P209R

C CELL SOLAR CHARGER
Same style as our 4 x AA charger but holds 2 C cells. Fully cased with flip top lid. Our price £8.00 Ref 6P79R

IN SUSSEX? CALL IN AND SEE US!

Continued from page 54

program told me this was far too much, and a waste of memory. The software still froze and crashed.

By contrast the Guardian on CD-ROM is a dream to use. But it took the makers, Chadwyck-Healey of Cambridge, a long time to get there. The first discs the company released, a patent database, were a nightmare to use, with the sales team clearly trained to sell paper and hopelessly out of their depth on ROM publishing.

The publishers of the Indie disc, Bowker-Sauer, and people on the Indie now acknowledge that I am by no means the only user to throw up my hands in horror and give up trying to use their ROM. But no attempt seems to have been made to warn potential customers. Is it any wonder that CD-ROM remains a great missed opportunity?

CD-ROM cannot become the consumer product which the Frost and Sullivan report predicts until the industry grasps the consumer principle of "buy and play" or "plug and go". Any CD-ROM disc then plays on any drive, without the need to make any adjustments or modifications to the controlling PC.

So far there is only one company with a "plug and go" policy on CD-ROM, and that is Nimbus. Often working for third party publishers, Nimbus produces most of the CD-ROMs available in this country. Wherever possible, the ROM disc contains all the search software needed to use the information stored on the disc. No installation is needed.

The long term answer may well be a standalone ROM system, like Sony's Data Discman. This has the search software permanently stored inside, on ROM chips. The discs or Electronic Books carry no software, so there is no installation and no setting up to be done. DD is a true buy-and-play system.

But publishers are not anxious to invest in mastering electronic software for a format which sold like hot cakes in Japan during its first six months and much less well in the USA. Data Discman works well but the small monochrome LCD screen is very hard to use. The publishers were thus reassured by Sony's pledge to make Electronic Books compatible with the CD-I consumer interactive CD system which Philips has now launched in the USA and will launch in Europe this summer.

But Sony has not yet honoured this pledge. When Data Discman is launched in the UK this April, the Electronic Books launched with it will not be compatible with the CD-I players in the pipeline from Philips. ■

MMC THE NAME IN
INNOVATIVE
COMMUNICATION
PRODUCTS

NORTHERN MARKETING CONCEPTS
UNIT 1, 26 WOODLANDS ROAD, RILLINGTON, MALTON, NORTH YORKSHIRE, YO17 8LD
TELEPHONE: 09442-8887 MON-SAT 9-6 CALLERS BY APPOINTMENT ONLY

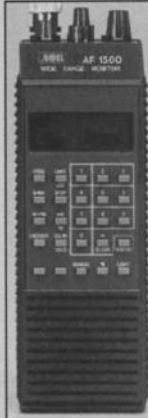

AR1500

The AR1500 is a hand held wide band receiver featuring SSB as standard, many said it couldn't be done! Coverage is from 500kHz to 1300MHz with no gaps. Channel steps are programmable in multiples of 5kHz and 12.5kHz. Modes available are NFM, WFM, AM and SSB (USB, LSB and CW with the BFO switched on). Many features have been carried across from the popular and reliable AR2000 receiver but fitted into an even smaller cabinet, the AR1500 truly has to be seen to be believed. There are 1000 memory channels and the usual AOR collection of search, lockout, priority etc. Power is from an internally fitted NiCad pack or from an external 12V D.C. source, all accessories are provided to enable you to switch on and start listening. All this from a small cabinet of approximately 170mm (H), 55mm (W), 45mm (D) including projections except aerial. The weight is a mere 345g with NiCads fitted.



AR3000A

The AR3000A is a follow on from the highly acclaimed AR3000. Many major improvements have been implemented at the request of enthusiasts. The tuning control is now 'free running' to provide a smooth feel for SSB/CW, x10 buttons have been added to make step size faster

and more convenient. All information is contained on the LCD instead of a separate status LED indication. The RS232 facility has a switch on the rear panel to enable/disable operation. Memory clear and full microprocessor reset functions are available from the front panel. The re-writing of microprocessor firmware using an even more efficient language has further increased scan and search speeds.



Radio Facsimile Terminal WX-2000

The WX2000 is a stand alone radio facsimile terminal designed to produce hard copy images from various facsimile services including weather charts, maps, news media and even satellite pictures from NOAA, GOES and METEOR etc. The WX2000 simply requires an audio signal from a shortwave or satellite receiver capable of receiving facsimile signals. The built-in high resolution (8 dots per mm) thermal line printer produces crisp images with high resolution. The WX2000 is also capable of simulating grey scale which is ideal for automatic picture transmission by weather satellites.

In addition to the basic functions, the WX2000 provides full operation controls such as auto start, sync, adjustment, position alignment, tuning LED etc., to produce the highest quality images. The power requirement is 12-13.5V D.C. @ 3A, this makes the WX2000 ideal for both on land and off shore applications.

Printing method: Thermal line printer 8 dots per mm. *Printing scale:* 2 (B/W) or 16, selectable. *Paper width:* A4 (210mm) x 30m. *Audio Input:* FM1900+/-400Hz 0.7V/600 OHM; AM 2400Hz 0-1V/600 OHM. *Auto start:* APSS type. *Synchronisation:* Independent type. *Reception speed:* 60, 90, 120 and 240 rpm, selectable. *Collaboration factor:* 576 or 288. *Power requirements:* 12-13.5V D.C. @ 3A. *Size:* 310mm (W) x 70mm (H) x 200mm (D)

OMP MOS-FET POWER AMPLIFIERS
HIGH POWER, TWO CHANNEL 19 INCH RACK

THOUSANDS PURCHASED BY PROFESSIONAL USERS



THE RENOWNED MXF SERIES OF POWER AMPLIFIERS
FOUR MODELS:- MXF200 (100W + 100W) MXF400 (200W + 200W)
MXF600 (300W + 300W) MXF900 (450W + 450W)

ALL POWER RATINGS R.M.S. INTO 4 OHMS, BOTH CHANNELS DRIVEN
FEATURES: ★ Independent power supplies with two toroidal transformers ★ Twin L.E.D. Vu meters ★ Level controls ★ Illuminated on/off switch ★ XLR connectors ★ Standard 775mV inputs ★ Open and short circuit proof ★ Latest Mos-Fets for stress free power delivery into virtually any load ★ High slew rate ★ Very low distortion ★ Aluminium cases ★ MXF600 & MXF900 fan cooled with D.C. loudspeaker and thermal protection.

USED THE WORLD OVER IN CLUBS, PUBS, CINEMAS, DISCOS ETC.

- SIZES:- MXF200 W19" x H3 1/2" (2U) x D11"
- MXF400 W19" x H5 1/4" (3U) x D12"
- MXF600 W19" x H5 1/4" (3U) x D13"
- MXF900 W19" x H5 1/4" (3U) x D14 1/2"

PRICES:- MXF200 £175.00 MXF400 £233.85
MXF600 £329.00 MXF900 £449.15
SPECIALIST CARRIER DEL. £12.50 EACH



OMP VARISPEED TURNTABLE CHASSIS

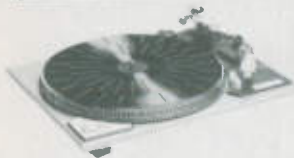

★ Manual arm ★ Steel chassis ★ Electronic speed control 33 & 45 R.P.M. ★ Vari pitch control ★ High torque servo driven DC motor ★ Transit screws ★ 12" die cast platter ★ Neon strobe ★ Calibrated balance weight ★ Removable head shell ★ 1/2" cartridge fixings ★ Cue lever ★ 220/240V 50/60Hz ★ 390x305mm ★ Supplied with mounting cut-out template.

PRICE £61.30 + £3.70 P&P

OPTIONAL MAGNETIC CARTRIDGES **STANTON AL500mkII** **GOLDRING G950**
PRICE £16.95 + 50p P&P PRICE £7.15 + 50p P&P

STEREO DISCO MIXER DJ6500

STEREO DISCO MIXER with 2 x 7 band L & R graphic equalisers with bar graph LED Vu meters. MANY OUTSTANDING FEATURES:- including Echo with repeat & speed control, DJ Mic with tone control & talk-over switch, 7 Channels with individual faders plus cross fade, Cue Headphone Monitor. Useful combination of the following inputs:- 3 turntables (mag), 3 mics, 5 Line for CD, Tape, Video etc.



★ WITH ECHO ★

Price £134.99 + £5.00 P&P

SIZE: 482 x 240 x 120mm

PIEZOELECTRIC TWEETERS - MOTOROLA

Join the Piezo revolution! The low dynamic mass (no voice coil) of a Piezo tweeter produces an improved transient response with a lower distortion level than ordinary dynamic tweeters. As a crossover is not required these units can be added to existing speaker systems of up to 100 watts (more if two are put in series. FREE EXPLANATORY LEAFLETS ARE SUPPLIED WITH EACH TWEETER.



TYPE 'A' (KSN1036A) 3" round with protective wire mesh. Ideal for bookshelf and medium sized Hi-Fi speakers. Price £4.90 + 50p P&P.
TYPE 'B' (KSN1005A) 3 1/2" super horn for general purpose speakers, disco and P.A. systems etc. Price £5.99 + 50p P&P.
TYPE 'C' (KSN1016A) 2" x 5" wide dispersion horn for quality Hi-Fi systems and quality discos etc. Price £6.99 + 50p P&P.
TYPE 'D' (KSN1025A) 2" x 6" wide dispersion horn. Upper frequency response retained extending down to mid-range (2KHz). Suitable for high quality Hi-Fi systems and quality discos. Price £9.99 + 50p P&P.
TYPE 'E' (KSN1038A) 3 1/4" horn tweeter with attractive silver finish trim. Suitable for Hi-Fi monitor systems etc. Price £5.99 + 50p P&P.
LEVEL CONTROL Combines, on a recessed mounting plate, level control and cabinet input jack socket. 85x85mm. Price £4.10 + 50p P&P.

OMP LINNET LOUSPEAKERS

THE VERY BEST IN QUALITY AND VALUE

Made especially to suit today's need for compactness with high output sound levels, finished in hard wearing black vinyl with protective corners, grille and carrying handle. Each unit incorporates a 12" driver plus high frequency horn for a full frequency range of 45Hz-20KHz. Both models are 8 Ohm impedance. Size: H20" x W15" x D12".

CHOICE OF TWO MODELS
POWER RATINGS QUOTED IN WATTS RMS FOR EACH CABINET
OMP 12-100WATTS (100dB) PRICE £163.50 PER PAIR
OMP 12-200WATTS (200dB) PRICE £214.55 PER PAIR
SPECIALIST CARRIER DEL. £12.50 PER PAIR



IN-CAR STEREO BOOSTER AMPS

THREE SUPERB HIGH POWER CAR STEREO BOOSTER AMPLIFIERS
150 WATTS (75 + 75) Stereo, 150W Bridged Mono
250 WATTS (125 + 125) Stereo, 250W Bridged Mono
400 WATTS (200 + 200) Stereo, 400W Bridged Mono
ALL POWERS INTO 4 OHMS
Features:
★ Stereo, bridgible mono ★ Choice of high & low level inputs ★ L & R level controls ★ Remote on-off ★ Speaker & thermal protection



150W £49.99 250W £99.99
400W £109.95 P&P £2.00 EACH

POSTAL CHARGES PER ORDER £1.00 MINIMUM. OFFICIAL ORDERS FROM SCHOOLS, COLLEGES, GOVT. BODIES, PLC. ETC. PRICES INCLUSIVE OF V.A.T. SALES COUNTER, VISA AND ACCESS ACCEPTED BY POST, PHONE OR FAX.

OMP MOS-FET POWER AMPLIFIER MODULES SUPPLIED READY BUILT AND TESTED.

These modules now enjoy a world-wide reputation for quality, reliability and performance at a realistic price. Four models are available to suit the needs of the professional and hobby market i.e. Industry, Leisure, Instrumental and Hi-Fi etc. When comparing prices, NOTE that all models include toroidal power supply, integral heat sink, glass fibre P.C.B. and drive circuits to power a compatible Vu meter. All models are open and short circuit proof.

THOUSANDS OF MODULES PURCHASED BY PROFESSIONAL USERS

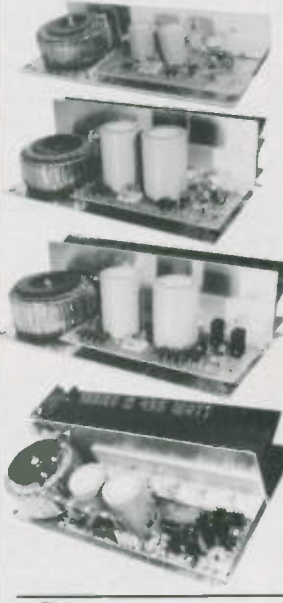

OMP/MF 100 Mos-Fet Output power 110 watts
R.M.S. into 4 ohms, frequency response 1Hz - 100KHz -3dB, Damping Factor >300, Slew Rate 45V/uS, T.H.D. typical 0.002%, Input Sensitivity 500mV, S.N.R. -110 dB. Size 300 x 123 x 60mm.
PRICE £40.85 + £3.50 P&P

OMP/MF 200 Mos-Fet Output power 200 watts
R.M.S. into 4 ohms, frequency response 1Hz - 100KHz -3dB, Damping Factor >300, Slew Rate 50V/uS, T.H.D. typical 0.001%, Input Sensitivity 500mV, S.N.R. -110 dB. Size 300 x 155 x 100mm.
PRICE £64.35 + £4.00 P&P

OMP/MF 300 Mos-Fet Output power 300 watts
R.M.S. into 4 ohms, frequency response 1Hz - 100KHz -3dB, Damping Factor >300, Slew Rate 60V/uS, T.H.D. typical 0.001%, Input Sensitivity 500mV, S.N.R. -110 dB. Size 330 x 175 x 100mm.
PRICE £81.75 + £5.00 P&P

OMP/MF 450 Mos-Fet Output power 450 watts
R.M.S. into 4 ohms, frequency response 1Hz - 100KHz -3dB, Damping Factor >300, Slew Rate 75V/uS, T.H.D. typical 0.001%, Input Sensitivity 500mV, S.N.R. -110 dB, Fan Cooled, D.C. Loudspeaker Protection, 2 Second Anti-Thump Delay. Size 385 x 210 x 105mm.
PRICE £132.85 + £5.00 P&P

NOTE: MOS-FET MODULES ARE AVAILABLE IN TWO VERSIONS: STANDARD - INPUT SENS 500mV, BAND WIDTH 100KHz. PEC (PROFESSIONAL EQUIPMENT COMPATIBLE) - INPUT SENS 775mV, BAND WIDTH 50KHz. ORDER STANDARD OR PEC.

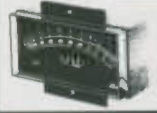

Vu METER Compatible with our four amplifiers detailed above. A very accurate visual display employing 11 L.E.D.s (7 green, 4 red) plus an additional on/off indicator. Sophisticated logic control for very fast rise and decay times. Tough moulded plastic case, with acrylic tinted front. Size 84 x 27 x 45mm.
PRICE £8.70 + 50p P&P

LOUDSPEAKERS

LARGE SELECTION OF SPECIALIST LOUSPEAKERS AVAILABLE, INCLUDING CABINET FITTINGS, SPEAKER GRILLES, CROSS-OVERS AND HIGH POWER, HIGH FREQUENCY BULLETS AND HORNS, LARGE (A4) S.A.E. (50p STAMPED) FOR COMPLETE LIST.
P - From McKenzie Professional Series
S - From McKenzie Studio Series

McKENZIE - INSTRUMENTS, P.A., DISCO, ETC

ALL MCKENZIE UNITS 8 OHMS IMPEDANCE
8" 100 WATT C8-100GP GEN. PURPOSE, LEAD GUITAR, EXCELLENT MID, DISCO. PRICE £31.45 + £2.00 P&P
RES. FREQ. 80Hz, FREQ. RESP. TO 7KHz, SENS 96dB.
10" 100WATT C10-100GP GUITAR, VOICE, KEYBOARD, DISCO, EXCELLENT MID. PRICE £38.89 + £2.50 P&P
RES. FREQ. 72Hz, FREQ. RESP. TO 6KHz, SENS 97dB.
10" 200WATT C10-200GP GUITAR, KEYB'D, DISCO, EXCELLENT HIGH POWER MID. PRICE £53.21 + £2.50 P&P
RES. FREQ. 69Hz, FREQ. RESP. TO 5KHz, SENS 97dB.
12" 100WATT C12-100GP HIGH POWER GEN. PURPOSE, LEAD GUITAR, DISCO. PRICE £40.35 + £3.50 P&P
RES. FREQ. 49Hz, FREQ. RESP. TO 7KHz, SENS 98dB.
12" 100WATT C12-100TC (TWIN CONE) HIGH POWER, WIDE RESPONSE, P.A., VOICE, DISCO. PRICE £41.39 + £3.50 P&P
RES. FREQ. 45Hz, FREQ. RESP. TO 12KHz, SENS 97dB.
12" 200WATT C12-200B HIGH POWER BASS, KEYBOARDS, DISCO, P.A. PRICE £71.91 + £3.50 P&P
RES. FREQ. 45Hz, FREQ. RESP. TO 5KHz, SENS 99dB.
12" 300WATT C12-300GP HIGH POWER BASS, LEAD GUITAR, KEYBOARDS, DISCO ETC. PRICE £95.66 + £3.50 P&P
RES. FREQ. 49Hz, FREQ. RESP. TO 7KHz, SENS 100dB.
15" 100WATT C15-100BS BASS GUITAR, LOW FREQUENCY, P.A., DISCO. PRICE £59.05 + £4.00 P&P
RES. FREQ. 40Hz, FREQ. RESP. TO 5KHz, SENS 98dB.
15" 200WATT C15-200BS VERY HIGH POWER BASS. PRICE £80.57 + £4.00 P&P
RES. FREQ. 40Hz, FREQ. RESP. TO 3KHz, SENS 98dB.
15" 250WATT C15-250BS VERY HIGH POWER BASS. PRICE £90.23 + £4.50 P&P
RES. FREQ. 39Hz, FREQ. RESP. TO 4KHz, SENS 99dB.
15" 400WATT C15-400BS VERY HIGH POWER, LOW FREQUENCY BASS. PRICE £105.46 + £4.50 P&P
RES. FREQ. 40Hz, FREQ. RESP. TO 4KHz, SENS 100dB.
18" 500WATT C18-500BS EXTREMELY HIGH POWER, LOW FREQUENCY BASS. PRICE £174.97 + £5.00 P&P
RES. FREQ. 27Hz, FREQ. RESP. TO 2KHz, SENS. 98dB.

EARBENDERS - HI-FI, STUDIO, IN-CAR, ETC

ALL EARBENDER UNITS 8 OHMS (Except EBB-50 & EB10-50 which are dual impedance tapped @ 4 & 8 ohm)
BASS, SINGLE CONE, HIGH COMPLIANCE, ROLLED SURROUND
8" 50watt EBB-50 DUAL IMPEDENCE, TAPPED 4/8 OHM BASS, HI-FI, IN-CAR. PRICE £8.90 + £2.00 P&P
RES. FREQ. 40Hz, FREQ. RESP. TO 7KHz SENS 97dB.
10" 50WATT EB10-50 DUAL IMPEDENCE, TAPPED 4/8 OHM BASS, HI-FI, IN-CAR. PRICE £13.65 + £2.50 P&P
RES. FREQ. 40Hz, FREQ. RESP. TO 5KHz, SENS. 99dB.
10" 100WATT EB10-100 BASS, HI-FI, STUDIO. PRICE £30.39 + £3.50 P&P
RES. FREQ. 35Hz, FREQ. RESP. TO 3KHz, SENS 96dB.
12" 100WATT EB12-100 BASS, STUDIO, HI-FI, EXCELLENT DISCO. PRICE £42.12 + £3.50 P&P
RES. FREQ. 26Hz, FREQ. RESP. TO 3 KHz, SENS 93dB.
FULL RANGE TWIN CONE, HIGH COMPLIANCE, ROLLED SURROUND
5 1/2" 60WATT EB5-60TC (TWIN CONE) HI-FI, MULTI-ARRAY DISCO ETC. PRICE £9.99 + £1.50 P&P
RES. FREQ. 63Hz, FREQ. RESP. TO 20KHz, SENS 92dB.
6 1/2" 60WATT EB6-60TC (TWIN CONE) HI-FI, MULTI-ARRAY DISCO ETC. PRICE £10.99 + £1.50 P&P
RES. FREQ. 38Hz, FREQ. RESP. TO 20KHz, SENS 94dB.
8" 60WATT EBB-60TC (TWIN CONE) HI-FI, MULTI-ARRAY DISCO ETC. PRICE £12.99 + £1.50 P&P
RES. FREQ. 40Hz, FREQ. RESP. TO 18KHz, SENS 89dB.
10" 60WATT EB10-60TC (TWIN CONE) HI-FI, MULTI ARRAY DISCO ETC. PRICE £16.49 + £2.00 P&P
RES. FREQ. 35Hz, FREQ. RESP. TO 12KHz, SENS 98dB.

TRANSMITTER HOBBY KITS

PROVEN TRANSMITTER DESIGNS INCLUDING GLASS FIBRE PRINTED CIRCUIT BOARD AND HIGH QUALITY COMPONENTS COMPLETE WITH CIRCUIT AND INSTRUCTIONS
3W TRANSMITTER 80-108MHz, VARICAP CONTROLLED PROFESSIONAL PERFORMANCE. RANGE UP TO 3 MILES. SIZE 38 x 123mm. SUPPLY 12V @ 0.5AMP. PRICE £14.85 + £1.00 P&P
FM MICRO TRANSMITTER 100-108MHz. VARICAP TUNED, COMPLETE WITH VERY SENS FET MIC, RANGE 100-300m. SIZE 56 x 46mm. SUPPLY 9V BATTERY. PRICE £8.99 + £1.00 P&P



PHOTO: 3W FM TRANSMITTER

B.K. ELECTRONICS

UNITS 1 & 5 COMET WAY, SOUTHOEN-ON-SEA, ESSEX. SS2 6TR.
Tel: 0702 - 527572 Fax: 0702 - 420243

GoldStar

QUALITY, PROFESSIONAL PC'S
AT AFFORDABLE PRICES

EVERY PC COMES WITH:
1 YEAR ON-SITE WARRANTY
VGA GRAPHICS AS STANDARD
FREE UK DELIVERY

GoldStar is a key division of the Lucky GoldStar Group, one of the world's largest international corporations, employing over 100,000 people with a turnover approaching £14 billion. GoldStar, with their unrivalled resources and technical ability, have manufactured and labelled computers for many of the world's leading computer companies for over 30 years! In fact, other PCs you may have been considering, because they have a different brand "name" on the outside, may well be a GoldStar on the inside!

Silica Systems, an official GoldStar appointed dealer, are pleased to recommend this comprehensive range which combines the very latest technology with years of manufacturing experience. GoldStar's quality and reliability coupled with the Silica Systems service, provide you with the perfect PC solution for the home, business or education. From an entry level 286 desktop workstation to a powerful 486 EISA tower system, Silica and GoldStar have the answer, at an affordable price!

286 12MHz £399^{+VAT}

- 12.5MHz 286 (Landmark 17MHz)
- 1Mb RAM (4Mb max on Motherboard)
- 2Mb RAM on Plus Series
- EMS (LIM 4.0)
- 42Mb, 130Mb or 210Mb IDE Hard Disk
- 3½" or 5¼" Floppy Disk Drive
- 3 Expansion Slots
- VGA (Paradise-1M) Graphics - 256K RAM
- Serial, Parallel & PS/2 Mouse Ports
- 12 Months On-site Maintenance
- DOS 4.01, DOS Shell, GW BASIC, EMS 4.0, & Utility Software
- PLUS SERIES (from £599), Includes:
 - Dual Floppy Disk Drives
 - Mouse, Mouse Mat & Windows 3
- Price - £399+VAT without Hard Drive

+£100 for VGA Mono Monitor
+£200 for VGA Colour Monitor

£499 WITH 42Mb HARD DRIVE



PLUS SERIES with GS1425 VGA Colour Monitor. Model Shown is GT212 286 12MHz

Model	PROCESSOR	RAM INC	MAX RAM ON BOARD	1 YEAR ON SITE	EXPA-N SION SLOTS	LANDMARK MHz	CO-PROCESSOR SOCKET	VGA		PLUS SERIES WITH DUAL FLOPPY, WINDOWS 3 & MOUSE				
								VIDEO RAM	COLOURS	NO HARD DISK + Single Floppy 3½" or 5¼"	42Mb HD + Single Floppy 3½" or 5¼"	42Mb HD + Dual Floppies 3½" & 5¼"	130Mb HD + Dual Floppies 3½" & 5¼"	210Mb HD + Dual Floppies 3½" & 5¼"
GT 212	286 12MHz	1½ Mb	4 Mb	●	3	17 MHz	287-10	PARADISE	16 Colours	£399	£499	£599*	£799*	£1099*
GT 316	386 16MHz	2 Mb	8 Mb	●	5	21 MHz	387-16	PARADISE	16 Colours	£599	£699	£799	£999	£1299
GS 318	386 20MHz	2 Mb	8 Mb	●	5	25 MHz	387-20	PARADISE	256 Colours	£699	£799	£899	£1099	£1399
GS 320	386 20MHz	2 Mb	10 Mb	●	8	25 MHz	387-20	OAK	16 Colours	—	—	£899	£1099	£1399
GS 347	386 25MHz	4 Mb	8 Mb	●	5	40 MHz	386-25	PARADISE	16 Colours	—	—	£1399	£1599	£1899
GS 335	386 33MHz	8 Mb	16 Mb	●	8	50 MHz	386-33	ATI Wonder	256 Colours	—	—	—	£2099	£2399
GS 425	486 25MHz	8 Mb	16 Mb	●	8	114 MHz	N/A	ATI Wonder	256 Colours	—	—	—	£3499	£3799

14" VGA MONITORS

MODEL NO	MONO/COLOUR	DOT PITCH	VGA	S-VGA	E-VGA	1 Yr On Site	Tilt & Swivel	EXC VAT	INC VAT
GS 1405	MONO	N/A	640x480	800x600	—	●	●	£100	£117.50
GS 1425	COLOUR	39mm	640x480	—	—	●	●	£200	£235.00
GS 1430	COLOUR	31mm	640x480	—	—	●	●	£230	£270.25
GS 1460	COLOUR	28mm	640x480	800x600	1024x768	●	●	£250	£293.75

OPTIONS

DESCRIPTION	EXC VAT	INC VAT
1Mb x9-bit SIMM Memory Board	£50	£58.75
287 -12MHz Maths Co-Processor - For GT 212	£100	£117.50
387dx-16MHz Maths Co-Processor - For GT 316	£85	£99.88
387dx-20MHz Maths Co-Processor - For GS 318	£100	£117.50

OPTIONS

DESCRIPTION	EXC VAT	INC VAT
387dx-20MHz Maths Co-Processor - For GS 320	£150	£176.25
387dx-25MHz Maths Co-Processor - For GS 347	£150	£176.25
387dx-33MHz Maths Co-Processor - For GS 335	£160	£188.00
337Mb SCSI Hard Disk Drive - 10.7ms Access	£999	£1173.83

SILICA SYSTEMS OFFER YOU

- **FREE OVERNIGHT DELIVERY:** On all hardware orders shipped in the UK mainland.
- **TECHNICAL SUPPORT HELPLINE:** Team of technical experts at your service.
- **PRICE MATCH:** We normally match competitors on a "Same product - Same price" basis.
- **ESTABLISHED 12 YEARS:** Proven track record in professional computer sales.
- **BUSINESS + EDUCATION + GOVERNMENT:** Volume discounts available for large orders.
- **SHOWROOMS:** Demonstration and training facilities at our London & Sidcup branches.
- **THE FULL STOCK RANGE:** All of your requirements from one supplier.
- **FREE CATALOGUES:** Will be mailed to you with offers and software/peripheral details.
- **PAYMENT:** By cash, cheque, all major credit cards, or extended payment plan.

Before you decide when to buy your new GoldStar PC, we suggest you think very carefully about WHERE you buy it. Consider what it will be like a few months after you have made your purchase, when you may require additional peripherals or software, or help and advice. And, will the company you buy from contact you with details of new products? At Silica Systems, we ensure that you will have nothing to worry about. We have been established for over 12 years and, with our unrivalled experience and expertise, we can now claim to meet our customers requirements with an understanding which is second to none. But don't just take our word for it. Complete and return the coupon now for our latest Free literature and begin to experience the "Silica Systems Service".

MAIL ORDER HOTLINE
081-309 1111

SILICA SYSTEMS



MAIL ORDER: 1-4 The Mews, Hatherley Rd, Sidcup, Kent, DA14 4DX Tel: 081-309 1111
Order Lines Open: Mon-Sat 9:00am-6:00pm No Late Night Opening Fax No: 081-308 0608

LONDON SHOP: 52 Tottenham Court Road, London, W1P 0BA Tel: 071-580 4000
Opening Hours: Mon-Sat 9:30am-6:00pm No Late Night Opening Fax No: 071-323 4737

LONDON SHOP: Selfridges (1st Floor), Oxford Street, London, W1A 1AB Tel: 071-629 1234
Opening Hours: Mon-Sat 9:30am-6:00pm Late Night: Thursday until 8pm Extension: 3914

SIDCUP SHOP: 1-4 The Mews, Hatherley Rd, Sidcup, Kent, DA14 4DX Tel: 081-302 8811
Opening Hours: Mon-Sat 9:00am-5:30pm Late Night: Friday until 7pm Fax No: 081-309 0017

To: Silica Systems, Dept PRNOW-1291-66, 1-4 The Mews, Hatherley Rd, Sidcup, Kent, DA14 4DX

PLEASE SEND ME A GOLDSTAR CATALOGUE

Mr/Mrs/Ms: _____ Initials: _____ Surname: _____

Address: _____

Postcode: _____

Tel (Home): _____ Tel (Work): _____

Company Name (if applicable): _____

Which computer(s), if any, do you own? _____ 66B