

# ELECTRONICS

MARCH 1984

90p

## PE LOGIC DESIGN CARD No.1

PRESENTED FREE WITH PRACTICAL ELECTRONICS MARCH 84

### DIGITAL LOGIC

Digital logic is based on the idea of only two (bistable) states or levels of voltage. These are true (1) and false (0). More than two states for digital logic are not available as logic gates, with their corresponding outputs, for all 16 functions.

### GATE FUNCTIONS

A two-input gate can have 16 possible outputs. An 81 of these are available as logic gates, the logic which realises the possible inputs with their corresponding outputs, for all 16 functions.

Inputs	Outputs
0 0	0
0 1	0
1 0	0
1 1	1
0 0	1
0 1	1
1 0	1
1 1	0
0 0	0
0 1	1
1 0	1
1 1	0
0 0	1
0 1	0
1 0	0
1 1	1

### LOGIC LEVELS

The voltage levels used to represent logic 0 and logic 1 are defined for TTL as follows. Voltages for these levels are not permitted to exceed the values given.

Gate inputs: Logic 0 = 0V to 0.8V; Logic 1 = 2.0V to 5.0V

Gate outputs: Logic 0 = 0V to 0.4V; Logic 1 = 2.4V to 5.0V

### BOOLS

Boolean algebra is a shorthand way of expressing the behaviour of gates and logic 0 for parts of A, B, and C. The Boolean shorthand is as follows:

- X = A
- X = A
- X = A + B
- X = A · B
- X = A - B
- X = A ⊕ B
- X = A ⊙ B

### USEFUL IDENTITIES

The following are useful Boolean identities which allow simplification of logic circuits, or the use of a simulator to perform the same function.

- A + 0 = A
- A + 1 = 1
- A + A = A
- A + A = 1
- A · 0 = 0
- A · 1 = A
- A · A = A
- A · A = 0
- A ⊕ 0 = A
- A ⊕ 1 = A
- A ⊕ A = 0
- A ⊕ A = 1

### SMTELEBEN

Manufacturer's prefix (may be any letters) indicates which TTL family.

74 indicates 7400 series TTL family.

LS = standard LS = low-power Schottky

LS = high speed LS = low-power Schottky

LS = quad 2-input NAND

LS = quad 2-input OR

### PIN NUMBERING

TTL ICs are available in dual in-line plastic packages. These have 16, 18, 20, 24, 28, 32, 40, 44, 48, 56, 64, 80, 84, 88, 96, 108, 128, 144, 160, 176, 192, 208, 224, 240, 256, 272, 288, 304, 320, 336, 352, 368, 384, 400, 416, 432, 448, 464, 480, 496, 512, 528, 544, 560, 576, 592, 608, 624, 640, 656, 672, 688, 704, 720, 736, 752, 768, 784, 800, 816, 832, 848, 864, 880, 896, 912, 928, 944, 960, 976, 992, 1008, 1024, 1040, 1056, 1072, 1088, 1104, 1120, 1136, 1152, 1168, 1184, 1200, 1216, 1232, 1248, 1264, 1280, 1296, 1312, 1328, 1344, 1360, 1376, 1392, 1408, 1424, 1440, 1456, 1472, 1488, 1504, 1520, 1536, 1552, 1568, 1584, 1600, 1616, 1632, 1648, 1664, 1680, 1696, 1712, 1728, 1744, 1760, 1776, 1792, 1808, 1824, 1840, 1856, 1872, 1888, 1904, 1920, 1936, 1952, 1968, 1984, 2000, 2016, 2032, 2048, 2064, 2080, 2096, 2112, 2128, 2144, 2160, 2176, 2192, 2208, 2224, 2240, 2256, 2272, 2288, 2304, 2320, 2336, 2352, 2368, 2384, 2400, 2416, 2432, 2448, 2464, 2480, 2496, 2512, 2528, 2544, 2560, 2576, 2592, 2608, 2624, 2640, 2656, 2672, 2688, 2704, 2720, 2736, 2752, 2768, 2784, 2800, 2816, 2832, 2848, 2864, 2880, 2896, 2912, 2928, 2944, 2960, 2976, 2992, 3008, 3024, 3040, 3056, 3072, 3088, 3104, 3120, 3136, 3152, 3168, 3184, 3200, 3216, 3232, 3248, 3264, 3280, 3296, 3312, 3328, 3344, 3360, 3376, 3392, 3408, 3424, 3440, 3456, 3472, 3488, 3504, 3520, 3536, 3552, 3568, 3584, 3600, 3616, 3632, 3648, 3664, 3680, 3696, 3712, 3728, 3744, 3760, 3776, 3792, 3808, 3824, 3840, 3856, 3872, 3888, 3904, 3920, 3936, 3952, 3968, 3984, 4000, 4016, 4032, 4048, 4064, 4080, 4096, 4112, 4128, 4144, 4160, 4176, 4192, 4208, 4224, 4240, 4256, 4272, 4288, 4304, 4320, 4336, 4352, 4368, 4384, 4400, 4416, 4432, 4448, 4464, 4480, 4496, 4512, 4528, 4544, 4560, 4576, 4592, 4608, 4624, 4640, 4656, 4672, 4688, 4704, 4720, 4736, 4752, 4768, 4784, 4800, 4816, 4832, 4848, 4864, 4880, 4896, 4912, 4928, 4944, 4960, 4976, 4992, 5008, 5024, 5040, 5056, 5072, 5088, 5104, 5120, 5136, 5152, 5168, 5184, 5200, 5216, 5232, 5248, 5264, 5280, 5296, 5312, 5328, 5344, 5360, 5376, 5392, 5408, 5424, 5440, 5456, 5472, 5488, 5504, 5520, 5536, 5552, 5568, 5584, 5600, 5616, 5632, 5648, 5664, 5680, 5696, 5712, 5728, 5744, 5760, 5776, 5792, 5808, 5824, 5840, 5856, 5872, 5888, 5904, 5920, 5936, 5952, 5968, 5984, 6000, 6016, 6032, 6048, 6064, 6080, 6096, 6112, 6128, 6144, 6160, 6176, 6192, 6208, 6224, 6240, 6256, 6272, 6288, 6304, 6320, 6336, 6352, 6368, 6384, 6400, 6416, 6432, 6448, 6464, 6480, 6496, 6512, 6528, 6544, 6560, 6576, 6592, 6608, 6624, 6640, 6656, 6672, 6688, 6704, 6720, 6736, 6752, 6768, 6784, 6800, 6816, 6832, 6848, 6864, 6880, 6896, 6912, 6928, 6944, 6960, 6976, 6992, 7008, 7024, 7040, 7056, 7072, 7088, 7104, 7120, 7136, 7152, 7168, 7184, 7200, 7216, 7232, 7248, 7264, 7280, 7296, 7312, 7328, 7344, 7360, 7376, 7392, 7408, 7424, 7440, 7456, 7472, 7488, 7504, 7520, 7536, 7552, 7568, 7584, 7600, 7616, 7632, 7648, 7664, 7680, 7696, 7712, 7728, 7744, 7760, 7776, 7792, 7808, 7824, 7840, 7856, 7872, 7888, 7904, 7920, 7936, 7952, 7968, 7984, 8000, 8016, 8032, 8048, 8064, 8080, 8096, 8112, 8128, 8144, 8160, 8176, 8192, 8208, 8224, 8240, 8256, 8272, 8288, 8304, 8320, 8336, 8352, 8368, 8384, 8400, 8416, 8432, 8448, 8464, 8480, 8496, 8512, 8528, 8544, 8560, 8576, 8592, 8608, 8624, 8640, 8656, 8672, 8688, 8704, 8720, 8736, 8752, 8768, 8784, 8800, 8816, 8832, 8848, 8864, 8880, 8896, 8912, 8928, 8944, 8960, 8976, 8992, 9008, 9024, 9040, 9056, 9072, 9088, 9104, 9120, 9136, 9152, 9168, 9184, 9200, 9216, 9232, 9248, 9264, 9280, 9296, 9312, 9328, 9344, 9360, 9376, 9392, 9408, 9424, 9440, 9456, 9472, 9488, 9504, 9520, 9536, 9552, 9568, 9584, 9600, 9616, 9632, 9648, 9664, 9680, 9696, 9712, 9728, 9744, 9760, 9776, 9792, 9808, 9824, 9840, 9856, 9872, 9888, 9904, 9920, 9936, 9952, 9968, 9984, 10000.

# FREE INSIDE LOGIC DESIGN CARD-1

# Spectrum AUTO-SAVE



Also... **INMOS - THE BRITISH CHIP MANUFACTURER**

# Low-price robots from POWERTRAN

— hydraulically powered  
— microprocessor controlled

The UK-designed and manufactured range of Genesis general purpose robots provides a first-rate introduction to robotics for both education and industry. With prices from as low as £425, even the home enthusiast can aspire to his or her own robot.

Each robot in the Genesis range has a self-contained hydraulic power source operated from single phase 240 or 120v AC or from a 12v DC supply. Up to six independent axes are capable of simultaneous operation and all except the grip axis have sensing devices fitted to provide positional control by a closed loop system based on a dedicated microprocessor. Movement sequences can be programmed by means of a hand-held controller or the systems can be interfaced with an external computer via a standard RS232C link.

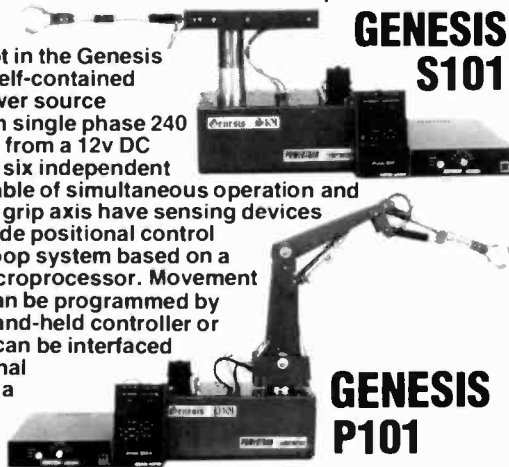

**GENESIS S101**

The top-of-the-range P102 has dual speed control, enhanced memory and double acting cylinders for increased torque on the wrist and arm joints. There is position interrogation via the RS232C interface, increasing the versatility of computer control and inputs are provided for machine tool interfacing.

All Genesis robots are available either ready-built or in kit form. The latter provides not only extra economy but also valuable additional training as an assembly project.

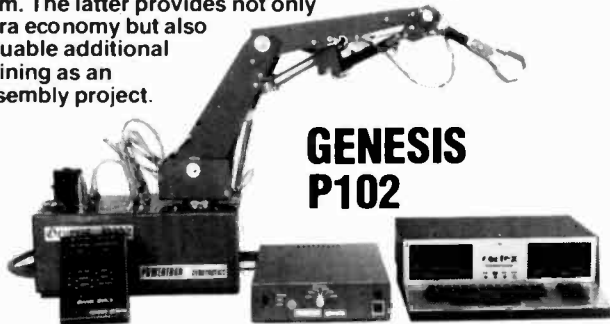

**GENESIS P102**

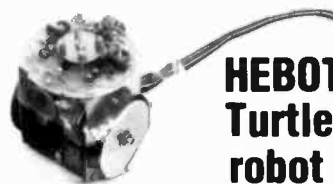

**HEBOT II Turtle-type robot**

For under £100, Hebot II takes programming off the VDU and into the real world. Each wheel is independently controlled by a computer, enabling the robot to perform an almost infinite number of moves. It has blinking eyes, a two-tone bleep and a solenoid-operated pen to chart its moves. Touch sensors, coupled to its shell return data about its environment to the computer enabling evasive or exploratory action to be calculated.

The robot connects directly to an I/O port or, via the interface board, to the expansion bus of a ZX81 or other microcomputer.

## HEBOT II

Weight 18g  
complete kit with assembly instructions **£85**  
Interface board kit **£10**

## MICROGRASP



A real, programmable robot for under £200! Micrograsp has an articulated arm jointed at shoulder, elbow and wrist positions. The entire arm rotates about its base and there is a motor driven gripper. All five axes are motor driven and four of these are servo controlled giving positive positioning. The robot can be controlled by any microcomputer with an expansion bus – the Sinclair ZX81 being particularly suitable.

## MICROGRASP

Weight 8.7kg, max. lifting capacity 10.3g  
Robot kit with power supply **£145.00**

Universal computer interface board kit **£48.50**  
23 way edge connector AX81 peripheral/RAM pack **£2.50**  
splitter board **£3.00**

## GENESIS S101

Weight 29kg, max. lifting capacity 1.5kg  
4-axis model (kit form) **£425**

5-axis model (kit form) **£475**  
5-axis complete system (kit form) **£737**

## GENESIS P101

Weight 34kg, max lifting capacity 1.8kg  
6-axis model (kit form) **£675**  
6-axis complete system (kit form) **£945**

## GENESIS P102

Weight 36kg, max lifting capacity 2kg  
6-axis system (kit form) **£1175.00**  
Powertran Cortex microcomputer self-assembly kit **£295.00**



# POWERTRAN cybernetics Ltd.

PORTWAY INDUSTRIAL ESTATE, ANDOVER, HANTS SP10 3PE. TEL (0264) 64455

ALL PRICES ARE EXCLUSIVE OF VAT – ALLOW 21 DAYS FOR DELIVERY.



# PRACTICAL ELECTRONICS

VOLUME 20

No. 3

MARCH 1984

## CONSTRUCTIONAL PROJECTS

<b>SPECTRUM AUTOSAVE</b> by R. A. Penfold .. .. .	14
Automatic cassette control unit for the Spectrum	
<b>ANTI THEFT ALARM</b> by M. Tooley BA and D. Whitfield MA MSc CEng MIEE .. .. .	24
Audio and visual protection unit for property or goods	
<b>COMPUTER TERMINAL Part 2</b> by Ray Stuart .. .. .	28
Construction and use	
<b>EXPANDING THE VIC 20 Part Five</b> by Sam Withey .. .. .	36
Two stepper motor drivers	

## GENERAL FEATURES

<b>SEMICONDUCTOR CIRCUITS</b> by Tom Gaskell BA(Hons) .. .. .	18
Tachometers (LM 2917N-8 and LM 2917N)	
<b>VERNON TRENT AT LARGE</b> .. .. .	23
<b>MONITORS FOR HOME COMPUTERS</b> by M. Tooley BA and D. Whitfield MA MSc CEng MIEE .. .. .	47
A review of two commercial monitors	
<b>INMOS</b> by Tom Ivall .. .. .	50
The UK semiconductor company in detail	
<b>INTRODUCTION TO DIGITAL ELECTRONICS</b> by M. Tooley BA and D. Whitfield MA MSc CEng MIEE .. .. .	54
Part 6 of our electronics course	
<b>MICRO-BUS</b> .. .. .	61
A monthly focus on micro's for the home constructor	

## NEWS AND COMMENT

<b>EDITORIAL</b> .. .. .	11
<b>NEWS AND MARKET PLACE</b> .. .. .	12
Including Countdown	
<b>BAZAAR</b> .. .. .	16, 20, 44, 62
Free readers' advertisements	
<b>INDUSTRY NOTEBOOK</b> by Nexus .. .. .	17
News and views on the electronics industry	
<b>SPECIAL OFFER-CASSETTES</b> .. .. .	27
<b>READOUT</b> .. .. .	34, 62
<b>SPACEWATCH</b> by Frank W. Hyde .. .. .	35
The European Space Station Project	

## SPECIAL SUPPLEMENT

<b>MICRO-FILE</b> by R. W. Coles .. .. .	between pages 34 and 35
Filesheet 14 8073	

OUR APRIL ISSUE WILL BE ON SALE FRIDAY, MARCH 2nd, 1984  
(for details of contents see page 14/6 of Micro-file)

© IPC Magazines Limited 1984. Copyright in all drawings, photographs and articles published in PRACTICAL ELECTRONICS is fully protected, and reproduction or imitations in whole or part are expressly forbidden. All reasonable precautions are taken by PRACTICAL ELECTRONICS to ensure that the advice and data given to readers are reliable. We cannot, however, guarantee it, and we cannot accept legal responsibility for it. Prices quoted are those current as we go to press.







<b>SPEAKERS</b> 8Ω, 0.3W, 2", 2.25", 2.5", 3" 3W, 2.5" 40W; 64Ω or 80Ω	<b>DIODES</b> AA119 16 AA129 20 AA130 15 BA100 15 BA130 20 BY100 24 BY126 12 BY127 14 CRO33 250 OA9 40 OA47 12 OA70 12 OA79 15 OA81 20 OA85 15 OA90 8 OA91 8 OA95 8 OA200 8 OA202 8 IN914 4 IN916 5 IN4001/2 5 IN4003/4 6 IN4004/5 6 IN4006/7 7 IN4148 4 IN5401 15 IN5404 16 IN5406 17 IN5408 19 1S44 9 1S921 9 6A/100V 40 6A/400V 50 6A/800V 65	<b>BRIDGE RECTIFIERS</b> (plastic case) 1A/50V 18 1A/100V 20 1A/400V 26 1A/600V 34 2A/50V 30 2A/100V 40 2A/400V 46 2A/600V 65 6A/100V 83 6A/200V 128 10A/600V 298	<b>ZENERS</b> Range: 2V7 to 38V 400mW 8p each Range: 3V3 to 33V, 1.3W 15p each	<b>VARICAPS</b> MVMAM2 188 BA102 30 BB105B 40 BB106 40	<b>TRIACS</b> 3A/100V 48 3A/400V 56 3A/800V 85 8A/100V 60 8A/400V 69 8A/800V 118 12A/100V 78 12A/400V 82 12A/800V 135 16A/100V 103 16A/400V 120 16A/800V 203 25A/100V 78 25A/400V 185 25A/800V 295 30A/400V 525 30A/800V 120	<b>SCR's Thyristors</b> 0.8A/100V 32 5A/300V 38 5A/400V 40 5A/600V 48 8A/300V 60 8A/600V 95 12A/100V 78 12A/400V 95 12A/800V 188 BT106 150 BT116 180 C106D 38 TIC44 24 TIC45 29 TIC47 35 2N5064 38 2N4444 130	<b>SOLDERCON PINS</b> 100 75p 500 370p	<b>DIAC</b> ST2 25
---	--	---	--	--	---	--	--	-----------------------

<b>OPTO</b> LEDS price Includes Clips TL109 Red 3mm 10 TL121 Green 3mm 14 TL122 Yellow 14 TL120 2" Red 12 0.2" Yel, Grn, Amber Rectangular LEDs with two part clasp. R, G & Y LEDs 45 Rectangl. Stackable LEDs 16 Triangular LEDs R&G 18 0.2" Flashing LED Red 56 0.2" Bi colour LEDs Red/Green 65 Green/Yellow 80 0.2" Tri colour LEDs Red/Green/Yellow 85 0.2" Red High Bright High Bright Green or Yellow 59 LD271 Infra Red (emit) TL32 Infra Red (emit) SFH205 (detector) 118 TL78 (detector) 52 TL38 90 TL181 82; TL100 90	<b>0.5" LIQUID CRYSTAL DISPLAYS</b> 10 3 digit 495 4 digit 530 6 digit 625 BPX25 250 BPW21 240 BPX65 320 16 LD74 85 16 IL074 220 56 ILC76 Darlington Isolator 135 TL111 70 OCF71 120 ORP72 78 2N5777 85 4N33 135 Pin diode 720 Schmitt Receiver 65 SWITCH Reflective 52 TL139 225 Slotted similar to RS 186	<b>ALUM. BOXES</b> 4x2x2 100 4x2x2 1/2 103 4x4x2 120 5x4x2 108 5x2x2 1/2 130 5x4x1 1/2 99 5x4x2 1/2 120 6x4x2 120 7x5x2 180 8x6x3 210 10x4x3 240 10x7x3 270 12x5x3 285 12x8x3 295	<b>FERRIC CHLORIDE</b> Crystals 1lb 195p + 50p p&p	<b>DALO ETCH RESIST</b> Pen plus spare tip 100p	<b>COPPER CLAD BOARDS</b> Fibre Single- Double- Glass sided sided 6"x12" 100p 125p 225p	<b>VEROBOARDS 0.1"</b> Clad Plain 'VQ' Board 180 'DIP' Board 395 Vero Strip 144	<b>PROTO-DECS</b> 31x17 390-420 275p 41x18 495p Pkt. of 100 pins 55p Spot Face Cutter 150p Pin Insertion Tool 185p	<b>VERO WIRING PEN and Spool</b> Spare Wire (Spools) 75p; Wire Wrapping Station 100
---	---	---	--	--	--	--	---	---

<b>VOLTAGE REGULATORS</b> 1A To220 Plastics +ve -ve 5V 7805 40p 7905 45p 12V 7812 40p 7912 45p 15V 7815 40p 7915 45p 18V 7818 40p 7918 45p 24V 7824 40p 100mA T092 Plastic Casing 5V 78L05 30p 79L05 50p 6V 78L06 30p 7.5V 78L07 30p 8V 78L08 30p 9V 78L09 30p 15V 78L15 30p 79L15 50p	<b>SLIDE 250V</b> 1A DPDT 15 SPST 35 1A DPDT C/OFF 15 DPDT 48 1A DP on/on/cn 40 4 pole on/off 54	<b>TOGGLE 2A 250V</b> 15 DPDT 48 4 pole on/off 54	<b>PUSH BUTTON</b> Spring loaded Latching or Momentary 6A SPDT c/ofer 110 DPDT c/ofer 160	<b>SUB-MIN TOGGLE 2 amp</b> SP changeover 60 SPST on/off 54 SPDT c/ofer 85 DPDT Biased 105 DPDT 6 tags 75 DPDT C/OFF 88 DPDT on/on/on 185 DPDT Biased 145	<b>MINIATURE Non Locking</b> Push to make 15p Push break 25p	<b>ROTARY: (Adjustable Stop Type)</b> 1 pole/2 to 12 way, 2P/2 to 6 way, 3 pole/ 2 to 4 way, 4 pole/2 to 3 way 48p ROTARY: Mains 250V AC, 4 Amp 64p	<b>ROTARY SWITCHES: (SPST)</b> 4 way 65p; 6 way 80p; 8 way 87p; 10 way 100p; (SPDT), 4 way 190p.	<b>AMPHENOL PLUG</b> 24 way IEEE 475p 36 way Centronics 525p	<b>ASTEC UHF MODULATORS</b> 9MHz Standard 325p 9MHz Wideband 450p	<b>Telephone orders by Access. Simply phone your order through 0923-50234 &amp; we do the rest.</b>
--	---	---	--	---	--	--	---	--	---	---

<b>DIL SOCKETS</b> Low Wire profile wrap 8 pin 8p 25p 14 pin 10p 35p 16 pin 10p 42p 18 pin 16p 52p 20 pin 20p 60p 22 pin 22p 65p 24 pin 25p 70p 28 pin 28p 80p 40 pin 38p 99p	<b>ZIF DIL SOCKET</b> 24 way 565p 28 way 750p 40 way 799p	<b>DIL PLUGS (Headers)</b> Pins Solder IDC 14 38p 55p 16 42p 100p 24 88p 138p 28 185p 290p 40 195p 218p	<b>RIBBON CABLE (price per foot)</b> Way Grey Colour 10 15p 28p 16 25p 40p 20 30p 50p 26 40p 65p 34 60p 85p 40 70p 90p 100p 135p	<b>DC CONNECTORS:</b> Pins 9 15 25 37 way way way way	<b>MALE</b> Solder 80p 110p 160p 240p Angle 150p 210p 250p 355p Strait 170p 160p 220p 310p	<b>FEMALE</b> Solder 105p 160p 200p 338p Angle 165p 215p 290p 440p Strait 175p 200p 300p 420p	<b>COVERS 80p 75p 75p 90p</b>	<b>IDC 25 way Plg. 385p, Skt. 450p</b>	<b>EDGE CONNECTORS</b> SIL Sockets 2x18 way 180p 2x22 way 199p 2x23 way 170p 2x25 way 225p 2x28 way 210p 2x30 way 245p 2x36 way 295p 2x40 way 315p 2x43 way 395p 2x75 way 550p
--	--	---	--	---	---	--	-------------------------------	--	---

<b>BEEBFONT ROM</b> This is a character FONT ROM that gives you 5 16x16 predefined FONT. The ROM is ideal for high quality demonstration on screen and when used in conjunction with EPSON printer, allows printing of letters etc. in mixed type faces. The package is complete, including an Editor to de- sign your own Fonts and several spare Fonts which could not be fitted in the ROM can still be run from RAM. Supplied complete with ROM, software on DISC/tape and Manual. Price £45	<b>IDC CONNECTORS</b> (Speed block type) PCB Male Female with latch Header Socket Sirt. Angle Sirt. Angle Pins Pins 2 rows 10 way 90p 99p 85p 120p 16 way 130p 150p 110p 155p 20 way 145p 168p 125p 240p 26 way 175p 200p 150p 320p 34 way 205p 230p 169p 340p 40 way 220p 250p 190p 420p 50 way 235p 270p 200p 470p	<b>EURO CONNECTORS</b> Gold flashed contacts DIN 41612 2x32 way 275p 320p 220p 285p DIN 41612 2x32 way 295p 340p 240p 300p DIN 41612 3x32 way 360p 385p 260p 395p	<b>TRANSFORMERS</b> (mains Prim. 220-240V) 3-0-3V, 6-0-6V 100mA; 9-0-9V 75mA; 12-0-12V 75mA; 15-0-15V 75mA 6VA; 2x6V-5A; 2x9V-4A; 2x12V-0.3A; 2x15V-2.5A 12VA; 2x4V5-1.3A; 2x6V-1.2A; 2x12V-5A; 2x15V-4A 345p (35p p&p) 24VA; 6V-1.5A 6V-1.5A; 9V-1.2A 9V-1.2A; 12V-1A 12V-1A; 15-8A 15-8A; 20V-6A; 20V-6A 385p (60p p&p) 50VA; 2x6V-4A; 2x9V-2.5A; 2x12V-2A; 1.5A; 2x20V-1.2A; 2x25V-2A; 2x30V-0.8A 520p (60p p&p) 100VA: 2x12V-4A; 2x15V-3A; 2x20V-2.5A; 2x30V-1.5A; 2x40V-1.25A; 2x50V-1A 965p (60p p&p)	<b>JUMPER LEADS</b> Ribbon Cable Assembly DIL Plug (Headers) Single Ended Lead, 24" long Length 14pin 16pin 24 pin 40 pin 24" 145p 165p 240p 325p Double Ended Leads 6" 185p 205p 300p 465p 12" 198p 215p 315p 490p 24" 210p 235p 345p 540p 36" 230p 250p 375p 595p	<b>IDC FEMALE RECEPTACLE</b> Jumper Leads 36" 1 end 20pin 26pin 34pin 40pin 2 ends 160p 200p 260p 300p 290p 370p 480p 525p
--	--	---	---	--	---

### COMPUTER CORNER

- **SEIKOSHA GP100A** - Unihammer Printer, normal & double width characters, dot resolution graphics 10" Tractor feed, parallel interface standard. **FREE 500 Sheets £155**
- **SEIKOSHA GP 250X Printer £199**
- **EPSON FX80 PRINTER** 160 CPS, 11x9 matrix, proportional spacing, superscript, subscript, dot addressable graphics, Normal, Italic & Elite characters. Up to 256 user definable characters. Down loadable character set. Condensed and double width printing. 4 user define margin positions. Tractor and Friction feed. 10" maximum width, Bi-directional, logic seeking. Centronix Interface standard. **£349**
- **EPSON RX80 PRINTER £235**
- **EPSON RX80 FT PRINTER £259**
- **KAGA - RGB** 12 inch medium resolution colour monitors **£215**  
Connecting lead for KAGA monitors **£5**
- **ZENITH 12" Hi-RES**, Green Monitor 40/80 column select switch, value for money. **£75**
- **MICROVITEC 14"** colour monitor. RGB input. Lead incl. **£205**
- **MICROVITEC 1451 Hi-res 14"** Monitor incl. Lead **£319**
- **TEX EPROM ERASER**. Erases up to 32 ICs in 15-30 min. **£33**
- **Spare UV lamp bulbs £9**
- **POWER SUPPLY** Regulated, Variable from +5V to +15V, 4A. Fully Cased **£39**
- **MULTIRAIL PSU KIT**. Output: +5V/5A; +12V; +25V; -5V; -12V @ 1A. **£40**
- **4 x 4 matrix keypad** (reed switch assembly) **£4**
- **C12 COMPUTER Grade BASF Cassettes** in Library Cases **40p**
- **8 1/2" or 9 1/2" Fan fold paper** (1000 sheets) **£7 (150p)**
- **Teleprinter Roll** (no VAT) **£3.50**

MANY MORE PRINTERS, MONITORS, INTERFACES. AVAILABLE. CALL IN AT OUR SHOP FOR DEMONSTRATION OR WRITE IN FOR OUR DESCRIPTIVE LEAFLET.

(P&P on some of the above items is extra)  
Call in at our shop for demonstration of any of the above items. Be satisfied before you buy.

### BROTHER HR-15 DAISEY-WHEEL PRINTER/

An exceptionally high quality Daisy Wheel printer at the price of a Dot matrix printer. 18CPS; Bi-directional, has 3K of Buffer; has clear buffer facility. Carriage skip movement, Proportional spacing; underlining; Bold print and Shadow print. Prints in two colours; Super and subscript facility. Impact control facility to vary pressure on paper for making carbon copies. Has Centronics parallel or RS-232 interface. Connects directly to BBC Micro. A ribbon cassette plus a separate red ribbon. Optional extras: Single Sheet Feeder takes up to 150 A4 sheets; & Keyboard that transforms HR15 into a sophisticated electronics typewriter. Attractively finished in Beige. Special Introductory Offer:  
**Only £375 (Carr. £7)**

### NEW LAUNCH Z80A 2nd PROCESSOR BOARD FOR BBC

With CP/M and Double Density Disc Interface for BBC MICRO

Yes it's here. Z80A 4 MHz 2nd processor Board with 64K memory, 4K Monitor EPROM, Parallel printer interface, CP/M handling, double density board will handle, 3 1/2", 5 1/4" & 8" Floppy Disk Drives and many more facilities. All neatly housed in a twin slimline disc drive case.  
**Only £350**

<b>ANTEX Soldering Irons</b>	<b>Spare bits</b>	<b>85</b>
G15W	510	230
G17W	510	270
G18W	525	170
XS25W	530	30

<b>CRYSTALS</b> 32.768KHz 100 100KHz 235 200KHz 268 455KHz 370 1MHz 275 1.068M 275 1.588M 392 1.59M 420 1.6MHz 395 1.9MHz 395 1.8432M 200 2.0MHz 225 2.4576M 200 2.5MHz 225 2.56250M 220 3.2768M 150 3.57954M 98 3.6864M 300 4.0MHz 150 4.032MHz 220 4.194304M 200 4.433619M 100 4.608MHz 200 4.80MHz 200 5.0304M 160 5.185MHz 300 5.2428MHz 390 6.0MHz 140 6.144MHz 150 6.5536MHz 200 7.0MHz 150 7.168MHz 250 7.68MHz 200 8.0MHz 150 8.08333M 395 8.867237M 178 9.00MHz 200 9.375MHz 350 10.0MHz 175 10.5MHz 250 10.7MHz 150 10.24MHz 175 12.0MHz 200 12.8MHz 300 14.31818M 170 14.7456M 175 14.765MHz 250 15.0MHz 200 16.0MHz 200 17.5MHz 250 18.432M 150 19.968MHz 150 20.0MHz 200 24.0MHz 175 24.930MHz 325 29.995MHz 150 26.670MHz 325 27.125MHz 295 27.145M 190 27.648MHz 300 38.66667M 175 48.0MHz 175 55.5MHz 400 100MHz 295 116.0MHz 300 145.8MHz 225
--

### BBC MICROCOMPUTER

Model A £299; Model B £399 (incl. VAT). We stock the full range of BBC Micro peripherals, Hardware & Software like, Disc Drives (Top quality Cumana & Mitsubishi), Diskettes, Printers, Printer Paper, Interface Cable, Dust Covers, Cassette Recorder & Cassettes, Monitors, Connectors (Ready made Cables, Plugs & Sockets), Plotter (Graphic Tablet) EPROM Programmer, Lightpen Kit, Joysticks, Sideways ROM Board, EPROM Eraser, Machinecode ROM, The highly sophisticated Watford's 16K BEEB DFS, WORDWISE, BEEBCALC, Software (Educational Application & Games), BOOKS, etc. etc. Please send SAE for our descriptive leaflet.

### DISC DRIVES FOR BBC MICRO

- **CS100 - TEAC** Cased with own Power Supply, S/S, 40 track, 5 1/4", 100K **£135**
- **CD200 - TEAC** Twin Cased with own PSU, S/S, 40 track, 5 1/4", 200K **£350**
- **CS200 - TEAC** Single Cased with own PSU, S/S, 80 track, 5 1/4", 200K **£250**
- **CD400 - TEAC** Twin Cased with own PSU, S/S, 80 track, 5 1/4", 400K **£475**
- **SINGLE MITSUBISHI** Slim line - Cased with own PSU, DS/DD, 1 Megabyte (400K with BBC) **£275**
- **TWIN MITSUBISHI** Slim line - Cased with own PSU, DS/DD, 2 Megabyte (800K with BBC) **£535**
- Single Drive Cable for BBC Micro **£8**
- Twin Drive Cable for BBC Micro **£12 (5 year warranty)**
- 10 Verbatim or 3M Diskettes, S/S **£18**
- 10 Verbatim or 3M Diskettes, D/S **£28**
- (2 year warranty on WABASH Diskettes)
- 10 WABASH Diskettes, 5 1/4", S/S **£15**
- 10 WABASH Diskettes, 5 1/4", D/S **£25**

Many more types available.  
Please send SAE for our detailed leaflet.  
N.B. Carriage is extra on drives.

# TOROIDALS

The toroidal transformer is now accepted as the standard in industry, overtaking the obsolete laminated type. Industry has been quick to recognise the advantages toroidals offer in size, weight, lower radiated field and, thanks to I.L.P., PRICE.

Our large standard range is complemented by our **SPECIAL DESIGN** section which can offer a prototype service within 7 DAYS together with a short lead time on quantity orders which can be programmed to your requirements with no price penalty.

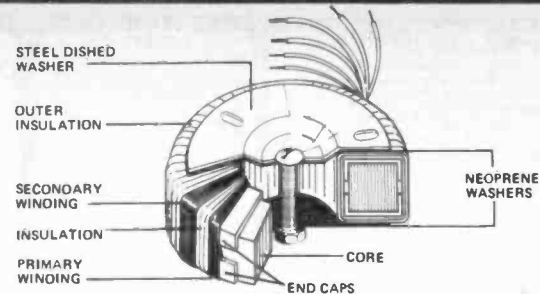

15 VA 62 x 34mm 0.35Kg Regulation 19%		
SERIES No	SECONDARY Volts	RMS Current
0x010	6+6	1.25
0x011	9+9	0.83
0x012	12+12	0.63
0x013	15+15	0.50
0x014	18+18	0.42
0x015	22+22	0.34
0x016	25+25	0.30
0x017	30+30	0.25

(encased in ABS plastic)

30 VA 70 x 30mm 0.45Kg Regulation 18%		
SERIES No	SECONDARY Volts	RMS Current
1x010	6+6	2.50
1x011	9+9	1.66
1x012	12+12	1.25
1x013	15+15	1.00
1x014	18+18	0.83
1x015	22+22	0.68
1x016	25+25	0.60
1x017	30+30	0.50

50 VA 80 x 35mm 0.9Kg Regulation 13%		
SERIES No	SECONDARY Volts	RMS Current
2x010	6+6	4.16
2x011	9+9	2.77
2x012	12+12	2.08
2x013	15+15	1.66
2x014	18+18	1.38
2x015	22+22	1.13
2x016	25+25	1.00
2x017	30+30	0.83
2x028	110	0.45
2x029	220	0.22
2x030	240	0.20

80 VA 90 x 30mm 1Kg Regulation 12%		
SERIES No	SECONDARY Volts	RMS Current
3x010	6+6	6.64
3x011	9+9	4.44
3x012	12+12	3.33
3x013	15+15	2.66
3x014	18+18	2.22
3x015	22+22	1.81
3x016	25+25	1.60
3x017	30+30	1.33
3x028	110	0.72
3x029	220	0.36
3x030	240	0.33

120 VA 90 x 40mm 1.2Kg Regulation 11%		
SERIES No	SECONDARY Volts	RMS Current
4x010	6+6	10.00
4x011	9+9	6.66
4x012	12+12	5.00
4x013	15+15	4.00
4x014	18+18	3.33
4x015	22+22	2.72
4x016	25+25	2.40
4x017	30+30	2.00
4x018	35+35	1.71
4x028	110	1.09
4x029	220	0.54
4x030	240	0.50

160 VA 110 x 40mm 1.8Kg Regulation 8%		
SERIES No	SECONDARY Volts	RMS Current
5x011	9+9	8.89
5x012	12+12	6.66
5x013	15+15	5.33
5x014	18+18	4.44
5x015	22+22	3.63
5x016	25+25	3.20
5x017	30+30	2.66
5x018	35+35	2.28
5x026	40+40	2.00
5x028	110	1.45
5x029	220	0.72
5x030	240	0.66

225 VA 110 x 45mm 2.2Kg Regulation 7%		
SERIES No	SECONDARY Volts	RMS Current
6x012	12+12	9.38
6x013	15+15	7.50
6x014	18+18	6.25
6x015	22+22	5.11
6x016	25+25	4.50
6x017	30+30	3.75
6x018	35+35	3.21
6x026	40+40	2.81
6x025	45+45	2.50
6x033	50+50	2.25
6x028	110	2.04
6x029	220	1.02
6x030	240	0.93

300 VA 110 x 50mm 2.6Kg Regulation 6%		
SERIES No	SECONDARY Volts	RMS Current
7x013	15+15	10.00
7x014	18+18	8.33
7x015	22+22	6.82
7x016	25+25	6.00
7x017	30+30	5.00
7x018	35+35	4.28
7x026	40+40	3.75
7x028	45+45	3.33
7x033	50+50	3.00
7x028	110	2.72
7x029	220	1.36
7x030	240	1.25

500 VA 140 x 60mm 4Kg Regulation 4%		
SERIES No	SECONDARY Volts	RMS Current
8x016	25+25	10.00
8x017	30+30	8.33
8x018	35+35	7.14
8x026	40+40	6.25
8x025	45+45	5.55
8x033	50+50	5.00
8x042	55+55	4.54
8x028	110	4.54
8x029	220	2.27
8x030	240	2.08

625 VA 140 x 75mm 5Kg Regulation 4%		
SERIES No	SECONDARY Volts	RMS Current
9x017	30+30	10.41
9x018	35+35	8.92
9x026	40+40	7.81
9x025	45+45	6.94
9x033	50+50	6.25
9x042	55+55	5.68
9x028	110	5.68
9x029	220	2.84
9x030	240	2.60

#### Why a Toroid?

- Smaller size & weight to meet modern 'slimline' requirements.
- Low electrically induced noise demanded by compact equipment.
- High efficiency enabling conservative rating whilst maintaining size advantages.
- Lower operating temperature.

#### Why ILP?

- Ex-stock delivery for small quantities.
- Gold service available. 21 days manufacture for urgent deliveries.
- 5 year no quibble guarantee.
- Realistic delivery for volume orders.
- No price penalty for call off orders.

Prices including P&P and VAT

VA	Size	£	VA	Size	£
15	0	7.43	160	5	12.90
30	1	8.08	225	5	16.30
50	2	10.10	300	7	18.55
80	3	10.81	500	8	25.73
120	4	11.73	625	9	31.63

Mail Order — Please make your crossed cheques or postal orders payable to ILP Electronics Ltd.

Trade — We will open your credit account immediately upon receipt of your first order.

Post to: ILP Electronics Ltd., Dept. 6  
Graham Bell House, Roper Close,  
Canterbury, Kent. CT2 7EP  
Tel: (0227) 54778 Telex: 965780

For 110V primary insert "O" in place of "X" in type number.  
For 220V primary (Europe) insert "1" in place of "X" in type number.  
For 240V primary (UK) insert "2" in place of "X" in type number.  
**IMPORTANT: Regulation - All voltages quoted are FULL LOAD.**  
Please add regulation figure to secondary voltage to obtain off load voltage.



**ILP**  
ELECTRONICS LTD.

## GET READY FOR THE SPRING EDITION



Book now  
by sending  
**80p**

or watch your newsagent's  
shelf around the end of  
January 1984

Order as Stock No.

**02-0009**

**ambit** INTERNATIONAL

200 North Service Road, Brentwood, Essex CM14 5G

We must apologise to our readers for missing out with our Winter edition — but we've been preparing something a little special to tempt you out of your Winter hibernation and back to the soldering iron.....

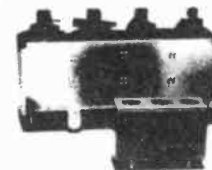

PRICE ON THE PAGE as usual,  
**3 x £1 discount vouchers**  
as usual, and the  
components you  
need for

- ★ COMMUNICATIONS
- ★ ELECTRONICS
- ★ COMPUTING
- ★ AUDIO

### HOME LIGHTING KITS

These kits contain all necessary components and full instructions & are designed to replace a standard wall switch and control up to 300w. of lighting.

- TDR300K Remote Control Dimmer **£14.95**
- MK6 Transmitter for above **£4.50**
- TD300K Touchdimmer **£7.75**
- TS300K Touchswitch **£7.75**
- TDE/K Extension kit for 2-way switching for TD300K **£2.50**
- LD300K Rotary Controlled Dimmer **£3.95**



### MINI KITS

- MK1 ELECTRONIC THERMOSTAT Uses LM3911 IC to sense temperature (80°C max) and triac to switch heater (1KW). Mains powered. **£4.60**
- MK2 SOLID STATE RELAY Switches 240V ac motors, lights, heaters from logic/computer circuits. Zero voltage switching, opto isolated. Supplied without triac. **£2.60**
- MK4 PROPORTIONAL TEMPERATURE CONTROLLER Uses "burst fire" technique to maintain temperature to within 0.5°C. Ideal for photography, incubators, wine making, etc. Max. load 3kW (240V ac). Temp. range up to 90°C. **£8.50**

**MKS MAINS TIMER**  
Mains powered timer enabling a load up to 1kW at 240V ac to be switched on or off for a variable time from 20 mins. to 25 hrs. Longer or shorter periods possible with minor component changes. **£9.50**

**MK15 DUAL LATCHED SOLID STATE RELAY**  
Comprises two MK2s with latch circuit enabling the MK12 kit to control two mains loads independently. Two output tracks not supplied. (See remote control kits.) **£4.50**

**NEW! MK19 DC CONTROLLED AUDIO AMPLIFIER**  
May be used with virtually any stereo audio amplifier to control bass, volume, treble and balance remotely either using a wire link or the MK11 infra red receiver. A 1 of 10 decoder with LEDs is also included for remote input selection/display. (See remote control kits.) **£10.70**

### MICROPROCESSOR CONTROLLED MULTI-PURPOSE TIMER

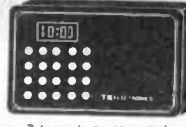

Now you can run your central heating, lighting, hi-fi system and lots more with just one programmable timer. At your selection it is designed to control four mains outputs independently, switching on and off at pre-set times over a 7 day cycle, e.g. to control your central heating including different switching times for weekdays, just connect it to your system programme and set it and forget it — the clock will do the rest.

- \* 7mm LED 12 hour display
- \* Day of week, am/pm and output status indicators
- \* 4 open collector outputs for driving relays, triacs, etc.
- \* 50/60Hz mains operation
- \* Battery backup saves stored programmes and continues low-keeping during power failures. (Battery not supplied).
- \* Display blanking during power failure to conserve battery power
- \* 18 programmable time sets
- \* Powerful "Everyday" function enabling output to switch everyday but use only one time set
- \* Useful "sleep" function — turns on output for one hour
- \* Direct switch control enabling output to be turned on immediately or after a specified time interval
- \* 20 function keypad for programme entry

**NOW ONLY £39.00**

- \* Programme verification at the touch of a button
- \* Plastic box with attractive screen printed front panel 15 x 10 x 5.5cm

(Kit includes all components, PCB, box, assembly and programming instructions) Order as CT6000

**MK114 OPTIONAL RELAY KIT**  
Kit includes one relay, PCB to accommodate up to 4 relays, terminal blocks, etc. To fit into the CT6000 box. Provides up to 4 x 3amp 240V AC changeover contacts. **£3.90**

Additional relays £1.65 each

### DISCO LIGHTING KITS

- DL1000K This value for money kit features a bi-directional sequence speed of sequence and frequency of direction change being variable by means of potentiometers and incorporates master dimming control. **£15.95**
- DL2100K A lower cost version of the above, featuring unidirectional channel sequence with speed variable by means of a preset potentiometer switched only at mains zero crossing points to reduce radio interference to a minimum. **£8.95**



Optional opto input (DL1) Allowing audio ("beat") light response. **60p**  
DL3000K This 3 channel sound to light kit features zero voltage switching, automatic level control and built-in mic. No connections to speaker or amp required. No knobs to adjust — simply connect to mains supply and lamps. (Use 4 channels) **Only £12.95**

### 24 HOUR CLOCK/APPLIANCE TIMER KIT

Switches any appliance up to 1kW on and off at preset times once per day. Kit contains: AY-51230 IC, 0.5" LED display, mains supply, display drivers, switches, LEDs, triacs, PCBs and full instructions.

- CT1000K Basic Kit **£14.90**
- CT1000K with white box (58 131 71mm) **£17.40** (Ready Built) **£22.50**



### DVM/ULTRA SENSITIVE THERMOMETER KIT

This new design is based on the ICL7126 (a lower power version of the ICL7106 chip) and a 3 1/2 digit liquid crystal display. This kit will form the basis of a digital multimeter (only a few additional resistors and switches are required — details supplied), or a sensitive digital thermometer (-150°C to +150°C) reading to 0.1°C. The basic kit has a sensitivity of 200mV for a full-scale reading, automatic polarity indication and an ultra low power requirement giving a 2 year typical battery life from a standard 9V PP3 when used 8 hours a day, 7 days a week. **Price £15.50**



### XK113 MW RADIO KIT

Based on ZN414 IC, kit includes PCB, wound aerial and crystal earpiece and all components to make a sensitive miniature radio. Size: 5.5 x 2.7 x 2cms. Requires PP3 9V battery. IDEAL FOR BEGINNERS. **£5.50**

### 3-NOTE DOOR CHIME

Based on the SAB600 IC the kit is supplied with all components, including loudspeaker, printed circuit board, a pre-drilled box (95 x 71 x 35mm) and full instructions. Requires only a PP3 9V battery and push-switch to complete. AN IDEAL PROJECT FOR BEGINNERS. Order as XK 102. **£5.50**

### COMPONENT PACKS

- PACK 1 650 Resistors 47 ohm to 10 Mohm — 10 per value **£4.00**
- PACK 2 40 — 10V Electrolytic Capacitors 10µF to 1000µF — 5 per value **£3.25**
- PACK 3 60 Polyester Capacitors 0.01 to 1µF 250V — 5 per value **£5.55**
- PACK 4 45 Sub-miniature Presets 10k ohm to 1 Mhm — 5 per value **£2.90**
- PACK 5 30 Low Profile IC Sockets 8, 14 and 16 pin — 10 of each **£2.40**
- PACK 6 25 Red LEDs 5mm dia **£1.50**

### LCD 3 1/2 DIGIT MULTIMETER

16 ranges including DC voltage (200mV to 1000V) and AC voltage, DC current (200mA to 10A) and resistance (10Ω to 1MΩ). NPN & PNP transistor gain and diode check. Input impedance 10MΩ. Size 155 x 31mm. Requires PP3 9V battery. Test leads included. **ONLY £29.00**

### ELECTRONIC LOCK KIT

With hundreds of uses in doors, garages, car anti-theft devices, electronic equipment etc. Only the correct easily changed four digit code will open it!

Requires a 5 to 15V dc supply. Output 750mA. Fits into standard electrical wall box. Complete kit (excl. front panel) XK101 **£11.50**

Electronic lock mechanism for use with the above kit, 70 150 **£14.95**

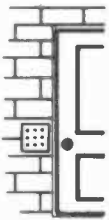

### INFRA RED GARAGE CONTROLLER KIT



For opening and closing motorised garage doors plus switching garage and drive lights on and off up to a range of

40ft and numerous other applications like controlling lights and TV's etc. in the home. Ideal for aged or disabled persons, this coded kit comprises of a mains powered infra red remote control receiver with a normally open relay output plus two latched transistor outputs; battery-powered four button transmitter and an opto isolated solid state mains switch. As with all our kits, full instructions are supplied.

XK103 **£25**

Extra transmitters

XK105 **£10.00**

### HOME CONTROL CENTRE

This kit enables you to control up to 16 different appliances by means of coded pulses in the mains wiring which may be decoded by special receivers anywhere in the house. The transmitter may be controlled manually or by the computer interface enabling your favourite micro to make your coffee in the morning, switch lights anywhere in the house, or your electric blanket in your bedroom. Just think of the possibilities — and no wiring!



The Kit comprises a transmitter with pre-drilled box and two receiver.

XK112 **£42.00**  
ADDITIONAL RECEIVERS  
XK111 **£10.00**

### WE ALSO STOCK A WIDE RANGE OF ELECTRONIC COMPONENTS

SEE CATALOGUE FOR DETAILS

Send SAE 9" x 6" for our FREE YELLOW CATALOGUE. It's packed with a full list of our stock range all at very competitive prices.

Add 65p postage & packing + 15% VAT to total Overseas Customers: Add £2.50 (Europe), £6.00 (elsewhere) for p&p. Send S.A.E. for further STOCK DETAILS. Goods by return subject to availability.

OPEN 9am to 5pm (Mon to Fri) 10am to 4pm (Sat)

COMPUTER SHOWROOM TOP HARDWARE, LATEST SOFTWARE PERIPHERALS, ACCESSORIES AND MUCH, MUCH MORE!

## FAST SERVICE - TOP QUALITY - LOW LOW PRICES

No circuit is complete without a call to —

# TK ELECTRONICS PE

11-13 Boston Road London W7 3SJ

01-567 8910 ORDERS  
01-579 9794 ENQUIRIES  
01-579 2842 TECHNICAL AFTER 3PM



ALL PRICES EXCLUDE VAT



# HENRY'S AUDIO ELECTRONICS

COMPUTERS • COMMUNICATIONS • TEST EQUIPMENT • COMPONENTS

VISIT OR PHONE • OPEN 6 DAYS A WEEK • ALL PRICES INC VAT

## STEREO TUNER/AMPLIFIER

4 wave-band stereo tuner amplifier by GEC. MW/LW/SW/stereo FM radio. 10 + 10 watt stereo amplifier. Inputs for PU tape in/out. Supplied as two assembled units, as illustrated.

**£21.95**  
—easy to connect. (UK C/P £1.50)

## DIGITAL MULTIMETERS

■ With case (rotary switches)  
+ Side button — case £2.95  
K D25C ■ 13 range 6.2A DC  
2 meg ohm £23.50  
K D305 ■ 16 range 10A DC  
2 meg ohm £26.95  
K D30C ■ 26 range 1A  
AC/DC 20 meg ohm £29.50  
K D55C ■ 28 range 10A AC/DC 20 meg ohm £33.50  
Metex 3000 ■ 30 range 10A AC/DC  
20 meg ohm £33.24  
6010 - 28 range 10A AC/DC 20 meg ohm £34.40  
7030 4- AS6010 High acc. 0.1% basic  
K D615 ■ 16 range 10A DC 2 meg plus  
Hie tester £39.95  
SIFAM 2200B 21 range 2A AC/DC 20 meg  
Bench Models £29.95  
TM355 29 range LEO 10A AC/DC 20 meg.  
Thandar £86.25  
TM356 26 range LCD 10A AC/DC 20 meg.  
Thandar £97.75  
TM351 29 range LCD 10A AC/DC 20 meg.  
Thandar £120.75

## THERMAL MATRIX & LINE PRINTER

**NEW LOW PRICE**

COMPLETE WITH FULL HANDBOOK 3 ROLLS PAPER  
(UK post etc £1.05)  
(Inst. order £187)

**£69.95** inc. VAT  
SUITABLE FOR TANDY • BSC • ORIC • NASCOM • GEMINI •  
ACORN • NEW BRAIN • ORAGON • etc. etc.  
(Interface unit with leads £15 - state model)  
(Your enquiries invited).

## PRESTEL ADAPTOR

3 card set with data etc (P/S +/- 12V and +5V) £69.95 inc. VAT

## MULTIMETERS (UK C/P £5p)

M200 20K/volt. 30 ranges. AC/DC. 20 KHZ. List £ 21.85. £12.95  
HM102B 20K/V 10A DC 22 range & cont. buzzer £13.50  
TMK500 23 ranges 30K/V.  
12A DC plus cont. buzzer £23.95  
NH56R 20K/V. 22 range pocket  
B30A 26 range 30K/V. 10A AC/DC overload protection, etc. £23.95  
SGOTR 23 range 100K/V. Large scale 10A AC/DC plus Hie £39.95  
AT1200 31 range 100K/V deluxe. 12A AC/DC £33.50  
AT1020 18 range 20K/V. Deluxe plus Hie tester £18.95  
YN360TR 19 range 20K/V plus Hie tester £15.95

## MODEM CARD

BT approved ready assembled unit with data and accessories. £39.95 inc. VAT

## SIGNAL GENERATORS (220/240V AC)

FUNCTION: All sine/square/triangle/TTL etc.  
TG101 0.2HZ-200KHZ £113.85  
T2102 0.2HZ-2 MHZ £166.75  
PULSE  
TG105 Various facilities 5 Hz-5 MHz  
A010: Multiband Sine/Square  
LAG27 10 HZ to 1 MHZ £90.85  
AG202A 20 HZ to 200 KHZ (list £94.50) £83.50  
LAG120A 10 HZ-1 MHz Low Distortion RF £159.85  
RG  
SG402 100 KHZ to 30 MHZ (list £79.50) £69.50  
LSG17 100 KHZ to 150 MHZ £79.35

## I.T.T. 2020 CABINET

Professional Computer Case  
18" x 15" x 4 1/2"  
(front slopes). As previously advertised.  
**£27.50** inc. VAT (UK C/P £2.50)

## LOGIC PROBES

LP10 10 MHZ £22.95  
DLPS50 50 MHZ with carry case and accessories £49.95

## HIGH VOLTAGE METER

Direct reading 0/40 KV.  
20K/Volt £23.00 (UK C/P £5p)

## DIGITAL CAPACITANCE METER

(UK C/P £5p)  
0.1 pF to 2000 mfd LCO 8 ranges  
DM6013 £52.75

## VARIABLE POWER SUPPLIES

(UK C/P £1.00)  
PP241 0/12/24V. 0/1A £35.00  
PP243 3 amp version £59.95  
Z300 0/30V 1A twin meter £99.50

## FREQUENCY COUNTERS

PFM200A 200 MHZ hand held pocket  
8 digit LEO £77.60  
MET1008 8 digit LEO bench 2 ranges 100 MHZ £102.35  
MET6008 8 digit LEO bench 3 ranges 600 MHZ £132.25  
MET1000 8 digit LEO 3 ranges 1 GHz £182.85  
TFD40 8 digit LEO 40 MHZ Thandar £126.50  
TF200 3 digit LEO 200 MHZ Thandar £166.75

## OSCILLOSCOPES

Full specification any model on request. SAE by post.  
HM Series HAMEG: SC THANDAR: CS TRIO.  
"3 CROTECH" Y HITACHI  
SINGLE TRACE UK C/P £3.00  
3030 15 MHz 5mV. 95mm tube plus component tester £177.10  
SC110A Miniature 10 MHZ battery portable Post free £171.00  
Optional carry case £6.84 AC adaptor EG 69 Nicars £12.50  
HM103 15 MHz 2mV. 5 x 7 display plus component tester C/P £3.00 £181.70  
DUAL TRACE (UK C/P £4.00)  
HM203/4 Dual 20 MHZ plus component tester £303.60  
CS1562A Dual 10 MHZ (list £321.00) £269.50  
313 2 Dual 20 MHZ - component tester £325.45  
CS1566A Dual 20 MHZ All facilities (list £401.35) £349.50  
HM204 Dual 20 MHZ plus component tester sweep delay £419.75  
HM705 Dual 70 MHZ sweep delay £676.00  
V212 Dual 20 MHZ £399.25  
V222 Dual 20 MHZ plus extra facilities £391.00  
V422 Dual 40 MHZ portable £586.50  
V203F Dual Trace 20 MHZ sweep delay V134 Dual Trace 10 MHz storage £1092.50  
All HITACHI, CROTECH TRIO & HAMEG MODELS AVAILABLE  
• With probes

## SCOPE PROBE KITS

X1 £7.95 X10 £9.45 X1 - X10 £10.50

ORDER BY POST OR PHONE.  
Post with CHEQUES, ACCESS, VISA or you can telephone your order. All orders dispatched within 5 days unless advised.

**HENRY'S**  
404-406 Edgware Road, London, W2 1EQ  
Computer: 01-402 6822. Components: 01-723 1008  
Test Equipment & Communications: 01-724 0323

**AUDIO ELECTRONICS**  
301 Edgware Road, London, W2 1BN 01-724 3564

**CALL IN AND SEE FOR YOURSELF**

**CATALOGUE**  
Send large S.A.E. (20p UK)  
All mail to Cubegate Ltd 1st floor, 406 Edgware Road, London, W2 1ED

# MIDWICH

COMPUTER COMPANY LIMITED

RICKINGHALL HOUSE, HINDERCLAY ROAD, RICKINGHALL, SUFFOLK IP22 1HH. TEL. DISS (0379) 898751

## BBC Microcomputers

Model B 348.26  
Model B + Disc Int. 433.21  
NB Credit cards are not accepted in payment for BBC Microcomputers.

## BBC Micro Econet

Full range of products available. Installation service available.

## BBC Compatible Disc Drives

Cased drives, finished to match the BBC Micro are supplied complete with connecting cables, manual and utilities disc.  
All single cased drives may be expanded to dual configuration by the addition of the appropriate uncased mechanism.

Disc capacity	Single	Dual	Uncased
100K 40T	175.00	215.00	140.00
200K 40T D.S.	225.00	420.00	135.00
400K 40/80T D.S.	285.00	525.00	240.00

Trade/quantity discounts are available.  
BBC3 Disc Interface 84.95  
Please send for our BBC Micro price list. Full range of accessories available.

## 6500 Family

6502	D3	4.40	SN75454BP	0.24
6502A	D3	4.67	SN75468N	1.08
6520	D1	2.67	SN75491AN	0.46
6520A	D1	2.80	SN75492AN	0.61
6522	D5	3.47	TL010CP	0.38
6522A	D5	4.40	TL061CPL	0.27
6532	D2	5.33	TL062CP	0.48
6532A	D2	5.87	TL064CN	0.89
			TL066CP	0.28
			TL071CP	0.28
			TL072CP	0.47
			TL074CN	0.91
			TL081CP	0.24
			TL082CP	0.41
			TL084CN	0.85
			TL091CP	0.41
			TL092CP	0.60
			TL094CN	1.37
			TL499CP	0.55
			TL499CN	1.66
			TL496CP	0.30
			TL507CP	1.02
			ZN450E	5.25
			ZN451E	6.38
			ZN451KIT	25.65

## Linear & Interface

Device	Price
AY3-1015	6.00
AY3-1015 D2	2.92
AY3-1270	6.50
AY3-8910	D6 4.40
AY3-3600	D2 7.37
DP8304	D1 1.92
L203	0.80
LF798	3.17
LM301AN	0.24
LM308AN	0.73
LM308N	0.47
LM311N	0.84
LM319	2.23
LM324N	0.32
LM339N	0.37
LM348N	0.53
LM358N	0.28
LM393N	0.34
LM725CN	1.33
LM741CP	0.18
LM747CP	0.48
LM748CP	0.22
MC1413P	D1 0.61
MC1416	D1 0.66
MC1458CPL	0.26
MC1495L	7.13
MC1496P	0.65
MC1723P	0.32
MC3242A	5.22
MC3302P	0.40
MC3340P	1.97
MC3357P	1.56
MC3423P	0.67
MC3441AP	2.40
MC3446AP	D1 2.40
MC3447P	3.58
MC3448AP	D1 3.32
MC3470P	5.23
MC3480P	D5 4.47
MC3487P	D1 1.50
MC1411	D1 8.52
MC1412	11.87
NE555P	0.19
NE556CP	0.45
RO3 2513L	D1 7.82
RO3 2513U	D1 7.82
SN75107BN	0.58
SN7510AN	0.68
SN75150P	0.72
SN75154N	0.87
SN75159N	1.19
SN75160AN	2.15
SN75161AN	2.35
SN75162AN	3.31
SN75172GN	1.64
SN75173N	1.21
SN75174	1.64
SN75175	1.21
SN75182	0.62
SN75183	0.62
SN75188	0.44
SN75189	0.44
SN75451BP	0.24
SN75452BP	0.24
SN75453BP	0.24

## DIL Sockets

Pin	Gold	W/W
8	0.10	0.24
14	0.12	0.28
16	0.13	0.32
18	0.16	0.32
20	0.17	0.41
22	0.17	0.48
24	0.20	0.63
28	0.23	0.57
40	0.33	0.99

## ZIF Sockets

24 Pin	5.80
28 Pin	6.35
40 Pin	8.45

Data sheets are available on items marked D.  
Prices are as follows:

- D1 0.75 D5 2.50
  - D2 1.00 D6 3.00
  - D3 1.25 D7 4.00
  - D4 2.00
- A full range of the following products is carried in stock and is listed in our FREE catalogue
- ★ 74LS Series TTC
  - ★ 4000 Series CMOS
  - ★ TI Bipolar Memories
  - ★ 9900 Series Micros
  - ★ Crystals
  - ★ IDC, Card Edge & D-Type Connectors
  - ★ Dip Jumpers
  - ★ Monochrome & Colour Monitors (NEC & KAGA)
  - ★ Epron Programmers
  - ★ 6 Straps
  - ★ Custom Cable Assemblies

## SPECIAL OFFER! SPECTRUM 32K UPGRADE KIT £24.95

Carriage. Orders up to £199 are sent by 1st class post and £200+ by Securion.  
0-£100.50 £100-£199 125 £200+ 5.00 by Securion  
Prices quoted (+ carriage charges) are exclusive of VAT and are subject to change without notice.

Quantity Discounts are available on many products, please ring for details.  
Official Orders are welcome from Education Establishments, Government Bodies and Public Companies.

Credit Accounts are available to others subject to status. Payment is due strictly net by the 15th of the month.

Credit Cards are accepted (Access and Visa) for telephone and postal orders and NO SURCHARGE is made.

Out of stock items will follow automatically, at our discretion, or a refund will be given if requested.

## Memories

2114L-20	D1	0.92	78L05	0.28
4118-15	D2	1.05	78L12	0.28
4118-20	D2	0.88	78L15	0.28
4118-15 D1	D1	3.75	7805	0.33
4164-15	D2	4.38	7812	0.33
4164-20	D2	3.95	7815	0.33
4416-20	D2	6.00	7905	0.46
4564-15	5.25	7912	0.46	
5516-25	D1	7.73	7915	0.46
6116-3	D1	4.67	LM309K	0.98
6116-LP3	D2	4.67	LM317K	1.92
2532-45	D2	3.50	LM323K	4.58
2708-45	D2	3.25	LM338K	5.21
2716-35	D1	4.50	78HGASC	8.13
2716-45	D1	3.50	78H05SC	6.28
2718-3	D1	4.50	78H12ASC	7.40
2732-35	D1	4.58	78540DM	6.28
2732-45	D1	3.75	78540PC	2.50
2764-30	D1	3.92		
2764-25ONS TI	3.92			
2764-25ONS BNC	5.95			
2584-30	D2	6.00		
27128-30	D2	24.50		

## Regulators

6800	D7	2.67
6802	D5	2.61
6803C	5.83	
6809	D6	7.13
6810	D1	1.25
6821	D3	1.33
6842	D4	9.92
6843L	2.88	
6845	D5	5.88
6850	D2	1.31
6862	0.00	
6871-A1	14.17	
6848B	7.13	
6875	1.17	
6880	D7	4.30
6880B	D6	9.96
68821	D3	1.88
68810	D1	1.80
68840	D4	5.50
68850	D2	1.83
MC88B54P	7.75	

## Buffers

81LS95	0.95
81LS96	0.95
81LS97	0.95
81LS98	0.95
826A (6880AP)	0.78
8272A (6889)	0.78
8285 (6885)	0.78
8297A (6887)	0.78
8298 (6888)	0.78

## 6800 Family

6800	D7	2.67
6802	D5	2.61
6803C	5.83	
6809	D6	7.13
6810	D1	1.25
6821	D3	1.33
6842	D4	9.92
6843L	2.88	
6845	D5	5.88
6850	D2	1.31
6862	0.00	
6871-A1	14.17	
6848B	7.13	
6875	1.17	
6880	D7	4.30
6880B	D6	9.96
68821	D3	

# MASTER ELECTRONICS NOW! The PRACTICAL way!

YOUR CAREER..YOUR FUTURE..YOUR OWN BUSINESS..YOUR HOBBY  
**THIS IS THE AGE — OF ELECTRONICS!**  
the world's fastest growth industry...

There is a world wide demand for designers/engineers and for men to service and maintain all the electronic equipment on the market today — industrial — commercial and domestic. No unemployment in this walk of life!

Also — the most exciting of all hobbies — especially if you know the basic essentials of the subject. . . .

A few hours a week for less than a year — and the knowledge will be yours. . . .

We have had over 40 years of experience in training men and women successfully in this subject.

Our new style course will enable anyone to have a real understanding of electronics by a modern, practical and visual method. No previous knowledge is required, no maths, and an absolute minimum of theory.

You learn by the practical way in easy steps, mastering all the essentials of your hobby or to start, or further, a career in electronics or as a self-employed servicing engineer.

All the training can be carried out in the comfort of your own home and at your own pace. A tutor is available to whom you can write personally at any time, for advice or help during your work. A Certificate is given at the end of every course.

You will do the following:

- Build a modern oscilloscope
- Recognise and handle current electronic components
- Read, draw and understand circuit diagrams
- Carry out 40 experiments on basic electronic circuits used in modern equipment using the oscilloscope
- Build and use digital electronic circuits and current solid state 'chips'
- Learn how to test and service every type of electronic device used in industry and commerce today. Servicing of radio, T.V., Hi-Fi, VCR and microprocessor/computer equipment.

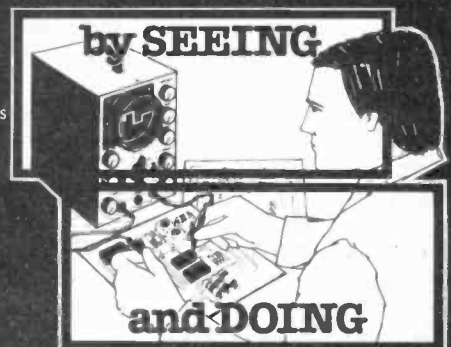

**CACC**  
www

**British National Radio & Electronics School Reading, Berks. RG1 1BR**

**FREE!**

COLOUR BROCHURE



POST NOW TO

Please send your brochure without any obligation to

NAME \_\_\_\_\_

PE/3/841

ADDRESS \_\_\_\_\_  
\_\_\_\_\_  
\_\_\_\_\_

BLOCK CAPS PLEASE

I am interested in:

- COURSE IN ELECTRONICS  
as described above
- RADIO AMATEUR LICENCE
- MICROPROCESSORS
- OTHER SUBJECTS  
please state below

OR TELEPHONE US  
0734 51515 OR  
TELEX 22758  
(24 HR SERVICE)



**British National Radio & Electronics School Reading, Berks. RG1 1BR**

# Electronic Brokers Test Equipment DISTRIBUTORS

"For detailed specifications of our complete range send for our new catalogue."

**PHILIPS**



◀ **Philips PM 2517X Handheld DMM £172**  
Multi-function, 4 digit autoranging with manual override. True RMS to 10Amp. Battery operation. Optional accessories extend measurement capabilities.

**Philips PM 3207 15MHz Oscilloscope £325 ▶**



Tough light-weight portable for field service work with big screen. Dual trace, TV triggering, X-Y operation, add and invert.



◀ **Philips PM 5107 Function Generator £295**  
Designed for audio and educational applications. Low distortion LF generator 10Hz to 100kHz, sine and square waveforms. TTL output.

**Philips PM5503 Pattern Generator ▶**

**£139** Small, light-weight for TV servicing. Five different test patterns for colour and monochrome. Tone for audio checking. Video output.



◀ **Philips PM 6667/01 Frequency Counter £290** High resolution 7 digit computing counter from 10Hz to 120MHz. Auto ranging on all waveforms. PM 6668/01 (£425) performs to 1GHz.

**FLUKE**

**New Fluke 70 series Analog/Digital Handheld Meters** All meters have 3 year warranty, all feature measurement functions of volts, ohms, amps and diode test.

**JF 73 £65** DC accuracy 0.7% Autoranging

**JF 75 £75** DC accuracy 0.5% Auto/manual ranging

**JF 77 £95** DC accuracy 0.3% Touch hold function Multi purpose holster



**HAMEG**

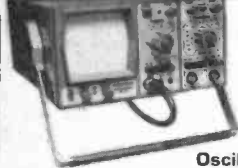

◀ **Hameg HM 103 10MHz Oscilloscope £158** Single trace, suitable for field service or home constructor. Two year warranty applies to this and all Hameg instruments.

**Hameg HM ▶ 203-4 20MHz Oscilloscope £264**



Dual trace for general purpose applications in industry and education. X-Y operation, TV triggering, add/invert and component tester.



◀ **Hameg HM 204 20MHz Oscilloscope £365** High performance instrument with sweep delay. Versatile triggering to 50MHz, variable hold off control, Z modulation and internal illuminated graticule.

**ICE**

**I.C.E. Microtest 80 Multimeter £19**  
Compact meter in robust case. 40 ranges of measurement with high sensitivity and accuracy. Large range of inexpensive accessories.

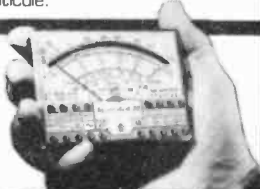

ADD 15% VAT TO ALL PRICES. Carriage and Packing extra

**Electronic Brokers Ltd., 61/65 Kings Cross Road, London WC1X 9LN. Tel: 01-833 1166. Telex 298694**



Electronic Brokers

## THE 1984 GREENWELD CATALOGUE IS NOW AVAILABLE

It's Bigger, Brighter, Better, more components than ever before. With each copy there's discount vouchers, Bargain List, Wholesale Discount List, Bulk Buyers List. Order Form and Reply Paid Envelope. All for just £1.00! Order now for early delivery!

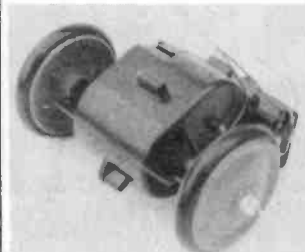

### MOTORIZED GEARBOX

These units are as used in a computerized tank, and offer the experimenter in robotics the opportunity to buy the electro-mechanical parts required in building remote controlled vehicles. The unit has 2 x 3V motors, linked by a magnetic clutch, thus enabling turning of the vehicle, and a gearbox contained within the black ABS housing, reducing the final drive speed to approx 50rpm. Data is supplied with the unit showing various options on driving the motors etc. £5.95. Suitable wheels also available; 3" Dia plastic with black tyre, drilled to push-fit on spindle, 2 for £1.30 (limited qty). 3" dia aluminium disc 3mm thick, drilled to push-fit on spindle. 2 for 68p.

### COMPUTER GAMES

**Z901** Can you follow the flashing light/pulsating tone sequence of this famous game? Supplied as a fully working PCB with speaker (no case) plus full instructions. Only £4.95

**Z902** Probably the most popular electronic game on the market - based on the old fashioned pencil and paper battleship game, this computerized version has brought it bang up to date! We supply a ready built PCB containing 76477 sound effect chip, TMS1000 micro-processor chip, R's, C's etc. Offered for its component value only (board may be cracked or chipped, R's only £1.95. Instructions and circuit, 30p.

### PUSH BUTTON BANKS

**W4700** An assortment of latching and independent switches on banks from 2 to 7 way, DPCO to 6DPCO. A total of at least 40 switches for £2.95; 100 £6.50; 250 £14.00; 1000 £45.00.

### "THE SENSIBLE 64"

David Highmores new book on the Commodore 64 now available £5.95.

### TELESCOPIC AERIALS

As used in Sinclair microvision, 9 section 100-610mm. Only 95p.

### NICAD CHARGER

Versatile unit for charging AA, C, D and PP3 batteries. Charge/test switch, LED indicators at each of the 5-charging points. Mains powered. 210 x 100 x 55 mm £7.95.

### RIBBON CABLE

Special purchase of multicoloured 14 way ribbon cable - 40p/metre; 50m £18.00; 100m £32.00; 250m £65.00.

### TTL PANELS

Panels with assorted TTL Inc. LS types. Big variety. 20 chips £1.00; 100 chips £4.00; 1000 chips £30.00.

### STABILIZED PSU PANEL

A199 A versatile stabilized power supply with both voltage (2-30V) and current (20mA-2A) fully variable. Many uses inc. bench PSU, Ni-cad charger, gen purposes testing Panel ready built, tested and calibrated. £7.75. Suitable transformer and pots, £6.00. Full data supplied.

### FERRIC CHLORIDE

New supplies just arrived - 250mg bags of granules, easily dissolved in 500ml of water. Only £1.15, 10 for £8, 100 for £60. Also abrasive polishing block 95p.

### VEROBLOC £1 OFF!!

Our biggest selling breadboard on offer at a special price of £4.10.

### 2N3055 SCOOP!!

Made by Texas - full spec devices 60p each; 10 for £4; 25 for £9; 100 for £34; 250 for £75; 1000 for £265.

### 5mm RED LED SCOOP!!

Full spec brand new devices at a low, low price!! 25 £1.95; 100 £6; 250 £13.50; 1000 £39.50.

### 1N5400 3A 50V RECTS

Bulk purchase enables us to offer these at special low prices: 25 £1.50; 100 £4.50; 250 £12; 1000 £43; 5000 £200.

### LOGIC POWER SUPPLY

This ready built mains adaptor supplies 4.5V @ 150mA DC, so can easily be modified to a stabilized 5V supply. Built in continental plug for standard mains supply. Only £1.95; 10 £16; 25 £32; 100 £110.

### EPROM PANEL

2 x 2716 EPROM's on small board with 64 way gold plated PCB mntd plug £4.95

## SHOP SALE

FEB 4-11

THOUSANDS OF BARGAINS

### SEAT BELT ALARM

Originally for sale at £8.95, these well made units 70 x 50 x 25mm provide both audible and visual alarms. Uses 2 IC's, PB2720 transducer, etc. Available ready built, with circuit and instructions for just £4.95. Also available as a kit, PCB + all components, box, wire, etc, together with instructions. Only £3.95.

### BULK BUYERS LIST

Send for our latest wholesale list - IC's from 5p, R's £2/1000, transistors 2p, C's 0.8p etc. Bargains galore!!



### TREAT YOURSELF TO A NICE NEW DIGITAL MULTIMETER!!

**KD55C** A DVM for the professional - this 3 1/2 digit multimeter has overload protection, low battery and over range indication. Full auto-polarity operation. AC Volts: 0.2-700 DC Volts: 0.2-1000 AC Current: 200uA-10A DC Current: 200uA-10A Resistance: 200R-200M Total 28 ranges for just £44.95

# GREENWELD

443c Millbrook Road Southampton SO1 0HX

A full range of components is kept in our shop.

**ALL PRICES INCLUDE VAT; JUST ADD 60p P&P EX-STOCK**



# BI-PAK BARGAINS

## BI-PAK SOLDER - DESOLDER KIT

Kit comprises: ORDER NO. VP90  
1 High Quality 25 watt General Purpose Lightweight Soldering Iron  
240v mains incl 3/16" (4.7mm) bit  
1 Quality Desoldering Pump High Suction with automatic ejection knurled anti-corrosive casing and Teflon nozzle  
1.5 metres of De-Soldering braid on plastic dispenser  
2 yds (1.83m) Resin Core Solder on Card  
1 Heat Shunt tool tweezer Type  
Total Retail Value over £12.00  
**OUR SPECIAL KIT PRICE £9.95**

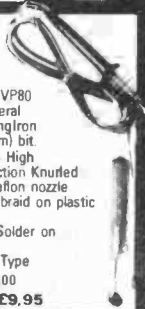

## BI-PAK PCB ETCHANT AND DRILL KIT

Complete PCB Kit comprises  
1 Expo Mini Drill 10,000RPM 12v DC incl 3 collets & 3 x Twist Bits  
1 Sheet PCB Transfers 210mm x 150mm  
1 Etch Resist Pen  
1 1/2 pack FERRIC CHLORIDE crystals  
3 sheets copper clad board  
2 sheets Fibreglass copper clad board  
Full instructions for making your own PCB boards  
Retail Value over £15.00  
**OUR BI-PAK SPECIAL KIT PRICE £9.95**  
ORDER NO. VP81



## VALUE PACKS

Pack No.	Qty	Description	Price
VP1	300	Assorted Resistors Mixed Types	£1.00
VP2	300	Carbon Resistors 1/4 Watt Pre-Formed	£1.00
VP3	200		
VP4	150	1/4 Watt Resistors 100 ohm-1M Mixed	£1.00
VP5	200	Assorted Capacitors All Types	£1.00
VP6	200	Ceramic Caps Miniature - Mixed	£1.00
VP7	100	Mixed Ceramic Disc. 1pf - 56pf	£1.00
VP8	100	Mixed Ceramic Disc. 68pf - 015pf	£1.00
VP9	100	Assorted Polyester/Polystyrene Caps	£1.00
VP10	60	C280 Type Caps Metal Foil Mixed	£1.00
VP11	100	Electronics - All Sorts	£1.00
VP12	60	Bead Type Polystyrene Min Caps	£1.00
VP13	50	Silver Mica Caps Ass. 56pf - 150pf	£1.00
VP14	50	Silver Mica Caps Ass. 180pf - 4700pf	£1.00
VP15	50	High Voltage Disc. Ceramic 750v - 8kv Mixed	£1.00
VP16	50	Wirewound Res. 9W (avg) Ass. 1 ohm - 12K	£1.00
VP17	50	Metres PVC Covered Single Strand Wire Mixed Colours	£1.00
VP18	30	Metres PVC Covered Multi Strand Wire Mixed Colours	£1.00
VP19	40	Metres PVC Single Multi Strand Hook-Up Wire Mixed	£1.00
VP20	6	Rocker Switches 5 Amp 240v	£1.00
VP21	20	Pcs. 1 - 2 & 4 mm Plugs & Sockets, Matching Sizes	£1.00
VP22	200	Sq. Inches Total, Copper Clad Board Mixed Sizes	£1.00
VP23	20	Assorted Slider Pots. Mixed Values	£1.00
VP24	10	Slider Pots. 40 mm 22K 5 x Log. 5 x Lin	£1.00
VP25	10	Slider Pots. 40 mm 47K 5 x Log. 5 x Lin	£1.00
VP26	20	Small .125" Red LED'S	£1.00
VP27	20	Large 2" Red LED'S	£1.00
VP28	10	Rectangular 2" Green LED'S	£1.00
VP29	30	Ass. Zener Diodes 250mW - 2W Mixed Vts. Coded	£1.00
VP30	10	Ass. 10W Zener Diodes Mixed Vts. Coded	£1.00
VP31	10	5 Amp SCR'S TO-66 50-400v Coded	£1.00
VP32	20	3 Amp SCR'S TO-66 Up To 400v Uncoded	£1.00
VP33	200	Sil. Diodes Switching Like IN4148 DO-35	£1.00
VP34	200	Sil. Diodes Gen. Purpose Like OA20V BAX13/16	£1.00
VP35	50	1 Amp IN4000 Series Sil. Diodes Uncoded All Good	£1.00
VP36	8	Bridge Rects. 4 x 1 Amp 4 x 2 Amp Mixed Vts. Coded	£1.00
VP37	8	Black Instrument Type Knobs With Pointer 1/2 Std	£1.00
VP42	10	Black Heatsinks To Fit TO-3, TO-220 Ready Drilled	£1.00
VP43	4	Power-Fin Heatsinks 2 x TO-3 2 x TO-66 Size	£1.00

## SEMICONDUCTORS FROM AROUND THE WORLD

**100** A collection of Transistors, Diodes, Rectifiers & Bridges SCR's, Triacs, IC's & Opto's all of which are current every-day useable devices.

Guaranteed Value Over £10 Normal Retail Price.

Data etc in every pack. Order No. VP56

Our Price £4.00

## BI-PAK'S OPTO SPECIAL

A selection of large and small sized LED's in various shapes, sizes & colours, together with 7 Segment Displays both anode & cathode plus photo transistors emitters and detectors. Cadmium Cell ORP12 and Germ. photo transistor OCP71 included. In all a total of 25 Opto pieces valued over £12 Normal Price

Order No. VP57  
Our Super Value  
Price Just  
£5.00



## HYBRID LED COLOUR DISPLAYS

Red, Green, Yellow - 3/5/6 inch Mixed types and colours  
**NUMERIC & OVER-FLOW** Common Anode/Cathode.  
GaAsP/GaP. Brand New, Full Data incl.

10 pieces (our mix) £4.00  
Normal Retail Value Over £10.00  
Order No. VP58

## IC BARGAINS

VP40 30 Assorted 74 Series TTL IC's Gates, Flip-Flops & M.S.I.'s + Data Book. All New. Normal Retail Value Over £5.00. Our price £2.50  
VP41 30 Assorted CMOS IC's CD4000 Series. Pack includes 00/09/12/14/18/21/23/25/28/30/35/44/68 AY/TE Types Plus Data Sheet Value Over £8.00. Normal retail £2.50  
YOU MAY ORDER any ONE TYPE of the above CMOS at £2.00 per 25 pieces. ORDER AS VP41 + type number required.

**RATCHET SCREWDRIVER KIT**  
Comprises 2 standard screwdriver blades 5 & 7mm size 2 cross point size 4 & 6.1 Ratchet handle. 5-in-1 Kit. £1.45 each. D/No 3298

## REGULATED VARIABLE Stabilised POWER SUPPLY

Variable from 2-30 volts and 0-2 Amps Kit includes -  
1 VPS30 Module, 1 25 volt 2 amp transformer,  
1 0-50v 2" Panel Meter, 1 0-2 amp 2" Panel Meter,  
1 470 ohm wirewound potentiometer; 1 - 4K7 ohm, wirewound potentiometer, Wiring Diagram, included. Order No. VPS30 KIT £20

## MINIATURE FM TRANSMITTER

Freq: 95-106MHz Range: 1 mile  
Size: 45 x 20mm. Add: 9v batt  
Not licenced in U.K.  
Ideal for: 007-M15-FBI-CIA-KGB etc. **ONLY £5.50**

## DIGITAL VOLT METER MODULE

3 x 7 segment displays Basic Circuit 0-2v instructions provided to extend voltage & current ranges Operating voltage 9/12v Typ. Power Consumption 50mA

D/No. VP99 Once only price £9.95

## SINGLE SIDED FIBREGLASS BOARD

Order No	Pieces	Size	Sq. Ins	Price
FB1	4	9 x 23"	100	£1.50
FB2	3	11 x 3"	100	£1.50
FB3	4	13 x 3"	156	£2.00

## DOUBLE SIDED FIBREGLASS BOARD

Order No	Pieces	Size	Sq. Ins	Price
FB4	2	14 x 4"	110	£2.00

## SILICON BRIDGE RECTIFIERS

Comprising 4 x 1/2 Amp rectifiers mounted on PCB. VRM - 150 vltz IFM - 1.5 Amps

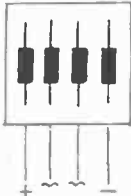

Size: 1 inch square  
10 off £1.00  
50 off £4.50  
100 off £7.50

ORDER NO: 4R1 B Rect.

## INTRUSION ALARM

The DOOR BIRD DB 2000 alerts you before your door is opened. Just hang on the inside door knob - alarm is activated as soon as the outside door knob is touched. **ONLY £3.95**



## OPTO 7-Segment Displays Brand new 1st Quality LITRONIX DL 707R 14-pin

Red 0.3" Common Anode Display 0-9 with right hand decimal point TTL compatible 5v DC Supply. Data supplied

IN	5 pieces	£3	(60p each)
PACKS	10 pieces	£5	(50p each)
OF	50 pieces	£20	(40p each)
	100 pieces	£35	(35p each)
	1,000 pieces	£300	(30p each)

THE MORE YOU BUY - THE LESS YOU PAY

## TRANSISTOR CLEARANCE

All Sorts Transistors. A mixed Bag NPN-PNP Silicon & Germ. Mainly Uncoded You 100 To Sort Pack includes Instructions For Making Simple Transistor Tester. Super Value Order No VP60 **£1.00**

## POWER SUPPLY OUR PRICE £3.25

Power supply fits directly into 13 amp socket Fused for safety. Polarity reversing socket. Voltage switch. Lead with multi plug Input - 240V AC 50HZ. Output - 3, 4, 5, 6, 7.5, 9 & 12V DC Rating - 300 ma MW98.

## MULTITESTERS

1,000 opv Including test leads in Battery  
AC volts: 0-15-150-500-1,000  
DC volts: 0-15-150-500-1,000  
DC currents: 0-1ma-150ma  
Resistance: 0-25 K ohms 100 K ohms  
Dims: 90 x 61 x 30mm

O/No. 1322. OUR PRICE £6.50 ONLY

## ELECTRONIC SIREN 12v DC



Red plastic case with adjustable fixing bracket. Emits high-pitched wailing note of varying pitch - 100 cycles per minute. Dims - 90mm (dia) 60mm (depth). Power - 12v DC.

Our Price: £5.50

## TECASBOTY

### THE ELECTRONIC COMPONENTS AND SEMICONDUCTOR BARGAIN OF THE YEAR!

This collection of Components and Semiconductors for the hobbyist is probably the most value-packed selection ever offered, it consists of Resistors, carbon and wirewound of various values. Capacitors: All types, sorts and sizes including electrolytics. Potentiometers - single, dual, slider and preset. Switches, Fuses, Heatsinks, Wire, P.C.B. Board, Plugs, Sockets etc., PLUS a selection of Semiconductors for everyday use in popular Hobby Projects. These include: SCR's, Diodes, Rectifiers, Triacs & Bridges as well as a first class mix of Transistors and IC's. In all, we estimate the value of this in current retail catalogues to be over £25! So, help yourself to a great surprise and order a Box TODAY for just £6.50

ONLY at BI-PAK. Remember, stocks are limited so hurry! You can call us on 0920-3182/3412 and order with your Barclaycard or Access Card - 24hr Answerphone Service NOW. Order No. V.P. 85.

## OUR GREAT NEW CATALOGUE

Presented with a Professional Approach and Appeal to ALL who require Quality Electronic Components, Semiconductors and other Accessories ALL at realistic prices. There are no wasted pages of useless information so often included in catalogues published nowadays. Just solid facts i.e. price, description and individual features of what we have available. But remember, BI-PAK's policy has always been to sell quality components at competitive prices and THAT WE STILL DO.

We hold vast stocks "in stock" for fast immediate delivery, all items in our Catalogue are available ex stock. The Catalogue is designed for use with our 24 hours "ansaphone" service and the Visa/Access credit cards, which we accept over the telephone.

To receive your NEW 1983 BI-PAK Catalogue, send 75p PLUS 25p p&p to:-

# BI-PAK

Send your orders to Dept PE3 BI-PAK PO BOX 6 WARE, HERTS  
SHOP AT 3 BALOOCK ST, WARE, HERTS  
TERMS CASH WITH ORDER. SAME DAY DESPATCH. ACCESS  
BARCLAYCARD ALSO ACCEPTED TEL (0920) 3182 GIRO 388 7006  
ADD 15% VAT AND 75p PER ORDER POSTAGE AND PACKING



Use your credit card. Ring us on Ware 3182 NOW and get your order even faster. Goods normally sent 2nd Class Mail. Remember you must add VAT at 15% to your order. Total Postage add 75p per Total order.

# SECURITY

Install your own system and save using built and tested modules

## A COMPLETE INTRUDER ALARM

EASILY ASSEMBLED ULTRASONIC UNIT CK 5063

Requires no installation. Easily assembled using our professionally built and tested modules.

- Adjustable range up to 25ft.
- Built-in entrance & exit delay
- Built-in timed alarm
- Key operated switch - Off, Test and Operate
- Provision for an extension speaker
- Fully self-contained
- Uses US 5063, PSL 1865 Key Switch 3901, 3" Speaker 3515

only **£37.00** + V.A.T.

Now you can assemble a really effective intruder alarm at this low price using tried and tested Riscomp modules. Supplied with full instructions, the kit containing everything necessary to provide an effective warning system for your house or flat. With a built-in LED indicator and test position the unit is easily set-up requiring no installation. It may simply be placed on a cupboard or desk. Movement within its range will then cause the built-in siren to produce a penetrating 90db of sound, or even 110db's with an additional speaker. All parts included and supplied with full instructions for ease of assembly. Size 200 x 180 x 70mm. Order as CK 5063

### DIGITAL ULTRASONIC DETECTOR US 5063



only **£13.95** + V.A.T. **NEW**

- 3 levels of discrimination against false alarms
  - Crystal control for greater stability
  - Adjustable range up to 25ft.
  - Built-in delays
  - 12V operation
- This advanced new module uses digital signal processing to provide the highest level of sensitivity whilst discriminating against potential false alarm conditions. The module has a built-in exit delay and timed alarm period, together with a selectable entrance delay, plus many more outstanding features.

### ULTRASONIC MODULE US 4012



**£10.95** + V.A.T.

- Adjustable range from 5-25ft.
- This popular low cost ultrasonic detector is already used in a wider range of applications from intruder detectors to automatic light switches and door opening equipment, featuring 2 LED indicators for ease of setting up.

### INFRA-RED SYSTEM IR 1470

only **£25.61** + V.A.T.

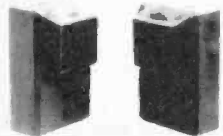

Consisting of separate transmitter and receiver both of which are housed in attractive moulded cases, the system provides an invisible modulated beam over distances of up to 50ft, operating a relay when the beam is broken. Intended for use in security systems, but also ideal for photographic and measurement applications. Size 80 by 50 by 35mm.

### POWER SUPPLY & RELAY UNIT PS 4012

Provides stabilised 12V output at 85mA and contains a relay with 3 amp contacts. The unit is designed to operate with up to 2 ultrasonic units or 1 infra-red unit IR 1470. Price **£4.25** + V.A.T.

### SIREN MODULE SL 157

Produces a loud penetrating sliding tone which when coupled to a suitable horn speaker, produces S.P.L.'s of 110db's at 2 metres. Operating from 9-15V. Price **£2.95** + V.A.T.

### 5 1/2" HORN SPEAKER HS 588

This weather-proof horn speaker provides extremely high sound pressure levels (110db's at 2 metres) when used with the CA 1250. PS 1865 or SL 157. Price **£4.95** + V.A.T.

### 3-POS. KEY SWITCH 3901

Single pole, 3 pos. key switch intended for use with the CA 1250. Price **£3.43** + V.A.T. Please allow 7 days for delivery

Add 15% VAT to all prices  
Add 50p post & packing to all orders  
Units on demonstration  
Shop hours 9.00 to 5.30 p.m.  
Closed Wednesday  
Saturday 9.00 to 1.00 p.m.  
SAE with all enquiries  
Order by telephone or post  
using your credit card

### ALARM CONTROL UNIT CA 1250



Price **£19.95** + V.A.T.

The heart of any alarm system is the control unit. The CA 1250 offers every possible feature that is likely to be required when constructing a system, whether a highly sophisticated installation or simply controlling a single magnetic switch on the front door.

- Built-in electronic siren drives 2 loud speakers
- Provides exit and entrance delays together with fixed alarm time
- Battery back-up with trickle charging facility
- Operates with magnetic switches, pressure pads, ultrasonic or I.R. units
- Anti-tamper and panic facility
- Stabilised output voltage
- 2 operating modes - full alarm/anti-tamper and panic facility
- Screw connections for ease of installation
- Separate relay contacts for external loads
- Test loop facility

### SIREN & POWER SUPPLY MODULE PSL 1865

only **£9.95** + V.A.T.



A complete siren and power supply module which is capable of providing sound levels of 110db's at 2 metres when used with a horn speaker. In addition, the unit provides a stabilised 12V output up to 100mA. A switching relay is also included so that the unit may be used in conjunction with the US 5063 to form a complete alarm.

### HARDWARE KIT HW 1250

only **£9.50** + V.A.T.



This attractive case is designed to house the control unit CA 1250, together with the appropriate LED indicators and key switch. Supplied with the necessary mounting pillars and punched front panel, the unit is given a professional appearance by an adhesive silk screened label. Size 200 by 180 by 70mm

### ULTRASONIC MODULE ENCLOSURE

only **£2.95** + V.A.T.



Suitable metal enclosure for housing an individual ultrasonic module type US 5063 or US 4012. Supplied with the necessary mounting pillars and screws etc. For US 5063 order SC 5063; for US 4012 order SC 4012

## RISCOMP LIMITED

Dept PE9  
21 Duke Street,  
Princes Risborough,  
Bucks. HP17 0AT  
Princes Risborough (084 44) 6326

# T.V. SOUND TUNER

SERIES II

BUILT AND TESTED

In the cut-throat world of consumer electronics, one of the questions designers apparently ponder over is "Will anyone notice if we save money by chipping this out?" In the domestic TV set, one of the first casualties seems to be the sound quality. Small speakers and no tone controls are common and all this is really quite sad, as the TV companies do their best to transmit the highest quality sound. Given this background a compact and Independent TV tuner that connects direct to your Hi-Fi is a must for quality reproduction. The unit is mains-operated.



COMPLETE WITH CASE

**£26.50** + £2.00 p&p.

This TV SOUND TUNER offers full UHF coverage with 5 pre-selected tuning controls. It can also be used in conjunction with your video recorder. Dimensions: 10 1/2" x 7 1/2" x 2 1/2".

## PRACTICAL ELECTRONICS STEREO CASSETTE RECORDER KIT

COMPLETE WITH CASE

ONLY **£31.00** plus **£2.75** p&p.

- NOISE REDUCTION SYSTEM.
- AUTO STOP.
- TAPE COUNTER.
- SWITCHABLE E.Q.
- INDEPENDENT LEVEL CONTROLS.
- TWIN V.U. METER.
- WOW & FLUTTER 0.1%.
- RECORD/PLAYBACK I.C. WITH ELECTRONIC SWITCHING.
- FULLY VARIABLE RECORDING BIAS FOR ACCURATE MATCHING OF ALL TYPES.

Kit includes tape transport mechanism, ready punched and back printed quality circuit board and all electronic parts, i.e. semiconductors, resistors, capacitors, hardware, top cover, printed scale and mains transformer. You only supply solder & hook-up wire. Featured in April P.E. reprint 50p. Free with kit.

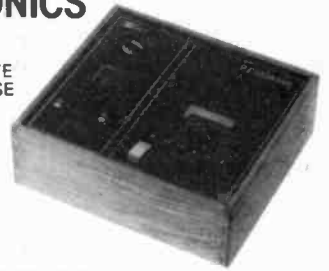

## STEREO TUNER KIT

SPECIAL OFFER! **£13.95** + **£2.50** p&p.

This easy to build 3 band stereo AM/FM tuner kit is designed in conjunction with P.E. (July '81). For ease of construction and alignment it incorporates three Mullard modules and an I.C. IF System. FEATURES: VHF, MW, LW Bands, interstation muting and AFC on VHF. Tuning meter. Two back printed PCB's. Ready made chassis and scale. Aerial: AM-ferrite rod, FM-75 or 300 ohms. Stabilised power supply with 'C' core mains transformer. All components supplied are to P.E. strict specification. Front scale size 10 1/2" x 2 1/2" approx. Complete with diagram and instructions.



## BSR RECORD DECKS

3 speed, manual, auto, setdown; with auto return. Fitted with viscous damped cue, tubular aluminium counter-weighted arm, fitted with stereo ceramic head. Ideally suited for home or disco use. **£17.50** + **£1.75** p&p.

Auto Changer model - takes up to six records with manual override. Also supplied with stereo ceramic cartridge. **£12.95** + **£1.75** p&p.

PLINTH to suit BSR Record Player Deck (with cover). Size 16 1/2" x 14 1/2" x 2". Cover size: 14 1/2" x 13 1/2" x 3 1/2". Due to fragile nature, Buyer collect only. Price: **£8.95**.



## 125W HIGH POWER AMP MODULES

The power amp kit is a module for high power applications - disco units, guitar amplifiers, public address systems and even high power domestic systems. The unit is protected against short circuiting of the load and is safe in an open circuit condition. A large safety margin exists by use of generously rated components, result, a high powered rugged unit. The PC board is back printed, etched and ready to drill for ease of construction and the aluminium chassis is preformed and ready to use. Supplied with all parts, circuit diagrams and instructions.

ACCESSORIES: Stereo/mono mains power supply kit with transformer: **£10.50** plus **£2.00** p&p.



### SPECIFICATIONS:

Max. output power (RMS): 125 W. Operating voltage (DC): 50 - 80 max. Loads: 4 - 16 ohm. Frequency response measured @ 100 watts: 25Hz - 20KHz. Sensitivity for 100w: 400mV @ 47K. Typical T.H.D. @ 50 watts, 4 ohms: 0.1%. Dimensions: 205x90 and 190x36mm.

KIT **£10.50** + **£1.15** p&p.

BUILT **£14.25** + **£1.15** p&p.

## HI-FI SPEAKER BARGAINS

AUDAX 8" SPEAKER **£5.95** + **£2.20** p&p.

High quality 40 watts RMS bass/mid. Ideal for either HiFi or Disco use this speaker features an aluminium voice coil and a heavy 70mm dia. magnet. Freq. Res.: 20Hz to 7kHz. Imp.: 8 ohms.

AUDAX 40W FERRO-FLUID HI-FI TWEETER Freq. res.: 5KHz - 22KHz. Imp.: 8 ohms. 60mm sq. **£5.50** + **60p** p&p.

GOODMANS TWEETERS 8 ohm soft dome radiator tweeter (3 1/2" sq) for use in systems up to 40W. **£3.95** ea + **£1** p&p. **£6.95** pr + **£1.50**.

## MONO MIXER AMP

Ideal for halls and clubs. **£45.00** + **£2** p&p.

50 Watt, six individually mixed inputs for 2 pickups (Cer. or mag), 2 moving coil microphones and 2 auxiliary for tape tuner, organs etc. Eight slider controls - 6 for level and 2 for master bass and treble. 4 extra treble controls for mic. and aux. Inputs. Size: 13 1/2" x 6 1/2" x 3 1/2" ap. Power output 150 W RMS (cont.) for use with 4 to 8 ohm speakers. Attractive black vinyl case with matching fascia and knobs. Ready to use.



All mail to: 21A HIGH ST, ACTON W3 6NG. Callers welcome from 9.30 - 5.30. Half day Wednesday.

Note: Goods despatched to U.K. postal addresses only. All items subject to availability. Prices correct at 30/11/83 and subject to change without notice. Please allow 14 working days from receipt of order for despatch. RTVC Limited reserve the right to update their products without notice. All enquiries send S.A.E. Telephone or mail orders by ACCESS welcome.

CALLERS TO: 323 EDGWARE ROAD, LONDON W2. Telephone: 01-723 8432. (5 minutes walk from Edgware Road Tube Station) Now open 6 days a week 9 - 5.30. Prices include VAT.



## BRITAIN'S FUTURE

**D**OES Britain have an independent future in high technology? Has £50m of public money assured the UK of its own chip maker? Will the Transputer put the UK ahead of the world in electronics?

There are no single word answers to these questions but the answers could be vital to the future UK economy. Just recently the name of Inmos has been hitting the headlines again for a number of reasons not the least being their need to find more finance and the resulting talks with GEC and other companies—names like Philips, SGS, Fujitsu and Western Electric have also been reported. Inmos was the subject of much press comment back in '79 and '80 when the 'new' Government hesitated about providing its second £25m.

In the October 1980 issue of PE Nexus wrote the following words "As I write there is still no decision on Inmos an ominous sign reflecting lack of enthusiasm for, if not imminent abandonment of, Government (i.e. taxpayers) support". Within a week or two of that being written the Government

(i.e. taxpayers) did cough up and Inmos was away, albeit after losing a valuable six months waiting for a decision. Over the last three years Inmos has quietly built a reputation in the industry for technical excellence and has proved its ability to process high volume chips at Newport; surely it would be madness to let it slip into foreign ownership now.

Sir Clive Sinclair recently predicted that a "wall of secrecy" will soon be built around high tech. research and he went on to add "Either we get ourselves back into the hardware business or we're out of the game".

Sir Clive suggested that hardware and software would be so closely related that to ensure our ability to stay in the field, and not be reliant on foreign manufacturers, we must develop both. He stressed the "very serious implications" if Inmos was allowed to be bought by a non-UK company.

With this background PE has commissioned Tom Ivall to look at Inmos and its first five years. The article does not provide straightforward answers to the above questions but it gives clear

indications of where the UK chip maker is now, how it got there and where it might go in the near future.

## TRANSPUTER

The future of Inmos is closely tied up with the Transputer so in order to round off the scene we also commissioned Ray Coles (who writes Micro-File) to take an in depth look at this exciting device. The Transputer article will be published next month in place of Micro-File.

These two articles should interest anyone involved in electronics at any level, because of the implications outlined above, make sure you read them.

Incidentally Sir Clive is not slow in developing new products—see *News and Market Place* for details of his new computer.



**EDITOR** Mike Kenward  
**Gordon Godbold** ASSISTANT EDITOR  
**David Shortland** ASSISTANT  
 EDITOR/PRODUCTION  
**Mike Abbott** TECHNICAL EDITOR  
**Brian Butler** TECHNICAL SUB EDITOR

**Jack Pountney** ART EDITOR  
**Keith Woodruff** ASSISTANT ART EDITOR  
**John Pickering** SEN. TECH. ILLUSTRATOR  
**Isabelle Greenaway** TECH. ILLUSTRATOR  
**Jenny Tremaine** SECRETARY

*Technical and Editorial queries and letters (see note below) to:*  
 Practical Electronics Editorial,  
 Westover House,  
 West Quay Road, Poole,  
 Dorset BH15 1JG

**Phone: Editorial Poole 671191**

**We regret that lengthy technical enquiries cannot be answered over the telephone**

**ADVERTISEMENT MANAGER** D. W. B. Tilleard } **01-261 6676**  
 SECRETARY **Christine Pocknell**  
 AD. SALES EXEC. **Alfred Tonge 01-261 6819**  
 CLASSIFIED SUPERVISOR **Barbara Blake 01-261 5897**  
 AD. MAKE-UP/COPY **Brian Lamb 01-261 6601**

*Queries and letters concerning advertisements to:*  
 Practical Electronics Advertisements,  
 King's Reach Tower,  
 Stamford Street, London SE1 9LS  
 Telex: 915748 MAGDIV-G

### Letters and Queries

We are unable to offer any advice on the use or purchase of commercial equipment or the incorporation or modification of designs published in PE. All letters requiring a reply should be accompanied by a stamped, self addressed envelope, or addressed envelope and international reply coupons, and each letter should relate to one published project only.

Components and p.c.b.s are usually available from advertisers; where we anticipate difficulties a source will be suggested.

### Back Numbers and Binders

Copies of most of our recent issues are available from: Post Sales Department (Practical Electronics), IPC Magazines Ltd., Lavington House, 25 Lavington Street, London SE1 0PF, at £1 each including Inland/Overseas p&p. Please state month and year of issue required.

Binders for PE are available from the same address as back numbers at £5.50 each to UK or overseas addresses, including postage, packing and VAT where appropriate. State year and volume required.

### Subscriptions

Copies of Practical Electronics are available by post, inland for £13, overseas for £14 per 12 issues, from: Practical Electronics, Subscription Department, IPC Magazines Ltd., Room 2816, King's Reach Tower, Stamford Street, London SE1 9LS. Cheques, postal orders and international money orders should be made payable to IPC Magazines Limited. Payment for subscriptions can also be made using any credit card and orders placed via Teledata. Tel. 01-200 0200.



Items mentioned are available through normal retail outlets, unless otherwise specified. Prices correct at time of going to press.

## SINCLAIR'S QUANTUM LEAP

You are probably going to see the computer shown here a great deal over the next few years. It's Sinclair's new QL (Quantum Leap, would you believe) the name is perhaps OTT but then so is the computer. Based on the Motorola 68 008 32 bit chip the QL has 128K of usable RAM (up to 32K can be required from a screen bit map) extendable up to 640K, and 32K of ROM extendable up to 64K containing a new "Sinclair Super BASIC" and Sinclair QDOS operating system.

The unit has a full size "proper" keyboard, two 100K microdrives built-in and sockets for microdrive extension (up to six extra drives), local area network, RGB monitor port, u.h.f. tv port, two standard RS-232-C sockets, two joysticks sockets, ROM cartridges slot and expansion slot for extra memory or peripherals.



Planned enhancements under development are: PASCAL compiler, 68000 assembler, terminal emulator, 0.5mb memory expansion, A to D converter, Winchester interface, modem, parallel printer interface and IEEE-488 interface.

Super BASIC is said to be a radical enhancement of Spectrum BASIC, and QDOS is a new Sinclair development which allows single-user multiple tasking, time sliced priority job scheduler, display handling for multiple screen windows and device-independent I/O.

The QL comes complete with an extensive manual in an A4 ring binder, a 1.8A

power supply, a suite of four software programs on microdrive cartridges and four blank cartridges. The software supplied has been developed by Psion and is claimed to "completely out perform existing software for micros" it comprises QL Abacus for spreadsheet analysis, Archive or database management, Easel for graphics and Quill for word processing. All are said to be immediately usable and very advanced, so much so that it is claimed "you probably won't refer to the manual"!

All this is provided for £399 including VAT; by mail order only at present. Other things that may be of interest are: The 68008 runs at 7.5MHz and a second processor (Intel 8049) controls keyboard, sound, RS-232-C receive and real time clock functions.

## FOOD FOR THOUGHT

It is unlikely that Ocean Software have bitten off more than they can chew with 'Mr Wimpey', a new game for the 48K Spectrum, indeed it looks like a recipe for success.

The game involves a culinary concoction of ingredient pinching nasties who constantly hamper the player's attempts to assemble hamburgers. The program also incorporates the company logo and jingle.

Even if this first UK company commissioned program does not go down well the business principle behind it certainly will. In the USA company sponsored programs are already big business, the advantages are obvious if the games climb high in the popularity charts. This will certainly be the first of many such attempts by companies to cash in on the infinite commercial possibilities within the home computer market. Interesting variations spring to mind, who knows what Andrex could come up with.

'Mr Wimpey' is written in 100% machine code and has hi-res graphics and sound. It can be snapped up from leading stores for around £5.90 and will shortly be available for the Commodore 64K.

## MULTI-FUNCTION KEYBOARD

The Concept keyboard is a new approach to educational computing, allowing easier pupil-computer integration.

The Concept keyboard takes interchangeable A4-size overlays which define the number, shape, size, colour, position and legending of the keys. Each program can use a separate overlay, with keys appropriate to the application. The ability to respond directly to programmed questions, via keys labelled 'Yes', 'No', 'True', 'False' for example, greatly improves pupils' interaction with the computer.

The keys can be made large enough to allow operation by visually or physically handicapped pupils.

The flat pressure-sensitive keyboard also gives great flexibility in designing teaching programs. A program to teach shopping skills, for example, could use a model trolley and an overlay showing the floor-plan of a supermarket with the various aisles and counters.

The Concept keyboard can be used with any microcomputer. It is of value in any educational application and special education where the normal QWERTY keyboard presents operating difficulties.

The keyboard has an 8x16 matrix of touch-sensitive areas, each producing a unique 7-bit ASCII code which the programmer defines as required. A bleeper with on/off con-

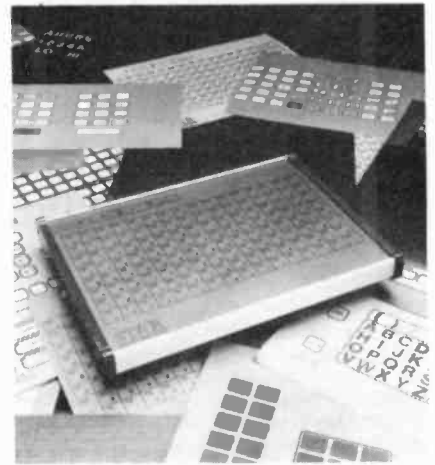

trol, and two additional user-dedicated touch pads, are also provided.

The price of the Concept keyboard (£91.00 ex VAT) includes full documentation and, for educational applications, a connecting lead for the majority of micros and a set of demonstration software.

Star Microterminals Limitd, 22 Hyde Street, Winchester, Hampshire, SO23 7DR. (0962) 51422.

## RT-VC CHANGE

One of PE's oldest advertisers have just reopened their original Acton premises as an Electronics Discount Centre. RT-VC have used the premises as a mail order operation for many years with shop sales from their Edgware Road address.

The Edgware Road shop remains unaltered while 21 High Street, Acton, is now open for trading and carries a wide range of consumer electronics including telephones, watches, calculators, speakers and record decks plus the well known RT-VC kits and modules. The latter include the PE Stereo Cassette Recorder and a VHF Stereo Tuner that were published in PE in conjunction with RT-VC.

RT-VC have always been known for their low price products and these are now readily available in Acton High St. They are of course continuing their mail order operation from the same address.

# MARKET PLACE

## PICO-POWER

Probably the smallest power supply of its type available is the Picopac range from Rastra Electronics; these 1W mains packages would certainly fit into the proverbial matchbox.

The supplies feature small physical size (43.2 x 25.4 x 21.5mm) coupled with high reliability. Modules are available with inputs at 115/220V a.c. 50/60/400Hz and with single or dual outputs. Single outputs range from 5V to 24V d.c. the dual output type being  $\pm 15V$  d.c. Since the units feature series regulation, the residual ripple is well under 1mV.

Despite the tiny size of these units the manufacturers claim an impressive 2kV a.c. isolation for 1 minute between primary and secondary. The Picopac is encapsulated and is intended for p.c.b. mounting. Prices however are not quite so small at £26 for the single and £42 for the dual output version, exc VAT. Details from Rastra Electronics Ltd, 275-281 King Street, Hammersmith, London W6 9NF (01-748 3143/2960).

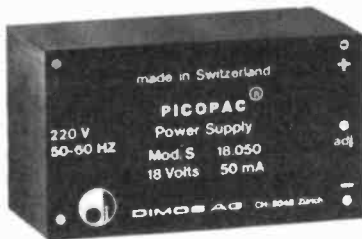

## Silicon News Corner

Zilog (Exxon) introduces 12MHz version of entire Z8 micro family. Zilog (UK) Ltd., Zilog House, Moorbridge Rd., Maidenhead, Berks SL6 8PL.

Omron Flat mini-sized relay uses "see-saw" system which is free from contact bounce and highly shock resistant. IMO Precision Controls, 1000 North Circular Rd., Staples Corner, London NW2.

IMS1400M high performance 16K static RAM. 70ns CE access, 165mW standby power (660mW active). Single supply (5V). I/O is TTL compatible. Inmos, Whitefriars, Lewins Meads, Bristol BS1 2NP.

CTS101AGB is a high performance, general purpose op. amp. High gain, s/c protected, excellent temp. stability and simplified compensation.

CTS0002GB buffer amp., high speed, high impedance follower.

CTS00081B hybrid, high voltage, high current driver, TTL/DTL to 3A (pulsed) drive.

Inmos IMS2600 high performance 64K x 1 dynamic RAM. 100ns access, 22mW standby power (303W active). Single supply (5V) with on-chip refresh. I/O is TTL compatible. Bit & nibble mode capability.

## Briefly...

An electronic potato has been developed by the Scottish Institute of Agricultural Engineering in an attempt to reduce damage during mechanical processing.

The potato—a direct descendant of a similarly pseudo raspberry from the same stable uses an Entran accelerometer to gather information about the forces acting upon it during its automated journey. A v.h.f. transmitter sends out data from the foam potato to remote recording equipment.

It is hoped that the present day loss of over 10 per cent of the nation's maincrop will be reduced using data gleaned from this unlikely 'spudnik'.

Got any bright ideas? Unemployed? Live in London? The GLC are spending £40 million on a scheme to make University and Polytechnic equipment and know-how available to the public. Ideas can be brought to the prototype stage using the scheme which already has a list of new ideas including medical systems and a robot arm. It is hoped that jobs may ultimately be created to fill up some of the 33 million square feet of idle factory space in the capital.



Sixty of the world's top CMOS experts agree that Ultra Large Scale Integration will, within five years, allow chips with one billion transistors on them, to go into production. How this will be achieved is shrouded in some mystery, but Alan Aitken, of Mitel, has stated that ULSI is already possible, the only thing holding up production he said is the investment required to adapt existing equipment.

## Countdown . . .

Please check dates before setting out, as we cannot guarantee the accuracy of the information presented below. Note: some exhibitions may be trade only. If you are organising any electrical/electronics, radio or scientific event, big or small, we shall be glad to include it here. Address details to Mike Abbott.

Barclays Techmart Feb. 21-25. NEC, B/ham. J4  
 Electrex Feb. 27-March 2. NEC, B/ham. L3  
 Hybrid Microtech Feb. 28. Cunard Int. Hotel, London. R2  
 Scotest March 6-8. Anderson Exhibition Cntr., Glasgow. T  
 Scottish Sensors March 6-8. Anderson Ex. Cntr., Glasgow. T  
 Home Appliances International March 12-15. NEC, B/ham. M  
 Computer Trade Show March 13-15. Wemb. Conf. Cntr. Z1  
 Business Telecom March 13-15. Barbican Cntr., London. O  
 Visit to Firefly Electric Vehicles (Milton Keynes). March 17. R1  
 Electro-Optics/Laser Int. March 20-22. Metropole, Brighton. T1  
 Information Technology (Conf. & Ex.) March 20-22. London.  
 ☎ 01-828 2333  
 Scottish Computer Show March '84. Holiday Inn, Glasgow. T1  
 Fibre Optics May 1-3. Porter Tun Room, Whitbread Brewery. E

All Electronics /ECIF May 1-3. Barbican, London. E  
 Biotech Europe May 15-17. Wembley Conf. Cntr., London. O  
 Micro City May 15-17. Exhibition Complex, Bristol. F3  
 Scotex June 5-7. Royal Highland Exhibition Halls, Ingliston, Edinburgh. O5  
 IBM System User Show June 12-14. Wembley Conf. Cntr., London. O  
 Qualex June 19-21. Corn Exchange, Brighton. D4  
 Surface Treatment & Finishing Show June 25-29. Birmingham. M  
 Networks July 3-5. Wembley Conf. Cntr., London. O  
 Cable July 10-12. Wembley Conf. Cntr., London. O  
 Testmex Sept. 11-13. Grosvenor Ho. Pk. Lane, London. E  
 Building & Home Improvement Sept. 25-30. Earls Court, London. M

D4 Network ☎ 0280 815226  
 E Evan Steadman ☎ 0799 26699  
 F3 Tomorrow's World ☎ 0272 292156  
 J4 NEC ☎ 021 780 4141  
 L3 Electrex Ltd. ☎ 0483 222888  
 M Montbuild ☎ 01-486 1951  
 O5 Institute of Electronics ☎ 0706 43661  
 R1 Battery Vehicle Association. ☎ Brian Hampton, 0908 316991  
 R2 ☎ 08956 32476  
 T Trident ☎ 0822 4671  
 T1 Cahners ☎ 0483 38085  
 Z1 IPC ☎ 01-643 8040

# Spectrum

# AUTO-SAVE

## R.A. Penfold

THE popular Sinclair ZX Spectrum computer has a quite fast and efficient cassette interface, but it can be a little awkward to use. One reason for this is that problems can arise if the "Ear" and "Mic" sockets of the computer are both connected to their respective sockets on the cassette recorder, and for satisfactory results it is usually necessary to only connect the lead that is actually being used. Another problem is the lack of any automatic control of the cassette motor when loading and saving. This is not really too important when loading since the computer will continue to search until the program is found, giving the user unlimited time to load the cassette into the recorder and run it through to the beginning of the appropriate program. On the other hand, when saving a program it is very much easier if the cassette and recorder can be set up ready to record, and the computer will then automatically start the recorder, record the program, and switch the recorder off again.

### SIMPLE AUTO SWITCH

The problem of having to unplug one lead and plug in the other, every time a change is made from loading to saving (or vice versa), is easily overcome by using a switch to disconnect whichever of the leads is not required. A simple way of providing an auto-save facility would be to have a switch which would activate the cassette motor when an output from the "Mic" socket of the recorder was detected. There would obviously be some slight delay between the start of an output from the computer and the recorder beginning to record properly, but the Spectrum precedes all data with a tone leader (to operate the auto recording level of the recorder), and in practice this system gives no loss of data.

This auto-save unit uses what is basically the system outlined above, as can be seen from the block diagram of the unit which is shown in Fig. 1.

A two pole switch is used to connect either the "Mic" lead or the "Ear" lead, depending on the mode of operation selected. A set of relay contacts control the cassette motor via the "Rem" (remote) socket of the recorder, and a third pole on the save/load switch is used to place a short circuit on the "Rem" output when the unit is in the "load" mode and the auto switching is inoperative. This also enables the recorder to be used in the fast forward and rewind modes without having to unplug the remote lead.

Although it might, on the face of it, appear that using a simple amplifier, rectifier, smoothing circuit, and relay driver would give satisfactory results and activate the relay in the presence of an output signal, in practice things are slightly less straightforward. The problem stems from the fact that signals other than the "save" signal are fed to the "Mic" socket. These come from the computer's sound generator, and apart from the signal produced by BEEP commands there is also the signal generated each time a key is operated.

The problem is largely overcome by using a phase locked loop tone decoder to drive the relay. This does not respond to the short bursts of keyboard tone even if a number of them follow in rapid succession. It will respond to any signals within its narrow lock range that are caused by BEEP

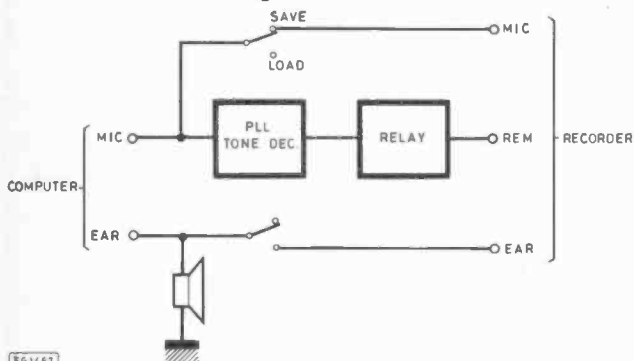

Fig. 1. Block diagram of the Auto-Save



instructions, but this can be overcome by avoiding this small range of frequencies, and in practice the tape recorder would normally be switched off anyway when a program is running. It would therefore be irrelevant even if a spurious operation of the unit did occur.

It can be very helpful to monitor the output of the recorder when loading programs as it is then immediately obvious if a program is being fed into the computer but is failing to load, or if some other loading problem occurs. A loudspeaker is therefore used to monitor the signal being fed into the computer.

## THE CIRCUIT

It will be apparent from the circuit diagram of Fig. 2 that the unit uses few components and has a very simple circuit.

IC1 is an NE567 PLL tone decoder, and as this requires an input signal of only about 20 millivolts r.m.s. no pre-amplification is required. However, as there is normally a very low input impedance at the microphone input of a cassette recorder, R1 is added in series with the output to the recorder to prevent loading from reducing the signal to an inadequate level. Of course, losses through R1 substantially reduce the signal level reaching the "Mic" input of the recorder, but in practice the signal level still seems to be far higher than the minimum acceptable level.

The timing components for the oscillator in the PLL are VR1, R2 and C2. The Spectrum has a nominal tone leader frequency of 800 hertz, and VR1 is adjusted for an 800 hertz centre frequency.

A switching action is used to detect whether or not the oscillator has locked on to the same frequency as that of the incoming signal. Basically, all that happens is the oscillator operates an electronic switch and the input signal is fed through this switch. If the two signals are at the same frequency the switch cuts off negative half cycles but allows positive ones to pass. This rectified signal is smoothed and used to drive an internal npn switching transistor. C4 is the smoothing capacitor and the collector of the switching transistor connects to pin 8 of the NE567. C3 is the capacitor in the lowpass filter of the PLL, incidentally.

If the input signal and the oscillator are at different fre-

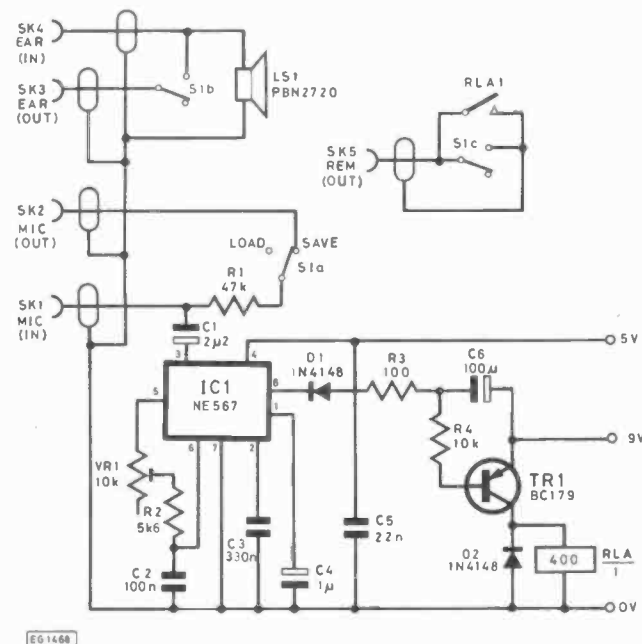

Fig. 2. Circuit diagram of the Auto-Save

quencies the two signals will have a constantly changing phase relationship so that the electronic switch passes a mixture of positive and negative signals. This gives zero average voltage across C4 and the output transistor is not switched on.

The output transistor is activated continuously when the 800 hertz tone leader is present, but when data is being saved the output tone is modulated and the output transistor is pulsed on intermittently. The output of IC1 is therefore used to drive a smoothing circuit which has a fast attack and a long decay of about 4 seconds, and this drives discrete switching transistor TR1 which in turn drives the relay. This system prevents the relay from cutting out while a program is being saved and gives good reliability. A relay is better than some form of electronic switching in this application since the relay contacts are totally isolated from the rest of the circuit. With some tape recorders neither side of the REM socket is at earth potential. Also, using a relay there is no significant voltage drop through the switch.

LS1 is the loudspeaker which monitors the signal entering the computer during load operations. This is actually a ceramic resonator rather than a normal loudspeaker, and although it only provides limited volume, it is adequate in this respect. In fact, higher volume would be unnecessary and undesirable in this application.

S1 is the switch which connects the "Ear" or "Mic" lead, as appropriate, and places a short circuit across the "Rem" socket when the unit is set in the "load" mode. Power for the circuit is obtained from the 0V, 5V and 9V rails of the Spectrum edge connector.

## COMPONENTS ...

### Resistors

R1	47k
R2	5k6
R3	100
R4	10k
All resistors 1/4W 5% carbon film	

### Potentiometer

VR1	10k 0.1W horizontal preset
-----	----------------------------

### Capacitors

C1	2µ2 63V radial electrolytic
C2	100n polyester
C3	330n polyester
C4	1µ 63V radial electrolytic
C5	22n ceramic plate
C6	100µ 10V radial electrolytic

### Semiconductors

D1, D2	1N4148 (2 off)
TR1	BC179
IC1	NE567

### Miscellaneous

S1	4 way 3 pole rotary (with end stop)
LS1	PBN2720 ceramic resonator
SK1, 2, 3, 4	3.5mm jack sockets (4 off)
SK5	2.5mm jack socket
RLA	12 volt 400 coil, s.p.s.t. contacts, min PCM (Maplin)
Printed circuit board 3.1 x 1.6in.	
Metal box 133 x 70 x 38mm	
28 way Spectrum edge connector (Watford or Technomatic)	
Control knob	
Wire, fixings, etc.	

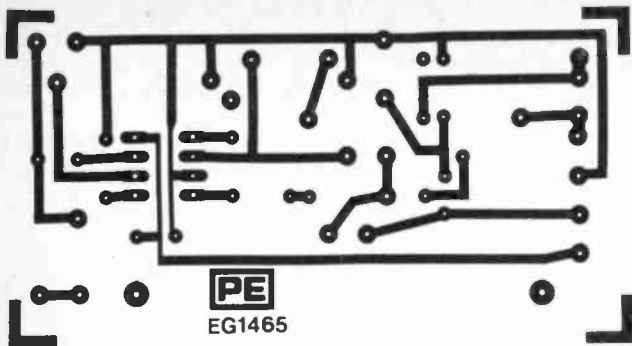

Fig. 3. P.c.b. design



decoupling capacitor C5 should be fitted close to IC1 or instability is almost certain to occur. S1 is a 4 way 3 pole rotary type having an adjustable end-stop which is set for 2 way operation.

Provided the specified relay is used it can be mounted on the printed circuit board, but if an alternative is used it will be necessary to modify the p.c.b. or mount the relay off-board. Any relay having at least one set of make contacts (or a set of changeover contacts), a coil resistance of about 300 ohms or more, and capable of operating from a 9 volt supply can be used in the unit.

The plain side of ceramic resonator LS1 is glued to the inside of the case at any convenient place using a good quality general purpose adhesive. This component does not have any tags or ready-connected leads, and soldered connections are made direct to the inner disc and outer ring. The connection to the inner disc should be completed fairly rapidly, to avoid damaging the component due to overheating.

As mentioned earlier, the "Rem" socket of the recorder may have neither terminal at earth potential, and if a metal case is used SK5 should be an insulated socket, or it should be insulated from the case. Alternatively, a plastic case could be used, but a wire to connect the earth tags of the other four sockets would then be needed.

The connection to the Spectrum edge connector is made via a 3 way cable, and an exit hole is drilled for this in one side of the case. The edge connector is a 2 x 28 way type, and should preferably be a type having the Spectrum polarising "key". Refer to page 160 of the Spectrum manual for connection details of the edge connector.

VR1 must be given the correct setting before the finished unit will function properly, and a suitable setting is found by empirical means. ★

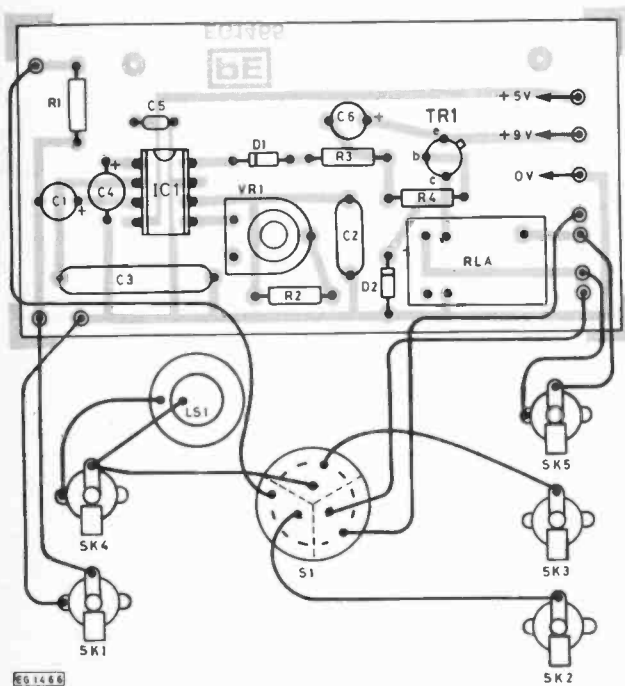

Fig. 4. Component layout and wiring diagram

### CONSTRUCTION

The printed circuit board design is shown in Fig. 3, with the component layout and wiring diagram shown in Fig. 4. If a different form of construction is used, note that supply

# BAZAAR

**PET 2001 8K RAM** (expandable) with integral monitor and cassette deck £200 o.n.o. Tel: Lytham (0253) 737397. D. R. Worley, 14 Mythop Ave., Lytham, Lancs.

**CASIO FX31** scientific cal. Book-wallet-price £6.00. Holdway, Flat 20, Studland Close, Millbrook, Southampton.

**OLIVETTI PR 1350 DOT** Matrix printer with reference and service manuals. £130 o.n.o. Swop twin beam — scope. D. Bevan, 17 Beaufort Rd, Kingswood, Bristol. Tel: (0272) 616936.

**WANTED** any service information on G.E.C. TERMINET 300 Printer. Will pay. Tel: 01-651 4885. A. G. Seagrave, 175 Sorrel Bank, Linton Glade, Forestdale, Croydon CR0 9LZ.

**CCTV** Camera B/W early Crofton kit model complete and working full manuals v.g.c. £70 with lens. D. Russell, 9 South Beach Road, Ardrossan, Ayrshire, KA22 8AX. Tel: (0294) 64144.

**WANTED** Smart 2-update Nov. 1980—assembly instructions, especially page 7—system layout—one sheet copy only. Claessens Guido, Oversneslaan 51-2610 Wilryk, Belgium. Tel: 03-828 2314.

**VOCODER**, best of ETIs—Elektors, sensible offers, or exchange for colour computer plus accessories (value £200). J. Logsdon, Top Flat, 13 Bowmans Road, Dartford, Kent DA1 3QP.

**PE 'Orion' amp**, new Sanyo speakers, McDonald 610 turntable, small tuner, v.g. stereo sound £15 o.n.o. Mr. A. L. G. Senior, 22 Robinia Walk, Whitchurch, Bristol BS14 0SH. Tel: (0272) 830213.

**WANTED** manual for Tektronix scope type 545B. Will buy or borrow to copy, willing to pay. T. Measor, 5 Midlothian Road, Hartlepool, Cleveland TS25 3RH.

**TELEQUIPMENT** D61a dual trace oscilloscope with X10 probe and manual wanted. E. M. Jackson, Coombe Farm, Gidleigh, Chagford, Newton Abbot, Devon TQ13 8HP.

**CLEF** Microsynth. Fully built and housed. £125 o.n.o. Tel: (0272) 516304. B. Wiltshire, 7 South Hayes, Eastville, Bristol.

**BREAKING**, UK101 Cegmon Word Processor new basics 1, 3 & 4 assembler editor chips available. Tel: (0642) 484122. D. Doyle, 21 Skelton Drive, Marske-by-the-Sea, Redcar, Cleveland TS11 1TH.

**VALVES** wanted, must be new and boxed. Also valve sockets and plugs, transformers, capacitors, tuners, amplifiers. N. Covington, 25 Ridge Road, Letchworth, Herts SG6 1PT. Tel: (04626) 79681.

**MENTA**, Z80 Microcomputer for control applications, including manual £75, five interface modules designed for Menta, s.a.e. Mr. D. H. Slater, rear of 25 New Market Street, Colne, Lancs BB8 9BJ.

**WANTED** circuit diagram or service manual for ferograph series Seven Model 71SH. Bob Allen, 69 Callcott Road, Kilburn, London NW6

**RS232** interface module with instruction booklet for Microline 80 printer. Unused. £25. Tel: Oxford (0865) 779855.

**HELP!** Tandy 603043 Radio controlled Lamborghini—TX/RX Circuit and service info required. Chris Finn, 11 Alexandra Drive, Beverley, E. Yorks. Tel: (0482) 868899.

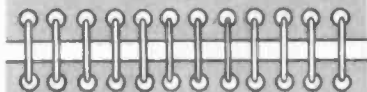

# INDUSTRY NOTEBOOK

*By Nexus*



## One World

We learn something new every day. For example that the greatest civil engineer of his time, Isambard Kingdom Brunel, was not as British as I had believed, his father having been French and the young Brunel educated in Paris. I learnt this from an IBM advertisement designed to convince us all that this huge multinational corporation, though not British in parentage, is at least as British as Brunel ever was because it practises its skills in Britain just as Brunel did in his time.

So what? The electrical and electronic sciences have always been international in character and, in fact, origin. Our own fundamental units of measurement, the Volt, Amp and Ohm are derived from the names of early Italian, French and German pioneers, the Farad from an Englishman.

The developments that led to radio are attributed to Maxwell, Hertz, Popoff and Marconi, respectively British, German, Russian and Italian. In television the inventor of the first camera tube, the iconoscope, was Zworykin who emigrated to the United States after the Russian revolution. Zworykin was building on earlier work such as the discovery of cathode rays by Crookes (British) and the invention of the cathode ray oscilloscope by Braun (German).

The scientific community has always believed in open publication of findings for the benefit of all. Not so the business community who guard their secrets, prudently patenting their products before disclosure.

But while protecting their products individually the electronics industry has always been a big sharer of ideas and even designs through cross licensing both within and across national boundaries whenever it is to mutual advantage. This sharing has accelerated in the age of solid state when it soon became apparent that second-sourcing was not giving a product away to a competitor but greatly expanding a market. Joint ventures are also common, a recent example being CMOS gate arrays designed in Britain by Smiths Industries' subsidiary Micro Circuit Engineering to be

processed by ITT in establishments in the United States and Belgium.

One American company, Advanced Micro Devices, is trying to go beyond cross-licensing into co-operative R & D. AMD's president, Jerry Sanders, is clearly worried over his own company's 100 million dollar spend on R & D in a single year. He recently stated that he and other like-minded semiconductor manufacturers together with equipment manufacturers were contemplating joint formation of R & D organisations and then sharing the research results.

This idea has its parallel in government-sponsored schemes for advancing technology. Whether a private enterprise R & D co-operative would be more effective or even workable is an open question. The most likely cash benefit is in the potential for reducing duplication in R & D activities among participating companies. On the other hand it can be argued that the intense competition in private enterprise to introduce exciting new products is the prime mover of technological advance.

The proof is clearly visible in a comparison of the competitive system of the West with the non-competitive Soviet Union. There is no reason to suppose Russian engineers to be dimmer or less numerous than those in the West and yet they continue to lag behind in almost every field with the possible exceptions of space exploration and armaments.

Let's get back to IBM and Brunel! I may be wrong but I have it as a dim memory that the founder of IBM was himself British, or of British parentage. But who cares in any serious way? My colour TV bears the label of a famous British company whose parent organisation is in the Netherlands where it was most probably designed. The receiver was assembled in Singapore from components manufactured in several other countries.

IBM's long awaited personal computer will proudly bear the IBM label. But its 'works', the p.c.bs, will be made by a British company unheard of by those not in the trade. I refer to AB Electronics whose shares gained over £1 on announcement of the IBM contract which, through IBM Greenock, will serve the computer markets in Europe, the Middle East and Africa. Electronics is truly international, one world, and I'm glad it's so. But I suspect that all of us still enjoy a patriotic glow on achievements by and in our own country.

## Piracy

Joint ventures, cross-licensing and other mutually advantageous deals have proved their worth over many years through legal or even gentlemen's agreements arranged in a civilised way. In October 1983 I drew attention to look-alike personal computers flooding the market from the Far East and, in particular, the possibility of pirated software becoming an even greater menace.

My fears seem to have been fully justified with software houses claiming collective losses of tens of millions of

pounds. Pirating goes right across the board from schoolboy amateurs to skilled computer crooks who can make a good living by selling pirated programs of the more expensive business types at about one tenth of the list price. Protective devices have so far proved ineffective and the copyright laws, as far as the UK is concerned, cover only literature, music and artistic content. New legislation is contemplated.

## Lady Harrison

One of the least publicised activities of the Racal Group is services for oil exploration. These were inherited through Decca's earlier involvement in navigation and precise positioning systems and, since the acquisition of Decca by Racal, have been greatly expanded through the formation of Racal Energy Resources Ltd.

Last November Lady Harrison, wife of Racal chairman Sir Ernest Harrison, launched a new geophysical survey ship, the m.v. 'Lady Harrison'. The vessel was launched from the Bergen, Norway, shipyard where she was built. She entered service in January and will operate wherever required in the world and almost certainly in offshore China where Racal already operates joint venture companies with the China National Offshore Oil Corporation for positioning and survey work.

Needless to say the ship is stuffed full of electronics and her complement of 34 crew and scientists are all accommodated in single-berth air-conditioned cabins.

## Cablesat

Whatever the merits of privatisation (the controversy is still very much alive) the mere prospect continues to galvanise British Telecom. On March 1st BT starts routing, via Intelsat V, entertainment TV programmes to local cable networks.

The programmes come from United Cable Programmes, a consortium of British companies. They will be transmitted to London Telecom Tower and then on to the London Earth Station at North Woolwich where they will be transmitted to Intelsat V. The participating cable operators will each have their own small satellite dish aerials at their cable head-ends for reception and feed-in to their cable systems. The signals will travel 44,600 miles in space before arriving at their destination. It may sound a long way round but is clearly a more economical method than relaying the signals individually to cable companies whose networks are geographically widely spaced.

Another advanced project for BT is the first transatlantic fibre-optic cable. This has been talked about for a year or two but has now been firmed up as TAT-8 costing in all £225 million shared between British Telecom, AT & T Communications (US) and Submarcom (France).

A new innovation apart from the fibre-optic cable itself is the world's first underwater junction box where the main link divides with one branch to the UK landing point at Widemouth Bay, Cornwall, the other to Penmarche on the coast of Brittany.



# SEMICONDUCTOR CIRCUITS

TOM GASKELL B.A. (Hons)

## TACHOMETERS (LM 2917N-8 AND LM 2917N)

ALTHOUGH the measurement of frequencies and speeds often involves digital techniques, it is preferable in some cases to obtain a purely analogue representation of these parameters. Analogue displays can have advantages in resolution, readability under rapidly changing conditions, and simplicity. The LM 2917N-8 is an 8 pin 'tachometer', or frequency-to-voltage converter i.c. which is specifically designed for this type of application. The i.c. incorporates not only tachometer circuitry, but also extra general purpose facilities such as internal voltage regulation, a driver transistor for external loads, and an op-amp with an uncommitted inverting input. This allows for considerable flexibility in use, and makes the device ideal for incorporation into many frequency or speed sensing and measuring systems. The LM 2917N is also available; this is a 14 pin version, with extra connections available to parts of the internal circuitry. It does not have input protection for negative voltages, unlike the LM 2917N-8, so be careful not to confuse the two! All diagrams will refer to the '-8' version, unless otherwise stated, although '-8' circuits are generally able to use the 14 pin i.c., with the necessary extra connections, bearing in mind that all-important input protection.

The pinout and specifications are given in Fig. 1, with block diagrams given in Fig. 2 and Fig. 3. A current limiting resistor must be provided for the internal 7.5V Zener diode, to limit the current to a maximum of 25mA. The minimum current should be 6mA (the maximum internal quiescent current). If this Zener diode is unacceptable, the LM 2907N-8 and LM 2907N are equivalent devices without it.

### METHOD OF OPERATION

The input to the i.c. is a differential amplifier with hysteresis. (Hysteresis is the effect whereby the input passes through a threshold voltage in the positive going direction, then has to drop to a somewhat lower, or more negative, voltage in the negative going direction before the output will turn off. It helps to prevent spurious oscillations at the exact point of changeover). In the '-8' device, the input is protected to  $\pm 28V$ , since the input must swing about 0V, inferring an a.c. coupled input in most cases. Since it is possible to bias both inputs to the 14 pin i.c., this has no such protection, hence the earlier warning. Because of the very high gain of the input amplifier, and the absence of any negative feedback, the output is a square wave, the frequency of which is identical to the input signal.

The square wave signal causes the 'charge pump' circuit to charge, or discharge (as

appropriate) the timing capacitor  $C_T$  between two internal voltage references which are half the Zener supply voltage apart. As a result, the average of the current pulses pumping into

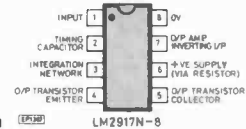

Fig. 1. Pin out and specification

Characteristic	Notes	Min.	Typically	Max.	Units
Supply voltage	All spec's measured at +12V		+12	+28	V
Quiescent current			3.8	6	mA
Temperature range		-40		+85	$^{\circ}C$
ZENER VOLTAGE REGULATOR					
Zener voltage	Measured at pin 6		7.56		V
Effective internal series resistance			10.5	15	$\Omega$
Max. supply current	Fed into pin 6			25	mA
OP-AMP AND O/P TRANSISTOR					
Input offset voltage	Input voltage = 6V		3	10	mV
Input bias current	Input voltage = 6V		50	500	nA
Voltage gain			200		V/mV
Input common-mode voltage range		0		(Zener voltage -1.5)	V
Output sink current	$V_{ce(sat)} = 1.0V$	40	50		mA
Output source current	$V_{ce(sat)} = 2.0V$		10		mA
Saturation voltage	5mA collector current		0.1	0.5	V
Op-amp i/p voltage	(Also, collector voltage)	0		+28	V
I/P AMPLIFIER AND CHARGE PUMP					
I/p voltage		$\pm 10$	$\pm 15$	$\pm 28^*$	V
I/p thresholds	} I/p = 1kHz, 250mV p/p		$\pm 30$	$\pm 40$	mV
Hysteresis			5	15	mV
Input offset voltage			0.1	1	$\mu A$
Input bias current	I/p voltage = $\pm 50mV$ d.c.		0.3	+1.0	%
Linearity	I/p = 1kHz to 10kHz	-1.0			
(Variation in correct o/p voltage, with respect to 5kHz voltage)					

\* 0-28V for the LM 2917N

$C_T$  is given by:

$$\text{average current} = V_z \times f_1 \times C_T$$

where  $V_z$  = Zener voltage and  $f_1$  = input frequency.

The output of the charge pump 'mirrors' an exactly equivalent current into the integration network  $C_1$  and  $R_1$ . The resistor acts as a load for the current mirror, and the capacitor smooths the pulsed waveform to provide a d.c. voltage at pin 3 (for LM 2917N-8) given by: voltage at pin 3 =  $V_z \times f_1 \times C_T \times R_1$   
In practice, due to i.c. tolerances, the d.c. voltage can vary from 0.9 to 1.1 times this value. This 'gain constant' error varies from one i.c. to the next, but stays constant within each i.c.

### PRACTICAL CONSIDERATIONS

The larger the value of  $C_1$ , the less ripple

will be produced, but the slower the circuit will be to respond to changes in frequency. The values of  $C_T$  and  $R_1$  will also affect response speed;  $C_1$  should be kept larger than 100p to avoid voltage errors. The value of ripple on the output is given by:

$$\text{ripple voltage p/p} = \frac{V_z \times C_T}{(2 \times C_1)} \times \left( 1 - \frac{V_z \times f_1 \times C_T}{I_o} \right)$$

$I_o$  is the available output current from pin 2 or pin 3. This can vary from 140-240 $\mu A$ ; typically it is 180 $\mu A$ . Finally, the maximum input frequency for the system is:

$$f_{\max} = \frac{I_o}{V_z \times C_T}$$

### BASIC CIRCUITS

The most effective way to illustrate the use

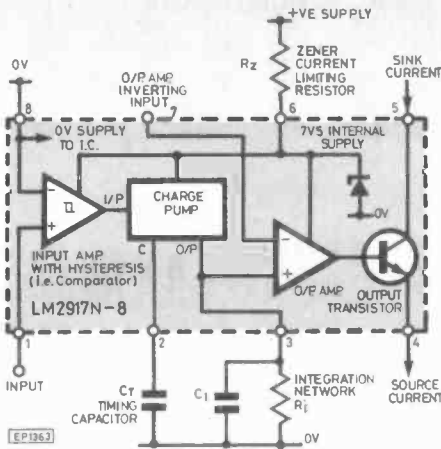

Fig. 2. Block diagram of LM 2917-8

of the output op-amp and transistor is to consider two typical examples of basic circuits. Fig. 4 shows a simple tachometer, with the transistor connected as an emitter follower. The connection to pin 7 therefore provides negative feedback to the op-amp, which acts as a unity gain voltage follower.  $R_L$  is a load resistor, which can be replaced with a 5V (full scale) meter movement, or can feed into a l.e.d. bargraph circuit if required. Remember to a.c. couple the input (and tie down pin 1 to 0V with a high value resistor) for most applications, or in the case of the LM 2917N, bias the inputs up to around half rail voltage.

Fig. 5 shows a speed activated switch, with the op-amp acting as a comparator. When the voltage at pin 3 exceeds the voltage at pin 7 (set up by the two 4k7 resistors), the output transistor turns on, sinking up to 40mA from the load. This occurs at the frequency given by:

$$f_{\text{switch}} = \frac{1}{(2 \times R_1 \times C_T)}$$

**APPLICATION**

Fig. 6 shows the circuit diagram of a more sophisticated 'speed switch', with Fig. 7 showing the Veroboard layout required for this. R2, R3, and R4 set the threshold at which the output amplifier switches. When this happens, the

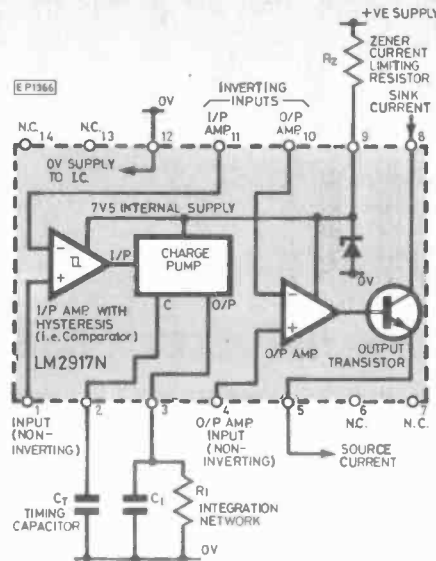

Fig. 3. Block diagram of LM 2917N

i.c.'s output transistor turns on, causing D2 to light up and TR1 to turn on, effectively connecting R14 in parallel with C6, which results in the voltage on C6 gradually dropping. This dropping occurs until the output op-amp turns off again, turning off the output transistor and TR1 in turn; the voltage across C6 starts to rise again when this happens, which in turn causes the output op-amp to turn on, etc. The connection from the resistor chain R2, R3, and R4 to pin 7 of IC1 provides extra

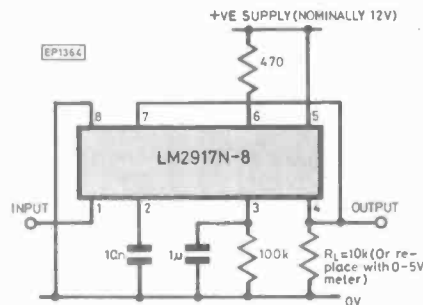

Fig. 4. Simple tachometer

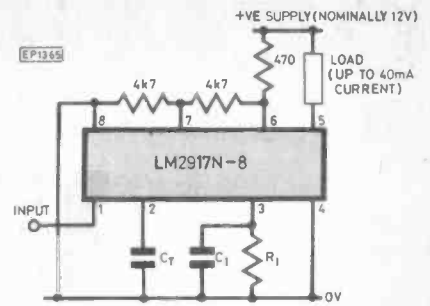

Fig. 5. Simple speed activated switch

hysteresis in the system, ensuring that the system does not oscillate at high frequencies around the turn on/turn off point of the output op-amp. There will, of course, be the low frequency oscillation as described above, the frequency of which will be determined by the rate at which IC1 pin 3 can charge up C6, which in turn is determined by the input frequency.

The circuit will have no effect until a certain frequency is exceeded, at which point D2 will start to flash on and off slowly. If the input frequency increases, the l.e.d. will flash at a faster and faster rate, until it remains illuminated continuously. The threshold frequency at which the l.e.d. first lights up can be set via VR1.

**AUDIBLE WARNING**

IC2 is a 555 timer i.c. connected as an audio frequency oscillator. TR2 and TR3 turn the enable pin (pin 4) of the i.c. on whenever D2 is illuminated, providing an audible warning. The transducer used for this can be a piezo-sounder, in which case no series resistor is likely to be needed, or a loudspeaker, in which case the impedance of the loudspeaker, in series with dropper resistors, should ideally be approximately 70 ohms or more. The series dropper resistors shown asterisked in Fig. 6 should total 1W for low impedance loudspeakers. Use a pair of 0.5W 150 ohm resistors in parallel for a 4 to 16 ohm loudspeaker.

Fig. 6 (Below). Circuit diagram of overspeed alarm or 'speed switch'

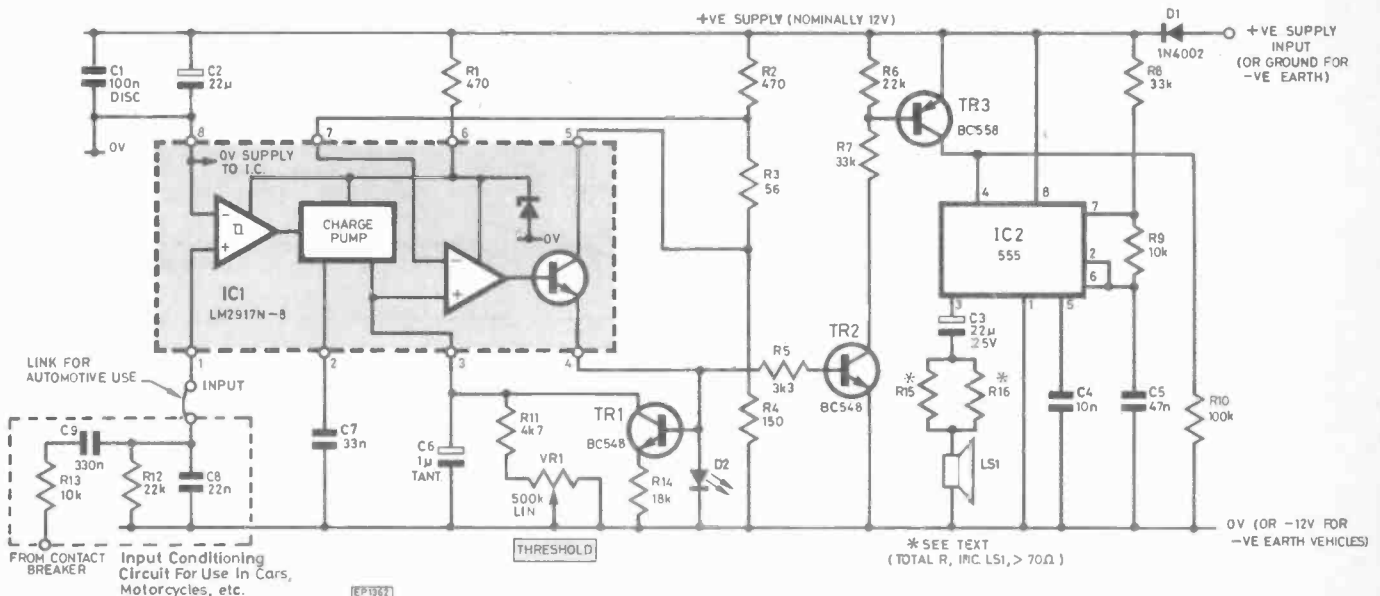





# The Logic Probes

## Spend Less Test More



### LP-1 Logic Probe

The LP-1 has a minimum detachable pulse width of 50 nanoseconds and maximum input frequency of 10MHz. This 100 K ohm probe is an inexpensive workhorse for any shop, lab or field service tool kit. It detects high-speed pulse trains or one-shot events and stores pulse or level transitions, replacing separate level detectors, pulse stretchers and pulse memory devices.

All for less than the price of a DVM

**£34.50\***

© Model LP-3 illustrated



### LP-2 Logic Probe

The LP-2 performs the same basic functions as the LP-1, but, for slower-speed circuits and without pulse memory capability. Handling a minimum pulse width of 300 nanoseconds, this 300 K ohm probe is the economical way to test circuits up to 1.5 MHz. It detects pulse trains or single-shot events in TTL, DTL, HTL and CMOS circuits, replacing separate pulse detectors, pulse stretchers and mode state analysers.

(Available in kit form LPK-1 £14.50)

**£21.00\***

© Model LP-3 illustrated

\*price excluding P.&P. and 15% VAT

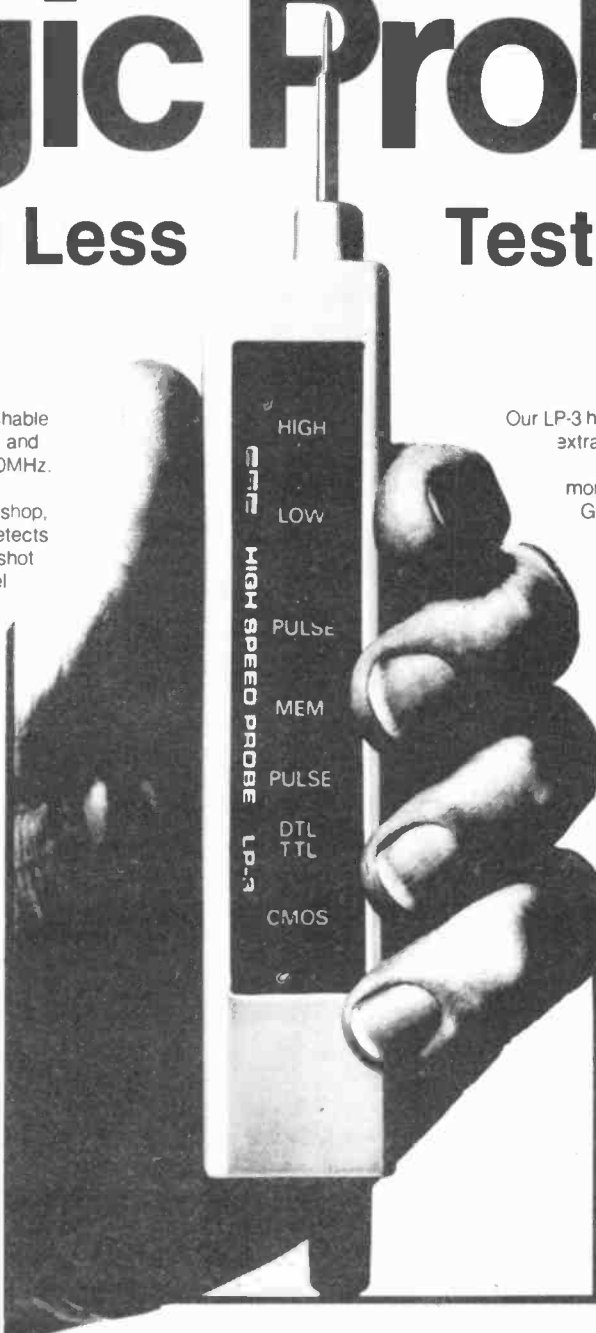

### LP-3 Logic Probe

Our LP-3 has all the features of the LP-1 plus extra high speed. It captures pulses as narrow as 10 nanoseconds, and monitors pulse trains to over 50 MHz. Giving you the essential capabilities of a high-quality memory scope at 1/1000th the cost.

LP-3 captures one shot or low-rep-events all-but-impossible to detect any other way.

All without the weight, bulk, inconvenience and power consumption of conventional methods.

**£53.50\***

© Model LP-3 Illustrated

### The New Pulser DP-1

The Digital Pulser: another new idea from G.S.C. The DP-1 registers the polarity of any pin, pad or component and then, when you touch the 'PULSE' button, delivers a single no-bounce pulse to swing the logic state the other way. Or If you hold the button down for more than a second, the DP-1 shoots out pulse after pulse at 1000 Hz. The single LED blinks for each single pulse, or glows during a pulse train. If your circuit is a very fast one, you can open the clock line and take it through its function step by step, at single pulse rate or at 100 per second. Clever! And at a very reasonable price.

**£56.00\***

© Model LP-3 Illustrated

GOODS DESPATCHED WITHIN 48 HRS.

GLOBAL SPECIALTIES CORPORATION



G.S.C. (UK) Limited, Dept. 511,  
Unit 1, Shire Hill Industrial Estate,  
Saffron Walden, Essex CB11 3AQ.  
Telephone: Saffron Walden (0799) 21682

G.S.C. (UK) Limited, Dept. 511, Unit 1, Shire Hill Industrial Estate, Saffron Walden, Essex CB11 3AQ.  
Prices include P&P and 15% VAT.

LP-1	£41.40	Only	LP-2	£25.87	Only	LP-3	£63.82	Only	DP-1	£66.70	Only	LPK-1	£17.82	Only
------	--------	------	------	--------	------	------	--------	------	------	--------	------	-------	--------	------

Name \_\_\_\_\_ Address \_\_\_\_\_

I enclose Cheque/P.O. for £ \_\_\_\_\_ or debit my Barclaycard/Access/  
American Express card no. \_\_\_\_\_ exp. date \_\_\_\_\_

FOR IMMEDIATE ACTION — The G.S.C. 24 hour, 5 day a week service  
Telephone (0799) 21682 and give us your Barclaycard, Access, American Express  
number and your order will be in the post immediately. for FREE catalogue tick box

# Heathkit - IT'S A PLEASURE TO BUILD

Bring the enjoyment back into your hobby with a kit from Heathkit. The beautifully illustrated documentation and step-by-step instructions make building a Heathkit a relaxing, absorbing pleasure! Choose from their huge range of fascinating kits and self-instruction electronics and computing courses.

The Heathkit range includes the ultimate in amateur radio kits, computerised weather stations, a highly sophisticated robot, a 16-bit computer kit and a range of home (or classroom) learning courses. These state-of-the-art courses have easy-to-understand texts and illustrations, divided into sections so that you can progress at your own pace, whilst the hands-on experiments ensure long-term retention of the material covered.

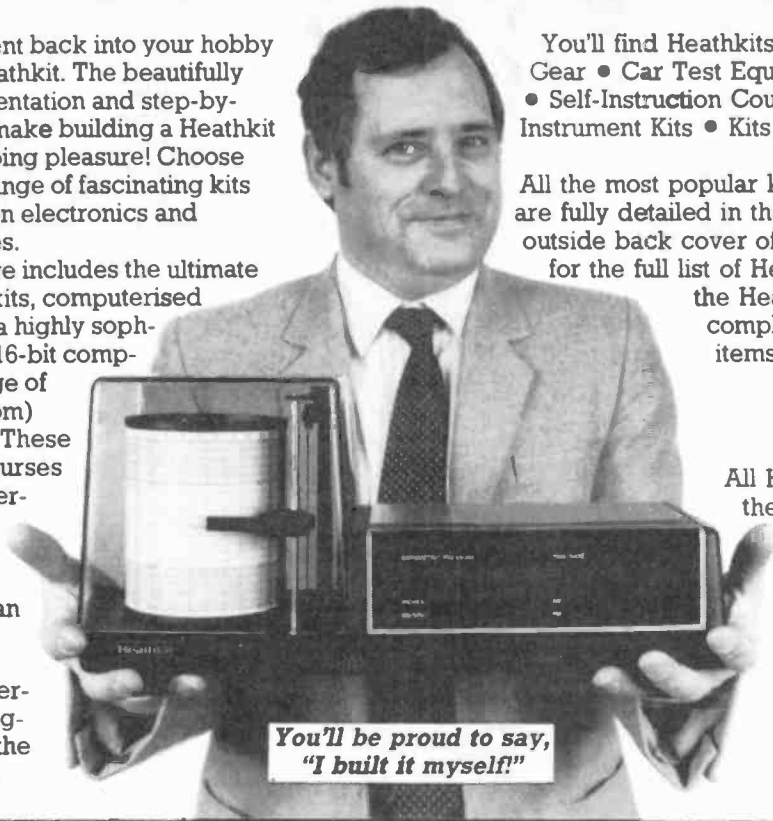

You'll be proud to say, "I built it myself!"

You'll find Heathkits available for Amateur Radio Gear • Car Test Equipment • Kits For The Home • Self-Instruction Courses • Computer Kits • Test Instrument Kits • Kits For Weather Measurements.

All the most popular kits and educational products are fully detailed in the 1984 Maplin catalogue (see outside back cover of this magazine for details) or for the full list of Heathkit products send 50p for the Heathkit International Catalogue complete with a UK price list of all items.

All Heathkit products available in the UK from:

**Maplin Electronic Supplies Ltd.**  
P.O. Box 3, Rayleigh,  
Essex, SS6 8LR.  
Tel: (0702) 552911.

(For shop addresses see back cover.)

## ORIC AND SINCLAIR COMPUTERS



Oric 1 computer 48K £143 (£141) £151. Oric Colour Printer £134 (£123) £140. Sinclair Spectrum 48K £131 (£131) £143. Spectrum 16K £101 (£105) £117. 32K memory upgrade kit for 16K Spectrum (Issue 2 and 3 only) £31 (£28) £30. Fuller Master Unit for the spectrum including speech unit, sound synthesizer, amplifier and joystick port £56 (£56) £62. Fuller full sized FDS keyboard for the spectrum with proper space bar £52 (£52) £62. Spectrum printer interfaces with cables:- Centronics £57 (£53) £58. RS232 £35 (£33) £38. ZX printer with 5 free rolls paper £41 (£46) £56. ZX printer alone £36 (£38) £50. 5 printer rolls £13 (£16) £21. Special offer pack ZX81 computer + 16K ram pack + four game tapes £55 (£61) £71. ZX81 16K ram packs £31 (£28) £30.

**COMMODORE COMPUTERS**  
Commodore 64 £204 (£184) £204. Vic 20 £104 (£97) £117. Converter to allow most ordinary mono cassette recorders to be used with the Vic 20 and Commodore 64:- built £9.78 (£9) £11, kit £7.47 (£7) £9. Bargain package:- cassette converter + compatible cassette recorder £37 (£38) £44. Commodore cassette recorder £43 (£44) £50. Centronics printer interfaces:- for Vic 20 £42 (£41) £46, for Commodore 64 £45 (£44) £50, 1541 Disc drive £233 (£209) £234. 1525 Printer £235 (£220) £245. 1526 Printer £350 (£330) £360.

## SWANLEY ELECTRONICS

The Computer Export Specialists  
Dept PE, 32 Goldsel Rd., Swanley, Kent BR8 8EZ, England.  
Please allow 7 days for delivery.

Tel: Swanley (0322) 64851. Nothing extra to pay. All prices are inclusive. UK prices are shown first and include post and VAT. The second price in brackets is for export customers in Europe and includes insured air mail postage. The third price is for export customers outside Europe (including Australia etc) and includes insured airmail postage. Official orders welcome.

## ACORN COMPUTERS

Electron £203 (£209) £229. BBC Model B £424 (£388) £408. Kenda double density disk interface system for beeb £139 (£125) £135. We stock the whole range of Cumana disc drives for the beeb e.g. 100K single £230 (£220) £240, Double 2 x 400K £625 (£560) £580.

## PRINTERS

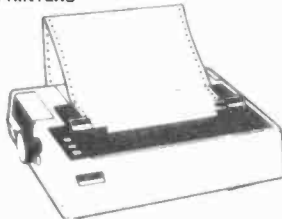

Epson RX80 £326 (£309) £340. Epson RX80FT £346 (£316) £346. Shinwa CT1 CP80 £293 (£271) £312. Epson FX80 £440 (£408) £438. Epson MX100/3 £494 (£465) £495. Seikosha GP100A £234 (£219) £254. Oki Microline 80 £223 (£207) £248. Oki Microline 84 £831. The Ultra 21 combined daisy wheel and electric typewriter £438 (£415) £445. The brother EP22 combined matrix printer and electric typewriter £173 (£166) £186. Juki 6100 proportional daisy wheel printer £423 (£404) £434. MCP40 colour printer £134 (£123) £140. Star STX80 thermal printer £165 (£159) £169. Interfaces to run the above printers from Commodore machines:- Vic 20 £42 (£41) £46, Commodore 64 £45 (£44) £50. We can supply interfaces to run all the above from Sharp computers £58 (£52) £55.

# CLEF ELECTRONIC MUSIC

## MICROSYNTH

21 Octave Music Synthesizer with two Oscillators, two Sub-Oct, Switched Routing and Thumbwheel. A comprehensive instrument offering the full range of Synth Music & effects. FULL KIT £137 Also available in 3 parts.

## PERCUSSION MICROSYNTH

Two Channel touch Sensitive unit plus variable angle L.F.O., phaser, internal and external triggering.



KIT £89  
(Published in P.E.)



(Published in P.E.)

## BAND-BOX PROGRAMMABLE BACKING TRIO

**THREE PIECE BACKING BAND**  
Generates the sounds of three instrumentalists to back Soloists

## DRUMS + BASS + KEYBOARDS

Over 3,000 chord changes (60 scores) on 132 different chords - extendable to 200 scores. Master Rhythm also required

FULL KIT £235 EXTENSION £82

(Published in P.E.)

## 88/72 NOTE PIANOS SPECIALISTS SINCE 1972

Using Patented electronic technique to give advanced simulation of Piano Key Inertia.



## COMPONENT KITS

Including Keyboard  
88 NOTE £266  
72 NOTE £234

The above may also be purchased in four parts.

## DOMESTIC KITS

Inc. Cabinet, P.A., & Spkr.  
88 NOTE £442  
72 NOTE £398

## STAGE MODEL

inc. Cabinet & Stand  
72 NOTE £383

ALL PRICES INC. VAT. CARR. & TELEPHONE ADVICE S.A.E. for full Specs & MANF. PRICES. VISA-ACCESS Competitive quotations can be given for export. Please allow 3-14 days for normal despatch.

## CLEF PRODUCTS (ELECTRONICS) LIMITED

(Dept PE)  
44A BRAMHALL LANE SOUTH BRAMHALL  
STOCKPORT CHESHIRE SK7 1AH  
TEL 061 439 3297



## MASTER RHYTHM PROGRAMMABLE DRUMS

Twenty-Four Rhythm programmable Drum Machine with twelve instruments. Eight sections are extended to 24/32 measures for two bar programming. Sequence operation and instrument tone adjust.

COMPLETE KIT £198.50  
STRING ENSEMBLE £198.50  
ROTOR-CHORUS £98.00

## SQUARE FRONT KEYBOARDS

88 NOTE £60 49 NOTE £29  
73 NOTE £50 30 NOTE £19  
KEYSWITCH ITEMS ALSO AVAILABLE

# VERNON at TRENT Large!

V.T.'s views and opinions are entirely his own and not necessarily those of PE

I could tell immediately that he was an engineer of the old school. A dead giveaway was the slide rule poking out of his top pocket. Remember the slide rule? I rated him classical junction transistor vintage. He sighed and shook his head sadly.

"You know," he said. "I sometimes think this high-technology electronics business is getting a bit too clever for comfort. Sophistication, as they call it, is becoming an end in itself. Complexity is chic and it's jolly hard on the old hands like myself. Most mind-boggling of all is this computer-age language. I just can't get the hang of it.

"Words and phrases we learned at mother's knee have been deprived of their original meanings by the chip brigade. For instance, before the microprocessor processed itself into our lives, a bus driver was a chap who swore at cabbies and didn't always stop at one's request. A byte (see, they can't even spell anymore) was a munch on a cheese and pickle sandwich or something you got from a playful wasp while rolling in the long grass. And a RAM was a character much sought after by broody ewes."

I could have gone on with the usual gaff about the forward march of science and the need to keep up with the rest of the world. But he didn't seem in the right frame of mind to take it. So the best comfort I could offer was an invitation to join me on a visit to the HQ of the Sutton (Surrey) Talking Newspaper for the Blind. For him it would be a trip down the memory lane of basic electronics—which, when all is said and done, continues to serve humanity without benefit of the sophistication he finds so difficult to cope with. There's nothing particularly new about talking newspapers. They had their origin in Sweden and first reached our shores in the early 1960s. The STN was mooted in neighbouring Carshalton in 1974 and came out with its first issue three months later.

Lesley Page, a one-time employee of the Bank of England and a socially-active lady with a rare gift for organisation, is the STN's secretary. She told me: "In the initial stages we were financed by interest-free loans from the local Rotary Club. But thanks to our own fund-raising activities we were able to redeem them within a year. The local library lent us their recording equipment and we worked from the flat of the late John Bradley, the much-missed president of the British Amateur Tape Recording Society.

"Then came a splendid stroke of luck. The Wallington & Carshalton Round Table offered to buy us our own equipment if we could find ourselves permanent premises. Sutton Council helped generously here by giving us a suite of rooms in the building which we share with the Registrar of Births, Deaths & Marriages and the Rent Officer. Distinguished company indeed."

It was Thursday—'Press day'—when my morose friend and I called on STN. In one room a trio of ladies were busy unpacking and sorting the returned C60 cassettes carrying the previous week's issue (five mailbags of them in all). In another room a team of editors were scanning the local newspapers, supplied free by the publishers, for the 'hard news' side of the tape. Contrary to what you might expect, there is no bias in selection towards only pleasant or neutral news. "The blind dislike the idea of being protected from unpleasant things," said Lesley. "They want to hear about both the good and the bad so that they can discuss current events with their sighted friends. Anything goes, from muggings to garden fetes." The second side of the tape accommodates the 'magazine' section. In this the blind themselves have a large slice of the action. They provide articles, seek out interviews with local officials and prominent personalities. There are items about holidays and leisure pursuits. One blind man has even contributed an account of his experiences as a mountaineer!

**"You're out of date, dad. Your mind is pre-microchip"**

In the control room I spoke with Doug Cook, formerly an engineer with the Post Office. He was in the process of making the master tape of the magazine section. "With our duplicating machines," he said, "we can turn out 13 copies in three minutes. We edit them so that halfway through there's a break for music which gives our 'readers', as we call the listeners, a chance to put the kettle on." By now all was ready for recording the news. The team consisted of one presenter and four readers, all of whom identified themselves by name. Their professionalism was remarkable, though, says Lesley: "We don't really need professionals—just people with enthusiasm and clarity."

The clock stood at 8.30 p.m. All the tapes were completed and checked. A standard procedure, by the way, is to include a reminder to turn off the recorder and to turn over the reversible label on the postal pouch for return of the tape to STN headquarters. And in case you're wondering how blind persons differentiate between the two sides of the tape, there's a tactile strip on the face of the cassette.

The rest was sheer humping. First, the registration of each pouch before it went into the mailbag. Then a trip to the back door of the main Post Office. The mailings—handled free of charge in both directions—would be dealt with overnight and the majority of tapes would reach their destinations by first post

Friday. As Lesley said: "Sometimes we even beat the newspapers."

Some 300 blind people (out of a registered total of about 500) in the Sutton area regularly receive the STN. Applications come mostly through social workers. Most of the 'readers' are elderly, but there is a fair sprinkling of younger ones too. Many people have their own tape recorders, but those who do not borrow them from the STN free of charge. Between 200 and 300 public-spirited citizens, all unpaid and totally dedicated, working on a well-organised rota system, help to produce the newspaper every week. They come from all walks of life and many of them have blind relatives. "At the moment we have no shortage of volunteers," says Lesley.

The STN, which is a registered charity, costs between £1500 and £2000 a year to run. But rather than simply exist from year-to-year, a move has been made to set up an investment fund of around £20,000 to provide an assured income. This is being achieved by gala concerts, street collections, the sale of ballpoint pens and other novelties. Some schools have adopted STN as their pet charity for a specified period. There are regular carol-singing forays at Christmas. Even the local police force has contributed by making over some of the proceeds from the sale of unclaimed stolen property.

Backing the STN and similar organisations throughout Britain, is the Talking Newspaper Association of the UK. It deals with such matters as copyright, is the principal contact with official bodies and provides many other kinds of ideas and help. Here again, all concerned are unpaid volunteers.

For those who have been reared on modern technology and all its wonders, the STN and others like it may seem an age away from the sophistication of the present. OK, so basic electronics may be old hat for the whiz-kids of the 1980s. But those same basics are helping to bring a fuller life and a broader involvement with society to a lot of people who wouldn't know, and couldn't care less about, the difference between a random access memory and a plate of fish and chips. My old engineer liked that sentiment.

★ ★ ★

I see that Football League clubs are likely to be offered some sort of microprocessor gubbins that will bring knife-toting, chain-carrying and otherwise mayhem-oriented louts to a standstill at the turnstiles. Anyone purporting to be a genuine supporter would be issued with a plastic card to establish his identity. This would then be screened for authenticity before he was allowed on to the ground. But would this really completely deter those who seem hell-bent on bover and have little or no interest in the game?

★ ★ ★

I loved that piece by Ray Connolly in the London evening newspaper, The Standard. Failing to follow the interpretation by an 11-year-old of a War Games movie, he was told: "You're out of date, Dad. Your mind is pre-microchip. You need re-programming." Hard cheese, Ray. Maybe you'd better link up with my old mate with the slide rule. You seem to have a lot in common.

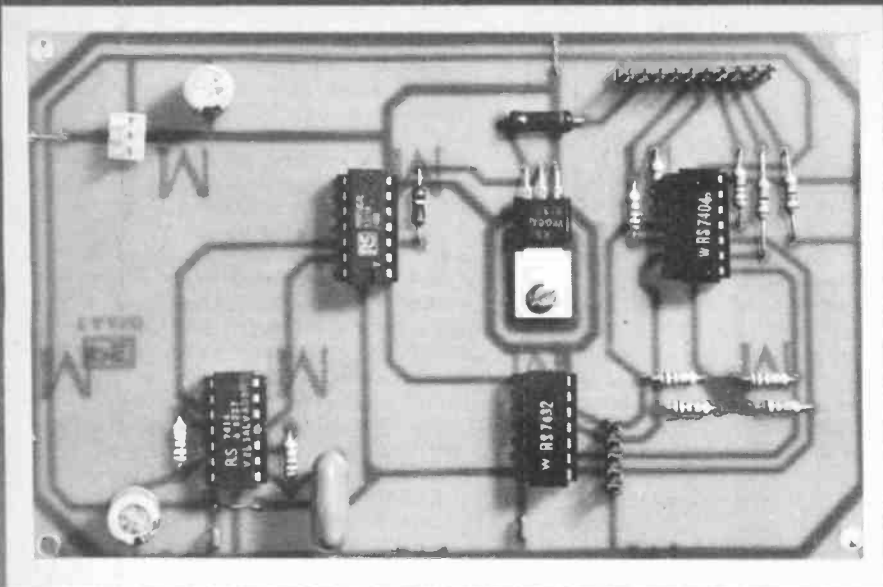

# Anti-theft alarm

MICHAEL TOOLEY BA

DAVID WHITFIELD MA MSc CEng MIEE

IN this month's issue we begin a new series which provides some practical examples of digital techniques. These projects, which have been carefully selected to complement the series entitled 'Introduction to Digital Electronics', also make excellent constructional projects in their own right, finding numerous applications in the home, school and workplace. Each project uses low-cost, readily available components and single-sided p.c.b.s are used throughout.

We start, this month, with a simple Anti-Theft Alarm which is designed to provide an audible and visual warning that property or goods are being tampered with. This project illustrates the use of some of the basic logic gates, demonstrates techniques for driving l.e.d.s, and shows how simple square wave oscillators can be constructed using Schmitt logic gates. A separate power supply module is also described. This module provides a regulated 5V supply of up to 500mA and is suitable for use with both the Anti-Theft Alarm and any of the subsequent projects.

## CIRCUIT DESCRIPTION

The complete circuit of the Anti-Theft Alarm is shown in Fig. 1. The alarm is provided with four input loops which link points A, B, C, and D respectively to the common 0V rail. Whenever one, or more, of the loops is broken the respective pull-up resistor, R1 to R4, will generate a logic 1 input at IC1 which is arranged to form a four-input OR gate. The normal state of the output of IC1c, when all of the loops are closed, will be a logic 0. If, however, any of the loops is broken, the output from IC1c will become logic 1.

In order to provide a visual indication of which one of the loops is broken, IC4 is arranged as an l.e.d. driver, inverting the logical input to IC1 so that the respective l.e.d. becomes illuminated whenever an output goes low. A fifth l.e.d. is included merely to indicate that the supply is connected and that the alarm is active.

IC2a uses a Schmitt inverter to form a simple oscillator which produces a square wave output at approximately

3kHz. A similar stage, IC2f, operates at the much lower frequency of 3Hz. An inverting buffer follows each oscillator and then both square wave signals are applied to a two-input AND gate, IC3d. The resulting output from IC3d consists of 200ms bursts of 3kHz signal which is then fed to a further two-input AND gate, IC3a.

The gated square wave signal from IC3d only appears at the output of IC3a when a logic 1 appears at the output of IC1c (i.e. when any one, or more, of the loops is broken). In order to provide an audible output at ample volume, a VMOS f.e.t., TR1, follows IC3a. This device has a near infinite input impedance and is capable of driving the low impedance load presented by the loudspeaker. A series resistor, R13, is included in order to both reduce the volume of the output signal and reduce the peak drain current flowing in TR1 to an acceptable value.

The circuit diagram of the Power Supply Module is shown in Fig. 2. This uses a conventional i.c. regulator and an l.e.d. is incorporated in order to provide a visual indication of the d.c. output. Little further comment is necessary other than that the nominal 6V a.c. input is derived from a fully encapsulated mains transformer of similar type to that used with the Logic Tutor.

## CONSTRUCTION

The Anti-Theft Alarm is built on a single sided p.c.b. measuring approximately 140x90mm, the copper foil layout of which is shown in Fig. 3. The corresponding component layout on the top surface of the p.c.b. is given in Fig. 4. Interconnections from the p.c.b. to the four input loops, l.e.d. indicators, loudspeaker and power supply are all made via 0.1" matrix p.c.b. connectors, the wiring for which is shown in Fig. 5.

Components should be assembled on the p.c.b. in the following sequence: d.i.l. sockets, p.c.b. connectors, resistors, capacitors, f.e.t. Once assembly has been completed the underside of the p.c.b. should be carefully



## COMPONENTS ...

### ANTI-THEFT ALARM

#### Resistors

R1, R2, R3, R4, R10, R11	1k (6 off)
R5, R6, R7, R8, R9	270 (5 off)
R12	100k
R13	10

#### Capacitors

C1	220 $\mu$ 16V p.c. elect.
C2	220n polystyrene
C3, C4	10n ceramic disc (2 off)
C5	10 $\mu$ 16V p.c. elect.

#### Semiconductors

D1, D2, D3, D4	Red l.e.d. (4 off)
D5	Green l.e.d.
TR1	VN66AF
IC1	7432
IC2	7414
IC3	7408
IC4	7404

#### Miscellaneous

P.c.b.	
14-pin d.i.l. sockets (4 off)	
3-way 0.1" p.c.b. plug and socket	
5-way 0.1" p.c.b. plug and socket	
10-way 0.1" p.c.b. plug and socket	
80 ohm loudspeaker	

### POWER SUPPLY MODULE

#### Resistors

R1	270
----	-----

#### Capacitors

C1	1000 $\mu$ 16V p.c. elect.
C2	100 $\mu$ 16V p.c. elect.
C3, C4	100n polyester (2 off)

#### Semiconductors

D1	Red l.e.d.
BR1	50V 1A bridge rectifier
IC1	7805

#### Miscellaneous

P.c.b.	
3-way 0.1" p.c.b. plug and socket (2 off)	
1A 20mm fuse and p.c. fuse clips	

carefully checked for soldering faults. The mains transformer is rated at 6V 3VA and should be housed in a fully insulated plastic encapsulation integral with the mains lead and plug.

### TESTING

Testing the Anti-Theft Alarm is simply a matter of checking that the 5V supply is present and, if this is the case, D5 should be illuminated. Each of the input loops should then be open-circuited in turn. The alarm should be activated whenever any one of the loops is broken and the corresponding l.e.d., D1 to D4, should become illuminated. The input loops will normally consist of lengths of stranded insulated wire running through the goods to be protected.

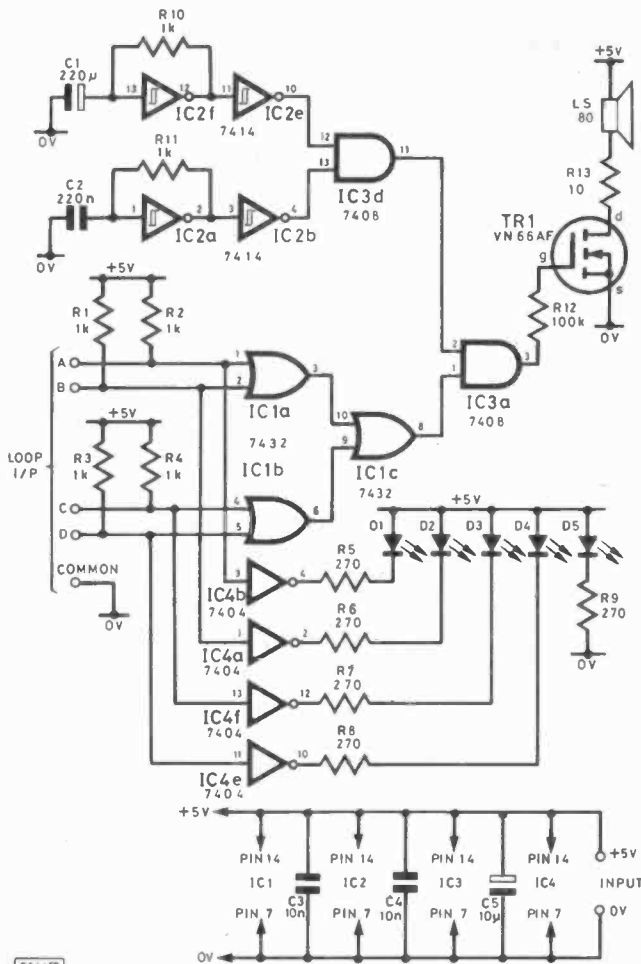

Fig. 1. Circuit diagram of the Anti-Theft Alarm

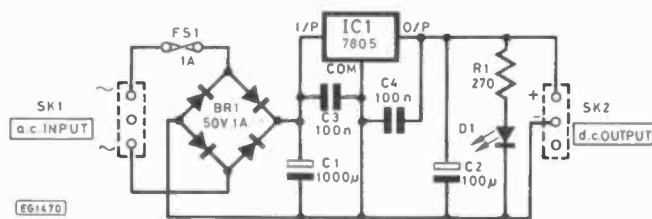

Fig. 2. Power supply circuit

checked for solder splashes, bridges between adjacent tracks, and dry joints. Finally, the i.c.s may be inserted in their respective holders, taking care to ensure the correct orientation of each device. Constructional details of the enclosure and off-board wiring have not been given since this will undoubtedly be a matter of preference for the individual constructor.

The p.c.b. layout for the Power Supply Module and corresponding component layout are shown in Figs. 6 and 7. Assembly is very straightforward; however, care should be taken to ensure that the bridge rectifier is correctly orientated. The i.c. regulator should not require a heatsink for this project; however, if one is available rated at around 17.5° C/W, it may be fitted to meet the supply current demands of more ambitious projects. Once complete, and before the a.c. input is applied, the Power Supply Module should be

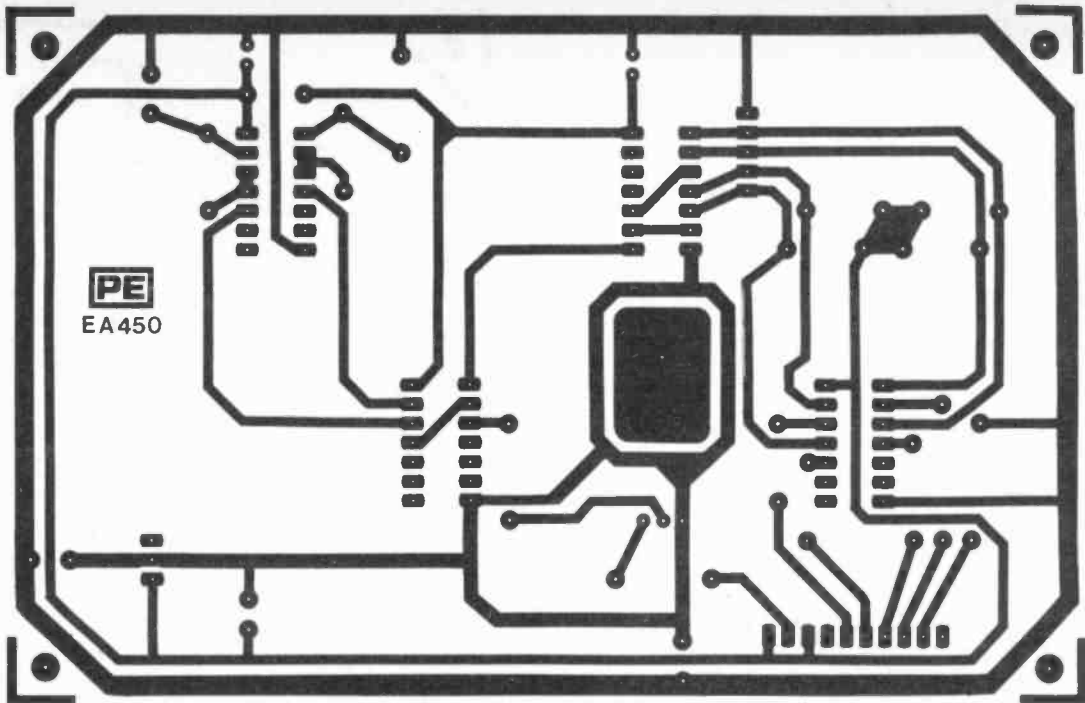

Fig. 3. Main p.c.b. design

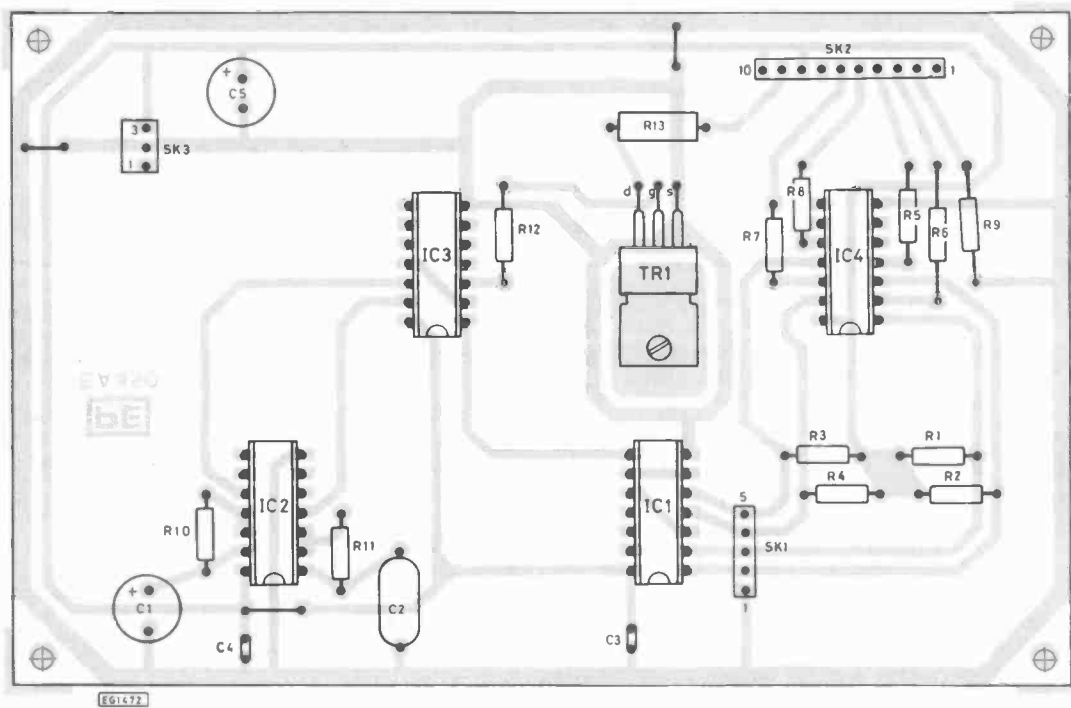

Fig. 4. Component layout

They may also consist of thin strips of foil fastened to windows and glass doors by means of a suitable adhesive. Indiscriminate breaking of the glass will cause the foil strip to break and the alarm to be set off.

#### MODIFICATIONS

The sound level of the output may be adjusted by varying R13 which should be reduced in value if more output is re-

quired or increased in value if less output is required. If R13 is reduced to less than 5.6 ohms a small heatsink will be required for TR1.

The frequency (pitch) of the audible warning signal may be changed by altering the value of C2. A larger value (say 470nF) will decrease the frequency, whilst a smaller value (say 100nF) will increase the frequency. If it is necessary to alter the rate at which the audible output is pulsed on and

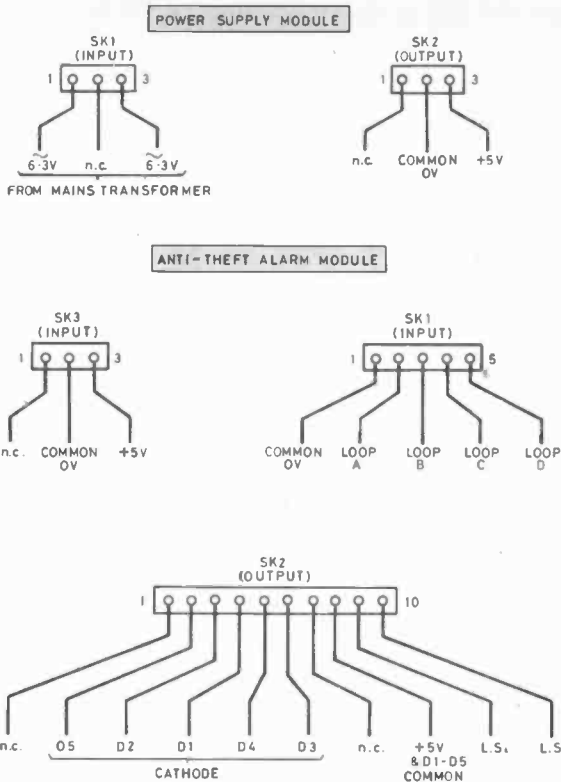

Fig. 5. Inter board wiring

off, C1 may be similarly varied. Appropriate values lie in the range 100 $\mu$ F to 680 $\mu$ F.

To drive several loudspeakers, the circuit around R12, TR1, and R13 should be duplicated. Each loudspeaker then has its own driver circuit. The signal input for all of the driver circuits is derived from pin 3 of IC3a. The loudspeakers

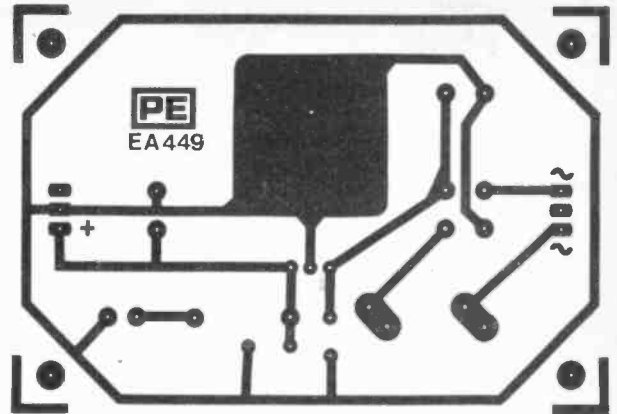

Fig. 6. P.s.u. board design

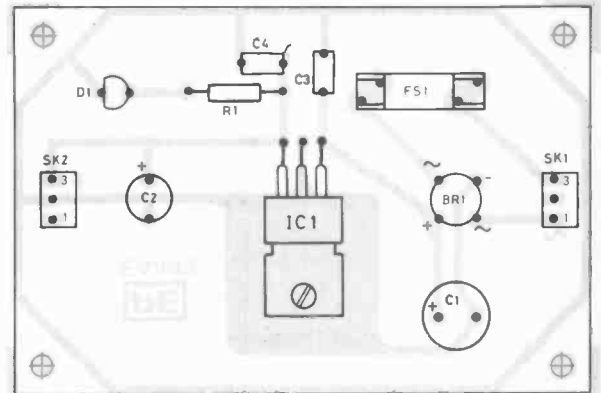

Fig. 7. Component layout

should be placed at various strategic points. These may, for example, include passageways, doorways, counter and checkout areas. ★

## PE SPECIAL CASSETTES OFFER

### CHROME C60 & C90

**CRO2 C60 CASSETTES**  
90p each (minimum of 5); 80p each (minimum of 25)

**CRO2 C90 CASSETTES**  
115p each (minimum of 5);

### FERRIC C90 AUDIO

**C90LH CASSETTES**  
56p each (minimum of 5); 53p each (minimum of 25).

**PRICES INCLUDE VAT AND POSTAGE.**

Send coupon to: Videotone Ltd., Unit 4, The Airport Industrial Estate, Biggin Hill, Kent.

Please send me ..... CRO2 C60 Audio cassettes at ..... p each (90p for 5 to 24, 80p for 25 or more; including VAT and postage).

Please send me ..... CRO2 C90 Audio cassettes at ..... p each (115p for 5 to 24, 105p for 25 or more; including VAT and postage).

Please send me ..... C90LH Audio tapes at ..... p each. (56p for 5 to 24, 53p for 25 or more; including VAT & postage.)

I enclose cheque/PO for £ ..... No. ....

Name .....

Address .....

BLOCK CAPITALS PLEASE

Coupon valid for posting before 2 Mar '84 (or one month later for overseas readers).

## EVERYDAY ELECTRONICS and computer PROJECTS

### ★ NI-CAD BATTERY CHARGER ★

Enables ni-cad cells to be recharged from standard 12V car battery charger. Caters for PP3, HD7, HP11, and HP2 in banks of up to 12 cells (of same type).

### ★ REVERSING BLEEPER ★

Emits loud bleeping sound to warn pedestrians when driver moves gear into "reverse".

### ★ LOW-POWER STEREO AMPLIFIER ★

Modest budget project, ideal for the beginner. Output 2.5 watts per channel. Three inputs: for ceramic cartridge pickup, tape recorder and auxiliary. Bass and treble tone controls. 8 ohm outputs.

### ★ MULTIMETER ADD-ON FOR BBC MICRO ★

Connects to the User and Analogue Ports to produce an accurate digital multimeter with screen readout. Voltage, Resistance, Capacitance measurements, in ranges up to 100V, 10M $\Omega$  and 10 $\mu$ F respectively.

MARCH ISSUE  
ON SALE FEBRUARY 17



# COMPUTER TERMINAL

PART TWO RAY STUART

**I**N THIS, the concluding part, details of the p.c.b. assembly and case construction are given. The project is a remote VDU/Keyboard terminal capable of RS232 serial communication with any home computer with an RS232 port.

## P.C.B. ASSEMBLY

The p.c.b. foil pattern and component layout are shown in Figs. 2.1 and 2.2.

The components should be installed on the p.c.b. in the following order:

- a) Links, terminal pins and regulator leads.
- b) I.c. sockets.
- c) Capacitors and resistors.
- d) Modulator, buzzer and crystals.
- e) Connectors.

It is strongly recommended that i.c. sockets are used, as it is difficult to change faulty or incorrectly installed devices if they are soldered to the p.c.b. Before proceeding any further it is wise to check for incorrect component locations and solder bridges. These are most likely to be found in the RAM area of the p.c.b.

## CASE

There is a wide range of commercially available cases that the reader may choose from to house the system. However, the author found none suitable for his requirements and so constructed the case shown in the photographs. The side plates are made of solid mahogany, with the chassis, back and cover plates made from aluminium sheet, spray painted. The wooden side plates are cut to size and the support battens screwed to them as shown in Fig. 2.3, and the aluminium panels cut and drilled to the dimensions shown in that Fig. The back panel carries the UHF and monitor output sockets, mains input socket, the full/half duplex switch, the 25-way D-series connector for the RS232 link, and is also used as a heat sink by the three voltage regulators which should be fitted using insulating mica washers. The back plate is connected to the chassis by a length of 13mm aluminium angle as shown. Two identical covers should be constructed, one of these being cut to accept the chosen keyboard. All the aluminium panels should be rubbed down with wire wool before being sprayed. The keyboard is then secured to its cover, the various components fitted to the back plate which can be bolted to the chassis. The p.c.b.,

mounted on insulating spacers, and the transformer are then fitted to the chassis. The various parts should next be wired together as shown in Fig. 2.4. Finally, No. 5 x 1/2 inch countersunk screws are used to mount the aluminium panels to the side plate battens, with the exception of the top cover plate which should be fitted after the Computer Terminal has been tested.

## TESTING

Before inserting any i.c.s the power supplies should be checked to establish that the correct voltages are being produced. Check that the correct voltages are present on the various i.c. power pins. If all is well the unit should be switched off and the i.c.s inserted, taking care to insert IC12 and IC15 the correct way round. The normal precautions should be employed when handling the i.c.s, *especially the RAMs*. The full/half duplex switch should be set to the half duplex position, the monitor or television connected and switched on.

The terminal can now be switched on. If a television is being used, it should be tuned to channel 36 (that used by video recorders). The screen will be filled with random characters. It may be necessary to adjust VR1 and VR2 for best results. The reader will notice a flashing cursor somewhere on the screen: characters entered on the keyboard will be displayed at the cursor position. The cursor itself may be moved around the screen, or the screen cleared by entering the ASCII control characters listed in Part 1.





## COMPONENTS ...

### Resistors

R1-9, R11, R17	10k (11 off)
R10	10M
R12	100R
R13	2k
R14, R18	1k (2 off)
R15	4k7
R16	82R ( $\frac{1}{2}$ W)

All resistors  $\frac{1}{8}$ W 5% unless otherwise stated

### Potentiometers

VR1	470R
VR2	100R

### Capacitors

C1	100p
C2	22 $\mu$ /10V
C3,4	2200 $\mu$ /25V (2 off)
C5-30	100n (26 off)

### Semiconductors

IC1-7	2102 (7 off)
IC8	74LS374
IC9	SFF96364
IC10	2716 EPROM
IC11	6402 or AY-5-1013 (see text)
IC12	2716 EPROM
IC13	74LS163
IC14	74121
IC15	74LS165
IC16	COM8126
IC17	74LS08
IC18	74LS00
IC19	74LS08

IC20	74LS132
IC21	1488
IC22	1489
IC23	7805
IC24	7812
IC25	7912
TR1,2	BC109, BC547 etc (2 off)
D1-4	1N4001 (4 off)

### Miscellaneous

X1	1 MHz crystal
X2	5.0688MHz crystal
UHF modulator	Astec 1233 (8MHz)
S1-4	4-way p.c.b.
S5-10	6-way p.c.b.
S11	S.p.d.t.
SK1	25-way D-Series
SK2,3	BNC Chassis Mounting
SK4	IEC Mains Connector
SK5	5-way p.c.b. Connector
SK6	3-way p.c.b. Connector
SK7	8-way p.c.b. Connector
Buzzer	Verospeed 41-22515K
T1	12-0-12 25VA transformer
Keyboard	
Case (see text)	
Double Eurocard	single-sided p.c.b.
I.c. sockets	

### Constructors' Note

A Hex dump of the EPROM contents is available from P.E. (Poole office); please send 230 x 150mm SAE. Pre-programmed EPROMs and COM8126s are available from: "Peripheral Projects," 25 Braycourt Avenue, Walton-on-Thames, Surrey KT12 2AZ. Printed circuit boards, if not found available from P.E.'s usual suppliers (see advertisers), will in any case be available from this supplier.

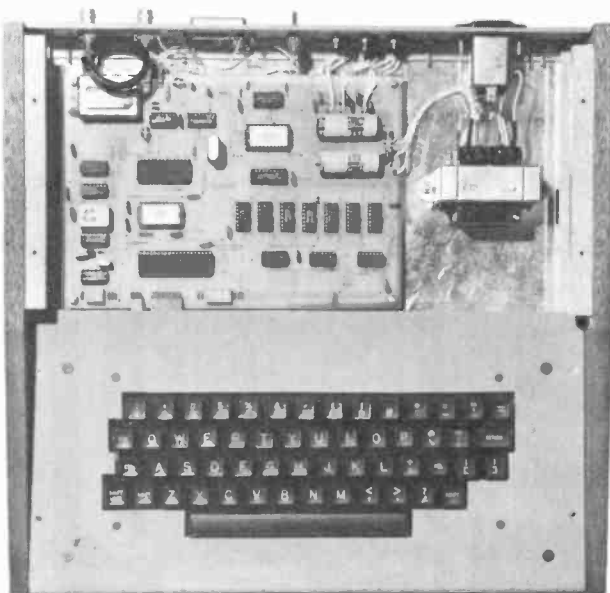

Internal views of the Computer Terminal

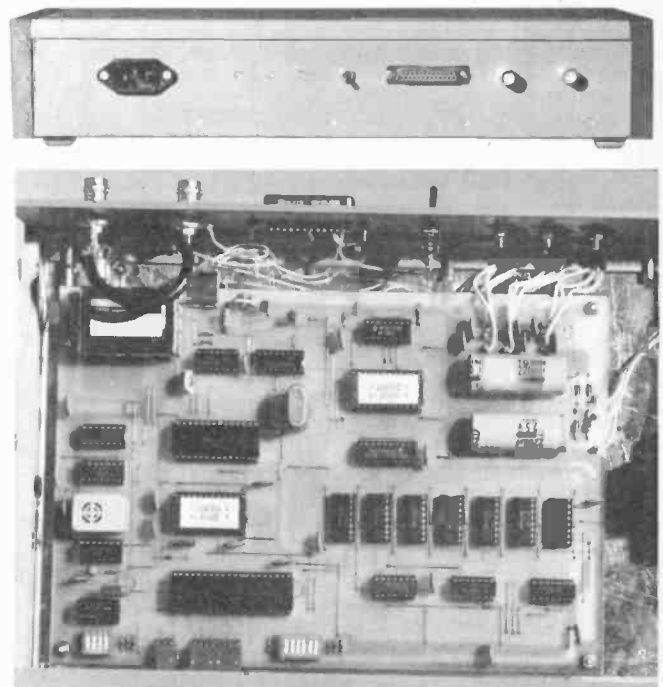

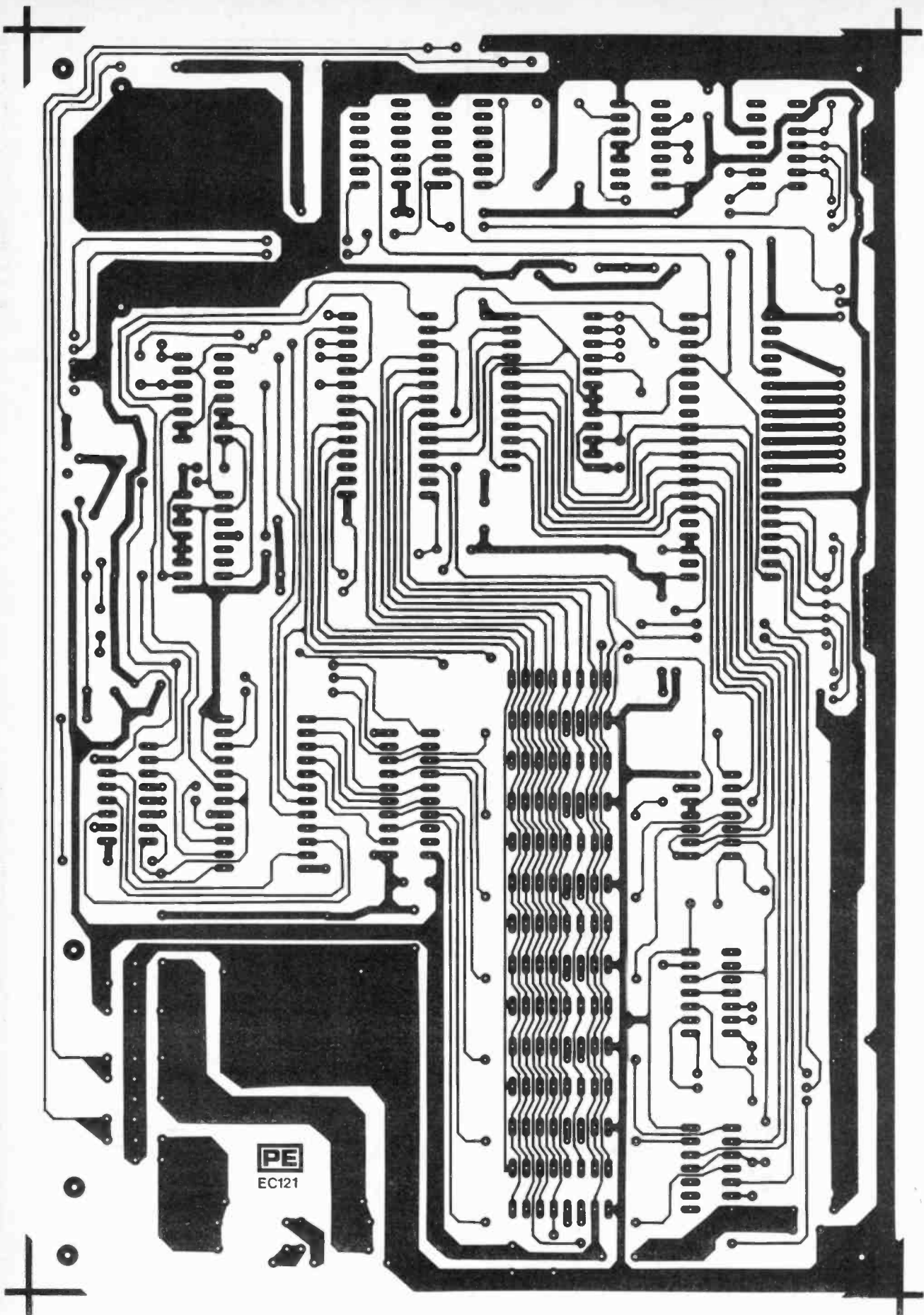

PE  
EC121

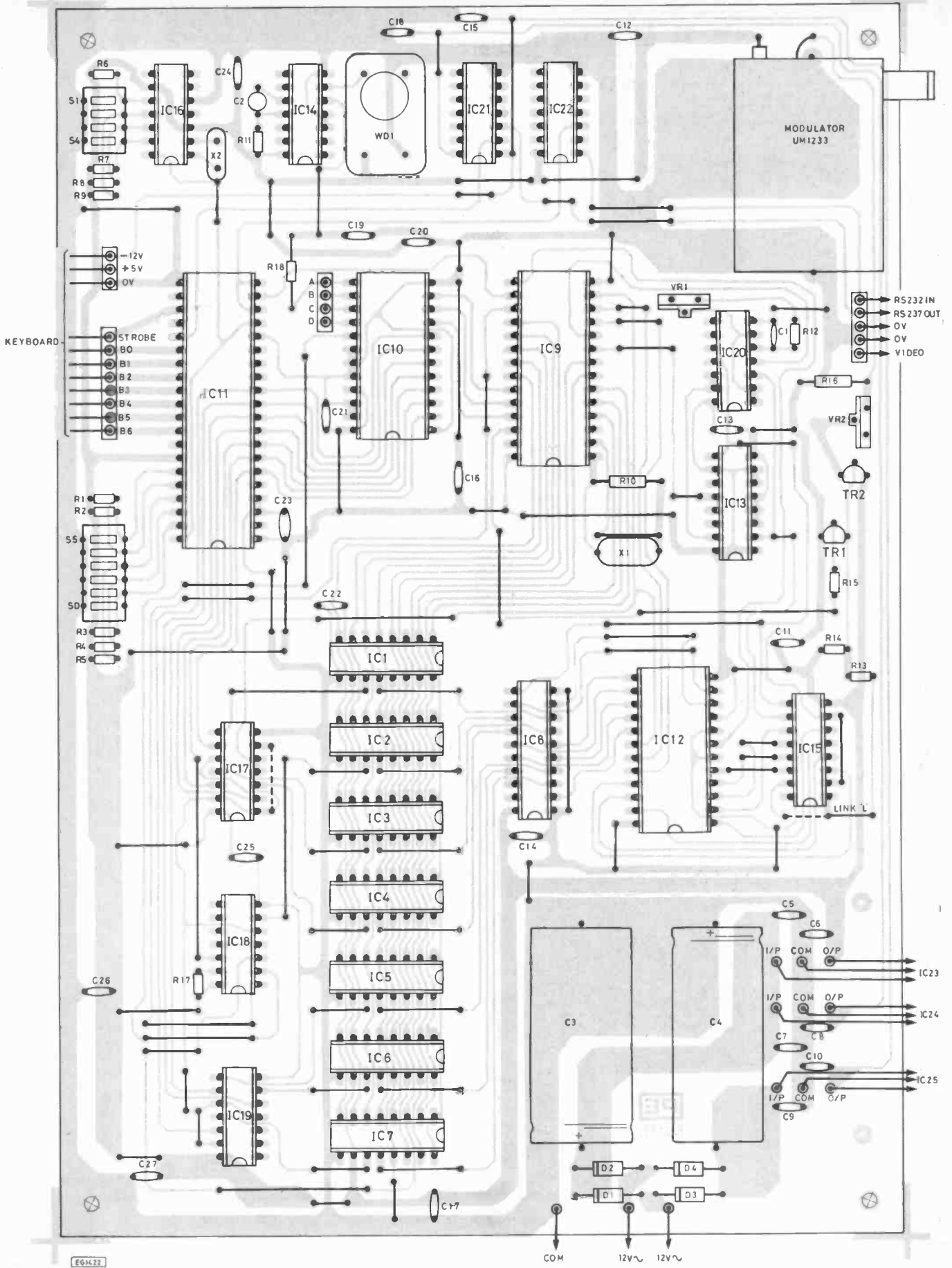
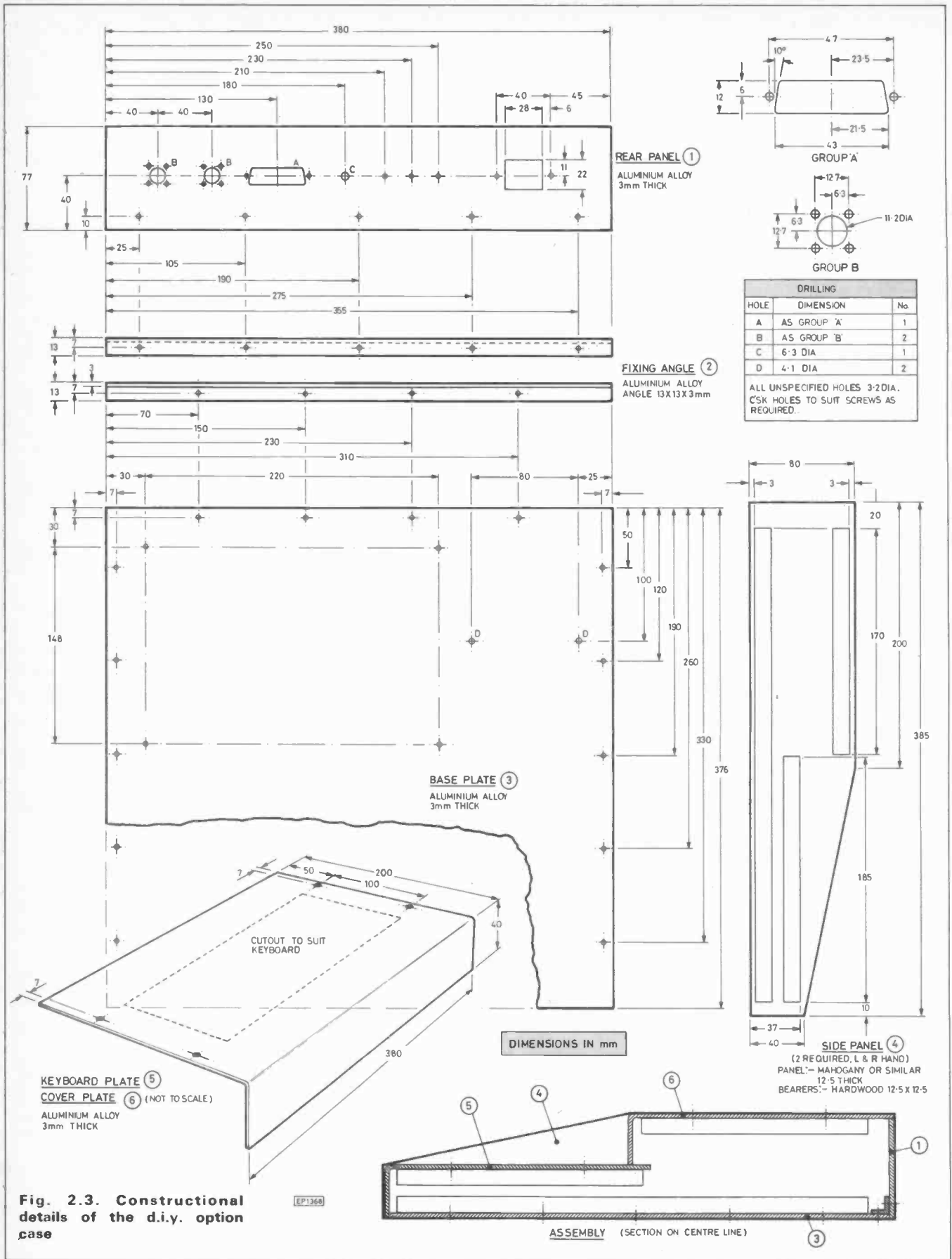

Fig. 2.2 (above). Component layout

Fig. 2.1 (facing page). P.c.b. layout of the Computer Terminal (actual size)



**Fig. 2.3. Constructional details of the d.i.y. option case**

EP1368



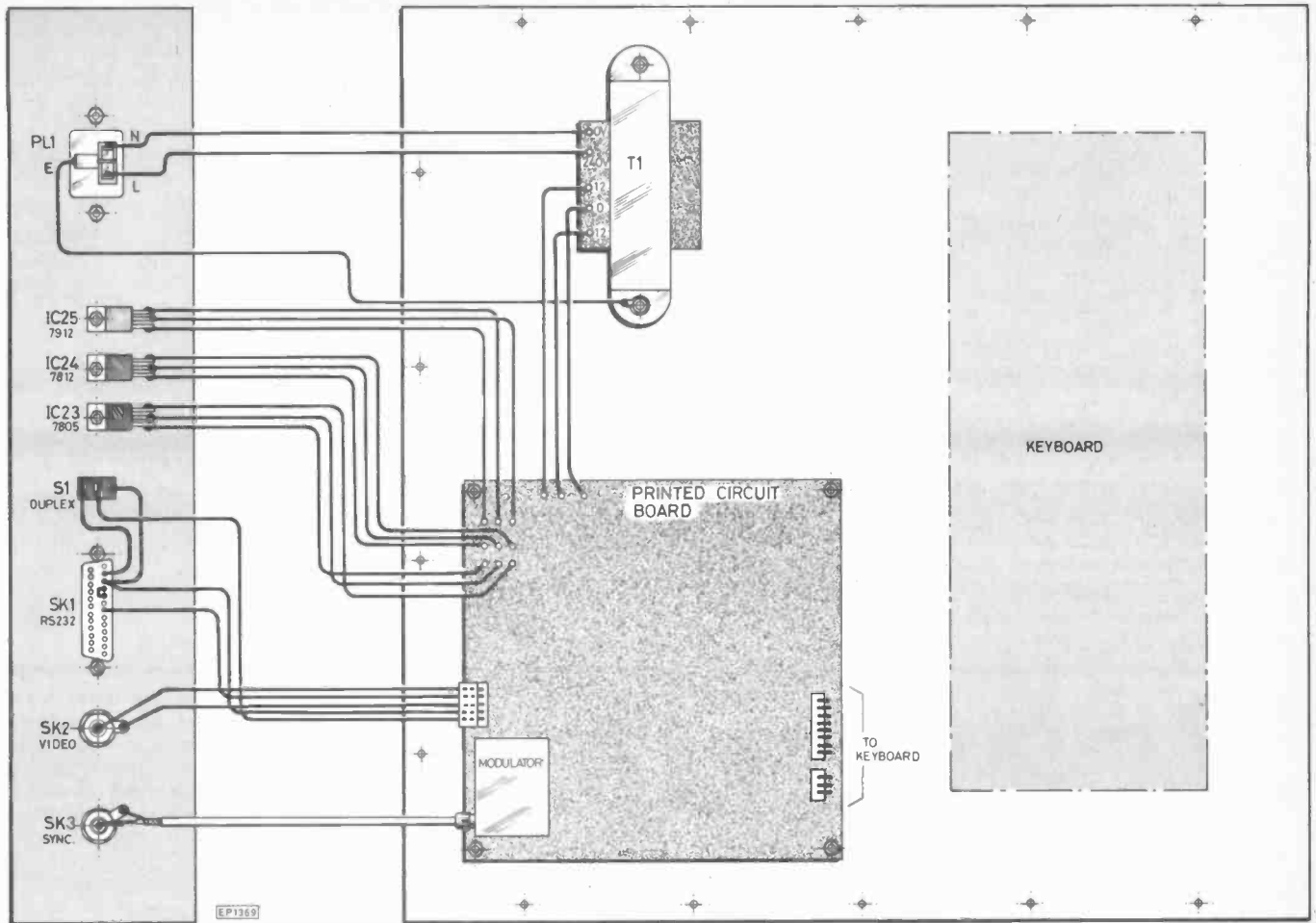

Fig. 2.4. Wiring diagram of the Computer Terminal

The BEL function can be checked by pushing the CTL and G keys together, whereupon a buzzing sound should be heard. Note that the UART latches its receiver outputs to the last character detected. As the buzzer's monostable is edge triggered it will only respond to the *first* CTL/G when several are sent consecutively. Normally CTL/G would be followed by a different character.

Switch to full duplex, the screen will remain unchanged, but characters entered on the keyboard will not appear on the screen. Connect the terminal to the host system via an RS232 cable. The host system's output should now be displayed on the screen. Similarly the host system should respond to characters entered on the keyboard.

**ADDITIONAL FEATURES**

As previously described, the control EPROM is programmed so that four of its outputs respond to the ASCII control characters as shown below:

- 03 — CTL/G (BEL) — p.c.b. pin A
- 04 — CTL/Q (DC1) — p.c.b. pin B
- 05 — CTL/R (DC2) — p.c.b. pin C
- 06 — CTL/S (DC3) — p.c.b. pin D

A p.c.b. plug is provided so that these signals may be used to drive additional circuitry.

The circuit in Fig. 2.5 shows how normal or reversed video could be selected using the ASCII control characters DC2 and DC3. Gates 1A and 1B form a bistable flip-flop, set

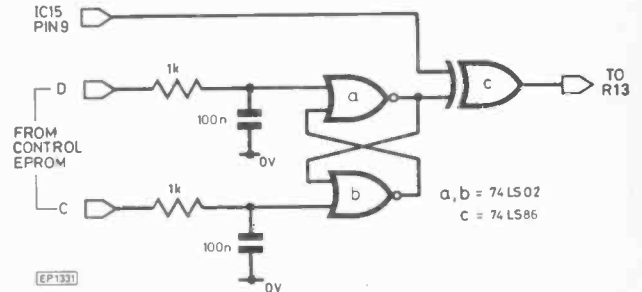

Fig. 2.5. Reversed video using ASCII characters DC2 and DC3

by DC2 and reset by DC3. The flip-flop's output is exclusive ORed with the normal video signal to produce normal or reversed video which is fed to the transistor mixer TR1. Issuing a DC2 character will cause all following characters to be reversed until a DC3 character is issued to revert back to normal video. The reader can therefore select various parts of the screen to display reversed video at will. If this circuit is used link "L" must be removed from the p.c.b.

A similar circuit (see Fig. 2.6) could be used to control a relay which could drive, for example, a cassette recorder's motor. DC3 would turn it on and DC2 turn it off. These two examples serve to indicate the types of additional facilities that may be included in the system and is by no means an exhaustive list.

## INTERFACING WITH THE BBC COMPUTER

As stated at the beginning of this article, the Computer Terminal can be used as a second terminal for a BBC computer. The following notes describe how this can be achieved. With this terminal, or "glass teletype", connected to the BBC's RS423 socket, the command \*FX2,1 allows the BBC computer to get characters from the "glass teletype", whilst \*FX3,7 allows data to be sent from the BBC computer to the "glass teletype". Note that in this mode the BBC computer's keyboard and screen are disabled. The BBC computer's Baud rate is set to the same value as that of the PE terminal (say 2400 Baud) by using the commands \*FX7,5 and \*FX8,5 for receive and transmit rates respectively. Reference should be made to the BBC computer's "user guide" for further information on the use of the RS423 port.

## CONCLUSION

Although reference has been made to the BBC computer, it is by no means the only system to which the terminal may be interfaced. The Computer Terminal can be used with any system fitted with a RS232 or RS423 interface. Examples of such systems are: Microprocessor development systems, Modems, EPROM programmers, Printers, as a terminal for a RTTY radio receiver, or on its own in half duplex as a practice typewriter. ★

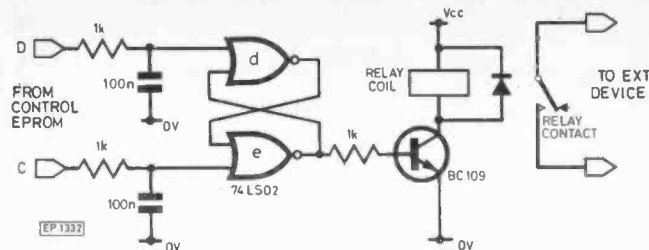

Fig. 2.6. A relay control circuit suitable for a cassette recorder

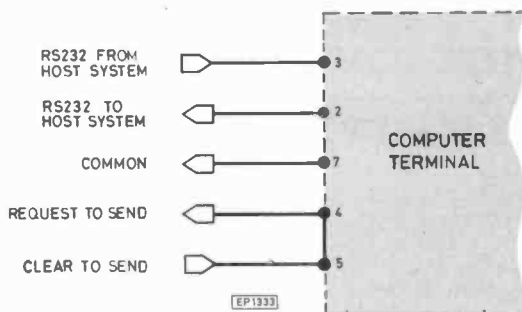

Fig. 2.7. RS232 connections

# Readout...

## Gas Saver

Sir—The boiler referred to in this article is obsolete, production finishing in 1970; although later series continued the basic design through to 1980.

The heating interests of Ideal-Standard Ltd. were incorporated into the Stelrad Group Ltd. in 1976 and it is with Stelrad that I am employed as Senior Controls Engineer within Group R&D department. In this capacity I must point out the problems associated with "add-on" modifications to approved gas appliances.

Interference with the working parts (in particular the electrical controls) of an approved gas boiler could invalidate the approval and warranty/service agreements as well as infringing the Gas Safety Regulations and, more to the point, could seriously impair the safe working of the appliance.

Any modification must give due regard as to the consequences—in particular taking full responsibility for the modifications carried out.

Obviously appreciable running cost savings can be made and manufacturers are currently investigating many possibilities for future incorporation into manufactured appliances.

The article also seems to suggest that only electronics can give the savings indicated. However, with the inclusion of a clamp-on cylinder thermostat and some simple wiring modifications the indicated savings could be achieved for less initial outlay, without invalidating the above comments.

It would appear that there is little appreciation for heating, as the article seems to concentrate on controlled hot water and con-

trolled boiler temperature rather than total comfort and cost effectiveness. As regards to controlling the gas valves via triacs and the associated gates and comparators, this is at present not accepted by the Industry for primary output because of its possible failure mode resulting in an unsafe condition, among other factors. It is true though that the article does suggest the thermostats provided with the boiler should be connected in series with the "Gas Saver" but this is not shown on the diagram and is not highlighted sufficiently within the article.

As you state in the article "... Safety is all important in any equipment ... using gas and electricity simultaneously, particularly, when running continuously without supervision." Hence we would suggest this should be left to experts as a little knowledge can be, so often, dangerous.

The subject is too large to handle in a few lines but it is hoped that the foregoing will be seen as constructive and helpful as we all endeavour to further the interest of electronics to the benefit of the Industry and our customers.

M. J. Blissett,  
Senior Controls Engineer,  
Stelrad Group Ltd.

*We have received a couple of similar letters, and it seems I must first plead guilty to perpetuating the misconception that the copper tube in the typical boiler thermostat conducts heat directly. In fact, it contains a fluid which expands when heated, and the capillary action is used to operate electrical contacts via a "bellows" mechanism. Although not as rapid as electronics, the action is not as slow as the article suggested.*

*To respond to the particular points raised by Mr. Blissett: First, I believe most consumers cannot afford to replace their C.H. system (or any other appliance) each time it is declared obsolete. Gas Saver was intended to allow the older, or cheaper, system to become more economical, given its inherent limitations.*

*An older system will not be covered by a manufacturer's warranty, but of course, Mr. Blissett is right to point out that a consumer should not carry out d.i.y. modifications that will invalidate a service agreement, and is indeed personally responsible for any such alterations. Beyond this, it is difficult to see how Gas Saver could impair reliability when connected, as suggested, in series with the existing thermostat. However, if I did not "highlight" this precaution sufficiently in the article, let me stress it now. A number of hobbyists experiment with electronics C.H. control, and look upon published material as further input, which is why I emphasised safety in general.*

*We accept the fact that "mechanical" equivalents to circuits published in Practical Electronics often do exist; as in "timers" for example. The clamp-on cylinder thermostat will not be as cheap if a professional is called in to install it—which I presume is advocated. The electronics enthusiast will argue that his approach paves the way to more flexible programming, making it possible to consider a timer that not only turns the C.H. system on and off, but which permits a programme of differing temperatures etc.*

*Failure modes should obviously be taken into account, and the article did underline this, hopefully to benefit also the hobbyist with his own ideas. But whether or not magazines should publish projects with which someone could have an accident, is a broader issue. I am sure the d.i.y. brand of hobbyist generally knows his own limitations and has the sense to avoid activities about which he has doubts.*

M.A.

# PE micro~file

## FILESHEET 14

## R.W.Coles 8073

It would appear that about the only thing the various single-chip microprocessor families have in common is that they are all different! This month we are going to take a look at the gospel according to National Semiconductor as expounded by their 8070 family, and as usual there are a few surprises in the approach they have taken.

At first sight National appear to have been an also-ran in the great microprocessor race, because although they have produced a number of original chip designs, they have never become a serious challenge to the Intel-Motorola-Zilog "Big three", and have probably made more money from second-sourcing Intel designs such as the 4040, 8080, and 8048 than they have from the chips from their own stable. Whether this somewhat mediocre performance is a reflection on the quality of their designs or whether it is due to shortcomings in their marketing policy I cannot say, but it will be interesting to see how their latest offering, the very powerful 16 bit NS16032 fares in the coming months.

The first National microprocessor to achieve popular prominence was the 8 bit SC/MP, which pioneers in the microprocessor hobby field may remember as one of the first devices to become available in hobby kit form. I certainly remember reviewing for P.E. one of the first evaluation kits in the country, and I remember being impressed by its "generous" provision of 512 bytes of ROM based monitor software and its 256 byte RAM area for user programs. All of that squeezed onto just *one* single Eurocard! Of course, that was in the antediluvian days of 1976 or 1977 and things have changed a lot since then. The PMOS SC/MP caught on quite well, especially in Europe, and was soon followed by a 5 volt NMOS version, the SC/MP 8060, but in the end its limited processor performance and restrictive 12 bit direct addressing range caused it to lose ground to the competing Intel and Motorola processors.

National did not abandon the basic architecture of the 8060 however, and in 1980 they introduced the 8070 family which features extended performance and the capability to use an on-chip ROM and RAM array, a logical move since the original 8060 had proved most successful in the low cost controller applications most suited to single chip processors.

One of the most successful features of the 8060 family was its suitability for use in multi-processor systems thanks to an extensive set of control inputs and outputs, and it was decided to retain this feature on the 8070. A decision was also made to have separate non-multiplexed data and address busses, using 24 pins in all, and this, combined with the extensive control facilities, left only five pins available for I/O use.

This lack of the usual complement of parallel I/O ports puts the 8070 family on the fringes of the single chip processor scene, and makes the use of external I/O chips a necessity in most applications, but despite this apparent disadvantage there are certainly plenty of jobs in which the particular characteristics of the 8070 family make it the most suitable choice.

There are currently three devices in the family, the 8070 itself which has 64 bytes of on-chip RAM but no ROM, the 8072 which has 2.5K bytes of masked ROM for high volume applications, and the 8073 which is an 8072 with the ROM preprogrammed with a monitor and a Tiny BASIC interpreter, in the style of the Zilog Z8671 discussed last month. All three chips have the same basic internal architecture, instruction set, and pin connections, and all feature an 8 bit data bus, a 16 bit address bus and a 16 x 16 bit hardware multiplier/divider.

The 8070 and 8073 are both usable for hobby applications, but there seems to be little to recommend the multichip 8070 solution

over competitive devices unless a potential user suffers from 8060 nostalgia! Since there is no EPROM version I have chosen to feature the 8073 which is one of the two devices available which feature on-chip BASIC (the other being the Z8671).

Even when programming in BASIC, it is desirable to know something about the internal architecture of the chip itself, and so these details, common to the whole family are given as usual. Details of the BASIC interpreter which is of course specific to the 8073, are given in the Software section.

As you may have expected, the launch of the on-chip BASIC 8073 caused quite a surge of interest and more requests for data sheets than had ever been received for any previous National product. This must have generated mixed feelings at National, because data mailings are expensive and they must have realised that most recipients were either just plain curious, or were serious potential customers who would ultimately buy only one or two devices, since a device programmed in BASIC is not a cost effective solution for high volume applications.

Still, their loss is our gain, since a single-chip processor programmable in BASIC is an excellent choice for many one-off hobby applications!

### REGISTERS

The original 8060 register set is carried through into the 8070 family with little change, although some names have been changed to reflect improvements in register usage and flexibility. The new family uses a single 8 bit accumulator register which acts as the implied source or destination for many instructions in typical first generation style, but this has been extended by means of an additional 8 bit register called the Extension register (E) which can be used either by itself as a temporary data store, or together with the accumulator to form the 16 bit EA accumulator for 16 bit operations.

There are five 16 bit registers, two of which are the Program Counter (PC) and the Stack Pointer which are quite conventional. There are two pointer registers (P2 and P3), which would be called index registers in most other processors, and finally something a little different, the Temporary (T) register which is needed for the 16 bit multiplier or divisor in multiplication or division operations, and can also be used as a general purpose 16 bit data store.

The only other user accessible register is the Status register (S), and this contains the eight flag bits as shown on the file sheet. Five of the flag bits are used for the two input lines, SA and SB, and the three output lines F1, F2 and F3, which are the closest the 8070 family comes to having any parallel I/O capability on-chip.

The only other flags available are the conventional Carry (CY), Overflow (OU), and Interrupt Enabled (IE), which means that there are no zero, sign, or auxiliary carry flags. No doubt the zero and sign functions can be simulated easily enough, but the lack of an auxiliary carry flag has the potentially serious implication that no direct BCD arithmetic is possible. Fortunately however, there is no requirement for BCD arithmetic when using the 8073's Tiny BASIC, and so there is no need to worry too much about this feature unless the use of an 8070 is being considered.

Apart from the above mentioned flag limitations, the 8070 family has quite a useful complement of registers.

### INSTRUCTION SET

Although the 8070 family instruction set has obvious links with the earlier SC/MP 8060 set, there are some deletions and several useful additions.

## GENERAL

The 8073 is a member of the National Semiconductor range of 8 bit NMOS processors which has been developed from the earlier SC/MP 8060 family. The 8073 has the outstanding feature of an on-chip Tiny BASIC interpreter stored in 2.5K bytes of ROM and is designed for low cost controller applications which do not require the high speed of machine code. Unlike most other single chip microprocessors the 8073 has very few on-chip I/O lines, but it does have extensive control features to allow multiprocessing.

## REGISTERS & MEMORY

THE 8073 HAS A USEFUL SET OF DEDICATED REGISTERS INCLUDING 3 16 BIT MEMORY POINTERS (SP, P2, P3). THERE IS A 2.5K ROM ARRAY AND 64 BYTES OF RAM ON-CHIP.

7 EXTENSION (E)	0	7 ACCUM (AC)	0	EA	0000H	ON-CHIP ROM CONTAINING TINY BASIC INTERPRETER
15 TEMPORARY REG	0	T			09FFH	MANDATORY EXTERNAL RAM
15 POINTER 2	0	P2			10FFFH	OPTIONAL EXTERNAL RAM/EPROM
15 POINTER 3	0	P3				
15 STACK POINTER	0	SP				
7 STATUS REG.	0	S			FFCOH	ON-CHIP RAM
15 PROGRAM COUNTER	0	PC			FFFFH	

7 CY	6 OVF	5 SB	4 SA	3 F3	2 F2	1 F1	0 IE
------	-------	------	------	------	------	------	------

## INSTRUCTION SET AND SOFTWARE

The machine code instruction set of the 8073 is identical to that of the other chips in the family and contains some very useful features such as signed 16 bit multiply and divide instructions. The Tiny BASIC is based on National's earlier NIBL interpreter, offers 16 bit integer arithmetic, a useful set of control orientated BASIC statements and functions, and allows the use of embedded machine code routines if required.

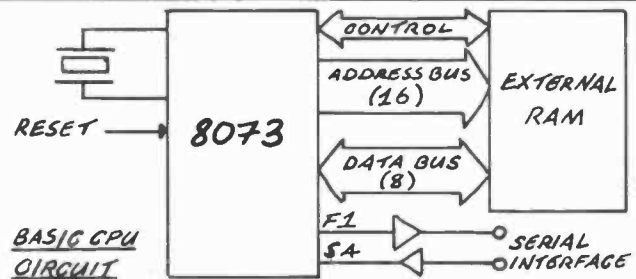

## PERFORMANCE DATA 8073

MEMORY ADDRESS RANGE: 64KB

I/O ADDRESS RANGE: MEMORY MAPPED

CLOCK FREQUENCY: 4MHZ

POWER SUPPLIES: 5V

INTERRUPTS: INTA, INTB

NEN OUT	1	40 VCC
NEN IN	2	39 SB (INTB)
NBREQ	3	38 SA (INTA)
NRDS	4	37 NRST
NHOLD	5	36 F3
NWDS	6	35 F2
XOUT	7	34 F1
XIN	8	33 D0
A15	9	32 D1
A14	10	31 D2
A13	11	30 D3
A12	12	29 D4
A11	13	28 D5
A10	14	27 D6
A9	15	26 D7
A8	16	25 A0
A7	17	24 A1
A6	18	23 A2
A5	19	22 A3
GND	20	21 A4

## OTHER FAMILY MEMBERS

**8060 (SC/MP)** this device was the predecessor of the 8070 family but had limited addressing and no on-chip memory

**8070** Basic family member with 64 bytes of RAM but no ROM.

**8072** Like 8073 with 2.5K of on-chip ROM but without Tiny BASIC. For mass production applications.

## BENCHMARKS

ADD REGISTER TO ACCUM.	4μS
O/P ACCUM TO PORT	7μS*
MOVE FROM MEMORY TO MEMORY	14μS*

\* DIRECT (8BIT) MODE

## MANUFACTURERS

ORIGINATOR: NATIONAL SEMICONDUCTOR

2ND. SOURCE: AMD

## SUPPORT CHIPS

UNLIKE THE 8748, 68701 AND Z8 THE 8073 DOES NOT HAVE MUCH ON-CHIP PARALLEL I/O CAPABILITY BUT CAN INTERFACE TO THE 8080 PERIPHERAL CHIP FAMILY EXTERNALLY. ALTHOUGH THERE ARE 64 BYTES OF RAM ON-CHIP, THE 8073 NEEDS AT LEAST 256 BYTES OF EXTERNAL RAM.



# INSTRUCTION SET SUMMARY

INSTRUCTION	MNE-MONIC	FIRST OPERAND	SECOND OPERAND	OPERATION PERFORMED
LOAD	LD	A		(A) ← (addr)
		EA		(EA) ← (addr + 1, addr)
		T		(T) ← (addr + 1, addr)
		SP		(SP) ← (PC + 2, PC + 1)
		P2		(P2) ← (PC + 2, PC + 1)
STORE	ST	P3		(P3) ← (PC + 2, PC + 1)
		A	E	(A) ← (E)
		E	A	(E) ← (A)
		A	S	(A) ← (S)
		S	A	(S) ← (A)
		EA	PC	(EA) ← (PC)
		EA	SP	(EA) ← (SP)
		EA	P2	(EA) ← (P2)
		EA	P3	(EA) ← (P3)
		SP	EA	(SP) ← (EA)
EXCHANGE REGISTERS	XCH	P2	EA	(P2) ← (EA)
		P3	EA	(P3) ← (EA)
		T	EA	(T) ← (EA)
		EA	T	(EA) ← (T)
		A		(A) ← (addr)
		EA		(AE) ← (addr + 1, addr)
		A		(A) ← (A) + (addr)
		A	E	(A) ← (A) * (E)
		EA		(EA) ← (EA) * (addr + 1, addr)
		A		(A) ← (A) / (addr)
MULTIPLY	MPY	A	E	(A) ← (A) * (E)
		EA		(EA) ← (EA) * (addr + 1, addr)
DIVIDE	DIV	EA	T	Quotient: (EA) ← ((EA) / (T)) / 150 Remainder: (T) ← ((EA) / (T))
		A		(A) ← (A) / (addr)
AND	AND	A	E	(A) ← (A) ∧ (E)
		A		(S) ← (S) ∧ (addr)
		S		(A) ← (A) ∨ (addr)
OR	OR	A	E	(A) ← (A) ∨ (E)
		S		(S) ← (S) ∨ (addr)
EXCLUSIVE-OR	XOR	A		(A) ← (A) ⊕ (addr)
		A	E	(A) ← (A) ⊕ (E)

INSTRUCTION	MNE-MONIC	FIRST OPERAND	SECOND OPERAND	OPERATION PERFORMED
EXCHANGE REGISTERS	XCH	A	E	(A) ↔ (E)
		EA	SP	(EA) ↔ (SP)
		EA	P2	(EA) ↔ (P2)
		EA	P3	(EA) ↔ (P3)
SHIFT RIGHT	SR	A		(A) ← (A) / 2
		EA		(EA) ← (EA) / 2
SHIFT RIGHT WITH LINK	SRL	A		(A) ← (A) / 2, CY ← A7
		EA		(EA) ← (EA) / 2, CY ← A7
ROTATE RIGHT	RR	A		(A) ← (A) / 2, A0 → A7
		EA		(EA) ← (EA) / 2, A0 → A7
ROTATE RIGHT WITH LINK	RRL	A		(A) ← (A) / 2, A0 → CY → A7
		EA		(EA) ← (EA) / 2, A0 → A7
SHIFT LEFT	SL	A		(A) ← (A) * 2
		EA		(EA) ← (EA) * 2
SEARCH AND SKIP IF CHARACTER MATCHED	SSM			See Test
				If (A) ≠ ASCII (PC) → addr, if not digit 7 or 9, if digit 7
BRANCH IF NOT DIGIT	BND			
				(SP) ← (SP) + 1, ((SP)) ← (A)
PUSH	PUSH	EA		(SP) ← (E), ((SP)) ← (A), (SP) ← (SP) + 2
		PC		(SP) ← (PC), ((SP)) ← (PCL), (SP) ← (SP) + 2
		P2		(SP) ← (P2), ((SP)) ← (P2), (SP) ← (SP) + 2
		P3		(SP) ← (P3), ((SP)) ← (P3), (SP) ← (SP) + 2
		P2		(SP) ← (P2), ((SP)) ← (P2), (SP) ← (SP) + 2
		P3		(SP) ← (P3), ((SP)) ← (P3), (SP) ← (SP) + 2
PUSH AND LOAD IMMEDIATE	PLI	A		(SP) ← (SP) + 1
		EA		(A) ← ((SP)), (E) ← (EA), (SP) ← (SP) + 2
		P2		(P2) ← ((SP)), (P2H) ← ((SP)) - 1, (SP) ← (SP) + 2
BRANCH UNCONDITIONAL	BRA			(P3) ← ((SP)), (P3H) ← ((SP)) - 1, (SP) ← (SP) + 2
				(PC) ← (PC) - disp
				If (A) = 0, (PC) ← (PC) - disp
BRANCH POSITIVE	BP			If (A) = 0, (PC) ← (PC) - disp
				If (A) = 0, (PC) ← (PC) + disp
BRANCH ZERO	BZ			If (A) = 0, (PC) ← (PC) - disp
				If (A) = 0, (PC) ← (PC) + disp
BRANCH NOT ZERO	BNZ			(PCH) ← byte 3, (PCL) ← byte 2
				(SP) ← (SP) - byte 3, ((SP)) ← ((SP)) - 2, (PCL) ← byte 2
JUMP UNCONDITIONAL	JMP			(SP) ← (SP) - byte 3, ((SP)) ← ((SP)) - 2, (PCL) ← byte 2
				(SP) ← (SP) - byte 3, ((SP)) ← ((SP)) - 2, (PCL) ← byte 2
JUMP TO SUBROUTINE	JSR			(SP) ← (SP) - byte 3, ((SP)) ← ((SP)) - 2, (PCL) ← byte 2
				(SP) ← (SP) - byte 3, ((SP)) ← ((SP)) - 2, (PCL) ← byte 2
CALL	CALL	0-15		(PCL) ← ((SP)), (PCH) ← ((SP)) - 1, (SP) ← (SP) + 2
				(PCL) ← ((SP)), (PCH) ← ((SP)) - 1, (SP) ← (SP) + 2
RETURN	RET			(PC) ← (EA)
				(PC) ← (EA)
LOAD PC	LD	PC	EA	(PC) ← (EA)
				(PC) ← (EA)
EXCHANGE PC	XCH	PC	EA	(A) ← (addr) ← (addr) + 1
				(A) ← (addr) ← (addr) + 1
INCREMENT AND LOAD	ILD	A		(A) ← (addr) ← (addr) + 1
				(A) ← (addr) ← (addr) + 1
DECREMENT AND LOAD	DLD	A		(A) ← (addr) ← (addr) - 1
				(PC) ← (PC) + 1
NO OPERATION	NOP			

Gone are the flag manipulations (Carry Set and Clear, Interrupt Enable and Disable) and these functions now have to be performed by means of logic instructions operating on the status register. Also missing are the unique SC/MP Delay instruction, which now has to be simulated with a counter loop, and the decimal arithmetic operators which represent a more serious loss.

Improvements include the inclusion of a true Jump to Subroutine Instruction, Push and Pop stack instruction, and a new one byte Call instruction which operates like JSR but uses up to 16 fixed vectors as indirect jump addresses, just like the 8080 style Restart. The new signed 16 bit Multiply and Divide instructions are particularly useful for high level language operation of course, and the unique "Search and Skip if character Matched" (SSM) and "Branch if Not Digit" (BND) appear to have been included with the needs of the 8073 BASIC interpreter very much in mind.

The SSM instruction searches through a 256 byte memory block for a character that matches the accumulator contents using the P2 or P3 register as a pointer. When a match is found the following two program bytes are skipped and the chosen pointer register indicates the address of the matching byte, very useful for interpretive programming.

The BND instruction tests the ASCII character in the accumulator to see if it corresponds to one of the ASCII decimal digit codes (30H to 39H). If it does not then a PC relative branch is executed, but if it does the ASCII character is converted into its binary equivalent (00H to 09H) thus saving several program steps. A useful feature for keyboard orientated applications.

There are 192 instruction types in the 8070 set, supplemented by a useful set of 9 addressing modes including Implied, Immediate, Direct Absolute, Indirect, Indexed, Auto Indexed, Program Counter Relative, and Pointer Relative. All in all, quite a useful instruction set with some nice features.

## SOFTWARE

The 8070 family is intended mainly for controller applications and does not aspire to the dizzy heights of a common user software base or a disc operating system, so this section will be devoted to a description of the 8073 Tiny BASIC interpreter.

Tiny BASIC is not intended for general purpose data processing applications of course, because it has only integer arithmetic, no array capability and only limited string handling. It is mainly useful for the rapid creation and testing of controller type programs as an alternative to assembly language, and is a boon wherever the fatal flaw of slow operation can be tolerated (tens of milliseconds rather than the hundreds of microseconds possible with an assembly language version).

The 8073 contains the complete Tiny BASIC interpreter and system monitor code within its 2.5K bytes of on-chip ROM, and needs only some external RAM and an RS232 interface to a terminal to function as a complete system. The external RAM must total at least 256 bytes, plus any additional amount required to hold the user program (a bytewise 2K x 8 RAM such as the Mostek 4802 would be ideal). No external UART is required because the system monitor contains routines which emulate a UART, making F1 the serial output, F2 a "ready" flag, and SA the serial input. Baud rates of between 110 and 4800 are handled by the monitor and can be selected by programming the D1 and D2 bits of memory or I/O location FDOOH appropriately. If bit D7 of the same location is set to zero, the monitor I/O routines are not used, but instead a branch is made to user supplied routines located at addresses stored in FDO1H/FDO2H for character output, and FDO3H/FDO4H for character input. This useful facility allows the connection of other types of character I/O device (such as a parallel ASCII keyboard and LED display) if required. Note however, that the user subroutines have to be in machine code, not BASIC!

When the 8073 is powered up or reset the Tiny BASIC automatically performs a memory search to find the address range of any external RAM which is connected as a contiguous block above 1000H. After locating the RAM area and extent, Tiny BASIC then tests location 8000H to see if it is RAM. If it is, COMMAND mode is entered and user inputs via the terminal are awaited. If it is not, the interpreter will assume that an EPROM based BASIC program resides there and execution will be attempted. If there is not an EPROM program resident, the execution attempt will be aborted and COMMAND mode will be entered.

This feature makes possible the creation of stand-alone, BASIC programmed control systems, which need not use a terminal (for example a central heating controller). Programs can be developed using RAM and a terminal, then blown into EPROM for continued automatic use.

In program development (or RAM) mode, the user is required to initialise the system by entering two commands as follows:—

NEW (ADDRESS)

NEW Carriage Return.

These commands establish the start and end addresses for the new program which can then be entered, with line numbers, in the normal way.

In addition to NEW, the RUN, CONT (Continue), and LIST commands are available.

A useful range of BASIC statements is catered for, as follows:

**REM anything:** Remark (no operation).

**CLEAR:** Initializes all variables to 0, disables interrupts, and resets all stacks (GOSUB FOR-NEXT DO-UNTIL).

**(LET) var = expr:** Assigns expression value to variable.

**(LET) STAT = expr:** Sets the STATUS word equal to the least significant byte of "expr." When the STATUS word is used to enable interrupts at the hardware level, interrupt processing will be deferred for one statement.

**(LET) @ factor = expr:** Sets the memory location pointed to by 'factor' equal to the least significant byte of 'expr.'

**(LET) \$ factor = "string":** Assigns a string in RAM starting at the address 'factor.' Strings are terminated by a carriage return.

**(LET) \$ factor = \$ factor:** Memory to memory assignment (copy).

**PRINT expr:** Prints the value of 'expr.'

**PRINT "string":** Prints the string.

**PRINT \$ factor:** Prints the string starting at the memory address 'factor.'

**IF expr (THEN) statements:** Remainder of the program line is executed if 'expr' is true (non-zero).

**FOR var = expr TO expr (STEP expr):** FOR loop initiation. Loops may be nested to four levels.

**NEXT var:** For loop termination.

**DO:** DO loop initiation. DO loops may be nested to eight levels.

**UNTIL expr:** DO loop termination.

**GO TO expr:** Transfer control to statement number 'expr.'

**GO SUB expr:** Call subroutine at statement number 'expr.' Subroutines may be nested to eight levels.

**RETURN:** Return from subroutine.

**INPUT var:** Read value from console into variable.

**INPUT \$ factor:** Read string from console into memory beginning at address 'factor.'

**LINK expr:** Links to an assembly language subroutine which begins at address 'expr.' A "RET" instruction in this routine will cause continuation of the NSC Tiny BASIC program. hprogram.

**⌘ expr:** Interrupt processing definition. When interrupt number 1 or 2 occurs, NSC Tiny BASIC will execute a GOSUB beginning at line number 'expr.' If 'expr' is zero, the corresponding interrupt is disabled at the software level.

**DELAY expr:** Delay for 'expr' time units (nominally milliseconds. 1-1040). DELAY 0 gives the maximum delay of 1040 milliseconds.

**STOP:** Terminate program execution. A message is printed and the Microinterpreter returns to COMMAND mode.

Note the useful machine code LINK statement, ON 1 or 2 interrupt handler, and the DELAY capability, each of which make the 8073 BASIC ideal for control applications.

All arithmetic is performed in 16 bit signed integer format (-32768 to +32767) and the following operators and functions are provided:—

**Arithmetic operators:** addition, subtraction, multiplication, division

**Relational operators:** less than, greater than, equal to, not equal to, less than or equal to, greater than or equal to

**Logical operators:** logical AND, logical OR, logical NOT

## FUNCTION SUMMARY

**@ factor:** The memory/peripheral address for memory-I/O read/write operations.

**STAT:** STATUS register.

**TOP:** Top-Of-Program address (first available memory address after end-of-program byte).

**INC (x), DEC (x):** Increment or Decrement a memory location (non-interruptable for multiprocessing).

**MOD(x,y):** Modulus function (remainder of x/y).

**RND(x,y):** Random number generator (in interval x,y).

There can be little doubt that the 8073 represents an excellent way into do-it-yourself microprocessor applications.

## INTERFACING

The 8070 family all run from a single 5 volt supply and have on-chip clock oscillators to keep external components to a minimum.

A full set of control lines are provided to allow the design of multi-processor systems sharing a common memory and I/O bus, as follows:—

- NWDS tri-state output similar to the  $\overline{WR}$  line of 8080 style processors.
- NRDS tri-state output similar to the  $\overline{RD}$  line of 8080 style processors.
- NENIN when this input is low, the 8070 is allowed access to the bus. When set high by another device such as a second 8070 or a DMA chip the 8070 is denied bus access.
- NENOUT This active low bus enable output provides a "bus-grant" to other devices which require bus access.
- NBREQ A bi-directional input/output which accepts bus requests from other devices as an input when set high, and generates an own-request when set low.

When required, for example in DMA or multiprocessor systems, the extensive set of internal 8070 bus control logic can save a considerable number of external gate packages.

Two interrupt inputs are available on the 8070 family of processors by utilising the two sense lines SA and SB, called INTA and INTB when used for this purpose. Both interrupt lines are dis-

abled when the IE flag in the status register is set to zero, and the SA SB flag bits can be used as program readable inputs.

When used as interrupts (IE = 1) INTA has higher priority than INTB, but both inputs are edge triggered to remove the need for external interrupt acknowledge logic. A high to low transition on either input causes the program counter contents to be pushed onto the stack, the program counter to be set to 0004H (INTA) or 0007H (INTB), and the IE bit set to zero. The programmer is responsible for storing appropriate BRANCH or JUMP instructions in locations 0004H and 0007H, so that access to interrupt routines stored anywhere in memory can be achieved. (In the case of the 8073, this is handled automatically by the Tiny BASIC interpreter of course.)

There are no special peripheral chips designed especially for the 8070 (or even the earlier 8060) family, but this is not a major drawback because most Intel 8080 peripherals can easily be used. Unlike the 8080 however, the 8070 family has no separate I/O address space and so the peripherals must be memory-mapped.

For serial I/O an external UART could be used, but a cheaper way is to implement a software UART using the sense and flag lines like that provided in the 8073 interpreter.

## APPLICATIONS

The 8070 provides a useful compromise between the 8048/Z8 style "everything-on-board" single chip processors and the 6800/8080 style multi-chip solutions. It is probably not as good as the 68701 which can also provide this compromise, but it is, after all, a good deal less expensive!

I personally would not use the basic no-ROM 8070, because it has few advantages over other multi-chip processors like the 6802, but the 8073 with its on-chip BASIC interpreter is an excellent choice for hobby projects and can be recommended to everyone who wants to get into system design with the minimum financial outlay and risk. The design of a homebrew 8073 development system is quite straightforward, but for those who want to get started quickly there are a number of 8073 single board systems now available, such as the one designed by Essex University.

# IT PAYS TO HAVE THE BEST CONNECTIONS

especially to PRACTICAL ELECTRONICS—the magazine for connecting hobbyists. The latest technology in a monthly selection of useful constructional projects for your home... for your car—in fact, there are hundreds of ways PRACTICAL ELECTRONICS can help you.

The biggest problem is avoiding breakdowns, like missing important issues—but now it's made easy with the PRACTICAL ELECTRONICS subscription service.

Just fill in the coupon below and have PRACTICAL ELECTRONICS delivered direct to your door every month. Avoid disconnection send off the coupon today.

Alternatively ring our special Teledata Hotline. And why not order a subscription for a friend too!

## PRACTICAL ELECTRONICS SUBSCRIPTION ORDER FORM

Annual Subscription Rates	
U.K.	£13.00
U.S.A. CANADA	\$28.60
Other Overseas Surface Mail	£14.00
(Students: Deduct £1.00 (\$2.20) and quote Student number.)	

Complete this form and post it, with payment or Credit Card authorisation to:  
IPC Magazines Ltd.,  
Room 2816, King's Reach  
Tower, Stamford Street,  
London SE1 9LS.  
You can use this form to order a gift subscription too. Hotline. Phone TELEDATA 01-200 0200 with your Credit Card No. Allow 4 weeks for order processing.



**HOTLINE**  
PHONE  
TELEDATA

01 200 0 200

Post copies to:

NAME: \_\_\_\_\_

ADDRESS: \_\_\_\_\_

Post Code: \_\_\_\_\_

If a Gift Subscription enter your own name and address here.

NAME: \_\_\_\_\_

ADDRESS: \_\_\_\_\_

Post Code: \_\_\_\_\_

I enclose my cheque/P.O. payable to IPC Magazines Ltd. for £ \_\_\_\_\_

Charge my Credit Card A/C at quoted rate.

Card Valid from: \_\_\_\_\_ to: \_\_\_\_\_

Signature \_\_\_\_\_

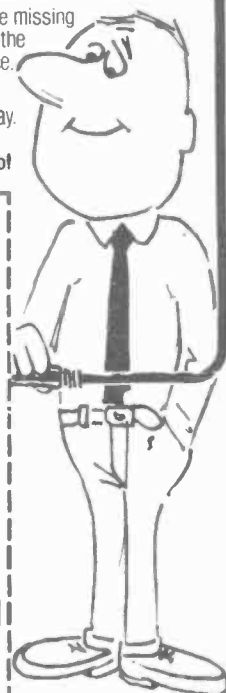

all in your **APRIL** issue!

**FREE**

## No.2 LOGIC DESIGN CARD

Our second logic card covers logic sources, TTL supplies, supply distribution and a typical p.s.u. design for TTL.

## MICROSTEPPER



"Freeze frame" your micro, instruction by instruction, to see what's going on during educational and debugging exercises.

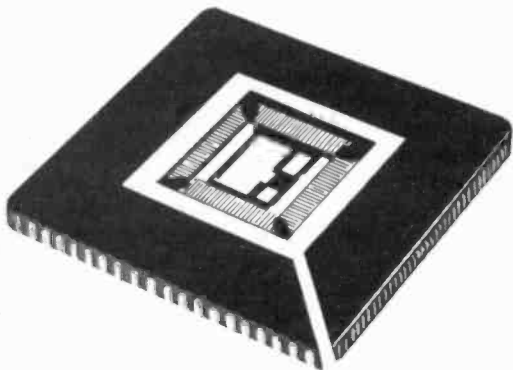

## TRANSPUTER

Inmos claim the Transputer array processor will set new standards in ease of programming, provide maximum performance to the user, exploit future developments in VLSI within a compatible family and be able to form fifth generation systems with large numbers of concurrent computing elements. Next month we take a close look at the device.

PRACTICAL

# ELECTRONICS

APRIL ISSUE ON SALE FRIDAY, MARCH 2, 1984





## Space Watch...

### EUROPEAN SPACE AGENCY PROJECT

It is proposed that the ESA should submit designs for a space station for a joint enterprise with the United States. It is expected that it will require funding of some ten million pounds. ESA would retain the option of going it alone if the United States decided not to participate. It is, however, apparent that the radical re-designing necessary for use with a single shot launcher suggests that it is better to spend the money on launching by shuttle and concentrate on space stations. The experience with Ariane may also have influenced the decision. Greater attention is now being paid to finance when dealing with these very large projects. Of course, it is also true that new techniques are more reliable and that hardware can be built to a high standard. The source of money has realised that risks are reduced by the methods in use, it must also be remembered that failures are less likely now so that insurance rates have fallen. It is true that precise anticipation of costs is dealt with in a more efficient way, since the guesswork of the past is almost gone. There is everything to gain as far as the ESA is concerned, since co-operation has proved successful in the past and the rapid advances in know-how are available for every country.

This new venture could well be the beginning of a successful co-operative. A significant part of this study is the long, hard look approach. In principle there are three parts, the modules, the platform units and the orbital manoeuvring units.

**Modules**—These are pressurised segments and would be used for experiments and logistics. They could be adapted for crew living quarters, though it is possible that the USA might keep this within their own confines.

**Platform units**—This study will look at unpressurised components and in the main this will refer to free-flying unmanned units that could be used for materials processing and the like.

**Orbital manoeuvring units**—Studies of unmanned orbit transfer and space station service vehicles will be included. This valuation will be set at about £250,000 and will be carried out by the Messerschmitt-

Boelkow-Blohm consortium and Erno, with the help of AEG, Aeritalia, British Aerospace, Dornier, Fokker, Matra, Sibra, Sener and Aerospatiale. West Germany and Italy have already done work to this end (Columbia programme).

### COLUMBIA PROGRAMME

The study carried out by Germany and Italy was called Columbus. This was undertaken as a special study and centres on a pressurised module, capable of being docked with a station, for long duration missions. Thus it could be used as a building brick for space stations. The module could contain a docking facility, complete with pressurised docking-berthing port, and one experimental air-lock. This module would be compatible with the shuttle space orbiter's payload bay, since it will be of the standard size. A service module using a portion of the Columbus module could be developed as a support/link vehicle to the space station. It would be equipped with a Solar array that could provide power when going to and from the station. There would be a small manoeuvring system. Crew transfer would be by a manned space vehicle.

Unmanned platforms would be derived from Eureka or the German SPAS to operate from the station as free-flying carriers of scientific experiments. It is evident that commercially viable processes may be achieved effectively, as the shuttle has proved, it is already attracting finance. This is clear with the fall in insurance rates and movement to get places in the launch queue. It would be wise, for the sake of the vital experiments that science needs to continuously carry out, that the two sides get together. One way of doing itself a commercial service would be for commerce to finance science in a more extensive manner. It is true that some of the large organisations do this, but what of the smaller commercial concerns whose work is essential in the new world to come? It is essential in the long run that co-operation is the operative word, and by co-operation that it means all the nations of the world would participate.

### FUEL CELLS

In the Orbiter Columbia, each fuel cell has been tested to a peak power of 16kW. Hitherto this has been at the lower level of 14/15kW, the reason for this being that the power was much more in demand for the 54 workdays of the mission of Columbia 9.

The fuel cell power and water generation system contained one-third more than previously allotted. There are three stacks of 32 cells each in the vehicle. Earlier units flew with two stacks of 32 cells each. Each cell contains hydrogen and oxygen electrodes and an electrolyte of potassium hydroxide and water. The fuel cell normally will supply 2.12kW. At 2kW per cell, each stack can supply 32.5V and 61.5A of direct current. At 12kW it can supply 27.5V at a current of 43.6A. Water is recovered from the system which is used for drinking and cooling. The designers, United Technologies Power Systems, claim that the system can be developed to supply a 24kW output and a 5,000 hour operating lifetime.

### HEARING AND SPACE

Spacelab has proved an old theory of hearing originally proposed in 1914. This was related to the semi-circular canals of the inner ear. It was found that if air at different temperatures was blown into the ear, then the sensation of turning was induced, even if the person was not moving. It was believed that the cause was the different density of the air and the fluid in the semi-circular canal. Spacelab have now confirmed this theory. The investigators used the eye movements of the astronauts to assess the temperatures. Another test, which was designed to determine the adaptation of the body to weightlessness, caused motion sickness for specialist crew member Byron K. Lichtenberg, requiring the termination of a life-sciences experiment.

A further test designed by an English psychology scientist, and mentioned in a recent *Spacewatch*, was designed for estimating different densities of pairs of balls which were visually of the same size.

A partially completed experiment was undertaken by Owen Garriott and Byron Lichtenberg; it was completed by Owen Garriott only because it caused Lichtenberg pain. The object was to discover the effect of weightlessness on reflexes and posture. The method was to drag the astronaut towards the floor and slightly shock him behind the knees during his descent. In order to minimise motion sickness the crew slowed all their movements during the mission. It is believed by Garriott that the movement of the head plays an important part in solving the problem. It certainly seems that some re-thinking needs to be done on these matters. Another experiment consisted of observing a field of dots which is rotating, followed by 35mm photographs of eye movements of the reaction of the subjects. This could not be completed owing to the failure of the photoflash. There will be a report published later and this will appear in a future issue of *Spacewatch*.

### VENUS OBSERVED

There have been some reports of the Russian Space Explorer which are quite informative in that they confirm the finding of earlier space and ground-based instruments. The information is interesting for the planet has been the subject of two probes, Venera 15 and 16, which have been orbiting Venus since October. They have radar for investigating in close-up mode. It is claimed that resolution of one to two kilometres has been achieved. It needs a resolution of as good as at least one kilometre to assess the mountain elevations. If the resolution on these vehicles is less than one kilometre then we will have to wait for the publication of the results. The USA will not be ready to map at this level before 1988 or thereabouts. There are some pictures of the Soviet work around Venus. These are clear and show the general terrain, both craters and elevated land. There are large craters and considerable signs of volcanic activity. Near the pole it was noticeable that there is a large volcanic dome rising from an undulating terrain. One picture shows distinct lava flows, another shows a crater some 32 x 43 miles in size. Such pictures are only available after penetration of the cloud cover. The Soviet orbiters are able to overcome this.

# VIC 20

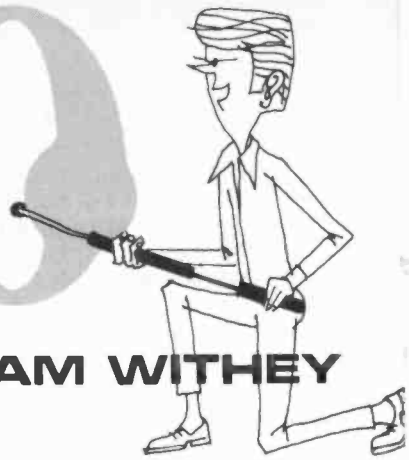

## PART FIVE SAM WITHEY

### STEPPER MOTOR CONTROL . . .

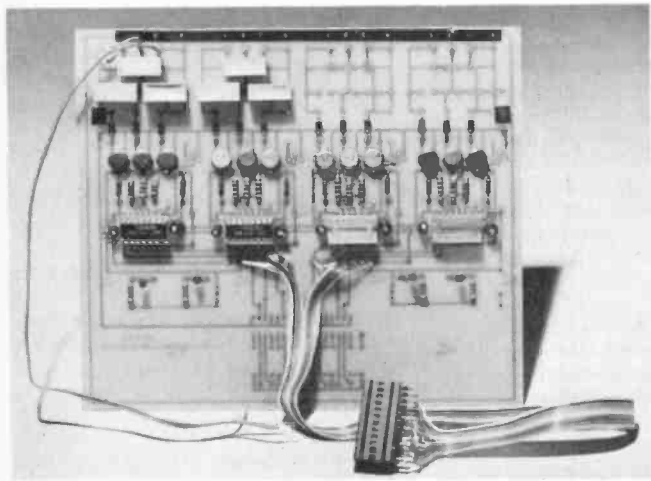

### FOR AROUND £29

THIS month, we first catch up on the input and output routines held over from Part 4, and then go on to look at two stepper motor control boards ideal for the robotics experimenter

Fig. 5.1. OUTPUT ROUTINE for displaying the state of ports in Binary

The following programs are not the most sophisticated, but it is hoped that they will help realise the potential of this series of interfaces.

```

05 PRINT"Shift/ClrHome":REM Clear screen
10 POKE 37138,255:REM Set DDR to required state
15 PRINT"DDR SETTING"
18 PRINT PEEK(37138):REM Display DDR setting
19 PRINT:PRINT:REM Spaces
20 PRINT"SET I/O REGISTER"
30 INPUT X:REM To put a decimal value in I/O Register
35 IF X<0 OR X>255 GOTO 20:REM Must be 0 to 255 inclusive
40 POKE 37136,X:REM Enter value
50 PRINT"I/O REGISTER"
55 PRINT PEEK(37136):REM Display it:PRINT:PRINT
60 PRINT"STATE OF PORTS"
70 PRINT"P7 P6 P5 P4 P3 P2 P1 P0"
80 GOSUB 100:REM Go to Decimal to Binary conversion routine
    
```

```

90 GOTO 20:REM To reset I/O Registers
100 P0=X-INT(X/2)*2:REM Decimal to Binary conversion
105 X=INT(X/2)
110 P1=X-INT(X/2)*2
115 X=INT(X/2)
120 P2=X-INT(X/2)*2
125 X=INT(X/2)
130 P3=X-INT(X/2)*2
135 X=INT(X/2)
140 P4=X-INT(X/2)*2
145 X=INT(X/2)
150 P5=X-INT(X/2)*2
155 X=INT(X/2)
160 P6=X-INT(X/2)*2
165 X=INT(X/2)
170 P7=X-INT(X/2)*2
175 X=INT(X/2)
200 PRINT P7;P6;P5;P4;P3;P2;P1;P0
205 PRINT:PRINT
210 RETURN:Return to line 80 in program
    
```

The conversion program is an integer arithmetic process and should therefore be possible on even the simplest machines. The principle is to divide the decimal figure by 2 and place the remainder in the least significant bit.

e.g. 255 Decimal becomes 1 1 1 1 1 1 1 1 Binary

	Rem	P7	P6	P5	P4	P3	P2	P1	P0
255/2	0	0	0	0	0	0	0	0	1
127/2	0	0	0	0	0	0	0	1	0
63/2	0	0	0	0	0	0	1	0	0
31/2	0	0	0	0	1	0	0	0	0
15/2	0	0	0	1	0	0	0	0	0
7/2	0	0	1	0	0	0	0	0	0
3/2	0	1	0	0	0	0	0	0	0
1/2	1	0	0	0	0	0	0	0	0
		1	1	1	1	1	1	1	1

Similarly, 131 Decimal becomes 1 0 0 0 0 0 1 1

	Rem	P7	P6	P5	P4	P3	P2	P1	P0
131/2	0	0	0	0	0	0	0	0	1
65/2	0	0	0	0	0	0	0	1	0
32/2	0	0	0	0	0	0	0	0	0
16/2	0	0	0	0	0	0	0	0	0
8/2	0	0	0	0	0	0	0	0	0
2/2	0	0	0	0	0	0	0	0	0
1/2	1	0	0	0	0	0	0	0	0
		1	0	0	0	0	0	1	1

Fig. 5.2. This program makes further use of changing outputs during the running of a program

```

05 PRINT"Shift/CirHome":REM Clear screen
10 POKE 37138,255:REM Set DDR to required state
15 PRINT"DDR SETTING"
18 PRINT PEEK(37138):REM Display DDR setting
19 PRINT:PRINT:REM Spaces
20 PRINT"SET I/O REGISTER"
30 INPUT X:REM To put a decimal value in I/O Register
35 IF X<0 OR X>255 GOTO 20:REM (0 to 255)
40 POKE 37136,X:REM Enter decimal value
42 PRINT:PRINT
45 PRINT"INITIAL STATE OF PORT"
50 Z=X:REM Put value of X into Z
55 GOSUB 200:REM To dec/bin conversion routine
60 PRINT"CHANGE OUTPUT?"
65 INPUT Y:REM Enter decimal value
70 IF Y <0 OR Y>255 GOTO 60
72 Z=Y:REM Put value of Y into Z
75 GOSUB 200
80 INPUT"YES OR NO";AS:REM Examine output
82 IF AS="YES" GOTO 90:REM pattern before accepting
85 IF AS="NO" GOTO 60
90 POKE 37136,Y:REM Satisfactory, so enter
95 PRINT:PRINT:PRINT
100 PRINT"I/O REGISTER"
105 PRINT PEEK(37136):REM Display it:PRINT:PRINT
110 PRINT"STATE OF PORTS"
120 PRINT"P7 P6 P5 P4 P3 P2 P1 P0"
130 GOSUB 200:REM To dec/bin conversion routine
140 GOTO 60:REM To reset I/O Registers
200 P0=Z-INT(Z/2)*2:REM Decimal to Binary conversion
205 Z=INT(Z/2)
210 P1=Z-INT(Z/2)*2
215 Z=INT(Z/2)
220 P2=Z-INT(Z/2)*2
225 Z=INT(Z/2)
230 P3=Z-INT(Z/2)*2
235 Z=INT(Z/2)
240 P4=Z-INT(Z/2)*2
245 Z=INT(Z/2)
250 P5=Z-INT(Z/2)*2
255 Z=INT(Z/2)
260 P6=Z-INT(Z/2)*2
265 Z=INT(Z/2)
270 P7=Z-INT(Z/2)*2
275 Z=INT(Z/2)
200 PRINT P7;P6;P5;P4;P3;P2;P1;P0:REM Display ports
205 PRINT:PRINT
210 RETURN:REM Return to line 140 in program

```

Fig. 5.3. INPUT ROUTINE for changing the DDR register and displaying the state of ports in Binary

```

05 PRINT"Shift/Cir Home":REM Clear screen
10 PRINT"INITIAL DDR SETTING"
15 PRINT PEEK(37138):REM Display it
20 PRINT:PRINT
30 PRINT"KEY THIS IN"
35 INPUT D
40 Z=D:REM Put value of D into Z
45 GOSUB 200:REM Go to Decimal to Binary converter routine
50 PRINT:PRINT
60 PRINT"CHANGE DDR SETTING?"
70 INPUT"Y OR N";AS
80 PRINT:PRINT
90 IF AS="Y" GOTO 300:REM To bin/dec

```

```

95 IF AS="N" GOTO 100:REM Carry on
100 PRINT"I/O REGISTER"
105 PRINT PEEK(37136):REM Display it:PRINT:PRINT
110 PRINT"KEY THIS IN":PRINT:PRINT
115 INPUT Y
120 PRINT"STATE OF PORTS"
125 PRINT"P7 P6 P5 P4 P3 P2 P1 P0"
130 Z=Y:REM Put value of Y into Z
132 REM Note here that Vic 20 requires logic '0' for Input and
133 REM holds lines without inputs at logic '1' on simulator
135 GOSUB 200:REM To dec/bin conversion routine
140 GOTO 100:REM To reset display of I/O Registers
200 P0=Z-INT(Z/2)*2:REM Decimal to Binary conversion
205 Z=INT(Z/2)
210 P1=Z-INT(Z/2)*2
215 Z=INT(Z/2)
220 P2=Z-INT(Z/2)*2
225 Z=INT(Z/2)
230 P3=Z-INT(Z/2)*2
235 Z=INT(Z/2)
240 P4=Z-INT(Z/2)*2
245 Z=INT(Z/2)
250 P5=Z-INT(Z/2)*2
255 Z=INT(Z/2)
260 P6=Z-INT(Z/2)*2
265 Z=INT(Z/2)
270 P7=Z-INT(Z/2)*2
275 Z=INT(Z/2)
200 PRINT P7;P6;P5;P4;P3;P2;P1;P0:REM Display ports
205 PRINT:PRINT
210 RETURN:REM Return to line 140 in program
300 INPUT"ENTER BIT PATTERN :";BS:REM Binary to
    Decimal converter
310 IF LEN(BS) <> 8 THEN PRINT"8 BITS PLEASE"
315 GOTO 300:REM Do again if wrong
320 M=0:N=0
330 FOR P=8 TO 1 STEP-1:N=N+1
340 M=M+VAL(MID$(BS,N,1))*2*(P-1)
350 NEXT P
360 PRINT BS;"=";M
365 PRINT"KEY THIS IN"
370 INPUT M:POKE 37138,M
380 PRINT"STATE OF DDR"
390 Z=M:GOTO 45:REM Return to program

```

#### STEPPER MOTOR INTERFACES

The next stage in this series concerns interfacing the computer with stepper motors, and their application in practical experiments. Two stepper motor controllers are described, with designs for two p.c.b.s which will each accommodate four controllers. This enables experimentation with XY movement involving two axes, or simple robotics having four axes, as opposed to the usual five or six axes normally found on commercial controllers, but of course, at a fraction of the cost of the latter.

The SDB520 i.c. is chosen for its versatility and power handling capabilities, whilst the SAA1027, though more limited in its application, has been a popular device in schools and colleges for several years.

The prime consideration in interfacing is always the safety of the host computer. The SDB520 and SAA1027, because of their different inherent characteristics, are treated differently where the method of electrical isolation from the computer is concerned. This is explained within the text covering the individual devices.

Stepper motors are available, suitable for such a wide variety of applications that it is impossible to report on them to any great extent in the space available here. A useful

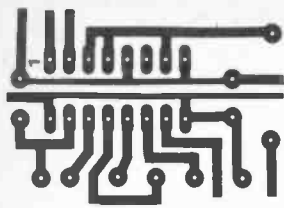

Single-phase excitation

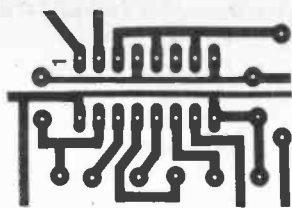

Dual-phase excitation

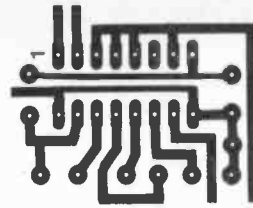

Single/dual-phase excitation

Fig. 5.7. P.c.b. configurations (IC1-4) for stepper motor control 1

4-PHASE MOTOR LINKS

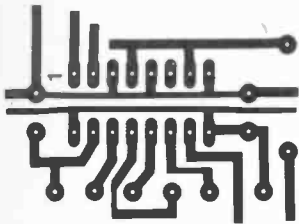

Single-phase excitation

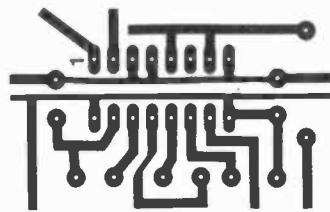

Dual-phase excitation

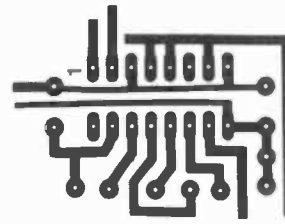

Single/dual-phase excitation

3-PHASE MOTOR LINKS

source of very cheap, yet top quality low and medium power motors is ex-equipment. This source often provides much of the hardware required for constructing a functional machine. A visit to an Amateur Radio rally is well worth the entrance fee, as many of the advertisers in *Practical Electronics* and *Practical Wireless* attend with such bargain packages. More important, in general, these people are not just salesmen, but practical constructors who have tried the equipment out for themselves, and are free with advice on wiring and serviceability. Some general comments are therefore included which are applicable to the article.

Some programming hints are included, suggesting methods of "stepping" the motors clockwise, counter-clockwise, and for angular movement where more than one motor is being operated.

Those who have constructed the l.e.d.s and switches board can use it for development of their programs as with any other output program.

### THE SDB520 DRIVER BOARD

The first p.c.b. described uses the versatile SDB520 Stepper Motor Driver i.c., which can be used with 3-phase or 4-phase motors. In addition to this, the chip enables the use of either type of motor in single, dual, or single/dual phase excitation.

In order to accommodate all these functions, connections from pins 3, 4 and 5 have been left open. In all modes, pins 7 and 10 are connected via a 2k2 resistor to the +5V d.c. supply, whilst pins 3, 4 and 5 are either individually coupled with these, or taken to ground. Provision has also been made to mount capacitors between motor coils 1 and 2, 2 and 3, 1 and 3 for 3-phase motors and 1 and 3, 2 and 4 for 4-phase motors.

Opto isolated output from the computer is provided, a feature that the author normally recommends. However, in the case of the SDB520, it is well protected internally against short circuit, making opto isolation at low motor voltages and current, less necessary. It is provided for the less experienced constructor, and those who may have larger motors available.

The SDB520 uses the +5V d.c. supply from the computer, provision for external supply being made for use with computers other than the Vic 20. The outputs from the driver turn on their associated transistors sequentially, allowing current to flow through the relevant motor coil. The transistors used on the board are BFY51, 2N3053 or similar 0.7W NPN transistors that can handle up to 1A of current.

## COMPONENTS . . .

### STEPPER MOTOR CONTROL 1

#### Resistors

R1,2,6,7,11,12,17,18	2k2 (8 off)
R3,4,5,8,9,10,13-16,19-22	100 (14 off)
R23	See note
All resistors $\frac{1}{4}$ W 5%. R23 (if necessary) depends upon motors/supply voltage, and is not mounted on the board.	

#### Capacitors

C1,6,11,15	2 $\mu$ 2 (4 off)
C2,7,12,16	10 $\mu$ (4 off)
C3,4,5,8,9,10,13,14,17,18	1 $\mu$ F poly (10 off)

#### Transistors & Diodes

D1-14	1N4001 (14 off)
TR1-14	2N3053 or similar (14 off)

#### Integrated Circuits

IC1-4	SDB520 (4 off)
-------	----------------

## COMPONENTS . . .

### STEPPER MOTOR CONTROL 1

#### Opto-coupling option (shown in comp. layout)

#### Resistors

R23-26,31-34	470 (8 off)
R27-30,35-37	12k (8 off)

#### Diodes

D15	1N4001
-----	--------

#### Integrated Circuits

IC5,6	1LQ74
-------	-------

Should there be a need for greater current handling, 2N3055 transistors can be mounted externally on heatsinks. Motor voltages are typically 12 to 24V d.c. and might require a small value 50W wirewound resistor at the common positive motor supply to correct L/R ratio. This information should be available with the motor.

The p.c.b. is single-sided fibre-glass, approximately 165 x 148mm, and requires short links on the upper surface. As mentioned earlier, in order to increase the versatility of the board, connections have to be made between pins 3, 4 and 5 and ground, or commoned with pins 7 and 10. A solder blob is all that is required, and this can be carried out neatly by using a single strand from multi-strand cable to bridge the gap and allowing solder to flow over it from side to side.

Pulses are supplied to two inputs, CD Counter clockwise, at pin 1 and CU Clockwise, at pin 2. A change from Low to High and back to Low will trigger the i.c. The inputs are designed with high noise margin, and comprise a Schmitt trigger circuit.

OC at pin 3 selects 3 phase, Low, or 4 phase, High, operation. EA and EB on pins 4 and 5, comprise the mode switching terminal.

EB	EA	Mode
0	0	Line drive facility
0	1	Single phase excitation
1	0	Dual phase excitation
1	1	Single/dual phase excitation

Mo at pin 6, provides a sequence monitor, low, when counter content is 000.

OFF 01.3 on pin 7 and OFF 02.4 on pin 10 provide excitation OFF or line drive input terminal, when terminals become Low without relation of sequence content, when output terminals are = 0. At pin 8 is the 0V supply terminal. Vcc2 at pin 9, the output driver power supply.

Output driver terminals are at pin 11, 4, pin 12, 2, pin 13, 3, and pin 14, 1. A clamping diode is inserted in the output.

R at pin 15 is the Reset input terminal, tied to Vcc via a 2k2 resistor. Vcc1 at pin 16 is the power supply for the logic circuit.

## COMPONENTS . . .

### STEPPER MOTOR CONTROL 2

#### Resistors

R1-4	470 (4 off)
R5,6,11,12,21,22,27,28	12k (8 off)
R7,8,13,14,23,24,29,30	4k7 (8 off)
R9,15,25,31	100 (4 off)
R10,16,26,32	150 ½W (4 off)
All resistors ½W 5% unless otherwise stated.	

#### Capacitors

C1-4	100n (4 off)
------	--------------

#### Diodes

D1	1N4001
----	--------

#### Integrated Circuits

IC1,4	1LQ74 (2 off)
IC2,3,5,6	SAA1027 (4 off)

## USE OF OPTO ISOLATORS

Those who have followed this series will note that the i.e.d.s in the opto isolators are turned on by making the cathode low relative to the power supply. This means, without the inclusion of inverters, that the logic is incorrect for an output on the Vic 20. For the purists this is overcome by complementing the binary pattern required at the output port and placing this value in the I/O Register.

Output required	10101010	Decimal 170
Complement	01010101	Decimal 85
Total	11111111	255

The easiest way, of course, is to treat the outputs required as inputs.

## SDB520 DRIVER EXCITATION SEQUENCE

### 3-Phase motor excitation

Single phase					Dual phase					Single/dual phase								
	Q1	Q2	Q3	Q4	CCW		Q1	Q2	Q3	Q4	CCW		Q1	Q2	Q3	Q4	CCW	
0	1	0	0	0	↑	0	1	1	0	0	↑	0	1	0	0	0	↑	
1	0	1	0	0	↓	1	0	1	1	0	↓	1	1	1	0	0	↓	
2	0	0	1	0	CW	2	1	0	1	0	CW	2	0	1	0	0	↓	
													3	0	1	1	0	↓
													4	0	0	1	0	↓
													5	1	0	1	0	CW

### 4-Phase motor excitation

Single phase					Dual phase					Single/dual phase								
	Q1	Q2	Q3	Q4	CCW		Q1	Q2	Q3	Q4	CCW		Q1	Q2	Q3	Q4	CCW	
0	1	0	0	0	↑	0	1	1	0	0	↑	0	1	0	0	0	↑	
1	0	1	0	0	↓	1	0	1	1	0	↓	1	1	1	0	0	↓	
2	0	0	1	0	CW	2	0	0	1	1	CW	2	0	1	0	0	↓	
													3	0	1	1	0	↓
													4	0	0	1	0	↓
													5	0	0	1	1	↓
													6	0	0	0	1	↓
													7	1	0	0	1	CW

Sequence monitor (pin 6) is logic 0 at sequence stage 0 and logic 1 at other stages of sequence.

Pads are provided on the p.c.b. should it be wished to monitor the outputs whilst developing programs and setting up motors.

The monitor is active low, therefore when it becomes active at the beginning of each sequence, the cathode of the monitor i.e.d. is pulled down relative to the 5Vd.c. supply and comes on.

## THE SAA1027 DRIVER BOARD

The SAA1027 is intended for pulse to step control of four-phase two stator motors. It is capable of driving a motor winding load of 350mA per phase and is encased in a 16 pin dual in line plastic package.

Pulses are supplied to a single input, whilst the direction of rotation is controlled by a voltage level applied to a gate input. A further input sets the four output stages. Supply voltages can be between 9.5 and 18Vd.c., but a single 12Vd.c. power supply is normally used to operate the driver



Fig. 5.4(a). Circuit diagram of SDB520 driver (3-coil motor type) annotated as in the p.c.b. layout shown below (channels A and B)

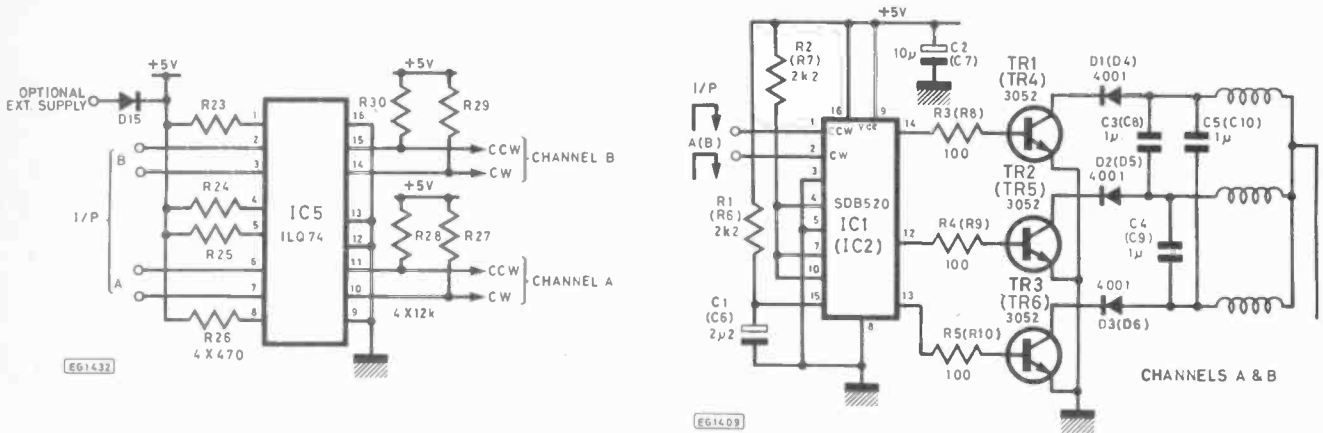
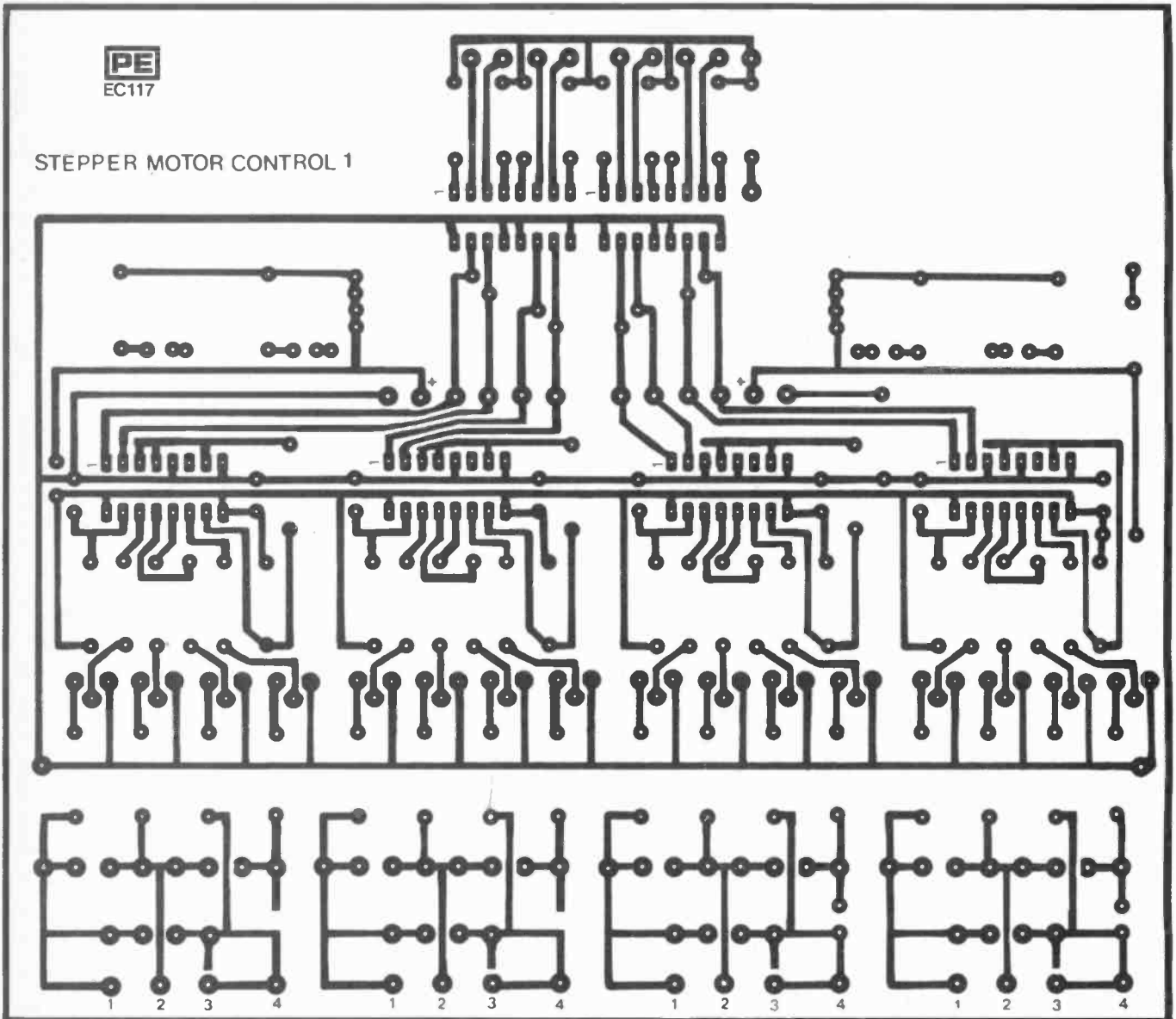
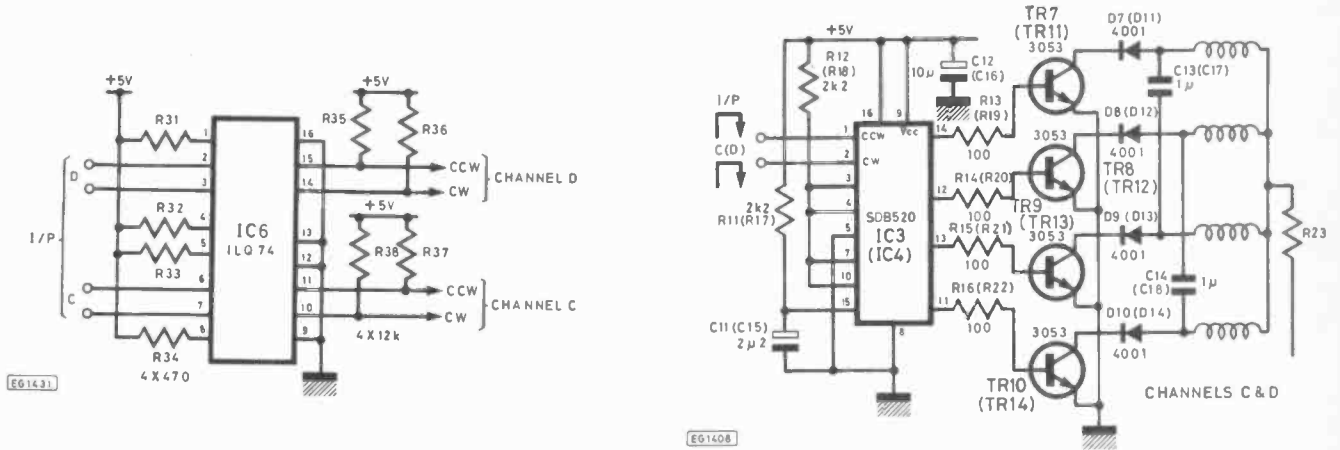

Fig. 5.5. P.c.b. layout of stepper motor control board 1. SDB520 type (actual size). This is a versatile board, designed to accommodate various component configurations. For example, the ILQ74s (IC5 & IC6) opto-isolators are optional



**Fig. 5.4(b). Circuit diagram of SDB520 driver (4-coil motor type) annotated as in the p.c.b. layout shown below (channels C and D)**



**Fig. 5.6. Stepper motor control board 1 component layout, shown with channels A & B dedicated to the 3-coil configuration, and channels C & D dedicated to the 4-coil configuration. Asterisks draw attention to the link areas that allow reconfiguration. The l.e.d.s allow optional data signal monitoring**

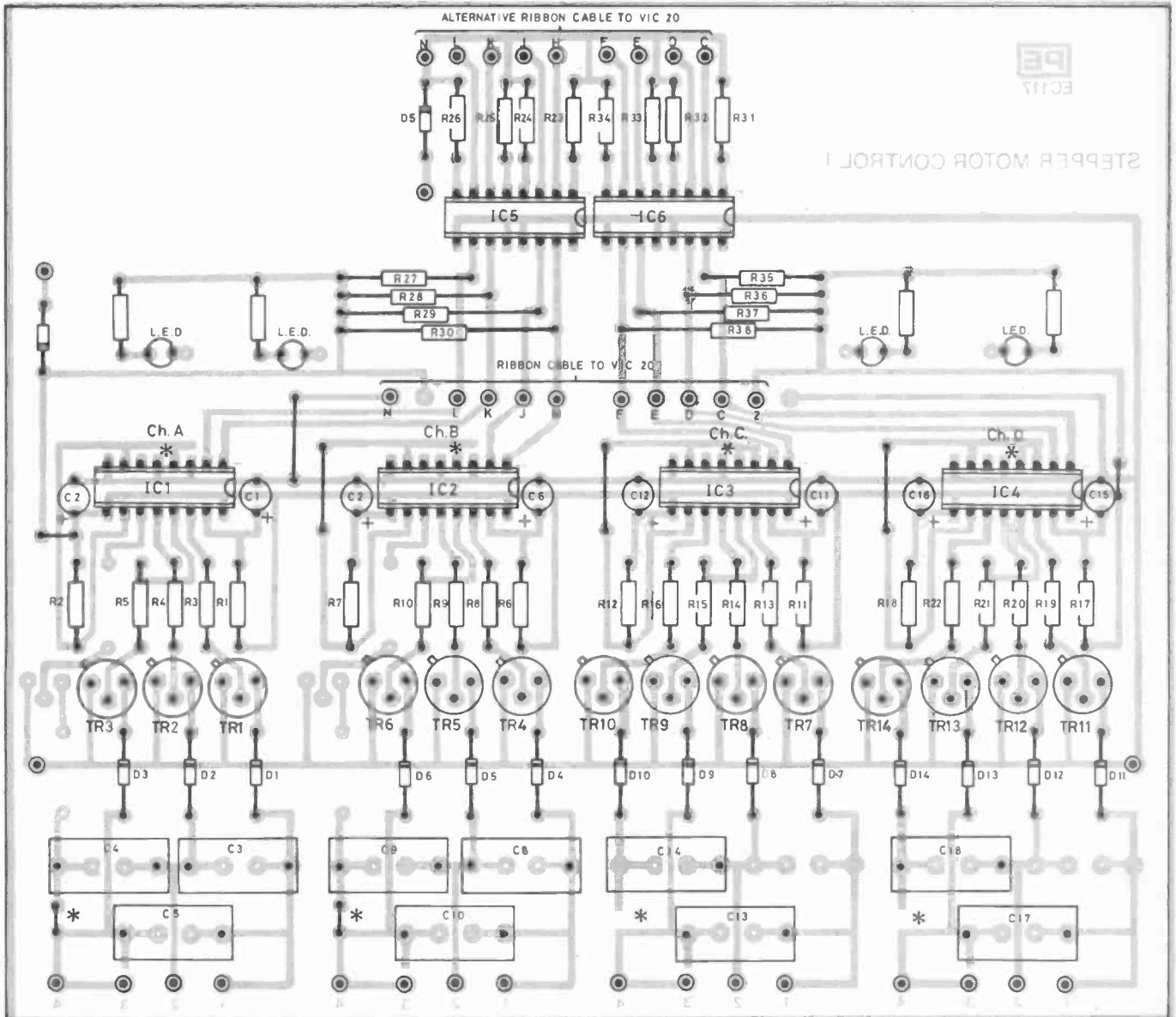

EG1427

i.c. and the motor. The output drivers (pins 6,8,9,11) are open collector. The breakdown voltage is 18Vd.c. and this must not be exceeded.

**Pin connections**

- (1) no connection
- (2) Set input S
- (3) Direction input (CW/CCW) R
- (4) Bias resistor B (positive supply)
- (5) Ground (negative supply)
- (6) Q1 (output)
- (7) no connection
- (8) Q2 (output)
- (9) Q3 (output)
- (10) no connection
- (11) Q4 (output)
- (12) Ground (negative supply)
- (13) VD (positive supply)
- (14) VP (positive supply)
- (15) Trigger input T
- (16) no connection

**INPUTS**

The three inputs are controlled by applying high or low voltage levels to the terminals. The high level voltage can be between 7.5 and 18Vd.c. (12Vd.c. typical) and is normally equal to, but not greater than, the voltage on pin 14. Input

current is high, typically 1µA. The low level voltage can be between 0 and 4.5Vd.c. maximum. Low level current is typically -30µA per input.

**TRIGGER INPUT**

The voltage on T, pin 15 is normally high when not being pulsed and is held at Vs via a 4k7 resistor. A change from high to low and back to high will trigger the i.c. The motor is connected to the output stages on the positive edge, low to high of the pulse.

**SET INPUT**

Pin 2, S is tied to Vs, enabling all outputs.

**DIRECTION INPUT**

Applying a high level to pin 3 causes the motor to be stepped CCW, whilst a low level to pin 3 causes the motor to step CW. The input is tied high via 4k7 resistor for maximum noise immunity.

**BIAS RESISTOR**

RB can be calculated, first from supply voltage and motor coil resistance to arrive at IQ. Then, by reference to graph, IB and VS permits calculation of RB.

When motors with current of 350mA (max) per winding are used, the bias current to pin 4 should be 80mA (max).

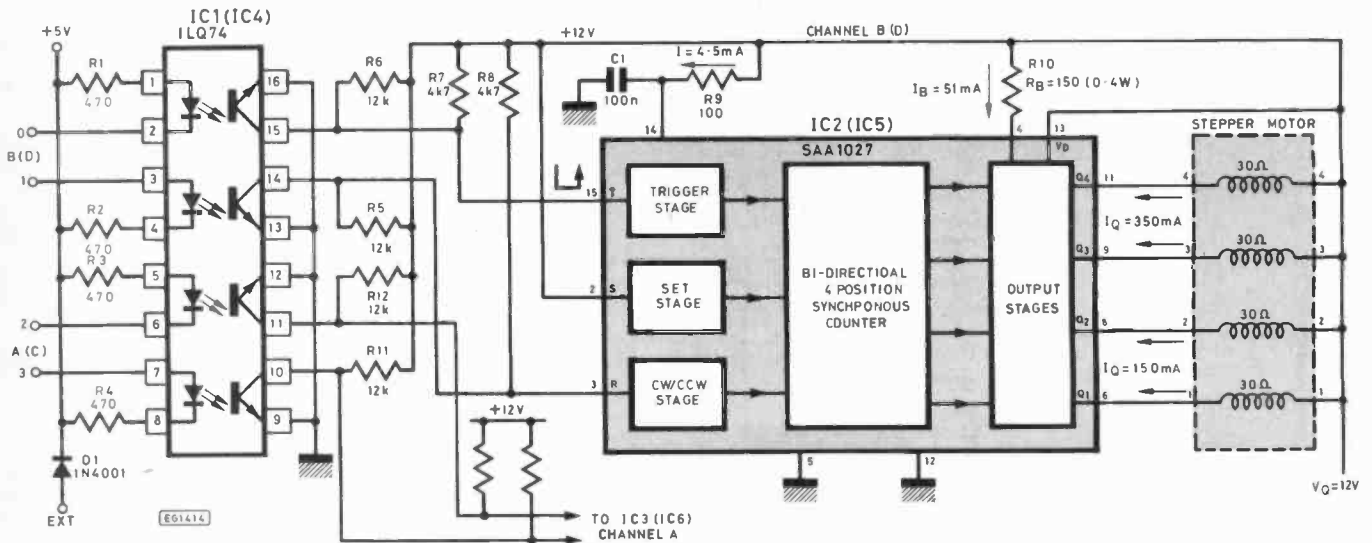

**Fig. 5.8. Circuit diagram of the SAA1027 type driver board. There are four identical channels. Channel B is shown here**

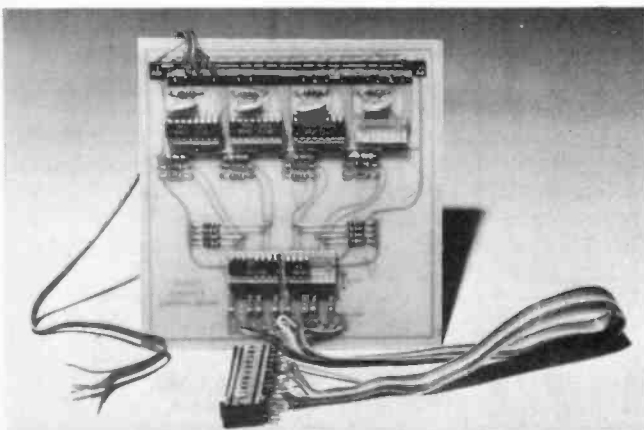

**CHANNEL**

A	B	C	D
-	R1	-	R17
-	R2	-	R18
R3	-	R19	-
R4	-	R20	-
R11	R5	R27	R21
R12	R6	R28	R22
R13	R7	R29	R23
R14	R8	R30	R24
R15	R9	R31	R25
R16	R10	R32	R26
C1	C2	C3	C4
IC3	IC2	IC5	IC6

There are four channels. The circuit diagram shows a single channel, and this table indicates the equivalent components for the other channels.

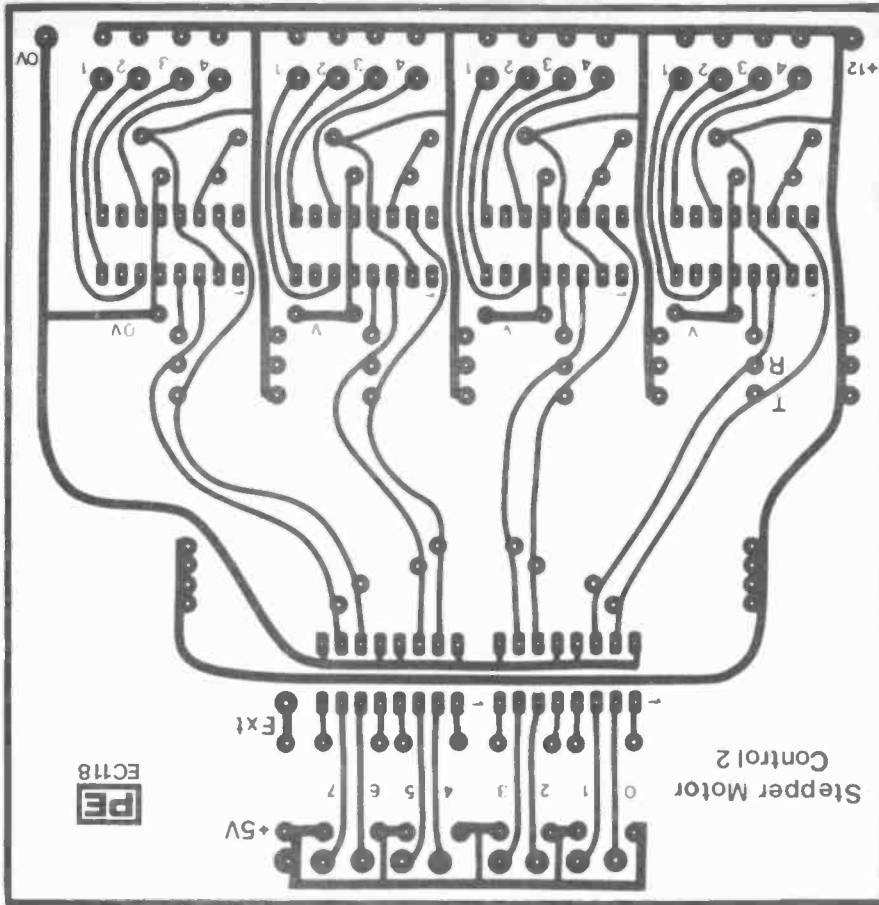
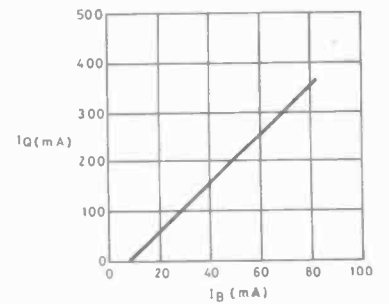
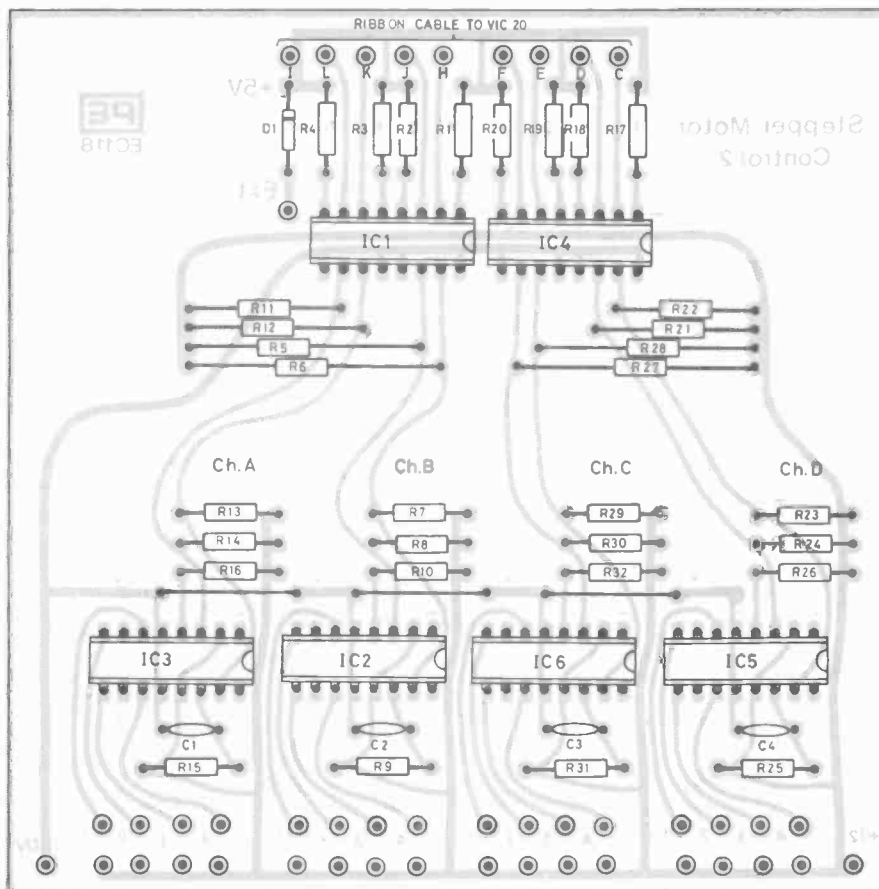
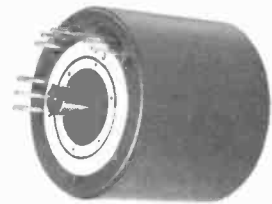

Fig. 5.9. P.c.b. layout of stepper motor control 2. SAA1027 type (actual size)

A typical surplus/ex-equipment stepper motor



Bias current and output current relationship of SAA1027 output stage

Fig. 5.10. Component layout of stepper motor control 2

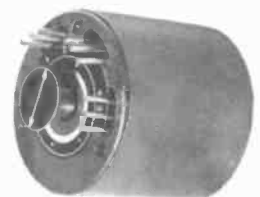

Likewise, when the output current is 50mA, bias current should be 20mA. A linear graph plotted between these values is shown on page 43.

The R/C network at pin 14 stretches the pulse from trigger input, pin 15, to a length detectable by the trigger stage.

## OUTPUTS

The switching sequence of the four phases is controlled by the logic part of the circuit and the four output stages, Q1 at pin 6, Q2 at pin 8, Q3 at pin 9 and Q4 at pin 11 are protected against transient spikes by integrated diodes.

## OPTO ISOLATION

It is usual to use TTL Buffers between the computer and the SAA1027, but due to the danger of the maximum 18Vd.c. being exceeded, and added susceptibility of the i.c. to overheating and breakdown, it was decided to use opto isolation.

The collector of the transistor in the opto isolator is held high, at logic "1" via the 270k resistor connecting it to the power supply. When a logic "0" at the output port sinks the l.e.d. and turns it "on", the transistor is turned on also, causing the collector to go low. When the output changes back to logic "0" the l.e.d. turns off. The transistor also turns off, bringing the collector once again to high, causing excitation and creating a pulse.

Should overheating be experienced, clip-on d.i.l. heatsinks are available from most advertisers.

This board is much smaller than the SDB520 board because the driver is complete in itself and requires no external components beyond the capacitor and resistors mentioned. It is made on a 120mm square of single sided fibre-glass p.c.b. Short links are required on the component side to connect the ground rails. Provision is made for an external 5Vd.c. power supply if used on a computer other than the Vic 20.

## STEPPER MOTORS

A summary of various descriptions of a stepper motor would be "a direct digital motion control device that converts electrical pulses into discrete mechanical rotational movements. It possesses the ability to rotate in either direction, as well as start and stop at various mechanical, rotational positions. Its shaft moves in precise angular increments for each input excitation or step. The stepper motor allows control of position, velocity, distance and direction".

## STEPPING

Due to the nature of its construction, unlike a normal free running motor, a stepper motor moves through a precisely defined arc of a complete revolution for each pulse and is

held in that position until the next pulse, which moves the rotor through the same angle of rotation. Small motors usually come in 3 or 4 phase types and the number of steps to a complete revolution varies greatly, typically from 4 to 90, or angular movements varying from 90 degrees to 4 degrees.

## SEQUENCE

Each phase is excited sequentially, the rotor moving in precise steps, in the same direction, for each excitation. Reversing the stepping sequence of the phases reverses the direction of movement of the rotor by the same precise angle. These processes are controlled by the internal logic of the stepper motor driver i.c.

## ACCURACY

Unlike a normal motor, which keeps running after removal of power until stopped by friction, the stepper motor stops at a predictable position. Any errors of angular position are restricted to each single movement and are non-accumulative. An error of 1 degree in each and every step, no matter how many steps are performed, will be an error of just 1 degree at the end of a cycle. Accuracy varies from 0.01 degree for small steps to 5 degrees for large steps. Obviously, for precise positioning, the greater the number of steps the greater the accuracy.

In dual-excitation mode, two coils are excited simultaneously. This stops the motor in a position half-way between normal stopping positions, but because of increased holding torque gives consistent accuracy.

## HOLDING TORQUE

At standstill, the torque required to deflect the motor a full step is called the Holding Torque. This is normally higher than the running torque and acts as a strong brake in holding the load. The higher the holding torque the more accurate the position of the rotor. Most stepper motors will operate at much lower voltages than that recommended by the manufacturer, but with decreased holding torque and therefore decreased accuracy. A similar situation can arise with increased step frequency due to the fact that the rise time of the coil limits the percentage of power actually delivered to the motor. The result can be incorrect starting or loss of steps. This effect is sometimes compensated for by increasing the supply voltage and including a series resistor to correct the L/R ratio of the circuit as depicted in the SDB520 4-phase schematic.

**Next Month:** Applications and control of stepper motor boards. Also, DAC and ADC boards.

# BAZAAR

**PYE** AM25B Crystal, 4 Metres, 70.26MHz, Tx, Rx, v.g.c., £12. DX200L receiver covers all bauds to 30MHz, £75. Mr R. A. Pearson, Tel: Swansea 582941.

**WANTED** ZX Spectrum any condition, 16K or 48K. Tel: Aberdeen (0224) 742358, after 6.30p.m. Alan Stewart, 11 Straik Place, Elrick, Skene, Aberdeenshire, AB3 6TN, Scotland.

**MAPLIN**, 3800 synth parts from unfinished synth, PCB's, components, keyboard, pots, etc. £95. Tel: 01-393 1577 (evenings). V. Carter, Fitznells, 2 Chessington Road, Ewell, Epsom, Surrey, KT17 1TF.

**HAVE** Chinon, Super 8 sound cine camera, many extras. Swop multi band scanner or sell

£120. Tel: (0734) 340052. Mr E. Chopin, 34 Paddock Heights, Twyford, Berks, RG10 0AR.

**MZ80K**, I/O Box, unused £70. Serial Board £50. Bidirect 80 Column Printer £220. Wanted Twin Fdos for Sharp NIZ 80K. Phone R. H. Pearce, 8 Holly Oak Road, Southampton, SO1 6GD (0703) 788278.

**ZX81** + keyboard and 32K RAM pack £45 o.n.o., includes manual, all leads, etc. D. Snowdon, 124 Walpole Road, S. Woodford, London, E18 2LL. Tel: 01-504 0565.

**STEREO** Amp and preamp transistor. Three inputs. 25 watts each channel output, working, but no case. £20, p.p. £5. L. T. Hill, 14 Rothesay Terrace, Bedlington, Northumberland.

**RELAYS** new 24V d.p.d.t., open type boxed (20). Labgear television distribution amplifiers, new boxed (2). Offers. Tel: R. Yates (0342) 832078 Lingfield, Surrey.

**WANTED** ZX81 in good working condition. Will

pay up to £30 delivered in Sweden. Mr. L. E. Abrahamsson, Kovra 3184, S-84044 Oviken, Sweden.

**WANTED** UK101 p.c.b. or any discarded 101's, working or not. Fair price for suitable boards. C. Hellen, Tel: Wivenhoe (020622) 5671.

**FORGESTONE** 400 TV 22" with spare decoder and manual. Offers Tel: 0634 812629. P. Topping, 10 Applery Close, Rochester, Kent.

**WANTED.** Expansion Boards for Microtan. Already have Tane Tandos. Working order or unfinished kits. Jan France, 29 Roy Road, Northwood, Middx, HA6 1EQ.

**ASR/KSR** and RO33 Teletype technical manual set. £8 inc. post. Tel: 0242 603938. J. Humphries, 35 Greenways, Winchcombe, Glos, GL54 5LQ.

**WANTED.** Good basic electronics correspondence course. J. Anderson, 22 Landaw House, Chatsworth Road, London, NW2 4BW.



Step-by-step fully illustrated assembly and fitting instructions are included together with circuit descriptions. Highest quality components are used throughout.

# Sparkrite

SELF ASSEMBLY ELECTRONIC KITS

PRICES REDUCED ON SUPER SAVE D.I.Y. KITS

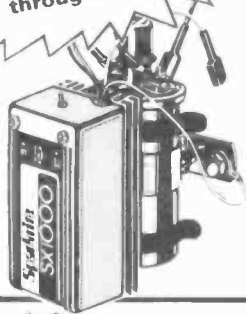

## SX 1000 Electronic Ignition

- Inductive Discharge ● Extended dwell circuit stores greater energy in coil ● Three position changeover switch ● Patented clip-to-coil fitting ● Easy to assemble, easy to fit ● Contact breaker triggered - includes bounce suppression circuit.

**SUPER SAVE**

## SX 2000 Electronic Ignition

- Reactive Discharge ● Combines inductive & capacitive energy storage ● Gives highest possible spark energy ● Patented clip-to-coil fitting ● Easy assembly sequence ● Contact breaker triggered - includes bounce suppression circuit.

**SUPER SAVE**

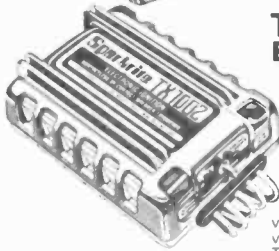
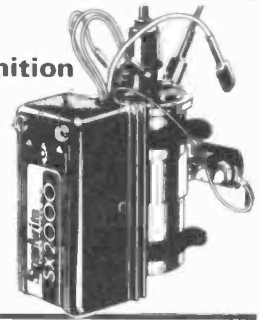

## TX 1002 Electronic Ignition

- Inductive discharge ● Extended dwell circuit stores greater energy in coil ● Three position changeover switch ● Contactless or contact breaker triggered ● Clip-to-coil or remote mounting ● Rugged die-cast case ● Contactless adaptors included for majority of 4 & 6 cylinder vehicles ● Easy to build ● For details of vehicles fitted by contactless trigger, ring Technical Service Dept on (0922) 611338-9.

## TX2002 Electronic Ignition

- Two separate systems in one unit ● Reactive Discharge OR Inductive Discharge, with three position changeover switch ● Gives highest possible spark energy ● Clip-to-coil or remote mounting ● Rugged die-cast case ● Contactless or contact breaker triggered ● Contactless adaptors included for majority of 4 & 6 cylinder vehicles ● For details of vehicles fitted by contactless trigger, ring Technical Service Dept on (0922) 611338-9.

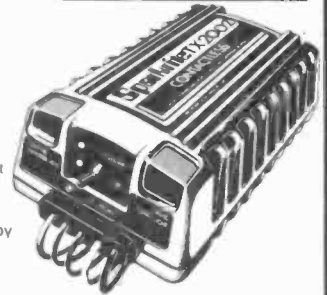

## AT-40 Electronic Car Alarm

- Guards doors, boot, bonnet from unauthorised entry ● Armed/disarmed using concealed switch ● 30 second delay-to-arm: 7 second entry delay ● Can alternatively be wired to exterior key switch ● Flashes headlights & sounds horn intermittently for 60 seconds when activated ● Security loop protects accessories ● Low consumption C-MOS circuitry.



**NEW**

## AT-80 Electronic Car Security System

- Guards doors, boot, bonnet from unauthorised entry ● Armed/disarmed from outside vehicle by magnetic key fob passed across sensor pad adhered to inside of windscreen ● Individually programmable code ● 30 second delay-to-arm ● Flashes headlights and sounds horn intermittently for 60 seconds when activated ● Security loop protects accessories ● Function lights to assist setting-up ● Low consumption C-MOS circuitry.

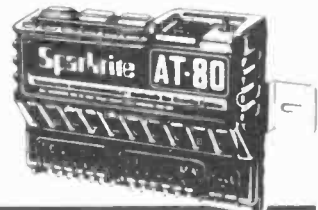

**SUPER SAVE**

## ULTRASONIC Intruder Detector

- Supplementary to AT-40 & AT-80 ● Will work in conjunction with any door switch input or voltage sensing alarm ● Detects attempted break-in and movement within passenger compartment & triggers alarm ● Includes high efficiency ultrasonic transducers ● Crystal controlled for low drift ● Ingenious sensitivity control allows freedom from false alarms ● Low current consumption



**NEW**

## VOYAGER Car Drive Computer

- 12 functions centred on Fuel, Speed, Distance and Time ● Single chip microprocessor ● Large high brightness fluorescent display with auto-dimming feature ● High accuracy distance & fuel transducers included ● Displays MPG, L/100km and miles/litre at the flick of a switch ● Visual & audible warnings of excess speed, ice, lights-left-on ● Independent LOG & TRIP functions ● Low consumption crystal controlled circuitry.



## SPECIAL OFFER

"FREE" MAGIDICE KIT WITH ALL ORDERS OVER £40.00



## MAGIDICE Electronic Dice

- Triggered by waving hand over dice ● Completely random selection ● Bleeps & flashes during 4 sec tumble ● Throw displayed for 10 seconds then flashes to conserve battery ● Low consumption C-MOS circuitry.

**SUPER SAVE**

SPARKRITE (A Division of Stadium Ltd.) 82 Bath Street, Walsall, WS1 3DE England Tel: (0922) 614791

Allow 28 days for delivery.

KIT	OLD PRICE	NEW PRICE
SX 1000	<del>£12.95</del>	£11.95
SX 2000	<del>£19.95</del>	£18.95
TX 1002	<del>£22.95</del>	£22.95
TX 2002	<del>£32.95</del>	£32.95
AT-40	—	£9.95
AT-80	<del>£32.95</del>	£24.95
ULTRASONIC	—	£17.95
VOYAGER	<del>£64.95</del>	£64.95
MAGIDICE	<del>£9.95</del>	£6.95

PRICES INC. VAT, POSTAGE & PACKING.

PHONE YOUR ORDER WITH

NAME \_\_\_\_\_  
 ADDRESS \_\_\_\_\_  
 \_\_\_\_\_  
 I ENCLOSE CHEQUE(S)/POSTAL ORDERS FOR  
 £ \_\_\_\_\_ KIT REF. \_\_\_\_\_  
 CHEQUE No. \_\_\_\_\_ PE/3/84

**BRANDLEADING BRITISH ELECTRONICS**  
**CUT OUT THE COUPON NOW!**

TWO FABULOUS OFFERS FROM

# ALCON

**SUPER 20**  
20k $\Omega$ /V a.c. & d.c.

**A SUPER  
PROTECTED  
UNIVERSAL  
MULTIMETER**

Undestructible, with automatic protection on all ranges but 10A.

**ONLY £33.50**

inc. VAT, P&P, complete with carrying case, leads and instructions.

This special offer is a wonderful opportunity to acquire an essential piece of test gear with a saving of nearly £20.00.

**Accuracy:** d.c. ranges and  $\Omega$  2% a.c. 3% (of f.s.d.)  
**39 ranges:** d.c. V 100mV, 1.0V, 3.0V, 10V, 30V, 100V, 300V, 1000V.  
d.c. I 50 $\mu$ A, 100 $\mu$ A, 300 $\mu$ A, 1.0mA, 3mA, 10mA, 30mA, 100mA, 1A, 10A  
a.c. V 10V, 30V, 100V, 300V, 1000V.  
a.c. I 3mA, 10mA, 30mA, 100mA, 1.0A, 10A.  
 $\Omega$  0-5.0k $\Omega$ , 0-50k $\Omega$ , 0-500k $\Omega$ , 5M $\Omega$ , 50M $\Omega$ .  
dB from -10 to +61 in 5 ranges.

**Dimensions:** 105 x 130 x 40mm.



**SUPER TESTER 50** 50k $\Omega$  V a.c. and d.c.

A 39 ranges - fool-proof - multimeter with protective diodes, quick acting 1.25A fuse and resettable cut-out.

**PROFESSIONAL  
SOLUTION  
TO GENERAL  
MEASUREMENT  
PROBLEMS**

**ONLY £36.30**

incl. VAT, P&P, complete with carrying case, leads and instructions. Goods normally by return of post.

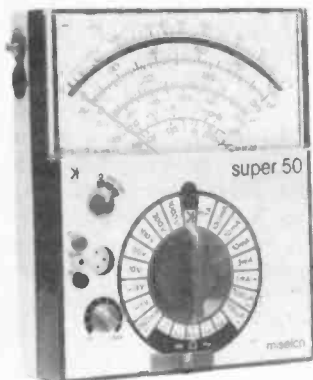

The best instrument for the workshop, school, toolbox, TV shop and anywhere accurate measurement is needed quickly and simply.

**Accuracy:** d.c. ranges and  $\Omega$  2% a.c. 3% (off.s.d.)  
**39 ranges:** d.c. V 150mV, 1V, 3V, 10V, 30V, 100V, 300V, 1000V;  
d.c. I 20 $\mu$ A, 100 $\mu$ A, 300 $\mu$ A, 1.0mA, 3mA, 10mA, 30mA, 100mA, 1A, 3A.  
a.c. V 10V, 30V, 100V, 300V, 1000V;  
a.c. I 3mA, 10mA, 30mA, 100mA, 1A, 3A.  
Ohms 5k $\Omega$ , 50k $\Omega$ , 500k $\Omega$ , 5M $\Omega$ , 50M $\Omega$ .  
dB from -10 to +61 in 5 ranges.

**Dimensions:** 105 x 130 x 40mm.

For details of these and the many other instruments in the Alcon range, including multimeters, components measuring, automotive and electronic instruments, please write or telephone:

**ALCON** Instruments Ltd.

19 MULBERRY WALK · LONDON SW3 6DZ · TEL: 01-352 1897 · TELEX: 918867

**DISPLAY DISTRIBUTION LTD.**

SUPPLIERS OF THE 'SUPERB'

**NOVEX 12/800**  
MONOCHROME MONITOR  
REVIEWED IN THIS ISSUE



**DISPLAY DISTRIBUTION LIMITED**

35 GROSVENOR ROAD, TWICKENHAM, MIDDX O1-891 1923/1513 Telex 295093

## SUPERKITS! FOR BETTER MUSIC & EFFECTS

Sets include PCBs, Electronic Parts, Instructions, Boxes, Wire, Solder. Batteries not included, but most will run from 9V to 15V DC supplies. Fuller details in list.

CHORUS UNIT: A solo voice or instrument sounds like more!	...KIT162	£31.40
COMPRESSOR: Limits & levels maximum signal strength	...KIT133	£10.86
COMPUTER RHYTHM GEN: 9 drums for digital control	...KIT185	£30.64
COMPUTER-SYNTH INTERFACE: Sequencing & composing aid	...KIT184	£17.44
DRUM SIRENS: Triggered variable siren effects	...KIT199	£19.93
ECHO UNIT: With double tracking	...KIT168	£44.30
FREQUENCY DOUBLER: Raises guitar frequency by 1 octave	...KIT98	£9.80
FREQUENCY CHANGER & WAVEFORM MODIFIER - Tunable	...KIT172	£34.46
FLANGER: Fascinating effects plus phasing	...KIT153	£22.74
FUZZ: Smooth distortion whilst keeping natural attack & decay	...KIT91	£10.57
GUITAR EFFECTS: Multiple variation of level & filter modulation	...KIT42	£19.73
GUITAR OVERDRIVE: Fuzz plus variable filter quality	...KIT56	£19.73
GUITAR SUSTAIN: Extends effective note duration	...KIT75	£10.04
GUITAR TO SYNTH INTERFACE: With voltage & trig outputs	...KIT173	£32.87
HAND CLAPPER: Triggered & auto claps, variable tone	...KIT197	£22.69
METRONOME: With audio & visual beat & down beat	...KIT143	£13.81
MULTIPROCESSOR: Flng, Rvb, Faze, Fuz, Wah, Trem, Vib	...KIT189	£57.14
MICROPHONE PRE-AMP: with base & treble switching	...KIT144	£9.21
NOISE LIMITER: reduces tape & system hiss	...KIT145	£9.97
PHASER: with automatic & manual depth & rate controls	...KIT164	£18.40
REVERB: Mono/stereo, variable depth & delays	...KIT203	£25.54
RHYTHM GENERATOR: 15 switchable rhythms	...KIT170	£35.64
RING MODULATOR: with integral oscillator control	...KIT179	£15.76
ROBOVOX: versatile robot type voice modifier	...KIT165	£21.03
ROGER 2-GONG: 2 gongs sounded at end of transmission	...KIT126	£11.38
SPEECH PROCESSOR: for clearer transmission	...KIT110	£9.68
STORM EFFECTS: Automatic & manual, wind, rain, surf	...KIT154	£15.86
TOM-TOM SYNTH: Triggered variable tone drum effects	...KIT190	£15.05
TREMULO: deep tremelo with depth & rate control	...KIT136	£9.71
VOCODAVOX: modular vocoder	...KIT152	£64.31
VOICE-OP-SWITCH: with variable sensitivity & delay	...KIT123	£13.41
WAH-WAH: with auto-trigger, manual & oscillator control	...KIT140	£17.26

MANY OTHER GREAT KITS IN CATALOGUE such as Autowah, bass boost, call sign, comparator, frequency generator, Funky-wobulol, hamonola, hum-cut, mixers, sequencers, synthesiser interface, treble boost, tone control, vibrato, voice filter, voice operated fader, Wheeby-jeebly, wobble-wah. Plus digital synthesiser, junior synthesiser, envelope shapers, D-A converter, multiwaveform VCO, Keyboards, contacts, etc. - Send S.A.E. for comprehensive catalogue (overseas send £1).

YES - WE ALSO HAVE A KIT MAINTENANCE & REPAIR SERVICE!

Add £1 P&P & 15% VAT to all orders. (Overseas post details stated in cat.) Payment CWO, Chq, PO, Access, Barclay, or pre-arranged collection. Despatch usually 10-14 days. Details correct at press, E&OE.

PHONOSONICS, DEPT PE43, 8 Finucane Drive, Orpington, Kent, BR5 4ED.  
Tel: Orpington (STD 0689) 37821. Mon-Fri 10-7. Callers by appointment.

# MONITORS... for Home Computers

MICHAEL TOOLEY BA    DAVID WHITFIELD MA MSc CEng MIEE    PART TWO

**T**HIS month we complete our brief look at monitors for home computers by reviewing two current models. The two units tested are representative of the most popular types of monitor for home computing: a high resolution monochrome monitor, and a medium resolution RGB monitor. The monitors have been reviewed primarily from a user's viewpoint, and the usual technical tests have been largely replaced by an extended practical evaluation with a BBC Micro.

## NOVEX MONOCHROME MONITOR

**First Impressions** The Novex 12/800 is a transistorised custom-designed monochrome monitor from Taiwan. It comes well packed, and is supplied complete with a manual and a phono-to-phono lead. The manual, although rather quaintly worded in places, is well illustrated and provides all of the necessary information.

The unit has a 12-inch green (P31) phosphor display tube, and is attractively packaged in a two-tone beige and brown steel case measuring approximately 30x29x30cm. The colour scheme and styling are pleasing to the eye, and are a good match for Apple or BBC computers. The tube has a moulded surround which includes an illuminated mains switch and a door concealing a number of controls. The monitor weighs approximately 8kg, and is mounted on rubber feet. The video connectors, mains lead and two slide switches are located on the rear panel.

**Front Panel** The screen surround includes the illuminated mains switch, and a button to release the door concealing the preset adjustments and controls. The two screwdriver preset adjustments are for picture height and width. These are factory adjusted for optimum setting, and should therefore need little or no attention. The remaining controls are intended for user adjustment and allow setting of brightness, contrast, horizontal hold, and vertical hold. All of the presets and controls are clearly labelled.

The four controls all have a useful range of adjustment. Correct setting of the two hold controls is well described in the manual. The adjustment of contrast and brightness is not quite so well covered in the manual. The best way to perform the adjustment was easily found to be as follows. Both controls should be turned fully clockwise for the brightest possible picture; the raster should then be clearly visible. Next the brightness is reduced until the raster just disappears. Finally the contrast should be adjusted to produce an acceptable picture; the actual setting here is a matter of personal preference. Once set, little adjustment to any of the controls is necessary, and then usually only to take account of different ambient lighting conditions.

**Rear Panel** The mains power lead enters through a securing grommet on the monitor's rear panel. The length of this lead is a rather miserly 1.5 metres (in common, it must be said, with much other equipment); no plug is provided.

Also on the rear panel are two miniature slide switches and two phono sockets, all clearly labelled. The reviewers' first reaction to the use of phono sockets was to look around for a spare pair of BNC sockets to fit in their place, but this again is a matter of personal preference.

The video input signal is connected to one of the phono sockets, and the second socket is internally connected to the input socket. This provides a video output signal which is useful for loop-through connection to more than one monitor. In order to be able to obtain the maximum video bandwidth, the video signal should be terminated (by 75 ohms) at the last monitor in the chain. A switch is provided to allow the signal to be left unterminated (high impedance for an intermediate unit), or terminated in 75 ohms (for the last or only monitor). In practice, the two phono sockets are interchangeable, and are labelled merely for convenience.

The second slide switch on the rear panel is labelled 'GRAPHICS' and 'DATA'. This allows the monitor's performance to be separately optimised for high resolution graphics and 80-column text.

**Inside The Case** On the rear of the case is a removable panel bearing warnings of electrical shock risk, and advising of no user servicable components. The internal construction is based on a large single-sided p.c.b. which is securely mounted on the base plate. This contains the majority of the components, and is screen printed for ease of component identification. Mounted on the base of the tube is a much smaller p.c.b. which carries the video amplifier. This is a common practice to minimise stray capacitance, and hence allow the the maximum video bandwidth to be retained.

The internal construction is very compact, and represents a utilitarian appearance in interesting contrast to the external styling. The unit is clearly a custom designed monitor, rather than a modified television chassis. The power supply incorporates a mains transformer, and has no provision for operation from an external 12 volt d.c. supply.

Looking inside the case from the rear, there are three



preset controls mounted on the edge of the main circuit board. These turn out to be (left to right): picture height, focus and black level adjustments. These are factory presets which are not intended for user adjustment.

**Picture Quality** In order to evaluate the picture quality, the monitor was connected to the video output of a BBC Micro. Tests were conducted using 20, 40 and 80-column text, and high resolution coloured graphics displays. The video signal was terminated by 75 ohms.

After using a black and white television, the first thing that strikes the user is the clarity of the display. The difference between the display on a monochrome television, and the display on the monitor, has to be seen to be believed. In fact going back to the television display after a number of hours of use with the monitor can cause acute frustration. The temptation is to keep trying to adjust the television tuning to regain the 'lost' definition; a substantially fruitless exercise. It is on 80-column displays, however, that the difference is most apparent. The test is easily readable on the monitor, whereas on a television display, prolonged viewing is tiring.

The other factor which is quite noticeable is that the green phosphor has a significantly longer persistence than the white phosphor. This is quite typical of the P31 phosphor, and probably contributes to the strain-free display which can happily be viewed for many hours.

In 80-column mode the use of the 'graphics/data' switch eventually becomes clear. When switching from 'graphics' to 'data', very close observation of the screen shows that the leading edges of all characters become very slightly emphasised. This does not have any noticeable effect except on a very narrow vertical line (e.g. the centre upright of 'W'), which then becomes more clearly visible. Such lines represent very high video frequencies, and often result in a slightly fainter display, although remaining quite visible. The 'data' position appears to compensate for this effect by altering the time constant of the video amplifier to induce slight ringing. The end result is to allow the display of 80-column text to be outstandingly clear, but without compromising very high resolution graphics displays.

The overall display shows good linearity in both horizontal and vertical directions. There is no evidence of power supply problems with the display brightness, and the unit runs cool even after many hours of use. The picture focus is generally excellent, with only slight defocussing evident in the top right corner of the display. This would normally go unnoticed in everyday use. The display resolution is quoted at 1000 lines in the screen centre, and 800 lines in the corner. This is more than adequate for 80-column text, and in practice individual pixels can be distinguished (the BBC Micro uses 640 pixels per line in 80-column text mode).

The BBC Micro produces displays in up to eight colours, although black is not really a colour as such. When displayed on the Novex monitor, these colours appear as shades of green, but they are still distinguishable by virtue of their different brightness levels. In order of decreasing brightness, the colours appear as:—

WHITE	(Brightest)
YELLOW	
CYAN	
GREEN	
MAGENTA	
RED	
BLUE	
(BLACK)	(Darkest)

As delivered, the review unit was unable to display blue at all, and had some difficulty with red. However, after adjustment of the black level internal preset (not a user adjustment), all of the colours were visible and distinguishable.

**VERDICT** The overall impression after prolonged use (including preparing this review!) is excellent. The monitor is neat, compact, pleasant to use and fuss-free. It is ideal for word processing and any high resolution applications, and would make a very welcome addition to any home computer system.

## CABEL RGB MONITOR

**First Impressions** The Cabel 370A is an RGB colour monitor which is supplied complete with a BBC Micro compatible RGB video lead. The unit as delivered has its colour settings optimised for the BBC Micro, and is extremely well packed in a double box. A single A4 instruction sheet is supplied which gives basic operating information, but this appears to have been rather hastily prepared, and contains a number of typographical errors. Hopefully this is an interim measure, pending production of a more substantial manual.

The monitor has a 14-inch Mullard colour tube with a dot pitch of 0.65mm, and is packaged in a strong moulded case with an integral combined carrying handle and ventilation slot. The colour scheme is beige (case body) and black (front panel). It must be said, however, that the overall styling is spoilt by poor design of the front panel. This is a great shame because the effect could have been so much better with only a little more effort and attention to matters of styling and ergonomics. As it is the two front panel controls (round knobs) are too close together, and in sharp contrast to the (square) mains switch. The mains indicator is a small (round) i.e.d. in the middle of a large blanking plug filling the hole occupied on previous models by the video connector. This said, we should remember that the prime function of the unit is to produce colour displays.

The overall dimensions of the monitor are probably the smallest possible for a unit using a 14-inch tube, and are approximately 39x36x41cm. The case itself tapers from front to back, and also inclines the screen usefully backwards to assist viewing. The height of the screen above the bench would allow it to stand behind many micros, in the (unlikely) event that sufficient bench space is available. The best alternative viewing position involves placing the monitor beside the computer. The unit weighs approximately 13kg, and is mounted on four rubber feet. All controls are on the front panel, and all leads connect at the rear.

**Front Panel** The front panel contains the mains switch and power indicator. The indicator provides a useful indication of whether the automatic power supply shut-down



circuitry has operated. Two controls allow adjustment of brightness and 'interlacing'. The latter control seems wrongly labelled (and spelt!), and behaves as a contrast control; it certainly has no effect on picture scan interlacing. Both controls work well and have a useful range of adjustment.

**Rear Panel** The mains power lead enters the unit through a grommet on the rear panel. This lead is approximately 2 metres long (still a little on the short side, but a useful length), and has a fitted 13A plug. The video input is via a 6-pin DIN socket, wired to be compatible with the BBC Micro. The RGB input is terminated in 75 ohms, and automatically switches to accept inputs with positive or negative sync. The rear of the case contains ventilation slots, which are numerous enough to provide a good flow of air, yet narrow enough to prevent the intrusion of foreign objects.

**Inside The Case** At the rear of the case is a label which warns of electrical shock hazard if the cover is removed, and indicates that there are no user serviceable parts inside. Access is provided to ten preset adjustments through small holes in the base and rear of the case, obviating the need to remove the cover. The adjustments provided are for: red/green/blue input sensitivity, horizontal/vertical shift, field sync/linearity/amplitude, line width and linearity, and focus. The unit is provided fully aligned, and no adjustments were found to be necessary to the review sample.

The case itself is of substantial construction, and is removed by unscrewing the four feet. The internal construction of the monitor is extremely impressive, and is based around a standard Mullard colour monitor chassis, to which the case is attached. The chassis is built around the cradle which supports the colour tube. The tube itself is a standard television style 90-degree tube. The main circuit board is mounted in the base of the cradle, and is neatly laid out for automatic component insertion. The three (red, green, blue) video amplifiers, and the focus control, are mounted on a smaller second board mounted on the tube base. Signal connections between the sub-assemblies are by means of multi-way cables/connectors. All in all, a very well constructed unit incorporating the very latest technology.

**Picture Quality** The picture quality of the Cabel monitor was evaluated by driving it from the RGB output of a BBC Micro. The tests involved 20,40 and 80-column text, and high resolution coloured graphics.

When set against a standard, well-adjusted domestic colour television, the picture quality from the monitor can only be described as excellent. The difference has to be seen to be believed. The saturated, stable colours which are obtained are a delight to observe, and it is possible (using only the front panel controls) to obtain a colour display to suit all tastes. The usual problem is that no two people can ever agree on the subjectively 'correct' settings for any colour display; the reviewers certainly disagreed! The important point, however, is that the range of adjustment available on the monitor is more than enough to cater for all tastes. Whatever your preference, the final picture quality is excellent.

When used for text displays, the CE370A produces perfectly acceptable and stable displays for 20 and 40-column text. However, the 10MHz bandwidth causes a few problems with 80-column text. The actual horizontal resolution quoted for the display is 430 pixels per line, and the BBC Micro uses 640 pixels per line for 80-column text. The resulting text is still quite readable, but not pleasantly so for prolonged periods. A viewing distance of approximately 1.2 metres (eye-to-screen) was found to be the optimum for 80-column text. If contemplating frequent and prolonged use with 80-column text, the higher resolution CAT370 (22MHz,

0.65mm dot pitch, 430 pixel) or HR370 (22MHz, 0.3mm dot pitch, 640 pixel) models should be considered as possible alternatives.

The ideal, and the recommended, position for the monitor is behind the computer console. This has the advantage of increasing the separation between the eye of the user and the screen. The bottom of the screen is then 9cm above the bench level, and this means that it is not obscured by most micros. The screen size should be considered when deciding where to position any monitor; a large screen too close can be as bad as a small screen too far away. Both situations can lead to fatigue with prolonged use. In use the monitor normally runs warm, but the ventilation is quite adequate, and no hot spots are evident.

**VERDICT** The overall impression gained from prolonged use (including preparing last month's article) is of a unit which offers good performance for price. The styling is a matter of personal taste, but the colour quality of the display is unreservedly excellent. It would be unreasonable to expect too much from a medium resolution RGB monitor when it comes to displaying 80-column text. The performance achieved is as good as could be expected, and in general it is necessary to spend around twice as much to obtain a monitor to match (say) the Novex in this respect.

#### FINAL THOUGHTS

The selection of a monitor for your particular application, and to suit your budget, will always be a matter of personal choice. The two units reviewed are both worthy of serious consideration. The reviews also indicate some points which might be considered when making a selection. Wherever possible, try and see your final choice of monitor in action before you take delivery; both review samples arrived damaged after carriage by road and rail, despite having been very well packed. Prices for monitors appear to have substantially stabilised, so there is unlikely to be any significant price reductions in the near future.

**The Novex 12/800 is priced at £75.62 excluding VAT and p&p and is available from Display Distribution Limited, 35 Grosvenor Road, Twickenham, Middlesex (01-891 1923).**

**The Cabel 370A is priced as £199.50 excluding VAT and p&p and is available from Cabel Electronics, 19 High Street, Tewkesbury, Glos. (0684 298840). ★**





SOON after Britain's state-owned microelectronics company passed its fifth anniversary it sent out advance information on its latest development, a single-chip microcomputer called a Transputer. The fact that the device did not at that moment exist as a real component illustrates both the confidence of Inmos and the commercial conditions in which the company has to operate.

With fierce competition from the mighty American and Japanese semiconductor industries and prices of integrated circuits falling all the time, the only way to survive commercially is to keep on developing new products that will leapfrog their rivals in facilities, performance or price. In such conditions you have to announce and describe your latest development well ahead of its actual existence as a component on the market.

The idea, of course, is to stake a claim as soon as possible with the potential customers—the electronic equipment manufacturers—who are always waiting to pounce on devices using the latest and most advantageous technology to give their own products a competitive edge. To make such claims ahead of actuality you have to be very confident.

#### GENESIS

So what has Inmos actually achieved in its first five years in this dangerously competitive world? Inmos International PLC, as it is now known, was founded in August 1978 specifically to develop, manufacture and sell very large scale integrated circuits (VLSI) as standard devices in volume production. This means ICs with 100,000 or more transistors on a single chip.

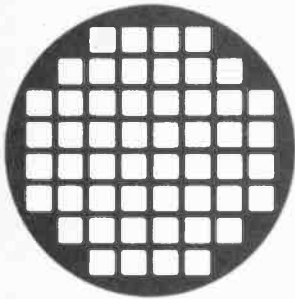

**inmos**

**The British Chip Manufacturer**

The Labour government of that time had become convinced that the UK should have a stake in this high-technology business. Apart from the international trading advantages of being in such a field of manufacture, they felt it would create more jobs and would also help the UK electronics industry to be less dependent on imported devices, or the products of foreign-owned companies, and therefore less vulnerable to technical/commercial decisions made in other parts of the world.

As British private capital had not produced any such VLSI company it was decided to invest £50M of public money in the venture, £25M immediately (1978) and a further £25M at a later date. This was arranged through the National Enterprise Board (NEB), a state run agency already existing to launch or support industrial companies felt to be important to the economy.

The NEB is now part of the British Technology Group. Recently it has been given the new role of assisting technology transfer and will be divesting itself of its holdings in the share capital of various companies.

It so happened that the government's aim had coincided with the ambitions of two very able technologists, who were then looking for an opportunity to exploit their ideas of producing large information processing systems on small silicon chips. Iann Barron, an English systems research specialist, then aged 42, had formed the first UK minicomputer company, Computer Technology Ltd, in 1965 and later had been a consultant in computers and information technology. The second party was Dr Richard Petritz, an American physicist, then 55, who had directed Texas Instruments' semiconductor research for ten years from 1958 and later had formed a company in Dallas for launching new electronics firms—one of which was Mostek.

Legend has it that these two discussed and formulated their common aims at Chicago Airport after a technical conference in 1977. Iann Barron was already aware of UK government intentions through his consulting work for the Department of Industry (now DTI), and it was only a matter of months before an agreement was signed to set up the new British VLSI company with these two individuals as founders.

A third founder was another American physicist, Dr Paul Schroeder, then 38, who had worked for Bell Telephone Laboratories on memory design and in 1967 had become director of memory design engineering at Mostek. (Dr Schroeder, an expert on MOS dynamic memory devices, resigned from Inmos in 1982.)

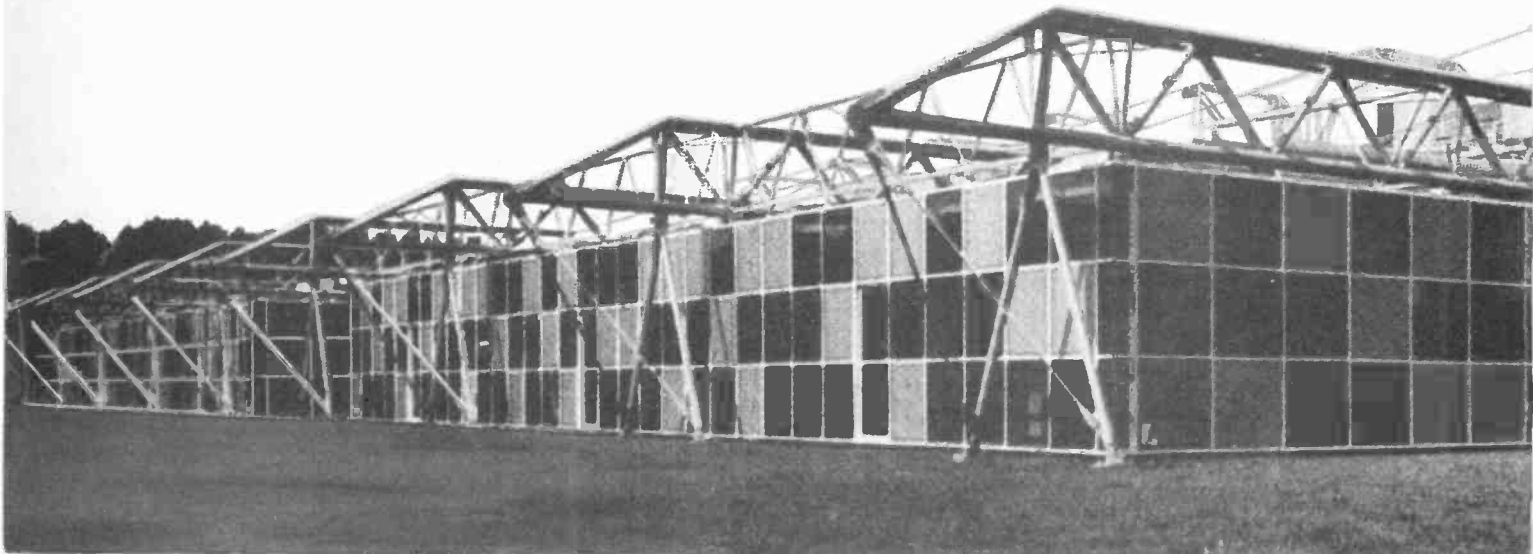

The essence of the setting-up agreement was that Inmos would be a subsidiary of the NEB. In return for the £50M of public funds, the NEB was to hold 72½ per cent of the equity in the company. A further 15 per cent of the shareholding was to be divided among the three founders and the remaining 12½ per cent between key employees of the company. Richard Petritz was appointed managing director.

The overall plan was to start by developing, manufacturing and selling random access memories (RAMs) because there was already a large and growing market for these devices. This activity would provide a manufacturing and commercial base from which other VLSI devices would be launched. Process technology and initial manufacturing would be based in the USA because that country had a large pool of people already skilled in VLSI technology. Then, after the products had been launched there, they would be transferred to the UK for volume production. Memories would be marketed and sold from the USA because North America provided a very big demand for these products.

### THE EARLY YEARS

Less than a year after the founding of Inmos, and before the NEB had produced the second £25M of the investment capital, the 1979 General Election brought in a Conservative government—a government opposed to the principle of state-owned industries, committed to keeping down public expenditure and unwilling to use public funds to support loss-making private sector companies. The affairs of Inmos then moved into the political arena.

The new government hesitated for about a year and clearly would have liked the second £25M to be found from private sources of capital. There was dissension within the Department of Industry and lengthy deliberations on where the UK factory was to be sited. But Sir Keith Joseph, the then industry minister, was in favour of the original method of funding and in the end the remaining £25M of public money was provided, by a new NEB, in August 1980.

Meanwhile the Inmos plans for an American plant had gone ahead on schedule. Colorado Springs had been chosen as a good area for potential employees and by September 1979 the company had started building a plant there. By March 1980 an experimental establishment at Harrison Park had developed an NMOS process for making RAMs with 2–3µm active area widths in the silicon. And by May 1980 the first samples of 16K static RAMs made by this process were available. The Colorado Springs plant started operations in March 1981 and by December of that year had produced the first samples of dynamic RAMS.

The abbreviation MOS stands for the three kinds of material, metal—oxide—semiconductor, used to construct the integrated field-effect transistors in these devices. The N in NMOS indicates that the conducting channel of these integrated f.e.t.s is silicon containing impurity atoms giving it a greater density of conduction electrons, making them the majority carriers, than of mobile holes—in other words the silicon is an n-type semiconductor. In the RAMs referred to the f.e.t. structures within the silicon are 2–3µm wide.

Static RAMs are constructed on the principle of using an integrated flip-flop or bistable circuit to store each binary digit, 1 or 0. They are faster than dynamic RAMs but dissipate power continuously to hold the information, have a lower packing density and are usually more expensive.

Dynamic RAMs are constructed on the principle of using a MOS capacitor, in conjunction with a MOS field-effect transistor, to store each 1 or 0 binary digit as an electric charge. Consequently, to hold information the charge in the capacitor has to be constantly maintained, or 'refreshed', by other circuitry. Dynamic RAMs use power only when reading and writing is taking place and their standby power dissipation is very low.

### UK FACTORY SITE

Back in the UK the government eventually decided that the factory for volume production should be built in South Wales, and in January 1981 the construction of a plant of spectacularly advanced architectural design was initiated at Cardiff Road, Duffryn, Newport, Gwent. This was conveniently just a few miles over the Severn Bridge from the Inmos administration and R&D centre in Bristol, at Whitefriars, Lewins Mead. The Newport factory started operations in June 1982 and by November of that year was producing in volume the first 16K static RAMs, initially manufactured at Colorado Springs. And in February 1983 the Newport factory started volume production of the dynamic RAMs.

Altogether these three Inmos establishments now employ an average of 1350 people. There are 750 at Inmos Corporation, Colorado Springs; 500 at Inmos Limited, Newport; and 100 at Bristol. The R&D people at Bristol work on microcomputers and computer aided design, while those at Colorado Springs are concerned with memory products and process technology.

### INMOS TODAY

What, then, is the position of Inmos now, in terms of its products, markets, technical developments, commercial viability and plans for the future?

# Tom Ivall

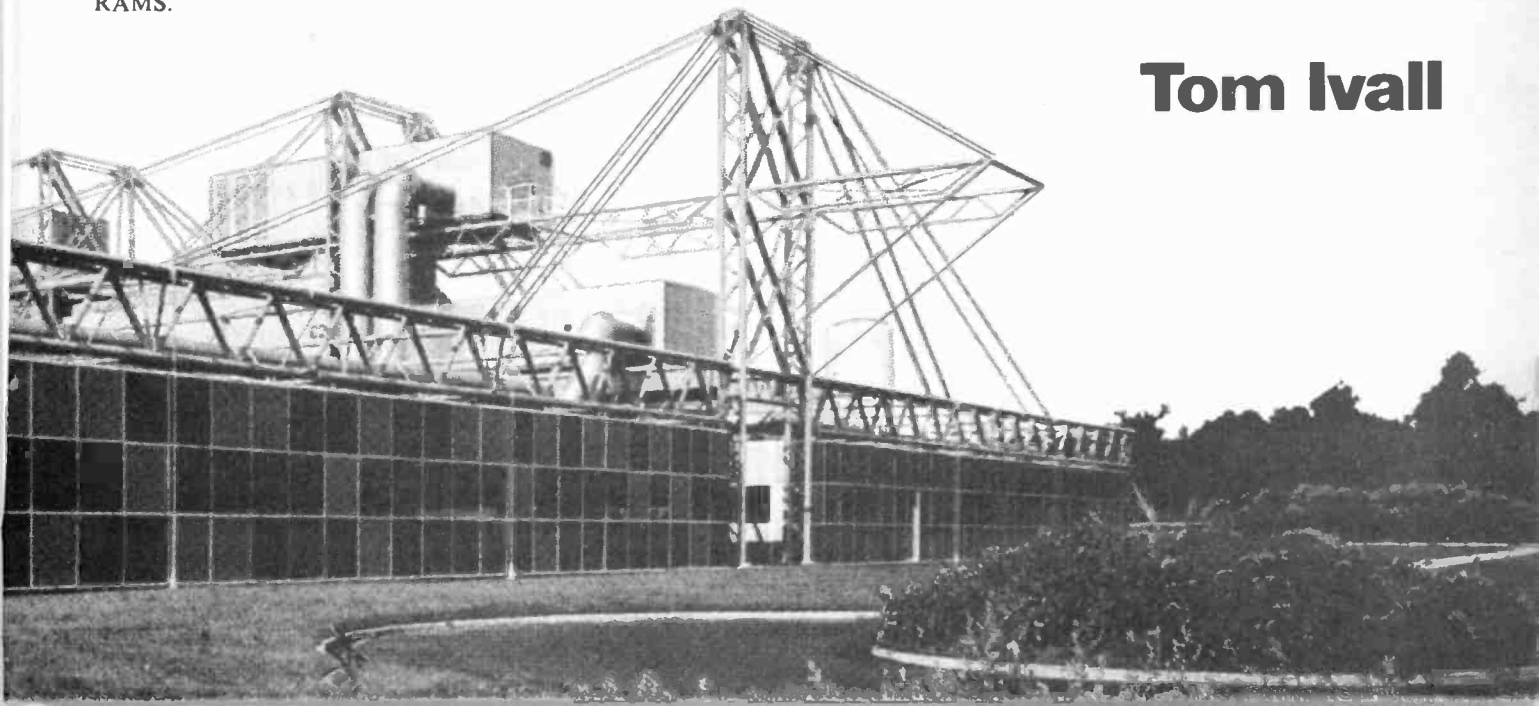

First, the products. At the time of writing the i.c.s in production and on the market are all semiconductor memories. Categorized purely in terms of storage capacity and/or chip organization there are seven basic products, but these have variants with different specifications, packaging etc. that make a total of 32 type numbers.

The range of 16K static RAMs contains the 16K  $\times$  1 type IMS1400 in versions with access times down to 35ns; the 4K  $\times$  4 type IMS1420; and the slightly different 4K  $\times$  4 IMS1421, both in versions with access times down to 45ns.

All these are available in plastic or ceramic d.i.p. or in chip carrier packaging. In addition there are military specification versions, the IMS1400M and 1420M, both available in d.i.p. or chip carrier form. Inmos claim that the 16K IMS1400 and 1420 are "the fastest static RAMs available for use in military and computer applications."

The company also make a range of 64K dynamic RAMs. The 64K  $\times$  1 type IMS2600 comes in versions with access times down to 100ns and is available in either d.i.p. or chip carrier packaging. IMS2620 has a 16K  $\times$  4 organization and is also in versions with access times down to 100ns, while the IMS2630 is an 8K  $\times$  8 memory in versions with access times down to 120ns—these two devices both being packaged in d.i.p. form. Recently Inmos and the Intel Corporation have agreed a common specification for future dynamic RAMs made by a new high speed CMOS process, so that users will have two sources of functionally identical products.

Finally, to complete the seven basic products, the latest to be marketed is a 64K electrically erasable programmable read-only memory (EEPROM) in a d.i.p. package, the IMS3430. Made by a process called Nitrox which produces memory cells of very small area, this device has an 8K  $\times$  8 organization and requires only a single 5V supply. The whole ROM can be programmed in 1.3s.

In the dynamic RAMs, two particular features contributing to good performance and convenience in use are what are called the 'nibble' mode of operation and the 'CAS before RAS' method of refresh assistance. The term 'nibble' means simply half a byte (a metaphor built on a pun!), or four bits. It describes a facility in the 64K dynamic RAM which allows four data bits to be read or written sequentially for a single address access. It is a design response to the electronic industry's demand for faster and faster memory operation and is provided by other manufacturers under the name 'serial access'. In the IMS2600, for instance, the nibble mode allows serial access to two, three or four bits at a bit rate of 25MHz.

All dynamic RAMs need refresh assistance, but the tech-



niques used by some manufacturers have the effect of restricting memory expansion and increasing the standby power dissipation. The Inmos method of refresh assistance avoids these problems. To determine whether a normal access or a refresh cycle should be performed the chip samples the high/low state of the column address strobe ( $\overline{\text{CAS}}$ ) as the row address strobe (RAS) falls to the low state. If  $\overline{\text{CAS}}$  is low as RAS goes low, the memory ignores any address inputs and substitutes the contents of an on-chip 8-bit counter to determine the row to be refreshed.

## MANUFACTURING PROCESSES

All these memory devices are manufactured by advanced VLSI processes, in which Inmos invested very heavily in order to remain competitive. This technology has three main characteristics. First, the etching of the different layers of material on a chip is done by the plasma, or dry, method, to achieve greater dimensional stability than is possible by the use of acids.

Secondly, ion implantation is used to give a more controllable depth of impurity atoms in the crystal lattice below the semiconductor surface than is possible with the conventional diffusion method. Depth of penetration is controlled by the energy imparted by acceleration to the ions bombarding the silicon surface. Thirdly, the Inmos process technology uses wafer stepping photolithography, in which the circuit patterns are projected onto the semiconductor wafer one chip at a time. This gives better line definition and alignment accuracy, and hence higher yields, than when a pattern is projected onto the whole wafer in one operation.

Another technique which improves the yield of memory chips is to introduce redundancy, in the form of spare rows and columns of cells in the memory matrix. At the wafer testing stage any failed cells are identified and this information is programmed into the chips in such a way that when these cells are addressed the device brings in the spare good cells to replace them.

## MARKETS

The principal markets of Inmos memories are in the USA and these take over 70% of the company's output. The remainder are distributed throughout the rest of the world. Inmos claims to have secured "a major share" of the world market for 16K fast static RAMs, which are going mainly to the USA, Europe and Japan. In general the firm's memory products are used in mainframe and mini computers, peripheral buffers, radar systems, aircraft flight computers, video displays and telecommunications digital switching equipment.





### RECENT TECHNICAL DEVELOPMENTS

In the past few years technical developments from Inmos have included the OCCAM programming language for single and multiple microcomputer applications and a set of computer based aids for designing VLSI devices. In semiconductor products probably the most advanced development is the Transputer (see January issue editorial, p.13). This name, derived from 'transistor' and 'computer', actually refers to a family of products. The first of these, due on the market soon as the IMS T424, is a 32-bit microcomputer on a single chip capable of handling 10 million instructions per second. An article by Ray Coles will explain the device in more detail next month.

The most significant thing about this device is that, as well as being suitable for conventional applications, it is designed to allow operation in arrays of similar microcomputers all working in co-ordination with each other—'concurrent processing' as Inmos calls it. For this purpose the single VLSI chip includes circuits allowing it to communicate with other such microcomputers—four 15Mbyte/s two-way serial data links. This principle of array processing is very much aimed at the future 'fifth generation' computer systems, which will probably ~~work at about~~ a thousand times the performance level of present computers to provide intelligent interaction between people and machines. The CMOS silicon chip of the IMS T424 contains 250,000 active devices, includes 4Kbyte of RAM and is packaged in an 84-contact ceramic chip carrier.

### HOW THE MONEY WAS USED

From the beginning the Inmos management realized that the original funding of £50M would not be enough to sustain the corporate plan aimed at profitability. In the intervening years the effects of inflation and the falling value of the pound sterling relative to the US dollar have made the deficiency even worse. A market and technical assessment by independent consultants later confirmed this situation. The directors wanted to raise a further £50M in the form of loans, but the government had already set a borrowing limit of £35.5M. The upshot was that in 1983 the NEB agreed to provide a further £15M as an additional equity investment. This increased the NEB's holding in the share capital to 75 per cent and correspondingly reduced the proportion held by individual directors and employees.

Thus the capitalization was increased to £65M. On top of this, the leasing, loans and investment grants arranged with banks and other sources (including the EEC) have brought the

total funding to about £100M to date.

How has all this money been used? The ultimate purpose of the investment, of course, is to create a profitable company financing itself out of its own trading activity. The NEB, having performed its function of launching the enterprise, would then be able to sell off its shareholding in a going concern to good advantage, at the least recovering the investment of public money and at the best obtaining some return for it.

The 1982 annual report is the latest account showing how far Inmos has progressed along this road. First of all, its use of the capital investment. The company now has tangible fixed assets of £44.1M, in the form of various buildings and their equipment. This sum is made up of £20.2M in freehold land and buildings, £168,000 in short-leasehold land and buildings and £23.7M in plant and equipment. There are also current assets, in the form of stocks, cash and debts, and after the current liabilities have been deducted this leaves the company with total assets of £47.2M.

Now to the current trading position. In 1982 sales of MOS memory products amounted to £13.7M. This was a very big increase from the corresponding 1981 sales figure of £2.1M. However, the operating costs relating to these 1982 sales—manufacturing, engineering, product support, distribution and administration—totalled £22.3M, resulting in an operating loss of £8.6M. Apart from this, starting up the Newport factory cost £3.6M, the continuing research and development work required £4.5M, the interest charges on loans were £1.2M, while losses on the dollar-pound exchange rate came to £2.3M.

Altogether the profit and loss account for 1982 showed a loss of £20.3M. Losses brought forward from previous years amounted to £21.6M, so the accumulated loss carried forward from 1982 was £42M.

### PROFIT IN 84?

Obviously Inmos still has a long way to go. In the 1982 report the directors said that they expected the 1983 results to show "a move towards profitability", while the chairman, Malcolm Wilcox, said that if all went well "the scene will be set for a move into profit in 1984." The 1983 annual report, soon to be published, will show to what extent these optimistic comments are justified. They seem to suggest that by the end of 1983 Inmos would at least have broken even on its monthly revenues. At the turn of the year company officials were saying no more, but seemed to be quietly confident that the 1983 results would show a more than doubled turnover.

So what does the future hold for Inmos? To begin with, a company spokesman told PE that there is "no immediate danger of going bust." The firm now has enough money to keep going. But it still has to keep up with the relentless march of technical innovation to remain among the leaders in the field of manufacture, and also has to contend with equally relentless commercial competition in world markets. This means, for example, that "significant sums" will be needed to build new wafer processing facilities.

For such future investment Inmos is now looking towards private sources of finance, and the 1982 annual report stated that "discussions in this regard are now on course." One result could be that other companies or financial institutions will be buying significant minority shareholdings in the firm.

If this does indeed happen and the process continues, with the NEB gradually divesting itself of its majority shareholding as intended, Inmos will eventually end up as a public company with share prices quoted on the Stock Exchange. This transformation, from ownership by the state to a variegated ownership by pension funds, insurance companies, institutions, trade unions and even private individuals, is a process that could well be starting some time this year. ★

# INTRODUCTION TO DIGITAL ELECTRONICS

MICHAEL TOOLEY BA DAVID WHITFIELD MA MSc CEng MIEE

## O & A Level Part Six

SO FAR in the series we have only dealt with logic gates having two inputs. The time has now come to extend our knowledge to include gates having three, or more, inputs. The two-input gates which we have previously considered are: AND, OR, NAND and NOR. We shall now consider their three-input counterparts.

A three-input logic gate has inputs which we shall, for convenience, label A, B and C. Again there is no particular significance in the choice of letters other than that they are simply the first three letters of the alphabet. To be consistent with the two-input gates previously considered, we shall again refer to the outputs as X. The Boolean expression for each of the three-input gates will, of course, involve the three variables A, B and C. Taking the three-input AND gate first, we find that its output is A AND B AND C. Putting this in correct Boolean form gives:

$$X = A \cdot B \cdot C$$

In terms of the logical state of the inputs, the output X will be a 1 whenever A, B and C are all 1. Any other combination of inputs (e.g. A = 0, B = 0, C = 1) will produce a 0 output. Since we are dealing with a three-input gate, there are  $2^3$  (= 8) possible combinations of the logical input states. The truth table will, therefore, consist of eight lines covering the input states arranged in four columns, three for the inputs and one for the output, as shown in Table 6.1.

The output of a three-input OR gate is A OR B OR C. In correct Boolean form this is:

$$X = A + B + C$$

The output X will be a 1 whenever any one, or more, of the inputs is a 1. The truth table will take the same form

INPUTS			OUTPUT
A	B	C	X
0	0	0	0
0	0	1	0
0	1	0	0
0	1	1	0
1	0	0	0
1	0	1	0
1	1	0	0
1	1	1	1

EG1269

Table 6.1. Truth table for a three-input AND gate

as that used for the three-input AND except that the output column will contain 1's in each line except for that which corresponds to the input state: A = 0, B = 0, C = 0. This, incidentally, yields the important result that the output of a three-input OR gate is the logical opposite (complement) of the output of a gate for which the Boolean expression is (NOT A) AND (NOT B) AND (NOT C). Thus we conclude that:

$$\overline{A + B + C} = \overline{A} \cdot \overline{B} \cdot \overline{C}$$

This is an important result which we shall be returning to in Part Seven when we introduce De Morgan's Theorem.

The truth table for a three-input OR gate is shown in Table 6.2. As in the case of their counterparts, three-input inverting gates, NAND and NOR, produce the complement of their respective AND and OR counterparts. The output of a three-input NAND is NOT (A AND B AND C), or:

$$X = \overline{A \cdot B \cdot C}$$

The output of a three-input NOR gate is NOT (A OR B OR C), or:

$$X = \overline{A + B + C}$$

INPUT			OUTPUT
A	B	C	X
0	0	0	0
0	0	1	1
0	1	0	1
0	1	1	1
1	0	0	1
1	0	1	1
1	1	0	1
1	1	1	1

EG1270

Table 6.2. Truth table for a three-input OR gate

The truth tables for the three-input NAND and NOR gates are respectively shown in Tables 6.3 and 6.4. Unfortunately, these two are easily confused and the recommended method for distinguishing between them is to FIRST consider the output of the corresponding non-inverting gate (i.e.

INPUTS			OUTPUT
A	B	C	X
0	0	0	1
0	0	1	1
0	1	0	1
0	1	1	1
1	0	0	1
1	0	1	1
1	1	0	1
1	1	1	0

EG1271

Table 6.3. Truth table for a three-input NAND gate

AND or OR) and simply complement its output state (i.e. whenever a 1 appears in the output column change it for 0, and vice-versa).



INPUTS			OUTPUT
A	B	C	X
0	0	0	1
0	0	1	0
0	1	0	0
0	1	1	0
1	0	0	0
1	0	1	0
1	1	0	0
1	1	1	0

EG1272

**Table 6.4. Truth table for a three-input NOR gate**

### FOUR (AND MORE!) INPUT GATES

Having dealt with three-input gates it is worth considering what happens when we are presented with gates with four, and more, inputs. The procedure for deriving the Boolean expressions and truth tables naturally follows that adopted for the three-input gates. The Boolean expression for a gate with  $n$  different inputs will have  $2^n$  lines. The truth table will have  $n$  columns for the inputs and just one column for the output. Hence the Boolean expression for the output of a four-input gate ( $n = 4$ ) will involve four variables (A, B, C and D) and its truth table will have  $2^4 (= 16)$  lines.

The Boolean expressions of the outputs of four-input gates are shown below. The symbols for these gates are, together with those for their three-input counterparts, shown in Fig. 6.1.

$$\begin{aligned} \text{AND} \quad X &= A \cdot B \cdot C \cdot D \\ \text{OR} \quad X &= A + B + C + D \\ \text{NAND} \quad X &= \overline{A \cdot B \cdot C \cdot D} \\ \text{NOR} \quad X &= \overline{A + B + C + D} \end{aligned}$$

By now, readers should be familiar with Boolean expressions and truth tables for gates with up to four inputs. We shall, however, be returning to this topic in Part Seven when the important applications of De Morgan's Theorem will be discussed.

### J-K BISTABLES

Unlike the two types of bistable which we have met previously in Part Five, the J-K bistable provides direct as well as clocked inputs. The direct inputs, usually labelled 'preset' and 'preclear', are normally used to initialise the state of the bistable before data is clocked into it by means of the J and K inputs. There is, incidentally, no particular significance in the letters J and K other than that they are consecutive letters in the alphabet and are

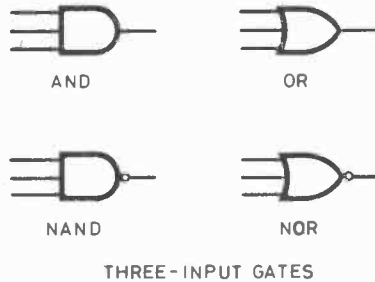

THREE-INPUT GATES

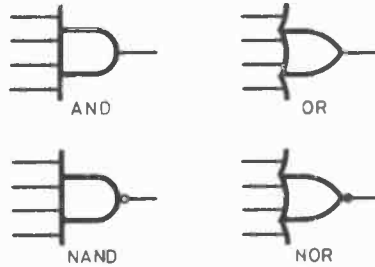

FOUR-INPUT GATES

EG1273

**Fig. 6.1. Symbols used for three and four-input logic gates. Note: BS symbols follow the style of the two-input gates previously described in Part Two**

unlikely to be confused with other letters used thus far to identify inputs and outputs.

The symbol for a J-K bistable is shown in Fig. 6.2. Note that there are five inputs: preset and preclear (the two direct inputs), J and K (the two clocked inputs), clock, and two outputs: Q and  $\bar{Q}$ . As with the previous forms of bistable, the two outputs are complementary (i.e. when  $Q = 1$ ,  $\bar{Q} = 0$ , and vice versa). It should also be noted that, in the case of practical J-K bistables like the 7473 that we shall be describing later, the preset and preclear inputs are often 'active low'. This means that they are normally connected to logic 1 and must be taken 'low' (to logic 0) in order to preset or preclear the Q output.

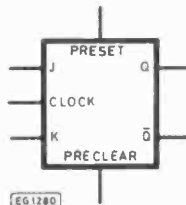

EG1280

**Fig. 6.2. Symbol for a J-K bistable**

In all circumstances the direct inputs dominate and clocked operation is

enabled when both of these inputs are taken to logic 1. It is, therefore, necessary to consider TWO truth tables: one for the operation of the direct inputs and one for the clocked inputs. These two truth tables are

PRESET	PRECLEAR	Q
0	0	INDETERMINATE
0	1	1
1	0	0
1	1	ENABLES CLOCKED OPERATION

EG1273

**Table 6.5. Truth table for the direct inputs of a J-K bistable**

J	K	Q <sub>n+1</sub>	COMMENT
0	0	Q <sub>n</sub>	NO CHANGE [0 → 0 OR 1 → 1]
0	1	0	OUTPUT PRECLEARED
1	0	1	OUTPUT PRESET
1	1	$\bar{Q}_n$	O/P CHANGES STATE [1 → 0 OR 0 → 1]

EG1274

**Table 6.6. Truth table for the clocked inputs of a J-K bistable**

respectively shown in Tables 6.5 and 6.6. The truth table for the clocked inputs is relatively complex; however, for three of the input conditions it is similar to that of an R-S bistable. The output column of the clocked input truth table (Table 6.6) shows the state of the Q output after a falling edge clock transition (i.e. after a change of clock state from 1 to 0). This is denoted by  $Q_{n+1}$  whereas the previous clock state is  $Q_n$ . We shall now consider separately the four possible conditions which can arise for both the direct and clocked inputs, referring initially to Table 6.5:

1. If both preset and preclear inputs are taken to logic 0 an indeterminate state exists and the outputs, Q and  $\bar{Q}$ , may no longer be complementary. This condition must be avoided.

2. If the preset input is taken to logic 1 and the preclear input is taken to logic 0, the state of the Q output immediately becomes logic 0 whilst the Q output becomes logic 1; i.e. the bistable is precleared.

3. If the preset input is taken to logic 0 and the preclear input is taken to logic 1, the Q output immediately becomes logic 1 whilst the Q output immediately becomes logic 0; i.e. the bistable is preset.

4. If both preset and preclear inputs are taken to logic 1 the bistable is ready for clocked operation and the following rules are obeyed (as in Table 6.6):

(a) If both J and K inputs are taken to logic 0 the Q and  $\bar{Q}$  outputs do not change state on a falling clock transition. Thus  $Q_{n+1}$  is the same as  $Q_n$  and  $\bar{Q}_{n+1}$  is the same as  $\bar{Q}_n$ .

(b) If the J input is at logic 0 and the K input is at logic 1, the Q output stays, or becomes, 0 when the next falling clock transition occurs. The  $\bar{Q}$  output takes the opposite logical state.

(c) If the J input is at logic 1 and the K input is at logic 0, the Q output stays, or becomes, 1 when the next falling clock transition occurs. The  $\bar{Q}$  output takes the opposite logical state.

(d) If both the J and K inputs are taken to logic 1, the Q and  $\bar{Q}$  outputs change state when the next falling clock transition occurs. Thus  $Q_{n+1}$  is the same as  $\bar{Q}_n$  and conversely  $\bar{Q}_{n+1}$  is the same as  $Q_n$ .

In case (a) the bistable ignores the clock transition whilst in cases (b) and (c) the complementary states of the J and K inputs are effectively passed, on the falling clock edge, to the Q and  $\bar{Q}$  outputs respectively. In case (d) the bistable is configured for operation as a binary divider. If this still appears to be a little difficult to understand the following practical investigation should help to make things clear!

## THE 7473 J-K BISTABLE

The 7473 contains two independent J-K bistables, as shown in Fig. 6.3. The 74107 is electrically identical to the 7473 but has more conventional supply connections (TTL devices usually have pins 14 and 7 as the +5V and 0V connections respectively). The two internal bistable stages are themselves identical and each has the usual J, K and clock inputs. A preset input is,

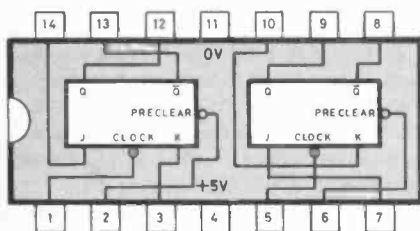

EG:261

**Fig. 6.3. Internal arrangement of the 7473 J-K bistable. Note: The circle on the clock and preclear inputs indicate an 'active low'**

however, not provided and only a preclear input is available for the direct control of the bistable. The preclear is, incidentally, an 'active low' input as

mentioned previously. To all intents and purposes, the bistable operates as if the missing preset input were internally connected to logic 1. Thus, for normal clocked operation, it is only necessary to connect the preclear input to logic 1. In actual fact the preclear input 'floats' to logic 1 if left unconnected. However, since leaving inputs unconnected is not generally considered good practice, it is recommended that a physical link to logic 1 be made external to the i.c. There can then be absolutely no doubt about the logical condition present on the preclear input! It should also be noted that the state of the J and K inputs should be changed once only during each clock cycle. Ideally this change should be made immediately after the clock transition. Any subsequent changes in the logical state of the J and K inputs can cause invalid states within the bistable.

Insert the 7473 into the dual-in-line socket marked 'A' on the Logic Tutor. The chip should be orientated so that pin 1 is in position A1, pin 7 in position A7, pin 8 in position A10 and pin 14 in position A16. During this investigation we shall be using only one of the two available J-K bistables contained within the i.c. The following connections should be made in order to facilitate clocked operation of the bistable:

A1	to	S1	(S1 will act as the clock)
A2	to	logic 1	(preclear to 1)
A3	to	S4	(S4 will act as the K input)
A4	to	+5V	(positive supply)
A13	to	0V	(0V)
A14	to	S3	(S3 will act as the J input)
A15	to	D2	(D2 indicates the $\bar{Q}$ output)
A16	to	D1	(D1 indicates the Q output)

Set S3 and S4 initially to produce logic 0 outputs and note the state of the Q and  $\bar{Q}$  outputs by observing the indication produced by D1 and D2 respectively. The outputs should, of course, be complementary! Now depress and release S1. This causes a 0  $\rightarrow$  1  $\rightarrow$  0 pulse on the clock input. There should be no change in the Q and  $\bar{Q}$  outputs. Set S4 to produce a logic 1 K input whilst S3 should remain at logic 0. Now depress and release S1 for a second time. This time the Q output should go to logic 0 and  $\bar{Q}$  should

go to 1 regardless of their previous state. Set S3 to produce a logic 1 on the J input and S4 to produce a logic 0 on the K input. Depress and release S1 again and check that the Q output becomes 1 whilst the  $\bar{Q}$  output becomes 0. Finally, set both S3 and S4 to logic 1. Repeatedly depress and release S1 to produce a train of successive clock pulses. This should cause the Q and  $\bar{Q}$  outputs to alternate between logic 1 and logic 0, a change being made each time S1 is operated.

## MASTER-SLAVE BISTABLES

At this point readers may be wondering what the internal logic of a J-K bistable looks like. It is, in fact, an elegant and ingenious arrangement known as a 'master-slave'. Both the master and the slave are simply conventional R-S bistables, the trick comes in the arrangement of the logic gates which interconnect them.

The basic arrangement of a J-K master-slave bistable is shown in Fig. 6.4. Let us assume that, initially, J, K and clock are all at logic 0. If preset is taken to logic 1 whilst preclear remains at logic 0 then the master bistable is set and its Q output becomes logic 1. Since the clock is at logic 0, the inverted clock will be a 1. This, together with the Q output from the master bistable, is fed to a two-input AND gate which generates a logic 1 to set the slave bistable. The final Q output of the complete arrangement is thus logic 1. The operation of the preclear input is similar. In this case, however, the resulting final Q output is a 0. When both preset and preclear are taken to logic 1 an attempt is made to set and reset both bistables at the same time. It is thus impossible to predict what will happen and the final output is indeterminate. When both preset and preclear are taken to logic 1 the two OR gates are ready to pass data from the three-input AND gates to the set and reset inputs of the master bistable. Note that the final Q and  $\bar{Q}$  outputs are fed back to the three-input AND gates and thus they must generate complementary logic states by virtue of the opposite state of the Q and  $\bar{Q}$  outputs. The master is thus set or reset depending upon the state of the J and K inputs whenever the clock is at logic 1. When the clock changes to logic 0, data is transferred from the master to the slave by means of the two-input AND gates.

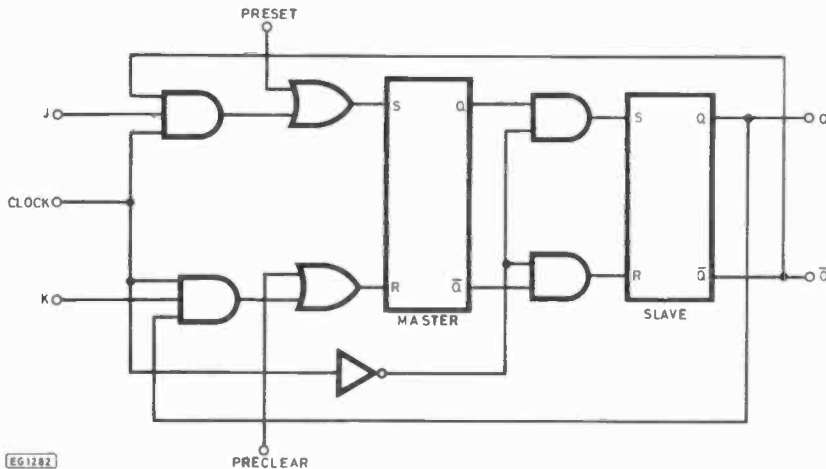

**Fig. 6.4. Basic arrangement of a master slave bistable**

In practice J-K bistables may also be of the edge-triggered variety. Unlike the master-slave type, where data is fed into the bistable during the logic 1 part of the clock cycle and appears at the output when the clock goes to logic 0, the edge-triggered bistable transfers data from input to output on the same edge of the clock cycle. This is achieved by means of an internal pulse narrowing circuit which converts the clock to a narrow 'spike' shorter in duration than the delay which occurs in the bistable changing its state. The truth table is, however, identical for both types.

### CLOCKS AND OSCILLATORS

Clocks are vital to the correct timing of operations in digital logic circuits. The basic requirement of a clock is that it provides a repetitive pulse waveform of accurate period. The most basic form of clock is merely a TTL compatible oscillator which produces a square wave output of 5V pk-pk at a known frequency. More complex clocks, such as those which are used for 'real time' applications, may be required to operate with a frequency stability and accuracy of better than ten parts per million. Oscillators may also be required for purposes other than purely timing. These applications include the testing of logic systems, the generation of alarm and warning signals, and the transmission of data in serial form. Before examining the subject in greater detail it is worth defining some of the relevant terms in popular use.

**FREQUENCY:** The frequency of an oscillator is the number of cycles of its output which occur in a second. An oscillator which, for example, generates

50 pulses per second has a frequency of 50Hz. Similarly, an oscillator which provides an output of 1kHz is producing 1000 pulses per second.

**PERIOD:** The period of an oscillator is the time for one complete cycle of its output. Naturally, the higher the frequency the smaller the period will be. In the previous examples the periods are 1/50 second (or 20ms) and 1/1000 second (or 1ms), respectively. The period of a waveform (in seconds) is thus simply the reciprocal of its frequency (in Hz).

**MARK TO SPACE RATIO:** The mark to space ratio of a pulse waveform is the ratio of 'on' (logic 1) to 'off' (logic 0) time. For a perfect square wave the 'on' and 'off' times will be the same, hence it is said to exhibit a 1:1 mark to space ratio.

**DUTY CYCLE:** The duty cycle of a pulse waveform is the ratio of the 'on' to ('on' plus 'off') times, normally expressed as a percentage. A perfect square wave would thus exhibit a 50% duty cycle.

### OSCILLATOR USING SCHMITT INVERTERS

A very simple TTL oscillator configured around two gates of a hex inverter is shown in Fig. 6.5. This arrangement uses a 7414 device rather than the more familiar pin-compatible 7404. The 7414 is much to be preferred for this particular application by virtue of its internal Schmitt action which offers an amount of hysteresis in the voltage levels for the logic 0 and 1 thresholds. The 7404 will not operate reliably in this circuit.

The first of the two gates has two external components: a resistor which

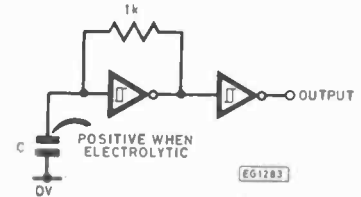

**Fig. 6.5. Simple TTL oscillator using Schmitt inverters**

C	f out
470 μ	1.5 Hz
47 μ	15 Hz
4 μ	150 Hz
470 n	1.5 kHz
47 n	15 kHz
4 n	150 kHz
470 p	1.3 MHz
47 p	8 MHz

EG1275

**Table 6.7. Values of C and corresponding output frequency for the circuit in Fig. 6.5**

provides positive feedback from the output to the input, and a timing capacitor connected from the input to 0V. The second gate merely acts as an inverting buffer to provide a measure of isolation of the first gate from the load connected to the output.

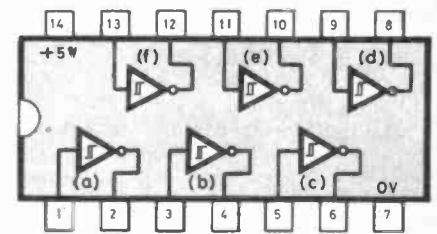

**Fig. 6.6. Pin connections for the 7414 hex Schmitt inverter**

In order to explain the operation of the oscillator we must consider what happens when power is first applied to the circuit (A in the waveform diagram of Fig. 6.7). Furthermore, we shall only be concerned with the first of the two logic gates since the second stage merely acts as an inverter and takes no part in the oscillatory action. The capacitor C will be initially uncharged and thus the voltage across it will be zero. The input to the first logic gate will then be logic 0 whilst its output must be logic 1 by virtue of the inverting action of the gate. The logic 1 state of the output will be represented by a voltage of somewhat less than the 5V supply. Current will thus flow through resistor R (from right to left in

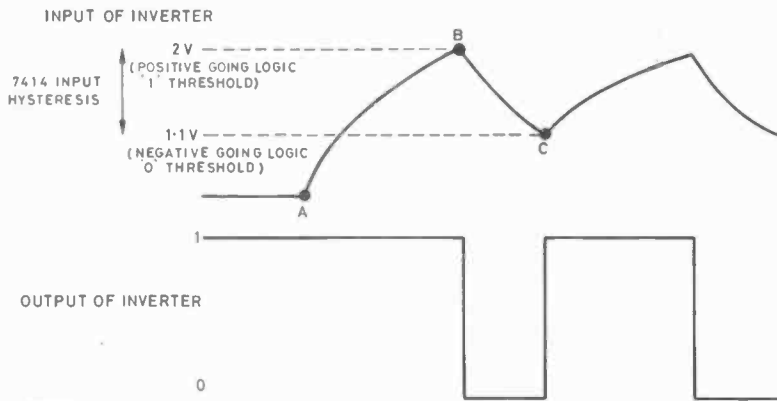

**Fig. 6.7. Waveforms for the Schmitt oscillator**

CRYSTAL FREQUENCY RANGE	C <sub>1</sub>
2 - 4 MHz	220p
4 - 9 MHz	68p
9 - 15 MHz	47p

EG1276

**Table 6.8. Typical values of C and frequency for the circuit of Fig. 6.7**

the circuit diagram) to charge the capacitor. This causes the voltage across the capacitor to rise in an exponential fashion until it reaches the point at which the gate recognises a logic 1 at its input (B on the waveform diagram). For the 7414 this condition occurs at an input voltage of approximately 2V. The time taken to achieve this value of input voltage depends upon the CR time constant (i.e. the product of capacitance, C, and resistance, R). The output of the logic gate rapidly falls to 0V as the gate changes state to produce a logic 0 output. The capacitor now discharges through R (current flowing left to right in the circuit diagram) until the voltage at the input of the gate falls exponentially to the level at which a logic 0 is recognised (C on the waveform diagram). This condition is reached at approximately 1.1V and, at this point, the gate returns to its earlier state with a logic 1 output. The cycle thus repeats itself indefinitely or until the power is removed from the circuit. The output waveform of the oscillator is square and TTL compatible but has a mark to space ratio of approximately 3:1. This is not, however, a very severe drawback since we can achieve a precise 50% duty cycle by simply adding an extra bistable stage as we shall later show.

## CRYSTAL OSCILLATORS

Many applications for clocks require

the oscillator to be exceptionally stable in output frequency and, where precise timing is important, accurately maintained at a particular frequency. Furthermore, in many applications the clock is required to operate at a high frequency, often in excess of 1 or 2MHz. In such applications a quartz crystal may be employed to act as the frequency determining element, as shown in Fig. 6.8. This circuit is somewhat similar to that shown previously with the addition of a crystal and extra capacitor. The circuit can be considered as a free-running oscillator, like those previously described, which is locked to the crystal frequency. The value of C<sub>1</sub> in particular has to be chosen so that the stage will operate at, or near, the desired output frequency with the crystal disconnected. Values for C<sub>1</sub> of 47pF and 220pF are appropriate to the frequency ranges 8 to 15MHz and 2 to 8MHz respectively. A clock frequency of greater than 2MHz may appear to be somewhat high at first sight. It is, however, a relatively simple matter to divide the oscillator output frequency by a fixed amount (e.g. 10, 100, 16, 64 etc.) as we shall see in Part Seven.

Even when the circuit is correctly operating in the crystal locked condition there may still be a very slight error between the actual frequency produced and that desired (or that marked on the crystal). In such a case a small amount of capacitance may be connected in parallel with the crystal to trim the frequency precisely. This capacitance should not normally exceed a value of 68pF. A practical solution would be to connect a 50pF trimmer directly across the crystal terminals and adjusting this component using a digital frequency meter connected to the clock output.

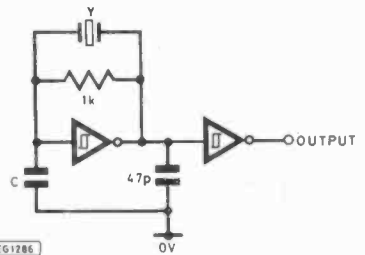

**Fig. 6.8. Typical TTL crystal oscillator**

C	f <sub>min</sub>	f <sub>max</sub>
470μ	0.25 Hz	1 Hz
47μ	2.5 Hz	10 Hz
4μ7	25 Hz	100 Hz
470n	250 Hz	1 kHz
47n	2.5 kHz	10 kHz
4n7	25 kHz	100 kHz
470p	250 kHz	1 MHz
47p	2.3 MHz	9 MHz

EG1277

**Table 6.9. Values of C and corresponding frequency range for the circuit of Fig. 6.8**

## VARIABLE FREQUENCY OSCILLATORS

Occasionally one requires a variable frequency oscillator capable of adjustment over a wide range. Whilst such a signal can, of course, be readily derived from a conventional laboratory signal generator, there is a very simple and effective circuit arrangement based on the 74S124 which provides this function using only two external components.

The circuit of a variable frequency clock using a 74S124 is shown in Fig. 6.9. This produces a reasonable 50% duty cycle square wave output and is capable of reliable operation extending from below 1Hz to beyond 20MHz. The frequency is continuously variable by means of the control potentiometer which provides an adjustment range of approximately 4:1. Typical values of capacitor together with maximum and minimum operating frequencies are shown in Table 6.9.

## TWO-PHASE CLOCKS

In microprocessor systems, and sophisticated logic systems generally, there is often a need for a clock which produces complementary outputs. Such a clock is known as a two-phase (or bi-phase) clock, the typical output waveform of which is shown in Fig. 6.10. Fortunately, complementary outputs are easy to obtain from a bistable

element and thus a two-phase clock may simply consist of an oscillator followed by a bistable. There is, however, one minor complication: the bistable effectively operates as a binary divider and hence the oscillator must

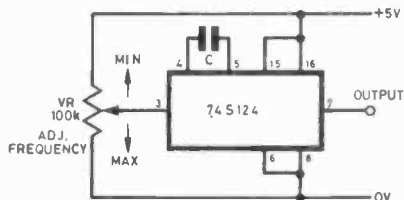

**Fig. 6.9. Variable frequency clock using the 74S124**

RESISTANCE, R	CAPACITANCE, C	APPX. MONOSTABLE PERIOD, t
10k	10p	70ns
2k2	100p	150ns
10k	100p	700ns
2k2	1n	1.5µs
10k	1n	7µs
2k2	10n	15µs
10k	10n	70µs
2k2	100n	150µs
10k	100n	700µs
2k2	1µ	1.5ms
10k	1µ	7ms
2k2	10µ	15ms
10k	10µ	70ms
2k2	100µ	150ms
10k	100µ	700ms

EG1278

**Table 6.10. Typical values of CR and monostable period for the circuit of Fig. 6.9**

operate at twice the desired clock frequency.

## TWO-PHASE CLOCK USING THE 7414 and 7473

A two-phase clock which illustrates some of the principles discussed earlier, is shown in Fig. 6.11. Here the oscillator uses a 7414 hex Schmitt inverter which produces an output at about 2Hz with a mark:space ratio of approximately 3:1. The oscillator output is fed to the clock input of a 7473 J-K bistable. The timing diagram for the circuit is shown in Fig. 6.12. It should be noted that the output frequency is a symmetrical square wave having a frequency which is exactly half that of the oscillator. This arrangement can be tested by inserting 7414 and 7473 devices in sockets A and B respectively of the Logic Tutor and then making the following connections:

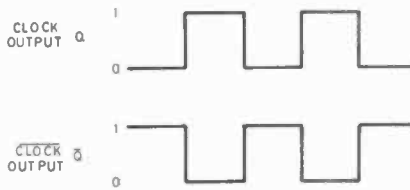

EG1288

**Fig. 6.10. Output waveforms for a two-phase clock**

- A1 to 0V via 220µF capacitor (timing capacitor)
- A2 to A1 via 1kΩ resistor (timing resistor)
- A3 to A2 (linking inverter stages)
- A4 to D1 (D1 indicates oscillator output)
- A7 to 0V (0V)
- A16 to +5V (positive supply)
- B1 to A4 (bistable clock input)
- B2 to logic 1 (preclear to logic 1)
- B3 to logic 1 (K to logic 1)
- B4 to +5V (positive supply)
- B13 to 0V (0V)
- B14 to D2 (D2 indicates the clock output)
- B15 to D3 (D3 indicates the clock output)
- B16 to logic 1 (J to logic 1)

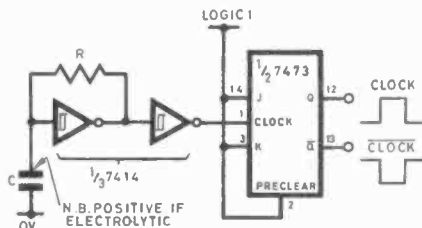

EG1289

**Fig. 6.11. Two-phase clock using 7414 and 7473 devices**

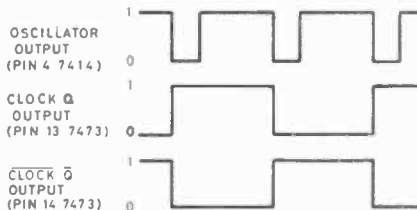

EG1290

**Fig. 6.12. Timing diagram for the circuit in Fig. 6.11**

The state of D1, D2 and D3 are used to indicate the oscillator, clock, and clock outputs respectively. D1 should be seen to flash at approximately 2Hz whilst D2 and D3 flash at exactly half

this rate and will always have opposite states. The speed of operation may be varied by making suitable changes to the value of C. The value of R should, however, not be changed since 1kΩ is optimum for this circuit. Increasing the value much above 1kΩ will render the circuit inoperative (the logic 0 input state is no longer properly maintained) whilst reducing it much below 1kΩ means that an impractically large value of capacitor has to be used in order to obtain a particular clock rate. Values of C, together with approximate output frequencies produced, with R = 1kΩ are shown in Table 6.9.

## MONOSTABLES

The R-S, D, and J-K bistables which we have met so far all possess two stable states. Once put in one or other of the states they will remain in that state until something happens to produce a change of state. There are, however, a number of applications in which a momentary pulse of fixed duration is required. A device which fulfils this function has only one stable state and is known as a monostable.

The action of a monostable is quite simple: its output is initially logic 0 until a level change or edge arrives at its trigger input. This level change can be from 0 to 1 (positive edge trigger) or 1 to 0 (negative edge trigger). Immediately the trigger is received, the output of the monostable changes state to logic 1. Then, after a time interval determined by external components, the output reverts to logic 0. The monostable then awaits the arrival of the next trigger.

Monostables are available in a variety of forms and, whereas it is possible to make a simple form of monostable from individual logic gates, the use of a purpose designed integrated circuit monostable is much to be preferred. To understand the basic principles of monostable pulse generators we will, however, first consider some simple yet effective monostables which employ familiar logic gates.

## SIMPLE MONOSTABLES USING INVERTERS

The simplest method of generating a monostable pulse involves the use of an inverting gate together with an external capacitance-resistance (C-R) network. The arrangement of Fig. 6.13 shows how a negative output pulse (1 → 0 → 1) can be generated by a positive edge trigger. If we need to



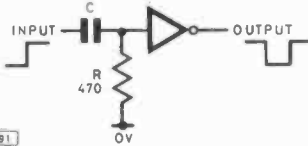

EG1291

**Fig. 6.13. Simple negative-going output positive edge triggered monostable using an inverter**

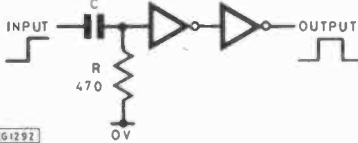

EG1292

**Fig. 6.14. Simple positive-going output positive edge triggered monostable using inverters**

produce a positive output pulse (0 → 1 → 0) then we only need to add a second inverting stage, as shown in Fig. 6.14. In order to explain how the circuit operates we need to consider what happens when the trigger arrives. Initially, capacitor C is uncharged since the voltage level at the input is zero before the trigger pulse arrives. When the trigger does arrive, the input voltage rapidly rises from 0V to approximately 5V. This is conveyed, via the capacitor, to the input of the inverting gate. The inverter recognises a logic 1 input whenever the voltage at its input exceeds approximately 1.5V thus its output changes state, from 1 to 0 when the input voltage passes through 1.5V. The capacitor then charges through the resistor, R, and the voltage at the input of the gate then falls exponentially back towards 0V. When the input voltage falls below approximately 1.5V, the gate recognises a logic 0 input and its output state reverts to logic 1. Waveforms for this circuit arrangement are shown in Fig. 6.15. The time taken for the capacitor to charge depends upon the time constant of the circuit (C x R). Thus the duration of the monostable output pulse can be varied simply by changing the values present.

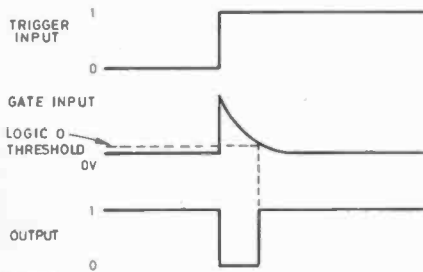

EG1293

**Fig. 6.15. Waveforms for the circuit shown in Fig. 6.13**

Note, however, that a value of 470Ω for R is optimum for this circuit. It should not be increased much above, or below, this value and hence the value of capacitance should be varied in order to achieve different pulse durations. Long duration pulses may require the use of large value capacitors and hence electrolytic types may have to be used. In such cases, it is essential that capacitors are low leakage types and, furthermore, close tolerance varieties are necessary if an accurately defined output pulse duration is required.

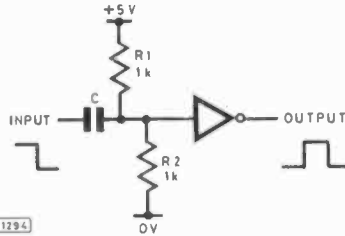

EG1294

**Fig. 6.16. Simple positive-going output negative edge triggered monostable using an inverter**

Figs. 6.16 and 6.17 respectively show how positive and negative output pulses may be derived from a negative edge trigger. These circuits are somewhat similar in operation to those which operate from a positive edge trigger. In this case, however, the input

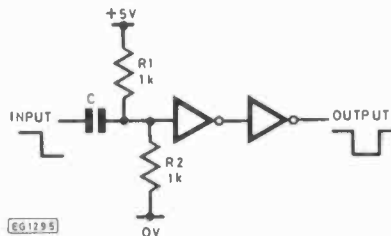

EG1295

**Fig. 6.17. Simple negative-going output negative edge triggered monostable using inverters**

of the inverting gate is biased into the logic 1 condition by means of an additional resistor connected to the positive supply rail. This places a quiescent voltage of approximately 2.5V at the input of the logic gate.

### PULSE GENERATOR USING THE 7404

The two short exercises which follow are designed to confirm the operation of the 7404 hex-inverter as a monostable pulse generator. Both exercises involve the generation of a positive pulse, the first being triggered by a positive edge whilst the second is triggered by a negative edge.

The positive edge triggered monostable follows the arrangement shown in Fig. 6.14 and is constructed using the following links on the Logic Tutor:

- A1 to S1 via 100μF capacitor (+ve to S1)
- A1 to 0V via 470Ω resistor
- A2 to A3
- A4 to D1 (D1 indicates the output)
- A7 to 0V (0V)
- A16 to +5V (positive supply)

The 7404 should be inserted into socket A, taking care to orientate the package so that pin 1 aligns with A1. In the absence of any input from S1, D1 should remain extinguished. Immediately S1 is depressed, however, a positive edge is generated and D1 should flash momentarily (i.e. approx. 0.2 second) and then become extinguished again. If S1 is pressed, and held down, only one flash will be generated. If S1 is pressed and then released repeatedly D1 will flash once for each positive edge generated.

The negative edge triggered monostable follows the arrangement shown in Fig. 6.16 and uses the following links on the Logic Tutor:

- A1 to S1 via 100μF capacitor (-ve to S1)
- A1 to 0V via 1kΩ resistor
- A1 to +5V via 1kΩ resistor
- A2 to D1 (D1 indicates the output)
- A7 to 0V (0V)
- A16 to +5V (positive supply)

The 7404 should again be inserted into socket A. In the absence of any input from S1, D1 should again remain extinguished. When S1 is depressed nothing should happen and D1 should remain extinguished since the circuit is designed to ignore a positive edge transition. Releasing S1, which produces a negative edge, should cause D1 to flash momentarily and then become extinguished again. If S1 is pressed and released repeatedly D1 should flash once for each negative edge generated.

**NEXT MONTH: We continue by looking at the 74121 monostable, pulse stretching techniques, a variable width pulse generator, De Morgan's Theorem, Karnaugh Maps and an intruder alarm for our electronic shop.**

# MICRO-BUS

## and MICROPROMPT

Appearing every month, Micro-Bus now presents ideas, applications and programs for the most popular micro-computers and all micro-related projects so far published in PE. Ideas must be original, and payment will be made for any contribution featured.

### COPYING M/C

Sir—when copying machine code tapes for the UK101 to make back-up copies or for a high speed cassette interface, there can be problems due to some programs overwriting e.g. page zero memory. Also in order to exit machine code games etc. it is very often necessary to press reset, and this may foul up the program making it pointless to attempt to save it.

A way round this problem is to use the NMI (non-maskable interrupt). By connecting a push-to-make switch from ground to either pin 6 of the 6502 or pin 2 of J1 you can jump to any memory location via the NMI vector at HEX 0130. With Cegmon the ideal place to jump to is FE0C, the machine code monitor warm start. To do this enter the monitor by reset M and enter 0130 4C,0C,FE. (0130 JMP FE0C.)

Before the program can be SAVED you need to know the start, end and entry points (RAM addresses) of the code. To make it easy to find the end address it is advisable to fill all RAM with the same number so that when loading the program it will only overwrite the RAM it occupies. For example the original BASIC 4 chip will, when cold-starting, fill all user RAM with HEX 24, and by finding the last "24" overwritten you can find the end address of the code to be saved.

The start and entry (or "Go") addresses can usually be found by watching the screen when loading. When loading with Cegmon the start address appears first, followed by Hex pairs of digits and then the "Go" address. It is possible that the first address may be that of a checksum or other loader so this method may not work in every case. A better way is to use Exmon but you may need a relocated version that doesn't clash with the program for memory space.

To summarise, cold start (if RAM test doesn't fill RAM then fill all RAM with a FOR-NEXT loop e.g. FOR J = 768 TO 16348 : POKE J,36 : NEXT), then enter the machine code monitor and enter 0130 4C,0C,FE. Now LOAD the program to be SAVED and note down the start address and entry address when they appear on the screen—but you'll have to be ready as they will disappear almost immediately. The

program or game will start but press the NMI switch and the computer will jump to the monitor warm start. Cegmon's tabulate command will assist in finding the last RAM location before all the "24s"—you can now tell the end address. Finally SAVE by typing S START,END ENTRY e.g. S 0240,0FFF 0800.

Here are some useful routines:

To jump out of BASIC and load M.C.:  
POKE 251,1 : &GOE F988

or

POKE 251,1 : CALL -1655

To jump out of M.C. and run BASIC :

JSR EA477

JMP EA5C2

If saving non-continuous blocks of RAM then the "Go" address is EA2E e.g. S 0235,02FF EA2E then S 1C00,1CFF 0000 .

To double space text on screen : POKE 15,0 .

To prevent carriage returns half way along lines when for example printing "TEST", within a loop : POKE 14,0 (within the loop).

To LIST within a program without returning to command mode :

POKE 4,194 : POKE 5,165 : LIST : POKE 4,195 : POKE 5,168

( for BASIC 5 after LIST put POKE 4,136 : POKE 5,146 )

If you have BASIC 5 from Premier then try POKEing 316 with 63 or 65 when doing blocks, vertical lines etc.

Dave Henniker,  
Edinburgh.

### UK101 REM REMOVER

Sir—I have a UK101 with 48K of RAM and the original monitor.

The following program may be of interest to your readers. It is a "REM remover" for UK101. As the program is fairly long (303 bytes) it is shown as a memory dump. The program occupies locations 1E80 to 1FAF. Memory will need restricting if the program is to be resident while BASIC programs are running.

To use the program, have the code resident and load a BASIC program with lots of REMs. It is worthwhile doing a ?FRE(I) at this point. Press reset, M, 1E80 and G. The program returns to BASIC when it has finished. All REMs should have been

removed. Do a ?FRE(I) to see how much space has been recovered.

S. Jaworski,  
Walsall.

```
1E80 A9 01 85 30 A9 03 85 31
1E88 A9 00 85 38 A0 00 EA B1
1E90 30 D0 2E C8 B1 30 D0 29
1E98 A5 38 F0 22 A9 00 A8 91
1EA0 36 C8 91 36 38 A5 30 E5
1EA8 36 85 36 A5 31 E5 37 85
1EB0 37 38 A5 7B E5 36 85 7B
1EB8 A5 7C E5 37 85 7C 4C 74
1EC0 A2 A0 00 EA B1 30 85 32
1EC8 C8 B1 30 85 33 A0 04 EA
1ED0 B1 30 C9 8E D0 1B A5 38
1ED8 D0 0C A5 30 85 36 A5 31
1EE0 85 37 A9 01 85 38 A5 32
1EE8 85 30 A5 03 85 31 4C 8C
1EF0 1E A5 38 D0 2D A0 05 EA
1EF8 B1 30 F0 EA C9 8E F0 04
1F00 C8 4C F8 1E 18 98 65 30
1F08 85 36 A9 00 65 31 85 37
1F10 A9 00 88 91 30 A8 A5 36
1F18 91 30 C8 A5 37 91 30 4C
1F20 E2 1E 38 A5 30 E5 36 85
1F28 2C A5 31 E5 37 85 2D 38
1F30 A5 7B E5 2C 85 7B A5 7C
1F38 E5 2D 85 7C A5 36 85 2E
1F40 A5 37 85 2F A5 30 85 34
1F48 A5 31 85 35 A0 00 EA 38
1F50 B1 30 85 32 E5 2C 91 30
1F58 C8 B1 30 85 33 E5 2D 91
1F60 30 88 A5 33 F0 0B A5 32
1F68 85 30 A5 33 85 31 4C 4C
1F70 1F A5 32 D0 F1 A9 00 91
1F78 30 C8 91 30 88 A0 00 EA
1F80 B1 34 91 36 E6 36 E6 34
1F88 A5 34 D0 02 E6 35 A5 36
1F90 D0 02 E6 37 A5 37 C5 7C
1F98 D0 E6 A5 36 C5 7B D0 E0
1FA0 A5 2E 85 30 A5 2F 85 31
1FA8 A9 00 85 38 4C 8C 1E
```

### HELP!

Sir—I would very much like to hear from any reader who might be in a position to supply me with either a R.O.M., tape or just a listing of the full advertised plot routines for the Computer User Aids UK101 High Resolution Board.

Harry Odes,  
London.

## ZX81 SCREEN SAVE

Sir—This should interest owners of the ZX81 (16K), and provide a means whereby the contents of the screen can be recorded on tape and then retrieved at a later date.

The program puts the contents of the display file into a numeric string, which is recorded on tape following the command Save. After a Load instruction this same string is loaded into memory and on the command GOTO 50 the string is POKED into the new display file. There is just one important proviso: Do not use the instruction Run, as its use will wipe out the string and cause the program to crash. Lines 18, 40, 42, 52, 54, 56, 76 and 78 check for just such a crash and advise the user should it happen.

The Screen Save program is meant to run with any other user program (space permitting) and has been specially condensed into less than 100 lines such that it can be sandwiched into existing programs. To illustrate the point, Screen Save (lines 10-80) has been written in conjunction with "Cheese Nibbler" (lines 95-130).

To operate the program/programs run "Cheese Nibbler" at 100. When an interesting pattern presents itself, press any key which will cause the display to be memorised in "A" string. At this stage the program and the display can be taped by "SAVE Screen Save". At a later date the tape can be loaded back with "LOAD

Screen Save". The original display is available on the command "GOTO 50" or the "Cheese Nibbler" program is entered on the instruction "RUN 100". The illegal command "RUN" or "RUN 50" will cause a crash into the user advice in line 78.

Incidentally I do not claim any originality for "Cheese Nibbler"; it is straight out of the ZX81 BASIC programming book chapter 18.

J. Vella,  
Carlisle.

```
10 REM "SCREEN SAVE"
12 REM "TO RETRIEVE DISPLAY,
    ASK ZX81 TO GOTO 50"
14 REM "A,C,D,E,L,P,Q,V USED AS
    SUBSCRIPTS IN PRG 1-90"
16 REM "MAIN PRG AT 100"
18 GOTO 76
20 FAST
22 LET D=PEEK 16396+256*
    PEEK 16397
24 LET V=PEEK 16400+256*
    PEEK 16401
26 LET L=V-D
28 DIM A(L)
30 LET Q=0
32 FOR P=D TO (V-1)
34 LET Q=Q+1
36 LET A(Q)=PEEK P
38 NEXT P
40 LET E=PEEK 16405
```

```
42 POKE 16507, E
44 PRINT AT 21, 0; " DISPLAY
    SAVED IN MEMORY "
46 SLOW
48 GOTO 100
50 FAST
52 LET C=PEEK 16507
54 LET E=PEEK 16405
56 IF E>C+1 OR E<C-1 THEN
    GOTO 76
58 LET D=PEEK 16396+256*
    PEEK 16397
60 LET V=PEEK 16400+256*
    PEEK 16401
62 LET Q=0
64 FOR P=D TO (V-2)
68 POKE P, A(Q)
70 NEXT P
72 SLOW
74 GOTO 140
76 SLOW
78 PRINT " YOU HAVE WIPED OUT
    THE DATA RELOAD TAPE
    AND GOTO 50 MAIN
    PRG AT 100"
80 STOP
95 REM "CHEESE NIBBLER"
100 PLOT INT (RND*64), INT (RND*44)
110 UNPLOT INT (RND*64), INT
    (RND*44)
120 IF CODE INKEY$=0 THEN
    GOTO 100
130 GOTO 20
140 STOP
NOTE: Bold characters represent inverse video
```

# Readout...

## Temperature Sense

Sir—As a regular reader of PE, I was interested in the article *Gas Saver* in the December issue. The point of my letter concerns additional experiments (using diode sensors on a solid fuel system), and these included monitoring the hot water tank temperature to obtain a differential control of the system in a similar manner to the author's; and there may be a simpler method of assessing the hot water tank temperature indirectly. This entails siting the "remote" sensor at the boiler end of the hot water return pipe rather than on the storage tank itself.

Due to the exchange losses in the boiler the temperature in the return pipe will initially be lower than the outflow pipe, but will increase as less heat is absorbed in the heat exchanger, and it is possible to obtain a correlation between the pipes' differential and tank temperature.

The reason for my suggestion is two-fold—it removes the possible requirements of any structural work for the feed wire and access to the tank, and therefore reduces the feed wire to a foot or two. The length of this lead caused me problems, not structural as I only had a free lead, but I found that due to the length of

the lead my central heating was being operated by my son's CB, even after I used screened lead and attempted several filtering methods.

This suggestion is offered to anyone suffering from a similar problem, as it would not appear to entail any circuit changes, and the original calibration could accommodate it.

N. L. Smith,  
Stoke-on Trent.

## Chip Query

Sir—In your current issue is a letter by E. J. Hatch about the series "Introduction to Digital Electronics". I endorse what he says but I would like to query your reply, giving a list of necessary i.c.'s; the last of these is given as 74S124, which doesn't exist.

Could you please tell me what was intended? Also do we need more than one of any of these i.c.'s?

J. A. J. Jarvis  
Chester.

We are sorry but an error did in fact creep into our reply. The 74S124 should have been a 74S124 which is available from Watford Electronics.

Only one of each of the i.c.s is necessary.

# BAZAAR

**NEEDED** to complete collection: 'Practical Electronics' volume One issue Three (January 1965) any price considered. Pete Wilcox, Cottage No. 2, Kilduncan Farm, Kingsbarns, Nr. St. Andrews, Fife, Scotland KY16 8QF. Tel: St. Andrews 76161, Ext. 7269, 9a.m.-5.30p.m.

**UK101**, cased, Cegmon-screen and keyboard expansions. 20K RAM, five extended ROMS, sound, software, manuals. £100. D. Fellows, 26 Westbourne Avenue, Emsworth, Hants, PO10 7QU.

**ACORN** Atom 12K RAM 12K ROM, software including asteroids invaders power supply leads and manuals included £120 o.n.o. Ian Wood, 118 Burford, Brookside, Telford, Shropshire, TF3 1LL. Tel: Telford 592973.

**FREE!** Diodes small types. Send s.a.e. by return. Also clearing bags of components. Wanted C.B. sets. Dave, 29 St. Johns Close, Leatherhead, Surrey.

**TEKTRONIX** oscilloscopes, dual trace, dual timebase. Good condition. 545A £130. 545B £160. Airmec type 399 oscillator £35. T. J. L. Haley, 8 Woodhall Gate, Pinner, Middlesex. Tel: 01-868 4221.

**2716-1/2** Intel. Eproms. £1 each or £30 the lot (35 Eproms). An exchange would be considered (EG 6116 RAMS). L. Faragher, 17 Lyndene Close, Earlsilton, Leics. Tel: Hinckley (0455) 46354.

**ELECTRIC** piano with pedals (soft and sustain). Has 3 voices: piano, honky-tonk and harpsichord, £130. Mr. A. R. Andrews, 6 Lower Bevendean Ave, Brighton, E. Sussex BN2 4FE. Tel: (0273) 606755 Ex. 608 (office hours).

# P.E. STAR DESK

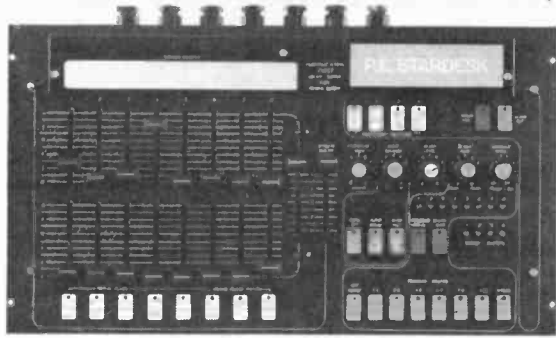

A full kit of parts for this exciting project including case, panel, P.C.B. etc. is available from us for **£195\***  
\*Includes VAT & Carr.

**MOSFET AMPLIFIERS** – 100/200W KIT or COMPLETE  
A range of top quality amplifiers to suit all requirements. Two tone front panel – compact – reliable – up to date circuitry.

SLAVE Amplifiers	AP100 100W	Kit Complete	AP200 200W	£42	£49
Two outputs 4/8 ohms	AP200 200W	£62	£69		
<i>(Illustrated)</i>					
<b>TWO</b> input general purpose – two volume controls – wide range bass/ treble 4/8 ohm outputs – suit mics & all instruments, disco etc.	AP100S 100W	£51	£59		
<b>SIX</b> input P.A. amplifiers. Six volume controls – three sets bass/ treble controls – presence – master – echo in/out – slave output – two outputs 4/8 ohms – suits all mics, musical instruments, disco etc.	AP200S 200W	£69	£79		



Kit Complete  
AP100M 100W £69 £79  
AP200M 200W £89 £99  
N.B. Carr. on all amplifiers £4

Telephone your order on 01-684 8007 or send Cash/ Cheque/ Credit Card No. to:

**BENSHAM RECORDING LTD.**

327-333 Whitehorse Road, Croydon, Surrey CR0 2HS.  
Shop open 9am-5pm Mon-Sat.

Please allow 14 days for delivery.



# ELECTROVALUE

Your **SPECIALIST SUPPLIERS** for **SOLDER TOOLS**



From a simple 15 watt model to a precision temperature controlled iron, we stock solder irons to suit all manual requirements together with supporting stocks of bits, de-solder tools, materials, etc.

## ANTEX

C.240 – 15W/240V;  
CSCN – 15W/240V  
CS – 17W/240V  
CSBP – 17W/240V + 13A plug  
XS – 25W/240V  
XSBP – 25W/240V + 13A plug  
Replacement bits from 3/32" to 1/4"

De-solder heads, stands, elements and handles.

## ERSA

'Sprint' high speed iron: 80/150W, 240V. Heats in 10 seconds!

## ORYX

Temperature controlled solder iron TC.82 45W/240V with scale.  
Oryx 50 – 50 watt version of above.

### Standard types

Oryx 30 – 30W/240V

Viking – 27W/240V

Oryx M3 – 17 watts, 12 volts.

A wide range of replacement tips available for all models, also tips from 0.8 to 6.4mm dia. and flat tips

Oryx safety stand.

Oryx de-solder tool.

### MINIATURE SOLDER STATION

SOLDER and DE-SOLDER BRAID SOLDER in many grades

Please mention PE when sending for latest free A-Z list.

**BRITAIN'S LEADING QUALITY COMPONENT SUPPLIERS - SEND FOR FREE 32 PAGE A-Z LIST**  
**ATTRACTIVE DISCOUNTS - FREE POSTAGE - GOOD SERVICE & DELIVERY**

**ELECTROVALUE LTD**

28 St. Judes Rd.,  
Englefield Green, Egham,  
Surrey TW20 0HB.

(0784) 33603; Telex 264475. North – 680 Burnage Lane, Manchester.

061-432 4945.

EV Computing Shop –

700 Burnage Lane, Manchester. 061-431 4866.

**ACCESS AND  
BARCLAYCARD  
Phoned Orders  
Welcome**

5

# FREE CAREER BOOKLET

Train for success in **Electronics Engineering, T.V. Servicing, Electrical Engineering**—or running your own business!

ICS have helped thousands of ambitious people to move up into higher paid, more secure jobs in the fields of electronics, T.V., electrical engineering—now it can be your turn. Whether you are a newcomer to the field or already working in these industries, ICS can provide you with the specialised training so essential to success.

## Personal Tuition and 80 Years of Success

The expert and personal guidance by fully qualified tutors, backed by the long ICS record of success, is the key to our outstanding performance in the technical field. You study at the time and pace that suits you best and in your own home.

You study the subjects you enjoy, receive a formal Diploma, and you're ready for that better job, better pay.

**TICK THE FREE BOOKLET YOU WANT AND POST TODAY**

### ELECTRONICS ENGINEERING

A Diploma Course, recognised by the Institute of Engineers & Technicians as meeting all academic standards for application as an Associate.

### T.V. & AUDIO SERVICING

A Diploma Course, training you in all aspects of installing, maintaining and repairing T.V. and Audio equipment, domestic and industrial.

### ELECTRICAL ENGINEERING

A further Diploma Course recognised by the Institute of Engineers & Technicians, also covering business aspects of electrical contracting

### RUNNING YOUR OWN BUSINESS

If running your own electronics, T.V. servicing or electrical business appeals, then this Diploma Course trains you in the vital business knowledge and techniques you'll need

Name .....

Address .....

**ICS**

ICS  
Dept ED134  
160 Stewarts Road,  
London SW8 4UJ.



01 622 9911  
tall hours

# INDEX TO ADVERTISERS

A.C. Electronics	64
Alcon Instruments	46
Ambit International	4
Audio Electronics	6
Bensham Recordings	63
Bimsales	66
Bi-Pak	9
British National Radio & Electronics School	7
Clef Products	22
Cricklewood	Cover 3
C.R. Supply Co, The	64
C-Tec Security	64
Display Distribution	46
Electronic Brokers	8
Electronic Mail Order Ltd.	64
Electrovalue	63
Global Specialties	21
Greenweld	8
Hallett Gordon	64
ICS Intertext	63
ILP Electronics	4
Institution of Diagnostic Engineers	65
London Electronics College	64
Maplin	22 & Cover 4
Marco Trading	66
Midwich	6
Millhill Supplies	66
Modern Book Co.	65
Parndon Electronics	66
Phonosonics	46
P.K.G. Electronics	65
Powertran	Cover 2
Radio Component Specialists	65
Radio & T.V. Components	10
Riscomp	10
Scientific Wire Co, The	65
Simpsons Electronic Alarms	64
Sparkrite	45
Swanley Electronics	22
T.K. Electronics	5
Watford	2 & 3

## PARNDON ELECTRONICS LTD.

Dept. 21, 44 Paddock Mead, Harlow, Essex CM18 7RR Tel: 0279 32700

**RESISTORS:**  $\frac{1}{4}$  Watt Carbon Film E24 range  $\pm 5\%$  tolerance. Bandollered and colour coded. Full Range 1R0-10M £1.00 per hundred mixed (Min 10 per value), £8.50 per thousand mixed (Min 50 per value). Special stock pack 60 values, 10 of each £5.50

**RECTIFIERS**  
 1A 3A  
 50V 3p 14p  
 100V 4p 14p  
 200V 5p 14p  
 400V 6p 19p  
 600V 8p 20p  
 1000V 9p 25p

**$3\frac{1}{2}$  Digit LCD Display:** 1 colon, 3 decimal points, plus/minus sign and lo bat indicator. Complete with low power 7106 display driver. Driver set at £8.95 Display £3.50 each Driver £6.50 each

**DIODES:** IN4148 £1.60 per hundred.

**DIL SOCKETS** 8 pin - 10p. 14 pin - 11p. 16 pin - 12p. 18 pin - 19p. 20 pin - 21p. 22 pin - 23p. 24 pin - 25p. 28 pin - 27p. 40 pin - 42p.

Full List Available - Send SAE

ALL PRICES INCLUDE V.A.T. & POST & PACKING - NO EXTRAS  
 MIN ORDER - UK £1.00 OVERSEAS £5 CASH WITH ORDER PLEASE  
 Same Day Despatch

## BUY NOW WHILE STOCKS LAST!

**MULTI-METER SPECIAL**  
 Complete with rechargeable cells and leads, etc. Russian type U4324 20,000 O.P.V.  
 D.C. Voltage: 0.6, 1.2, 3, 12, 30, 60, 120, 600, 1200;  
 A.C. Voltage: 3.6, 15, 60, 150, 300, 600, 900;  
 D.C. Intensity M/A: 0.06, 0.6, 6, 60, 600, 3000;  
 A.C. Intensity M/A: 0.3, 3, 30, 300, 3000;  
 D.C. Resistance: 0.2, 5, 50, 500, 5000, kOhm;  
 g.e. level dB: -10 to +12.

**£12 FANTASTIC SPECIAL PRICE:** including P/P and VAT

### TRANSFORMERS

British made transformers at very attractive prices.

Primary	Secondary	Current	1+	10+	100+
240v:	4.5-0-4.5v	400m/a	50p	45p	35p
240v:	6-0-6v	100m/a	58p	52p	43p
240v:	6-0-6v	500m/a	65p	60p	48p

(Postage & Packing: 45p per transformer or £1.60 per 10, £4.50 per 100)

complete range of components. Includes Special Offer list, order form and pre-paid envelope. Please add 15% VAT to the above prices.

**MARCO TRADING, DEPT. PE3,**  
 THE MALTINGS, HIGH STREET, WEM, SHROPSHIRE, SY4 5EN.  
 All orders despatched by return of mail. Tel: (0939) 32763



**MULTIBLOC**  
 A 4-way 13A extension socket. PVC body with internal cable grip. Fitted with 13A fuse and a neon indicator. Max total load - 13A 250V. L: 10.5", W: 2.5". Price: £3.95 each plus VAT, 35p P&P.



Send now for our latest catalogue. 35p plus 30p P+P. Over 72 pages packed with

**Bimconsoles** - Metal Brown base, Beige top

Part No.	A	B	C	D	E	
BIM 2601	178	51	210	38.5	70	10.96
BIM 2602	280	51	210	38.5	70	12.19
BIM 2603	381	51	210	38.5	70	14.10
BIM 2604	483	51	210	38.5	70	16.01
BIM 2605	480	51	261	38.5	70	17.85
BIM 2701	178	76	210	38.5	70	11.52
BIM 2702	280	102	210	38.5	70	13.40
BIM 2703	381	102	210	38.5	70	14.86
BIM 2704	483	102	210	38.5	70	16.97

**Bimconsoles** - ABS Black or Grey base with Grey Aluminium top

BIM 6005	105	55.5	143	31.5	37.5	2.25
BIM 6006	170	55.5	143	31.5	37.5	2.80
BIM 6007	170	81.8	21.8	31.5	57.8	3.85

### BIMBOARDS

Prototype with plug-in breadboards. Component support brackets supplied with all except Eurobreadboard

Type	Number of Contact Points	
Eurobreadboard	500	6.25
Eurobreadboard PCB	500	0.75
Bimboard 1	550	6.55
Bimbusstrip	80	2.50
Bimboard PCB	630	1.44
Bimboard Layout Pad		0.46
MP Urobreadboard	1422	17.25
Bimboard Designer		77.00

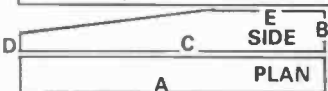

All prices inc VAT. Add 60p per order on Bimboards, £2.30 per order on Bimconsoles for p&p. SAE for full list. Mail Order only.



### BIMSALES

Dept PE4, 48a Station Road, Cheadle Hulme, Cheadle, Cheshire, SK8 7AB. Tel: 061 485 6667.

## STORAGE CABINETS

Steel cabinets, 12" wide x 5 1/2" deep x 22" high finished blue with clear plastic drawers.

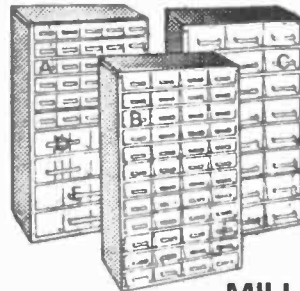

Available units:-	
Type	Drawers
2260	60 x A
2248	48 x B
2224	24 x C

Type	Drawers
2216	16 x D
2208	8 x E
2236	30 x A, 4 x D, 2 x E

Price each £22.75  
 Price per 3 ONLY £60.00 (inc. p&p and VAT)

### MILLHILL SUPPLIES

66 THE STREET, CROWMARSH, WALLINGFORD OX10 8ES. Tel. 0491 38653  
 Delivery within 7 days.

Access/Barclaycard welcome or cheque/PO to:-





FOR FULL DETAILS  
PLEASE CONSULT THE  
**CRICKLEWOOD**  
CATALOGUE  
NOW ONLY 60p + SAE FREE  
TO SCHOOLS, COLLEGES ETC.

**CRICKLEWOOD**  
ELECTRONICS LTD.  
40 CRICKLEWOOD BROADWAY  
LONDON NW2 3ET  
01-452 0161/01-450 0995 Tlx: 914977

This list contains only a fraction of  
**CRICKLEWOOD'S** stock. Please add  
60p p & p / 15% VAT to all orders.  
Official orders from schools, colleges,  
Govt. Depts. etc. welcome.

RESISTORS	Siemens	7491	44p	74LS161	50p	4072	19p	1 Amp TO220	40412	90p	BC338	15p	BFY50	23p	ZTX50C	14p	6 amp type	SL480	2.97	Single sided
CARBON FILM		7492	44p	74LS162 <td>50p</td> <td>4073 <td>19p</td> <td>7905T</td> <td>40673 <td>70p</td> <td>BC440</td> <td>32p</td> <td>BFY51</td> <td>23p</td> <td>ZTX50T</td> <td>14p</td> <td>Square with hole</td> <td>SL490 <td>3.40</td> <td>100 - 160 210</td> </td></td></td>	50p	4073 <td>19p</td> <td>7905T</td> <td>40673 <td>70p</td> <td>BC440</td> <td>32p</td> <td>BFY51</td> <td>23p</td> <td>ZTX50T</td> <td>14p</td> <td>Square with hole</td> <td>SL490 <td>3.40</td> <td>100 - 160 210</td> </td></td>	19p	7905T	40673 <td>70p</td> <td>BC440</td> <td>32p</td> <td>BFY51</td> <td>23p</td> <td>ZTX50T</td> <td>14p</td> <td>Square with hole</td> <td>SL490 <td>3.40</td> <td>100 - 160 210</td> </td>	70p	BC440	32p	BFY51	23p	ZTX50T	14p	Square with hole	SL490 <td>3.40</td> <td>100 - 160 210</td>	3.40	100 - 160 210
5% HI STAB		7493	44p	74LS163 <td>50p</td> <td>4075</td> <td>19p</td> <td>7912T</td> <td>40822</td> <td>1.00</td> <td>BC441</td> <td>33p</td> <td>BFY52</td> <td>23p</td> <td>ZTX50Z</td> <td>14p</td> <td>PW01 100 99p</td> <td>SN76003</td> <td>2.95</td> <td>100 - 220 250</td>	50p	4075	19p	7912T	40822	1.00	BC441	33p	BFY52	23p	ZTX50Z	14p	PW01 100 99p	SN76003	2.95	100 - 220 250
LOW NOISE	10M	7494	72p	74LS164 <td>50p</td> <td>4076</td> <td>45p</td> <td>7915T</td> <td>40871</td> <td>1.00</td> <td>BC480</td> <td>32p</td> <td>BFY53</td> <td>23p</td> <td>ZTX50Z</td> <td>14p</td> <td>PW02 100 99p</td> <td>SN76013</td> <td>2.95</td> <td>203 - 114 240</td>	50p	4076	45p	7915T	40871	1.00	BC480	32p	BFY53	23p	ZTX50Z	14p	PW02 100 99p	SN76013	2.95	203 - 114 240
10% TO 10M		7495	35p	74LS165 <td>50p</td> <td>4077</td> <td>45p</td> <td>7917T</td> <td>40872</td> <td>1.00</td> <td>BC481</td> <td>33p</td> <td>BFY54</td> <td>23p</td> <td>ZTX50Z</td> <td>14p</td> <td>PW04 100 130</td> <td>SN76023</td> <td>2.95</td> <td>233 - 220 520</td>	50p	4077	45p	7917T	40872	1.00	BC481	33p	BFY54	23p	ZTX50Z	14p	PW04 100 130	SN76023	2.95	233 - 220 520
1/4W 24 2p		7496	1.19	74LS168 <td>1.0</td> <td>4078</td> <td>19p</td> <td></td> <td>AC125</td> <td>45p</td> <td>BC516</td> <td>40p</td> <td>BSK20</td> <td>24p</td> <td>ZTX53C</td> <td>24p</td> <td>PW06 600 1 30</td> <td>SN76033</td> <td>2.95</td> <td>Double Sided</td>	1.0	4078	19p		AC125	45p	BC516	40p	BSK20	24p	ZTX53C	24p	PW06 600 1 30	SN76033	2.95	Double Sided
1/2W 24 2p		7497	1.19	74LS169 <td>1.0</td> <td>4081</td> <td>19p</td> <td></td> <td>AC126</td> <td>32p</td> <td>BC517</td> <td>40p</td> <td>BSK21</td> <td>24p</td> <td>ZTX53C</td> <td>24p</td> <td>PW06 600 1 30</td> <td>TA7204</td> <td>1.99</td> <td>100 - 160 220</td>	1.0	4081	19p		AC126	32p	BC517	40p	BSK21	24p	ZTX53C	24p	PW06 600 1 30	TA7204	1.99	100 - 160 220
1/2W 24 2p		7498	1.19	74LS170 <td>1.0</td> <td>4082</td> <td>19p</td> <td></td> <td>AC127</td> <td>32p</td> <td>BC546B</td> <td>15p</td> <td>BU104</td> <td>2.22</td> <td>ZTX531</td> <td>25p</td> <td></td> <td>TA7205</td> <td>1.20</td> <td>100 - 200 280</td>	1.0	4082	19p		AC127	32p	BC546B	15p	BU104	2.22	ZTX531	25p		TA7205	1.20	100 - 200 280
1/2W 24 2p		7499	1.19	74LS171 <td>1.0</td> <td>4083</td> <td>19p</td> <td></td> <td>AC128</td> <td>32p</td> <td>BC547A</td> <td>14p</td> <td>BU108</td> <td>2.22</td> <td>ZTX535</td> <td>25p</td> <td></td> <td>TA7222</td> <td>1.75</td> <td>203 - 114 290</td>	1.0	4083	19p		AC128	32p	BC547A	14p	BU108	2.22	ZTX535	25p		TA7222	1.75	203 - 114 290
1/2W 24 2p		7500	40p	74LS174	40p	4086	60p		AC132	58p	BC547B	14p	BU109	2.22	ZTX535	25p		TA7223	1.75	213 - 220 530
1/2W 24 2p		7501	40p	74LS175	40p	4089	1.23		AC141K	28p	BC547C	14p	BU109	2.22	ZTX535	25p		TA7224	1.75	213 - 220 530
1/2W 24 2p		7502	40p	74LS181	1.0	4093	19p		AC142K	28p	BC547D	14p	BU126	1.47	N3A4	30p		TBA5000	3.17	Developer for above lido not
METAL FILM		7503	9p	74LS183	1.0	4094	61p		AC151	51p	BC548	12p	BU204	2.25	N821	72p		TBA5001	2.95	50um Sodium Hydroxide
0.4W EXTRA		7504	30p	74LS190	60p	4095A	71p		AC153	55p	BC548A	13p	BU205	1.75	N823	92p		TBA5002	2.95	500ml 2.95
LOW NOISE	10% TO 10M	7505	30p	74LS191	60p	4096	65p		AC155	55p	BC548B	14p	BU206	1.89	N814	6p		TBA5003	2.95	100 - 160 220
10% TO 10M		7506	30p	74LS192	60p	4097	2.88		AC156K	64p	BC548C	13p	BU228	1.98	N916	6p		TBA5004	2.95	100 - 160 220
1/4W 24 2p		7507	30p	74LS193	60p	4098	7.4p		AC176	27p	BC549	13p	BU228	1.98	N916	6p		TBA5005	2.95	100 - 160 220
1/4W 24 2p		7508	30p	74LS194	60p	4099	89p		AC176K	37p	BC549A	14p	BU228	1.98	N916	6p		TBA5006	2.95	100 - 160 220
1/4W 24 2p		7509	30p	74LS195	60p	4102	55p		AC176K	37p	BC549B	14p	BU228	1.98	N916	6p		TBA5007	2.95	100 - 160 220
1/4W 24 2p		7510	30p	74LS196	60p	4103	39p		AC187K	25p	BC550	15p	BU407	1.45	N4005	4.5p		TBA5008	2.95	100 - 160 220
1/4W 24 2p		7511	30p	74LS197	60p	4107	33p		AC187K	25p	BC550C	15p	BU408	1.35	N4005	4.5p		TBA5009	2.95	100 - 160 220
1/4W 24 2p		7512	30p	74LS240	95p	4108	1.26		AC188K	25p	BC550T	15p	BU500	2.95	N4006	6.5p		TBA5500	3.27	100 - 160 220
1/4W 24 2p		7513	30p	74LS241	95p	4111	44p		AC250	29p	BC567A	15p	BU500	2.95	N4007	7p		TBA5501	3.27	100 - 160 220
1/4W 24 2p		7514	30p	74LS242	1.0	4112	48p		AC250	29p	BC567B	15p	BU500	2.95	N4007	7p		TBA5502	3.27	100 - 160 220
1/4W 24 2p		7515	30p	74LS243	1.0	4113	48p		AC250	29p	BC567C	15p	BU500	2.95	N4007	7p		TBA5503	3.27	100 - 160 220
1/4W 24 2p		7516	30p	74LS244	1.0	4114	48p		AC250	29p	BC567D	15p	BU500	2.95	N4007	7p		TBA5504	3.27	100 - 160 220
1/4W 24 2p		7517	30p	74LS245	1.0	4115	48p		AC250	29p	BC567E	15p	BU500	2.95	N4007	7p		TBA5505	3.27	100 - 160 220
1/4W 24 2p		7518	30p	74LS246	1.0	4116	48p		AC250	29p	BC567F	15p	BU500	2.95	N4007	7p		TBA5506	3.27	100 - 160 220
1/4W 24 2p		7519	30p	74LS247	1.0	4117	48p		AC250	29p	BC567G	15p	BU500	2.95	N4007	7p		TBA5507	3.27	100 - 160 220
1/4W 24 2p		7520	30p	74LS248	1.0	4118	48p		AC250	29p	BC567H	15p	BU500	2.95	N4007	7p		TBA5508	3.27	100 - 160 220
1/4W 24 2p		7521	30p	74LS249	1.0	4119	48p		AC250	29p	BC567I	15p	BU500	2.95	N4007	7p		TBA5509	3.27	100 - 160 220
1/4W 24 2p		7522	30p	74LS251	1.0	4120	48p		AC250	29p	BC567J	15p	BU500	2.95	N4007	7p		TBA5510	3.27	100 - 160 220
1/4W 24 2p		7523	30p	74LS252	1.0	4121	48p		AC250	29p	BC567K	15p	BU500	2.95	N4007	7p		TBA5511	3.27	100 - 160 220
1/4W 24 2p		7524	30p	74LS253	1.0	4122	48p		AC250	29p	BC567L	15p	BU500	2.95	N4007	7p		TBA5512	3.27	100 - 160 220
1/4W 24 2p		7525	30p	74LS254	1.0	4123	48p		AC250	29p	BC567M	15p	BU500	2.95	N4007	7p		TBA5513	3.27	100 - 160 220
1/4W 24 2p		7526	30p	74LS255	1.0	4124	48p		AC250	29p	BC567N	15p	BU500	2.95	N4007	7p		TBA5514	3.27	100 - 160 220
1/4W 24 2p		7527	30p	74LS256	1.0	4125	48p		AC250	29p	BC567O	15p	BU500	2.95	N4007	7p		TBA5515	3.27	100 - 160 220
1/4W 24 2p		7528	30p	74LS257	1.0	4126	48p		AC250	29p	BC567P	15p	BU500	2.95	N4007	7p		TBA5516	3.27	100 - 160 220
1/4W 24 2p		7529	30p	74LS258	1.0	4127	48p		AC250	29p	BC567Q	15p	BU500	2.95	N4007	7p		TBA5517	3.27	100 - 160 220
1/4W 24 2p		7530	30p	74LS259	1.0	4128	48p		AC250	29p	BC567R	15p	BU500	2.95	N4007	7p		TBA5518	3.27	100 - 160 220
1/4W 24 2p		7531	30p	74LS260	1.0	4129	48p		AC250	29p	BC567S	15p	BU500	2.95	N4007	7p		TBA5519	3.27	100 - 160 220
1/4W 24 2p		7532	30p	74LS261	1.0	4130	48p		AC250	29p	BC567T	15p	BU500	2.95	N4007	7p		TBA5520	3.27	100 - 160 220
1/4W 24 2p		7533	30p	74LS262	1.0	4131	48p		AC250	29p	BC567U	15p	BU500	2.95	N4007	7p		TBA5521	3.27	100 - 160 220
1/4W 24 2p		7534	30p	74LS263	1.0	4132	48p		AC250	29p	BC567V	15p	BU500	2.95	N4007	7p		TBA5522	3.27	100 - 160 220
1/4W 24 2p		7535	30p	74LS264	1.0	4133	48p		AC250	29p	BC567W	15p	BU500	2.95	N4007	7p		TBA5523	3.27	100 - 160 220
1/4W 24 2p		7536	30p	74LS265	1.0	4134	48p		AC250	29p	BC567X	15p	BU500	2.95	N4007	7p		TBA5524	3.27	100 - 160 220
1/4W 24 2p		7537	30p	74LS266	1.0	4135	48p		AC250	29p	BC567Y	15p	BU500	2.95	N4007	7p		TBA5525	3.27	100 - 160 220
1/4W 24 2p		7538	30p	74LS267	1.0	4136	48p		AC250	29p	BC567Z	15p	BU500	2.95	N4007	7p		TBA5526	3.27	100 - 160 220
1/4W 24 2p		7539	30p	74LS268	1.0	4137	48p		AC250	29p	BC567AA	15p	BU500	2.95	N4007	7p		TBA5527	3.27	100 - 160 220
1/4W 24 2p		7540	30p	74LS269	1.0	4138	48p		AC250	29p	BC567AB	15p	BU500	2.95	N4007	7p		TBA5528	3.27	100 - 160 220
1/4W 24 2p		7541	30p	74LS270	1.0	4139	48p		AC250	29p	BC567AC	15p	BU500	2.95	N4007	7p		TBA5529	3.27	100 - 160 220
1/4W 24 2p		7542	30p	74LS271	1.0	4140	48p		AC250	29p	BC567AD	15p	BU500	2.95	N4007	7p		TBA5530	3.27	100 - 160 220
1/4W 24 2p		7543	30p	74LS272	1.0	4141	48p		AC250	29p	BC567AE	15p	BU500	2.95	N4007	7p		TBA5531	3.27	100 - 160 220
1/4W 24 2p		7544	30p	74LS273	1.0	4142	48p		AC250	29p	BC567AF	15p	BU500	2.95	N4007	7p		TBA5532	3.27	100 - 160 220
1/4W 24 2p		7545	30p	74LS274	1.0	4143	48p		AC250	29p	BC567AG	15p	BU500	2.95	N4007	7p		TBA5533	3.27	100 - 160 220
1/4W 24 2p		7546	30p	74LS275	1.0	4144	48p		AC250	29p	BC567AH	15p	BU500							

Full-travel, full size

# KEYBOARD

Simply plugs into expansion port on your

# SPECTRUM



**KIT ONLY**  
**£39.95**  
**READY-BUILT**  
**£44.95**

Case included in both prices

- ★ Single-key selection of all major multi-key functions.
- ★ Plugs directly into Spectrum expansion port and extends port for other peripherals.
- ★ Can accept Atari-type joysticks (optional extra).
- ★ Absolutely no soldering or dismantling of Spectrum.
- ★ Available in kit-form or ready-built.

The kit is sold in three parts — the Keyboard Main Kit which allows you to make your own arrangements for connection to the Spectrum — the Adaptor Kit which contains the extension board and socket for the expansion port and the cable between the

extension board and the keyboard — and the Case Kit which includes all the necessary mounting hardware.

Order As	LK29G (Keyboard Main Kit)	Price £28.50
	LK30H (Adaptor Kit)	Price £6.50
	XG35Q (Case)	Price £4.95

Full construction details in Projects Book 9.

Also available ready-built for direct connection and including case.

Order As	XG36P (Spectrum Keyboard)	Price £44.95
----------	---------------------------	--------------

## Maplin's Fantastic Projects

Full details in our project books. Price 70p each.

**In Book 1 (XA01B)** 120W rms MOSFET Combo-Amplifier • Universal Timer with 18 program times and 4 outputs • Temperature Gauge • Six Vero Projects.

**In Book 2 (XA02C)** Home Security System • Train Controller for 14 trains on one circuit • Stopwatch with multiple modes • Miles-per-Gallon Meter.

**In Book 3 (XA03D)** ZX81 Keyboard with electronics • Stereo 25W MOSFET Amplifier • Doppler Radar Intruder Detector • Remote Control for Train Controller.

**In Book 4 (XA04E)** Telephone Exchange for 16 extensions • Frequency Counter 10Hz to 600 MHz • Ultrasonic Intruder Detector • I/O Port for ZX81 • Car Burglar Alarm • Remote Control for 25W Stereo Amp.

**In Book 5 (XA05F)** Modem to European standard • 100W 240V AC



Inverter • Sounds Generator for ZX81 • Central Heating Controller • Panic Button for Home Security System • Model Train Projects • Timer for External Sounder.

**In Book 6 (XA06G)** Speech Synthesiser for ZX81 & VIC20 • Module to Bridge two of our MOSFET amps to make a 350W Amp • ZX81 Sound on your TV • Scratch Filter • Damp Meter • Four Simple Projects.

**In Book 7 (XA07H)** Modem (RS232) Interface for ZX81/VIC20 • Digital Enlarger Timer/Controller • DXers Audio Processor • Sweep Oscillator • CMOS Crystal Calibrator.

**In Book 8 (XA08J)** Modem (RS232) Interface for Dragon and Spectrum • Synchime • I/O Ports for Dragon • Electronic Lock • Minilab Power Supply • Logic Probe • Doorbell for the Deaf.

**In Book 9 (XA09K)** Keyboard with electronics for ZX Spectrum • Infra-Red Intruder Detector • Multimeter to Frequency Meter Converter • FM

Radio with no alignment • Hi-Res Graphics for ZX81 • Speech Synthesiser for Oric • VIC Extendboard • ZX81 ExtendRAM • Dynamic Noise Limiter for Personal Cassette Players • TTL Levels to Modem/RS232 Converter • Logic Pulser • Psuedo-Stereo AM Radio • Ni-Cad Charger Timer • Adder-Subtractor • Syndrums' Interface • Microphone Pre-Amp Limiter.

## THE MAPLIN MODEM KIT

Exchange programs with friends, leave or read messages from the various Billboard services, talk to computer bureaux, or place orders and check stock levels on Maplin's Cashtel

service. A Maplin Modem will bring a whole new world to your computer and vastly increase its potential.

Now you can exchange data with any other computer using a 300 baud European standard (CCITT) modem and because the Maplin Modem uses this standard, you could talk to any one of tens of thousands of existing users.

Some computers need an interface and we have kits for the ZX81, VIC20/Commodore 64, Dragon and Spectrum and shortly Atari, whilst the BBC needs only a short program which is listed in Projects Book 8.

A Maplin Modem will add a new dimension to your hobby.

Order As LW99H (Modem Kit) excluding case. Price £39.95.

YK62S (Modem Case) Price £9.95.

Full construction details in Projects Book 5.



## 1984 CATALOGUE

A massive 480 big pages of description, pictures and data and now with prices on the page. The new Maplin catalogue is the one book no constructor should be without. Now includes new Heathkit section. On sale in all branches of W.H. Smith. Price £1.35 — It's incredible value for money. Or send £1.65 (including p & p) to our mail-order address.

## Great Projects From E&MM

Our book "Best of E&MM Projects Vol. 1" brings together 21 fascinating and novel projects from E&MM's first Year.

Projects include Harmony Generator, Guitar Tuner, Hexadrum, Syntom, Auto Swell, Partylite, Car Aerial Booster, MOS-FET Amp and other musical, hi-fi and car projects. Order As XH61R. Price £1.

Post this coupon now for your copy of the 1984 catalogue. Price £1.35 + 30p post and packaging. If you live outside the U.K. send £2.20 or 11 International Reply Coupons. I enclose £1.65

Name .....

Address .....



P.E. 384

608

Despatch by return of post where goods available

## MAPLIN ELECTRONIC SUPPLIES LTD

Mail Order: P.O. Box 3, Rayleigh, Essex SS6 8LR. Tel: Southend (0702) 552911 • Shops at: 159-161 King Street, Hammersmith, London W6. Tel: 01-748-0926. • 8 Oxford Road, Manchester. Tel: 061-236-0281. • Lynton Square, Perry Barr, Birmingham. Tel: 021-356-7292. • 282-284 London Road, Westcliff-on-Sea, Essex. Tel: 0702 554000. • 46-48 Bevois Valley Road, Southampton. Tel: 0703 25831.

All shops closed all day Monday.

All prices include VAT and carriage. Please add 50p handling charge to orders under £5 total value (except catalogue).



# PE LOGIC DESIGN CARD

No.1

PRESENTED FREE WITH PRACTICAL ELECTRONICS MARCH '84

No.1

## DIGITAL LOGIC

Digital logic is based on the idea of only two (binary) states. These two states are known variously as true & false, on & off, logic 1 & logic 0, or more frequently just 1 & 0. A digital signal is always in one of these two states (or moving between them). Digital logic gates allow these signals to be manipulated. Suitable combinations of digital signals and logic gates allow circuits to be built to perform a wide range of useful functions.

## LOGIC SYMBOLS

Digital circuit diagrams use standard symbols to represent logic gates. The most frequently used symbols are from the BS or the MIL series. The common symbols from these two series are shown below.

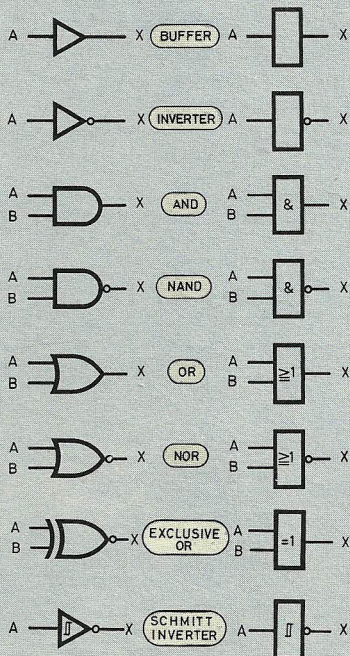

## PIN NUMBERING

TTL i.c.s are usually in dual-in-line (d.i.l.) packages. These have oblong plastic or ceramic bodies which protect the silicon chip. Parallel rows of pins 0.1" apart protrude from the two long sides of the i.c., with a total of usually 14, 16 or 24 pins. The pins are numbered anti-clockwise from 1 when look-

ing from the top (i.e. pins pointing downwards). The end of the package containing pin 1 is identified by an indentation, and/or there is a smaller hole next to pin 1.

## GATE FUNCTIONS

A two-input gate can have 16 possible functions. Not all of these are actually available as logic gates. The table below identifies the possible inputs, with their corresponding outputs, for all 16 functions.

LOGICAL FUNCTION	INPUTS								OUTPUTS
	A=0	B=0	A=0	B=1	A=1	B=0	A=1	B=1	
LOGIC 0	0	0	0	0	0	0	0	0	
A.B	0	0	0	0	0	1	1	1	
n/a	0	0	0	1	0	0	0	0	
A	0	0	0	1	1	1	1	1	
n/a	0	1	0	0	0	0	0	0	
B	0	1	0	1	0	1	1	1	
A ⊕ B	0	1	1	1	0	0	0	1	
A+B	0	1	1	1	1	1	1	1	
A+B	1	0	0	0	0	0	0	0	
A ⊙ B	1	0	0	0	1	0	0	1	
B̄	1	0	1	0	1	0	1	0	
n/a	1	0	1	1	1	1	1	1	
Ā	1	1	0	0	0	0	0	0	
n/a	1	1	0	0	1	0	1	1	
A.B̄	1	1	1	1	1	0	0	0	
LOGIC 1	1	1	1	1	1	1	1	1	

## 7400 TTL FAMILY

Logic families are collections of logic gates based on the same basic gate, and they greatly simplify the construction of logic circuits. Gates from a family all use a common power supply, and they may be connected together using a simple set of rules, safe in the knowledge that they are all compatible. The most common family is the 7400 series of TTL gates. Within this family there are a number of sub-families, and the numbering of TTL i.c.s is according to the following general rules.

### SN74LS86N

- SN Manufacturer's prefix (may be any letters)
- 74 Indicates 7400 series TTL
- LS Indicates which TTL sub-family:

- null = standard
  - H = high speed
  - L = low power
  - 86 Indicates gate function
- LS = low-power Schottky  
 S = Schottky  
 e.g. 00 = quad 2-i/p NAND  
 86 = quad 2-i/p Ex-OR

N Manufacturer's package code e.g. N = plastic d.i.l. pack

Typically, TTL i.c.s are referred to in circuits without any reference to the manufacturer's prefix or suffix, e.g. the device above would be described as a 74LS86.

## LOGIC LEVELS

The voltage levels used to represent logic 0 and logic 1 are defined for TTL signals as below. Voltages between these levels are not permitted TTL levels.

- Gate outputs: Logic 0 0V to +0.8V
- Logic 1 Above +2.4V
- Gate inputs: Logic 0 0V to +0.8V
- Logic 1 Above +2.0V

An unloaded standard TTL gate has output levels of around +0.2V for logic 0 and +3.5V for logic 1. These levels tend to move up and down, respectively, as more gates are connected to the output.

## BOOLEAN SYMBOLS

Boolean Algebra is a shorthand way of representing the behaviour of gates. It uses true and false to represent logic 1 and logic 0. For inputs of A and B, and an output of X, the Boolean shorthand for the common gates is as follows.

- Buffer X = A
- Inverter X = Ā
- AND X = A . B
- OR X = A + B
- NAND X = A . B̄
- NOR X = A + B̄
- Exclusive-OR X = A ⊕ B

## USEFUL IDENTITIES

The following are useful Boolean Identities which allow simplification of logic circuits, or the use of a smaller number of different gates, to perform the same function.

- A + 0 = A
- A + 1 = 1
- A + A = A
- A + Ā = 1
- A . 0 = 0
- A . 1 = A
- A . A = A
- A . Ā = 0
- A ⊕ 0 = A
- A ⊕ 1 = Ā
- A ⊕ A = 0
- A ⊕ Ā = 1
- Ā = A

When looking at inverting gates, each logical inversion introduces an over-rule on the signal (to represent the inversion). Over-rules of identical length cancel out in pairs, as indicated in the last identity.



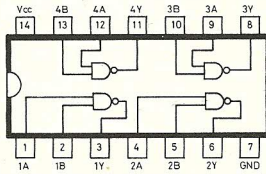

**7400 Quad**  
**2-input NAND**

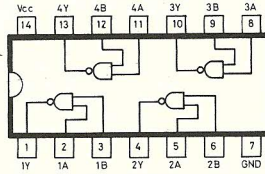

**7401 Quad**  
**2-input NAND oc**

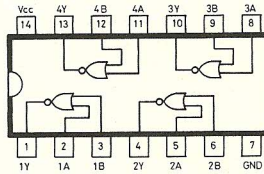

**7402 Quad**  
**2-input NOR**

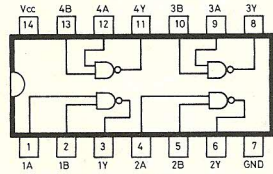

**7403 Quad**  
**2-input NAND oc**

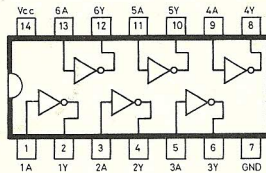

**7404 Hex**  
**inverter**

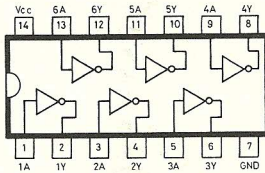

**7405 Hex**  
**inverter oc**

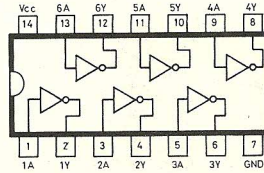

**7406 Hex**  
**inverter 30V o/p**

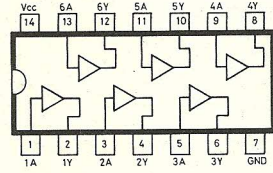

**7407 Hex**  
**buffer 30V o/p**

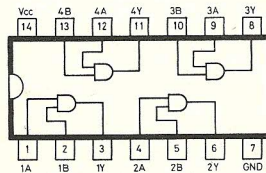

**7408 Quad**  
**2-input AND**

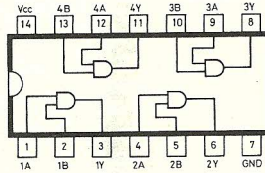

**7409 Quad**  
**2-input AND oc**

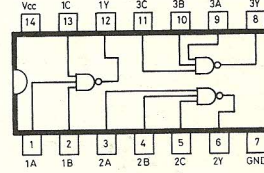

**7410 Triple**  
**3-input NAND**

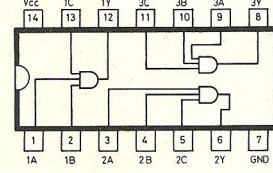

**7411 Triple**  
**3-input AND**

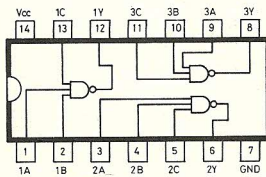

**7412 Triple**  
**3-input NAND oc**

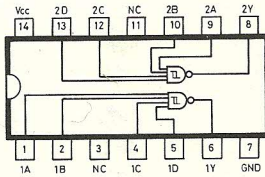

**7413 Dual**  
**4-input NAND Schmitt**

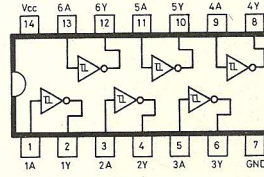

**7414 Hex**  
**inverter Schmitt**

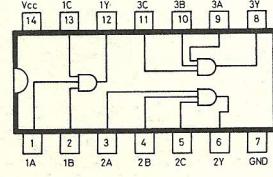

**7415 Triple**  
**3-input AND oc LS**

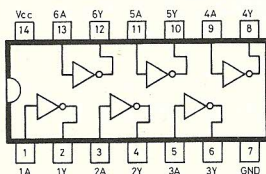

**7416 Hex**  
**inverter 15V o/p**

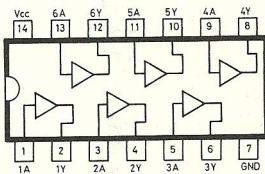

**7417 Hex**  
**buffer 15V o/p**

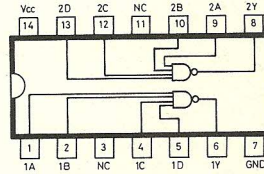

**7420 Dual**  
**4-input NAND**

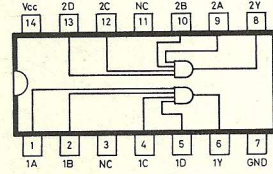

**7421 Dual**  
**4-input AND**

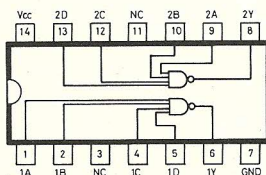

**7422 Dual**  
**4-input NAND oc**

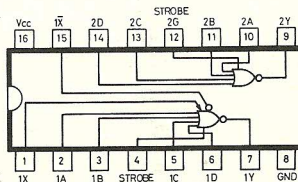

**7423 Dual**  
**4-input NOR expand**

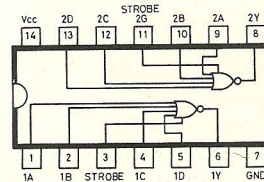

**7425 Dual**  
**4-input NOR strobe**

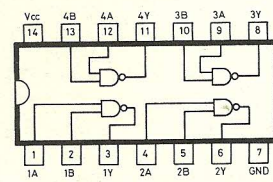

**7426 Quad**  
**2-input NAND high volts**