

**PRACTICAL**

Australia \$1.35 New Zealand \$1.60 Malaysia \$4.95 IR £1.14 (inc. VAT)

# **ELECTRONICS**

**AUGUST 1982**

**75p**

## **Comprehensive HOME ALARM SYSTEM**

- \* **Infra-Red**
- \* **Radar**
- \* **Ultrasonic**

**ALSO INSIDE...**

**Combo  
AMPLIFIER**

# YOUR GUIDE TO THE WORLD OF MICROPROCESSORS

# MICRO-PROFESSOR

*A low cost tool for learning,  
teaching & prototyping.*

**Micro-Professor** is a low-cost Z80 based microcomputer which provides you with an interesting and inexpensive way to understand the world of microprocessors.

**Micro-Professor** is a complete hardware and software system whose extensive teaching manual gives you detailed schematics and examples of programme code. A superb learning tool for students, hobbyists and microprocessor enthusiasts, as well as an excellent teaching aid for instructors of electrical engineering and computer science courses.

The **Micro-Professor** is much more than a teaching device. With it you can do bread boarding and prototyping, designing your own custom hardware and software applications with Z80, 8080 and 8085 compatible code.

The standard 2K bytes of RAM is expandable to 4K, and the standard 2K bytes of ROM can be increased to 8K.

All this plus built-in speaker, a cassette interface, and sockets to accept optional CTC/PIO. Bus is extendable.

As well as being an exciting learning tool, the **Micro-Professor** is a great low-cost board for OEM's.



**Micro-Professor**  
**£79.95**  
+ p&p

**SSB-MPF Speech  
Synthesizer Board**  
**£69.95 + p&p**

A vocabulary of up to 400 words based on the TMS 5200 chip.

**EPB-MPF EPROM  
Programming Board**  
**£84.95 + p&p**

For all +5V 1KB/2KB/4KB EPROMS. Read/Copy/List/Verify Capability

**BASIC-MPF Tiny  
Basic** **£9.95 + p&p**

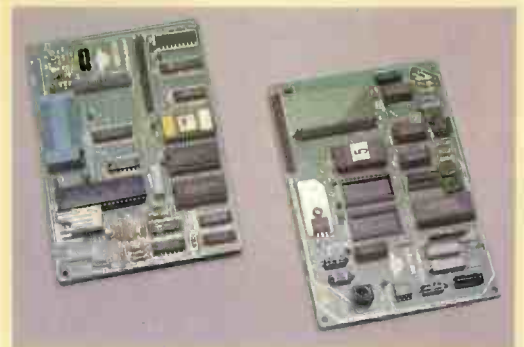

Micro-Professor is a trade mark of Multitech Industrial Corporation. Z80 is a trade mark of Zilog Inc.

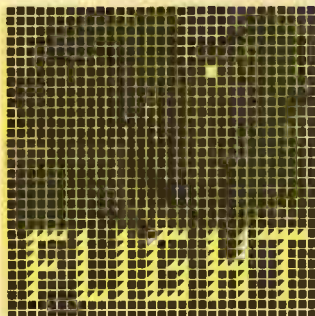

**Flight Electronics Ltd.**

Complete the coupon today! Please allow 28 days for delivery.

Please send me:	Price	Qty	p&p	Name .....
Micro-Professor	£79.95		£2.95	Address .....
SSB-MPF board	£69.95		£2.95	.....
EPB-MPF board	£84.95		£2.95	.....
BASIC-MPF	£9.95		0.50p	.....
			Total	.....

I enclose cheque/P.O. for £.....

Mail order only • Trade enquiries welcome • Bulk order discounts • Prices include VAT

**Flight House, Quayside Rd, Southampton, Hants SO2 4AD**  
**Tel: (0703) 34003/27721. Telex: 477793**

## CONSTRUCTIONAL PROJECTS

<b>COMPREHENSIVE HOME ALARM SYSTEM</b> by <i>Gilbert Davies</i> .. .. .	14
<b>ULTRASONIC</b> —8 metre range, operating at 32.7kHz	
<b>RADAR</b> —30 metre range, operating at 10.687GHz	
<b>INFRA-RED</b> —18 metre range, covering 12 zones	
<b>COMBO AMPLIFIER</b> Part 1 by <i>Fred Judd and E. A. Rule</i> .. .. .	26
The preamplifiers: their performance and construction	
<b>MICROSYNTH</b> Part 3 by <i>A. R. Bradford MSc</i> .. .. .	36
Setting up the synthesiser with test programs	
<b>AUTOMATIC PHOTOGRAPHER</b> by <i>M. J. A. Turner</i> .. .. .	42
If it moves—snap it!	
<b>AUDIO TEST SET</b> Part 2 by <i>Michael Tooley BA and David Whitfield MA MSc</i> .. .. .	48
Conclusion, including measurement examples	

## GENERAL FEATURES

<b>MICRO-PROFESSOR REVIEW</b> by <i>Michael Tooley BA</i> .. .. .	32
An in-depth analysis of this Z80 based teaching computer	
<b>SEMICONDUCTOR UPDATE</b> by <i>R. W. Coles</i> .. .. .	47
Featuring CY360 TL068 SAB8256A	
<b>STRICTLY INSTRUMENTAL</b> by <i>K. Lenton-Smith</i> .. .. .	54
The wonder of Casio .. .	
<b>MICROPROMPT</b> .. .. .	56
Hardware and software ideas for PE computer projects	
<b>INGENUITY UNLIMITED</b> .. .. .	62
Courtesy light delay—CB “Roger Bleep”—Loudspeaker de-thump	

## NEWS AND COMMENT

<b>EDITORIAL</b> .. .. .	11
<b>NEWS &amp; MARKET PLACE</b> .. .. .	12
Including Countdown and Points Arising	
<b>INDUSTRY NOTEBOOK</b> by <i>Nexus</i> .. .. .	25
News and views on the ever changing electronics industry	
<b>BAZAAR</b> .. .. .	41, 52, 55
Free readers' advertisements	
<b>SPECIAL OFFER—CASSETTES</b> .. .. .	45
Regular bargain offer on high quality cassettes	
<b>SPACEWATCH</b> by <i>Frank W. Hyde</i> .. .. .	61
Extra-terrestrial activities chronicled	
<b>PATENTS REVIEW</b> .. .. .	64
Ingenious ideas from around the world	

**OUR SEPTEMBER ISSUE WILL BE ON SALE FRIDAY, AUGUST 13th, 1982**  
(for details of contents see page 40)

© IPC Magazines Limited 1982. Copyright in all drawings, photographs and articles published in PRACTICAL ELECTRONICS is fully protected, and reproduction or imitations in whole or part are expressly forbidden. All reasonable precautions are taken by PRACTICAL ELECTRONICS to ensure that the advice and data given to readers are reliable. We cannot, however, guarantee it, and we cannot accept legal responsibility for it. Prices quoted are those current as we go to press.



**SPEAKERS**

8Ω 0.3W, 2"	2.25"	2.5"	3"
0.3W, 2.5"	40Ω	640	80p
80Ω			80p

**DIODES**

AA119	25		
AA129	15		
AA30	15		
BA100	15		
BAX13	20		
BY100	24		
BY125	12		
BY127	12		
CRC03	250		
QA9	40		
QA47	12		
QA70	12		
QA79	15		
QA81	20		
QA85	15		
QA90	8		
QA91	8		
QA95	8		
QA200	8		
QA202	8		
IN914	4		
IN916	5		
1N4001/2	5		
1N4003	6		
1N4004/5	6		
1N4006/7	6		
1N4148	4		
1N6401	15		
1N5404	16		
1N5406	17		
1N5408	19		
1S44	9		
1S921	9		
6A/100V	40		
6A/400V	50		
6A/800V	65		

**OPTO ELECTRONICS**

LEDs including Clips			
TIL209 Red 3mm	11		
TIL211 Green 3mm	14		
TIL212 Yellow	14		
TIL220 2" Red	14		
0.2" Yel, Grn, Amber	14		
Rectangular LEDs with two part clip, R, G & Y			
Rectangl. Stackable	28		
1A/50V	18		
1A/100V	20		
1A/400V	25		
1A/800V	34		
2A/50V	30		
2A/100V	40		
2A/400V	46		
2A/800V	65		
6A/100V	83		
6A/400V	95		
6A/800V	125		
10A/200V215			
10A/600V298			
25A/200V240			
25A/400V395			
25A/800V395			
BY164	50		
VM18	50		

**0.5" LIQUID CRYSTAL DISPLAYS**

3 1/2 digit	525
4 digit	650
6 digit	750

**8PX25**

28	IL74	45
18	IL074	99
18	IL074	99
18	TL111	75
18	TL117	90
18	ORP11	120
85	ORP12	78
85	ORP11	85
85	2N5777	45
85	4N33	135

**OPTO SWITCH**

Reflective	52
SFHZ05 (detector)	118
TL328 Infra Red (emit)	52
TL328 Infra Red (emit)	52
TL78 (detector)	54
TL38	45
TL81	82
TL780	90

**SPECIAL OFFER**

1 + 25 +

NE555	16p	14p
2114L-3	80p	75p
2114L-2	80p	75p
2532	365p	335p
2716	215p	205p
2732	380p	355p
4116	70p	65p
4816-120ns	225p	205p
6116-150ns	390p	370p
6520/21	115p	105p
6522	320p	295p

**EPSON PRINTERS**

- **MX80T** 10" Tractor Feed, 9x9 matrix, 80 column, 80 CPS, Bi-directional, Centronic Interface. Baud Rate 110-9600. **£275**
- **MX80T** Friction & Tractor Feed plus all the MX80T features. **£325**
- **MX80FT** 3 Has hi-resolution, bit image graphics, Subscript & Superscript, italics & underlining facility plus all the MX80FT features. **£339**
- **MX100** 15 1/2" Fr.&Tr. **£489**

**DIL SOCKETS (TEXAS)**

8 pin	Low profile	Wire wrap
14 pin	8p	25p
16 pin	10p	35p
16 pin	10p	42p
18 pin	16p	52p
20 pin	22p	80p
20 pin	25p	70p
24 pin	25p	70p
28 pin	28p	80p
40 pin	30p	99p

**ZIF DIL SOCKET**

24 way	575p
28 way	850p
40 way	975p

**WATFORD'S Ultimate Monitor IC.**

A 4K Monitor Chip specially designed to produce the best from your: Superboard Series I & II, Enhanced Superboard & UK101. As reviewed by Dr. A. A. Berk in Practical Electronics, June 1981. **Price only £15.00 + 50p P&P.**

**TRIACS**

3A/100V	48
3A/400V	56
3A/800V	85
8A/100V	60
8A/400V	68
8A/800V	115
12A/100V	78
12A/400V	86
12A/800V	135
16A/100V105	
16A/800V220	
25A/400V185	
25A/800V295	
25A/1000V	
30A/400V525	
2T800D	120

**VERO BOARDS**

0.1" Clad Plain	150
0.1" Clad Plain	330
0.1" Vero Strip	144
0.1" S100 Board	£14

**VERO WIRING PEN and Spool** 310p  
Spare Wire (Spool) 75p; Wire Wrapping Stakes 100 250p

**ALUM. BOXES**

3x2x1"	65
4x2x2"	85
4x2x2 1/2"	103
4x4x2 1/2"	120
5x4x2	105
5x2x1 1/2"	90
5x2x1 1/4"	130
5x4x1 1/2"	99
5x4x2 1/2"	120
6x4x2 1/2"	120
6x4x3"	150
7x5x3"	180
8x6x3"	210
10x4 1/2x3"	240
10x7x3"	275
12x5x3"	260
12x8x3"	295

**COPPERCLAD BOARDS**

Fibre Single-sided	SRP
Glass sided	9.5"x8.5"
6"x6"	90p
6"x12"	150p

**VERO BOARDS 0.1"**

VQ Board	150
'DIP Board	330
Vero Strip	144
S100 Board	£14

**PROTO-DECS**

Veroblock	375
S-Dec	350
Eurobreadboard	520
Spd. Inserter	118p
Pin Inserter Tool	162p
Superstrip SS2	£13

**EDGE CONNECTORS**

2x10 way	156
2x15 way	140p
2x18 way	180p
2x22 way	199p
2x23 way	210p
2x25 way	225p
2x30 way	245p
2x36 way	295p
2x40 way	315p
2x43 way	395p
2x75 way	550p

**ANTEX Soldering Irons**

C15W	450
CX17W	475
CX15W	490
X25W	500

**Gas & Smoke Detectors**

TGS812 & 813	575
Sockets	40

**ULTRASONIC TRANSDUCERS**

40KHz Transmitter & Receiver	325p/pair
------------------------------	-----------

**Buy with Access**

**Just phone through, we do the rest.**

**Gas & Smoke Detectors**

TGS812 & 813 575  
Sockets 40

**ULTRASONIC TRANSDUCERS**

40KHz Transmitter & Receiver 325p/pair

**'D' CONNECTORS: Miniature**

Pins	9	15	25	37
PLUGS way way way way				
Solder	80p	110p	160p	240p
Angle	150p	210p	250p	355p
Straight	170p	160p	220p	310p

**SOCKETS**

Solder	105p	160p	200p	338p
Angle	165p	215p	290p	440p
Straight	175p	200p	300p	420p

**COVERS**

95p	90p	100p	110p
-----	-----	------	------

**TRANSFORMERS ( mains Prim. 220-240V)**

6.0-6V 100mA;	9.0-9V 75mA;	12.0-12V 75mA;	15.0-15V 75mA;
6VA;	2x6V-.5A;	2x9V-.4A;	2x12V-.3A;
2x15V-.25A			
12VA;	2x4V5-1.2A;	2x12V-.5A;	2x15V-.4A
24VA;	6V-1.5A	6V-1.5A;	9V-1.2A
12V-1A	12V-1A;	15-.8A	15-.8A;
20V-.6A			
50VA;	2x6V-4A;	2x9V-2.5A;	2x12V-2A;
2x15V-1.5A;	2x20V-1.2A;	2x25V-2A;	2x30V-1.5A;
100VA;	2x12V-4A;	2x15V-3A;	2x20V-2.5A;
2x2x3V-1.5A;	2x40V-1.25A;	2x50V-1A	
			920p (60p p&p)

**JUMPER LEADS Ribbon Cable Assembly**

Single Ended Lead, 24" long			
Length 14pin 16pin	24pin	40pin	
24"	145p	165p	240p

**Double Ended Leads**

6"	185p	205p	300p	465p
12"	198p	215p	315p	490p
24"	21p	235p	345p	540p
36"	230p	250p	375p	595p

**ID HEADER SOCKET Jumper Leads 24"**

20pin	26pin	34pin	40pin
1end 160p	200p	280p	300p
2ends 290p	370p	480p	525p

**COMPUTER CORNER**

- **VIC 20 MICROCOMPUTER.** Connects directly to a colour TV. 5K RAM expandable to 32K PET type graphics. **£165**
- **CASSETTE DECK** for VIC20 including a free 6 programme Cassette. **£39**
- **EPSON MX Series Printers.** Full range available. See box above for details.
- **SEIKOSHA GP100A** - Unihammer Printer, gives normal and double width characters as well as dot resolution graphics 10" tractor feed. Parallel Interface standard. **£185**
- **SOFTY-2.** The complete microprocessor development system for Engineers & Beginners. New powerful instruction. Accepts any 24 pin 5V single rail EPROM. Supplied fully built, tested & enclosed in a black ABS case. Price including plug-in PSU & Watford's extended warranty. **£169**
- **VIDEO MONITOR 9"** fully cased. B&W. Fully guaranteed. 15MHz bandwidth value for money. **£75**
- **TEX EPROM ERASER.** Erases up to 32 ICs in 15-30 min. **£33**
- **TEX EPROM ERASER** with the Solid-State 30 minute Electronic Timer. **£43**
- **Spare UV lamp bulbs** **£9**
- **5V/5A PSU** Ready built and tested **£25**
- **Attractive Beige/Brown ABS CASE** for Superboard/UK101 or Home Brew **£29**
- **Space Invaders** for Superboard **£6**
- **Full ASC11** coded keyboard type '756' **£39**
- **4 x 4 matrix keypad** (reed switch assembly) **£4**
- **C12 COMPUTER Cassettes** in Library Cases **40p**
- **STACK-PACK** Drawers rack including 10 x C12 Computer grade Cassettes. **550p**
- **8 1/2" Fan fold paper** (500 sheets) (no VAT) **£5**
- **9 1/2" Fan fold paper** (500 sheets) (no VAT) **£5**
- **Teletprinter Roll** (no VAT) **£3.50**

(P&P on most of the above items is extra)  
Call in at our shop for demonstration of any of the above items. Be satisfied before you buy.

**VOLTAGE REGULATORS**

1A	T03	+ve	-ve	
5V	7805	145p	7905	220p
12V	7812	145p	7912	220p
15V	7815	145p	7915	220p
18V	7818	150p		
1A	TO220 Plastic Casing			
5V	7805	40p	7905	45p
12V	7812	40p	7912	45p
15V	7815	40p	7915	45p
18V	7818	40p	7918	45p
24V	7824	40p		
100mA	TO92 Plastic Casing			
5V	7805	30p	7905	60p
6V	7812	30p		
8V	7812	30p		
12V	7812	30p	7912	60p
15V	7815	30p	7915	60p

**SWITCHES**

SLIDE 250V	TOGGLE 2A 250V	
1A DPDT	14 SPST	33
1A DPDT C/OFF	15 DPDT	44
3A DP on/off	40 4 pole on off	54
4 pole c/o ver	240	

**PUSH BUTTON**

Spring loaded		
Latching or Momentary 6A		
SPDT c/o ver	99	
DPDT c/o ver	145	

**SUB-MIN TOGGLE**

SP changeover	60		
SPST on off	54		
SPDT c/o off	85		
SPDT Biased	105		
DPDT 6 lags	75		
DPDT C/OFF	88		
DPDT on/off on 185			
DPDT Biased	145		
Push break	15p	3 pole c/o ver	205

**ROCKER: 5A, 250V, SPST** 28p  
**ROCKER:** (white) 10A 250V SPDT 38p

**ROCKER:** With neon lights red when on. 10A 250V, DPST 85p  
**ROCKER:** (White) 10A/250V DPDT 72p

**ROTARY:** Make your own Multiway Switch. Shunting Assembly accommodates up to 6 wafers. 90p  
Break before make Wafers. Silver contacts. 1 pole/2 way; 2 pole/6 way; 3 pole/4 way; 4 pole/3 way; 6 pole/2 way 85p  
Mains DPST Switch to fit Screen & Spacers 6p

**ROTARY:** (Adjustable Stop Type) 1 pole/2 to 12 way, 2p/2 to 6 way, 3 pole/2 to 4 way, 4 pole/2 to 3 way 45p  
**ROTARY:** Mains 250V AC, 4 Amp 56p

**DIL SWITCHES:** (SPST) 4 way 65p; 6 way 80p; 8 way 87p; 10 way 135p; (SPDT) 4 way 190p.

**CRYSTALS**

32 768KHz	100
100KHz	350
200KHz	295
455KHz	370
1MHz	295
1.00MHz	275
1.28MHz	392
1.6MHz	395
1.8MHz	395
1.8432M	200
2.0MHz	225
2.4576M	220
3.2768M	150
3.5795M	150
3.8564M	300
4.0MHz	290
4.032MHz	150
4.80MHz	200
4.194304M	200
4.47619M	200
5.0MHz	160
5.185MHz	300
5.24288M	390
5.6144MHz	140
6.5536MHz	200
7.0MHz	150
7.188MHz	250
7.68MHz	200
8.0MHz	150
8.08333M	395
8.867237M	175
9.00MHz	200
9.375MHz	350
10.0MHz	175
10.7MHz	150
10.24MHz	200
12.0MHz	290
12.528MHz	300
14.31818M	170
16.0MHz	250
18.0MHz	180
18.432M	150
19.968MHz	150
20.0MHz	325
20.0MHz	170
24.300MHz	325
26.69M	150
26.670MHz	325
27.125MHz	295
27.648M	330
27.145M	190
38.8667M	175
48.0MHz	175
100.0MHz	375
116.0MHz	300

**ASTECUHF Modulators**

6MHz	280
8MHz Wide-bandwidth	425

**ZX81 16K RAM PACK**

Watford's 16K RAM pack for ZX81: Fully built and tested. Plugs straight on to your ZX81. **Only £17.35 (50p p&p)**

**BBC MICRO & UPGRADE**

BBC Microcomputer Model B

**£399 incl. VAT + P&P**

Upgrade your BBC Micro with our upgrade and save yourself £ s s...

- **16K MEMORY (8x4 186A) BBC1** **£18.00**
- **Printer User I/O Port BBC2** **£8.20**
- **SK10 with 36" Cable** **£2.00**
- **Complete Printer Cable 36"** **£13.00**
- **SK9 with 36" Cable** **£3.00**
- **Disc.Interface Kit BBC3** **£41.00**
- **Analogue I/O Kit BBC4** **£6.75**
- **Serial I/O Kit BBC5** **£7.50**
- **Expansion Bus Kit BBC6** **£6.50**
- **SK11 with Cable 36"** **£3.00**
- **SK12 with Cable 36"** **£3.**

# LOOK

Kit includes tape transport mechanism, ready punched and back printed quality circuit board and all electronic parts. i.e. semiconductors, resistors, capacitors, hardware, top cover, printed scale and mains transformer. You only supply solder and hook-up wire. Self assembly simulated wood cabinet - only £4.50 + £1.50 p+p.

Featured in April issue of P.E. Reprint 50p. Free with kit.

## ELECTRONICS ONLY!

Ideal for updating your existing cassette. Includes pcb diagram, all semiconductors, IC's, Capacitors, resistors. +£1.40p&p

**£18.95**

**£32.95**

+ £2.75 p&p.



# P.E. STEREO CASSETTE RECORDER KIT

- NOISE REDUCTION SYSTEM
- AUTO STOP
- TAPE COUNTER
- SWITCHABLE E.O.
- INDEPENDENT LEVEL CONTROLS
- TWIN V.U. METER
- WOW & FLUTTER 0.1%
- RECORD PLAYBACK I.C. WITH ELECTRONIC SWITCHING
- FULLY VARIABLE RECORDING BIAS FOR ACCURATE MATCHING OF ALL TAPES

## STEREO AMPLIFIER KIT

- Featuring latest SGS/ATES TDA 2006 10 watt output IC's with in-built thermal and short circuit protection.
- Mullard stereo preamplifier module.
- Attractive black vinyl finish cabinet, 9" x 8 1/4" x 3 1/4" (approx).
- 10+10 stereo converts to a 20 watt disco amplifier.

To complete you just supply connecting wire and solder. Features include din input sockets for ceramic cartridge, microphone, tape or tuner. Outputs - tape, speakers and headphones. By the press of a button it transforms into a 20 watt mono disco amplifier with twin deck mixing. The kit incorporates a Mullard LP1183 pre-amp module, plus power amp assembly kit and mains power supply. Also features slider controls, push button switches, fascia, knobs and contrasting case. Instructions 50p - supplied free with kit.

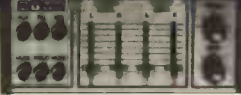

**£16.50** + £2.90 p&p.

**SPECIFICATIONS:** Suitable for 4 to 8 ohm speakers. Frequency response: 40Hz - 20KHz. Input sensitivity: P.U. 150mV, Aux. 200mV, Mic. 1.5mV. Tone controls: Bass ±12dB @ 60Hz, Treble ±12dB @ 10KHz. Distortion: 0.1% typ. @ 8W. Mains supply: 220-250V 50Hz. **8" SPEAKER KIT-** Two 8" twin cone dome tic speakers. £4.75 a stereo pair plus £1.70 p&p.

## 125W HIGH POWER AMP MODULE

**SPECIFICATIONS.** Max output power: 125w rms. Operating voltage (DC): 50-80max. Loads: 4 - 16 ohms. Frequency response measured @ 100 watts: 25Hz - 20KHz. Sensitivity for 100 watts: 400mV @ 47K. Typical T.H.D. @ 50 watts: 4 ohms: 1%. Dimensions: 205 x 90 and 190 x 36 mm.

**KIT: £10.50** + £1.15 p&p  
**BUILT: £14.25** + £1.15 p&p



## P.E. STEREO TUNER KIT

This easy to build 3 band stereo AM/FM tuner kit is designed in conjunction with P.E. (July 81 issue). For ease of construction and alignment it incorporates three Mullard modules and an I.C. IF System.

**FEATURES:** VHF, MW, LW bands, Interstation muting and AFC on VHF. Tuning meter. Two back printed pcb's. Ready made chassis and scale. Aerial: AM - ferrite rod, FM - 75 or 300 ohms. Stabilised power supply with 'C' core mains transformer. All components supplied are to P.E. strict specification. Front scale size: 10 1/2" x 2 1/4" app. Complete with diagram and instructions. Self assembly simulated wood cabinet sleeve to suit tuner only. Finish size: 11 1/4" x 8 1/2" x 3 1/4". £3.50 Plus £1.50 p&p. Reprint 50p - FREE with kit.



**£17.95** + £2.50 p&p.

**SPECIAL OFFER! TUNER KIT PLUS:**  
• Matching I.C. 10 watt per channel Power amp kit. • Mullard LP1183 built pre-amp, suitable for ceramic pickup and aux. inputs.  
• Matching power supply kit with transformer. • Matching set of 4 slider controls for bass, treble + vols. £21.95 + £3.80 p&p.

All mail to: 21B HIGH STREET, ACTON, W3 6NG. Note: Goods despatched to U.K. postal addresses only. All items subject to availability. Prices correct at 30/6/82 and subject to change without notice. Please allow 7 working days from receipt of order for despatch. RTVC Limited reserve the right to update their products without notice. Send S.A.E. for full list of products. Telephone or mail orders by ACCESS are welcomed.

ALL CALLERS TO: 323 Edgware Rd, London W2. Tel: 01-723 8432. 9.30 - 5.30, closed all day Thurs. ALL PRICES INCLUDE VAT AT 16%.



# MASTER ELECTRONICS NOW! The PRACTICAL way!

This new style course will enable anyone to have a real understanding of electronics by a modern, practical and visual method. No previous knowledge is required, no maths, and an absolute minimum of theory.

You learn the practical way in easy steps mastering all the essentials of your hobby or to start or further a career in electronics or as a self-employed servicing engineer.

All the training can be carried out in the comfort of your own home and at your own pace. A tutor is available to whom you can write personally at any time, for advice or help during your work. A Certificate is given at the end of every course.

You will do the following:

- Build a modern oscilloscope
- Recognise and handle current electronic components
- Read, draw and understand circuit diagrams
- Carry out 40 experiments on basic electronic circuits used in modern equipment
- Build and use digital electronic circuits and current solid state 'chips'
- Learn how to test and service every type of electronic device used in industry and commerce today. Servicing of radio, T.V., Hi-Fi and microprocessor/computer equipment.

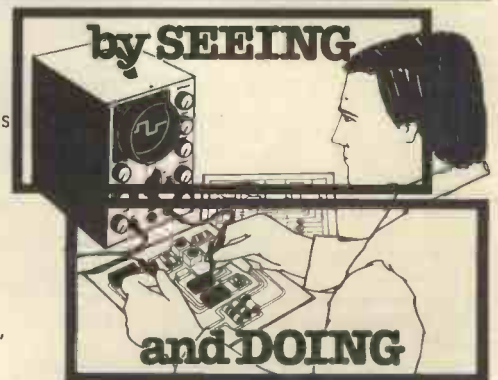

## New Job? New Career? New Hobby? Get into Electronics Now!

**FREE!**  
COLOUR BROCHURE

Please send your brochure without any obligation to

I am interested in:

NAME

COURSE IN ELECTRONICS as described above

ADDRESS

RADIO AMATEUR LICENCE

MICROPROCESSORS

OTHER SUBJECTS

PE/8/821

BLOCK CAPS PLEASE

POST NOW TO:

**British National Radio & Electronics School Reading, Berks. RG1 7BR**

## THE MULTI-PURPOSE TIMER HAS ARRIVED

Now you can run your central heating, lighting, hi-fi system and lots more with just one programmable timer. At your selection it is designed to control four mains outputs independently, switching on and off at pre-set times over a 7 day cycle, e.g. to control your central heating (including different switching times for weekends), just connect it to your system programme and set it and forget it—the clock will do the rest.

### FEATURES INCLUDE:-

- 0.5" LED 12 hour display.
- Day of week, amp/m and output status indicators.
- 4 zero voltage switched mains outputs.
- 50/60Hz mains operation.
- Battery backup saves stored programmes and continues time keeping during power failures. (Battery not supplied).
- Display blanking during power failure to conserve battery power.
- 18 programme time sets.
- Powerful "Everyday" function enabling output to switch every day but use only one time set.
- Useful "sleep" function—turns on output for one hour.
- Direct switch control enabling output to be turned on immediately or after a specified time interval.
- 20 function keypad for programme entry.
- Programme verification at the touch of a button.

(Kit includes all components, PCB, assembly and programming instructions).



**NOW ONLY £39 WITH SO MANY EXTRA FEATURES. OPTIONAL BLACK PLASTIC CASE. READY DRILLED. £2.50**

## HOME LIGHTING KITS

These kits contain all necessary components and full instructions & are designed to replace a standard wall switch and control up to 300w. of lighting.

- TDR300K Remote Control Dimmer £14.30
- MK6 Transmitter for above £4.20
- TD300K Touchdimmer £7.00
- TDE/K Extension kit for 2-way switching for TD300K £2.00
- LD300K Rotary Controlled Dimmer £3.50



## MINI KITS

### MK1 TEMPERATURE CONTROLLER/THERMOSTAT

Uses LM311 IC to sense temperature (80°C max.) and triac to switch heater. 1KW £6.00

MK2 Solid State Relay Ideal for switching motors, lights, heaters, etc. from logic. Opto-isolated with zero voltage switching. Supplied with triac £2.60

MK3 BAR/DOT DISPLAY Displays an analogue voltage on a linear 10 element LED display as a bar or single dot. Ideal for thermometers, level indicators, etc. May be stacked to obtain 20 to 100 element displays. Requires 5-20V supply. £4.50

MK4 PROPORTIONAL TEMPERATURE CONTROLLER Based on the SL441 zero voltage switch, this kit may be wired to form a "burst fire" power controller, enabling the temperature of an enclosure to be maintained to within 0.5°C. Max. load 3KW £9.55

MK5 MAINS TIMER Based on the ZN1034E Timer IC this kit will switch a mains load on (or off) for a preset time from 20 mins. to 35 hrs. Longer or shorter periods may be realised by minor component changes. Max. load 1KW. £4.50

## 3-NOTE DOOR CHIME

Based on the SAB0600 IC the kit is supplied with all components. Including loudspeaker, printed circuit board, a pre-drilled box (95 x 71 x 35mm) and full instructions. Requires only a PP3 9V battery and push-switch to complete. AN IDEAL PROJECT FOR BEGINNERS. Order as XK102. £5.00

For a detailed booklet on remote control — send us 30p & SAE today.

## "OPEN-SESAME"

The XK103 is a general purpose infra-red transmitter/receiver with one momentary (normally open) relay contact and two latched transistor output. Designed primarily for controlling motorised garage doors and two auxiliary outputs for drive/garage lights at a range of up to 40 ft. The unit also has numerous applications in the home for switching lights, TV, closing curtains, etc. Ideal for aged or disabled persons.

The kit comprises a mains powered receiver, a four button transmitter, complete with pre-drilled box, requiring a 9V battery and one opto-isolated solid state switch kit for interfacing the receiver to mains appliances. As with all our kits, full instructions are supplied.

Only £23.75

Extra Solid State Switch Kits (XK104) and transmitters (XK105) can be supplied.

XK104 £2.40 XK105 £10.50

## THE HOME CONTROL CENTRE

This New Remote Control Kit enables you to control up to 16 different appliances anywhere in the house from the comfort of your armchair. The transmitter injects coded pulses into the mains wiring which are received by receiver modules connected to the same mains supply and used to switch on the appliance addressed. Receivers are addressed by means of a 16-way keyboard, followed by an on or off command. Since pushing buttons can become rather boring, the transmitter also includes a computer interface so you can programme your favourite micro to switch lights, heating, electric blanket, make your coffee in the morning, etc. without rewiring your house. **JUST THINK OF THE POSSIBILITIES.** The kit includes all PCBs and components for one transmitter and two receivers plus a pre-drilled box for the transmitter.

Order as XK112 £42.00

## DISCO LIGHTING KITS

### DL 1000K

This value-for-money kit features a bi-directional sequence, speed of sequence and frequency of direction change, being variable by means of potentiometers and incorporates a master dimming control. Only £14.60

A lower cost version of the above, featuring unidirectional channel sequence with speed variable by means of a pre-set pot. Outputs switched only at mains, shorter periods to reduce radio interference to a minimum. Only £8.00

Optional opto input DLA1 Allowing audio ("beat") —light response. 60p

## DVM/ULTRA SENSITIVE THERMOMETER KIT

This new design is based on the ICL7126 (a lower power version of the ICL7106 chip) and a 3 1/2 digit liquid crystal display. This kit will form the basis of a digital multimeter (only a few additional resistors and switches are required—details supplied), or a sensitive digital thermometer (-50°C to +150°C) reading to 0.1°C. The basic kit has a sensitivity of 200mV for a full scale reading, automatic polarity indication and an ultra low power requirement—giving a 2 year typical battery life from a standard 9V PP3 when used 8 hours a day, 7 days a week. £15.50



ALL PRICES EXCLUDE VAT

## REMOTE CONTROL KITS

MK6 SIMPLE INFRA RED TRANSMITTER Pulsed infra red source complete with hand-held plastic box. Requires a 9V battery. £4.20

MK7 INFRA RED RECEIVER Single channel, range approx. 20ft. Mains powered with a triac output to switch loads up to 500W at 240V a.c. £3.00 (PC500K—Special Price for MK6 and MK7 together £12.50)

MK8 CODED INFRA RED TRANSMITTER Based on the SL490, the kit includes all components to make a coded transmitter and only requires a 9V (PP3) battery. 8 x 2 x 1.3cms £5.90

MK10 16-WAY KEYBOARD For use with MK8 and MK18 to generate 16 different codes for decoding by the ML928 or MK1926 receiver (MK12) kit. £5.40

MK11 10-Channel + 3 Analogue a/p IR Receiver Based on ML922 decoder IC. Functions include on/standby output, toggle, control of volume, tone and lamp brightness. Includes its own mains supply. £12.00

MK12 16-CHANNEL IR RECEIVER For use with MK8 kit with 16 on/off outputs, which was further interface circuitry, such as relays or triacs, will switch up to 16 items of equipment on or off remotely. Latched or momentary output — please specify when ordering. Includes its own mains supply. £11.95

MK13 11-WAY KEYBOARD For use with MK8, MK18 and MK11 kits. £4.35

MK16 Mains Powered IR Transmitter: Mains powered for continuous operation — single channel, for applications such as burglar alarms, automatic door openers, etc. Range approx. 6ft. £2.50

MK17 12V d.c. IR RECEIVER For use with MK6 or MK16. Relay output with DP3 Amp change-over contacts, may be used as latched, momentary or "break beam" receiver. Operates from 6-13V d.c. £3.50

MK18 HIGH POWER IR TRANSMITTER Similar to MK8 but with range of approx. 60ft. £8.20

Auxiliary Kits: MK2 Solid State Relay Opto-isolated with zero voltage switching. No. triac supplied. £2.60

MK15 DUAL LATCHED SOLID STATE RELAY Comprises 2 x solid state relays and latch for use with momentary version of the MK12. 2 output triacs required (not supplied). £4.50

## THE KEY TO YOUR SECURITY IS IN OUR LOCK

If the thought of car thieves, house breakers or people tampering with your electrical and electronic equipment upsets you, we have just the kit for you.

Our ELECTRONIC LOCK KIT includes a 10-way keyboard and a special IC which provides a 750mA output to drive a solenoid or relay (not supplied) when four keys are depressed in the correct sequence. This gives over 5,000 possible combinations. The sequence is prewired and may be easily changed by means of a small plug and socket. A "SAVE" function is also available enabling the open code to be stored (especially useful in a car when it is left in a garage for servicing as the open code need not be disclosed). Size: 7x6x3 cms. Power Consumption is 40uA at 5V to 15V d.c.

At only £10.50 + VAT, it will make a smaller hole in your pocket than a bunch of keys!

Electric Lock Mechanism Suitable for use with existing door locks and above electronic lock kit. £12.50

## 24 HOUR CLOCK/APPLIANCE TIMER KIT

Switches any appliance up to 1kW on and off at present times once per day. Kit contains: AY-5-1230 IC, 0.5" LED display, mains supply, display drivers, switches, LEDs, triacs, PCBs and full instructions.

CT1000K Basic Kit £14.90  
CT1000K with white box (56/131 x 71mm) £17.40  
(Ready Built) £22.50

Add 50p postage & packing +15% VAT to total. Overseas Customers;

Add £1.50 (Europe), £4.00 (elsewhere) for p&p. Send S.A.E. for further STOCK DETAILS. Goods by return subject to availability.

**OPEN** 9am to 5pm (Mon to Fri)  
10am to 4pm (Sat)



FREE

SHORT FORM CATALOGUE — send SAE (6" x 9"). We also stock Verobooks, Resistors, Capacitors, Semi-Conductors etc.

## FAST SERVICE - TOP QUALITY - LOW LOW PRICES

No circuit is complete without a call to

# ELECTRONICS PE

11 Boston Road  
London W7 3SJ



TEL: 01-578 8910 ORDERS  
01-579 2842 TECHNICAL AFTER 3PM

ENQUIRIES 01-579 9794



# Technical Training in Radio, Television and Electronics

ICS have helped thousands of ambitious people to move up into higher paid, more secure jobs in the field of electronics—now it can be your turn. Whether you are a newcomer to the field or already working in the industry, ICS can provide you with the specialised training so essential to success.

## Personal Tuition and Guaranteed Success

The expert and personal guidance by fully qualified tutors, backed by the ICS guarantee of tuition until successful is the key to our outstanding record in the technical training field. You study at the time and pace that suits you best and in your own home. In the words of one of our many successful students: "Since starting my course, my salary has trebled and I am expecting a further increase when my course is completed".

## CITY AND GUILDS CERTIFICATES

Excellent job prospects await those who hold one of these recognised certificates. ICS can coach you for:

Basic Electronic Engineering (C&G/ICS)  
Radio Amateurs

## CERTIFICATE COURSES

TV & Audio Servicing  
TV, Radio and Audio Engineering  
Radio & Amplifier Construction  
Electronic Engineering\*  
Computer Electronics\*  
Industrial Electronics\*  
Radio Frequency Electronics\*  
Introduction to Microprocessing\*  
Electrical Contracting & Installation

\*Qualify for IET Associate Membership



Approved by CACC

**ICS**

Div. National Corporation  
Education



Member of ABCC

## POST OR PHONE TODAY FOR FREE BOOKLET

Please send me your FREE School of Electronics Prospectus.

Subject of Interest \_\_\_\_\_

Name \_\_\_\_\_

Address \_\_\_\_\_

Post to: Dept 273X  
ICS School of Electronics  
160 Stewarts Road  
London SW8 4UJ



01-622 9911  
(All Hours)

## ★ SPECIAL OFFER ★

1-24	25-99	1-24	25-99
2114L-450 90p	85p	2732 400p	375p
2114L-200 95p	90p	4116-200 90p	85p
2716 (+5V) 225p	210p	6116-150 410p	375p
2532 400p	375p	6522 350p	325p

## CONNECTOR SYSTEMS

I.D. CONNECTORS (Speedblock Type)			D-CONNECTORS 9 way 15 way 25 way 37 way				DIL HEADER PLUGS		RIBBON CABLE (Gray)	
No. of Header	Recept.	Edge Conn.	MALE				Solder IDC		10 way	60p
ways	Plug	Jack	Solder	90p	130p	160p	250p	14 way	80p	
10	90p	90p	Angled	160p	230p	265p	425p	16 way	80p	
20	145p	125p	FEMALE				type	type	20 way	105p
26	175p	150p	Solder	110p	160p	210p	350p	26 way	140p	
34	200p	160p	Angled	175p	240p	310p	500p	34 way	220p	
40	220p	190p	Hood	95p	95p	95p	125p	40 way	265p	
50	235p	200p	37 way Centronix Type Conn	£6.50					50 way	330p
							40 pin	200p	64 way	370p

JUMPER LEADS			EURO CONNECTORS (Indirect Edge Conn.)			EDGE CONNECTORS		
24" Ribbon Cable with headers			DIN STD	Plug	Skt	0.1"	0.156"	
14 pin	16 pin	24 pin	41617 21 way	170p	170p	2x18 way	—	
1 end	145p	165p	41617 31 way	180p	180p	2x22 way	200p	
2 ends	210p	230p	41612 2x32 way	250p	320p	2x23 way	210p	
24" Ribbon Cable with sockets			41612 2x32 way	250p	320p	2x25 way	225p	
20 pin	26 pin	34 pin	Angled 2x32 way	325p	375p	1x43 way	260p	
1 end	160p	210p	41612 3x32 way	275p	380p	2x43 way	395p	
2 ends	290p	385p	Angled 3x32 way	—	400p	2x50 way	—	
24" Ribbon Cable with D Conn.			2x32 way IDC a+c	525p				
25 way Male	500p	Female 550p	(for 2x32 way specify a+b or a+c)				1x77 way	700p
							S100 Conn	—
								600p

## OFFICIAL **BBC** STOCKIST

<b>MEMORY PACK</b> IC61-68 16K RAM 100nS AP-3 £25.60	<b>PRINTER &amp; USER PORTS</b> IC69, 70; PL9, 10 £9.50 Printer Lead Complete £13.50
<b>ANALOGUE PORT</b> IC72, PL6 £7.30; SK6 £1.80	<b>F.D. PORT</b> IC77-87, PL8 £44
<b>BUS/TUBE PORTS</b> BBC Model B £399 (incl. VAT) + Carr.	IC71-72, PL11 £4.30; PL12 £3.00 (Enquire about availability)

## PRINTERS

SEIKOSHA GP100A dot matrix printer, full graphics double width characters, up to 10" wide paper, self testing parallel interface £189 + Carriage £6.  
EPSON MX80 Friction and Tractor 9 x 9 matrix 80 CPS bi-directional with logic seeking, variety of char.  
MX80 F/T 1 £335 + £6 carr. MX80 F/T 2 with High Res Graphics £340 + £6 carr.  
**NEW MX80 F/T3**  
This upgraded version of MX80 F/T2 also includes new features like super & sub scripts, auto underlining and improved graphics facilities as well as aesthetics.  
Price only £360 + £6 carr.

## FLOPPY DISC DRIVES

Single TEAC FD-50A in cabinet with PSU £190 + £6 Carr.  
Two TEAC FD-50A in cabinet with PSU £360 + £8 Carr.  
Single Drive for Apple II  
Siemens FDD 100-5 Drive housed in attractive case. Drive complete with track zero micro switch, motor control pcb, read, write & control electronics + cable £270 + £6 carr.

## MONITORS

BMC 12" Green Screen 18MHz Bandwidth £100 + £6 carr.  
BMC 14" Colour Monitor (25 x 40 chars.) £240 + £6 carr.

## ACORN ATOM

**BASIC BUILT 8K + 2K £135 EXPANDED 12K + 12K £180**  
**5K RAM + 8K ROM + COLOUR CARD £175**  
(p&p £3/unit)

ATOM PSU £7.00 (£1.20 p&p) 3A5V Regulated PSU £22 (p&p £2)  
F.P. ROM £20 1K RAM (2x2114L) £2 TOOL BOX ROM £25  
NEW COLOUR CARD £32

ATOM DISC PACK: 5 1/4" drive with controller card and 4K DOS ROM. PSU to run drive and 12K+12K ATOM. Full instruction and operating manual. £299 + £7 carr.  
SEND FOR OUR ATOM LIST FOR DETAILS ON ATOM SOUND BOARD, ATOM VISION & SOFTWARE.

## SOFTY II EPROM PROGRAMMER

The complete microprocessor development system for both Engineers and Hobbyists. You can develop programs, debug, verify and commit them to EPROMs. Will accept most +5V EPROMs. Can also be used as a ROMULATOR. Full review in September '81 P.E. Built unit complete with PSU and TV lead £169.

## MENTA

A sophisticated Z80 development system and trainer. Direct interface to TV & cassette recorder. Powerful keyboard assembler & program debugging facility — ideal for both engineers and students. Audible feedback on keyboard input. Menta + PSU + TV Lead £115.

**PLEASE ADD 40p p&p & 15% VAT**  
(Export no VAT p&p at Cost)

Orders from Government Depts, & Colleges etc. welcome.  
BARCLAYCARD & ACCESS CARDS ACCEPTED  
Detailed Price List on request.  
Stock items are normally by return of post.



TTLS

7400	11p	74388	40p	74LS373	60p	4007	15p
7401	11p	74366	40p	74LS375	45p	4008	24p
7402	12p	74367	40p	74LS376	60p	4010	24p
7403	12p	74368	55p	74LS378	60p	4011	11p
7404	12p	74390	75p	74LS390	50p	4012	16p
7405	15p	74393	100p	74LS393	45p	4013	23p
7406	20p	74490	95p	74LS399	20p	4014	48p
7407	20p	74LS SERIES		74LS445	110p	4016	20p
7408	14p	74LS00	11p	74LS440	100p	4017	36p
7409	14p	74LS01	11p	74LS441	100p	4018	45p
7410	14p	74LS02	12p	74LS429	180p	4019	25p
7411	18p	74LS03	12p	74LS420	200p	4020	48p
7412	18p	74LS04	12p	74LS421	200p	4021	48p
7413	18p	74LS05	12p	74LS422	200p	4022	45p
7414	20p	74LS08	12p	74LS423	200p	4023	15p
7416	20p	74LS09	12p	74LS424	200p	4024	32p
7417	20p	74LS10	13p	74LS425	200p	4025	15p
7420	20p	74LS11	13p	74LS426	200p	4026	80p
7421	20p	74LS12	12p	74LS427	200p	4027	22p
7422	20p	74LS13	20p	74LS428	200p	4028	45p
7423	20p	74LS14	34p	74LS429	50p	4029	50p
7426	24p	74LS15	15p	74LS430	40p	4030	20p
7426	24p	74LS20	12p	74LS400	40p	4031	125p
7427	22p	74LS21	12p	74LS401	40p	4032	80p
7428	26p	74LS22	12p	74LS402	40p	4033	125p
7430	14p	74LS26	12p	74LS403	40p	4034	140p
7432	22p	74LS27	14p	74LS404	75p	4035	60p
7433	22p	74LS28	14p	74LS405	75p	4036	275p
7437	25p	74LS30	12p	74LS406	60p	4037	110p
7438	25p	74LS31	12p	74LS407	60p	4038	44p
7440	15p	74LS33	15p	74LS408	60p	4040	48p
7441	70p	74LS37	15p	74LS409	60p	4041	50p
7442A	32p	74LS38	15p	74LS410	60p	4042	44p
7445	50p	74LS42	30p	74LS411	60p	4044	45p
7446A	60p	74LS47	36p	74LS412	30p	4045	105p
7447A	60p	74LS48	36p	74LS413	30p	4046	50p
7448	45p	74LS51	14p	74LS414	30p	4047	45p
7450	15p	74LS55	15p	74LS415	30p	4048	50p
7451	15p	74LS73	18p	74LS416	30p	4049	24p
7454	15p	74LS74	16p	74LS417	30p	4050	24p
7455	15p	74LS75	18p	74LS418	30p	4051	45p
7456	15p	74LS76	18p	74LS419	30p	4052	60p
7457	25p	74LS77	18p	74LS420	30p	4053	90p
7473	25p	74LS85	50p	74LS421	30p	4054	50p
7474	20p	74LS86	18p	74LS422	30p	4055	90p
7475	35p	74LS90	24p	74LS423	30p	4056	90p
7476	30p	74LS92	32p	74LS424	30p	4059	450p
7483A	30p	74LS93	32p	74LS425	30p	4060	55p
7485	60p	74LS95	60p	74LS426	30p	4063	100p
7486	20p	74LS96	50p	74LS427	30p	4064	250p
7489	210p	74LS107	40p	74LS428	30p	4067	250p
7490A	20p	74LS109	27p	74LS429	30p	4068	14p
7491	35p	74LS112	22p	74LS430	40p	4069	14p
7492A	35p	74LS113	22p	74LS431	40p	4070	14p
7493A	24p	74LS114	22p	74LS432	40p	4071	14p
7494	35p	74LS122	36p	74LS433	40p	4072	14p
7495A	60p	74LS123	36p	74LS434	40p	4073	14p
7496	40p	74LS124	36p	74LS435	40p	4074	14p
7497	30p	74LS125	24p	74LS436	40p	4075	14p
74100	80p	74LS126	24p	74LS437	40p	4076	16p
74107	22p	74LS132	40p	74LS438	40p	4077	16p
74109	25p	74LS133	30p	74LS439	40p	4078	16p
74116	50p	74LS136	25p	74LS440	650p	4082	15p
74118	60p	74LS138	30p	74LS441	600p	4086	55p
74119	60p	74LS139	30p	74LS442	600p	4089	150p
74120	60p	74LS140	30p	74LS443	600p	4093	24p
74121	25p	74LS147	160p	74LS444	600p	4094	90p
74122	40p	74LS148	75p	74LS445	600p	4095	90p
74123	40p	74LS151	40p	74LS446	600p	4096	70p
74125	34p	74LS153	40p	74LS447	600p	4097	290p
74126	34p	74LS154	40p	74LS448	600p	4098	90p
74129	35p	74LS155	40p	74LS449	600p	4099	100p
74130	35p	74LS156	36p	74LS450	600p	4100	120p
74136	28p	74LS157	27p	74LS451	600p	4103	180p
74141	55p	74LS158	30p	74LS452	600p	4105	120p
74142	200p	74LS160	36p	74LS453	600p	4106	40p
74145	50p	74LS161	36p	74LS454	600p	4109	100p
74147	90p	74LS162	36p	74LS455	600p	4110	28p
74148	70p	74LS163	36p	74LS456	600p	4111	28p
74150	50p	74LS164	40p	74LS457	600p	4112	60p
74151A	40p	74LS165	60p	74LS458	600p	4113	75p
74153	40p	74LS166	65p	74LS459	600p	4114	35p
74155	40p	74LS170	75p	74LS460	600p	4115	35p
74156	40p	74LS171	40p	74LS461	600p	4116	150p
74157	30p	74LS175	40p	74LS462	600p	4117	150p
74159	75p	74LS181	100p	74LS463	600p	4118	115p
74160	60p	74LS190	40p	74LS464	600p	4119	115p
74161	60p	74LS191	40p	74LS465	600p	4120	115p
74161	60p	74LS192	40p	74LS466	600p	4121	115p
74162	48p	74LS192	40p	74LS467	600p	4122	115p
74163	48p	74LS193	40p	74LS468	600p	4123	115p
74164	48p	74LS194	35p	74LS469	600p	4124	115p
74165	48p	74LS195	35p	74LS470	600p	4125	115p
74166	48p	74LS196	48p	74LS471	600p	4126	115p
74170	120p	74LS197	60p	74LS472	600p	4127	115p
74172	275p	74LS221	50p	74LS473	600p	4128	115p
74173	60p	74LS240	55p	74LS474	600p	4129	115p
74174	55p	74LS241	55p	74LS475	600p	4130	115p
74175	50p	74LS242	55p	74LS476	600p	4131	115p
74178	40p	74LS243	55p	74LS477	600p	4132	115p
74177	45p	74LS244	60p	74LS478	600p	4133	115p
74178	80p	74LS245	75p	74LS479	600p	4134	115p
74180	40p	74LS251	35p	74LS480	600p	4135	115p
74181	115p	74LS253	35p	74LS481	600p	4136	115p
74182A	60p	74LS256	35p	74LS482	600p	4137	115p
74185	90p	74LS259	60p	74LS483	600p	4138	115p
74186	500p	74LS260	22p	74LS484	600p	4139	115p
74188	250p	74LS262	20p	74LS485	600p	4140	115p
74190	48p	74LS273	60p	74LS486	600p	4141	115p
74191	48p	74LS278	60p	74LS487	600p	4142	115p
74192	48p	74LS280	150p	74LS488	600p	4143	115p
74193	48p	74LS283	40p	74LS489	600p	4144	115p
74194	48p	74LS293	40p	74LS490	600p	4145	115p
74195	48p	74LS298	90p	74LS491	600p	4146	115p
74196	48p	74LS298	90p	74LS492	600p	4147	115p
74197	48p	74LS303	140p	74LS493	600p	4148	115p
74198	85p	74LS323	180p	74LS494	600p	4149	115p
74199	85p	74LS324	180p	74LS495	600p	4150	115p
74221	55p	74LS348	120p	74LS496	600p	4151	115p
74259	140p	74LS352	80p	74LS497	600p	4152	115p
74278	10p	74LS353	80p	74LS498	600p	4153	115p
74279	50p	74LS354	80p	74LS499	600p	4154	115p
74283	55p	74LS356	450p	74LS500	600p	4155	115p
74284	175p	74LS364	140p	74LS501	600p	4156	115p
74285	175p	74LS365	140p	74LS502	600p	4157	115p
74290	100p	74LS367	30p	74LS503	600p	4158	115p
74293	100p	74LS368	30p	74LS504	600p	4159	115p

74298	80p	74LS373	60p	4007	15p
74387	40p	74LS375	45p	4008	24p
74366	40p	74LS376	60p	4010	24p
74367	40p	74LS378	60p	4011	11p
74368	55p	74LS390	50p	4012	16p
74390	75p	74LS393	45p	4013	23p
74393	100p	74LS399	20p	4014	48p
74490	95p	74LS399	20p	4015	48p
74LS SERIES		74LS445	110p	4016	20p
74LS00	11p	74LS440	100p	4017	36p
74LS01	11p	74LS441	100p	4018	45p
74LS02	12p	74LS429	180p	4019	25p
74LS03	12p	74LS420	200p	4020	48p
74LS04	12p	74LS421	200p	4021	48p
74LS05	12p	74LS422	200p	4022	45p
74LS08	12p	74LS423	200p	4023	15p
74LS09	12p	74LS424	200p	4024	32p
74LS10	13p	74LS425	200p	4025	15p
74LS11	13p	74LS426	200p	4026	80p
74LS12	12p	74LS427	200p	4027	22p
74LS13	20p	74LS428	200p	4028	45p
74LS14	34p	74LS429	50p	4029	50p
74LS15	15p	74LS430	40p	4030	20p
74LS20	12p	74LS400	40p	4031	125p
74LS21	12p	74LS401	40p	4032	80p
74LS22	12p	74LS402	40p	4033	125p
74LS26	12p	74LS403	40p	4034	140p
74LS27	14p	74LS404	75p	4035	60p
74LS28	14p	74LS405	75p	4036	275p
74LS29	14p	74LS406	60p	4037	110p
74LS30	12p	74LS407	60p	4038	44p
74LS31	12p	74LS408	60p	4040	48p
74LS33	15p	74LS409	60p	4041	50p
74LS37	15p	74LS410	60p	4042	44p
74LS38	15p	74LS411	60p	4043	48p
74LS42	30p	74LS412	30p	4044	45p
74LS47	36p	74LS413	30p	4045	105p
74LS48	36p	74LS414	30p	4046	50p
74LS51	14p	74LS415	30p	4047	45

# TRANSFORMERS +VAT 15%

Delivery 7 days

30 V RANGE (2x15V tapped secs)  
Sec Volt 3, 4, 5, 6, 8, 9, 10, 12, 15, 18, 20, 24,  
30V or 12V-0-12V or 15V-0-15V.

Ref	30V	15V	Price	P&P
112	0.5	1	£3.19	£1.20
79	1	2	£4.32	£1.40
3	2	4	£6.99	£1.60
20	3	6	£8.10	£1.85
21	4	8	£9.67	£1.90
51	5	10	£11.95	£2.00
117	6	12	£13.52	£2.26
88	8	16	£18.10	£2.24
89	10	20	£20.88	£2.24
90	12	24	£23.20	£2.40
91	15	30	£26.60	£3.00
92	20	40	£35.64	£4.83

50 VOLT RANGE (Split Sec) Pri  
120/240V (2x25V tapped secs) Voltages  
available 5, 7, 8, 10, 13, 15, 17, 20, 33, 40 or  
20V-0-20V or 25-0-25V

Ref.	50V	25V	P&P	Ref.
102	0.5	1	£4.13	£1.40
103	1	2	£5.03	£1.40
104	2	4	£8.69	£1.84
105	3	6	£10.36	£1.90
106	4	8	£14.10	£2.12
107	6	12	£18.01	£2.34
118	8	16	£24.52	£2.70
119	10	20	£30.23	£3.00
109	12	24	£36.18	£3.00

MAINS ISOLATORS  
Pri 0-120V, 0-100-120V (120, 220, 240V) Sec  
0-CT-120V twice.

Ref.	VA	Price	P&P
*07	20	£5.30	£1.50
149	60	£8.63	£1.60
150	100	£10.00	£1.84
151	200	£13.69	£2.12
152	250	£16.31	£2.64
154	500	£25.02	£2.90
155	750	£35.91	O.A.
156	1000	£45.89	O.A.
157	1500	£60.02	O.A.
158	2000	£72.43	O.A.
159	3000	£101.12	O.A.
	6000	£207.92	O.A.

\*Pri 0-240V Sec 115 or 240V only.  
State sec volts required.

## CASED AUTO TRANSFORMERS

240V cable in 115V USA flat pin outlets

VA	Price	P&P	Ref.
20	£7.21	£1.25	56W
75	£9.35	£1.50	64W
150	£12.10	£1.84	4w
250	£14.73	£1.60	69W
500	£22.14	£2.24	67W
1000	£33.74	£2.80	84W
2000	£60.47	O.A.	95W

## AUTO TRANSFORMERS

Volts out: 105, 115, 190, 200, 210, 220,  
230, 240, for step up or step down.

Ref.	(Watts)	Price	P&P
113*	15	£2.39	£1.20
64	80	£4.85	£1.40
4	150	£6.48	£1.60
67	500	£13.30	£2.24
84	1000	£22.70	£2.80
93	1500	£28.17	O.A.
95	2000	£42.14	O.A.
73	3000	£71.64	O.A.
80	4000	£93.01	O.A.
57	5000	£108.30	O.A.

\*0, 115, 220, 240.

## 96/48/36V RANGE

Pri 0-120/240V  
Sec 2 windings 0-36-48V to give  
36-0-36V or 48-0-48V or 96V.

72v/96v	36v/48v	Ref.	Price	P&P
1	2	431	£8.93	£1.64
2	4	432	£14.69	£1.60
3	6	433	£17.79	£2.40
4	8	434	£22.24	£2.40
5	10	435	£32.23	£2.40
6	12	436	£40.36	O.A.
8	16	437	£44.03	O.A.

## AVO METERS + VAT 15%

AVO 8 MKS. Latest Model	£122.10
AVO 71 Electronics &	£49.30
AVO 73 TV Service	£68.90
AVO MMS Minor	£43.60
AVO EM272 316KΩ/2	£72.30
AVO DA116 LC9D. Digital	£131.50
AVO DA211 L.C.D. Digital	£58.50
AVO DA212 L.C.D. Digital	£81.90
Battery MEGGER BM7/500V	£71.60
Wec MEGGER hand crank	£101.50

METAL OXIDE RESISTORS £1per 100 (Electrosil) TR4 5%  
47Ω/75Ω/180Ω/360Ω/390Ω/430Ω/470Ω/510Ω/560Ω/820Ω/1K/  
1K1/1K2/1K3/1K6/1K8/2K/2K4/3K/16K/20K/22K/24K/47K/82K/  
100K/110K/120K/130K/180K/220K/270K/300K. P&P 50p+VAT.

Telephones: Desk Type. Model 746 £11.50+£1.20 P&P. Wall phones  
£18.80+£1.20 P&P+VAT 15%. Push button Trim phone £28.00+P&P.

# Barrie Electronics Ltd.

3, THE MINORIES, LONDON EC3N 1BJ  
TELEPHONE: 01-488 3316/7/8  
NEAREST TUBE STATIONS: ALDGATE & LIVERPOOL ST.

UK Postages. Overseas extra.  
Voltages stated are on full load  
Continuous Ratings

60 VOLT RANGE (2x30V tapped  
secs)  
Pri 120/240V. Voltages available 6, 8, 10, 12,  
16, 18, 20, 24, 30, 36, 40, 48, 60 or  
24V-0-24V or 30V-0-30V.

Ref.	60V	30V	Price	P&P
124	0.5	1	£4.70	£1.50
126	1	2	£7.15	£1.50
127	2	4	£9.20	£1.90
125	3	6	£13.31	£2.02
123	4	8	£15.15	£2.26
40	5	10	£19.16	£2.24
120	6	12	£21.86	£2.64
121	8	16	£30.72	O.A.
122	10	20	£35.76	O.A.
189	12	24	£41.22	O.A.

12 OR 24V OR 12-0-12V Pri 220-240

Ref.	12V	24V	Price	P&P
213	1.0	0.5	£3.19	£1.20
71	2	1	£4.25	£1.20
18	4	2	£4.91	£1.60
85	5	2.5	£6.78	£1.50
70	6	3	£7.69	£1.40
108	8	4	£8.98	£1.64
72	10	5	£9.82	£1.80
116	12	6	£10.89	£1.90
17	16	8	£12.97	£2.12
115	20	10	£17.46	£2.44
187	30	15	£21.69	£2.64
226	60	30	£44.45	O.A.

## SCREENED MINIATURES

Ref.	mA	Volts	£	P&P
238	200	3-0-3	3.11	0.90
212	1A, 1A	0-6, 0-6	3.45	1.20
13	100	9-0-9	2.59	0.80
235	330, 330	0-9, 0-9	2.41	0.60
207	500, 500	0-8-9, 0-8-9	3.36	1.20
208	1A, 1A	0-8-9, 0-8-9	4.27	1.40
236	200, 200	0-15, 0-15	2.41	0.90
214	300, 300	0-20, 0-20	3.39	1.20
221	700(DC)	20-12-0-12-20	4.13	1.20
206	1A, 1A	0-15-20 (*x2)	5.60	1.60
203	500, 500	0-15-27 (*x2)	4.83	1.50
204	1A, 1A	0-15-27 (*x2)	7.30	1.60
239	50	12-0-12	3.11	0.90
234	500	6-0-6	2.41	0.90

Send 20p stamps for Catalogue  
Prices correct 21/4/82.

## Constant Voltage Transformers (1%)

Clean mains to computers/peripherals

250 VA	£127.36
500 VA	£149.43
1kVA	£203.12

Also I.C. "sensing types" for low mains  
voltage fluctuations

## ISV CT Range (7.5V-0-7.5V)

Ref.	Price	P&P
171	500mA £2.53	£0.90
172	1A £3.59	£1.20
173	2A £4.35	£1.20
174	3A £4.54	£1.20
175	4A* £6.93	£1.40

## TOROIDAL'S now stocked

### PANEL METERS

	43mm x 43mm	82mm x 78mm
0.500µA	£6.70	0.500µA £7.37
0.500µA	£6.70	0.500µA £7.37
0.1mA	£6.70	0.1mA £7.37
0.30V	£6.70	0.30V £7.37

Educational Meters. 2 Amp, or 10 amp  
or 0-30V at £4.50. P&P 66p + VAT. Size  
75x78mm Scaler. Finger screw terminals.

## BRIDGES

VA	Price	P&P
100V 25A	60	£8.11
£1.80	250	£16.07
100V 35A	350	£19.88
£2.00	500	£24.77
P&P 30p	1000	£50.53
+ VAT 15%	2000	£74.79
	3000	£104.86
	6000	£207.92

OPEN FRAME MONITORS AVAILABLE FOR OEM'S  
**The 'PRINCE' of Monitors**  
offers better Monitoring.  
24MHz Bandwidth—ensures a clear crisp display.  
Available with P4 White P31 Green AND L1 ORANGE



Scan: 625 lines/50 Hz. Deflection: 110°. Active raster: 240x172mm.  
Bandwidth (3dB): 10 Hz-24 MHz (at 3dB points). Character display:  
80 characters x 24 lines. Horizontal frequency: 15625 Hz ± 0.5 KHz.  
Vertical frequency: 50 Hz. Horizontal linearity: ± 3%. Vertical  
linearity: ± 2%. Geometric distortion: ± 1.5%. EHT (at zero beam  
current): 13kV ± 0.5kV. Power drain: 30 Watt approx. Voltage  
supply: 110V A.C. 50 Hz/220V A.C. - 50 Hz/240V A.C., 50Hz/±  
10% upon request. Video Input: 2 x BNC - or CINCH - or  
PL 259. (composite video) negative sync. Input 0.5-4V p.p. across  
75 Ohms. X-Ray radiation: conforms to I.E.C. Spec. No. 65. Overall  
dimensions: 320 x 270 x 265 mm. Weight: 7 Kg. approx. Ambient  
temperature: 0-45°C.

OTHER CROFTON PRODUCTS INCLUDE: Computer peripheral  
equipment. Frame grabber. Floppy disk drives. Floppy disks.  
Computer power supplies. C.C.T.V. monitors. Uncased monitors.  
Monitor P.C.B.'s. Cathode ray tubes. VHF/UHF modulators. Video  
switchers. Video distribution amplifiers. Camera housings. Pan and  
tilt units. Camera lens. Camera tubes. Printed circuit board service.

## CROFTON ELECTRONICS LTD

35, Grosvenor Road, Twickenham, Middx, TW1 4AD.  
Telephone: 01-891 1923/1513 Telex: 295093 CROFTN G



*Bigger and Better for 1982*  
the colourful Wilmslow Audio brochure  
— the definitive loudspeaker catalogue!

Everything for the speaker constructor — kits, drive units,  
components for HiFi and PA.

50 DIY HiFi speaker designs including the exciting new  
dB Total Concept speaker kits, the Kef Constructor range,  
Wharfedale Speakercraft, etc.

Flatpack cabinet kits for Kef, Wharfedale and many others.

- ★ Lowest prices — Largest stocks ★
- ★ Expert staff — Sound advice ★
- ★ Choose your DIY HiFi Speakers in the comfort of our ★  
two listening lounges  
(Customer operated demonstration facilities)
- ★ Ample parking ★

Send £1.50 for catalogue  
(cheque, M.O. or stamps — or phone with your credit card number)

★ Access — Visa — American Express accepted ★  
also HiFi Markets Budget Card.



0625 529599

35/39 Church Street, Wilmslow, Cheshire SK9 1AS



Lightning service on telephoned credit card orders!



Step-by-step fully illustrated assembly and fitting instructions are included together with circuit descriptions. Highest quality components are used throughout.

# Sparkrite

BRANDEADING ELECTRONICS  
NOW AVAILABLE IN KIT FORM

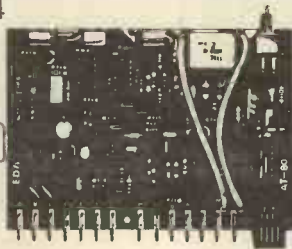
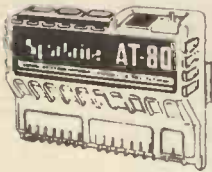

## AT-80

### Electronic Car Security System

- Arms doors, boot, bonnet and has security loop to protect fog/spot lamps, radio/tape, CB equipment
- Programmable personal code entry system
- Armed and disarmed from outside vehicle using a special magnetic key fob against a windscreen sensor pad adhered to the inside of the screen
- Fits all 12V neg earth vehicles
- Over 250 components to assemble

## VOYAGER Car Drive Computer

- A most sophisticated accessory
- Utilises a single chip mask programmed microprocessor incorporating a unique programme designed by EDA Sparkrite Ltd
- Affords 12 functions centred on Fuel, Speed, Distance and Time
- Visual and Audible alarms warning of Excess Speed, Frost/Ice, Lights-left-on
- Facility to operate LOG and TRIP functions independently or synchronously
- Large 10mm high 400ft-L fluorescent display with auto intensity
- Unique speed and fuel transducers giving a programmed accuracy of + or - 1%
- Large LOG & TRIP memories, 2,000 miles, 180 gallons, 100 hours
- Full Imperial and Metric calibrations
- Over 300 components to assemble
- A real challenge for the electronics enthusiast!



## SX1000 Electronic Ignition

- Inductive Discharge
- Extended coil energy storage circuit
- Contact breaker driven
- Three position changeover switch
- Over 65 components to assemble
- Patented clip-to-coil fitting
- Fits all 12v neg. earth vehicles

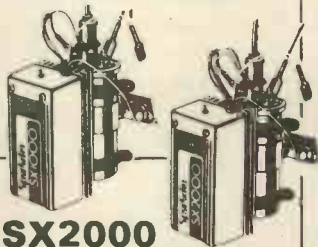

## TX1002 Electronic Ignition

- Contactless or contact triggered
- Extended coil energy storage circuit
- Inductive Discharge
- Three position changeover switch
- Distributor triggerhead adaptors included
- Die cast weatherproof case
- Clip-to-coil or remote mounting facility
- Fits majority of 4 & 6 cyl. 12V. neg. earth vehicles
- Over 145 components to assemble.



## SX2000 Electronic Ignition

- The brandleading system on the market today
- Unique Reactive Discharge
- Combined Inductive and Capacitive Discharge
- Contact breaker driven
- Three position changeover switch
- Over 130 components to assemble
- Patented clip-to-coil fitting
- Fits all 12v neg. earth vehicles

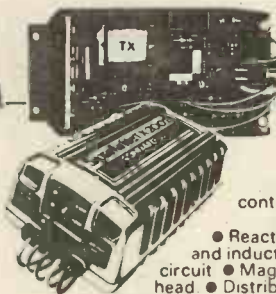
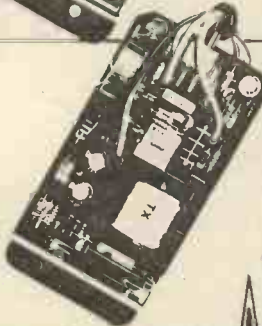

## TX2002 Electronic Ignition

- The ultimate system
- Switchable contactless
- Three position switch with Auxiliary back-up inductive circuit
- Reactive Discharge. Combined capacitive and inductive.
- Extended coil energy storage circuit
- Magnetic contactless distributor triggerhead
- Distributor triggerhead adaptors included
- Can also be triggered by existing contact breakers
- Die cast waterproof case with clip-to-coil fitting
- Fits majority of 4 and 6 cylinder 12v neg. earth vehicles
- Over 150 components to assemble

All EDA SPARKRITE products and designs are fully covered by one or more World Patents

## SPECIAL OFFER

"FREE" MAGIDICE KIT WITH ALL ORDERS OVER £45.00

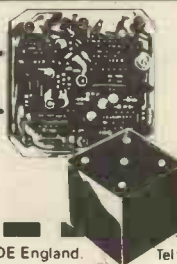

## MAGIDICE Electronic Dice

- Not an auto item but great fun for the family
- Total random selection
- Triggered by waving of hand over dice
- Bleeps and flashes during a 4 second tumble sequence
- Throw displayed for 10 seconds
- Auto display of last throw 1 second in 5
- Muting and Off switch on base
- Hours of continuous use from PP7 battery
- Over 100 components to assemble

EDA, 82 Bath St., Walsall, W. Midlands WS1 3DE.

EDA SPARKRITE LIMITED 82 Bath Street, Walsall, West Midlands, WS1 3DE England.

Tel: (0922) 614791 Allow 28 days for delivery

	SELF ASSEMBLY KIT	READY BUILT UNITS
SX 1000	£12.95	£25.90
SX 2000	£19.95	£39.90
TX 2002	£29.95	£59.90
TX 1002	£22.95	£45.90
AT 80	£29.95	£59.90
VOYAGER	£59.95	£119.90
MAGIDICE	£9.95	£19.90

PRICES INC. VAT, POSTAGE & PACKING

NAME \_\_\_\_\_ PE  
ADDRESS \_\_\_\_\_

I ENCLOSE CHEQUE(S)/POSTAL ORDERS FOR

£ \_\_\_\_\_ KIT REF. \_\_\_\_\_

CHEQUE NO. \_\_\_\_\_  
24 hr. Answerphone  
PHONE YOUR ORDER WITH ACCESS/ BARCLAYCARD  
SEND ONLY SAE IF BROCHURE IS REQUIRED

BRANDEADING BRITISH ELECTRONICS

CUT OUT THE COUPON NOW!

# Rapid Electronics

Tel: 0206 36412  
Hill Farm Industrial Estate  
Boxed  
Colchester Essex CO4 5RD



LINEAR	ICL7106	790	LM358	50	LM3914	200	*NE570	400	T0L064	96	
*555 CMOS	ICL7611	150	LM377	150	LM3915	220	*NE571	400	T0L071	30	
*556 CMOS	ICL7621	180	LM380	150	LM3960	120	*RC4136	68	T0L072	50	
709	25	ICL8038	320	LM382	120	MC1496	60	RC4558	60	T0L074	95
*741	14	ICL8211A	200	LM384	130	*LM922	400	SL480	170	T0L082	45
748	35	ICM7224	785	*LM386	65	ML924	195	SN76477	250	T0L084	95
9400CJ	350	ICM7655	80	LM387	120	ML925	210	SP8629	250	T0L170	50
AY-3-1220	840	LF351	25	LM393	400	LM926	140	*UA2240	120		
AY-3-8910	600	LF353	85	LM709	25	ML927	140	TBA120S	70	ULN2003	85
AY-3-8912	625	LF356	90	LM711	60	ML928	140	TBA800	80	ULN2004	90
CA3080	60	LM10	360	LM725	350	ML929	140	TBA810	96	ZN414	100
CA3089	65	LM301A	25	LM733	75	MM5387A	465	TBA820	80	ZN423	135
CA3089	215	LM311	70	*LM741	14	NE529	225	TBA950	290	ZN424	135
CA3090A	375	LM318	120	LM747	75	NE531	150	TDA1008	320	ZN425E	350
CA3130E	90	LM324	40	LM748	40	NE544	205	*TDA1022	525	ZN426E	330
CA3140E	45	LM334Z	100	LM7517	200	*NE555	15	525	ZN427E	650	
CA3161E	100	LM335Z	125	LM3900	50	*NE556	45	TDA1024	125	ZN428E	480
CA3189	290	LM339	50	LM3909	70	NE566	100	T0L61	40	ZN459	285
*CA3240E	110	LM348	65	LM3911	120	*NE567	100	T0L62	60	ZN1034E	200

CMOS	*4017	38	4036	275	4055	95	4082	16	4502	60	4529	150	
4000	4018	45	4039	290	4059	80	4085	65	4503	40	4532	80	
*4001	10	4019	25	4040	50	4060	65	4086	60	4507	38	4534	485
4002	12	4021	50	4042	45	*4066	30	*4093	30	4510	50	4543	100
4006	50	4022	50	4043	50	4067	295	4094	120	*4511	50	4549	360
4007	15	4023	16	4044	50	4068	16	4095	75	4512	50	4553	275
4008	48	4024	33	4046	60	4069	16	4097	290	4514	120	4555	35
4009	24	4025	15	4047	32	4070	75	4098	75	4515	120	4556	350
4010	24	*4026	80	4048	40	4071	15	4099	90	4516	65	4559	390
*4011	11	4027	24	*4049	25	4072	15	4106	50	*4518	40	4560	175
4012	15	4028	50	*4050	25	4073	15	4109	100	4520	70	4564	45
*4013	25	4029	60	4051	45	4075	15	4163	100	4521	130	4585	60
4014	50	4030	30	4052	60	4076	50	4173	100	4526	70	4724	140
4015	50	4031	25	4053	60	4077	18	4175	100	4527	80		
*4016	20	4032	140	4054	95	4081	14	4193	95	4529	70		

LS TTL	LS21	12	LS76	18	LS125	26	LS161	37	LS221	54	LS365	30	
LS500	11	LS26	14	LS83	40	LS132	42	LS163	37	LS241	69	LS366	30
LS501	11	LS27	12	LS85	52	LS136	26	LS164	43	LS242	75	LS367	35
LS502	11	LS30	12	LS86	19	LS138	32	LS165	75	LS243	75	LS373	65
LS503	12	LS32	13	LS90	28	LS139	32	LS166	75	LS244	60	LS374	65
LS504	12	LS37	15	LS92	32	LS140	35	LS167	75	LS245	70	LS375	65
LS505	13	LS38	15	LS93	28	LS147	150	LS173	65	LS247	60	LS377	70
LS508	12	LS40	13	LS95	40	LS148	85	LS174	45	LS251	35	LS378	60
LS509	12	LS42	32	LS96	95	LS151	38	LS175	45	LS252	35	LS390	55
LS510	12	LS47	38	LS107	90	LS153	40	LS190	45	LS258	35	LS393	55
LS511	12	LS48	45	LS109	21	LS154	90	LS191	45	LS259	75	LS399	175
LS512	12	LS51	14	LS112	21	LS155	35	LS192	45	LS266	22	LS441	120
LS513	22	LS58	15	LS47	23	LS156	36	LS193	45	LS273	68	LS670	150
LS514	38	LS73	18	LS114	22	LS157	30	LS195	36	LS279	35		
LS515	12	LS74	18	LS122	38	LS158	30	LS196	50	LS283	40		
LS520	12	LS75	22	LS123	38	LS160	37	LS197	60	LS353	88		

TTL	7413	18	7442	32	7480	48	74107	25	74155	40	74177	45	
7400	11	7416	24	7444	65	7483	65	74109	25	74157	30	74180	80
7401	11	7417	25	7447	40	7485	65	74122	60	74160	60	74181	115
7402	11	7420	15	7448	45	7486	20	74123	40	74161	50	74182	50
7403	12	7421	20	7450	16	7489	180	74125	35	74162	50	74189	50
7404	13	7422	20	7451	16	7490	21	74126	35	74163	50	74191	50
7405	15	7427	22	7453	18	7491	45	74132	30	74164	50	74192	50
7406	24	7428	26	7454	16	7492	25	74141	60	74165	50	74193	45
7407	25	7430	14	7456	18	7493	25	74145	50	74167	150	74194	50
7408	14	7432	15	7457	18	7494	25	74146	125	74169	75	74195	50
7409	14	7433	25	7473	26	7495	35	74148	70	74173	60	74196	50
7410	14	7438	25	7474	20	7496	40	74150	55	74174	60	74197	50
7411	16	7437	25	7475	26	7497	95	74153	40	74175	55	74198	90
7412	18	7440	15	7476	30	74100	80	74154	55	74176	40	74199	90

TRANSISTORS	BC548	40	BC549	40	BC548	40	BC549	40	*2TX107	8	2N3053	23	
AC125	35	BC157	10	BC558	10	BC558	10	BC558	10	*2TX108	8	2N3054	55
AC126	25	BC158	10	BC710	10	BC584	25	BC584	25	*2TX109	12	2N3055	50
AC127	25	BC159	8	BC711	18	BC585	25	BC585	25	*2TX301	14	2N3056	120
*AC128	20	BC160	45	BC722	18	BC586	28	BC586	28	*2TX302	15	2N3073	6
AC176	25	BC168C	10	BD115	80	BC587	25	BC587	25	*2TX304	17	*2N3074	6
AC187	22	BC169C	10	BD131	35	BC588	25	BC588	25	*2TX341	30	2N3075	5
AC188	22	BC170	10	BD132	35	BC589	23	BC589	23	*2TX500	15	2N3076	5
AD142	120	AD142	120	BD133	50	BC590	23	BC590	23	*2TX501	15	2N3077	10
AD149	80	BC172	8	BD135	50	BC591	23	BC591	23	*2TX502	15	2N3078	10
AD161	40	BC177	8	BD136	30	BC592	23	BC592	23	*2TX503	12	2N3079	10
AD162	40	BC178	8	BD137	30	BC593	23	BC593	23	*2TY504	25	2N3072	190
AF124	60	BC179	18	BD138	30	BC594	23	BC594	23	*2N697	20	2N3073	210
AF126	50	BC180	18	BD139	35	BC595	20	BC595	20	2N698	40	*2N3818	18
AF139	40	*BC182L	8	BD140	35	BC596	20	BC596	20	2N706A	20	2N3820	18
AF186	70	BC183L	10	BD204	110	BC597	20	BC597	20	2N708	20	2N3823	65
AF239	75	BC184	10	BD206	110	BC598	20	BC598	20	2N718	35	2N3866	90
BC107	10	BC184L	7	BD222	85	BU206	20	TIP41A	60	2N1132	22	2N3903	60
BC107B	12	*BC184L	7	BF180	35	BU208	170	TIP42A	60	2N1613	30	2N3904	10
*BC108	9	BC212	10	BF182	35	BU208	170	TIP42B	60	2N2218A	45	2N3905	6
BC108C	12	BC213	10	BF184	25	MJE2955	99	TIP122	90	2N2219A	25	2N3906	10
*BC109	9	BC213L	10	BF185	25	MJE340	50	TIP141	120	2N2221A	25	2N4037	30
BC109C	12	BC214	10	BF194	12	MJE350	50	TIP142	120	2N2222A	25	2N4058	10
BC114	22	*BC214L	8	BF196	12	MJE355	70	TIP147	120	2N2368	25	2N4060	10
BC115	22	BC231	8	BF198	12	MJE357	70	2N2955	99	2N2369	16	2N4061	10
BC117	22	BC238	14	BF197	12	MPF104	40	TIP305	55	2N2484	25	2N4062	10
BC119	35	BC306	15	BF198	10	MPSA05	22	TIS44	45	*2N2646	45	2N4547	36
BC137	40	BC327	14	BF199	10	MPSA06	25	TIS45	45	2N2904	20	2N4548	36
BC139	40	BC328	14	BF200	30	MPSA07	25	TIS46	45	2N2904A	20	2N4549	36
BC140	30	BC337	14	*BF204B	22	MPSA12	30	TIS90	30	2N2905	22	2N4550	36
BC141	30	BC338	14	BF245	30	MPSA13	30	TIS91	30	2N2905A	22	2N5777	70
BC142	25	BC347	30	BF256B	45	MPSA16	30	*VN10KM	55	2N2906	25	2N6027	30
BC143	25	BC348	30	BF257	32	MPSU05	35	*VN206A	45	2N2906A	25	4036	40
BC147	8	BC479	30	BF258	25	MPSU06	35	VN46AF	75	2N2907	25	4036	50
BC148	8	BC517	40	BF259	35	MPSU07	35	VN66AF	85	2N2907A	25	4036	50
BC149	9	BC547	7	BF337	40	MPSU08	35	VN88AF	95	2N2926	9	40408	70

SWITCHES	Submin toggle	SPST 55p	SPDT 60p	*DPDT 50p
	Miniature toggle	SPST 60p	SPDT centre off 90p	DPDT 90p
	Standard toggle	SPST 55p	DPDT 48p	Standard toggle
	Miniature DPDT slide	12p		
	*Push to make	12p	Push to break	22p
	Rotary type adjustable	50p	1P12V 2P6V 3P4V 4P3V	all 55p ea.
	DIL switches	4 SPST 10p	6 SPST 80p	8 SPST 100p

VERO	*Verobloc 350p	*Size 0-1 matrix	2-5 - 1	22p
			2-5 - 3-75	75p
			3-75 - 5	85p
			5-15	50p

## ELECTRONIC HOBBIES FAIR

As promised last month some more news on our exciting new exhibition for all interested in the various forms of our hobby. This new venture will take place at the recently built Alexandra Pavilion (in the grounds of the now burnt out Alexandra Palace) from the 18th to 21st of November this year. The new pavilion has been hailed as one of the best exhibition venues in the country. It is London's third largest exhibition hall, has masses of parking space, is easily approached by road, British Rail, underground or bus and has a free shuttle bus service to ferry visitors from Alexandra Palace station. For wives/girlfriends there is the added attraction of the nearby Wood Green Shopping City, one of the largest centres in the U.K., although we are sure they will find plenty to interest them in the special exhibits at the Fair.

Although planning is still in the early stages we anticipate many special exhibits, showing all aspects of the application of electronics in hobbies, broadcasting, forces communications and weapons systems, entertainment, vehicle technology etc. etc. We also expect to attract trade stands dealing with Amateur Radio, Computing, Radio

Control and CB, in addition to the "regular" electronic hobby suppliers.

Next month we will be starting a monthly Electronic Hobbies Fair information section, within *News and Market Place* to lead up to the event and to keep readers up to date on every aspect of the Fair. We already have the backing of some of the biggest names in the electronic hobby retail business.

## COMPUTING

Probably the fastest growing electronic hobby area at the present time is that of computing and many companies have expanded into the computer business or have been launched into it. Like any booming market it attracts all types of new venture and small supplier, as well as the large, established names. There are the usual supply problems and the inevitable failures in the business. There are also the dubious areas where companies sail close to the law.

One area where we do not entirely approve of some practices is in the "user clubs" or "groups", set up—often by hobbyists—to assist each other in their hobby. This is to be commended and is in the spirit of "amateur

electronics" but when such user groups are run as businesses for the financial benefit of the founders, possibly without the members or subscribers being aware of such a situation, we wonder just how ethical it all becomes?

Comments from readers, members and proprietors of such organisations are welcome for our *Readout* section!

## FRONT COVER

Just in case you are wondering about this month's front cover, which is a departure from our normal illustration of projects, it's not just a fancy design. The photograph shows the view looking into the faceted mirror used on the *Infra-Red Burglar Alarm*. One of the three projects in our *Comprehensive Home Alarm System* article. (The "T" piece holds the pyroelectric sensor).

## PRICE

We must reluctantly announce an increase in cover price next month. We know only too well the effects of increasing prices, but believe PE will continue to represent good value.

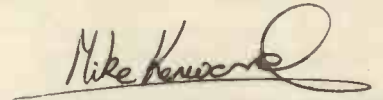

**EDITOR** Mike Kenward

**Gordon Godbold** ASSISTANT EDITOR

**Mike Abbott** TECHNICAL EDITOR

**David Shortland** PROJECTS EDITOR

**Jasper Scott** PRODUCTION EDITOR

**Jack Pountney** ART EDITOR

**Keith Woodruff** ASSISTANT ART EDITOR

**John Pickering** SEN. TECH. ILLUSTRATOR

**Isabelle Greenaway** TECH. ILLUSTRATOR

**Jenny Tremaine** SECRETARY

*Technical and Editorial queries and letters (see note below to):*

Practical Electronics,  
Westover House,  
West Quay Road, Poole,  
Dorset BH15 1JG

**Phone: Editorial Poole 671191**

**We regret that lengthy technical enquiries cannot be answered over the telephone**

*Queries and letters concerning advertisements to:*

Practical Electronics Advertisements,  
King's Reach Tower,  
King's Reach, Stamford Street, SE1 9LS  
Telex: 915748 MAGDIV-G

## ADVERTISEMENT MANAGER

**D. W. B. Tilleard**

SECRETARY

**Christine Pocknell**

} 01-261 6676

AD. SALES EXEC.

**Alfred Tonge** 01-261 6819

CLASSIFIED SUPERVISOR

**Barbara Blake** 01-261 5897

AD. MAKE-UP/COPY

**Ian Sweeney** 01-261 6601

## Letters and Queries

We are unable to offer any advice on the use or purchase of commercial equipment or the incorporation or modification of designs published in PE. All letters requiring a reply should be accompanied by a stamped, self addressed envelope, or addressed envelope and international reply coupons, and each letter should relate to one published project only.

Components and p.c.b.s are usually available from advertisers; where we anticipate difficulties a source will be suggested.

## Back Numbers

Copies of most of our recent issues are available from: Post Sales Department (Practical Electronics), IPC Magazines Ltd., Lavington House, 25 Lavington Street, London SE1 0PF, at £1 each including Inland/Overseas p&p. Please state month and year of issue required.

## Binders

Binders for PE are available from the same address as back numbers at £4.60 each

to UK or overseas addresses, including postage and packing, and VAT where appropriate. Orders should state the year and volume required.

## Subscriptions

Copies of PE are available by post, inland or overseas, for £13.00 per 12 issues, from: Practical Electronics, Subscription Department, Oakfield House, Perrymount Road, Haywards Heath, West Sussex RH16 3DH. Cheques and postal orders should be made payable to IPC Magazines Limited.

# NEWS &

Edited by Jasper Scott

## BBC introduce packaged learning for TV engineers

The BBC's Engineering Training Department have recently produced a revolutionary method of training students in the fundamentals of television engineering.

Based on the "packaged-learning" concept, the students work at their own pace using purpose-designed demonstration equipment, supported by specially written learning texts. Packaged learning has been a feature of BBC Engineering Training for some time, but because of the high cost of broadcast television equipment, it has not been possible to teach television fundamentals in this way until now.

The overall package, which consists of two main racks of equipment, plus four supporting books, and a VHS tape, covers the fundamentals of television engineering. Scanning is covered first, together with synchronisation and interlace. Picture signal processing is covered next including clamping and gamma correction. The associated equipment enables demonstration of many aspects covered in the text.

A colorimetry section deals with the principles of colour vision and the simulation of spectral colours using additive mixing techniques. The separation of a scene into its red,

green and blue components is considered and the analysis required of a camera determined.

The third and final section of the package describes the coding and decoding of the colour television signal, with specific reference to PAL system 1. In addition to the text this section is supported by its own demonstration equipment.

The total package comes in three parts: i) the basic television principles equipment ii) the colour fundamentals demonstration equipment iii) the support literature and video cassette tape. Each part is easily identified, but is not necessarily self-supporting. For example, the literature requires the appropriate equipment for the student to work with.

It is possible that the package may be made available to colleges, institutions, industry and other broadcasting organisations in the near future. In comes complete except for monitors and oscilloscopes. At present there are no plans to produce SECAM or other television standard versions.

## LOW COST LOGIC PROBE



Stotron Ltd inform us that they can now supply a new, low cost, high performance, 10MHz Logic Probe from Sabtronics—the LP-10. Operation is high speed and pulses as narrow as 50 ns are stretched to be easily detected. 'Floating' input levels, caused by open lines, bad sockets and dirty connectors, etc, are easily detected by this logic probe. There is a high impedance input of 100k $\Omega$  which avoids circuit loading.

Two l.e.d.'s indicate the presence of a logic '0' or a logic '1'. The relative brightness of these two l.e.d.'s, in a rapidly switching signal, indicates the amount of time spent at each logic state. Invalid logic outputs fail to light either of the l.e.d.'s. Logic transitions are detected and displayed on a third l.e.d.

Clip leads, supplied with the unit, allow the approximately 35 mA required to power the probe to be supplied from the circuit under test.

The LP-10 is priced at £24.95 plus VAT and p & p, and is available from Stotron Ltd, 72 Blackheath Road, London SE10 8DA (01-691 2031).



## TIME TO LISTEN

It's gimmicks time again! Not content with the abundance of Walkman-size cassette players and radios, an American company JS&A has gone one step further and produced a digital watch that also incorporates an AM radio. The Advance Digital Watch Radio is sold complete with lightweight samarium cobalt headphones, and the radio is said to run for over 100 hours before a new battery is needed (don't worry, the watch department has a separate battery).

Doubtless it won't be long before a similar machine is available in this country, and if the price stays about the same (\$49 in America), it could mean serious competition for the 'Walkman' market.

# MARKET PLACE

Items mentioned are available through normal retail outlets unless otherwise specified. Prices correct at time of going to press.

## Briefly...

Hobbyists in the Thornton Heath area will be pleased to hear of a new company which has recently been launched. CMC Electronics supply a range of components, hi-fi, televisions, telephone answering machines and technical books. As well as the retail side of their business, CMC also provide a repair service. Opening hours are 9 am to 6 pm, Monday to Saturday.

CMC Electronics, 70 Brigstock Road, Thornton Heath, Surrey (01-684 2188).

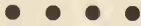

Component suppliers Rapid Electronics have recently moved from their original premises in Eynsford to new tailored premises at Boxted, Colchester, Essex. Their new catalogue which is priced at 45p (or free with orders over £5) is now available and contains over 2,500 lines. Among new lines in stock are Denco coils, l.c.d.s, cremet presets and an extended and very comprehensive CMOS and linear range.

Personal shoppers are welcome at the premises which are open from 9am to 6pm Monday to Friday, and from 9am to 5pm on Saturdays. Rapid Electronics, Hill Farm Industrial Estate, Boxted, Colchester, Essex CO4 5RD (0206 36412).

## NEW FLUKE DMMs

Two new 4½ digit handheld DMMs are the latest models to emerge from the Fluke stable.

Fluke say that the 8060A is virtually a handheld test-lab, providing direct frequency measurement, dB computation and relative/offset modes in addition to traditional multimeter functions. A simplified sister machine, the 8062A, provides the same high performance, but without the frequency and dB facilities.

The 8060A is the first general purpose handheld DMM to be able to measure modem and communications equipment performance, and as such should be of particular interest to engineers working in the field of computer communications.

Key features include a true RMS capability up to 100kHz, voltage ranges from 10mV to 1000V, autoranging frequency measurements to 200kHz, current to 2 amps, resistance to 300 Mohms, audible continuity detection, conductance and diode test facilities. Readings can be displayed in volts, relative dB or dBm referenced to 600 ohms. Using the relative function, any reading can be offset to zero and only the deviation is displayed on the l.c.d.

To achieve all this performance in a handheld DMM, Fluke have used microcomputer techniques and have even designed and manufactured their own custom CMOS LSI circuit. The built-in microcomputer not only controls all the functions and computes the readings, but also allows sophisticated self-testing to be carried out automatically every time it is used.

The 8060A is priced at £270 and the 8062A at £210. Further information from Fluke (GB) Ltd., Colonial Way, Watford, Herts. WD2 4TT (0923 40511).



## Countdown...

Please check dates before setting out, as we cannot guarantee the accuracy of the information presented below.

**BAEC Amateur Electronics** Jul. 17-25. Penarth Esplanade, S. Glamorgan. B9

**Harrogate International Festival of Sound & Video** Aug. 14-17. Exhibition Cntr. and hotels. X

**BEX Manchester** Sept. K

**Personal Computer World Show** Sept. 9-12. Barbican Cntr, London. M

**Laboratory London** Sept. 14-16. Grosvenor Ho. Park Lane. E

**ElectroWEST** Sept. 14-16 Bristol Exhibition Centre Q

**Two Counties Fair** Sep. 15-18. Plymouth Ex. Centre, Millbray, Plymouth, Devon. T

**IBC** Sept. 18-21. Metropole, Brighton. N

**Microprocessors In Audiology** Sept. 24 A7

**Holographic Techniques** Sept. 30-Nov. 28. Light Fantastic Gallery, Covent Gdn. A8

**BEX Cardiff** Oct. K

**Viewdata** Oct. 12-14. Wembley Conf. Centre. O

**Video Show** Oct. 16-18. West Cnt. Hotel. Z1

**Computer Graphics** Oct. 19-21. London. O

**Testmex** Oct. 26-28. Wembley Conf. Centre, London. T

**Compec** Nov. 16-19. Olympia, London. Z1

**Hobby Electronics Fair** (taking exhibitions for the amateur a bold step forward!) Nov. 18-21 Alexandra Palace, London Z1

**ElectroNORTH** Dec. 7-9 Harrogate Supercentre Q

**Continuous events at the National Microprocessor and Electronics Centre** (Nr. Tower of London) L1

**Christmas Holography** (and sales items) Dec. 2-Mar. 83. Light Fantastic Gallery, London. A8

A7 Institute of Acoustics, ☎ 031-225 2143

A8 Holographic Exhibitions ☎ 01-836 6423

B9 BAEC, Penarth ☎ 0222-707813

E Evan Steadman, Saffron Walden ☎ 0799 22612

K Douglas Temple, Bournemouth ☎ 0202 20533

L1 World Trade Cntr. ☎ 01-488 2400

M Montbuild ☎ 01-486 1951

N IEEE

O Online, Northwood, Middx. ☎ 0822 4671

Q Exhibitions For Industry, ☎ 08833 4371

T Trident Tavistock ☎ 0822 4671

X Exhibition & Conference Services ☎ 0423 62677

Z1 IPC Exhibitions, Sutton ☎ 01-643 8040

# Comprehensive HOME ALARM SYSTEM

G. DAVIES

The three alarms featured in this article are all based around one p.c.b. design which can accommodate any one of the systems.

The first is a Doppler shift ultrasonic alarm with 32.7kHz transducers driven from a crystal oscillator, resulting in no alignment or interaction problems with other such alarms. The alarm has a range adjustable up to 8 metres.

The second is a Doppler shift radar alarm based on the Mullard CL8960 module which operates on 10.687GHz and has a range up to 30 metres. With suitable weatherproofing it can be used outdoors—some consideration must be given to the fact that rain is a moving object in the eyes of radar. **To operate this Radar module a Home Office licence is required which lasts for 5 years and costs a few pounds.**

The third is the latest development in the alarm field—an infra-red heat sensor with a sensitivity peaking at human body heat. This device detects a change in heat and gives an electrical signal output. As the device only responds to a change in heat a multi-faceted mirror (US Patent 3703718) or a Fresnel lens is required to concentrate the detected area into zones, so that anyone entering these zones can be detected.

The above alarms all have their own merits for particular uses:—

	ULTRASONIC	RADAR	INFRA-RED
Range	8 metres	30 metres	15 metres
Field of coverage	full field	full field	zones
Indoor	yes	yes	yes
Outdoor	no	yes	yes
Detection	movement	movement	heat
Draughts	poor	good	good
Cost	low	high	med
Consumption at 12Vd.c. (typical in standby)	15mA	150mA	10mA

## CIRCUIT DESCRIPTION (ULTRASONIC)

The circuit diagram for the Ultrasonic Alarm is shown in Fig. 1. The mains supply feeds T1 via R1 and its secondary

feeds D1–D4, a full wave rectifier, before being smoothed by C1. This unstabilised voltage is fed to IC1 and stabilised to 12V d.c., and further decoupled by C2 and C16.

IC2 forms a crystal oscillator, R3 and R4, R5 and the crystal form the feedback components, whilst C3 terminates the crystal loading capacitance, C4 aids oscillator start up. The output of the oscillator at pin 3 is a 32.7kHz square wave which is filtered by R6 and C5 to remove harmonics before driving the Ultrasonic transducer X1.

The Ultrasonic sound is received by X2, then decoupled by C18 feeding IC3, the 32.7kHz amplifier. R7, R8, R9 and C6 form the biasing for IC3. VR1, R10 and C7 form the feedback components to determine the gain and response of the stage—VR1 being the sensitivity control.

D6, R11, R12 and C8 form a diode detector to remove the 32.7kHz and recover the Doppler frequency envelope which is fed to IC4, a high gain Doppler frequency amplifier. The gain is set by feedback components R14, R13 and C9 and selected for optimum performance for 32.7kHz ultrasound.

The output of IC4 feeds a bootstrapped diode pump detector consisting of C10, D7, TR1, C11 and R15 which converts the Doppler frequency into a d.c. level then buffered by IC5.

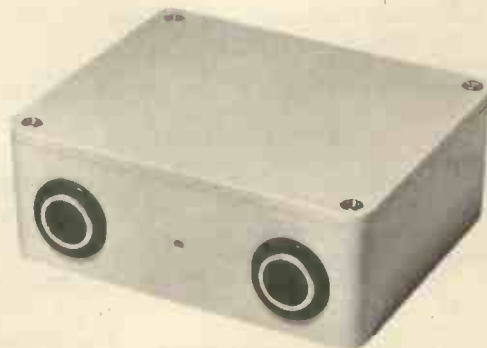

Ultrasonic Alarm



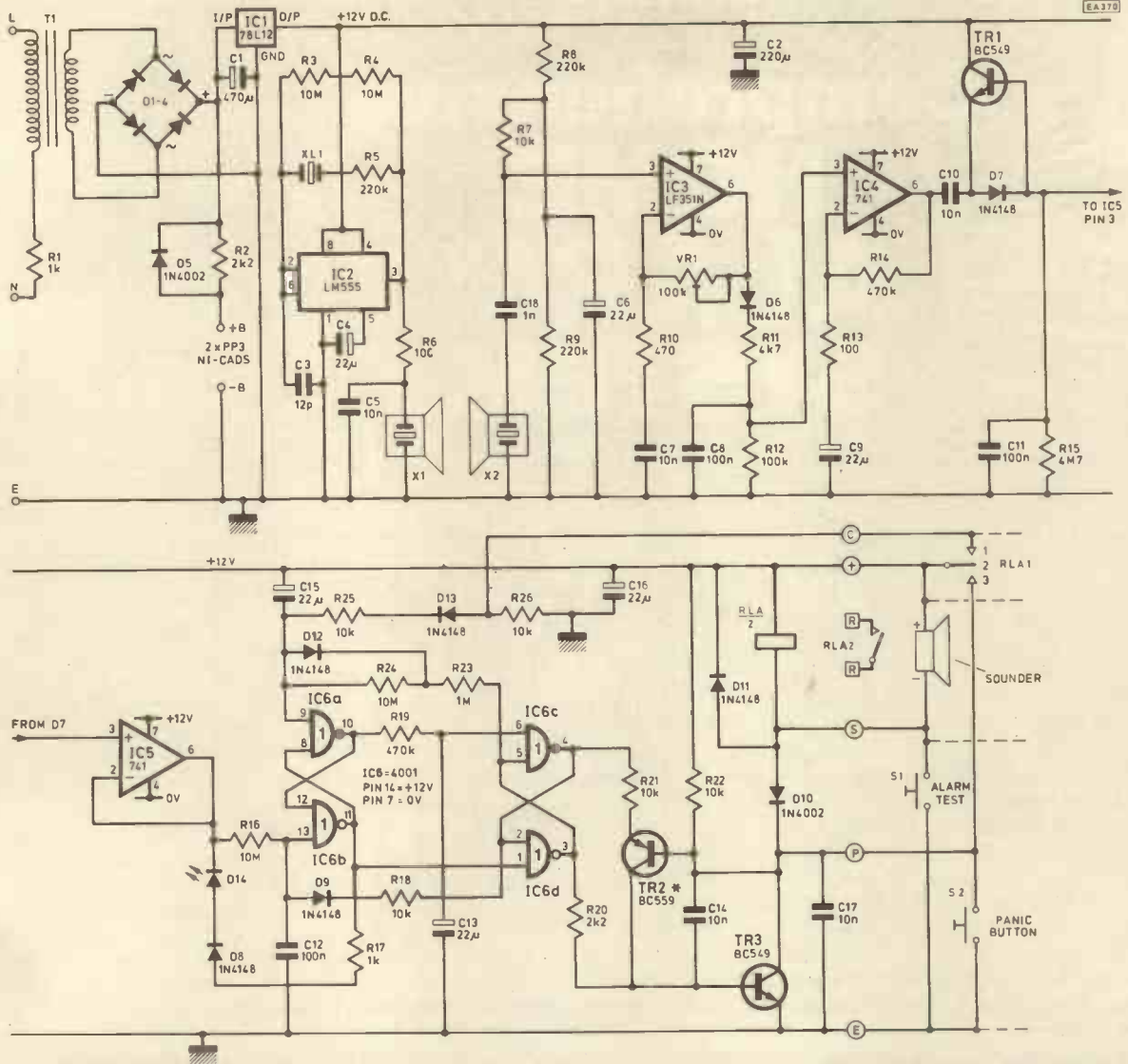

Fig. 1. Complete circuit diagram of the Ultrasonic Alarm Unit. \*Not required if the panic button is not used.

## SPECIFICATIONS

### CONTROL SECTION

- 1 second invalid movement delay (IR 0.1 sec)
- 20 second delay on leaving (IR 1 min at power up)
- 10 second delay on entry
- 2-3 minutes alarm-on time
- 10 second inhibit after alarm has ended

Timing activated at power switch on/external control  
 Panic button facility will instantly sound the alarm and latch until reset—this can be used for other applications, i.e. pressure mats, fire detector etc. The output is designed to easily accommodate common switching and alarm switching. A s.p.c.o. centre off keyswitch provides all switching:—

- Position (1) Detection 'OFF' panic active
- (2) Detection 'ON' panic active
- (3) Panic reset only—MUST NOT be left in this position

### ALARM UNITS

- ULTRASONIC: 8 metres range—full field coverage
- RADAR: 30 metres range—full field coverage
- INFRA-RED 15 metres range—12 zones covering 80 degrees

Both the ultrasonic and radar are most sensitive to objects moving in front of and towards the unit. The sensitivity will be reduced when the unit is approached from the side. The infra-red however is most sensitive to humans moving across the field and this must be considered when installing the alarm.

When setting up the alarm the red l.e.d. on the front of the unit should not flicker; if it does the unit is detecting a signal—either re-site the unit or reduce the sensitivity.

All units can drive a solid state sounder rated at 12V d.c. at 25mA directly which can therefore be driven from the alarm's own Ni-Cad power in the event of power failure. These high efficiency sounders can produce sound levels from 95 to 110dB at 1 metre which should be enough to deter all but the most persistent intruder.

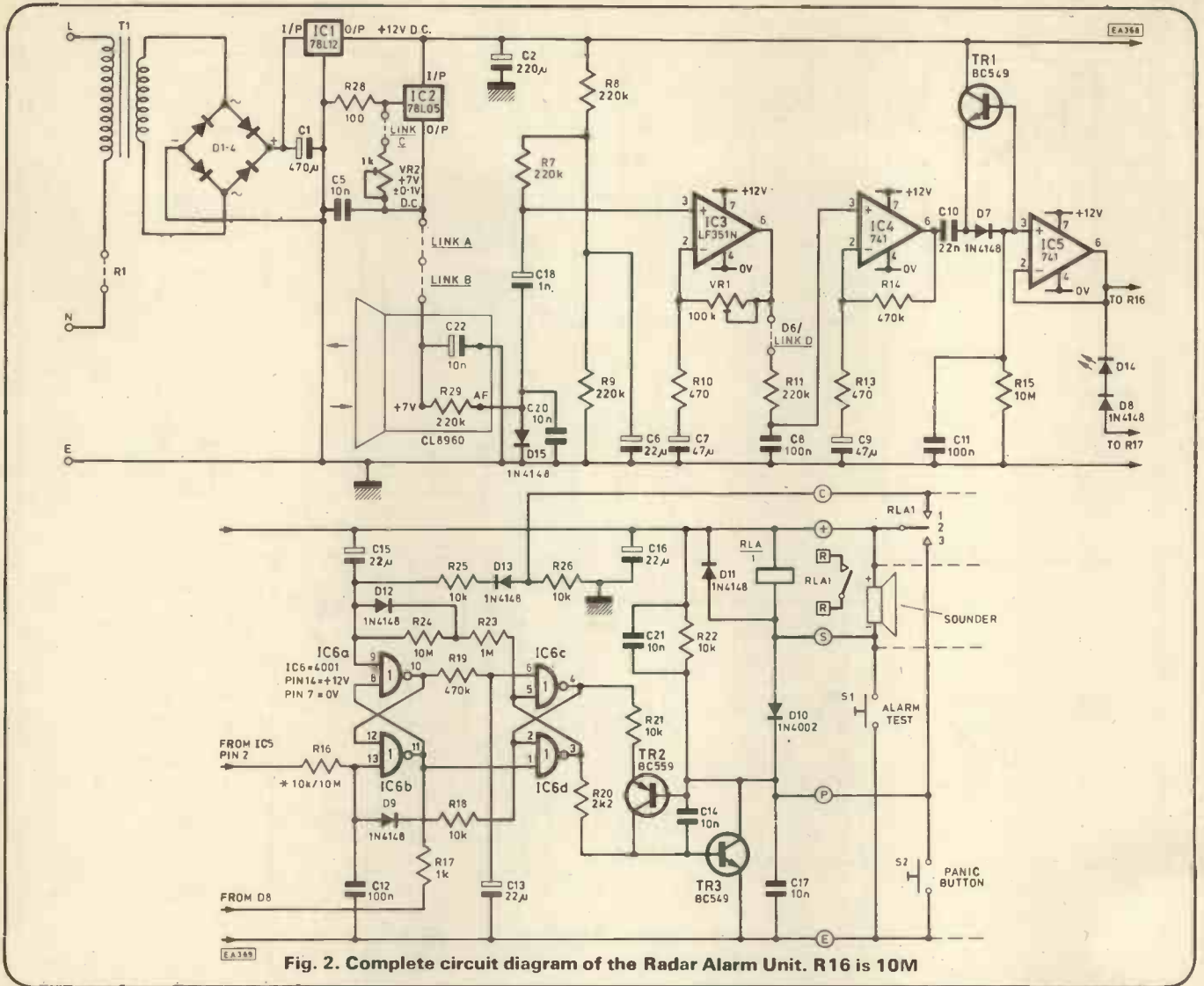

Fig. 2. Complete circuit diagram of the Radar Alarm Unit. R16 is 10M

**CIRCUIT DESCRIPTION (RADAR)**

The circuit diagram for the radar system is shown in Fig. 2. The mains supply feeds T1 and its secondary feeds D1–D4, a full wave rectifier, before being smoothed by C1. This unsmoothed voltage is fed to IC1 and stabilised to 12V d.c., and further decoupled by C2 and C16.

As the radar module requires +7V d.c. within 0.1V d.c. at 150mA, IC2, VR2 and R28 form an adjustable voltage regulator set by VR2. This voltage is adjusted BEFORE the CL8960 is connected to prevent damage to the module and then finely adjusted when connected, measuring the voltage at the module end to compensate for any volt drop in the supply leads. C22 is connected directly onto the module using short leads and provides local rail decoupling. R29 provides correct biasing for the mixer diode, again mounted on the module.

The Doppler output 'AF' is terminated by D15 and C20 to prevent surges being induced in the mixer diode, then decoupled by C18 to IC3, the Doppler frequency pre-amp. R7, R8, R9 and C6 form the biasing for IC3. VR1, R10 and C7 form the feedback components to determine the gain of this stage and select a suitable response for the 10.687GMz radar module. VR1 is the sensitivity control. R11 and C8 form a low pass filter to remove frequencies not required

before further amplification by IC4, the 2nd Doppler frequency amplifier, the gain being set by feedback components R14, R13 and C9.

The output of this stage feeds a bootstrapped diode pump detector consisting of C10, D7, TR1, C11 and R15 (the ratios of C10 to C11 and the time constant C11 and R15



Radar Unit

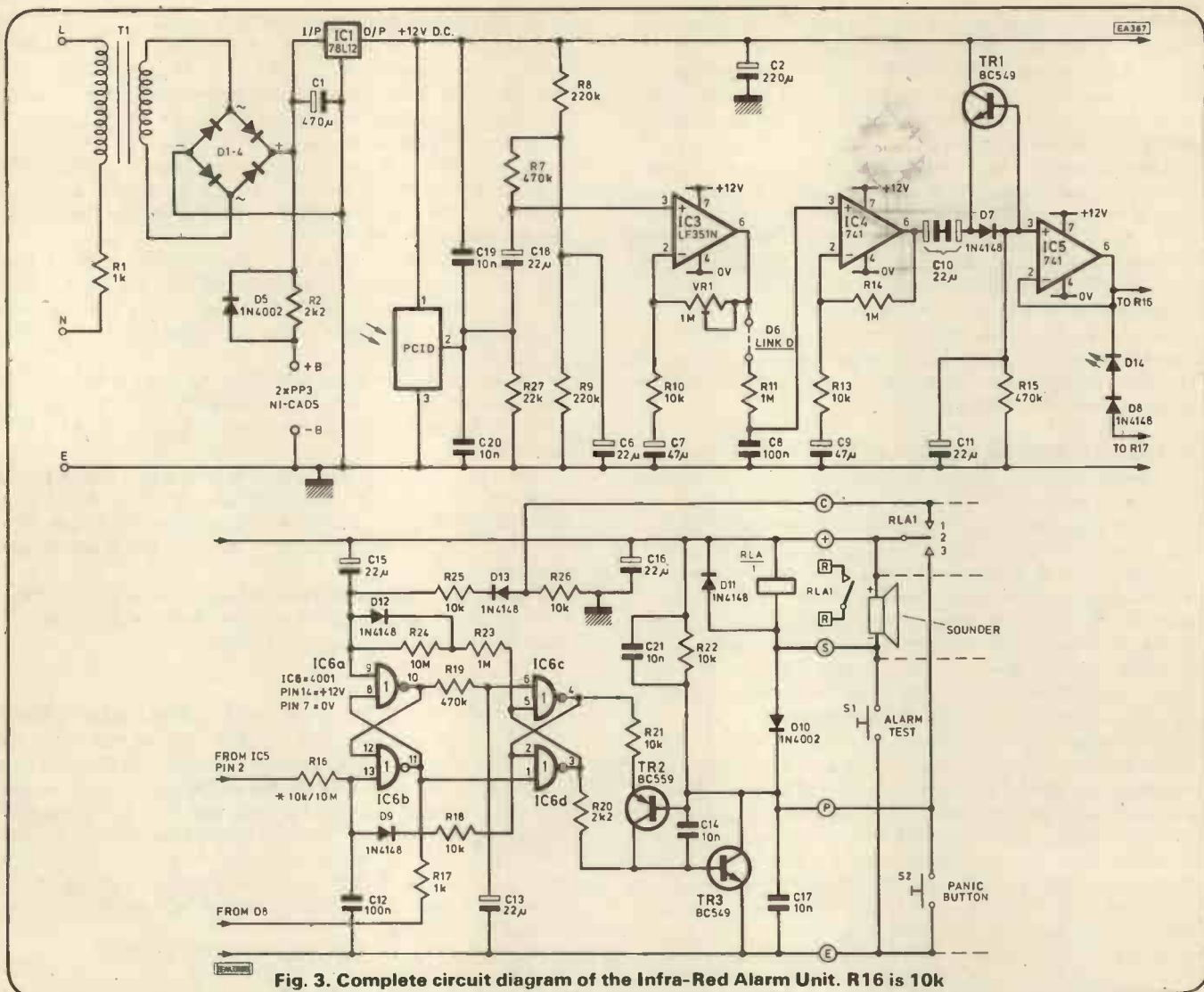

Fig. 3. Complete circuit diagram of the Infra-Red Alarm Unit. R16 is 10k

chosen for Doppler frequencies for the 10.687GHz radar) which converts the Doppler frequency into a d.c. level then buffered by IC5.

**PYROELECTRIC CERAMIC INFRA-RED DETECTOR**

The development of infra-red detectors that are both rugged and sensitive such as pyroelectric detectors makes them ideal for use in intruder alarms. Each detector consists of two pyroelectric ceramic elements mounted in a TO5 transistor header complete with silicon filter window coated for maximum transmission at 10μ, blocking radiation and visible light below 6.5μ.

Incorporated within the package is an impedance matching JFET preamplifier.

**THE PYROELECTRIC EFFECT**

The pyroelectric effect, exhibited by all ferroelectric materials, has been utilised to develop a series of infra-red detectors. Pyroelectric material exhibits a strong temperature sensitive spontaneous electric polarisation. Any infra-red energy absorbed by the material will increase its temperature and produce an associated change in electric polarisation. Before the effect can be utilised, the normally random oriented electric dipoles which exist in the bulk of the material, must be 'poled'. The effect of this operation is



Infra-Red Unit

to line up the dipoles along one axis in the crystal.

In many single crystal materials, poling must occur along specific crystallographic axes. Ceramic materials can be poled along any axis, the dipoles themselves as near as possible along this axis in the randomly oriented crystallites.

Depending on the material type, poling is normally perfor-

med at an elevated temperature. The process involves applying an electric field to the material and allowing it to cool under the influence of the field. Heating the material reduces the coercive field and hence the voltage that must be applied for poling to occur. The electric field is applied by depositing electrodes on the opposite faces of the material and applying a potential across them. As a result of the poling process a permanent polarisation of the crystal exists, resulting in an excess of one particular charge at the surface of the material. This charge is captive within the structure of the material, but the equal and opposite charge on the electrodes are free to move. Thus the electrode which was positive during the poling process acquires a positive charge.

A pyroelectric element, which makes use of its self-polarisation effect, produces a change in surface charge with temperature which is detected by the integral JFET to produce a varying current output.

#### APPLICATIONS OF PYROELECTRIC DETECTORS

A healthy human being dissipates approx 100 watts of detectable radiation. Thus, with suitable collecting optics, it is possible to detect a man well over 100 metres distance. In this project the mirror used has 6 facets and a range of 15 metres which is more in keeping with domestic requirements. The peak emission from a human being, resulting from the natural body temperature, occurs at around  $10\mu\text{m}$  in the infra-red range. Passive infra-red alarm systems respond to the combined movement and emission of the intruder which provides a varying radiation signal at the detector. Faceted mirrors or Fresnel lens are used to sub-divide the protected area into separate zones. Movement of the intruder between zones provides the required modulation of the infra-red signal. In practice, broadband thermal detectors are used in these systems and anti-reflection coated germanium windows are included to restrict the response to  $8\text{--}14\mu\text{m}$  spectral region. Exclusion of radiation below  $7\mu\text{m}$  avoids such potential sources of false alarms as sunlight and car headlamps, which can be transmitted through external windows. Pyroelectric detectors respond readily to varying infra-red signals but not to a steady radiation level.

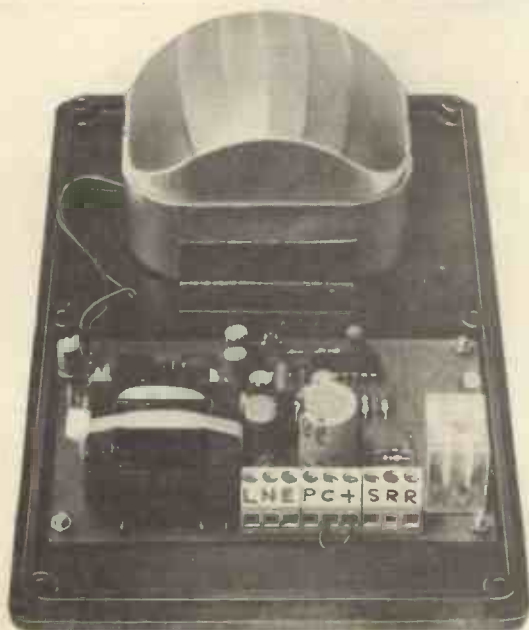

Prototype Infra-Red Alarm

#### CIRCUIT DESCRIPTION (INFRA-RED)

The circuit diagram for the infra-red system is shown in Fig. 3. The mains supply feeds T1 via R1 and its secondary feeds D1–D4, a full wave rectifier, before being smoothed by C1. This unsmoothed voltage is fed to IC1 and stabilised to 12V d.c., and further decoupled by C2 and C16.

When a variation in IR heat is sensed ( $9\mu\text{m}$  to  $14\mu\text{m}$ ) the output current of the detector varies, producing a voltage change across load resistor R27 (C19 and C20 form interference suppression).

This small voltage change is then decoupled by C18 to IC3, a very low frequency amplifier. R7, R8, R9 and C6 form the bias for IC3 whilst VR1, R10 and C7 are the feedback components to determine the gain of this stage, VR1 being the sensitivity control.

R11 and C8 form a low pass filter to remove frequencies not required before further amplification by IC4, a second very low frequency amplifier, the gain being set by R14, R13 and C9.

The output from IC4 feeds a bootstrapped diode pump detector consisting of C10 (two back to back electrolytic capacitors), D7, TR1, C11 and R15, the ratios of C10 to C11 and time constant C11 to R15 chosen for the infra-red detector.

The invalid movement delay formed by R16 and C12 has been reduced to prevent filtering of 'peak' waveforms encountered with pyroelectric detectors.

#### CONTROL SECTION (COMMON TO ALL ALARMS)

The output of IC5 is normally low and the output of IC6 pin 11 is normally high, driving the l.e.d. D14 via R17 and D8. As movement is detected the output of IC5 rises, reducing the resultant drive to the l.e.d., reducing the brightness indicating movement. If movement and therefore the voltage at IC5 pin 6 is sufficient to reach the threshold of IC6 pin 13, the output of the gate at pin 11 will go low, turning off the l.e.d. D8 is included so that the l.e.d. will not be reversed biased for reliability.

Therefore the l.e.d. indicates:—

- (1) That power is connected.
- (2) Aids correct setting of sensitivity control—important to prevent false alarms. (Decreasing brightness with movement.)
- (3) Indicates the trip threshold of the alarm.
- (4) Functions as a walk test—with the alarm in the 'OFF' mode.
- (5) The l.e.d. is off when alarm is tripped to be inconspicuous.

Gates a and b of IC6 form a bistable which is held in the reset mode via R26, D13 and R25 when control terminal 'C' is at 12V d.c. When terminal 'C' is open circuit C15 charges via D12 and R23 (the delay on leaving) until the lower threshold of gate a pin 9 is reached, allowing the bistable to be set by pin 13 going high.

When pin 13 goes high pin 10 goes high, charging C13 via R19 (the entry delay) when the threshold voltage of gate c is reached the bistable formed by IC6 gate c and d is set, causing the output at pin 3 to go high, driving TR3 via R20. TR3 turns on and drives the relay RLA via D10. D11 suppresses the back e.m.f. of the relay coil whilst D10 forms an 'OR' function when more than one unit is used, such as in multiple alarm systems.

As the output of IC6 pin 3 is now high C15 is discharged via R23 and R24 (the alarm on time) until the threshold of

IC6 pin 9 is reached, resetting the bistable, causing its output at pin 11 to go high feeding IC6 pin 1 and resetting the output of the bistable, turning off TR3 and RLA. Pin 10 goes low, discharging C13 via R19 when the threshold of IC6 pin 6 is reached IC6 pin 4 goes high, removing the inhibit formed by R18 and D9 (alarm inhibit) at pin 13 IC6.

The bistable formed by IC6c and d is normally in its reset state, pin 4 high and pin 3 low. TR2 is normally turned off. If terminal 'P' is connected to terminal 'E' by an external button TR2's base goes low causing it to turn on. Its collector drives the base of TR3, limited by R21, turning it on causing the relay to be activated and instantly sounding the alarm and will latch until reset. If the external button is released TR3 now holds on TR2. By connecting 'P' to '+' TR2 loses its base drive from TR3 and in turn cancels the alarm. C14 and C17 are included to prevent spurious spikes from tripping the panic.

The panic reset switch **MUST NOT** be left in this position as this will cause the output transistor to overheat and die as the alarm in this position is also in the Ultrasonic active mode and could be tripped via movement. When battery back up is used R2 trickle charges the 2 x PP3 Ni-Cad cells when power is connected and in the event of power failure D5 supplies power for the battery to C1.

When battery back up is required with the radar system, because of the higher current requirements, the PP3's have insufficient capacity. In this case it is suggested that a more powerful external battery is connected, i.e. 12V car battery. For such a system it is worth while trickle charging a car battery and powering the alarm system from the battery feeding the alarm unit's 12V rail directly, therefore dispensing with the transformers etc.

**SWITCHING**

All alarm switching is done at 12V d.c., an s.p.c.o. centre off keyswitch provides the control of the alarm whilst a normally open push button operates the panic. If an alarm test is required a normally open push button will sound the alarm but will not latch and will sound the alarm as long as the button is pressed.



Prototype Radar Alarm

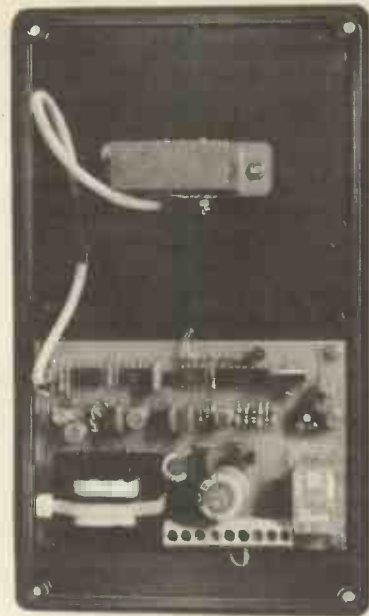

Prototype Radar Alarm

**PRECAUTIONS WHEN HANDLING CL8960**

The microwave module requires some cautionary remarks because the mixer contains a diode of extremely small proportions to enable it to respond to the 10.687GHz frequency. If the mixer or the lead between it and the amplifier is touched with a measuring lead or an object which has not been grounded to the module metalwork, the mixer may be destroyed by static discharge. The mixer is supplied with protection which should be left permanently in situ.

The following procedure should be adopted when connecting the module to the amplifier.

- (1) Use screened lead to the main p.c.b. keeping the un-screened ends short (about 12mm).
- (2) Connect the 0V rail (E) to the module metalwork 0V tag.
- (3) Clip a lead between the module metalwork and the soldering iron bit to equalise potentials.
- (4) If the soldering iron is not earthed, clip a second lead between the module and earth.
- (5) Touch the live input lead from the amplifier on the module metalwork just prior to connection.
- (6) Make the connection to the mixer while maintaining one finger on the module metalwork. Use an iron hot enough to solder quickly to avoid prolonged heat resulting in damage.
- (7) Do not measure the voltage at the mixer diode directly—a 10k resistor must be fitted to the end of the lead and touched on the metalwork prior to the measurement.

**CONSTRUCTION**

Any one of the three alarm units can be constructed on the p.c.b. design shown in Fig. 4. The components layouts are shown in Figs. 5, 6 and 7. The prototype ultrasonic alarm unit was housed in a standard ABS box with the two transducers mounted inside 20mm grommets. Before inserting any components into the case the p.c.b. mounting holes should be drilled along with the adjustment hole in the bottom of the case for VR1. Five 10mm holes should be drilled in the rear of the case for the mains and output leads. These holes should be fitted with 10mm grommets. The centre of the front panel should be drilled to accommodate the indicating l.e.d.

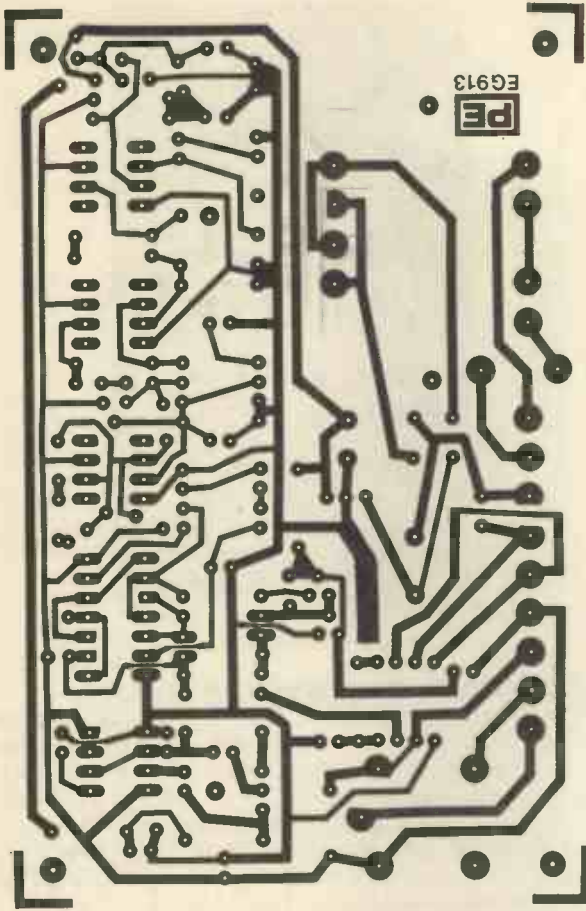

Fig. 4. P.c.b. design for all three alarm units

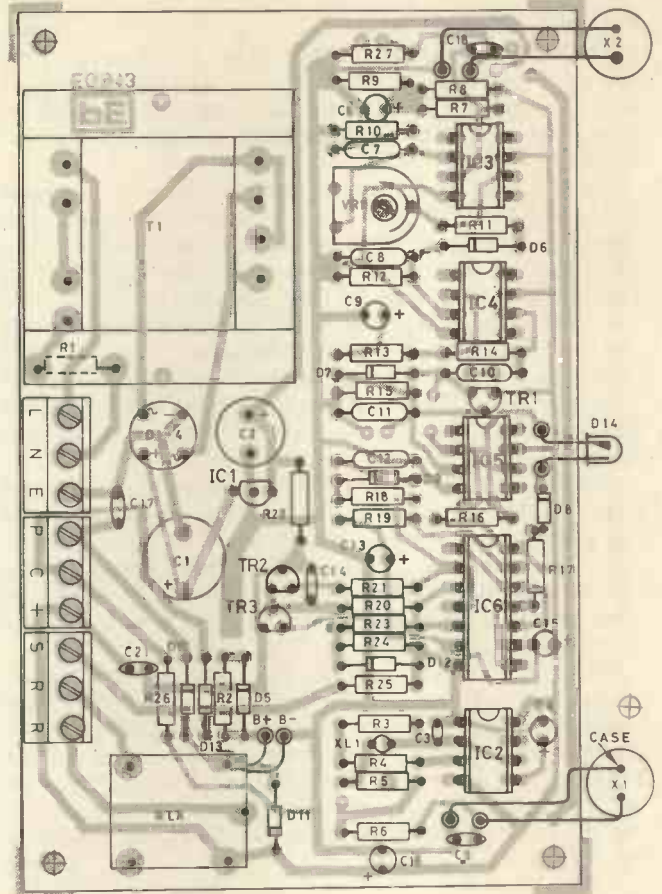

Fig. 5. Component layout for the Ultrasonic Alarm

## COMPONENTS . . .

### Resistors

	Ultrasonic	Radar	Infra-Red
R1	1k	Link	1k
R2	2k2	—	2k2
R3	10M	Link	—
R4	10M	—	—
R5	220k	—	—
R6	100	Link	—
R7	10k	220k	470k
R8	220k	220k	220k
R9	220k	220k	220k
R10	470	470	10k
R11	4k7	220k	1M
R12	100k	—	—
R13	100	470	10k
R14	470k	470k	1M
R15	4M7	10M	470k
R16	10M	10k	100k
R17	1k	1k	1k
R18	10k	10k	10k
R19	470k	470k	470k
R20	2k2	2k2	2k2
R21	10k	10k	10k
R22	10k	10k	10k
R23	1M	1M	1M
R24	10M	10M	10M
R25	10k	10k	10k
R26	10k	10k	10k
R27	—	22k	22k

R28	—	100k	—
R29	—	220k	—

All resistors 1/4W 5% carbon

### Capacitors

	Ultrasonic	Radar	Infra-Red
C1	470µ 25V elect	470µ 25V elect	470µ 25V elect
C2	220µ 16V elect	220µ 16V elect	220µ 25V elect
C3	12p ceramic	—	—
C4	22µ 16V elect	—	—
C5	10n ceramic	10n ceramic	—
C6	22µ 16V elect	22µ 16V elect	22µ 16V elect
C7	10n polyester	47µ 16V elect	47µ 16V elect
C8	100n polyester	100n polyester	100n polyester
C9	22µ 16V elect	47µ 16V elect	47µ 16V elect
C10	10n polyester	22n polyester	2 x 22µ 16V elect
C11	100n polyester	100n polyester	22µ 16V elect
C12	100n polyester	100n polyester	100n polyester
C13	22µ 16V elect	22µ 16V elect	22µ 16V elect
C14	10n ceramic	10n ceramic	10n ceramic
C15	22µ 16V tant	22µ 16V tant	22µ 16V tant
C16	22µ 16V elect	22µ 16V elect	22µ 16V elect
C17	10n ceramic	10n ceramic	10n ceramic
C18	1n ceramic	1n ceramic	22µ 16V elect
C19	—	—	10n ceramic
C20	—	10n ceramic	10n ceramic
C21	10n ceramic	10n ceramic	10n ceramic
C22	—	10n ceramic	—

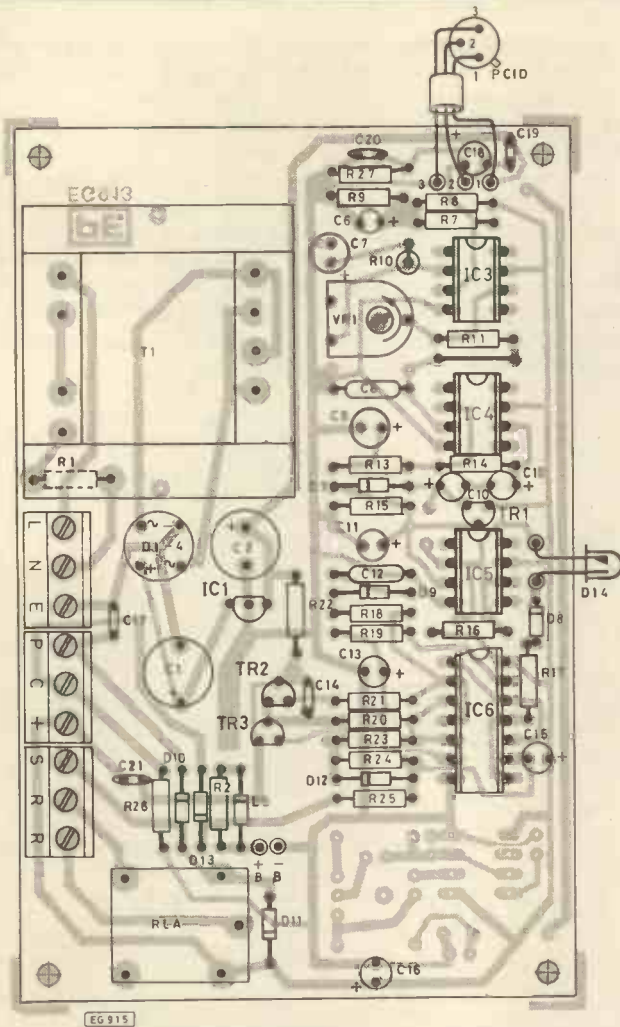

Fig. 6. Component layout for the Infra-Red Alarm

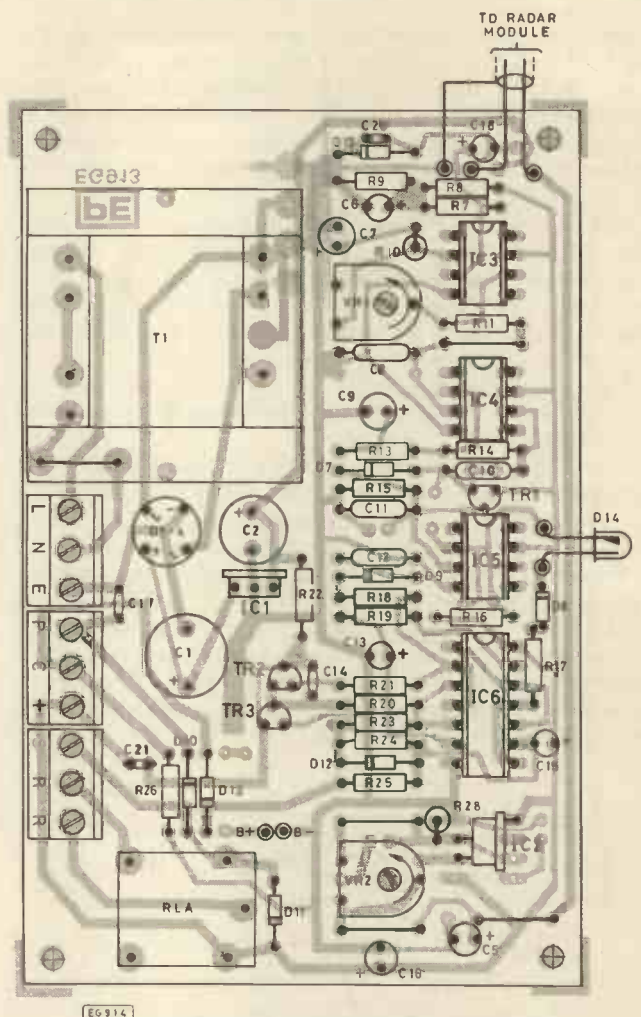

Fig. 7. Component layout for the Radar Alarm

**Semiconductors**

	Ultrasonic	Radar	Infra-Red
D1-D4	1A bridge rect.	1A bridge rect.	1A bridge rect.
D5	1N4002	—	1N4002
D6	1N4148	Link	Link
D7	1N4148	1N4148	1N4148
D8	1N4148	1N4148	1N4148
D9	1N4148	1N4148	1N4148
D10	1N4002	1N4002	1N4002
D11	1N4148	1N4148	1N4148
D12	1N4148	1N4148	1N4148
D13	1N4148	1N4148	1N4148
D14	3mm i.e.d.	3mm i.e.d.	3mm i.e.d.
TR1	BC549	BC549	BC549
TR2	BC559	BC559	BC559
TR3	BC549	BC549	BC549
IC1	78L12	78L12	78L12
IC2	LM555	78L05	—
IC3	LF351N	LF351N	LF351N
IC4	741	741	741
IC5	741	741	741
IC6	4001	4001	4001

**Potentiometers**

	Ultrasonic	Radar	Infra-Red
VR1	100k	100k	1M
VR2	—	1k	—

**Miscellaneous**

T1 15V at 200mA 15V at 200mA 15V at 200mA  
 RLA LCNIN-E LCNIN-E LCNIN-E  
 case, grommets, M3 hardware, p.c.b., mounting box, PP3  
 battery clips, p.c.b. mounting terminals. s.p.c.o. keyswitch.

**Special components**

**Ultrasonic system**

XL1	32.7kHz sub-min
X1	T32-18
X2	R32-18

**Radar system**

CL8960 radar module

**Infra-Red system**

Pyroelectric dual element detector (PCID)  
 Faceted mirror  
 Fresnel lens

**Constructor's Note**

Complete sets of kits are available from **GJD Electronics**,  
 105 Harper Fold Road, Radcliffe Road, Manchester.

After the components have been assembled onto the p.c.b. carefully check the tracks for any solder splashes and then check the orientation of the semiconductors and the electrolytic capacitors. The leads to the transducers should be kept as short as possible if unscreened cable is used. If screened cable is used then ensure the braid is connected to the 0V terminal on both transducers.

The prototype radar alarm unit was mounted in a larger ABS box with both the p.c.b. and radar module mounted onto the case lid. The components and leads should be mounted onto the radar module as shown in Fig. 8. A thin layer of polythene should be placed between the module and base to prevent the ingress of dirt and moisture.

Mounting holes for the p.c.b., the two presets and the l.e.d. should be drilled before the components are mounted on the board.

The infra-red alarm was also fitted into a large ABS box with both the board and the faceted mirror mounted on the lid. After the lid has been drilled for the p.c.b. mounting holes, l.e.d. and mirror the p.c.b. can be assembled.

The mirror should be placed in position using double sided adhesive tape. The pyroelectric detector is fitted into a plastic spider to position it correctly at the focal point of the mirror. With the mirror used an 80 degree horizontal angle is obtained over six zones. The dual element pyro doubles this coverage to twelve zones. The mirror can be protected using black polythene although some types may reduce the sen-

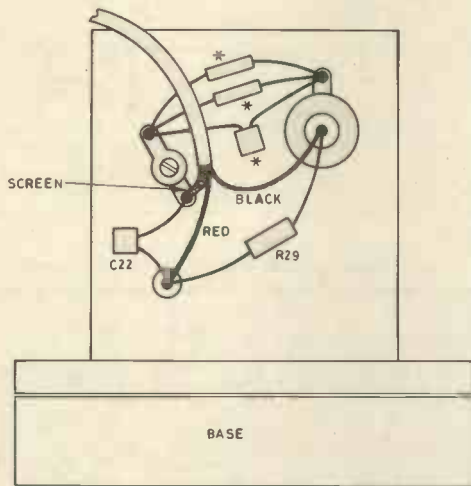

**Fig. 8. Wiring diagram of the Radar Module. \*These components are supplied ready fitted.**

sitivity of the unit. Because the infra-red band used is relatively new to this application commercially made filters are not readily available.

**INSTALLATION-ULTRASONIC**

The alarm is prone to both vibration and air currents therefore the following points should be observed to avoid false triggering.

- DO NOT place the alarm on a vibrating surface.
- CLOSE all doors and windows.
- DO NOT point the alarm at a radiator or convector heater.
- Try to install the unit away from direct sunlight because of its heating effects.
- Try to install the unit away from telephone bells as they can produce high frequency sound which could trigger the alarm.

Dogs, cats, insects and automatic washing machines should be taken into consideration along with warm air central heating.

In practice best results have been obtained with the unit at floor level as air currents are minimal and foot movement is detected. Objects in front of the unit will limit its range.

When setting up the unit with no movement the red l.e.d. should not flicker; if it does the sensitivity is set too high or air currents are being detected—always use the minimum sensitivity required as over sensitivity could give rise to a false alarm. When adjusting the sensitivity externally a clockwise rotation will increase the sensitivity—a very small screwdriver is required for this adjustment.

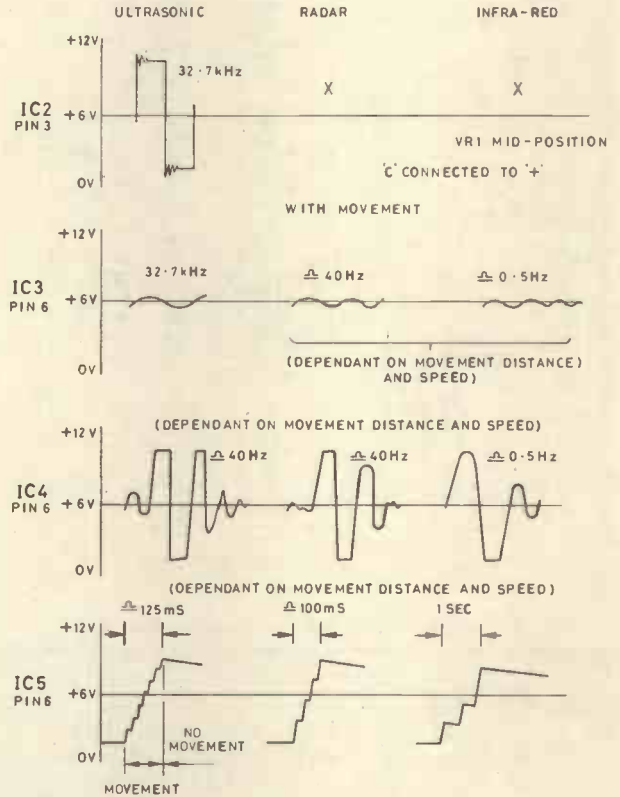

**Fig. 9. Test waveforms (Ultrasonic)**

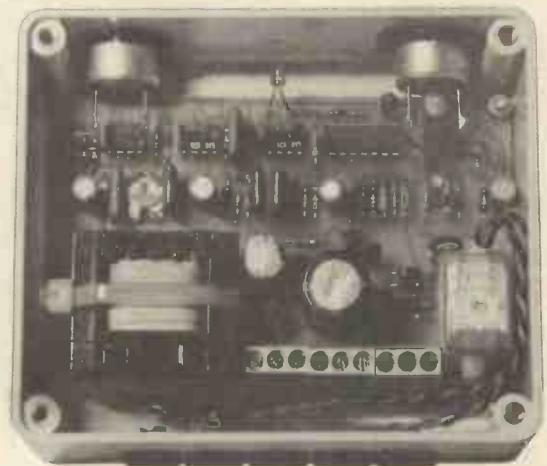

**Internal view of the Ultrasonic Alarm**



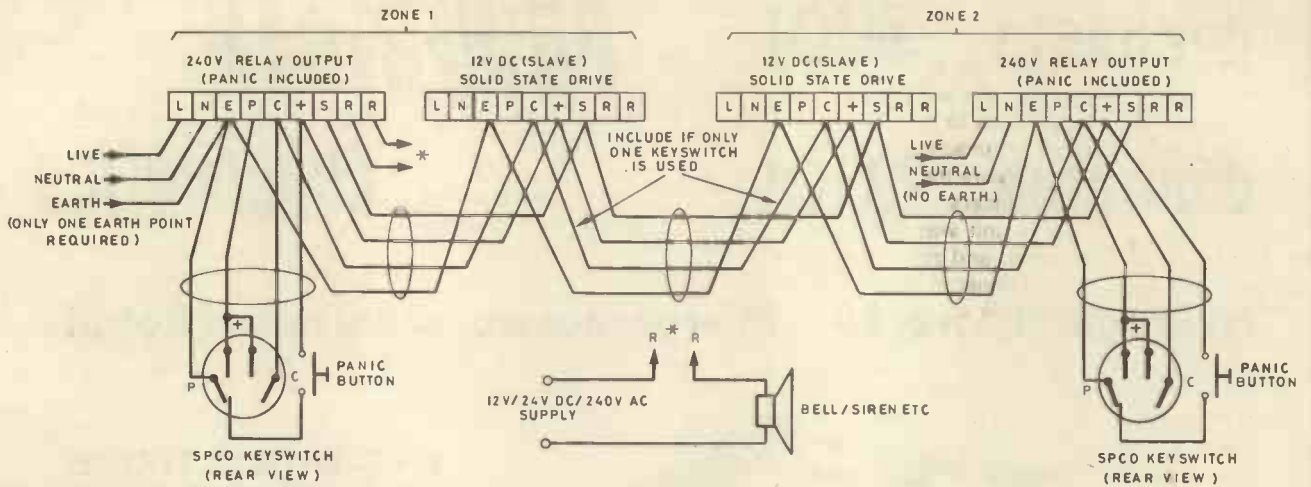

Fig. 10. Wiring diagram for multi-zone protection. A slave unit is powered from a master and does not require its own p.s.u.

TEST VOLTAGES (NOMINAL)

	ULTRASONIC	RADAR	INFRA-RED
Supply	15V d.c.	15V d.c.	15V d.c.
IC2 pin 3	5V	—	—
IC3 pin 7	12V	12V	12V
IC3 pin 6	6V	6V	6V
IC4 pin 6	5.5V	6V	5V
IC5 pin 6	3V	3V	3V
IC6 pin 11	12V	12V	12V
IC6 pin 10	0V	0V	0V
IC6 pin 3	0V	0V	0V
IC6 pin 4	12V	12V	12V

VR1 fully anticlockwise  
'C' connected to the supply (no movement)

TERMINAL CONNECTIONS

- 'L' Mains live feed
- 'N' Mains neutral
- 'E' Earth—also the 0V rail of the alarm
- 'P' When connected to 'E' instantly trips the alarm and latches until reset
- 'P' When connected to '+' instantly cancels the alarm
- 'C' When connected to '+' the Ultrasonic is inactive, but in the walk test mode—panic active
- 'C' When left open circuit activates the Ultrasonic after the 20sec leaving delay
- '+' Provides external power up to 12V d.c. at 50mA for solid state sounders
- 'S' When connected to 'E' activates the alarm sounder for as long as the connection is made—also provides expansion facility.
- 'R' Normally open relay contacts for switching loads up to 3A at 240V a.c. resistive

The above switching is all done by a s.p.c.o. centre off keyswitch with separate panic and alarm test buttons.

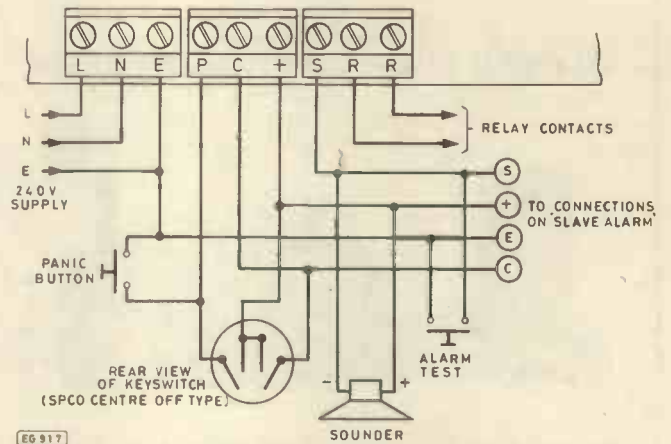

Fig. 11. Connections to a slave unit

Radar reflects off metal objects such as radiators, garage doors, etc. and this effect can be used to increase the area covered by the alarm and also for 'seeing' around corners.

INSTALLATION—INFRA-RED

As most of the heat from a human body comes from the head (when it is clothed) the best position for the unit is around eye level; individual tests will soon reveal the correct height. This still enables pet lovers to protect their home even with the family pet roaming around the house. Because draughts and open windows do not readily cause false triggering open fronted premises and warehouses can also be protected.

If an electronic fence is required a narrow twin beam using a Fresnel lens (suitable for transmission of 10µm) can be used to focus the heat onto the pyro. This lens eases weatherproofing problems as the enclosure can now accommodate the lens as a weatherproof window.

Although the pyro itself does not detect draughts it should be protected from direct draughts to reduce any imbalance between the two pyro elements contained within the TO5 style can. The pyro is also microphonic and should not receive any mechanical shocks which could give rise to false triggering.

To prevent excessive heat, do not allow direct sunlight to fall onto the pyro or mirror. ★

# Genesis S101

# POWERTRAN

# Genesis P101

# cybernetics

## Hydraulic Powered Microprocessor Controlled Robots

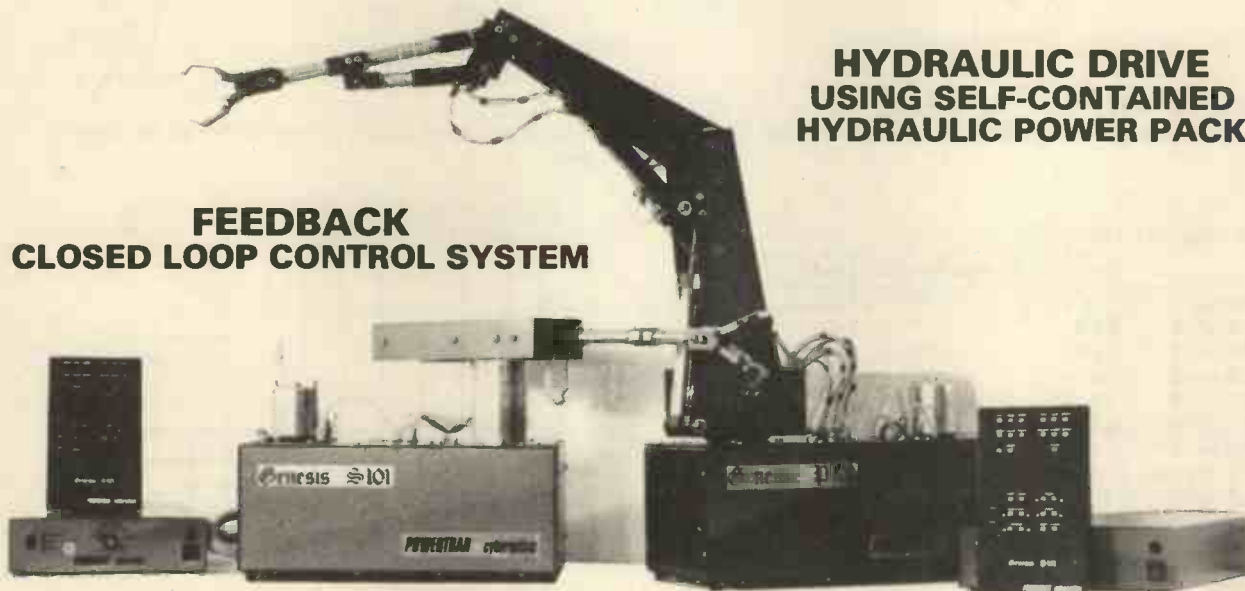

**HYDRAULIC DRIVE  
USING SELF-CONTAINED  
HYDRAULIC POWER PACK**

**FEEDBACK  
CLOSED LOOP CONTROL SYSTEM**

With prices starting below £1,000 the Genesis range of general purpose robots provide a first rate introduction to robotics for both education and industry. Each has a self-contained hydraulic power source, which enables loads of several pounds to be smoothly handled. The system operates from a single phase 240 or 120V AC supply or a 12V DC supply. The machine can be supplied with up to 6 axes each of which is fully independent but capable of simultaneous operation. Position control is achieved by means of a closed-loop feedback system based around a dedicated microprocessor. Movement sequences can be entered, stored and replayed by use of a hand held controller, alternatively the systems can also be interfaced to an external computer via a standard RS 232C link.

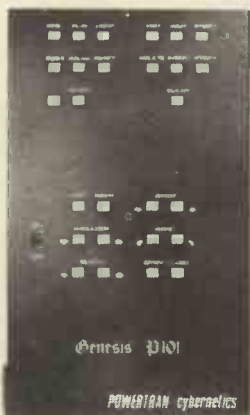

P101 Hand Held Controller.

### Example prices and specifications

#### Genesis S101

Base: 19.5" x 11" x 7.5"  
Lifting capacity: 1500gm  
Arm lift: 6.6"  
Weight: 29Kg

4 axis model in kit form **£390**  
5 axis model in kit form **£445**  
5 axis model **READY BUILT £790**

#### Genesis P101

Base: 19.5" x 11" x 7.5"  
Lifting capacity: 2000gm  
Arm lengths between axles: 14.0"  
Weight 34Kg

4 axis model in kit form **£495**  
6 axis model in kit form **£595**  
6 axis model **READY BUILT £950**

### COMPLETE SYSTEMS AS SHOWN IN PHOTOGRAPH ABOVE

#### Genesis S101

4 axis system in kit form **£635.50**  
5 axis system in kit form **£895.00**  
5 axis system **READY BUILT £1355.00**

#### Genesis P101

4 axis system in kit form **£742.00**  
6 axis system in kit form **£852.00**  
6 axis system **READY BUILT £1525.00**

As featured in this journal November '81-April'82 issues.

For further details please contact:

**POWERTRAN CYBERNETICS**

PORTWAY INDUSTRIAL ESTATE, ANDOVER, HANTS SP10 3WN

Telephone: ANDOVER (0264) 64455



# INDUSTRY NOTEBOOK

By Nexus



## £12k Off!

We are all suckers for the supposed 3p or 5p off a bar of soap or a packet of cornflakes in the local supermarket but when exhorted to save £12,000 even the most cynical shopper feels compelled to investigate.

This is the enticing offer made by Piher, the big name in small resistors. Certainly an eye-catching ploy but reading the smaller print we discover that the saving is per million resistors on assembled cost.

Productivity and cost-cutting is the name of the game on production lines so production managers are keenly examining Piher's offer and analysing the argument advanced for using resistor modules.

The modules consist of factory-assembled (by Piher) resistor arrays in 14 or 16-pin dual-in-line packages containing, respectively, 7 or 8 carbon-film resistors to the customer's specified values. Piher's £12,000 is the saving obtained through inserting 125,000 8-resistor modules into PCBs compared with inserting a million individual resistors one at a time.

Certain assumptions are made in Piher's calculations which will probably surprise the electronic hobbyist unfamiliar with large-scale electronics assembly or production costings. First is the assumption that the assembly worker is paid £2.25 per hour wage but with factory overheads added the true cost to the company is £9 per hour. Second is that resistors cost £4 per thousand. Third is that on average throughout the day 360 resistors are manually inserted per hour. On these assumptions the total cost of buying a million resistors and manually inserting them in PCBs is £29,000 of which £25,000 is labour cost.

With the same resistors pre-assembled into 16-pin packages the line assembler inserts only 140 units per hour but as each module contains eight resistors the insertion rate is much faster per resistor and labour cost per million resistors falls to £8,000, a saving of £17,000. But whereas the discrete million resistors cost £4,000

the cost of the same million pre-assembled into modules is more than double at £8,750. This, however, still represents a net gain of £12,250, handsomely meeting Piher's claim of £12,000 'off'.

Of course there are a lot of variables in individual cases and Piher thoughtfully provide a set of graphs on which production managers can plot their own labour, overhead and other costs to determine the benefit, if any, he may expect to obtain.

I have described the philosophy of resistor modules in some detail because it so ably illustrates the facts of life in competitive industry. Clearly the equipment manufacturer stands to gain. Equally clearly the resistor manufacturer gains because he has doubled the cost of his product and so increased his turnover and profit. The end customer stands to gain if the equipment manufacturer passes some part of his saving on to the purchaser.

It looks as if everybody wins. But not quite. As labour costs have tumbled by two-thirds it suggests that only one assembler is now required rather than three. The resistor manufacturer has increased his workload, of course, but as the modules will be machine-assembled he needs only a marginally increased workforce, a tiny fraction of one of the two workers made redundant. The transfer of work between the two companies does not result in an equal transfer of employment.

## Look-Alikes

Piher's low-cost resistor modules are available to anybody, the more the merrier as far as Piher is concerned. The cost benefits, whether more or less, depending on individual circumstances, are universal.

When it comes to an end-product a typical aim is exclusivity. The commonly used protection is to take out a patent but this is not always fully effective. There are many direct infringements bringing good business to lawyers and much ingenuity is often applied to getting round existing patents by would-be copiers.

Thus, Fluke's novel 8020 Series of hand-held digital multimeters which appeared in 1978 were unique. Their 'brain' was a custom-built IC chip which gave them exclusivity. Or so Fluke thought at the time. But similar instruments soon appeared on the market and today some 25 manufacturers are making look-alikes using what is said to be an almost identical but commercially available chip.

Fluke's response has been to set up their own chip-making plant in the USA in the hope that a new digital multimeter due for launch about now will retain the marketing edge conferred by a Fluke-designed, Fluke-manufactured IC. By bringing the whole operation in-house the possibility of leak of chip design to outsiders is minimised. No doubt the new design will attract copiers but this time a look-alike competitor model could take longer to achieve and probably not worth while in time or money.

Despite the rash of imitations a Fluke spokesman claims that the company holds over 30 percent of the market in hand-held digital multimeters and expects to win a much larger slice with the new model.

## On the Beam

The laser, in its early days very much an invention in search of an application, has turned out to be more versatile than any of us ever imagined and has generated plenty of new business.

Who would have thought that the ladies, God bless 'em, would be queueing up for laser rejuvenation courses at beauty salons? Both pulsed and CW lasers are in use with rival claims for success in revitalising skin tissue. One treatment depends on the laser beam being directed at acupuncture points, so bringing space-age technology and an ancient Chinese therapy into newly fashionable conjunction.

Those most ardent perfectionists, banknote forgers, have latched on to the merits of the laser beam colour scanner in the printing industry. Highest quality counterfeit notes produced by this technique are appearing in several countries and, according to Interpol, are difficult to detect. In the UK the £10 and £20 denominations are most commonly forged. You have been warned!

## Defence

The political and military confrontation over the Falkland Islands is bound to have a long term effect on the defence electronics industry. This was the first ever major naval engagement in which the whole range of modern defence electronics has been fully deployed in real, rather than simulated, battle. Moreover, deployment was in the most testing physical environment. What equipment worked well, badly or not at all will be the subject of months of study. How efficient was the man-machine interface when the man himself was weary after weeks at action stations and constant alarms? How reliable the communications and command network? How effective the electronic countermeasures?

The analysis will be rigorous, the lessons one hopes honestly faced and acted upon. But as well as performance analysis of the equipment in the South Atlantic environment there is certain to be a reappraisal of overall defence strategy which will probably result in greater emphasis on the conventional surface fleet and less on the sub-surface nuclear deterrent.

Defence electronics is a key element in the industry as a whole and is likely to be stimulated rather than retarded by the Falklands experience.

## Indicators

Meanwhile, despite the crisis, all the economic indicators showed continued improvement. Shares, balance of payments, strength of sterling remained on an upward trend. Investment continued with Honeywell putting up £1.3 million for a new keyboard plant in Scotland as just one example. Employment remains the domestic trouble spot. That £1.3 million, for instance, creates only 40 new jobs initially, with a potential of 100 jobs, but the probability is that they will be filled by internal transfers as productivity increases elsewhere in Honeywell.

# COMBO AMPLIFIER

## PART ONE Fred Judd E.A. Rule

A TOP performance "combo amplifier" costs a good deal of money these days. The design offered here can be constructed for about half the price of an amplifier with similar facilities and comparable performance, in fact the performance is *better* than comparable with others at present available since it is based on the *Practical Wireless* "Winton" high fidelity amplifier design by E. A. Rule.

The facilities available with the *PE* combo amplifier are as follows:

- 1) Completely self-contained.
- 2) Maximum power output: 50 watts—single 8 Ohm speaker/100 watts—two 8 Ohm speakers in parallel.
- 3) Twin preamplifier channels with mixing facilities.
- 4) Bass and treble controls both channels.
- 5) Auxiliary preamplifier for high level signals.
- 6) 6dB bass lift (20Hz) for full frequency range—hi-fi range.
- 7) Inputs for microphone or guitar on each channel.
- 8) Output/input sockets for external accessories such as Wah and Fuzz units etc.
- 9) Speaker system tested and proved in an Anechoic chamber to hi-fi standards.
- 10) Output stages use latest and virtually indestructible power MOS-FET's.

### PRE-AMP SPECIFICATION

<b>Mic. inputs</b>	Suitable 200 ohm or higher 2mV for max output
<b>Guitar input</b>	Impedance approx 100Kohms 30mV for max output
<b>Aux. input</b>	Impedance approx 100Kohms 30mV for max output
<b>Accessories socket OUT</b>	J5 or J7 low Z 200mV
<b>Accessories socket IN</b>	J6 or J8 low Z 150mV
<b>Signal to Noise</b>	Guitar and mic inputs—60dB relative to maximum output
<b>Signal to Noise</b>	Auxiliary input —75dB relative to maximum output
<b>Distortion factor</b>	Comparable with that of power amplifier
<b>Tone controls</b>	±10dB 50Hz–10,000Hz.
<b>Frequency response</b>	Flat 20—20,000Hz (with S1 at +dB bass recovery). See responses in Fig. 2.

### THE CIRCUITRY

A block diagram of the system is shown in Fig. 1. The primary inputs on each of two channels are for microphone (200 Ohms or higher) and/or guitar. The arrangement therefore allows one microphone and one guitar to be used simultaneously at any set level, or, of course, two microphones or two guitars.

The Accessories Links (one for each channel) allow for the insertion of wah-wah, fuzz unit or reverb units etc. on either channel. The following stage (IC2) provides full bass and treble lift or cut (approx ±10dB) after which the channel outputs are mixed into IC3 (one half). This stage, and the auxiliary amplifier (half of IC3) each have a facility for a +6dB bass lift at 20Hz to compensate for speaker roll-off. The combined outputs from IC3 then go to the main amplifier which is capable of driving one 8 Ohm bass mid/range speaker system at 50 watts or two similar speaker systems in parallel at 100 Watts.

### PREAMPLIFIER PERFORMANCE SPECIFICATION

The full circuit for the preamplifier stages is given in Fig. 3 in which IC1 is the initial stage for the microphone and guitar inputs on each channel. The output (each channel) is taken to an accessory output socket (JK5 and JK7) for feeding wah, fuzz, phasing or reverb units etc. with outputs being returned to the input(s) of IC2, and which also has the tone control networks in feedback between output and input. The outputs from IC2 are taken via a mixing network VR3-VR4 and R15-R16 to the final stage (IC3B) which has provision



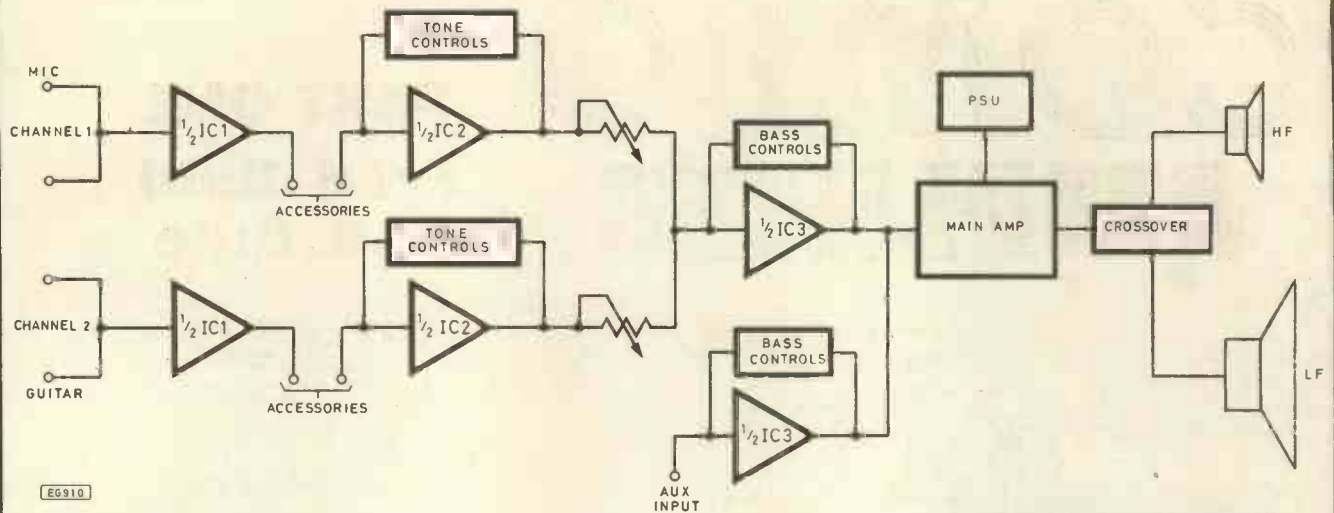

Fig. 1. Block schematic showing details of the combo-amplifier system

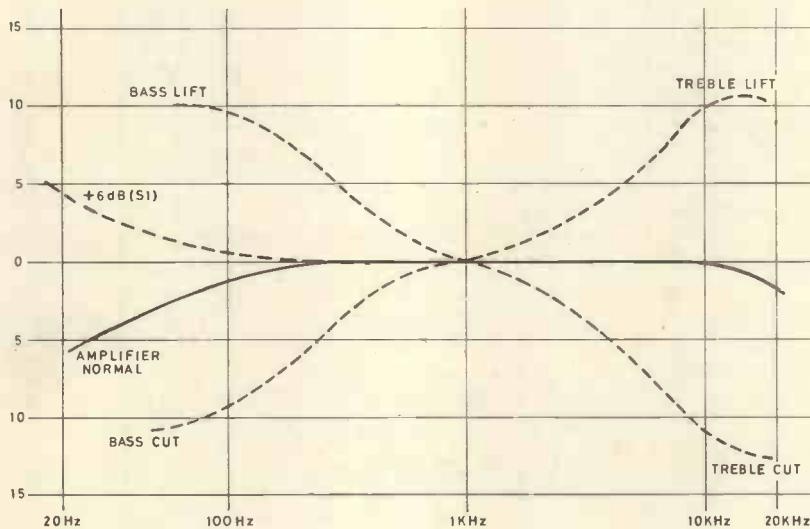

Fig. 2. Frequency responses including those of the tone controls

for a bass lift (S1) of 6dB at 20Hz to make the overall frequency response including speaker system virtually flat between 20 and 20,000Hz. The remaining half of IC3 is the auxiliary input amplifier with feedback adjusted gain to provide an input sensitivity of 300mV suitable for line output from a tape recorder or similar source. This also has provision for the 6dB bass lift at 20Hz. The combined outputs of channel 1 and 2 (via IC3b) and the auxiliary amplifier (IC3a) are taken directly to the power amplifier unit which will be fully dealt with in Part 2.

**NOTE:** R21 and R41 in the preamplifier circuit have been deleted and the capacitors (68p) marked CX1, 2 and 3 have been added.

#### THE CIRCUIT BOARD

Layout and component positions for the preamplifier printed circuit board are given in Fig. 4. Note that R21 and R41 as in the circuit diagram Fig. 3 have been replaced by wire

**A three part project describing the following:**

- 1) Pre-amplifiers performance and construction
- 2) Power amplifier and PSU construction
- 3) Cabinet construction

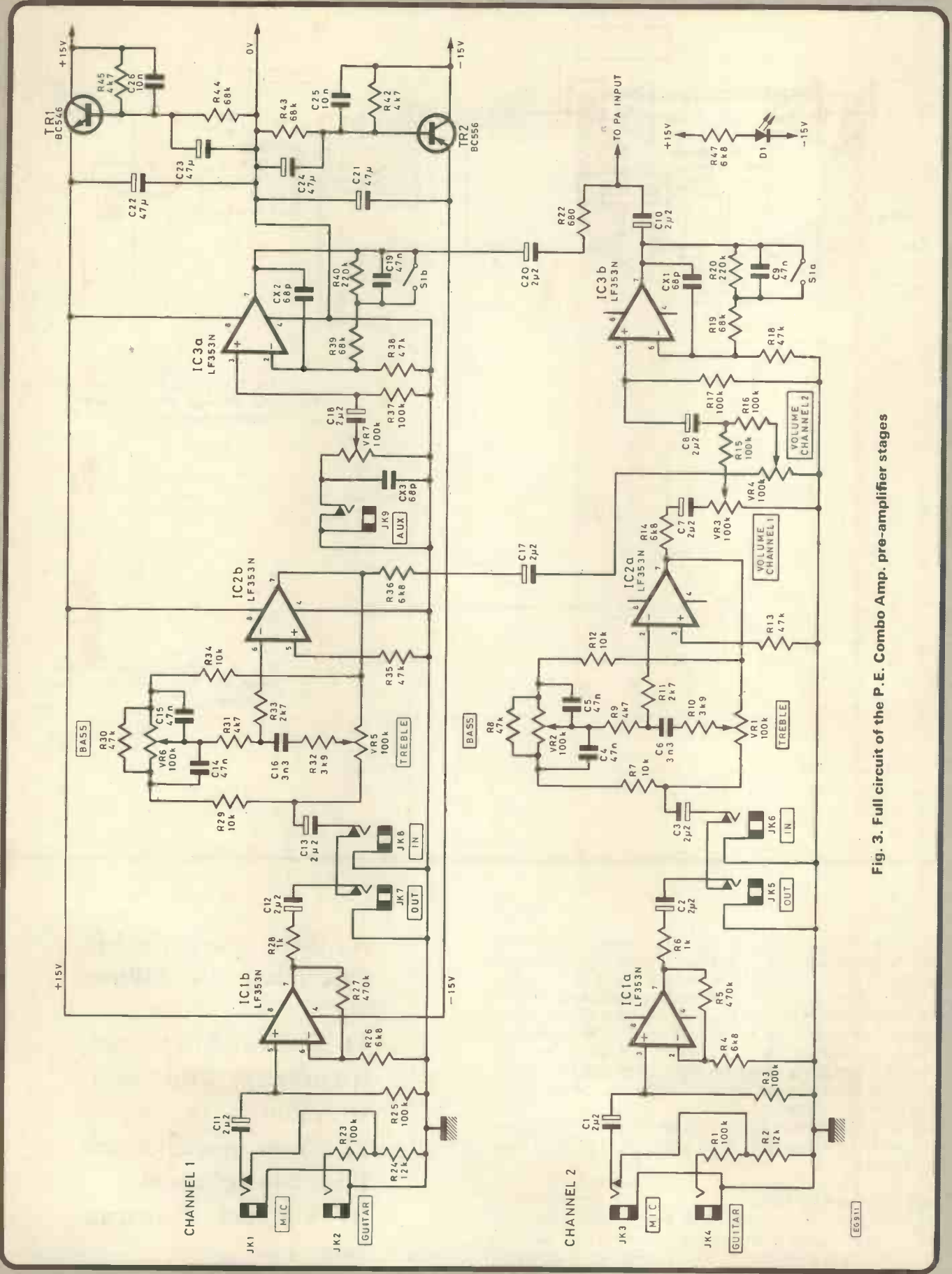

Fig. 3. Full circuit of the P.E. Combo Amp. pre-amplifier stages

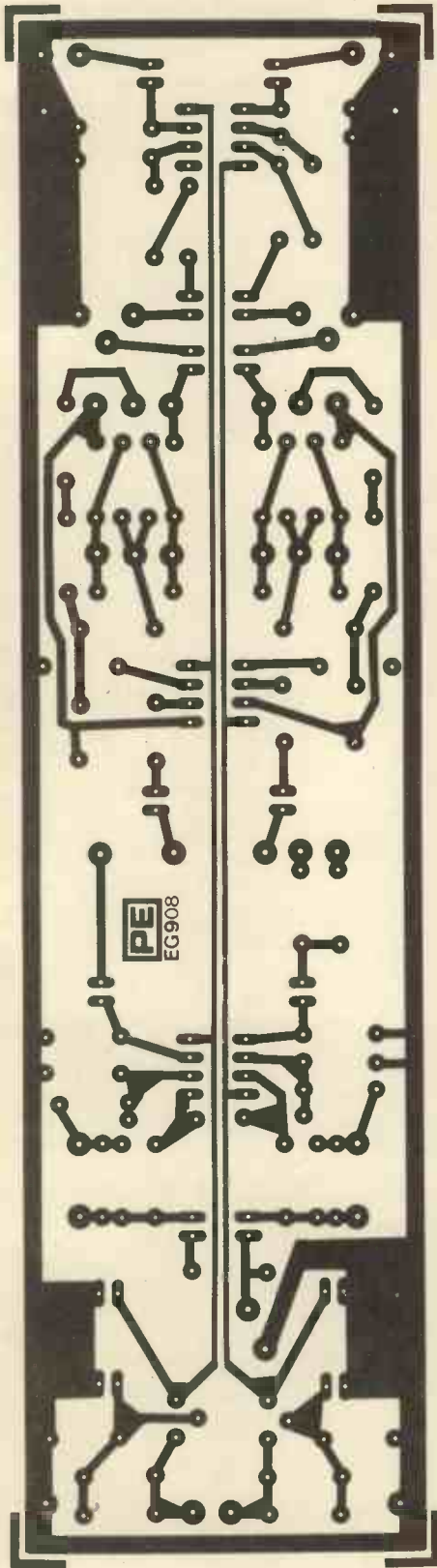

Fig. 4. Printed circuit layout of preamp

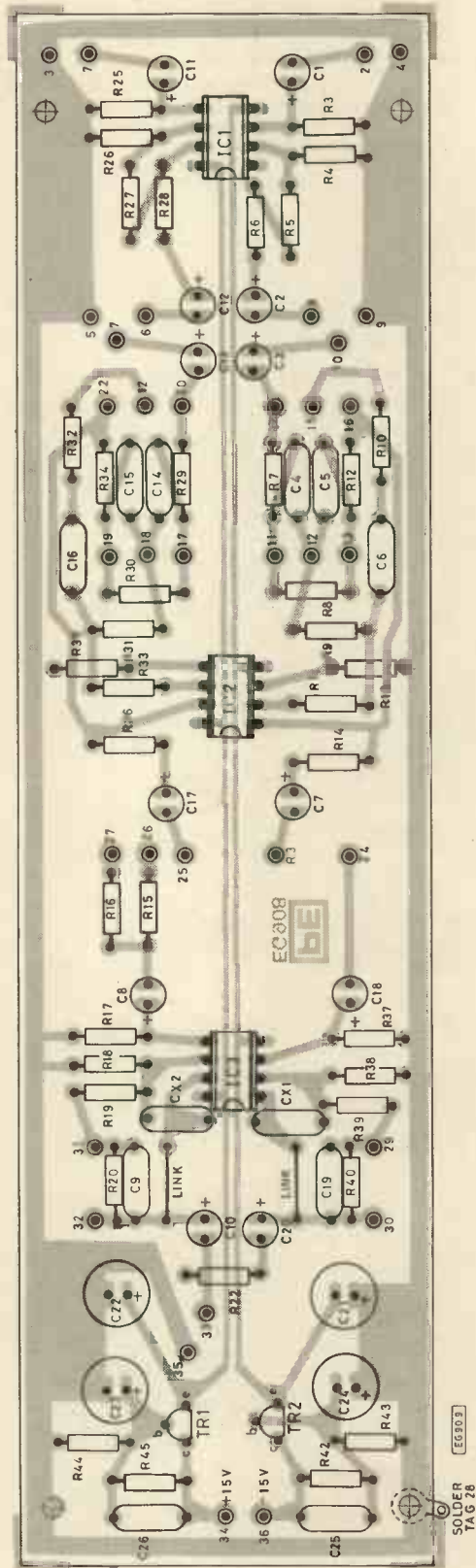

Fig. 5. Component overlay of preamp

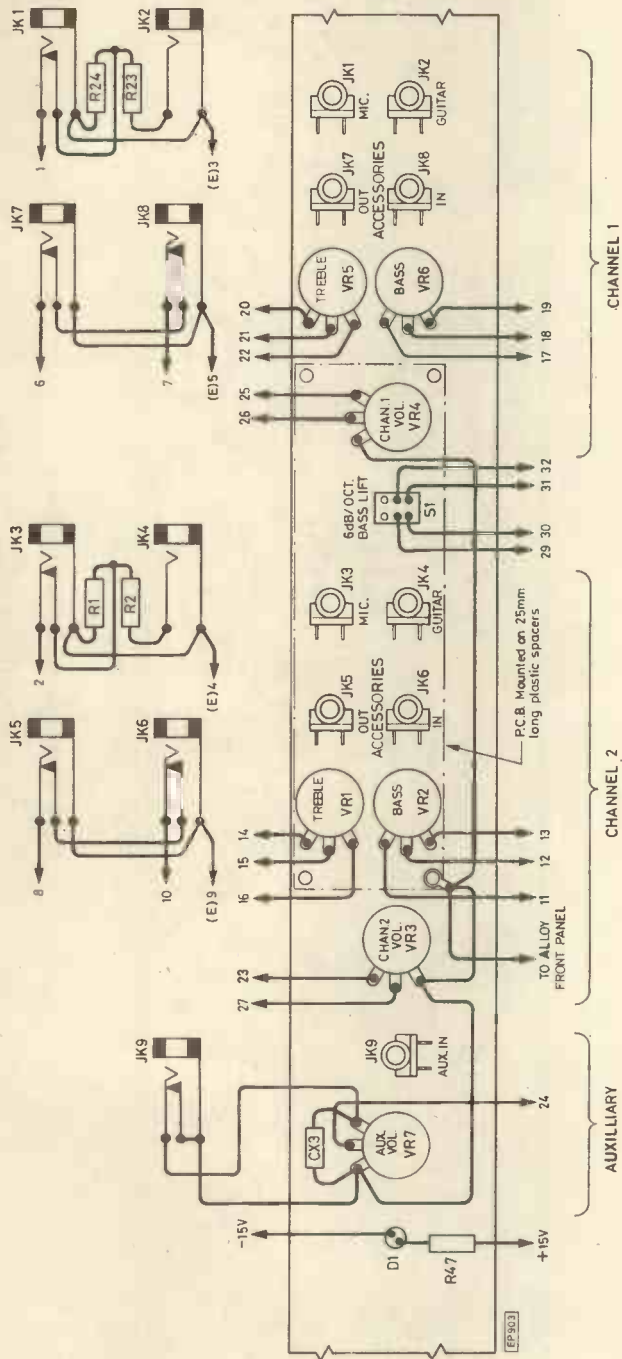

Fig. 6. Location of input/output sockets, panel controls and wiring. (Circuit board is mounted on pillars)

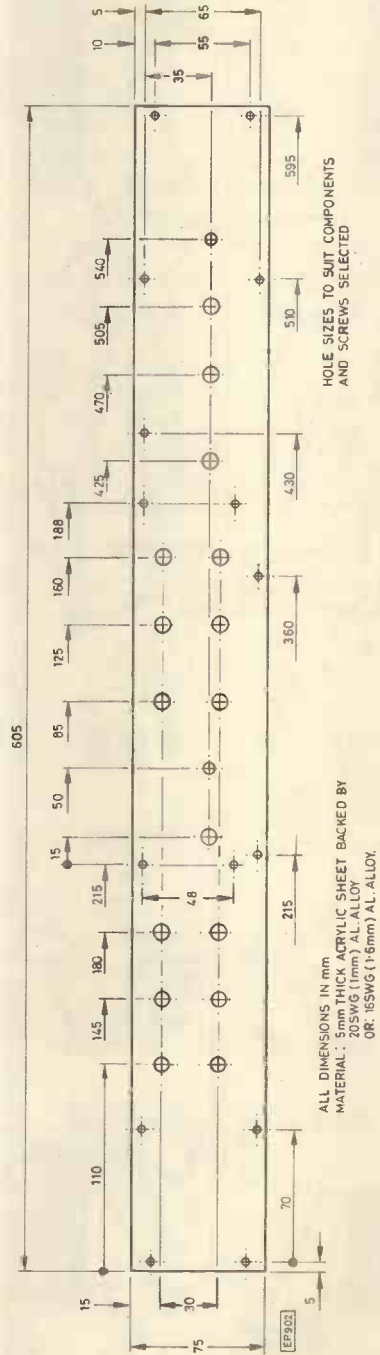

Fig. 7. Details for drilling of front panel



# COMPONENTS . . .

## PREAMPLIFIERS

### Resistors

R1, R3, R15, R16, R23, R25, R37	100k (7 off)
R2, R24	12k (2 off)
R4, R14, R26, R36, R47	6k8 (5 off)
R5, R27	470k (2 off)
R6, R8	1k (2 off)
R7, R12, R29, R34	10k (4 off)
R8, R13, R18, R30, R35, R38	47k (6 off)
R9, R31, R42, R45	4k7 (4 off)
R10, R32	3k9 (2 off)
R11, R33	2k7 (2 off)
R19, R39	68k (2 off)
R20, R40	220k (2 off)
R21 and R41 (deleted—see text)	
R22	680 ohms
All resistors $\frac{1}{4}$ W 5%	

### Potentiometers

VR1, VR2, VR5, VR6	100k midget linear (RS161-818) (4 off)
VR3, VR4, VR7	100k midget log (RS161-723) (3 off)

### Capacitors

C1, C2, C3, C7, C8, C10, C11, C12, C13, C17, C18, C20	2 $\mu$ 2 50V elect. (12 off)
C21, C22, C23, C24	47 $\mu$ 50V elect. (4 off)
C4, C5, C9, C14, C15, C19	47n (6 off)
C16, C17	3n3 (2 off)
C25, C26	10n (2 off)
CX1, 2, 3	68p (silver mica)
Type immaterial unless stated	

### Semiconductors

D1	Red l.e.d.
TR1	BC546
TR2	BC556
IC1, 2, 3	National LF353N or Texas TL072CP (3 off)

### Miscellaneous

Printed circuit board	
Front panel	
JK1-JK9	Standard $\frac{1}{4}$ in. jack sockets with closed contacts (RS477-573) (9 off)
S1	DPDT miniature toggle (RS316-989)
P.c.b. pillars	



straps and CX1 and CX2 (68p) have been connected between pins 1 and 2 and 6 and 7 respectively on IC3. *Note also that screened leads must be used for connections to the jack sockets JK1/2, JK3/4, JK5/6, JK7/8.* The finished board is mounted on stand-off pillars on the front panel and details of this will be found in Fig. 6.

The front panel may be made from black or coloured

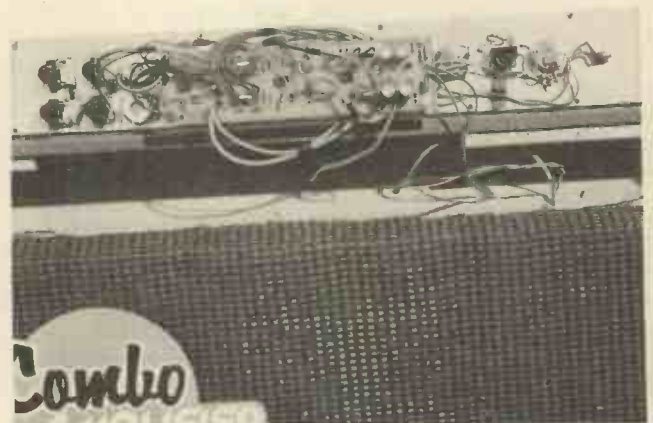

perspex backed with a thin aluminium panel (20 or 22SWG) as in the prototype or the panel may be all aluminium of 16SWG thickness. If perspex, or other non-conducting material, is used, the thin aluminium backing panel must be included. Details for drilling are given in Fig. 7. Distribution of the panel components is shown in Fig. 6.

The preamplifier could, of course, be completed before the main amplifier (details in part 2) and this could be checked out with a suitable voltage supply. Input signal levels and frequency responses etc., as quoted, can be related to approximately 150mV output from the preamplifier with volume controls at maximum.



**NEXT MONTH:**  
the power  
amplifier and  
PSU module

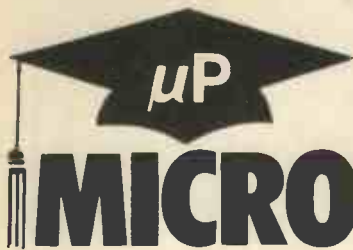

# MICRO-PROFESSOR REVIEW

MICHAEL TOOLEY B.A.

Michael Tooley is Principal Lecturer in Electronics at Brooklands Technical College, Weybridge.

**T**HE Micro-Professor is a low-cost Z80 based microcomputer system intended for the hobbyist and enthusiast as well as the student and technician. The Micro-Professor aims to provide the user with an interesting and inexpensive introduction to the microprocessor world and, since it is primarily intended as a learning aid, the accompanying "User's and Experiment Manual" forms a significant part of the package. Other applications include process control, timing, sequential tone generation ("music") and as a low-cost microprocessor development aid.

The basic system incorporates an Z80 central processor unit (CPU), 2K read-only memory (ROM) and 2K random access memory (RAM) together with a keyboard and hexadecimal display consisting of six seven-segment i.e.d. indicators. A cassette tape interface is included; also a small loudspeaker. An on-board regulator provides power for the system in conjunction with an external a.c. mains adaptor. The system is fully expandable and a range of additional modules is available which includes additional RAM and ROM, programmable input/output (PIO) and counter/timer circuits (CTC). For those wishing to develop the system even further, speech synthesis and EPROM programmer boards may also be added.

## FIRST IMPRESSIONS

The Micro-Professor comes securely packed in a corrugated cardboard box measuring 350 x 210 x 70mm (approx.). Inside, the Micro-Professor itself is contained within a neat, but rather "plastic", book-style case measuring 255 x 200 x 48mm (approx.). The case is secured by means of a press-stud fastener and opens out to reveal the microprocessor board in the right hand leaf and a deep recess in the left hand leaf. Just what this, apparently unused, space is intended for is not immediately obvious since neither the "User's Manual" nor the a.c. power unit will fit into the space! However, it appears that an earlier (and smaller) edition of the manual was intended to occupy this position and it can also be used to accommodate such items as the optional speech synthesiser or EPROM programmer boards.

The a.c. mains adaptor operates from a nominal 240V 50Hz supply and provides a nominal 9V output at 600mA. Early Micro-Professor power units were enclosed in a moulded case fitted with an integral 2-pin round mains plug. This type of plug is very inappropriate for use in the U.K. unless, of course, you happen to have an abundance of shaver sockets in your home! Happily, the unit is now supplied with a conventional 13A mains plug.

The sizeable manual has a format just slightly smaller than standard A4 size and contains well over 300 pages. The manual is divided into three parts; a "User's Manual", monitor listing, and a section entitled "Microcomputer Experiments (Software/Hardware)". The first section (111 pages) is extremely comprehensive and includes basic operations, program debugging and monitor sub-routines as well as a description of the software and hardware (including full circuit diagrams and

i.c. pin-outs). The second section (51 pages) contains a full monitor listing (Copyright Multitech Industrial Corporation) which has 2659 statements. The final section (144 pages) provides an introduction to the design of microcomputer programs and gives details of 18 varied experiments based on the Micro-Professor system.

The system hardware is mounted on a neat and tidy p.c.b. measuring 220 x 155mm (approx.). This screen printed, double sided p.c.b. is a push-fit into the book-style case and includes a user breadboard area. The display and keyboard are both eminently visible and easy to use. These items alone render the Micro-Professor superior to many of its rivals.

## HARDWARE

The hardware specification of the Micro-Professor is shown in Table 1. The system clock at 1.79MHz is derived from a TTL oscillator and 3.58MHz crystal. The fundamental frequency is divided by a 74LS74 bistable and then applied to the Z8—CPU. A second 74LS74 bistable provides system reset from the keyboard 'RS' button. A 2516 EPROM contains the monitor (address 0000—07FF) whilst a 6116 static RAM provides 2K bytes of user memory (address 1800—1FFF). To provide a further 2K bytes of memory a second 6116 RAM may be fitted in a "memory expansion area". Alternatively a 2516 (or similar) EPROM may be fitted in order to facilitate demonstration or

**The Micro-Professor in its case together with the EPROM and Speech Synthesis boards and respective manuals.**

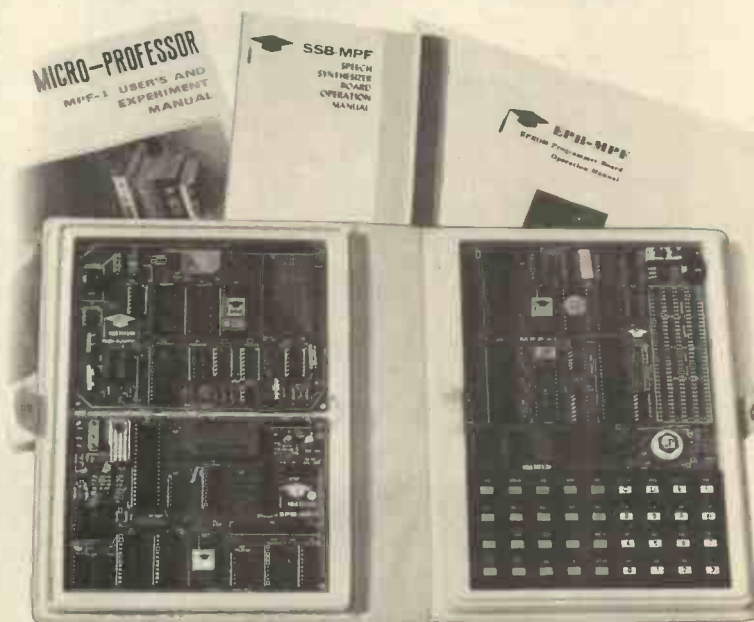

**Table 1 HARDWARE SPECIFICATION OF THE MICRO-PROFESSOR**

<b>CPU:</b>	Zilog Z-80 CPU with 158 instructions and 2.5MHz maximum clock rate. For MPF-I, system clock is 1.79MHz.		
<b>ROM:</b>	Single +5V EPROM 2516(2532)x1, total 2K(4K) bytes. Monitor EPROM Address: 0000-07FF(0FFF).		
<b>RAM:</b>	Static RAM: 6116, total 2K bytes. Basic RAM Address: 1800-1FFF.		
<b>Memory Expansion Area:</b>	Single +5V EPROM 2516/2716/2532/2732 EPROM or 6116 static RAM on-Board Expansion Address: 2000-2FFF.		
<b>I/O Port:</b>	Programmable I/O Port 8255x1, total 24 parallel I/O lines. I/O Address: 00-03.		
	Programmable PIO, a total of 16 parallel I/O lines. I/O Address: 80-83H.		
	Programmable CTC, a total of 4 independent counter timers. I/O Address: 40-43H.		
<b>Display:</b>	6 digit 0.5 inch 7-Segment red l.e.d. display.		
<b>Keyboard:</b>	36 keys including 19 function keys, 16 hexadecimal keys and 1 user defined key.		
<b>Speaker and Speaker Driver Circuits:</b>	A 2.25 inch diameter speaker is provided for user's expansion.		
<b>User Area:</b>	Provides a 3.5 inch x 1.36 inch wire wrapping area for user's expansion.		
<b>Audio Tape Interface:</b>	Can be connected to any cassette. Data rate is 165 bps.		
<b>System Clock Rate:</b>	3.58MHz crystal divided by 2, cycle time is 0.56 micro-sec.		
<b>System Power Consumption:</b>	Single 5V power supply, current consumption 500mA.		
<b>Mains Power Input:</b>	Power adapter Input 240V 9V/600mA.		
<b>Physical Characteristics:</b>	Height:	1.60mm (W/O case)	
	Width:	15.75cm (W/O case)	
	Depth:	22.30cm (W/O case)	
	Weight:	1.41lb (with case)	

user-defined programs in ROM. A somewhat primitive, but none the less effective, 2K BASIC ROM is also available for those wishing to extend the system for programming in this ever-popular high level language.

An 8255 programmable input/output port interfaces the keyboard and display with the rest of the system. In addition sockets are fitted for Z80—PIO (programmable input/output) and Z80—CTC (counter/timer) integrated circuits. The PIO/CTC bus is available on a 40-way connector as is the Z80—CPU bus. The left-hand four digit of the seven segment display indicate the address while the two remaining digits indicate the data. The segments (anodes) are fed from the 8255 via two 75491 drivers whereas the cathodes are multiplexed from the 8255 and driven by a single 75492.

The keyboard has 36 keys; 19 are function keys, 16 are hexadecimal keys and there is 1 user-defined key. The function keys occupy the left-hand side of the keyboard whilst the hex. keys are grouped together at the right-hand side. Despite the relatively small size of the individual keys, there is plenty of clearance around them and, furthermore, the action is quite "positive"; requiring a depression of approximately 2mm before the contacts make. Altogether the keyboard is very satisfactory from the ergonomic as well as mechanical and electrical standpoints.

The user breadboard area measures 90 x 35mm (approx.) and has 175 separate pads on a 0.1 inch matrix for mounting dual-in-line integrated circuits at either 0.3 inch or 0.6 inch spacing. Supply rails are also provided and there is ample space for mounting either 1 x 40-pin, or 2 x 28-pin, or 8 x 14-pin DIL devices together with associated components.

The on-board 7805 regulator has barely adequate heatsinking which is provided by a small area of copper foil on the component side of the p.c.b. At 500mA load current the regulator is dissipating 2.5W and runs at an alarmingly high temperature. The tape recorder sockets (3.5mm printed circuit mounting jacks) are adjacent to the regulator and consequently they also run warm. One wonders whether this was intentional or just a fortunate coincidence? Despite the very high temperature of the regulator, no adverse effects were noticed after soak testing the unit for several hours at an ambient temperature of 30 degrees C and with the display reading "8888—FF". (*We understand that all units are now being supplied with a heat sink fitted to the regulator—Ed.*)

## SOFTWARE

The software specification of the Micro-Professor is shown in Table 2. The 2K byte monitor program contained in a 2516 EPROM provides the necessary facilities to enable the user to develop and run his own programs. The most elementary function of the monitor is that of allowing the user to inspect and alter the data at each address in the user RAM. Various other functions, such as single-step, set break point etc, are available together with routines which allow reading and writing of data from an external cassette recorder. A full listing of the monitor program is included in the "User's Manual" and, although this may be of little use to the beginner, it will undoubtedly prove to be of considerable value to the more advanced student.

A few simple safeguards are provided in order to warn the user of error conditions. One of these alerts the user to "illegal" key entry by blanking out the display. The display returns when the "illegal" key is released. The monitor functions are, on the whole, straightforward and easy to use however, the "User's Manual" has some serious shortcomings, particularly when the user is unfamiliar with the terminology and may have no previous experience of programming in machine-code. Furthermore, the relatively complex Z80 is a rather inappropriate choice of microprocessor for use in an elementary training aid which concentrates on machine level programming. Many other 8-bit microprocessors would have been better suited to this application and one can only speculate as to why the Z80 was chosen.

## THE USER'S MANUAL

The "User's Manual" is extremely comprehensive but does not, unfortunately, adequately cater for the absolute beginner. This may be of little consequence when the user is following an established course of study but could present very severe problems for the individual starting from scratch. An early introduction to the general concepts and terminology of microprocessor systems would be highly desirable. The manual is also a little illogical in its structure. Early "examples" of the use of the keyboard are more readily understood if the "description" (which follows each section) is studied *before* attempting to key the examples into the microcomputer. Furthermore, some of the examples are explained in bewildering terms and there are numerous (and sometimes inexcusable) typographical errors. It

Table 2

**SOFTWARE SPECIFICATION OF THE MICRO-PROFESSOR**

2K-byte monitor provides key functions and incorporates a memory checking routine. The key functions are as follows:—

RS	: system reset.
ADDR	: set memory address.
REG	: set register name.
DATA	: input data to memory or register.
PC	: recall program counter.
+	: check the next memory address or register.
-	: check the last memory address or register.
STEP	: execute user's program, a single step.
SBR	: set break point of user's program.
CBR	: clear break point of user's program.
MONI	: immediately break user's program.
GO	: go to user's program or execute some monitor function.
INS	: insert 1 byte into memory.
DEL	: delete 1 byte from memory.
MOVE	: move data block from one area to another.
RELA	: relative address calculation.
TAPE WR	: store memory data onto audio tape.
TAPE RD	: retrieve data from audio tape.
INTR	: maskable interrupt, connected to CPU's INT pin.
USER KEY	: user defined key, connected to input port 00, bit 6.

*	AF	BC	DE	HL	AF	BC	DE	HL	IX	IY	SP	I-IF	SZ-H	PNC	SZ-H	PNC
	0	1	2	3	4	5	6	7	8	9	A	B	C	D	E	F

: hexa-digit or register name. EA371

really is a great shame that, with so much useful information presented, it has not been offered in a form that can be readily assimilated.

The experiments themselves occupy the last part of the manual. They are adequately structured; each has a declared "purpose", the "time required" is stated (often this is 4-8 hours), and some "theoretical background" is given for each. The experiments have been chosen so as to familiarise the student with various facets of microcomputers. The topics are varied and well chosen and include such items as branch instructions, program loops, sub-routines, binary-to-BCD, and BCD-binary conversion, and keyboard and display multiplexing. Altogether this is a program which will be welcomed by both teachers and students of microprocessors.

**EXPANSION**

One of the most crucial aspects of any microcomputer system is the degree of expansion that is possible. Where a microcomputer is purchased primarily as a learning aid it is, of course, quite likely that the owner will wish to progress to a more powerful system when the time comes. For many, however, the cost of such an upgrade can be prohibitive and, whilst there seems to be an active second hand market for microcomputers, it would be nice to think that a "first" system would be sufficiently flexible to adapt and grow to meet its user's future needs. What, then, has the Micro-Professor to offer?

Firstly there are three vacant sockets on the Micro-Professor's p.c.b. One of these constitutes the "memory expansion

area" to use its rather grandiose title! This 24-pin i.c. socket can accept either RAM or ROM devices and thus the user-memory may be extended to 4K or, alternatively, a 2K tiny-BASIC ROM may be fitted. The remaining two unoccupied i.c. sockets accept the Z80-CTC and Z80-PIO devices. These i.c.'s may, of course, be obtained from a large number of U.K. suppliers. They are, however, very competitively priced when purchased as part of the Micro-Professor system.

Secondly two expansion boards are available. One of these is a complete speech synthesis unit whilst the other provides EPROM programming facilities. Both boards are built to the same high standard of construction as that of the Micro-Professor and occupy exactly half the area of the host-controller p.c.b. They thus fit together neatly in the left hand leaf of the Micro-Professor book-style case. Connection to the Z80-CPU bus is by means of 40-way ribbon connectors — the only slight criticism being that the case will not close when the ribbon connectors are in place. All this makes for a very neat, tidy, and compact system.

**BASIC**

The 2K tiny-BASIC ROM plugs into the "memory expansion area" and allows the user to program in BASIC. The available commands and statements include CALL, CONTINUE, FOR . . . NEXT, GOTO, GOSUB, IF . . . THEN, LET, LIST, LOAD, NEW, PRINT, RETURN, RUN, SAVE and STOP. Users may also call machine-code sub-routines resident in the Micro-Professor memory. A keyboard overlay is provided and the display is used to examine the program on a line-by-line basis. This, unfortunately, takes some getting used to—particularly when the display moves! Tiny-BASIC is, of course, very limited by comparison with its more powerful counterparts. It does, however, help to bridge the gap between machine-code and high level language and may be a worthwhile addition for those wishing to progress beyond Hex.

**SPEECH SYNTHESIS**

The speech synthesis board is designed around the TMS5200/5220 voice synthesis processor. This device employs linear predictive coding and data held in ROM determines the instantaneous signal frequency and amplitude. The ROM fitted is a 4K TMS2532 which contains 32 words; sufficient for a simple time-clock program. Sockets are fitted which can accept two further ROMs in order that the vocabulary to over 150 words and there is a choice of eight ROMs, each containing approximately 30 words. The ROM supplied provides two speech programs a test/demonstration vocabulary and a small user storage area. The speech synthesiser uses the Micro-Professor as host controller and the keyboard, display and loudspeaker of the Micro-Professor act as input and output devices.

Voice pitch and volume are adjustable by means of multi-turn pre-set potentiometers. The manual contains operating instructions (which are somewhat brief by comparison with those supplied with the Micro-Professor), hardware details, and a program listing. There are no "experiments" as such, however, the system can be regarded as more a demonstration than an experiment package. There is, of course, considerable scope for the more intrepid programmer wishing to include speech output with programs devised for the Micro-Professor. For him, the speech synthesis board can be considered an exciting and challenging extension to the basic unit.

**EPROM PROGRAMMER**

Like the speech synthesis board, the EPROM programmer connects to the Z80-CPU bus via a 40-way ribbon cable. It is, in fact, possible to have both the speech synthesis board and the EPROM programmer board linked to the Micro-Professor

simultaneously by virtue of duplicate 40-way male connectors fitted to each p.c.b. The EPROM programmer caters for TMS2508, 2516, 2532 and I2758, 2716, and 2732 devices. It incorporates an 8255 PIO together with 4K of static RAM in the form of two 6116 integrated circuits. The monitor is a 2516 and the 5V and 25V rails are regulated by 7805 and 723 devices respectively. A zero insertion force socket is fitted to accept the EPROMs for programming.

The manual explains the function of the monitor program and contains instructions in much the same form as that used in the Micro-Professor "User's Manual". The EPROM programmer has its own mains adaptor (as is the case with the speech synthesis board) and the system becomes a little cumbersome when all three a.c. adaptors are connected to it. The alternative would be to have one power supply for the whole system. This, of course, would have to be substantially up-rated by comparison with any one of the existing power units. If the whole system were to be powered from a single +5V rail (from, say, an external 317 bolted to an adequate heatsink) the +25V rail for the EPROM programmer could be derived from a simple on-board d.c.-d.c. converter. In the first instance this would, of course, make the system a little more expensive but it would effect a considerable saving later on and would make the fully expanded system a good deal tidier.

### SUMMARY

In any equipment review, the question "Is it good value for money?" inevitably arises sooner or later. In the case of the Micro-Professor, it really depends upon what you want from the package. In terms of the hardware offered the Micro-Professor certainly does represent good value. The keyboard and display are of a particularly high standard and the quality of construction is excellent. In terms of software, and the "User's Manual" in particular, it is important to be aware of the shortcomings of the system. Prospective purchasers should be warned that the system (in its most basic form) is really only suitable for those requiring a rigorous, if a little tedious at times, introduction to machine-code programming. For those having aspirations to proceed to a higher level language the Micro-Professor, with its tiny-BASIC, is not particularly to be recommended.

As a thorough introduction to machine level programming it succeeds admirably and, as a teaching aid, it could prove invaluable. Users with no previous experience of microprocessors will, however, have to do a considerable amount of background reading in order to derive full benefit from the Micro-Professor.

The Micro-Professor is available from the U.K. distributors; Flight Electronics Ltd, at Flight House, Quayside Road, Bitterne Manor, Southampton, Hampshire SO2 4AD.

The price of the basic Micro-Professor (including mains adaptor and manual) is £69.95. The Z80 PIO and CTC devices each cost £4.02, the Speech Synthesiser Board £64.95 and the EPROM Programmer Board costs £74.95. The latter items both include power supplies, manuals, and interconnecting ribbon cables. The tiny-BASIC ROM costs £15 and is supplied with a manual and keyboard overlay. Note that prices do not include VAT. Postage and packing is £2.95 per system and 50p for individual ROM's and i.c.'s.

**NOTE:** The following information has been received from Flight Electronics since this review was written:

From the middle of June all Micro-Professor 1 systems will have the 2716 Monitor EPROM replaced with a 2532 EPROM that will contain both the monitor source program list and the BASIC Interpreter. Also included will be a BASIC Manual, Keyboard Overlay and a seven segment i.e.d. Interpreter Card. In addition, the User's Manual will be supplied as three separate parts to aid the user. However, the price of the system will remain the same.

# Beginners' luck

**30% OFF**  
10 selected kits  
for first-time  
builders

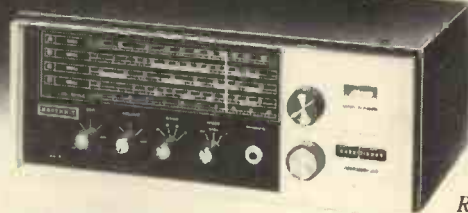

Shortwave  
Listener's  
Receiver

With Heathkit, you're all set for a great deal. And not just big savings.

Whichever kit you choose, you'll find it easy to build. Simple, but detailed instructions take you through every stage. Everything is included. Even the solder you need is there.

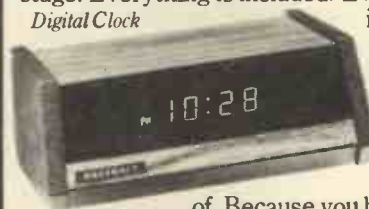

Digital Clock

Follow the steps and you'll end up with a hand-crafted, well-designed piece of equipment. One you'll be proud

of. Because you built it yourself.

There are 10 great kits to start you off. An interesting choice of a digital clock to a metal locator, including a short wave listener's receiver, windspeed and direction indicator, digital readout electronic scale and five more useful kits.

All at 30% off to first-timers. Send for your catalogue right now for a start.



Metal  
Locator



Windspeed and Direction  
Indicator

To Heath Electronics  
(UK) Limited, Dept ( PE8 ),  
Bristol Road, Gloucester GL2 6EE.

PE8

To start me off, please send me a copy of the Heathkit catalogue. I enclose 28p in stamps.

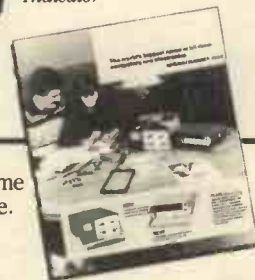

Name \_\_\_\_\_

Address \_\_\_\_\_

HEATH TELETYPE You build on our experience  
**HEATHKIT**

# Microsynth...

## Part Three A.R. Bradford M.Sc.

In this final part setting up of the synthesiser will be covered together with a series of test programs. Case construction is also covered.

### VCOs

Selecting the square wave output from VCO1, take VCO1 down to its lowest frequency by pressing the lowest key, setting the Range switch to 16', and then using the Sweep pot routed via the thumbwheel into the Keyboard, so that VCO1 is just oscillating. Adjust VR13 for the fastest buzz. Reduce frequency again using the thumbwheel and readjust VR13 for the fastest ticking. This process has nulled the offset on VCO1 integrator IC11, enabling the oscillator to stay in tune for very low input currents. Switch off VCO1 using the switch on the "Shape" pot and turn the thumbwheel to zero (towards the front). Repeat the above process for VCO2, selecting the square wave output and using the VCO2 frequency control and adjusting VR17. Remember to turn VCO2 Level up.

The ramp waveforms from each VCO are now adjusted in turn. Turn VCO2 Level down and switch VCO1 on. Selecting the ramp waveform from VCO1 sweep the oscillator over its entire range using the Range switch and the Sweep/Thumbwheel combination, and adjust VR15 to ensure that the output does not disappear or become distorted at either end of the range. An oscilloscope is useful here but by no means essential. Repeat the process for VCO2 adjusting VR19.

Next, using VCO1 at the low end of its range (16'), play a scale; this should be in tune, so bend the frequency down very low using the thumbwheel and adjust VR8 for an accurate scale. This process nulls out the offset on the keyboard range amplifier, IC7.

### OCTAVES

Now the octaves may be set up using the keyboard and the Range switch. Working either side of the 4' range, which requires no adjustment, set the ranges an octave apart by adjusting VR5 and VR6 (8' and 2' respectively), followed by VR4 and VR7 (16' and 1' respectively).

Tuning of the whole instrument relative to another instrument is achieved by turning VR1.

### VCF

Select a ramp waveform from VCO1 and switch the VCF "Kbd Mod" on. Set the VCF frequency control half way thus filtering the ramp waveform down to a smooth tone and sweep the keyboard using the range switch. VR22 should be adjusted so that there is no obvious change in harmonic content as the keyboard is swept. Switch both VCOs off and turn up the Noise Level control. With the Q control at maximum it should now be possible to play a crude scale of whistles from the filtered white noise.

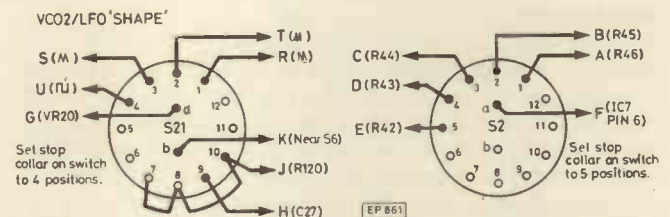

Fig. 10. Wiring of rotary switches viewed from underside of main p.c.b.

### ENVELOPE

Set the Attack and Release controls about one quarter turn, and switch the Envelope Shaper to "Auto" using S8. Upon pressing a key the output may latch up (not decay away once the Attack cycle has been completed). If this is the case turn VR11 anti-clockwise until the sound dies away again. If VR11 is too far anti-clockwise, the output volume in "Auto" mode may be appreciably quieter than in "Manual" mode. Therefore turn VR11 clockwise to equalise the output volume in the two modes of operation, but making sure that the envelope resets correctly without latching up. Check also that the 'Repeat' functions. If not turn VR11 clockwise. Finally, each time a key is pressed there will probably be a thump at the output; this should be nulled out using VR25.

### FAULT FINDING

Assuming there are no faults up to now the Microsynth should be set up and ready for use. If the VCOs malfunction for no apparent reason, it may be that CMOS chip IC14 has been damaged by static during insertion. Replacing this chip usually cures such inexplicable faults. It now remains to test out all the various functions of the Microsynth. It is

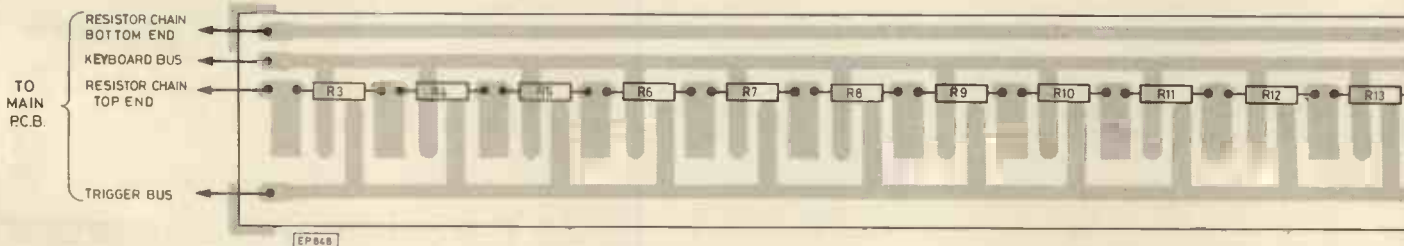

Fig. 11. Showing copper side of keyboard p.c.b.

suggested that the test programs listed below are run through—if these all work it is unlikely that there is anything wrong with the circuitry.

Should any function fail to work, check the p.c.b. against the component schedule and circuit diagrams, inspecting the relevant area of the p.c.b. for incorrect components, dry joints, solder bridges, diodes or transistors in the wrong way round, etc. Where one part of the synthesiser is connected to another some distance away, follow the relevant tracks making sure that there are no breaks, shorts, pins missing, etc. in these links. 99 per cent of all faults can be isolated in this way and will generally be found to be due to some trivial mistake in construction.

### TEST PROGRAMS

Set all function switches (except "Drift") to the left between programs.

#### Star Wars

Switching VCO2 to LFO mode disables the audio output and sets the operating range from about 0.1Hz to 30Hz. The LFO may be used to sweep the keyboard automatically; use the ramp waveform from VCO1 and try the effect of the various waveforms available from VCO2/LFO. Route the LFO output either directly into the Keyboard using S14, or via the thumbwheel, setting "Source" to "LFO" and "Destination" to "KBD". Use the square wave from the LFO in conjunction with the "Shape" control to vary the duty cycle.

#### Waa-waa

Switch the Envelope output into the VCF. Set the Q control about two thirds up and VCF Frequency fairly low; set Envelope Level about half way positive. Keep Attack and Release times fairly short and remember to only use VCO waveforms with a high harmonic content, that is, ramp or square waves. You should now have the typical Moog sound. A slightly longer Attack and shorter Release and you will start to get a trumpet-like voice. Try switching in some Sub Octaves at this point!

#### Wind

Disable both VCOs and turn up the Noise Level control. With the VCF Q knob set fairly high and the low pass output selected, varying the VCF Frequency control will generate wind effects. Switch the VCF output to band pass and get rain too! Try the envelope on "Auto" and "Repeat" (or alternatively triggered from a slow-running LFO) for generating percussive, rhythmic effects—steam trains are quite easy using a repeat time of about 0.3 seconds and suitably short Attack and Release times. Don't have the Q control too high though. Alternatively, turn the Attack and Release times right round to maximum and switch the Sustain to "Hold". Use the "Repeat" facility rather than LFO triggering. Q low, VCF frequency mid-way, and a small positive Envelope Modulation in to the VCF and you will start to get a seascape. When you are happy with this, turn VCO1 on with

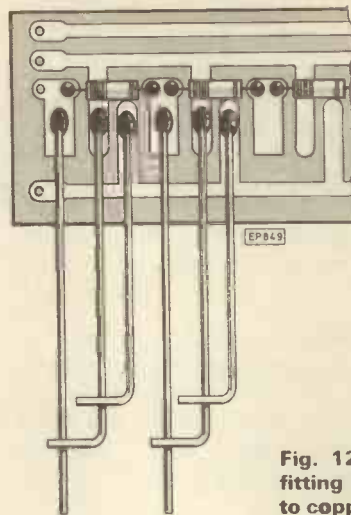

Fig. 12. Showing method of fitting key contacts (soldered to copper side)

a triangle output, switch the Range to 2' and the "Drift" switch to "Down". The repeatedly hit keys at random for the complete treatment.

#### Bells

Using the triangle outputs from both VCOs, switch VCO2 to "Ring Mod" and switch VCO2/LFO modulation into the VCA. Pressing a key and bringing up the volume of VCO2 will gradually introduce sum and difference tones. Set VCO2 at some anharmonic ratio of VCO1's frequency. Switch the Envelope to "ADSR" and sustain to "Auto" with short Attack and fairly long Release times. Alternatively use VCO2 in LFO mode to modulate the keyboard with a slow, low amplitude triangle (vibrato!). Note that the LFO speed can be changed by the Envelope as it rises and falls (switch Envelope Modulation into VCO2) so that the speed of the vibrato is fast to start with and slows as the envelope dies away, or vice versa. Try the effect of the sub octaves with VCO1

#### Organ

The use of triangle oscillators to provide relatively pure tones, while the VCF filters other waveforms (in this case the Sub Octaves, one each under VCO1 and VCO2), really comes into its own with this program. Switch the "ADSR" off, Sustain to "Manual", with Attack and Release times short. Tune VCO2 to, say, an octave and a third below the pitch of VCO1, and there you have it!

#### Random/Staircase

Have the envelope repeating at a fairly brisk rate (remember to have the Sustain on "Auto" for this effect to work; with Sustain on "Manual" and the "Repeat" on you will get a sort of echo every time you release a key!) and switch the thumbwheel Source to "S & H" (Sample and Hold). Push the thumbwheel fully up. Route the thumbwheel output into the keyboard. With VCO1 and VCO2 tuned to some interval

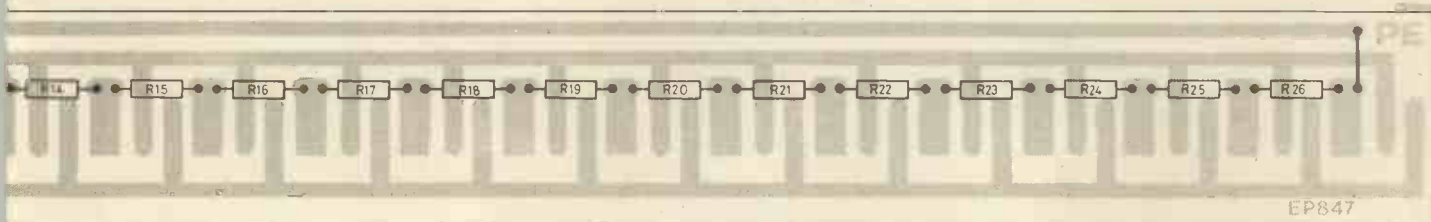

or other, the Sample and Hold will sample VCO2 waveform and the pitch of both VCOs will be modulated apparently at random. Alternatively switch VCO2 to LFO mode, running slowly with a ramp or triangle output. VCO1 will now be modulated by the staircase waveform coming from the Sample and Hold. Next set up the wind effect again and switch the thumbwheel output into the VCF to achieve trendy random or staircase filtering effects (the LFO must be running, with the level control fully up). This also works well with a ramp output from one or both VCOs—listen to a Jean Michel Jarre album sometime!

### VCO1 mark/space modulation

Use the triangle output from the LFO to modulate the VCO1 squarewave (remembering to select the square wave output from VCO1). Slow, large amplitude modulation will give a phasing effect while somewhat faster, small amplitude modulation will give a chorus or string ensemble effect. Try switching in the Sub Octaves.

### Harpichord

Try the chorus effect with a sharp Attack and longish Release, the "ADSR" switch on, and the VCF switched to band pass. Vary VCF Frequency control for the best result. Try the sub octaves. See what effect the VCF "Keyboard Mod" switch has.

Once the whole instrument has been tested you can really start experimenting! Try anything and everything—the most interesting effects tend to be discovered by accident. Keep a stock of program sheets and record the settings for any effect you wish to keep—there are so many possibilities it is pointless relying on memory.

### CASE CONSTRUCTION

Ready built cases and panels will be available from *Clef*, but for those constructors wishing to make their own the dimensions are shown here. It is possible to use a longer keyboard if desired simply by extending the length of the case and the front panel. The end cheek shown in Fig. 14 is the same regardless of the length of keyboard used, while the front, back and keyboard support bars (all of equal length) should be  $15\frac{1}{2}$ in for the 25 note keyboard.

The case was assembled by drilling  $\frac{1}{4}$ in holes in the end cheeks in the positions shown and screwing 2in wood screws through these directly into the front and back pieces, but if preferred there is ample room for gluing batons into the corners and screwing into these. Either way the screw heads should be countersunk into the wood of the end cheeks. Having built the basic frame, the bottom panel is cut from  $\frac{1}{4}$ in plywood or hardboard and glued and screwed in place, again countersinking. This bottom panel should be cut slightly larger than the framework and then planed off flush with the walls once in place.

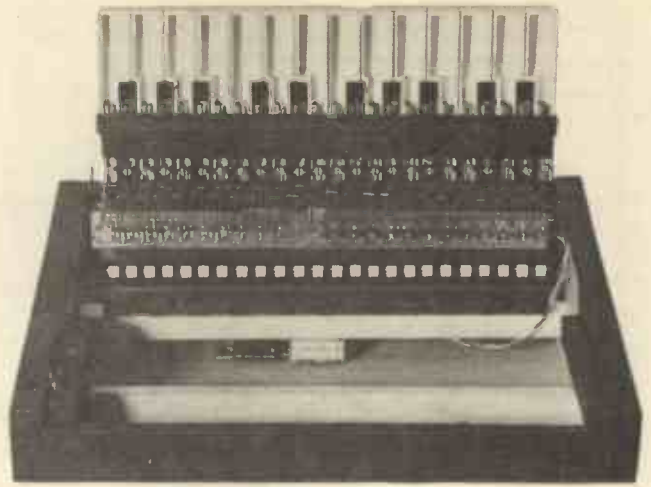

Showing hinged keyboard assembly

Dummy keys are cut from  $\frac{1}{4}$ in wood as shown in Fig. 13 and glued inside each end cheek, having first securely araldited the thumbwheel to the left hand end cheek. Remember to solder the wires to the edge pot first, as you won't be able to get at it afterwards.  $\frac{3}{8}$ in square x 6in strips of wood are glued along inside the top edges of the end cheeks to form panel supports, being placed slightly below the tops of the end cheeks to allow for the thickness of the panel. Plane off also the top edge of the back wall at a slight angle to allow for panel thickness, so that when in place the panel will fit flush with the tops of the end cheeks.

A cut out should be made in the back wall of the cabinet and a small piece of 16 s.w.g. aluminium drilled to take the sockets and the mains cable. This should then be sprayed black and labelled and screwed in place behind the cut out, see Fig. 15. The dimensions will depend on the type and number of sockets used: the sequencer terminal should be a 5 pin 180° latching DIN socket; the outputs will normally be  $\frac{1}{4}$ in jack sockets, although professional users may prefer cannons, while for purely domestic use through a hi-fi, phono sockets may be best.

Fill the screw holes with wood filler and sand down; the

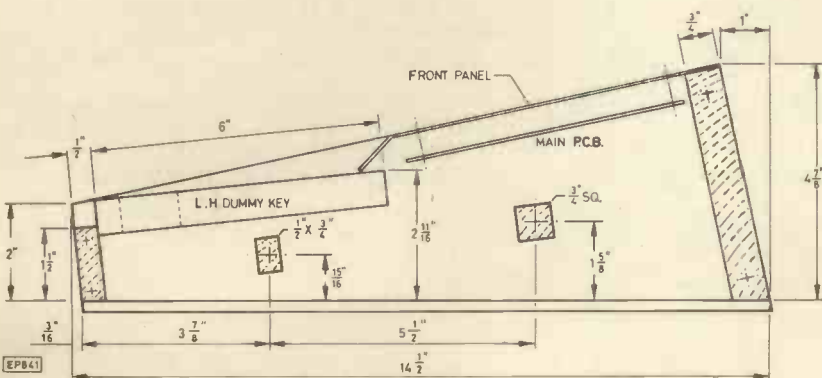
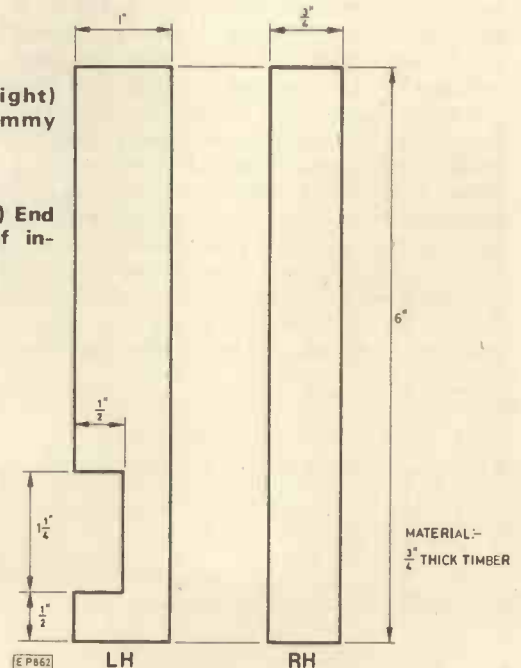

Fig. 13. (Right) Showing dummy keys

Fig. 14. (Below) End cheek detail of instrument





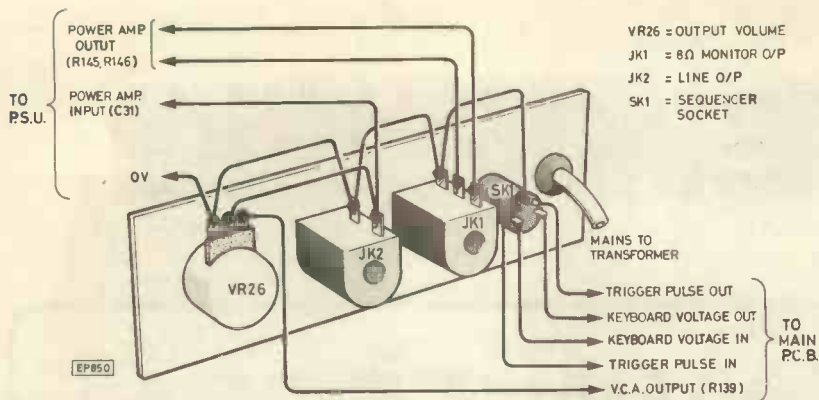

Fig. 15. Rear panel connections

entire case is now covered with black plasticised cabinet cloth (obtainable from Maplin or most electronic/disco shops), using a "Thixofix" type adhesive. Both surfaces must be completely covered with a thin layer of adhesive and allowed to dry, in order to obtain the best finish and avoid peeling.

Screw some rubber feet to the corners and bolt a strap handle through the left hand end cheek if required.

### PANEL

The panel is constructed from 16 s.w.g. aluminium as shown in Fig. 16. Having cut all the holes, thoroughly clean the drilled and filed aluminium with "Brillo", then thoroughly dry with tissues taking care not to get any grease back onto the metal, and spray with several thin coats of matt black car paint, allowing a few minutes to dry between each coat. The white lines are put on with  $\frac{1}{8}$ in white car stripe (from most car spare shops and garages). The panel is labelled with white "Letraset" or similar, and the labelled panel is finished by spraying with a thin coat of clear matt fixative (from stationers).

### FITTING THE KEYBOARD

If the keyboard chassis protrudes beyond the ends of the keys, the excess must be cut off with a hacksaw; then fix the hinge at the back of the keyboard to the rear support in the cabinet using self tapping screws. If the keyboard used does not have a hinge at the back, it is recommended that the rear support be made to pivot in the cabinet by drilling  $\frac{1}{2}$ in deep holes in the end cheeks and in the ends of the support bar and inserting 1in metal rods (such as 1in 4BA bolts with the

heads sawn off) into the holes. In any case, position the keyboard carefully so that it will pivot freely between the dummy keys at either side, and so that the keys do not foul the front of the cabinet. Check that the panel fits correctly with a slight gap between the sloping front and the tops of the keys.

The keyboard p.c.b. of Fig. 11 is glued underneath the keyboard chassis, having first mounted the resistors. The gold wire contacts should then be soldered in place so that the longest wire presses against the bottom of the key plungers. The other contacts are then added, and bent so that there is a small gap between each of the wires when the keys are not pressed. Ensure that all three wires under each key meet when that key is depressed, but avoid having too small gaps between them when the keys are not depressed, or else mechanical vibration may cause spurious triggering.

### FINAL ASSEMBLY

Having made all the various connections between the three p.c.b.s, the thumbwheel edge pot and the back panel, and after setting up the circuitry, the main p.c.b. bolts beneath the front panel using 2in threaded spacers. The power supply p.c.b. should be bolted to the floor of the cabinet behind the keyboard using  $\frac{1}{4}$ in threaded spacers. Assembly is completed by fixing the front panel in place with four self tapping screws and then pushing the knobs over the pot spindles protruding through the panel. ★

Fig. 16. Front panel drilling detail

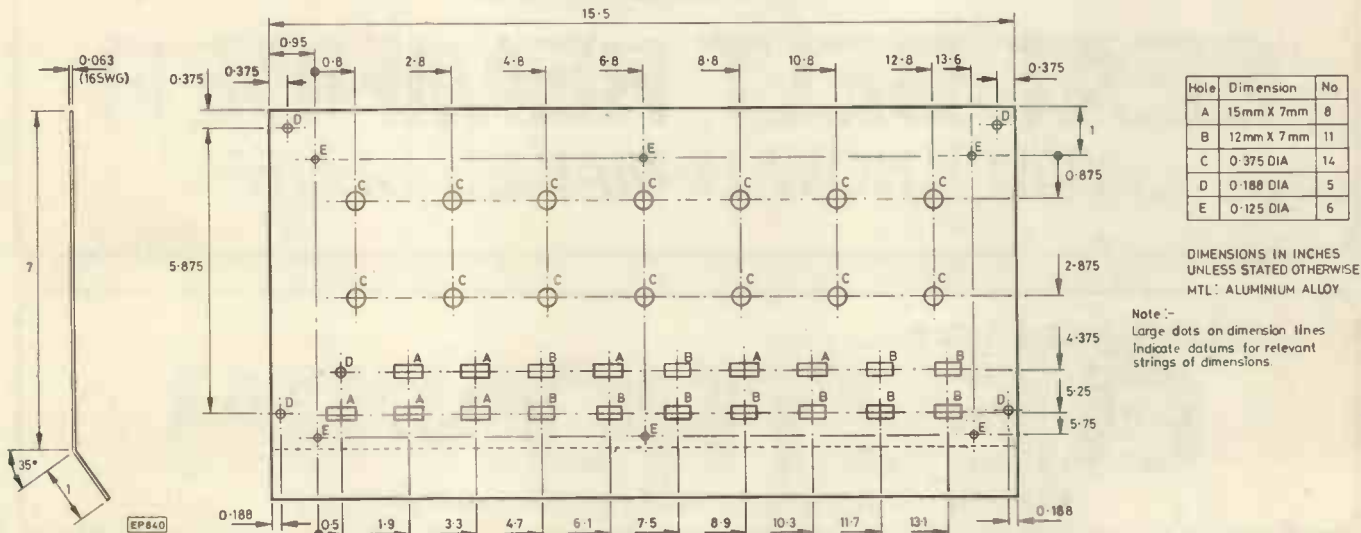

all in your  
**SEPTEMBER**  
issue!

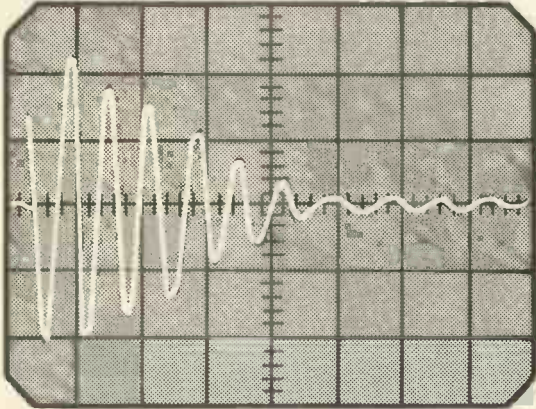

## WAVEFORM DIGITISER

Able to store a waveform in memory and replay it for analysis or troubleshooting. It is particularly useful for capturing transient events such as musical instrument waveforms, power supply glitches, etc. Another application is the recording of daily temperature variation, the result of which can be retraced on an oscilloscope at much higher frequency to provide a time compressed record.

## C.B. SCANNER

This design provides push button up/down single step or channel scan with pause on channels in use. Simply key the mic to stay on any channel. The neat p.c.b. can be fitted inside most rigs and, with the option of all controls on the mic, provides an easy to use system—especially when driving.

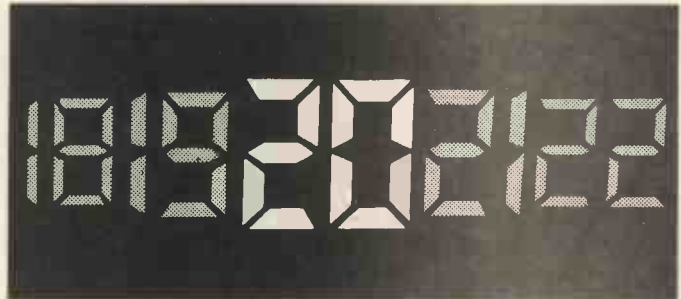

## SEAT BELT REMINDER

... YOU KNOW IT MAKES SENSE!

# PRACTICAL ELECTRONICS

SEPTEMBER ISSUE ON SALE FRIDAY, AUGUST 13th

# FREE! READERS' ADVERTISEMENT SERVICE

# PE BAZAAR

**RULES** Maximum of 16 words plus address and/or phone no. Private advertisers only (trade or business ads. can be placed in our classified columns). Items related to electronics only. No computer software. PE cannot accept responsibility for the accuracy of ads. or for any transaction arising between readers as a result of a free ad. We reserve the right to refuse advertisements. Each ad. must be accompanied by a cut-out valid "date corner". Ads. will not appear (or be returned) if these rules are broken.

**ZX81 16K** in homemade case with proper keyboard and built-in power supply £110. F. R. Barros, 35 Rectory Lane, Tooting, London SW17 9PZ.

**RICHARD ALLEN** CG8 8 inch twin cone speakers. Never used. £16 for the pair. D. Ward, 9 Little Lane, East Morton, Keighley, West Yorks. Tel: 0274 567570.

**SINCLAIR ZX81** Personal computer, plus fifty programs, plus two books, plus p.s.u. all for £55 C.W.O. R. Wood, 35 Criffel Road, Bellevue, Carlisle, Cumbria CA2 7QP. Tel: 0228 28412.

**WANTED** service manual or circuit diagram Tektronix Oscilloscope Type 502A to buy or loan, small fee? A. Bouskill, 129 Lyminster Road, Birley Carr, Sheffield, S. Yorks. Tel: 0742 311191.

**TI 58, 58C, 59** owners, for sale, one PC-100C printer as new, £95 ono. Mr. G. Bearzot, 294 Hitchin Road, Lower Stondon, Beds. Tel: Hitchin 815417.

**WOULD** like to correspond with Atom owner. Raanan Herrmann, 6 Barkai Street, Ramat-Gan 52-376, Israel.

**PYE 24 INCH** monitors, four at £30 each or £100 the lot. Good working order. A. D. Woodcock, 12 Valescourt Road, West Derby, Liverpool L12 9EX. Tel: 051 228 5678.

**SINCLAIR ZX81**, p.s.u. manual leads, etc. plus two cassettes for sale £40. G. Potter, 7 Oxford Road, Birstall, West Yorkshire WF17 9JR. Tel: Batley 440389.

**AVO CT446** transistor analyser, v.g.c. in carry case, battery power supply, 8 Nicads and PP9, £15. R. Garas, 147 Seaforth Avenue, New Malden, Surrey.

**ELECTRIC** typewriter, serial or parallel input with tape reader and punch inc. manual and tape £65. Tel: Melksham (0225) 707164 (after 7.0 p.m.).

**WANTED** Eitel 3AZP31 tube for Hartley CT436 Oscilloscope. G. Cox, 18 Barnfield Road, Bollington, Cheshire. Tel: 0625 73003.

**SINCLAIR** built ZX-81, 16K RAM, software only 5 months old. Only £95 ono. Tel: Norwich 810662.

**ZX81 (16K)** Sinclair computer, in packing with adaptor, leads and manual, £100. S. Mathie, 185 Glasgow Road, Dumbarton G82 1DW. Tel: 0389 61308.

**SPEAKERS**, pair of Wharfedale Denton HiFi with metal stands. Tel: Basingstoke 781032.

**ZX81** computer and 16K RAM, p.s.u. and extras, £110 ono, owner moving abroad soon. T. G. Kua, 95 Cedar Walk, Hemel Hempstead, Hertfordshire HP3 9ED.

**ZX81 16K** external keyboard, books and cassettes, £100. 4 1/2 inch black and white video monitor, £35. Tel: Roger (evenings) 0702 67453.

**WANTED**, any books on the Z80. Programming, Interfacing, etc. Good price paid (Sargo Chess perhaps?). E. Ball, 49 Brandearth Hey, Cantril Farm, Liverpool L28 1SB. Tel: 051 489 9708.

**TRANSFORMERS**, 330/0/330V, 300mA, 4V2A, 5V2A, 6-3V7.5A, and 600/0/600V, 260mA, 5V3A, encased, both 200/250VIn, £5 each. G. Jordan, 60 Thorndon Gardens, Stoneleigh, Epsom, Surrey. Tel: 01-393 9870.

**HEATHKIT** oscilloscope model 10-103 10MHZ, 5 inch single beam. Perfect condition, new mains transformer, £90. Offers considered. Mr. P. Metcalfe, 36 Quarry Bank Road, Market Drayton, Shropshire TF9 1DT. Tel: M/Drayton 3535.

**AVO** electronic test meter, ohms, dc/ac, volts, dc amps, capacitance, watts, very good order, offers. D. R. Halsall, 6 Lincoln Drive, Littleborough, Lancs OL15 0NE. Tel: 76590.

**PRACTICAL** Electronics magazines for sale. 1969 to 1980. 125 copies. Any reasonable offer accepted. G. W. Pretty, Church Farm, Broughton, Nr. Stockbridge, Hampshire. Tel: Broughton (079430) 239.

**VIC-20**, plus VIC tape deck. Books £200, swop Olympus, Tamron photo gear, UK101, etc. w.h.y. write. M. A. Saunders, 7 Drumcliff Road, Thurnby Lodge, Leicester LE5 2LH.

**ZX81**, plus 16K RAM, plus large software library and machine code primers, was £150+ now £65. Hugh Reynolds, 10 Lingfield Avenue, Kingston-on-Thames. Tel: 01-546 1997.

**TAPE-DECK**, Garrard portable, 9V, new. Mains h.t. transformers, chokes, valves. CRTS VCR139A 2 1/2 inch VCR 522 1 1/2 inch. Collect. Tel: Odiham 2224.

**TRS80** Video monitor, 12 inch green screen, perfect working order, little used, cost £100, accept £70 ono. Paul C. O'Neil, 187 Main Street, Chapelhall, Airdrie, Strathclyde M26 DSF. Tel: Airdrie 51476.

**NASCOM 1**, 32K, NAS-SYS 3, DE-BUG, Dis- assembler, toolkit, graphics in ROM, 8A p.s.u. sound, software, 300/600/1200/2400 Baud. £345 ono. S. Haque, 99 Durlston Road, Clapton, London E5 8RP. Tel: 01-806 5995.

**ZX81** with custom built case and loads of peripherals, including monitor, fantastic offer, £110 (worth £210+). M. Read, The Old Punch Bowl and Grapes, Adstock, Buckingham, Bucks. Tel: Winslow 2757.

**MULTIMETER** for radio t.v. incl. case, £16. Tel: 01-554 2913 (evenings).

**WANTED** all types of unused radio/amplifier valves and bases. Urgent are: PM4, PX25, MP-PEN, 41-MP. Mr. Covington, 41 Western Way, Letchworth, Herts SG6 4SE. Tel: Letchworth 79681.

**ZX80** with manual and circuit, £30, MK14 with video board and extras, £35. Mr. J. W. Walsh, 29 Crompton Avenue, Bolton BL2 6PG. Tel: 382796.

**SOLARSCOPE** CD.513 'Scope. Not working but repairable. No manual, hence price only £10. Break value. G. Hunt, 22 Usk Road, Tilehurst, Reading. Tel: Rdg 21119.

**MAPLIN** 5600S Synth. ready to play in Maplin case reasonable offer accepted. Mr. R. Massey, 7 Ivy Road, Northampton. Tel: Northampton (0604) 27644.

**ZX81 +16K** complete, Sinclair built. Books: ZX81 Companion, Mastering m/c. Programs: Assembler, Games, Home, Business, £85. D. Farrance, 24 Prestbury Road, Cheltenham, Glos. Tel: Cheltenham 36461.

**ZX81** Sinclair built + Inverse Video, white characters on Black background + joystick, £70. 16K ZX81 memory, £35. S. Thickett, "Edgeside", Church Road, Brown Edge, Stoke-on-Trent, Staffs ST6 8RA.

**WANTED**, circuit diagram for solid state automatic pulse generator to h.t. transformer. Gene Hetherington, Ballinamore, Co. Leitrim, Ireland.

**QUANTITY** small components new or used once only, all serviceable list, large s.a.e. G. A. Noble, 50 Croft Hill Road, Slough, Berks SL2 1HF.

**SHARP** MZ80 K Computer 48K RAM with Integral v.d.u. and cassette. Lots of progs and newsletters, £350. A. Deacon, 7 Ingleside, Lenzie, Glasgow G66 4HN. Tel: 041 776 3250.

Please publish the following small ad. FREE in the next available issue. I am not a dealer in electronics or associated equipment. I have read the rules.

Signature .....

Date .....

Please read the RULES then write your advertisement here— one word to each box. Then add your name, address and/or phone no. Maximum of 16 words plus address.

**COUPON VALID FOR POSTING BEFORE 13 AUGUST, 1982.** (One month later for overseas readers.)

**SEND TO: PE BAZAAR, PRACTICAL ELECTRONICS, WESTOVER HOUSE, WEST QUAY ROAD, POOLE, DORSET BH15 1JG.**

## BLOCK CAPITALS PLEASE

Name & Address:			

For readers who don't want to damage the issue send a photostat or a copy of the coupon (filled in of course) with a cut-out valid "date corner".

# Automatic Photographer

M.J.A. Turner

THE PRODIGIOUS invasion of photography by electronics has resulted in the automation of almost every function of the modern camera, including focussing. Now, even the *photographer* can be replaced by this electronic robot!

## MOVING IMAGE DETECTOR

As the name suggests, the Moving Image Detector is a device for detecting the presence of moving objects. It can be used in applications where a light gate would usually be required. But unlike a light gate, it does not require a beam. The M.I.D. is a versatile self-contained unit.

The M.I.D. unit described here is designed to operate the shutter of cameras which have an *electrical* release socket, such as most Contax/Yashica models. This type of release fires the shutter when shorted.

However, with the addition of a servo unit to fire the mechanical release, almost any camera could be used.

## GENERAL DESCRIPTION

An image is focussed by lens 1 (see Fig. 1), on to two photosensitive elements 2 and 3, which form a potential divider. These elements occupy only a small central area of the total scene.

Under normal circumstances, the two elements are of approximately equal resistance and so about half the supply voltage will exist at point A.

This condition is maintained indefinitely, despite ambient light fluctuations, clouds obscuring the sun for instance. The reason for this is that both photo-elements would be affected equally, which means that the potential divider ratio would remain the same and therefore, so would the voltage at point A.



If now, something moves across the scene being monitored and affects the amount of light falling on the elements consecutively, the ratio will be unbalanced and the voltage at point A will change.

This triggers the voltage change detector 4, the output of which is used to fire the shutter of the camera.

## PRACTICAL CIRCUITS

The most simple circuit that it is possible to build is shown in Fig. 2.

The two photo-transistors TR1 and TR2 are extremely small devices, measuring just a few millimetres across. They only have two leads, as the base connection is not made. The anode lead has a small tag on it.

Resistors R1 and R2 limit the current flowing through TR1 and TR2. Two are necessary to maintain balance under fluctuating light conditions.

C1 blocks the d.c. level at the junction of TR1 and TR2 and transmits any a.c. pulses to the thyristor SCR1. This is the Voltage Change Detector, although of course it will only fire on reception of a positive going pulse. This is perfectly adequate, as the moving object will produce a positive going pulse sooner or later, regardless of whether it be lighter or darker than the background.

Objects that contrast poorly with the background may escape detection, but this is a surprisingly rare event.

The 2N5062 is a very sensitive thyristor. Other types might not be suitable.

The circuit works well in fairly bright daylight. The following circuits, however, will operate in bright sunlight down to quite dim domestic lighting.

In Fig. 3, a comparator is used to detect changes in the voltage at point A. When this rises above a reference voltage at the inverting input of IC1, the output goes positive and fires SCR1.

The fine control VR2 is initially set at its central position. Then the coarse control VR1 is adjusted so that D1 is just on. Finally VR2 is readjusted until D1 just goes out.

Capacitors C1, C2 and C4 provide transient suppression. The circuit will be prone to repetitive triggering if they are omitted.

The circuit in Fig. 4 uses the same i.c., but connected in the "follower with gain" mode, which amplifies the pulses before feeding them to the thyristor.

It does not require adjustments of any kind and also has the advantage of negative feedback at 50Hz and above via C2. This prevents the circuit from being triggered by mains interference, especially from fluorescent lighting. Fig. 7 shows the pattern for a p.c. board suitable for the circuit of Fig. 4. Fig. 8 shows the component layout.

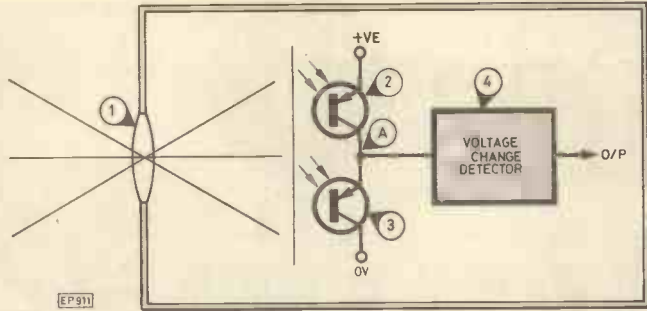

Fig. 1. Differential light detection system. Ambient changes common to the whole field are cancelled out

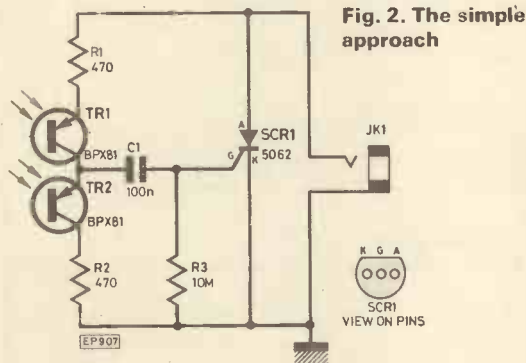

Fig. 2. The simple approach

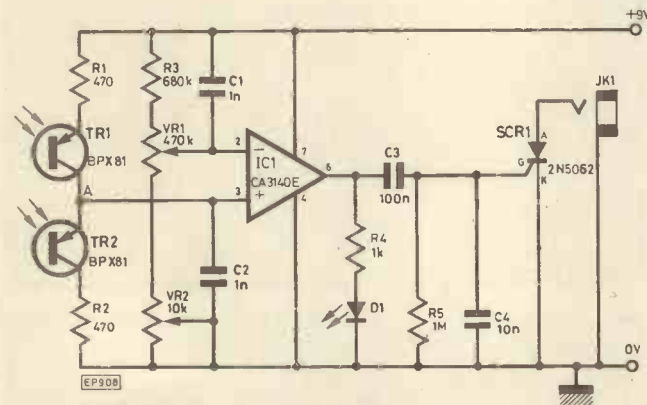

Fig. 3. Adjustable comparator approach

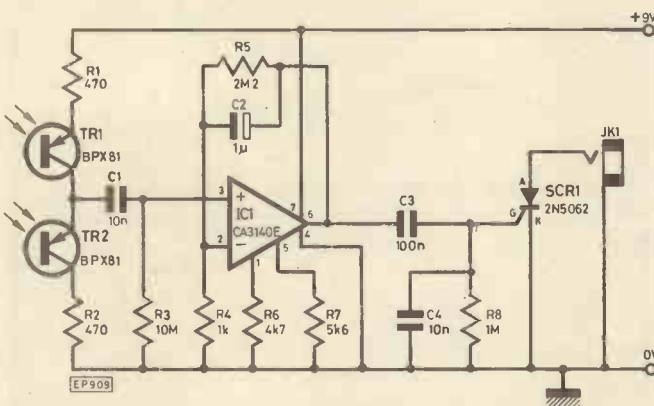

Fig. 4. Full circuit, including i.f. rejection to exclude artificial light "flicker"

Fig. 5. Without 50Hz rejection. (Natural light)

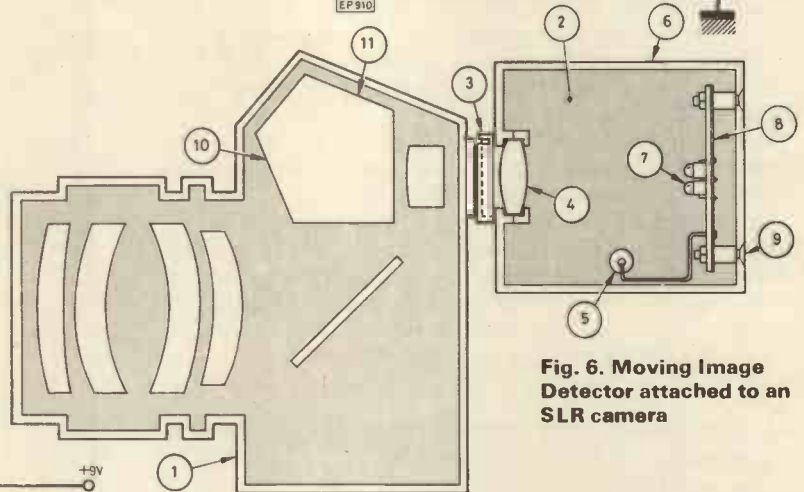
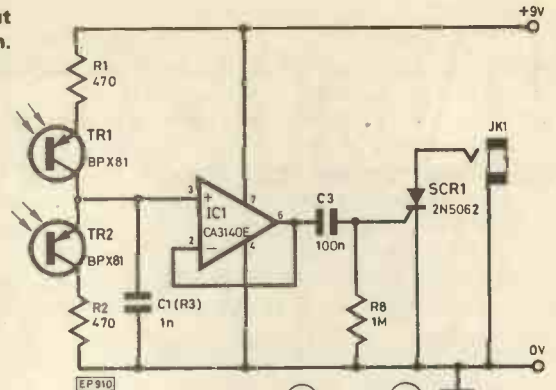

Fig. 6. Moving Image Detector attached to an SLR camera

Diodes, for protecting the thyristor from excessive back e.m.f., are not required in the preceding circuits if they are used for operating automatic cameras directly, as these include such a diode internally.

### CONSTRUCTION

It is recommended that the two photo-transistors are soldered to the board first. Avoid overheating the leads. The encapsulation should be polished with a soft cloth. A small piece of black card may be placed between the photo-transistors to cut down reflections, but this is not absolutely vital.

The completed circuit board is housed in a small box. This is made of aluminium to provide screening and must be lightproof. Fig. 6 shows a M.I.D. unit (2) attached to an SLR camera (1).

The lens (4) need not be an expensive one. Any single element lens with a focal length of between one and three inches can be used.

For maximum picture brightness however, the lens should be a short focus type, and its diameter should be equal to the diagonal length of the camera viewfinder.

The prototype used a two inch lens, taken from an inexpensive 35mm slide viewer. The lens should be focussed at infinity if it is intended to look through the viewfinder. The detachable eyeshade of the author's camera was used for the bracket (3). This unscrews into two parts, so is easily fixed to the M.I.D. unit.

The output from the unit is connected to a coaxial socket (5), which is coupled to the electrical release socket of the camera by a short length of coaxial cable bearing corresponding plugs.

The metal housing (6), is connected to the negative rail of the printed circuit board (8) by way of the fixing pillar and screw (9).

## TESTING

The completed circuit may be tested by connecting a 6V bulb and battery, wired in series, between the output and 0V terminals of the board, the negative terminal of the battery going to 0V. The 9V separate supply needs to be connected also. Passing a shadow or light source across the photo-transistors should light the bulb.

Now all that remains is to install the board inside its box and test it on your camera.

Initially, the unit does not have to look through the viewfinder. Just plug it in and walk in front of the lens. Don't stand too close, as the M.I.D. tends to ignore subjects that are out of focus!

Switching the M.I.D. on or off while connected to the camera may fire the shutter. So to avoid wasting film, always switch on before plugging in and unplug before switching off. Moving the camera will also fire the shutter.

Where  $>50\text{Hz}$  rejection is not required, then the buffer circuit of Fig. 5 is recommended.

Here, the 3140 is used to match the high output resistance (at low light levels), of the photo-transistors to the relatively low input resistance of the thyristor.

The circuit of Fig. 4 can be readily converted to the buffer circuit, using the same p.c.b. Referring to the component overlay, Fig. 8, the necessary changes are: Remove R4, R6, R7, C2 and C4. Replace R5 and C1 with links. Replace R3 with a 1n capacitor. ★

## COMPONENTS...

(for the circuit of Fig. 3)

### Resistors

R1, R2	470 (2 off)
R3	4k7
R4	1k
R5	1M

### Potentiometers

VR1	470k linear
VR2	10k linear

### Capacitors

C1, C2	1n (2 off)
C3	100n
C4	10n

### Semiconductors

D1	I.e.d. red
SCR1	2N5062
TR1, TR2	BPX 81 (2 off)
IC1	CA3140E

### Miscellaneous

P.C.B. or strip board  
JK1 jack socket (sub min)  
PP3 battery and stud

## COMPONENTS...

(for the circuit of Fig. 4)

### Resistors

R1, R2	470 (2 off)
R3	10M
R4	1k
R5	2M2
R6	4k7
R7	5k6
R8	1M

### Capacitors

C1, C4	10n (2 off)
C2	1n elect.
C3	100n

### Semiconductors

SCR1	2N5062
TR1, TR2	BPX81 (2 off)
IC1	CA 3140E

### Miscellaneous

P.C.B. or stripboard  
JK1 sub. min. jack socket  
PP3 battery and stud

### CONSTRUCTORS' NOTE

The BPX81 photo-transistors are available from:  
Synchro Services,  
High Street, Harrold, Bedford.  
☎ 0234-720575.

The 2N5062 thyristor is available from:  
**Macro Marketing Ltd.**,  
396 Bath Road, Slough, Bucks.  
☎ 06286-4422

## COMPONENTS...

(for the circuit of Fig. 5)

### Resistors

R1, R2	470 (2 off)
R8	1M

### Capacitors

C1	1n
C3	100n

### Semiconductors

SCR1	2N5062
TR1, TR2	BPX81 (2 off)
IC1	CA3140E

### Miscellaneous

P.c.b. or stripboard

JK1 sub. min. jack socket  
PP3 battery and stud

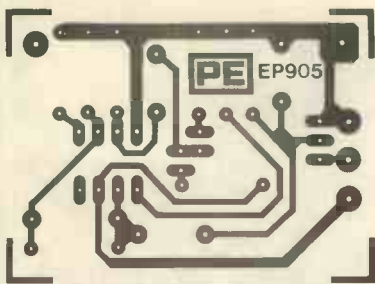
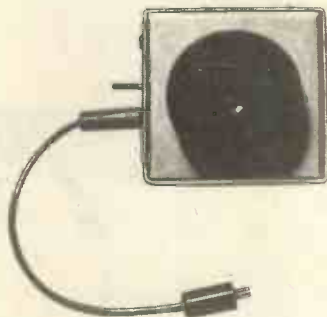
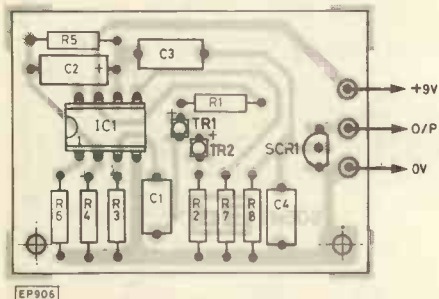
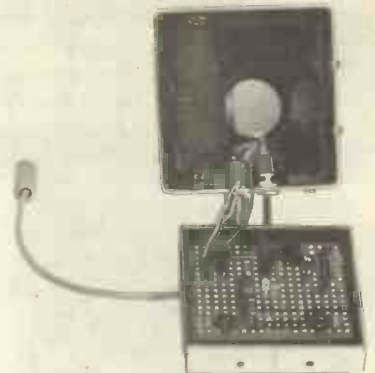
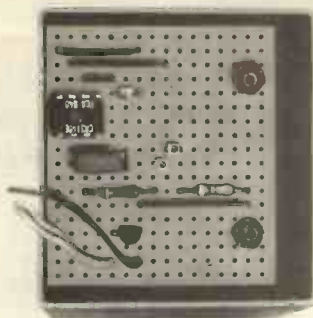

Fig. 7. Printed circuit board (actual size)



**UNIQUE FOR WILDLIFE PHOTOGRAPHY, SECURITY, AND PERHAPS EVEN SNAPPING PASSING OBJECTS . . . AUTOMATICALLY!**

Fig. 8. Component layout

**PE SPECIAL CASSETTES OFFER!**

**C90LH CASSETTES**

**56p each** (minimum of 5); **53p each** (minimum of 25). Prices include VAT and postage

Made by a leading European manufacturer for Videotone, these tapes are of excellent quality and we are pleased to announce this new PE service.

Over the last couple of years PE offers arranged with Videotone have proved highly successful and we have now been able to arrange special prices (only available to PE readers) on these high quality tapes. The offer is a result of Videotone's direct selling policy; send in a current special PE coupon for prompt delivery of tapes.

We believe these tapes are the best value around and we are pleased to offer them to readers. They are covered by a money back guarantee (return within 21 days for refund). Not only are the tapes of high quality but the cassettes are of screw together construction and the case label has space for notes on the recordings.

Send valid coupon to: **Videotone Ltd., 98 Crofton Park Road, Crofton Park, London SE4.**

**BLOCK CAPITALS PLEASE**

Please send me .... tapes (minimum of 5) at .... p each. (56p for 5 to 24, 53p for 25 or more; including VAT & postage.)

I enclose cheque/PO for £ .....

Name .....

Address .....

.....

.....

Coupon valid for posting before 13th August '82 (or one month later for overseas readers).

# Tandy **NEW** CB

## Versatile 4-Watt 40 Channel "Emergency CB" Unit

*As Essential To The Motorist as His Spare Tyre*

# £79.95

- Telescopic Magnetic Base Antenna
- LED "On-The-Air" Indicator
- LED Channel Indicator
- 12v DC Power Cord

**Realistic TRC-1004.** Its major advantage over "fixed" mobile CB units is its versatility - it can be switched from vehicle to vehicle (making it ideal for the two car family) in seconds. It's ultra simple to set up and use - just connect the supplied antenna, plug-into your car's cigarette lighter socket and you have instant communication! Now you're prepared for emergencies and can call for or give assistance to others, you may want to warn friends of unexpected hazards and delays or tell them that you are safe and well, but will be late, or hear of traffic conditions in advance.

When not in use it can be stored under-seat, in the glove compartment or in the boot until needed again! Features PLL synthesizer circuitry and three ceramic filters for superior selectivity and freedom from adjacent channel interference.

21-9113 ..... £79.95



- **Swaps From Vehicle To Vehicle - Ideal For The Two Car Family**
- **Store It Under The Seat, In The Boot - Or Even In The Glove Compartment**

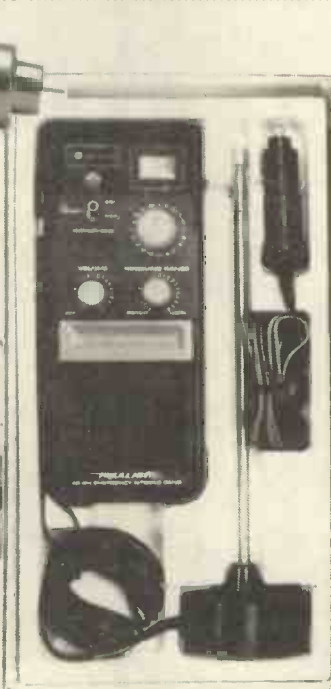

- Complete With Protective Case

**OVER 290 STORES AND DEALERSHIPS NATIONWIDE**  
Check your phone book for the **Tandy** Store or Dealer nearest you



**Known as Radio Shack in the USA**  
Prices may vary at individual stores.  
Offers subject to availability.



# SEMICONDUCTOR UPDATE

R.W.Coles

FEATURING CY360 TL068 SAB8256A

## MICRO SYNTHESISER

Some time ago I reported on a device coded CY500 produced by a newcomer to the Semiconductor scene called Cybernetic Micro Systems of Los Altos, California. The CY500 is being sold as a CMS product, and it performs the task of an intelligent stepper motor controller which can be instructed by either a microprocessor or by a simple ASCII keyboard. The most interesting thing about the CY500 is that it is *not* a special chip design and it is not even made by Cybernetic Micro Systems!

The secret behind this apparent sleight-of-hand is, as if you hadn't guessed, a single chip microprocessor from a source not acknowledged by CMS but probably a member of the Intel 8048 family. This device was an exciting development because it demonstrated that it is possible for a second party to produce a brand new functional building block based on its own software which is frozen into someone else's microprocessor chip at manufacturing stage, for sale to third parties. The CY500 was such a success that it was soon joined by a more powerful version coded the CY501!

But Cybernetic Micro Systems are not resting on their laurels by any means, and we can expect from them a number of other useful building blocks based on single chip micros before long.

First on the list is the CY360 which performs the useful function of waveform synthesis and function generation. Like the CY500 this device is controlled via a parallel ASCII interface from either a keyboard for simple systems, or a microprocessor for the bells-and-whistles applications. Also like the CY500, the CY360 has its own on-chip high level language interpreter for its set of generation and synthesis functions which come complete with Jumps and Loops so that a complete synthesis program or Macro can be coded with a very few steps and stored in the on-board RAM space.

At this point the similarities with the CY500 end, because, of course, the CY360 has a totally different purpose in life. Its instruction set is based on single alphabetic characters which may be mixed where necessary with numeric data describing waveform parameters such as amplitude, phase, frequency and delay. Readily available from the CY500 are sine, triangle, sawtooth and square waveforms with programmable frequency and number of cycles per burst. It is also possible to synthesise pseudo-random (i.e. noise) signals and to generate linear approximations of many arbitrary functions—for example exponential delay.

The CY360 is a digital processor of course so it does not output analogue voltages directly. Instead, it outputs

numeric data on two eight-bit ports which can be connected directly to Digital to Analogue converters to recover the analogue waveform. These ports can be used to provide two separate phase-different signals, or they can be used together for a single higher resolution signal if necessary.

Because of the digital synthesis used by the CY360, there are of course some disadvantages. If the generated waveform is examined closely enough it will be seen to be made up of a stair-step approximation to the desired function, a fact which may not be a problem in many applications and which can anyway be reduced by filtering. Also, because of the need for the processor to execute code between waveform steps, the device is limited to low frequency applications.

The CY360 draws 100 milliamps from a single 5 volt supply and is housed in a 40 pin plastic package.

## VOLTAGE FOLLOWER

A voltage follower can be made with a single transistor with an input to the base and an output from the emitter. Its job is to provide impedance transformation so that the input voltage from a high impedance source can drive a low impedance load: a current amplifier if you prefer. In these days of integrated circuits people have tended to forget the simple approach and use instead an Operational Amplifier with unity gain feedback (equals a piece of wire!). In some cases this is the proper thing to do because the OP AMP solution does not suffer from the base-emitter offset voltage of the transistor which makes all output voltages from the emitter 700 millivolts or so less than the input voltage. In other applications, particularly small signal amplification, the transistor may be better as it contributes much less noise than the multi-transistor OP AMP.

In future it seems there will be a third choice in the shape of the TL068 from Texas Instruments. This device is a sort of OP AMP-in-transistor-clothing, because although it lives in an innocuous looking 3-pin plastic transistor package, internally it contains an f.e.t. input amplifier with a ready made feedback connection to provide the voltage follower configuration. This device provides a number of improvements over the transistor scheme because it has an extremely high input impedance, an input bias current of less than 400 picoamps, and an offset voltage of less than 15 millivolts. In addition it has a 1MHz bandwidth, can draw as little as 125 microamps from its supply, and will operate with input signals of 3 to 36 volts.

The three pins of the TL068 are labelled INPUT, OUTPUT and VEE (ground), with the connection of this device into a practical circuit being as easy as you might

expect from such a simple package. The lack of a positive supply pin is overcome by obtaining bias from the driven load via a bias resistor.

The TL068 will be most useful as a buffer amplifier for remote transducers which have to drive long lines, but its extremely high impedance also makes it suitable as a charge amplifier for capacitive devices such as electret microphones.

The main advantages it has over the use of standard OP AMPs are its simplicity and low cost.

## MUART

Most microprocessor systems need extra peripheral circuits to provide the essential system facilities which cannot easily be placed on the processor device because of the extra cost incurred or because of a lack of package pins. The usual "extras" required are a UART (Universal Asynchronous Receiver Transmitter) to provide serial communication to a system console or a modem, a parallel port to drive a line printer or accept data input from panel switches, a few timer/counters to provide pulse generation and the ability to measure the time taken by external events, and an interrupt controller to ensure that all those other devices get a fast response from the processor when they need attention.

Until now you needed to buy as many as four additional and expensive chips to provide these functions, and these chips may have had many fancy features which the average system did not need, not to mention the extra system complexity caused by all the necessary interconnections. Now Siemens have decided to come to the rescue of the small systems builder by combining all the required features onto one relatively inexpensive chip. The new device is coded SAB8256A and is called a MUART by its designers, although how that M manages to convey the provision of a parallel interface, five timer/counters and an interrupt controller in addition to the UART I really don't know! I personally think that the MUART is the best development to appear in microprocessor peripherals for a long time, and it seems that I am not alone, because no less a manufacturer than Intel has decided to act as an alternative source for the chip.

The SAB8256A is basically 8080 system orientated and is therefore easy to hook up to 8085 and Z80 systems, but this device is so attractive that it will almost certainly be in demand for 6800 or 6502 based systems too. Interface to these processors can be easily achieved with the addition of a few external gates.

The MUART comes in a 40-pin plastic package and will operate from a single 5 volt supply.

# AUDIO TEST SET

## PART TWO

MICHAEL TOOLEY B.A. & DAVID WHITFIELD M.A. M.Sc.

THIS final part sets out initial tests, calibration and examples from the wide range of measurements possible.

### INITIAL TESTS

Before connecting to the supply the front and rear panel controls (shown in Figs. 8 and 9, respectively) should be set as follows:—

Front Panel	Function	'Voltage out'
	Voltage Range	'1V'
	Voltage Calibration	'Pk-Pk'
	Frequency Range	'1kHz-10kHz'
	Frequency Fine	Fully clockwise—'Min'
	Output Level Range	'2V'
Rear Panel	Output Level Fine	Fully anticlockwise—'Off'
	Monitor	'Out'
	Waveform	'Sine'
	Monitor Volume	'Min.'
	Supply	'a.c.'

The pre-set resistors on the p.c.b. should all be set to mid-position. An 8 ohm loudspeaker should be connected to the headphone/loudspeaker socket. The a.c. supply should then be connected and the instrument should be switched 'on' using the output level control which should be advanced to about 30% of its full travel.

A d.c. voltmeter should be used to check the voltage at the positive connection of C38. This should be in the range 16V to 18V. If there is no voltage at this point check the a.c. supply connections, mains transformer and fuse. Now transfer the d.c. voltmeter to measure the voltage at the link (LKA). This should be in the range 11.5V to 12.5V. If this is not the case check IC2. Transfer the d.c. voltmeter to the emitter of TR8 and adjust VR7 to obtain a reading of approximately 6.5V at this point. If this cannot be obtained check the wiring and connections to the p.c.b. in the vicinity of TR6, TR7 and TR8. Advance the monitor volume control to about 30% of its full range and adjust VR6 until a relatively pure tone (at about 1kHz) is heard from the loudspeaker. If necessary adjust the monitor volume to obtain a comfortable listening level from the loudspeaker once oscillation has commenced. Observe the indication on the meter and note the effect of (a) changing the calibration to 'r.m.s.' and (b) switching from the '1V' to the '3V' range. Both should cause the deflection on the meter to fall to about one-third of its previous reading. If necessary adjust VR4 to provide a sensible indication on the meter before carrying out this test. Now switch to 'square' wave and change the function to 'Frequency Out'. The meter reading should increase as the frequency-fine control is turned anti-clockwise. (The tone

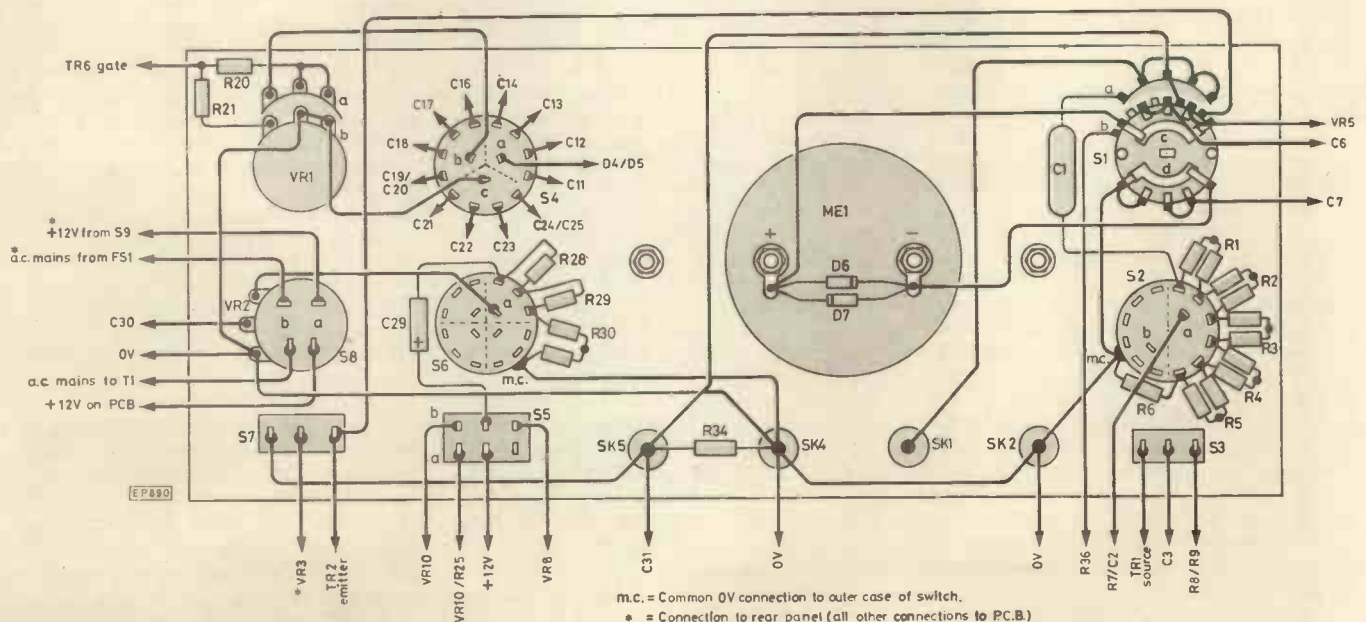

Fig. 8. Showing wiring of front panel

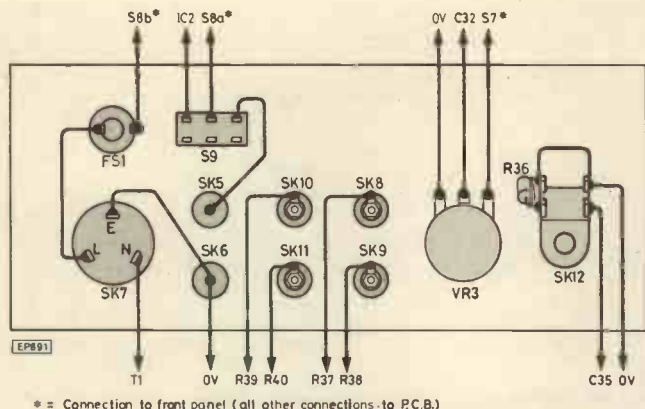

Fig. 9. Showing wiring of rear panel

from the loudspeaker should also increase in frequency.)

The foregoing tests establish that, in the order given, the power supply, signal generator, monitor amplifier, a.c. voltmeter, and frequency meter sections are functional. If, at any stage, the required indications are not produced, reference should be made to the d.c. voltage table. The presence of unusually high or low voltages will rapidly pinpoint the area of a fault. Note that a difference of about 10% can be expected without indicating that a fault is definitely present. When a fault has been identified the p.c.b. and associated wiring should be checked in the appropriate area. Full calibration cannot be carried out without the aid of additional test equipment. This should consist of a digital frequency meter and an oscilloscope. An accurate r.m.s. reading a.c. voltmeter may also prove to be useful.

### CALIBRATION

Connect an oscilloscope and digital frequency meter in parallel to the signal output socket. Adjust the signal generator to produce a sine wave output at 1kHz (use the 1kHz to 10kHz frequency range). Adjust VR6 for a pure sine wave output as viewed on the oscilloscope. This may be close to the position at which oscillation just ceases and it may be necessary to confirm that oscillation continues over the full frequency range of the instrument. With the output attenuator controls set at maximum, adjust VR8 and VR10 respectively for 2V pk-pk sine and square wave outputs as observed on the oscilloscope. Now set the frequency of the signal generator output accurately to 5kHz (again using the 1kHz to 10kHz frequency range). Set the function switch to

'Frequency Out' and adjust VR5 for a reading of exactly '5' (on the '0-10' meter scale). Vary the frequency over the full range and check that the meter indication agrees with the digital frequency meter reading. Repeat this check over the full range of the instrument and check that the accuracy is within 5% of full-scale on each range. Re-set the output frequency to 1kHz and check that the output is still 2V pk-pk. Set the function switch to 'Voltage Out' and select the '3V' range with 'pk-pk' calibration. Adjust VR4 for a meter indication of '2' (on the '0-3' meter scale). Finally switch to 'square' wave output and adjust VR9 for a perfectly symmetrical square wave as displayed on the oscilloscope. This completes the calibration of the instrument and it is now ready for use.

### USING IT

The Audio Tester is an instrument which allows the user to make a wide range of measurements on items of audio equipment and on whole systems. The capabilities of the constituent modules within the tester (signal generator, frequency meter, voltmeter, monitor amplifier, and load) do not, however, restrict their use solely to conventional audio applications. Individual modules, or combinations, may be used in a wide range of general applications which involve repetitive waveforms at frequencies up to 100kHz.

An example of this alternative use is in generating test signals for digital circuits. This requires the use of the signal generator and the monitor amplifier, with the frequency meter used to set the output frequency. The signal generator is capable of producing a signal of maximum amplitude of 2V pk-pk. The monitor amplifier can be used to boost the level to a maximum of approximately 9.5V pk-pk; the output is then taken from SK12 rather than SK3/4. Similarly, the frequency meter may be used directly to measure the frequency of digital signals.

When used in fault finding in audio systems, the Audio Tester modules can be used to replace system components when trying to identify the faulty unit. The signal generator is used to substitute for programme sources, the amplifier may be replaced by the monitor amplifier, and the dummy loads may be used in place of the loudspeakers. Continuity of leads can be checked using the signal generator as a signal source, and the voltmeter.

The mainstream purpose of the Audio Tester, however, remains the testing of audio circuits. The following section gives some examples of typical audio measurements which may be made using the Audio Tester.

The output of an audio amplifier is normally quoted in terms of the maximum power which it is capable of delivering continuously into a stated load at a particular frequency before the onset of any significant distortion. The actual values given will vary from model to model, and the method of quoting the performance usually varies among manufacturers. Typically, however, the output power is quoted in terms of the number of watts r.m.s. which can be delivered into an 8 ohm load at 1kHz at the onset of waveform clipping.

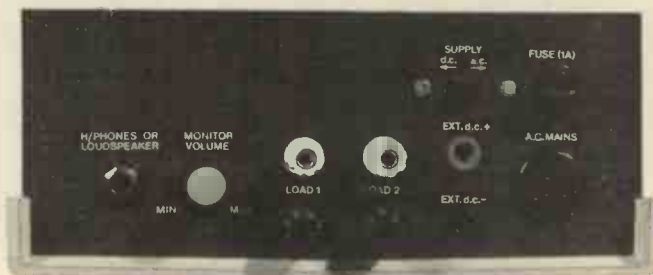
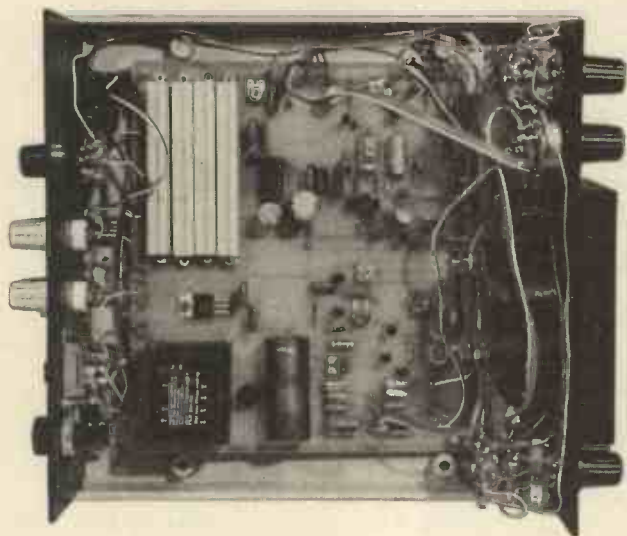

The loudspeaker, which forms the normal load in a hi-fi system, has an impedance which shows an often significant variation across the audio range (see Fig. 10). In addition, the impedance which is presented to the amplifier is rarely a purely resistive quantity, and this only serves to further complicate the measurement of output power when attempting to use a loudspeaker as a test load. The dummy loads in the audio tester, however, provide test loads which have substantially constant resistive impedances across the audio range. The impedances available (4 ohms, 8 ohms and 16 ohms) are suitable for the vast majority of contemporary audio equipment, and the various load connection arrangements are shown in detail in Fig. 12.

Where it is intended to carry out sustained high power testing, care should be taken to avoid the possibility of overheating of either the dummy loads (rated at a minimum of 30 watts r.m.s.) or the output stages of the amplifier under test. It may be advantageous, therefore, to increase the ventilation in the audio tester if sustained testing is envisaged since the load resistors will reach a temperature of 70°C at maximum dissipation. Driving both 8 ohm loads at full power simultaneously will require the dissipation of 60 watts of heat! It should also be borne in mind that the efficiency of the amplifier under test may fall significantly at frequencies above the audio spectrum (i.e. above approximately 20kHz), and this can lead to the possibility of unexpected amplifier over-heating. For this reason, a check that correctly rated line and output fuses have been fitted is a very worthwhile precaution before any prolonged high power testing; prevention is always cheaper than cure.

Fig. 13 shows an arrangement which can be used to measure the output power characteristics of an audio amplifier. The Audio Tester's dummy loads are used here in place of the loudspeaker, the signal generator provides the input signal, and the oscilloscope (or distortion meter, etc.) is used to detect the onset of waveform clipping. Fig. 14 shows the type of oscilloscope trace which is obtained when waveform clipping occurs; users who wish to observe these waveforms before testing an amplifier may do so by connecting the generator output, set to maximum sine wave output, to the monitor amplifier, and turning up the volume control while observing the output. In the test set-up the signal generator output should be connected to an 'auxiliary' or 'radio' amplifier input since these inputs should have a nominally flat frequency response. The generator output level should be set in accordance with the amplifier specifications (to typically 250mV or 500mV r.m.s.), and the frequency to 1kHz in sine wave mode. Starting at low amplifier volume control settings, the output power may be found by measuring the r.m.s. voltage across the load and then converting to power with the following equation:

$$\text{Power in watts r.m.s.} = \frac{(\text{r.m.s. voltage across the load})^2}{\text{Load impedance in ohms}}$$

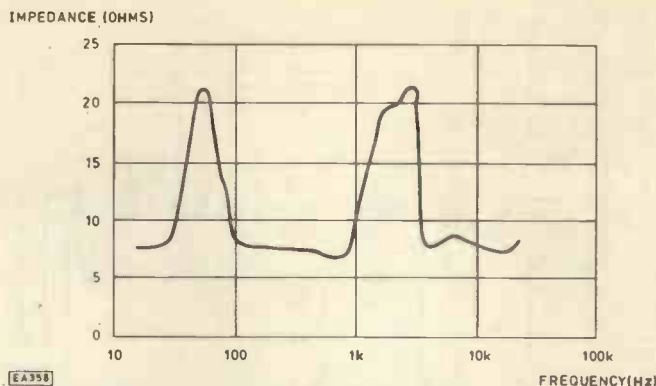

Fig. 10. Variation of impedance with frequency for a typical two speaker system

Alternatively, the conversion from voltage to power may be performed using either the graphs in Fig. 15 or the figures given in Table 3. These give conversions for the three different load impedances catered for by the audio tester. Conversions for other loads may be prepared using the equation given above.

An interesting measurement which is easily made is to determine how the output power varies according to the setting of the volume control on the amplifier. The result, which is usefully plotted on a graph, can also be compared for different load impedances. It is a good idea to adjust the level from the signal generator so that, at maximum volume setting, the amplifier's rated power is achieved or clipping commences, whichever is sooner. The results can then be

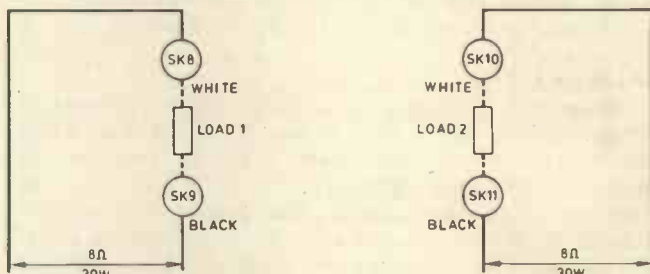

Fig. 12(a). Stereo load arrangement rated at 8 ohm/30W per channel

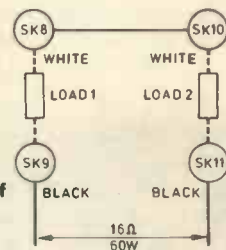

Fig. 11. (Lower left) Layout of the front panel controls

Fig. 12(b). Mono load rated at 16 ohm/60W

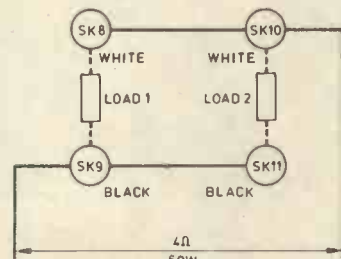
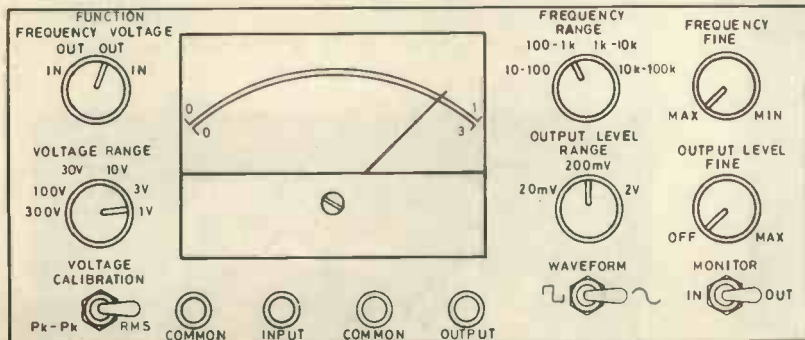
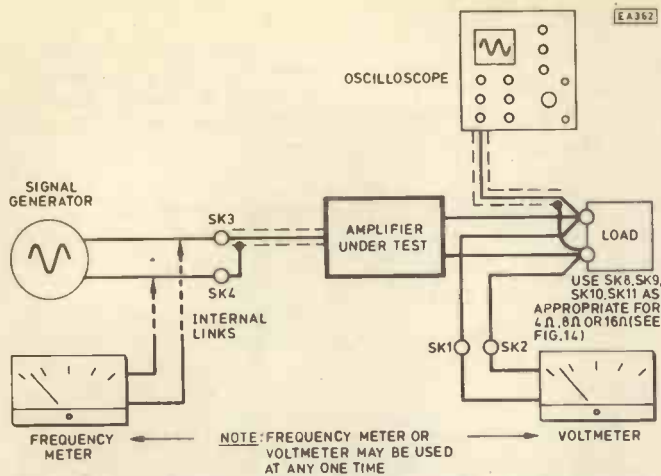

Fig. 12(c). Mono load rated at 4 ohm/60W



EG905

EA359



**Fig. 13. Arrangement for measuring amplifier output power characteristics**

presented in terms of the percentage of maximum power which is attained at various control settings. The amplifier under these conditions is much less likely to overheat at maximum level, but load impedances lower than the minimum specified for the amplifier should not be used.

The measurement of the input sensitivity of an amplifier involves finding the lowest signal level at which it is still possible to achieve the maximum rated power into the stated load. This is a relatively simple test to perform and uses the same arrangement as before. The signal generator output is initially set to minimum and the amplifier's volume control to maximum. The signal generator's output level is then slowly increased until the rated power is developed across the load, as determined by measuring the equivalent r.m.s. voltage. The signal generator output at this point is then equal to the amplifier input sensitivity. Measurements on more sensitive inputs may be simplified by the use of an additional attenuator, but care should be taken to avoid hum pick-up in the wiring.

### FREQUENCY RESPONSE

An 'ideal' audio amplifier has a gain which is constant for all frequencies across the audio range. The DIN 45-500 standard specifies a range of 40Hz to 16kHz over which the gain should not vary by more than  $\pm 1.5$ dB, although this standard is usually considered by hi-fi enthusiasts to be a

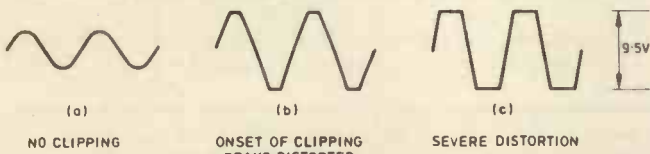

**Fig. 14(a). Output waveforms from the signal generator plus monitor amplifier as the gain is increased**

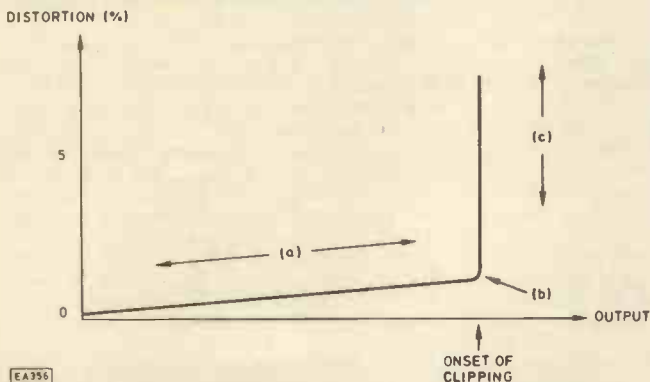

**Fig. 14(b). Response of amplifier as the output level is raised through the onset of waveform clipping**

**Table 3 Voltage developed across a load and power**

Voltage across load (Volts r.m.s.)	Power (watts r.m.s.)		
	4Ω load	8Ω load	16Ω load
1	0.250	0.125	0.063
2	1.00	0.500	0.250
3	2.25	1.13	0.563
4	4.00	2.00	1.00
5	6.25	3.13	1.56
6	9.00	4.50	2.25
7	12.3	6.13	3.06
8	16.0	8.00	4.00
9	20.3	10.1	5.06
10	25.0	12.5	6.25
11	30.3	15.1	7.56
12	36.0	18.0	9.00
13	42.3	21.1	10.6
14	49.0	24.5	12.3
15	56.3	28.1	14.1
16	* 64.0	*32.0	16.0
17	* 72.3	*36.1	18.1
18	* 81.0	*40.5	20.3
19	* 90.3	*45.1	22.6
20	*100	*50.0	25.0

\*Testing at this power level will require the use of alternative loads.

bare minimum requirement. The frequency response characteristic of a real amplifier shows how its gain actually varies across the audio spectrum. A typical response characteristic is shown in Fig. 16.

Measurement of the frequency response characteristic is usually carried out at full output power. The frequency range between the upper and lower  $-3$ dB points (where the output power falls to 50% or the voltage across the load falls to 70.7% of the maximum) is known as the full power bandwidth of the amplifier. An equally useful measurement, and probably more appropriate to normal listening, is to measure the amplifier bandwidth at a level which is more representative of average listening levels. The high power level which is available from most systems is provided to allow programme peaks to be handled without distortion. The average level of even 'loud' music can be surprisingly low, and speech typically has a 'peak factor' (ratio of the peak to the r.m.s. value) over a period of time of 20dB. For these reasons, therefore, it is often of interest to measure both the full power bandwidth and the low power (typically 1 watt r.m.s.) bandwidth in order to fully characterise an amplifier; anyone in any doubt about power levels is invited to

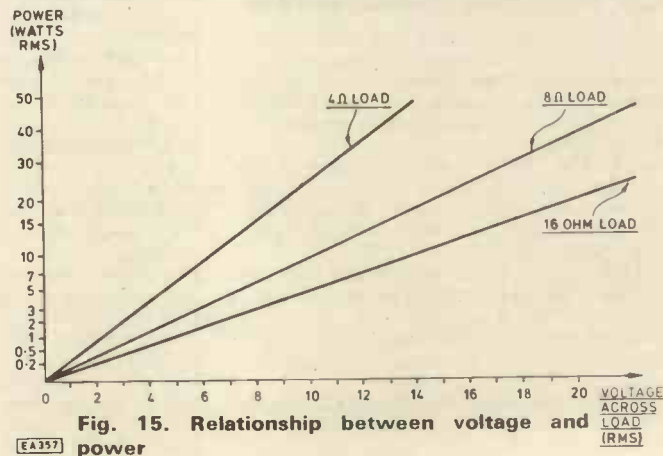

**Fig. 15. Relationship between voltage and power**

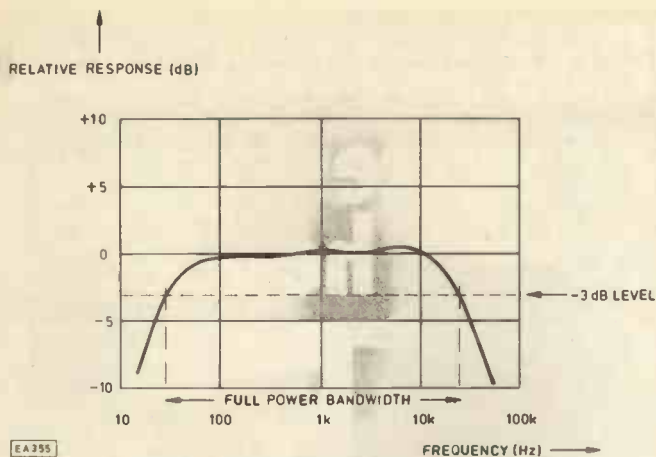

Fig. 16. Frequency response at full power

listen to 1 watt of 1kHz sine wave output from a loudspeaker system, and then imagine 40+40 watts!

The frequency response characteristic of an amplifier may be measured using the arrangement previously described in Fig. 13. The signal generator is set to a frequency of 1kHz and the tone controls on the amplifier, and any filters, are set to the 'flat' positions. The input level is set in accordance with the amplifier's specifications, and the volume control is then adjusted to produce the required power dissipation in the selected test load. The generator frequency is then varied, keeping the other generator and amplifier controls constant, over the audio range and beyond. The output level will typically show some variation across the audio range,

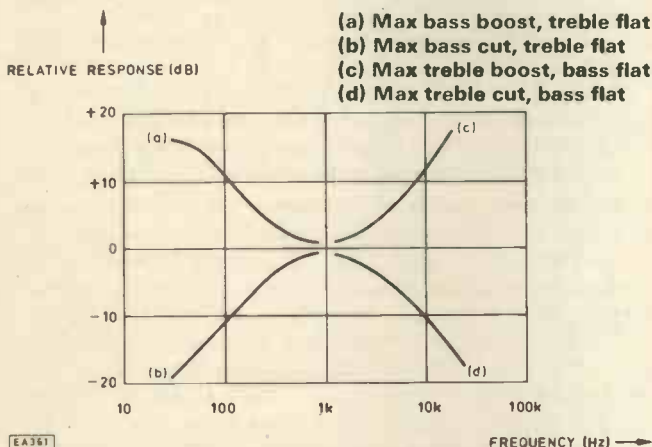

Fig. 17. Tone control characteristics

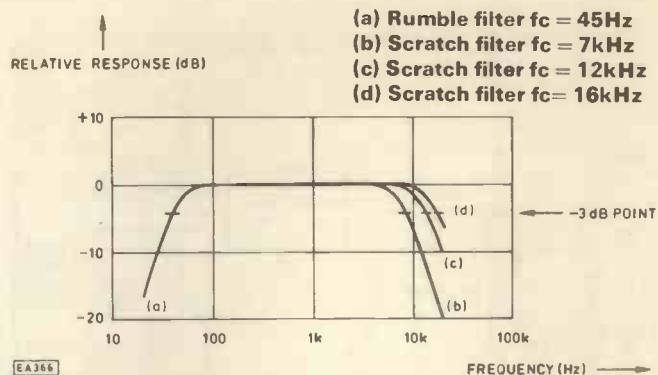

Fig. 18. Response characteristics for an amplifier with a rumble and three scratch filters

with noticeable roll-off at very high and very low frequencies and a substantially flat response between the two extremes.

Once the basic frequency response characteristic has been measured, the effects of the amplifier's tone controls can be investigated. Setting each of the tone controls to the extremes in turn, and then re-measuring the frequency response, will show the total range of bass and treble boost and cut which is available. Fig. 17 shows the type of response which can be expected in any amplifier, but the exact rates of boost and cut, and the associated frequencies will vary. The measurements on tone controls are best made at a level of around 1-2 watts in order to allow for the wide range of boost and cut provided on most amplifiers. Similar measurements may then be made on any fixed frequency filters which may be provided on the amplifier. Typical responses for an amplifier fitted with a 'rumble' filter at 45Hz and three 'scratch' filters at 7kHz, 12kHz, and 16kHz are shown in Fig. 18.

It is quickly apparent from a brief look through the specifications for any item of hi-fi equipment that the range of possible tests is almost inexhaustible. The measurements described above are a few examples of the range of amplifier tests which are possible with the Audio Tester. These tests provide useful and meaningful results without the need for an abundance of additional and sophisticated equipment. As such, they serve to demonstrate the usefulness of the Audio Tester as an item of general purpose test equipment. The constructor will doubtless be able to find a wide range of situations where the Audio Tester alone will suffice in place of what would normally require a number of separate instruments.

## BAZAAR

**GRUNDIG** GMU3 four-channel audio mixer unit, valve, plus 4 dynamic mikes. £25 inc. postage. Oxford (0865) 779855.

**TPA30 EAGLE** P.A. Amp, £20. Heatkit OSC2 Scope with book, £10. Post extra or collect. Tel: 01-591 4248.

**SINCLAIR ZX81** with 16K RAM, plus keyboard, graphics board, books and some software tapes, £110. M. Broom, 19 Nally Drive, Woodcross, Coseley, West Midlands. Tel: Segeley (83) 61323.

**UK101** 32 x 48 screen, cased, 24K RAM with room for 16K more, Cegmon, Wemon monitors, software, £170. Tel: Sedgley 74804.

**AMPLIFIER** or kit suitable deaf aid. Firm with address wanted. G. H. Reeson, 23 Lealands, Lesbury, Alnwick, Northumberland.

**DIGITAL** multi-meters. Philips PM 2522 mains, PM 2517E battery. Good condition. Offers. Tel: 074 785 397.

**R.S.C.** 5 watt practice amp for guitar as new, £20. A. Hallas, Tottlebank, Manor Way, Wrea Green, Preston, Lancs.

**WANTED.** Goldring Lenco GL69 record deck. Mr. A. Henderson. Tel: Great Harwood 0254 884658.

**LOW COST** printer. Data Dynamics 80 column, 10 CPS, current loop interface. Genuine sale, £90 ono. Chris Swift, Crowthorne 03446 77426.

**TRANSCENDENT 2000**, £200 ono; also ZX80, £35 ono. L. Faragher, 17 Lyndene Close, Earl Shilton, Leics. Tel: 0455 46354.

**2708 EPROM's**, little used, erased, £1.50 each. Tel: Ilkeston (Derbyshire) 304339 (evenings and weekends).

**ZX81 16K RAM** with full size keyboard plus software under guarantee. V.g.c. a bargain at £90. Dave Elliott, 13 Chilton Road, Wendover, Bucks HP22 6DR. Tel: Wendover (0296) 622527.

**ORANGE 120W** graphic valve bass amp plus 200W 'White' bass Bin with electrovoice speakers, £280 ono. Mr. J. Henderson. Tel: Gt. Harwood 0254 885129.

**ELKA 20 Organ**, 15 months old, £800. New price £1250. Tel: 0473 218392.

**PRINTER** IBM Selectric 'Golfball' Wait/Output Typewriter, Tractor/Friction Feed, with manual and interfacing details—£90. Philip J. Tait. Tel: Hampreston (Dorset) 7463.

**R.A.E.** Correspondence Course, complete £25 o.n.o. McCallum, 'The Limes', South Willingham Road, Hainton, Lincoln LN3 6LU.

**KSR 35** Heavy-duty teletype (uncased) plus 110V transformer and driver circuit. 110 Baud. Works very well. £100. Brian Candler, 32A Grosvenor Avenue, Sawley, Long Eaton, Nottingham NG10 3FO.

**8K MICROSOFT** Basic Reference Manual £4.50. Nick Hardy, Tel: Leeds 781532.

**WANTED** urgently RS Components panel meter: 100uA-1-25K, dual scale; 0-10 & 0-3. RS part No. MR31S. P. Faccenda, 5/5 Murrayburn Gardens, Edinburgh EH14 2PZ, Scotland.

**2 MTR TRX** 80 watts output complete 160m 2 mtr TRX 10 watts complete GEC 2 mtr TRX Chassis QOV6/40 offers. L. S. Ellsmore G3RHT, 9 Barston Road, Oldbury, Warley, West Midlands.

# ACTIVE COMPONENTS

MAIL ORDER SPECIALISTS

Lowest Prices — Fastest Delivery

Device	Price	Device	Price	Device	Price	Device	Price	Device	Price
<b>MEMORIES</b>		<b>REGULATORS</b>		4049	0.26	74LS243	0.79	18" Cable Double	
2114 Low Power		7805	0.39	4050	0.26	74LS244	0.60	Ended	
200ns	0.80	7812	0.39	4051	0.59	74LS245	0.88	14 pin	2.05
2708 450ns	2.79	7815	0.39	4052	0.68	74LS251	0.40	18" Cable Double	
2716 450ns		78L05	0.29	4060	0.79	74LS257	0.43	Ended	
(+5V)	2.29	78L12	0.29	4066	0.34	74LS259	0.78	16 pin	2.25
2716 350ns		78L15	0.29	4069	0.17	74LS266	0.22	18" Cable Double	
(+5V)	3.59	7905	0.55	4070	0.17	74LS273	0.70	Ended	
2716 (3 rail)		7912	0.55	4071	0.17	74LS279	0.39	24 pin	3.40
450ns	5.95	7915	0.55	4073	0.19	74LS283	0.44	18" Cable Double	
2732 450ns	3.90	LM309K	0.99	4075	0.17	74LS365	0.34	Ended	
2732 350ns	4.40	LM317K	3.20	4081	0.14	74LS366	0.36	40 pin	5.25
2532 450ns	3.90	LM323K	4.95	4093	0.39	74LS367	0.34		
4116 200ns	0.70			4508	1.90	74LS368	0.35		
4116 150ns	0.84	<b>Z80 FAMILY</b>		4511	0.89	74LS373	0.70		
4116 200ns	3.38	Z80 CPU	3.49	4512	0.60	74LS374	0.70	<b>ZERO-INSERTION</b>	
4164 200ns	4.65	Z80 CPU	3.99	4518	0.40	74LS377	0.70	<b>FORCE DI.</b>	
4516/4816		Z80 CTC	2.99	4520	0.69	74LS390	0.54	24 pin	6.30
100ns	3.25	Z80 CTC	3.10	4526	0.70	74LS393	0.59	28 pin	7.40
5516 200ns	9.38	Z80 DART	5.70	4528	0.70			40 pin	8.80
6116 200ns	5.10	Z80 DMA	11.95	4541	0.99				
6116 LP 200/150ns	7.61	Z80 PIO	2.85	4543	0.99				
		Z80 PIO	3.15						
<b>BUFFERS</b>		Z80A SIO-0	11.99	<b>74LS SERIES</b>		<b>DIL SOCKETS</b>		<b>CRYSTALS</b>	
81LS96	0.90	Z80A SIO-1	11.99	74LS00	0.10	<b>LOW PROFILE</b>		1 MHz	2.90
81LS96	0.90	Z80A SIO-2	11.99	74LS01	0.11	8 pin	0.07	1.008 MHz	2.90
81LS97	0.90	MK3886	11.00	74LS02	0.12	14 pin	0.09	3.5864 MHz	2.95
81LS98	0.90	MK3886-4	14.47	74LS03	0.12	16 pin	0.09	4 MHz	1.65
8T26A	1.20			74LS04	0.12	18 pin	0.13	6 MHz	1.90
8T28A	1.20			74LS05	0.13	20 pin	0.14	8 MHz	1.95
8T95	1.35			74LS08	0.12	22 pin	0.17		
8T97A	1.35	<b>8000 FAMILY</b>		74LS09	0.12	24 pin	0.19		
8T98	1.45	8800	2.99	74LS10	0.12	28 pin	0.25		
		8802	3.99	74LS11	0.12	40 pin	0.29	<b>UHF</b>	
<b>DATA CONVERTERS</b>		8803C	12.10	74LS12	0.12			<b>MODULATORS</b>	
ZN425E-8	3.45	8809	9.99	74LS14	0.37			6 MHz	3.70
ZN427E-8	5.99	8810	1.12	74LS15	0.12			8 MHz	4.40
ZN428E-8	4.75	8821	1.25	74LS20	0.12				
ZN433CJ-10	2.59	8840	4.20	74LS21	0.12				
ZN432E-10	13.00	8845	9.50	74LS26	0.15				
		8850	1.50	74LS27	0.12				
		8880	1.07	74LS28	0.15	<b>LOW PROFILE -</b>			
<b>FLOPPY DISC CONTROLLERS</b>		8887	0.80	74LS30	0.12	<b>GOLD</b>		<b>BBC MICRO-COMPUTER UPGRADES</b>	
FD1771	17.21	8848	9.11	74LS32	0.12	8 pin	0.22	(Please phone for delivery date)	
WD1391 kit	45.50	8875	5.62	74LS37	0.15	14 pin	0.29	BBC 1 RAM	
WD1393 kit	45.50	8843	13.39	74LS38	0.15	16 pin	0.31	Kit	26.00
WD1395 kit	45.50	8800	6.30	74LS40	0.12	18 pin	0.33	BBC 2 Printer	
WD1397 kit	45.50	8802	19.11	74LS42	0.33	20 pin	0.35	User I/O Kit 9.50	
(kits include		8821	2.29	74LS47	0.39	22 pin	0.40	BBC 4 Analogue	
FD179X		88B10	2.00	74LS51	0.14	24 pin	0.42	I/P Kit	9.50
+ WD2143-01		88B20	4.70	74LS54	0.15	28 pin	0.54	BBC 5 Serial I/O and RGB	
+ WD1691).		88B50	2.86	74LS74	0.19	40 pin	0.81	Kit	11.45
				74LS75	0.24			BBC 6 Expansion	
<b>MISCELLANEOUS SUPPORT CHIPS</b>		<b>6500 FAMILY</b>		74LS76	0.20	<b>DIL JUMPERS</b>		BUS Kit	7.95
AY-3-1015	2.95	6502	3.45	74LS78	0.20	24" Cable Single		BBC 4/4	
AY-3-1270	7.99	6520	2.99	74LS83	0.44	Ended		Connectors	2.25
AY-3-8910	5.99	6522	4.75	74LS85	0.60	14 pin	1.40	BBC 5/5	
AY-3-1013	2.99	6532	6.65	74LS86	0.15	24" Cable Single		Connectors	0.80
AY-5-3600	7.95			74LS88	0.15	Ended		The above kits make up the full model 'A' to model 'B'	
AY-5-2376	5.99	<b>8080 FAMILY</b>		74LS109	0.21	18 pin	1.60	Upgrade for the BBC Microcomputer. Special price when bought complete.	62.00
DP8304	4.50	8080A	5.20	74LS122	0.39	16 pin	1.60		
MC1488	0.55	8212	1.70	74LS123	0.39	24 pin	3.10		
MC1489	0.55	8216	0.60	74LS125	0.24	6" Cable Double			
MC3446	2.95	8251	3.19	74LS126	0.25	6" Cable Double			
MC3448A	4.25	8255	3.90	74LS132	0.44	18 pin	2.05		
MC3480	7.95			74LS136	0.28	6" Cable Double			
MC3487	2.95			74LS138	0.33	Ended			
MC14411	6.94			74LS139	0.35	40 pin	3.25		
MC14412	7.99			74LS148	0.90	6" Cable Double			
RO-3-2513L	6.99	<b>CMOS 4000 B' SERIES</b>		74LS151	0.39	Ended			
RO-3-2513U	5.99	4000	0.11	74LS153	0.28	14 pin	1.90		
		4001	0.11	74LS155	0.38	6" Cable Double			
<b>DVM CHIPS</b>		4002	0.13	74LS156	0.36	6" Cable Double			
ZN450E	7.61	4007	0.15	74LS157	0.29	16 pin	2.05		
ZN450E DVM Kit	17.35	4011	0.12	74LS158	0.31	6" Cable Double			
		4012	0.15	74LS161	0.37	Ended			
		4013	0.29	74LS163	0.38	24 pin	3.10		
		4015	0.50	74LS164	0.45	6" Cable Double			
<b>LINEARS</b>		4016	0.25	74LS165	0.75	Ended			
LM301AN	0.25	4017	0.45	74LS166	0.84	40 pin	4.85		
LM308N	0.89	4020	0.58	74LS173	0.69	12" Cable Double			
LM311N	0.69	4022	0.17	74LS174	0.45	Ended			
LM319N	2.14	4023	0.35	74LS175	0.45	14 pin	2.00		
LM324N	0.30	4024	0.16	74LS191	0.49	12" Cable Double			
LM348N	0.59	4025	0.17	74LS192	0.49	Ended			
LM555CN	0.16	4026	0.16	74LS193	0.45	18 pin	2.15		
LM556CN	0.45	4027	0.30	74LS194	0.39	12" Cable Double			
LM725CN	3.20	4028	0.55	74LS196	0.39	Ended			
LM741CN	0.14	4040	0.54	74LS221	0.54	24 pin	3.25		
LM747CN	0.64	4042	0.54	74LS200	0.69	12" Cable Double			
LM748CN	0.34	4046	0.68	74LS241	0.69	Ended			
		4047	0.68	74LS242	0.78	40 pin	5.10		

# Has seven years of success gone to our heads?



NEW IMPROVED

## MINIMAX 2

With the Minimax II, Videotone revolutionised the market by establishing an opening for small, high quality speakers. Natural evolution has brought about the new Minimax 2, retaining all the qualities of clarity and sensitivity. This ideal combination of size and performance is a proven success, acclaimed by the press and public for seven years.

**POPULAR HI-FI**  
"Switching to the Minimaxes' from any of the others produced an open and natural sound as though something had been taken away. It had, the colouration had gone." **Comparative test OCTOBER 1975.**

**HI-FI ANSWERS**  
Their modest appearance and price disguise their startling abilities. Never have we heard such a small speaker sound so big!" **JANUARY 1975.**

**PRACTICAL HI-FI & Audio**  
"The depth, clarity and openness of sound produced is quite astonishing". **JUNE '75**

**WHAT HI-FI**  
"... the ability of the Mini-

max to take a lot of power and still sound good could be decisive" - **Comparative test, APRIL 1977.**

**PRACTICAL HI-FI**  
The little Videotone scored highly for such a small inexpensive loudspeaker". **JANUARY 1981.**

**Specification:**  
Recommended amplifier power: 10 to 40 watts rms into 8 ohms.  
Frequency Response: 80Hz - 20KHz ± 5dB.  
Finish: natural teak, veneer with black frets.  
Size: 10 7/8" high, 6 3/4" wide, 7 1/2" deep.  
Weight: 4.1 Kgs (9 lbs) each.

**ONLY £69.95 A PAIR**

- We welcome callers to our South London Showroom for demonstrations.
- Enquiries and information phone: 01-690 8511, Ex. 32.
- All products are only available direct or from selected authorised dealers throughout the U.K.

**VIDEOTONE** 98 CROFTON PARK ROAD LONDON SE4.

Send for our free brochure and details of outlets in the U.K.

Post to: Videotone, Crofton Park Road, London SE4. PEB

NAME \_\_\_\_\_

ADDRESS \_\_\_\_\_

53

# Strictly

# Instrumental

by K. Lenton-Smith

CASIO, makers of those ingenious and reliable calculators, started to add musical bleeps to their machines a few years ago. Thus you could programme in a short, simple melody to annoy office colleagues! Perhaps we should have guessed what was coming next...

The idea was extended to something more musical when the Casio VL-Tone was introduced and featured in 'Tomorrow's World' early last year.

## VL-TONE

Everything in this two-octave instrument derives from a 64-pin LSI chip which provides 5 pre-programmed voices. It is also possible to choose waveform, envelope parameters, vibrato and tremolo and programme these variables. Auto-rhythm, 100-note sequencing, stepping and a calculator are featured, the latter's display doubling for numerical readout of pitches entered from the keyboard.

The price of this keyboard, considering its many facilities, is very reasonable: the instrument is suitable for a young and enquiring mind getting used to music and its technicalities. Unfortunately, the keyboard is composed of press-buttons, its size is roughly one half of the standard and it only suits a small hand as a result.

My reaction at the time was that this instrument was an interesting toy (because of its keyboard) but that it might be the start of something big. It certainly seems that the VL-Tone was a test-bed and its popularity has been such that new and improved keyboards have followed.

It is fitted with a pitch control but, oddly enough, somewhat larger keyboards (M-10, CT-201 and MT-30) lack this important feature and keyboards were still non-standard. Even so, they were often extremely close to concert pitch as supplied.

I suppose that these problems are inevitable when a concern—even as experienced as Casio—breaks into a new field. More recent additions to the Casio keyboard range have seen improvements to the point that we now have really interesting and totally playable instruments.

## COMPUTER

These keyboards are occasionally described as polyphonic synthesizers. One immediately thinks of voltage-controlled circuitry but the heart of these instruments is a CPU so 'computer keyboard' may well be a better term. The attraction of the current keyboards, especially to those who

have engaged in synthesizer construction in the past, is polyphony: eight notes may be keyed simultaneously.

It is probably unnecessary to add that it would be impossible to build similar keyboards—and at the price—because of the use of special purpose LSI chips!

Using computer principles is not new: the computer organ has been with us for some years and the RMI Computer Keyboard was described in this column six years ago. What is new is the value for money aspect and the neat but rugged design of these compact keyboards.

Let us look briefly at just three of the current keyboards:—

## MODEL 202

This instrument and Model 403 are similar in price and the choice between them will depend on musical requirements.

The 202 has 49 preset sounds, their names being inscribed above the keys of the four-octave polyphonic manual. Four Tone-Memory keys allow recall and changes of registration, the capture system operating as follows: in 'Set' mode, a tone-memory switch is pressed, followed by pressing the key representing the chosen tone-colour; after returning the mode switch to 'Play', the playing keys operate normally and the musician can make changes between the four memories as he wishes.

Sustain, Volume and degrees of Vibrato may be altered by means of controls on the left hand cheek. Alternatively, Sustain and Volume may be foot-controlled from jack sockets on the rear panel, which also include 'line out' for external amplification and a phone jack. A fine tuning control completes the back panel line-up.

An internal 4" speaker delivers up to 10W and the instrument weighs about 16lb. The preset sounds are varied and include various pianos and pipe organs and their electronic varieties. The usual orchestral instruments are featured and there are several harps and guitars. Certainly, it could be said that some of these sound similar to others, but there is still plenty of variety. With four octaves of polyphonic sound, the 202 could be used equally well by a choirmaster or pop musician.

## OPERATION

Naturally, circuitry differs from model to model as do the LSI chips involved. Taking model 202 as being a typical and uncom-

plicated member of this keyboard family, a clock feeds one of the main LSI chips. This runs at a nominal 1.134MHz and is effectively voltage controlled by means of varicap diodes altered by the pitch control. The output is squared before being fed to the CPU, which generates key common signals. These are matrixed by conductive rubber contacts under the playing keys onto key input lines and the signals are decoded by flip-flops before being fed back into the two main chips.

Digital signals emerging from the LSIs are passed through D/A Converter blocks. The process of converting from digital to analogue can cause serious 'glitches' as the most significant bit changes: Casio engineers have gone to great lengths to remove these unmusical spikes and ensure that the analogue waveform is totally musical.

The two Converter Blocks in Model 202 are known as the consonant and vowel blocks and each has its associated set of high and low pass filters, with electronic switching operated by the LSI.

Consonants have their own electronic volume control circuit before the various signals are combined in a Mixer. Because operation of the tone memory switches causes a transient, a special 'cut' circuit momentarily mutes as the memory switches are changed.

## MODEL 403

In this case there are 25 preset sounds and capture, but still the 8-note polyphonic facility across the four octave keyboard and a simplified vibrato and sustain. As a trade-off, there are sixteen built-in rhythms, automatic chords and bass synchronised to the rhythm unit. Chords that are fingered may simply be triggered by the rhythm pattern.

The keyboard in this case is split, the lower 1½ octaves being reserved for chords. Automatic chords are normally major but may be changed to minor and dominant seventh by pressing additional keys. The rhythm and chords can be switched in with the start/stop control, when a red l.e.d. indicates beats. Alternatively, Synchro Start will produce a green l.e.d. indication of tempo in stand-by and the accompaniment will start in response to playing a note on the lower part of the keyboard.

One LSI is used for the Melody section of the keyboard, followed by the D/A Converter Block and filters—a rather simplified version of the 202 circuitry. Another CPU handles the accompaniment and there are additional chips for its I/O port and the chord generator. The rhythm unit, tempo oscillator and the eight instrument generators are mainly discrete circuitry.

## MODEL 701

It seems to be Casio policy to offer models with similar basic features but one having extra facilities. Both Models 601 and 701 are five-octave 8-note polyphonic instruments with 20 preset sounds, 16 rhythms and fill-in, chords, arpeggio, sustain and vibrato. The 701, however, has



very advanced programming features.

Introduced only a month or so ago, Model 701 has a programmable memory play function with storage capacity of 345 steps of notes and 201 steps of chords. It can be programmed by manual entry through the keyboard or by means of Casio bar-code music. Once the keyboard has been programmed, the performer can play along with the pre-programmed sound.

A light pen is used to read the bar-codes, which supply the memory with information on pitch, duration and chords. These codes look similar to those printed on grocery packets. A 3-digit display at the right hand end of the keyboard counts the program steps as the light pen is moved from left to

right along the bar-code score: chord information is read in a similar manner. Audible indications tell the user whether the information has been accepted, or an error has arisen. Editing allows for changes in taste or error correction.

The chosen chords can be fingered or used in Autochord mode when the memory is being recalled. For the beginner, 'Melody Guide' can be used. This function causes the stored music to light i.e.d.s fitted above each playing key, inviting the learner to press the key: when he has done so, the next i.e.d. in the sequence lights. The usual jack sockets are fitted to the 701's back panel, including connection for the light pen. Two books of music and a wire stand

are supplied with the keyboard: an optional pedalboard is available.

It is not possible to cover adequately all the features of these keyboards in this article. Take a look at them locally and I am sure you will agree that they are excellent value musically. And, unlike many VCOs, the tuning of the computer system is something easy to live with—in short accurate!

Casio has not entered the field of organ manufacture—which is already overcrowded—so far, but it is interesting to note the optional pedal board for Model CT-701. Bearing in mind what has already been achieved in a short time, the Casio organ may not be that far distant.

# BAZAAR

**VIDEOGRAPH** William Stuart eight changing background colours amazing visual effects on colour t.v. £45. (0772) 24463 (6.00 p.m.).

**EXPANDED** Atom with extra sound board. Plenty articles and software, £180. K. Miller, 19 Skye Place, Seafar, Cumbernauld, Glasgow. Tel: 02367 23650.

**24GHZ** Rank Precision slotted line SWR meter including dial gauge, boxed instructions, £95. M. Mann. Tel: 0223 860150.

**ZX81** Computer and 16K RAM. As new, £85. Stan Desnos, 37 Devonshire Road, Sherwood, Nottingham. Tel: 609548.

**WANTED** old oscilloscope with 5 inch tube, any condition considered. R. Rowland, 31 Ashby Close, Coventry CV3 2LN. Tel: Coventry 456096.

**UK101 16K**, cased, 1-2MHz, 300/600 Baud, inverse video, lots of software, £120. 20-2114, 400ns, £10. Jamies Oriel, 138 Small Gains Avenue, Canvey Island, Essex SS8 8LW.

**4600** Synthesiser, almost finished, needs wiring and setting up. All parts included, £375 ono. Mr. A. Pettitt, 2 Caburn View, Firle, Nr. Lewes, Sussex. Tel: Glynde 492.

**TERMI PRINTER** RS232 300 Baud upper/lower case friction feed plain roll paper, very quiet. Can be demonstrated. £85 ono. S. Higgins, 138 Lower Farnham Road, Aldershot, Hants. Tel: Aldershot 28796.

**ALMOST TWO** electronic organs stripped down two consoles, three keyboards, many p.c.b.s and units, £50. D. Green, 27 Ellery Court, Ash Vale, Nr. Aldershot, Hants. Tel: Aldershot 314713.

**UK101**, cased, 8K RAM, new monitor separated power supply, inverse video programs, cables, etc., £120 ono. H. S. Cook, 11 Normandy Avenue, Burnham-on-Crouch, Essex. Tel: Maldon 0621 784065.

**TRANSCENDENT** D.P.X., working, £400. ZX81 with Rampack and tapes, £90. Amstrad stereo tuner, £15. Post paid. Richard Rix, 76 Ber Street, Norwich, Norfolk NR1 3ES.

**SINCLAIR** ZX81, plus 16K RAM, manual, 4 books, 4 tapes, software. £75 or offer. David Brook, 113 Leigham Vale, London SW2.

**ROTEL 1000** Hi-Fi system, cost £900, exchange for good quality computer with hardware, approx. value £550. Mr. Mike Cooper, 409 Holcombe Road, Helmsshore, Rossendale, Lancs BB4 4NF.

**SWAP** Elektor H.B. from N1, P.W., P.E., E.T.I., E.E., W.W., 200 Philips 1501 for communic. radio. J. A. N. Ferreira, 13 Danehurst Street, London SW6. Tel: 01-731 1509.

**PE RANGER** CB 6 Chs., pair £80, National Panasonic stereo radio cassette RX5300F, £50. Tel: 01-505 9137.

**ZX81 16K** RAM built kit, working perfectly. No p.s.u., £70. N. Johnson, P.O. House, Longforgan DD2 5EW. Tel: Longforgan 200.

**MOTHERCARE** baby alarm, £4.00; Curzon player-recorder, £6.00. Mr. A. C. Holdway, Flat 9, 10 Westwood Road, Portswood, Southampton, Hants.

**OK1 CP110** Upper case matrix printer RS232 + parallel interfaces, suitable for UK101, video genie, etc. £175. Peter Vince, 19 Links Road, Ashted, Surrey KT21 2HB. Tel: 03722 72713.

**MIZUHO** 5B2M two metre SSB transceiver, £50. Creed teleprinter with interface, £5. VVW2 38 sets, offers. L. Fletcher, 21 Shakespeare Avenue, Andover, Hants. Tel: Andover 65368.

**ZX81** computer with 16K RAM plus 4 books, cassettes and software. Only 6 months old, £95. Mark Chidlow, 22 Glen Rise, King's Heath, Birmingham. Tel: 021 777 5635.

**WANTED** C.R. tube for oscilloscope. 9-pin, 2½ in. 350V, 6-3V in good order. Reasonable cost. Mr. C. F. Toms, Springfield, Chapel Road, Sledddau, Fishguard, Dyfed SA65 9RD.

**UK101 8K** cased, R.T.C. TV, new monitor, tapes, books, £150 ono, cash only. Write or phone. Mr. R. Griffiths, 5 St. James Mansions, McAuley Close, London SE1. Tel: 01-928 5013.

**TELETYPE** model 32, ASR, 75 Baud, paper tape punch/reader, £35 ono. R. Munson, 16 Woodcote Way, Benfleet, Essex. Tel: South Ben. 2998.

**FOR SALE.** Pye record maker radiogram model P117 RM with magnetic disc, offers. D. Moore, 24 Beaufort Close, Guisborough, Cleveland TS14 7PW. Guisborough 35349.

**WANTED.** Hameg scope dual trace preferred though single trace considered. J. G. Grieve, Makerhouse, Dounby, Orkney KW17 2JE. Tel: 085 677 279.

**ACORN** Atom 12K + 12K Flt. Pt. ROM, VIA, p.s.u. magic book, space invaders, asteroids, £199. M. Stalnsbury, 1B The Oaks, Billericay, Essex. Tel: 57527.

**FOR SALE** new GSC LPK-1 assembled logic probe, £115.00. K. Y. Chang, 70 1-up, Ashley Street, Glasgow G3 6HW.

**SMALL** quantity uni-selector switches, 10 bank, 25 way, ex telephone equipment, £5 each. M. Greenslade, 11 Cherry Road, Chipping Sodbury, Bristol BS17 6HJ.

**COLOUR** graphics board for UK101/Nascom. Cost £60. Accept £45. M. McNinch, 16 Fifth Avenue, Bangor, Co. Down BT20 5JP, N.I.

**WANTED** circuit and details of PW push button multimeter. M. J. Kerridge, 73 Ampleforth Grove, Willeby Road, Hull.

**ZX81**, 16K RAM, plus £30 of software including ZXChessII and OS-Asteroids, £85 ono. David Bell, 56 Cradlehall Park, Westhill, Inverness. Tel: 0463 791349.

**ZX81 WANTED** in good condition, preferably with power supply and leads. R. S. Matheson, Aviemore, Gwydry Road, Crieff, Tayside PH7 4BS. Tel: 0764 3582 (after 4.00 p.m.).

**ELEKTOR** Junior computer, p.s.u., Harvard 410T 40-channel walkie talkie, SWR meter, boomerang, matcher, offers. Mr. K. Y. Leong, 104 Gretney Walk, Moss Side, Manchester M15 5ND. Tel: 061 226 0791.

**SUPERBOARD II** 300/600 Baud, case, 10 issues OSIUK User Group Magazines, £180. 5V 6A PSU, £30. Both £200. Nicholas Brasier, 32 Henley Drive, Frimley Green, Camberley, Surrey. Tel: Deepcut 7487.

**Z81 16K** RAM software, £100, plus 17 inch TV b/w £50, used with above. F. B. Miles, 131 Dudley Road, Kenilworth, Wark's CV8 1GR. Tel: Kenilworth 54086.

**POWERTRAN.** Vocodex Calibrated by Circolec Electronics. Never used, £270 ono. P. McGeechan, 113 Old Mill Road, Uppingston, Glasgow G71 7JB. Tel: Uppingston B1 5565.

**2 KIL0** multicore solder £5, plus carriage. Resistance wire, one ohm per inch £1 p/order per 20 yds. J. S. Hind, 7 Carlyle Road, West Bridgford, Nottingham.

**WANTED.** Cheap! Secondhand! Transcendent DPX. Write with details to: D. Wood, 16 Donnington Grove, Portswood, Southampton, Hants SO2 1RW.

**SERVISCOPE** Minor Oscilloscope, £40. Signal generators advance H1 A.F., £30. Heatkit RF-1U R.F., £25. D. Russell, 9 South Beach Road, Ardrossan, Ayrshire KA22 8AX. Tel: Ardrossan 64144.

**PRINTER.** Olivetti TE318 complete with RS232 interface seen working with PET, £50. Tel: High Wycombe 0494 33164.

**AUDIO-GENERATOR.** BECCO AG 761 Sine/Square wave, £35. Tel: 051 734 0987.

**POWER** supplies: 5V/35A (switch mode), £20, 5V/20A (transformer), £15, 24V/1A (transformer), £10 or w.h.y. computer bits? John Cartwright, 96 Cranberry Lane, Alsager, Cheshire. Tel: Alsager 6513.

**6800 77-68** CPU card, 4K RAM card, 16K Eprom card, 32K Dynamic RAM card. Offers. 051 653 6918.

**UK101 8K** wood/aluminium case, integral cassette recorder. Room for internal expansion boards, £170. R. W. Hillman, 79 Pope Road, Underhill Estate, Wolverhampton WV10 8LU. Tel: Wolverhampton 734448.

**PET 2001** 8K with manual, v.g.c also dust cover and various cassettes, £300. Tel: Hornchurch 72222.

**ZX81** computer and 16K RAM plus full size keyboard, £90. Gordon Clarke, 37 Gladstone Grove, Heaton Moor, Stockport SK4 4BX. Tel: 061 432 2189.

**ZX81** 1K built with everything. V. good condition, £50 of books, Sinclair tape, only £90. Buyer collects. Monsur Miah, 27 Highcroft Gardens, Golders Green, London NW11 0LY. Tel: 01-458 7567 (after 6 p.m.).

**SINCLAIR ZX81** 1K RAM + Games cassette. Offers Ring 0782 625989.

# MICRO PROMPT.

The hardware and software exchange point for PE computer projects

## INSTANT SOUND DEVELOPMENT

The use of the AY-3-8912 or AY-3-8910 sound chip with the UK101 adds a new dimension particularly to games. Being such a versatile device employing 14 registers can sometimes mean that producing the exact sound you want is a lengthy process bogged down with bit-patterns and binary to decimal conversions to give the values to be POKEd into the registers. Ideally for sound development one would like to be able to call upon the resources of the device in a straightforward manner.

To this end a program has been written which uses the keyboard to control the sounds in much the same way as an audio mixer. Each of the three channels can be independently selected to contain tone, noise and envelope effects. Frequency sweeps can be carried out until the required sound has been produced. At this point another keypress gives a printout of register contents so that the same sound can be produced in any program. For complex sweeps the start and finish sounds can be printed out separately. It will be clear from the printouts how to program the sweep with a FOR...NEXT loop.

Recapping on what the chip is capable of: Each of the three channels can independently produce tone and/or noise. The tone generators can give different frequencies on each channel but there is only one noise generator which all channels must share. The amplitude of each channel can be set unless control of that channel is given to the envelope generator. The shape and period of the envelope can be specified.

Fig. 1 shows a simplified diagram of the generator showing the effect of selecting the various options in the program (T1, E1,

N1 etc.). It also indicates where the period and amplitude controls fit into the system.

At program startup, all of these options are deselected and all the periods and amplitudes are set to zero. A single keypress will select an option and a second press will deselect again. A printout on the VDU shows the status of the device after each selection.

Envelope shape selection is by means of an increment key which steps through the ten profiles returning eventually back to the first again.

The use of the keyboard is shown below right. Below, right, are some examples which demonstrate how quickly different sounds can be demonstrated:

```

1  REM *** SOUND DEVELOPMENT **
2  REM *** PETER BECKETT JAN 81 **
3  REM *****
4  T1=256:T2=61808:Y3=61809
5  FORI=0T013:POKEY2,I:POKEY3,0:NEXT
6  POKE530,1:DP=4:DMX(13)
8  Y4=0:Y5=4095:Y6=31
9  Q1=1.01:Y7=15:Y8=65534
10 FORI=0T09:READNV(I):NEXT
11 DATA0,4,8,9,10,11,12,13,14,15
12 FORI=0T016:PRINT:NEXT:PRINT" SOUND DEVELOPMENT-P.BECKETT":PRINT
20 KB=57088
30 T1=-1:T2=-1:T3=-1:N1=-1:N2=-1:N3=-1:E1=-1:E2=-1:E3=-1
100 POKEKB,127:A=PEEK(KB):IFA=255THEN200
110 IFA=127THENT1=-T1:GOTO1000
120 IFA=191THENT2=-T2:GOTO1000
130 IFA=223THENT3=-T3:GOTO1000
140 IFA=239THENN1=-N1:GOTO1000
150 IFA=247THENN2=-N2:GOTO1000
160 IFA=251THENN3=-N3:GOTO1000
170 IFA=253THENE1=-E1:GOTO1000
180 GOTO1000
200 POKEKB,191:B=PEEK(KB):IFB=255THEN300
210 IFB=127THENE2=-E2:GOTO1000
220 IFB=191THENE3=-E3:GOTO1000
230 IFB=223THENES=ES+1:GOTO1000
240 IFB=239THENEP=1.1*EP+1:IFEP>Y8THENEP=Y8
241 IFB=239THENEP=190
250 IFB=247THENEP=1/1.1*EP-1:IFEP<Y4THENEP=Y4
251 IFB=247THENEP=190
260 IFB=251THEN3000
270 GOTO1000
300 POKEKB,239:C=PEEK(KB):IFC=255THEN400
310 IFC=127ANDE1=-1THEN6000
320 IFC=191ANDE2=-1THEN6100
330 IFC=223ANDE3=-1THEN6200
340 IFC=239ANDE1=-1THEN6300
    
```

```

350 IFC=247ANDE2=-1THEN6400
360 IFC=251ANDE3=-1THEN6500
370 IFC=253THEN6600
380 GOTO1000
400 POKEKB,247:D=PEEK(KB):IFD=255THEN100
410 IFD=127ANDE1=-1THEN6002
420 IFD=191ANDE2=-1THEN6102
430 IFD=223ANDE3=-1THEN6202
440 IFD=239ANDE1=-1THEN6302
450 IFD=247ANDE2=-1THEN6402
460 IFD=251ANDE3=-1THEN6502
470 IFD=253THEN6602
480 GOTO1000
    
```

Lines	cont. opposite
4-30	Set up constants. Sound = 61680, 61681.
4-30	Set up constants.
100-220	Scan keys 1-9 and select/deselect options
230	Increment envelope shape if "Q" pressed.
240-251	Increase/decrease envelope period.
300-380	Scan keys W to I.
400-480	Scan keys S to K.
1000-1099	Status printout.
2000	Delay to prevent too rapid response to option select.
3000-3031	Register printout of array X.
5000-5300	Put current values in array X prior to output to PSG.
5400	Output to PSG.
6000-6610	Calculate periods and amplitudes and output.

## Three Examples

- 5 second press on **[E]**, N1, Two presses on **[E]**, E1. This gives you an ancient aeroplane whose engine speed can be controlled by **[E]** and **[E]**.
- 15 second press on **[E]**, T1, N2, 10 second press on **[E]**, 2 or 3 second press on **[E]**. Now press **[W]** until a faint whistle is heard. Press **[E]** if it's too loud. Hold down **[E]** to hear the bomb fall, To explode the bomb press **[E]**.
- 7 second press on **[E]**, N1, 4 presses on **[E]**, E1 and you have a train which can be heard to pass by if **[E]** is held down. Fine tune the speed of the train with **[E]** and **[E]**.

Fig. 1. Simplified diagram of the Sound Generator, and the key functions related to it.

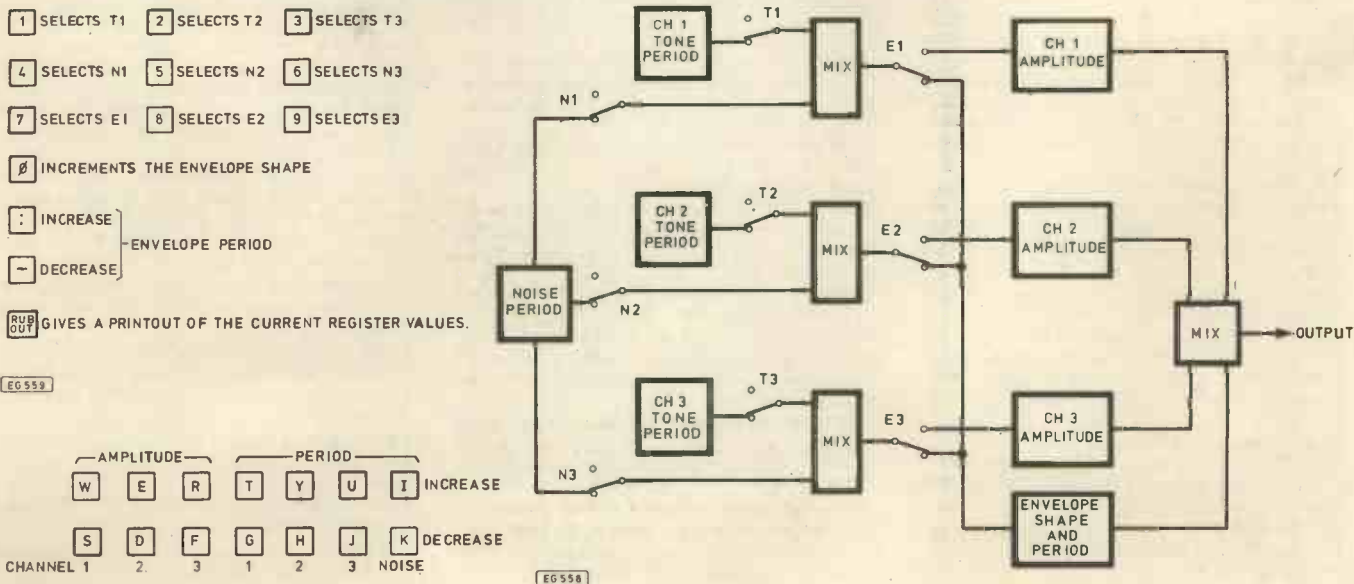

```

1000 IFT1=1THENPRINT"T1 ";
1020 IFT2=1THENPRINT"T2 ";
1030 IFT3=1THENPRINT"T3 ";
1040 IFN1=1THENPRINT"N1 ";
1050 IFN2=1THENPRINT"N2 ";
1060 IFN3=1THENPRINT"N3 ";
1070 IFE1=1THENPRINT"E1 ";
1080 IFE2=1THENPRINT"E2 ";
1090 IFE3=1THENPRINT"E3 ";
1092 IFES=1THENES=0
1099 PRINT"ENV SH=";ES
2000 FORI=1TO500:NEXT
2010 GOTO5000
3000 REM REG PRINTOUT
3005 PRINT
3010 FORI=0TO4:PRINT"R"+RIGHT$(STR$(I),1)+"="+STR$(X(I))+" ";:NEXT
3011 PRINT" "
3012 FORI=5TO9:PRINT"R"+RIGHT$(STR$(I),1)+"="+STR$(X(I))+" ";:NEXT
3013 PRINT" "
3014 FORI=10TO13:PRINT"R1"+RIGHT$(STR$(I),1)+"="+STR$(X(I))+" ";:NEXT
3015 PRINT" "
3020 PRINT
3030 GOTO1000
5000 REM ENTER REGS
5010 X(1)=INT(P1/Y1)
5020 X(0)=P1-X(1)*Y1
5030 X(3)=INT(P2/Y1)
5040 X(2)=P2-X(3)*Y1
5050 X(5)=INT(P3/Y1)
5060 X(8)=A1:IFE1=1THENX(8)=X(8)+16
5070 X(9)=A2:IFE2=1THENX(9)=X(9)+16
5080 X(10)=A3:IFE3=1THENX(10)=X(10)+16
5090 X(12)=INT(EP/Y1)
5095 X7=64+12B
5097 IFT1=-1THENX7=X7+1
5100 IFT2=-1THENX7=X7+2
5110 IFT3=-1THENX7=X7+4
5120 IFN1=-1THENX7=X7+8
5130 IFN2=-1THENX7=X7+16
5140 IFN3=-1THENX7=X7+32
5150 X(7)=X7

```

```

5160 X(8)=A1:IFE1=1THENX(8)=16
5170 X(9)=A2:IFE2=1THENX(9)=16
5180 X(10)=A3:IFE3=1THENX(10)=16
5190 X(12)=INT(EP/Y1)
5200 X(11)=INT(EP-X(12)*Y1)
5300 X(13)=NV(ES)
5400 FORI=0TO13:POKEY2,I:POKEY3,X(I):NEXT
5500 GOTO100
5999 REM AMPL AND PERS COME HERE
6000 A1=A1+1:IFA1>Y7THENA1=Y7
6001 GOTO6010
6002 A1=A1-1:IFA1<Y4THENA1=Y4
6010 X(8)=A1:POKEY2,8:POKEY3,A1:GOTO100
6100 A2=A2+1:IFA2>Y7THENA2=Y7
6101 GOTO6110
6102 A2=A2-1:IFA2<Y4THENA2=Y4
6110 X(9)=A2:POKEY2,9:POKEY3,A2:GOTO100
6200 A3=A3+1:IFA3>Y7THENA3=Y7
6201 GOTO6210
6202 A3=A3-1:IFA3<Y4THENA3=Y4
6210 X(10)=A3:POKEY2,10:POKEY3,A3:GOTO100
6300 P1=INT(P1+Q1+1):IFP1>Y5THENP1=Y5
6301 GOTO6310
6302 P1=INT(P1/Q1-1):IFP1<Y4THENP1=Y4
6310 X(1)=INT(P1/Y1):X(0)=P1-X(1)*Y1
6311 POKEY2,0:POKEY3,X(0):POKEY2,1:POKEY3,X(1):GOTO100
6400 P2=INT(P2+Q1+1):IFP2>Y5THENP2=Y5
6401 GOTO6410
6402 P2=INT(P2/Q1-1):IFP2<Y4THENP2=Y4
6410 X(3)=INT(P2/Y1):X(2)=P2-X(3)*Y1
6411 POKEY2,2:POKEY3,X(2):POKEY2,3:POKEY3,X(3):GOTO100
6500 P3=INT(P3+Q1+1):IFP3>Y5THENP3=Y5
6501 GOTO6510
6502 P3=INT(P3/Q1-1):IFP3<Y4THENP3=Y4
6510 X(5)=INT(P3/Y1):X(4)=P3-X(5)*Y1
6511 POKEY2,4:POKEY3,X(4):POKEY2,5:POKEY3,X(5):GOTO100
6600 NP=NP+1:IFNP>Y6THENNP=Y6
6601 GOTO6610
6602 NP=NP-1:IFNP<Y4THENNP=Y4
6610 X(6)=NP:POKEY2,6:POKEY3,NP:GOTO100

```

P. Beckett,  
Blackpool.

### KEYBOARD ANNUNCIATOR

Sir—When typing a program into the computer, I found it convenient to have the solid state annunciator "bleep" to show that I had correctly entered a figure or letter, this saved me having to continually view the monitor screen for missed characters. It also proved useful in some animated games to have the "bleep" function sounding for added interest.

The annunciator may be switched off by two methods. Firstly, by a switch in the 5 volt rail to the unit. If this is done, then R1, D9 and TR1 are not needed. The second method is to make use of the RTS line at Pin 6 of J2 on the rear of the computer board. For the RTS line to function, IC68 and associated components need to be fitted on the computer board.

On first switching on the computer the "bleep" will not sound until the screen is cleared of the garbage with the Reset key, thereafter it will be actuated by any keystroke. To disable the "bleep", the RTS line is actuated by typing POKE 61440,81. To return to "bleep" mode just type POKE 61440,17.

The circuit is very simple, TR2, T1, R2, and C1 form the oscillator circuit which drives the flat, disc-like, piezo-electric buzzer. Operating the keyboard puts a lower voltage on the cathode of one of the diodes D1 to D8, this switches TR3 on and puts about 4 volts on to the centre tap primary of a small audio output transformer, the secondary winding is not used. Capacitor C1 need not be fitted and is only fitted if the total quality does not suit the user's ear. A typical value of 100n or less may be used.

TR1 is switched on by the command POKE 61440,81 and damps the oscillator circuit so that all that can be heard is a faint click from the piezo stripboard buzzer. The circuit was built on a small piece of strip-board and stuck on to the computer board close to the "Q" key with the piezo buzzer glued to a clear spot on the computer board.

Anthony Green A.S.M.  
Hong Kong.

```

10 DEF FNA(A)=53194+X+(Y*64)
15 DEF FNB(A)=INT(FNA(A)/256)
20 DEF FNC(A)=FNA(A)-FNB(A)
*256
30 PRINT CHR$(12);
50 PRINT "[CTRL A] ENTER X AND Y";
60 INPUT X, Y
70 POKE 549, FNB(A):POKE 512, FNC(A)
80 PRINT "UK 101"
90 GOTO 50

```

X and Y should be integers between 1-48 and 1-16 respectively. No test for range is made so characters can be PRINTed off the screen.

This routine is especially useful for PRINTing onto the top line which is normally protected from PRINTing by the Wemon. If X and Y are set to one it will PRINT on the top line. Whatever is PRINTed will not scroll with the rest of the screen and will remain there until Clear Screen is executed. If the routine is to be used exclusively for PRINTing on to the top line, line 10 can be changed to:—

```
10 DEF FNA(A)=53259
```

(CTRL A executes HOME CURSOR)

David A. Rogerson,  
Morpeth.

### PRINT WITH FN

Sir—here is a short routine which works on my UK101 with Wemon:

```

10 DEF FNA(A)=53194+X+(Y*64)
15 DEF FNB(A)=INT(FNA(A)/256)
20 DEF FNC(A)=FNA(A)-FNB(A)
*256
100 POKE 549, FNB(A):POKE 512, FNC(A)

```

It demonstrates how you can PRINT on to any part of the screen using X/Y coordinates. Lines 10-20 need only be written once and the contents of line 100 need to be written just before each PRINT statement. Here is an example:

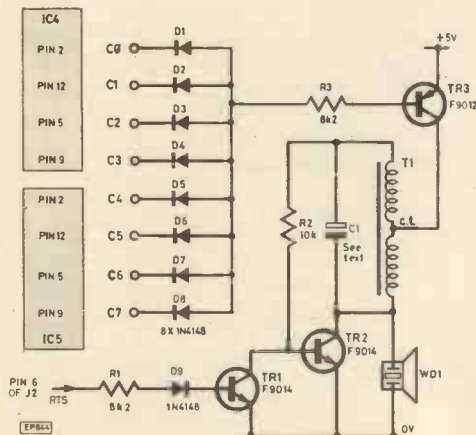

## FREE SOUND

Sir—For those who may not have the skill or the money to build a programmable sound generator, I have found a cheap and easy alternative. A great many weird and wonderful sounds can be heard by placing a small Medium Wave radio beside, or carefully on the computer itself and tuning it for the best results.

I myself use a cheap radio which I have placed on top of the Basic and Monitor ROMs which give excellent results on fast games such as Space Invaders and Gremlins. The different cycles set up for different routines inside the ROMs appear as audio signals on the radio.

Y. Gilhan,  
Sittingbourne,  
Kent.

## INITIAL SNAGS

Sir—I think your readers might be interested in the following modifications to the UK101, if recently bought from Comp-shop with 2716 substitute chips, for the BAS 2 and CHR GEN.

### 1) CHR GEN

Pins 18 and 20 should be connected to ground, if this is not done only half the characters are available. (None if the pins are still in the sockets.)

### 2) BAS 2

(a) Pin 18 should also be connected to ground; or invalid Syntax errors appear if even the simplest program is executed.

(b) A note supplied suggests linking a wire link between pin 6 of 1C17 and pin 8 of 1C16; this converts the BS2 pulse to a NOT BS1 pulse necessary for the 2716, all good stuff, but it doesn't work! Errors still persisted.

The above can be solved by the following method, this either inserts a necessary buffer or presents a slight delay to the pulse, but it certainly works.

Connect pin 8 of 1C16 to pin 9 of 1C18

Connect pin 8 of 1C18 to pin 20 of 1C10 [BAS 2].

Cut the track on the top side of the board leading to pin 20 of 1C10. Pins 8 and 9 on 1C18 are a spare NOT gate.

The chips were supplied with the pins bent outward but there were no notes saying why, so of course I bent them in again thinking they were bent because they were not packed properly, after all i.c. pins usually have to go somewhere!

Although I feel the UK101 is an excellent introduction to Micro Computing, I find it slightly disconcerting that a brand new machine should need so much extra work through lack of Technical Proving.

A. Jones,  
RAF North Luffenham.

It should be emphasised that material presented in Prompt has not necessarily been proven by us. Neither can compatibility with all generations of the computer equipment to which it relates be guaranteed.

Software and hardware designs submitted should be accompanied by a declaration to the effect that it is the original work of the undersigned, and that it has not been accepted for publication elsewhere.

## E/MONITOR HELP

Sir—In reply to Mr. J. Walton's letter requesting information on relocation of the extended monitor.

To relocate the extended monitor:

1) Use the relocate command (R) to relocate the monitor.

2) Change look up table between \$0960 + d and \$0999 where d is the displacement of the new monitor location from the original.

If for example the monitor is moved to the top of 8K ie. \$1800 - \$2000 the table will be between \$1960 and \$1999.

Some of the addresses in the table will have been changed by the relocate command. The first value to be changed is in \$1961 this is \$0B and must be changed to \$1B proceed through the table changing alternate values if they start with a zero i.e. \$0B, \$0C, etc.

These values are the high bytes of the addresses and if the monitor has been moved \$1000 bytes ie. moved to the top of 8K then \$10 will have to be added to these values.

You can now save the relocated monitor using the checksum save. ie. \$1800, 2000.

R. Webster,  
Sutton Coldfield.

## UK101 KEYBOARD GRAPHICS

Sir—The program opposite enables the total range of characters to be accessed easily and directly from the keyboard, thereby greatly simplifying graphical display design and more importantly, saving valuable user RAM space.

eg. 10 PRINTCHR\$(216);

CHR\$(218); CHR\$(216);

CHR\$(218)

= 33 bytes

10 PRINT "HH"

= 12 bytes

The graphics program occupies 163 bytes and one zero page address at 00E7; and is located at 0235-02D8. Unfortunately, the programming of the UK101's ROMs masks the MSB of all characters whilst loading, so a simple load routine must also be used, and occupies 24 bytes of RAM from 02D9-02FD. Both routines reside in an otherwise unused and protected area of RAM and are consequently unaffected by "Cold Starts".

The graphics routine is entered by changing the Input Vectors from FFBA to 0235.

i.e. POKES36,53: POKES37,2 (Note: both POKEs must be executed together).

The keyboard will still function as before, but on pressing CONTROL G, a display block will appear in the top right-hand corner of the screen. Any graphic character may now be obtained by a two-stage operation:

1) Select a letter (A-Z), which will be displayed within the display block. RUBOUT will delete this letter.

(The letters actually correspond with the vertical column of the UK101 character set published in the March 1980 edition of PE.)

2) Select a number (0-9). The corresponding graphic character will be

displayed. RUBOUT will delete the last entry.

Return will commit the BASIC line to memory and automatically exits the graphics routine. CONTROL C also exits the routine but enables the user to continue the program line using a "standard" keyboard. However, the input vectors remain unaffected and CONTROL G can be operated at any time.

Certain characters such as CR and LF can be used within program lines but they will produce error messages when loaded and should therefore be avoided unless a different form of load routine is used. Also, NULL is not displayed and causes subsequent characters to be deleted from that particular line.

As already stated, an additional LOAD routine must be used to retrieve recorded programs, due to the character mask of the UK101.

To place the routine in a LOAD mode enter:

**POKE536,217: POKES37,2**

The data from the cassette will be loaded as normal, but at the end of the listing the Reset keys must be operated and Warm Start selected. (A Warm Start resets the Input Vectors to FFBA.)

It has already been mentioned that although CR/LF can be used within program lines, these lines will be rejected when loaded from cassette.

However, if we assume that CR/LF characters are always correctly enclosed by character string inverted commas, then loading is possible.

A suitable routine is provided and is located at 0235-026B plus a zero page address at 00E0. The program initially searches for at least 12 consecutive NULLS, placed at the beginning of a program listing on tape, in order that the character string flag may be correctly set.

From then on, after every other inverted comma, the routine accepts every character as a string rather than a control. Therefore, if the tape is halted within the program or a string exists without a terminating inverted comma, the LOAD routine may then be out of step with the character strings and subsequent error messages will result.

The routine is entered by:

**POKES36,53: POKES37,2**

and RESET must be operated at the end of the LOAD cycle.

In order to SAVE a program containing control characters, one must ensure that all character strings have their associated terminating inverted comma and the following line is added to the program.

**1 SAVE: FORI = 1 TO 20:**

**PRINTCHR\$(I); ;NEXT:**

**LISTN-**

(where N is the 1st program line to be SAVED)

Then enter RUN, start the tape recorder and press RETURN to execute the SAVE.

A. J. Jameson,  
Ross Shire.

Graphics Routine			
0235	LDA	AD	2AD0
0238	CMP	C9	0C
023A	BEQ	F0	07
023C	JSR	20	00FD
023F	CMP	C9	07
0241	BNE	D0	6D
0243	JSR	20	C202
0246	LDA	A9	20
0248	STA	8D	74D0
024B	JSR	20	00FD
024E	CMP	C9	1C
0250	BEQ	F0	5E
0252	CMP	C9	20
0254	BEQ	F0	41
0256	CMP	C9	03
0258	BEQ	F0	4D
025A	CMP	C9	0D
025C	BEQ	F0	45
025E	CMP	C9	41
0260	BMI	30	E9
0262	CMP	C9	5B
0264	BPL	10	E5
0266	STA	8D	74D0
0269	SEC	38	
026A	SBC	E9	40
026C	TAY	A8	
026D	LDA	A9	F5
026F	ADC	69	0A
0271	CLC	18	
0272	DEY	88	
0273	BNE	D0	FA
0275	STA	85	E7
0277	JSR	20	00FD
027A	CMP	C9	1C
027C	BEQ	F0	C8
027E	CMP	C9	20
0280	BEQ	F0	15
0282	CMP	C9	03
0284	BEQ	F0	21
0286	CMP	C9	0D
0288	BEQ	F0	19
028A	CMP	C9	30
028C	BMI	30	E9
028E	CMP	C9	3A
0290	BPL	10	E5
0292	SBC	E9	2F
0294	CLC	18	
0295	ADC	65	E7
0297	STA	95	13
0299	JSR	20	E5A8
029C	INX	E8	
029D	LDA	A9	00
029F	CPX	E0	47
02A1	BNE	D0	0D
02A3	LDA	A9	0D
02A5	BNE	D0	02
02A7	LDA	A9	00
02A9	PHA	48	
02AA	LDA	A9	20
02AC	JSR	20	B302
02AF	PLA	68	
02B0	RTS	60	
02B1	LDA	A9	0C
02B3	LDY	A0	0C
02B5	STA	99	29D0
02B8	STA	99	69D0
02BB	STA	99	A9D0
02BE	DEY	88	
02BF	BNE	D0	F4
02C1	RTS	60	
02C2	JSR	20	B102
02C5	LDY	A0	08
02C7	LDA	B9	D002

02CA	STA	99	6AD0
02CD	DEY	88	
02CE	BNE	D0	F7
02DO	RTS	60	
02D1	47 52	41	50 48 49 43 53
02D9	LDA	AD	00F0
02DC	ROR	6A	
02DD	BCC	90	FA
02DF	LDA	AD	01F0
02E2	CMP	C9	0A
02E4	BEQ	F0	F3
02E6	CMP	C9	00
02E8	BEQ	F0	EF
02EA	CMP	C9	0D
02EC	BEQ	F0	0F
02EE	STA	9D	CDD3
02F1	STA	95	13
02F3	INC	EE	0002
02F6	INX	E8	
02F7	CPX	E0	47
02F9	BNE	D0	DE
02FB	LDA	A9	0D
02FD	RTS	60	

Simple Graphics Load Routine			
02D9	LDA	AD	00F0
02DC	ROR	6A	
02DD	BCC	90	FA
02DF	LDA	AD	01F0
02E2	CMP	C9	0A
02E4	BEQ	F0	F3
02E6	CMP	C9	00
02E8	BEQ	F0	EF
02EA	CMP	C9	0D
02EC	BEQ	F0	0F
02EE	STA	9D	CDD3
02F1	STA	95	13
02F3	INC	EE	0002
02F6	INX	E8	
02F7	CPX	E0	47
02F9	BNE	D0	DE
02FB	LDA	A9	0D
02FD	RTS	60	

Graphics Load Routine			
0235	LDY	A0	0C
0237	DEY	88	
0238	BNE	D0	02
023A	STY	84	E0
023C	LDA	AD	00F0
023F	ROR	6A	
0240	BCC	90	FA
0242	LDA	AD	01F0
0245	BEQ	F0	F0
0247	TAY	A8	
0248	CPY	C0	22
024A	BNE	D0	06
024C	LDA	A5	E0
024E	EOR	49	01
0250	STA	85	E0
0252	LDA	A5	E0
0254	BNE	D0	08
0256	CPY	C0	0A
0258	BEQ	F0	DB
025A	CPY	C0	0D
025C	BEQ	F0	0B
025E	TYA	98	
025F	STA	95	13
0261	JSR	20	E5A8
0264	INX	E8	
0265	CPX	E0	47
0267	BNE	D0	CC
0269	LDA	A9	0D
026B	RTS	60	

Graphics Message  
 (02C7)  
 GRAPHICS ASCII Characters

Cassette Port  
 (02D9) Data Ready?  
 Get Data  
 (02D9) LF?  
 (02D9) NULL?  
 (02FD) CR?  
 Display Store  
 Cursor Position  
 Cursor Pointer  
 Max. Line Length?  
 (02D9)

REM To call Graphics Routine:  
**POKE536,53: POKE537,2**  
 REM To call Graphics Load:  
**POKE536,217: POKE537,2**  
 To enter Graphics Mode—Control G  
 To exit Graphics Mode—Control C  
 RETURN automatically exits and executes LF/CR  
 RUBOUT either deletes 1st letter entry or backspaces  
 SPACE continues to function correctly

(CR/LF+ other control characters)  
 Set Tally  
 Tally-1  
 Tally=0?  
 Clear CR/LF Flag  
 Cassette Port  
 (023C) Data Ready?  
 Get Data  
 (0237) NULL?  
 (0252) ""  
 EX-OR CR/LF Flag  
 (025E) CR/LF Flag Set?  
 (0235) LF?  
 (0269) CR?  
 Store Data  
 Display Data  
 Cursor Pointer  
 (0235) Max. Line Length?  
 CR

REM To call Graphics Load Routine:  
**POKE536,53: POKE 537,2**  
 REM To Save Programs:  
 Line No.  
**SAVE: FORI=1 TO 20: PRINTCHR\$(0);**  
**NEXT: LIST N—**  
 e.g. (where N is the 1st Prog. Line)  
**10 SAVE: FORI=1 TO 20: PRINTCHR\$(0); NEXT:**  
**LIST20—**



# CASIO WATCHES



# Casiotone ELECTRONIC KEYBOARDS



BAR-CODED PROGRAMMABLE MINI

1000 VOICE DIGITALIZED SYNTHESIZER

VL-5

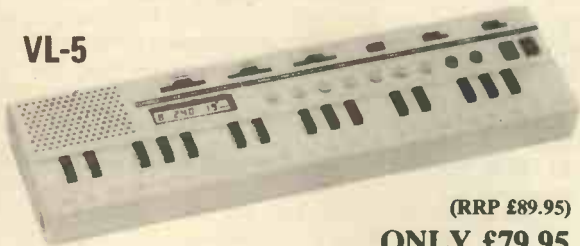

(RRP £89.95)  
**ONLY £79.95**

PLUS £10 worth of accessories FREE

The VL-5 can read and store Casio's unique bar-coded music, or alternatively you can program the memory directly from the 3-octave keyboard. Select one of the 10 instrument voices and choose one of the 8 auto rhythms, then play back your stored melody by means of the One Key Play button, or by the Auto Play button. The 4 note polyphonic mini keyboard can also be played manually.

With integral amplifier and speaker; Line Out and Headphone jacks; Sustain and Pitch control. Powered by 5 AA size batteries, or the optional mains adaptor, AD-1E (£5). Supplied with light pen, instruction manual and music book. Dims. 33 x 320 x 86mm (1 1/4 x 12 1/2 x 3 1/4). Weight 510g (18oz).

CT-1000P



(RRP £375)  
**ONLY £325**

PLUS £40 worth of accessories FREE!

This revolutionary new synthesizer has 10 superb preset instrument voices, PLUS switchable FEET, ENVELOPE and MODULATION – the three elements of sound creativity – giving 10 x 10 x 10 variations, numbered from 0 to 999. You may store up to 10 of your favourite sounds, in a battery protected memory, for instant selection.

The 5-octave, 8-note polyphonic keyboard can be split into two separate keyboards, with different preset voices.

In addition to a 16-step preset arpeggio, there is a programmable arpeggio function with up to 127 steps, 9 note pitches, and rests, which can also be used as a real time sequencer.

Frequency is displayed digitally, and the wide range pitch control allows transposition between -1 octave and +0.5 octave.

Complete with Sustain, and 3 Vibrato functions, etc; integral amplifier/speaker; Output and Headphone jacks; protective moulded end plates. Dimensions: 117 x 916.5 x 363.5mm (4 1/2 x 36 x 14 1/4). Weight 10kg (22lbs).

### CASIOTONE SUMMER OFFERS

FREE accessories (value in brackets), until September 30th.					
CT-701 (£50)	£495	CT-601 (£50)	£395	CT-403 (£35)	£275
CT-202 (£35)	£275	CT-101 (£25)	£195	MT-40 (£10)	£99
MT-31 (£7)	£69	VL-1 (£5)	£35.95	VL-10 (£3)	£26.95

ACCESSORY PRICE LIST  
INTEREST FREE CREDIT

Details on request

FREE SECURICOR 24 HOUR DELIVERY (CT models)  
Same day despatch by post for smaller models.

### LCD ANALOG/DIGITAL AX-5 ONLY £19.95

Black resin cased version of the AX-210 below

THE WORLD'S MOST VERSATILE  
WATCH?

- Analog Display  
LC Display of hours and minutes  
Digital display  
★ Local time, 12 or 24 hour  
★ Full calendar display  
★ Dual time, 12 or 24 hour  
★ Alarm time display  
★ Countdown alarm timer with memory function  
★ Professional 1/100 second stop-watch  
Hourly time signal. Daily alarm electronic buzzer or 3 selectable melodies.  
Rapid forward/back setting. 9.4 x 35.4 x 36mm.  
Deletions.  
AX-210 £29.95



### 50 METRE WATER RESISTANT



W-20 £12.95  
W-35 £19.95  
AA-92W £25.95  
W-20 Black resin case/strap. 12/24 hour time and auto calendar. Alarm and hourly chimes. Professional 1/100 second stopwatch. Compact case, approx 8mm thick. 5 year battery life.  
W-35 Stainless steel version of W-20, with countdown alarm timer.  
AA-92W Analog/digital (dual 12 hour times) with graphic alarm displays. Otherwise similar to W-35.

### MULTI ALARMS

4 ALARMS,  
6 MELODIES

- 12/24 hour time & calendar.  
Time is always on display.  
12/24 hour dual time.  
Professional 1/100 stopwatch.  
Optional hourly signal.  
Daily alarm with pre-alarm.  
Daily alarm with post-alarm.  
Weekly alarm/extra daily alarm.  
Monthly alarm/extra daily alarm.



MM 400 £29.95

### 100 METRE WATER RESISTANT



W-100 Resin case/strap £17.95  
W-150C S/S case, resin strap £21.95  
W-150 All S/S £24.95

Time and auto calendar. Alarm and hourly chimes. Countdown alarm timer with repeat memory function. Professional 1/100 second stopwatch. Time is always on display, regardless of display mode. Amazing 5 year lithium battery life. Superior to the W-250.

4 ALARMS,  
2 MELODIES,  
CALCULATOR

- 12/24 hour time & calendar 8 digit calculator.  
Professional 1/100 second stopwatch to 24 hours.  
Optional hourly signal.  
Daily alarm.  
Daily alarm with pre-alarm.  
Daily alarm with post-alarm.  
Weekly alarm.



CA-95 Resin £19.95  
CA-951 Metal £29.95



### TRUE ANALOG/DIGITAL

Classical analog with simultaneous digital display. Hour, minute, second, month, date, day. Daily alarm and hourly time signal. Date memory. auto calendar. 1/100 second stopwatch.

AQ-101 £39.95

Price includes VAT and P&P. Send cheques, PO, or phone your ACCESS, VISA or B'CARD number to:

# TEMPUS

LEADING CASIO SPECIALISTS  
Dept PE  
38 Burleigh Street, Cambridge CB1 1DG  
Telephone: 0223 312866

DELIVERY  
NORMALLY  
BY RETURN



## Space Watch...

Cosmos-1355 was launched at 0953 GMT from Tyuratom on the 29th April. It was put into a 402 x 128-km orbit at an inclination of 65.1 deg. After the initial orbit was satisfactorily achieved it was put into a higher orbit of 459 x 438-km but in the original inclination. This would take it over the Falkland Islands.

### SHUTTLE CREWS

In accordance with the new policy to be adopted by NASA for the Shuttle Missions of the future, the next three crews have been named. For Mission 7 the commander will be Robert L. Crippen with Frederick H. Hauck as pilot. The Mission specialists will be John M. Fabian and the first woman astronaut Sally K. Ride. She has already gained much experience as a key communicator for shuttle crews from her post at the Johnson Spaceflight Centre. This shuttle will be named Challenger and is due for launch on a date in April 1983.

The payloads will be a pallet satellite from Germany, a Canadian communications satellite, Telesat-F, a second instrument package from the Office of Space and Terrestrial Applications and an Indonesian communications satellite, Palapa-81. The Mission will be for six days.

In July 1983 shuttle Mission 8 will be launched with Richard H. Truly as commander and Daniel C. Brandenstein as pilot. The Mission specialists will be Dale A. Gardner and Guion S. Bluford, Jr. This will be a three day mission. On this flight there will be an Indian communications satellite, Insat-B, and a satellite from NASA for tracking and data relay named TDRS-B. This is the second and final part of a system for advanced voice control and data control between the orbiting shuttles and the mission control centres.

Mission 9 will be the European Spacelab. The date is set at September 1983. This will be a seven day mission. The commander will be John W. Young and the pilot Brewster H. Shaw, Jr. The two specialists will be Owen K. Garriot and Robert A. Parker. The payload specialists for this mission have not yet been released.

### SALYUT ACTIVITIES

Another cycle in the Soviet manned space station missions began with Salyut 7. This is probably intended for the Soviet-French joint cosmonaut team which has been expected in June or July 1982. The orbital parameters are apogee -278km, perigee -219km, with a revolution period of 89.2 min. The inclination of the orbit is 51.6 deg. A Soviet team may visit the station before the joint mission takes place.

Meanwhile, Salyut 6 remains docked with Cosmos 1,267 and will remain in orbit as a back-up for the joint mission. A progress supply vehicle is expected to visit the station between the inspection team and the final joint Soviet-French team.

Salyut-7 will continue to test systems and space station equipment. This mission is controlled from the Moscow control centre and tracked by the research ship Sergey Korolev somewhere in the Atlantic.

It is worth remembering that the Soviet approach was, from the early days of space research, geared to space station technology.

On the many occasions that invitations came from Kensington Gardens to attend film shows and discussion sessions there was always the same question put by the hosts 'which do you consider the best way to plan visits to the Moon and other planets'. Many of us were of the opinion that the two step method seemed the most economical. The concept is still the same but the method now is the Shuttle. Alas there are fewer invitations for such discussions now. The early dreams are somewhat later than was expected yet perhaps the improvements in the techniques have been worth it.

There is however another side to all this. At the moment the financial restraints are beginning to bite. The bite is indeed so great that there is a danger that a great deal of expertise and valuable data will be thrown away at a time when quite exceptional new knowledge is available for collection. Yet these so very successful units are to be axed. Axed for the want of funds so small when considered against the background of the whole of industry. Half a century of endeavour will be jettisoned at the very moment when the object of that endeavour is within reach.

Is it that the world has become so blasé that a football match is of more importance than an achievement which can contribute to the eradication of problems? Is it perhaps too much to expect that every thinking person should have some regard for the future and be willing to learn that their peace of mind and well being can be assured by wise use of the resources of the solar system? The exploitation of these resources for the benefit of the people of the solar system is, surely, a worthwhile goal. The sum of money required to continue is the cost of the annual operations to collect and analyse data which cannot be repeated perhaps for as much as a hundred years, yet that cost is less than the cost of an airplane for weather research.

### PIONEER 10 AND 11

The principal objects which technology has put into space and which have given returns so far which exceed by a great margin the design expectations, are the spacecraft Pioneer 10 and 11. The chronicle of what has been achieved and the impact made on even general knowledge is immense. Part of the next SPACEWATCH will be devoted to a survey of the accomplishments such as the accurate survey of the magnetic field of Jupiter; determination of the distribution of high energy particles in Jupiter's magnetosphere (including an explanation of the source of Jupiter's previously known decimetric radio emission); discovery of absorption effects of the Galilean satellites; discovery of the planet's magnetodisc and many contributions to understanding the sources; and the physical dynamics of charged particles trapped in the planet's magnetic field.

At the present time both these craft are in the outer areas of the solar system and moving out in opposite directions. By 1990 Pioneer 10 will be in the interstellar medium and still healthy.

## Frank W. Hyde

### SHUTTLE ORBITER

A new problem of natural science has shown itself on the last shuttle mission. Photographs show that the vehicle glows in the dark. It was an unexpected phenomenon and could give rise to adverse conditions when carrying out observation on the dark side of the vehicle. There are a number of planned optical payloads for observations on the dark side of each orbit. Also there are scheduled tasks involving infrared techniques, low level light sensors and astronomical tasks.

The glow appears on the edges of the manoeuvring systems, the vertical stabiliser and other edged parts. The theory is that this is a chemiluminescent effect caused by atomic oxygen. It is thought that the atomic oxygen impacting the vehicle builds up into molecules of oxygen and when these are shed they may give off photons as they slow down when separating from the vehicle. It is believed that all parts of the spacecraft which are covered with tiles give off this glow when facing into the velocity vector.

### INSAT 1A SATELLITE TESTED IN ORBIT

The first pictures from the Indian satellite, a multipurpose spacecraft, indicated weather patterns over India and the surrounding oceans and land mass. This satellite will enable India to make observations for detailed forecasts of flooding. The image is provided by a very high resolution radiometer operating in the range 0.55-0.75 micrometres. There is also infrared imagery capability in the range 12.5 to 10.5 micrometres.

Most systems seem to be working according to the planned programme. It is however a disappointment that the solar sails were not able to be successfully deployed.

### SOVIET ACTIVITIES

The Soviet Union have been active in orbits which can monitor happenings in the South Atlantic. It has been the custom by the Soviet Union to regularly use this region in order to replace spacecraft which become degraded. The task of surveillance is thus kept in continuing operation. A particular vehicle

# Ingenuity Unlimited

A selection of readers' original circuit ideas. Why not submit *your* idea? Any idea published will be awarded payment according to its merits.

Each idea submitted must be accompanied by a declaration to the effect that it has been tried and tested, is the original work of the undersigned, and that it has not been offered or accepted for publication elsewhere. It should be emphasised that these designs have not been proven by us. They will at any rate stimulate further thought.

Articles submitted for publication should conform to the usual practices of this journal, e.g. with regard to abbreviations and circuit symbols. Diagrams should be on separate sheets, not in the text.

## COURTESY LIGHT DELAY

WITH this circuit, when a door is opened and the ignition turned off, in either order, capacitor C1 is discharged through switch S1 via diode D1 and transistor TR2 is turned off. When the door is closed, switch S1 opens and transistor TR1 conducts the lamp current since its gate is held at +12V via resistor R1. The potential drop across transistor TR1 causes capacitor C1 to charge through resistor R2. As the potential across capacitor C1 increases transistor TR2 begins to conduct and the potential at the gate of transistor TR1 is reduced. This reduces the current through transistor TR1 which increases the potential drop across it and therefore increases the charging rate of capacitor C1, so that the lamp is turned off rapidly. Consequently the power dissipated in transistor TR1 is very low and there is no real need for a heatsink.

Transistor TR2 can also be turned on by the ignition supply through resistors R3 and R4 and diode D2, hence starting the car will extinguish the light.

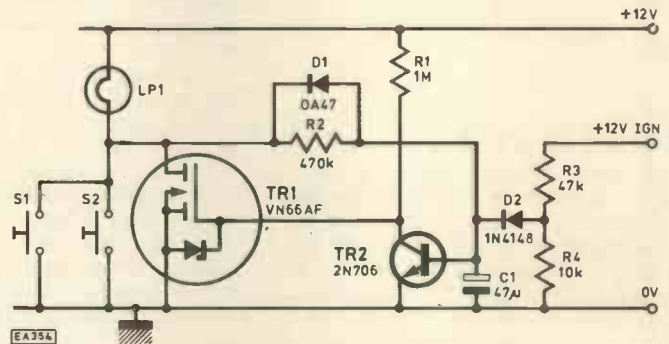

The time delay can be altered by varying capacitor C1 and resistor R2. Check that diode D2 does not have a significant reverse leakage current as this could prevent capacitor C1 from charging sufficiently. The circuit should be tested using a lamp of the same rating as that in the vehicle to which it is to be fitted as this will affect the potential drop across transistor TR1 and hence the charging rate of capacitor C1. If too large a value is chosen for resistor R1 the unit may never turn the light off. The reason for this is that the

potential at the base of transistor TR2 is determined by resistor R1 and the leakage resistances of capacitor C1 and diode D2 and this could be too low for transistor TR2 to conduct. A germanium diode is preferable for D1 because capacitor C1 will then discharge faster when switch S1 is closed. This ensures that the full time delay is obtained even if the door is only opened for a short time.

G. H. Wostenholm,  
Manchester.

## CB "ROGER BLEEP"

THIS circuit has been used in conjunction with my CB radios for some three months now. It produces a short burst of tone, on releasing the transmit switch, whilst also holding the radio in the transmit mode for the duration of the tone. I have found it very useful for communicating over a distance when the signals are weak and barely audible in that it gives a positive indication of when one party has ceased transmission.

Apart from supply and ground, there are two connections to the radio. One is the 'press to talk' (ptt) line and the other is the microphone input to the radio. In order to transmit, the ptt line is grounded. On releasing the transmit switch the line moves to nearly  $V_{cc}$ . TR1 and its CR input converts this voltage change into a pulse, inverts it and triggers the monostable IC1. The output of IC1 goes high releasing the reset hold on the oscillator IC2. The tone output of this is fed, via C4 and R7, to the microphone input. TR2 inverts IC1 output

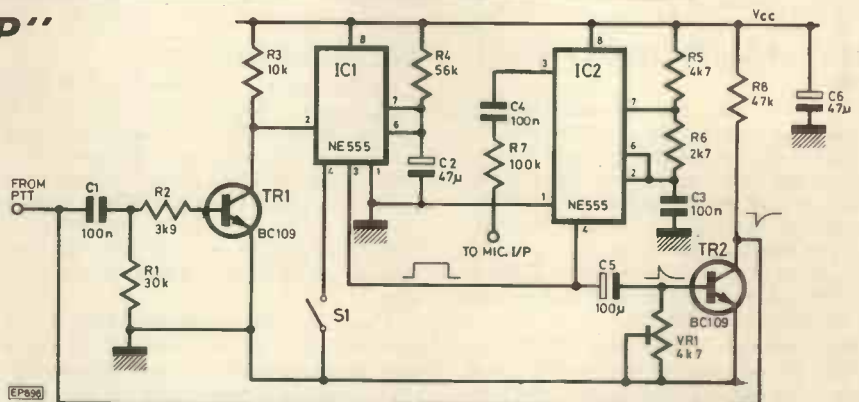

and uses it to hold down the ptt line. C5/VR1 ensure ptt goes high again, switching off the transmitter, just before IC1 completes its monostable action, thus ensuring it does not retrigger itself.

R4/C2 will set the monostable time. R5/R6/C3 set the frequency of the tone. Finally, VR1 is set to maximum then backed off, whilst keying the transmitter

on and off, until IC1 stops retriggering itself. S1 (on/off) holds down the reset on IC1 disabling the circuit. I rewired the channel 9/off switch on my radios to accomplish this.  $V_{cc}$  may vary from radio to radio so some experimentation may be necessary with the CR times.

C. J. Lawrie,  
Norwich, Norfolk.



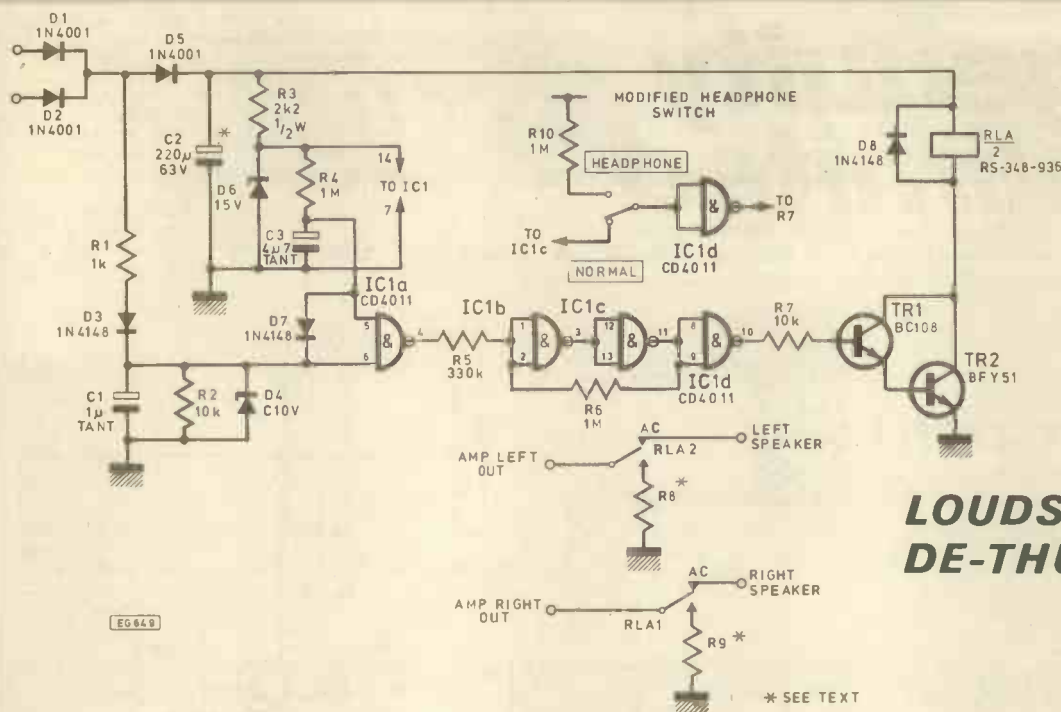

## LOUDSPEAKER DE-THUMP

**T**HE thumps, hisses and crackles that emerge from the speakers as most audio amplifiers are switched on and off are annoying and probably damaging. These noises arise from several sources, although the biggest offenders are capacitors which give rise to current surges as they charge and discharge.

It is desirable to prevent these from reaching the speakers and the easiest way to do this is to connect a relay in series with the amplifier outputs. This relay should close (connecting the speakers) about five seconds after switch on and open immediately after switch off. The circuit described here performs this function at a reasonably low cost, and is, above all, easy to connect to an existing amplifier. Apart from the relay only three connections are required, these being two a.c. lines and a centre tap.

An unrectified a.c. supply with a centre tap is required from the amplifier. The exact voltage is unimportant, but at least 15 volts must be available.

The a.c. supply is rectified by D1 and D2. The unsmoothed d.c. is passed via the current limiting resistor R1 to the power down detector. D3 allows C1 and R2 to develop a very rough d.c. voltage clamped by D4 at 10 volts. This d.c. voltage decays very rapidly (in less than 15 ms) when the power is removed. As a result pin 6 of the i.c. is high when power is applied and falls very quickly once the power is removed. It is worth noting that 10 volts is well above the threshold for a CMOS gate with a 15 volt supply but obviously decays more quickly than 15 volts would under the same circumstances.

The rectified d.c. is also passed via D5 to C2 which forms the circuit's power supply. D5 is necessary to prevent the smoothed d.c. from affecting the operation of the power down detector. The voltage available on C2 is then fed to a simple resistor/Zener network to generate a 15 volt supply for the i.c.

R4 and C3 form the switch on delay. Initially C3 will be discharged and pin 5 of the i.c. will be low. When power is applied C3 will charge up by means of R4, taking pin 5 above the gate threshold some 5 seconds after switch on. D7 removes the charge from C2 immediately the power is removed by forming a discharge path through the power down detector's resistor, R2. This ensures that a delay will occur even if the power is removed for a very short period.

The i.c. contains four NAND gates, details of which are easily available— suffice to say a NAND gate's output will be low if both inputs are high, otherwise the output will be high. So far then, the output of IC1a will be high for five seconds after switch on and immediately after switch off. A Schmitt trigger follows because the inputs to the gate are slow edged and the output will be prone to jitter. The Schmitt trigger is composed of gates b and c, R5 and R6. The values of resistor have been chosen to give hysteresis between  $\frac{1}{2}$  and  $\frac{2}{3}$  of the gate threshold.

The output from the trigger is inverted by gate d and drives the relay by means of the Darlington pair TR1 and TR2. Any back e.m.f. from the relay is caught by D8.

The relay used is a 2-pole heavy duty

continental type. This relay will be suitable for all amplifiers with up to 27 volt a.c. supplies (indicating an amplifier of greater than 33 watts per channel output). A printed circuit board socket must be purchased with the relay.

For larger amplifiers a member of the Octal series is recommended, and the 48 volt version is generally suitable. This relay will not fit onto the circuit board and must be connected using flying leads from the relay drive points marked on the p.c.b. If R8 and R9 (see below) are not required either, the end of the p.c.b. is redundant and may be cut off.

If the d.c. voltage on C2 is likely to exceed 63 volts, a 100 volt version must be used for C2 and a 560 ohm 1 watt resistor connected in series with the relay coil. It is assumed that if this is the case the "Octal" style relay will be used as a matter of course.

If the amplifier is d.c. coupled (i.e. has no output capacitor) then R8 and R9 may be omitted. However, an a.c. coupled amplifier must be provided with a means to allow the output capacitors to charge up. In this case R8 and R9 must be installed—a value of 8 ohms will do for all amplifiers. The resistors should be at least 3 watt wire wound types.

It is quite probable that the amplifier will have some resistors already present to attenuate the headphone signals. It is quite convenient to use these. Indeed, a small modification to the circuit allows the relay to be used as a headphone switch or a convenient mute system.

I. C. Lare, B.Sc., M.Sc.,  
Hartford, Cheshire.

# Patents Review

Copies of Patents can be obtained from:  
the Patent Office Sales, St. Mary Cray, Orpington, Kent. Price £1.60 each.

## ICE WARNING

British patent application 2 083 244, from Damien McDonnell of Malvern, Worcestershire, gives full technical details of a new development from the Royal Signals and Radar Establishment in Malvern. The idea is to replace existing road cat's eyes with a new type which use the temperature sensitivity of a liquid crystal material to give a tell-tale of road conditions. For instance above 0°C the cat's eye reflects blue light, but as the temperature drops to 0°C and below the colour changes through green and yellow to red. In this way a car driver knows whether there is likely to be black ice on the road. The invention is particularly interesting because it ties in with other work on liquid crystals which is going on at Malvern.

Much of the pioneering work on liquid crystal displays was carried out at Malvern. Even now many Japanese companies buy their liquid crystal raw materials from British companies, such as BDH of Poole. (It is a tragedy that Britain, having developed liquid crystal technology, never took advantage of the lead and left the mass production of finished liquid crystal displays to Japan.) Several Japanese companies, for instance Hitachi and Toshiba, have already demonstrated prototype pocket tv sets which use a liquid crystal display for the screen. Until recently it had been supposed that l.c.d.s, which modify ambient light rather than generated light, could not be used to produce colour tv pic-

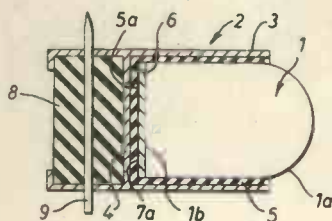

Fig. 1

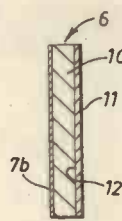

Fig. 2

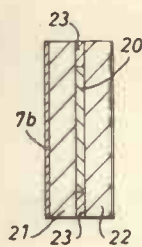

Fig. 3

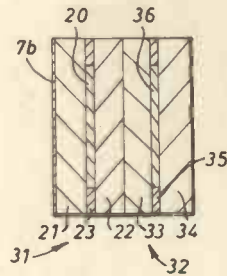

Fig. 4

tures. But Professor Hilsum of RSRE recently demonstrated a liquid crystal display which changes colour in an electric field and hinted that the technology could be used to make colour tv screens of l.c.d. type. British patent application 2 083 244 gives a detailed insight into Malvern's work on l.c.d. materials that change colour with temperature. Hopefully patents on the colour tv technology will eventually be published.

Light which falls on the cat's eye shown in Figure 1 is focused by lens 1 onto reflector 6. This can take the form shown in Figure 2. A transparent substrate 10, of Mylar plastics, has a front surface layer 11 of cholesteric liquid crystal material and is backed with layer 7b of light absorbing material, such as graphite. The wavelength, and thus the colour, of the light reflected back through lens 1 depends directly on the temperature of the cholesteric material.

In the alternative construction shown in Figure 3, layer 20 of cholesteric material is

sandwiched between two pieces of Mylar 21, 22. Again the colour of the light reflected back through the lens 1 depends on the temperature of the cholesteric layer. The patent gives the formula for a material which changes from violet to red, through blue turquoise, green and yellow across the temperature range of 24°C down to -2.2°C.

Figure 4 shows a clue to the future. In this case two separate liquid crystal layers 20 and 36 are sandwiched between Mylar sheets. Front layer 36 is clear above 0°C, but turns red below freezing point. The rear layer 20 changes its colour at temperatures above 0°C. So coloured light from the rear layer 20 is seen through layer 36 while it remains clear. Then the front layer takes over as the active element. In this way a much wider range of colour changes can be produced. This suggests one line of approach towards producing a full spectrum of colour from an l.c.d. tv screen.

## FM NOISE ELIMINATION

The Clarion Company of Tokyo patents (BP 1 573 160 filed under the Old Laws and dating back to 1976) a circuit which is claimed to eliminate noise from an FM radio receiver. The Japanese inventors say they are seeking an alternative to the conventional system in which an impulsive noise switches a low pass filter for a few tens of microseconds. The problem is that in such circuits the 19kHz pilot tone and 38kHz sub-carrier are lost unless the circuit is peaked to let these frequencies through; in which case 19kHz and 38kHz noise is not eliminated.

Figure 5 shows the patented Clarion circuit. The output of low pass filter 1 is branched and one half of the split signal fed through phase inverter 2 to stereo blocking circuit 3, amplifier 4 and combining potentiometer 5. Circuit 3 includes 19kHz

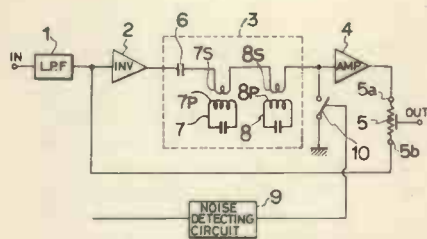

Fig. 5

parallel resonance circuit 7 and 38kHz parallel resonance circuit 8. Gate 10 can short circuit 3 to earth under the control of circuit 9 which detects impulsive noise. The second signal path branched from filter 1 goes direct to combiner 5.

In the absence of noise the first signal

path is earthed by gate 10. Capacitor 6 charges with L+R, and current flows through resonance circuits 7 and 8 which store the pilot tone and carrier signal energy. Only the signal from the second path reached combiner 5. When noise is detected at 9, gate 10 changes state and the charge on capacitor 6 is cancelled by the phase-inverted signal from circuit 2. Simultaneously, resonance circuits 7, 8 release their stored energy to cancel the pilot tone and sub-carrier. Hence only the noise components are faithfully transmitted to input 5a of the combiner 5 while the complete stereo signal is applied to terminal 5b. Because the noise is phase inverted it is cancelled out across resistor 5 and a noise-free output is derived. There is no circuit element connected to the second signal path so the noise reduction circuit should have no effect on phase and amplitude of the stereo signal.

# THE CASE FOR



## It's the chance every constructor wants

## Did you know

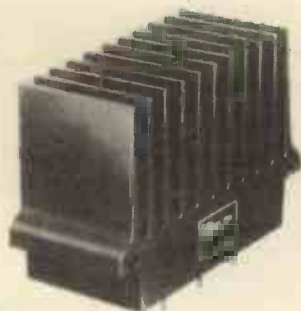

**POWER AMPS**



**P.S.U's**



**PRE-AMP MODULES**

It's something you have always wanted....something to build your equipment into that's smart, modern, strong, adaptable to requirement and not expensive. The 'UniCase' is yet another triumph of I.L.P. design policy. It presents totally professional appearance and finish, ensuring easier and better assembly to make it equal to the most expensive cased equipment. The all-metal 'UniCase' is enhanced by precision aluminium extruded panels engineered for speedy and perfect aligned assembly within a mere five minutes. Designed in the first case to accommodate I.L.P. power amps with P.S.U's, the range will shortly be extended to house any other modular projects.

I.L.P. are the world's largest designers and manufacturers of hi-fi audio modules?

I.L.P. pioneered encapsulated power amps and pre-amps for enhanced thermal stability, mechanical protection and durability?

There are TWENTY power amplifiers from 15 to 240 watts RMS including the very latest super-quality Mosfets to choose from?

TWENTY pre-amp modules allow you to incorporate exciting professional applications to your equipment never before available to constructors and experimenters?

I.L.P. are suppliers to the B.B.C., I.B.A., N.A.S.A., British Aerospace, Marconi, Racal, Ferranti, G.E.C., Rolls Royce etc?

Goods are despatched within 7 days of your order reaching us and covered by our 5 year no-quibble guarantee?

## WHAT WE DO FOR CONSTRUCTORS

Our product range is now so vast we cannot possibly hope to show it all in our advertisements without overcrowding or abridging information to the point of uselessness. So we have devised a solution which we invite you to take advantage of without delay. ALL YOU NEED DO IS FILL IN AND FORWARD THE COUPON BELOW TO RECEIVE OUR NEWEST COMPREHENSIVE I.L.P. CATALOGUE POST FREE BY RETURN. It gives full details of all current I.L.P. products for the constructor together with prices, full technical and assembly details, wiring and circuit diagrams etc. and it's yours, FREE. You don't even have to stamp the envelope if you address it the way we tell you.



**FREEPOST 2**  
GRAHAM BELL HOUSE, ROPER CLOSE, CANTERBURY CT2 7EP  
Telephone Sales (0227) 54778 Technical Only (0227) 64723 Telex 965780

**FREEPOST**  
Mark your envelope clearly FREEPOST 2 and post it WITHOUT a stamp to I.L.P. at address above. We pay postage when your letter reaches us.

**SEND COUPON**  
(NO STAMP NECESSARY)  
**FOR YOUR FREE**  
**I.L.P. CATALOGUE**  
**AND OPEN UP**  
**TO A**  
**NEW WORLD OF**  
**QUALITY & VALUE**

To: I.L.P. ELECTRONICS LTD.  
PLEASE SEND ME I.L.P. CATALOGUE,  
POST PAID BY RETURN

Name: \_\_\_\_\_

Address: \_\_\_\_\_

I HAVE/HAVE NOT PREVIOUSLY  
BUILT WITH I.L.P. MODULES

*I.L.P. products are available also from Henry's, Marshall's, Technomatic & Watford.*

# BI-PAK

## "IRRESISTABLE RESISTOR BARGAINS"

Pak No	Qty	Description	Price
SX10	400	Mixed 'All Type' Resistors	£1
SX11	400	Pre formed 1/2 watt Carbon Resistors	£1
SX12	200	1/2 watt Carbon Resistors	£1
SX13	200	1/2 watt Carbon Resistors	£1
SX14	150	1/2 watt Resistors 22 ohm 2m2 Mixed	£1
SX15	100	1 and 2 watt Resistors 22 ohm 2m2 Mixed	£1

Paks SX12-15 contain a range of Carbon Film Resistors of assorted values from 22 ohms to 2.2 meg. Save pounds on these resistor paks and have a full range to cover your projects.  
Quantities approximate. Count by weight.

## "CAPABLE CAPACITOR PAKS"

Pak No	Qty	Description	Price
SX16	250	Capacitors Mixed Types	£1
SX17	200	Ceramic Capacitors Miniature Mixed	£1
SX18	100	Mixed Ceramics 1p1 5 pf	£1
SX19	100	Mixed Ceramics 68p1 0.5m1	£1
SX20	100	Assorted Polyester/Polystyrene Capacitors	£1
SX21	60	Mixed C280 Type capacitors metal foil	£1
SX22	100	Electrolytics, all sorts	£1
SX23	50	Quality Electrolytic 50 1000mf	£1
SX24	20	Tantalum Beads mixed	£1

Quantities approximate. Count by weight.

## AUDIO PLUGS, SOCKETS AND ACCESSORIES

**25** pieces of Audio Plugs, Sockets and Connectors to include DIN 180, 240, In-line 3 & 6 Pin Speakers, Phono Jack Stereo and Mono etc. Valued at well over £3 normal. Order No. SX25 Our Price £1.50 per pak. Guaranteed to save you money.

SX26	3 Pcs.	of 6 pin 240 DIN Plugs and Chassis Sockets	50p
SX27	1 x Right Angle Stereo Jack Plug & 3mm plus matching metal chassis mounting socket	30p	
SX28	1 Phono plug, and 2 dual phono connectors	20p	
SX29	1 x 2.5mm Plug to 3.5mm Socket adaptor	20p	
SX30	1 x 3.5mm Plug to 2.5mm Socket adaptor	20p	
SX31	1 x 3.5mm Plug to Phono Socket adaptor	20p	

## 1 Amp SILICON RECTIFIERS

Glass Type similar IN4000 SERIES IN4001-IN4004 50 - 500v - uncoded - you select for ULTS - ALL perfect devices - NO duds Min 50v 50 for £1.00 - worth double ORDER NO. SX76

Silicon General Purpose NPN Transistors TO-18 Case Lock In leads - coded CV7644 Similar to BC147 - BC107 - Z789 ALL NEW! VCE 70v IC500mA Hfe 75-250 50 off 100 off 500 off 1000 off  
PRICE £2.00 £3.80 £17.50 £30.00

Silicon General Purpose PNP Transistors TO-18 Case Lock In leads coded CV9507 similar ZN950A to BF430 Vc 60 IC 600mA Min Hfe 50 ALL NEW! 50 off 100 off 500 off 1000 off  
PRICE £2.50 £4.00 £19.00 £35.00  
Order as CV9507

## BARGAINS

SX91	20 x Large 2" RED LED	£1
SX42	20 small 125 Red LED's	£1
SX43	10 Rectangular Green LED's 2	£1
SX46	30 Assorted Zener Diodes	£1
	250mw 2 watt mixed voltages all coded New	£1
SX47	4 Black Instrument Knobs - winged with pointer 1/2" Standard screw Fit size 29 x 20mm	50p
SX49	20 Assorted Slider Knobs Black/Chrome etc	£1
SX80	12 Neons and Filament Lamps Low voltage and mains - various types and colours - some panel mounting	£1

## Silicon NPN'L' Type Transistors

TO-92 Plastic centre collector Like BC182L - 183L - 184L VCEO 45 VCE0 30 IC200mA Hfe 100-400 ALL perfect devices - uncoded ORDER AS SX183L 50 off 100 off 500 off 1000 off  
£1.50 £2.50 £10.00 £17.00

## PNP SILICON TRANSISTORS:

Similar ZTX500 - ZTX214 - E-Line VCEO 40 VCB0 35 Ic 300mA Hfe 50-400 Brand New - Uncoded Perfect Devices 50 off 100 off 500 off 1000 off  
£2.00 £3.50 £15.00 £25.00  
Order as ZTXPNP

## BI-PAK PCB ETCHANT AND DRILL KIT

Complete PCB Kit comprises  
1 Expo Mini Drill 10 000RPM 12v DC incl 3 collets & 1 x 1mm Twist bit  
1 Sheet PCB Transfers 210mm x 150mm  
1 Etch Resist Pen  
1 1/2lb pack FERRIC CHLORIDE crystals  
3 sheets copper clad board  
2 sheets Fibreglass copper clad board  
Full instructions for making your own PCB boards  
Retail Value over £15.00  
OUR BI-PAK SPECIAL KIT PRICE £9.75  
ORDER NO. SX81

## BI-PAK SOLDER - DESOLDER KIT

Kit comprises ORDER NO. SX80  
1 High Quality 40 watt General Purpose Lightweight Soldering Iron 240v mains 3/16" (4.7mm) bit  
1 Quality Desoldering pump - High Suction w/ automatic ejection knurled anti-corrosive casing and teflon nozzle  
1 5 metres of De-soldering braid on plastic dispenser  
2 yds 1/16" 83mi Resin Cored Solder on Card  
1 Heat Shunt tool tweezers Type  
Total Retail Value over £12.00  
OUR SPECIAL KIT PRICE £8.95

## BI-PAK'S COMPLETELY NEW CATALOGUE

Completely re-designed. Full of the type of components you require, plus some very interesting ones you will soon be using and of course, the largest range of semiconductors for the Amateur and Professional you could hope to find.

There are no wasted pages of useless information so often included in Catalogues published nowadays. Just solid facts - price, description and individual features of what we have available. But remember, Bi-Pak's policy has always been to sell quality components at competitive prices and THAT WE STILL DO.

BI-PAK'S COMPLETELY NEW CATALOGUE is now available to you. You will be amazed how much you can save when you shop for Electronic Components with a Bi-Pak Catalogue. Have one by you all the time - it pays to buy BI-PAK.

To receive your copy send **75p** plus 25p p&p

Send your orders to Dept PE8  
BI-PAK PO BOX 6 WARE HERTS.  
SHOP AT 3 BALDOCK ST.  
WARE HERTS.



Use your credit card. Ring us on Ware 3182 NOW and get your order even faster. Goods normally sent 2nd Class Mail.  
Remember you must add VAT at 15% to your order.  
Total Postage add 75p per Total order.

## PE CAR COMPUTER

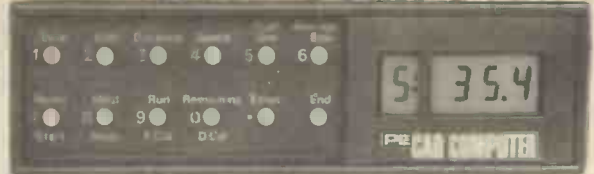

"One of the neatest, most comprehensive and most useful of these car computers that we have yet come across..." PRACTICAL MOTORIST  
The PE Car Computer was designed to exceed the specification of all others, both for number of functions and accuracy.

It provides three classes of information:

**Driving information** - 7 functions including miles per gallon (or litres per 100 kilometres), speed, fuel used.

**Journey information** - 11 functions such as how far to go, ETA, how far you can go on fuel left, how fast you need to drive to meet an arrival time.

**Car performance information** - measure acceleration (eg. 0 to 60), starting quarter miles, braking tests and much more using the unique "programmed" mode. Check which types of driving are particularly uneconomic, tune your car for optimum performance and economy.

The unit also incorporates an ignition cut-out as an optional extra. Set the lock and the engine will not restart until a three digit combination is entered.

The unit is housed in a custom designed box with high quality printed panels and can be fitted above or below the dashboard. The display is liquid crystal for clarity in all lighting conditions.

The kit includes all sensors, wiring, etc and is suitable for all cars except those fitted with diesel or fuel injection engines.

**Kit price: £78.50 Assembled Price: £88.50**

Ignition cut-out £7.75 + £1 p&p includes VAT.

Goods by return of post. Send S.A.E. for list of separately available parts.



## PIMAC SYSTEMS LTD

20 Bloomfield Road, Moseley, Birmingham B13 9BY.  
Tel: 021-449 0384

## SINCLAIR COMPUTERS

We are the leading world-wide Sinclair export specialist including Norway, Sweden, Finland and Denmark. Write for our surprising low prices.

## PRINTERS

Buy any of the below and get a free interface kit and word processor program for UK101 or Superboard only £10. The below accessories suit both the UK101 and Superboard - Extra ram £2.10 per K. Cegmon £22.50, Wernon £14.95. Word processor program £10. Centronics interface kit £10. 610 expansion board £179. Cased minifloppy disc drives with DOS single £275, dual £415.

Buy any of the below and get a free interface kit and word processor program for UK101 or Superboard only £10. The below accessories suit both the UK101 and Superboard - Extra ram £2.10 per K. Cegmon £22.50, Wernon £14.95. Word processor program £10. Centronics interface kit £10. 610 expansion board £179. Cased minifloppy disc drives with DOS single £275, dual £415.

Buy any of the below and get a free interface kit and word processor program for UK101 or Superboard only £10. The below accessories suit both the UK101 and Superboard - Extra ram £2.10 per K. Cegmon £22.50, Wernon £14.95. Word processor program £10. Centronics interface kit £10. 610 expansion board £179. Cased minifloppy disc drives with DOS single £275, dual £415.

Buy any of the below and get a free interface kit and word processor program for UK101 or Superboard only £10. The below accessories suit both the UK101 and Superboard - Extra ram £2.10 per K. Cegmon £22.50, Wernon £14.95. Word processor program £10. Centronics interface kit £10. 610 expansion board £179. Cased minifloppy disc drives with DOS single £275, dual £415.

Buy any of the below and get a free interface kit and word processor program for UK101 or Superboard only £10. The below accessories suit both the UK101 and Superboard - Extra ram £2.10 per K. Cegmon £22.50, Wernon £14.95. Word processor program £10. Centronics interface kit £10. 610 expansion board £179. Cased minifloppy disc drives with DOS single £275, dual £415.

Buy any of the below and get a free interface kit and word processor program for UK101 or Superboard only £10. The below accessories suit both the UK101 and Superboard - Extra ram £2.10 per K. Cegmon £22.50, Wernon £14.95. Word processor program £10. Centronics interface kit £10. 610 expansion board £179. Cased minifloppy disc drives with DOS single £275, dual £415.

Buy any of the below and get a free interface kit and word processor program for UK101 or Superboard only £10. The below accessories suit both the UK101 and Superboard - Extra ram £2.10 per K. Cegmon £22.50, Wernon £14.95. Word processor program £10. Centronics interface kit £10. 610 expansion board £179. Cased minifloppy disc drives with DOS single £275, dual £415.

Buy any of the below and get a free interface kit and word processor program for UK101 or Superboard only £10. The below accessories suit both the UK101 and Superboard - Extra ram £2.10 per K. Cegmon £22.50, Wernon £14.95. Word processor program £10. Centronics interface kit £10. 610 expansion board £179. Cased minifloppy disc drives with DOS single £275, dual £415.

Buy any of the below and get a free interface kit and word processor program for UK101 or Superboard only £10. The below accessories suit both the UK101 and Superboard - Extra ram £2.10 per K. Cegmon £22.50, Wernon £14.95. Word processor program £10. Centronics interface kit £10. 610 expansion board £179. Cased minifloppy disc drives with DOS single £275, dual £415.

Buy any of the below and get a free interface kit and word processor program for UK101 or Superboard only £10. The below accessories suit both the UK101 and Superboard - Extra ram £2.10 per K. Cegmon £22.50, Wernon £14.95. Word processor program £10. Centronics interface kit £10. 610 expansion board £179. Cased minifloppy disc drives with DOS single £275, dual £415.

Buy any of the below and get a free interface kit and word processor program for UK101 or Superboard only £10. The below accessories suit both the UK101 and Superboard - Extra ram £2.10 per K. Cegmon £22.50, Wernon £14.95. Word processor program £10. Centronics interface kit £10. 610 expansion board £179. Cased minifloppy disc drives with DOS single £275, dual £415.

Buy any of the below and get a free interface kit and word processor program for UK101 or Superboard only £10. The below accessories suit both the UK101 and Superboard - Extra ram £2.10 per K. Cegmon £22.50, Wernon £14.95. Word processor program £10. Centronics interface kit £10. 610 expansion board £179. Cased minifloppy disc drives with DOS single £275, dual £415.

Buy any of the below and get a free interface kit and word processor program for UK101 or Superboard only £10. The below accessories suit both the UK101 and Superboard - Extra ram £2.10 per K. Cegmon £22.50, Wernon £14.95. Word processor program £10. Centronics interface kit £10. 610 expansion board £179. Cased minifloppy disc drives with DOS single £275, dual £415.

Buy any of the below and get a free interface kit and word processor program for UK101 or Superboard only £10. The below accessories suit both the UK101 and Superboard - Extra ram £2.10 per K. Cegmon £22.50, Wernon £14.95. Word processor program £10. Centronics interface kit £10. 610 expansion board £179. Cased minifloppy disc drives with DOS single £275, dual £415.

Buy any of the below and get a free interface kit and word processor program for UK101 or Superboard only £10. The below accessories suit both the UK101 and Superboard - Extra ram £2.10 per K. Cegmon £22.50, Wernon £14.95. Word processor program £10. Centronics interface kit £10. 610 expansion board £179. Cased minifloppy disc drives with DOS single £275, dual £415.

Buy any of the below and get a free interface kit and word processor program for UK101 or Superboard only £10. The below accessories suit both the UK101 and Superboard - Extra ram £2.10 per K. Cegmon £22.50, Wernon £14.95. Word processor program £10. Centronics interface kit £10. 610 expansion board £179. Cased minifloppy disc drives with DOS single £275, dual £415.

Buy any of the below and get a free interface kit and word processor program for UK101 or Superboard only £10. The below accessories suit both the UK101 and Superboard - Extra ram £2.10 per K. Cegmon £22.50, Wernon £14.95. Word processor program £10. Centronics interface kit £10. 610 expansion board £179. Cased minifloppy disc drives with DOS single £275, dual £415.

Buy any of the below and get a free interface kit and word processor program for UK101 or Superboard only £10. The below accessories suit both the UK101 and Superboard - Extra ram £2.10 per K. Cegmon £22.50, Wernon £14.95. Word processor program £10. Centronics interface kit £10. 610 expansion board £179. Cased minifloppy disc drives with DOS single £275, dual £415.

Buy any of the below and get a free interface kit and word processor program for UK101 or Superboard only £10. The below accessories suit both the UK101 and Superboard - Extra ram £2.10 per K. Cegmon £22.50, Wernon £14.95. Word processor program £10. Centronics interface kit £10. 610 expansion board £179. Cased minifloppy disc drives with DOS single £275, dual £415.

Buy any of the below and get a free interface kit and word processor program for UK101 or Superboard only £10. The below accessories suit both the UK101 and Superboard - Extra ram £2.10 per K. Cegmon £22.50, Wernon £14.95. Word processor program £10. Centronics interface kit £10. 610 expansion board £179. Cased minifloppy disc drives with DOS single £275, dual £415.

Buy any of the below and get a free interface kit and word processor program for UK101 or Superboard only £10. The below accessories suit both the UK101 and Superboard - Extra ram £2.10 per K. Cegmon £22.50, Wernon £14.95. Word processor program £10. Centronics interface kit £10. 610 expansion board £179. Cased minifloppy disc drives with DOS single £275, dual £415.

Buy any of the below and get a free interface kit and word processor program for UK101 or Superboard only £10. The below accessories suit both the UK101 and Superboard - Extra ram £2.10 per K. Cegmon £22.50, Wernon £14.95. Word processor program £10. Centronics interface kit £10. 610 expansion board £179. Cased minifloppy disc drives with DOS single £275, dual £415.

Buy any of the below and get a free interface kit and word processor program for UK101 or Superboard only £10. The below accessories suit both the UK101 and Superboard - Extra ram £2.10 per K. Cegmon £22.50, Wernon £14.95. Word processor program £10. Centronics interface kit £10. 610 expansion board £179. Cased minifloppy disc drives with DOS single £275, dual £415.

Buy any of the below and get a free interface kit and word processor program for UK101 or Superboard only £10. The below accessories suit both the UK101 and Superboard - Extra ram £2.10 per K. Cegmon £22.50, Wernon £14.95. Word processor program £10. Centronics interface kit £10. 610 expansion board £179. Cased minifloppy disc drives with DOS single £275, dual £415.

Buy any of the below and get a free interface kit and word processor program for UK101 or Superboard only £10. The below accessories suit both the UK101 and Superboard - Extra ram £2.10 per K. Cegmon £22.50, Wernon £14.95. Word processor program £10. Centronics interface kit £10. 610 expansion board £179. Cased minifloppy disc drives with DOS single £275, dual £415.

Buy any of the below and get a free interface kit and word processor program for UK101 or Superboard only £10. The below accessories suit both the UK101 and Superboard - Extra ram £2.10 per K. Cegmon £22.50, Wernon £14.95. Word processor program £10. Centronics interface kit £10. 610 expansion board £179. Cased minifloppy disc drives with DOS single £275, dual £415.

Buy any of the below and get a free interface kit and word processor program for UK101 or Superboard only £10. The below accessories suit both the UK101 and Superboard - Extra ram £2.10 per K. Cegmon £22.50, Wernon £14.95. Word processor program £10. Centronics interface kit £10. 610 expansion board £179. Cased minifloppy disc drives with DOS single £275, dual £415.

Buy any of the below and get a free interface kit and word processor program for UK101 or Superboard only £10. The below accessories suit both the UK101 and Superboard - Extra ram £2.10 per K. Cegmon £22.50, Wernon £14.95. Word processor program £10. Centronics interface kit £10. 610 expansion board £179. Cased minifloppy disc drives with DOS single £275, dual £415.

Buy any of the below and get a free interface kit and word processor program for UK101 or Superboard only £10. The below accessories suit both the UK101 and Superboard - Extra ram £2.10 per K. Cegmon £22.50, Wernon £14.95. Word processor program £10. Centronics interface kit £10. 610 expansion board £179. Cased minifloppy disc drives with DOS single £275, dual £415.

Buy any of the below and get a free interface kit and word processor program for UK101 or Superboard only £10. The below accessories suit both the UK101 and Superboard - Extra ram £2.10 per K. Cegmon £22.50, Wernon £14.95. Word processor program £10. Centronics interface kit £10. 610 expansion board £179. Cased minifloppy disc drives with DOS single £275, dual £415.

Buy any of the below and get a free interface kit and word processor program for UK101 or Superboard only £10. The below accessories suit both the UK101 and Superboard - Extra ram £2.10 per K. Cegmon £22.50, Wernon £14.95. Word processor program £10. Centronics interface kit £10. 610 expansion board £179. Cased minifloppy disc drives with DOS single £275, dual £415.

Buy any of the below and get a free interface kit and word processor program for UK101 or Superboard only £10. The below accessories suit both the UK101 and Superboard - Extra ram £2.10 per K. Cegmon £22.50, Wernon £14.95. Word processor program £10. Centronics interface kit £10. 610 expansion board £179. Cased minifloppy disc drives with DOS single £275, dual £415.

Buy any of the below and get a free interface kit and word processor program for UK101 or Superboard only £10. The below accessories suit both the UK101 and Superboard - Extra ram £2.10 per K. Cegmon £22.50, Wernon £14.95. Word processor program £10. Centronics interface kit £10. 610 expansion board £179. Cased minifloppy disc drives with DOS single £275, dual £415.

Buy any of the below and get a free interface kit and word processor program for UK101 or Superboard only £10. The below accessories suit both the UK101 and Superboard - Extra ram £2.10 per K. Cegmon £22.50, Wernon £14.95. Word processor program £10. Centronics interface kit £10. 610 expansion board £179. Cased minifloppy disc drives with DOS single £275, dual £415.

Buy any of the below and get a free interface kit and word processor program for UK101 or Superboard only £10. The below accessories suit both the UK101 and Superboard - Extra ram £2.10 per K. Cegmon £22.50, Wernon £14.95. Word processor program £10. Centronics interface kit £10. 610 expansion board £179. Cased minifloppy disc drives with DOS single £275, dual £415.

Buy any of the below and get a free interface kit and word processor program for UK101 or Superboard only £10. The below accessories suit both the UK101 and Superboard - Extra ram £2.10 per K. Cegmon £22.50, Wernon £14.95. Word processor program £10. Centronics interface kit £10. 610 expansion board £179. Cased minifloppy disc drives with DOS single £275, dual £415.

Buy any of the below and get a free interface kit and word processor program for UK101 or Superboard only £10. The below accessories suit both the UK101 and Superboard - Extra ram £2.10 per K. Cegmon £22.50, Wernon £14.95. Word processor program £10. Centronics interface kit £10. 610 expansion board £179. Cased minifloppy disc drives with DOS single £275, dual £415.

Buy any of the below and get a free interface kit and word processor program for UK101 or Superboard only £10. The below accessories suit both the UK101 and Superboard - Extra ram £2.10 per K. Cegmon £22.50, Wernon £14.95. Word processor program £10. Centronics interface kit £10. 610 expansion board £179. Cased minifloppy disc drives with DOS single £275, dual £415.

Buy any of the below and get a free interface kit and word processor program for UK101 or Superboard only £10. The below accessories suit both the UK101 and Superboard - Extra ram £2.10 per K. Cegmon £22.50, Wernon £14.95. Word processor program £10. Centronics interface kit £10. 610 expansion board £179. Cased minifloppy disc drives with DOS single £275, dual £415.

Buy any of the below and get a free interface kit and word processor program for UK101 or Superboard only £10. The below accessories suit both the UK101 and Superboard - Extra ram £2.10 per K. Cegmon £22.50, Wernon £14.95. Word processor program £10. Centronics interface kit £10. 610 expansion board £179. Cased minifloppy disc drives with DOS single £275, dual £415.

Buy any of the below and get a free interface kit and word processor program for UK101 or Superboard only £10. The below accessories suit both the UK101 and Superboard - Extra ram £2.10 per K. Cegmon £22.50, Wernon £14.95. Word processor program £10. Centronics interface kit £10. 610 expansion board £179. Cased minifloppy disc drives with DOS single £275, dual £415.

Buy any of the below and get a free interface kit and word processor program for UK101 or Superboard only £10. The below accessories suit both the UK101 and Superboard - Extra ram £2.10 per K. Cegmon £22.50, Wernon £14.95. Word processor program £10. Centronics interface kit £10. 610 expansion board £179. Cased minifloppy disc drives with DOS single £275, dual £415.

Buy any of the below and get a free interface kit and word processor program for UK101 or Superboard only £10. The below accessories suit both the UK101 and Superboard - Extra ram £2.10 per K. Cegmon £22.50, Wernon £14.95. Word processor program £10. Centronics interface kit £10. 610 expansion board £179. Cased minifloppy disc drives with DOS single £275, dual £415.

Buy any of the below and get a free interface kit and word processor program for UK101 or Superboard only £10. The below accessories suit both the UK101 and Superboard - Extra ram £2.10 per K. Cegmon £22.50, Wernon £14.95. Word processor program £10. Centronics interface kit £10. 610 expansion board £179. Cased minifloppy disc drives with DOS single £275, dual £415.

Buy any of the below and get a free interface kit and word processor program for UK101 or Superboard only £10. The below accessories suit both the UK101 and Superboard - Extra ram £2.10 per K. Cegmon £22.50, Wernon £14.95. Word processor program £10. Centronics interface kit £10. 610 expansion board £179. Cased minifloppy disc drives with DOS single £275, dual £415.

Buy any of the below and get a free interface kit and word processor program for UK101 or Superboard only £10. The below accessories suit both the UK101 and Superboard - Extra ram £2.10 per K. Cegmon £22.50, Wernon £14.95. Word processor program £10. Centronics interface kit £10. 610 expansion board £179. Cased minifloppy disc drives with DOS single £275, dual £415.

Buy any of the below and get a free interface kit and word processor program for UK101 or Superboard

# ENFIELD ELECTRONICS

## SPECIAL MONTHLY OFFER No. 1

Hand held Micro Cassette Tape Recorder. Compact and handy, this memory device records at two speeds providing up to one hour of recording. Comes complete with mini cassette, earphone and carrying pouch.



ONLY £20.70 + 50p p&p

## SPECIAL MONTHLY OFFER No. 2

Illustrated is one of a wide range of SWR meters in stock. Other examples are:— Model 171, only £16.95 SWR/50A—just £12.95



ONLY £8.95 + 50p p&p

## BELOW IS JUST A SHORT LIST OF OUR TRANSISTORS, 74 SERIES & C MOS 4000 SERIES

TRANSISTORS				74 SERIES				C MOS 4000 SERIES			
AC107 27	BC137 32	BC212B10	BCY71 15	BD233 45	7400 zu	7480 60	7163 90	4000 22	4069 30		
AC122 27	BC138 32	BC213 10	BCY72 15	BD234 45	7401 20	7481 175	7164 100	4001 20	4070 30		
AC125 27	BC139 32	BC213A10	BCX31 17	BD235 45	7402 20	7482 70	7166 100	4002 22	4071 27		
AC126 27	BC140 32	BC213B10	BD106 65	BD236 45	7403 20	7483 68	7167 400	4006 30	4072 27		
AC127 27	BC141	BC213C10	BD115 64	BD237 45	7404 20	7484 295	7170 195	4007 26	4073 25		
AC128 27	BC142 32	BC214 10	BD116 62	BD238 45	7405 20	7485 95	7173 120	4008 36	4076 90		
AC141 28	BC143 32	BC214B10	BD121 80	BD239 45	7406 28	7486 28	7174 90	4009 36	4077 40		
AC142 28	BC147 12	BC214C10	BD123 240	BD240 55	7407 48	7489 195	7175 80	4010 45	4078 30		
AC175 28	BC148 12	BC214L10	BD131 45	BD240A55	7408 20	7490 36	7176 85	4011 24	4081 28		
AC187 28	BC149 12	BC237 18	BD132 45	BD241 55	7409 20	7491 75	7177 85	4012 28	4082 30		
AC188 28	BC153 12	BC238B30	BD133 45	BD437 47	7410 28	7492 30	7180 90	4013 40	4085 92		
AC191 70	BC154 12	BC239C30	BD135 45	BD438 47	7411 25	7493 50	7181 200	4014 92	4093 52		
AC192 70	BC157 12	BC251 12	BD136 45	BD506 55	7412 22	7494 75	7182 200	4015 98	4099 155		
AD130 100	BC158 32	BC258B30	BD137 55	BD519 47	7413 40	7495 65	7184 200	4016 39	4100 140		
AD143 95	BC159 32	BC301 30	BD138 45	BD520 55	7414 80	7496 65	7185 200	4017 82	4106 140		
AD140 95	BC160 32	BC303 30	BD139 45	BD589 100	7416 28	7497 80	7188 500	4018 87	4107 115		
AD149 105	BC161 32	BC307 30	BD140 45	BD648 100	7417 28	7100 310	7190 100	4019 61	40174 95		
AD161 50	BC162 32	BC308 30	BD155 55	BD711 48	7420 20	7104 150	7191 100	4020 96	4160 83		
AD162 50	BC168 12	BC309 10	BD175 75	BD712 48	7425 28	7105 150	7192 95	4021 72	4161 83		
AF106 50	BC169 12	BC317 10	BD176 52	BF115 28	7426 30	7107 48	7193 100	4022 82	4162 83		
AF114 65	BC170 12	BC318 10	BD177 87	BF117 28	7427 25	7109 27	7194 90	4023 25	4163 83		
AF115 50	BC171 12	BC327 10	BD178 68	BF119 100	7428 54	7110 25	7195 90	4024 30	4175 83		
AF116 65	BC172 12	BC328 10	BD179 80	BF121 55	7432 28	7116 170	7197 85	4026 152	4412 83		
AF126 55	BC173 12	BC337 12	BD180 80	BF123 60	7433 36	7118 95	7198 145	4027 50	4419 83		
AF127 50	BC174 12	BC338 12	BD185 75	BF125 55	7433 36	7119 340	7199 145	4028 102	4445 83		
AF139 52	BC177 12	BC384L30	BD186 75	BF127 60	7437 30	7121 36	7221 200	4029 140	4446 83		
AF157 50	BC178 12	BC440 40	BD187 75	BF152 32	7438 30	7129 46	7279 95	4038 117	4449 83		
AF159 52	BC179 12	BC441 32	BD188 75	BF154 15	7440 25	7122 60	74284 95	4040 97	4501 83		
BC107 12	BC181 12	BC461 30	BD189 80	BF153 32	7441 60	7123 60	74285 95	4041 115	4502 83		
BC107B12	BC182 12	BC477 20	BD190 80	BF155 50	7442 60	7126 60	74286 64	4042 80	4503 83		
BC107C12	BC183 10	BC478 20	BD195 90	BF156 40	7443 100	7135 50	74366 84	4043 90	4510 99		
BC108 12	BC183A10	BC479 20	BD196 90	BF157 35	7444 100	7141 60	74390 375	4043 90	4510 99		
BC108A12	BC183B10	BC517 12	BD197 90	BF158 35	7445 90	7143 550	74393 195	4044 95	4511 125		
BC108B12	BC183C10	BC527 12	BD198 90	BF159 35	7446 90	7144 250	75107 120	4045 90	4512 85		
BC108C12	BC184 10	BC537 12	BD199 95	BF160 35	7447 65	7147 125	75110 240	4046 152	4514 205		
BC109 12	BC184B10	BC547 12	BD200 95	BF162 32	7450 25	7148 65	75140 160	4048 67	4516 72		
BC109B12	BC184C10	BC548 12	BD201 85	BF163 32	7451 25	7150 120	75141 95	4049 60	4518 95		
BC109C12	BC184L10	BC549 12	BD202 85	BF166 30	7451 25	7151 75	75150 200	4050 47	4526 115		
BC113 18	BC186 12	BC550 12	BD203 78	BF166 60	7453 50	7153 65	75154 166	4051 80	4528 80		
BC114 18	BC187 20	BC556 12	BD204 90	BF167 60	7454 25	7154 100	75182 150	4052 85	4538 155		
BC115 18	BC204 20	BC557 12	BD205 85	BF173 32	7460 25	7155 80	75451 45	4053 75	4539 85		
BC116 18	BC205 20	BC558 12	BD206 85	BF177 35	7470 32	7156 80	75452 45	4054 150	4541 110		
BC117 18	BC207 20	BC559 12	BD207 95	BF178 32	7472 28	7157 70	75453 45	4055 135	4555 68		
BC118 18	BC208 10	BCY30 110	BD208 95	BF179 32	7473 32	7161 90	75454 95	4056 145	4561		
BC125	BC209 10	BCY31 120	BD222 45	BF180 35	7474 30	7160 90	75494 110	4066 60	4568 85		
BC126 32	BC212 10	BCY32 120	BD225 45	BF181 35	7475 35	7162 90	76003 220	4068 30	4569 85		
BC136 32	BC212A10	BCY70 15	BD232 45	BF182 35	7476 35	7162 90					

WE ARE OPEN 9 AM - 6 PM MONDAY TO SATURDAY

Delivery within 14 days

208 Baker Street · Enfield · Middlesex · 01-366 1873



# PHONOSONICS SUPERSONIC DIY KITS

## MUSIC

**KIMBER-ALLEN KEYBOARDS**  
Details in lists = From £32.43

**128-NOTE SEQUENCER**  
A digital, kbd controlled unit for most synths.  
Kit incl kbd = SET-76 £120.45

**16-NOTE SEQUENCER**  
Analogue, panel controlled unit for most synthesizers = SET-86 £64.63

**AUTOWAH UNIT**  
Automatic Wah & Swell sounds from each guitar note played = SET-58 £14.01

**CHOROSYNTH**  
30-Note chorus synth with wide variety of voices. Kit incl kbd = SET-100 £125.04

**GUITAR EFFECTS**  
8-mode filter & envelope shaper for most instruments = SET-98 £11.75

**GUITAR FREQUENCY DOUBLER**  
Orig & doubled signals can be mixed for greater depth = SET-98 £11.75

**GUITAR MULTIPROCESSOR**  
Extremely versatile sound processor. Details in list. From £84.90

**GUITAR OVERDRIVE**  
Sophisticated fuzz with filter & shape controls = SET-56 £21.17

**GUITAR SUSTAIN**  
Retains natural attack whilst extending note duration = SET-75 £11.77

**P.E. MINISONIC SYNTH\***  
Excellent 3-Oct multi-module portable synth. Kit incl kbd = From £181.56

**PHASER**  
6-Stage automatic unit with variable control = SET-88 £21.08

**PHASING & VIBRATO**  
Manual & auto control producing superb full sounds = SET-70 £36.25

**SMOOTH FUZZ**  
As the name implies! = SET-91 £11.68

**SPLIT-PHASE TREMOLO**  
Modulation, depth, rate & level under full control = SET-102 £29.98

**SWITCHED TREBLE BOOSTER**  
4 Selectable preset tone changes = SET-89 £12.51

**SYNTHESIZER INTERFACE**  
Enables guitars, mics etc to be synthesizer processed = SET-81 £9.49

**TRANSIENT GENERATOR**  
Facilities mandolin, banjo sounds etc. From a synthesizer = SET-63 £16.86

**TREMOLO UNIT**  
For most instruments. Incl speed, depth & by-pass controls = SET-116 £13.47

**WAVEFORM CONVERTER**  
Allows 5 different waveforms from synthesizer VCO = SET-67 £21.98

## EFFECTS

**AUDIO EFFECTS UNIT**  
Variable siren gen = SET-405 £15.12

**RHYTHM GENERATORS**  
Several in list = From £61.71

**WIND & RAIN EFFECTS**  
As the name says! = SET-28 £11.39

## AUDIO

**3-CHANNEL STEREO MIXER**  
With left, right & master level controls & headphone monitor = SET-107 £21.50

**3-MICROPHONE STEREO MIXER**  
Improves stereo reality = SET-108 £12.99

**6-CHANNEL MIXER**  
High spec mixer with variable impedances = SET-90 From £96.67

**COMPRESSOR**  
With level & decay-rate controls, line & mic inputs with mixer = SET-120 £25.05

**DYNAMIC NOISE LIMITER**  
Helps clean up noisy recordings = SET-97 £15.96

**GUITAR PRACTISE AMPLIFIER**  
3-Watt practise or test-monitor amp. = SET-106 £22.15

**HEADPHONE AMPLIFIER**  
For most pick-ups, decks, tuners & headphones. RIAA specs = SET-104 £21.15

**REVERBERATION UNITS**  
Several in lists = From £15.85

**VOICE OPERATED FADER**  
Automatically reduces music volume during disco talk-over = SET-30 £9.85

## TEST

**METRONOME**  
Variable for 40-240 beats per minute = SET-118 £10.58

**PULSE GENERATOR**  
Pulse width 100NS-2 secs, freq 0.1 Hz-100KHz = SET-115 £24.84

**SIGNAL TRACER & GENERATOR**  
Aids circuit testing. With frequency & level controls = SET-109 £17.50

**TUNING FORK**  
Eases tuning of acoustic & electronic instruments = SET-46 £37.04

**WAVEFORM GENERATOR**  
3 Waveforms, range 1Hz to 100KHz, up to 10V P-P = SET-112 £23.13

## C.B.

These are suitable for CB or standard audio use depending on socket type chosen.

**FUNNY TALKER**  
Modified ring modulator for fascinating metallic quality to your voice.  
Set with 4-pin CB skts = KIT CB-99 £18.32  
Set with std jck skts = SET-99 £16.55

**MUSICAL BLEEPER**  
Programme your own individual 8-note call sign. Push button operated for use when you want.  
Set with 4-pin CB skts = KIT CB-121 £16.41  
Set with std jck skts = SET-121 £14.64

**SIMPLE REVERB**  
Enhances the spacious quality of your transmitted voice. With control over depth and duration.  
Set with 4-pin CB skts = KIT CB-122 £15.85  
Set with std jck skts = SET-122 £14.08

**SPEECH PROCESSOR**  
Dramatically improves the intelligibility of speech signals. This is the unit that so many CB owners are talking about on the air!  
Set with 4-pin CB skts = KIT CB-110 £13.98  
Set with std jck skts = SET-110 £12.18

**VOICE SCRAMBLER**  
For coding or decoding speech signals for greater transmission security.  
Set with 4-pin CB skts = KIT CB-117 £23.58  
Set with std jck skts = SET-117 £21.81

**KIT CONTENTS**  
Sets include PCBs, U.K. P&P, 15% VAT, Res. Caps S's, P's, most also include Knobs, SW's, skts, Wire, Solder, Photocopy of orig text, & a case unless marked\*. Most are battery operated, but PSU units are also available. Most parts can be bought separately. Fuller details & more great kits in our catalogue. Send S.A.E. for free copy.

Prices correct at press. E.&O.E., subject to stock. Despatch usually 24hrs on all ex-stock items.

**EXPORTS WELCOME!**  
Sterling payment with order please. Postage rates in our lists. Europe send 50p for lists, other countries send £1.

**PHONOSONICS** DEPT PE28, 22 HIGH STREET, SIDCUP, KENT, DA14 6EH.  
FOUNDED 1972. A DECADE OF DESIGN AND DELIVERY!

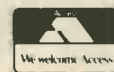

Terms: Mail Order C.W.O. or collection by appointment. Access, Barclay & Am-Express orders accepted. Tel. 01-302 6184, Mon-Fri.



## AERIALS

AERIAL BOOSTERS trebles incoming signal, price £7.00. SAE leaflets. Velco Electronics, Ramsbottom, Lancashire BL0 9AG.

## SERVICE SHEETS

BELL'S TELEVISION SERVICES for Service Sheets on Radio, TV, etc £1.25 plus S.A.E. Colour TV Service manuals on request. S.A.E. with enquiries to B.T.S. 190 Kings Road, Harrogate, N. Yorkshire. Tel. (0423) 55885.

## EDUCATIONAL

CAREERS IN MARINE ELECTRONICS. Courses commencing September and January. Further details, The Nautical College, Fleetwood FY7 8JZ. Tel. 03917 79123.

## MISCELLANEOUS

CLEARING LABORATORY: scopes, generators, P.S.U.'s, bridges, analysers, meters, recorders, etc. 0403 76236.

## TIME WRONG?

MSF CLOCK is ALWAYS CORRECT - never gains or loses, SELF SETTING at switch-on, 8 digits show Date, Hours, Minutes and Seconds, auto GMT/BST and leap year, also parallel BCD output, receives Rugby 60KHz atomic time signals, built-in antenna, 1000Km range, TIME RIGHT, £89.60. 60KHz RUGBY RECEIVER, as in MSF Clock, data output, decoding details and ZX81 listing for local, GMT and sidereal time, £22.20.

Each fun-to-build kit includes all parts, printed circuit, case, instructions, postage etc, money back assurance so GET yours NOW.

## CAMBRIDGE KITS

45 (FH) Old School Lane, Milton, Cambridge.

LARGE QUANTITY of reusable micros, phone cords, earpieces, cable etc. etc., ideal equipment for security alarm installations. Trade enquiries only. Box No. 88.

## THE SCIENTIFIC WIRE COMPANY

PO Box 30, London, E.4. 01-631 1568.

### ENAMELLED COPPER WIRE

SWG	1lb	8oz	4oz	2oz
8 to 34	3.30	1.90	1.00	0.80
35 to 39	3.52	2.10	1.15	0.85
40 to 43	4.87	2.65	2.05	1.46
44 to 47	8.37	5.32	3.19	2.50
48 to 49	15.96	9.58	6.38	3.69

### SILVER PLATED COPPER WIRE

14 to 30	6.63	3.86	2.28	1.50
----------	------	------	------	------

### TINNED COPPER WIRE

14 to 30	3.97	2.41	1.39	0.94
10 x 10 Mtr reels 3 amp PVC cable mixed colours	£5.00.			

Prices include P&P, VAT. Orders under £2 add 20p. SAE for list of copper and resistance Wire. Dealer enquiries welcome.

PARAPHYSICAL JOURNAL (Russian Translations): Psychotronic Generators, Kirlianography, Gravity Lasers, Telekinesis. Details SAE 4 x 9" PARALAB, Downton, Wilts.

NEW ILLUSTRATED CATALOGUE available 85p with two 25p vouchers. Griffiths Electronics (PE), 15, Windmill Gardens, Whixall, Whitechurch, Shropshire.

## MAKE YOUR OWN PRINTED CIRCUITS

Eth Resist Transfers - Starter pack (5 sheets, lines, pads, i.c. pads) £2.10. Large range of single sheets in stock at 45p per sheet.

Master Positive Transparencies from P.C. layouts in magazines by simple photographic process. 2 sheets negative paper, 2 sheets positive film (A4) £2.10. Photo-resist spray (200 ml) £3.50 (p+p 65p). Drafting Film (A4) 25p. Precision Grids (A4) 65p. 22p stamp for lists and information. P&P 50p per order except where indicated.

Closed from 15th July until 15th August

P.K.G. ELECTRONICS  
OAK LODGE, TANSLEY, DERBYSHIRE.

ELECTRONIC GAMES. Build your own microchip games from our detailed circuits. SAE for details. G.H.T. LTD., P.O. Box DR95, Dover, Kent. CT16 1UL.

IN CIRCUIT TRANSISTOR TESTER £14.25. S.A.E. for details of this and other products. C.M.J. ELECTRONICS, 52/54, Worcester Street, Wolverhampton WV2 4LL.

## PRACTICAL ELECTRONICS P.C.B.'s

APR 82 Medium Resolution Graphics Equaliser for UK101 EP710	£1.38
Enlarger Timer EA236	£3.67
MAY 82 Function Generator EG816	£2.45
Freq. Meter set of 3 EP823-5 & EA96	£2.93
JUNE 82 Auto Flash EA334	£1.18

For full list and current pcb's send SAE. CWO Please. Postage - add 35p postage and packing to complete order. Europe 70p.

## PHOTO DESIGN

14 Downham Road, Ramsden Heath, Billericay, Essex CM11 1PU. Telephone 0268-710722

DIGITAL WATCH REPLACEMENT parts, batteries, displays, back-lights etc., also reports, publications, charts. SAE for full list. Profords, Copners Drive, Holmergreen, Bucks HP15 6SGG.

BURGLAR ALARM EQUIPMENT. Ring Bradford (0274) 308920 for our catalogue or call at our large showrooms opposite Odsal Stadium.

## CABINET FITTINGS

Fretcloths, Coverings, Handles, Castors, Flight Case Locks & Parts, Jacks, XLRs, Bulgins, Reverb Trays, P & N mic Stands, ASS Glassfibre Horns, CELESTION POWER Speakers.

ADAM HALL SUPPLIES LTD.

Send 30p cheque/P.O. for illustrated catalogue: Adam Hall (PE Supplies), Unit G, Carlton Court, Grainger Road, Southend-on-Sea.

ULTRASONIC TRANSDUCERS, miniature, 40KHz. £2.85 per pair + 25 P+P. DATAPLUS DEVELOPMENTS, 81 Cholmeley Road, Reading, Berks.

### STEREO DISCO MIXER/PREAMP

LBPA3  
M - Magnetic  
C - Ceramic

Main supply £7.20  
PFL supply £1.00

**£36.70**

Magnetic or ceramic deck versions - please state

All the requirements of a stereo disco preamp on one board, left and right deck mixers/tone controls/misc. mixer/tones/mic. auto fade over decks/and P.F.L. The unit can be used with virtually any power amp.

### 3 CHANNEL SOUND/LIGHT CHASER

LB31000SLC **£35.70**

A high performance sound to light providing bass, middle and treble separation employing active filters. Automatic switching to chase in the absence of a music signal. 1000W/chan.

### 3-WAY ACTIVE CROSSOVER

LBAC01 **£17.90**

Supply £7.20

Bass/mid/treble active crossover with stage booster! Available with crossover points of 200 or 300Hz, and 2K or 3KHz (please specify) LBPSUI supply for LBAC01, (1 or 2).

### 3 CHANNEL SOUND/LIGHT

LB31000SL **£22.70**

All the advantages of the SLC without chase

Controls: bass/mid/treble/master sensitivity.

**NOW AVAILABLE!**

BLUE FASCIA PANELS (White lettering)

Type	Knobs	Leds	Swch	Price
Multi	5	4	1	£9.70
41000 SLC	2	4	1	£9.20
31000 SLC	5	-	1	£8.70
31000 SL	4	-	1	£7.70

**AND MORE!**

4 ch Sound/light **£49.90**

4 ch Multi Chaser **£48.90**

4 ch Sequencer **£19.20**

**AND DONT FORGET OUR FAMOUS POWER DIMMERS**

## L & B ELECTRONIC GROUP

PROFESSIONAL ENGINEERING BY PROFESSIONALS

45 Wortley Road, West Croydon Surrey CR0 3EB. Tel. 01-689 4138

(Goods by return (stocks allowing) We are open Mon to Fri 9 to 5.

Each module is manufactured from the highest quality components, fully tested, supplied with a connection diagram and guaranteed for twelve months.

All prices shown are VAT inclusive. Please include 75p post/packing. To mail order send cheque/P.O./Registered cash/Access number. C.O.D. service £1 extra. For further information send s.a.e. stating which model or simply phone!

OVERSEAS DISTRIBUTORS Enquiries are invited from overseas companies interested in distributing our high quality products.

JAYkit



+

Standard Parts



=



DM-2



DIGITAL MULTIMETER

- ★ DC Volts . . . . . 1mV to 1000V
- ★ AC Volts . . . . . 1V to 500V
- ★ DC Current . . . . . 0.1mA to 0.2A
- ★ Resistance . . . . . 1Ω to 20MΩ
- ★ 3½ digit LCD
- ★ Auto Low Battery Indication
- ★ Auto Polarity & Zero
- ★ 1% accuracy (DC volts)
- ★ Designed around Intersil 7106 IC
- ★ Total cost around £30 (incl. case)

FG-1a

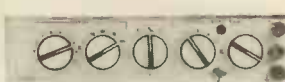

- FUNCTION GENERATOR
- ★ 30mV to 10V pk-pk
  - ★ 1Hz to 100kHz
  - ★ DC coupled
  - ★ Sine, Square & Triangle
  - ★ Separate TTL output
  - ★ Designed around Intersil 8038 IC
  - ★ Total cost around £30 (incl. case)

Provided in a JAYkit is a Printed Circuit Board, a punched and lettered Front Panel overlay, a Circuit Diagram and Instruction Sheet and a comprehensive and up to date Component List showing suppliers and current prices. Difficult to obtain pieces of hardware are supplied with the kit.

Jayen Developments, 12B Milton Road, Highgate, London N6 5QD

To: JAYEN Developments  
12B Milton Road,  
Highgate,  
London N6 5QD.  
Tel. 01-348 3538

Name \_\_\_\_\_  
Address \_\_\_\_\_

Please send:

- DM-2 @ £5.45  
 FG-1a @ £4.95  
(Incl. VAT and P&P)

Money to be refunded if the kit is returned within 10 days.  
Goods by return subject to stock.

# JAYkits

# CLEF ELECTRONIC MUSIC

## ELECTRONIC PIANOS

**SPECIALISTS SINCE 1972**

Clef Pianos adopt the most advanced form of Touch Sensitive action which simulates piano Key inertia using a patented electronic technique.

**7 1/4 OCTAVE DOMESTIC MODEL COMPONENT KIT £244 COMPLETE KIT £399.90 MANUFACTURED £675**

Two Domestic Models are available including the 88 note full-size version. Four interchangeable Voice Controls may be used to obtain a wide variation of Piano tone, including Harpsichord. Both Soft and Sustain Pedals are incorporated in the Design and internal Effects are provided in the form of Tremolo, Honky-Chorus, and Phase/Flanger. A power amplifier integrates into the Piano top which may be removed from the Base for easy transportation.

**SIX OCTAVE DOMESTIC MODEL COMPONENT KIT £217 MANUFACTURED £595**

Component Kits include Keyboard, Key-switch hardware, and all electronic components and may be purchased in four stages at no extra cost. Complete Kits further contain Cabinets, wiring harness, Pedals and in the case of Domestic Models both Power Amplifier and Speaker. The Six Octave Stage Piano has the same range of Voices and Effects and is designed for use with an External Amplifier and Speaker.

**SIX OCTAVE STAGE MODEL COMPONENT KIT £217 MANUFACTURED £530**

Please allow 7 days for normal despatch

COMPLETE KIT £363.90

COMPLETE KIT £349

## MICROSYNTH A NEW MUSIC PROJECT FROM PRACTICAL ELECTRONICS



We are pleased to announce that

### STRING ENSEMBLE

(As Published in conjunction with 'Practical Electronics')

A very popular Keyboard Synthesizer Kit, for Group or Home use, with a four octave compass and split Keyboard facility.

COMPONENT KIT £179.00

Since 1972 Clef Products have consistently produced leading designs in the field of Electronic Musical Instruments, many of which have been published in technical magazines. With musical quality of paramount importance, new techniques have been evolved and the latest musically valid technology has been incorporated into projects which have been successfully completed by constructors over a wide range of technical capability. Back up TELEPHONE advice is available to all our customers.

PRICES INCLUDE VAT, UK CARRIAGE & INSURANCE (CARRIAGE EXTRA ON MFD PIANOS). Please send S.A.E. for our complete lists, or use our telephone VSA/ACCESS Service. Competitive quotations can be given for EXPORT orders - in Australia please contact JAYCAR in Sydney.

### CLEF PRODUCTS (ELECTRONICS) LIMITED

(Dept. P.E.) 44A Bramhall Lane South, Bramhall, Stockport, Cheshire SK7 1AH 061-439-3297

we have been appointed by A. R. Bradford M.Sc. as the kit supplier for this exceptional Instrument.

**COMPLETE KIT £118.50**

### ROTOR-CHORUS

Comprehensive two speed organ rotor simulator plus a three phase chorus generator.

COMPONENT KIT £29.00

### KEYBOARDS

Our Square Front Keyboards

88 NOTE (A-C) £57.00

73 NOTE (F-F) £47.00

FIVE OCTAVE £38.00

FOUR OCTAVE £28.75

## "THE COMPUTER BAND-BOX" (As Published in conjunction with "Practical Electronics") COMPLETE KIT

£289

£399  
MANFD.



PRICES INCLUDE MASTER RHYTHM

A revolution in the field of Computer Music Generation!

A MUSICIANS INSTRUMENT FOR:  
SOLOISTS - SINGERS - RECORDING - PRACTICE  
LIVE PERFORMANCE - COMPOSITION

The BAND-BOX provides an Electronic Backing Trio consisting of Drums, Bass, and a Chord Instrument (one of 16 Waveform/Envelope combinations), with the capacity to store over 3,000 User Programmable Chord Changes on more than 120 different Chords. Using advanced Microprocessor technology, Playback of 50-100 Scores can be executed in any Key and at chosen Tempo. Complete Music Pad is electronically Indexed and stored on secondary battery back-up. Facility exists for composition of Intro, Repeat Chorus, and Coda sections including Multiple Score Sequences. Sockets are provided for Volume Pedal and Footswitch plus separate and mixed instrument Outputs. Total size 19" x 11" x 4 1/2" incorporating Master Rhythm.

## THE Programmable DRUM MACHINE

(As Published in conjunction with 'Practical Electronics')

EIGHT TRACK PROGRAMMING / TWENTY-FOUR PATTERNS / TWELVE INSTRUMENTS SEQUENCE OPERATION. COMPLETE KIT £79.00 MANFD. £119.00



The Clef Master Rhythm is capable of storing 24 selectable rhythmic drum patterns, invented, modified, and entered by the Operator on to Eight Instrumentation tracks. A three position Instrumentation control expands the number of instruments available to twelve, grouped into sounds typical of playing with Drumsticks, Brushes, or Latin American Bongos and Claves. Sequence operation allows two rhythm sections to be coupled with the second (B) section appearing at four, eight or sixteen Bar repetition. All drums can be adjusted for level and resonance on internal controls to suit individual taste, thus producing good musical sounds in a battery driven unit 8 1/2" x 5" x 2 1/2".

# ELECTROVALUE

A SPECIAL SUMMER PROMOTION

FREE VOUCHERS TO SAVE YOU UP TO

£2.10

Send for EV Catalogue 82 before Aug. 31 (60 pages A4 - 70p post paid) and we give you THREE 70p. REFUND VOUCHERS FREE! Each is valid at any time for spending singly on any one C.W.O. order minimum list value £10 to quickly represent a useful saving for you. Send 70p now for your catalogue and 3 vouchers by return.

+ USUAL DISCOUNTS + FREE POSTAGE

### DISCOUNTS

5% on Orders over £23 (inc V.A.T.)  
10% on orders over £57.50 (inc V.A.T.) on most catalogue items, but not on payments by credit cards.

### POSTAGE

Not charged on U.K. C.W.O. orders over £5.75 inc V.A.T. If less, add 40p handling charge.

ELECTROVALUE LTD. 28c St. Jude's Rd, Englefield Green, Egham, Surrey TW20 0HB.

Telephone Egham (STD 0784; London 87) 33603; Telex 264475.

Northern Branch (Personal shoppers only) 680 Burnage Lane, Burnage, Manchester M19 1NA. Telephone 061 432 4945.

- ★ SEMI-CONDUCTORS/ICs/OPTOs
- ★ COMPUTERS/SOFTWARE
- ★ CAPACITORS/RESISTANCES
- ★ CONNECTORS/SWITCHES/KNOBS
- ★ POTS/FERRITES
- ★ BOOKS/BOXES/TOOLS

and more and more and more

MAKE IT WITH BRADLEY

# Marshall's

OF LONDON

SPECIALIST ELECTRONIC COMPONENT DISTRIBUTORS

TEL: 01-723 4242

PROBABLY THE LARGEST STOCK OF ICs & TRANSISTORS IN THE SOUTH TRY US FIRST

LARGE RANGE OF ACCESSORIES

PLUGS  
SOCKETS  
AUDIO CONNECTORS  
VERO BOARDS  
IC SOCKETS  
SOLDERING EQUIPMENT  
SCREW DRIVERS (BAHCO)  
SIFAM KNOBS ETC.

LARGE RANGE OF ICs RESISTORS  
TRANSISTORS  
POTENTIOMETERS  
CAPACITORS FUSES  
DIODES BRIDGES  
TRIACS THYRISTORS  
OPTO

PLEASE SEND S.A.E. FOR LIST

**SPECIAL OFFER**  
STEINAL  
MULTICHECK  
**£7.50**  
+ VAT

Normal Price £10.26

BUY WITH ACCESS  
BARCLAYCARD  
A/EXPRESS  
DINERS  
JUST PHONE  
WE DO THE REST

MAIL ORDER  
FASTER SERVICE  
PHONE  
01-732 4242

40 WAY RIBBON CABLE  
£2.20 metre

HEADER PLUGS  
14 way, 16 way, 40 way

BAHCO TOOLS  
SIDE CUTTERS

2132 £7.10  
2112 £9.40

END CUTTERS  
2211 £10.43

PLIERS  
2411 £6.75  
2415 £6.78

ICE MULTIMETERS  
Microtest 80 £16.60  
Supertest 680R £32.00  
Supertest 680E £24.50

EXPERIMENTER BREADBOARDS  
EXP 325 EXP 600  
EXP 350 EXP 650  
EXP 300 EXP 413

LOGIC PROBES  
LP1 £31.00  
LP2 £18.00

EXPERIMENTS & KITS

PB6 £9.20  
PB100 £11.80

325 EDGWARE RD,  
LONDON W2 1BN

BARCLAYCARD . ACCESS . DINERS . A/EXPRESS

PLEASE REMEMBER TO ADD 15% VAT



# INDEX TO ADVERTISERS

Adam Hall Supplies .....	69	Maplin Electronics .....	Cover 4
A.D. Electronics .....	72	Midwich Computers .....	53
Barrie .....	8	Modern Book Co. ....	71
Bi Pak .....	66	Myers Electronics .....	68
Bradley Marshalls .....	70	Parndon .....	72
British National Radio & Electronics School	4	Phonosonics .....	67
Brystep Electronics .....	68	Pimac Systems .....	66
Cambridge Kits .....	69	PKG Electronics .....	69
Clef Products .....	70	Powertran .....	24
Crofton Electronics .....	8	Proto Design .....	69
C.R. Supply Co. ....	68	Radio Component Specialists .....	71
E.D.A. ....	9	Radio & T.V. Components .....	4
Electrovalue .....	70	Rapid Electronics .....	10
Enfield Electronics .....	67	Response Company .....	68
Flight Electronics .....	Cover 2	Scientific Wire Co. ....	69
GJD Electronics .....	68	Stort Technology .....	68
Heathkit .....	35	Swanley .....	66
ICS Intertext .....	6	Tandy .....	46
ILP Electronics .....	65, 72	Technomatic .....	6, 7
Jayen Developments .....	69	Tempus .....	60
L & B .....	69	T.K. Electronics .....	5
		Videotone .....	53
		Watford Electronics .....	2, 3
		Wilmslow Audio .....	8

## SERVICING RADIO, HI-FI AND TV EQUIPMENT

by Gordon J. King Price: £7.50

HOW TO USE OP AMPS by E. A. Parr Price: £2.50

RADIO COMMUNICATION HANDBOOK by R.S.G.B. Price: £13.00

ILLUSTRATING BASIC BY D. Alcock Price: £3.00

BYTEING DEEPER INTO YOUR ZX81 by M. Harrison Price: £5.45

ZX81 BASIC BOOK by R. Norman Price: £5.45

INTRODUCTION TO 6800/6802 MICROPROCESSOR SYSTEMS by R. J. Simpson Price: £7.50

PRACTICAL PROGRAMS FOR THE BBC COMPUTER & ACORN ATOM by D. Johnson-Davies Price: £6.45

INTRODUCTION TO MICROPROCESSORS SOFTWARE, HARDWARE, PROGRAMMING by L. A. Leventhal Price: £12.95

1982 THE RADIO AMATEUR'S HANDBOOK by A.R.R.L. Price: £8.50

★ ALL PRICES INCLUDE POSTAGE ★

## THE MODERN BOOK CO.

BRITAIN'S LARGEST STOCKIST of British and American Technical Books

19-21 PRAED STREET LONDON W2 1NP

Phone 01-402 9176 Closed Saturday 1 p.m. Please allow 14 days for reply or delivery.

## MAIL ORDER ADVERTISING

### British Code of Advertising Practice

Advertisements in this publication are required to conform to the British Code of Advertising Practice. In respect of mail order advertisements where money is paid in advance, the code requires advertisers to fulfil orders within 28 days, unless a longer delivery period is stated. Where goods are returned undamaged within seven days, the purchaser's money must be refunded. Please retain proof of postage/despatch, as this may be needed.

### Mail Order Protection Scheme

If you order goods from Mail Order advertisements in this magazine and pay by post in advance of delivery, PRACTICAL ELECTRONICS will consider you for compensation if the Advertiser should become insolvent or bankrupt, provided:

- (1) You have not received the goods or had your money returned; and
- (2) You write to the Publisher of PRACTICAL ELECTRONICS summarising the situation not earlier than 28 days from the day you sent your order and not later than two months from that day.

Please do not wait until the last moment to inform us. When you write, we will tell you how to make your claim and what evidence of payment is required.

We guarantee to meet claims from readers made in accordance with the above procedure as soon as possible after the Advertiser has been declared bankrupt or insolvent.

This guarantee covers only advance payment sent in direct response to an advertisement in this magazine not, for example, payment made in response to catalogues etc, received as a result of answering such advertisements. Classified advertisements are excluded.

## BAKER LOUDSPEAKERS

Model	Ohms	Inch	Watts	Type	Price	Post
Major	4, 8, 16	12	30	Hi-Fi	£14	£2
Superb	8, 16	12	30	Hi-Fi	£24	£2
Auditorium	8, 16	12	45	Hi-Fi	£24	£2
Auditorium	8, 16	15	60	Hi-Fi	£34	£2
Group 45	4, 8, 16	12	45	PA	£14	£2
Group 75	4, 8, 16	12	75	PA	£18	£2
Group 100	8, 16	12	100	Guitar	£24	£2
Disco 100	8, 16	12	100	Disco	£24	£2
Group 100	8, 16	15	100	Guitar	£32	£2
Disco 100	8, 16	15	100	Disco	£32	£2

DISCO MIXER. 240V, 4 stereo channels, 2 magnetic, 2 ceramic/tape. 1 mono mic channel, twin v.u. meters, headphone monitor outlet, slider controls, panel or desk mounting, grained aluminium face. £40. Post £2.

DELUXE STEREO DISCO MIXER/EQUALISER as above plus L.E.D. V.U. displays 5 band graphic equaliser, left/right fader, switchable inputs for phono/line, mike/line. Headphone Monitor, Mike Talkover Switch £95. PP £2.

BOOKSHELF HI-FI ENCLOSURES TEAK £32 pair. 18 x 11 x 6in. 10 watts, 8 or 4 ohm. 2 way system. Post £2.

GARRARD 6-200 SINGLE PLAYER DECK Brushed Aluminium Arm with stereo ceramic cartridge and Diamond Stylus. 3-speeds. Manual and Auto Stop/Start. Large Metal Turntable. £22. Post £2. Cueing Device and Pause Control.

METAL PLINTH cut for Garrard or BSR Size: 16 x 14 x 3in £4.00. Silver or Black finish. Post £2.

B.S.R. P204 SINGLE PLAYERS SPECIAL OFFERS Two speed 33/45 rpm Hi-Fi Decks with Stereo Cartridges, cueing device and snake arm. Ceramic Cartridge 240V AC £15 or 9V DC £19. Magnetic Cartridge 240V AC £20 or 12V DC £24.

B.S.R. SINGLE PLAYER P232 BELT DRIVE £20.00 2-speeds 11in. turntable. "Snake" arm, cueing device, stereo ceramic cartridge, bias compensator, 240V AC. Post £2.

B.S.R. DE-LUXE AUTOCHANGER £20 Stereo cartridge, plays all size records. 3-speed. Post £2.

DECCA B.S.R. TEAK PLINTH 18 x 14 x 4in. Space for small amplifier, BSR Board £6.50 post paid. With Garrard Board £4.50 post paid. PVC covers £7.50 extra.

TINTED PLASTIC EQUIPMENT COVERS Sizes: 14 x 12 x 3in. £5. 15 x 13 x 4in. £3. 14 x 13 x 3in. £5. 18 x 12 x 3in. £6. 16 x 13 x 4in. £6. 17 x 13 x 4in. £6. 21 x 14 x 2 1/2in. £6. POST £1.50.

R.C.S. LOW VOLTAGE STABILISED POWER PACK KITS £3.95. Post 65p. All parts and instructions with Zener diode printed circuit, mains transformer 240V a.c. Output 6 or 7 1/2 or 9 or 12V d.c. up to 100mA or less. Please state voltage required.

PP BATTERY ELIMINATOR BRITISH £4.50 Mains stabilized power-pack 9 volt 400mA D.C. with overload cut out Size 5 x 3 1/2 x 2 1/2in. Post 50p. DELUXE MODEL Switched 3, 6, 7 1/2; 9 volt 400mA D.C. Stabilized. £7.50. Post £1.

MAINS TRANSFORMERS	Post
250-0-250V 70mA 6-3V 2A	£4.50 £2
250-0-250 80mA 6-3V, 3-5A, 6-3V 1A	£5.00 £2
350-0-350V 250mA 6-3V 6 amp.	£12.00 £2
300-0-300V 120mA 2 of 6V 2A C.T. 5V, 6V 2A	£13.00 £2
220V, 25ma 6v/a	£2.00 £1
220V 45mA, 6-3V 2A	£3.00 £1
250V 60mA, 6-3V 2A	£3.50 £1

GENERAL PURPOSE LOW VOLTAGE	Post
2A, 3, 4, 5, 6, 8, 9, 10, 12, 15, 18, 24 and 30V	£6.00 £2
1A, 6, 8, 10, 12, 16, 18, 20, 24, 30, 36, 40, 48, 60	£6.00 £2
2A, 6, 8, 10, 12, 16, 18, 20, 24, 30, 36, 40, 48, 60	£10.50 £2
3A, 6, 8, 10, 12, 16, 18, 20, 24, 30, 36, 40, 48, 60	£12.50 £2
5A, 6, 8, 10, 12, 16, 18, 20, 24, 30, 36, 40, 48, 60	£18.00 £2
6V 1/2 amps	£2.00 £1
6-0-6V 100ma	£1.50 £1
9V 250mA	£1.50 80p
9V 3 amp	£3.50 £1
9-0-9V 50mA	£1.50 80p
10-30-40V 2 amps	£3.50 £1
12V 3 amps	£3.50 £1
6-0-6V 1 1/2A	£3.50 £1
17-0-17V 2a	£4.50 £2
15-0-15V 2 amps	£3.75 £1
16V 2 amps	£3.00 £1
20V 1 amp	£3.00 £1
20-0-20V 1 amp	£3.50 £1
20-0-60V 1 amp	£4.00 £2
30V 1 1/2 amp	£3.50 £1
30V 5 amps and	
30V 5 amp	£4.50 £2

AUTO TRANSFORMER 115V to 240V 500W	Post
CHARGER TRANSF. Post RECTIFIERS	£12.00 £2
6-12V-3A	£4.00 £2
6-12V-4A	£6.50 £2
6-12V-6A	£8.50 £2
6-12V-1A	90p
6-12V-2A	£1.10
6-12V-4A	£2.00
TOROIDAL 30-0-30V 4A + 20-0-20V 1A	£10.00 £2

BLANK ALUMINIUM CHASSIS. 6 x 4in. £1.45; 8 x 6in. £1.80; 10 x 7in. £2.30; 12 x 8in. £2.80; 14 x 9in. £3.00; 16 x 5in. £2.90; 16 x 10in. £3.20. All 2 1/2in. deep. 18 swg. ALUMINIUM PANELS. 18 swg. 6 x 4in. 45p; 8 x 6in. 75p; 14 x 3in. 95p; 10 x 7in. 95p; 12 x 8in. £1.10; 12 x 5in. 75p; 16 x 6in. £1.10; 14 x 9in. £1.45; 12 x 12in. £1.50; 16 x 10in. £1.75. ANGLE ALU. 6 x 3 x 3in. 18 swg. £25p. ALUMINIUM BOXES. 4 x 4 x 1 1/2in. £1.4 x 2 1/2 x 2in. £1. 3 x 2 x 1in. £1. 6 x 4 x 2in. £1.60. 7 x 5 x 3in. £2.40. 8 x 6 x 3in. £2.50. 10 x 7 x 3in. £3. 12 x 5 x 3in. £2.75. 12 x 8 x 3in. £3.60. All 18 swg with lids.

HIGH VOLTAGE ELECTROLYTICS	Post
8/450V 45p	8+8/450V 75p
16/350V 45p	8+16/450V 75p
32/500V 75p	32+32/450V £1.20
50/450V 95p	32+32/350V 75p
32/350V 50p	32+32/500V £1.80
50+50/300V 50p	100+100/275V 65p
150+200/275V 70p	220/450V 95p
32+32/350V 95p	32+32+32/325V 90p

HEATING ELEMENTS, WAFER THIN Semi-flexible. 11 x 9 X in. Operating voltage 240V, 250W approx. Suitable for Heating Pads, Food Warmers, Convector Heaters, Propagation, etc. Must be clamped between two sheets of metal, etc. ONLY 60p EACH (FOUR FOR £2) ALL POST PAID.

Radio Component Specialists 337, WHITEHORSE ROAD CROYDON, SURREY, U.K. TEL: 01-684 1665 Post 65p Minimum. Callers Welcome. Closed Wed. Same day despatch. Access-Bac-Visa. Lists 31p.

# TOROIDALS



The toroidal transformer is now accepted as the standard in industry, overtaking the obsolete laminated type. Industry has been quick to recognise the advantages toroidals offer in size, weight, lower radiated field and, thanks to I.L.P., PRICE.

Our large standard range is complemented by our SPECIAL DESIGN section which can offer a prototype service within 7 DAYS together with a short lead time on quantity orders which can be programmed to your requirements with no price penalty.

TYPE	SERIES No.	SECONDARY Voits	RMS Current	PRICE
30 VA 70 x 30mm 0.45kg Regulation 10%	1a010	6+6	2.50	<b>£5.12</b> +VAT £1.04 +VAT £0.97 TOTAL £7.08
	1a011	9+9	1.66	
	1a012	12+12	1.25	
	1a013	15+15	1.00	
	1a014	18+18	0.83	
	1a015	22+22	0.68	
	1a016	25+25	0.50	
1a017	30+30	0.50		
50 VA 80 x 30mm 0.9kg Regulation 13%	2a010	6+6	4.16	<b>£5.70</b> +VAT £1.30 +VAT £1.25 TOTAL £8.25
	2a011	9+9	2.77	
	2a012	12+12	2.08	
	2a013	15+15	1.66	
	2a014	18+18	1.38	
	2a015	22+22	1.13	
	2a016	25+25	1.00	
80 VA 90 x 30mm 1kg Regulation 12%	3a010	6+6	5.64	<b>£6.08</b> +VAT £1.67 +VAT £1.16 TOTAL £8.91
	3a011	9+9	4.44	
	3a012	12+12	3.33	
	3a013	15+15	2.66	
	3a014	18+18	2.22	
	3a015	22+22	1.81	
	3a016	25+25	1.60	
120 VA 90 x 40mm 1.2kg Regulation 11%	4a010	6+6	10.00	<b>£6.90</b> +VAT £1.87 +VAT £1.29 TOTAL £9.96
	4a011	9+9	6.66	
	4a012	12+12	5.00	
	4a013	15+15	4.00	
	4a014	18+18	3.33	
	4a015	22+22	2.72	
	4a016	25+25	2.40	
160 VA 110 x 40mm 1.8kg Regulation 8%	5a010	6+6	8.89	<b>£7.91</b> +VAT £2.07 +VAT £1.44 TOTAL £11.02
	5a011	9+9	5.93	
	5a012	12+12	4.44	
	5a013	15+15	3.53	
	5a014	18+18	3.03	
	5a015	22+22	2.52	
	5a016	25+25	2.20	

- ★ 294 TYPES TO CHOOSE FROM!
- ★ ORDERS DESPATCHED WITHIN 7 DAYS OF RECEIPT FOR SINGLE OR SMALL QUANTITY ORDERS
- ★ 5 YEAR NO QUIBBLE GUARANTEE

TYPE	SERIES No.	SECONDARY Voits	RMS Current	PRICE
225 VA 110 x 45mm 2.2kg Regulation 7%	6a012	12+12	9.38	<b>£9.20</b> +VAT £2.00 +VAT £1.88 TOTAL £12.58
	6a013	15+15	7.50	
	6a014	18+18	6.25	
	6a015	22+22	5.11	
	6a016	25+25	4.50	
	6a017	30+30	3.75	
	6a018	35+35	3.21	
	6a019	40+40	2.81	
	6a025	45+45	2.50	
	6a033	50+50	2.25	
300 VA 110 x 50mm 2.6kg Regulation 6%	7a013	15+15	10.00	<b>£10.17</b> +VAT £2.00 +VAT £1.83 TOTAL £14.00
	7a014	18+18	8.33	
	7a015	22+22	6.82	
	7a016	25+25	6.00	
	7a017	30+30	5.00	
	7a018	35+35	4.28	
	7a026	40+40	3.75	
	7a025	45+45	3.33	
	7a033	50+50	3.00	
	7a029	220	1.36	
500 VA 140 x 60mm 4kg Regulation 4%	8a016	25+25	10.00	<b>£13.53</b> +VAT £3.35 +VAT £3.38 TOTAL £16.76
	8a017	30+30	9.33	
	8a018	35+35	7.14	
	8a026	40+40	6.25	
	8a025	45+45	5.55	
	8a033	50+50	5.00	
	8a042	55+55	4.54	
	8a028	110	4.54	
	8a029	220	2.27	
	8a030	240	2.08	
625 VA 140 x 75mm 4kg Regulation 4%	9a017	30+30	10.41	<b>£16.13</b> +VAT £3.30 +VAT £3.28 TOTAL £19.42
	9a018	35+35	8.92	
	9a026	40+40	7.61	
	9a025	45+45	6.94	
	9a033	50+50	6.25	
	9a042	55+55	5.68	
	9a028	110	5.68	
	9a029	220	2.84	
	9a030	240	2.60	

**IMPORTANT:** Regulation—All voltages quoted are FULL LOAD. Please add regulation figure to secondary voltage to obtain off load voltage.

### The benefits of ILP toroidal transformers

ILP toroidal transformers are only half the weight and height of their laminated equivalents, and are available with 110V, 220V or 240V primaries coded as follows:

For 110V primary insert "0" in place of "X" in type number.

For 220V primary (Europe) insert "1" in place of "X" in type number.

For 240V primary (UK) insert "2" in place of "X" in type number.

### How to order Freepost:

Use this coupon, or a separate sheet of paper, to order these products, or any products from other ILP Electronics advertisements. No stamp is needed if you address to Freepost. Cheques and postal orders must be crossed and payable to ILP Electronics Ltd. Access and Barclaycard welcome. All UK orders sent within 7 days of receipt of order for single and small quantity orders.

Also available at Electrovalue, Maplin and Technomatic.

ILP Electronics, Graham Bell House, Roper Close, Canterbury, Kent, CT2 7EP.

Please send \_\_\_\_\_  
 Total purchase price \_\_\_\_\_  
 I enclose Cheque  Postal Orders  Int. Money Order   
 Debit my Access/Barclaycard No. \_\_\_\_\_  
 Name \_\_\_\_\_  
 Address \_\_\_\_\_  
 Signature \_\_\_\_\_

Post to: ILP Electronics Ltd, Freepost, 2 Graham Bell House, Roper Close, Canterbury CT2 7EP, Kent, England.

Telephone Sales (0227) 54778: Technical (0227) 64723: Telex 965780.



(a division of  
ILP Electronics Ltd)  
**TRANSFORMERS**

# HOW DARE THEY!

If you see an advertisement in the press, in print, on posters or a cinema commercial which makes you angry, write to us at the address below. (TV and radio commercials are dealt with by the I.B.A.)

The Advertising Standards Authority. If an advertisement is wrong, we're here to put it right.

ASA Ltd, Brook House, Torrington Place, London WC1E 7HN.

## PARNDON ELECTRONICS LTD.

Dept. No. 21 44 Paddock Mead, Harlow, Essex. CM18 7RR. Tel: 0279 32700

**RESISTORS:** 1/2 Watt Carbon Film E24 range ± 5% tolerance. High quality resistors made under strictly controlled conditions by automatic machines. Banded and colour coded.  
 £1.00 per hundred mixed. (Min 10 per value)  
 £8.50 per thousand mixed. (Min 50 per value)  
 Special stock pack 60 values. 10 off each £5.50

**DIODES:** IN4148 3p each. Min order quantity - 15 items.  
 £1.60 per hundred

**DIL SWITCHES:** Gold plated contact in fully sealed base - solve those programming problems.  
 4 Way 86p each. 6 Way £1.00 each. 8 Way £1.20 each.

**DIL SOCKETS:** High quality, low profile sockets.  
 8 pin - 10p. 14 pin - 11p. 16 pin - 12p. 18 pin - 19p. 20 pin - 21p.  
 22 pin - 23p. 24 pin - 25p. 28 pin - 27p. 40 pin - 42p.

ALL PRICES INCLUDE V.A.T. & POST & PACKING — NO EXTRAS  
 MIN. ORDER - U.K. £1.00. OVERSEAS £5 - CASH WITH ORDER PLEASE  
 Same Day Despatch

# ALARMS

## 'DIY KITS 'N' BITS

PROFESSIONAL EQUIPMENT AT DISCOUNT PRICES!

- KITS £32, £50, £75, £85 INCLUDING FULL INSTRUCTIONS
- CONTROL PANELS £18, £23, £29, £37
- BELL BOXES £6.25, £7.50
- PRESSURE PADS £1.06, £1.45, £1.95
- 4 CORE CABLE (100m) £8.00
- SIRENS £7.50
- CONTACTS 72p, 74p, 76p
- ULTRASONICS £34.50
- DOOR PHONES £49.42

### BUY A KIT OR DESIGN YOUR OWN SYSTEM

SEND S.A.E. OR 'PHONE NOW FOR FREE FULLY ILLUSTRATED CATALOGUE.  
 IT TELLS YOU ALL YOU NEED TO KNOW!  
 CARRIAGE INCLUDED. VAT EXTRA 15%  
 Please allow 14 days for delivery.

A.D. ELECTRONICS, 217 WARBECK MOOR, AINTREE, LIVERPOOL L9 0HU, 051 523 8440

TRADE ENQUIRIES WELCOME

**30% MORE PRINT AREA**

# GIANT SUPERPRINTS PLUS FREE FILM

**For every one you send for processing  
by the Practical Electronics Colour  
Print Service.**



Fast, efficient, high quality film processing is now as close to you as your nearest post box. Hundreds of thousands of magazine readers are delighted with this reliable Colour Print Film Service—and the replacement film that comes free every time they use it! So why don't you give it a try?

Here's what you do. Send any make of colour print film inside the envelope enclosed in this issue. Or fill in the coupon below and send it with your colour film in a strong envelope to:

**Practical Electronics Colour Print Service, FREEPOST, READING RG1 1BR. No stamp is required.**

### SEND NO MONEY

We are so confident in the reliability of the service and the quality of our prints, (each one is date stamped with the month and year of developing) that you don't pay until you have received them!

### LUXURY COLOUR PRINTS

You will be amazed at the beautiful colours and hi-definition sheen finish of the prints we

In the event of any query, please write to: Customer Relations Dept., Colour Print Express Ltd., P.O. Box 180, READING RG1 3PF or phone Reading (0734) 597332.

supply... with elegant rounded corners and borderless to give you maximum picture area. And now with the new Giant Superprints you get 30% more picture area than the standard enprints at no extra cost.

### UNBEATABLE VALUE

The new Giant Superprints cost you only 17p each and a further charge of £1.10 is made towards developing, postage and packing. That's all you pay and, when we send your prints, a replacement film, of the size you use, is included absolutely free. That's a saving of up to £2.39.

The offer is limited to the U.K. For Eire, C.I. and B.F.P.O., a handling surcharge will be made.

*Offer exc. Minolta & Sub-miniature film: Roll film 20p surcharge. 400 ASA 20p surcharge. Superprints can only be produced from Kodacolor II, C41 and Agfa CNS cassette and cartridge film not half frame. Prices correct at time of going to press.*

**Use this label if you have no envelope, or pass it to a friend. It is used to send your prints and FREE film.**

### FREE ALBUM SHEETS

One album voucher is sent with each film we process. Collect 3 vouchers and we send you a set of FREE album sheets to fit into our specially designed album to show off both superprints and standard prints.

### MORE BENEFITS TO YOU

You benefit in two additional ways. Firstly, you enjoy a personal service with every care taken over each individual order. And secondly, you pay only for what you get—with no credit vouchers as with many other companies. An invoice comes with your prints, so it is a straight business transaction.

Your prints will normally be despatched within five working days of receipt, but please allow for postal times and possible delays.

From: Practical Electronics Colour Print Service. FREEPOST. READING RG1 1BR. Please print my film Superprint/Standard Enprint size. (delete size which is not required).

Mr/Ms \_\_\_\_\_

Address \_\_\_\_\_

Postcode \_\_\_\_\_

# Make it with MAPLIN



## KEYBOARD WITH ELECTRONICS FOR ZX81

- \* A full size, full travel 43-key keyboard that's simple to add to your ZX81 (no soldering in ZX81).
- \* Complete with the electronics to make "Shift Lock", "Function" and "Graphics 2" single key selections making entry far easier.
- \* Powered from ZX81's own standard power supply - with special adaptor supplied.
- \* Two-colour print for key caps.
- \* Amazing low price.

Full details in our projects book. Price 60p.  
Order As XA030

Complete kit for only £19.95 incl. VAT and carriage.  
Order As LW72P

## 25W STEREO MOSFET AMPLIFIER



A superb new amplifier at a remarkably low price.

- \* Over 26W per channel into 8Ω at 1kHz both channels driven.
- \* Frequency response 20Hz to 40kHz ±1dB.
- \* Low distortion, low noise and high reliability power MOSFET output stage.
- \* Extremely easy to build. Almost everything fits on main pcb, cutting interwiring to just 7 wires (plus toroidal transformer and mains lead terminations).
- \* Complete kit contains everything you need including pre-drilled and printed chassis and wooden cabinet.

Full details in our projects book. Price 60p.  
Order As XA030

Complete kit for only £49.95 incl. VAT and carriage.  
Order As LW71N

## MATINEE ORGAN

Easy-to-build, superb specification. Comparable with organs selling for up to £1,000. Full construction details in our book. Price £2.50.  
Order As XH55K.

Complete kits available:  
Electronics - £299.95,  
Cabinet - £99.50 (carriage extra).  
Demo cassette price £1.99. Order As XX43W.



## HOME SECURITY SYSTEM



Six independent channels - 2 or 4 wire operation. External horn. High degree of protection and long term reliability. Full details in our projects book.  
Price 60p.  
Order As XA02C.

## MILES PER GALLON METER

Digital display shows you how economical your driving is as you go along. Complete kits available. Full details in our projects book.  
Price 60p.  
Order As XA02C.



## DIGITAL MULTI-TRAIN CONTROLLER

Control up to 14 trains individually on the same track with any four simultaneously! Low cost kits available. Full details in our projects book. Price 60p.  
Order As XA02C.

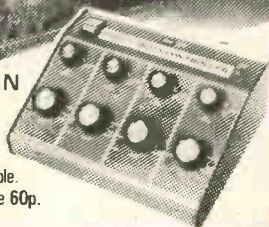

Don't miss out - get a copy of our catalogue now!  
Over 140,000 copies sold already!

On sale now in all branches of WHSMITH price £1.

320 big pages packed with data and pictures of over 5,500 items.



## Post this coupon now!

Please send me a copy of your 320 page catalogue. I enclose £1.25 (inc. 25p p&P). If I am not completely satisfied I may return the catalogue to you and have my money refunded.

If you live outside the U.K. send £1.68 or 12 International Reply Coupons.

Name \_\_\_\_\_

Address \_\_\_\_\_

Delivery within 14 days.

PE.8.82

# MAPLIN

ELECTRONIC SUPPLIES LTD.

All mail to:

P.O. Box 3, Rayleigh, Essex SS6 8LR  
Tel: Sales (0702) 552911 General (0702) 554155

Shops at:

159 King St., Hammersmith, London W6. Tel: 01-748 0926  
284 London Rd., Westcliff-on-Sea, Essex. Tel: (0702) 554000

Note: Shops closed Mondays

12 Swh