

PRACTICAL

ELECTRONICS

JANUARY 1969

THREE SHILLINGS

LIGHTWEIGHT
METAL LOCATOR



ALSO in this issue...

HIGH PERFORMANCE LOW
VOLTAGE STABILISED POWER SUPPLY

SONIC  FISH BAIT

ADCOLA
PRODUCTS LIMITED
(Regd. Trade Mark)

**Soldering
Instruments**

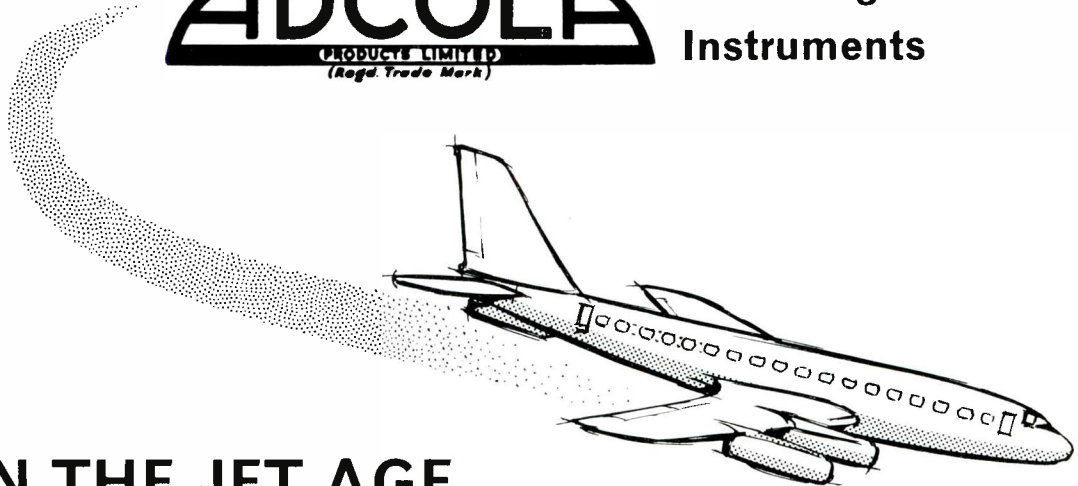

IN THE JET AGE

**EFFICIENCY AND RELIABILITY,
AND CONSISTANT, SUSTAINED PERFORMANCE
ARE BASIC REQUIREMENTS.**

**ADCOLA SOLDERING INSTRUMENTS MEET THESE NEEDS
AND GO ON MEETING THEM, DAY AFTER DAY, YEAR AFTER YEAR,
WITH UNFAILING REGULARITY.**

**LEADING MANUFACTURERS THROUGHOUT THE WORLD LIKE THIS,
THEY ALSO LIKE THE QUICK SERVICE WHEN REPLACEMENTS
DO BECOME NECESSARY. SO THEY SPECIFY ADCOLA.**

WHY DON'T YOU!

**AVAILABLE FROM SHOPS EVERYWHERE
OR DIRECT FROM**

**SALES & SERVICE DIVISION,
ADCOLA PRODUCTS LTD.,
ADCOLA HOUSE,
GAUDEN ROAD,
LONDON, S.W.4.**

TELEPHONE 01-622 0291

**SEND COUPON
FOR LATEST LEAFLET**

NAME	_____
ADDRESS	_____

P.E.167	

Lasky's Radio

SPECIAL INTEREST ITEMS!

MIDLAND Model 10-502 VHF AIRCRAFT BAND CONVERTER

An entirely new item for the radio enthusiast bringing instant reception of the ground-to-air, air-to-ground waveband. For use with any standard AM or FM radio covering 535 to 1,605kc/s, 88 to 108Mc/s respectively—with no electrical conversion or connection required. The Model 10-502 (self powered by one 9V (PP3 type) battery) is merely placed close to the receiving set and then tuned over 110 to 135Mc/s which covers the whole aircraft communications band. Volume and reception effectiveness is adjusted by moving both sets to the most favourable position and balancing the volume controls of each accordingly. The Model 10-502 has a smartly designed black plastic cabinet with brushed metal front panel and 18in chrome telescopic antenna, size only 4 x 2½ x 2½in (inc. knobs). Complete with battery and full instructions.



Lasky's Price 79/6 Post 3/6

SPECIAL TRANSCRIPTION MOTOR OFFER — FAMOUS Connoisseur Classic

2 speed transcription deck. One synchronous motor for each speed—45 and 33 r.p.m. List Price £15.15/7.

Lasky's Price £9.19.6. P. & P. 5/-



ALSO AVAILABLE Connoisseur SCU.1 pickup arm and cartridge. List Price £8.13.4.

Lasky's Price £5.19.6. P. & P. 3/6

PACKAGE PRICE IF BOUGHT TOGETHER £12.19.6. P. & P. 5/-

GARRARD RECORD PLAYERS

AUTOCHANGERS

1025	£7/19/6
2028	£9/19/6
SL96	£45/0/0
3000LM with stereo cart.	£9/19/6
AT60 Mk. II	£13/19/6
A70	£13/19/6
AP75	£20/10/0
A50	£7/7/0

SINGLE PLAYERS

GARRARD SP25 Mk. II	£11/19/6
GARRARD SP22	£6/10/6

TRANSCRIPTION DECKS

GARRARD 401	£27/19/0
GARRARD Lab. 80 Mk. II with base	£30/9/0

CLEARVIEW PERSPEX COVERS

SPC1	£3/3/10
SPC2	£4/4/4
SPC4	£4/4/11

Postage on all above 5/- extra.

GARRARD BASES

WB1	£3/5/8
WB2	£4/13/8
WB4	£5/0/11

HITACHI CAR RADIO SHORT WAVE ADAPTOR

Model WM20

New from Hitachi—world famous for high quality transistor radios—a push button Short Wave adaptor enabling you to receive all foreign broadcasts in the 3-22Mc/s waveband. The WM-20 adaptor is suitable for use with any make or model of AM car radio (covering the usual 535-1,605kc/s) in any make or model of car (6 or 12V, positive or negative ground). The WM-20 as will be seen has 10 push buttons which cover metre bands 13, 16, 19, 25, 31, 41, 49, 60 and 90 plus OF button. Having selected the required band by pushing the appropriate button—fine station tuning is effected by use of the parent radio's tuning system—details with the adaptor show corresponding centres for each short wave band on the radio dial. Double superhet IFM circuit and the use of a Zenor diode and compensating condenser, provides great stability. Switched adjustment for 6 or 12V and pos. or neg. ground; external aerial trimmer provided. Connection to the parent radio is via the aerial jack, power is taken direct from the car A.U.X. supply with sep. line fuse. All necessary mounting brackets, leads and jacks are provided with instruction manual. The WM-20 is very smartly styled with brushed and bright chrome front panel and black push buttons. Size 8½" wide x 1½" high x 3½" deep.

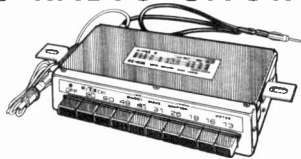

List Price 14 Gns. Lasky's Price £9.19.6. P. & P. 5/-.

GET YOUR LASKY'S CATALOGUE

FREE Third great issue now in preparation—more pages—1,000's more items. Make sure of your copy now. Just send your name, address and 1/- for post only

Branches

207 EDGWARE ROAD, LONDON, W.2 Tel.: 01-723 3271
Open all day Saturday, early closing 1 p.m. Thursday

33 TOTTENHAM CT. RD., LONDON, W.1 Tel.: 01-636 2605

Open all day, 9 a.m.—6 p.m. Monday to Saturday

152/3 FLEET STREET, LONDON, E.C.4 Tel.: FLEet St. 2833

Open all day Thursday, early closing 1 p.m. Saturday

ALL MAIL ORDERS AND CORRESPONDENCE TO: 3-15 CAVELL ST., TOWER HAMLETS, LONDON, E.1 Tel.: 01-790 4821

COMMUNICATION RECEIVERS

TRIO

MODEL 9R-59DE

Brief spec.: 4 band receiver covering 650kc/s to 30Mc/s continuous and electrical band spread on 10, 15, 20, 40 and 80 metres. 8 valve plus 7 diode circuit. 4/8 ohm output and phone jack. Special features: 8SB-CW • ANL • Variable BFO • S meter • Sep. band spread dial • IF frequency 455kc/s • Audio output 1.5W • Variable RF and AF gain controls. For use on 115/250V a.c. Mains. Beautifully designed control layout finished in light grey with dark grey case, size 7 x 15 x 10in. Weight 19lb. Fully guaranteed, complete with instruction manual and service data.

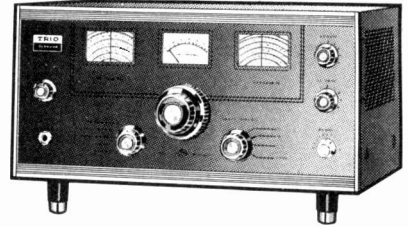

Lasky's Price £39.15.0 Carriage and Packing 12/6

SPECIAL INTEREST ITEM JUST ARRIVED

TTC Model A.1009 AM TUNER ADAPTOR PACK FOR CASSETTE RECORDERS

An amazingly ingenious AM Tuner that looks like and is exactly the same size as a standard tape cassette—which converts your tape cassette recorder/player instantly into a radio! The tuner pack is a completely self-contained unit with built-in ferrite rod aerial, power source (one miniature Eveready type 1223 giving approx. 150 hrs operation. All you do is take out the tape cassette and slip in the tuner. Tunable over 535-1,605kc/s (full Medium waveband). Suitable for use with all standard tape cassette recorders and players. Complete with battery.

Lasky's Price 89/6. P. & P. 2/6.

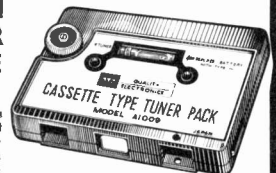

CONSTRUCTORS BARGAINS

LASKY'S ENCAPSULATED SOLID STATE MODULES

8 completely new special function circuit modules. Size of each module only 2½ x 1½ x ¼in. Ready for immediate use—just connect to power source (usually 9V batt.), input and output. Encapsulated modules are shockproof and almost indestructible. Comp. with full ins. Post 1/6 each.

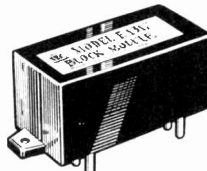

- E-1311 Phono Pre-amp Module—max. output 3V. RMS, input 50mV, input imp. 100kΩ, gain 28dB, R.I.A.A. compensation. **29/6**
- E-1312 Tape Head Pre-amp Module—max. output 3V, RMS, input 50mV, input imp. 100kΩ, gain 25dB, N.A.R.T.B. compensation. **29/6**
- E-1313 Microphone Pre-amp Module—max. output 4V, RMS, input 50mV, input imp. 100kΩ, gain 28dB, response 10-50kc/s. **29/6**
- E-1314 Power Amplifier Module—max. output 300mW, input imp. 1kΩ, gain 20dB, response 50-10kc/s, distortion 3% at 20mW. **29/6**
- E-1315 Electronic Organ (tone oscillator) Module—frequency 200-1,000c/s, output 80mW. For use with keyboard, variable resistors and 8Ω speaker. **25/-**
- E-1316 Morse Code Practice Oscillator Module—frequency 400c/s, output 50mW. For use with Morse key and speaker. **25/-**
- E-1317 Modulated Wireless Signal Transmitter for use in test bench fault finding—frequency 400c/s-30Mc/s, tone freq. 400c/s. For use with any AM receiver. **25/-**
- E-1318 Lamp Flasher Module—flashes two miniature lamps alternately. For use with 6V, 100/200mA bulbs and 6V power supply. **25/-**

CLEAR PLASTIC PANEL METERS

Precision made in Japan by TTC. Each meter boxed and fully guaranteed with all fixing nuts and washers. Sizes are of front panel. Add 1/6 P. on each. (Quotes for quantities.)

Type KR-52 3" 2½in (illustrated).

1mA	38/6	50μA	56/-
5mA	38/6	1mA S Meter	39/6
100mA	38/6	100μA	52/6
300V	35/-	500μA	45/-

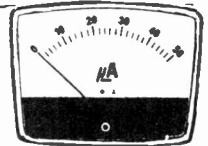

Type MK-38A 1½in square	Type KR-65 3½ 3in	Type MK-45A 2in square	
1mA	29/6	1mA	29/6
5mA	27/6	5mA	37/6
100mA	27/6	100mA	38/6
300V	27/6	300V	38/6
50μA	37/6	50μA	59/6
1mA S meter	29/6	1mA S meter	42/-
100μA	37/6	100μA	54/-
500μA	29/6	500μA	46/-

6mA	29/6
100mA	28/6
300V	28/6
50μA	49/6
1mA S meter	38/6
100μA	42/6
500μA	35/-

High Fidelity Audio Centres

42 TOTTENHAM CT. RD., LONDON, W.1 Tel.: 01-580 2573
Open all day Thursday, early closing 1 p.m. Saturday

118 EDGWARE ROAD, LONDON, W.2 Tel.: 01-723 9789
Open all day Saturday, early closing 1 p.m. Thursday

Take your Wellerchoice

LOW INITIAL COST

Marksman irons to cover all your soldering needs. 25W, 40W, 80W, 120W, 175W. Nickel-plated factory pre-tinned tips in stainless steel shanks.

INSTANT HEAT FOR RAPID SOLDERING

THE tool for intermittent work such as servicing. Working heat in a few seconds. The job is done in less time than it takes a normal iron to heat up. Expert dual-heat and Heavy Duty models.

TEMPERATURE CONTROL FOR RELIABILITY

For sophisticated production line soldering or to replace several conventional irons. No dry joints. Control of temperature without inhibiting performance. Mains or low voltage.

Send for full information

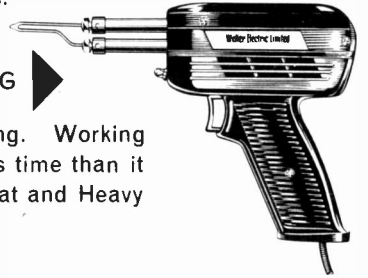

Weller Electric Limited

Redkiln Way, Horsham, Sussex

Tel: 0403. 61747

YOURS FREE FOR 7 DAYS



The 'New Picture-Book' way of learning BASIC ELECTRICITY (5 vols.) BASIC ELECTRONICS (6 vols.)

You'll find it easy to learn with this outstandingly successful NEW PICTORIAL METHOD—the essential facts are explained in the simplest language, one at a time, and each is illustrated by an accurate, cartoon-type drawing. The books are based on the latest research into simplified learning techniques. This has proved that the PICTORIAL APPROACH to learning is the quickest and soundest way of gaining mastery over these subjects.

TO TRY IT, IS TO PROVE IT

The series will be of exceptional value in training mechanics and technicians in Electricity, Radio and Electronics.

WHAT READERS SAY

"May I take this opportunity to thank you for such enlightening works and may I add, in terms, easily understood by the novice." L. W. M., Birmingham.

"I find that the new pictorial method is so easy to understand and I will undoubtedly enjoy reading the following five volumes: thank you for a wonderful set of books." C. B., London.

"Please accept my admiration for producing a long felt want in the field of understanding Electronics." S. B. J., London.

"The easiest set of manuals it has been my pleasure to study." J. P. P., Taunton.

A TECH-PRESS PUBLICATION

POST NOW FOR THIS OFFER !!

To The SELRAY BOOK CO., 60 HAYES HILL, HAYES, BROMLEY, KENT BR2 7HP

Please send me WITHOUT OBLIGATION TO PURCHASE, one of the above sets on 7 DAYS FREE TRIAL, I will either return set, carriage paid, in good condition within 7 days or send the following amounts. BASIC ELECTRICITY 75/- . Cash Price or Down Payment of 20/- followed by 3 fortnightly payments of 20- each . BASIC ELECTRONICS 90/- . Cash Price or Down Payment of 15/- followed by 4 fortnightly payments of 20/- each. This offer applies to UNITED KINGDOM ONLY. Overseas customers cash with order, prices as above.

Tick Set required (Only one set allowed on free trial)

BASIC ELECTRICITY BASIC ELECTRONICS

Prices include Postage and Packing.

Signature

(If under 21 signature required of parent or guardian)

NAME

BLOCK LETTERS

FULL POSTAL ADDRESS

NEW - FIELDMASTER CASSETTE-TYPE TUNER PACK

THE BEST OF ITS TYPE

Uses 4 top grade transistors. Fits in place of tape cassette and converts recorder to radio reception. Covers full medium wave battery operated. Highly sensitive circuit. 99/6. P. & P. 2/6.



NEW ONLY - MAGNAVOX 4 TRACK TAPE DECKS. £11.19.6. Carr. 12/6.

NEW - ADASTRA "DOUBLE 5" STEREO AMPLIFIER.

10 transistor circuit. Volume, Treble, Bass, on/off and Balance controls. Inputs for magnetic and ceramic cartridges, tuner and microphone. Output 4 watts per channel. Complete with operating booklet. £12.19.6. P. & P. 4/6.

"ADASTRETTE" Record Player Amplifier.

ECL82 and E280 valves. Output imp 3/5 ohms. Easy to fit into cabinet. Separate control panel with on/off, volume and tone controls. Complete with instructions. £4.7.8. P. & P. 4/6.



SINCLAIR MICROMATIC M.W. POCKET RADIO

The set that plays anywhere! 6 stage transistor set complete with earpiece. Ready built and fully guaranteed. Only 59/8. P. & P. 3/6.



SHIRA 89D MULTI-TESTER 20,000 o.p.v.

D.C. voltage: 5, 25, 50, 250, 500, 2.5kV (20,000Ω per volt). A.C. voltage: 10, 50, 100, 500, 1,000V (10,000Ω per volt). D.C. current: 0-50A, 0-2.5MA, 0-250MA. Resistance: 0-4k, 0-50k, 0-500k, 0-250MΩ. Resistance 0-60kΩ. 0-6MΩ. Decibels -20 to +22dB. Size of meter 4 1/2" x 3 1/2". £11.85/-. P. & P. 3/6.



TTC-C1001 MULTI-TESTER.

In leather case. 20,000 o.p.v. A.C. volts 10, 50, 250, 1,000V. D.C. volts 5-25, 125, 500, 2,000V. D.C. current 0-50A, 0-250mA. Resistance 0-60kΩ. 0-6MΩ. Decibels -20 to +22dB. Size of meter 4 1/2" x 3 1/2". £11.85/-. P. & P. 3/6.

GARRARD DECKS

1025 Stereo/mono cart	£7.19.6
2025 Stereo/mono cart	£9.19.6
3000/8 Stereo/mono cart	£8.19.6
3000/D Stereo Diamond cart	£10.19.6
SP25 less cart	£11.19.6
SP25/Deram Stereo cart	£17.4.6
AT60 less cart	£13.19.6
AT60/Deram Stereo cart	£19.4.6
AP75 less cart	£22.11.6
SL75 less cart	£24.18.9
SL95 less cart	£44.6.9

All plus P. & P. 12/6.

NEW STEREO/MONO HEADPHONES

8DH7. Soft rubber earpieces with slide switch for mono/stereo listening and individual volume controls. Impedance 8-16Ω. Frequency response, 25Hz-15kHz. With lead and stereo plug. £8.6.0. P. & P. 3/6.



STEREO HEADPHONES G1111

With soft rubber earpieces. Impedance 8-16Ω. Frequency response, 23Hz-13kHz. With lead and stereo plug. £3.19.6. P. & P. 3/6.

SINCLAIR Z12 12 watt integrated amp and pre-amp.

Size 3 1/2" x 1 1/2". Ready built with manual £4.9.6. P. & P. 3/6.

STEREO HEADPHONE JUNCTION BOX

Enable headphones to be used with any amplifier. Incorporates amplifier leads, speaker terminals, jack socket and speaker/headphone switch. 20/6. P. & P. 2/-.

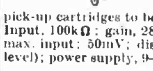

NEW TRANSISTOR MODULES

E1311. Phono Pre-Amplifier. Size 2 1/2" x 1 1/2" built in R.I.A.A. Characteristics enabling low output magnetic pick-up cartridges to be amplified up to 1V. Input 100kΩ; gain 28dB; max. output 3V; max. input 50mV; distortion 0.15% (at 1V level); power supply, 9-12V. 29/6. P. & P. 2/-.

E1312. Tape Pre-Amplifier. Incorporating N.A.R.T.B. curve characteristics, this amplifies tape head signals up to 1V within the frequency range of 30Hz-15kHz. Input imp. 100kΩ; gain 25dB; max. output 2V; max. input 50mV; distortion 0.15% (at 1V level); power supply, 9-12V. 29/6. P. & P. 2/-.

E1313. Microphone Pre-Amplifier. Enables a low output microphone to be used with an amplifier or radio. Input imp. 100kΩ; gain 28dB; max. output 3V; max. input 50mV; distortion 0.15% (at 1V level); freq. res. 10Hz-50kHz; power supply, 9-12V. 29/6. P. & P. 2/-.

E1314. Power Amplifier. When used in conjunction with E1311, E1312 and E1313 units, this amplifier module produces about 300mW output for an output transformer (8-16Ω), without necessity for a power transformer. Input imp., 1,000Ω; gain, 20dB output level; distortion, 3% (at 200mW output level); freq. res., 50Hz-10kHz; power supply, 9V; current 20mA at no signal, 80mA at max. output. 29/6. P. & P. 2/-.

E1315. Electronic Organ Tone Oscillator. Used in conjunction with an organ keyboard, variable resistances and a 9V power supply, this module acts as the oscillator unit for an electronic organ. Tone frequency, 200-1,000Hz; output, 80mW; current, 15mA. 25/-. P. & P. 2/-.

E1316. Morse Code Oscillator. A transistorised Morse code oscillator (buzzer) to be used in conjunction with an operating key. Suitable for direct connection to a loud-speaker. Tone frequency, 400Hz; power output, 80mW; power supply, 3-9V; current, 45mA. 25/-. P. & P. 2/-.

E1317. Wireless Code Oscillator/Transmitter. Can be used with an ordinary A.M. radio receiver for modulated signal transmissions, and for bench trouble shooting when servicing. Transmitter freq., 400Hz-30MHz; tone freq., 400Hz; power supply, 9V d.c.; current 30mA. 25/-. P. & P. 2/-.

E1318. Dual Lamp Flasher. A switch module for electronically alternating two miniature bulbs, 6V, 100-200mA. Ideal for models, toy boats and planes, displays, warning and security devices, communication signals, etc. Flasher time, 1/2 second; power supply, 6V d.c.; current, 150mA; lamp, 6V 150mA. 25/-. P. & P. 2/-.

COMPACT 2-WAY INTERCOMS

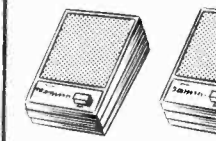

For table or wall mounting. Smart two tone grey case size 3 1/2" x 1 1/2" x 2 1/2". Complete with lead, staples and 9V battery. 49/6. P. & P. 3/6.



AC/DC CONVERTOR

Enables transistor equipment to be operated from a.c. mains. 6/9/12V output selector switch and on/off switch. Grey case, size 4 2 1/2" x 2". Complete with mains lead, connecting leads and instructions. 59/6. P. & P. 3/6.

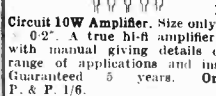

Circuit 10W Amplifier.

Size only 1" x 0 4" with manual giving details of a wide range of applications and instructions. Guaranteed 5 years. Only 59/6. P. & P. 1/6.

NEW VHF AIRCRAFT BAND CONVERTOR.

When placed within 1" of a MW band radio full coverage of VHF Aircraft Band 108-130Mc/s can be obtained. All transistor, 9V battery operation. Fully tunable 181" 7 section telescopic aerial. Size 4" x 2 1/2". 79/6. P. & P. 3/6.



4 AMP BATTERY CHARGER

Smart hammer grey case. 1 1/2" x 1 1/2" x 1 1/2". 12V switching. Safety fuses and heat vents. Complete with 5 three core mains lead, 5" red and black battery leads with heavy duty crocodile clips. 50/6. P. & P. 4/6.

CAR BURGLAR ALARM

With combined emergency warning light system. Fits any 6V or 12V car. With switch panel alarm unit and fitting instructions. 39/6. P. & P. 3/6.



NEW TRANSISTOR CHECKER.

For measuring alpha, beta and Ico factors of transistors, also for checking germanium and silicon diodes. Internal 9V battery. Wide reading scale. Moulded case size 7 1/2" x 4 1/2" x 2 1/2". Ranges: alpha, 0.7-0.9967; beta, 0-300; Ico, 0.50-5,000A. Diode Test: forward and reverse internal resistance. Resistance: 200Ω-1MΩ. Complete with connectors and instruction booklet. £7.19.6. P. & P. 3/6.

EAGLE TT144 TRANSISTOR TESTER

Tests in-circuit or out of circuit. Identifies PNP and NPN types. Indicator lamp provides positive information on the following tests: Electrode open circuits and current drain. Provides reliable GO-NO-GO tests at practical collector currents of from 5-50mA or more on power transistors. With accessories and instructions. Size 3 1/2" x 6 1/2" x 2 1/2". £4.19.6. P. & P. 3/6.

"HI-TEN" LOUDSPEAKER

British made full-range 10" unit handles up to 10W. Ceramic magnet. Frequency response, 40Hz-10kHz; imp., 15Ω; flux density, 10,000 lines. 49/6. P. & P. 4/6.



8-DeC BREAD BOARD

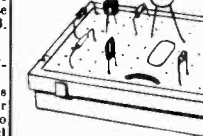

Solderless bread board panels, for fast reliable component connections. Single DeCs. One 8-DeC with control panel, jig and accessories, for solderless connections to controls, etc., with booklet "Projects on 8-DeC", giving construction details for a variety of circuits. 29/6. P. & P. 2/6.

2 DeC Kit.

Two decks, control panel and accessory kit together with components tray and lid all in a black plastic box. Instructions and project book included. 69/6. P. & P. 2/6.

4-DeC Kit.

Four 8-DeCs with two control panels, jigs and accessories, and the booklet "Projects on 8-DeC", all contained in a strong attractive plastic case. Ideal for the professional user. £5.17.6. P. & P. 3/6.



9 in 1 ELECTRONIC KIT

Build nine different projects from one basic kit - no mechanics or knowledge required. Build a Police Siren, Metronome, Morse Code Amplifier, Electronic Massager, W/T Transmitter, Radio Telephone, One-transistor Radio, Two-transistor Radio, Electronic Music Kit. Completely safe - operated on 9V PP3 battery. Complete with simple step by step instructions. Only 69/6. P. & P. 3/6.



SOLDERING GUN

With interchangeable tips, extension barrels, comfortable grip with trigger control, "T" shaped 3/8" bit to minimise wear. Light beam is automatically directed on to end of bit when on/off trigger is in use. Complete with 9-pin plug 230-250V. Spares available. 85W element. 49/6. P. & P. 2/6.



"ADASTRA" SOLDERING IRON

30W. Employs its protective cover as a handle. A.C. 230/250V. Adjustable bit. With 4' lead. Spares available. 12/6. P. & P. 2/6.



E.M.I. COMBINATION LOUDSPEAKERS

13 1/2" x 8 1/2" elliptical with two 2 1/2" tweeters; 15Ω impedance. 10W power handling. 10W. Brand new and guaranteed. 99/6. P. & P. 7/6. (Also available without tweeters. 59/6. P. & P. 7/6.)



NOW OPEN - OUR NEW

- ★ HI-FI DEMONSTRATION ROOM
 - ★ RECORDING TAPE BAR
 - ★ SCIENTIFIC CENTRE - wonderful selection of Microscopes, Binoculars, Telescopes
- At 18 Tottenham Court Road, W.1

LIND-AIR(OPTRONICS)LTD

18 Tottenham Court Road, London, W.1. Tel. 01-580 2255
 25 Tottenham Court Road, London, W.1. Tel. 01-580 7679
 53 Tottenham Court Road, London, W.1. Tel. 01-580 4534
 Open 9-6 p.m. Monday to Saturday. Thursday until 7 p.m.

ALL MAIL ORDERS

To Dept. PE169
 53 Tottenham Court Road, London, W.1

Look What's New from HEATHKIT

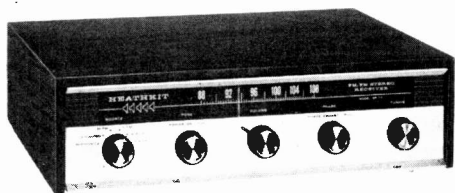

Cabinet walnut or teak finish **£3.10.0** extra

Low-cost FM Stereo Receiver, AR-17

Kit K/AR-17

£39.0.0

P.P. 10/6

28 transistor, 7 diode circuit, 14 watts music power, 10 watts r.m.s. from 25-35,000Hz @ ± 1 dB. Automatic stereo indicator light. Adjustable phase control. Complete front panel controls. Flywheel tuning. Factory assembled and aligned FM front-end. Circuit board assembly. Compact 10 $\frac{3}{4}$ " deep \times 3" high \times 12" wide. Use free standing with Heathkit cabinet optional extra.

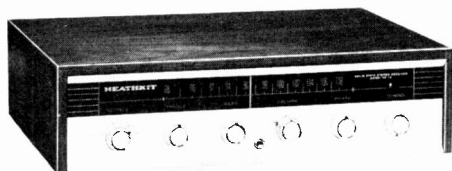

Cabinet walnut or teak finish **£4.10.0** extra

Quality FM Stereo Receiver, AR-14

Kit K/AR-14

£54.0.0

P.P. 13/6

31 transistor, 10 diode circuit can deliver ± 1 dB, 15 to 50,000Hz at 10 watts per channel (20 watts total) 15 watts per channel 1HF music power (30 watts total). Wide-band FM/FM stereo tuner plus two preamps, two power amplifiers. Compact only 3 $\frac{3}{4}$ " high \times 15 $\frac{1}{2}$ " wide \times 12" deep. Install in a wall, free standing or in Heathkit cabinet optional extra. 210-240V 50Hz a.c.

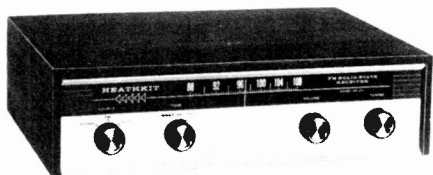

Cabinet walnut veneered **£3.10.0**

Low-cost FM Mono Receiver, AR-27

Kit K/AR-27

£22.10.0

P.P. 10/6

13 transistor, 6 diode circuit. 7 watts music power. ± 1 db, 25 to 60,000Hz at 6 watts. Input connectors for phono and aux. Complete front panel controls. Flywheel tuning, factory pre-aligned FM tuner. Circuit board assembly. Compact bookshelf size. Install in a wall, free standing or in cabinet optional extra. 210-240V 50Hz a.c. operation.

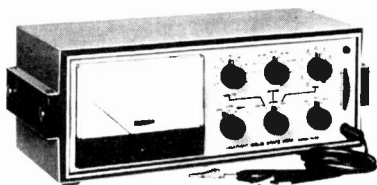

Kit K/IM-25

£48.10.0

P.P. 10/6

9 a.c. and 9 d.c. ranges 150mV up to 1,500V f.s. 7 resistance ranges, 10 ohms centre scale with multipliers $\times 1$, $\times 10$, $\times 100$, $\times 1k$, $\times 10k$, $\times 100k$ and $\times 1$ Meg. . . . measures from 1 ohm to 1,000Mohms. 11 current ranges from 15 μ A full scale to 1.5A full scale. 11Mohm input impedance d.c. 10Mohm input impedance a.c. 6" 200 μ A meter. Internal battery power or 120/240V a.c. 50Hz supply. PCB construction.

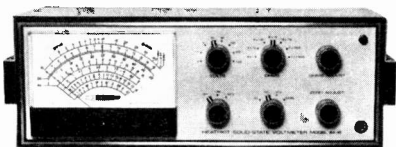

Solid-State Volt-ohm Meter, IM-16

Kit K/IM-16

£28.8.0

P.P. 10/6

8 a.c. and 8 d.c. ranges 0-5V to 1,500V f.s. 7 ohm-meter ranges with 10 ohms centre scale with multipliers $\times 1$, $\times 10$, $\times 100$, $\times 1k$, $\times 10k$, $\times 100k$ and $\times 1$ Meg. . . . 11Mohm input on d.c., 1Mohm on a.c. Internal battery power or 120/240V a.c. 50Hz supply.



Solid-State Low Voltage Power Supply, IP-27

Kit K/IP-27

£46.12.0

P.P. 10/6

0.5 to 50V d.c. with better than ± 15 Millivolts regulation. Four current ranges 50mA; 150mA, 500mA, and 1.5 amperes. Adjustable current limiter: 30 to 100% all ranges. Panel meter for output voltage or current.

PLEASE USE COUPON ON RIGHT FOR FREE CATALOGUE

Build Your Own HEATHKIT Electronics!

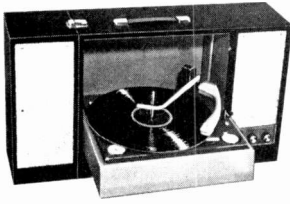

STEREO RECORD PLAYER, SRP-1

Two built-in speakers
Suitcase portability

Kit **£28.6.0** P.P. 10/6



CAR RADIO, CR-1

High performance at low cost. 12 v pos. or 12 v neg. operation. 4 watts output

Kit (incl. spkr.) **£14.12.0** P.P. 4/6



STEREO TAPE RECORDER, STR-1

Built-in speakers. Many features unobtainable elsewhere at this price

Kit **£58.0.0** P.P. 10/6

MANY OTHER INSTRUMENTS FOR TEST AND SERVICE IN RANGE

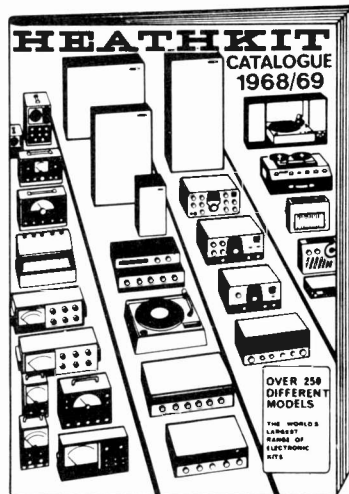

MANY SHORTWAVE RECEIVERS including:

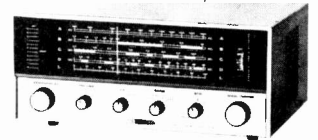

4-BAND RECEIVER, GR-64E

Cover 1 MHz/z to 30 MHz/z plus 550 kHz/z to 1620 kHz/z AM broadcast band. Built-in speaker. Handsome low-boy styling. Kit **£22.8.0** P.P. 9/-

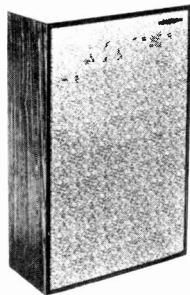

BERKELEY Slim-line SPEAKER SYSTEM

Kit **£21.4.0** P.P. 13/6

See these and many more in the Latest CATALOGUE ... it's FREE

PORTABLE RADIO UXR-1

Kit coloured case **£12.8.0** P.P. 4/6

Kit leather case **£13.8.0** P.P. 4/6

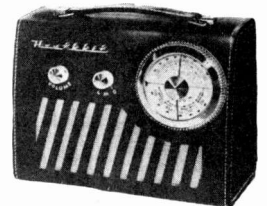

PORTABLE RADIO UXR-2

In black or natural leather

Kit **£15.10.0** P.P. 6/-

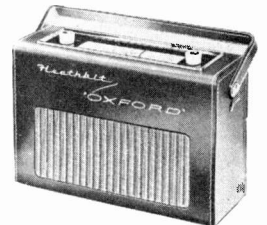

SEE HEATHKIT MODELS

in LONDON

233 Tottenham Court Road

BIRMINGHAM

17-18 St. Martin's House, BULL RING

GLOUCESTER

Factory and Showroom:
Bristol Road, GLOUCESTER



DAYSTROM LTD.

Dept. P.E.1

GLOUCESTER. Tel. 29451

Please send me FREE CATALOGUE Tick

NAME _____

ADDRESS _____

Prices and specifications subject to change without notice

PRINTED CIRCUIT KIT

BUILD 40 INTERESTING PROJECTS ON A PRINTED CIRCUIT CHASSIS with PARTS and TRANSISTORS from your SPARES BOX

CONTENTS: (1) 2 Copper Laminate Boards 4" x 2 1/2". (2) 1 Board for Matchbox Radio. (3) 1 Board for Wristwatch Radio, etc. (4) Resist. (5) Resist Solvent. (6) Etchant. (7) Cleanser/Degreaser. (8) 16-page Booklet *Printed Circuits for Amateurs*. (9) 2 Miniature Radio Dials SW/MW/LW. Also free with each kit. (10) Essential Design Data, Circuits, Chassis Plans, etc. for 40 TRANSISTORISED PROJECTS. A very comprehensive selection of circuits to suit everyone's requirements and constructional ability. Many recently developed very efficient designs published for the first time, including 10 new circuits.

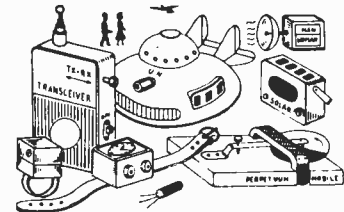

EXPERIMENTER'S PRINTED CIRCUIT KIT 8/6

Postage & Pack. 1/6 (UK)
Commonwealth:
SURFACE MAIL 2/-
AIR MAIL 8/-
Australia, New Zealand,
South Africa, Canada.

(1) Crystal Set with biased Detector. (2) Crystal Set with voltage-quadrupler detector. (3) Crystal Set with Dynamic Loudspeaker. (4) Crystal Tuner with Audio Amplifier. (5) Carrier Power Conversion Receiver. (6) Split-Load Neutralised Double Reflex. (7) Matchbox or Photocell Radio. (8) "TRI-FLEXON" Triple Reflex with self-adjusting regeneration (Patent Pending). (9) Solar Battery Loudspeaker Radio. The smallest 3 designs yet offered to the Home Constructor anywhere in the World. 3 Subminiature Radio Receivers based on the "Triflexon" circuit. Let us know if you know of a smaller design published anywhere. (10) Postage Stamp Radio. Size only 1.62" x 0.95" x 0.25". (11) Wristwatch Radio 1.15" x 0.80" x 0.65". (12) Ring Radio 0.70" x 0.70" x 0.55". (13) Bacteria-powered Radio. Runs on sugar or bread. (14) Radio Control Tone Receiver. (15) Transistor P/P Amplifier. (16) Intercom. (17) 1-valve Amplifier. (18) Reliable Burglar Alarm. (19) Light-seeking Animal, Guided Missile. (20) Perpetual Motion Machine. (21) Metal Detector. (22) Transistor Tester. (23) Human Body Radiation Detector. (24) Man/Woman Discriminator. (25) Signal Injector. (26) Pocket Transceiver (Licence required). (27) Constant Volume Intercom. (28) Remote Control of Models by Induction. (29) Inductive-Loop Transmitter. (30) Pocket Triple Reflex Radio. (31) Wristwatch Transmitter/Wireless Microphone. (32) Wire-less Door Bell. (33) Ultraasonic Switch/Alarm. (34) Stereo Preamplifier. (35) Quality Stereo Push-Pull Amplifier. (36) Light-Beam Telephony "Photophone". (37) Light-Beam Transmitter. (38) Silent TV Sound Adaptor. (39) Ultraasonic Transmitter. (40) Thyristor Drill Speed Controller.

PHOTOELECTRIC KIT

CONTENTS: 2 P.C. Chassis Boards, Chemicals, Etching Manual, Infra-Red Phototransistor, Latching Relay, 2 Transistors, Condensers, Resistors, Gain Control, Terminal Block, Elegant Case, Screws, etc. In fact everything you need to build a Steady-Light Photo-Switch/Counter/Burglar Alarm, etc. (Project No. 1) which can be modified for modulated-light operation.

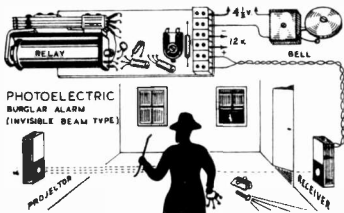

PHOTOELECTRIC KIT 39/6

Postage and Pack. 2/6 (UK)
Commonwealth:
SURFACE MAIL 3/6
AIR MAIL £1.0.0
Australia, New Zealand
S. Africa, Canada and U.S.A.
Also Essential Data Circuits
and Plans for Building

12 PHOTOELECTRIC PROJECTS. (1) Steady-Light Photo-Switch/Alarm. (2) Modulated-Light Alarm. (3) Long-Range Steady-Light Alarm. (4) Relay-less Alarm. (5) Warbling-Tone Alarm. (6) Closed-Loop Alarm. (7) Project Lamp Stabiliser. (8) Electronic Project Modulator. (9) Mains Power Supply. (10) Car Parking Lamp Switch. (11) Automatic Headlamp Dipper. (12) Super-Sensitive Alarm.

INVISIBLE BEAM OPTICAL KIT

Everything needed (except plywood) for building: 1 Invisible-Beam Projector and 1 Photocell Receiver (as illustrated). Suitable for all Photoelectric Burglar Alarms, Counters, Door Openers, etc.

CONTENTS: 2 lenses, 2 mirrors, 2 45-degree wooden blocks, Infra-red filter, projector lamp holder, building plans, performance data, etc. Price 19/6. Postage and Pack. 1/6 (U.K.). Commonwealth: Surface Mail 2/-; Air Mail 8/-.

JUNIOR PHOTOELECTRIC KIT

Versatile invisible-beam, Relay-less, Steady-light Photo-Switch, Burglar Alarm, Door Opener, Counter, etc., for the Experimenter.

CONTENTS: Infra-Red Sensitive Phototransistor, 3 Transistors, Chassis, Plastic Case, Resistors, Screws, etc. Full Size Plans, Instructions, Data Sheet "10 Advanced Photoelectric Designs". Price 19/6. Postage and Pack. 1/6 (U.K.). Commonwealth 2/-; Air Mail 4/-.

JUNIOR OPTICAL KIT

CONTENTS: 2 Lenses, Infra-red Filter, Lampholder, Bracket, Plans, etc. Everything (except plywood) to build 1 miniature invisible beam projector and photocell receiver for use with Junior Photoelectric Kit. Price 10/6. Post and Pack. 1/6 (U.K.). Commonwealth: Surface Mail 2/-; Air Mail 4/-.

PHOTOELECTRIC PARKING LAMP SWITCH

Automatically turns parking lamp on at dusk, off at dawn. Protects your car. Saves the battery. Miniature construction. Simply insert in parking lamp lead. Price: 27/6. Post and Packing 2/6 (U.K.).

THYRISTOR LIGHT DIMMER

Add a touch of luxury to your home. Adjust the light at parties, while watching TV, etc. Ideal for Children's bedroom. (100 watts max.) Replaces on-off switch. Price: 59/6. Post and Packing 2/6 (U.K.).

YORK ELECTRICS

333 YORK ROAD, LONDON, S.W.11

Send a S.A.E. for full details, a brief description and Photographs of all Kits and all 52 Radio, Electronic and Photoelectric Projects Assembled.

ENGINEERS TEST EQUIPMENT AND ACCESSORIES

MULTIMETERS. Complete range of high precision instruments.

TRANSISTOR CHECKERS. For use with PNP NPN Transistors, IF and RF Resistors, Diodes, Rectifiers.

RESISTOR SUBSTITUTION BOX.

CAPACITANCE SUBSTITUTION BOX.

ADJUSTABLE AC/DC CONVERTER.

TEST LEAD KITS, ETC.

We also stock large range of **MICROPHONES, AUDIO UNITS, RECORDING TAPES, INTERCOMS, TELEPHONE AMPLIFIERS, CAR RADIOS, T.V. SPARES, ETC.**

Send S.A.E. for illustrated brochures and price list.

D. WEBB, Wholesalers

61-63 Clifton Street, Hull, E. Yorkshire

Telephone 36016

HIGH SPEED MAGNETIC COUNTERS (4 x 1 in). 4 digit. 12/24/48V (state which) 6/6 each. P. & P. 1/-.
COPPER LAMINATE BOARD 8 1/2 x 5 1/2 x 1/8 in. 2/6 each. 5 for 10/-.
RE-SETTABLE HIGH SPEED COUNTER (3 1/2 x 1 1/2 in). 3 digit. 12/24/48V (state which) 32/6 each.

BULK COMPONENT OFFERS

100 Capacitors 50pF to 0.5µF.
250 Carbon Resistors 1/2 and 1/4 W (Transistor types).
250 Carbon Resistors 1/2 and 1 W.
100 Ceramic Capacitors 2-1,000pF.
25 Vitreous W/W Resistors (5%).
12 Precision Resistors (0.1% several standard values included)
25 Close Tolerance Caps. (2%).
12 Silicon Diodes 500 p.i.v. 750 m.a.
4 Silicon Rects. 400 p.i.v. 3 amp.
8 Silicon Rects. 100 p.i.v. 3 amp.
50 Silicon Trans. (2N706/708, BSY28/29. BCY41/42 types.) Unmarked, Untested.
ANY ITEM 12/6. ANY 5 ITEMS 22.10.0.

S.C.R.s. (Thyristors) CRS1/20 5/6; CRS1/40 7/6; CRS3/10 7/6; CRS3/30 8/6; CRS3/40 10/-; CRS3/50 12/6 each.

'3000' TYPE RELAYS (ex. new equip.) 10 for 25/- (our choice) P. & P. 5/-.

VENNER LIGHTWEIGHT ACCUMULATORS (lox 1 1/2 x 1 1/2 in). 1.5 Ahr 12/6 each. **COMPUTER LOGIC BOARDS** containing: 14 BCZ11, 2 trim pots, diodes, etc., 20/- each.

LIGHT DIMMER/SPEED CONTROL MODULES: 200 watt, 35/-; 500 watt, 45/-; 1,000 watt, 60/-.

RECORD LEVEL METERS (By Smiths). 1 1/2 x 1/2 in, 15/- each. P. & P. 2/6.

MINIATURE RELAYS (lox 1/2 x 1/2 x 1/2 in). 24V 1 c/o, 7/6 each. 12V. 10/- each.

P. C. CONNECTORS (13 way in-line), 4/6 pair.

LARGE CAPACITY ELECTROLYTICS: 100 + 400µF, 275V; 1,000µF, 50V; 2,500µF, 70V; 3,200µF, 16V; 5,000µF, 15V, 4/- each. 4,000µF, 90V; 5,000µF, 25V, 7/6 each. 5,000µF, 50V; 6,300µF, 68V; 10,000µF, 30V; 16,000µF, 15V; 25,000µF, 15V, 10/- each.

SPEAKER BARGAINS (E.M.I. 13 x 8 in.) With two Tweeters and x/over, 15 ohm, 65/-; with Dual Cone, 15 ohm, 52/6; Single Cone, 3 or 15 ohm, 45/-; P. & P. 3/-.

FANE, 12in, 20watt (Dual Cone), 95/- P. & P. 5/-.

TWEETER (E.M.I. 3in), 15 ohm, 12/6.

CAR RADIO (3/5 ohm), 7 x 4in, 15/-; 8 x 6in, 17/6.

L.T. TRANSFORMERS. Prim 240V. SEC. 10/20/25V. and 3.5 amp, 20/-; P. & P. 5/-; 5 amp, model 25/-; P. & P. 5/-.

PATTRICK & KINNIE

81 PARK LANE, HORNCHURCH, ESSEX

ROMford 44473

BI-PRE-PAK LIMITED

TRANSISTORS PRICE

AC107	3/-	OC170	3/-
AC126	2/4	OC171	4/-
AC127	2/4	OC200	3/6
AC128	2/4	OC201	7/-
ACY17	3/-	2G301	2/6
AF114	4/-	2G303	2/6
AF115	3/6	2N711	10/-
AF116	3/6	2N1302-3	4/-
AF117	3/6	2N1304-5	5/-
AF118	3/6	2N1306-7	6/-
AF119	3/6	2N1308-9	6/-
AF186	10/-	2N3844A	5/-
AF139	10/-	Power Transistors	
BFY50	4/-	OC20	10/-
BSY25	7/6	OC23	10/-
BSY26	3/-	OC25	8/-
BSY27	3/-	OC26	5/-
BSY28	3/-	OC28	7/6
BSY29	3/-	OC35	5/-
BSY95A	3/-	OC36	7/6
OC41	2/6	AD149	10/-
OC44	1/11	AUY10	30/-
OC45	1/9	Diodes	
OC71	2/6	AA42	2/-
OC72	2/6	OA95	2/-
OC73	3/6	OA70	1/9
OC81	2/6	OA79	1/9
OC81D	2/6	OA81	1/9
OC83	4/-	OA73	2/-
OC139	2/6	IN914	1/6
OC140	3/6		

TRY OUR X PAKS FOR UNEQUALLED VALUE

XA PAK

Germanium PNP type transistors, equivalents to a large part of the OC range, i.e. 44, 45, 71, 72, 81, etc.

PRICE £5 PER 1000

XB PAK

Silicon TO-18 CAN type transistors NPN/PNP mixed lots, with equivalents to OC200-1, 2N706A, BSY27/29, BSY95A.

PRICE £5.50 PER 500
PRICE £10 PER 1000

XC PAK

Silicon diodes miniature glass types, finished black with polarity marked, equivalents to OA200, OA202, BAY31-39 and DK10, etc.

PRICE £5 PER 1000

ALL THE ABOVE UNTESTED PACKS HAVE AN AVERAGE OF 75% OR MORE GOOD SEMICONDUCTORS. FREE PACKS SUSPENDED WITH THESE ORDERS. ORDERS MUST NOT BE LESS THAN THE MINIMUM AMOUNTS QUOTED PER PACK.
P/P 2/6 PER PACK (U.K.)

PRE-PAKS

Selection from our lists

No.	Description	Price
B1	50 Unmarked Trans. Untested	- 10/-
B2	4 Photo Cells Inc. Book of Instructions	- 10/-
B6	17 Red Spot AF Transistors	- 10/-
B6A	17 White Spot RF Transistors	- 10/-
B9	1 ORP 12 Light Sensitive Cell	- 9/-
B53	25 Sil. Trans. 400 Mc/s	Brand New - 10/-
B54	40 " " NPN To 5	Trans Voltage - 10/-
B55	40 " " NPN To 18	& Gain Fallouts 10/-
B56	40 " " NPN/PNP	All Tested - 10/-
B68	10 Top Hat Recs. 750 M/A	100-800 PIV - 10/-
B69	20 Diodes. Gld-Bnd. Germ Sil. Planer	- 10/-
B74	5 Gld-Bnd. Diodes, 2-OA9, 3-OA5	- 10/-
B75	3 Comp. Set. 2G371, 2G381, 2G339A	- 10/-
C2	1 Unijunction Transistor 2N2160	- 15/-
C32	6 Top Hat Recs. 15100 Type	- 15/-
C35	3 Unijunction Transistors = to 2N2160	- 15/-
A1	7 Silicon Rectifiers BY100 Type	- 20/-
A3	25 Mixed Marked and Tested Transistors	- 20/-
A21	5 Power Transistors 1-AD149/1-OC26 and 3 others	- 20/-

AND MANY MORE

FREE!

PACKS OF YOUR OWN CHOICE UP TO THE VALUE OF 10/- WITH ORDERS OVER £4

TRANSISTORS ONLY 1/- EACH

SILICON • PLANAR • N.P.N. • P.N.P

All these types available

2N929	2N706	2S131	2S103	2N696	2N1613	2S733	BFY10
2S501	2N706A	2S512	2S104	2N697	2N1711	2N726	2S731
BC108	2N3011	2S102	2N2220	2N1507	2N1893	2N2484	2S732

All tested and guaranteed transistors—unmarked. Manufacturers over runs for the new PRE-PAK range.

BRAND NEW PAK • JUST RELEASED

REPLACES OUR VERY POPULAR B.39 PAK. BRAND NEW SHORT LEAD COMPONENTS ALL FACTORY MARKED AND MOUNTED ON PRINTED CIRCUIT PANELS.

80 TRANSISTORS & DIODES ALL 10/-
50 HIGH TOLERANCE RESISTORS
20 VARIOUS CAPACITORS FOR 10/-

PLEASE STATE WHEN ORDERING PAK P.1 2/- P. & P. WITH THIS PAK.

Make a Rev. Counter for your Car. The 'TACHO BLOCK'. This encapsulated block will turn any 0-1mA meter into a perfectly linear and accurate rev. counter for any car. State 4 or 6 cylinder. **20/- each**

FREE CATALOGUE AND LISTS for:—

ZENER DIODES
TRANSISTORS, RECTIFIERS
FULL PRE-PAK LISTS
& SUBSTITUTION CHART

MINIMUM ORDER 10/- CASH WITH ORDER PLEASE. Add 1/- post and packing per order. OVERSEAS ADD EXTRA FOR AIRMAIL.

THERE IS ONLY ONE
BI-PRE-PAK LTD
BEWARE OF IMITATIONS

FIRST EVER LOGIC KITS

Learn for yourself how computers work even make one for yourself! Full instructions for a noughts and crosses machine, binary counters, timers, etc. L.1. 5gns. L.2. 10gns. Introducing the Norkit range. Norkit Junior £8. Norkit Senior £15.

Details Free
Free Paks suspended with Logic Kit Orders.

NEW UNMARKED UNTESTED PAKS

25	BSY95A NPN Silicon	TRANSISTORS 10/-
10	OC45-OC81 Mull. Glass Type	TRANSISTORS 10/-
25	BSY28-27 NPN Silicon	TRANSISTORS 10/-
10	10 Watt Silicon All Voltages	ZENERS 10/-
25	BFY50-1-2 NPN Silicon	TRANSISTORS 10/-
10	4 amp. Stud. Silicon	RECTIFIERS 10/-
25	BC107-8-9 NPN Silicon	TRANSISTORS 10/-
40	1N914-6 OA200/202 Sub. Min. Silicon	DIODES 10/-
150	Min. Germ. High Quality	DIODES 10/-
25	2N706 A NPN Silicon	TRANSISTORS 10/-

PRE-PAK, N.605 POWER TRANSISTOR EQUIVALENT TO NKT301-2-3-4 **5/- each**
COMPLIMENTARY SET NPN/PNP GERM. TRANS. **2/6 pair**

FREE! A WRITTEN GUARANTEE WITH ALL OUR SEMICONDUCTORS

BI-PRE-PAK LTD DEPT. A, 222-224 WEST ROAD, WESTCLIFF-ON-SEA, ESSEX
TELEPHONE: SOUTHEND (0702) 46344

LOOKING FOR SOMETHING DIFFERENT?

EAGLE'S new range of plug-in all-transistor miniature modules.
 EM.1 Phono Pre-amplifier
 EM.2 Tape Head Pre-amplifier
 EM.3 Microphone Pre-amplifier
 EM.4 Power Amplifier
 Each module is completely assembled and supplied with mounting socket to enable them to plug in and out of circuits. Visit your EAGLE dealer to inspect these new miniature modules... such good value at 32/6d. each.

FOR VERSATILITY
 RELIABILITY AND
 SOUND VALUE
 INSIST ON



Distributed by
 B. Adler & Sons (Radio) Ltd.
 Coptic Street, London, W.C.1

4-STATION INTERCOM

£7/15/0

Solve your communication problems with this 4-Station Transistor Intercom system (1 master and 3 Subs), in de-luxe plastic cabinets for desk or wall mounting. Call/talk/listen from Master to Subs and Subs to Master. Ideally suitable for Business, Surgery, Schools, Hospital, Office and Home. Operates on one 9V battery. On/off switch. Volume control. Complete with 3 connecting wires each 66ft. and other accessories. P. & P. 7/6.

WIRE-LESS INTERCOM

No batteries—no wires. Just plug in the mains for instant two-way, loud and clear communication. On/off switch and volume control. Price 12 gns. P. & P. 9/6 extra.

INTERCOM/BABY ALARM

Originally 6gns. Now 59/6

Same as 4-Station Intercom for two-way instant communication. Ideal as Baby Alarm and Door Phone. Complete with 66ft. connecting wire. Battery 2/6. P. & P. 4/6.

Transistor TELEPHONE AMPLIFIER

Usually 6gns. Now 59/6

Why not boost business efficiency with this incredible De-Luxe Telephone Amplifier. Take down long telephone messages or converse without holding the handset. A useful office aid. On/off switch. Volume control. Battery 2/6 extra. P. & P. 3/6. Full price refunded if not satisfied in 7 days.

WEST LONDON DIRECT SUPPLIES (PE/1)
 169 KENSINGTON HIGH STREET, LONDON, W.8

new VARI-STAT

thermostatic soldering iron

High Production Model D
 Miniature Iron 50 watt
 Voltage 12-250 volt
 Weight 1 3/4oz.
 "Screw on" Bit sizes 1/16in., 3/32in., 1/8in., 3/16in., 1/4in.

Our range also includes:
 Standard Miniature Model 50W
 Standard Instrument Model 70W
 High Production Instrument Model 125W
 Industrial Model 500W

PRICE **60/6**

All these irons give excellent bit and element life since the thermostat completely eliminates overheating and controls reserve heating capacity which makes possible continuous soldering without chilling of the bit. The consistent temperature makes these irons ideal for printed circuit work.

CARDROSS ENGINEERING CO. LTD.,
 Woodyard Road, Dumbarton.
 Phone: Dumbarton 2655

IT'S A MUST
 OUR CATALOGUE
 JOIN THE THOUSANDS
 OF SATISFIED CUSTOMERS
 SEND NOW FOR

OUR NEW 1968/69 illustrated catalogue NOW AVAILABLE
 (send 2/- in stamps for your copy)

Catalogue contains prices and details of Amplifiers — Hi-Fi Tuners — Loudspeakers — Pick-ups — Playing Decks — Microphones — Test Meters — Hand Tools — Valves — Soldering Irons — Tape Recording Accessories, etc.

ALPHA RADIO SUPPLY CO
 103 Leeds Terrace, Leeds 7. Tel. 25187

Build yourself a quality transistor radio guaranteed results backed by our after sales service!

roamer seven mk iv

SEVEN WAVEBAND PORTABLE AND CAR RADIO WITH A SUPER SPECIFICATION GIVING OUTSTANDING PERFORMANCE!
7 FULLY TUNABLE WAVEBANDS—MW1, MW2, LW, SW1, SW2, SW3 AND TRAWLER BAND.



Extra M.W. band for easier tuning of Luxembourg, etc. Built-in ferrite rod aerial for Medium and Long Waves. 5 Section 22in. chrome-plated telescopic aerial for Short Waves—can be angled and rotated for peak S.W. listening. Socket for Car Aerial. Powerful push-pull output. 7 transistors and two diodes including Micro-Alloy R.F. Transistors. Famous make 7 x 4in. P.M. speaker for rich-tone volume. Air spaced ganged tuning condenser. Separate on/off switch, volume control, wave change switches and tuning control. Attractive case now with inset carrying handle. Size 9 x 7 x 4in. approx. First-grade components. Easy to follow instructions and diagrams make the Roamer 7 a pleasure to build with guaranteed results.

Total building costs
£5.19.6 P. & P. Personal Earpiece with switched socket for private listening 5/- extra.
7/6

Parts price list and easy build plans 3/- (Free with parts).

pocket five

MEDIUM WAVE, LONG WAVE AND TRAWLER BAND (to 50 metres approx.) PORTABLE WITH SPEAKER AND EARPIECE

Attractive black and gold case. Size 5½ x 1½ x 3½in. Fully tunable over both Medium and Long Waves with extended M.W. band for easier tuning of Luxembourg, etc. All first grade components—7 stages—5 transistors and 2 diodes, supersensitive ferrite rod aerial, fine tone moving coil speaker, also Personal Earpiece with switched socket for private listening. Easy build plans and parts price list, 1/6 (FREE with parts).

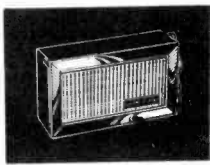

Total building costs
44/6 P. & P.
3/6

transona five

MEDIUM WAVE, LONG WAVE AND TRAWLER BAND (to 50 metres approx.) PORTABLE WITH 3" SPEAKER AND EARPIECE

Attractive case with red speaker grille. Size 6½ x 4½ x 1½in. Fully tunable. 7 stages—5 transistors and 2 diodes, ferrite rod aerial, tuning condenser, volume control, fine tone moving coil speaker also Personal Earpiece with switched socket for private listening. All first grade components. Easy build plans and parts price list 1/6 (FREE with parts).



Total building costs
47/6 P. & P.
3/9

super seven

THREE WAVEBAND PORTABLE WITH 3in. SPEAKER

Attractive case size 7½ x 5½ x 1½in. with gill fittings. The ideal radio for home, car or outdoors. Covers Medium and Long Waves and Trawler Band. Special circuit incorporating 2 R.F. Stages, push pull output, ferrite rod aerial, 7 transistors and 2 diodes, 3in. speaker (will drive larger speaker) and all first grade components. Easy build plans and parts. Price list 2/- (FREE with parts). (Personal Earpiece with switched socket for private listening 5/- extra.)

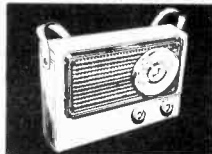

Total building costs
69/6 P. & P.
4/6

roamer six

SIX WAVEBAND PORTABLE WITH 3in. SPEAKER

Attractive case with gill fittings, size 7½ x 5½ x 1½in. World wide reception. Tunable on Medium and Long waves, two short waves, Trawler Band Plus an extra M.W. band for easier tuning of Luxembourg, etc. Sensitive ferrite rod aerial and telescopic aerial for Short waves. All top grade components. 8 stages—6 transistors and 2 diodes including Micro-Alloy R.F. Transistors, etc. (Carrying strap 1/6 extra.) Easy build plans and parts price list 2/- (FREE with parts). Personal Earpiece with switch socket for private listening 5/- extra.)



Total building costs
79/6 P. & P.
4/6

NEW LOOK

melody six

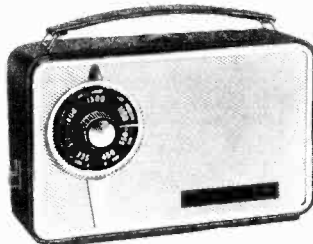

8 stages—6 transistors and 2 diodes. Covers Medium and Long Waves. Top quality 3in. Loudspeaker for quality output and also with Personal Earpiece with switched socket for private listening. Two R.F. Stages for extra boost. High "Q". Ferrite Rod Aerial. Push-pull output. Handsome pocket size case with gill fittings. Size 6½ x 4 x 2in. Easy build plans and parts price list 2/- (FREE with parts).

Total building costs
69/6 P. & P.
4/3

RADIO EXCHANGE LTD

61 HIGH STREET, BEDFORD. Tel.: Bedford 52367

I enclose £..... please send items marked

ROAMER SEVEN ROAMER SIX
TRANSONA FIVE SUPER SEVEN
POCKET FIVE MELODY SIX

Parts price list and plans for.....

Name.....

Address.....

- Callers side entrance Stylo Shoe Shop.
- Open 10-1, 2.30-4.30 Mon.-Fri. 9-12.30 Sat.

RADIONIC

**LEARN AS YOU BUILD
AT HOME
THE EXCITING WAY**

Clear, simple, versatile, this rugged system can build almost any electronic circuit. Ideal for the experimenter; the teacher; and the complete beginner. Already used by well over 1,500 schools in the U.K.

Selected by the Council of Industrial Design for all British Design Centres. Featured in Sound and Television broadcasts.

Beautifully engineered; battery operated; no soldering; no prior knowledge needed. Results guaranteed by our technical department. People say:

"I can only describe the results as brilliant, absolutely brilliant."
"You have opened up a new world."
"Nothing could paint the picture clearer than building these sets."
"The kit has been used by my son (aged 10) with complete success."
"Most impressive—a stroke of genius whoever devised it."

UNIQUE: Our "No soldering" printed circuit board for superhet portable. Simply insert components and tighten nuts.

No. 1 Set £7.10.0. 14 Circuits (Earphone)

No. 2 Set £9.0.0. 20 Circuits (Earphone)

No. 3 Set £13.10.0. 22 Circuits (7" x 4" Loudspeaker Output)

No. 4 Set £18.10.0. 26 Circuits (incl. 6-transistor and reflex superhets)

ELECTRONICS KIT: 30 plus circuits £19.7.0. (Prices Post Free)

Full details from:

RADIONIC PRODUCTS LIMITED
ST. LAWRENCE HOUSE
29-31 BROAD STREET, BRISTOL BS1 2HF
Tel. (0272) 25351

RADIO & ELECTRONIC INSTRUCTIONAL SYSTEM

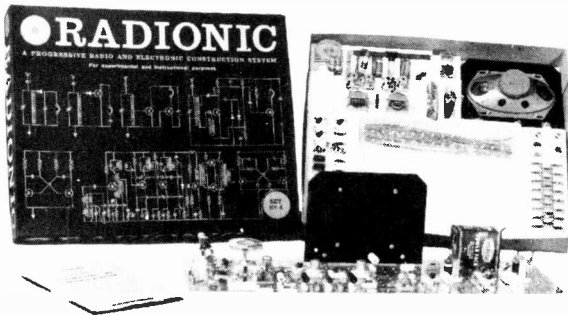

A No. 4 SET and 6-TRANSISTOR SUPERHET

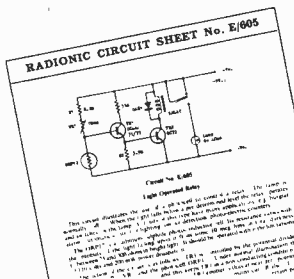

Theoretical Circuit

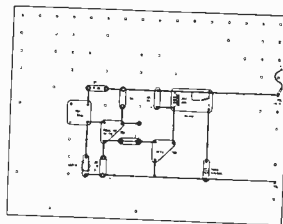

Practical Layout

E/605 Light Operated Relay.

Our 'E' Series of basic electronic circuits is available separately.

SEND S.A.E.
NEW STOCK LIST

WENTWORTH RADIO
104 SALISBURY ROAD, HIGH BARNET

01-449 3087

AF114 4/3
AF115 3/9
AF116 2/3
AF117 2/3
BFY50 6/-
BFY51 4/9
BFY52 6/-
BFY53 4/9
BFY127 4/6
2G302 6/-
2G303 4/7
2G304 7/6
2G308 7/3
2G371 3/6
2N404 5/-
2M696 5/-
2M697 5/-

RETURN OF POST SERVICE

CARBON RESISTORS

¼ watt—3d, 1 watt—5d

VALVE HOLDERS—6d—9d

TUBULAR CAPACITORS—4d to 8d

QUOTATIONS SENT ON REQUEST

CASH WITH ORDER

P. & P. 1/-

OC44 2/6
OC45 1/8
OC71 2/3
OC72 2/6
OC81 2/2
OC810 2/3
OC170 2/9
OC171 2/3
OC201 2/3
MKT121 8/6
MKT122 5/11
MKT123 4/11
NKT124 8/9
NKT211 5/-
NKT212 5/-
NKT213 6/-
NKT713 5/3

EAGLE MULTIMETERS

EP30K, 180/-, p.p. 4/6; EP10KN, 108/-, p.p. 4/6;
EP20KN, 90/-, p.p. 3/-; EP30KN, 150/-, p.p. 4/6;
EP50LN, 210/-, p.p. 4/6, details on request.

High Stability Resistors 1% ½W, 2/- . Full standard range plus many multimeter values. 5% ½W, 4d. Full stock list on request.

0-50 microamp level meters, 15/-, post 1/-

High Res. Phones, 2,000Ω, 15/-, p.p. 1/-

Multimeter ITI-2, 20,000 o.p.v. d.c., 0-5, 25, 50, 250, 2,500V d.c., 10, 50, 100, 500, 1,000V a.c.; 0-50μA, 0-2.5mA, 250mA; 0-60kΩ, 0-5MΩ. capacity and dB ranges, 67/-, post 3/-.

Postage extra, cash with order.

PLANET INSTRUMENT CO.
25(E) DOMINION AVENUE, LEEDS 7

Hi-Fi Solid State Audio Amplifier

10 Watts continuous sign wave output. 15 Watts music power.

Output 3-16 ohms impedance. Frequency response 15 Hz to 18 KHz—1 DB.

Distortion at full power <0.15%.

This instrument comes to you complete with pre-amplifier, main amplifier and power unit (A.C. Mains) in modern styled aluminium stelvetic case.

Factory built and tested for the amazingly low price of 15 GNS. P. & P. 5/6.

SUNDERLAND ELECTRICS LTD.
48 Princess Street, Manchester 1

Trade enquiries invited. S.A.E. with enquiries please.

The most accurate
pocket size
CALCULATOR
in the world

The 66 inch OTIS KING scales give you extra accuracy. Write today for free booklet, or send 82/6 for this invaluable spiral slide rule on approval with money back guarantee if not satisfied.

CARBIC LTD. (Dept. PE20)
54 Dundonald Road, London, S.W.19



MULTIMETERS for EVERY purpose!

LAFAYETTE DE-LUXE 100 KΩ/VOLT "LAB TESTER"
Giant 6½in. scale. Built-in meter protection. 0/5/2.5/10/50/250/500/1,000V d.c. 0/2.5/10/50/250/500/1,000V a.c. 0/10/100μA/10/100/500MA/2.5/10A. 0/1K/10K/100K/10M/10MΩ. -10 to 49.4dB **£18.18.0.** P. & P. 5/-.

LAFAYETTE 57 Range Super 50,000 O.P.V. Multimeter. D.c. Volts 125V-1000V. A.c. Volts 1.5V-1000V. D.c. Current 25μA-10 Amp. Ohms. 0-15 MegΩ. dB. -20 to +41dB. Overload Protection. **£12.10.0.** Carr. 3/6.

NEW MODEL 500.30,000 O.P.V. with overload protection. Mirror scale. 0/0.5/2.5/10/25/100/250/500/1,000V. d.c. 0/2.5/10/25/100/250/500/1,000V. a.c. 0/50μA/5/50/500mA. 12 amp. d.c. 0/60/1K6. Meg./60megohm **£8.17.6.** Post paid.

PROFESSIONAL 20,000 O.P.V. LAB. TESTER
Automatic overload protection, mirror scale. Ranges: 1/10/50/250/500/1,000 Volts, d.c. and a.c. 0-500μA, 10mA, 250mA. Current: 0/20K, 200K, 2 megohm. Decibels: -20 to +22dB. **£5.19.6.** P. & P. 2/6.

MODEL TE-70. 30,000 O.P.V. 0/3/15/60/300/600/1,200V. d.c. 0/6/30/120/600/1,200V. a.c. 0/30μA/3/30/300mA. 0/16K/160K/1.6M/16megohm. **£5.10.0.** P. & P. 3/-.

MODEL 250J. 2,000 O.P.V. 0/10/50/500/2,500V. d.c. 0/10/50/500/2,000V. a.c. 0-2megohm. 0/250mA. -20 to +36dB. **49/8.** P. & P. 2/6.

ADVANCE TEST EQUIPMENT

- Brand new and boxed in original sealed cartons.
- VM76. VALVE VOLTMETER**
R.F. measurements in excess of 100Mc/s and d.c. measurements up to 1,000V with accuracy of ±2%. D.c. range 300mV to 1kV. A.c. range 300mV to 300V RMS. Resistance 0.02-500MΩ. Price £72.
- VM78. A.C. MILLIVOLT METER**
Transistorised. 1mV to 300V. Frequency 1c/s to 1Mc/s. Price £55.
- VM79. UHF MILLIVOLT METER**
Transistorised. A.c. range 10mV to 3V. D.c. current range 0.01 μA to 0.3mA. Resistance 1 ohm to 10 megohms. £125.
- H1B. AUDIO SIGNAL GENERATOR**
15c/s to 50kc/s, sine or square wave. Price £30.
- J1B. AUDIO SIGNAL GENERATOR**
15c/s to 50kc/s. Price £30.
- J2B. AUDIO SIGNAL GENERATOR**
As per J1B except fitted with output meter. £35.
- TT15. TRANSISTOR TESTER**
£37.10.0.
Carriage 10/- per item.

TE-900 20,000Ω VOLT GIANT MULTIMETER
5in. full view meter. 2 colour scale, overload protection. 0/2.5/10/25/100/500/1,000V a.c. 0/2.5/12.5/10/50/250/1,000/5,000V d.c. 0/50μA/110/100/500mA 10A d.c. 20K/200K/2M Ω. **£16. P. & P. 5/-.**

MODEL AS-100D. 100KΩ/VOLT 5in. mirror scale. Built-in meter protection. 0/3/12/60/120/300/600/1,200V. d.c. 0/6/30/120/300/600V. a.c. 0/10μA/6/60/300MA/12 Amp. 0/2K/200K/2M/20MΩ. -20 to +17dB. **£12.10.0.** P. & P. 3/6.

MODEL AF-105. 50KΩ/V Built-in meter protection. 0/3/3/12/60/120/300/600/1,200V. d.c. 0/6/30/120/300/600/1,200V. a.c. 0/30μA/6/60/300MA/12 Amp. 0/10K/1M/10M/100MΩ -20 to +17 dB. **£8.10.0.** P. & P. 3/6.

MODEL TE-12. 20,000 O.P.V. 0/0.6/30/120/600/1,200/3,000/6,000V. d.c. 1/6/30/120/600/1,200V. a.c. 0/60μA/6/60/600MA. 0/6K/600K/6meg./60. Megohm 50PF. 2 MFD **£5.19.6.** P. & P. 3/6.

MODEL TE 80. 20,000 O.P.V. 0/10/50/100/500/1,000V. a.c. 0/5/25/50/250/500/1,000V. d.c. 0-50μA. 5/50/500mA. 0/6K/60K/600K/6 Meg. **£4.17.6.** P. & P. 3/-.

MODEL ZQM TRANSISTOR CHECKER
It has the fullest capacity for checking on A, B and Ico. Equally adaptable for checking diodes, etc. Spec: A: 0-7-0-9967. B: 5-200. Ico: 0-50 Microamps 0-5mA. Resistance for diode 200Ω-1MΩ. Supplied complete with instructions, battery and leads. **£5.19.6.** P. & P. 2/6.

TRANSISTORISED TWO-WAY TELEPHONE INTERCOM
Operative over amazingly long distances. Separate call and press to talk buttons. 2-wire connection. 1000's of applications. Beautifully finished in ebony. Supplied complete with batteries and wall-brackets. **£6.19.6.** P. & P. 3/6.

INTERCOM/BABY SITTER
Transistorised Intercoms, ideal for home/office/workshop etc. 2-way buzzer call system. For desk or wall mounting. Supplied complete with connecting wire, batteries, instructions, 2 station **£9/8.** P. & P. 2/6. 4 station **£8.12.6.** P. & P. 5/-.

RECORDING HEADS
Reuter 1-track. As fitted to Collaro Mk. IV and Studio Decks. High imp. record play back, low imp. erase. Brand new. 19/6 pair. MIFELUX 1-track record 12/6. COSMOCORD 1 track heads. High imp. record/playback 65/-, Low imp. erase 20/-. MARRIOTT 1 track heads. High imp. record/playback 65/-. Low imp. erase 20/-. Post extra.

NEW CATALOGUE

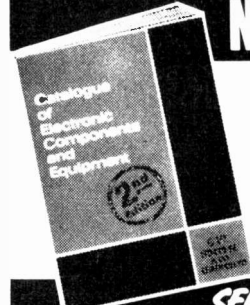

Nearly 200 pages giving full details of a comprehensive range of **COMPONENTS, TEST EQUIPMENT, COMMUNICATION EQUIPMENT AND HI-FI EQUIPMENT.**

Each section greatly enlarged and fully illustrated. Thousands of items many at bargain prices.

FREE DISCOUNT COUPONS VALUE 10/-.

SEND NOW-ONLY 7/6 PER P.

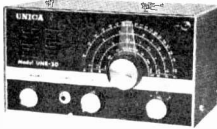

UNR-30. 4-BAND COMMUNICATION RECEIVER

Covering 560Kc/s-30Mc/s. Incorporates variable BFO for CW/SSB reception. Built in speaker and phone jack. Metal cabinet. Operation 220/240V. a.c. Supplied brand new guaranteed with instructions. Carr. 7/6. **13 GNS.**

NEW LAFAYETTE SOLID STATE HAG00 RECEIVER

5 BAND AM/CW/SSB AMATEUR AND SHORT WAVE. 150KC/S TO 400KC/S AND 550KC/S TO 30MC/S. F.E.T. front end • 2 mechanical filters • Huge dial • Product detector • Variable BFO • Noise limiter • S Meter • 24pin. Bandspread • 250V a.c./12V d.c. neg. earth operation • RF gain control. Size 15in x 9in x 8in. Wt. 18 lb. **EXCEPTIONAL VALUE £45.** Carr. 10/-.

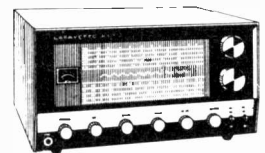

S.A.E. for full details.

TRIO COMMUNICATION RECEIVER MODEL 9R-59DE

4 band receiver covering 550Kc/s to 30Mc/s. continuous and electrical band spread on 0, 15, 20, 40 and 80 metres. 8 valve plus 7 diode circuit. 4/8 ohm output and phone jack SSB-CW • ANL • Variable BFO • 8 meter • Sep. band spread dial • IF 445Kc/s • Audio output 1.5W. • Variable RF and AF gain controls. 115/230V. a.c. Mains. Beautifully designed. Size: 7 x 15 x 10in. With instruction manual and service data. **£38.15.0.** Carr. Psjd.

S.A.E. for full details.

TRIO Communication Type Headphones. Normally **£5.19.6.** OUR PRICE **£3.15.0** if purchased with above receiver.

LAFAYETTE PF-60 SOLID STATE VHF FM RECEIVER

A completely new transistorised receiver covering 152-174Mc/s. Fully tunable or crystal controlled (not supplied) for fixed frequency operation. Incorporates 4 INTEGRATED CIRCUITS. Built in speaker and illuminated dial. Squelch and volume controls. Tape recorder output. 75Ω aerial input. Headphone jack. Operation 230V a.c./12V d.c. Neg. earth. **£37.10.0.** Carr. 10/-



LAFAYETTE LA-224T TRANSISTOR STEREO AMPLIFIER

19 transistors, 8 diodes, 1HF music power. 30W at 8Ω. Response 30-20,000 ±2dB at 1W Distortion 1% or less. Inputs 3mV and 260mV. Output 3-16Ω. Separate L. and E. volume controls. Treble and bass control. Stereo phone jack. Brushed aluminium, gold anodised extruded front panel with complementary metal case. Size 10½ x 3½ x 7½in. Operation 115/230V. A.V. **£28.** Carr. 7/6.

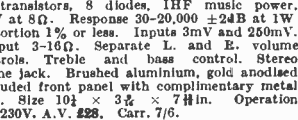

GARRARD DECKS

Brand new and guaranteed.

1000 stereo	£6.6.0.
1025 mono	£7.10.0.
1025 stereo	£7.19.6.
2000 stereo	£7.19.6.
2025 TC less cart.	£7.19.6.
2025 TC stereo	£8.19.6.
SP25 Mk.II less cart.	£11.19.6.
470 Mk.II less cart.	£12.10.0.

Wooden Plinths for Garrard Series 1,000, 2,000, 3,000, etc., with perspex cover. **£4.10.0.** P. & P. 4/6.

★TRANSISTORISED FM TUNER★

8 TRANSISTOR HIGH QUALITY TUNER, SIZE ONLY 6 x 4 x 2½in. 3 I.F. stages. Double tuned discriminator. Ample output to feed most amplifiers. Operates on 9V. battery. Coverage 88-108Mc/s. Ready built ready for use. Fantastic value for money. **£9.7.6.** P. & P. 9/6. Stereo multifeed adaptors **£8. gns.**

HOSDEN DH04S 2-WAY STEREO HEADSETS

Each headphone contains a 2½in woofer and a 1in tweeter. Built in individual level controls. 8Ω Imp. 25-18,000c/s. with cable and stereo plug. **£5.19.6.** P. & P. 2/6.

GARRARD TAPE MOTORS
Brand new stock as used by famous manufacturer. 200/250V a.c. Capstan motor 18/-, Fast Forward 10/6, Fast Rewind 10/6. P. & P. 3/-, Set of three motors **£32/6.** P. & P. 5/-.

G.W. SMITH & CO (RADIO) LIMITED

Phone GERRARD 8204/9155
Cables SMITHEX LESQUARE
3-34 LISLE STREET, LONDON, WC2

OPEN
9 a.m. to 6 p.m. every day Mon. to Sat. Trade supplied.

STEAM or solid state

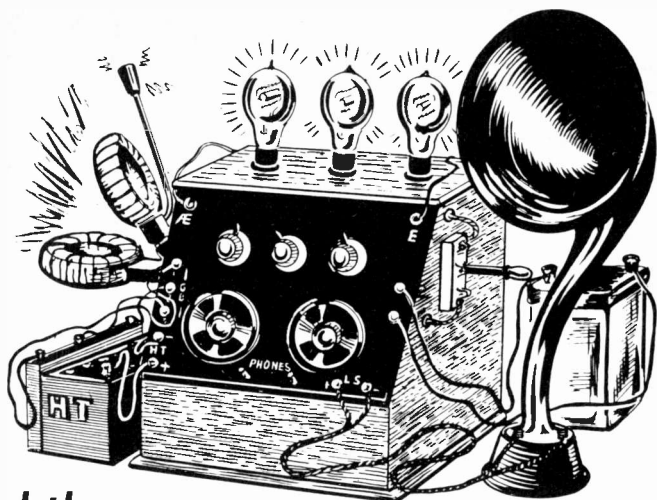

you
need the

HOME RADIO CATALOGUE !

If your interest lies in *last year's gear, or next year's...* if you go for transmitting, receiving, reproducing, or *the lot...* if you're working on a *tight budget, or an elastic one...* the HOME RADIO Components Catalogue is a **MUST!** In its 256 pages, listing over 7,000 items (more than 1,300 of them illustrated) you can track down any component you're ever likely to need. At 7/6, plus 3/- p. & p. it's the best ever bumper book... and every copy contains 5 vouchers, each worth a shilling when used as directed. Send the coupon now with your cheque or P.O. for 10/6. *It'll be the best Christmas gift you've ever given yourself.*



**A Merry
Christmas**
to all our
Readers!

Please write your Name and Address in block capitals

Name.....

Address.....

Home Radio (Mitcham) Ltd., Dept. PE, 187 London Rd., Mitcham
CR4 2YQ

THE TRANSISTOR THREATENED ?

IN the two decades since the Americans Bardeen, Brattain, and Shockley invented the transistor, countless new and dramatic developments have occurred in the field of semiconductors. The material originally used, the rare element germanium, has given way to the more common material silicon, with drastic reduction in costs. Manufacturing techniques have advanced, so bringing about further economies, and also making possible a variety of active circuit devices closely related to the transistor, but endowed with certain features which allow each of them to make a marked individual contribution to progress in electronics technology.

Dissimilar in certain respects, such as construction, mode of operation and circuit function, all present day semiconductor devices do share a common physics background: all exploit the property of conduction through solid crystalline material by means of positive and negative current carriers.

But now a further discovery has been made that may revolutionise solid state technology. Another American, S. Ovskinsky, has discovered that non-crystalline substances possess the property of changing from high to low resistivity under certain conditions, and he has invented a microminiature two-way switching device based on this effect. The material used is an inexpensive amorphous glass substance and it is claimed that this device will have considerable advantages over the transistor, especially for computer and communications applications. Apart from cheapness of production, this new device is claimed to be more reliable than existing devices.

Professor Mott, director of the Cavendish Laboratory at Cambridge has described this as the newest, and most exciting discovery in solid state physics at the moment. Prof. Mott was speaking as a scientist of course, and it rests with the technologists to develop and prove this as a practical circuit element. There may be certain yet unseen snags in transferring this invention from the research laboratory to the production floor. There may also be a lack of enthusiasm from the semiconductor manufacturers if this newcomer seems likely to become a serious rival to the established transistor and diode. But the expansion of the computer industry and the widespread adoption of pulse techniques for control and communication purposes suggest there will be an ever growing demand for electronic switching devices in the future. Such commercial doubts are likely therefore to be quickly dispelled.

For the layman, it is difficult to contemplate a component that will outshine the transistor in efficiency, cost, and size. We can only wait and see.

F. E. Bennett—*Editor*

THIS MONTH

CONSTRUCTIONAL PROJECTS

METAL LOCATOR	16
SQUARE WAVE OSCILLATOR	24
SONIC FISH BAIT	38
STABILISED POWER SUPPLY	42

SPECIAL SERIES

BIONICS—3	30
-----------	----

GENERAL FEATURES

ZENER DIODES	50
PROBING THE OCEAN	54
INGENUITY UNLIMITED	66

NEWS AND COMMENT

EDITORIAL	15
MARKET PLACE	23
POINTS ARISING	36
BBC EXPERIMENTAL SOUND-IN-VISION SYSTEM	37
ELECTRONORAMA	40
BOOK REVIEWS	49
NEWS BRIEFS	49

*Our February issue will be published on
Monday, January 13*

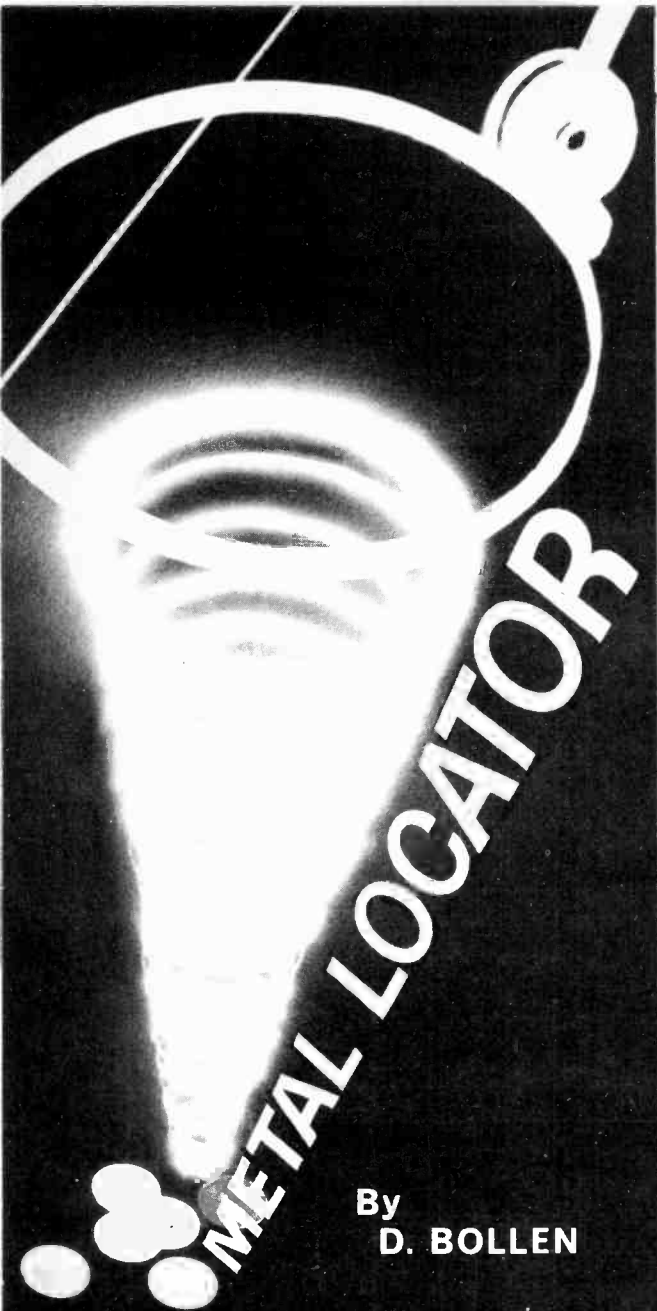

By
D. BOLLEN

WITH the aid of a mine detector, or its civilian counterpart the metal locator, valuable antiquities are sometimes unearthed. Veterinary surgeons can find indigestible objects in the stomachs of animals; policemen discover offensive weapons or loot; plumbers and electricians track pipes and cables.

The metal locator described here is designed primarily for ease of operation, and only weighs 1½ pounds, but nevertheless has a large diameter search coil, which provides good sensitivity. In the hands of a practiced operator, something the size and weight of a penny can be located under three inches of soil, while larger objects are traceable at greater depths.

MODE OF OPERATION

When certain materials are placed in close proximity to a coil of wire they will influence the inductance value of the coil. Readers will already be familiar with ferrite and brass tuning slugs, and will know that a ferrite slug increases the effective inductance of a coil, while a brass slug acts like a shorted turn and reduces inductance. Less well known is that some "lossy" insulators, such as wood or p.v.c., can also promote a slight increase in inductance.

If a large diameter unscreened coil is employed as an inductor in the tuned circuit of an r.f. oscillator, quite small amounts of metal introduced into the field surrounding the coil will produce detectable shifts in frequency.

However, the tuned circuit of such an oscillator must also contain capacitance, some of which will be distributed between adjacent turns of the coil, making the circuit susceptible to frequency shifts when the coil is brought close to large non-metallic bodies, such as earth, water, and masonry. Yet another unwanted effect is mechanical modulation of the oscillator frequency caused by poor construction and general lack of rigidity. Obviously, any change of frequency which is not due to the presence of metal will act as interference, and reduce sensitivity.

Moving on to the block diagram (Fig. 1) of the metal locator, the output from the metal sensitive search oscillator (frequency f_1) is compared with a fixed reference frequency f_2 , by mixing both frequencies to produce a difference signal or beat note f_3 . Assume that f_2 is at 300,000Hz, while f_1 is temporarily at 300,100Hz, the resulting beat note f_3 will be $f_1 - f_2$ or 100Hz.

If f_1 is increased, by metal introduced into the field surrounding the search coil, to 300,101Hz, the beat note will become 101Hz. Although f_3 has experienced a one per cent change of frequency, which is about the limit of discrimination of the human ear, this corresponds to a much smaller percentage change in search oscillator frequency, some 0.0003 per cent, and an approximate coil inductance change of 0.0012 per cent.

Hence, this simple method of comparing two frequencies by audible beating magnifies minute alterations in search coil inductance without the need for delicate measuring instruments.



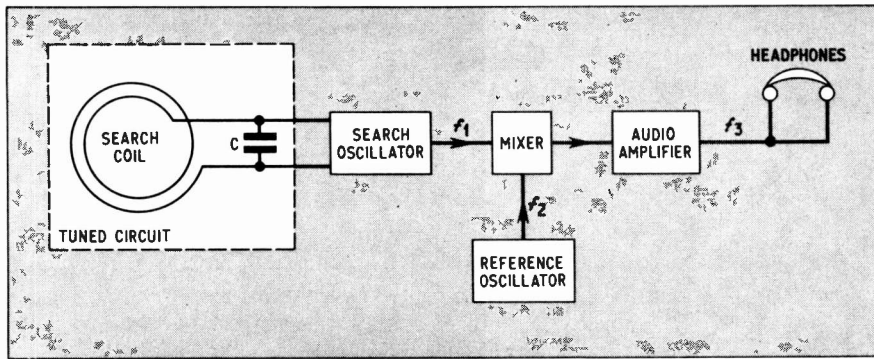

Fig. 1. Block diagram of the metal locator

OSCILLATOR CIRCUIT

The complete metal locator circuit appears in Fig. 2. Looking first at the search coil, this consists of two windings, L1 and L2, which are inductively coupled. L1, tuned by fixed capacitor C1 and trimmer VC1, is intentionally left "floating" to reduce capacitive effects when the coil is brought close to non-metallic bodies. Also, 4-turn coil L1 has a low intrinsic value of inductance, so that any unavoidable stray capacitance changes will be swamped by the large values of C1 and VC1 needed to bring L1 to resonance at the working frequency of 300kHz.

Coupling coil L2 forms the collector load of common base oscillator TR1, while collector-emitter capacitor C4 introduces positive feedback, and trimmer VC2 acts as a fine frequency control for adjustment of the audio note when the metal locator is in use. A small proportion of the available output from TR1 emitter is tapped off by VR1, and this particular arrangement largely eliminates the tendency of one oscillator to "pull" and lock with the other when their frequencies are almost the same.

The combined mixer and reference oscillator TR2 is similar to that used in a superhet receiver, and in fact employs a standard transistor medium-wave

oscillator coil (L3, L4, L5), tuned by C8 to a fixed frequency of about 300kHz. Inductive coupling between L3 and L4 provides self-oscillation, and the reference frequency, while the signal derived from the search oscillator is fed to the base of TR2 and is amplified. Both frequencies are combined at the collector of TR2, but instead of the usual i.f. transformer, a simpler arrangement of a fixed resistor and a capacitor (R7 and C7) suffices to filter out the two high frequencies and leave the resulting difference or beat frequency.

The two remaining stages, consisting of components associated with TR3 and TR4, merely serve to amplify the audio beat note to a level adequate for headphone listening in a noisy environment.

CONSTRUCTION

A 6ft length of nylon curtain rail is bent round to form a 23in diameter circular search coil former. Although not particularly rigid when unbraced, the coil former is tough and light, and can be prevented from vibrating by a string stay. The stay also serves as a shoulder strap when transporting the folded metal locator to and from a site.

Fig. 2. Circuit diagram of the metal locator and connection details for the oscillator coil and transistors

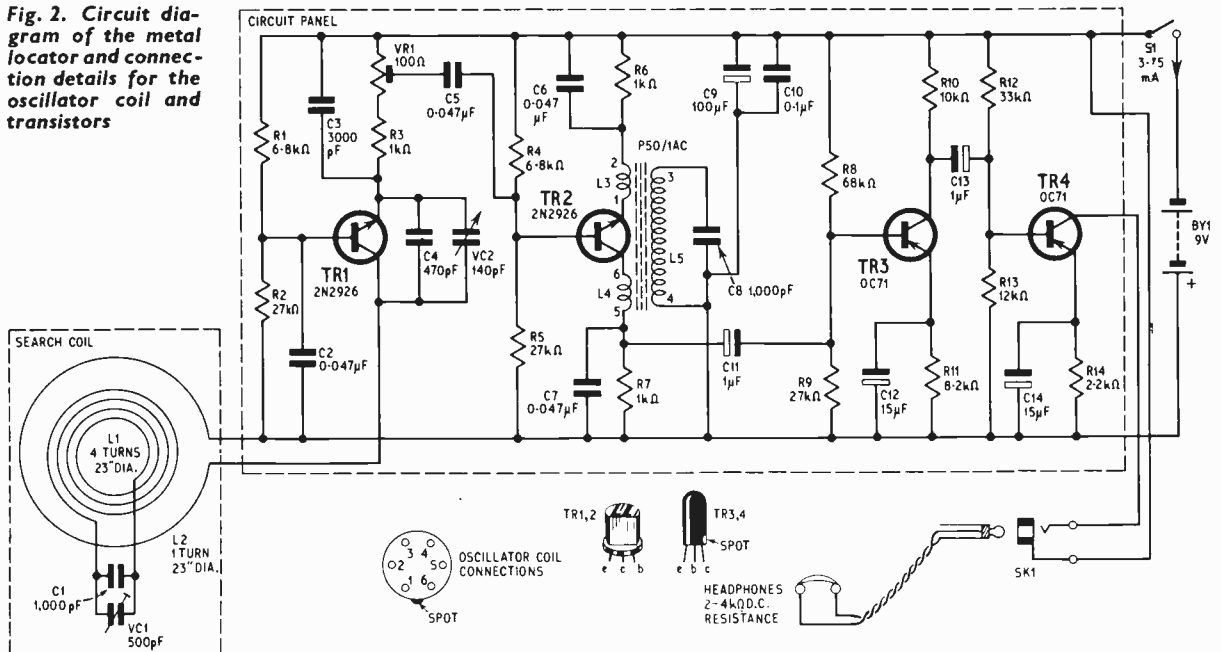

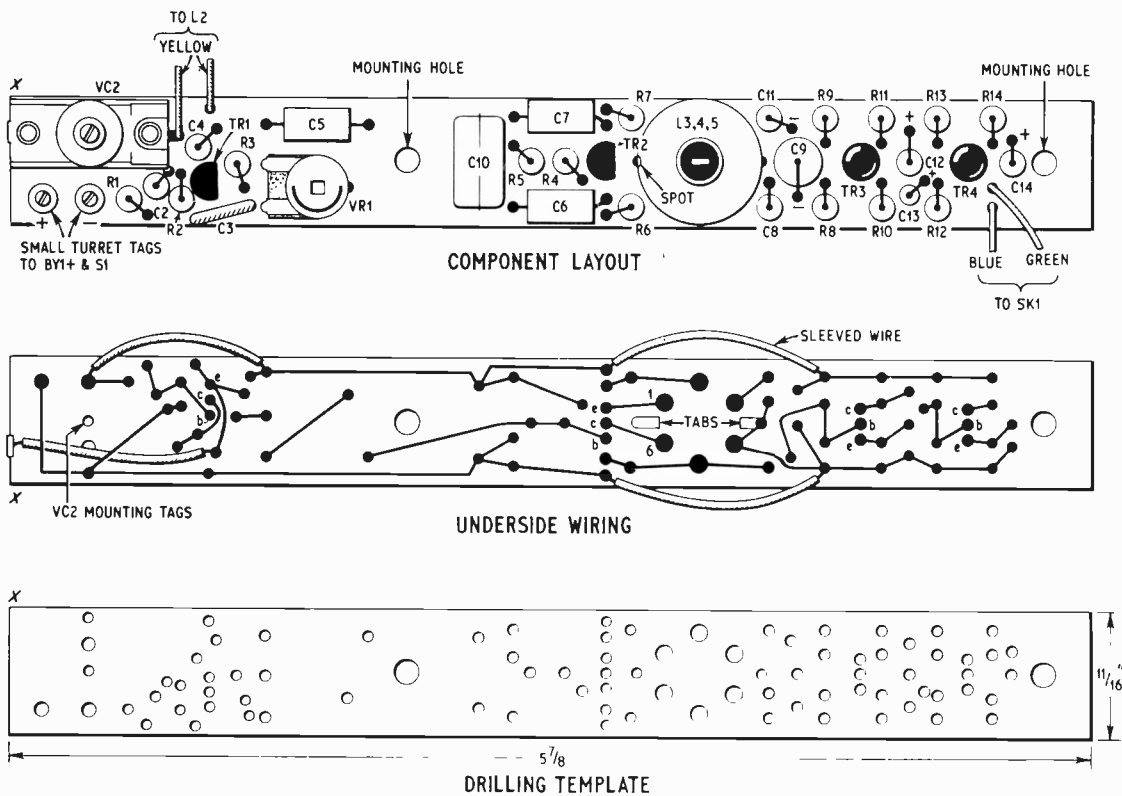

Fig. 6. Component layout and wiring details and drilling template for the circuit panel contained in the handle of the metal locator

COMPONENTS . . .

Resistors

R1	6.8k Ω	R8	68k Ω
R2	27k Ω	R9	27k Ω
R3	1k Ω	R10	10k Ω
R4	6.8k Ω	R11	8.2k Ω
R5	27k Ω	R12	33k Ω
R6	1k Ω	R13	12k Ω
R7	1k Ω	R14	2.2k Ω

All 10%, $\frac{1}{2}$ W carbon

Potentiometer

VR1 100 Ω miniature horizontal skeleton preset
(Body size 0.5in \times 0.37in \times 0.12in)

Capacitors

*C1	1,000pF polystyrene	125V	0.6in \times 0.25in dia
C2	0.047 μ F polyester	250V	0.45in \times 0.17in dia
C3	3,000pF disc ceramic		0.1in \times 0.5in dia
*C4	470pF polystyrene	125V	0.4in \times 0.2in dia
C5	0.047 μ F polyester	250V	0.45in \times 0.17in dia
C6	0.047 μ F polyester	250V	0.45in \times 0.17in dia
C7	0.047 μ F polyester	250V	0.45in \times 0.17in dia
*C8	1,000pF polystyrene	125V	0.6in \times 0.25in dia
C9	100 μ F elect.	15V	0.75in \times 0.3in dia
C10	0.1 μ F polyester	250V	0.53in \times 0.41in \times 0.26in dia
C11	1 μ F elect.	15V	0.5in \times 0.12in dia
C12	16 μ F elect.	15V	0.6in \times 0.22in dia
C13	1 μ F elect.	15V	0.5in \times 0.12in dia
C14	16 μ F elect.	15V	0.6in \times 0.22in dia

* C1, C4, C8 are \pm 2.5% tolerance types

Trimmer Capacitors

VC1	500pF	0.94in \times 0.62in \times 0.18in
VC2	140pF	0.81in \times 0.38in \times 0.25in

Both VC1 and VC2 are "postage stamp" type

Inductors

L1	Wound with 14/0076 p.v.c. covered wire (see text)
L2	Wound with 7/0048 p.v.c. covered wire (see text)
L3, L4, L5	M.W. oscillator coil type P50/1AC (Weyrad)

Transistors

TR1, TR2	2N2926 (orange grade) (2 off)
TR3, TR4	OC71 (2 off)

Switch

S1	Single-pole changeover miniature toggle switch
----	--

Plug and Socket

PL1 and SK1	Jack plug and socket open circuit jack type J2 and plug $\frac{1}{8}$ in dia, 2 contacts (Bulgin)
-------------	---

Miscellaneous

Headphones 2 to 4k Ω d.c. resistance
Nylon curtain rail 7ft (Swish) (see text)
Plywood $\frac{1}{8}$ in thick, 1 sq ft
Plywood $\frac{3}{8}$ in thick, 8in \times 4in
Dowel rod $\frac{3}{8}$ in dia, 31in long
S.R.B.P. sheet 6in \times $\frac{3}{8}$ in \times $\frac{1}{16}$ in
Battery connectors, plastics wheel, nuts and bolts
(see text)

will help to hold the dowel in place. Take care to keep the slot in the dowel free from glue, and facing towards the interior of the handle.

The $\frac{3}{8}$ in diameter plastics screw used to clamp the dowel and discs on the prototype was taken from a broken toilet seat; it is important to avoid the use of metal attachments (bolts) at the search coil end of the metal locator. Drill the discs and flat end of dowel to suit the size of clamping screw employed.

Drill holes in the handle to take S1 and SK1, in the positions shown in Fig. 4, and make up a battery box from three pieces of s.r.b.p. sheet or plywood. All wooden parts should be finally sandpapered and given one or two coats of protective varnish.

WINDING THE SEARCH COIL

Small holes can be drilled through the nylon coil former to take start and finish leads of L1 and L2. L1 consists of four close wound turns of 14/0076 p.v.c. covered wire, while L2 is a single turn of 7/0048 insulated wire, the latter with ends left long enough to go up the slot in the dowel and into the handle (shown colour coded yellow in Fig. 2). Note that the single turn L2 is wound in the upper channel of the curtain rail, away from L1. It is advisable to fit protective sleeving to all coil lead-outs; L1 turns should be covered with a layer of plastics insulating tape to prevent movement.

Obtain a small plastics box, or make one up from wood, s.r.b.p. or polystyrene sheet glued at the edges, to take C1 and VC1. Two holes are drilled at one end of the box to admit L1 leads. There are holes also to take VC1 mounting screw, and a trimming tool. To mount the completed box assembly on the search coil

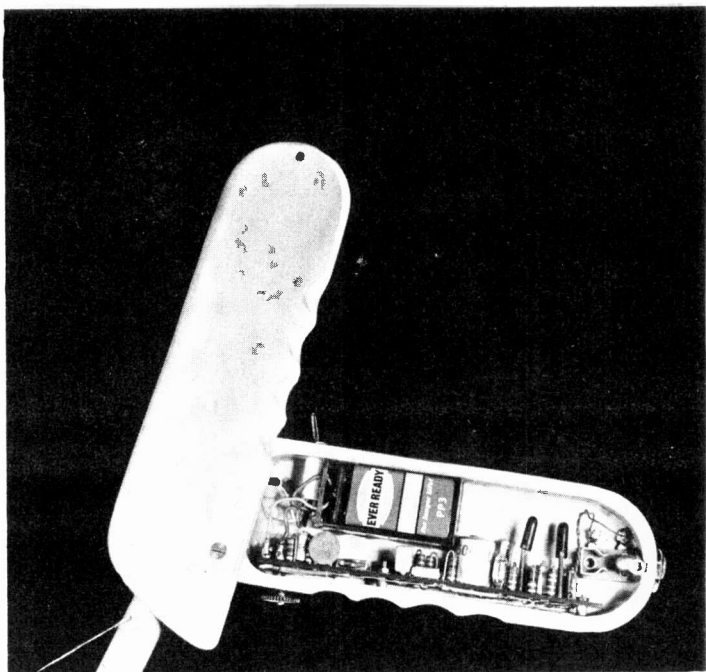

Layout of components mounted inside the handle

Drill a $5\frac{1}{2}$ in \times $\frac{3}{8}$ in piece of s.r.b.p., from the full size plan given in Fig. 5. Prior to mounting components, fit a 1in long 8B.A. screw to trimmer VC2, in place of the existing adjuster screw, and bend up one of the trimmer solder tags. Also, at this stage, use the circuit panel as a template to mark out and drill holes in the handle for VC2 screw, and the two 6B.A. countersunk mounting screws.

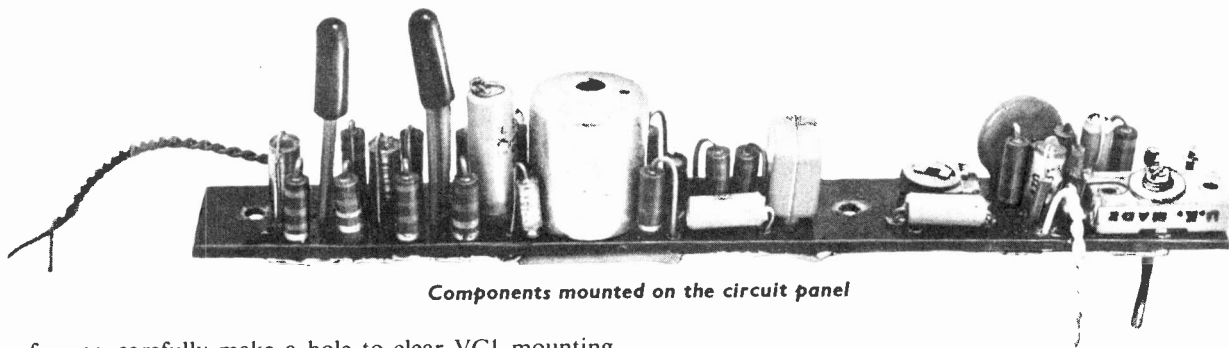

Components mounted on the circuit panel

former, carefully make a hole to clear VC1 mounting nut, in the top of the two short rail sections and glue the box to the rails in the position shown in Fig. 2.

If it is intended to use the search coil submerged in several inches of water, when exploring river bed or pond, for example, then the box, VC1 mounting screw and nut, and L1 lead entry holes must be thoroughly waterproofed with a generous layer of epoxy resin glue, before fixing to the search coil former. The trimming tool hole can be rendered waterproof with a small rubber bung.

CIRCUIT PANEL

In order to accommodate the complete circuit panel in the space provided by the hollow handle, components used must not be much larger than those employed in the prototype. It is often the case, especially with capacitors, that components of near identical electrical specification will differ in size, and for this reason certain dimensions are included in the component list, to assist the reader.

After riveting the two turret tags to the panel, progressively mount all components and complete underside wiring. VC2 only needs to be initially secured to the circuit panel by blobs of solder on its push-through tags. Ensure that one of the oscillator coil can tags is wired to the positive circuit rail for screening purposes, and that the polarity of electrolytic capacitors is correct.

FINAL ASSEMBLY

Mount S1 and SK1 in the handle, and solder a 4B.A. nut to the lug on SK1, to take the lid fixing screw (see Fig. 3). Wire the battery connector to S1 and leave short red and blue leads for later connection to the circuit panel turret tags.

Slide the plywood discs on to the search coil former and clamp the dowel between the discs. Take the L2 leads and thread them into the handle, then retain the leads in the dowel slot with a thin smear of glue.

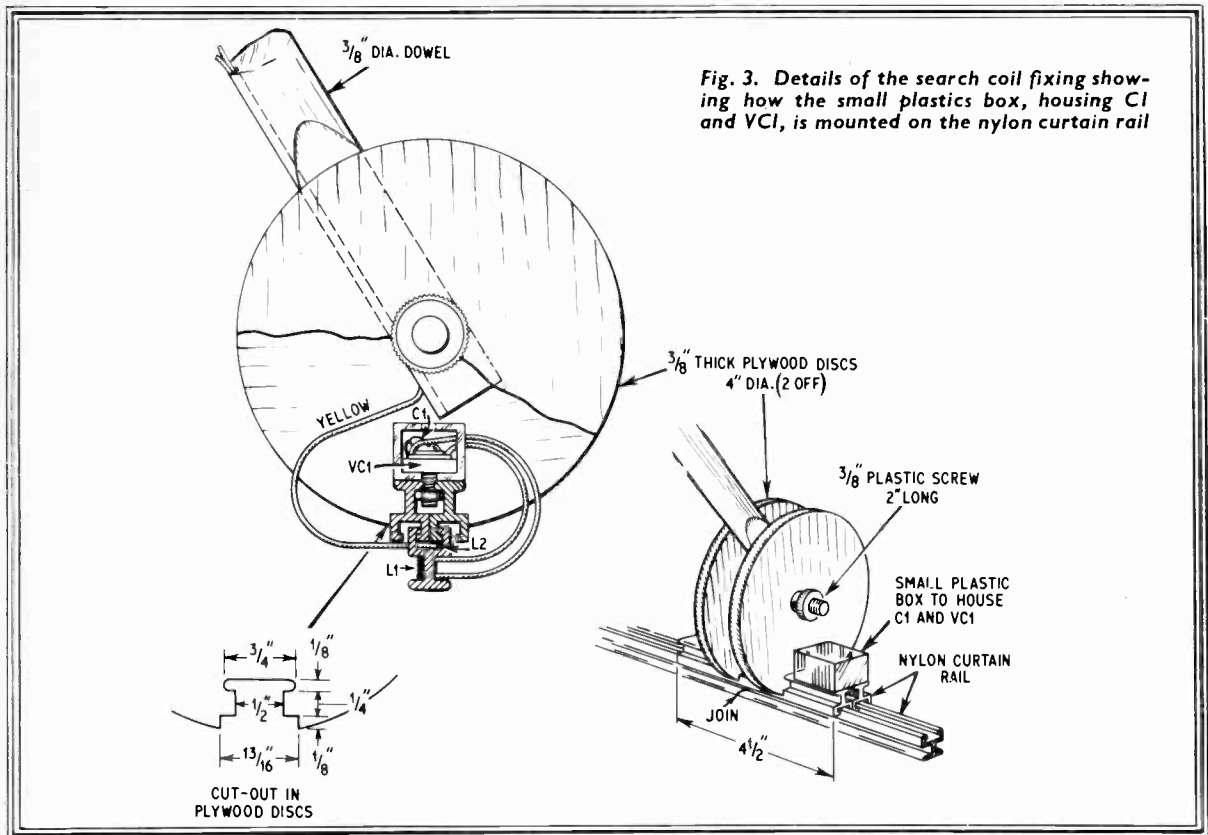

Referring to Fig. 3, two plywood discs are slotted on to the search coil former, and a wooden dowel stick is clamped between the discs by a large plastics screw and nut. Leads from L2 are taken up the stick, inside a groove, to the handle, which houses the circuit panel, battery, on/off switch, fine frequency control, and a headphone socket (Fig. 4). The handle is made from a hollowed out sandwich of plywood,

Close-up view of the search coil fixing

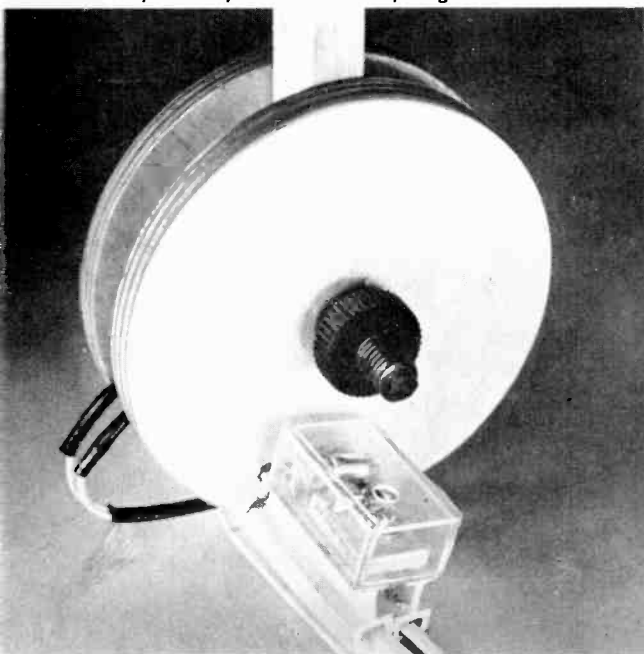

with internal layout arranged so that the on/off switch S1 can be operated by the thumb, and the fine frequency control VC2 by the forefinger of one hand, leaving the other hand free to carry a digging implement.

Commence construction by making up the nylon search coil former. Cut a 6ft length, plus two 4½in lengths of curtain rail, and smooth off the ends with sandpaper and a file. With the aid of an assistant, bend the curtain rail into a circle and butt the ends into the two short pieces of rail, as shown in Fig. 2. The resulting assembly should hold together quite firmly, without gluing.

Cut out two 4in diameter ¾in thick plywood discs and five ¼in thick plywood handle laminations from the templates shown in Fig. 5, using either a fretsaw or a suitable power tool. The cut-outs at the edges of the discs, shown in Fig. 3, should be a good fit on the curtain rail sections, but if they are sloppy, a thin wooden wedge can later be driven between the short lengths of rail to grip the discs.

Glue four of the handle laminations together under the pressure of a heavy weight or clamps (Fig. 5), and when dry temporarily clamp the lid to the rest of the laminations without gluing and sandpaper to the finished shape, not forgetting to chamfer the edges of the fingerholds.

Next take a 3in x ¾in diameter dowel and make a straight groove ¼in deep along the entire length with a tenon saw or plough plane, then cut and sandpaper flats at one end of the dowel to allow for clamping between the plywood discs. The other end of the dowel should be glued into the rectangular hole provided by the handle laminations; a small woodscrew

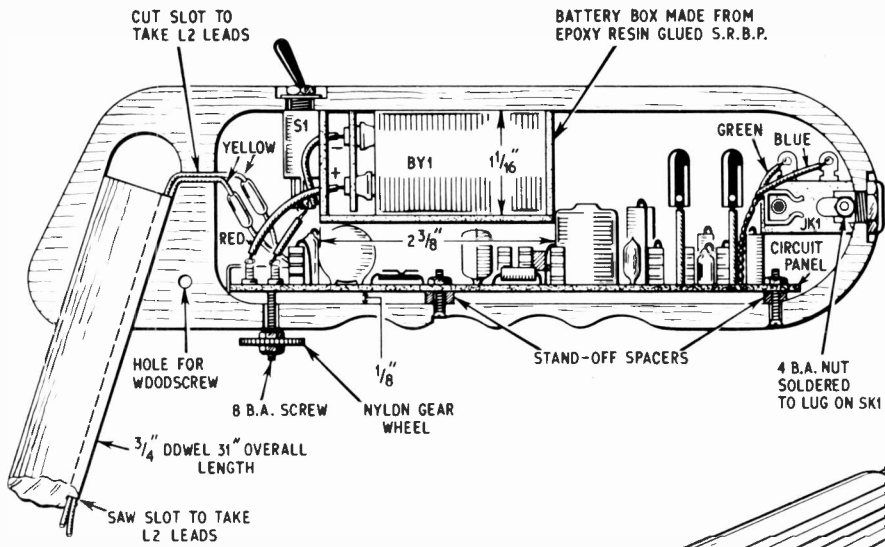

Fig. 4 (above). Layout and mounting details for all components contained in the handle of the metal locator. Note the 4B.A. nut soldered to lug on SK1 for securing the lid

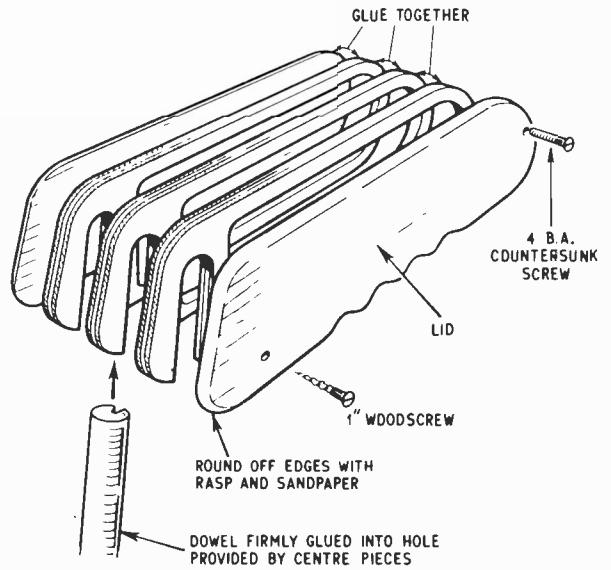
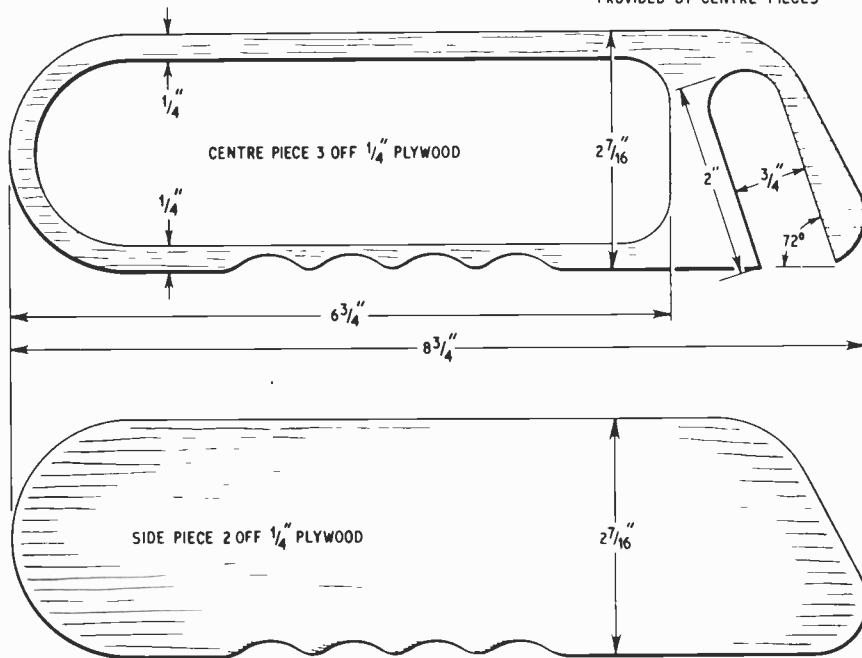

Fig. 5. Method of constructing the handle from pieces of 1/4 in plywood



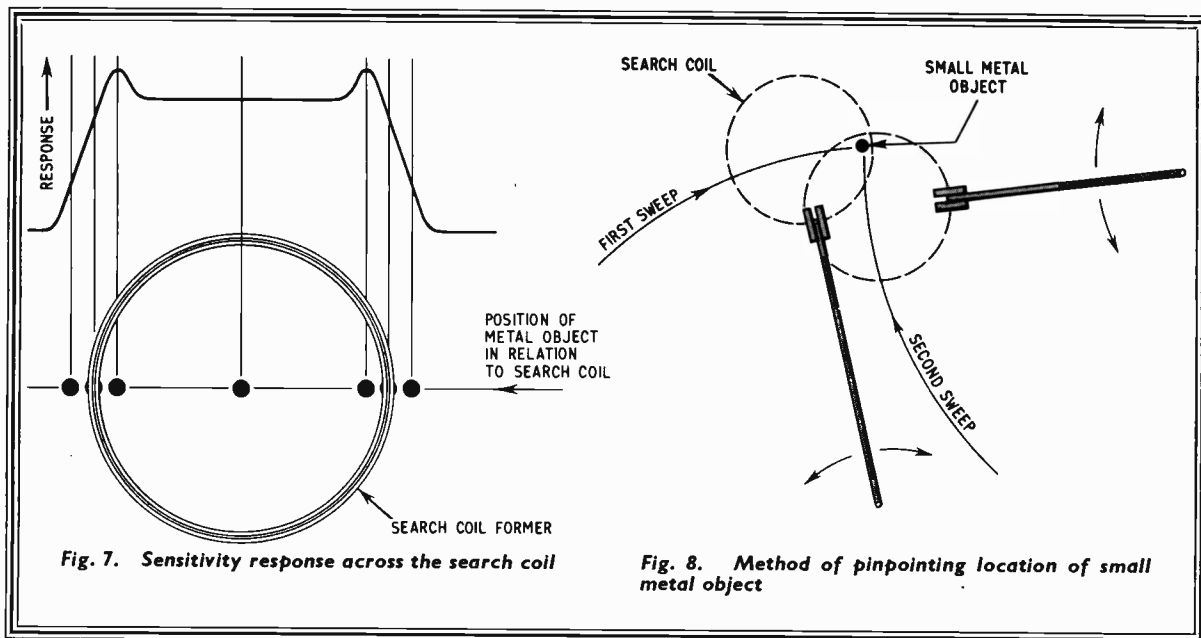

Fig. 7. Sensitivity response across the search coil

Fig. 8. Method of pinpointing location of small metal object

Next, install the circuit panel on stand-off spacers inside the handle, and connect up yellow panel wires to L2 leads, green and blue wires to JK1, and the red battery wire to its turret tag. A small plastic disc or gear wheel should be fixed between two 8B.A. nuts on the VC2 screw.

TESTING OPERATION

To test for correct circuit action, connect a milliammeter between the blue battery wire and its turret tag, fit a battery, and switch on S1. A meter reading of about 3.75mA will show that there are no serious faults. Set VR1 to half track and insert the headphone plug in SK1. A hiss should be heard with perhaps a low level whistle. Rotate VC2 knob fully clockwise (maximum capacitance), then turn back half a turn. With a trimming tool, screw down VC1 slowly, and listen for a succession of whistles produced by oscillator harmonics. Near the maximum capacitance position of VC1 a much louder whistle should occur, indicating that L1 is tuned close to the reference oscillator frequency.

Now with the search coil laid flat on the ground, away from metal objects, it will be found that a null point—where the audible note drops in pitch to zero frequency and then begins to rise again—can be obtained by adjusting VC1 and trimming VC2. Without moving the search coil, bring a metal object into the field of the coil and listen for a note of rising pitch.

It only remains to attach the handle lid by its screws and fit the search coil string stay. Drill a small hole in the top of the search coil former at a point opposite the plywood discs, also drill a hole in the dowel just below the handle. Set the dowel at an angle to the search coil which suits the height and arm length of the user, then tie plastics sleeved string between the search coil and the dowel.

HINTS ON METAL LOCATION

Best sensitivity results from having a steady low frequency note in the headphones, which is caused to increase in pitch as the search coil is brought near metal. As a given beat frequency occurs twice, on

each side of the zero frequency null point, it is important to select the right one. First obtain zero frequency with VC1, then unscrew VC2 towards minimum capacitance, so that the frequency of the search oscillator is slightly above that of the reference oscillator.

A sudden decrease of beat frequency will be observed when the search coil is lowered through the last $\frac{1}{4}$ in before touching the ground. It can be easily verified that this phenomenon is not wholly due to capacitive effects, but that the ground is acting as a "lossy" insulator. Suspend a large sheet of p.v.c. from the ceiling, positioned well away from all metal objects, and then bring the search coil towards the plastic, whereupon a similar decrease of frequency will be experienced. The "lossy" insulator effect is not too troublesome, and will only reduce sensitivity when searching over rough ground or in long grass.

It is possible to locate metal objects when they are submerged in fresh water, but sea water—being a good conductor—will affect the inductance value of the search coil. Nevertheless, it is still feasible to search for metal on a dry beach, or above the high water mark.

Despite the large diameter of the search coil, small buried objects can be located precisely by making use of the peak of maximum response which is situated near the inside edge of the search coil, see Fig. 5. The method given in Fig. 6, of first sweeping the edge of the coil across the object, then making a second sweep at 90 degrees to the first, will reveal the exact point of intersection.

As a rough guide to sensitivity, a 5in diameter 9 ounce brass ashtray should be detected under some 15in of soil, and something the size and weight of a motor car body will give a clear response at a distance of more than 9ft when submerged in fresh water. ★



BATTERY CHARGER

The demand for small battery chargers for the more common alkaline cells now being used more frequently in transistor radios, cameras, tape recorders, etc. has long been needed to offset the relatively high cost as well as the superior performance obtainable with these types of batteries.

The Pencil battery charger from DCB Instrument and Lighting Co., Austin House, Croft Road, Crowborough, Sussex, is one of many now appearing on the market designed specially for the more standard type of alkaline battery. Designed to cover the type of battery used in domestic equipment, it is claimed that 1.5V cells can be recharged between ten and thirty times, depending on operational conditions.

The Pencil charger is very neatly finished and as our photograph shows the cells are simply pressed into a holder mounted on the top of the unit. The charger costs 79s 6d, including four alkaline batteries which should soon pay for itself in increased battery life/hours.

TEST METERS

A neat and versatile pocket test meter has just been introduced by West Hyde Developments Ltd., 30, High Street, Northwood, Middlesex.

Called the Tech Test Meter it costs only 45s including test leads, has 15 ranges for measuring 0 to 1kV a.c./d.c. and 0 to 100 kilohms. The meter movement has jewelled bearings and has a sensitivity of 1,000 ohms per volt.

The low cost of this meter means that it is possible to leave a number of multi-meters in circuit on the bench instead of using a more expensive, single range meter.

A more expensive, sensitive and professional multimeter is the Kelvo 6E Electronic Multimeter. This meter incorporates a self contained battery-operated d.c./a.c. amplifier enabling measurements to be made with an accuracy of ± 1 per cent.

The instrument has 26 voltage ranges, permitting measurements from 1mV f.s.d. to 1kV d.c. and a.c. The sensitivity of the meter is 1 megohm per volt at 1mV to 10V and 10 megohm per volt at 30V to 1kV. There are 28 current ranges from 1 μ A to 3A d.c. and a.c. Also, there are six resistance ranges for measurements between 0.2 ohm and 50 megohms, and six capacity ranges from 50pF to 5,000 μ F.

The meter is fitted with a sensitive and effective automatic electrical cutout which operates independently of the condition of the batteries, protecting the instrument from damage if subjected to overload.

It is claimed that under continuous 24 hour usage the batteries will enable the instrument to operate satisfactorily for approximately two months.

The Kelvo 6E multimeter is marketed by Smiths Industries Ltd., Kelvin House, Wembley, Middlesex, and cost £72.

RESEARCH INSTRUMENT

Designed for Industrial Laboratories and University Research Departments is the Universal Digital Instrument type EU-805 from Daystrom Ltd., Bristol Road, Gloucester.

The Heath 805 Universal Digital Instrument is a multi-purpose instrument capable of many high accuracy standard measurements and has the adaptability and versatility required of modern research instrumentation. Some of the functions include events counter; frequency meter; integrating digital voltmeter; ratio meter; time interval meter and voltage integrator.

The unit incorporates a modular design based on 16 plug-in cards using TTL Integrated Circuit. This design enables card additions for new functions to be added, protecting it against obsolescence.

In both academic and industrial use it is intended as a companion to the Heath Analogue Digital Designer EU-801-A, a device for teaching digital logic and instrumentation.

FILMS FOR CLUBS AND SCHOOLS

Of interest to schools and clubs are two films from the Central Office of Information and Mullard Ltd.

The Mullard film is entitled *Mullardability*, is in colour, runs for 9 minutes and is of 16mm gauge.

The film begins with illustrations of Mullard's capability to mass-produce vast ranges of electronic components, from television picture tubes to micro-electronic circuits. Finally the film deals with the Mullard Research Laboratories and its study and development of new materials, systems and techniques of the future.

Copies of the film are available on free loan from Mullard Film Library, Kingston Road, Merton Park London, S.E.19.

The COI film is entitled *Moviz from Computers*, runs for 20 minutes and is of 16mm gauge. The film contains extracts from existing computer-generated industrial and research films. The use of computers in mathematics, physics and engineering, and also the use in flight training techniques are shown.

The film is available from the Central Film Library, Government Building, Bromyard Avenue, Acton, London, W.3. The hire charge is £1 for one day only (reduced charges for additional days). In addition to the hire charge there is a surcharge of 1s 6d per 16mm reel to cover despatch and certain other handling costs for the first day of hire only.

The current edition of the Films in Industry catalogue is also available from the Central Film Library, price 4s 6d post free.

MARKET PLACE

Items mentioned in this feature are usually available from electronic equipment and component retailers advertising in this magazine. However, where a full address is given, enquiries and orders should then be made direct to the firm concerned.

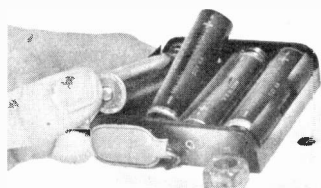

Pencil battery charger from DCB Instrument and Lighting



West Hyde Developments Tech Test Meter

Heath EU-805 Universal Digital Instrument from Daystrom

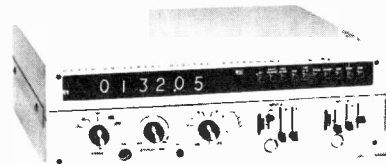

Kelvo 6E meter marketed by Smiths Industries

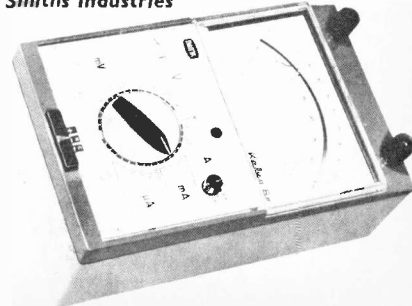

SQUARE WAVE TEST OSCILLATOR

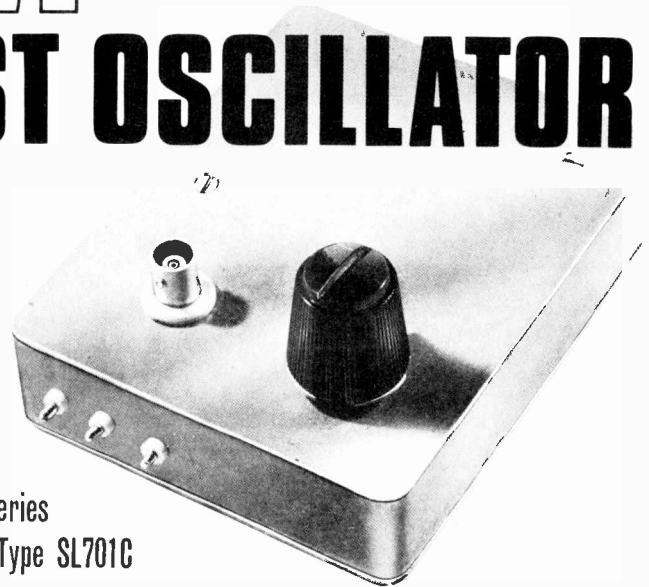
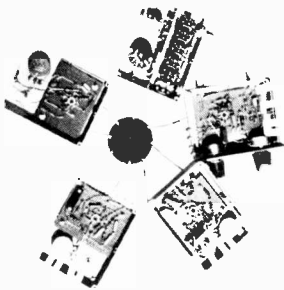

This is the concluding project in our five-part series featuring the integrated circuit linear amplifier Type SL701C

THE use of a square wave in audio testing to detect overshoot, instability, or ringing of an amplifier is well known, and a straightforward single test with a square wave can be much more informative than even a complete frequency response curve. From the tilt on the top of the square wave we can obtain the l.f. bandwidth, from the rise time we have the h.f. bandwidth, and from the overshoot or ringing (if any) we can determine the approximate magnitude and frequency of any peak at the h.f. end of the frequency response.

This article is the last of this series on the practical uses of the Plessey SL701 integrated circuit, and deals with a simple square wave generator at 1kHz; Fig. 1 shows the basic diagram of the arrangement.

CIRCUIT OPERATION

Positive feedback is applied round the amplifier through the divider chain R1 and R3, while negative feedback is applied through R2 in conjunction with C1, and the circuit changes state regeneratively each time the two inputs are at the same potential. For our purposes we can make all three resistors equal in value, and for our explanation of how the circuit works we can assume that the output level is limited to $\pm 2V$.

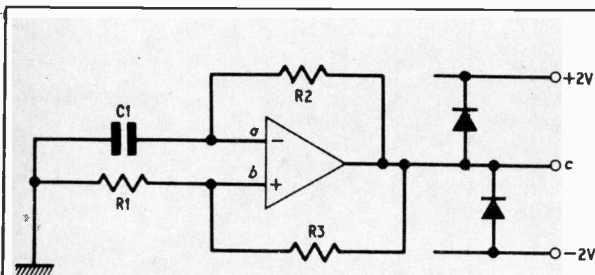

Fig. 1. Basic diagram for the square wave oscillator

The expected waveforms are drawn in Fig. 2. If we assume that immediately we switch on, the output c goes to $+2V$, then the input b will go to $+1V$, and C1 will charge up (through R2) from zero towards $+2V$. When the input a just exceeds the $+1V$ of input b , the circuit will rapidly switch to the other state of c at $-2V$ and b at $-1V$. C1 then discharges from $+1V$ towards $-2V$ and the circuit reverts to its previous state when a now reaches $-1V$; and so on. The a waveform is therefore of an exponential form. The mark to space ratio of the waveform should be one to one, and the frequency is given by:

$$f = \frac{1}{2.2 C_1 R_2} \text{ Hz}$$

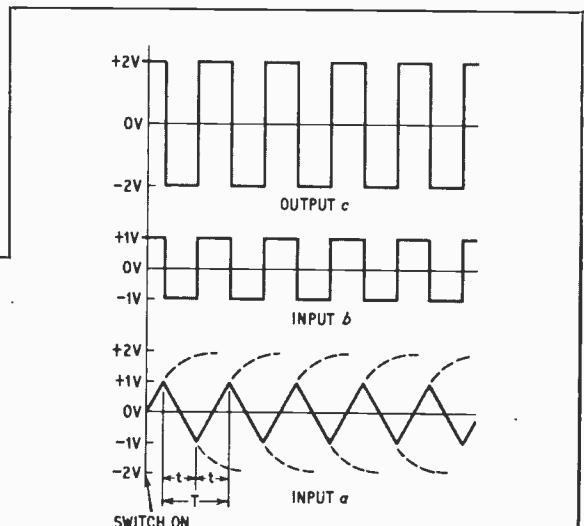

Fig. 2. Waveforms associated with Fig. 1 arrangement

LOOK!

PRACTICAL!
VISUAL!
EXCITING!



a new 4-way method of mastering
ELECTRONICS
by doing — and — seeing . . .

1 ▶ OWN and HANDLE a

complete range of present-day **ELECTRONIC PARTS** and **COMPONENTS**

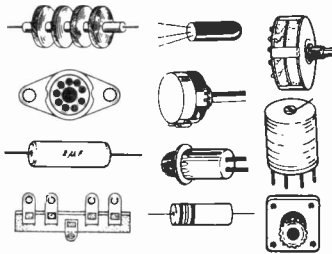

2 ▶ BUILD and USE

a modern and professional **CATHODE RAY OSCILLOSCOPE**

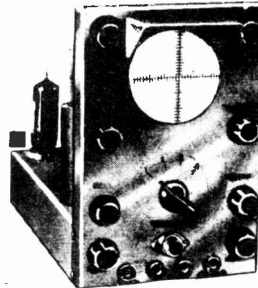

3 ▶ READ and DRAW and

UNDERSTAND **CIRCUIT DIAGRAMS**

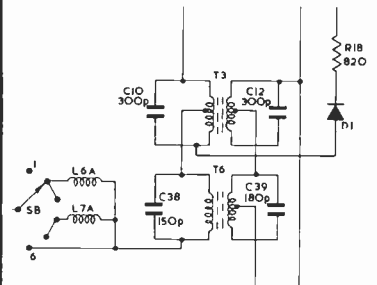

4 ▶ CARRY OUT OVER 40 EXPERIMENTS ON BASIC ELECTRONIC CIRCUITS AND SEE HOW THEY WORK . . . INCLUDING . . .

- VALVE EXPERIMENTS
- PHOTO ELECTRIC CIRCUIT
- A.C. EXPERIMENTS
- TRANSISTOR EXPERIMENTS
- COMPUTER CIRCUIT
- D.C. EXPERIMENTS
- AMPLIFIERS
- BASIC RADIO RECEIVER
- SIMPLE COUNTER
- OSCILLATORS
- ELECTRONIC SWITCH
- TIME DELAY CIRCUIT
- SIGNAL TRACER
- SIMPLE TRANSMITTER
- SERVICING PROCEDURES

This new style course will enable anyone to really understand electronics by a modern, practical and visual method—no maths, and a minimum of theory—no previous knowledge required. It will also enable anyone to understand how to test, service and maintain all types of Electronic equipment, Radio and TV receivers, etc.

FREE POST NOW
for
BROCHURE

or write if you prefer not to cut page

To: **BRITISH NATIONAL RADIO SCHOOL, READING, BERKS.** Please send your free Brochure, without obligation, to: we do not employ representatives

NAME..... BLOCK CAPS

ADDRESS..... PLEASE PE II



THE DORSET (600mW Output)

7-transistor fully tunable M.W.-L.W. superhet portable—with baby alarm facility. Set of parts. The latest modulated and pre-alignment techniques makes this simple to build. Sizes: 12" x 8" x 3".

MAINS POWER PACK KIT: 9/6 extra.

Price £5.5.0 plus 7/6 p. & p. Circuit 2/6 FREE WITH PARTS.

THE ELEGANT SEVEN MK. III (350mW output)

7-transistor fully tunable M.W.-L.W. portable. Set of parts. Complete with all components, including ready etched and drilled printed circuit board—back printed for foolproof construction.

MAINS POWER PACK KIT: 9/6 extra.

Price £4.9.6 plus 7/6 p. & p.

Circuit 2/6 FREE WITH PARTS.

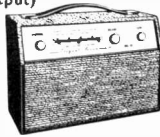

50 WATT AMPLIFIER A.C. MAINS 200-250V

An extremely reliable general purpose valve amplifier—with six electronically mixed inputs. Suitable for use with: mics, guitars, gram, tuner, organs, etc. Separate bass and treble controls.

Price 27 gns. plus 20/- p. & p.

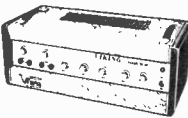

X101 10W SOLID-STATE HI-FI AMP WITH INTEGRAL PRE-AMP

Specifications: R.M.S. Power Output (into 3 ohms speaker): 10 watts continuous (sine wave), 13 watts music power. Sensitivity (for rated output): 1mV into 3K ohms (0-33 micro-amp) Total Distortion (@ 1KHz): at 5 watts 0-35%, at rated output 1-5%. Frequency Response: Minus 3dB points 20Hz and 40KHz. Speaker: 3-4 ohms (3-15 ohms may be used). Supply voltages: 24V d.c. @ 800mA (6-24V may be used).

Control assembly: including resistors and capacitors.

1. Volume: PRICE 5/-.

2. Treble: PRICE 5/-.

3. Comprehensive bass and treble: PRICE 10/-.

The above 3 items can be purchased for use with the X101.

Power Supplies for the X101:

P101 M (for mono) 35/- plus 4/6 p. & p. P101 S (for stereo) 42/6 plus 4/6 p. & p.

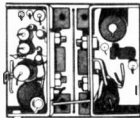

Price 49/6

plus 2/6 p. & p.

THE CLASSIC

Controls: Selector switch. Tape speed equalisation switch (3 1/2 and 7 1/2 i.p.s.). Volume. Treble. Bass. 2 position scratch filter and 2 position rumble filter.

Specification: Sensitivities for 10 watt output at 1KHz. Tape head: 3mV (at 3 1/2 i.p.s.) Map. P.U.: 2mV. C.T.U.: 80mV. Radio: 100mV. Aux.: 100mV. Tape/Rec. output: 100mV. Equalisation for each input is correct to within ±2dB (R.I.A.A.) from 20Hz to 20KHz. Tone control range: Bass ±13dB at 60Hz. Treble ±14dB at 15KHz. Total distortion: (for 10 watt output) <1.5%. Signal noise: <-60dB. A.C. mains 200-250V. Size 12 1/2" long, 4 1/2" deep, 2 1/2" high. Teak finished case. Price 8 gns. p. & p. 7/6.



THE RELIANT 10W SOLID-STATE HIGH QUALITY AMPLIFIER

Specifications: Output: 10 watts R.M.S. Sine-wave; 13 watts R.M.S. Music-power. Output impedance: 3 to 4 ohms. Inputs: 1. Xtal mic 10mV; 2. Gram/radio 250mV. Tone controls: Treble control range ±12dB at 10KHz; Bass control range ±13dB at 100Hz. Frequency response (with tone controls central): Minus 3dB points are 20Hz and 40KHz. Signal to noise ratio: better than -60dB. Transistors: 4 silicon Planar type and 3 Germanium type. Mains input: 220-250V a.c. Size of chassis: 10" x 3 1/2" x 2". A.C. Mains, 200-250V. For use with Std. or L.P. records, musical instruments, all makes of pick-ups and mikes. Separate bass and treble lift control Two inputs with control for gram, and mike. Built and tested. 8" 5" speaker to suit: Price 14/6 plus 1/6 p. & p. Crystal mike to suit: 12/6 plus 1/6 p. & p. PRICE £5.5.0 plus 5/- p. & p.

THE VISCOUNT

Integrated High Fidelity Transistor Stereo Amplifier

SPECIFICATIONS: Output: 10 watts per channel into 3 to 4 ohms speakers (20 watts mono). Input: 6 position rotary selector switch (3 pos. mono and 3 pos. stereo), P.U., Tuner, Tape and Tape Rec. Sensitivities: All inputs 100mV into 1.8M ohm. Frequency response: 40Hz-20KHz±2db. Tone controls: Tone control flat (Baxandall type), separate bass and treble controls. Treble 13db lift and cut at 15KHz. Bass 15db lift and 25db cut at 60Hz. Volume controls: Separate for each channel. AC Mains input: 200-240V. 50-60Hz. Size 12 1/2" x 6" x 2 1/2" in. teak-finished case. Built and tested.

PRICE 13 1/2 gns. Postage & Packing 7/6 extra.

CYLDON U.H.F. TUNER

Complete with PC88 and PC86 Valves. Full variable tuning. New and unused. Size 4 1/2" x 1 1/2". Complete with circuit diagram. 35/- plus 3/6 p. & p.

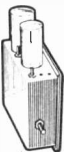

THREE-IN-ONE HI-FI 10 WATT SPEAKER

A complete Loud Speaker system on one frame, combining three matched ceramic magnet speakers with a low loss cross-over network. Peak handling power 10 watts. Impedance 15 ohms. Flux density 11,000 gauss. Resonance 40-60c/s. Frequency range 50c/s to 20kc/s. Size 13 1/2" x 8 1/2" x 4 1/2". By famous manufacturer. List price £7. Our price 69/6 plus 5/- p. & p. Similar speaker to the above without tweeters in 3 and 15 ohms 39/6 plus 5/- p. & p.

Goods not despatched outside U.K. Terms C.W.O. All enquiries S.A.E.

RADIO & TV COMPONENTS (ACTON) LTD.
21d High Street · Acton · London W.3
323 Edgware Road · London W.2
ORDERS BY POST TO OUR ACTON ADDRESS PLEASE

ERSIN



for quick,
easy, reliable
soldering

Contains 5 cores of non-corrosive flux, instantly cleaning heavily oxidised surfaces. No extra flux required. Ersin Multicore Savbit Alloy also reduces wear of copper soldering iron bits.



SIZE 5 HANDY SOLDER DISPENSER

Contains 10 ft. coil of 18 s.w.g. Ersin Multicore Savbit Alloy. 2/6 each.



SIZE 15 SOLDER DISPENSER

Contains 21 ft. coil of 60/40 Alloy, 22 s.w.g. Ideal for small components, transistors, diodes, etc. 3/- each.



SIZE 12

Ideal for home constructors. Contains 90 ft. of 18 s.w.g. Ersin Multicore Savbit Alloy on a plastic reel. 15/- each.



BIB MODEL 8 WIRE STRIPPER AND CUTTER

Strips insulation cleanly and quickly, fitted with unique 8 gauge wire selector. Plastic handles. 9/6 each.



From Electrical and Hardware shops. If unobtainable, write to: Multicore Solders Ltd., Hemel Hempstead, Herts.

STEREOGRAM CABINET £19

An elegant Stereogram Cabinet in modern Veneered Mahogany and cloth covered Front Panel
BLACK LEATHERETTE SIDE PANELS
Dimensions: 52" x 17 1/2" x 12". Speaker positions for Twin 10" x 5" Speakers

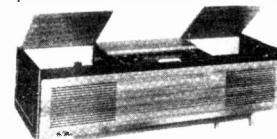

OTHER MODELS—SEND FOR LIST

SPEAKERS 6/6

2" — 75Ω, 2 1/2" — 35Ω. P. & P. 2/6.

ACOS MICRS. 35/- STANDARD

STICK MIC. 2gns. P. & P. 3/6.

ASSORTED CONDENSERS

10/- for 50. P. & P. 7/6.

ASSORTED RESISTORS

10/- for 50. P. & P. 4/6.

ASSORTED CONTROLS

10/- for 25. P. & P. 7/6.

TRANSISTORS

MULLARD MATCHED

OUTPUT KIT

9/- OC81D—2 OC81's.

P. & P. FREE.

FERRITE RODS 3/6

6", 8" x 3/8" complete with

LW/MW COILS. P. & P. FREE.

17in.—£11.10.0 Carr. 30/-

19in. SLIM-LINE FERGUSON 24 gns.

TWO-YEAR GUARANTEE EX-RENTAL TELEVISIONS

FREE ILLUSTRATED LIST OF TELEVISIONS 17"—19"—21"—23"



WIDE RANGE OF MODELS SIZES AND PRICES DEMONSTRATIONS DAILY

TRANSISTOR CHASSIS DI

59/6
6 Transistors, LW/MW, Brand New, Famous British Manufacturer (LESS SPEAKERS). Size 7 1/2" x 3 1/2" P. & P. 4/6.

TRANSISTOR RECORD PLAYER CABINETS 19/6 P. & P. 7/6.

SINGLE PLAYER CABINETS 15/6. P. & P. 7/6.

TRANSISTOR CASES 19/6. Cloth covered, many colours. Size 9 1/2" x 6 1/2" x 3 1/2". P. & P. 3/6. Similar cases in plastic 7/6.

AUTOCHANGERS £8.19.6

Garrard 3000 with Sonotone 9T HC. D/S Stereo Cartridge.

DUKE & CO. (LONDON) LTD.

621/3 Romford Road, Manor Park, E.12

Phone 01-478 6001-2-3

Stamp for Free List

SQUARE WAVE OSCILLATOR CIRCUIT

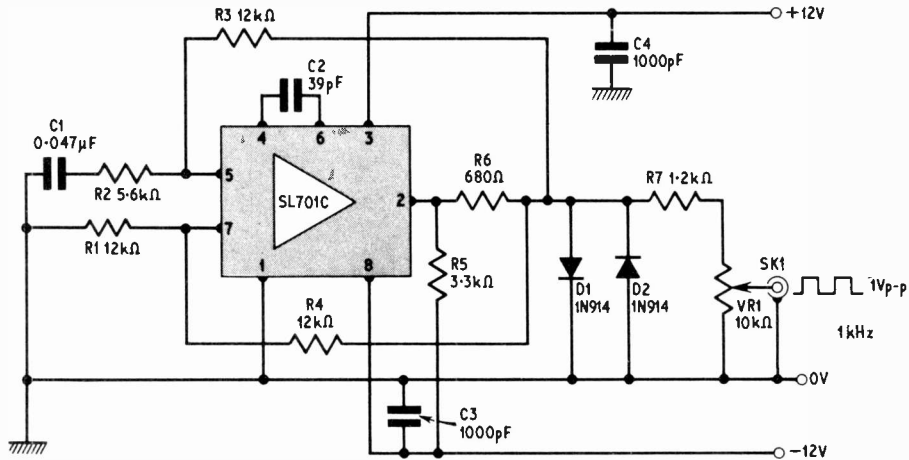

Fig. 3. Complete circuit diagram for the square wave test oscillator

CONSTRUCTIONAL DETAILS

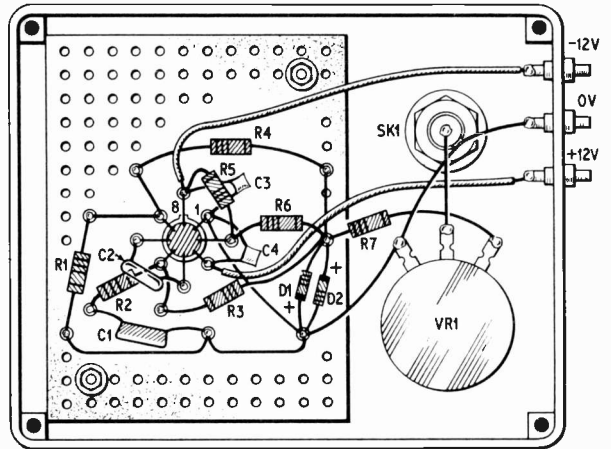
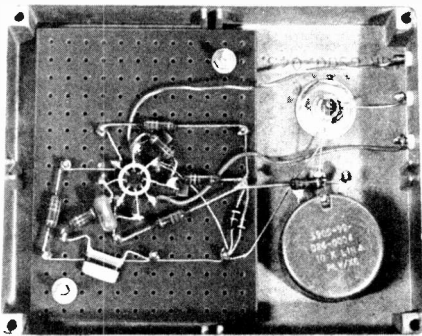

Fig. 4. Layout and wiring for the oscillator

COMPONENTS . . .

Resistors

R1	12k Ω
R2	5.6k Ω
R3	12k Ω
R4	12k Ω
R5	3.3k Ω
R6	680 Ω
R7	1.2k Ω
All $\pm 10\%$, $\frac{1}{4}$ W carbon	

Capacitors

C1	0.047 μ F ceramic or polyester
C2	39pF ceramic
C3	1,000pF ceramic
C4	1,000pF ceramic

Miscellaneous

IC1	Linear integrated circuit (d.c. coupled amplifier — SL701C) (available direct from the makers: The Plessey Co. Ltd., Components Group, Cheney Manor, Swindon, Wiltshire. Price: 18s)
VR1	10k Ω carbon potentiometer
D1, D2	1N914, 1N916 (2 off)
SK1	4mm socket and matching plug or coaxial socket and plug (Radiospares)
Die-cast box 4 $\frac{1}{2}$ in \times 3 $\frac{1}{2}$ in \times 1in (Electroniques 46R.043A)	
Perforated s.r.b.p. 3in \times 2 $\frac{1}{2}$ in	
Three insulated feed-through terminals	
Control knob	
6BA screws and nuts	

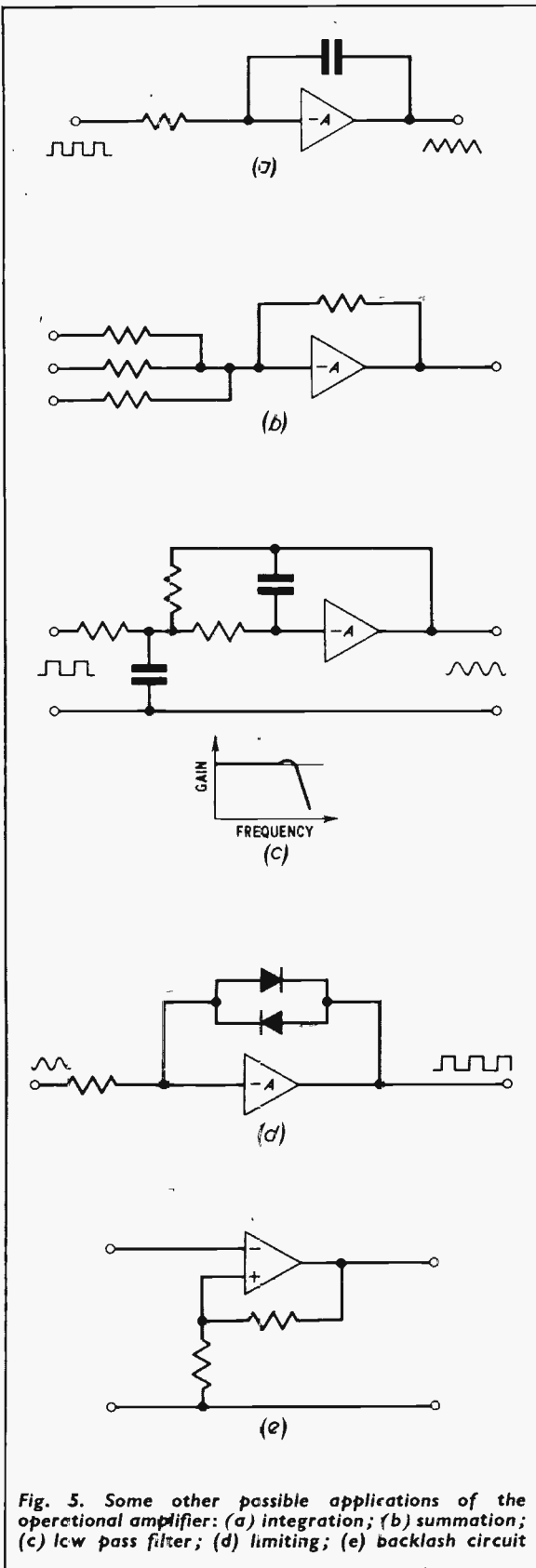

Fig. 5. Some other possible applications of the operational amplifier: (a) integration; (b) summation; (c) low pass filter; (d) limiting; (e) backlash circuit

THE PRACTICAL CIRCUIT

The practical circuit is shown in Fig. 3, and there are several additional points worthy of explanation.

The output is limited by the diodes D1, D2 to $\pm 0.6V$, which keeps b within the permitted value of $+0.5V$ for correct common mode working of the differential input stage. The peak output current from the amplifier through the diodes is limited in a positive direction by the 680 ohm resistor R6.

The Plessey SL701 integrated circuit is intended primarily for linear applications, rather than as a switching comparator, and therefore exhibits some hysteresis in its switching characteristics (like a Schmitt trigger) so that the output waveform from a circuit like Fig. 1 would be a rectangular waveform of about three to one mark to space ratio (rather than a square waveform as we would expect). This could be adjusted by returning R1 to a voltage rail slightly offset from earth, but this would mean a potential chain of two resistors. For our application we have chosen to include a resistor in series with the timing capacitor as an alternative approach. This ensures that the mark to space ratio is almost one to one, and for our particular circuit values, this measure increases the frequency from the 800Hz calculated from the formula to about 1kHz.

PERFORMANCE

The maximum output is about 1V peak to peak, spaced equally about earth potential, and has a rise time of 0.2μ seconds which is much faster than that required for audio applications. An amplifier with a bandwidth of 1.5MHz would degrade this edge to 0.3μ seconds.

Since the output impedance of the circuit depends on the setting of the output potentiometer VR1 and is in any case 1 kilohm at best, any capacitive load will degrade the edge. For video testing the output lead should be kept as short as practicable, while for audio use the rise time will be adequate in all positions of the potentiometer, provided the capacitive loading does not exceed 50pF.

CONSTRUCTION

Construction is detailed in the diagram of Fig. 4 and should present no difficulty provided a similar layout is followed.

All components except R7, SK1 and VR1 can be mounted on a piece of perforated s.r.b.p. $3in \times 2\frac{3}{4}in$. Holes are drilled in the base to accommodate VR1, SK1, the three feed through supply terminals and the mounting screws for the board. Spacers are used under the board to prevent shorting between it and the base.

It is essential to use reasonably fast diodes in order to maintain the fast rise time inherent in the circuit, but the type specified is available from a number of suppliers.

OTHER APPLICATIONS: USING THE I.C. IN TRUE OPERATIONAL MODE

In this series of five articles based upon the SL701C integrated circuit we have considered some of the many possible ways of using this high gain amplifier, but ironically we have not in fact considered any of the analogue computing techniques which would use the amplifier in a true operational mode. An operational amplifier is one which takes the input signal and operates on it in a known mathematical way. Some of the analogue computing circuits which can be realised with a high gain amplifier are given in Fig. 5.

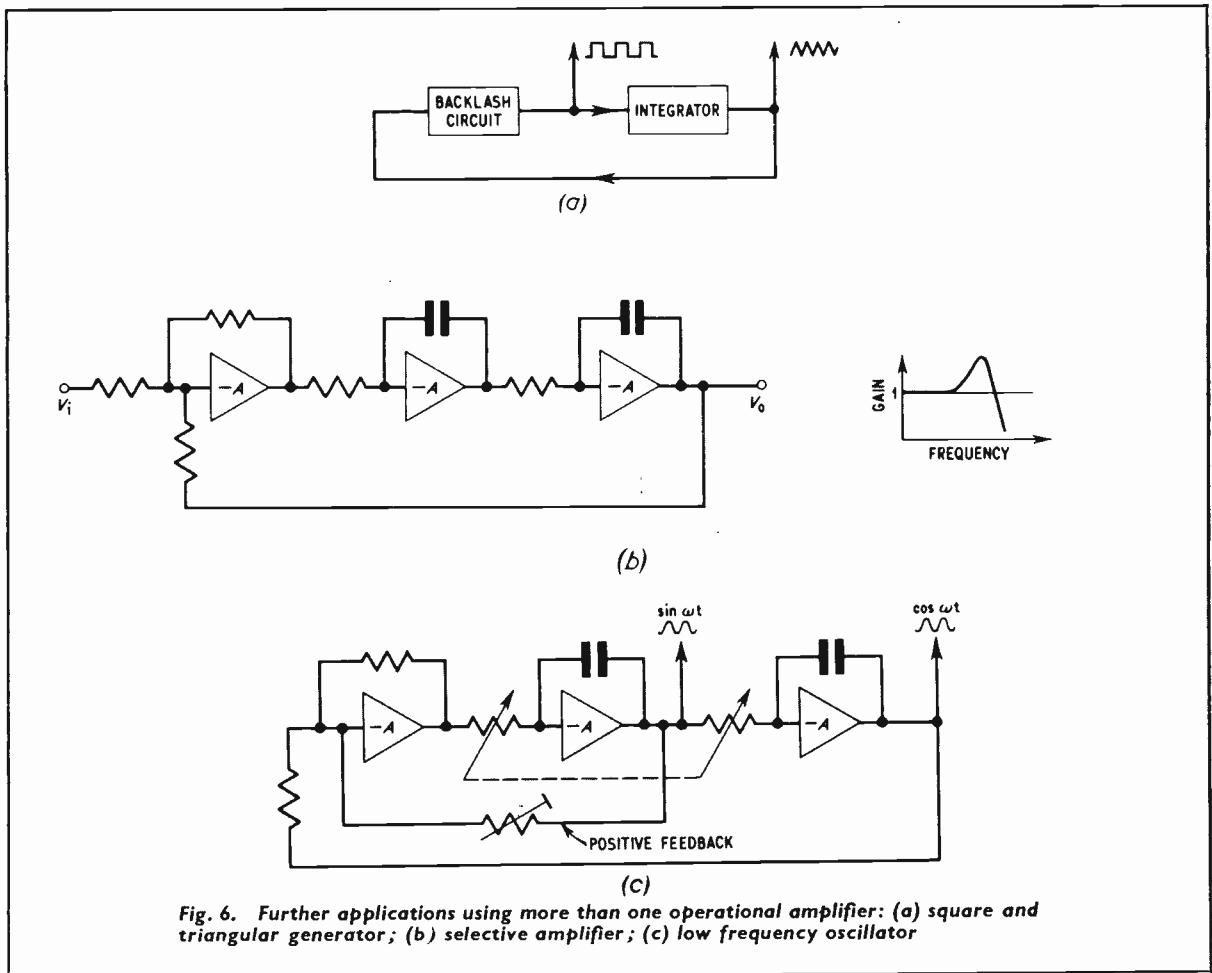

Fig. 6. Further applications using more than one operational amplifier: (a) square and triangular generator; (b) selective amplifier; (c) low frequency oscillator

Integration

We can, for example, integrate a square wave to obtain a triangular waveform.

Summation

We can add or mix a number of inputs to provide a combined output.

Low pass filter

This circuit could be used as a scratch filter for an audio amplifier.

Limiting

This circuit uses diodes to provide heavy negative feedback to limit an input signal to $\pm 0.6V$.

Backlash circuit

This can be used in a similar fashion to a Schmitt trigger.

If we are more ambitious we can use several integrated circuits, and projects such as Fig. 6 become possible.

Square and triangular waveform generator

By combining an integrator and a backlash circuit we can produce a square and triangular waveform

generator relatively simply. We could even shape the triangular waveform with yet a third circuit, to produce a sinewave.

Selective amplifier

Two integrators and an inverter can be used to form a frequency selective amplifier.

Low frequency oscillator

By adding positive feedback to the selective amplifier, this can be made into an oscillator which will work over a frequency range from seconds per cycle (heavy negative feedback sets the d.c. conditions and outputs can be directly coupled) up to about 20kHz for the Plessey amplifiers.

By using a fourth integrated circuit in a peak amplitude detector (not shown) the distortion of the arrangement can be kept down to 0.1 per cent. Using variable resistors and switched capacitors this circuit can give us a two phase oscillator from 2Hz to 20kHz, and, with appropriate switching, a selective amplifier covering the same range with a variable, known Q. This shows the range and versatility of the analogue approach.

But an instrument such as this must wait until we can afford to use four integrated circuits in one constructional project, and for the moment we must be content to incorporate the odd single integrated circuit. We hope that these five articles have been of some help in this respect.



BIONICS

3

SIMPLE LEARNING

BY G.C. BROWN

M.S.H.A.A., A.M.R.S.H.

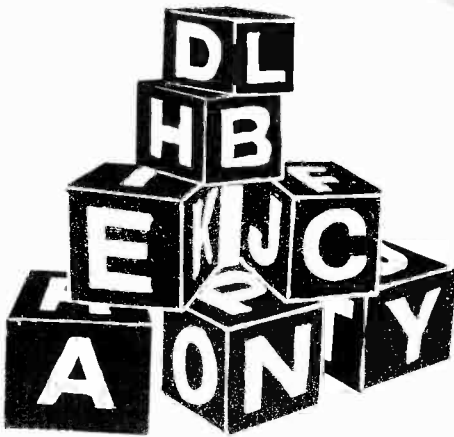

LAST month we examined the basic conditional reflex response as exhibited by some animals, and considered the possibilities for its synthesis. We shall discuss now the form which the hardware will take for the demonstration of this simple learning, also how it may be interconnected with the existing circuitry mentioned in the last article. There are in fact numerous circuit arrangements which will "fit the bill", but we shall deal with just one relatively simple example, this however will work quite successfully in our model.

LEARNING CIRCUIT

It will be remembered from our earlier "black box" hypothesis of a learning circuit that only a very few building bricks were utilised; i.e. a short term memory to extend S_n for a period of time to allow for coincidences with S_s , a differentiator for S_s , a means for summing the coincidences, and a few gates to route pulses at the correct times. A look at Fig. 3.1 will disclose just how simple the circuit really is. There are a few additional items of course such as the bistable flip-flop and the Schmitt; these however provide certain improvements and will be explained later on. Fundamentally, the results from a circuit without these extras would be very similar, in that it would exhibit the characteristics we are looking for.

The present circuit configurations of the model demand that the learning section be rather more digital than analogue, and so the basic schematic diagram has been tailored a little to meet this need. The reader will notice at once that our use of the term "differentiator" has been stretched considerably, so far in fact as to include in this instance a monostable! However, there is a reason for this.

LONG OVERLAP PERIOD

Look at Fig. 3.1 again. Imagine that the neutral stimulus has just occurred, and suppose now that the specific stimulus appears. Now if we are going to achieve any useful summing action during the overlap period of the specific and neutral stimuli, a differentiator using a capacitor of massive proportions would be required. It needs a while for us to appreciate this situation—in electronics we are used to things happening at enormous speeds: in this particular case though, everything has slowed right down and we are dealing with quantities which occur at rates we could comfortably count on our fingers.

The requirement then for our differentiator seems to be not that it chops off a very thin "slice" from the beginning of each S_s event, but that it takes a good sized chunk. If we make it behave in this way we are now the possessors of a very sloppy differentiator indeed, however this is of no concern.

The output waveform from this version naturally has none of the slender proportions of that seen from the normal type, and so it was decided that it might be as well to dispense with it altogether and use a monostable instead. This we have done. And where the "chastity" of the nice neat spikes from a normal differentiating circuit would have meant summing several hundred repetitions of the specific stimulus during the extension of S_n , we now need only a few.

CIRCUIT INTERCONNECTIONS

So that the reader can appreciate how the learning circuit is interconnected with the existing hardware, the relevant sections of the reflex circuitry are reproduced again in Figs. 3.2 and 3.3.

The design and construction of electronic "animals" or machines with artificial intelligence

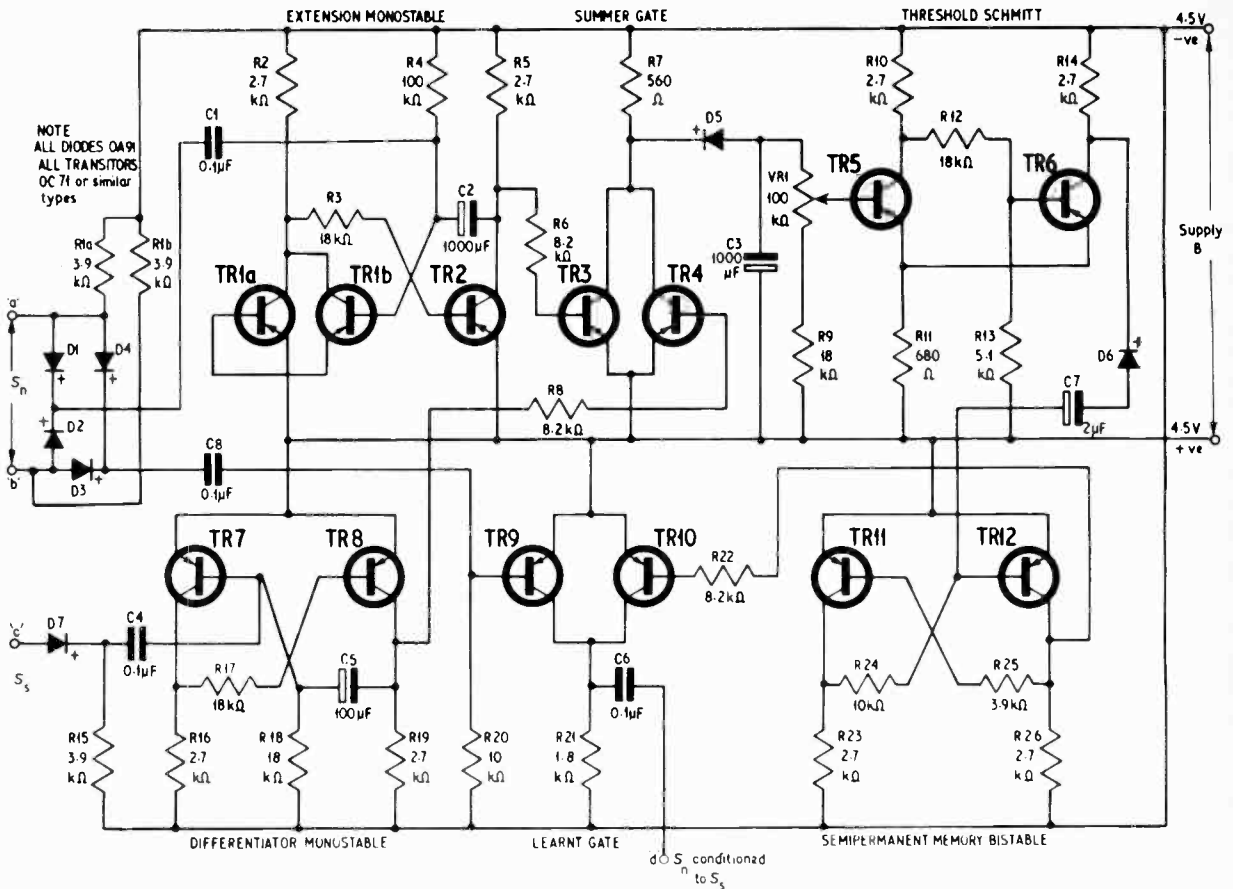

Fig. 3.1. The simple learning circuit. This is interconnected with the sensor and reflex sections of Fig. 2.4

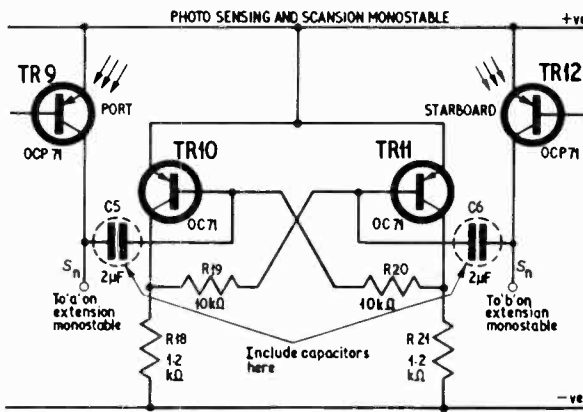

Fig. 3.2 Part of Fig. 2.4 with additions to permit extraction of the neutral stimulus S_n .

Fig. 3.2 shows the method for extracting the neutral stimulus S_n .

The specific stimulus S_s is picked-off direct at the tactile probe in the reversing monostable indicated in Fig. 3.3; a diode D9 has been included here, the purpose of which will be seen shortly. A further connection is also made to the other side of the reversing monostable for use when the model has "learnt" a particular combination of stimuli—this will be discussed later.

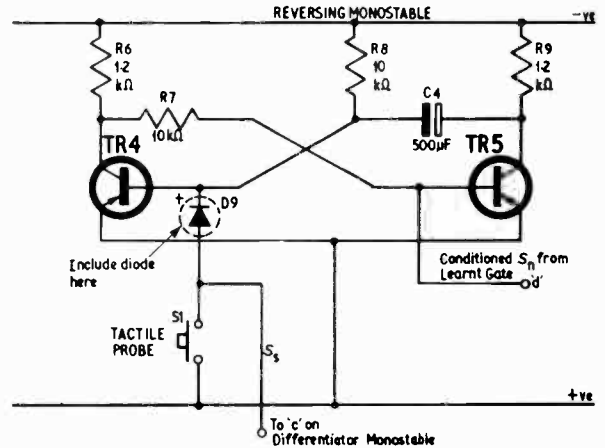

Fig. 3.3 Part of Fig. 2.4 with modifications to permit extraction of the specific stimulus and application of the "learnt" signal

OPERATION

Assuming now that all the necessary connections have been made between the reflex and "learning" sections of the model, we are now in a position to see how the circuits operate and interact with each other.

If a neutral stimulus (light) is applied by way of the photo-transistors in the reflex section, then a positive pulse will pass via either diode D1 or D2 to turn off transistors TR1a and TR1b of the extension mono-

stable. This monostable will now turn over and hence TR2 collector will become positive, resulting in one side of the summer gate being opened. The extension monostable will remain in the quasi-stable state for approximately 60 seconds. If the tactile sense is stimulated by way of the probe in the reflex section, then a positive pulse will be fed via diode D7 resulting in transistor TR7 of the differentiator monostable being switched off. Hence this monostable turns over and produces our so-called "differentiated" pulse which in fact lasts about 1 second.

The collector of TR8 being connected via R8 to the other side of the summer gate hence causes the base of TR4 to go positive, opening this side of the gate. Now if the stimulus S_n occurs any time up to 60 seconds before S_s , then the result of their coincidence, or overlap, will cause the common collector point of the summer gate to go negative (i.e. both sides of the gate opened).

Diode D5 will now be forward biased and capacitor C3 will commence charging towards the negative rail potential. This capacitor thus serves as a sort of short-term memory for coincidences of S_s and S_n , and at this stage could be connected almost directly to the learnt gate were it not for the fact that in practice we require a more permanent memory.

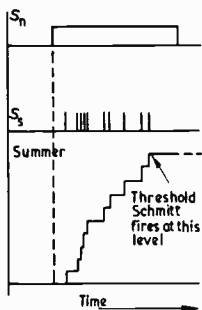

Fig. 3.4 Case where a conditioned reflex is evoked during one application of the neutral stimulus

THRESHOLD SCHMITT

In order to improve the learning circuit a little, the threshold Schmitt and the semi-permanent memory bistables have been added. Once potentiometer VR1 has been set to some value, the Schmitt will act as a threshold device and fire when the voltage due to the charging of C3 reaches a certain level (see Fig. 3.4). This will be equivalent to a given number of repetitions of S_s during extension of S_n , and in practice should be between 10 and 20 separate stimulations.

When the threshold Schmitt fires a negative going pulse will be passed via the diode D6 and capacitor C7 to the semi-permanent memory bistable.

MEMORY BISTABLE

It will be noticed that the base bias for transistor TR11 of the bistable is derived via a resistor (R25) whose value is relatively small compared with that in the opposite side (R24). This has been done deliberately to ensure that upon switching the circuit on an irrelevant memory is not produced.

Once the bistable has switched, one side of the learnt gate will be opened and hence any further S_n stimuli will open the other side also. The common collector point of the gate will thus go negative for all future applications of S_n and switch the reversing monostable via capacitor C6 (this could be replaced by a diode for analogue functions). Hence instead of S_n causing the usual homing response, this is now inhibited; the model now "cowers" and backs away with "its tail between its legs".

This will always be the result from now on, unless the permanent memory is disturbed by, say, the power supplies being switched off, or unless we make special arrangements for inhibiting the response. Suitable circuitry can be designed for this, modelled upon the black box systems shown earlier: however it is not at this stage intended to go into the actual design for the electronics.

CASE OF INSUFFICIENT STIMULI

Hitherto for the convenience of describing the operation of the learning circuit, we have assumed that a sufficient number of repetitions of S_s always occur during the extension period. But suppose S_s appears only a few times, insufficient to fire the threshold Schmitt: what will be the effect? The capacitor C3 will have received some charge, but if no further S_s arrives its voltage level will gradually diminish. However, this is the way we want it to be. This after all is the situation where an insufficient number of coincidences have occurred for the model to "see" any significant connection between S_s and S_n .

If on the other hand further combinations of the two stimuli occur during the slowly decaying voltage across C3, their result will be added to whatever level the capacitor has discharged to. This may, or may not, cause the threshold Schmitt to fire for it will depend solely upon the threshold voltage being reached.

In practice, if the coincidences are sufficiently infrequent, conditioning could take hours, and in fact may never take place at all. During conditioning experiments with real live animals exactly the same effect takes place if the neutral and specific stimuli are not allowed to overlap often enough.

FUNCTION OF D9

Earlier we mentioned the inclusion of diode D9 in the reversing monostable, its purpose will become clear upon examination: without the diode, after conditioning has taken place the neutral stimulus could thereafter trigger the differentiator monostable via the "avoidance system". This would result in capacitor C3 being charged due to S_n alone—not that this would matter, you might say, because the model has been conditioned.

However, if we decided to build in an inhibit circuit (which the constructor might choose to do) an irrelevant "short term" memory would already be stored in C3, and although this might not affect the inhibition it could none-the-less cause some problems. D9 thus overcomes this difficulty.

MORE FACTS ABOUT ANIMAL BEHAVIOUR

Having satisfied ourselves that we can indeed simulate the simple conditional reflex (albeit by quite different and less sophisticated means than those used by a biological example), we must now "press on" and discover some more facts about animal behaviour.

Adamin

MODEL 15

MICRO SOLDERING INSTRUMENT



● **EXTREME VERSATILITY**

Range of 8 interchangeable bits, from 3/64" (.047") to 3/16", including new non-wearing PERMATIPS.

● **ULTRA-SMALL SIZE**

Length 7 1/2". Weight 1/2 oz. Max. handle dia. 7/16".

● **EXTRA-HIGH PERFORMANCE**

Heating time 90 secs. Max. bit temp. 390°C. Loading 15 watts—equals normal 30/40 watt iron.

● **ALL VOLTAGES**

The ADAMIN range includes five other models (5, 8, 12, 18 and 24 watts), Thermal strippers (PVC and PTFE) and a De-Soldering Tool. Please ask for colour catalogue A/37.

LIGHT SOLDERING DEVELOPMENTS LTD.

28 Sydenham Rd., Croydon, CR9 2LL
Telephone 01-688 8589 & 4559



Now! A FAST EASY WAY TO LEARN BASIC RADIO AND ELECTRONICS



Build as you learn with the exciting new **TECHNATRON** Outfit! No mathematics. No soldering—but you learn the *practical* way.

Now you can learn basic Radio and Electronics at home—the *fast*, modern way. You can give yourself the essential technical 'know-how' sooner than you would have thought possible—read circuits, assemble standard components, experiment, build . . . and enjoy every moment of it. B.I.E.T.'s Simplified Study Method and the remarkable new **TECHNATRON** Self-Build Outfit take the mystery out of the subject—make learning *easy and interesting*.

Even if you don't know the first thing about Radio now, you'll build your own Radio set within a month or so!

and what's more, **YOU'LL UNDERSTAND EXACTLY WHAT YOU ARE DOING.** The Technatron Outfit contains everything you need, from tools to transistors . . . even a versatile Multimeter which we teach you how to use. You need only a little of your spare time, the cost is surprisingly low and the fee may be paid by convenient monthly instalments. You can use the equipment again and again—and it remains your own property.

You **LEARN**—but it's as fascinating as a hobby.

Among many other interesting experiments, the Radio set you build—and it's a good one—is really a bonus; this is first and last a *teaching* Course. But the training is as rewarding and interesting as any hobby. It could be the springboard for a career in Radio and Electronics or provide a great new, spare-time interest.

A 14-year-old could understand and benefit from this Course—but it teaches the real thing. Bite-size lessons—wonderfully clear and easy to understand, practical projects from a burglar-alarm to a sophisticated Radio set . . . here's your chance to master basic Radio and Electronics, even if you think you're a 'non-technical' type. And, if you want to carry on to more advanced work, B.I.E.T. has a fine range of Courses up to A.M.I.E.R.E. and City and Guilds standards.

Send now for free 132-page book. Like to know more about this intriguing new way to learn Radio and Electronics? Fill in the coupon and post it today. We'll send you full details and a 132-page book—'ENGINEERING OPPORTUNITIES'—Free and without any obligation.



BRITISH INSTITUTE OF ENGINEERING TECHNOLOGY

Dept. 371B, Aldermaston Court, Aldermaston, Berkshire.



To: B.I.E.T., Dept. 371B, ALDERMASTON COURT, ALDERMASTON, BERKS.

I would like to know more about your Practical Radio & Electronics Course. Please send me full details and FREE 132-page book.

name.....

address.....

..... age.....

Also whether or not we can arrange these facts to fit within our framework of black box analogies.

When we began discussing the conditional reflex, the reader will remember how we stressed the importance of the neutral stimulus being presented just before the specific stimulus if conditioning were to occur. As in all things there is the inevitable exception to the rule; this particular exception is, however, an important one as we shall see.

Let us assume we have conditioned an animal (it might be one of Pavlov's dogs) to, say, salivate when a bell is rung—the bell (neutral stimulus S_n) having been previously "paired" with food (specific stimulus S_s). We might now require the dog to salivate upon our touching its left ear. This presents no problem, we can simply combine this stimulus with S_s when the dog is fed, as we did with the bell. Suppose though that in this particular experiment we are forbidden to make this conditioning direct, is there any other method that can be adopted? This is where we meet the exception to the rule.

SECOND ORDER CONDITIONED REFLEX

Bearing in mind that the dog is conditioned to "bell-means-food", if we now wish to introduce a further stimulus (in this case tactile), to mean food, all that is

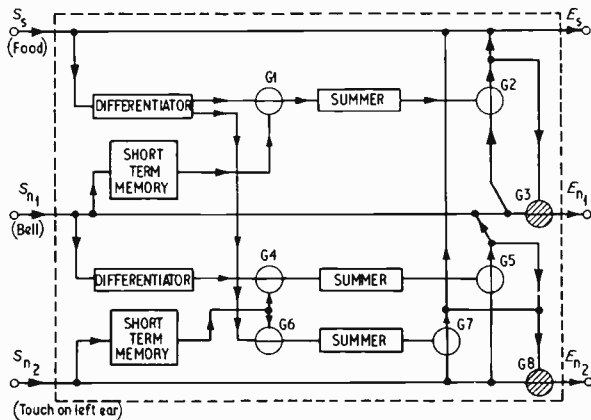

Fig. 3.5 Basic arrangement for synthesising higher or second order conditioning

necessary is to couple the new stimulus with S_n . After several repetitions of the new stimulus (call it S_{n2}) just prior to the original neutral stimulus (let us now call this S_{n1}) we will find that the condition "touch on left ear-means-bell-means-food" has been established. There will hence be an indirect connection between S_{n2} and S_s via S_{n1} , with the result that the dog will salivate upon application of S_{n2} alone.

This type of conditioning is called a second order conditioned reflex, and has been taken experimentally to third, fourth, and even higher orders. There does in fact seem to be almost no limit to how far this effect can be extended.

This carries us on to another interesting phenomenon, that of stimulus generalisation. Now that touching the dog's left ear elicits the salivation response, what if we touch the right ear, or the nose, or the right paw, or the tip of his tail—will there still be a response? Certainly there will: however if we measure the amount of saliva produced there will be a noticeable decrease as we move away from the site of initial conditioning.

The important fact that remains is that the animal was never conditioned to anything other than the tactile stimulation to the left ear. The dog seemingly generalises about all the other stimuli.

TRACE REFLEX

Yet another effect emerges in many ways similar to the phenomena just described, which is worthy of some explanation. Generally speaking if a conditional reflex is to be produced, the neutral stimulus must come just before S_s , certainly within a minute or so. There is though a method whereby even this rule may be broken.

If during the time we are establishing the conditioned reflex we gradually make S_s come later and later, it is possible to increase the S_n/S_s interval to quite considerable lengths and yet still produce the conditioning effect. This is known as a trace reflex and extends the period of time between stimuli whilst still allowing conditioning to take place.

Following our brief examination of higher order conditioned reflexes, stimulus generalisation, and the trace reflex we should now be able to see if the black box technique can help us establish what mechanisms might produce these effects.

THE BLACK BOX APPROACH

The black box in Fig. 3.5 shows one way in which second order conditioning might occur. The real picture must of course be very much more complex than in the example—in our case we are only manipulating just a few elements, whereas in a live animal millions of nerve cells could be involved.

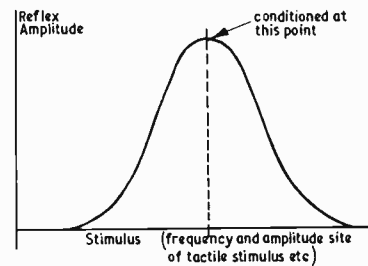

Fig. 3.6 Stimulus generalisation effect

As the reader will see, this hypothetical arrangement amounts to a compounded ensemble of our original learning units. S_{n1} as before has the ability to pair itself with S_s (there is no reason why it should not have equal facilities for its possible combination with S_{n2} either, except that the schematics become more complicated!). However, S_{n2} can be conditioned to either S_s direct, or indirectly via S_{n1} if S_{n1} has been previously conditioned to S_s .

Looking even closer into the black box we notice that S_{n2} could even become conditioned to S_s in another way. Suppose for a moment that the animal is in the unconditioned state, then we condition S_{n2} to S_{n1} so that "touch on left ear" means "bell". If later we then condition S_{n1} to S_s (the food) we have also involved S_{n2} . There are thus several possible ways here in which conditioning could take place.

STIMULUS GENERALISATION EFFECT

The stimulus generalisation effect probably does not need black box treatment here. One could liken the

effect to the response of some filters, say a low Q tuned circuit. Fig. 3.6 gives the general idea.

If the peak in the graph indicates the maximum amplitude of the animal's response to a given stimulus, then for stimuli even some distance away from it there would still be some response. The generalisation about the stimuli would thus seem to depend on the "pass-band" of the filter. As a general term this type of device might be called a "property filter", for it could be involved with the separation of pitches, amplitudes, pulse widths, spatial positions, etc.

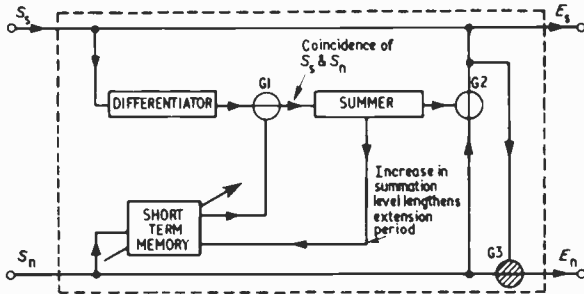

Fig. 3.7 The arrangement of Fig. 3.5 now modified to incorporate trace reflex conditioning

Trace reflex conditioning could be shown quite conveniently with a slight modification to our basic "learning" circuit Fig. 3.7. The "short-term" memory which provides for the extension of S_n has a fixed period, therefore any attempt to combine S_s with S_n after this time would be futile. However, if we arranged to feed part of the summation output back to control the short-term memory—so that increases in the summer level caused increases in the extension period—then the model would now by itself be capable of eliciting a trace reflex.

ABILITY TO ADAPT

Hitherto, our inquiries into learning led us to believe that the conditioned reflex depended upon it being bound quite rigidly to the exclusive characteristics of the stimuli that had been paired. Assuming this were the case, no further learning could occur—the animal would be in no position to vary or modify its responses and update them for current purposes. It therefore seems, that amongst other things, we have discovered in "generalisation", "higher order responses", and "trace reflexes", a quality which would allow the animal to adapt.

Animals *do* adapt, they are doing it constantly. Take, as an example, a television service engineer. At some early time in his career he undoubtedly received many electric shocks. However, the shocks weren't all the same, or from the same places. As time went by he adapted himself to avoid the characteristics that resulted in getting a shock: such things as seeing line output transformers, e.h.t. capacitors, large ceramic insulators, and so on. If it were not for "generalisation" in particular, he would probably now be the proverbial dead duck!

DEGREE OF REINFORCEMENT

It seems that we can therefore come to a very positive conclusion about this "generalisation", in that without it a difference in stimulus would have no effect in eliciting a response. Conversely, of course, it is equally

important that the animal can produce differing responses despite similarities in the stimuli that may be presented.

What a paradox all these requirements seem to cause—nonetheless they are necessary. The inevitable balance that occurs between the generalisation of stimuli on the one hand, and differentiation on the other, is seemingly dependent upon the degree of reinforcement, and indeed which stimuli are reinforced.

Throughout the article we have made considerable use of such indefinites as "seemingly" and "perhaps"—there will be no apologies though, for the subject of animal behaviour is fraught with so many variants that to be too specific about any particular aspect could be dangerous.

TRIAL AND ERROR

Because an animal exhibits what appear to be specific responses for certain stimuli there is no reason to believe that without these characteristics will not still occur. There is a general theory that during the process of learning, animals may very well hypothesise (or make an assumption) about a situation. This would pre-suppose that the animal "sits tight", makes a number of guesses, and then proceeds to reach a goal (if one exists) by trial and error, eliminating all un-rewarded responses.

We can only conjecture about all these multifarious possibilities at present, though in later articles we may be considering how they could be implemented in a synthetic device. Next month we shall be adding to our breadboard device a rather crude "self and mutual recognition" circuit. We will also see whether it might be feasible to conceive of a machine which could display a type of anxiety neurosis. Imagine an "electronic animal" with ulcers! This is perhaps being a little too anthropomorphic!

To be continued



LIGHT OPERATED SWITCH (October 1968)

The transistor type NKT127 can be replaced by type NKT128 which is readily obtainable from transistor stockists.

VARI WINDSCREEN WIPER (October 1968)

Some readers have experienced difficulty in correct operation of this circuit due to the device not switching off. The author emphasises that the earth return wire from the control circuit board to car chassis should be as short and thick as possible. All connections between this wire and the battery earth connection must be clean and sound. Cable resistance and contact resistances can provide sufficient voltage drop across the thyristor to maintain conduction, i.e. not fall below the holding current. The holding current of the thyristor is about 10mA while the anode-cathode potential at this current is 0.8V which can result from long cables or faulty connections. A resistance as low as 0.1 ohm could cause this trouble.

BBC EXPERIMENTAL SOUND-IN-VISION SYSTEM

On November 7 at Broadcasting House was given the first public demonstration of the transmission and reception of composite sound and vision signals. This unique system of "Sound-in-Vision" has been developed by the BBC Research Department for use with 625 line television signals.

Ordinarily, the two components of a television programme, both picture and sound, are separately distributed from studio to transmitting station. With the sound-in-vision system these two studio derived components are combined and the combination is sent over a single vision circuit to the transmitting station where the sound is extracted, converted into its usual form and sound and picture are transmitted in the usual way.

Besides offering an improved audio bandwidth of 14kHz and excellent noise immunity this system simplifies the operational requirements as the separate circuits and often different routes used in transmitting the two components of the conventional television signal are reduced to one circuit and one route in this composite system.

SYNC INTERVAL

How this is done without interaction between the composite video and sound components is by making use of the line synchronising interval. Reference to the sound-in-vision oscillogram (Fig. 1) shows that the sound signal occupies a period of $3.8\mu\text{s}$ within each $4.7\mu\text{s}$ line synchronising interval, its placement being equally disposed compared to the leading and trailing edges of the synchronising pulse. Apart from this interval the vision signal occupies the transmission circuit for the rest of the time. As can be seen the system constitutes in essence a form of time division multiplex.

SAMPLING

By sampling the sound signal at twice the 625 line frequency an audio bandwidth of 14kHz is possible for transmission. The two samples produced during each line period are converted to pulse code modulation signals then delayed and compressed in time then inserted into the television waveform during the next line synchronising interval.

In the 625 video oscillogram shown the p.c.m. signal precedes the colour burst. It consists of a marker pulse which identifies the start of the sound pulse group containing two 10 digit binary code groups so that 21 pulses in all are accommodated within each line synchronising period.

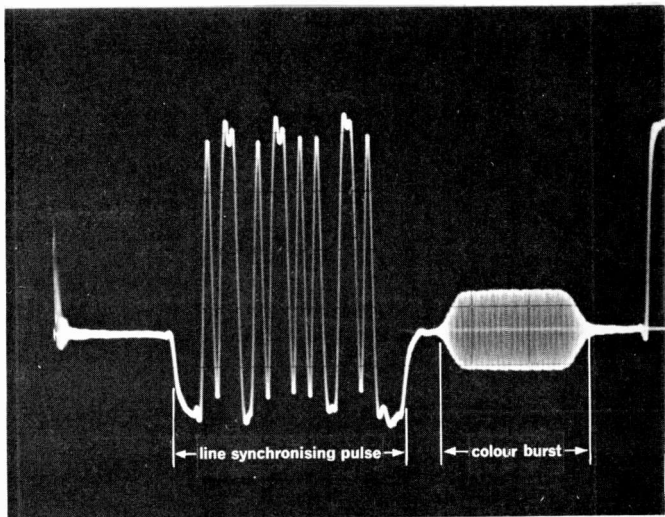

Fig. 1. 625 line video waveform during line blanking interval showing p.c.m. signal consisting of a marker digit plus two 10 digit groups inserted in line synchronising pulse

After transmission via the distribution link the sound pulses are extracted and reconverted to normal signals at the receiving terminal. The video waveform is also restored to standard form.

The use of p.c.m. and high amplitude pulses ensure that the sound signal is immune from all but the most severe interference and distortion.

TERMINAL EQUIPMENT

The sending and receiving terminal equipment are shown in block form, Fig. 2. The compressor and expander form a syllabic companding system which ensures that the mean signal level into the analogue to digital converter is as high as possible. This converter samples the audio frequency signal presented to it at twice line rate and provides an output in p.c.m. form to the combiner unit. This unit accepts the vision signal clamps it during the back porch and inserts the sound pulses.

At the receiving terminal this process is reversed with the combined sound-in-vision signal being fed to the separator unit from which a clamped and restored vision signal is produced. Separated sound pulses are decoded in the digital to analogue convertor which delivers an audio frequency signal.

Extensive use is made of integrated circuitry for the digital operations together with discrete transistor circuits for the analogue operations.

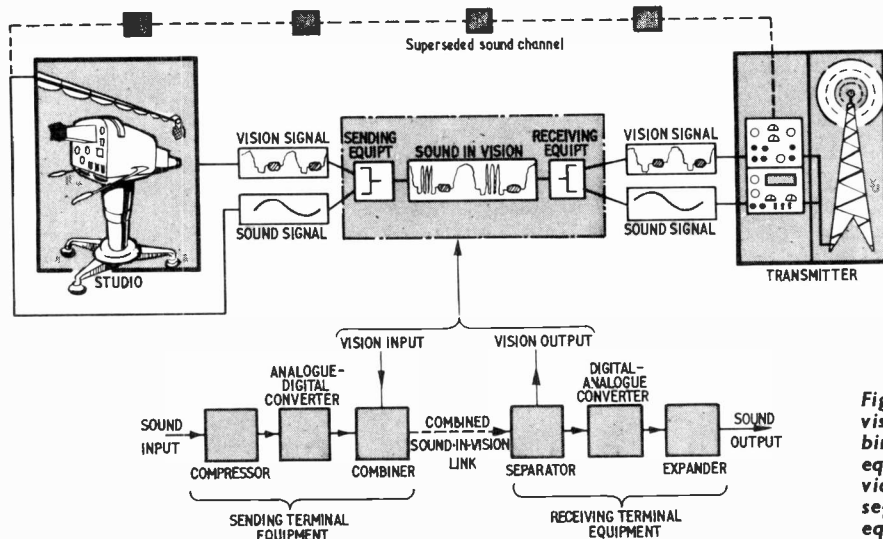

Fig. 2. Block diagram showing how vision and sound signals are combined at the sending terminal equipment, prior to transmission via the distribution link, and separated at the receiving terminal equipment

ANY seaman who has worked with sonar equipment knows that fish are attracted by certain man-made noises. Perhaps the fish believe that the sound must be coming from some source of food such as a trapped insect—or perhaps their motivation is simply curiosity.

The device described here produces a repeating high pitched bleep under water which will help lure some species of fish to the fly. In a practical test on a quiet stretch of the North Tyne, the author consistently landed a better average than nearby anglers.

CIRCUIT DESCRIPTION

The circuit consists of a single transistor Hartley oscillator with feedback via the tapped inductance (Fig. 1). With the component values shown the output frequency is about 1kHz with a bleep-rate of 60 to 150 times a minute depending on the setting of VR1. With VR1 at maximum resistance the unit produces a continuous tone.

The beeps are emitted from a high impedance ear-phone or microphone insert (detailed later), connected in parallel with the inductor.

CONSTRUCTION

The original model was built on a small 12-way tagboard, as shown in Fig. 3; layout is in no way critical. To augment the output in one direction a cone cut from the top of a plastics detergent bottle is glued to the face of the transducer, which is then glued to the underside of the tagboard. The battery is held by a Terry clip screwed to the tagboard on the same side as the transducer.

The unit must be fairly robust to withstand "casting" and retrieving when in use; it should also be kept as small as possible. All sharp projections must be rounded off or covered to protect the bag in which the unit is placed.

OPERATION OF "BAIT"

The completed bleeper can then be sprayed with a waterproofing compound as used on car electrical systems and enclosed in a polythene bag—carefully tested beforehand for leaks! Enough air should be left inside so that it will just float and the top sealed with an

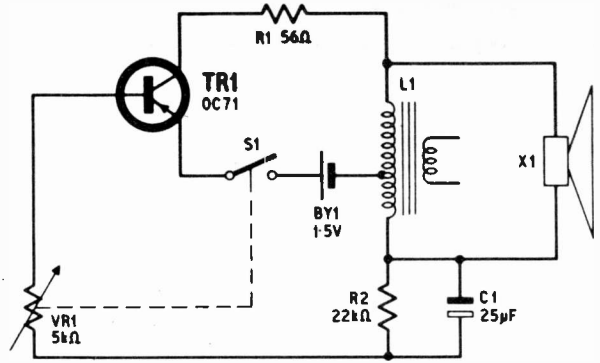

Fig. 1. Circuit diagram of fish bait

elastic band. A line and sinker are attached, as shown in Fig. 2, but the float is not required. To use the device adjust the distance between the unit and the sinker, so that the unit is held at hook depth, and cast the "bait" to the required position.

An alternative method is to squeeze the excess air out of the polythene bag and support the unit by using a float (Fig. 2). The float can be made from a small plastic detergent bottle or similar item and the depth of the unit is then set by adjusting the length of line between the float and the unit. If this method is adopted a weight may be required in order to keep the unit vertically below the float.

Note: if practicable the polythene bag can be heat sealed to ensure an airtight unit. This method of sealing can be carried out by some bait shops selling live bait in polythene bags.

Repetition rate is adjusted by trial and error to give the best results—VR1 can be manipulated through the polythene bag.

DIRECTION VANE

Where there are currents it will be possible to direct the sound by adding a vane (Fig. 2), as is done on hydrophones. The vane should be made as shown and the

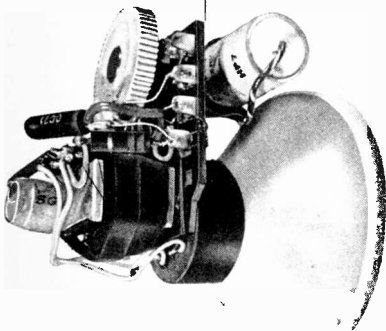

SONIC FISH BAIT

By J.HING

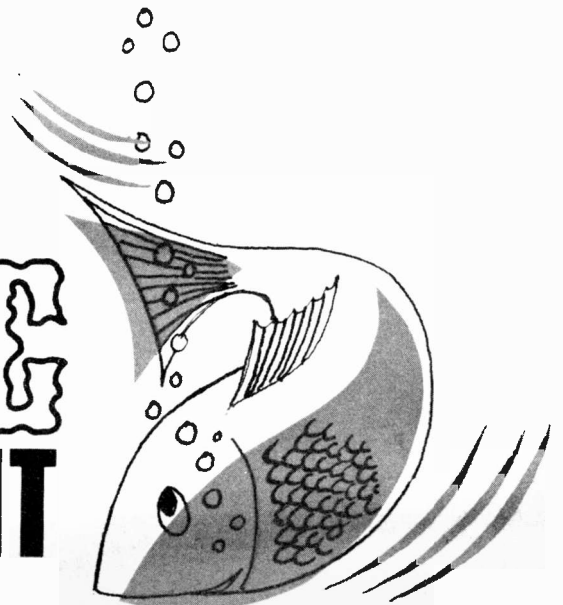

COMPONENTS . . .

Resistors

R1 56Ω
R2 22kΩ
All ±10%, ¼W carbon

Potentiometer

VR1 5kΩ min. with switch (Radiospares)

Capacitor

C1 25μF elect. 25V

Transistor

TR1 OC71

Miscellaneous

L1 Repanco TT4 using secondary with centre tap
X1 Crystal earpiece type MCI (Olrus Electronics,
748 High Road, London, E.11)
BY1 1.5V penlight cell
Tagboard: 12 way
Terry clip for battery
Float, small plastic detergent bottle (see text)
Fishing line and weight
Polythene bag



Complete unit sealed in polythene bag

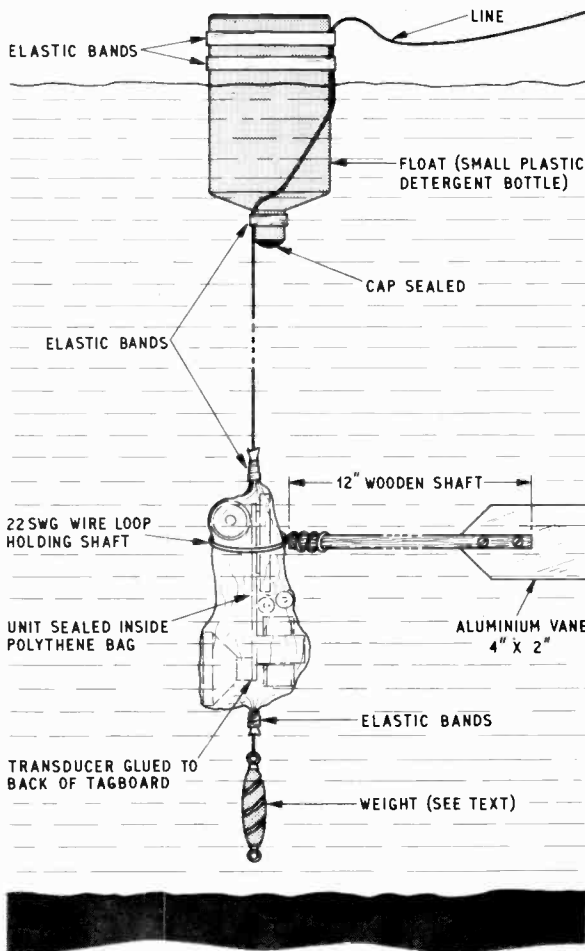

Fig. 2. Bait set up for use with float, vane and weight

length of the wooden shaft set to balance the weight of the vane when in the water. The vane can be attached to the unit by a shaped wire drawn around the polythene bag. Ideally, sound should be transmitted across currents.

COMPONENTS NOTE

Any crystal earpiece or microphone insert can be used—but the one specified in the components list gives more output than most. Use of the specified transformer for L1 is strongly recommended—although other types having a centre tapped winding with a total d.c. resistance of between 100 and 300 ohms may be tried. ★

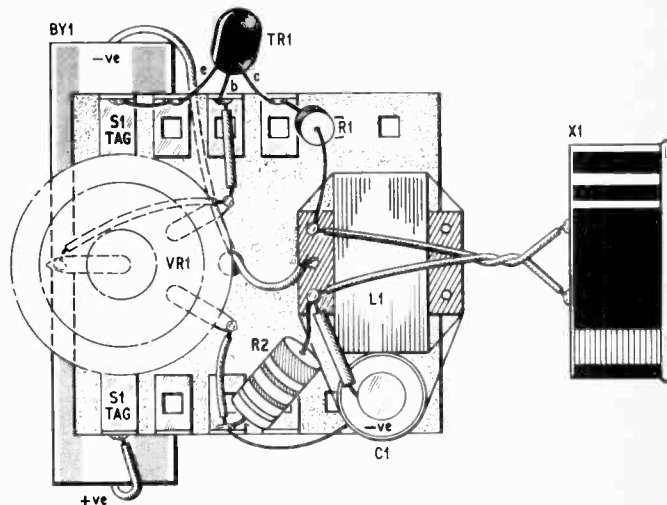
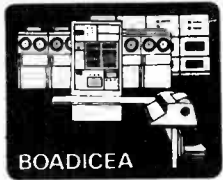

Fig. 3. Layout and wiring diagram showing position of components and tags removed from board



Passenger check-in



World-wide seat reservations



Statistics

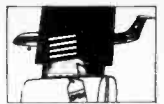

Crew schedules

ELECTRONORAMA



Accounting



Management information



Weight and balance



Flight planning



Cargo



Message switching



Timetables and Tariffs



Maintenance schedules



Personnel records



Stock control



In-flight data analysis

B RITISH Overseas Airways Digital Information Computer for Electronic Automation is one of the world's largest computer complexes linked to one of the most comprehensive communications networks surrounding the globe.

The complete computer, power supplies, air conditioning units and all other ancillary equipments are housed in Boadicea House at London's Heathrow Airport. The complex is protected by one of the most sophisticated security systems in the country and is completely screened by aluminium foil from radar interference.

BOADICEA is designed to meet the needs of all BOAC's requirements well into the future and will cover all operations shown. The main "brain" consists of three IBM 360 model 65 computers, interlinked to form a comprehensive back up system. These computers work in conjunction with three other computers also at Boadicea House. All information passing through the computer is taped and microfilmed to provide three information storage systems, enabling BOAC to continue operations in the event of the complex being destroyed.

The main advantage of BOADICEA to the travelling public is the reservations system which uses cathode ray tube readout and solid state keyboards for operator's use. Reservation staff in the UK, Europe and North America have, at their fingertips, instant reservation information on all flights of BOAC and its associated companies. Seat availability on any flight can be established within seconds and four flights are displayed on request to aid passengers selection. Seat reservations, hotel bookings, car hire and any special requirements can be made through the computer system, up to 11 months in advance.

BOADICEA network is comprised of over 50 computers and handles 350,000 messages a day.



Magnetic data storage machines and information input and access points, in use inside the computer room, are shown above, whilst below an engineer is shown setting up one of the three IBM computers which form the main brain of BOADICEA





VISITS BOADICEA

ULTRASONICS



Ferranti readout tube and Honeywell solid state keyboard are shown in use at one of BOAC's booking halls below. The keyboards are quiet in operation thus allowing many units to be used in a small area without undue clatter



ULTRASONIC equipment has been in use for some ten years, it is only recently however that many of its industrial uses have been fully realised and exploited. Some of the latest solid state equipments, incorporating many of the recent advances, was shown at the Ultrasonics for Industry Exhibition in London on October 15 and 16. A wide range of subjects from data collection to holographic displays were discussed in a series of lectures on Ultrasonics.

More and more ultrasonics are being employed in hospitals, both for cleaning and diagnostic work. Most of the cleaning equipment now operates at 40kHz and above as it has been found that lower frequencies are more liable to damage solid state electronic devices if they are to be cleaned. Units used for diagnostic work that are now in use include: solid state blood flow detectors, capable of detecting foetal blood flow after 10 to 12 weeks of pregnancy, and medicine sprayers which disperse aqueous solutions into a fine mist for inhaling by patients.

Equipment for use in the electronic industry is being manufactured by some firms; of particular interest is the Kerry wire bonding machine. The photograph below shows the solid state unit being used to bond wires to an integrated circuit. The unit has a variable output power of up to 10 watts and can be pre-set for varying "weld" times. An insertion and staking machine, capable of inserting metal tags or bushes in plastics, is produced by the same manufacturer and has a range of applications in electronics.

Another field where ultrasonics is increasing in popularity is in detection systems where one unit can be used to detect leaks in gas pressure or vacuum systems, internal defects in running machinery and electrical faults. Units such as this are being made fully portable with a variety of probes and "displays".

The uses of ultrasonics are forever growing and as more is learned about the subject the more sophisticated the equipment becomes.

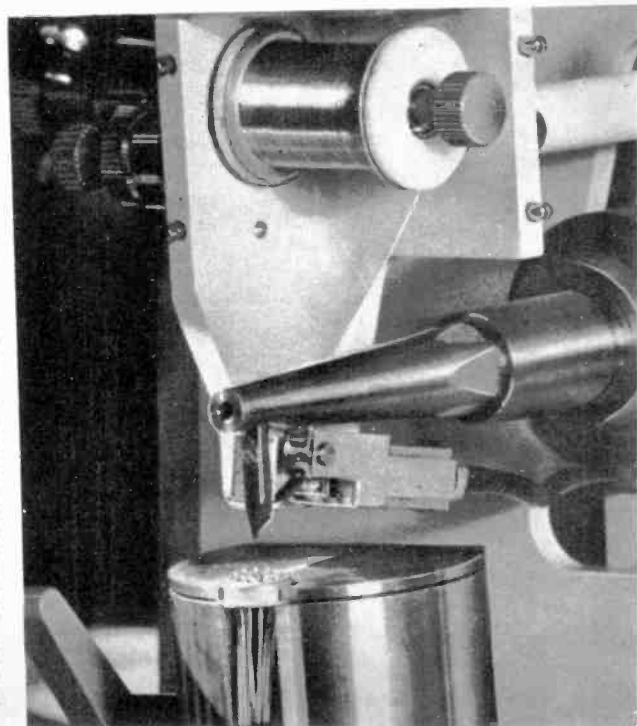

HIGH PERFORMANCE STABILISED POWER SUPPLY

By J.T. Tiernan

SPECIFICATION

Input: 240V 50Hz.
Output: 0 to 22V d.c. continuously variable.
Maximum load current: 1A continuous.
Current overload protection range: 25mA to 2.5A.
Output ripple at 1A load: 500 μ V.

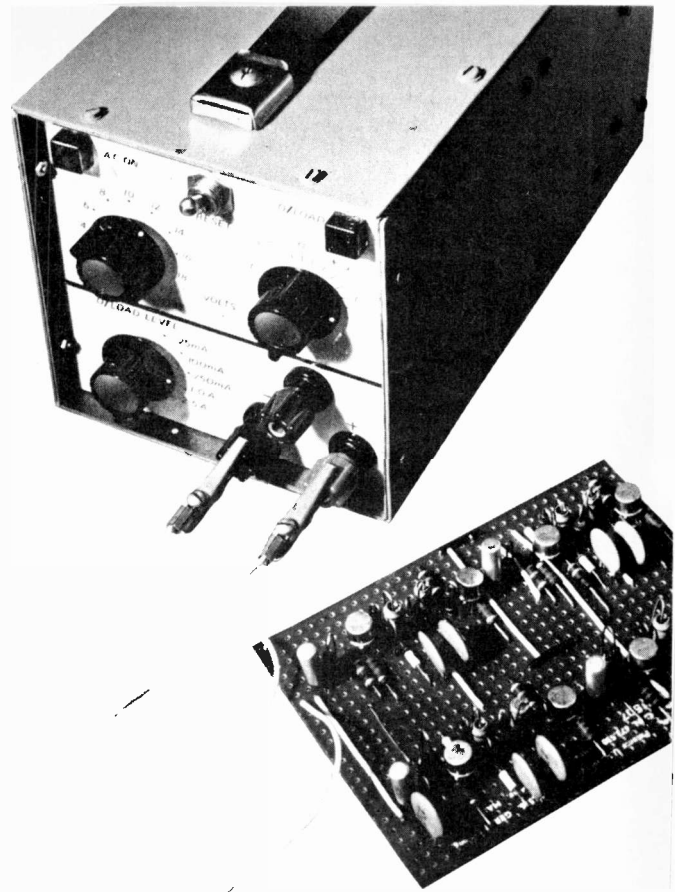

THE power supply design described in this article is a general purpose unit covering the range 0 to 22V at load currents up to 1A r.m.s. Silicon transistors are used throughout and the unit includes an extremely reliable overload protection circuit. Standard components have been used where possible, and little difficulty should be experienced as regards component availability.

The design is presented with the reasonably experienced constructor in mind, and though practical details are accordingly brief, a comprehensive testing and setting-up procedure is included.

Fig. 1 shows a general block diagram of the unit, and should be studied in conjunction with Fig. 2.

D.C. SUPPLY AND OVERLOAD CIRCUIT

The circuit diagram of the unit is shown in Fig. 2. The "main" a.c. secondary voltage is full wave rectified by D1, D2, D3 and D4, and smoothed by C1, before being routed to the overload protection circuit and series stabiliser elements (TR3, TR4 and TR5).

In series with the common line is a resistor, selected by S2, across which is developed a voltage proportional to the load current being supplied. S3a is normally closed and, if the load current increases such that 2.5V is developed across the selected series resistor, the thyristor will be triggered into its conducting state. The anode of the thyristor will fall from around 30V, to practically 0V, the thyristor current being limited to

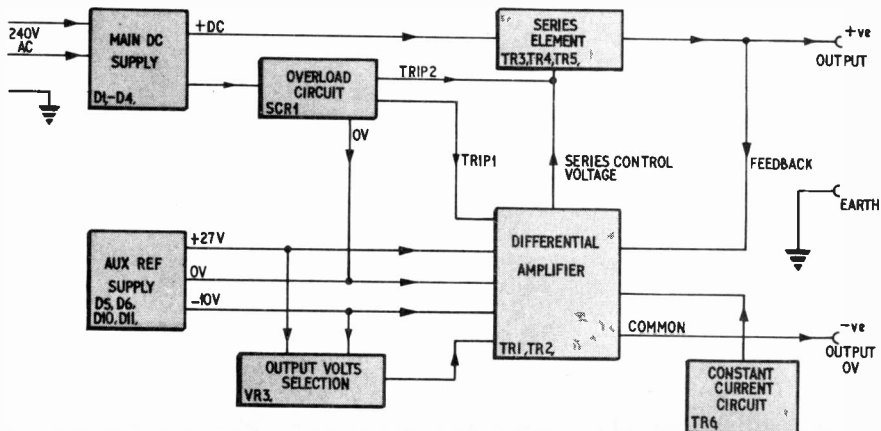

Fig. 1. Block diagram of power supply

between 30 and 40mA by R7 and LP2. Thus, 0V is reflected in the stabiliser section, via D8 and D9, causing the output voltage to fall to zero.

Momentarily opening S3a to the reset position will stop current flow in the thyristor, and on returning S3a to the normal position the output voltage will return to its original value, provided the excess load has been removed.

When the thyristor is not conducting, D8 and D9 are reverse biased and have no effect on the operation of the stabiliser section.

Reliable triggering of the thyristor is ensured by D7 and R8, and VR1 acts as a trip sensitivity control. D14 ensures tripping if LP2 is open circuit and C10 slows up the action of the trip circuit to prevent tripping when the output is increased (due to charging of C8).

REFERENCE SUPPLY

The auxiliary a.c. supply is rectified via the voltage doubler D5, D6, C2, C3 and fed to the reference supply diodes D10 and D11. The current through the Zener diodes is limited by R9 to approximately 25mA and C4 ensures minimum ripple on the reference supply lines.

The junction of D10 and D11 is connected to the common line, and the voltages at the cathode of D10 and the anode of D11 become the +27V and -10V lines respectively.

DIFFERENTIAL AMPLIFIER

The differential amplifier consists of TR1 and TR2, with a variable reference voltage applied to TR1 base, via VR3. The collector load for TR2 is R10, and feedback to TR2 base, via TR3, TR4, TR5 and D12, sets the voltage at TR2 base equal to that applied to TR1 base. Thus, by varying the reference voltage via VR3, the output voltage at the emitter of TR5 may also be varied.

A reasonable and steady collector-base voltage for TR2 is ensured by D12, a 3.3V Zener diode, which also allows any variations of the output line voltage to be passed in full to TR2 base. This results in maximum compensating action by TR2, keeping the output voltage constant over a wide range of load currents.

It is essential that the current through D12 is held as constant as possible, and to achieve this end D12 is fed from the constant current circuit formed by TR6. The values of R12, R13 and R14 are such that the current through D12 is approximately 2mA, and this changes by less than 2 per cent for an output voltage variation from 0 to 22V.

Since the voltage at the bases of TR1 and TR2 is 3.3V less than the output voltage, due to D12, the variation of voltage required from VR3 is -3.3V to +18.7V for an output range of 0 to 22V; VR2 and VR4 are adjusted to provide this variation across VR3.

The "trip 1" and "trip 2" lines are connected from D8 and D9 in the overload section to the bases of TR1 and TR3.

S3b ensures the load is removed when the overload circuit is being reset, and may be used to isolate the load from the unit. Whether a normal on-off switch or a spring loaded switch is used for S3 is a matter of individual preference.

It is important to note that C8 must be connected at the supply side of the switch, otherwise it will often not be possible to reset the overload circuit. The diode D13 is included to ensure tripping of all units if power supplies are used in series.

COMPONENTS AND CONSTRUCTION

A suggested layout and case size have been given (Fig. 8), but both depend on the size and shape of the transformer(s) and smoothing capacitors used. Most of the smaller components can be mounted

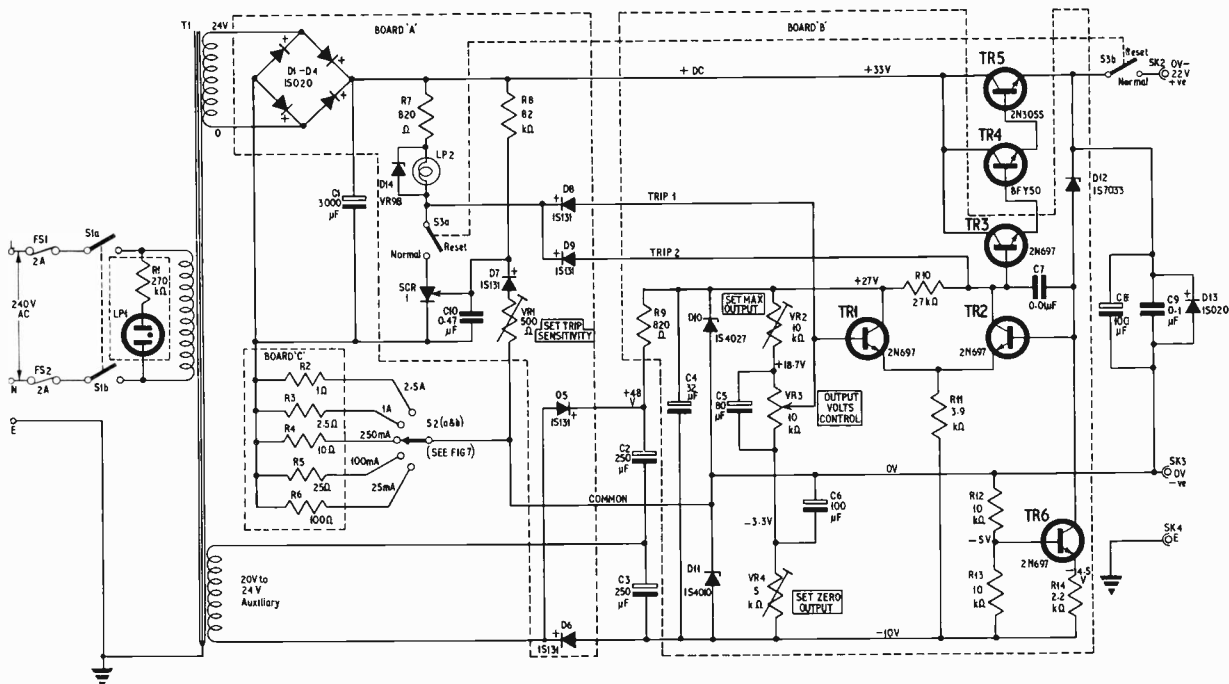

Fig. 2. Complete circuit diagram of the high performance stabilised power supply

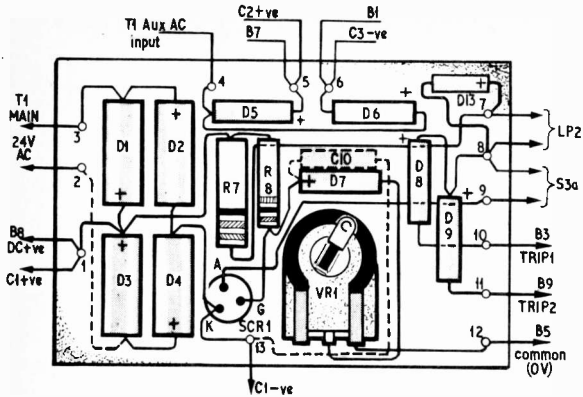

Fig. 3. Layout and wiring of overload and rectifier board "A"

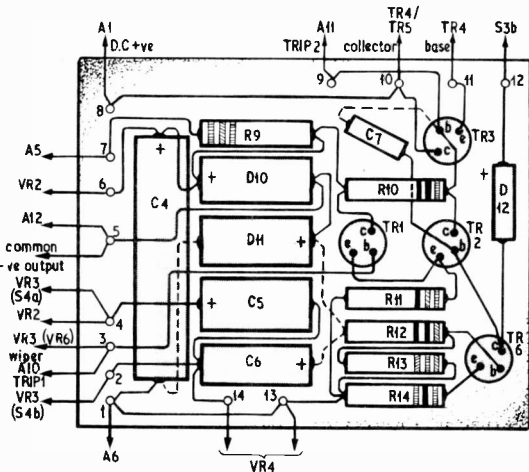

Fig. 4. Layout and wiring of differential amplifier and constant current board "B"

on pre-wired boards; layout and wiring diagrams for these are given in Figs. 3, 4 and 5. Plain Veroboard can be used with pins for component mounting. Solid wiring lines are on the non-component side of board and dotted lines indicate wiring on component side.

Layout of components within the unit is not critical and connections may, in general, be made with lightweight wire. It is recommended, though, that wiring carrying the main load current be 20 s.w.g. copper, or reasonably substantial multistrand wire.

TRANSFORMER DETAILS

The mains transformer is probably the only component which may prove at all difficult to obtain. Among firms which are able to supply transformers with a standard primary, and secondaries of 24V at 1A and 50mA are—T.R.S., Thornton Heath, Surrey, and Osmabet Ltd., Edgware, Middlesex. The cost being about 35s each.

However, in case of difficulty, the secondary voltages required may be conveniently obtained by using two separate transformers. The main secondary winding is required to deliver 1A, but the auxiliary supply may be obtained from quite a small transformer, since 24V at only 50 to 100mA rating is required. A suitable item is the Belclere type MS3169, however the one-off price for this item is a little high and cheaper alternatives can no doubt be found.

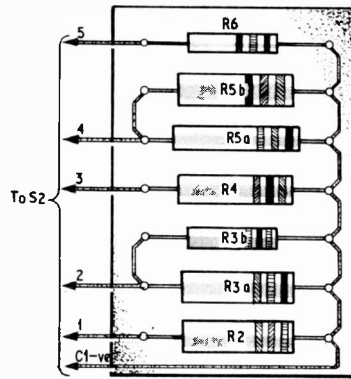

Fig. 5. Layout and wiring of overload resistor board "C"

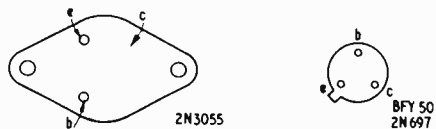

Fig. 6. Transistor connection outlines

Secondary voltage requirements are not critical; for the main supply this may be within the range 18 to 24 volts. The maximum output available from the unit, maintaining the 1A load capability, is about 2V below the a.c. voltage available. The auxiliary a.c. supply should be within the range 20 to 25 volts.

SEMICONDUCTORS

The thyristor specified is rated 1A at 50 p.i.v. and any similar component will be suitable provided trigger sensitivity is good. Poor trigger sensitivity will perhaps mean increasing the values of R2 to R6 if the overload current ranges are to be set as specified.

For example, a T140A4, 3A 400 p.i.v. thyristor, requires a 3 ohm series resistor for R3 before the unit will trip at 1A load current. The other series resistors would have to be increased by a factor of 1.2.

Transistor types used are also non-critical, apart from TR4 and TR5, and three suitable types have been specified in each case.

HEAT SINK REQUIREMENTS

The heat sink requirements for TR5 will vary according to the anticipated conditions under which the unit will work. The following may be used as a guide:

1. For continuous operation at full load, with output voltage above 12V, mount TR5 on an aluminium panel with a mica washer and insulating bushes. Minimum panel area required is 36sq in.
2. For continuous operation at full load, with output voltage above 6V, insulate the panel from the unit and mount TR5 in direct contact. Panel area 36sq in.
3. For continuous full load operation below 6V output, it is advisable to use two transistors in parallel for TR5, with a 0.5 ohm 3W wirewound resistor in each emitter lead. Mounting as in para. 2 above, but with a panel area of 48sq in.

A separate heat sink assembly may be used to meet all requirements, and a suitable item, size approx. 5in x 4in x 2in, is given in the component list. A fitted clip-on heat sink should be fitted to TR4.

COMPONENTS . . .

Resistors

- R1 270k Ω (may be incorporated in LPI)
- R2 1 Ω 7W wirewound
- R3 2.5 Ω 7W wirewound (may be made up from 2.7 Ω 7W and 33 Ω 1W in parallel)
- R4 10 Ω 3W wirewound
- R5 25 Ω 1W (may be made up from 27 Ω 1W and 330 Ω in parallel)
- R6 100 Ω 1W
- R7 820 Ω 1W
- R8 82k Ω
- R9 820 Ω 1W (for aux. supply voltages less than 22V, R9 is 680 Ω 1W)
- R10 27k Ω
- R11 3.9k Ω
- R12 10k Ω
- R13 10k Ω
- R14 2.2k Ω
- 18 \times 1k Ω 1% resistors (only needed if S4 is fitted)
- (All $\frac{1}{2}$ W, 10% carbon except where stated)

Potentiometers

- VR1 500 Ω skeleton preset
 - VR2 10k Ω wirewound preset
 - VR3 10k Ω wirewound (not needed if S4 is fitted)
 - VR4 5k Ω wirewound preset
 - VR5 25k Ω wirewound preset
 - VR6 2.5k Ω wirewound
- } (only needed if S4 is fitted)

Capacitors

- C1 3,000 μ F elect. 50V
 - C2 250 μ F elect. 50V
 - C3 250 μ F elect. 50V
 - C4 32 μ F elect. 64V
 - C5 80 μ F elect. 25V
 - C6 100 μ F elect. 6.4V
 - C7 0.01 μ F polyester or metal foil 160V
 - C8 100 μ F elect. 25V
 - C9 0.1 μ F polyester or paper 160V
 - C10 0.47 μ F polyester or paper 160V
- } (Mullard)

Transistors

- | | |
|------------------------|----------------------------------|
| TR1 2N697, 2S004, ZT82 | TR6 2N697, 2S004, ZT82 |
| TR2 2N697, 2S004, ZT82 | TR4 BFY50, 2N3053, 2N1507 |
| TR3 2N697, 2S004, ZT82 | TR5 2N3055, 2S024, ZT1702, 2S033 |

Diodes and Rectifiers

- D1 1.5A 100 p.i.v. (1S020)
- D2 1.5A 100 p.i.v. (1S020)
- D3 1.5A 100 p.i.v. (1S020)
- D4 1.5A 100 p.i.v. (1S020)
- D5 0.2A 100 p.i.v. (1S131)
- D6 0.2A 100 p.i.v. (1S131)
- D7 0.2A 100 p.i.v. (1S131)
- D8 0.2A 100 p.i.v. (1S131)
- D9 0.2A 100 p.i.v. (1S131)
- D10 27V 1.5W (Zener) (1S4027)
- D11 10V 1.5W (Zener) (1S4010)
- D12 3.3V 0.4W (Zener) (1S7033)
- D13 1.5A 100 p.i.v. (1S020)
- D14 9V 1.5W (Zener) (VR9B)

Thyristor

- SCR1 1S610, 2N1595

Sockets

- SK1 Mains (Bulgin type P360)
- SK2, 3 and 4 Output terminals (Bulgin type T103)

Miscellaneous

- TI Mains transformer sec. 1, 24V at 1A sec. 2, 24V at 50mA (see text)
- LPI Neon panel indicator (may include R1)
- LP2 6V, 0.04A lamp. (Electroniques SGF9/G/RD/6)
- FS1, FS2 2A fuse holder and fuse
- Plain Veroboard and Veropins (size depends on components used) (3 off)
- Heat sink—see text (Electroniques HSD5)
- 18 s.w.g. aluminium for case

Switches

- S1 Double pole single throw (see text)
- S2 Maka-switch shaft assembly and 2 Maka-switch 2-pole, 5 way, make-before-break wafers (Radiospares)
- S3 Double pole single throw toggle
- S4 Maka-switch shaft assembly and 2 Maka-switch single-pole, 11-way, make-before-break wafers (Radiospares) (if used)

CURRENT AND VOLTAGE CONTROLS

Switch S2 should be a make-before-break type and, unless a rotary stud switch is available, is made up from two 2-pole 5-way wafers. Each switch section should be connected in parallel as shown in Fig. 7.

The only other component worthy of special mention at this point is VR3, the output voltage control. This may be a normal 10 kilohm linear potentiometer as indicated in Fig. 2. S1 must then be a separate switch. The output will be varied linearly with rotation of VR3. However, with a power supply of this type it is somewhat pointless to use such a coarse control, and the following alternatives are suggested:

1. Use a 10-turn helical potentiometer for VR3, which will enable the output voltage to be set extremely accurately. These components occasionally appear on the "surplus" market at prices ranging from 10s to 30s, although they may need looking for. Again S1 will have to be a separate double-pole, single-throw switch.

2. Replace VR3 with the network as shown in Fig. 9 (S4). This arrangement gives switched increments of

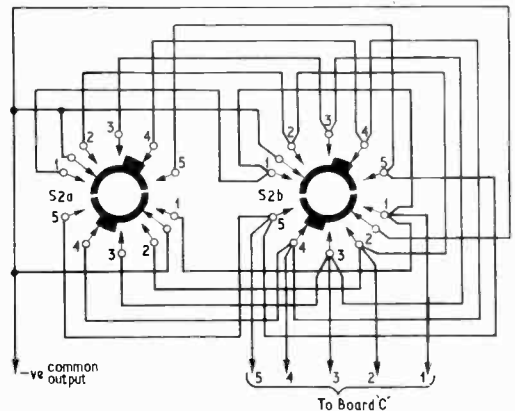
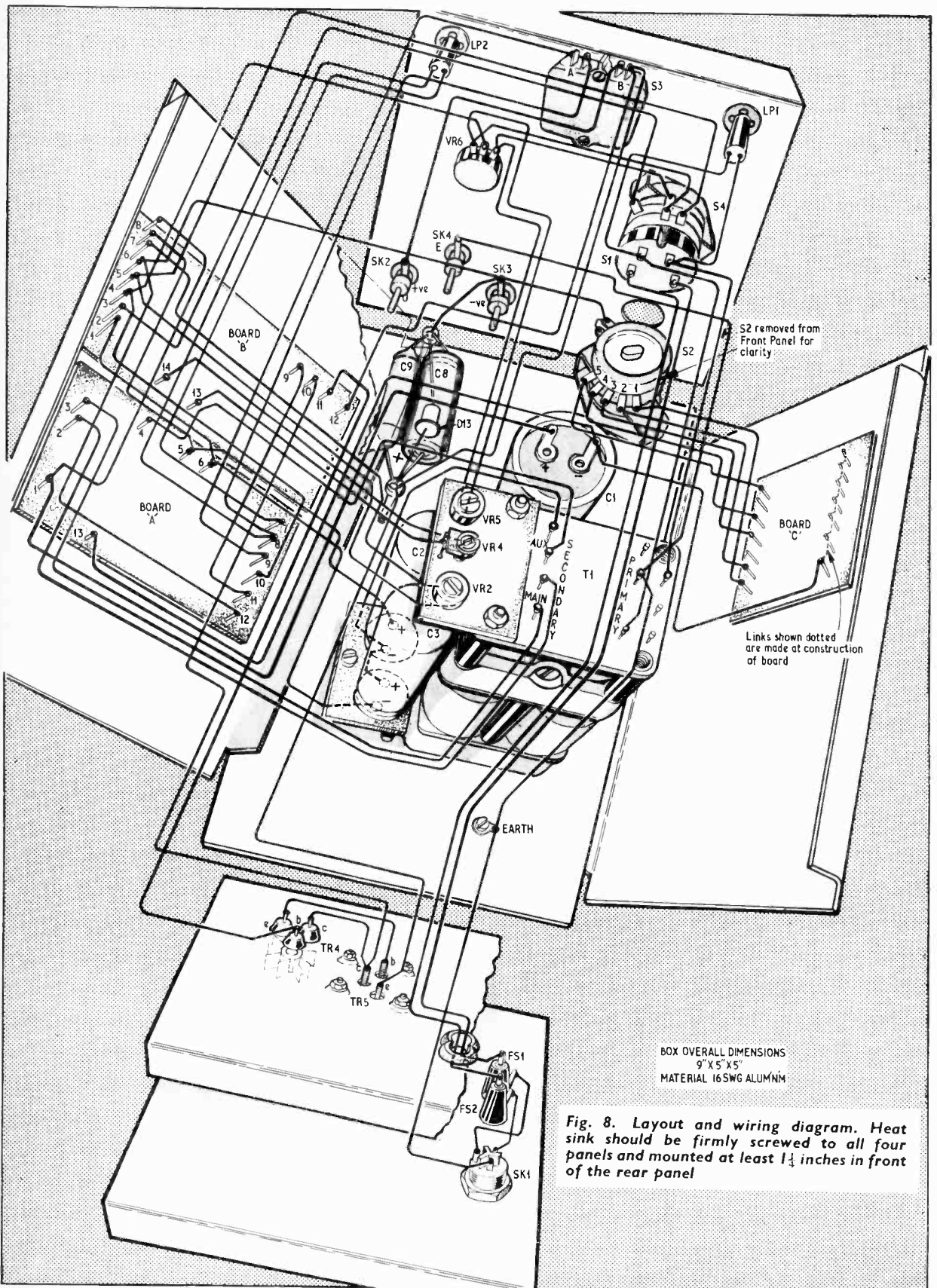

Fig. 7. Wiring of S2: 4 poles are wired in parallel to switch large currents



BOX OVERALL DIMENSIONS
 9" X 5" X 5"
 MATERIAL 16 SWG ALUMINUM

Fig. 8. Layout and wiring diagram. Heat sink should be firmly screwed to all four panels and mounted at least 1 1/4 inches in front of the rear panel

2V, and the 2.5 kilohm potentiometer (VR6) will vary the output $\pm 2V$ on the selected value. It is probably also the most convenient arrangement to use; S1 can then be incorporated in S4, as shown in Fig. 8. This is done by using a Radiospares "Mains-switch" which is made to mount on "Maka-switch" assemblies.

TESTING AND SETTING UP PROCEDURE

Complete assembly and wiring of the unit, but omit the following connections:

- Positive d.c. line between component boards;
- Connection between C2+ and the stabiliser board (B).
- All connections between TR4, TR5, and stabiliser board.

When this stage has been reached, first check that all diodes and rectifiers have been wired in the correct polarity, then switch on a.c. mains, whereupon LP1 should light.

(1) Check d.c. voltage across C1, which should be about 1.4 times the a.c. voltage available from the "main" secondary winding of the transformer.

(2) Check the d.c. voltage between C2+ and C3-, which should be approximately three times the a.c. voltage available from auxiliary secondary.

(3) Set VR1 for minimum resistance and select 100mA overload current with S2. Touch a 100 ohm resistor between the d.c. positive and the common output pins on the rectifier-overload board. Check that the voltage across the thyristor is less than 1V and that LP2 lights.

(4) Reset overload with S3 and return S3 to normal. LP2 should extinguish and the voltage across the thyristor should rise to equal the voltage across C1. Repeat Test 3.

(5) Switch off a.c. mains and wire in the connection between C2+ and the stabiliser board.

(6) Wire temporary links on stabiliser board as follows

- Between pins 11 and 12 on board.
- Between d.c. positive pin and C4+ (+27V line).

Set VR2 and VR4 to maximum resistance.

Note: d.c. line between boards and TR4, TR5 still out of circuit.

(7) Recheck connections, switch on a.c. mains and check that the voltage between common (-ve output) line, and C3- equals $-10V \pm 10$ per cent.

(8) Check that the voltage between C4+ and common line equals $+27V \pm 10$ per cent.

(9) Check that the output voltage is available from the unit, and may be varied by VR3 (or S4 if fitted).

(10) Set output voltage control to maximum and adjust VR2 to give 20V output.

(11) Set output voltage control to minimum and adjust VR4 to give 0.5V output.

(12) Set output to about 10V, and check that the overload setting is 100mA.

(13) Repeat Test 3, and check that the output from the unit falls to less than 2.5V, with LP2 lit.

(14) Switch off a.c. mains and remove temporary links wired in Test 6.

(15) Connect TR4 and TR5 to the stabiliser board, and link the d.c. positive line by connecting 100 ohm resistor between the d.c. positive pins on the two boards (positions 1A and 8B).

(16) Recheck connections, select 25mA overload, turn VR1 to maximum and switch on a.c. mains. (Overload circuit will probably operate.)

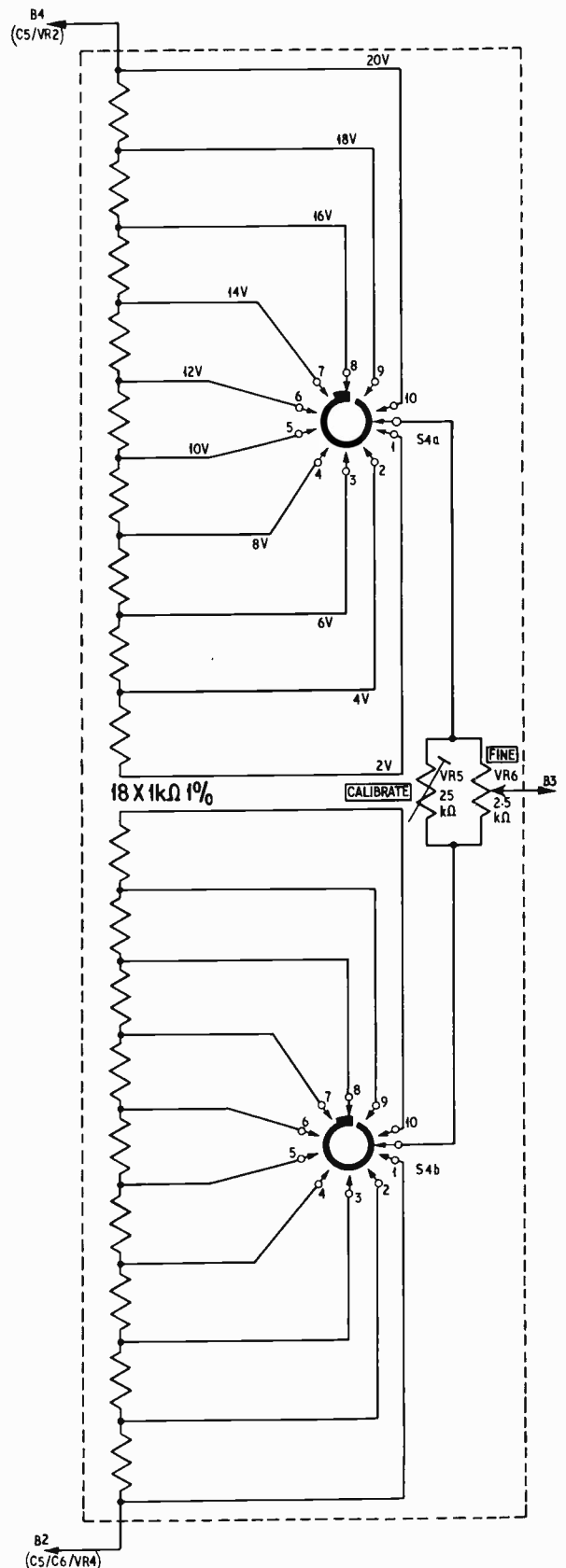
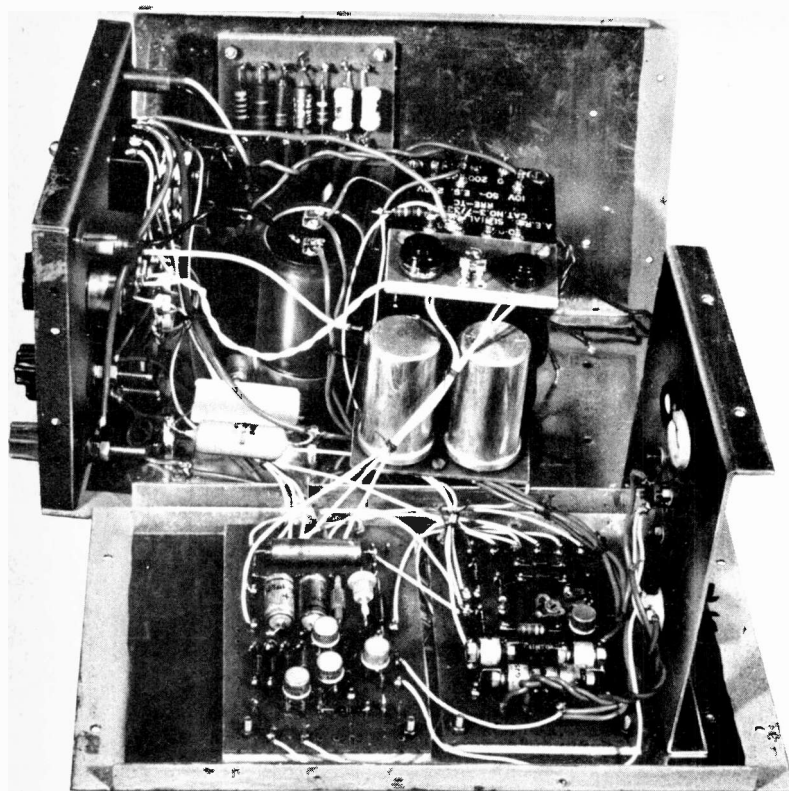

Fig. 9. Wiring of S4 output volts control. The 18×1 kilohm resistors are $\frac{1}{4}W$ h.s. and are wired around the switch wafers



Leave power unit switched on for about 10 minutes to settle down, and then reset with S3 if necessary.

(17) If a variable resistor is used for VR3, repeat Tests 10 and 11, setting these voltages to 22V and 0V respectively, then go to Test 25 when completed.

Note: VR2 and VR4 interact, and Tests 10 and 11 should be carried out as many times as necessary to achieve an optimum result.

If S4 is fitted as in Fig. 8, proceed as follows:

(18) Replace VR6 and VR5 variable resistors with two 1 kilohm 1 per cent resistors connected in series; junction of the two resistors to be connected to TR1 base.

(19) Select 20V output position and adjust VR2 to give 20V output.

(20) Select 2V output position and adjust VR4 for 2V output. Repeat Tests 19 and 20 as necessary.

(21) Remove the two 1 kilohm resistors and connect VR5 and VR6 back in circuit.

(22) Select the 2V output position, turn VR6 for minimum output, and adjust VR5 to give 0V output.

(23) Check that VR6 can now vary the output from 0 to 4V.

(24) Select 20V output position and check that VR6 can vary the output between 18V and 22V.

(25) Select 100mA overload and set output to 10V.

(26) Load output with 100 ohm, 1W resistor and adjust VR1 slowly until overload circuit operates.

(27) Remove 100 ohm load resistor and reset.

(28) Check overload trips when 100 ohm load is reconnected.

(29) Remove 100 ohm resistor, in series with +d.c. line, between boards, and replace with permanent connection. (Switch off to do this.)

(30) Recheck for correct output voltage variation range, and recheck operation of overload circuit as in Tests 25 and 26 (VR1 should not need to be altered).

(31) Select 20V output and 1A overload, connect an 18 ohm resistor across output terminals and check that unit trips.

(32) Check short circuit output current is less than 10mA. It will probably be much less than this, but is dependent on leakage current through TR3, TR4 and TR5.

PERFORMANCE DETAILS

The unit built by the author used a transformer with secondaries of 22.3V, 0.9A (main) and 21V, 60mA (auxiliary). The voltage range was set for an output of 0 to 20V and the output control was as per Fig. 8.

Measured performance was as follows:

Voltage range—	0 to 20V
Max. r.m.s. load current—	1A
Output resistance at 20V, 1A—	30 milliohm (0.03 ohm)
Output resistance at 0.2V, 1A—	40 milliohm (0.04 ohm)
Output ripple at 1A load—	500µV r.m.s.
Voltage setting accuracy—	Better than 1.5 per cent
Output variation for ±10 per cent mains variation—	Better than 0.1 per cent
Overload protection range—	25mA to 2.5A
Short circuit output current—	1mA

The only parameter not mentioned in the table is that of temperature stability.

When first switched on the output voltages will be, at worst, 6 per cent low, and this is due almost entirely to the temperature coefficients of D10 and D11. The output voltages settle very quickly and are within 1 per cent of their final value in about one minute of switching on.

If it is required to decrease the effects of temperature variation, then the following is suggested: make D10 from five Zener diodes, each rated at 5.6V, connected in series, and D11 from two Zener diodes each of 5.1V, connected in series.

However, unless the unit is to be used for applications where temperature stability better than 1 or 2 per cent is mandatory, then the extra cost of replacing D10 and D11 is not justifiable.

FINAL COMMENTS

There are two further points worth mentioning.

Although the unit is only intended to handle a maximum load current of 1A, a 2.5A overload position has been included. This allows the unit to be used where average currents are less than 1A but where high current peaks may be encountered. For example, class-B and class-C power amplifiers.

The -10V line may be made available on the front panel of the unit. Although currents of only 2 or 3mA may be drawn from this line without affecting the main supply, this can nevertheless be useful for small signal biasing applications. ★



BOOK REVIEWS

RCA HOBBY CIRCUITS MANUAL

Published by RCA Great Britain Limited,
Lincoln Way, Windmill Road, Sunbury-on-Thames,
Middlesex
224 pages, 8½ in × 5½ in. Price 17s 6d.

In this one reasonably priced volume are presented thirty five circuits which should have a broad appeal to electronics hobbyists.

Whilst including some games and novelty circuits, the majority fall into specific categories such as photography, motoring, ham radio, audio, etc., providing solid state aids or accessories in these pursuits.

The Manual opens with brief, but adequate, descriptions of the theory and operation of the semiconductor devices used in the various circuits and a general introduction to some commonly encountered circuit "bricks". A section on construction techniques provides all the information necessary both in the handling and assembly of the components used.

Sections on test circuits for component troubleshooting, and suggested circuit uses, preface the thirty five projects all of which are dealt with in detail both for circuit operation and construction.

Semiconductor types used can be obtained from RCA Great Britain at the address given above.

G.M.H.

COLOUR TELEVISION :

A Background to Colour Tube Adjustment for the Service Engineer
Published by Distributor Sales Division,
Mullard Limited
48 pages 8½ × 6 in. Price 17s 6d.

With the advent of colour television has come more rigorous demands on the service technician both in the understanding of new circuit techniques and the application of new and necessarily more complex setting up procedures.

In two parts this book provides a liberally illustrated "teach-in" on colour tube control assemblies and their adjustment. Part 1 provides a brief description of the shadowmask picture tube with explanations of convergence and colour purity and associated assemblies necessary to achieve this. Part 2 gives a typical setting up sequence of adjustments, the emphasis being on a simple easy-to-follow procedure which should appeal to the service man.

Colour pictures and diagrams are used to show the operation of the various controls and to give examples of the displayed picture before and after adjustments are made.

G.M.H.

AUDIO DIARY 69

Published by Link House Publications Ltd.
60 pages of information plus diary section,
4½ in × 2½ in. Price 8s 6d.

The information section of this diary will be a most useful and convenient work of reference for all who appreciate good music and the means for its reproduction in the home. The subject matter has been selected to embrace the musical art as well as acoustic science and audio engineering. Topics succinctly but objectively dealt with include: frequency and pitch, gramophone records and their reproduction, loudspeakers, and tape recording. There are also other data such as music terms, index of composers, audio terms, and circuit symbols. Illustrated with charts and diagrams.

TRANSISTOR SERVICING GUIDE

Prepared and published by RCA Institutes Inc.
194 pages, 8 in × 5 in. Price 35s.

Service engineers, who prefer to learn from straightforward factual reporting of technical information, might find this book helpful. For those hitherto unfamiliar with transistor techniques, the early chapters lay out clearly and concisely the necessary basic theory of circuit operation of amplifying and r.f. stages.

Typical circuits used in transistor radio receivers are given in Chapter 3, while the next chapter looks at transistor television circuitry. This is dealt with in some considerable length. One would have thought that by this stage in the book one might have read about typical fault diagnosis and practical work—according to the title—but this aspect is given only in the last 40 pages.

Although of American origin, this book has been Anglicized to a considerable degree making it more digestible to the British service man.

M.A.C.

NEWS BRIEFS

Safer Level Crossings

Television cameras are being mounted on Italian un-manned level crossings to provide an unobstructed view of the whole crossing area. The cameras, which use English Electric Vidicon picture tubes, feed monitors mounted in the signal box, these monitors provide the signalman with a continuous view of the crossing and, in the event of the track being obstructed when the barriers are lowered, allow him time to warn approaching trains.

Britain Contributed to Apollo 7!

Britain's contribution to the Apollo 7 space mission consisted of five Cable and Wireless stations in Antigua, Bermuda, Bermuda, Suva (Fiji) and Tortola (B.V.I.). The "NASCOM" communications network, used to control and track the entire flight, consisted of teleprinter, voice and data circuits and covered a large part of the globe. Circuits had to be maintained in the highest state of efficiency throughout the mission; reliability requirements being as high as 99.8 per cent.

Computer-Aided Design Centre

The Ministry of Technology have been negotiating with ICL to operate the new computer-aided design centre at Cambridge under Mintech direction. The design centre, which is expected to be operational in mid 1969, will provide multi-access facilities working largely through the medium of teleprinters but using displays and other devices in some instances. Expected costs and running expenses for the first five years are about £2½ million.

Integrated Circuits Joined by Electrons

An electron beam cutting and welding unit, which is to be used for connecting together micro-integrated circuits, is being developed by the research division of ICL. The heart of the control system for the unit is to be an English Electric M2140 multi-processor computer.

Computing Past and Present

A small exhibition of mechanical, electro-mechanical, and electronic computing machines, past and present, is now being shown in the Science Museum, South Kensington, London. It is open every day (except Christmas Day) until January 12, 1969, admission free.

Zener Diodes

By J.S. LAMB

BEFORE using any unfamiliar electronic device it is wise to examine the characteristics carefully and if possible try to understand its physical properties. With Zener diodes both these points are relatively simple to master. The Zener diode is very similar to any silicon diode and if used in the forward biased condition will give similar results. The difference, due to impurities injected during manufacture, is found when the device is reverse biased as it breaks down at a given voltage and will conduct large currents (see Figs. 1a and 1b).

Before proceeding it is important to note that, like all semiconductors, Zener diodes are likely to be damaged if excessive currents are allowed to pass through them. To avoid this ensure that a series resistor is used to limit that current whenever the breakdown voltage is to be exceeded.

ZENER BREAKDOWN

Looking at a typical characteristic curve (Fig. 2) of a Zener diode type 1N753, AB is a region in which very little current flows and the device presents a high impedance usually above 50 kilohms. Region BC is the breakdown voltage V_z and is usually a very sharp knee but it can be a steep curve especially at very low breakdown voltages, i.e. 3 to 4 volts. Finally in the region CD the breakdown voltage is exceeded and very large currents flow for small increases in voltage.

The manufacturers data for Zener diodes is presented with a definite value of Zener current $I_{z(min)}$ being quoted for the breakdown voltage. This is usually greater than required and lies well into the conducting portion of the curve, to ensure that the working point of the device never lies on the curved portion BC. It is important to note, however, that for large variations in Zener current the breakdown voltage increases slightly, i.e. this device still has a finite resistance R_z after breakdown. Two other parameters are also quoted $I_{z(max)}$ and maximum power dissipation $P_{c(max)}$. The maximum power dissipation depends on temperature, but for the purpose of this article it is assumed that an ambient temperature of 25 degrees C prevails and the devices are never subjected to maximum power dissipation. All Zener diodes are subject to a 5 or 10 per cent tolerance and it is not unreasonable for a nominal 6.2V Zener to have an actual breakdown voltage between 5.6 and 6.8V, although any one diode will always have a constant breakdown voltage within this range. Zener diodes also vary with temperature; those below 5V have a negative coefficient, those above 6V a positive coefficient, and those at 5 to 6V have a zero temperature coefficient. Thus by combining selected diodes (i.e. above 5V and below 5V) the total temperature coefficient of several devices can still be less than the temperature coefficient of one diode of corresponding voltage.

STABLE VOLTAGE SOURCE

The Zener diode is most commonly found in voltage reference and stabilising circuits. Fig. 3 shows the most common Zener diode circuit used to produce a constant voltage with a varying load current and supply voltage. As the latter varies, the voltage across R1 varies, allowing V_z to remain constant provided that $I_{z(min)}$ is allowed to flow continuously through the Zener diode. Under the conditions where no load current is taken, the maximum load current required in the external circuit plus $I_{z(min)}$ flows through the diode, while on full load the Zener diode conducts only $I_{z(min)}$.

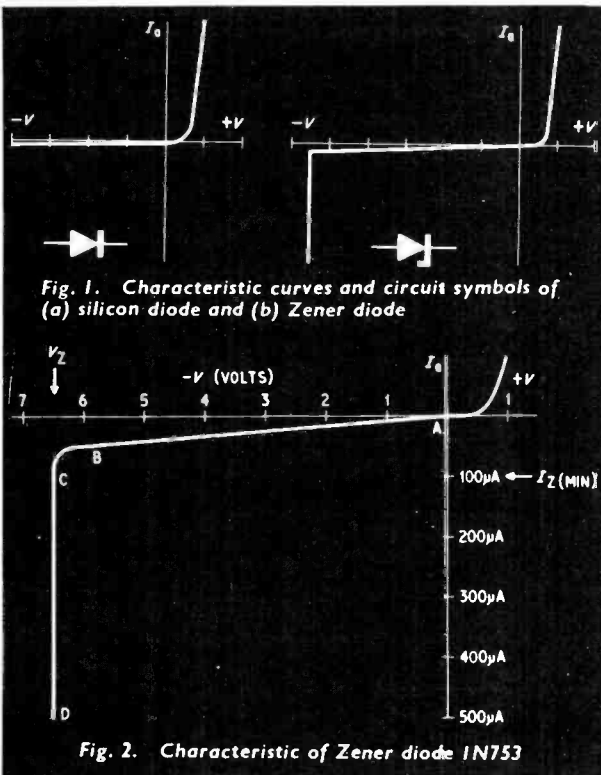

Fig. 1. Characteristic curves and circuit symbols of (a) silicon diode and (b) Zener diode

Fig. 2. Characteristic of Zener diode 1N753

DESIGN PROCEDURE

The design procedure for a stabiliser of 6.2V (as in Fig. 3) is as follows:

1. Stipulate maximum and minimum current I_L to be drawn in load (e.g. 10mA and 0mA).
2. Stipulate the maximum supply voltage V_i likely to occur (e.g. 12 volts) and ensure that the minimum supply voltage is at least 1V above the breakdown voltage of the Zener diode.
3. At any time $V_i = V_z + V_{R1}$, where V_z is the breakdown voltage V_{R1} is voltage across R1, and $I_z = I_{z(min)} + I_L$, where I_L is the maximum load current stipulated.

Using Zener diode 1N753 where $V_z = 6.5V$, $I_{z(min)} = 100\mu A$ (from Fig. 2).

$$\begin{aligned} \text{Maximum } I_z &= 100\mu A + 10\text{mA} \\ &= 10.1\text{mA} \end{aligned}$$

Therefore R1 must conduct 10.1mA at the minimum supply voltage.

Allowing 1.5 volts minimum across R1, i.e. $V_i - V_z$.

$$\begin{aligned} R_1 &= \frac{1.5}{10.1 \times 10^{-3}} \\ &= 148.5 \text{ ohms} \end{aligned}$$

The nearest preferred value resistor would be 150 ohms.

4. At maximum supply voltage 12V:

$$\begin{aligned} V_{R1} &= I_z R_1 \\ I_z &= \frac{(12 - 6.5)}{150} \\ &= 36.7\text{mA} \end{aligned}$$

Under no load conditions this current flows through the Zener diode when the Zener dissipates most power.

5. The power dissipation for these open circuit conditions is given by

$$\begin{aligned} P_c &= I_z V_z \\ P_c &= 6.5 \times 36\text{mA} \\ &= 234\text{mW} \end{aligned}$$

This is well within the 400 mW rating of the 1N753. The results of this circuit are shown graphically in Fig. 4.

ZENER DIODES IN SERIES

As stated earlier in this article it is possible to add two or more diodes in series (Fig. 5). The calculation is similar but in this circuit $I_{z(min)}$ must be a minimum value, so that the current passing through any diode is never less than the value at which the breakdown voltage of that diode occurs. If this condition is fulfilled then six different stable supplies can be obtained from three diodes as shown in Fig. 5.

ZENER DIODES IN PARALLEL

For very good stability at low voltages, especially for supplies containing a.c. ripple, two Zeners can be added in parallel, Fig. 6. The calculation is the same for both diodes, each being treated as a single stage. If a potentiometer is substituted for R2 then a variable stabilised supply can be obtained although stabilisation is not as good as in the fixed voltage circuit.

If large load circuits are required or the supply varies by more than 2 to 3V the Zener diodes can easily be over loaded; to overcome this a transistor is usually added.

VOLTAGE STABILISE WITH TRANSISTOR

In this type of circuit the Zener diode is used as a constant voltage source on the base of a transistor. The transistor is operated in the emitter follower configuration, with the load acting as the emitter resistor (see Fig. 7).

The voltage at the emitter follows the voltage at the base. In this circuit, the latter is constant so the output across the load is also constant and the maximum current through the load is the maximum emitter current of the transistor. The gain of the transistor h_{fe} should be high (e.g. 50) to ensure that under maximum load conditions the base current is not large enough to load the Zener diode circuit.

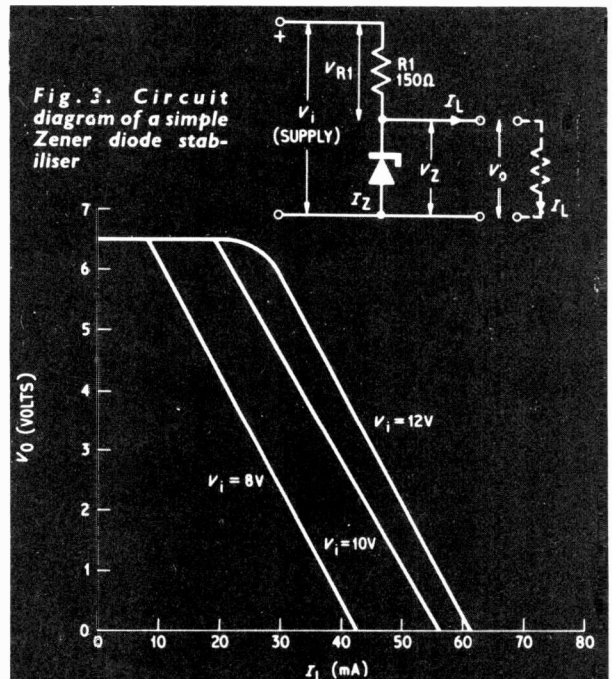

Fig. 4. Load characteristics for given inputs of Zener diode stabiliser

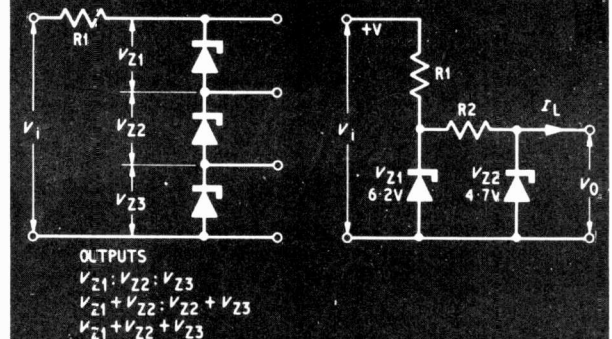

Fig. 6. Zener diodes connected in parallel

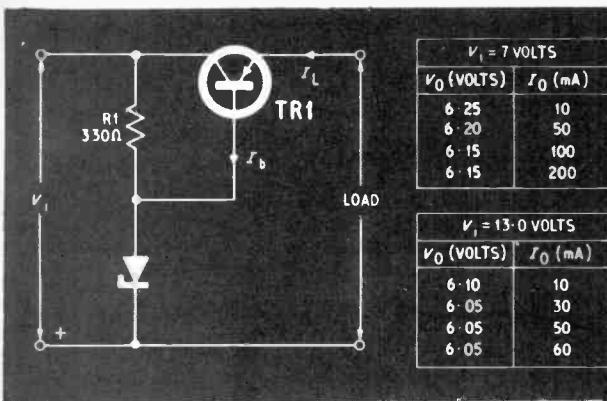

Fig. 7 (left). Circuit diagram and table of results of voltage stabiliser using a transistor connected in series.

STABILISER DESIGN

The procedure for designing a circuit using 1N753 to give 6.5 volts output, as in Fig. 7, is as follows:

1. Stipulate maximum and minimum load current, (e.g. 50mA and 0mA respectively).
2. Stipulate maximum and minimum supply voltage; again the minimum supply should be 1 to 2V above V_z (e.g. $V_{i(max)} = 12V$, $V_{i(min)} = 8V$), i.e. $V_{R1} = 1.5V$.
3. Select transistor for power dissipation P_{tot}

$$P_{tot} = (V_{i(max)} - V_o) \times I_{L(max)}$$

$$= (12 - 6.5) 50 \times 10^{-3}$$

$$= 275mW$$

It is also required that $h_{fe} = 50$ (use transistor type OC84)

Therefore $I_b = \frac{I_{L(max)}}{1 + h_{fe}} \approx \frac{I_{L(max)}}{h_{fe}}$

$$I_b = 1mA$$

4. For good regulation the current through the Zener diode should be much larger than the required base current, i.e. by a factor of 5. The value of R_L is then calculated as in the simple stabiliser.

i.e. $R_L = \frac{V_{i(min)} - V_z}{I_z}$

$$= \frac{8 - 6.5}{5 \times 10^{-3}}$$

$$= 300 \text{ ohms}$$

The nearest preferred value resistor is 300 or 330 ohms.

5. The power dissipation is given by

$$P_c = \left(\frac{V_{i(max)} - V_z}{R_1} - I_{b(min)} \right) V_z$$

If the minimum load current is zero, $I_b = 0$

$$P_c = \left(\frac{12 - 6.5}{330} \right) 6.5$$

$$= 112mW.$$

For the results of this circuit, see tables in Fig. 7.

It is interesting to note that as this circuit behaves as an emitter follower the output voltage is smaller by the V_{be} of the transistor. It is also worth noting that V_{be} increases slightly as the emitter current increases.

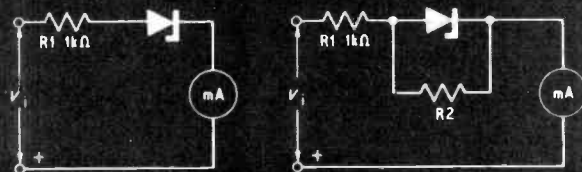

Fig. 8. Use of Zener diodes in meter circuits

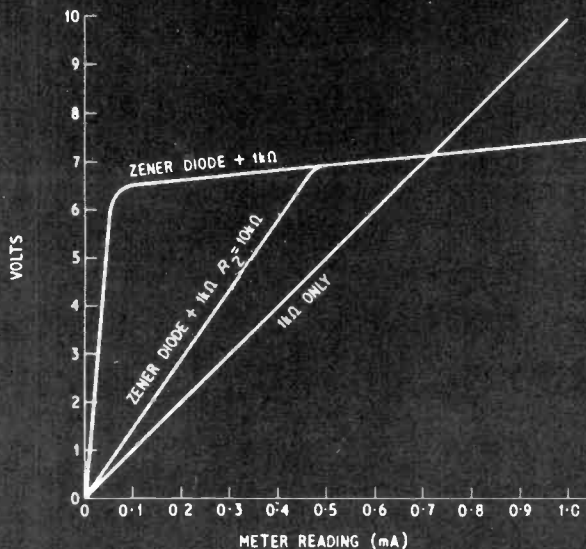

Fig. 9. The results of adding a Zener diode and parallel resistor to a 1mA meter

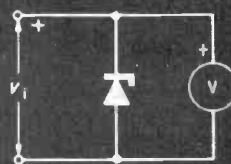

Fig. 10a. Zener diode used to protect a voltmeter against overload

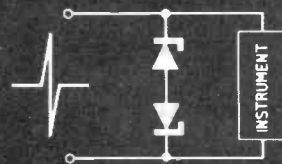

Fig. 10b. Two Zener diodes used "back to back" to give protection against positive and negative transients

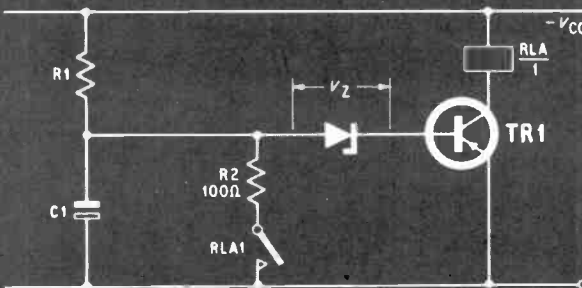

Fig. 11. A free running square wave generator using a Zener diode

ZENER DIODES FOR METER CIRCUITS

One of the most useful applications of Zener diodes to the amateur constructor is its addition to voltmeter circuits (Fig. 8a).

For this application a 1mA meter was used, with a series resistor R1, as a voltmeter. Sensitive meters should be shunted to measure at least 1mA f.s.d. to ensure that f.s.d. is not reached by Zener diode leakage current (Fig. 2).

The Zener diode presents a very high impedance (about 50 kilohms) until the voltage across it reaches the breakdown voltage, so from zero volts to the Zener breakdown voltage the meter reads only the Zener leakage current, i.e. Fig. 2 (A — B). After breakdown the Zener resistance is very small (e.g. in the region 10 to 100 ohms) so the meter now behaves as a normal voltmeter. The scale is compressed up to the Zener breakdown voltage, whereafter it is linear. If it is required to measure a voltage of 7V accurately then using a Zener diode of 6.5V and a 1mA meter, the meter will read 7.5V full scale with a deflection range of 1V if R1 = 1kilohm.

If a resistor is placed in parallel with the Zener diode (Fig. 8b) to form a potential divider then the lower part of the scale can be increased, while still being compressed, to give a reasonable reading outside the required range. Fig. 9 shows the results of adding a Zener and parallel resistor to a 1mA meter.

CIRCUIT PROTECTION

A Zener diode can be used very effectively to protect a voltmeter against overload or a reversed polarity signal (Fig. 10a). When the input reaches the breakdown voltage the diode conducts and short circuits the meter. In practice the diode used has a breakdown voltage 2 to 3 times that which would overload the meter. Also, if a voltage is applied which is of reversed polarity the Zener diode behaves like a normal diode, forward biased, thus again short-circuiting the meter. This method of protection can also be used to protect instruments from transients through supplies. In this case it is usual to place two Zener diodes back to back as in Fig. 10b, thus protection is gained against positive and negative transients.

SIMPLE TIMING CIRCUIT

In the circuit of Fig. 11 the capacitor C1 is charged through the resistor R1 until the voltage across it reaches the Zener breakdown voltage plus the V_{be} of the transistor.

The Zener diode then conducts allowing a base current to flow which switches the transistor hard on. The time taken for this to occur is given by

$$t \approx \frac{0.7C_1R_1V_z}{V_{cc}}$$

Unfortunately the value of R1 has a practical maximum. This resistor must be able to conduct the $I_{z(min)}$ of the Zener diode and a base current large enough to switch on the transistor. This means that large values of capacitance must be used for long time delays.

The repeatability of the time delay depends on the capacitance and the shape of the knee of the Zener diode. Thus this circuit can never be used in applications which require a high degree of accuracy.

If a relay is used in the collector circuit with one set of contacts used to discharge the capacitor then the circuit becomes a free running square wave generator.

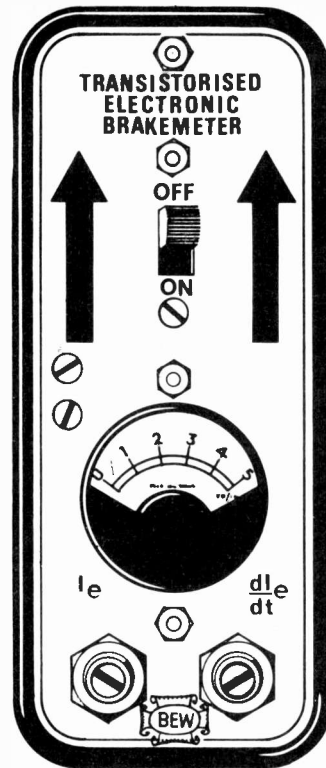

Next Month!

Special for
MOTORISTS

BUILD THIS ELECTRONIC BRAKEMETER

Don't risk accidents caused by faulty brakes. Play safe—take the guesswork out with this electronic brakemeter. Here's a simple constructional project which provides immediate visual readout of the braking efficiency of your vehicle. You need it—and you'll enjoy building it.

Also

ELECTRONIC FENCER FOR FARMERS

An all solid state battery operated version of the "Electric Fencer" widely used for livestock control. Small size, current economy and long-term reliability are features of this new design.

PRACTICAL ELECTRONICS

February Issue On Sale Monday Jan 13

MAKE SURE OF YOUR COPY—ORDER NOW!

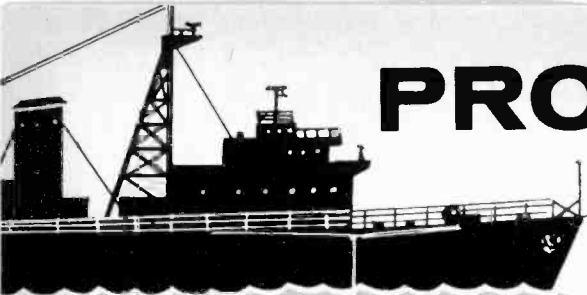

PROBING THE OCEAN

By P. R. HINCHCLIFFE B.Sc.

A STUDY of the ocean involves the accurate determination of such parameters as pressure, temperature, salt content and current flow in regions of the earth's surface where man could never live, without the aid of bulky and expensive protective vessels. The following article describes how the oceanographer enlists the aid of electronics to penetrate depths otherwise forbidden to him, and to study them both *in situ* and in the laboratory.

MEASUREMENT OF DEPTH

The earliest measurements of depth were, of course, taken by the technique of throwing a weighted rope over the side of a ship. In later years, a blob of candle grease on the weight also provided early marine geochemists with a convenient sample of the sediment from the sea floor.

However this procedure was inaccurate, and especially in deep waters, very lengthy. Paying out and winding in 3,000 fathoms of wire is a very tedious procedure, and a survey of a small area could take months using this procedure.

A modern day technique is to use sonar. A high frequency acoustic pulse (about 10-15kHz) is released from a transducer below the ship, at the same time that a pen recorder begins to sweep across a paper. The reflected echo is received and causes the pen to mark the paper.

The time pulse and echo gives the depth accurately, assuming that the velocity of sound in water is known. This value is taken to be 800 fathoms per second, but tables are available to correct for different parts of the ocean.

Accurate measurement of sound velocity is also useful for determining current flow or water densities under certain circumstances. The method usually used to measure velocity is based on the "sing-around" system (Fig. 1). A pulse emitted from the transmitting transducer travels an accurately known path and is received by a second transducer, which feeds the signal back to the transmitter via shaping and amplifying circuits, causing electrical oscillations to occur. The frequency of oscillation is dependent on the velocity of sound in the water between the transmitter and receiver.

This transmission of data as a frequency modulation is very convenient, requiring only one probe-to-ship cable to carry many different channels of information. Considerable modification is often incorporated into a sensor system so that a modulated frequency signal can be obtained, as we will see later.

DEPTH RECORDER

Knowing the velocity of sound enables accurate depth measurements to be made using the system mentioned above. Fig. 2 shows in block diagram form a typical depth recorder based on this principle.

Use of the "sing-around" principle would cause loss of definition of the structure of the sea bed as the interval between pulses may be several minutes in deep waters, and in this time the boat may have travelled quite a distance. To overcome this a string of pulses is given out and this is gated in a particular code to determine which echo came from which pulse.

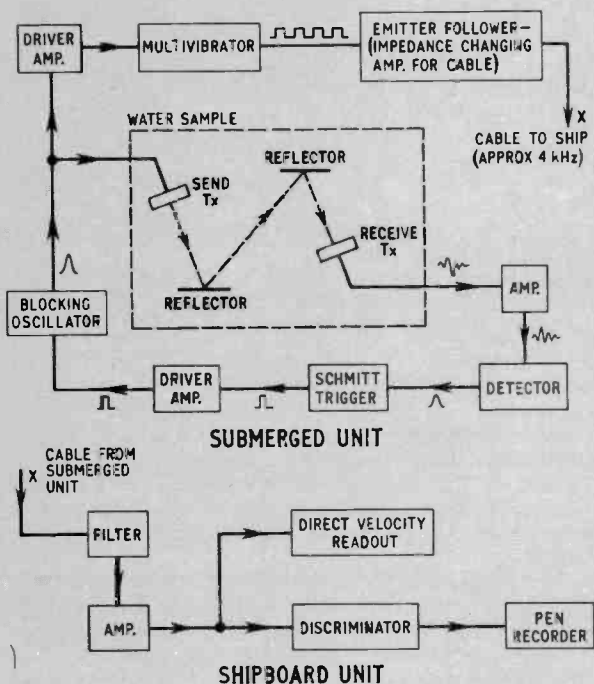
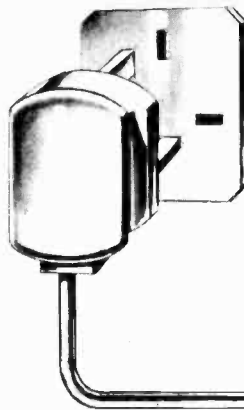

Fig. 1. Scund velocity meter using "sing-around" principle



**plug in
the smallest
soldering iron
available**

**Complete precision
soldering kit**



This kit—in a rigid plastic "tool-box" — contains everything you need for precision soldering.

- Model CN 15 watts miniature iron, fitted $\frac{3}{16}$ " bit.
- Interchangeable spare bit, $\frac{3}{32}$ ".
- Interchangeable spare bit, $\frac{3}{32}$ ".
- Reel of resin-cored solder
- Felt cleaning pad
- Stand for soldering iron
- Space for stowage of lead and plug

PLUS 36-page booklet on "How-to-Solder"—a mine of information for amateur and professional.

From Electrical and Radio Shops or send cash to Antex. **49/6**

... pin-point precision soldering ... fingertip control ... bits that do not stick to shafts ... bits that slide over elements ... sharp heat at the tip ... reliable elements ... spares always available ...

in Europe, Africa, Asia, America ... ANTEX soldering irons are used by experts and amateurs alike; they have found out the advantages of Antex ...

you can too ... buy one in a shop or direct from us ... or ask for our catalogue first.

CN 15 watts. Ideal for miniature and micro miniature soldering. 18 interchangeable spare bits available from .040" (1mm) up to 3/16". For 240, 220, 110, 50 or 24 volts.

32/6

From Electrical and Radio Shops or send cash to Antex.

ACTUAL SIZE

G 18 watts. Ideal for miniature work on production lines. Interchangeable spare bits. 3/32", 1/8", 3/16", and 1/4". For 240, 220 or 110 volts. 32/6.

E 20 watts. Fitted with 1/4" bit. Interchangeable spare bits 3/32", 1/8", 3/16". For 240, 220, 110 or 24 volts. 35/-.

ES 25 watts. Fitted with 1/8" bit. Interchangeable bits 3/32", 3/16" and 1/4". Ideal for high speed production lines. For 240, 220, 110, 24 or 12 volts. 35/-.

F 40 watts. Fitted 5/16" bit. Interchangeable bits 1/4", 3/16", 1/8", 3/32". Very high temperature iron. Available for 240, 220, 110, 24 or 20 volts. 42/6.

Spare bits and elements for all models and voltages immediately available from stock.



**Model CN240/2
15 watts - 240 volts**

Fitted with nickel plated bit (3/32") and in handy transparent pack. From Electrical and Radio Shops or send cash to Antex.

31/-



**PRECISION MINIATURE
SOLDERING IRONS**
made in England

Antex, Mayflower House, Plymouth, Devon
Telephone: Plymouth 67377/8. Telex 45296. Giro No./258 1000.

To: Antex, Mayflower House, Plymouth, Devon

Please send me the Antex colour catalogue

Please send me the following irons

Quantity	Model	Bit Size	Volts	Price
.....
.....
.....

I enclose cheque/P.O./cash value

NAME

ADDRESS

PE 1

Telephone:

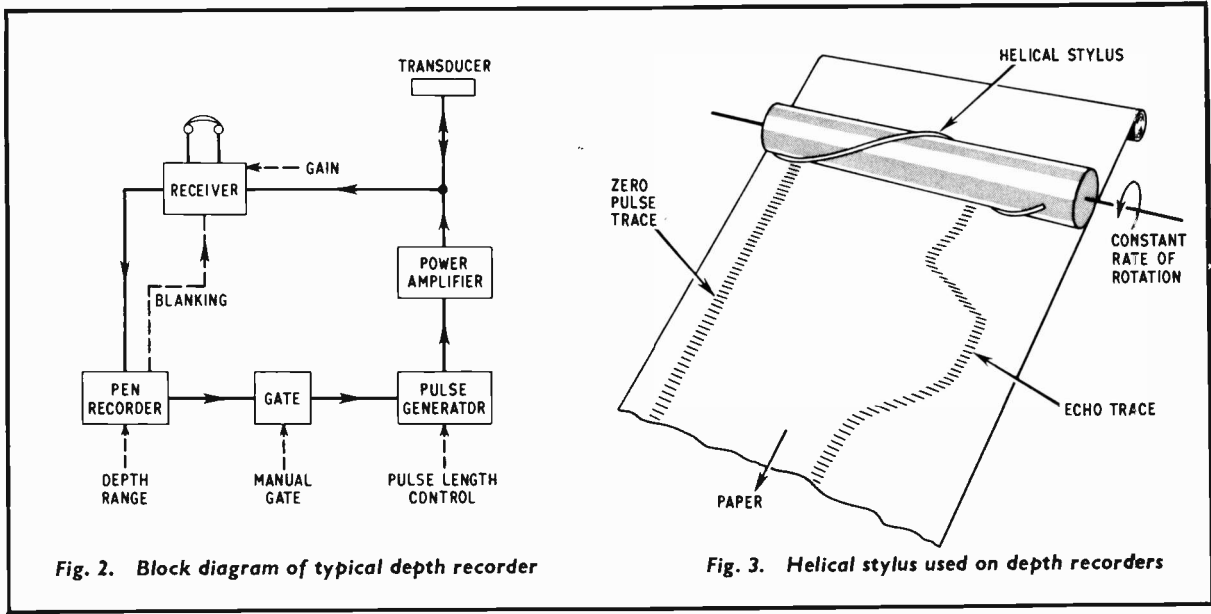

Fig. 2. Block diagram of typical depth recorder

Fig. 3. Helical stylus used on depth recorders

Sing-around type depth recorders, however, have the advantage that loss in signal strength by absorption in water can be compensated for automatically by using a time-variable gain on the receiver.

The recorder uses a pen which sweeps across the paper at a constant rate—often a helical stylus is used to achieve this effect (Fig. 3). A pulse is emitted as the stylus is at zero and the pen marks the paper again on receipt of the echo. Different rotating speeds of the stylus give different depth ranges.

The transducers used are usually multiple ceramic devices, but for some cases nickel/iron magnetostrictive rings or quartz crystal devices may be used.

Sonar systems are also used for giving the depth of probes or sampling devices below the sea surface. A "pinger" is fitted on to the probe, which gives out a string of sonar pulses. Two main pulses are received onboard the ship, one direct and one reflected from the sea bed. When the two traces on the recorder coincide, the probe or sampler will be on the sea bed.

VIBROTRON

Depth is closely related to pressure, to such an extent that a pressure recorder is often used to indicate the depth of an instrument. A useful sensor, which directly gives a signal whose frequency is dependent on

pressure, is the vibrotron, in which the pressure is used to tighten or slacken a vibrating wire, hence varying the frequency of vibration of the wire. Devices in which pressure varies the capacitance of the capacitor in an LC oscillator are also useful.

The vibration and the sonar device described may be used in wave measurement, which may become important in the future for predicting storms. However, these have to be resting on the sea bed and cables must run from the instrument to shore or ship, so they are only really useful as near-shore, shallow water devices.

For shipborne wave analysis a very elegant system is used. An arbitrary reference depth is fixed below the ship. Shipborne transducers measure the pressure (and hence the height of the wave) and compare this to the reference level to allow for the motion of this ship in both vertical and rolling motion. The reference level is fixed by measuring the vertical acceleration due to the wave motion at each side of the ship. Distance is found from acceleration by double integration.

The transducers used are variable inductance transformers (Figs. 4a and 4b). A voltage of 10V at 10kHz is fed to the fixed coil, and 10V ± 10 per cent is induced into the other, dependent on its height relative to the

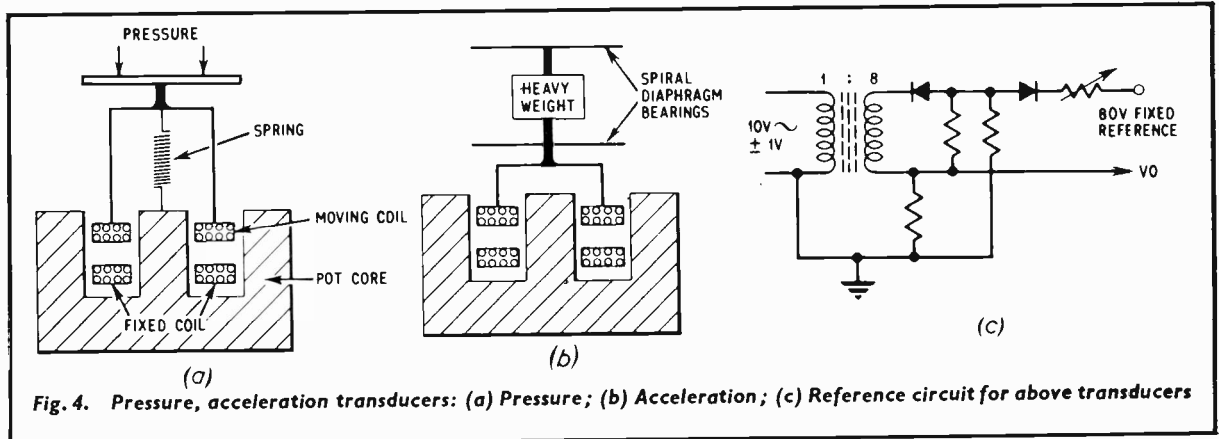

Fig. 4. Pressure, acceleration transducers: (a) Pressure; (b) Acceleration; (c) Reference circuit for above transducers

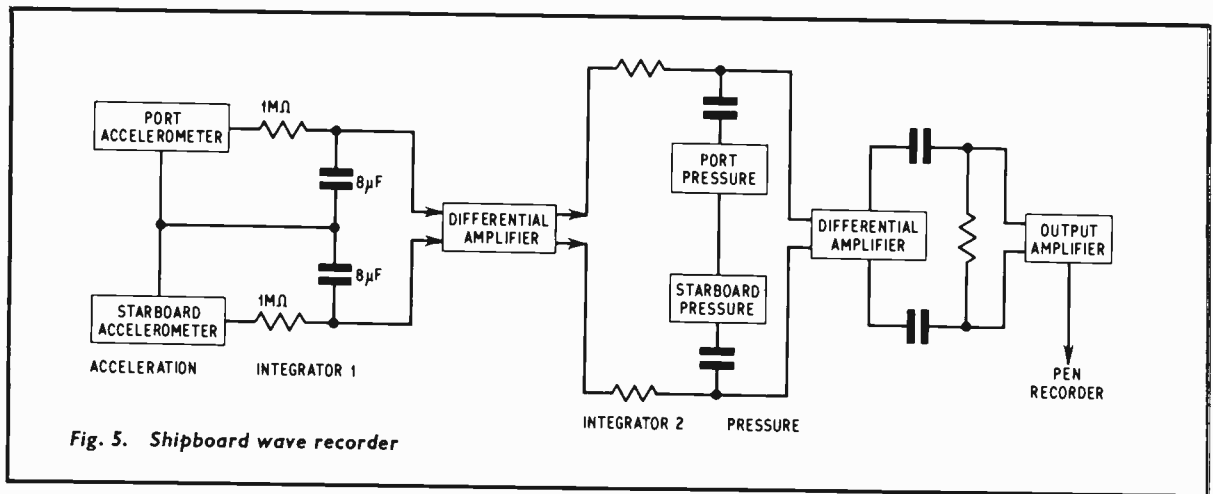

Fig. 5. Shipboard wave recorder

core. This is compared to the standard 80V reference to give an output V_o (Fig. 4c) dependent on either acceleration or pressure.

The acceleration signal is integrated twice (Fig. 5) and mixed with the pressure signal. The resultant is fed via a filter to eliminate long term drifting in the previous network into a pen recorder. The trace may then be analysed at leisure on land.

MEASUREMENT OF TEMPERATURE

There are two quite separate problems involved in temperature measurement of the ocean—the thin skin of the surface is often at a quite different temperature to that of the mixer layer immediately below. Measurements of the surface skin are usually carried out using an airborne radiation thermometer (a.r.t., see Fig. 6) which, as the name suggests, is usually carried in an aeroplane.

This device compares the infra-red radiation of the surface layer of the sea with the radiation reflected from a shutter in front of the thermostatically controlled container. The shutter rotates to give a chopped 20Hz signal in the thermistor; the signal is then filtered, analysed and recorded. This method was used to plot the Gulf Stream very accurately, as it can measure surface temperatures of large areas rapidly to within ± 0.2 degree C.

For sub-surface measurements, reversing thermometers and isothermal sampling bottles are often used, but for the fast temperature/depth contouring a device known as a bathythermograph (b.t.) is used. This is in the form of a fish which is towed behind the ship.

On paying out the hawser the weight at the end of the b.t. causes it to sink, and on stopping the winch and then winding in the hawser the b.t. rises to the surface by means of its fins. Pressure drives a smoked glass plate in one direction, whilst the expansion of a liquid in a copper tube drives a stylus over the plate to indicate temperature against depth.

However, a more modern procedure is to use the expendable bathythermograph (e.b.t.) which is in the form of a streamlined plumb carrying a thermistor. An extremely fine 3-core cable connects the thermistor to a compensated bridge circuit on board the ship. As the cable is reeled out from both the e.b.t. and the shipboard unit simultaneously, it will float along the sea surface allowing the plumb to fall freely at a known speed whilst the ship steams away from the spot where it dropped the e.b.t.

The temperature is recorded against time, and hence against depth. These e.b.t.'s cannot be recovered, as the cable is far too fine to stand the strain of rewinding the instrument. It is possible to record the temperature to within ± 0.1 degree C.

Contouring temperature recorders (strings of 20 or more thermistors on a single hawser) are often used to plot the variation of the depth of an individual isotherm. The thermistors are wired individually into circuits such as that shown in Fig. 7.

MEASUREMENT OF SALINITY

Water masses in the ocean can be accurately defined and their movements plotted by measurement of their depth, temperature and salt content. However, variations of salinity in the major oceans are fairly small, and measurements to within ± 0.01 per cent would be required.

The most reliable and accurate method of salinity measurement is by the chemical procedure of titration, but this requires isolated samples of sea water, and a good deal of time and care. Rapid laboratory techniques usually measure the resistance of a standard vessel of sea water. The resistance is inversely proportional to the salinity, but also varies with temperature and pressure of the water.

In the laboratory pressure presents no problems—if the sample has been taken from a great depth, the pressure may be allowed for by use of tables. However, temperature must be controlled to a very fine degree, and this is done by immersing the conduction "cells" in an accurate thermostat.

Fig. 8 shows the circuit of a simple conduction bridge. The circuit is a Wheatstone bridge compensating

Conductivity salinometer

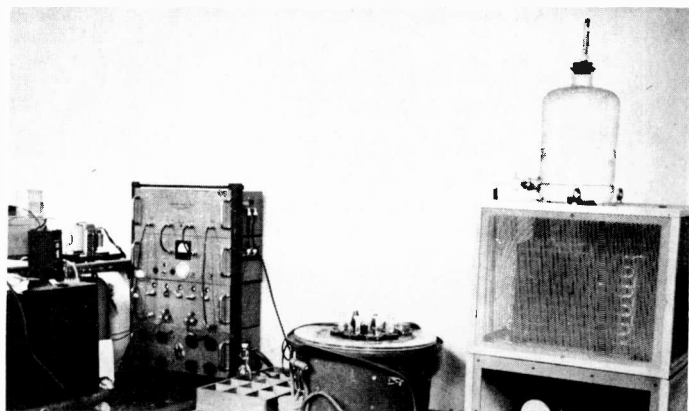

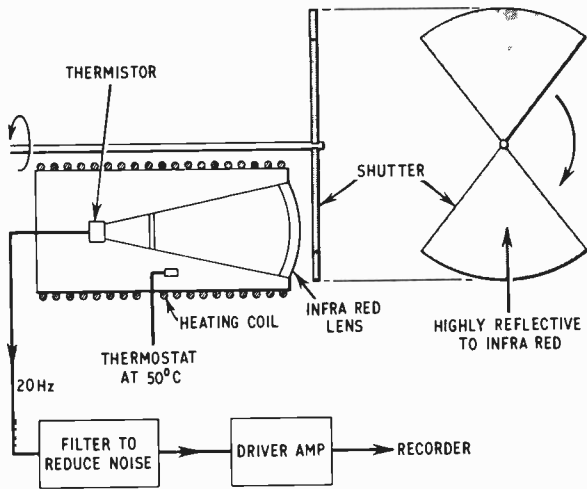

Fig. 6. Airborne radiation thermometer

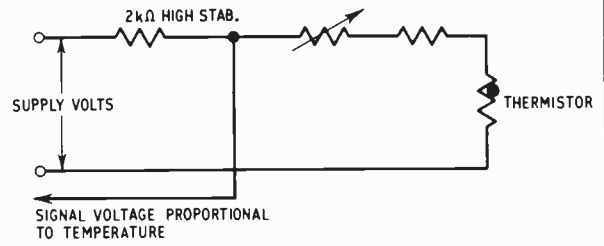

Fig. 7. Thermistor circuit, as used in temperature contourer

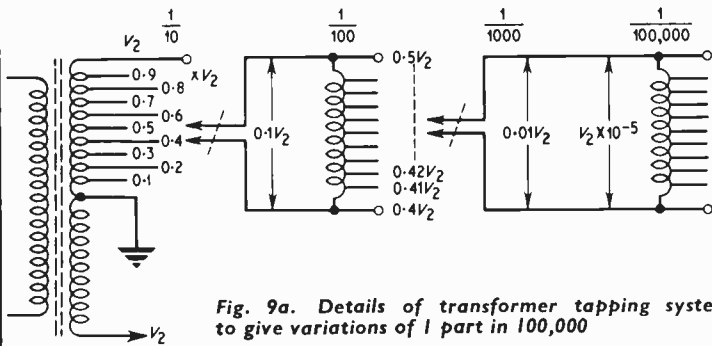

Fig. 9a. Details of transformer tapping system to give variations of 1 part in 100,000

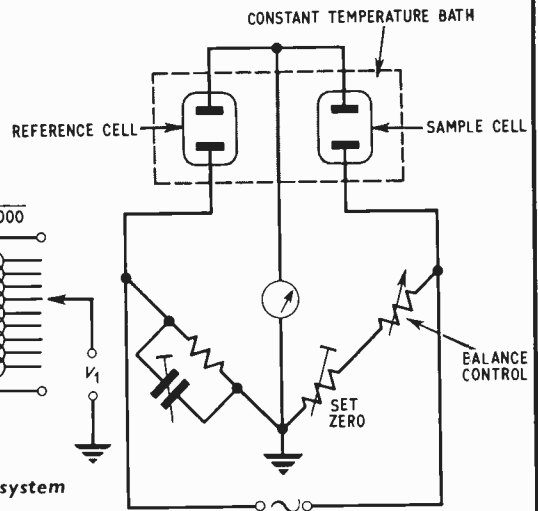

Fig. 8. Simple conduction bridge circuit

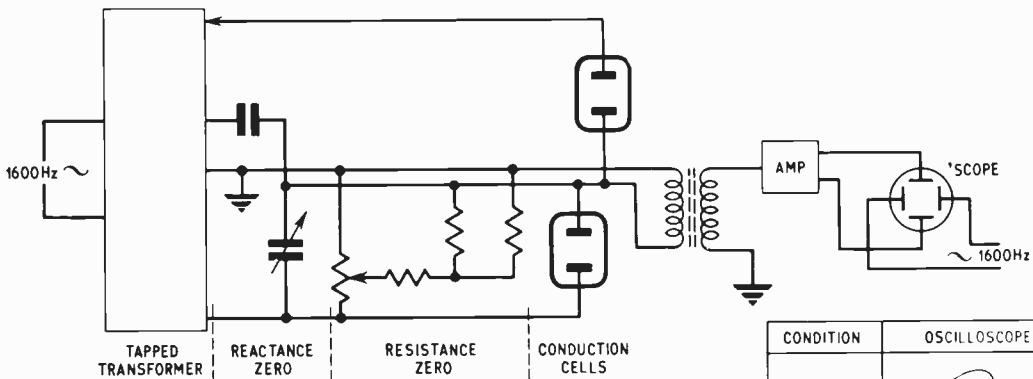





Fig. 9b (above). Typical conductance salinometer circuit

Fig. 9c (right). Traces obtained on oscilloscope

CONDITION	OSCILLOSCOPE TRACE
REACTANCE UNBALANCED	 ELLIPTICAL
REACTANCE BALANCED BRIDGE UNBALANCED	 STRAIGHT DIAGONAL LINE
BRIDGE BALANCED	 STRAIGHT HORIZONTAL LINE

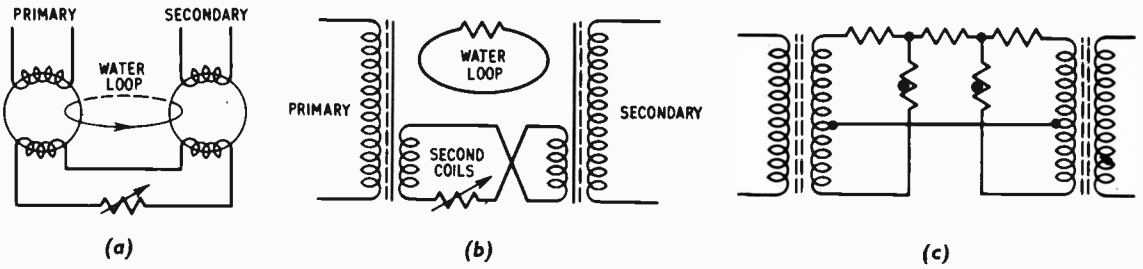

Fig. 10. Details of induction salinometer

Fig. 10a. Coil system of inductive conductivity sensor

Fig. 10b. Theoretical circuit of sensor

Fig. 10c. Circuit that will give approximately the correct compensation for a temperature change over a limited range

Fig. 10d. Pressure compensator

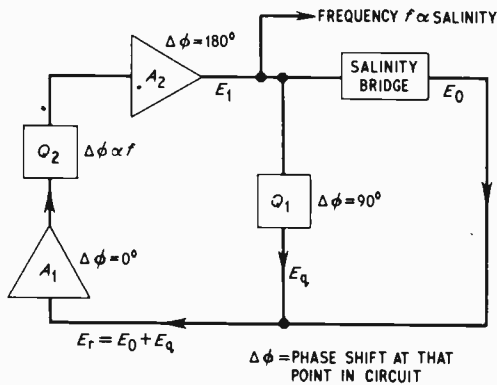
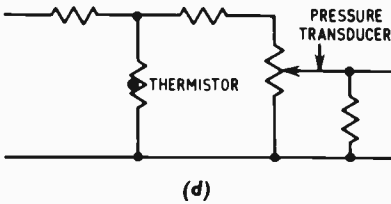

Fig. 11a. Paralog system

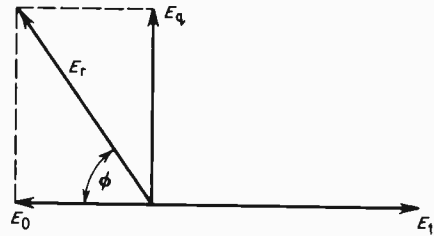

Fig. 11b. Vector diagram showing that phase ϕ varies with magnitude of E_0

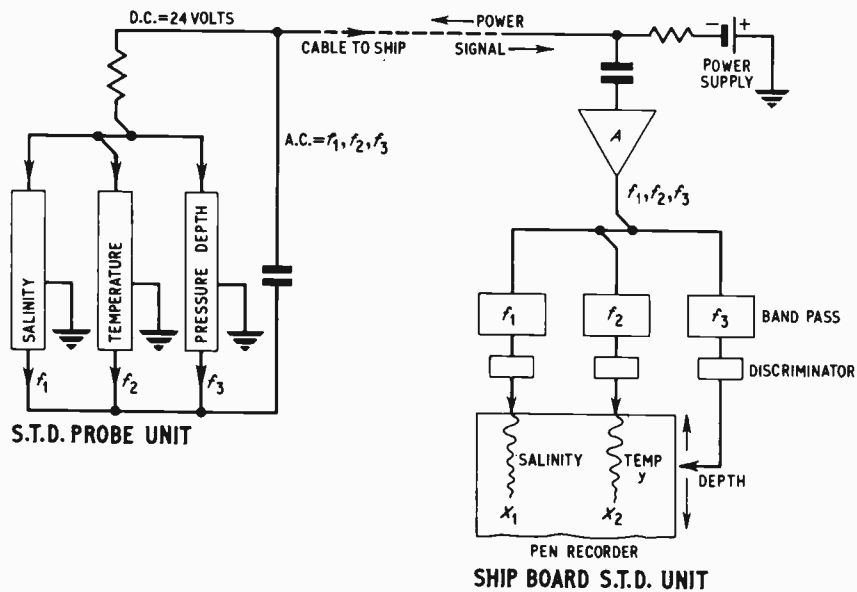

Fig. 11c. Salinity, temperature, depth probe

PEAK SOUND

Aids to economical high fidelity

ES/10-15 BAXANDALL SPEAKER

"A
thoroughbred"

SAYS
RALPH WEST
HI-FI NEWS
OCTOBER, '68

"The immediate impression was of a thoroughbred speaker, smooth and effortless... voices were uncannily real. Once again we see the possibility of Rolls Royce standards... when you know how."

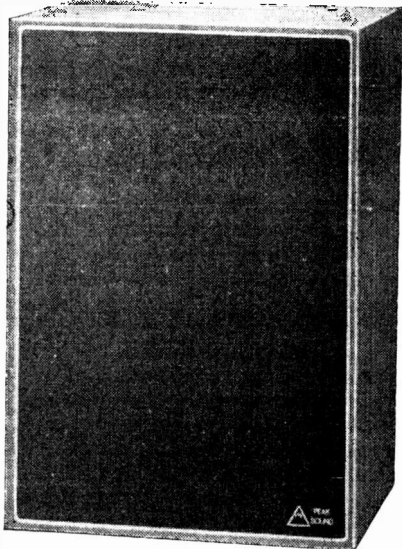

A revolutionary advance in design logic

We can only quote briefly from the report in *Hi-Fi News* which goes thoroughly into the merits of this remarkable loudspeaker. We supply the kit exactly to the specifications described by the designer, P. J. Baxandall in *Wireless World* (Aug. and Sept.). These designer-approved Peak Sound Kits come ready for instant assembly. Frequency range—60 to 14,000 Hz (100–10,000 Hz ± 3 dB); impedance—15 ohms; loading up to 10 watts R.M.S.; size 18" x 12" x 10". Here indeed is quality performance of a very high order for a very modest outlay.

Equaliser assembly £11.60: Special loudspeaker unit £11.80: *Purchase Tax 8/1*: Afrormosia Teak cabinet cut and drilled £6.15.0. *Cross-over choke for additional woofer, £1.2.6.*

£10.17.1

Carr. paid in UK

A new Peak Sound Power Amplifier

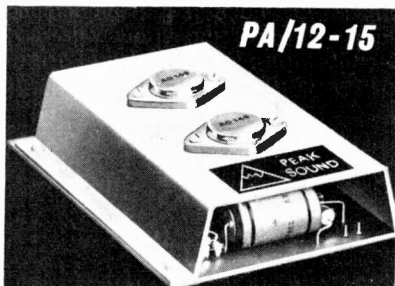

THE PEAK SOUND PA/12-15 (12 watts R.M.S. out into 15 Ω) is for the constructor who appreciates both sensible design and genuine power and hi-fi performance. Available built or in kit form. Response 10 Hz – 45 KHz ± 0.5 dB, distortion at max. output –0.1% 43 dB neg. feed back. Size 5" x 3 $\frac{1}{2}$ " x 1 $\frac{3}{8}$ ". With full instructions. Pre-amp. details available.

BUILT AND TESTED **£5.19.6** Kit less heat sink and board **£3.19.6** Heat sink 6/-

From your dealer or direct in case of difficulty.

PEAK SOUND (HARROW) LTD., 32 St. Judes Road, Englefield Green, Egham, Surrey Telephone: EGHAM 6318

—TO PEAK SOUND—

Please send (post free).....
for which I enclose £.....s.....d
NAME.....
ADDRESS.....
Block letters please

PE169

DUXFORD ELECTRONICS (PE) 97/97A MILL ROAD, CAMBRIDGE

Telephone: CAMBRIDGE (0223) 63687

(Visit us—at our new Mail Order, Wholesale & Retail Premises)

MINIMUM ORDER VALUE 5/-
C.W.O. Post and Packing 1/-

DISCOUNT 10% over £2
15% over £5

CERAMIC DISC CAPACITORS (Hunts.). 500V $\pm 20\%$; 100, 220, 330pF. —20%, +80%; 470, 680, 1,000pF. 5d each.

ELECTROLYTIC CAPACITORS (Mullard). —10% to +50%.

Subminiature (all values in μ F)

4V	8	32	64	125	250	400
6.4V	6.4	25	50	100	200	320
10V	4	16	32	64	125	200
16V	2.5	10	20	40	80	125
25V	1.6	6.4	12.5	25	50	80
40V	1	4	8	16	32	50
64V	0.64	2.5	5	10	20	32
Price	1/6	1/3	1/2	1/-	1/1	1/2

Small (all values in μ F)

4V	800	1,250	2,000	3,200
6.4V	640	1,000	1,600	2,500
10V	400	640	1,000	1,600
16V	250	400	640	1,000
25V	160	250	400	640
40V	100	160	250	400
64V	64	100	160	250
Price	1/6	2/-	2/6	3/-

POLYESTER CAPACITORS (Mullard)

Tubular, 10%, 160V: 0.01, 0.015, 0.022 μ F, 7d. 0.033, 0.047 μ F, 8d. 0.068, 0.1 μ F, 9d. 0.15 μ F, 11d. 0.22 μ F, 1/- 0.33 μ F, 1/3. 0.47 μ F, 1/6. 0.68 μ F, 2/3. 1 μ F, 2/8.

400V: 1,000, 1,500, 2,200, 3,300, 4,700pF, 6d. 6,800pF, 0.01, 0.015, 0.022 μ F, 7d. 0.033 μ F, 8d. 0.047 μ F, 9d. 0.068, 0.1 μ F, 11d. 0.15 μ F, 1/2. 0.22 μ F, 1/6. 0.33 μ F, 2/3. 0.47 μ F, 2/8.

Modular, metallised, P.C. mounting, 20%, 250V: 0.01, 0.015, 0.022 μ F, 7d. 0.033, 0.047 μ F, 8d. 0.068, 0.1 μ F, 9d. 0.15 μ F, 11d. 0.22 μ F, 1/- 0.33 μ F, 1/5. 0.47 μ F, 1/8. 0.68 μ F, 2/3. 1 μ F, 2/9.

POLYSTYRENE CAPACITORS: 5%, 160V (uncapsulated): 10, 12, 15, 18, 22, 27, 33, 39, 47, 56, 68, 82, 100, 120, 150, 180, 220, 270, 330, 390, 470, 560, 680, 820pF, 5d. 1,000, 1,500, 2,200pF, 6d. 3,300, 4,700, 5,600pF, 7d. 6,800, 8,200, 10,000pF, 8d. 15,000, 22,000pF, 9d.

1%, 100V (encapsulated): 100, 120, 150, 180, 220, 270, 330, 390, 470, 500, 560, 680, 820pF, 1/- 1,000, 1,200, 1,500, 1,800, 2,200, 2,700, 3,300, 3,900pF, 1/3. 4,700, 5,000, 5,600, 6,800, 8,200, 10,000, 12,000, 15,000pF, 1/6. 18,000, 22,000, 27,000, 33,000, 39,000pF, 1/9. 0.047, 5,000, 0.056 μ F, 2/- 0.068, 0.082, 0.1 μ F, 2/3. 0.12 μ F, 2/9. 0.15, 0.18 μ F, 3/- 0.22 μ F, 4/- 0.27, 0.33 μ F, 5/- 0.39 μ F, 5/9. 0.47, 0.5 μ F, 6/3.

JACK PLUGS (Screened): Heavily chromed, $\frac{1}{2}$ in Standard: 2/9 each.

Side-entry: 3/3 each.

Standard (Unscreened): 2/3 each.

JACK SOCKETS ($\frac{1}{2}$ in Plug): With chrome insert, 2/9 each. Available with: Break/Break, Make/Break, Break/Make, Make/Make contacts.

POTENTIOMETERS (Carbon): Long life, low noise, $\frac{1}{2}$ VW at 70°C. $\pm 20\% \leq \frac{1}{2}$ M, $\pm 30\% > \frac{1}{2}$ M. Body dia., $\frac{1}{2}$ in. Spindle, $\frac{1}{16}$ in $\times \frac{1}{2}$ in, 2/3 each. Linear: 100, 250, 500 ohms, etc., per decade to 10M. Logarithmic: 5k, 10k, 25k, etc., per decade to 5M.

SKELTON PRE-SET POTENTIOMETERS (Carbon): Linear: 100, 250, 500 ohms, etc., per decade to 5M.

Miniature: 0.3VW at 70°C. $\pm 20\% \leq \frac{1}{2}$ M, $\pm 30\% > \frac{1}{2}$ M. Horizontal (0.7in \times 0.4in P.C.M.) or Vertical (0.4in \times 0.2in P.C.M.) mounting, 1/- each.

Submin. 0.1W at 70°C. $\pm 20\% \leq \frac{1}{2}$ M, $\pm 30\% > \frac{1}{2}$ M. Horizontal (0.4in \times 0.2in P.C.M.) or Vertical (0.2in \times 0.1in P.C.M.) mounting, 10d each.

RESISTORS (Carbon film), very low noise. Range: 5%, 4.7 Ω to 1M Ω (E24 Series): 10%, 10 Ω to 10M Ω (E12 Series).

$\frac{1}{2}$ VW (10%), 1 $\frac{1}{2}$ d (over 99, 1 $\frac{1}{2}$ d), 100 off per value 12/- $\frac{1}{2}$ VW (5%), 2d (over 99, 1 $\frac{1}{2}$ d), 100 off per value 13/9. $\frac{1}{2}$ VW (10%), 2d (over 99, 1 $\frac{1}{2}$ d), 100 off per value 13/9. $\frac{1}{2}$ VW (5%), 2 $\frac{1}{2}$ d (over 99, 2d), 100 off per value 15/6.

SEMICONDUCTORS: OA5, OA81, 1/9. OC44, OC45, OC71, OC81, OC81D, OC82D, 2/- OC70, OC72, 2/3. AC107, OC75, OC170, OC171, 2/6. AF115, AF116, AF117, ACY19, ACY21, 3/3. OC140, 4/3. OC200, 5/- OC139, 5/3. OC25, 7/- OC35, 8/- OC23, OC28, 8/3.

SILICON RECTIFIERS (0.5A): 170 P.I.V., 2/9. 400 P.I.V., 3/- 800 P.I.V., 3/3. 1,250 P.I.V., 3/9. 1,500 P.I.V., 4/- (0.75A): 200 P.I.V., 1/6. 400 P.I.V., 2/- 800 P.I.V., 3/3. (6A): 200 P.I.V., 3/- (400 P.I.V., 4/- 600 P.I.V., 5/- 800 P.I.V., 6/- THYRISTORS (5A): 100 P.I.V., 8/- 200 P.I.V., 10/- 400 P.I.V., 15/-

SWITCHES (Chrome finish, Silver contacts): 3A 250V, 6A 125V.. Push Buttons: Push-on or Push-off 5/-. Toggle Switches: SP/ST, 3/6. SP/DT, 3/9. SP/DT (with centre position) 4/- DP/ST, 4/6. DP/DT, 5/-

PRINTED CIRCUIT BOARD (Vero).

0.15in Matrix: 3 $\frac{1}{2}$ in \times 2 $\frac{1}{2}$ in, 3/3. 5 $\frac{1}{2}$ in \times 2 $\frac{1}{2}$ in, 3/11. 3 $\frac{1}{2}$ in \times 3 $\frac{1}{2}$ in, 3/11. 5in \times 3 $\frac{1}{2}$ in, 5/6. 0.1in Matrix: 3 $\frac{1}{2}$ in \times 2 $\frac{1}{2}$ in, 4/- 5in \times 2 $\frac{1}{2}$ in, 4/6. 3 $\frac{1}{2}$ in \times 3 $\frac{1}{2}$ in, 4/6. 5in \times 3 $\frac{1}{2}$ in, 5/3.

RECORDING TAPE (Finest quality MYLAR—almost unbreakable).

Standard Play: 5in, 600ft, 7/6. 5 $\frac{1}{2}$ in, 850ft, 10/6. 7in, 1,200ft, 12/6. Long Play: 3in, 225ft, 4/- 5in, 900ft, 10/6. 5 $\frac{1}{2}$ in, 1,200ft, 13/- 7in, 1,800ft, 18/-

Send S.A.E. for January, 1969 Catalogue

circuit, two arms being the cells containing the sample and a reference standard, the third the balance control and zero setting trimmer, and the fourth having a capacitance zero trimmer to allow for the capacitance in the cells, across the reference resistor. To avoid electrolytic dissociation of the sea water damaging the electrodes, an a.c. source is used, between 500 and 5,000Hz. The cells must be of high resistance to avoid electrical heating.

The main difficulty of this circuit is the problem of measuring the variable resistor to 1 part in 50,000 as would be necessary to obtain the required accuracy. This may be overcome by using a transformer bridge. Other advantages of this form of circuit are that it has a negligible temperature coefficient and very little capacitance to earth. The number of turns must be controllable to 1 part in 100,000, and this is overcome by using a system of tapped coils shown in Fig. 9a.

Fig. 9b shows the complete bridge which will give an output as an oscilloscope trace indicating both resistive and reactive null-points.

INDUCTION CELLS

For *in situ* measurements of salinity the conductance bridge is quite unsuitable. The electrodes would be fouled very quickly with insoluble matter and the temperature would be difficult to control accurately or compensate for. These problems are not inherent, however, in the induction or electrodeless salinometer.

Figs. 10a and 10b show the principle of the induction cell. Two magnetically shielded toroids are wound on a non-inductive former with the water sample coupling them. On to each former a second coil is wound, one of which is in opposition to its primary, so that it may be used to give a null-reading at the balance point of the bridge, i.e. when the voltage induced in the secondary by the water link is balanced out by the voltage induced by the second coil system.

Close-up of the probe, showing inductive salinity sensor—upper of two cylinders near the base of the probe

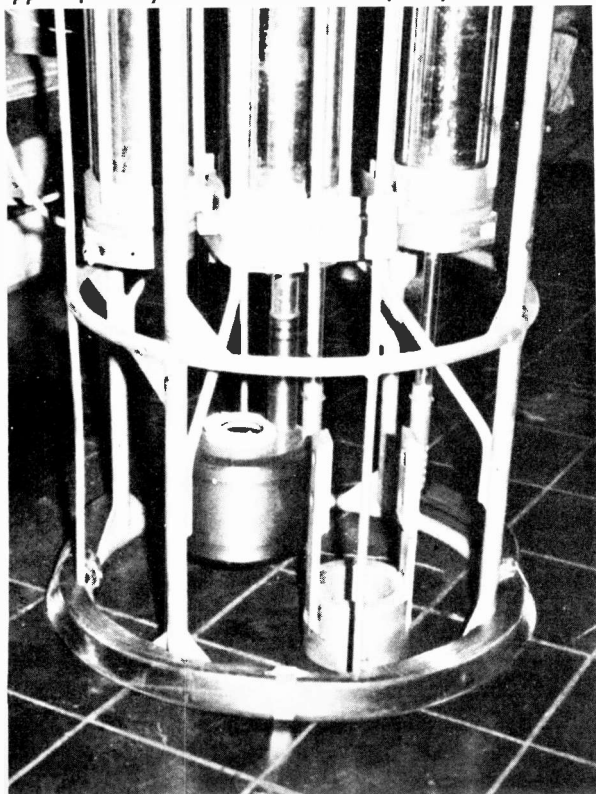

However, the salinity of a given sample is dependent on temperature and pressure in a rather complex way, and whilst some induction cells record pressure and temperature along with conductance for subsequent compensation, a more convenient way is to compensate within the instrument. Typical temperature and pressure compensating circuits are shown in Figs. 10c and 10d.

As mentioned earlier, the most efficient way of transmitting analogue data from a probe to a ship is in the form of a modulated frequency. This salinity system can be made to vary a frequency by use of positive feedback through a variable phase amplifier (Figs. 11a, 11b). In the paralog system positive feedback occurs through amplifiers A1 and A2. For this to occur the total phase shift around the circuit must be zero or 360 degrees, and the frequency of oscillation will change until the variable phase amplifier (Q2) can create this condition. The phase shift due to E_r , the combination of E_0 and E_1 shifted through 90 degrees, depends on the magnitude of E_0 , which in turn, is dependent on the state of the sensor.

In a typical survey probe three such systems may be incorporated using respectively an induction cell, a thermistor and a vibrotron unit, giving out three different main frequencies modulated to give the variation in salinity, temperature and pressure of the water surrounding the probe.

Fig. 11c shows how this information can be received on board the ship and analysed by use of narrow band-pass amplifiers and frequency modulation detectors to give a voltage dependent on frequency, and subsequently recorded as a plot of temperature and salinity against depth (equivalent to pressure) on an X1, X2, Y pen recorder.

To be continued

Salinity, temperature, depth probe
(Plessey)

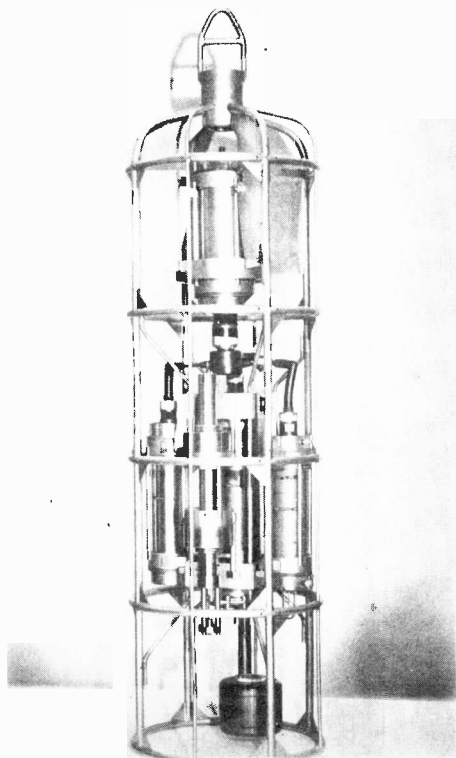



UNLIMITED!

A selection of readers' suggested circuits. It should be emphasised that these designs have not been proven by us. They will at any rate stimulate further thought.

This is YOUR page and any idea published will be awarded payment according to its merit.

SUPPRESSED ZERO CAR VOLTMETER

THE voltage appearing across the terminals of a car battery is a useful indication of the state of the battery and charging circuit. If a conventional voltmeter (say 0 to 15 volts) is connected across the battery it will be found that only a small portion of the scale is used, centred on the nominal battery voltage of 12 volts and extending a maximum of about 3 volts on either side, as the battery charges and discharges (see Fig. 1).

A Zener diode has the property of not conducting until a certain voltage, the Zener voltage, appears across it. The voltage drop across the diode then remains constant provided its wattage rating is not exceeded.

Consider now the circuit of the improved battery voltmeter (Fig. 2). A 9 volt Zener diode is connected in series with a conventional voltmeter circuit (moving coil meter plus multiplier resistance) which measures 6 volts full scale. If the voltage across the terminals of the instrument is less than 9 volts then the diode will not conduct and the meter will read zero. Suppose the voltage now rises to 12 volts. The diode will conduct and a voltage drop of 9 volts will appear across it, 3 volts will then appear across the voltmeter circuit which will then indicate half full scale deflection. If the voltage now increases to 15 volts, 9 volts will again appear across the diode and 6 across the meter, which will indicate full scale deflection. The meter will, therefore, only indicate voltages between 9 and 15 volts, thus spreading the useful part of the readings on a conventional voltmeter along the full scale length of the meter used.

In the prototype a 9 volt, $\frac{1}{4}$ watt Zener diode was used and the 0 to 6 volt voltmeter, M1, consisted of an ex-Government 5mA moving coil meter in series with a 3 kilohm potentiometer, VR1.

CONSTRUCTION

Construction consisted of mounting the two components on a small piece of Veroboard which was bolted to the back of the meter by the nuts on the meter terminal bolts. Connection to the meter terminals was by solder tags which were soldered to the board. A red lead and a black lead from the board formed the input connections to the instrument. Care was taken to observe the correct polarity and one lead was taken to the car chassis and the other to the ignition switch so that the voltmeter continuously monitored the battery voltage when the ignition was turned on.

CALIBRATION

Calibration was carried out by setting the potentiometer VR1 to its maximum resistance and connecting an accurate 12 volt supply to the instrument. The potentiometer was adjusted for half full scale deflection on the meter. The potentiometer was then sealed with a blob of wax. The original scale on the meter which read 0 to 5mA was covered with white paper, leaving the scale itself uncovered. The figures 9 to 15 were substituted for 0 to 5. The figure 12 appeared at the centre of the scale in place of the original 3.

A very neat and professional looking job was obtained with the aid of "Letraset" dry transfer letters. The legend VOLTS was also added.

This type of instrument is known as a suppressed zero voltmeter and this technique could be adapted for uses other than the one described. Care must be taken not to exceed the manufacturer's published wattage ratings of the diode. The prototype has been in use in the author's car for some months and has proved very useful.

P. A. Graves,
Westcliff-on-Sea,
Essex.

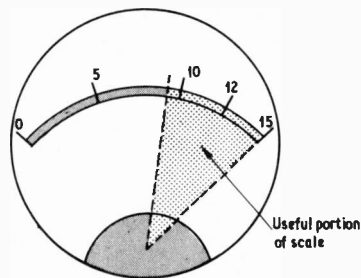

Fig. 1. The small segment of the scale that is used in conventional car voltmeters

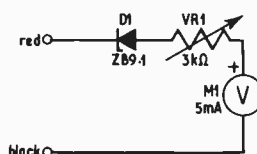

Fig. 2. Circuit diagram of the improved car battery voltmeter

Sinclair launch their System 2000 range with the amplifier, tuner and speaker shown here. The tuner and amplifier are separate units which may be mounted together for convenience. Each is complete in itself and may be used with existing high fidelity equipment. The System 2000 uses new components and ingenious construction in ways which reduce costs, increase performance and improve reliability.

For example, look at the circuits of most F.M. tuners and you will find that they vary very little. Look at the System 2000 tuner. You will notice the absence of conventional

coils. They have become an integral part of the printed circuit and never need adjustment—another step in increasing reliability and reducing the final price. Almost all other tuners use the Foster-Seeley discriminator or the ratio detector. The System 2000 tuner uses a pulse counting discriminator. This is free from drift and possesses a lower level of distortion than any other system. Inter-station noise suppression, mains tuning and stereo indicators together with a sensitivity for full limiting of an incredible 3 microvolts are all incorporated. An additional attractive feature is

provision for plug-in remote and switched tuning units (available separately). The amplifier and loudspeaker are equally outstanding and well worth comparing for yourself. Ask your dealer for a demonstration or write or ring us for a leaflet.

- System 2000 35 watt Integrated Stereo Amplifier 29 gns
 - System 2000 F.M. Tuner 25 gns
 - Plug-in stereo decoder 4 gns
 - System 2000 8 ohm loudspeaker 12 gns
- Sinclair Radionics Limited, 22 Newmarket Road, Cambridge. Tel. Cambridge 52996

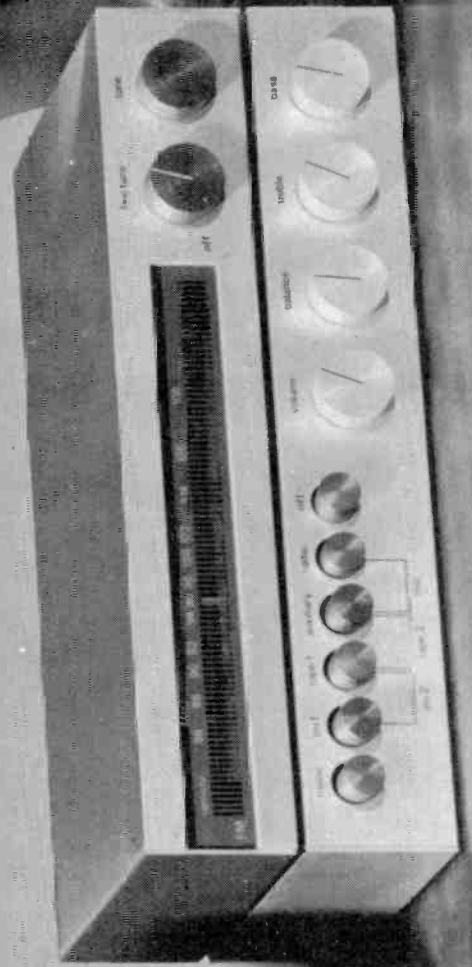
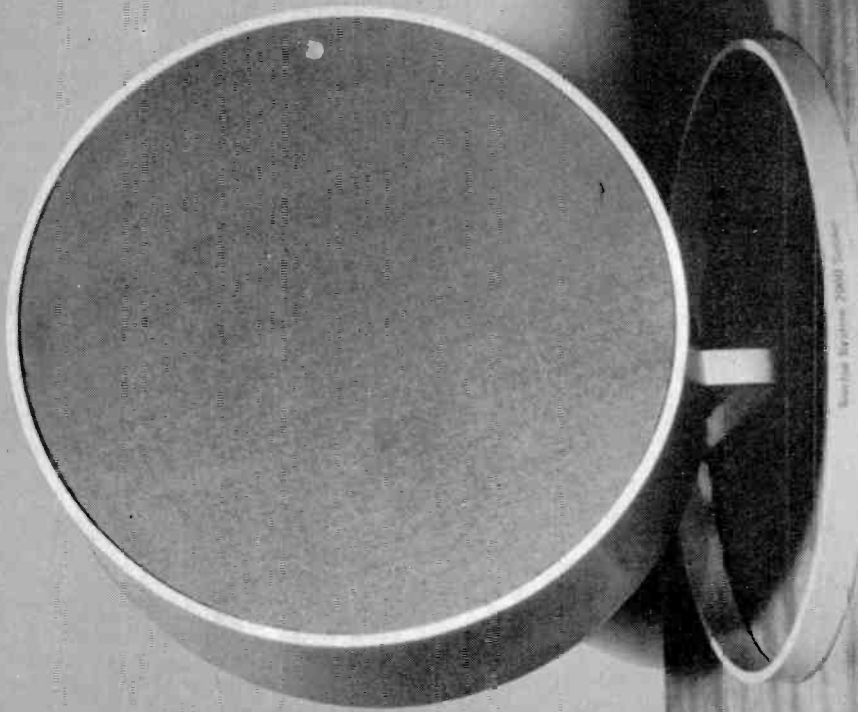

SINCLAIR

Shown here System 2000

SINCLAIR Z.12 12 WATT INTEGRATED HI-FI AMPLIFIER & PRE AMP

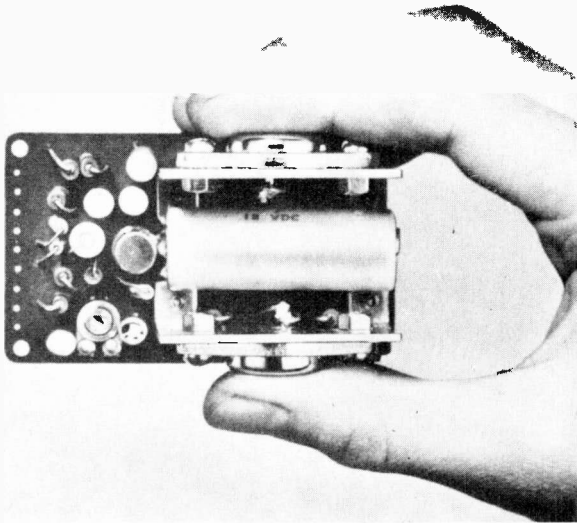

12 watts R.M.S. continuous sine wave output.

This is the recommended amplifier for those requiring greater power than that provided by the IC.10. This eight transistor amplifier is the most successful of its kind ever designed. It has an excellent power to size ratio and is easily adapted to a wide variety of applications. The Z.12 performs satisfactorily from a wide range of voltages and it can easily be run from car batteries. This true 12 watt amplifier comes to you ready built, tested and guaranteed together with useful manual of circuits and instructions for matching the Z.12 to your precise requirements. Two may be used for stereo, when the Sinclair Stereo 25 will be found the ideal control unit for use with it:

Size—3in x 1½in x 1½in. Class B Ultralinear Output: Frequency response from 15 to 15,000Hz \pm 1dB: Output suitable for loudspeakers from 3 to 15 ohms impedance. Two 3 ohm speakers may be used in parallel: Input 2 mV into 2K ohms: Output 12 watts R.M.S. continuous sine wave (24 watts peak); 15 watts music power (30 watts peak) Power requirements 6—20V d.c. from battery or PZ.4 Mains Supply Unit. Ready built, tested and guaranteed.

89/6

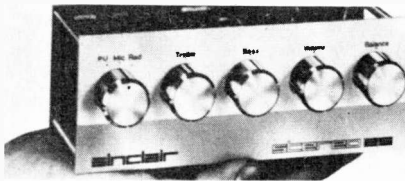

SINCLAIR STEREO 25

De Luxe Pre-amp and Control Unit for IC.10 or Z.12 Stereo assemblies. Switched inputs for P.U (equalised to R.I.A.A. curve from 50 to 20,000 Hz \pm 1dB), Radio and auxilliary. Supplied ready built with very attractive solid brushed and polished aluminium front panel. Control knobs for Bass/Treble/Volume/Balance/Input are solid aluminium. Size—6½ x 2½ x 2½in plus knobs. Built, tested and guaranteed.

£9.19.6

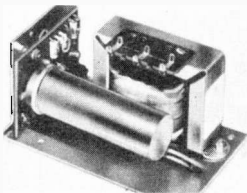

SINCLAIR PZ4

STABILISED MAINS POWER SUPPLY UNIT

Heavy duty transistorised power supply unit to deliver 18V d.c. at 1.5A. Designed specially for use with two Z.12 or IC.10 Amplifiers together with Stereo 25. Built, tested and guaranteed.

99/6

sinclair

SINCLAIR RADIONICS LTD, 22 NEWMARKET ROAD, CAMBRIDGE. OCA3-52996

SINCLAIR MICROMATIC



The world's smallest radio

This fantastic little British pocket receiver is available in kit form to build for yourself or ready built, tested and guaranteed. Its range and selectivity must be experienced to be believed; its power and quality everything you could want. The Micromatic tunes over the medium waveband and has A.G.C. to counteract fading from distant stations. Bandpass tuning makes reception of Radio 1 easier; in fact, you will find your Micromatic performing where other sets cannot be heard at all. The neat black case with aluminium front panel and tuning control give the Micromatic elegantly modern appearance.

- High quality magnetic earpiece
- Choice of many stations
- Plays anywhere

Kit in fitted pack with earpiece, solder and instructions. **49/6**

Built, tested and guaranteed. **59/6**

Mallro Mercury Cells RM.675 (2 reqrd) each 2/9

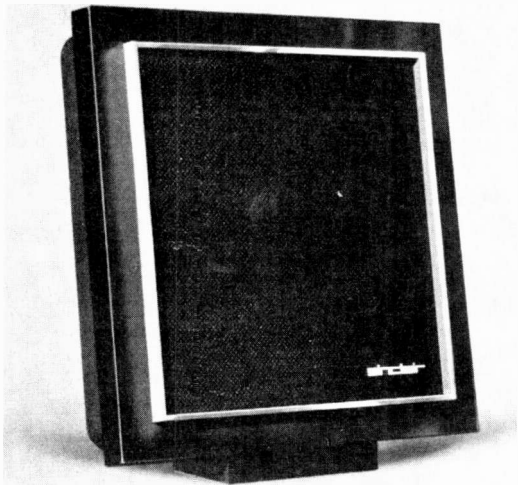

SINCLAIR Q.14

the most challenging loudspeaker design in years

It is more than a matter of saving money when you choose the Q.14. This is the loudspeaker that delights experts and critics alike for its fine forward quality, its clarity and exceptional adaptability. Designed on original lines and from unusual materials, the Q.14 will easily carry up to 14 watts and has very smooth response from 60 to 16,000 Hz. Size—9½ in square x 4¼ in deep, with matt black finish and solid aluminium bar embellishment. Input impedance—8 ohms.

The Q.14 costs about a quarter of what you might expect to pay for a good stereo speaker system. A pair used with IC.10s or Z.12s and the Stereo 25 will give you superb high fidelity to stand comparison with far costlier equipment.

Try the Q.14 in your own home without delay. If it does not delight you, send it back and your money including cost of postage will be refunded in full.

£7.19.6

GUARANTEE

Should you not be completely satisfied with your purchase when you receive it from us, your money will be refunded in full at once and without question. Full service facilities available to all purchasers.

ORDER FORM BRINGS PROMPT DELIVERY SENT TO YOU POST PAID

To: SINCLAIR RADIONICS LIMITED 22 NEWMARKET ROAD, CAMBRIDGE.

Please send POST FREE

NAME

ADDRESS

For which I enclose cash/cheque/money order.

PW.169

sinclair

SINCLAIR RADIONICS LIMITED
22 NEWMARKET ROAD,
CAMBRIDGE OCA3-52996

S-DeC BREADBOARDING

- Fast, reliable, solderless circuit assembly
- Contacts last indefinitely
- Use ordinary components again and again
- Test *all* the circuits in the magazines

This breadboard is used professionally by development engineers throughout the world. Over 80% of current production is exported.

A booklet of projects is included with each kit giving construction details for a variety of circuits such as amplifiers, oscillators, VHF transmitter, radio, etc.

S-DeC Kit: One S-DeC with Control Panel, Jig and Accessories for solderless connections to controls, etc., with booklet "S-DeC Projects" giving construction details for a variety of circuits. 29/6d retail.

4-DeC Kit: Four S-DeCs with two Control Panels, Jigs and Accessories and the booklet "S-DeC Projects" all contained in a strong, attractive, plastic case. Ideal for the professional user. £5.17.6 retail.

1/- Packing and Postage for S-DeCs, and 3/- Packing and Postage for 2- and 4-DeCs.

AVAILABLE FROM LEADING SUPPLIERS

or in case of difficulty from

S.D.C. PRODUCTS (Electronics) LTD

THE CORN EXCHANGE, CHELMSFORD, Essex

Telephone: Chelmsford (OCH 5) 56215

GOODMANS HIGH FIDELITY MANUAL



A Guide to full
listening enjoyment

The Manual is much more than a catalogue of Goodmans High Fidelity Loudspeakers—it contains informative articles, including advice on stereo, special beginners page, and full cabinet drawings. You'll find it interesting as well as informative.

**The Perfect Combination
MAXAMP 30**

TRANSISTORISED STEREPHONIC HIGH FIDELITY AMPLIFIER 15 + 15 watts · Silicon solid state integrated pre-amplifier · Negligible distortion · **£54.0.0.**

STEREOMAX

MATCHING AM/FM STEREPHONIC FM TUNER Transistorised · Outstanding specification · Stereo decoder (optional) · **£65.5.0 + £15.14.0 P.T.**

Both **MAXAMP 30** and **STEREOMAX** have polished wood cases (10½" × 5½" × 7¼" deep) in Teak or Walnut to order.

Full specifications of the Maxamp 30 and Stereomax are given in the High Fidelity Manual—send the coupon for your FREE copy—or pay an early visit to your Goodmans dealer.

FREE Please send Hi-Fi Manual together with name and address of my nearest Goodmans dealer.

Name

Address

PE169

GOODMANS LOUDSPEAKERS LTD
AXIOM WORKS · WEMBLEY · MIDDLESEX. Tel: 01-902 1200



Radio Technicians

required now for vital work in
Air Traffic Control

Join the National Air Traffic Control Service, a Department of the Board of Trade, and play a vital part in the safety of Civil Aviation. Work on the latest equipment in Computers, Radar and Data Extraction, Automatic Landing Systems and Closed-Circuit Television, at Civil Airports, Air Traffic Control Centres, Radar Stations and other engineering establishments in the South of England, including Heathrow, Gatwick and Stansted.

If you are 19 or over, with practical experience in at least one of the main branches of telecommunications, fill in the coupon now. Your starting salary would be £869 (at 19) to £1,130 (at 25 or over); scale maximum £1,304 (rates are higher at Heathrow). Non-contributory pensions for established staff.

Career Prospects. Your prospects are excellent, with opportunities to study for higher qualifications in this expanding field.

Apply today, for full details and application form.

Write for details to: Mr. T. H. Mallett, B.Sc., (Eng.), C.Eng., M.I.E.E., Room 754, The Adelphi, John Adam Street, London, W.C.2, marking your envelope 'Recruitment'.

Name

Address

RPE 2

Not applicable to residents outside the United Kingdom.

NATCS

National Air Traffic Control Service

Bargain—Car Radios. Our Price 9 gns. Retail value 16 gns. Negative or positive earth (switched) fully transistorised (12v) medium and long waves. Speaker and fitting kit supplied at no extra cost. P/p. 5/-.

Intercom/Baby Alarm System. Fully transistorised ideal for home, office or workshop. Robust construction, offered at a fraction of retail price 47/6 + 2/6 p/p.

Sonotone 9TA and 9TA/HC. Diamond Cartridge brand new, boxed in manufacturers' cartons 49/6 + 2/6 p/p. Acos GP 91-1 and GP 91-3 stereo compatible cartridges, new in sealed manufacturers' cartons 22/6 + 2/6 p/p.

TR10 Stereo Moving Magnet Cartridge Model AD76K. Diamond Stereo LP Stylus. Frequency response 20-20,000 c/s output 7mv tracking pressure 2 grammes ± 0.5 gm. Fully guaranteed. Price 85/- p/p free.

BASF TAPE	LONG PLAY	
5in.	900ft.	17/-
5½in.	1200ft.	21/6
7in.	1800ft.	33/-

Bargain—Changer Decks at Lowest Prices Ever

Plinth WB1	Garrard 1025	p/p. 7/6	£8. 0.0
£2.15.0	Garrard 2025	p/p. 7/6	£8.10.0
Cover SPCI	AT60 Mk. II	p/p. 8/6	£12.19.6
£2.15.0	SP25 Mk. II	p/p. 8/6	£12. 0.0
	3500 with Son 9TA Cart		£10.10.0



The greatest HI-FI Budget system to-day—Can't be beaten—price or quality anywhere—look at these great features—then compare.

Teleton F2000 tuner amp. AM-FM with multiplex decoder and A.F.C.—2 x 5w channels R.M.S. Bass Volume Treble Balance controls, a truly outstanding unit 35 8 11

Garrard SP 25 Mk II Transcription deck 15 6 4

Teleton SA 1003 matching speaker enclosures 9 5 0

Sonotone 9TA Diamond Cartridge 3 16 7

Plinth and perspex cover 7 0 0

£70 16 10

Exclusively offered by SBE at the remarkably low price of £59 gns.

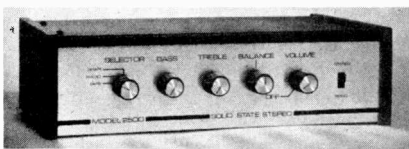

4 Watt Transistorised Amplifier with integral stabilised power unit. Complete ready built and tested, with volume and tone control on flying lead. Retail price £6.15.0. Now offered at price Only 99/6 plus 8/- p/p.

Beautiful oiled teak enclosure to suit EMI 13 x 8in. speakers. Retail value £8.15.0. Our low-low price Only 99/6 plus 8/- p/p.

This month's SBE offer 5 x 5W transistorised stereo amplifier. Undoubtedly a most remarkable offer—outstanding performance, comparable with amplifiers in the £25-£30 price range. Brief specification includes volume, bass, treble, balance control, stereo, mono, switch, inputs, sockets, tape tuner pick up AUX. Being Manufacturers' distributors of this fine stereo amplifier, as an initial promotion we are prepared to offer this unit at fractionally above cost for a limited period only. 15 gns. p/p free.

HI-FI The Baker Selhurst stalwart SPEAKERS 12in. round, 15 watt rating. **BARGAINS** 12,000 lines GAUSS, 3 or 15 OHMS response 45-12,000 c/s Bass resonance, 40-50 c/s. solid aluminium chassis. Our price £4.19.6.

The Baker Selhurst guitar group 25 12in. round, 25 watt rating, 12,000 lines GAUSS, 15 ohms response 30-10,000 c/s solid aluminium chassis. heavy duty cons. Our Price £4.19.6, p/p 6/6. Brand new. 12 month's unconditional guarantee.

E.M.I. 8 x 5 elliptical 5 watt 3 ohm alcomax magnet, sold elsewhere 50/- Our Price 27/6 p/p free. 13 x 8 elliptical 13,000 lines GAUSS 3 or 15 Ohm 10 watt alcomax magnet usually £4. Our price 47/6 p/p free. 13 x 8 elliptical with double tweeter and cross over unit, IMP 3 or 15 ohm 10 watt Bass res. 40,50hz. Magnadure 11 Magnet. Usually £6.10.0. Our Price 59/6 p/p free.

SBE. 12in. diam. 20 watt twin cone HI-FI speaker as sold by leading manufacturer. Usual price £5.17.6. Our price 87/6 p/p 5/-.

WALDON ELECTRONICS Atlas House, Chorley Old Rd., Bolton. Bolton 45628.

TRANSISTOR SUBSTITUTION HANDBOOK

AMERICAN, JAPANESE, BRITISH, ETC. NEW 8th EDITION. 16/- P. & P. 1/3.

MODERN DICTIONARY OF ELECTRONICS by Graf. 3rd ed. 70/- P. & P. 4/6.

SILICON CONTROLLED RECTIFIERS by Lytel. 21/- P. & P. 1/3.

F.E.T. CIRCUITS by Turner. 25/- P. & P. 1/3.

HAVING FUN WITH TRANSISTORS by Buckwalter. 24/- P. & P. 1/3.

COMPUTERS FOR THE AMATEUR CONSTRUCTOR by Warring. 20/- P. & P. 1/3.

CIRCUITS FOR AUDIO AND TAPE RECORDING by Judd. 7/6 P. & P. 1/-.

HI-FI IN THE HOME by Crabbe. 40/- P. & P. 2/-.

SYSTEMATIC ELECTRONIC FAULT DIAGNOSIS by Wingate. 17/6 P. & P. 1/3.

SOLID STATE POWER SUPPLIES AND CONVERTERS by Lytel. 20/- P. & P. 1/-.

TRANSISTORS IN LOGICAL CIRCUITS by Altas. 16/- P. & P. 1/-.

COLOUR T.V., PAL SYSTEM by Patchett. 40/- P. & P. 1/3.

UNIVERSAL BOOK CO.
12 LITTLE NEWPORT ST., LONDON, W.C.2
(Leicester Square Tube Station)
Phone 01-437 4560

AMPLIFIERS

SSAR3. 10W push-pull output. TW99 output trans. Four valve. Full chassis mounting. New and boxed. Complete with circuit drawings. £2.10.0. P. & P. 10/-.

SSAR7. 100W output. Three valve. TW182 output trans. Selenium rectifiers. 8µF. condenser. Full chassis mounting. New and boxed. Complete with circuit drawings. £2.10.0. P. & P. 00/-.

JUST RELEASED

R.A.F. Receiver Type R3673. Details on request.

Mixer Units Type 18. H.F., M.F., L.F. Valve V885. 10/- P. & P. 2/6

Micro-Ammeters for Instrument Mounting, etc. 0-100mA. 30/- P. & P. 2/6

Micro-Ammeters Type Y. 0-100mA. Heavy duty in case complete with leads. 43. P. & P. 5/-.

Flexible Metal Tubing. Galvanised. Watertight. 35/- 100ft. P. & P. 7/6

ELECTRO-METHODS. Low Inertia Motor 24V d.c. 2,000 r.p.m. 20/- P. & P. 2/6

CHASSIS UNIT. 7 valves ECC82 (3), EB91 (3), 6F33 (1). 45 Capacitors. Resistors, etc. Valve bases and cans. 20/- P. & P. 2/6

TRANSFORMERS (examples).

SSTR073. Pri. 230V. Sec. 35V (0.5A), 6-3V (2A), 225-0-225V (27mA), oil filled. 25/- P. & P. 5/-

SSTR009. Pri. 230V. Sec. 0-50V (50mA), 4V (1A), 6-3V (8A). 25/- P. & P. 5/-

1,000 Ohm Transformers in stock.

CAPACITORS. 20 assorted 0.01mF to 1mF (our selection). 10/- P. & P. 2/-

CABLE. Six core (100yd new) with drum assembly. 25/- P. & P. 4/6

TEST INSTRUMENTS, ETC. S.A.E. FULL LIST. STATUS SUPPLIES
STATUS HOUSE, WILKINSON AVE., BLACKPOOL

BATTERY ELIMINATORS

The ideal way of running your TRANSISTOR RADIO, RECORD PLAYER, TAPE RECORDER, AMPLIFIER, etc. Types available: 9v; 7½v; 6v; 4½ (single output) 39/6 each. P. & P. 2/9. 9v + 9v; 6v + 6v; or 4½v + 4½v (two separate outputs) 42/6 each. P. & P. 2/9. Please state output required. All the above units are completely isolated from mains by double wound transformer ensuring 100% safety.

R.C.S. PRODUCTS (RADIO) LTD.
(Dept. P.E.), 31 Oliver Road, London. E.17

CRESCENT RADIO LTD.

(Electronic component specialists)

For all regular components try

40 Mayes Road, Wood Green, N.22

For surplus components and equipment try

11 Mayes Road, Wood Green, N.22

GARRARD TURNTABLES AT BARGAIN PRICES

1025, with mono cartridge	£8.10.0
2025, with 9TA/HC. stereo cartridge	£9.15.0
3000, with 9TA/HC. stereo cartridge	£10.10.0
SP25, less cartridge	£11.10.0
Please include 7/6 postage with order	
Sonotone 9TA/HC, with diamond stylus	47/6 each
Please include 2/6 postage with this item	
Plinths for Garrard types teak finish	50/- each
Plinths as above complete with cover	95/- each
Postage on plinths 6/- each	
Stereo headphones 8 ohm Imp	£3.10.0
Ex Govt. low imp headphones	10/6 each
2,000 ohm headphones Foster type	15/- each
Please include 1/6 postage	
Mono microphone mixer 4 way transistor type	49/-
Stereo microphone mixer 4 way transistor type	59/6
Please include 2/6 postage	
MW/LW AM tuner, valve type, ready to work through any amplifier	£4.0.0
Please include 4/- postage	
Standard gram amplifier suitable for all turntables and above tuner. Single valve type	59/6 each

CASSETTES

C60	12/6 each
C90	18/6 each

With our new premises in Mayes Road we can now offer an even wider selection of components for the home constructor and enthusiast.

POSTAGE WITH ORDER PLEASE

P.S.
Our new catalogue is now available at 1/6 per copy

ELECTRONICS INSTRUCTORS

Due to reorganization within the Apprentice Training School, Borehamwood, Herts, vacancies now exist for two Electronics Instructors, working as a team, to teach theory, and to institute interesting projects for practical application.

The senior member of the team will be responsible for preparation of the working syllabus, together with care and calibration of instruments in the Electronics Laboratory, the teaching of electronic theory together with practical applications.

The junior member will give instructions on wiring, soldering, cable forms, etc. and assist the senior member generally. A general knowledge of machining practice would be advantageous, so that he may be employed in the Fitting Shop in an emergency.

The apprentices spend their first year in the Training School, during which time they acquire experience of basic fitting and machining, together with an introduction to electronics.

These positions will be monthly salaried staff posts, in the starting range £800-£1,300 per annum.

Those interested should please write, with brief particulars to the Personnel Officer,
Elliott-Automation Limited,
 Elstree Way, Borehamwood, Herts.
 Ref. No. PE 156.

ELLIOTT-AUTOMATION
 AN ENGLISH ELECTRIC COMPANY

Opportunity of a lifetime! Big price reductions on top quality Knight-Kits

Easy to build. Advanced design. Invaluable for both the professional and amateur. Faultless performance guaranteed.

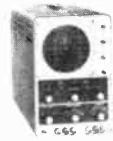

KG635 5-inch Oscilloscope Kit

For Colour TV Servicing and General Wideband Testing. D.C. to 5.2-MHz Bandwidth. 5 Linear time base ranges. Response: $\pm 1.5\text{dB}$. DC to 5.2 MHz (vertical), $\pm 1.5\text{dB}$. 1 Hz to 400 kHz (horizontal). Complete kit: £62.19.6. Postage 15s 0d plus 4s 0d per pcb.

KG687 Solid State

Sweep/Marker Generator

Silicon transistors.

Covers all colour/monochrome TV, FM, IF and

VHF frequencies. Sweep oscillator covers 3 to 220 MHz on 5 fundamental bands. Marker oscillator covers 2 to 225 MHz on four bands. Complete kit: £54.2.6. Postage 15s 0d.

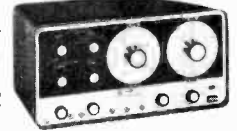

KG663 Regulated 0-40 Volt Solid State DC Power Supply Kit

Compact. 6 silicon transistors. 12 diodes. Output voltage and current 0-40V DC, 0-1.5 A, continuously variable. Complete kit: £40.19.6. Postage 10s 0d



KG661 Solid-State Regulated Low-Voltage DC Power Supply Kit

Compact and rugged. 4 silicon transistors. 7 diodes. Voltage output 0-25 volts DC. at 0-6 amp. Complete kit: £15.6.6. Postage 10s 0d.



KG686 Lab. Quality RF Signal Generator

100 kHz/1 MHz Crystal Calibrator. 10 silicon transistors. 6 diodes. Frequency coverage 100 kHz to 54 MHz. Accuracy $\pm 1.5\%$ on 5 fundamental bands. Complete kit: £39.13.6. Postage 15s 0d.

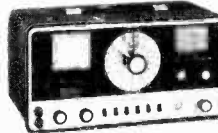

KG688 Solid-State Sine/Square Wave Generator Kit

Sine Wave: 20Hz to 2 MHz in 5 ranges. Square Wave: 20 Hz to 200 kHz in 4 ranges. Precision Sulzer oscillator circuit. All silicon transistors. Complete kit: £36.5.6. Postage 10s 0d.



G30 Grid-dip Meter Kit

Covers all frequencies from 1.5 to 300 MHz in 6 overlapping ranges. Extremely compact. Supplied with 6 coils in plastic case. Complete kit: £12.15.6. Postage 4s 0d.



KG675 R & C Substitution Box

Eliminates need for soldering and resoldering when substituting. 36 switch-selected Resistance Ranges. 19 Switch-selected Capacitance Ranges. 750 mA, 800 PIV Silicon Diode. 40 mfd 450V Capacitor. Complete kit: £7.19.6. Postage 7s 6d.

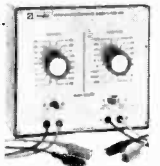

KG650 RF Signal Generator Kit

For TV, AM and FM alignment etc. Wide range fundamental output in 5 separate bands. Highly stable Colpitts type oscillator. Complete kit: £15.19.6. Postage 12s 6d.

Easy credit facilities available, ask for details.

New 960 page Hobbies Manual 12 Hobbies Sections · over 12,000 units & components for dozens of Hobbies 16/6

Please send me: Free Knight-Kits brochure
 The new Electronics Hobbies Manual. (16/6)
 Enclosed is a cheque/postal order for 16/6 (which includes the 5/- pp) made payable to Electronics (Prop. STC) Ltd.



Name

Address

knight-kit Quality built-in,
 built up by you

Electronics (Prop. STC) Ltd.,
 Edinburgh Way, Harlow, Essex.

PE6



electronics

Practical Electronics Classified Advertisements

MISCELLANEOUS

RHYTHM MODULES. Build your own rhythm box—simply, cheaply. Realistic sound guaranteed. S.A.E. for details. D.E.W. LTD., 254 Ringwood Rd., Ferndown, Dorset.

BUILD IT in a DEWBOX quality cabinet 2in x 2½in x any length. DEW LTD., Ringwood Road, Ferndown, Dorset. S.A.E. for leaflet. Write now—right now.

ARTIFICIAL LIFE

Well almost, because the NEW range of projects include: an electronic 'animal' which LEARNS, and a device capable of REPRODUCING itself! Other projects SURE TO INTRIGUE YOU are an audio transmitter/receiver which has quite an amazing range and requires NO LICENCE; also a machine which recognizes itself, and an electronic dog whistle, etc., etc. HOSTS OF EASY-TO-CONSTRUCT projects. SEND 2/6 for your list—NOW!

To: 'BOFFIN PROJECTS'

incorporating

BIONIC DESIGNS

4 CUNLIFF RD.

STONELEIGH, EWELL, SURREY

UFO DETECTOR CIRCUITS, data. 10s. (refundable). Paraphysical Laboratory (UFO Observatory), Downton, Wilts.

4 WATT GRAM AMPS.

Volume and tone controls, mains operation, 3Ω output, new and boxed **65/-** POST PAID

BIG BARGAIN PARCELS ONLY OF COMPONENTS **10/-**

SALOP ELECTRONICS POST PAID
2a Greyfriars Road
Coleham, Shrewsbury S.A.E. for lists

CALL OR SEND for list from the most interesting shop in Lancashire. Electrical Mechanical and Electronic Goods. ROGERS, 31 Nelson Street, Southport.



"NEW DIMENSIONS" gives fabulous Big Hall 3-dimension effect to all music. PLUS adjustable echo, vibrato and tone. Battery 9v. model for radio, tape or player. **8 gns.** Speaker 2b/- extra.
CAR VERSION for 6v. or 12v. + or - earth. 10 gns. including rear speaker. 6/- post and ins. either model.
Send S.A.E. for full details direct from manufacturers—NOW!
D.E.W. LTD.
P.E., 254 Ringwood Rd., Ferndown, Dorset

RATES: 1/3 per word (minimum 12 words). Box No. 1/6 extra.

Advertisements must be prepaid and addressed to Advertisement Manager,

"Practical Electronics"

15/17 Long Acre, London, W.C.2

EDUCATIONAL

STUDY RADIO, TELEVISION AND ELECTRONICS with the world's largest home study organisation. City & Guilds; R.T.E.B., etc. Also practical courses with equipment. No books to buy. Write for FREE Prospectus to ICS (Dept. 577), Intertext House, London, SW11.

EDUCATIONAL (continued)

ENGINEERS. A technical certificate or qualification will bring you security and much better pay. Elem. and adv. private postal courses for C.Eng., A.M.I.E.R.E., A.M.S.E. (Mech. & Elec.), City & Guilds, A.M.I.M.I., A.I.O.B. and G.C.E. exams. Diploma courses in all branches of Engineering—Mech., Elec., Auto., Electronics, Radio, Computers, Draughts., Building, etc. For full details write for FREE 132-page guide. BRITISH INSTITUTE OF ENGINEERING TECHNOLOGY (Dept. 125K), Aldermaston Court, Aldermaston, Berks.

GET INTO ELECTRONICS—big opportunities for trained men. Learn the practical way with low-cost Postal Training, complete with equipment. A.M.I.E.R.E., R.T.E.B., City & Guilds, Radio, T/V, Telecoms., etc. For FREE 100-page book, write Dept. 856K, CHAMBERS COLLEGE, 148 Holborn, London, E.C.1.



RADIO & TELEVISION SERVICING RADAR THEORY & MAINTENANCE TELECOMMUNICATIONS

This private College provides efficient theoretical and practical training in the above subjects. One-year day courses are available for beginners and shortened courses for men who have had previous training. Write for details to:—

The Secretary, London Electronics College, 20 Penywern Road, Earls Court, London, S.W.5. Tel. 01-373 8721

CITY AND COUNTY OF BRISTOL BRISTOL TECHNICAL COLLEGE

Principal: E. Poole, B.Sc.(Eng.), C.Eng., M.I.Mech.E., M.I.Prod.E.

CAREERS IN RADIO AND RADAR

Marine Radio Officers

2 year full-time course leading to the Second and First Class P.M.G. Certificates and the B.O.T. Radar Maintenance Certificate.

Conversion Course (Second Class to First Class).

R.T. Licences (Full or Restricted).

Courses for Qualified Marine Radio Officers

Single Sideband Techniques (2 weeks)
Marine Electronics Course (Phase I—duration 3 months)

Advanced Marine Electronics Course (Phase II—duration 3 months)

Training given on the latest types of Marine and Aircraft equipment in modern, approved laboratories at

THE SCHOOL OF RADIO AND RADAR

Senior Lecturer-in-Charge: F. E. Barltrop

For further information apply to:—

**The Registrar, BRISTOL TECHNICAL COLLEGE
ASHLEY DOWN, BRISTOL 7**

HOLIDAYS

HOLIDAY FOR BOYS 14/16 years August 1969, specialising in engineering, electronics, photography. Tuition and practical work including go-karting. 11 days—£14.10.0. Write for free brochure: INTER-SCHOOL CHRISTIAN FELLOWSHIP, 47 Marylebone Lane, London W.1.

BOOKS AND PUBLICATIONS

MAKE YOUR OWN TALKIES. An introduction to electronic tape/film synchronisation, with an explanation of the "Carol" Cinesound system, modifying equipment, filming in sync., etc. Price 7/6, post free (refundable against purchase of your "Carol" Cinesound equipment). Contronics Ltd., Deepcut, Camberley, Surrey.

GOVT. SURPLUS WIRELESS EQUIPMENT HANDBOOK

This useful handbook gives detailed information and circuits for British and American Government Surplus Receivers, Transmitters, and Test equipment, etc., plus suggested modification details and improvements for the equipment. Also a Surplus/commercial cross reference valve guide and Government component codings and references. Invaluable to Radio enthusiasts, Universities and Laboratories. Available only from us at **VERITEXT (LEEDS) LTD., 24 Stansfield Chambers, Gt. George St., Leeds 1, Yorkshire** at 30/- per volume post paid. Extra postage for Foreign Orders.

SURPLUS HANDBOOKS

19 set Circuit and Notes 6/6 P.P. 6d
 1155 set Circuit and Notes 6/6 P.P. 6d
 H.R.O. Technical Instructions 5/6 P.P. 6d
 38 set Technical Instructions 5/6 P.P. 6d
 46 set Working Instructions 5/6 P.P. 6d
 88 set Technical Instructions 7/- P.P. 6d
 BC. 221 Circuit and Notes 5/6 P.P. 6d
Wavemeter Class D Tech. Instr. 5/6 P.P. 6d
 18 set Circuit and Notes 5/6 P.P. 6d
 BC.1000 (31 set) Circuit & Notes 5/6 P.P. 6d
 CR.100/B.28 Circuit and Notes 10/- P.P. 9d
 R.107 Circuit and Notes 7/- P.P. 6d
 A.R.88D. Instruction Manual 18/- P.P. 6d
 62 set Circuit and Notes 6/6 P.P. 6d
 52 set Sender & Receiver Circuits 7/6, post free
Circuit Diagrams 5/- each post free.
 R.1116/A, R.1224/A, R.1355, R.F. 24, 25, & 26.
 A.1134, T.1154, CR.300, BC.342, BC.312,
 BC.348, J.E.M.P. BC.624, 22 set.
Resistor Colour Code Indicator... 2/6 P.P. 6d
 S.A.E. with all enquiries please.
 Postage rates apply to U.K. only.
 Mail order only to:
Instructional Handbook Supplies
 Dept. P.E., Talbot House, 28 Talbot Gardens
 Leeds 8

FOR SALE

TIME SWITCHES, 14 day clock, once on one off every 24 hours, reconditioned and fully guaranteed. 5 amp Horstmann 32/6, 15 amp Venner 42/6. P. & P. 4/6. A. R. BATCHELOR (P.E. Dept.), 4 Park Road, Bromley, BR1 3HP.

ILLUSTRATED CATALOGUE No. 17 Manufacturers' Surplus and New Electronic Components including Semiconductors. 3/- post free. **ARTHUR SALLIS LTD.**, 28 Gardner Street, Brighton.

HIGH GLOSS METALLIC HAMMERED ENAMEL

MAKES FANTASTIC DIFFERENCE TO PANELS

say hundreds of enthusiastic use. 'Crackle' pattern appears like mag. on wood and metal. No under-coat. Air dries 15 min. to hard glossy finish. Heat, liquid and scratchproof. Lt. BRUSH OR SPRAY-ON and Dk. Blue; Bronze; Silver; Green; Black. Send for Free list, or 8/- (- 1/9 post) for trial 1pt. TIN, colour samples and instructions. Send NOW.

FINNIGAN/SPECIALITY PAINTS Dept. P.E. STOCKSFIELD. Tel. 2280 Northumberland.

FOR SALE

(continued)

BRASS, STEEL, LIGHT ALLOY, STAINLESS STEEL TUBE. Bar Material, Tools, Mechanical, Electrical, plus Assorted Lots. Send S.A.E. for latest Cat. of 1,000 items. K. H. WHISTON, Dept. BPE, New Mills, Stockport

PRECISION POTENTIOMETERS

Multi-turn, continuous or ganged from 25/-; carbon from 2/-. Also resistors, mains rectifiers, synchros, geared motors, chokes, capacitors, meters, microswitches, semiconductors. 6d. stamp catalogue. **F. HOLFORD & CO.**, 6 Imperial Square, Cheltenham.

UNUSED SEALED ni-cad. cells 1.22v 5A.H. 3-625" x 1-25" diameter, 12/6 each, 3 with case 35/-. **MASON**, 72 The Drive, Romford, Essex.

FOR SALE

- Large quantity of electronic components including valves, transistors, resistors, capacitors, switches, chassis components, knobs, veroboard and pins. List value well over £40. Will accept £20 o.n.o.
- The following Practical Electronics projects:
 - Speed Reducer
 - Transistor Ignition (2 units unused)
 - AC Millivoltmeter
 - Signal Generator
 - Power Supply Unit
 - All at 50/- each.
- SANWA** transistor tester (as new) £4. All items available separately or £35 the lot. **P. C. SUTHER**, Alban House, Holly Hill Lane, Sarisbury, Southampton SO3 6AG

FOR SALE

(continued)

SOLARTRON DIGITAL VOLTMETER LM901. Three window display. Three ranges, 0-200v. Manual/auto/external sampling. Accuracy 0.1 per cent. Zero, calibration and printout facilities. Excellent condition, with all accessories. **£25** ono. **CAMBERLEY 23292.**

MORSE MADE EASY !!

FACT NOT FICTION. If you start **HIGHT** you will be reading amateur and commercial Morse within a month (normal progress to be expected). Using scientifically prepared 3-speed records you automatically learn to recognise the code **RHYTHM** without translating. You can't help it, it's as easy as learning a tune. 18 W.P.M. in 4 weeks guaranteed. For details and course C.O.D. ring S.T.D. 01-560 2896 or send 8d. stamp for explanatory booklet to: **GC3CH/H, 45 GREEN LANE, PURLEY, SURREY**

WANTED

NEW VALVES WANTED. Popular TV and Radio types. Best cash price by return. **DURHAM SUPPLIES**, 367F Kensington Street, Bradford 8, Yorkshire.

TAPE RECORDERS, TAPES, ETC.

TAPES TO DISC—using finest professional equipment—45 r.p.m. 18/-. S.A.E. leaflet. **DEROY**, High Bank, Hawk Street, Carnforth, Lancs.

SITUATIONS VACANT

TECHNICAL TRAINING by ICS IN RADIO, TELEVISION AND ELECTRONIC ENGINEERING

First-class opportunities in Radio and Electronics await the **ICS** trained man. Let **ICS** train YOU for a well-paid post in this expanding field.

ICS courses offer the keen, ambitious man the opportunity to acquire, quickly and easily, the specialized training so essential to success. Diploma courses in Radio/TV Engineering and Servicing, Electronics, Computers, etc. Expert coaching for:

- **C. & G. TELECOMMUNICATION TECHNICIANS' CERTS.**
- **C. & G. ELECTRONIC SERVICING.**
- **R.T.E.B. RADIO AND TV SERVICING CERTIFICATE.**
- **RADIO AMATEURS' EXAMINATION.**
- **P.M.G. CERTIFICATES IN RADIOTELEGRAPHY.**

Examination Students Coached until Successful.

NEW SELF-BUILD RADIO AND ELECTRONIC COURSES

Build your own 5-valve receiver, transistor portable, signal generator, multi-meter and valve volt meter—all under expert guidance.

POST THIS COUPON TODAY and find out how **ICS** can help YOU in your career. Full details of **ICS** courses in Radio, Television and Electronics will be sent to you by return mail.

MEMBER OF THE ASSOCIATION OF BRITISH CORRESPONDENCE COLLEGES

INTERNATIONAL CORRESPONDENCE SCHOOLS

A WHOLE WORLD OF KNOWLEDGE AWAITS YOU!

International Correspondence Schools
 (Dept. 152), Intertext House, Parkgate Road,
 London, S.W.11.

NAME
 Block Capitals Please

ADDRESS

1/69

CONTINUED OVERLEAF

INDUSTRIAL COMPUTERS

A number of positions are available at all levels within the

TEST AND QUALITY DEPARTMENT

of our INDUSTRIAL COMPUTER DIVISION at KIDSGROVE.

Applicants should preferably have a sound academic background, with a minimum of O.N.C. (Electrical) or equivalent and experience in at least one of the following fields:

- Computer or Electronics Industry
- Radio and Television or associated industry
- Radar equipment installation, maintenance or servicing.

These are excellent opportunities offering good scope and prospects, an attractive salary commensurate with past experience and academic achievement, and a contributory pension and life assurance scheme.

Please write giving brief career details and quoting reference PE0320H to the Personnel Officer, I.C. & A., The English Electric Company Limited, Kidsgrove, near Stoke-on-Trent, Staffs.

ENGLISH ELECTRIC

INDUSTRIAL CONTROL AND AUTOMATION

A.M.I.E.R.E., A.M.S.E. (Elec.), City & Guilds, G.C.E., etc., on "Satisfaction or Refund of Fee" terms. Wide range of Home Study Courses in Electronics, Computers, Radio, T.V., etc. 132-page Guide—FREE. Please state subject of interest. BRITISH INSTITUTE OF ENGINEERING TECHNOLOGY (Dept. 124K), Aldermaston Court, Aldermaston, Berks.

SERVICE SHEETS

SERVICE SHEETS. RADIO, TELEVISION, TAPE RECORDERS, 1925-1968, by return post, from 1/- with free fault-finding guide. Catalogue 6,000 models, 2/6. Please send stamped addressed envelope with all orders/enquiries. HAMILTON RADIO, 54e London Road, Bexhill, Sussex.

C. & A. SUPPLIERS

SERVICE SHEETS
T.V., RADIO, TRANSISTORS, TAPES, ETC.

Only 5/- each, plus S.A.E.

(Uncrossed P.O.'s please, returned if service sheets not available.)

71 BEAUFORT PARK
LONDON, N.W.11
MAIL ORDER ONLY

SERVICE SHEETS

(continued)

RADIO TELEVISION, over 8,000 Models, JOHN GILBERT TELEVISION, 1b Shepherd's Bush Rd., London, W.6. SHE 8441.

SERVICE SHEETS, Radio, TV, 5,000 models. List 1/6. S.A.E. enquiries. TELRAY, 11 Maudland Bank, Preston.

ELECTRICAL

240 VOLT
ELECTRICITY
ANYWHERE

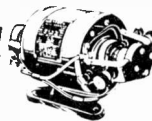

most brilliant performance ever from 12-volt Car Battery. BRILLIANT HEAVY DUTY 240 volt AMERICAN DYNAMOTOR with BIG 220 WATT OUTPUT. Marvellous for TELEVISION, ELECTRIC DRILLS, MAINS LIGHTING and ALL UNIVERSAL AC/DC MAINS EQUIPMENT. Marvellous for Fluorescent lighting. Thousands of uses. Tremendous purchase of this model makes fantastically low price possible.

ONLY £4.19.6 each plus 10/6 delivery. C.O.D. with pleasure. MONEY BACK if not DELIGHTED. Please send S.A.E. for full illustrated details.

Dept. PE, STANFORD ELECTRONICS
Rear Derby Road, North Promenade
BLACKPOOL, Lancashire

TRANS/RECEIVERS AIR/SEA/RESCUE TYPE

Must be dismantled or exported. Complete with mike/speaker aerial. Work up to 100 miles. Cost Govt. over £40 each. £210.0 per set, 10/- P. & P. 2 sets £6, post free.



Listen to the thrills of aircraft, pilots and airports at work. Also police fire/ambulance. Taxis and civil depts. Ideal for receiving 2 metre amateurs. A fully transistorised receiver covering 97-150Mc/s V.H.F. broadcasts. Robust steel, black crackle finish cabinet. Size 8" x 4" x 4". Operates from a 9V battery that fits inside. Speaker or headphone output. Simple to use. Worth over £15. Our price £8.10.0 car. and ins. 10/- C.W.O. or C.O.D.

MINIATURE MOVING COIL SPEAKERS

1 1/2" diameter. Only 3/8 each, p. & p. 1/6. Two for 8/6 post free. Four for 15/- post free.



Brand new fully transistorised Communications Receiver. Specifications: 4 complete ranges 550kc/s to 30Mc/s. Covering all amateur bands, shipping and trawler bands, and broadcast bands. A highly efficient double tuned superhet, comprising R/F aerial tuning section. A.V.C. and built-in B.F.O. for C.W. or S.S.B. reception. Ideal for fixed or mobile reception. Operates from Standard 9V battery, provided that fits internally. Gives over 1 watt audio output. With speaker and headphone output. Hammer finished robust steel case of pleasing modern design with all controls on well set-out front panel. Size approx. 9" x 7" x 6in. British manufacture. Due to huge purchase we can offer these excellent receivers at less than half their normal worth. Complete with handbook £16.10.0. Carr. and ins. 15/- Headphones if required 17/6 per pair. P. & P. 2/6.



SHIPPING/SOS/BAND RECEIVER

Hear shipping from all over the world. Covers the complete maritime, trawler and amateur bands. A neat little superhet. Attractive black crackle finish case approx. 7" x 5" x 5". Fully transistorised. 9 volt battery fits inside. Speaker or headphone output. Brand new direct from makers. Comparable with sets being sold at 30gns. Our Price only 20. Carr. & ins. 10/-. C.W.O. or C.O.D.



This is a miniature transistorised B.F.O. unit that is fully variable, that is a necessary accessory to any receiver. Completely self-contained and single hole fixing makes installation so easy. Full instructions provided. Can even be fitted to modern transistor receivers. Price only 49/6, post free.

TOP BAND TRANSMITTER

A fully transistorised compact transmitter for Licensed Amateur use. Fully portable. Suitable for mobile use. Fully Tunable 1.8 to 2Mc/s. Contains R/F output meter. Price £12.10.0. Carriage 10/-. G.P.O. Licence required.



DEPT. P.E. 20, 24 CAWOODS YARD,
MILL STREET, LEEDS 9

RECEIVERS AND COMPONENTS

BARGAIN PACKS!

- 4 FST3B STC Sil. Rectifiers New and Marked 800 pv 1/2 amp. Good substitute for BY100, etc. ...
4 RA5310AF STC Avalanche Rectifiers New and Marked 1,200 pv 1/2 amp 5A surge rated ...
6 GJ4M New and Marked AEI Germanium Rectifiers 50 pv 1 amp ...
4 GP2971 Sub-miniature power transistors Texas New and Marked ...
3 ZF16 STC New and Marked 16V 300mW Zener Diodes ...
1 Pair of AD161 AD162 NPN PNP Power Complementary Pair ...
1 Pair of AC128/AC176 NPN/PNP Driver Complementary Pair ...
1 Set OC82D 2 OC82 Matched Pair New Mullard Marked ...
4 BSY95A STC New and Marked Planar Transistors ...
4 BC108 Mullard Latest type Low noise planars New and Marked ...
6 NKT276 New and Marked Newmarket Audio General purpose transistor ...
36 Square inches of 0.15 in Matrix Veroboard—the most popular pack of all—only from LST ...
4 NKT162 New and Marked Newmarket Switching Transistor ...
2 OC19 New and Marked Mullard Power Transistors ...
5 BA115 New and Marked Mullard Colour Television Diodes ...
4 ZG371B New and Marked Texas Audio Transistors ...
4 BYX38/600 Mullard New and Marked Power Studs 600 pv 2 1/2 amp ...
1 "Designers Guide to British Transistors" New data book with over 1,000 types listed—Computer selected substitution chart. Just out from Publishers (add 2/6 this item post) ...

TIS43A Equivalent 2N2446/BEJ3000 UNIJUNCTION 6/9d including data

2N3819 Texas Paid Effect Transistor 8/-

FAIRCHILD uLogic uL900 Buffer, uL914 Dual Gate, uL923 JK Flip Flop

SL701C Planar Integrated Circuit 18/-

SCR1+2pc1S113 For PCB Drill Controls (July Issue) 10/- & p

BC107/8/9 2/9d

TD716 Tunnel Diode 12/-

SILICON RECT'S

FULLY TESTED GUARANTEED

Table with 2 columns: PIV (50, 100, 200, 400, 800, 1,000) and mA (1/3, 1/2, 2/3, 1, 2, 3, 4, 5, 10, 15, 20, 30, 40, 50)

LOOKING FOR QUALITY, VALUE & SERVICE? Write STOP. Catalogue of electronic components with various part numbers and prices.

LST COMPONENTS 7 COPFOLD ROAD BRENTWOOD ESSEX BRENTWOOD 7904 24 HOUR POSTAL SERVICE

RELEASE SEND 1968 CATALOGUE FREE TO: (Back Copies) NAME ADDRESS (PE67)

CAPACITORS AND RESISTORS Ministry release. Bargain prices. Electrolytic tubular, rectangular, large and small, wide range. Hunts Sangamo resistors, Colvern precision pots, ditto presets. Power resistors, sliders, etc. Bargain parcel, over 100 items, our selection, different values, 20/- post paid.

TELEVISION I.F. STRIPS (less valves) From BBC. 2 converters ideal for spares, contains smoothing capacitor, dropper resistors, 7 valve holders, I.F. transformers, coil formers, capacitors, resistors, diodes, tag strips, chokes, etc., etc., on chassis. 11in x 3 1/2in, no information or circuit. BRAND NEW for list of interesting and unusual value components for ONLY 16/6 each post paid. MAINS TRANSFORMERS 250V input, outputs 10V @ 500mA, 24V @ 100mA, 32V @ 10mA, size 2 1/2in x 1 1/2in x 1 1/2in (drop through type) ideal for transistor power supply, 10/- post paid. 250V input, output 22V @ 1 1/2A, size 2in x 2in x 2in, 11/- post paid. TRANSISTOR driver and output transformers for 3 ohm speaker, suit OC81B, etc., approx. 1 watt rating, only 6/- pair or 4/- each. As above but 500mW watt rating, 4/- pair, 3/- each. MIXED bag of silver mica and ceramic capacitors, approx. 150, 10/- per bag. ERIE 0.1mF, 12V wire ended disc ceramics, 3/- doz. 0.01 mF, 500Vw disc ceramics, P.C. type, 3in dia., 2/- doz., 10/- per 100. HUNTS 0.1mF, 350Vw paper capacitors, P.C. type, upright mounting, 2/6 doz., 15/- per 100, post paid per 100. TUBULAR ceramic capacitors, P.C. type, 33pF and 500pF, 0.1, 1, 3 doz. GOODMANS 4in sq. speakers 15 ohm imp. brand new, boxed, ex WD, 11/6 post paid. TRANSISTOR ELECTROLYTICS 2mF 6Vw, 4mF 64Vw, 10mF 12Vw, 20mF 6Vw, 50mF 6Vw, 100mF 6Vw, 6d each. 100mF 9Vw, 8d. 100mF, 25Vw, 1/-, 400mF 15Vw, 500mF 9Vw, 9d. 1,000mF + 1,000mF 18Vw can nes. 2/-, 1,000mF 50Vw can type, 4/-, CRYSTALS HC6/U, 12-700Mc/s. ex equipment tested, 5/-. SILVER MICA capacitors 80pF size only 3in x 3in 200Vw, 4/- per 100. MAIL ORDER ONLY SAE FOR LISTS Postal charges: up to £1 + 1/6; £1-£2 + 2/-; £2-£5 + 3/6; over £5 FREE.

A.J.H. ELECTRONICS 59 Waverley Road, The Kenn, Rugby, Warks.

WE ARE BREAKING UP COMPUTERS COMPUTER PANELS (as shown) 2in x 4in 8 for 10/-. P. & P. 2/- worth min. 30 transistors. 100 for 65/- + P. & P. 6/6; 2 power for £30 + carr. PANELS with 2 power transistors sim. to OC28 on each board + components. 2 boards (4 x OC28) 10/-. P. & P. 2/-. NPN GERMANIUM TO1 WATT POWER TRANSISTORS on small heat sink on 2in x 4in panel. 5 for 10/-, P. & P. 2/-. POWER TRANSISTORS sim. to 2N174 ex-eqpt., 4 for 10/-, P. & P. 2/-. POWER TRANSISTORS sim. to 2N174 ON Finned Heat Sink (10D) 4 for £1, P. & P. 3/-.

LONG ARM TOGGLE SWITCHES ex eqpt. SPST 13/6 doz., DPDT 22/6 doz., DPST 17/- doz. P. & P. all types 2/- doz. TRANSISTOR COOLERS TO5 7/6 doz., TO3 18/- doz. P. & P. 2/-. OVERLOAD CUT-OUTS. Panel mounting in the following values: 1, 1 1/2, 2, 3, 4, 5, 7, 8 amp. P. & P. 1/6. MINIATURE GLASS NEONS, 12/6 doz. P. & P. 1/6. NEW MIXED DISC CERAMICS. 150 for 10/-, P. & P. 2/-. LARGE CAPACITY ELECTROLYTICS 41in, 2in diam. Screw terminals. All at 6/- each + 1/6 each P. & P. 4,600mF 72V d.c. wkg. 5,000mF 55V d.c. wkg. 6,300mF 72V d.c. wkg. 1,500mF 150V d.c. wkg. 16,000mF 25V d.c. wkg. 25,000mF 12V d.c. wkg.

KEYTRONICS, 52 Earls Court Road London, W.8. Mail order only

BARGAIN PARCELS of new surplus Electronic Components, 3/-, 5/-, 10/-, post free. DOLPHIN ELECTRONICS, 5 Pooles Way, Brixia Close, Burntwood, nr. Lichfield.

ELECTRONIC STOCKMARKET KIT OF MOST PARTS ALSO 'REACTALYSER' AND WAA-WAA PEDAL. S.A.E. FOR LIST. D.E.W. LTD., RINGWOOD RD. FERNDOWN, DORSET

U.J.T.'s equiv. 2N2646, T1843 6/- each, Tested. P. & P. 6d per order. Data supplied, L.F.H. ELECTRONICS, 65 Flauders Mansions Flauders Road, London, W.4.

R & R RADIO 51 Burnley Road, Rawtenstall Rossendale, Lancs Tel.: Rossendale 3152 VALVES BOXED, TESTED & GUARANTEED BF80 3/- PCC84 3/- PY82 3/- EBF89 3/6 PCF80 3/- U191 4/6 ECC82 3/- PCF82 3/6 U301 4/6 ECL80 3/- PCL82 4/- 6F23 5/- EF80 1/6 PCL83 4/- 10P14 3/- EF85 3/- PCL84 5/- 20P5 3/- EF183 3/6 PL36 5/- 30F5 2/6 EF184 3/6 PL81 4/- 30L15 5/- EY86 4/- PL83 4/- 30P12 4/6 EL41 5/- PY33 5/- 30C15 5/- E240 4/6 PY81 3/6 30PL13 5/6 EBC41 4/6 PY800 3/6 30PL14 5/6 POST. ONE VALVE 9d. TWO TO SIX 6d. OVER SIX POST PAID.

S.E.S. RESISTOR KITS Pre-Pack—5 off each, 5% resistors 4.7 ohm to 1 Mohm, $\frac{1}{4}$ or $\frac{1}{2}$ watt. ONLY £2.12.6.
 Super Kit—10 off each, 5% resistors, through any decade (e.g. 10k to 100k) E24 values $\frac{1}{2}$ watt. E12 values $\frac{1}{2}$ watt. ONLY £2.17.6.
 Mini Kit—10 off each, 5% resistors through any decade, E12 values in $\frac{1}{4}$ or $\frac{1}{2}$ watt. ONLY 18/6.

For further information of all our stocks write sending 3/6 for catalogue (or 6d. for individual data sheets), phone or call:

STUDENT ELECTRONIC SERVICES

196 REGENT ROAD, SALFORD 5 Tel. 061-872 5187

SPECIAL OFFER FOR CHRISTMAS: Pre-set Pots. miniature, vertical, Linear track 100k, 250k, 500k. ONLY 9d. each.

TRANSISTOR PANELS

New boxed, size 9in x 6in x 1 1/2in with "Valvo" transistors type OC45 or similar, with full length leads, also an equal number of OA85 diodes, H/S resistors, etc. Built on perforated board in a metal frame.

Panel of 20 transistors, diodes, etc. 20/-
 30 — 25/- 60 — 40/-
 40 — 30/- 70 — 45/- Postage 2/- per panel.
 50 — 35/- 80 — 50/-

TRANSISTOR CAPACITORS (ELECTROLYTIC)
 500mF 4V 64mF 40V 16mF 25V
 320mF 10V 50mF 10V 10mF 25V
 250mF 4V 30mF 10V 6.4mF 64V
 200mF 10V 25mF 25V 4mF 64V
 20mF 12V 1mF 25V

1/- each, 9/- per doz. Min. order 10/-
COMPUTER PANELS with 40 sil. pnp or npn transistors, Diodes and res., 22/6 Post Paid.

COMPUTER PANELS WITH SEMI-CONDUCTORS

8—OC42 or 3—OC139 + 24—OA81	7/6
6—OC41 + 3—OC139 + Diodes	7/6
4—OC170 + 2—OC139 + 2—OC42	7/6
9—AS220 + 1—T2040 + 27 Diodes	7/6
4—OC42 + 6—GET875 + Diodes	7/6
2—OC170 + 1—2G306 + OC42	4/-
2—2G106 + 1—2N985 + 1—2N2410	4/-
6—2N388 + 2—2G403 + 2—T2040	8/6
4—OC36 + 8—GET103 + 4—Z531A	25/-
8—AS220 + 80 Diodes	7/6
6—AS221 + 15—OA91	6/-
9—SB240 + 18—OA47	12/6
12—2G106 + 24 Diodes	9/6
4—OC35 + 4—Z571	5/-
8—2G371 (Inverter)	5/-
6—OC44	4/6
6—2N388	7/6
12—2N388	12/6
48—OA81	5/-
36—OA5	5/-
4—OC42 + 80 Diodes	9/6
12—AS220 + 15—OA91	4/6
13—OC42 + 24—OA91	8/6
4—2G106 + 1—2N2410	4/-
2—OC42 + 8—OA47	3/-
24—Sil. h.f. Transistors	15/-

SINGLE SIDED P.C. BOARD 4 1/2in x 2 1/2in 20 for 10/-
TEST CARDS. 6 transistors 20 for 20/-
ELECTROLYTICS 25,000 @ 12V, 16,000 @ 12V, 15,000 @ 10V, 10,000 @ 30V, 4,000 @ 60V, 3,000 @ 80V, 2,000 @ 50V, 1,200 @ 180V, 8/6 Post Paid.

ZENER DIODES—2.4, 2.7, 3.6, 4.75, 5.25, 5.75, 6.2, 6.8, 7.5, 13, 15, 16, 18, 20, 27, 30, 33 volts, 3/6 each, most do. 1 watt.

POLYSTYRENE CAPACITORS 350V: 180, 270, 330, 390, 470, 560, 680, 820pF. 1,800, 2,200, 2,700, 3,300, 5,600, 6,800, 8,200

125V: 1,200, 1,500, 1,800, 2,200, 2,700, 3,300, 3,900, 4,700, 5,600, 6,800, 8,200, 0.015, 80pF ceramic 200pF S.M. any selection 2/- doz. 4—40pF trimmer, most do.

BRAND NEW BOXED CHASSIS containing 2—OC35, 2—OC29 12 WW resistors 25/- Postage 1/6.

NEW CROSS RADIO
 6 OLDHAM ROAD, MANCHESTER 4

TAPE HEADS

BSR BRAD 39/6 pair 2 TRACK	MICHIGAN REC./PLAY HIGH IMP. 4-TRACK	45/-
BSR MALL 39/6 pair 4 TRACK	BOGEN ERASE UL181/8 4-TRACK	27/6
REUTER — COLLARO ERASE 4-TRACK	COSMOCORD ERASE T.E.2/9 4-TRACK	15/-

F.M. WIRELESS MICROPHONE
 94.104Mc/s. Transistorised. Operates from 9V battery. Complete with additional secret tie clip microphone. List £12/10/- ONLY £6.15.0
 These cannot be operated in U.K.

TRANSISTORISED FM TUNER
 6 TRANSISTOR HIGH QUALITY TUNER. SIZE ONLY 6in x 4in x 2 1/2in 3 I.F. stages. Double tuned discriminator. Ample output to feed most amplifiers. Operates on 9V battery. Coverage 88-108Mc/s. Ready built ready for £6.12.6
 Fantastic value for money

FM MULTIPLEX STEREO ADAPTOR
 Printed circuit board, 4 trans. 6 diodes 9V with full instructions £5.2.6

LOUDSPEAKERS
 12" 20 watt, 15 ohm. TWIN CONE £5.7.0
 12" 25 watt, 15 ohm. GUITAR SPEAKER £5.7.0

FULL RANGE HIGH COMPLIANCE. 8" 16 ohm, 15 watt £5.18.0
 10" 10 watt, 16 ohm, CERAMIC — MAGNET 42/-
 30-20K

6 1/2" 16 ohm, 10 watt, 30-18K £5.0.0
 4" 16 ohm, 5 watt, 40-16K £3.3.0

MULTIMETERS 32/- from
 REFLEX CONE TYPE WATERPROOF SPKR. £3.10.0

5 watt, 3 ohm, 300-16,000c/s PA
 & Music Relay £3.10.0

LOUDSPEAKERS. 2" 9/6
 40 ohm, 2 1/2" 80 ohm, 12" TWIN CONE 10 watt PEAK 15 or 35/-
 3 ohm. TWEETER 16 ohm 26/9
 10 watt, 18K-CPS CROSSOVER NET-14/-
 WORK 16 ohm

SUPER SILICON RECT. T.V., etc., 1,200 PIV 800mA, 5/-; or complete with instr. resistor, condenser, 8/8; 400 PIV HW 6A, 6/-; 200 PIV HW 6A, 6/-.. No cheap rubbish.

Stamped envelope for full selection and bargain offers in Multimeters, Radios, Baby Alarms, Intercoms, Walkie-Talkies, Rectifiers, Sinclair, DULCI, and Eagle Lists UNDER £1—P. & P. 6d., £2-£3—1/6d. off 3 Post Free. C.O.D. 3/6. MAIL ORDER ONLY.

DURHAM SUPPLIES
 367F, KENSINGTON STREET
 BRADFORD 8, YORKSHIRE

"SUBMINIATURE ELECTROLYTICS" 15 volt, 2, 6, 8, 10, 15, 20, 30, 40, 50, 100 mfd. 8/6 dozen; 30 for £1. Brand New, Post Free. The C.R. SUPPLY CO., 127 Chesterfield Rd., Sheffield S8 0RN.

AERIALS

Enthusiasts THE T.M.P. EXPERIMENTAL AERIAL KIT

A unique collection of alloy elements, dipoles, booms, clamps, mast reflectors, nuts and bolts, cables, even a compass! etc., to make up various experimental aerials to cover all bands.

This includes TV transmissions, SW for the radio amateur, VHF for BBC FM. Amateurs on 2 and 4 MTrs, Aircraft, Police, etc., UHF for experiments on BBC 2 and Ultra High Frequencies. These Kits can be used indoor or outdoor. Robust construction with simplified detailed plans for easy assembly.

The Wonder T.M.P. Kit costs only 89/6—no extra for carriage.

Despatched to any address in UK within 7 days.

TUBULAR METAL PRODUCTS
 7 LOWESMOOR TERRACE
 WORCESTER

PARKERS SHEET METAL FOLDING MACHINES HEAVY VICE MODELS

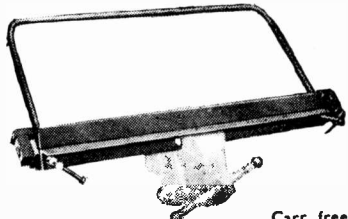

With Bevelled Former Bars Carr. free
 No. 1. Capacity 18 gauge mild steel x 36in. wide ... £14.0.0
 No. 2. Capacity 18 gauge mild steel x 24in. wide ... £8.0.0
 No. 3. Capacity 16 gauge mild steel x 18in. wide ... £8.0.0
 Also new bench models. Capacities 48in. x 18 gauge £40. 36in. x 18 gauge £27.10.0. 24in. x 16 gauge £26.10.0. Carriage free.
 End folding attachments for radio chassis. Tray and Box making for 36in. model, 5/6 per ft. Other models 3/6. The two smaller models will form flanges. As supplied to Government Departments, Universities, Hospitals.
 One year's guarantee. Money refunded if not satisfied. Send for details.

A. B. PARKER, Folding Machine Works, Upper George St., Heckmondwike, Yorks. Heckmondwike 3997

NEW F.M. STEREO TUNER £25
 Range 87 to 107 MHz Black crackle finish metal case with cast front escutcheon. Case size 13in. x 7in. x 3 1/2in. high. Mains transformer. Metal Rectifier and Valve ECC85, EF89, EF80, ECC82 as cathode follower. EM84 tuning indicator, 2 x AF17 and 2 diodes. A really fantastic performer. Price £25, tax paid and carr. paid. MONO VERSION as above but less stereo decoder £17.17.0 tax and carr. paid. Terms available this item.

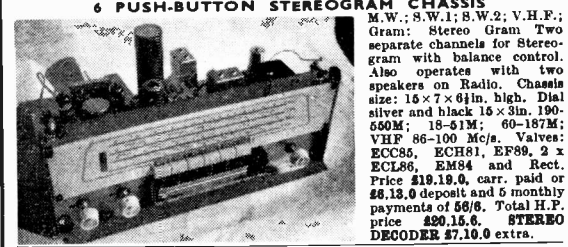

6 PUSH-BUTTON STEREOGRAM CHASSIS
 M.W.; S.W.1; R.W.2; V.H.F.P.; Gram: Stereo Gram Two separate channels for Stereogram with balance control. Also operates with two speakers on Radio. Chassis size: 16 x 7 x 9 1/2 in. high. Dial silver and black 15 x 3in. 190-500M; 18-61M; 60-187M; VHF 86-100 Mc/s. Valves: ECC85, ECH81, EF89, 2 x ECL86, EM84 and Rect. Price £19.18.0, carr. paid or £5.18.0 deposit and 6 monthly payments of 58/6. Total H.P.P. price £20.15.6. STEREO DECODER £7.10.0 extra.

GLADSTONE RADIO 66 ELMS ROAD ALDERSHOT, Hants. Aldershot 22240
 (2 mins. from Station and Buses). FULL GUARANTEE. CATALOGUE 1/-
 CLOSED WEDNESDAY AFTERNOON.

DIOTRAN SALES

P.O. BOX 5
WARE, HERTS
TEL.: WARE 3442

Nowhere in the world can you buy semiconductors cheaper than from us. We are the largest purchasers of manufacturers' surplus stocks, and can fulfil any requirements at competitive prices. S.A.E. for full lists.

Post and Packing costs are continually rising. Please add 1/- towards same. CASH WITH ORDER PLEASE

OVERSEAS QUOTATIONS BY RETURN SHIPMENTS TO ANYWHERE IN THE WORLD

I/- TESTED TRANSISTORS				
ONE PRICE ONLY PNP, NPN.				
SILICON PLANAR 1/- EACH				
BC108	2N696	2N1132	2N2220	2S733
BC109	2N697	2N1613	2N3707	2N3391
BF50	2N706	2N1711	2N3711	T1544
BF51	2N708	2N2904	2S102	2N2906
BFX84	2N929	2N2905	2S103	2N2907
BFX86	2N930	2N2924	2S104	2N2696
BFX88	2N1131	2N2926	2S732	2N3702
				2N3703

From Manufacturers' Over-runs—Unmarked Plastic and Metal cases.

GERM. PNP AND NPN TRANSISTORS FULLY TESTED, UNMARKED 1/6 EACH				
AC125	ACY22	ACY36	NKT677	OC81 2G381
AC126	ACY27	NKT141	NKT713	OC82 2G382
AC127	ACY28	NKT142	NKT713	2G301 2G399A
AC128	ACY29	NKT212	OC44	2G302
AC130	ACY30	NKT213	OC45	2G303
AC131	ACY31	NKT214	OC71	2G308
AC132	ACY32	NKT215	OC72	2G371
AC133	ACY33	NKT216	OC75	2G374

1/6 each

POWER TRANSISTORS				
OC25	OC35	NKT403	ASZ17	5/- each
OC26	AD130	NKT404	T13027	
OC28	AD140	NKT405	T13028	
OC29	AD149	NKT452	T13029	

Manufacturers' Surplus Germ. A.F.

TEXAS SILICON ALLOY TRANSISTORS			
2S302	Evt. OC200	VcB40	Hfe 15-50 1-49 off 3/6 each
2S303	" OC201	VcB25	Hfe 25-75 5-99 off 3/- each
2S304	" OC202	VcB15	Hfe 45-120 100 off 2/6 each

ALL BRAND NEW, FULLY GUARANTEED AND MARKED.

HIGH QUALITY SILICON PLANAR DIODES.
SUB-MINIATURE DO-7 Glass Type, suitable replacements for OA200, OA302, BAY38, 1S130, 1S940, 200,000 to clear at £4 per 1,000 pieces. GUARANTEED 80% GOOD.

MIXED SILICON PLANAR TRANSISTORS NPN TO-18 CASE. Transistors to fill a number of requirements like 2N706, 2N708, BSY27, BSY95A, etc. 500 off £5; 1,000 off £8.10.

THYRISTORS (S.C.R.'s), FULLY TESTED, BRAND NEW AND CODED:

TO-5 CASE	Type No.	PIV	Amp	Each
2N1595	50	1	7/6	
2N1596	100	1	9/-	
2N1597	200	1	10/6	
2N1598	300	1	14/-	
2N1599	400	1	15/-	
BTX30-500	500	1	22/6	
BTX30-600	600	1	25/-	

TO-46 CASE (STUD)	Type No.	PIV	Amp	Each
2N1771	50	4-7	9/-	
2N1772	100	4-7	9/6	
2N1774	200	4-7	12/6	
2N1776	300	4-7	16/6	
2N1777	400	4-7	19/-	
2N1778	500	4-7	25/6	
2N2619	600	4-7	30/-	
BTY79-150	150	4-7	12/-	
BTY79-250	250	4-7	14/-	
BTY79-400	400	4-7	20/-	

TO-48 CASE (STUD)	Type No.	PIV	Amp	Each
2N682	50	16	12/-	
2N683	100	16	15/-	
2N685	200	16	19/6	
2N687	300	16	25/6	
2N688	400	16	32/6	
2N689	500	16	47/6	
2N690	600	16	50/-	
2N691	700	16	56/-	
2N692	800	16	62/-	

PRINTED CIRCUIT BOARDS with usable length leads on both Transistors and diodes. All Mullard devices with the exception of the 2G371 which are Texas.

EACH PANEL CONSISTS OF THE FOLLOWING:—

"A"	8 x OC43, 24 x OA81	12/- per Panel
"B"	6 x OA81	20/- per Panel
"C"	8 x 2G371	5/- per Panel
"D"	16 x OC84	15/- per Panel
"E"	8 x GET875, 24 x OA81	11/- per Panel
"F"	8 x GET144, 20 x OA81	10/- per Panel
"G"	8 x 2G371, 12 x OA81	7/6 per Panel
"H"	8 x GET144, 12 x OA81	8/6 per Panel
"I"	8 x OC84	9/- per Panel
"J"	4 x OC28, 4 x FST1/0	15/- per Panel
"K"	4 x OC35, 4 x FST1/0	15/- per Panel
"L"	32 x OA81	12/- per Panel
"M"	4 x GET875, 2 x OA81	3/- per Panel

TRANSISTOR EQVT. BOOK

2,500 cross references of transistors—British, European, American and Japanese. A must for every transistor user. Exclusively distributed by DIOTRAN SALES. 15/- EACH.

Vast mixed lot of subminiature glass diodes. Comprising of silicon germ. point contact and gold bonded types plus some zeners. 500,000 available at Lowest of Low Price.
1,000 pieces £3.0.0. 5,000 pieces £13.10.0. 10,000 pieces £23.

BRAND NEW FULLY TESTED EPOXY CASE UNIJUNCTION TRANSISTORS. Type T1S43 and BEN 3000 and replacement for 2N2646. Full data available. **LOWEST PRICE AVAILABLE ANYWHERE.** 100 off 4/- each = £20; 500 off 3/6 each = £87.10; 1,000 off 3/- each = £190. Sample devices 7/- each on request.

SILICON PLANAR PLASTIC TRANSISTORS. 2N3708A VcB30 Hfe 20-60. All marked, fully tested and guaranteed. 1 off 1/6 each; 100 off 10d. each; 500 off 9d. each; 1,000 off 7½d. each.

TO-18 METAL CAN SILICON PLANAR TRANSISTORS. VERY HIGH QUALITY 99% good. Type 2N706 BSY27 £7.10 per 500 pieces; £12.10 per 1,000 pieces.

Sub-Min. Plastic 1 Amp Sil. Rect.

Type No.	PIV	Each
IN4001	50	1/3
IN4002	100	1/6
IN4003	200	2/-
IN4004	400	2/9
IN4005	600	3/3
IN4006	800	3/9
IN4007	1,000	4/9

STEP UP YOUR EARNINGS

WITH THIS LIBRARY OF KNOW-HOW AND PRACTICE

You can have PRACTICAL ELECTRICAL ENGINEERING sent to your home to examine free of charge. It will help you understand the many branches of the electrical industry from installation work, Equipment, Instruments, Motors and Machines, Transformers, Rectifiers, Lifts, Maintenance and Operation right through to the Generation and Distribution of Electricity. And, to make the 2,350 pages of facts and vital theory crystal clear, there are over 2,000 'action' photos and drawings. In addition you receive a slip-case of 36 large Blueprint charts; a fascinating booklet which shows how a Nuclear Power Station works; and a free Electrical Pocket Book of useful data.

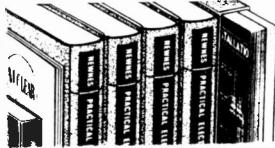

YOURS ON 7 DAYS FREE TRIAL

Buckingham Press Ltd., 18/19 Warren Street, London, W.1

Please send *Practical Electrical Engineering* without obligation to buy if you accept my application. I will return the books in 8 days or post—

Tick Full cash price of £16, or here 16/- dep. and 16 monthly payments of 20/-.

If you are under 21 your father must fill up coupon

Full Name (BLOCK LETTERS)
Address

County

Occupation

Signature { Mr. Mrs. Miss

(Credit price £16 16s.) For Eire and N. Ireland send £16 with coupon. Elsewhere Overseas add 28/- p. & p. PEE/3853

Please tick (✓) here

The address on left is

My/our property

Rented

unfurnished

Furnished accom

Temporary address

If none of the above please answer here

BUILD YOUR CIRCUITS ON VEROBOARD

—the Universal Wiring Board— obtainable from your local Retailer

Trade enquiries to:
NORMAN ROSE (ELECTRICAL) LTD.
8 St. Chad's Place, Gray's Inn Road, London, W.C.1

Technical enquiries to:
VERO ELECTRONICS LTD.
Industrial Estate, Chandler's Ford, Hants

12in. DE-LUXE MKII £9

The exceptional quality and performance of the "De-luxe MKII" brings truly breathtakingly rich sound from a single loudspeaker, recreating the musical spectrum virtually flat from 25 to 16,000 c.p.s. The unit consists of the latest double cone, woofer and tweeter cone together with a special Baker "FERROBA" magnet assembly having a flux density of 14,000 gauss and a total flux of 150,000 Maxwells. Bass resonance 32-38 c.p.s. Rated 15 watts. Voice coils available 3 or 8 or 15 ohms. Suitable for any High Fidelity System. Design capability concept and programmed third generation hardware giving fantastically delightful sound at this amazing bargain price.

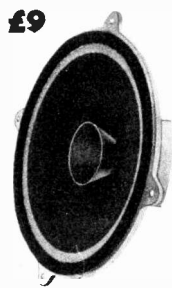

48 page Enclosure Manual 5/9 post paid.

Baker Reproducers Ltd

Bensham Manor Road Passage, Thornton Heath, Surrey, 01-684 1665

VALUABLE NEW HANDBOOK FREE TO AMBITIOUS ENGINEERS

Have you had your copy of "Engineering Opportunities"?

The new edition of "ENGINEERING OPPORTUNITIES" is now available—without charge—to all who are anxious for a worthwhile post in Engineering. Frank, informative and completely up to date, the new "ENGINEERING OPPORTUNITIES" should be in the hands of every person engaged in any branch of the Engineering industry, irrespective of age, experience or training.

On 'SATISFACTION OR REFUND OF FEE' terms

This remarkable book gives details of examinations and courses in every branch of Engineering, Building, etc., outlines the openings available and describes our Special Appointments Department.

WHICH OF THESE IS YOUR PET SUBJECT?

ELECTRONIC ENG.
Advanced Electronic Eng.—
Gen. Electronic Eng.—
Applied Electronics—
Practical Electronics—
Radar Tech.—
Frequency Modulation—
Transistors.

ELECTRICAL ENG.
Advanced Electrical Eng.—
General Electrical Eng.—
Installations—
Draughtsmanship—
Illuminating Eng.—
Refrigeration—
Elem. Elec. Science—
Elec. Supply—
Mining Elec. Eng.

CIVIL ENG.
Advanced Civil Eng.—
General Civil Eng.—
Municipal Eng.—
Structural Eng.—
Sanitary Eng.—
Road Eng.—
Hydraulics—
Mining—
Water Supply—
Petrol Tech.

RADIO & T.V. ENG.
Advanced Radio—
General Radio—
Radio & TV Servicing—
TV Engineering—
Telecommunications—
Sound Recording—
Automation—
Practical Radio—
Radio Amateurs' Examination.

MECHANICAL ENG.
Advanced Mechanical Eng.—
Gen. Mech. Eng.—
Maintenance Eng.—
Diesel Eng.—
Press Tool Design—
Sheet Metal Work—
Welding—
Eng. Pattern Making—
Inspection—
Draughtsmanship—
Metallurgy—
Production Eng.

AUTOMOBILE ENG.
Advanced Automobile Eng.—
General Auto. Eng.—
Auto. Maintenance—
Repair—
Auto. Diesel Maintenance—
Auto. Electrical Equipment—
Garage Management.

WE HAVE A WIDE RANGE OF COURSES IN OTHER SUBJECTS INCLUDING CHEMICAL ENG., AERO ENG., MANAGEMENT, INSTRUMENT TECHNOLOGY, WORKS STUDY, MATHEMATICS, ETC.

Which qualification would increase your earning power? A.M.I.E.R.E., B.Sc.(Eng.), A.M.S.E., A.M.I.P.E., A.M.I.M.I., A.R.I.B.A., A.I.O.B., A.M.I.Ex., A.R.I.C.S., M.R.S.H., A.M.I.E.D., A.M.I.Mun.E., C.ENG., CITY & GUILDS, GEN. CERT. OF EDUCATION, ETC.

BRITISH INSTITUTE OF ENGINEERING TECHNOLOGY
316A ALDERMASTON COURT, ALDERMASTON, BERKSHIRE

THIS BOOK TELLS YOU

- ★ HOW to get a better paid, more interesting job.
- ★ HOW to qualify for rapid promotion.
- ★ HOW to put some letters after your name and become a key man . . . quickly and easily.
- ★ HOW to benefit from our free Advisory and Appointments Depts.
- ★ HOW you can take advantage of the chances you are now missing.
- ★ HOW, irrespective of your age, education or experience, YOU can succeed in any branch of Engineering.

132 PAGES OF EXPERT CAREER - GUIDANCE

PRACTICAL EQUIPMENT

Basic Practical and Theoretic Courses for beginners in Electronics, Radio, T.V., Etc., A.M.I.E.R.E. City & Guilds Radio Amateurs' Exam. R.T.E.B. Certificate P.M.G. Certificate Practical Electronics Electronics Engineering Practical Radio Radio & Television Servicing Automation

INCLUDING TOOLS

The specialist Electronics Division of B.I.E.T. NOW offers you a real laboratory training at home with practical equipment. Ask for details.

B.I.E.T.

You are bound to benefit from reading "ENGINEERING OPPORTUNITIES"—send for your copy now—FREE and without obligation.



POST COUPON NOW!

TO B.I.E.T., 316A ALDERMASTON COURT, ALDERMASTON, BERKSHIRE.

Please send me a FREE copy of "ENGINEERING OPPORTUNITIES." I am interested in (state subject, exam., or career).

NAME

ADDRESS

WRITE IF YOU PREFER NOT TO CUT THIS PAGE

THE B.I.E.T. IS THE LEADING INSTITUTE OF ITS KIND IN THE WORLD

Published about the 15th of the month by GEORGE NEWNES LIMITED, Tower House, Southampton Street, London, W.C.2, at the recommended maximum price shown on the cover. Printed in England by THE CHAPEL RIVER PRESS, Andover, Hants. Sole Agents—Australia and New Zealand: GORDON & GOTCH (A/sia) Ltd.; South Africa and Rhodesia: CENTRAL NEWS AGENCY LTD.; East Africa: STATIONERY & OFFICE SUPPLIES LTD. Subscription rate including postage for one year: To any part of the World £2 2s. 0d.

ENGLANDS LEADING COMPONENT & EQUIPMENT CENTRES

SOLID STATE-HIGH FIDELITY AUDIO EQUIPMENT

Audio Equipment developed from Dinsdale Mk. II—each unit or system will compare favourably with other professional equipment selling at much higher prices.

COMPLETE SYSTEMS FROM £15.5.0

THE FINEST VALUE IN HIGH FIDELITY—CHOOSE A SYSTEM TO SUIT YOUR NEEDS AND SAVE POUNDS



All units available separately.

SEND FOR 16 PAGE BROCHURE (No. 21) TODAY!
DEMONSTRATIONS DAILY AT '303' EDGWARE ROAD

Acclaimed by everyone THE MAYFAIR ELECTRONIC ORGAN



A completely new development in portable electronic musical instruments and a new field for the home constructor. The 'MAYFAIR' produces a multitude of the most pleasing sounds with a wide range of tone colours suitable for classic or popular music. The organ is fully polyphonic, that is full chords can be played over the entire keyboard. Supplied as a kit of parts which includes 165 transistors, printed circuit panels, special fully sprung and depth of touch adjusted keyboard, attractive vinyl covered cabinet with carry handle. A complete detailed and illustrated construction manual is provided with circuits and full parts list. Cost can be spread by purchasing the components packet by packet. All parts supplied are fully guaranteed. Full after sales service.

A new source of construction for the keen electronics fan either amateur or professional. *Once built the MAYFAIR will then provide years of enjoyable entertainment.* **TOTAL COST 99 Gns.**

ORGAN COMPONENTS	Deferred terms available.	BUILT AND TESTED
We carry a comprehensive stock of organ components for TRANSISTOR AND VALVE FREE PHASE designs.	COMPLETE KIT Deposit £29.19.0. 12 monthly payments of £7. TOTAL £113.19.0.	Deposit £36.8.0 & 12 monthly payments of £9. Total £144.8.0.
Ask for BROCHURE 9	Call in. See it and play it yourself.	EXPORT ENQUIRIES INVITED

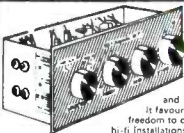

TRANSISTOR AMPLIFIER

INTEGRATED 7 WATT AMPLIFIER & PREAMPLIFIER—M47 With full Bass Treble and Volume Controls

A brilliant new design suitable for home or portable installations. For use with magnetic and crystal/ceramic cartridges, radio tuners, microphones, tape head replay and auxiliary inputs. Output is for 2 to 16 ohm speakers. It favours the user in so many ways... with fantastic power, with far greater adaptability, with freedom to operate it from batteries or mains power supply unit (the new PS.20 is ideal for this), it is ideal for installations, electronic guitars and organs. P.A. installations, intercom. systems, etc. This true 7-watt amplifier is supplied ready built, tested and guaranteed.

For complete listening satisfaction: FOR ONLY £8/10/0 P.P. 4/- (OPTIONAL MAINS UNIT PS.20 6/2/2, P.P. 3/-) Illustrated Brochure No. 12



BRITISH MADE CAR RADIOS

A fine precision engineered car radio that's perfect company for long hours on the road. So easy to install and operate—and the price is exactly right. Has quick push-button operation for immediate station selection and choice of Medium or Long wave frequency. Manual tuning facilities. Push-button control. Output of 31 watts ensures crisp, top quality sound even at high motoring speeds. Price includes 7" x 4" speaker, full accessories and instructions.

POSITIVE OR NEGATIVE EARTH **EASI-TUNE £12.12.0. pp. 4/6**

AUTOBAHN MANUAL as the EASI-TUNE, but with a single MW/LW Push Button. **£10.10.0 pp. 4/6**

CAR AERIALS * 3 Section Single Hole Wing or Boot Mounting 19/6 Brochure 15 Multi Section fully disappearing type with locking device, single hole mounting 35/- Post free with Car Radio or pp. 2/6 separately.

BUILD THESE PRACTICAL DESIGNS

I.C.F.M. TUNER	£5.2.6.	LIST 40B
Switched F.M. Tuner	£3.17.6.	39B
Fluorescent Camping Light	£3.2.6.	43

Let us have your enquiries for parts for complete PW and PE designs. S.A.E. PLEASE.



NEW MODELS **NOMBREX** TRANSISTORISED Test Equipment

MODEL	PRICE	Leaflet
22 Power Supply	14 0 0	22
30 Audio Generator	19 10 0	24
31 R.F. Generator	12 10 0	25
32 C.R. Bridge	10 10 0	26
33 Inductance Bridge	20 0 0	29

Send for descriptive illustrated Brochure.



DO IT YOURSELF MW/LW PORTABLE

New printed circuit design with full power output. Fully tunable on both mw/lw bands. 7 transistors plus diode, push-pull circuit. Fitted 5 inch speaker, large ferrite aerial and Mullard transistors. Easy to build with terrific results. All local and Continental stations. **TOTAL COST £6.19.6. P.P. 4/6**
TO BUILD Send for Brochure 1



MULLARD 1 WATT AMPLIFIER WITH VOLUME CONTROL

Suitable 7 x 4 inch 3 ohm speaker 17/6 Ideal for Portable Record Players, Inter-Coms, Baby Alarms etc. **45/- pp.** For 9 Volts operation. **45/- 3/6d.**

ITS SO EASY TO BUILD TO PROFESSIONAL STANDARDS

To get the best out of your MAGNAVOX STUDDIOMATIC DECK Type 363, you need a MARTIN RECORDKIT. This comprises a special high quality 6 valve amplifier and pre-amplifier which comes to you assembled on its printed circuit board, together with necessary transformers, switches, control knobs—in fact everything needed down to the last screw FOR MAKING A SUPERB TAPE RECORDER, which, when built, will compare favourably with instruments costing twice as much, yet you need no experience or technical skill to bring this about. THE INSTRUCTIONS MANUAL MAKES BUILDING EASY AND SUCCESS ASSURED.



TWO TRACK DECK Amplifier, Cabinet and Speaker. Complete kits with MICROPHONE 7 in 1, 200 ft. tape, spare spool. Today's value £55 OUR PRICE **36 gns.**
FOUR TRACK DECK Amplifier, Cabinet and speaker. Complete kits with MICROPHONE 7 in 1, 200 ft. tape, spare spool. Today's Value £60 OUR PRICE **39 gns.**
P.P. 22/6
ALL UNITS AVAILABLE SEPARATELY. Both models. ASK FOR BROCHURE 6.

VHF FM SUPERHET TUNER MKII

"S-MULLARD TRANSISTORS & 4 DIODES" 300 KC/S BANDWIDTH - PRINTED CIRCUIT CONSTRUCTION - HIGH FIDELITY REPRODUCTION MONO AND STEREO - MATCHES AUDIO MK II EQUIPMENT
A popular VHF FM Tuner now used throughout the country for quality reception of monophonic and, with the decoder, stereophonic broadcasts. There is no doubt about it—VHF FM gives the real sound! Excellent stability economically—1000 TOTAL COST £8.19.6. DECODER £5.19.6. (CABINET 20/- EXTRA) ASK FOR LEAFLET 3.

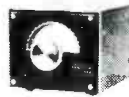

TRANSISTORS, RECTIFIERS, ZENERS, SCR'S TUNNEL DIODES, FIELD EFFECT TYPES, VALVES, CRYSTALS

New 1968 32-page Booklet
Price 1/- Post Paid
Circuits with Data, Details and Prices of over 2000 different types.
This booklet is a must for every enthusiast. MANUFACTURERS—DISTRIBUTORS. We also publish a QUANTITY, SEMI-CONDUCTOR BULLETIN. Please write to us for your copy.

NEW—MALLORY LONG LIFE MERCURY BATTERIES

50% OFF LIST PRICES
* RM12 1.35 volts 3500 mA/H OUR PRICE 5/- each size 2" x 1 1/2"
RM625 10.35 volts 350 mA/H Pack of 8 Size 2 1/4" x 1 1/2" OUR PRICE 10/- each
Easily split into eight 1.35v cells. These cells are ideal for any application where SMALL SIZE HIGH CAPACITY and LONG LIFE are required. QUANTITY QUOTATIONS WRITE OR PHONE EXTN 2.



GARRARD DECKS



BRAND NEW All below list price

2025 Mono/Stereo	£ 8 19 6
300 LM with 9TAHC	9 19 6
SP25 MK II	12 12 0
LAB80 MK II	25 0 0
AT60	10 19 6
AT60 Mk II	13 19 6
40 MK II	11 10 0
3500 Mono/Stereo	14 10 0
401	27 15 0
AP25	21 10 0
SL55	13 10 0
SL65	16 19 6
SL75	32 10 0
SL95	39 10 0
.A70 Mk II	13 12 0

Complete range of accessories available

Hi-Fi equipment to suit EVERY POCKET

Ask for Hi-Fi- Stock List Leaflet 16.17
VISIT OUR NEW HI-FI CENTRE at 309 EDGWARE RD.

for all leading makes
AMPLIFIERS
TUNERS
DECKS
SPEAKERS
MICROPHONES
SYSTEMS
ALL WITH DISCOUNTS
IT WILL PAY YOU TO PAY US A VISIT!

Fully Illustrated CATALOGUE

COMPLETELY NEW 9th EDITION (1968)
The most COMPREHENSIVE—CONCISE—CLEAR—COMPONENTS CATALOGUE
Complete with 10/- worth discount vouchers FREE WITH EVERY COPY.
* 32 pages of transistors and semi-conductor devices, valves and crystals.
* 200 pages of components and equipment.
* 65 pages of microphones, decks and Hi-Fi equipment.
6,500 ITEMS
300 BIG PAGES
Send today 8'6 Post Paid

HENRY'S RADIO LTD HR
OPEN MON.—SAT. 9 a.m.—6 p.m. THURS. 9 a.m.—1 p.m.

303 Edgware Road, London, W.2. Mail Order Dept.
all types of Components, Organ Dept. (01) 723-1008/9
309 Edgware Road, London, W.2. High Fidelity Sales, P.A. and Test Equipment, Record Decks (01) 723-4963