

PRACTICAL

ELECTRONICS

DECEMBER 1968

THREE SHILLINGS

Electronic

STOCKMARKET



ALSO

"FLIP FLOP"



**** Another Game For Partytime

ADCOLA
PRODUCTS LIMITED
(Regd. Trade Mark)

**Soldering
Instruments**

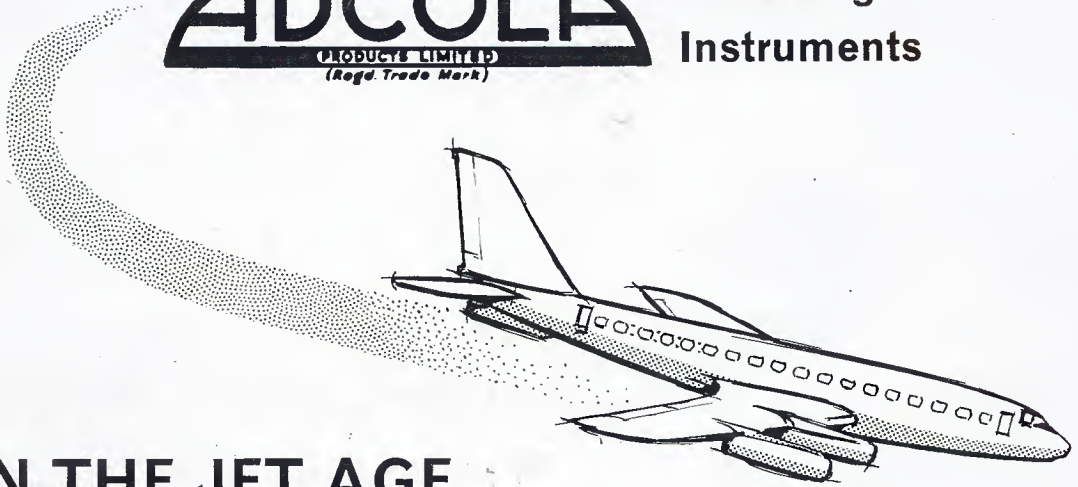

IN THE JET AGE

EFFICIENCY AND RELIABILITY,

AND CONSISTANT, SUSTAINED PERFORMANCE

ARE BASIC REQUIREMENTS.

ADCOLA SOLDERING INSTRUMENTS MEET THESE NEEDS

**AND GO ON MEETING THEM, DAY AFTER DAY, YEAR AFTER YEAR,
WITH UNFAILING REGULARITY.**

**LEADING MANUFACTURERS THROUGHOUT THE WORLD LIKE THIS,
THEY ALSO LIKE THE QUICK SERVICE WHEN REPLACEMENTS
DO BECOME NECESSARY. SO THEY SPECIFY ADCOLA.**

WHY DON'T YOU!

**AVAILABLE FROM SHOPS EVERYWHERE
OR DIRECT FROM**

**SALES & SERVICE DIVISION,
ADCOLA PRODUCTS LTD.,
ADCOLA HOUSE,
GAUDEN ROAD,
LONDON, S.W.4.**

TELEPHONE 01-622 0291

**SEND COUPON
FOR LATEST LEAFLET**

NAME _____
ADDRESS _____

P.E.167

Lasky's Radio

SPECIAL INTEREST ITEMS!

MIDLAND Model 10-502 VHF AIRCRAFT BAND CONVERTER

An entirely new item for the radio enthusiast bringing instant reception of the ground-to-air, air-to-ground waveband. For use with any standard AM or FM radio covering 535 to 1,605kc/s, 88 to 108Mc/s respectively—with no electrical conversion or connection required. The Model 10-502 (self powered by one 9V (PP3 type) battery) is merely placed close to the receiving set and then tuned over 110 to 135Mc/s which covers the whole aircraft communications band. Volume and reception effectiveness is adjusted by moving both sets to the most favourable position and balancing the volume controls of each accordingly. The Model 10-502 has a smartly designed black plastic cabinet with brushed metal front panel and 18in chrome telescopic antenna, size only 4 x 2½ x 2½in (inc. knobs). Complete with battery and full instructions.



Lasky's Price 79/6 Post 3/6

SPECIAL TRANSCRIPTION MOTOR OFFER — FAMOUS Connoisseur Classic



2 speed transcription deck. One synchronous motor for each speed—45 and 33 r.p.m. List Price £15.17.

Lasky's Price £9.19.6. P. & P. 5/-

ALSO AVAILABLE Connoisseur SCU.1 pickup arm and cartridge. List Price £8.13.4.

Lasky's Price £5.19.6. P. & P. 3/6

PACKAGE PRICE IF BOUGHT TOGETHER £12.19.6. P. & P. 5/-

GARRARD RECORD PLAYERS

AUTOCHANGERS

1025	£7/19/6
2025	£8/19/6
SL95	£45/0/0
3000ML with stereo cart.	£9/19/6
AT60 Mk. II	£13/19/6
A70	£13/19/6
AF75	£20/10/0
A50	£27/7/0

SINGLE PLAYERS

GARRARD SP25 Mk. II	£11/19/6
GARRARD SP22	£6/10/6

TRANSCRIPTION DECKS

GARRARD 401	£27/19/0
GARRARD Lab. 80 Mk. II	£30/9/0
with base	£30/9/0

CLEARVIEW PERSPEX COVERS

SPC1	£3/3/10
SPC2	£4/4/4
SPC4	£4/4/11

Postage on all above 5/- extra.

GARRARD BASES

WB1	£3/5/8
WB2	£4/13/8
WB4	£5/6/11

HITACHI CAR RADIO SHORT WAVE ADAPTOR

Model WM20

New from Hitachi—world famous for high quality transistor radios—a push button Short Wave adaptor enabling you to receive all foreign broadcasts in the 3-22Mc/s waveband. The WM-20 adaptor is suitable for use with any make or model of AM car radio (covering the usual 535-1,605kc/s) in any make or model of car (6 or 12V, positive or negative ground). The WM-20 as will be seen has 10 push buttons which cover metre bands: 13, 16, 19, 25, 31, 41, 49, 60 and 90 push Off button. Having selected the required band by pushing the appropriate button—fine station tuning is effected by use of the parent radio's tuning system—details with the adaptor show corresponding centres for each short wave band on the radio dial. Double superhet IFM circuit and the use of a Zenor diode and compensating—details with the adaptor show corresponding centres for each short wave band on the radio dial. Double superhet IFM circuit and the use of a Zenor diode and compensating—details with the adaptor show corresponding centres for each short wave band on the radio dial. Double superhet IFM circuit and the use of a Zenor diode and compensating—details with the adaptor show corresponding centres for each short wave band on the radio dial. Double superhet IFM circuit and the use of a Zenor diode and compensating—details with the adaptor show corresponding centres for each short wave band on the radio dial.

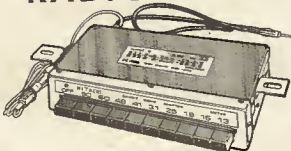

List Price 14 Gns. Lasky's Price £9.19.6. P. & P. 5/-

GET YOUR LASKY'S CATALOGUE

FREE Third great issue now in preparation—more pages—1,000's more items. Make sure of your copy now. Just send your name, address and 1/- for post only

COMMUNICATION RECEIVERS

TRIO

MODEL 9R-59DE

Brief spec.: 4 band receiver covering 550kc/s to 30Mc/s continuous and electrical band spread on 10, 15, 20, 40 and 80 metres. 8 valve plus 7 diode circuit. 4/8 ohm output and phone jack. Special features: 88B CW • ANL • Variable BFO • 5 meter • Sep. band spread dial • IF frequency 455kc/s • Audio output 1.5W • Variable RF and AF gain controls. For use on 115/250V a.c. Mains. Beautifully designed control layout finished in light grey with dark grey case, size 7 x 15 x 10in. Weight 19lb. Fully guaranteed, complete with instruction manual and service data.

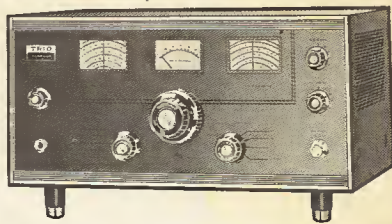

Lasky's Price £39.15.0 Carriage and Packing 12/6

SPECIAL INTEREST ITEM JUST ARRIVED

TTC Model A.1009 AM TUNER ADAPTOR PACK FOR CASSETTE RECORDERS

An amazingly ingenious AM Tuner that looks like and is exactly the same size as a standard tape cassette—which converts your tape cassette recorder/player instantly into a radio! The tuner pack is a completely self-contained unit with built-in ferrite rod aerial, power source (one miniature Eveready type D23) giving approx. 150 hrs operation. All you do is take out the tape cassette and slip in the tuner. Tunable over 535-1,605kc/s (full Medium waveband). Suitable for use with all standard tape cassette recorders and players. Complete with battery.

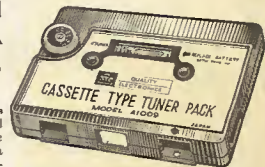

Lasky's Price 89/6. P. & P. 2/6.

CONSTRUCTORS BARGAINS

LASKY'S ENCAPSULATED SOLID STATE MODULES

8 completely new special function circuit modules. Size of each module only 2½ x 1½ x ¼in. Ready for immediate use—just connect to power source (usually 9V batt.), input and output. Encapsulated modules are shockproof and almost indestructible. Comp. with full ins. Post 1/6 each.

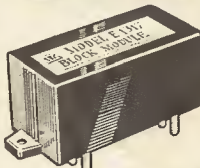

- E-1311 Phono Pre-amp Module—max. output 3V, RMS, input 50mV, input imp. 100kΩ, gain 28dB, RIAA compensation. 29/6
- E-1312 Tape Head Pre-amp Module—max. output 3V, RMS, input 50mV, input imp. 100kΩ, gain 25dB, NARTB compensation. 29/6
- E-1313 Microphone Pre-amp Module—max. output 4V, RMS, input 50mV, input imp. 100kΩ, gain 28dB, response 10-50kc/s. 29/6
- E-1314 Power Amplifier Module—max. output 300mW, input imp. 1kΩ, gain 20dB, response 50-10kc/s, distortion 3% at 20mV. 29/6
- E-1315 Electronic Organ (tone oscillator) Module—frequency 200-1,000c/s, output 80mW. For use with keyboard, variable resistors and 8Ω speaker. 25/-
- E-1316 Morse Code Practice Oscillator Module—frequency 400c/s, output 80mW. For use with Morse key and speaker. 25/-
- E-1317 Modulated Wireless Signal Transmitter for use in test bench fault finding—frequency 400c/s-30kc/s, tone freq. 400c/s. For use with any AM receiver. 25/-
- E-1318 Lamp Flasher Module—flashes two miniature lamps alternately. For use with 6V, 100/200mA bulbs and 6V power supply. 25/-

CLEAR PLASTIC PANEL METERS

Precision made in Japan by TTC. Each meter boxed and fully guaranteed with all fixing nuts and washers. Sizes are of front panel. Add 1/6 P. on each. (Quotes for quantities.)

Type KE-52 3 x 2 1/2 in (illustrated)			
1mA	38/6	50µA	56/-
5mA	38/6	1mA S Meter	39/6
100mA	36/6	100µA	62/6
300V	35/-	500µA	45/-
Type MK-38A 1 1/2 in square		Type KR-65 3 1/2 x 3 in	
1mA	29/6	1mA	38/6
5mA	27/6	5mA	37/6
100mA	27/6	100mA	38/6
300V	27/6	300V	36/-
50µA	37/8	50µA	42/-
1mA S meter	29/6	1mA S meter	42/-
100µA	37/6	100µA	56/-
500µA	29/6	500µA	46/-
Type MK-45A 2 in square			
1mA	29/6		29/6
5mA	29/6		29/6
100mA	29/6		29/6
300V	29/6		29/6
50µA	49/6		49/6
1mA S meter	32/6		32/6
100µA	42/6		42/6
500µA	35/-		35/-



Branches

207 EDGWARE ROAD, LONDON, W.2 Tel.: 01-723 3271

Open all day Saturday, early closing 1 p.m. Thursday

33 TOTTENHAM CT. RD., LONDON, W.1 Tel.: 01-636 2605

Open all day, 9 a.m.—6 p.m. Monday to Saturday

152/3 FLEET STREET, LONDON, E.C.4 Tel.: FLEet St. 2833

Open all day Thursday, early closing 1 p.m. Saturday

High Fidelity Audio Centres

42 TOTTENHAM CT. RD., LONDON, W.1 Tel.: 01-580 2573

Open all day Thursday, early closing 1 p.m. Saturday

118 EDGWARE ROAD, LONDON, W.2 Tel.: 01-723 9789

Open all day Saturday, early closing 1 p.m. Thursday

ALL MAIL ORDERS AND CORRESPONDENCE TO: 3-15 CAVELL ST., TOWER HAMLETS, LONDON, E.1 Tel.: 01-790 4821

VALVES/SEMICONDUCTORS

BRAND NEW & GUARANTEED

0A2	6	6J4	9	30FL1	15	ECF82	7/6	GZ32	11/8	PY801	8
0B2	6	6J6	3/6	30L15	15	ECH35	11	GZ34	11/8	U25	15
1R3	6	6J8	3/6	30P19	14/6	ECH42	11	MI14	8	U26	15
1S5	4/6	6L6	6/6	30PL15	15	ECH81	8/3	PBC80	7/6	U191	14
1T4	3/6	6Q7	6/6	30PL13	16	ECH83	8/3	PAC84	6/6	G281	8
1U4	6	68G7	6	35L6	8	ECL80	7/8	PCC85	8	U301	11
1U5	7	68J7	7	35Z4	8/6	ECL82	7	PCC88	11/6	U801	22/6
2D21	5	68L7	6	36W4	5/8	ECL83	10/6	PC89	11/6	UABC80	6
3A5	10	68M7	5/6	36Y5	6/6	PCML56	8/6	PCF89	12/6	UAF42	10
3Q4	7/6	6U7	7	50C5	6/6	PEF8A	8	PCF84	5	UCH41	8
3R4	5	6V6	5	80	7	EF40	10	PC88	11	UFB70	7
3V4	6	6X4	4/3	AZ31	10	EF41	9/6	PC97	8/6	UFB89	7
514	9	6X5	5	DAF91	4/6	EF42	10/6	PC900	9/6	UC884	10
514	5	7B7	7	DF96	7/6	EF90	5	PCF80	7/3	UC885	7
5V4	8/6	7C6	6/6	DF91	3	EF85	6/8	PCF82	7	UCF80	8/6
6AL5	3	7Y4	8/6	DF96	7	EF86	7	PCF84	5	UCH42	10
6Z4	8	10C2	15	DK91	6	EF88	6/3	PCF86	8/6	UCH81	7
6/30L2	12/6	10F1	9	DK92	8/9	EF91	4	PCF800/15	UC882	8	
6AC7	4	10P13	15	DK96	8/6	EF92	4	PCF801/10	UC883	10	
6AK7	6	10P14	16	DL92	5	EF183	7	PCF802/10	UF41	10	
6AK5	5	12AT6	5	DL94	6	EF184	7	PCF805/14	UF80	7	
6AL6	6	12BH7	6/8	DL96	8	EL33	17/6	PCL82	7/6	UF85	7/6
6AM6	4	12AU7	5	DY85	6/6	EL34	11	PCL83	9/6	UF88	7/6
6AQ5	6	12AX7	6	F58C	12/6	EL41	9/9	PCL84	8	UL41	10
6AS6	6	12BA6	6/9	EABC80	7	EL42	11	PCL85	9/6	UL84	7
6AT6	5	12BE6	6/3	EJ38F	15	EL51	9	PLC86	9	UY41	7/6
6B16	5/9	12BH7	6/8	EAF42	9/6	EL84	5	PLP200	12/6	UY85	6/6
6BE6	4	12C6	5/6	EB01	8	EL85	8/6	PL36	10/6	VR105/30	6
6BE6	5	12SQ7	6/6	EB04	9/6	EL88	7/6	PL37	10/6	VR50/30	5
6BH6	8	19AQ5	6	EB8C1	7	EL95	5/3	PL82	7		
6BJ6	8	20P2	14	EBF80	7/6	EM80	7/6	PL83	7		
6BR7	11	20L1	13	EBF83	9	EM81	8	PL84	6/9		
6BZ6	7	20P1	12	EBF89	7/6	EM84	7/6	PL500	14/6		
6C4	3/6	20P3	12	EC00	11/6	EM87	7/6	PY33	8/9		
6C6	4	20P8	22/6	EC08	2/6	EM91	7/6	PY30	2/6		
6CD6	20	25L6	6/6	ECC82	5	EY86	6	PY81	6/6		
6CH6	6	25Z4	8	ECC83	6	EZ40	8/6	PY82	6		
6CL6	10	30C15	13/6	ECC84	6/6	EZ41	8/6	PY83	6/6		
6D5	8	30C18	14	ECC85	5/6	EZ80	5/6	PY88	7/6		
6E5	8	30F5	14	ECCF80	7/6	EZ81	5/6	PY800	8		

TRANSISTORS

2N696	5	AF118	4/6	BSY56	17/3	0CT7	5
2N697	5	AF119	4/6	BSY65	4/6	0C74	5
2N706	3	AF186	12	BSY78	7/6	0C75	4/6
2N706A	4	ASZ28	6/6	BSY79	7/6	0C76	4/6
2N708	4	BC107	4/6	BSY98A	3/6	0C77	4/6
2N743	4	BC108	4/6	BUC10	12/6	0C80	5
2N744	4	BC109	4/6	GET106	4/6	0C81	4
2N753	4/6	BC170	3	GET113	5	0C81M	2/6
2N914	4/6	BC172	3/3	GET873	4/6	0C81D	3/6
2N916	4/6	BC173	3/3	GET874	4/6	0C81DM	2/6
2N929	4/6	BCY31	4/6	MA1100	7/9	0C82	4/6
2N930	5	BCY34	4/6	MA1101	6/6	0C83	5
2N1613	5	BCY39	4/6	MA1120	7/9	0C130	7/6
2N1711	6/6	BCY42	5	MA1121	8/6	0C140	9/6
2N1893	8	BCY43	5	NKT210	5/6	0C169	4/6
2N2160	14 11	BF115	4/6	NKT211	5	0C170	4/6
		BF112	6/6	NKT212	4/9	0C171	4/6
2N2147	17/6	BFX13	6/6	NKT213	5/6	0C200	5/6
2N2926	3	BFX10	4/6	NKT214	3/9	0C201	7/6
2S102	6/6	BFX11	4/6	NKT215	3/9	0C202	6
2S103	6/6	BFX17	4/6	NKT216	9/6	0C203	6
2S104	6/6	BFX18	4/6	NKT217	9/6	0C204	6
AC107	4/6	BFX19	4/6	NKT219	4/6	ST140	4
AC126	4/6	BFX50	4/6	NKT223	5	ST141	6
AC127	4/6	BFX31	4/6	NKT224	3/9	XA104	4/6
AC128	4/6	BFX52	4/6	NKT225	3/9	XA124	4/6
AC165	4	BFX90	12/6	NKT229	5	XA125	4/6
AC167	4/6	BKX19	15/6	NKT405		XB112	3/6
ACY19	4/6	BKX20	5/6		14/3	XC141	7
ACY20	4/6	BKX40	13/9	NKT403			
ACY21	4/6	BKX41	17		12/8		
ACY22	4	BSY10	5	OC23	8/6		
ACY40	4/3	BSY11	5	OC25	7/6		
ACY41	4/6	BSY26	4/6	OC26	6		
AD140	8/6	BSY27	4/6	OC28	8/6		
AD149	16	BSY28	4/6	OC35	8/6		
AD181	8	BSY29	8/6	OC36	8/6		
AD182	8	BSY38	4/6	OC41	5		
ADP140		BSY39	4/6	OC42	5		
	15	BSY51	7/9	OC44	4		
AF114	6/6	BSY52	8/9	OC45	3		
AF116	4/6	BSY53	8/3	OC70	3/6		
AF116	4	BSY54	9/6	OC71	3/6		
AF117	4/6	BSY55	15/9	OC72	4		

SILICON POWER DIODES

60 P.I.V.	6 AMP 5/8
290 MA	400 P.I.V.
70 P.I.V.	8 AMP 7/6
1 AMP 3/6	700 P.I.V.
140 P.I.V.	100 AMP
163 MA 1/1	800 P.I.V.
150 P.I.V.	5000A 5/6
25 AMP 10	800 P.I.V.
200 P.I.V.	5 AMP 7/6
6 AMP 5/6	1000 P.I.V.
400 P.I.V.	6 AMP 7/6
900 MA 3/6	1000 P.I.V.
400 P.I.V.	650MA 6/6

THYRISTORS SILICON CONTROL RECTIFIERS

400 P.I.V.	200 P.I.V.
3 AMP 7/6	7 AMP 15/6
100 P.I.V.	400 P.I.V.
7 AMP 13/6	7 AMP 15/6

PLEASE ADD POSTAGE

ZENER DIODES

OAZ22012	OAZ2208 6/6
OAZ220110	OAZ2209 6/6
OAZ2202 8/6	OAZ2210 6/6
OAZ2203 8/6	OAZ2211 6/6
OAZ2204 8/6	OAZ2212 6/6
OAZ2205 8/6	OAZ2213 6/6
OAZ2206 8/6	OAZ2217 5
OAZ2207 9/6	

SIGNAL DIODES

STC.1 WATT SERIES 5%	
2.4/2.7/3/3.9/4.3/13/16/18	
20/30/33 volt. 5% each.	
OA81 2	
OA80 2	
OA95 2/8	

TE-20RF SIGNAL GENERATOR

Accurate wide range signal generator covering 120Kc/s - 260 Mc/s on 6 bands, Directly calibrated. Variable R.F. attenuator. 200/240V a.c. Brand new with instructions. \$15.00. P. & P. 7/6. S.A.E. for details.



ARF-100 COMBINED AF-RF SIGNAL GENERATOR

AF. SINE WAVE
20 - 200,000c/s. Square wave 20 - 30,000 c/s. O.P. HIGH IMP. 21V P/P. 600Ω 3-8V P/P. 100kc/s-300 Mc/s.

Variable R.F. attenuation/intensity modulation. Incorporates dual purpose meter to monitor AF output and % mod. on R.F. 220/240V a.c. \$30.00. Carr. 7/6.

LAFAYETTE TE46 RESISTANCE CAPACITY ANALYSER

2pF-2,000 mfd 2 ohms-200 megohms. Also checks impedance, operation, 200/250V a.c.

Brand New \$17.10. Carr. 7/6.



T.E.40 HIGH SENSITIVITY A.C. VOLTMETER

10 meg. input 10 ranges: 0-1 / 003 / .1 / .3 / 1 / 3 / 10 / 30 / 100 / 300V. R.M.S. 4c/s.-1.2Mc/s. Decibels -40 to +50dB. Supplied brand new complete with leads and instructions. Operation 230V a.c. \$17.10. Carr. 5/6.



TE22 SINE SQUARE WAVE AUDIO GENERATORS

Sine: 20c/s to 200kc/s on 4 bands. Square: 20c/s to 30kc/s. Output impedance 5,000 ohms, 200/250V a.c. Supplied brand new and guaranteed with instruction manual and leads. \$15. Carr. 7/6.



TE-65 VALVE VOLTMETER

High quality instrument with 28 ranges. D.C. volts 1.5-1,500V. A.C. volts 1.5-1,500V. Resistance up to 1,000 megohms. 220/240V a.c. operation. Complete with probe and instructions. \$17.10. P. & P. 6/6. Additional Probes available: R.F. 35/-, H.V. 42/6.



AVO CT.38 ELECTRONIC MULTIMETERS

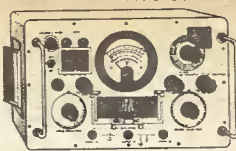

High quality 97 range instrument which measures a.c. and d.c. Voltage, Current, Resistance and Power output. Ranges d.c. volts 250mV-10,000V. (10megΩ-110megΩ input). D.c. current 10µA-25 amps. Ohms: 0-1,000mgΩ. A.c. volt 100mV-250V (with RF measuring head up to 250Mc/s). A.c. current 10µA-25 amps. Power output 50 micro-watts-5 watts. Operation 0/110/200/250V. C. Supplied in perfect condition complete with circuit lead and RF probe \$25. Carr. 15/-.

TYPE 13A DOUBLE BEAM OSCILLOSCOPES



An excellent general purpose D/B oscilloscope for 2c/s-730 kc/s. Bandwidth 5.5 Mc/s. Sensitivity 33mV/CM. Operating voltage 0/110/200/250V a.c. Supplied in excellent condition. The Ministry. \$22.10.0. Or complete with all accessories, probe, leads, lid, etc. \$25. Carrage 30/-.

AM/FM SIGNAL GENERATORS

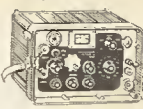

Oscillator Test No. 2. A high quality precision instrument made for the ministry by Airmec. Frequency coverage 20-50Mc/s. AM/CFW/FM. Incorporates precision dial, level meter, precision attenuator 1µV-100µV. Operation from 12V d.c. or 0/110/200/250V a.c. Size 12 x 8 x 9in. Supplied in brand new condition complete with all connectors fully tested. \$45. Carr. 20/-.



ADMIRALTY B.40 RECEIVERS

Just released by the Ministry. High quality 10 valve receiver manufactured by Murphy. Coverage in 5 bands. 650kc/s - 30Mc/s. 1/5F 500 kc/s. In-built crystal filter and 3 I.F. stages, band-pass filter, noise limiter, crystal controlled B.F.O., calibrator 1/5F. output, etc. Built-in speaker, output for phones. Operation 150/230V a.c. Size 13 1/2 x 15in. Weight 114lb. Offered in good working condition. \$22.10.0. Carr. 30/-. With circuit diagrams. Also available B.41 L.F. version of above 15kc/s-700kc/s. \$17.10.0. Carr. 30/-.

MARCONI CT44/TF956 AF ABSORPTION WATTMETER



1 µ watt to 6 watts. \$20. Carr. 20/-.



AVOMETERS

Supplied in excellent condition, fully tested and checked. Complete with probes, leads and instructions. Model 47A \$9.18.6. P. & P. 7/6 each.



CLASS D WAVEMETERS

A crystal controlled hetrodyne frequency meter covering 1.7-8Mc/s. Operation on 6 volts d.c. Ideal for amateur use. Available in good working condition \$5.18.6. Carr. 7/6. Or brand new with accessories \$7.19.6. Carr. 7/6.

AUTO TRANSFORMERS

0/115/230V. Step up or step down. Fully shrouded.

150 W.	\$12.8.6.	P. & P. 3/6
300 W.	\$2.7.8.	P. & P. 3/6
500 W.	\$3.10.0.	P. & P. 6/6
1,000 W.	\$5.10.0.	P. & P. 7/6
1,500 W.	\$6.10.0.	P. & P. 8/6
3,000 W.	\$7.10.0.	P. & P. 12/6
7,500 W.	\$15.10.0.	P. & P. 20/-

MARCONI TEST EQUIPMENT

EX-MILITARY RECONITIONED. TF144G STANDARD SIGNAL GENERATORS, 85kc/s-25 Mc/s, \$25. Carr. 30/-. TF.885. VIDEO OSCILLATOR 0-5Mc/s, \$45. Carr. 30/-. TF.1983M. BEAT FREQUENCY OSCILLATOR 0-40kc/s, 200/250V a.c. \$20. Carr. 30/-. TF.142E. Distortion Factor Meter, \$20. Carr. 20/-. All above offered in excellent condition fully tested and checked. TF.1100 VALVE VOLT-METER, Brand New. \$50. T.P.1267 TRANS-MISSION TEST SET, Brand New. \$75. TF.1371. Wide Band Millivolt Meter, \$50.

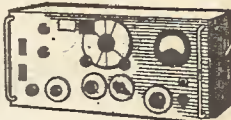

Variable Voltage Transformers



Brand new, guaranteed and carriage paid. High quality construction. Input 230V 50-60 cycles. Output full variable from 0-250V. Bulk quantities available. 1 amp. -£5.10.0; 2.5 amp. -£8.15.0; 5 amp. -£9.15.0; 8 amp. -£14.10.0; 10 amp. -£18.10.0; 12 amp. -£21; 20 amp. -£37.

ADVANCE D.I SIGNAL GENERATORS

A high quality U.H.F. signal generator covering 10-310 Mc/s. Operates on 200/250V a.c. Supplied in excellent condition complete with calibration charts. \$15. Carr. 15/-.

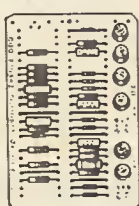

PRINTED CIRCUITS

Five assorted printed circuit boards with transistors, diodes, resistors, condensers, etc. Guaranteed minimum 20 transistors. Ideal for experimenters, 5 boards for 10/-, P. & P. 2/-.

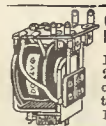

OMRON MK. 2 RELAYS

Brand New and Boxed. 24 volt d.c. coils. 2 Pole changeover. 5 amp contacts. 7/6 each. P. & P. 1/6.

G. W. SMITH & Co. (Radio) Ltd.
3-34 Lisle St., W.C.2
ALSO SEE OPPOSITE PAGE

MULTIMETERS for EVERY purpose!

LAFAYETTE DE-LUXE 100 KΩ/VOLT "LAB. TESTER"



Giant 6 1/2 in. scale. Built-in meter protection. 0/5/25/10/50/250/500/1,000V d.c. 0/3/10/50/250/500/1,000V a.c. 0/10/100A/10/100/500MA/2.5/10A/0.1K/10K/100K/10M/10MΩ. -10 to 49.4dB. £18.18.0. P. & P. 5/-.

TE-800 80,000 Ω VOLT GAUGE MULTIMETER



6 1/2 in. full view meter. 2 colour scale, overload protection. 0/2.5/10/250/1,000/5,000V a.c. 0/25/125/10/50/250/1,000/5,000V d.c. 0/50μA/110/100/500mA/10A d.c. 20K/200K/20MΩ. £15. P. & P. 5/-.

LAFAYETTE 57 Range Super 50,000 O.P.V. Multimeter.

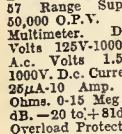

D.C. Volts 125V-1000V. A.C. Volts 1.5V-1000V. D.C. Current 25μA-10 Amp. Ohms. 0-15 MegΩ. dB. -20 to +81dB. Overload Protection. £12.10.0. Carr. 3/6.

MODEL AS-100D. 100KΩ/VOLT 5 1/2 in. mirror scale.

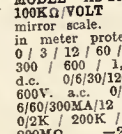

Built-in meter protection. 0/3/12/60/120/300/600/1,200V d.c. 0/30/120/300/600V a.c. 0/10μA/6/60/300MA/12 Amp. 0/2K/200K/2M/200MΩ. -20 to +17dB. £12.10.0. P. & P. 3/6.

NEW MODEL 500.30,000 O.P.V. with overload protection.



Mirror scale. 0/0.5/2.5/10/25/100/250/500/1,000V d.c. 0/2.5/10/25/100/250/500/1,000V a.c. 0/50μA/5/50/500MA. 12 amp. d.c. 0/60/1K6. Meg. 60megohm £8.17.6. Post paid.

MODEL AP-105. 50KΩ/VOLT. Mirror scale, built-in meter protection.



0/3/12/60/120/300/600/1,200V d.c. 0/6/30/120/300/600/1,200V a.c. 0/30μA/6/60/300MA/12 Amp. 0/10K/1M/10M/100 MΩ -20 to +17 dB. £8.10.0. P. & P. 3/6.

PROFESSIONAL 20,000 O.P.V. LAB. TESTER

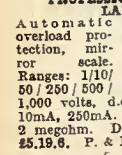

Automatic overload protection, mirror scale. Ranges: 1/10/50/250/500/1,000 volts, d.c. and a.c. 0-500μA, 10mA, 250mA. Current: 0/20K, 200K, 2 megohm. Decibels: -20 to +22dB. £5.19.6. P. & P. 2/6.

MODEL TE-12. 20,000 O.P.V.

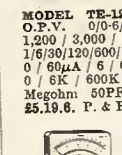

0/0.6/30/120/600/1,200/3,000/6,000V d.c. 0/1/6/30/120/600/1,200V a.c. 0/60μA/6/60/600MA. 0/6K/60K/6Meg. 50PF. 2 MFD. £5.19.6. P. & P. 3/6.

MODEL TE-70. 30,000 O.P.V.

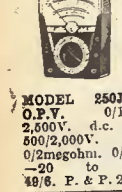

0/0.3/15/60/300/600/1,200V d.c. 0/6/30/120/600/1,200V a.c. 0/30μA/3/30/300mA. 0/16K/160K/1.6M/18megohm. £5.15.0. P. & P. 3/6.

MODEL TE 80. 20,000 O.P.V.



0/10/50/100/500/1,000V a.c. 0/5/25/50/250/500/1,000V d.c. 0-50μA. 5/50/500MA. 0/6K/60K/600K/6 Meg. £4.17.6. P. & P. 3/-.

MODEL 250T. 2,000 O.P.V.



0/10/50/500/2,500V d.c. 0/10/50/2,500/2,000V a.c. 0/2megohm. 0/250 mA. -20 to +36dB. £9/6. P. & P. 2/6.

NO. 76 TRANSMITTER

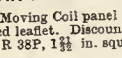

2-12 Mc/s. Crystal Controlled (not supplied). 807PA. Operation 12V. D.C. (Rotary transformer). 9 watts output. C.W. only. New condition. 72/8. Carr. 12/6.

CLEAR PLASTIC METERS

First grade quality Moving Coil panel meters available ex-stock. S.A.E. for illustrated leaflet. Discounts for quantity. Available as follows: Type MR 38F, 1 1/2 in. square fronts.

100-0-100μA	32/6	200mA	25/-	100V d.c.	25/-
500-0-500μA	25/-	300mA	25/-	150V d.c.	25/-
1-0-1mA	25/-	400mA	25/-	300V d.c.	25/-
2mA	25/-	750mA	25/-	500V d.c.	25/-
5mA	25/-	1A d.c.	25/-	750V d.c.	25/-
10mA	25/-	2A d.c.	25/-	15V a.c.	25/-
20mA	25/-	5A d.c.	25/-	50V a.c.	25/-
50mA	25/-	3V d.c.	25/-	150V a.c.	25/-
100mA	25/-	10V d.c.	25/-	300V a.c.	25/-
200mA	25/-	20V d.c.	25/-	500V a.c.	25/-
500mA	27/6	50V d.c.	25/-	'S' Meter 1mA	29/6
50-0-50μA	35/-	POST EXTRA. Larger sizes available—send for lists.			

TRANSISTORISED TWO-WAY TELEPHONE INTERCOM



Operative over amazingly long distances. Separate call and press to talk buttons. 2-wire connection. 1000's of applications. Beautifully finished in ebony. Supplied complete with batteries and wall brackets. £8.19.6. P. & P. 3/6.

GARRARD TAPE MOTORS



Brand new stock as used by famous manufacturer. 200/250V a.c. Capstan motor 15/-, Fast Forward 10/6. Fast Rewind 10/6. P. & P. 3/-, Set of three motors 32/6. P. & P. 5/-.

INTERCOM/BABY SITTER



Transistorised Intercoms. Ideal for home/office/workshop etc. 2-way buzzer call system. For desk or wall mounting. Supplied complete with connecting wire, batteries, instructions, 2 station 59/8. P. & P. 2/6. 4 station £8.12.6. P. & P. 5/-.

★TRANSISTORISED FM TUNER★

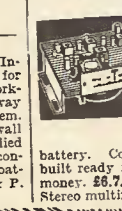

6 TRANSISTOR HIGH QUALITY TUNER. SIZE ONLY 6 1/2 x 2 1/2 in. 3 I.F. stages. Double tuned discriminator. Ample output to feed most amplifiers. Operates on 9V. battery. Coverage 88-108Mc/s. Ready built ready for use. Fantastic value for money. £8.7.6. P. & P. 2/6. Stereo multiflex adaptors 5 gns.

UNR-30. 4-BAND COMMUNICATION RECEIVER



Covering 550Kc/s-30Mc/s. Incorporates variable BFO for CW/SSB reception. Built in speaker and phone jack. Metal cabinet. Operation 220/240V. a.c. Supplied brand new guaranteed with instructions. Carr. 7/6. **13 GNS.**

LAFAYETTE MODEL HA700 AM/CW/SSB AMATEUR COMMUNICATION RECEIVER



8 valves, 5 bands incorporating 2 MECHANICAL FILTERS for exceptional selectivity and sensitivity. Frequency coverage on 5 bands 150-1500Kc/s, 550-1,600Kc/s, 1.6-4.0Mc/s, 4.8-14.5Mc/s, 40Kc/s, 450-1,600Kc/s, 1.6-4.0Mc/s, 4.8-14.5Mc/s, 10-5-30Mc/s. Circuit incorporates R.F. stage, aerial trimmer, noise limiter, B.F.O. product detector, electrical bandspread, 8 meter, slide rule dial. Output for phones, low to 2KΩ or speaker 4 or 8ohms. Operation 220/240V. a.c. Size 4 or 8ohms. Operation 220/240V. a.c. £36 GNS. Carr. 10/-.

NEW LAFAYETTE SOLID STATE HA600 RECEIVER



5 BAND AM/CW/SSB AMATEUR AND SHORT WAVE. 150Kc/s TO 400Kc/s AND 550Kc/s TO 30Mc/s. F.E.T. front end ● 2 mechanical filters ● Huge dial ● Product detector ● Squelch ● BFO ● Noise limiter ● S Meter ● Variable Bandspeed ● 230V a.c./12V d.c. neg. earth operation ● RF gain control. Size 15in x 9 1/2in x 8 1/2in. Wt. 18 lb. EXCEPTIONAL VALUE £45. Carr. 10/- S.A.E. for full details.

LAFAYETTE PF-60 SOLID STATE VHF FM RECEIVER



A completely new transistorised receiver covering 152-174Mc/s. Fully tunable or crystal controlled (not supplied) for fixed frequency operation. Incorporated 4 INTEGRATED CIRCUITS. Built in speaker and illuminated dial. Squelch and volume controls. Tape recorder output. 750 aerial input. Headphone jack. Operation 230V a.c./12V d.c. Neg. earth. £37.10.0. Carr. 10/-.

LAFAYETTE LA-224T TRANSISTOR STEREO AMPLIFIER



15 transistors, 8 diodes, 1HF music power, 30W at 8Ω. Response 30-20,000 ±2dB at 1W Distortion 1% or less. Inputs 3mV and 250mV. Output 3-16Ω. Separate L and R volume controls. Treble and bass control. Stereo phone jack. Brushed aluminium, gold anodised extruded front panel with complementary metal case. Size 10 1/2 x 15 x 7 1/2 in. Operation 115/230V. A.V. £28. Carr. 7/6.

TRIO COMMUNICATION RECEIVER MODEL 9R-59DE



4 band receiver covering 550Kc/s to 30Mc/s continuous and electrical band spread on 10, 15, 20, 40 and 80 metres. 8 valve plus 7 diode circuit. 4/8 ohm output and phone jack SSB-CW ● ANL ● Variable BFO ● S meter ● Sep. band spread dial ● IF 445Kc/s ● Audio output 1.5W ● Variable RF and AF gain controls. 115/230V. a.c. Mains. Beautifully designed. Size: 7 x 15 x 10 in. With instruction manual and service data. £39.15.0. Carriage 12/6.

ADVANCE TEST EQUIPMENT

Brand new and boxed in original sealed cartons

VM76. VALVE VOLTMETER
R.F. measurements in excess of 100Mc/s and d.c. measurements up to 1,000V with accuracy of ±2%. D.c. range 300mV to 1kV. A.c. range 300mV to 300V RMS. Resistance 0.02-500MΩ. Price £72.

VM78. A.C. MILLIVOLT METER
Transistorised. 1mV to 300V. Frequency 1c/s to 1Mc/s. Price £55.

VM79. UHF MILLIVOLT METER
Transistorised. A.c. range 10mV to 3V. D.c. current range 0.01 μA to 0.3mA. Resistance 1 ohm to 10 megohms. £125.

H1B. AUDIO SIGNAL GENERATOR
15c/s to 50kc/s. sine or square wave. Price £30.

J1B. AUDIO SIGNAL GENERATOR
15c/s to 50kc/s. Price £30.

J2B. AUDIO SIGNAL GENERATOR
As per J1B except fitted with output meter. £35.

TT1S. TRANSISTOR TESTER
£37.10.0. Carriage 10/- per item.

GARRARD DECKS

Brand new and guaranteed.

1000 stereo	£8.0.0
1025 mono	£7.10.0
1025 stereo	£7.19.6
2000 stereo	£7.19.6
2025 TC less cart.	£5.19.6
2025 TC stereo	£11.19.6
SP23 Mk-II less cart.	£12.10.0
A70 Mk-II less cart.	

Carr. 7/6 each

Wooden Plinths for Garrard Series 1,000, 2,000, 3,000, etc., with perspex cover. £4.10.0. P. & P. 4/6.

SINCLAIR EQUIPMENT



Z19 12 watt amplifier. 89/8.
P24 Power Supply Unit 99/6.
Stereo 25 Preamp. £9.19.6.
Q14 Speakers. £7.19.6.

Micromatic Radio Kit. 49/8. Built 89/8. ALL POST PAID

SPECIAL OFFER

2 Z19 Amps., P24 Power Supply, Stereo 25 Preamp., £22, or with two Q14 speakers £37.

NEW SINCLAIR 2000 SYSTEM
35 watt Integrated Amplifier £29. Carr. 5/-
Self powered F.M. Tuner. £25. Carr. 5/-.

G.W. SMITH & CO (RADIO) LIMITED

Phone GERRARD 8204/9135
Cables SMITHEX LESQUARE
3-34 LISLE STREET, LONDON, WC2

OPEN
9 a.m. to 6 p.m. every day Mon. to Sat. Trade supplied.

ERSIN

Multicore

5 CORE SOLDER

for quick,
easy, reliable
soldering

Contains 5 cores of non-corrosive flux, instantly cleaning heavily oxidised surfaces. No extra flux required. Ersin Multicore Savbit Alloy also reduces wear of copper soldering iron bits.



SIZE 5 HANDY SOLDER DISPENSER

Contains 10 ft. coil of 18 s.w.g. Ersin Multicore Savbit Alloy. 2/6 each.



SIZE 15 SOLDER DISPENSER

Contains 21 ft. coil of 60/40 Alloy, 22 s.w.g. Ideal for small components, transistors, diodes, etc. 3/- each.



SIZE 12

Ideal for home constructors. Contains 90 ft. of 18 s.w.g. Ersin Multicore Savbit Alloy on a plastic reel. 15/- each.



BIB MODEL 8 WIRE STRIPPER AND CUTTER

Strips insulation cleanly and quickly, fitted with unique 8 gauge wire selector. Plastic handles. 9/6 each.

From Electrical and Hardware shops. If unobtainable, write to: Multicore Solders Ltd., Hemel Hempstead, Herts.

TWO SCOOPS FROM "KING'S" CONTINUOUS LOOP (NEVER ENDING - NO REWINDING) TAPE CASSETTE

BULK PURCHASE RIDICULOUS PRICE

IDEAL BACKGROUND MUSIC - LANGUAGE COURSES, ETC. 200ft. HIGH QUALITY AMPEX TAPE. WILL FIT ALL TAPE RECORDERS.
CANNOT BE REPEATED

NEARLY ALL GONE
HURRY! NOW ONLY 18/- EACH P&P 6d.

ALSO
**BARGAIN PRICED-PHILIPS TYPE CASSETTES
TO FIT ALL CASSETTE RECORDERS**

TYPE C.90 LASTS 1½ Hrs. 18/11d

TYPE C.60 LASTS 1 Hr. 12/11d

SEND NOW. (post & pack 6d each)

KING'S TELE-SERVICE CO.
105/107 DAWES ROAD, FULHAM, S.W.6

FULHAM 1668-2998

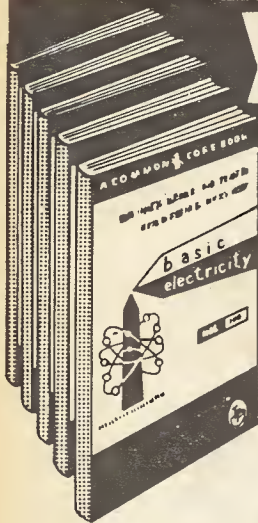

YOURS FREE FOR 7 DAYS

The 'New Picture-Book' way of learning **BASIC ELECTRICITY (5 VOLS.)** **BASIC ELECTRONICS (6 VOLS.)**

You'll find it easy to learn with this outstandingly successful NEW PICTORIAL METHOD—the essential facts are explained in the simplest language, one at a time, and each is illustrated by an accurate, cartoon-type drawing. The books are based on

the latest research into simplified learning techniques. This has proved that the PICTORIAL APPROACH to learning is the quickest and soundest way of gaining mastery over these subjects.

TO TRY IT, IS TO PROVE IT

The series will be of exceptional value in training mechanics and technicians in Electricity, Radio and Electronics.

WHAT READERS SAY

"May I take this opportunity to thank you for such enlightening works and may I add, in terms, easily understood by the novice."
L. W. M., Birmingham.

"I find that the new pictorial method is so easy to understand and I will undoubtedly enjoy reading the following five volumes: thank you for a wonderful set of books." C. B., London.

"Please accept my admiration for producing a long felt want in the field of understanding Electronics." S. B. J., London.

"The easiest set of manuals it has been my pleasure to study."
J. P. P., Taunton.

A TECH-PRESS PUBLICATION

POST NOW FOR THIS OFFER!!

To The SELRAY BOOK CO., 60 HAYES HILL, HAYES, BROMLEY, KENT BR2 7HP

Please send me WITHOUT OBLIGATION TO PURCHASE, one of the above sets on 7 DAYS FREE TRIAL, I will either return set, carriage paid, in good condition within 7 days or send the following amounts. BASIC ELECTRICITY 75/- Cash Price or Down Payment of 20/- followed by 3 fortnightly payments of 20/- each. BASIC ELECTRONICS 90/- Cash Price or Down Payment of 15/- followed by 4 fortnightly payments of 20/- each. This offer applies to UNITED KINGDOM ONLY. Overseas customers cash with order, prices as above.

Tick Set required (Only one set allowed on free trial)

BASIC ELECTRICITY BASIC ELECTRONICS

Prices include Postage and Packing.

Signature

(If under 21 signature required of parent or guardian)

NAME
BLOCK LETTERS

FULL POSTAL

ADDRESS

NEW-FIELDMASTER CASSETTE-TYPE TUNER PACK

THE BEST OF ITS TYPE

Uses 4 top grade transistors
Fits in place of tape cassette and converts recorder to radio reception.
Covers full medium wave, battery operated. Highly sensitive circuit. **99/6. P. & P. 2/6.**

FEW ONLY - MAGNAVOX 4 TRACK TAPE DECKS. #16.19.6. Carr. 12/6.

NEW - ADASTRA "DOUBLE 5" STEREO AMPLIFIER.

10 transistor circuit. Volume, Treble, Bass, on/off and Balance controls. Inputs for magnetic and ceramic cartridges, tuner and microphone. Output 5 watts per channel. Complete with operating booklet. **#12.19.6. P. & P. 4/6.**

"ADASTRETTE" 2/3 watt 8-ohm Board Player Amplifier. ECL82 and E280 valves. Output imp 3/5 ohms. Easy to fit into cabinet. Separate control panel with on/off, volume and tone controls. Complete with instructions. **#4.7.8. P. & P. 4/6.**

NEW - 7-TRANSISTOR RADIO KIT. Complete kit with all parts and easy to follow instruction book. Covers full medium wave. Speaker and earpiece. Attractive case 7 1/2" x 2 1/2" x 1 1/2" with carrying strap. **79/6. P. & P. 3/6.**

SHIRA 82D MULTI-TESTER 20,000 o.p.v. D.C. voltage: 5, 25, 50, 250, 500, 2.5kV (20,000% per volt). A.C. voltage: 10, 50, 100, 500, 1,000V (10,000% per volt). D.C. current: 0-50A, 0-2.5MA, 0-250MA. Resistance: 0-6K, 0-6mg (300Ω and 30kΩ at centre scale). Capacitance: 10F to 0.001F, 0.001F to 0.1F. Decibels: -20 to +22dB. Size 4 1/2" x 3 1/2" x 1". **69/6. P. & P. 3/6.**

TT-C1001 MULTI-TESTER. In leather case. 20,000 o.p.v. A.C. volts 10, 50, 250, 1,000V. D.C. volts 5, 25, 125, 500, 2,500V. D.C. current 0-50A, 0-250mA. Resistance 0-60kΩ, 0-6MΩ. Decibels -20 to +22dB. Size of meter 4 1/2" x 3 1/2" x 1". **85/- P. & P. 3/6.**

GARRARD DECKS

1025 Stereo/mono cart	27.19.6
2025 Stereo/mono cart	28.19.6
3000/S Stereo/mono cart	28.19.6
3000/D Stereo Diamond cart	31.19.6
SP25 less cart	21.19.6
SP25/Deram Stereo cart	217.4.8
AT60 less cart	213.19.6
AT60/Deram Stereo cart	219.4.8
AP75 less cart	222.11.8
SL75 less cart	234.13.9
SE95 less cart	244.6.9

All plus P. & P. 12/6.

NEW STEREO/MONO HEADPHONES

SDH7. Soft rubber earpieces with slide switch for mono/stereo listening and individual volume controls. Impedance 8-16Ω. Frequency response, 25Hz-15kHz. With lead and stereo plug. **28.6.0. P. & P. 3/6.**

STEREO HEADPHONES G1111. With soft rubber earpieces. Impedance 8-16Ω. Frequency response, 23Hz-13kHz. With lead and stereo plug. **23.19.6. P. & P. 3/6.**

STEREO HEADPHONE DETECTOR BOX Enable headphones to be used with any amplifier. Incorporates amplifier leads, speaker terminals, jack socket and speaker/headphone switch. **29/6. P. & P. 2/-.**

NEW TRANSISTOR MODULES E1311. Flono Pre-Amplifier. Size 2" x 1" x 3/4" built-in R.I.A.A. Characteristics enabling low output magnetic pick-up cartridges to be amplified up to 1V. Input, 100kΩ; gain, 28dB; max. output 3V; max. input, 50mV; distortion, 0.15% (at 1V level); power supply, 9-12V. **29/6. P. & P. 2/-.**

E1312. Tape Pre-Amplifier. Incorporating N.A.R.T.B. curve characteristic, this amplifies tape head signals up to 1V within the frequency range of 30Hz-15kHz. Input imp. 100kΩ; gain, 25dB; max. output, 2V; max. input, 50mV; distortion, 0.15% (at 1V level); power supply, 9-12V. **29/6. P. & P. 2/-.**

E1313. Microphones Pre-Amplifier. Enables a low output microphone to be used with an amplifier or radio. Input imp., 100kΩ; gain, 28dB; max. output, 3V; max. input, 50mV; distortion, 0.15% (at 1V level); freq. res. 10Hz-50kHz; power supply, 9-12V. **29/6. P. & P. 2/-.**

E1314. Power Amplifier. When used in conjunction with E1311, E1312 and E1313 units this amplifier module produces about 300mW output for speaker connection (8-16Ω), without necessity for an output transformer. Input imp., 1,000Ω; gain, 20dB output, 300mW; distortion, 3% (at 200mW output level); freq. res., 50Hz-10kHz; power supply, 9V; current, 20mA at no signal, 80mA at max. output. **29/6. P. & P. 2/-.**

E1315. Electronic Organ Tone Oscillator. Used in conjunction with an organ key board, variable resistances and a 9V power supply, this module acts as the oscillator unit for an electronic organ. Tone frequency, 200-1,000Hz; output, 80mW; current, 15mA. **25/- P. & P. 2/-.**

E1318. Morse Code Oscillator. A transistorised morse code oscillator (buzzer) to be used in conjunction with an operating key. Suitable for direct connection to a loud-speaker. Tone frequency, 400Hz; power output, 80mW; power supply, 3-9V; current, 45mA. **25/- P. & P. 2/-.**

E1317. Wireless Code Oscillator/Transmitter. Can be used with an ordinary A.M. radio receiver for modulated signal transmissions, and for bench trouble shooting when servicing. Transmitter freq., 400Hz-30MHz; tone freq., 400Hz; power supply, 9V d.c.; current 35mA. **25/- P. & P. 2/-.**

E1318. Dual Lamp Flasher. A switch module for electronically alternating two miniature bulbs, 6V, 100-200mA. Ideal for models, toy boats and planes, displays, warning and security devices, communication signals, etc. Flasher time, 1/2 second; power supply, 6V d.c.; current, 150mA; lamp, 6V 150mA. **25/- P. & P. 2/-.**

COMPACT 2-WAY INTERCOMS

For table or wall mounting. Smart two tone grey cases size 3 1/2" x 1 1/4" x 2 1/4". Complete with lead, staples and 9V battery. **49/6. P. & P. 3/6.**

AC/DC CONVERTER Enables transistor equipment to be operated from a.c. mains. 6/9/12V output selector switch and on/off switch. Grey case, size 4" x 2 1/2" x 2". Complete with mains lead, with manual giving details of a wide range of applications and instructions. Guaranteed 5 years. Only **59/6. P. & P. 3/6.**

NEW - SINCLAIR IC-10 Integrated Circuit 10W Amplifier. Size only 1" x 0.4" x 0.2". A true hi-fi amplifier complete with manual giving details of a wide range of applications and instructions. Guaranteed 5 years. Only **59/6. P. & P. 3/6.**

NEW - VHF AIRCRAFT BAND CONVERTOR. When placed within 1" of a MW band radio full coverage of VHF Aircraft Band 108-138Mc/s can be obtained. All transistor, 9V battery operation. Fully tunable. 181" x 7 section telescopic aerial. Size 4" x 2 1/2" x 1 1/2". **79/6. P. & P. 3/6.**

4 AMP BATTERY CHARGER Smart hammer grey case. 1 1/2" meter. 6V and 12V switching. Safety fuses and heat vents. Complete with 5' three core mains lead. 15' red and black battery leads with heavy duty crocodile clips. **59/6. P. & P. 4/6.**

CAR BURGLAR ALARM With combined emergency warning light system. Fits any 6V or 12V car. With switch panel alarm unit and fitting instructions. **39/6. P. & P. 3/6.**

NEW TRANSISTOR CHECKER. For measuring alpha, beta and Ico factors of transistors, also for checking germanium and silicon diodes. Internal 9V battery. Wide reading scale. Moulded case size 7" x 4 1/2" x 3 1/2". Ranges: alpha, 0.7-0.9967; beta, 0-300; Ico, 0-50-5,000A. Diode Test: forward and reverse internal resistance. Resistance: 200Ω-1MΩ. Complete with connectors and instruction booklet. **27.19.6. P. & P. 3/6.**

EAGLE TT144 TRANSISTOR TESTER Tests in-circuit or out of circuit. Identifies PNP and NPN types. Indicator lamp provides positive information on the following tests: Electrode open circuits and current drain. Provides reliable GO-NO-GO tests at practical collector currents of from 5-50mA or more on power transistors. With accessories and instructions. Size 3 1/2" x 6 1/2" x 2 1/2". **24.19.6. P. & P. 3/6.**

"HI-TEM" LOUDSPEAKER

British made full-range 10" unit handles up to 10W. Ceramic magnet. Frequency response, 40Hz-10kHz; imp., 15Ω; flux density, 10,000 lines. **49/6. P. & P. 4/6.**

S-DeC BREAD BOARD

Solderless bread board panels, for fast reliable component connections. **Single DeCs.** One S-DeC with control panel, jig and accessories, for solderless connections to controls, etc., with booklet "Projects on S-DeC" giving construction details for a variety of circuits. **29/6. P. & P. 2/6.**

2 DeC Kit. Two decks, control panel and accessory kit together with components tray and lid all in a black plastic box. Instructions and project book included. **69/6. P. & P. 2/6.**

4-DeC Kit. Four S-DeCs with two control panels, jigs and accessories, and the booklet "Projects on S-DeC", all contained in a strong attractive plastic case. Ideal for the professional user. **25.17.6. P. & P. 3/6.**

9 in 1 ELECTRONIC KIT Build nine different projects from one basic kit—no mechanical knowledge required. Build a Police Siren, Metronome, Morse Code Amplifier, Electronic Massager, W/T Transmitter, Radio Telephone, One-transistor Radio, Two-transistor Radio, Electronic Music Kit. Completely safe—operated on 9V PP3 battery. Complete with simple step by step instructions. Only **69/6. P. & P. 5/-.**

SOLDERING GUN With interchangeable tips, extension barrels, comfortable grip with trigger control, "U" shaped 3 1/2" bit to minimise wear. Light beam is automatically directed on to end of bit when on/off trigger is in use. Complete with 2-pin plug 230-250V. Spares available. **85W element. 49/6. P. & P. 2/6.**

"ADASTRA" SOLDERING IRON 30W. Employs its protective cover as a handle. A.C. 220/230V. Adjustable bit. With 4' lead. Spares available. **12/6. P. & P. 2/6.**

E.M.I. COMBINATION LOUDSPEAKERS 13 1/2" x 8 1/2" elliptical with two 2 1/2" tweeters; 15Ω impedance; power handling, 10W. Brand new and guaranteed. **99/6. P. & P. 7/6.** (Also available without tweeters. **59/6. P. & P. 7/6.**)

NOW OPEN - OUR NEW
★ HI-FI DEMONSTRATION ROOM
★ RECORDING TAPE BAR
★ SCIENTIFIC CENTRE - wonderful selection of Microscopes, Binoculars, Telescopes
At 18 Tottenham Court Road, W.1

LIND-AIR (OPTRONICS) LTD

18 Tottenham Court Road, London, W.1. Tel. 01-580 2255
25 Tottenham Court Road, London, W.1. Tel. 01-580 7679
53 Tottenham Court Road, London, W.1. Tel. 01-580 4534
Open 9-6 p.m. Monday to Saturday. Thursday until 7 p.m.

ALL MAIL ORDERS
To Dept. PE1268
53 Tottenham Court Road, London, W.1

4-STATION INTERCOM



£7/15/0

Solve your communication problems with this 4-Station Transistor Intercom system (1 master and 3 Subs), in de-luxe plastic cabinets for desk or wall mounting. Call/talk/listen from Master to Subs and Subs to Master. Ideally suitable for Business, Surgery, Schools, Hospital, Office and Home. Operates on one 9V battery. On/off switch. Volume control. Complete with 3 connecting wires each 66ft. and other accessories. P. & P. 7/6.

WIRE-LESS INTERCOM

No batteries—no wires. Just plug in the mains for instant two-way, loud and clear communication. On/off switch and volume control. Price 12 gns. P. & P. 9/6 extra.

INTERCOM/BABY ALARM



Originally 8 gns. OUR PRICE ONLY

59/6

Same as 4-Station Intercom for two-way instant communication. Ideal as Baby Alarm and Door Phone. Complete with 66ft. connecting wire. Battery 2/6. P. & P. 4/6.



Transistor TELEPHONE AMPLIFIER

Usualy 6 gns.

59/6

Why not boost business efficiency with this incredible De-Luxe Telephone Amplifier. Take down long telephone messages or converse without holding the handset. A useful office aid. On/off switch. Volume control. Battery 2/6 extra. P. & P. 3/6. Full price refunded if not satisfied in 7 days.

WEST LONDON DIRECT SUPPLIES (PE/10)
168 KENSINGTON HIGH STREET, LONDON, W.8

new VARI-STAT thermostatic soldering iron

High Production Model D
Miniature Iron 50 watt
Voltage 12-250 volt
Weight 1 3/4oz.
"Screw on" Bit sizes 1/16in., 3/32in., 1/8in., 3/16in., 1/4in.

PRICE
60/6

Our range also includes:
Standard Miniature Model 50W
Standard Instrument Model 70W
High Production Instrument Model 125W
Industrial Model 500W

All these irons give excellent bit and element life since the thermostat completely eliminates overheating and controls reserve heating capacity which makes possible continuous soldering without chilling of the bit. The consistent temperature makes these irons ideal for printed circuit work.

CARDROSS ENGINEERING CO. LTD.,

Woodyard Road, Dumbarton.

Phone: Dumbarton 2655

NEW RANGE BBC 2 AERIALS

All U.H.F. aerials now fitted with tilting bracket and 4 element grid reflectors.

Loft Mounting Arrays, 7 element, 37/6. 11 element, 45/-. 14 element, 52/6. 18 element, 60/-. Wall Mounting with Cranked Arm, 7 element, 60/-. 11 element, 67/-. 14 element, 75/-. 18 element, 82/6. Mast Mounting with 2in. clamp, 7 element, 42/6; 11 element, 55/-. 14 element, 62/-. 18 element, 70/-. Chimney Mounting Arrays, Complete, 7 element, 72/6; 11 element, 80/-. 14 element, 87/6; 18 element, 95/-. Complete assembly instructions with every unit. Low Loss Cable, 1/6 yd. U.H.F. Pre-amps from 75/-. State clearly channel number required on all orders.

BBC · ITV AERIALS



BBC (Band 1), Telescopic loft, 25/-. External S/D, 30/-. "H", £2.15.0.

ITV (Band 3), 3 element loft array, 30/-. 5 element, 40/-. 7 element, 50/-. Wall mounting, 3 element, 47/6. 5 element, 52/6.

Combined BBC/ITV. Loft 1+3, 40/-. 1+5, 50/-. 1+7, 60/-. Wall mounting 1+3, 57/6; 1+5, 67/6; Chimney 1+3, 67/6; 1+5, 75/-. VHF transistor pre-amps, 75/-.

COMBINED BBC1-ITV-BBC2 AERIALS
1+3+9, 70/-. 1+5+9, 80/-. 1+5+14, 90/-. 1+7+14, 100/-. Loft mounting only. Special leaflet available.

F.M. (Band 2), Loft S/D, 15/-. "H", 32/6. 3 element, 55/-. External units available. Co-ax cable, 8d. yd. Co-ax. plugs, 1/4. Outlet boxes, 5/-. Diplexer Crossover Boxes, 13/6. C.W.O. or C.O.D. P. & P. 5/-. Send 6d. stamps for illustrated lists.

CALLERS WELCOME

OPEN ALL DAY SATURDAY

K.V.A. ELECTRONICS (Dept. P.E.)
27 Central Parade, New Addington
Surrey—CRO-OJB
LODGE HILL 2266

MARTIN IS HIGH-FIDELITY

The first and still the most satisfactory unit assembly system



F.M. TUNER



STEREO CONTROL ASSEMBLY

ONLY FROM MARTIN

Cover the widest possible range of requirements. They are available for Mono, and can be doubled up for conversion to stereo, or as complete stereo units. 3 ohm and 15 ohm systems. Special pre-amp for low output pick-ups. Escutcheon panels to suit the arrangement you choose. Tuner is styled to match.

Start by sending for leaflets at once

MARTIN ELECTRONICS LTD.

UNITS INCLUDE:

- 5-stage input selector
- Pre-amp tone controls
- 10 watt amp. (3 ohms)
- 10 watt amp. (15 ohms)
- Mains power supply
- F.M. Tuner

Trade enquiries invited

154/5 HIGH STREET, BRENTFORD
MIDDLESEX. ISLeworth 1161/2

MARTIN ELECTRONICS

154 High Street, Brentford, Middlesex

Please send Recordakit/F.M.: Tuner/Audiokit Hi-Fi Leaflets. (Strike out items not wanted)

Name

Address

P.E.10/68

FOLLOW THE LEADERS

KING SIZE QUALITY-TESTED PAKS

2 Drift Trans. 2N1225 Germ. PNP	10/-
100 Mc/s.	10/-
6 Matched Trans. OC44/45/81/81D	10/-
2 Red Spot AF Trans. PNP	10/-
16 White Spot RF Trans. PNP	10/-
5 Silicon Rects. 3 A 100-400 PIV	10/-
2 10 A Silicon Rects. 100 PIV	10/-
2 OC140 Trans. NPN Switching	10/-
1 12 A SCR 100 PIV	10/-
3 Sil. Trans. 2S303 PNP	10/-
4 Zener Diodes 250mW 3-12V	10/-
3 200Mc/s. Sil. Trans. NPN BSY26/27	10/-
3 Zener Diodes 400mW 33V 5% Tol.	10/-
4 High Current Trans. OC42 Eqvt.	10/-
2 Power Transistors 1 OC26 1 OC35	10/-
5 Silicon Rects. 400 PIV 250mA	10/-
4 OC75 Transistors Mullard Type	10/-
1 Power Trans. OC20 100V	10/-
10 OA292 Sil. Diodes Sub-min. Marked	10/-
2 Low Noise Trans. NPN 2N929/30	10/-
1 Sil. Trans. NPN VCB 100 ZT86	10/-
8 OA81 Diodes	10/-
4 OC72 Transistors Mullard Type	10/-
4 OC77 Transistors Mullard Type	10/-
4 AC126 Trans. PNP High Gain	10/-
5 GET884 Trans. Eqvt. OC44	10/-
5 GET883 Trans. Eqvt. OC45	10/-
2 2N708 Sil. Trans. 300Mc/s. NPN	10/-
5 GT41/45 Germ. Trans. PNP	10/-
3 GT31 LP Low Noise PNP Trans.	10/-
6 IN914 Sil. Diodes 75 PIV 75mA	10/-
8 OA9 Germ. Diode Sub-min. IN69	10/-
3 NPN Germ. Trans. NK773	10/-
2 OC22 Power Trans. Germ.	10/-
2 OC25 Power Trans. Germ.	10/-
4 OC72 Mullard Trans.	10/-
4 AC128 Trans. PNP High Gain	10/-
2 AC127/128 Comp. pair PNP/NPN	10/-
3 2N1307 PNP Switching Trans.	10/-
10 CG62H Germ. Diodes Eqvt. OA71	10/-
3 AF116 Mullard Type Trans.	10/-

12 Assorted Germ. Diodes Marked	10/-
4 AC126 Germ. PNP Trans.	10/-
4 Silicon Rects. 100 PIV 750mA	10/-
3 AF117 Trans. Mullard Type	10/-
7 OC81 Type Trans.	10/-
7 OC81 Type Trans. Marked	10/-
5 2N2926 Sil. Epoxy Trans.	10/-
7 OC71 Type Trans.	10/-
25 Trans. Heatsinks fit TO18, SO12, etc.	10/-
2 2S701 Sil. Trans. Texas PNP	10/-
3 12V Zener 400mW	10/-
1 10A 600 PIV Sil. Rect. BSY42	10/-
3 BC108 Sil. NPN High Gain Trans.	15/-
1 2N910 NPN Sil. Trans. VCB100	15/-
2 1000 PIV Sil. Rect. 1-5A R53310 AF.	15/-
3 BSY95A Sil. Trans. NPN 200Mc/s.	15/-
3 OC290 Sil. Trans. Mullard	15/-
2 Sil. Power Rects. 2M23	15/-
1 Sil. Power Trans. NPN 100Mc/s. TK201A	15/-
6 Zener Diodes 3-15V Sub-min.	15/-
1 2N1132 NPN Epitaxial Planar Sil.	15/-
3 2N697 Epitaxial Planar Trans. Sil.	15/-
4 Germ. Power Trans. Eqvt. OC16	15/-
1 Unijunction Trans. 2N929	15/-
2 Sil. Trans. 200Mc/s. 60Vcb ZT83/84	15/-
1 Sil. Planar Trans. NPN 100Mc/s. BSY25	15/-
1 Unijunction Trans. 2N2160 TO-5	15/-
2 Sil. Rects. 5A 500 PIV Stud Type	15/-
2 Germ. Power Trans. 2N929	15/-
1 10A Sil. Stud Rect. 800 PIV	15/-
1 Tunnel Diode ABEY11 1050Mc/s.	15/-
2 2N2712 Sil. Epoxy Planar HFE225	15/-
8 BY 100 Type Sil. Rects.	20/-
25 Sil. and Germ. Trans. Mixed, all marked, New	30/- each
2 GET890 Low Noise Germ. Trans.	10/-
1 AF139 PNP High Freq. Trans.	10/-
3 NPN Trans. 1 ST141 & 2 ST140	10/-
4 Madt's 2 MAT100 & 2 MAT120	10/-
3 Madt's 2 MAT101 & 1 MAT121	10/-
4 OC44 Germ. Trans. AF	10/-
3 AC127 NPN Germ. Trans.	10/-
1 2N3906 Sil. PNP Trans. Motorola	10/-

FREE One 10/- Pack of your own choice free with orders value £4 or over.

ORP60 ORP61	8/- each
ORP12	8/6 each
MANY NEW PAK ITEMS	
FULL RANGE OF ZENER DIODES	
VOLTAGE RANGE 2-15V	
400mW (DO-7 Case)	2/8 each
1.5W (Top-Hat)	3/6 each
10W (SO-10 Stud)	5/- each
All fully tested 5% tol. and marked. Please state voltage required. Full range eqvt. to OAZ Mullard Type Z. Range of STC, I.R. Texas and IN types.	
TRANSISTOR EQVT. BOOK	
32 pages of cross references for trans. and diodes, types include British, European, American and Japanese. Specially imported by BI-PAK	
	10/- each

ANOTHER CROWNING SUCCESS— THIS MONTH'S BARGAIN PAKS ALL FULLY TESTED AND GUARANTEED SATISFACTION

Pak No.	Qty.	Description	Price
S1	10	Gold Bonded Diodes eqvt. OA47	10/-
S2	10	2N3707 NPN Planar Transistors	10/-
S3	5	BC108 NPN Sil. Transistors	10/-
S4	8	Zeners 400mW 2-13V Mixed	10/-
S5	8	2N3702 PNP Planar Transistors	10/-
S6	4	3A 600PIV Sil. Rects. Stud	10/-
S7	5	PNP Sil. Planar Trans. 2N2904	10/-
S8	5	2N696 NPN Sil. Trans.	10/-
S9	10	OC44 Type Trans. Gen. P. RF	10/-
S10	10	Sil. Diodes 50PIV 250mA MSI, Gen. P.	10/-

EACH MONTH FOR ONE MONTH ONLY WE OFFER SPECIAL BARGAIN PAKS AVAILABLE AT THIS SPECIAL PRICE. TAKE FULL ADVANTAGE AND SAVE EVEN MORE ON YOUR BI-PAK BARGAINS.

KING OF THE PAKS Unequaled Value and Quality SUPER PAKS BRAND NEW—UNTESTED SEMICONDUCTORS

Satisfaction GUARANTEED in Every Pak, or money back.

Pak No.	Description	Price
U1	120 Glass Sub-min. General Purpose Germanium Diodes	10/-
U2	60 Mixed Germanium Transistors AF/RF	10/-
U3	75 Germanium Gold Bonded Diodes sim. OA5, PA47	10/-
U4	40 Germanium Transistors like OC81, AC128	10/-
U5	60 200mA Sub-min. Sil. Diodes	10/-
U6	40 Silicon Planar Transistors NPN sim. BSY95A, 2N706	10/-
U7	16 Silicon Rectifiers Top-Hap 750mA up to 1000V	10/-
U8	50 Sil. Planar Diodes 250mA OA/200/202	10/-
U9	20 Mixed Volts 1 watt Zener Diodes	10/-
U11	30 PNP Silicon Planar Transistors TO-5 sim. 2N1132	10/-
U12	12 Silicon Rectifiers EPOXY 500mA up to 800 PIV	10/-
U13	30 PNP-NPN Sil. Transistors OC200 & 2S104	10/-
U14	160 Mixed Silicon and Germanium Diodes	10/-
U15	30 NPN Silicon Planar Transistors TO-5 sim. 2N697	10/-
U16	10 3-Amp Silicon Rectifiers Stud Type up to 1000 PIV	10/-
U17	30 Germanium PNP AF Transistors TO-5 like ACY 17-22	10/-
U18	8 6-Amp Silicon Rectifiers BYZ13 Type up to 600 PIV	10/-
U19	30 Silicon NPN Transistors like BC108	10/-
U20	12 1.5-amp Silicon Rectifiers Top-Hat up to 1,000 PIV	10/-
U21	30 A.F. Germanium alloy Transistors 2G300 Series & OC71	10/-
U22	10 1-amp Glass Min. Silicon Rectifiers High Volts	10/-
U23	30 Madt's like MAT Series PNP Transistors	10/-
U24	20 Germanium 1-amp Rectifiers GJM up to 300 PIV	10/-
U25	25 300Mc/s NPN Silicon Transistors 2N708, BSY27	10/-
U26	30 Fast Switching Silicon Diodes like IN914 Micro-min	10/-
U28	Experimenters' Assortment of Integrated Circuits, untested. Gates, Flip-Flops, Registers, etc., 8 Assorted Pieces	20/-
U29	10 1 amp SCR's TO-5 can up to 600 PIV CRS1/25-800	20/-
U30	15 Plastic Silicon Planar trans. NPN 2N2924-2N2926	10/-
U31	20 Sil Planar NPN trans. low noise Amp 2N3707	10/-
U32	25 Zener Diodes 400mW D07 case mixed Vols. 3-18	10/-
U33	15 Plastic case 1 amp silicon rectifiers 1N4000 series	10/-

Code Nos. mentioned above are given as a guide to the type of device in the Pak. The devices themselves are normally unmarked

ADI61 NPN ADI62 PNP MATCHED COMPLEMENTARY PAIRS OF GERM. POWER TRANSISTORS.

For mains driven output stages of Amplifiers and Radio receivers. OUR LOWEST PRICE OF 12/8 PER PAIR

HIGH POWER SILICON PLANAR TRANSISTORS. TEXAS 2S034. NPN TO-3.

VCB100 1c 4A 17.5M/50V VCE100 Ptot. 40W hFE(min.) VEB8

NEW SILICON RECTIFIERS TESTED

PIV	400mA	750mA	1-5A	3A	10A	30A
50	10d	1/-	1/8	2/9	4/8	9/6
100	1/-	1/3	2/8	3/3	4/6	15/-
200	1/8	1/9	2/6	4/-	4/9	20/-
300	2/-	2/3	3/9	4/6	6/8	22/-
400	2/-	2/6	4/-	5/6	7/8	25/-
500	3/-	3/-	4/-	6/-	8/8	30/-
600	2/9	3/3	4/6	6/9	9/-	37/-
800	3/6	4/9	7/6	11/-	40/-	—
1,000	5/-	6/-	9/3	12/6	50/-	—
1,200	6/8	7/8	11/6	15/-	—	—

SCR's

LOWEST PRICE LARGEST RANGE		
PIV	1A	7A 16A 30A
25	5/-	7/8
50	7/6	8/8 10/8 35/-
100	8/8 10/-	15/- 45/-
200	12/8 15/-	20/- 55/-
300	15/-	20/- 25/-
400	17/8 25/-	35/- 30/-
500	20/-	40/- 46/- 50/-
600	—	40/- 50/-

PLEASE NOTE. To avoid any further increased Postal Charges to our Customers and enable us to keep our "By Return Postal Service" which is second to none, we have re-organized and streamlined our Despatch Order Department and we now request you to send all your orders together with your remittance, direct to our Warehouse and Despatch Department, postal address: BI-PAK SEMICONDUCTORS, Despatch Dept., P.O. BOX 6, WARE, HERTS. Postage and packing still 1/- per order. Minimum order 10/-.



FET'S	
2N 3819	10/-
2N 3820	25/-
MPP105	8/-
OC71	8/6

UNIUNCTION U748, Eqvt. 2N2646, Eqvt. TIS43, BEN3000 **7/6 EACH**
25-99 5/- 100 UP 4/-

INTEGRATED CIRCUITS
I.C. Operational Amplifier with Zener output. Type 7016, ideal for P.E. Projects. 8 Lead TO-5 case. Full data.
Our price 12/6 each 5 off 11/- each. Large Qty. Prices quoted for.

FAIRCHILD EPOXY TO-5 8 Lead	
µL900 Buffer	10/6
µL914 Dual Gate	10/6
µL923 J.K. Flip-Flop	14/-
I.C. Data Circuits, etc.	1/6
MULLARD I.C. AMPLIFIERS	
TA A243 ORP. Amp.	70/-
TA A263 Min. AF Amp.	18/6
TA A293 G.P. Amp.	26/-
RCA CA3020 Audio Amp.	30/-

PRINTED CIRCUITS EX-COMPUTER
Packed with semiconductors and components, 10 boards give a guaranteed 30 trans and 30 diodes. Our price 10 boards 10/- Plus 2/- P. & P.

CADMIUM CELLS
ORP 60 ORP 61 8/- each ORP12 8/6

SIL. G.P. DIODES
300mW 30 10/-
25PIV (Min.) 100 25/-
Sub-Min. 500 25
Fully Tested 1,000 29
Ideal for Organ Builders.

BI-PAK



BI-PAK Semiconductors

ors

KING OF THE PAKS BI-PAK GUARANTEE SATISFACTION OR MONEY BACK

prepare now for tomorrow's world

Today there is a huge demand for technologists such as electronics, nuclear and computer systems engineers, radio and television engineers, etc. In the future, there will be even more such important positions requiring just the up-to-date, advanced technical education which CREI, the Home Study Division of McGraw-Hill Book Co., can provide.

CREI Study Programmes are directly related to the problems of industry including the latest technological developments and advanced ideas. The individual tuition given by the CREI panel of experts in each specialised field is comparable in technological content with that of technical colleges.

Take the first step to a better job now—enrol with CREI, the specialists in Technical Home Study Education.

CREI Programmes are available in:

Electronic Engineering Technology * Industrial Electronics for Automation * Computer Systems Technology * Nuclear Engineering * Mathematics for Electronics Engineers * Television Engineering * Radar and Servo Engineering * City and Guilds of London Institute: Subject No. 49 and Advanced Studies No. 300.



**CREI (London), Walpole House,
173-176 Sloane Street, London S.W.1.**
A Subsidiary of McGraw-Hill Inc.

Post this coupon today for a better future

To C.R.E.I. (London), Walpole House, 173-176 Sloane Street, London S.W.1.
Please send me (without obligation) details of your Educational Programmes

please tick
My interest is City and Guilds General

Name.....
Address.....
Electronics experience.....

PE10

S-DeC BREADBOARDING

- Fast, reliable, solderless circuit assembly
- Contacts last indefinitely
- Use ordinary components again and again
- Test *all* the circuits in the magazines

This breadboard is used professionally by development engineers throughout the world. Over 80% of current production is exported.

A booklet of projects is included with each kit giving construction details for a variety of circuits such as amplifiers, oscillators, VHF transmitter, radio, etc.

S-DeC Kit: One S-DeC with Control Panel, Jig and Accessories for solderless connections to controls, etc., with booklet "S-DeC Projects" giving construction details for a variety of circuits. 29/6d retail.

4-DeC Kit: Four S-DeCs with two Control Panels, Jigs and Accessories and the booklet "S-DeC Projects" all contained in a strong, attractive, plastic case. Ideal for the professional user. 55/17.6 retail.

AVAILABLE FROM LEADING SUPPLIERS

or in case of difficulty from

S.D.C. PRODUCTS (Electronics) LTD

THE CORN EXCHANGE, CHELMSFORD, Essex

Telephone: Chelmsford (OCH 5) 56215

RELIABLE COMPONENTS!—AT THE RIGHT PRICE!!

SUBMINIATURE TAGBOARDS (1½in. wide).—6-way at 1/3; 18-way at 3/- ea. CAPACITORS—CERAMIC TUBULAR (Standard values).—4.7pF to 0.01µF. 8d. ea.

RESISTORS—CARBON FILM.—½ watt 5%, 10 ohm to 10 megohm.—3½d. ea. or 3/3 per doz.

POTENTIOMETERS—MINIATURE CARBON.—5kΩ, 10kΩ, 25kΩ, 50kΩ, 100kΩ, 250kΩ, 500kΩ, 1MΩ, 2MΩ. LOG.; 5kΩ, 10kΩ, 25kΩ, 50kΩ, 100kΩ, 250kΩ, 500kΩ, 1MΩ. LIN. Less Switch.—all at 3/- ea. (2/9 ea. in quantities of 4 or more of the same value.)

DIODES.—0A47, 0A70, 0A71, 0A79, 0A81, 0A90, 0A91, 0A200, 0A202 at 2/4 ea.

TRANSISTORS.—OC44, 5/6; OC45, 5/4; OC71, 4/4; OC72, 5/4; OC83, 4/-; BC107, 3/11; BC108, 3/3; BC109, 3/11; NKT212, 4/4; NKT218, 3/11; NKT228, 3/11; NKT271, 3/4; NKT274, 3/4; NKT675, 4/3; NKT676, 4/-; NKT773, 4/8; 2G302, 4/-; 2G371, 2/10; 2G374, 3/8; 2N3706, 3/9; 2N3707, 4/6; 2N3819(FET), 14/3; 2N3820(FET), 20/-; BRY39(SCS), 10/6; 2N2646(UJT), 10/6; 2N2926 SERIES—all groups at 3/3 ea. (or 2/6 each in multiples of five).

Postage and Packing is charged at 1/- in the £ (Minimum 2/- per order).

M. R. CLIFFORD & COMPANY (Components Department)
209a MONUMENT ROAD, EDGBASTON, BIRMINGHAM 16
Terms: C.W.O. (or C.O.D.—over £3 only). Tel. 021-454 6515

HI-FI AUDIO CIRCUIT KITS

Complete with circuit diagrams

ACS1K. Everything for building a Hi-Fi mains powered transistor stereo amplifier. 250mV 800kΩ input for 6½V RMS output each channel. Baxendale type tone control. Attractive silver and black fascia. Panel mounting 12½in × 5½in × 3½in. £12. Solid teak case £3. Circuit board and chassis only 50s.

ACS2K. Kit for matching magnetic pick-up, etc. OR for Baxendale type tone control complement and pre-stage. 3 transistor circuit. £2 5s 6d each. Board only 17s.

ACS3K. For matching stereo magnetic pick-up. 4mV 47kΩ input. 300mV 100kΩ output with RIAA correction. Line voltage ±24V up to 350V d.c. £3 10s. Fitted plastic case 12s 6d. Board only 18s 6d.

Forget $\frac{P \text{ to } P V^2}{R} = W$. Deal in facts and get better value

$\frac{V^2 \text{ (RMS)}}{R} = W$ direct from ACS.

Styling and results must more than satisfy. S.A.E. for lists.

AUDIO COMPONENTS & SERVICES

Sound Studios, Bell Hill (off Crown Hill), Croydon, Sur: rey. Phone 688-3706

HARVERSON'S EXCLUSIVE BARGAIN! HI-FI GUITAR AMPLIFIERS



Refurbished units with a peak to peak output of approx 29 watts.

Brief spec: AC Mains 200/240V, EF86, ECC83, 2 x ECL82, Bridge Rect. Two inputs via standard jack sockets for 1 or 2 guitars or mikes controlled by single volume control. Separate bass and treble controls. Tremolo with variable speed control and standard jack socket for remote control of tremolo on/off by foot switch. Completely self contained unit in attractive portable case finished in dark resin with gold trim and folding handle. Size approx. 14 1/2 x 11 1/2 x 8 in. Also capable of really Hi-Fi reproduction when used with a gram deck or radio tuner. Each amplifier is carefully tested and checked by us before despatch, and due to the fact that the cabinets are slightly store soiled we are offering them at the unrepeatable price of

£12. 12. 0.

Standard Jack Plugs 2/6 each, if required. FOOT SWITCH for tremolo on/off control, complete with lead and jack plug 2/6.

BRAND NEW 3 OHM LOUDSPEAKERS

5in.14/-; 6in.18/6; 8in.27/-; 7 x 4in.18/6; 10 x 6in. 27/6. E.M.I. 8 x 6in. with high flux magnet 21/- . E.M.I. 13 1/2 x 8in. with high flux ceramic magnet 42/- (15 ohm 45/-). E.M.I. 13 x 8in. with two built-in tweeters and crossover network. 3 or 15 ohms 4/4 P. & P. 5in. 2/-, 6 1/2 x 8in. 2/6, 10 x 12in. 3/6 per speaker.

BRAND NEW. 12in. 15W H/D Speakers, 3 or 15 ohms. By well-known British maker. Now with Hi Flux ceramic ferrobar magnet assembly. **£5.10.0.** P. & P. 5/- . Guitar Models: **25w. 2/- 35w. 2/6**. E.M.I. 3in. **HEAVY DUTY TWEETERS.** Powerful ceramic magnet. Available in 3 or 8 ohms 15/- each; 15 ohms 18/6 each. P. & P. 2/6.

12in. "RA" TWIN CONE LOUDSPEAKER. 10 watts peak handling. 3 or 15 ohm. **35/-**. P. & P. 3/6.

85 OHM SPEAKERS

3 1/2in. 12/6; 7 x 4in. 21/-, P. & P. 2/- per speaker.

VYNAIR AND RESINE SPEAKERS AND CABINET FABRICS app. 6 1/2in. wide. Usually 35/- yd., our price 13/6 yd. length. P. & P. 2/6 (min. 1 yd.). S.A.E. for samples.

LATEST COLLARO MAGNAVOX 363 STEREO TAPE DECK. Three speeds 4 track, takes up to 7in. spools. Send S.A.E. for latest prices.

B.S.R. TD2-4 TRACK STEREO TAPE DECK. Send S.A.E. for latest price.

QUALITY PORTABLE TAPE RECORDER CASE. Brand new. Beautifully made. Only 49/6. P. & P. 8/6.

Dual Purpose Bulk Tape Eraser and Tape Head Demagnetiser. P. & P. 2/6.

ACOS CRYSTAL MIKES. High imp! for desk or hand use. High sensitivity. 18/6. P. & P. 1/6.

ACOS HIGH IMPEDANCE CRYSTAL STICK MIKES. Listed at 42/-. OUR PRICE 21/-. P. & P. 1/6.

SPECIAL OFFER! MOVING COIL STICK MIKE. Fitted on/off switch for remote control. High quality. High or low impedance. (State imp. required). **BARGAIN PRICE 30/-**. P. & P. 2/6.

NEW S.T.C. TYPE 25 MINIATURE RELAYS— 12 volts. 4, 8/6, c/o contacts. 1 amp rating. Coil resistance 185 ohms. Size approx. 1 1/4 x 1 1/2 in. high. 10/- each. P. & P. 1/6.

Also some similar to above but coil resistance 5,800 ohms 48 volt operation. 8/- each. P. & P. 1/6.

SPECIAL OFFER! PLESSEY TYPE 29 TWIN TUNING GANG. 400pF + 148pF. Fitted with trimmer and 5:1 integral slow motion. Suitable for nominal 470 kc/s E.I. Size approx. 2 x 1 1/2 in. Only 8/6. P. & P. 2/6.

MAINS TRANSFORMER. Primary 200-240V two separate 3 wave secondaries giving approx. 16V at 1 amp and 20V at 1.2 amp; secs. can be connected in series for 36V at 1.5 amp. Ideal for transistor power supplies. Drop through mounting. Stack size 2 3/4 x 3 1/2 in. 15/- . P. & P. 6/-.

MAINS TRANSFORMER. For transistor power supplies. Pri. 200/240V. Sec. 9-0-9 at 500mA. 11/- . P. & P. 2/6. Pri. 200/240V. Sec. 12-0-12 at 1 amp. 14/6. P. & P. 2/6. Pri. 200/240V. Sec. 10-0-10 at 2 amp. 27/6. P. & P. 3/6.

MATCHED PAIR OF 21 WATT TRANSISTOR DRIVER AND OUTPUT TRANSFORMERS. Stack size 1 1/2 x 1 1/2 x 3 in. Output trans. tapped for 3 ohm and 15 ohm output. 10/- pair plus 2/- . P. & P.

FARMER 7-10 watt OUTPUT TRANSFORMERS to match pair of ECL82's in push-pull. Sec. tapped 3-75, 7-5 and 15 ohm. Stack size 2 1/4 x 1 1/2 in. approx. **ONLY 12/-**. P. & P. 3/-.

7-10 watt OUTPUT TRANSFORMERS to match pair of ECL86's in push-pull to 3 ohm output. **ONLY 11/-**. P. & P. 2/6.

BRAND NEW MAINS TRANSFORMERS for Bridge Rectifier. Pri. 240V AC. Sec. 240V at 50mA and 6-3V at 1.5 amp. Stack size 2 1/4 x 2 1/2 in. 10/6. P. & P. 3/6. (Special quotations for quantities).

HIGH GRADE COPPER LAMINATE BOARDS 8 x 6 x 1/4 in. FIVE for 10/- . P. & P. 2/-.

TRANSISTOR STEREO 8 + 8 MK II

Now using Silicon Transistors in first five stages on each channel resulting in even lower noise level with improved sensitivity. A really first-class Hi-Fi Stereo Amplifier Kit. Uses 14 transistors giving 8 watts push pull output per channel (16W mono). Integrated pre-amp. with Bass, Treble and Volume controls. Suitable for use with Ceramic or Crystal cartridges. Output stage for any speakers from 3 to 15 ohms. Compact design, all parts supplied including drilled metal work. Cir-Kit board, attractive front panel, knobs, wire, solder, nuts, bolts—no extras to buy. Simple step by step instructions enable any constructor to build an amplifier to be proud of. Brief specification: Free, response +3dB, 20-20,000/c/s. Bass boost approx. to +12dB. Treble cut approx. to -16dB. Negative feedback 18dB over main amp. Power requirements 25V at 0.6 amp.

PRICES: AMPLIFIER KIT £10.10.0; POWER PACK KIT £3.0.0; CABINET £3.0.0. All Post Free.

Circuit diagram, construction details and parts list (free with kit) 1/6. (S.A.E.).



4-SPEED RECORD PLAYER BARGAINS

Mains models. All brand new in maker's packing. **E.M.I. MODEL 999 Single Player** with unit mounted pick-up arm and mono cartridge. **£5.5.0** B.S.E. UA25 with latest mono compatible cart. **£6.19.8** All plus carriage and Packing 6/6.

LATEST GARRARD MODELS. All types available **1000 SP25, 3000, AT60** etc. Send S.A.E. for latest Bargain Prices!

PLINTH UNITS cut out for Garrard Models 1000, 1025, 2000, 3000, AT60, SP25. With rigid perspex cover. **OUR PRICE 5 gns.** complete. P. & P. 8/6.

SONOTONE STAGH compatible Stereo Cartridge with diamond stylus 50/- . P. & P. 2/-.

MONO T/O CARTRIDGE. Complete with LP & 78 sapphire stylus. Brand new 12/6. P. & P. 2/-.

FEW ONLY! ACOS GP69/1. For EP and LP 10/- . P. & P. 2/-.

QUALITY RECORD PLAYER AMPLIFIER

A top-quality record player amplifier employing heavy duty double wound mains transformer, ECC83, EL84, E280 valves. Separate Bass, Treble and Volume controls. Complete with output transformer matched for 3 ohm speaker. Size 7in. w. x 3 d. x 6 h. Ready built and tested. **PRICE 75/-**. P. & P. 6/-.

ALSO AVAILABLE mounted on board with output transformer and speaker ready to fit into cabinet below. **PRICE 87/6.** P. & P. 7/6.

DE LUXE QUALITY PORTABLE R/P CABINET Uncut mono board size 14 1/2 in. clearance 2in. below, 5 1/2 in. above. Will take above amplifier and any B.S.R. or GARRARD Antichanger or Single Player Unit (except AT60 and SP25). Size 18 x 15 x 8in. **PRICE £3.9.6.** P. & P. 3/6.

F.M. AM TUNER HEAD

Beautifully designed and precision engineered by Dornier & Wadsworth Ltd. Supplied ready fitted with twin -0005 tuning condenser for AM connection. Prealigned FM section covers 86-102Mc/s. I.F. output 10-7Mc/s. Completes with ECC85 (6L12) valve and full circuit diagram of tuner head. Another special bulk purchase enables us to offer these at 27/6 each. P. & P. 3/-.

GORLER F.M. TUNER HEAD. 88-100 Mc/s. 10-7 Mc/s. I.F. 15/- plus 2/6 P. & P. (ECC85 valves, 8/6 extra).

3-VALVE AUDIO AMPLIFIER MODEL HA34

Designed for Hi-Fi reproduction of records. A.C. Mains operation. Ready built on plated heavy gauge metal chassis, size 7 1/2 in. w. x 4 1/2 in. h. Incorporates ECC83, EL84, E280 valves. Heavy duty, double wound mains transformer and output transformer matched for 3 ohm speaker, separate Bass, Treble and volume controls. Negative feedback line. Output 4 1/2 watts. Front panel can be detached and leads extended for remote mounting of controls. Complete with knobs, valves, etc., wired and tested for only **£4.5.0.** P. & P. 6/-.

HEL "FOUR" AMPLIFIER KIT. Similar in appearance to HA34 above but employs entirely different and advanced circuitry. Complete set of parts, etc. 79/6. P. & P. 6/-.

BRAND NEW TRANSISTOR BARGAINS. GET 15 (Matched Pair) 15/-; V15/10p, 10/-; OC11 5/-; OC76 6/-; AF117 7/6.

Set of Mullard 6 transistors OC44, 2-OC45, AC128D, matched pair AC128 25/-; Mullard LFH3 Audio Transistor Pack AC128D and matched pair AC128 12/6; ORP12 Cadmium Sulphide Cell 10/6. All post free.

SPECIAL OFFER!



A great opportunity to purchase a first class G E N E R A L P U R P O S E H I G H G A I N H I G H S E N S I T I V I T Y P O R T A B L E A M P L I F I E R . Completely self contained and can be used for a variety of purposes, i.e. Intercom, Baby Alarm, Booster unit for transistor radios etc., also ideal for classroom use etc. Works perfectly with our special offer High Impedance Dynamic Microphone (30/-). Output 100mW. Uses standard 9 volt battery. Smart two tone carrying case size 12 x 4 x 9in. fitted standard input jack socket, volume controls, 7 x 4in. speaker. Completely built and tested, brand new with full maker's guarantee.

Only 79/6 P. & P. 5/6

STEREO AMPLIFIER

Incorporating 2 ECL86's and 1 E280, heavy duty, double wound mains transformer. Output 4 watts per channel. Full tone and volume controls. Absolutely complete.

ONLY £5.9.6

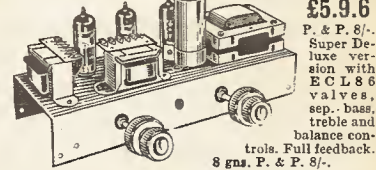

P. & P. 8/- . Super Deluxe verule-ux ECL86 valves, sep. bass, treble and balance controls. Full feedback. 8 gns. P. & P. 8/-.

HIGH GAIN 4 TRANSISTOR PRINTED CIRCUIT AMPLIFIER KIT

Type TA1

- Peak output in excess of 1 1/2 watts.
- 14 watt standard British components.
- Built on printed circuit panel size 6 x 3in.
- Generous size Driver and Output Transformers.
- Output transformer tapped for 3 ohm and 15 ohm speakers.
- Transistors (GET114 or S1 Mullard AC128D and matched pair of AC128 o/p).
- 9 volt operation.
- Everything supplied, wire, battery clips, solder, etc.
- Comprehensive easy to follow instructions and circuit diagram 2/6 (Free with Kit). All parts sold separately.

SPECIAL PRICE 45/-. P. & P. 3/- . Also ready built and tested, 52/6. P. & P. 3/-.

HARVERSON'S SUPER MONO AMPLIFIER

A super quality gram amplifier using a double wound mains transformer, E280 rectifier and ECL82 triode pentode valve as audio amplifier and power output stage. Impedance 3 ohms. Output approx. 3.5 watts. Volume and tone controls. Chassis size only 7in. wide x 3in. deep x 6in. high overall. AC mains 200/240V. Supplied absolutely Brand New completely wired and tested with valves and good quality output transformer. **LIMITED NUMBER.**

OUR ROCK BOTTOM BARGAIN PRICE 49/6 P. & P. 6/-

10/14 WATT HI-FI AMPLIFIER KIT

A stylishly finished monaural amplifier with an output of 14 watts from 2 EL84s in push-pull. Super reproduction of both music and speech, with negligible hum. Separate inputs for mike and gram allow records and announcements to follow each other. Fully shrouded section wound output transformer to match 3-15Q speaker and 2 independent volume controls, and separate bass and treble controls are provided giving good lift and cut. Valve line-up 2 EL84, ECC83, EF86 and E280 rectifier. Simple instruction booklet 2/6 (Free with parts). **All parts sold separately, ONLY £7.9.6.** P. & P. 8/6. Also available ready built and tested complete with std. input sockets, 29.5.0. P. & P. 8/6.

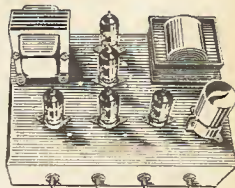

Open all day Saturday
Early closing Wed. 1 p.m.
A few minutes from South Wimbledon
Tube Station

HARVERSON SURPLUS CO. LTD.

170 HIGH ST., MERTON, S.W.19

Tel. 01-540 3985

SEND STAMPED ADDRESSED ENVELOPE WITH ALL ENQUIRIES

(Please write clearly)
PLEASE NOTE: P. & P. CHARGES
QUOTED APPLY TO U.K. ONLY.
P. & P. ON OVERSEAS ORDERS
CHARGED EXTRA.



the world's most advanced high-fidelity amplifier

The Sinclair IC-10 is the World's first monolithic integrated circuit high fidelity power amplifier and pre-amplifier. The circuit itself, which has an output power of 10 Watts, is a chip of silicon only a twentieth of an inch square by one hundredth of an inch thick. This tiny chip contains 13 transistors (including two power types), 2 diodes, 1 zenor diode and 18 resistors, all of which are formed simultaneously in the silicon by a series of diffusions. The chip is encapsulated in a solid plastic package which holds the metal heat sink and connecting pins.

Monolithic I.C.'s. were originally developed for use in computer and space applications where their extraordinary toughness and reliability were even more important than their minute size. These same advantages make them ideal for linear applications such as audio amplifiers, but hitherto they have been confined to low power applications. The IC-10 thus represents a very exciting advance. Not only is it far more rugged and reliable than any previous amplifier, it also has considerable performance advantages. The most

important are complete freedom from thermal runaway due to the close thermal coupling between the output transistors and the bias diodes and very low level of distortion.

The IC-10 is primarily intended as a full performance high fidelity power and pre-amplifier, for which application it only requires the addition of the usual tone and volume controls and a battery or mains power supply. However, the IC-10 is so designed that it may be used simply in many other applications including car radios, electronic organs, servo amplifiers (it is d.c. coupled throughout) etc.

The photographic masks required for producing monolithic I.C.'s. are expensive but once made, the circuits can be produced with complete uniformity and at very low cost. So we are able to sell the IC-10 at a price far below that of the components for a conventional amplifier of comparable power. At the same time, we give a 5 year unconditional guarantee on each IC-10 knowing that every unit will work as perfectly as the original and do so for a lifetime.

sinclair

SINCLAIR RADIONICS LTD, 22 Newmarket Rd. Cambridge. Tel: OCA3-52731

10 WATT MONOLITHIC INTEGRATED CIRCUIT AMPLIFIER

■ Specifications

Power Output	10 Watts peak, 5 Watts R.M.S. continuous.
Frequency response	5 Hz to 100 KHz \pm 1dB.
Total harmonic distortion	Less than 1% at full output.
Load impedance	3 to 15 ohms.
Power gain	110dB (100,000,000,000 times) total.
Supply voltage	8 to 18 volts.
Size	1 x 0.4 x 0.2 inches.
Sensitivity	5 mV.
Input impedance	Adjustable externally up to 2.5 M ohms for above sensitivity.

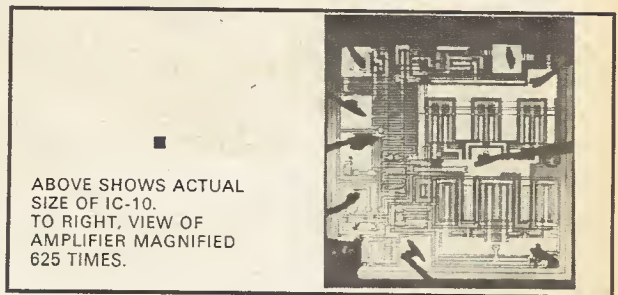

ABOVE SHOWS ACTUAL SIZE OF IC-10. TO RIGHT, VIEW OF AMPLIFIER MAGNIFIED 625 TIMES.

■ Circuit Description

The circuit diagram of the IC-10 is shown on the right. The first three transistors are used in the pre-amp and the remaining 10 in the power amplifier. The output stage operates in class AB with closely controlled quiescent current which is independent of temperature. A high level of overall negative feedback is used round both sections and the amplifier is completely free from cross-over distortion at all supply voltages. Thus battery operation is eminently satisfactory.

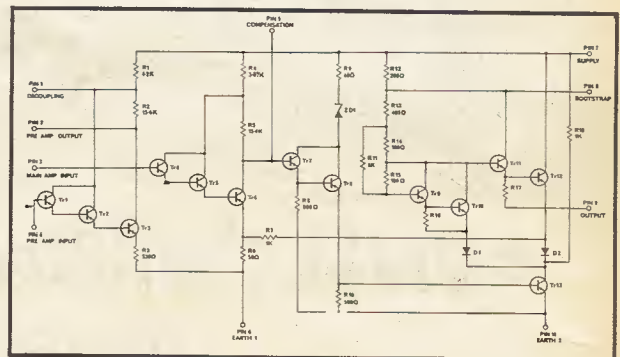

■ Applications

Each IC-10 is sold with a very comprehensive manual giving circuit and wiring diagrams for a large number of applications in addition to high fidelity uses. These include public address, loud-hailers, use in cars, inter-com., stabilised power supplies, electronic organs, oscillators, volt meters, tape recorders, solar cell amplifier, radio receivers.

The transistors in the IC-10 have cut off frequencies greater than 500 MHz so the pre-amp section can be used as an R.F. or I.F. amplifier making it possible to build complete radio receivers without any additional transistors.



■ Construction

The monolithic I.C. chip is bonded onto a gold plated area on the heat sink bar which runs through the package. Wires are then welded between the I.C. and the tops of the pins which are also gold plated in this region. Finally the complete assembly is encapsulated in solid plastic which completely protects the circuit. The final device is so rugged that it can be dropped thirty feet on to concrete without any effect on performance. The circuit will also work perfectly at all temperatures from well below zero to above the boiling point of water.

SINCLAIR RADIONICS LIMITED,
22 NEWMARKET ROAD, CAMBRIDGE
Telephone OCA3-52731

SINCLAIR
IC-10

The complete IC-10 with the manual and 5 year guarantee costs just

59⁶

Post free

ORDER FORM AND MORE SINCLAIR DESIGNS OVERLEAF

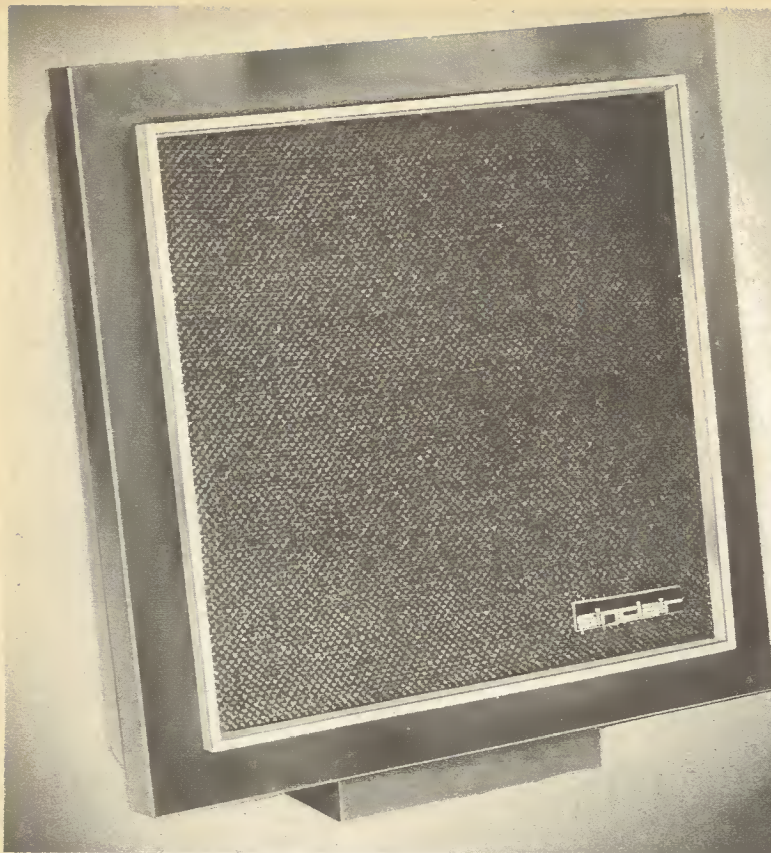

SINCLAIR Q.14

The most challenging loudspeaker development in years

It costs about a quarter of what you would expect to pay for a good stereo speaker system when you choose Q.14s. This is because of the considerable amount of research and experimentation into the acoustic properties of special materials that went into the design of this excellent speaker. It resulted in an instrument so outstandingly good that experts, reviewers and the public alike were unanimous in their praise for the Q.14 at this year's Audio Fair. The Q.14 is very compact, measuring only $9\frac{3}{4}$ in square on its face by $4\frac{3}{4}$ in deep. Its unusual contours permit it to be positioned where no ordinary speaker could be used to advantage. The neat black matt finish

with aluminium bar trim keep this speaker pleasantly in conformity with modern design trends. The Q.14 has acoustically contoured and sealed sound chamber. Smooth response from 60–16,000Hz. Loading up to 14 watts. 8 ohms impedance. Brilliant transient response. Size $9\frac{3}{4}$ in square on face. Finished black matt with aluminium bar trim. Detachable pedestal base. *Hear the Q.14 in your own home. If you are not delighted with it, send it back, and your money, including cost of return postage to this office, will be refunded in full.*

£7-19-6

sinclair

SINCLAIR RADIONICS LTD., CAMBRIDGE

Sinclair IC-10 a revolutionary new amplifier-See previous pages-

SINCLAIR MICROMATIC

The smallest radio set in the world

The Sinclair Micromatic is available ready built or in kit form. This latter now comes in a convenient new presentation pack complete down to a generous free supply of solder. The moulded polystyrene interior enables you to check the contents in an instant, and helps to make building even easier and surer. Now, the Micromatic is better than ever—more powerful and better sounding to assure superb listening. Selectivity is better than many larger sets. Whether you build it, or buy your Micromatic ready built, it is the best and the smallest personal radio in the world—and it's British. In elegant aluminium fronted black case with slow motion tuning.



- $1\frac{1}{2} \times 1\frac{1}{10} \times \frac{1}{2}$ in
- Tunes over medium waves
- Plays anywhere
- Magnetic earpiece
- In kit form or complete

Complete kit inc. magnetic ear-piece and instructions.

49/6

59/6

Ready built and tested

Mallory Mercury Cell RM.675 (2 needed) each 2/9.



IN THE NEW KIT PACK

This attractive new presentation pack enables you to check the contents of your kit instantly. Everything is there down to the last nut and includes easy to follow instructions and generous supply of free solder.

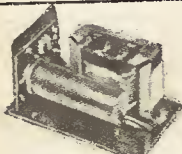

SINCLAIR PZ.4 STABILISED POWER SUPPLY UNIT

A heavy duty a.c. mains power supply unit delivering 18V d.c. at 1.5A. Designed for Sinclair IC-10 or for assemblies using two Z.12s and stereo 25 unit.

99/6

Ready built and tested.

SINCLAIR Z.12

12 WATT AMPLIFIER AND PRE-AMP

The Sinclair Z.12 has fantastic power-to-size ratio, and great adaptability. It will operate from batteries or PZ.4 mains power supply unit, and gives superb stereo reproduction for modest outlay. Thousands are in use throughout the world—in hi-fi, electronic music instruments, P.A., intercom systems, etc. This true 12 watt amplifier is supplied ready built, tested and guaranteed together with the Z.12 manual which details control circuits enabling you to match the Z.12 to your precise requirements. For complete listening satisfaction use your Z.12 system with Q.14 loudspeakers. It assures superb quality with substantial saving in outlay.

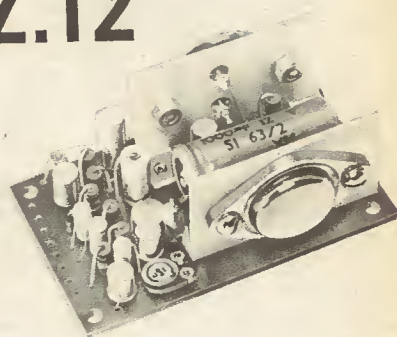

★ IDEAL FOR BATTERY OPERATION

3 x 12 x 14in ● Class B Ultralinear output ● 15-50,000Hz ± 1dB ● Suitable for 3, 5, 8 or 15Ω speakers. Two 3Ω speakers may be used in parallel ● Input—2mV into 2kΩ ● Output—12 watts R.M.S.

continuous sine wave (24W peak) 15W music power (30W peak) ● Ready built, tested and guaranteed.

89/6

SINCLAIR GUARANTEE

Should you not be completely satisfied with your purchase when you receive it from us, your money will be refunded in full at once and without question. Full service facilities available to all purchasers.



SINCLAIR RADIONICS LTD
22 NEWMARKET ROAD
CAMBRIDGE. OCA3-52731

To: SINCLAIR RADIONICS LTD., 22 NEWMARKET ROAD, CAMBRIDGE

Please send POST FREE

NAME

ADDRESS

.....

.....

For which I enclose cash/cheque/money order

PE1068

RADIONIC

RADIO & ELECTRONIC INSTRUCTIONAL SYSTEM

**LEARN AS YOU BUILD
AT HOME
THE EXCITING WAY**

Clear, simple, versatile, this rugged system can build almost any electronic circuit. Ideal for the experimenter; the teacher; and the complete beginner. Already used by well over 1,500 schools in the U.K.

Selected by the Council of Industrial Design for all British Design Centres. Featured in Sound and Television broadcasts.

Beautifully engineered; battery operated; no soldering; no prior knowledge needed. Results guaranteed by our technical department. People say:

"I can only describe the results as brilliant, absolutely brilliant."
"You have opened up a new world."
"Nothing could paint the picture clearer than building these sets."
"The kit has been used by my son (aged 10) with complete success."
"Most impressive—a stroke of genius whoever devised it."

UNIQUE! Our "No soldering" printed circuit board for superhet portable. Simply insert components and tighten nuts.

- No. 1 Set £7.10.0. 14 Circuits (Earphone)
 - No. 2 Set £9.0.0. 20 Circuits (Earphone)
 - No. 3 Set £13.10.0. 22 Circuits (7" x 4" Loudspeaker Output)
 - No. 4 Set £18.10.0. 26 Circuits (incl. 6-transistor and reflex superhets)
- ELECTRONICS KIT: 30 plus circuits £10.7.0.** (Prices Post Free)

Full details from:

RADIONIC PRODUCTS LIMITED
STEPHENSON WAY, THREE BRIDGES
CRAWLEY, SUSSEX
Tel.: CRAWLEY 27028

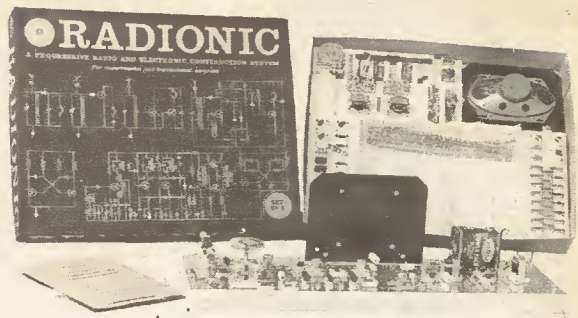

A No. 4 SET and 6-TRANSISTOR SUPERHET

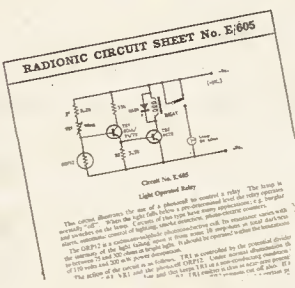

Theoretical Circuit

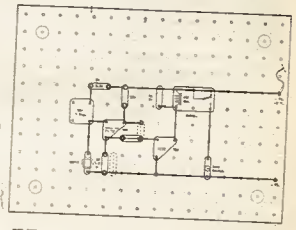

Practical Layout

E/605 Light Operated Relay.

Our 'E' Series of basic electronic circuits is available separately.

DIOTRAN SALES

P.O. BOX 5
WARE, HERTS
TEL.: WARE 3442

Nowhere in the world can you buy semiconductors cheaper than from us. We are the largest purchasers of manufacturers' surplus stocks, and can fulfill any requirements at competitive prices. S.A.E. for full lists.

Post and Packing costs are continually rising. Please add 1/- towards same. **CASH WITH ORDER PLEASE**

OVERSEAS QUOTATIONS BY RETURN SHIPMENTS TO ANYWHERE IN THE WORLD

I/- each TESTED TRANSISTORS

ONE PRICE ONLY PNP, NPN.
SILICON PLANAR 1/- EACH

BC108	2N696	2N1132	2N2220	2S733
BC109	2N697	2N1613	2N3707	2N3391
BFY50	2N706	2N1711	2N3711	T1544
BFY51	2N708	2N2904	2S102	2N2906
BFX84	2N929	2N2905	2S103	2N2907
BFX86	2N930	2N2924	2S104	2N2696
BFX88	2N1131	2N2926	2S732	2N3702
				2N3703

From Manufacturers' Over-runs—Unmarked Plastic and Metal cases.

GERM. PNP AND NPN TRANSISTORS FULLY TESTED, UNMARKED 1/6 EACH

AC125	ACY22	ACY36	NKT677	OC81	2G381
AC126	ACY27	NKT141	NKT713	OC82	2G382
AC127	ACY28	NKT142	NKT773	2G301	2G399A
AC128	ACY29	NKT212	OC44	2G302	
AC130	ACY30	NKT213	OC45	2G303	
ACY19	ACY31	NKT214	OC71	2G308	1/6
ACY20	ACY34	NKT215	OC72	2G371	
ACY21	ACY35	NKT271	OC75	2G374	each

POWER TRANSISTORS

OC25	OC35	NKT403	ASZ17
OC26	AD130	NKT404	T13027
OC28	AD140	NKT405	T13028
OC29	AD149	NKT452	T13029

Manufacturers' Surplus Germ. A.F.

TEXAS SILICON ALLOY TRANSISTORS

2S302 Eqvt. OC200 VcB40 Hfe 15-50 1-49 off 3/6 each
2S303 " OC201 VcB25 Hfe 25-75 5-99 off 3/- each
2S304 " OC202 VcB15 Hfe 45-120 100 off 2/6 each
ALL BRAND NEW, FULLY GUARANTEED AND MARKED.

HIGH QUALITY SILICON PLANAR DIODES.

SUB-MINIATURE DO-7 Glass Type, suitable replacements for OA200, OA202, BAY38, 1S110, 1S940. 200,000 to clear at £4 per 1,000 pieces. GUARANTEED 80% GOOD.

MIXED SILICON PLANAR TRANSISTORS NPN TO-18 CASE.

Transistors to fill a number of requirements like 2N706, 2N708, BSY27, BSY95A, etc. 500 off, £5; 1,000 off £8.10.

THYRISTORS (S.C.R.'s), FULLY TESTED, BRAND NEW AND CODED: TO-5 CASE

Type No.	PIV	Amp	Each
2N1595	50	1	7/6
2N1596	100	1	8/-
2N1597	200	1	10/6
2N1598	300	1	14/-
2N1599	400	1	15/-
BTX30-500	500	1	22/6
BTX30-600	600	1	25/-

TO-46 CASE (STUD)

Type No.	PIV	Amp	Each
2N1771	50	4.7	9/-
2N1772	100	4.7	9/6
2N1773	200	4.7	12/6
2N1774	200	4.7	16/6
2N1776	300	4.7	19/6
2N1777	400	4.7	25/6
2N1778	500	4.7	25/6
2N2619	600	4.7	30/-
BTY79-150	150	4.7	12/-
BTY79-250	250	4.7	14/-
BTY79-400	400	4.7	20/-

TO-48 CASE (STUD)

Type No.	PIV	Amp	Each
2N682	50	16	12/-
2N683	100	16	15/-
2N685	200	16	19/6
2N687	300	16	25/6
2N688	400	16	32/6
2N689	500	16	47/6
2N690	600	16	50/-
2N691	700	16	56/-
2N692	800	16	62/-

BRAND NEW FULLY TESTED EPOXY CASE UNIJUNCTION TRANSISTORS.

Type T1543 and BEN 3000 and replacement for 2N246. Full data available. LOWEST PRICE AVAILABLE ANYWHERE. 100 off 4/- each = £20; 500 off 3/6 each = £87.10; 1,000 off 3/- each = £150. Sample devices 7/- each on request.

SILICON PLANAR PLASTIC TRANSISTORS.

2N1798A VcB30 Hfe 20-60. All marked, fully tested and guaranteed. 1 off 1/6 each; 100 off 10d. each; 500 off 9d. each; 1,000 off 7½d. each.

TO-18 METAL CAN SILICON PLANAR TRANSISTORS.

VERY HIGH QUALITY 99% good. Type 2N706 BSY27 £7.10 per 500 pieces; £12.10 per 1,000 pieces.

PRINTED CIRCUIT BOARDS

with usable length leads on both Transistors and diodes. All Mullard devices with the exception of the 2G371 which are Texas.

EACH PANEL CONSISTS OF THE FOLLOWING:—

"A"	8 × OC43, 24 × OA81	12/- per Panel
"B"	64 × OA81	20/- per Panel
"C"	8 × 2G371	5/- per Panel
"D"	16 × OC84	15/- per Panel
"E"	8 × GET875, 24 × OA81	11/- per Panel
"F"	8 × GET114, 20 × OA81	10/- per Panel
"G"	8 × 2G371, 12 × OA81	7/6 per Panel
"H"	8 × GET114, 12 × OA81	8/6 per Panel
"I"	8 × OC84	9/- per Panel
"J"	4 × OC28, 4 × FST1/0	15/- per Panel
"K"	4 × OC35, 4 × FST1/0	15/- per Panel
"L"	32 × OA81	12/- per Panel
"M"	4 × GET875, 2 × OA81	3/- per Panel

TRANSISTOR EQVT. BOOK

2,500 cross references of transistors—British, European, American and Japanese. A must for every transistor user. Exclusively distributed by DIOTRAN SALES. 15/- EACH.

Vast mixed lot of subminiature glass diodes. Comprising of silicon germ. point contact and gold bonded types plus some zeners. 500,000 available at Lowest of Low Price.

1,000 pieces £3.0.0. 5,000 pieces £13.10.0. 10,000 pieces £23.

Sub-Min. Plastic 1 Amp Sil. Rect.

Type No.	PIV	Each
IN4001	50	1/3
IN4002	100	1/6
IN4003	200	2/-
IN4004	400	2/9
IN4005	600	3/3
IN4006	800	3/9
IN4007	1,000	4/9

THERMOSTAT WITH PROBE

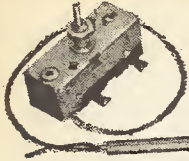

This has a sensor attached to a 15A switch by a 14in. length of flexible capillary tubing—control range is 20°F to 150°F so it is suitable to control soil heating and liquid heat.

ing especially when in buckets or portable vessels as the sensor can be raised out and lowered into the vessel. This thermostat could also be used to sound a bell or other alarm when critical temp. is reached in stack or heap subject to spontaneous combustion or if liquid is being heated by gas or other means not controllable by the switch. Made by the famous Teddington Co., we offer these at 12/6 each. Postage and insurance 2/9.

MINIATURE WAFER SWITCHES



4 pole, 2 way—3 pole, 3 way—4 pole, 3 way—2 pole, 4 way—3 pole, 4 way—2 pole, 6 way—1 pole, 12 way. All at 3/6 each, 36/- dozen, your assortment.

WATERPROOF HEATING ELEMENT

26 yards length 70W. Self-regulating temperature control. 10/- post free.

BLANKET SWITCH

Double pole with neon lens into side so luminous in dark, ideal for dark room light or for use with waterproof element—new plastic case. 5/6 each. 3 heat model 7/6.

PHOTO-ELECTRIC KIT

All parts to make light operated switch/burglar alarm/counter, etc. Kit comprises printed circuit, Laminated Boards and Components, Latching relay, Infra-red sensitive Photocell and Hood, 2 Transistors, cond., Terminal Block, Plastic case. Essential data, circuits and P.C. chassis plans of 10 photo-electric device including auto. car parking light, modulated light alarm. Simple invisible ray switch—counter—stray light alarm—warbling tone electronic alarm—projector lamp stabiliser, etc. Only 39/6, plus 2/- post and insur.

FP3 Eliminator. Play your pocket radio from the mains! Save 2s. Complete component kit comprises 4 rectifiers—mains dropper resistances, smoothing condenser and instructions. Only 6/6 plus 1/- post.

BECKASTAT

This is an instant thermostat, simply plug your appliance into it and its lead into wall plug. Adjustable setting for normal air temperatures. 13 A loading. Will save its cost in a season. 18/6. Postage and ins. 2/9.

QUICK CUPPA

Mini Immersion Heater, 350W, 200/240V. Bolls full cup in about two minutes. Use any socket or lamp holder. Have at bedside for tea, baby's food, etc. 10/6, post and insurance 1/6. 12v. car model also available.

THERMOSTATS

Type "A" 15A for controlling room heaters, greenhouse, airing cupboard. Has spindle for pointer knob. Quickly adjustable from 30–80°F. 8/6, plus 1/- post. Suitable box for wall mounting, 8/- P. & P. 1/1.

Type "B" 15A. This is a 17in long rod type made by the famous Sunvic Co. Spindle adjusts this from 50–550°F. Internal screw will alter the setting so this could be adjustable over 30° to 1,000°F. Suitable for controlling furnace, oven kiln, immersion heater or to make flame-start or fire alarm, 8/6, plus 2/6 post and insurance.

Type "C". We call this the Ice-stat as it cuts in and out at around freezing point, 2/3 ans. Many uses one of which would be to keep the loft pipes from freezing. If a length of our blanket wire pipes from freezing. If a length of our blanket wire pipes from freezing. 7/6. P. & P. 1/1.

Type "E". This is standard refrigerator thermostat. Spindle adjustments cover normal refrigerator temperature, 7/6, plus 1/- post.

Type "G". Glass encased for controlling the temp. of liquid—particularly those in glass tanks, vats or sinks—thermostat is hermetically submerged by rubber sucker or wire clip—ideal for fish tanks—developed and chemical baths of all types. Adjustable over range 60° to 150°F. Price 18/-, plus 2/- post and insurance.

DRILL CONTROLLER



Electronically changes speed from approximately 10 revs. to maximum. Full power at all speeds by finger-tip control. Kit includes all parts, case, everything and full instructions. 19/6 plus 2/6 post and insurance. Or available made up 25/-, plus 2/6 post.



INFRA-RED HEATERS

Make up one of these latest type heaters. Ideal for bathroom, etc. They are simple to make from our easy-to-follow instructions—uses silica enclosed elements designed for the correct infra-red wavelength (3 microns). Price for 750 watts element, all parts, metal casing as illustrated, 19/6, plus 4/6 post and insurance. Pull switch 3/- extra.



FLOUORESCENT LIGHTING SNIP THE TWENTYLITE

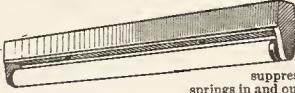

If left on all the time costs only one penny per day (uses 1 unit). Measures 2ft. long. Is ideal in Kitchen, Bedroom, Hallway, Porch, Loft, etc. Don't miss this amazing offer, 39/6 with tubes. Assembled ready to install. Postage and Insurance 6/6 extra. Other "Atlas" fluorescent fittings with tubes 4ft. 40W 49/6 5ft. twin 40W 59/6 5ft. 80W 89/6 4ft. and 5ft. fittings carriage 10/- on each sent at purchasers risk.

A 2ft. 20 watt lighting unit made by the famous Atlas company, with super silent polyester filled choke and radio suppressed starter. The tube springs in and out and the whole unit is beautifully made and finished white enamel. Amazingly economical. Also suitable for controlling the temperature of any other appliances using up to 1 amp. Listed at 27/6 each, we offer these while our stock lasts at only 12/6 each.

THIS MONTH'S SNIP

YOU SAVE £2-10-0

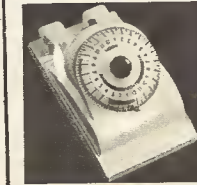

and always have a warm bed awaiting you. The wonderful DREAMLAND clock switch will automatically switch your blanket on and off each evening. It's luminous, you can always see the time and it's a really beautiful unit. An ideal gift. Can also control tape recorder, radio, lamp, etc. Up to 600 watts. Proper price 44.9.6. 39/6 plus 3/6 P. & P.

HI-FI BARGAIN

FULL FI 12 INCH LOUDSPEAKER. This is undoubtedly one of the finest loudspeakers that we have ever offered, produced by one of this country's most famous makers. It has a die-cast metal frame and is strongly recommended for Hi-Fi loud and Rhythm Guitar and public address. Flux Density 11,000 gauss—Total Flux 44,000 Maxwells—Power Handling 15 watts R.M.S.—Cone Moulded fibre—Freq. response 30-10,000c/s—Main resonance 60c/s—Chassis Diam. 12in—12in over mounting lugs—Baffle hole 11in Diam.—Mounting holes 4, holes 1in diam. on pitch circle 11 1/2in diam.—Overall height 5 1/2in. A 25 speaker offered for only 43/9/6, plus 7/6 P. & P. Specify three or fifteen ohms. Don't miss this offer.

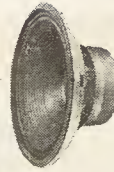

BATTERY OPERATED TAPE DECK

With Capstan control. This unit is extremely well made and measures approx. 6 x 5 x 2in. deep. Has three piano key type controls for Record, Playback and Rewind. Motor is a special heavy duty type intended for operation of 4 1/2 volts. Supplied complete with 2 spools ready to install. Record, Replay head is the sensitive M4 type intended for use with transistor, amplifier. Price 59/6. Post and insurance 4/6.



BARGAIN OF THE YEAR

MICRO-SONIC

7 transistor Key chain loudspeaker Radio in very pretty case, size 2 1/2 x 2 1/2 x 1 1/2in—complete with soft leather zipped bag. Specification: Circuit: 7 transistor superheterodyne. Frequency range: 530 to 1600kc/s. Sensitivity: 5mv/m. Intermediate frequency: 465kc/s, or 455kc/s. Power output: 40mW. Antenna: ferrite rod. Loudspeaker: permanent magnet type. In transit from the East these sets suffered slight corrosion as the batteries were left in them but when this corrosion is cleared away they should work perfectly—offered without guarantee except that they are new. 19/6 plus 2/6 post and ins., less batteries. A pair of rechargeable everlasting batteries 7/- pair.

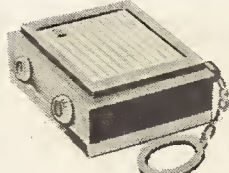

CENTRIFUGAL FAN

CENTRIFUGAL BLOWER or extractor by Torrington, very low noise but large capacity air flow, designed for central heating and air conditioning; ideal also for fume extraction over cooker, duct type outlet, 200–250V, 50c/s motor. 23.19.6, post and insurance 7/6.

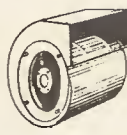

16 RPM GEARED MOTOR

Made by Smith's Electrics, there are almost silent running, but are very powerful. They operate from normal to 240V mains and the final shaft speed is 16 r.p.m. 15/-. Post and insurance 2/9.

Where postage is not definitely stated as an extra then orders over £3 are post free. Below £3 add 2/9. Semi-conductors add 1/- post. Over £1 post free. S.A.E. with enquiries please.

MAINS TRANSISTOR POWER PACK

Designed to operate transistor sets and amplifiers. Adjustable output 6V, 9V, 12V for up to 500mA (class B, working). Takes the place of any of the following batteries: PP1, FP3, FP4, FP6, FP7, FP9, and others. Kit comprises mains transformer rectifier, smoothing and load resistor, condensers and instructions. Real snip at only 16/6, plus 3/6 postage.

ELECTRONICS (CROYDON) LIMITED

(Dept. P.E.) 266 LONDON ROAD, WEST CROYDON, CRO 2TH
also at 102/3 TAMWORTH ROAD, CROYDON, SURREY

Ordering Components is FUN



with **THIS**
Catalogue
in your hands!

**A bargain
at 7/6
plus 3/- p&p.**

Ever had trouble locating a particular piece for your project? Ever wasted time thumbing through confusing price lists? Ever been foot-weary and frustrated tramping round the shops?

Sigh no more. Just sink into an armchair and enjoy life with a Home Radio Catalogue! Pick your parts. Grab your pen. Make for a letter-box. Your chosen items will be with you almost before you can get back to that armchair!

This Catalogue really is a *must* if you're interested in Radio and Electronics. It has 256 pages, over 7,000 items listed, over 1,300 illustrations. With each catalogue we supply a Book Mark giving Electronic Abbreviations, an Order Form and an Addressed Envelope. All this for only 7/6 plus 3/- post and packing. By the way, every catalogue contains 5 vouchers, each worth 1/- when used as directed. Send the coupon today with your cheque or P.O. for 10/6.

Please write your Name and Address in block capitals

Name

Address

Home Radio (Mitcham) Ltd., Dept. PE, 187 London Rd., Mitcham, CR4 2YQ

TRIAL AND ERROR DESIGN

DESIGNING by soldering iron, rather than by pencil and paper, is a "failing" most of us would admit to, sometime or the other. Once a rudimentary circuit has been sketched out, the temptation to wire up some components and see what happens is often irresistible. The resulting assemblage of parts is not exactly a joy to behold, not that we are under any delusions in this regard, for do we not describe it by some unflattering name such as a "bird's nest", a "lash-up", or a "breadboard design"? Nor of course are we surprised when the circuit fails to "go" first time. At this point we really start to think in earnest, though our thoughts, if we are honest, are likely to be directed towards component substitution, rather than back to first principles.

This is where the soldering iron takes over as an essential design tool. Why get involved in time consuming paper calculations when it is but a few seconds work to disconnect a component and insert a substitute? If the new one does not work, the process can be repeated *ad infinitum* until success is achieved. By the time this happy moment arrives, our "bird's nest" will have changed its geometry many times and the final arrangement may bear little resemblance to the original set-up. But now the circuit diagram can be drawn in its final form and those little details like component values filled in.

The purist can argue that this empirical approach to electronic design is completely wrong. True it is a back-to-front process, but it suits many private designers to arrive at the answer mainly through practical experiments.

Some non-professionals may be surprised to learn that the "trial and error" method of design is not uncommon in industry either. Indeed it is sufficiently widely practised to have provoked strong criticism from two members of the University of Edinburgh, Prof. W. E. J. Farvis and J. Murray, in a paper which they presented to a Conference on Electronics Design last September. The authors argue that this casual, undisciplined approach to design is not found in any other branches of engineering, and that it is uneconomical and inefficient, and is a serious liability that has to be borne by our electronics industry.

Amateur designers must be excused if they permit themselves a wry smile at this confirmation of what has long been suspected—that their "weakness" is shared by the professionals. For the industry, this criticism of its design methods is food for thought indeed. Will it prove indigestible?

F. E. Bennett—*Editor*

THIS MONTH

CONSTRUCTIONAL PROJECTS

DOOR CHIME	850
RHYTHM GENERATOR	861
STOCKMARKET GAME	872
SINE WAVE OSCILLATOR	886
FLIP FLOP GAME	897

SPECIAL SERIES

BIONICS—2	880
-----------	-----

GENERAL FEATURES

D.C. FEEDBACK PAIR	853
INGENUITY UNLIMITED	869
ELECTRONICS UNDERGROUND	901

NEWS AND COMMENT

EDITORIAL	849
R.S.G.B. EXHIBITION	858
POINTS ARISING	858
MANCHESTER SHOW	866
ELECTRONORAMA	878
MARKET PLACE	885
SPACEWATCH	890
NEWS BRIEFS	893
BOOK REVIEWS	894

Our January issue will be published on
Friday, December 13



DOOR CHIME

OPEN pipe door chimes have almost usurped the common or garden clamorous electric bell. The sweetly sonorous tones linger with each chime lulling you to the door.

Electronics offers a variant on these mechanical tintinnabulations for the unit to be described, whilst producing the true ringing sound of a bell, may be adjusted for rate of chiming, pitch, volume and sustain.

For hoteliers and guest house managers who would prefer a push button alternative to the dinner gong simple modifications to the unit are provided.

PULSE GENERATOR

The pulse generator is built around a complementary pair TR1, TR2 shown in Fig. 1. Assuming C1 and C2 are both discharged. When S1, the bell push switch, is made C1 charges by way of diode D1 and R3 whilst C2 charges via R2 and R3.

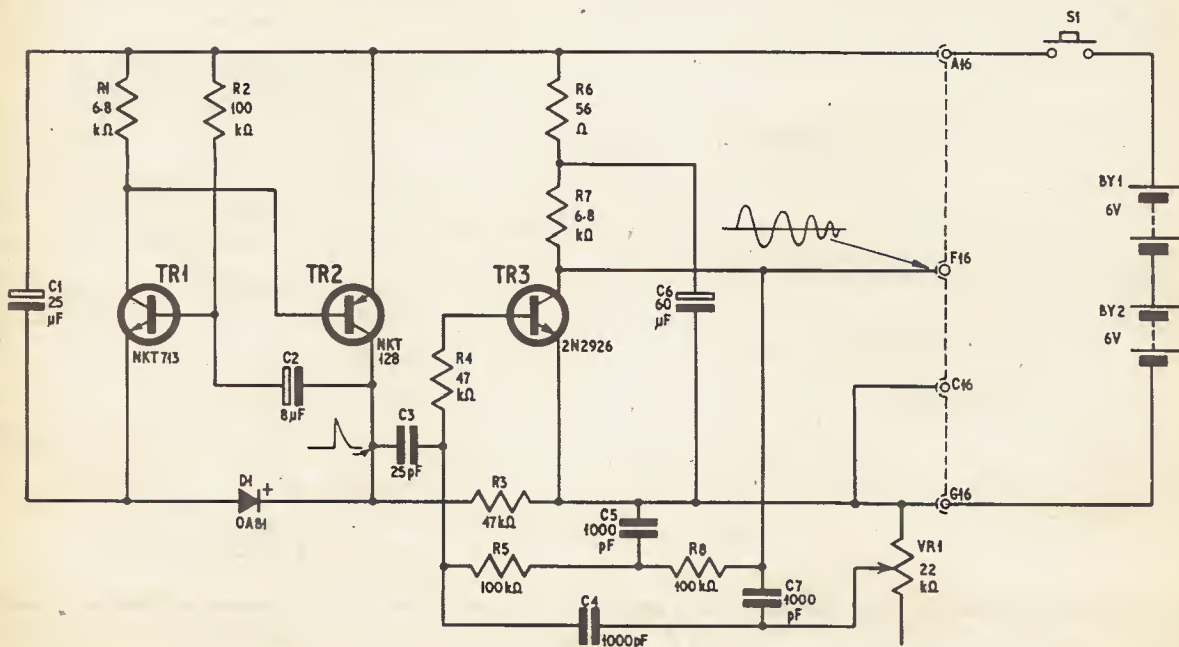
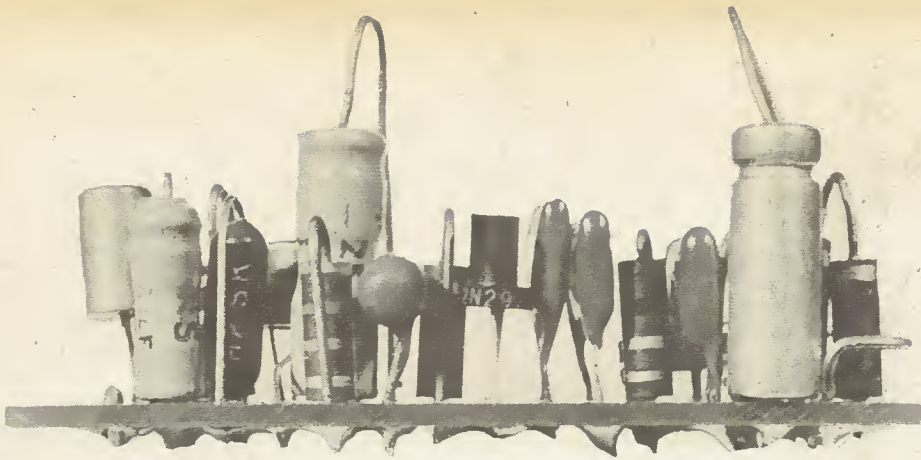

Fig. 1. Circuit diagram of chimes unit. Note that S1a and S1b are ganged. S1b switches the amplifier shown in Fig. 3



With the charging of C2, TR1 is held off by the negative voltage appearing across R2. Since no collector current is flowing no voltage appears across R1 and TR2 is similarly non conducting.

When C2 has charged the *npn* transistor TR1 conducts and switches TR2 hard in so that a positive going pulse appears across R3 and is applied to TR3 via the coupling capacitor C3.

This pulse reverse biases diode D1 so that capacitor C1 maintains TR1 in conduction.

As C1 discharges so does C2 and with the completion of these processes the circuit reverts to its initial passive state before another pulse cycle.

To increase the pulse repetition frequency either C1 or C2 should be diminished in value. To decrease the p.r.f. raise these values.

TWIN-TONE GENERATOR

The chimes producing circuit is a twin-T oscillator consisting of a high gain silicon transistor TR3 and attendant RC networks which determine the frequency of operation.

The twin-T geometry derives from the arms R5, C5, R8 and C4, C7 and VR1. As is common with sinusoidal RC oscillators frequency varies inversely with these component values. In this unit values were selected to produce a frequency of about 3kHz consistent with bell sounds.

SHOCKING

To produce a ringing tone the oscillator must be shocked into activity. This means that in its passive

COMPONENTS . . .

Resistors

R1	6.8k Ω	R5	100k Ω
R2	100k Ω	R6	56 Ω
R3	47k Ω	R7	6.8k Ω
R4	47k Ω	R8	100k Ω

All 10%, $\frac{1}{2}$ W carbon

Potentiometer

VR1 22k Ω miniature carbon preset

Transistors

TR1 NKT713 TR3 2N2926 (Green spot)
TR2 NKT128

Diode

D1 OA81

Capacitors

C1 25 μ F 15V sub-miniature elect.
C2 8 μ F 15V sub-miniature elect.
C3 25pF
C4 1,000pF
C5 1,000pF
C6 1,000pF
C7 60 μ F 15V sub-miniature elect.

Switch

S1 Push-to-make 2 pole miniature (Radiospares)

Batteries

BY1, BY2, BY3 Three PPI 6V batteries

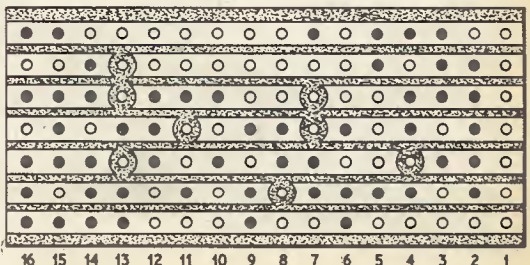
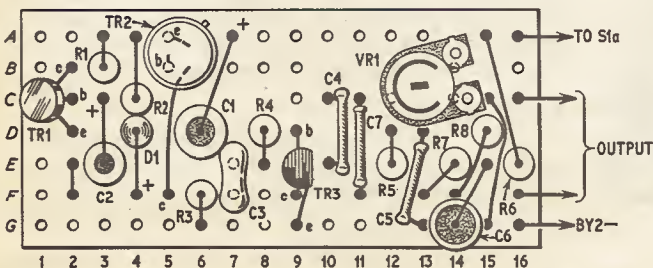

Fig. 2. Component layout on board and underside view showing the breaks in the copper strips

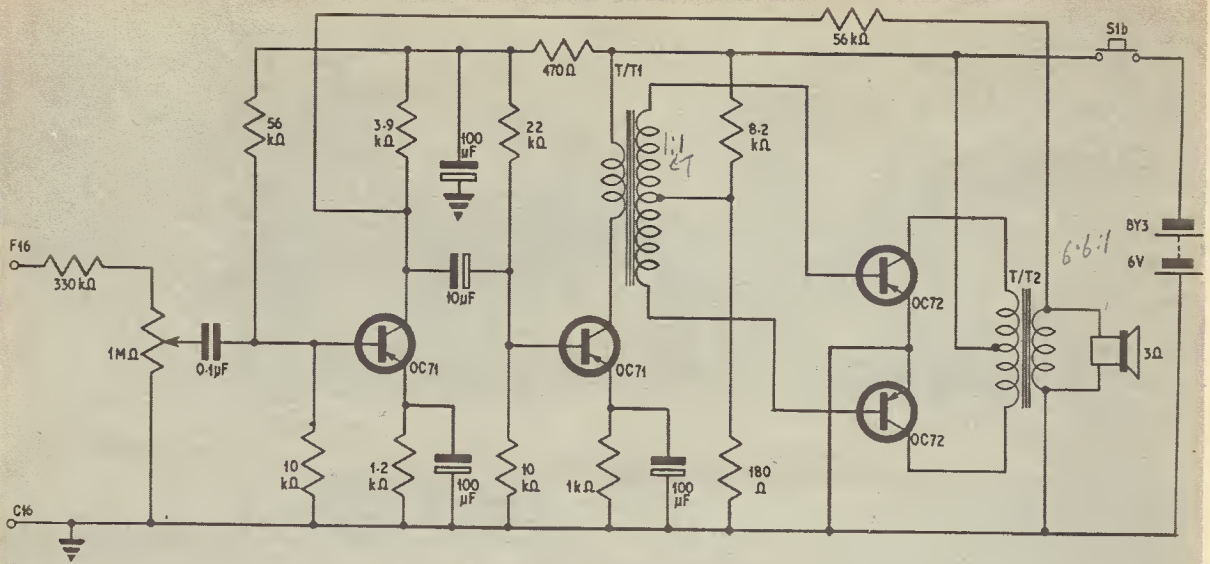

Fig. 3. Suitable 200mW amplifier (Mullard) for use with chimes unit

state no oscillations are produced, a condition which is determined by the setting of VR1.

With the arrival of incoming positive pulses developed across R3 the twin-T oscillator produces a train of progressively damped sine wave.

The R6/C6 combination sustains this so that the tone lingers gradually diminishing in intensity.

Adjustment of this time constant must be in accord with the p.r.f. of the pulse generator. As a rule of thumb the higher the frequency, the shorter the time constant. This means a reduction of C7 capacitance.

CONSTRUCTION

The complete circuit can be assembled on a piece of Veroboard, similar to that given free with the October issue of PRACTICAL ELECTRONICS. See Fig. 2 for arrangement of components and wiring.

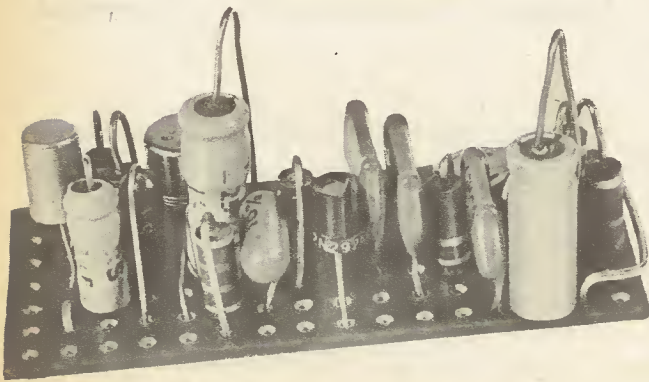

AMPLIFIER

The output at F16 can be applied to any high impedance amplifier but for those constructors who have no such unit a suitable design is given in Fig. 3. This will provide an output of up to 200mW. Volume is, of course, adjustable to suit personal requirements.

S1 ensures that no battery power is consumed until this switch is depressed when S1a and S1b route the required 12 and 6 volt supplies to the chime and amplifier circuits.

GONG

To produce the sound of a gong the capacitors C4, C5 and C7 should be changed to 0.01µFd. No other alterations are necessary.

FUNCTIONAL CHECKS

To check that the pulse generator is working successfully a 6V, 0.06A pilot bulb should be substituted for R3 when the wiring of this half of the circuit according to Fig. 3 is completed.

If the lamp continuously blinks the supply can be disconnected, R3 substituted and then the tone generator assembled. For checking the tone generator the amplifier must be attached. Rotation of VR1's wiper will produce an oscillation. This should be adjusted to the point when single chiming tones are produced; this completes the setting up of the unit.

TWO TONES

For those constructors wanting two tones at different pitches, another twin-T circuit is required. The pulse output of R3 can be applied to a flip flop circuit which would gate the two tone generators, the outputs being taken out to the amplifier.

For pitch variation the C4, C5 and C7 capacitors should be collectively altered.



D.C. FEEDBACK PAIR

By P. Williams B.Sc.

VERY simple circuits can be designed using the characteristics of silicon planar transistors to their best advantage. The biasing technique in particular has proved to be of great benefit in industrial practice and variations on it are very common in the design of integrated circuits. It is worth considering whether circuits can be further simplified without losing too much in performance.

POTENTIAL DIVIDER BIAS

The base-emitter voltage of a silicon transistor is surprisingly steady for a wide range of currents and temperatures. For example it will be changed by only 10 per cent for an eight-fold increase in current or a 30 degree C change in temperature. So under the conditions normally met by the home experimenter this voltage can be assumed constant for any one transistor and is not likely to differ by more than a few per cent for other transistors of the same type.

Even transistors from different manufacturers can be expected to be sufficiently close for most purposes. As a check on this two planar *npn* silicon transistors, an ME101 and a 2N3707, were operated at room temperature with emitter currents of 1mA. The corresponding base-emitter voltages were 675mV and 630mV respectively. As can be seen from their data sheets, these two are very different transistors by different manufacturers and yet the V_{be} is within 10 per cent in each case, a closer tolerance than the resistors often used in biasing networks. For most small signal planar transistors these figures are typical.

Consider Fig. 1; if the current in the potential divider chain can be made much greater than the base current, then, since the voltage across R_2 is 600mV (the base-emitter voltage of the transistor) the voltage at the

collector must be $\frac{R_1 + R_2}{R_2} 600\text{mV}$.

The errors in this figure will be due to:

1. The base current disturbing the potential divider.
2. Change in V_{be} with temperature replacement of the transistor, etc. As outlined above these changes are small.

In Fig. 2, an emitter follower is added in which the current can be higher, permitting a potential divider of as low a resistance as desired thus allowing the elimination of error (1) if desired. Too low a value of resistance in the divider will shunt the input signal too severely and reduce gain.

To achieve the highest possible voltage gain without sacrificing d.c. stability the emitter resistor of TR2 may be bypassed and a load inserted in the collector circuit (Fig. 3). Where this form of circuit is used, the emitter potential of TR2 is constant regardless of signal and the base of TR2 and hence the collector of TR1 will only have a small voltage swing. It is here that a further characteristic of transistors, not shared by valves, comes to our aid in producing a simple, stable design.

It is often assumed, since a transistor can be represented by two diodes back-to-back in explaining the bias voltage polarities, that it is necessary for the collector-base diode to be reverse-biased. Deeper investigation shows that what is required is only that the collector-base diode shall not be forward-biased sufficiently for it to conduct.

Thus in an *npn* transistor the base potential with respect to ground will be approximately equal to 600mV while the collector may fall to 200mV or less with only a small effect on the gain. This can be checked by looking at the saturation region characteristics of the transistor.

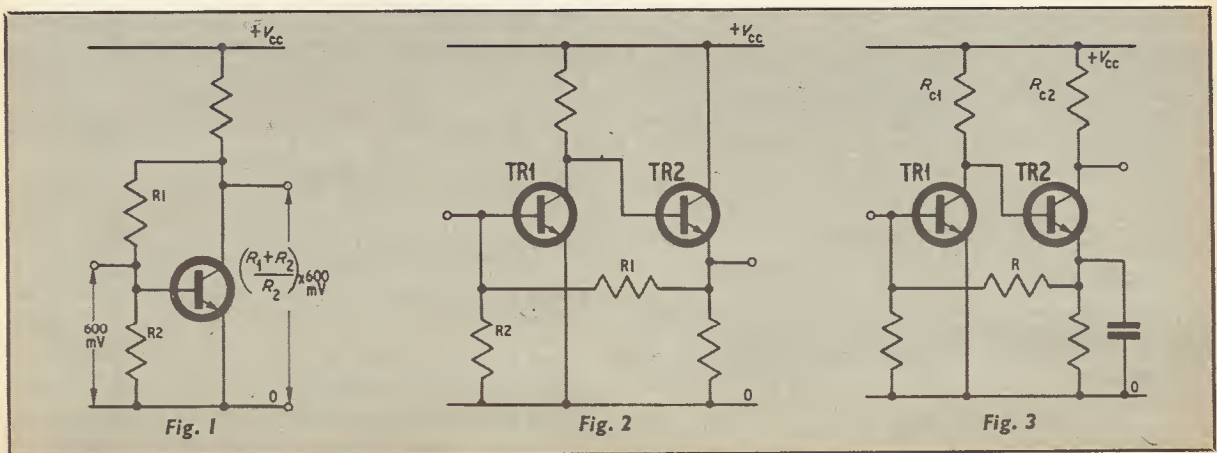

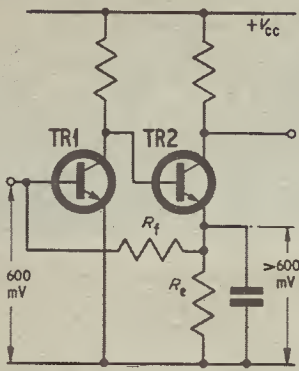

Fig. 4

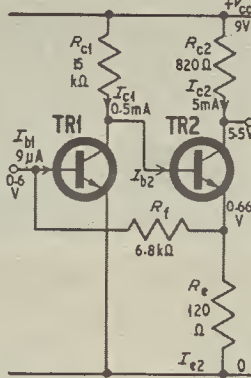

Fig. 5

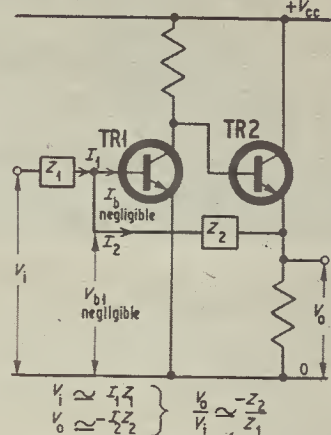

Fig. 6

SINGLE RESISTOR BIAS

Replace the potential divider by a single resistor again of a low enough value that base current provides only a small voltage drop. The voltage at the emitter of TR2 will now be little higher than that of TR1 base, i.e. approximately equal to 600mV. Thus the emitter resistor will have to be of a lower value if the current in TR2 is to be maintained (Fig. 4). Note that the collector of TR1 is now at about 1.2V giving an adequate safety margin for the avoidance of saturation.

The advantages of this circuit are two-fold:

1. The stability is as good as that of the original but with one less resistor.
2. A smaller voltage drop occurs across R_e , permitting a lower supply voltage, or alternatively, a slightly increased gain by increasing the load resistances and maintaining the currents constant.

The design procedure is then as follows:

1. Assume that R_f can be low enough that the voltage drop across it is negligible. Decide the current required in TR2 from a knowledge of the load. The voltage across R_e will now approximate to the V_{be} of TR1 (600mV). If R_e is in ohms

$$I_{c2} = I_{e2} = \frac{600}{R_e} \text{ mA}$$

2. The supply voltage will already be known either because the amplifier is to be fitted to an existing system or because the load voltage requirement has to be met. A safe procedure is to drop half the remaining volts across R_{c2}

$$\text{i.e. } R_{c2} = \frac{V_{cc} - 0.6}{2 \cdot I_{c2}}$$

if V_{cc} is in volts, I_{c2} is in mA, R_{c2} is in kilohms.

3. TR1 must carry sufficient current to supply the base of TR2 comfortably. If the d.c. current gain of TR2 is known (h_{FE2}) then the base current can be calculated as

$$\frac{I_{c2}}{h_{FE2}}$$

Otherwise a minimum gain of, say, 30 may be assumed, and the resulting value calculated for R_{c1} may be increased if experience shows this to be pessimistic.

The collector load current of TR1 can then be made at least twice the maximum expected base current of TR2; for safety a factor of three or four times might be preferable. The voltage at the collector of TR2 is, as previously indicated, about 1.2V. Hence

$$R_{c1} = \frac{V_{cc} - 1.2}{4 \times I_{b2}}$$

where I_{b2} is in mA and R_{c1} in kilohms.

The safety factor used here is 4, i.e. the base current will be one quarter of the collector resistor current and the collector current of TR1 three-quarters of it. Since the input impedance of TR2 is relatively low (operating at a larger current, r_{in} falls) then even larger safety factors may be used without R_{c1} falling enough to shunt the signal away from the base of TR2 and lower the gain.

For most silicon planar transistors the gain will be maintained even at low currents, but with alloy junction units or germanium ones it may be necessary to reduce R_{c1} considerably so that TR1 has sufficient current for satisfactory operation.

4. R_f can now be chosen so that the voltage drop across it is negligible compared with the 600mV at the base of TR1. If it is to be limited to say 10 per cent, then first calculate

$$I_{b1} = \frac{I_{c1}}{h_{FE1}}$$

Then

$$R_{f(\text{max})} = \frac{60}{I_{b1}}$$

where, if I_{b1} is in mA, $R_{f(\text{max})}$ will be in ohms; the voltage is 60mV.

PRACTICAL EXAMPLE

The above procedures may seem complicated so let us now apply them to a practical example. An output of

2V r.m.s. is required into a load of 2 kilohms. The peak load voltage is $2\sqrt{2}$ volts, i.e. peak load current is about 1.4mA. To give a safe margin on both voltage and current, a supply voltage of say 9V should be used with a standing current in the last transistor of 5mA.

Thus

$$R_{c2} = \frac{9 - 0.6}{2 \times 5} = 0.84 \text{ kilohms}$$

Choose the nearest preferred value of 820 ohms.

Similarly

$$R_c = \frac{600}{5} = 120 \text{ ohms,}$$

which is itself a preferred value. Note that in practice the voltage at the emitter of TR2 will be somewhat higher than at the base of TR1 and in choosing the nearest preferred value for R_e it would be preferable to err on the high side.

Now take current gains for the two transistors as being typically 40 each.

$$I_{b2} = \frac{I_{c2}}{40} = 0.125 \text{ mA.}$$

We can now make the current in the collector load of TR1 say four times this, i.e. 0.5mA, leaving a collector current in TR1 of $0.5 - 0.125 = 0.375 \text{ mA.}$

$$R_{c1} = \frac{9 - 1.2}{0.5} = 15.6 \text{ kilohms,}$$

i.e. a preferred value of 15 kilohms may be used.

The base current

$$I_{b1} = \frac{I_{c1}(\text{mA})}{40} = 9.4 \mu\text{A}$$

If the voltage drop across R_f is not to exceed, say, 10 per cent of the V_{be} for TR1, i.e. 60mV.

$$R_f = \frac{60}{9.4} = 6.4 \text{ kilohms.}$$

A preferred value of 6.8 kilohms would not be unreasonable, and the values are now shown in Fig. 5. The capacitors are not shown but would be required as usual at input and output, and one to bypass R_e .

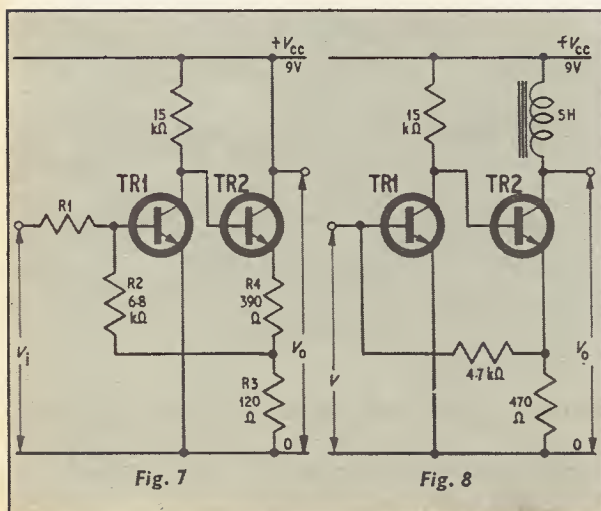

Fig. 7

Fig. 8

Typical values for input and output might be $25\mu\text{F}$; for bypass a similar capacitance is used although at a lower voltage working. These would give a lower cut-off frequency somewhere around 100Hz depending on source and load resistances.

AMPLIFIER BUILDING BRICK

This block is a most useful general purpose amplifier and can be made the basic building brick of most audio and many r.f. circuits. For example, if TR2 emitter is left unbypassed and its collector taken straight to the positive supply (Fig. 6) we have a very simple example of an operational amplifier, the basic circuit for analogue computers.

The voltage and current at the base of TR1 are both negligible compared with those at the output and for a.c. purposes the base may be considered as a "virtual earth". From this, $V_{out}/V_{in} \approx -Z_2/Z_1$ since Z_2 and Z_1 carry the same current and have a common point which is effectively at earth potential. Making Z_1 and Z_2 both resistors, we have an amplifier whose gain is almost independent of the transistor characteristics, provided that one aims at a gain very much less than the maximum of which the circuit is capable.

Fig. 7 shows a practical form of the circuit in which the feedback is taken from a tapping on the emitter resistor. This raises the emitter potential allowing a larger voltage swing at the output, but the gain calculation becomes a little more complicated. Consider Fig. 8, if the gain of the amplifier is high then V will be negligibly small compared to the output voltage and we may conveniently take it as zero. If, as before, we similarly ignore the base current then we have the following relationships:

$$I_f \approx I_{in}$$

$$\therefore \frac{V_f}{R_2} = -\frac{V_{in}}{R_1}$$

and

$$\frac{V_f}{V_{in}} = -\frac{R_2}{R_1} \quad \dots (1)$$

But

$$\frac{V_o}{V_f} \approx -\frac{(R_4 + R_3)}{R_3} \quad \dots (2)$$

Multiplying equations (1) and (2),

$$\frac{V_o}{V_{in}} \approx -\frac{R_2}{R_1} \times \frac{(R_4 + R_3)}{R_3}$$

Thus the working gain of the amplifier with feedback is defined by the value of the resistors and hence can be extremely stable. Unfortunately the initial gain of a two-transistor amplifier is not very high (perhaps a couple of hundred at most and often less). The actual gain will be appreciably less than that predicted by the equation unless, for example, the ratio R_2/R_1 is made so small that the overall gain is only 5 or 10. Even so the amplifier gain holds fairly steady in the region of 20 for a wide range of transistors.

If these are planar units, the response is to within 3dB up to at least 500kHz and in some cases to beyond 1MHz. It is not surprising that this particular circuit is commonly used in integrated form as a wide-band r.f. amplifier with bandwidths up to 10MHz and above. Note that R_1 plays no part in the biasing of the circuit but determines the input impedance of the circuit.

A given output voltage depends only on a specified input current, and this can be provided either by a small input voltage if R_1 is low, or a larger voltage if R_1 is high (Fig. 7). In the first case the input impedance is low and is more affected by the characteristics of the transistors, while the higher input impedance of the latter also means that the overall voltage gain is reduced.

RECORD AMPLIFIER

If the load is re-inserted in the collector of TR2 as in Fig. 5, but with no bypass capacitor across the emitter circuit, we have an output that is back in phase with the input. The output resistance at the collector is high because the current in the collector is almost equal to that in the emitter and the latter is closely controlled by the negative feedback. The overall output impedance at the collector is then roughly equal to the collector load.

If the collector can receive its current through some component with a very high impedance, then the circuit can deliver a current to an external load regardless of its impedance. For example, using a choke of high inductance as in Fig. 8 the circuit can serve as the final stage in the record amplifier of a tape recorder. The requirement is for a linear response of output current into the tape-head to provide a flat response (in practice some high frequency boost is required to help overcome head losses).

The head being inductive has a rising impedance with frequency, and the technique with valve amplifiers was often to swamp this by using a large series resistance, thus requiring a large voltage swing. With transistors, the same high source impedance must be duplicated by feedback as in this circuit. For a record current of up to $200\mu\text{A}$, a standing current of 1mA in the output transistor is adequate.

The circuit is not complete in that it would require a bias filter to prevent the amplifier being overloaded by the h.f. bias being fed to the head by the oscillator. Secondly, the boost in high frequency performance can be conveniently added in the output stage. Neither of these have been checked with these particular component values, though interested readers will find the ideas discussed in more detail in articles on tape recorder design that appear from time to time elsewhere.

In Fig. 9 some suggested values are given for the high frequency boost circuit to give a rising characteristic at about 3kHz , with a limit in this rise to a few decibels by the series resistor. The response will be limited by the falling impedance of the collector choke above its own self-resonant frequency.

PLAYBACK AMPLIFIER

Following up the characteristics of tape heads leads to a further application of the circuit in the playback amplifier. The e.m.f. generated in a tape head increases with the frequency of the recorded signal. In valve amplifiers the resulting voltage was fed to the grid of the first valve, with equalisation applied by negative feedback in the following stages. Since the impedance of the tape head rises with frequency at the same rate as does the e.m.f. generated, then the current flowing in a short circuit placed across the head will be independent of the frequency of the recorded signal.

Such an approach would be difficult with valves with their high input impedance, but the transistor is a "natural" in this circuit. Aided by a little judicious negative shunt feedback as in this form of circuit, the input impedance can be made sufficiently low to appear as a short circuit compared with the relatively high impedance of a large inductance tape head (about 0.5H). Thus the circuit of Fig. 9 provides an output voltage which would be constant with frequency were it not for the fall-off in head and tape characteristics above one or two kilohertz.

Again the solution is to boost the gain at these frequencies by shunting the emitter of TR2 with a capacitor. More care has to be taken in the playback system in that tape noise will also be boosted, and, for that reason, in more sophisticated systems the high frequency compensation is achieved by carefully calculated tuned circuits in the record amplifier. (The writer has found that circuits similar to Fig. 9, but using general purpose germanium transistors, gave adequate performance with tape-heads originally intended for valve amplifiers.)

It should be noted that low-impedance tape-heads would not provide a suitable current drive for this circuit unless its input impedance were lowered still more by heavier feedback. These heads have been specially designed for use with transistor amplifiers in a manner similar to the standard valve circuits.

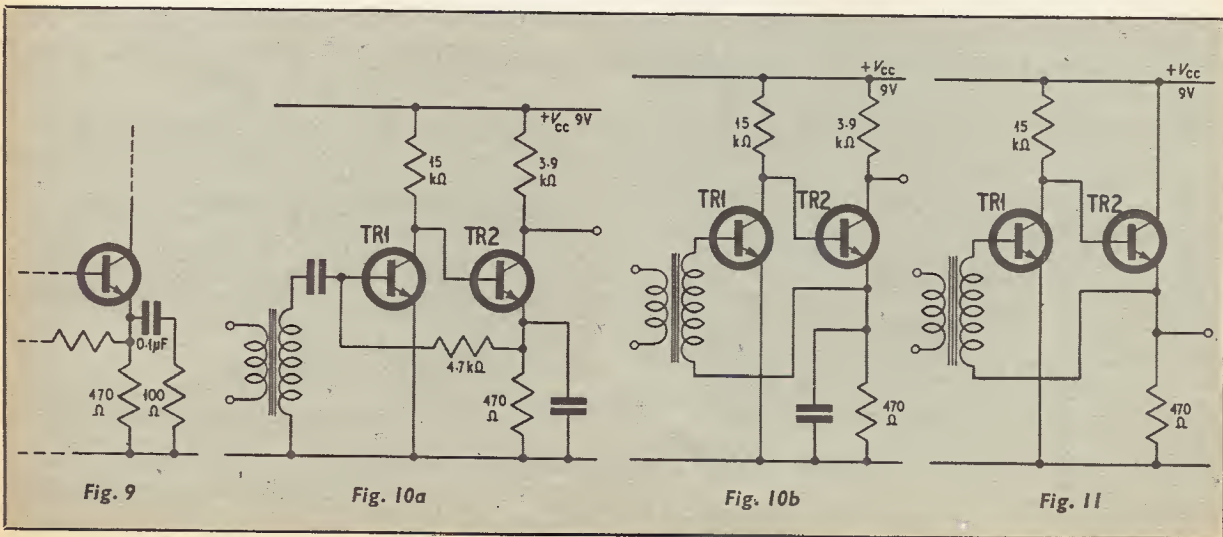

HIGH IMPEDANCE INPUT

We have now seen how to achieve and apply both low and high output impedances (emitter and collector outputs of TR2) and low input impedance. It remains to be seen whether the circuit can provide a high impedance input if desired, and if so, how to make use of this characteristic. As a first step, return to Fig. 4 and reconsider the function of R_f .

It serves to provide bias current for the base of TR1 and for best stability bias conditions should be as low as possible. The lower limit is set by the resulting loading of the source which is effectively in parallel.

Now take the particular case of a transformer coupled input as from, say, a low impedance microphone and step-up transformer. This could be connected as in Fig. 10a but would require a coupling capacitor to preserve the d.c. bias conditions, while R_f would provide an additional shunt path for signal current. If now R_f is replaced by the secondary of the transformer, the bias is fed via an almost zero resistance path, while the shunting effect of R_f is removed.

The secondary is still effectively earthed via the bypass capacitor on the emitter of TR2 and the result is a circuit from which one resistor and one electrolytic capacitor has been removed, the bias stability has been improved and the possibility is of a slight increase in gain. The input impedance, however, is still that of a grounded emitter stage, so our earlier question of high input impedance has not yet been answered.

VIRTUAL EARTH

Now remove the bypass capacitor from the emitter of TR2. The circuit characteristics are radically changed, most particularly in regard to the input impedance. Realising that the voltage gain between the base of TR1 and the emitter of TR2 can be large, we see that as in the operational amplifier (of which this is really a special case) the majority of the voltage across the secondary of the transformer appears between the emitter of TR2 and ground, i.e. TR1 base is again a "virtual earth".

For example, a secondary voltage of 1 volt might produce 0.99 volt at the emitter with only 0.01 volt at the base of TR1. This latter voltage will cause only a small current flow in the base, i.e. only a small current is drawn from the transformer. With the component values as shown in Fig. 10b this input current might be as little as one or two microamps, and this, for an input voltage of one volt, gives an input impedance of several hundred kilohms. Having removed the capacitance shunt on TR2 emitter, both collector and emitter become available as output points, see Fig. 11.

The emitter has the advantage of low impedance and is tolerant of heavier loads including capacitance of cables, but the voltage gain is slightly less than unity. It is worth noting that in these respects the circuit is comparable to a Darlington pair.

FLOATING INPUT

A disadvantage is that both sides of the input are floating and so the circuit is limited to cases where neither end of the source need be grounded. It is quite feasible to use it in conjunction with a crystal microphone, for example with a 1:1 transformer, though it is certainly not the best circuit for that application.

It is hoped that these examples illustrate the flexibility of the d.c. feedback pair and will persuade more readers to experiment with it. With the ever-falling cost of transistors such circuits are bound to replace single transistors as basic building blocks. ★

NEXT MONTH

BUILD THIS LIGHTWEIGHT METAL LOCATOR

You can use this super-sensitive electromagnetic locator to trace any type of metal object in earth, sand, masonry, etc.—anything of the size and weight of a penny, for instance, under three inches of soil; larger objects at greater depths. Full how-to-make details and instructions for use in next month's issue. An easy-to-build, easy-to-operate unit.

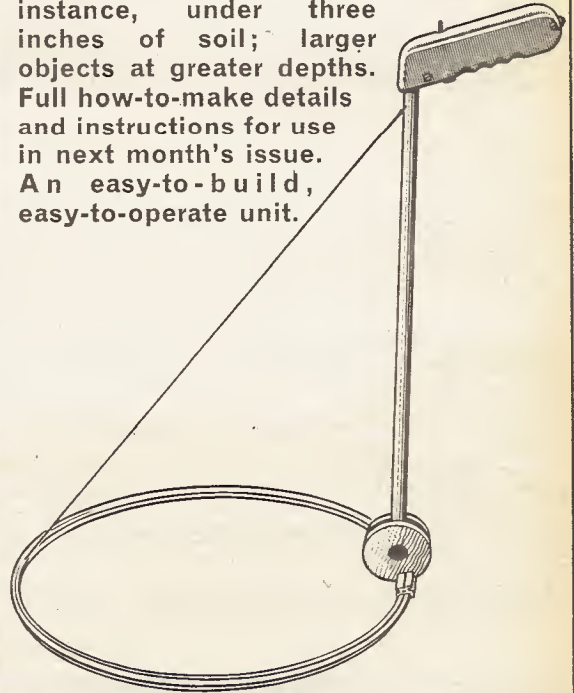

ALSO

HIGH PERFORMANCE STABILISED POWER SUPPLY

A versatile d.c. power supply, using silicon transistors, to add to your test gear. Continuously variable output of 0 to 22V at load currents up to 1A with stability better than 2 per cent.

PRACTICAL

ELECTRONICS

JANUARY ISSUE ON SALE FRIDAY DEC. 13

ORDER YOUR COPY NOW!

R.S.G.B. EXHIBITION

THE 21st International Radio Engineering and Communications Exhibition, the yearly meeting place of hams from many countries, was formally opened by Mr W. J. Sharp C.B.E., the Director of Communications, Diplomatic Wireless Service, on October 2. More than 30 officials attended the opening luncheon and mobile visitors were "talked-in" by a live transmitting station which continued operation throughout the exhibition. The 38 stands, set up in the New Horticultural Hall, London, showed a variety of equipment and displays from many manufacturers, clubs and distributors.

This year's innovation was presented by the Diplomatic Wireless Service who exhibited some modern sensitive equipment used in the "Piccolo" overseas radio telegraph and broadcasting system. The G.P.O. stand, which displayed methods of dealing with television interference and measuring the power output of S.S.B. transmitters, was well attended both by hams and visitors who were also enquiring about transmitting licences. Also of interest to hams was the new "Solid State 2 Metre A.M. Transceiver" which was shown by Daystrom Limited.

P.E. WAS THERE!

The combined stand of PRACTICAL ELECTRONICS, PRACTICAL TELEVISION and PRACTICAL WIRELESS attracted great attention from those particularly interested in working practical projects—the PEAC (Analogue Computer) was demonstrated and the new "Bionics" series was represented by a working display of the two electronic "animals" described in last month's issue. A "Wideband Triple Conversion Communications Receiver", which is to be a future project, commanded considerable interest from radio hams, who readily understood the impressive specification provided. Other items on the P.E. stand included the series of "IC Projects" and the "Hi Fi Transistor Microphone".

Other stands displayed a wide range of transceiver, receiver, audio, test, experimental and ancillary equipment from British, American and Japanese manufacturers. A large range of components were displayed on a number of stands and many visitors took advantage of the "special offers".

Specialised groups and clubs concerned with amateur communications who held displays were—the Radio

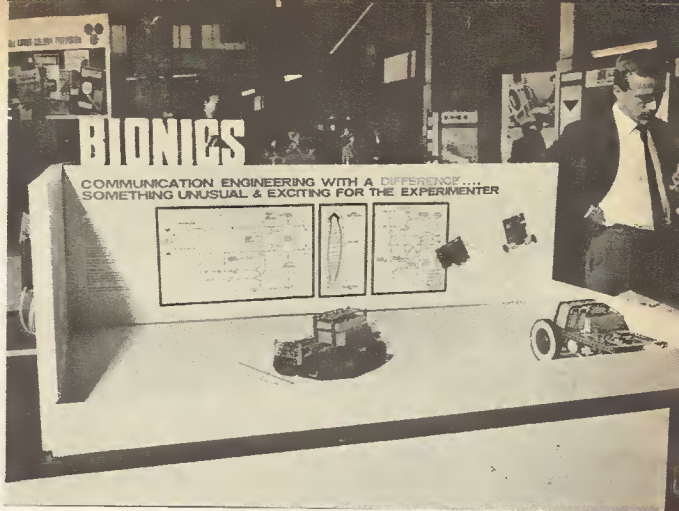

Amateur Invalid and Bedfast Club, The Radio Amateur Emergency Network, the British Amateur Television Club and the British Amateur Radio Teleprinter Club. Over 8,000 enthusiasts visited the exhibition.

POINTS ARISING

RADIO CONTROL FOR MODEL BOATS—3

(August 1968)

The author has had experience of three transmitters, which have all operated similarly, and has discovered that depending on where the coil of L3/L4 (Fig. 13) is with respect to the former, an ambiguity in setting-up procedure can exist if the technique used in the published articles is used. This was not apparent on the first transmitter. This ambiguity can result in reduced transmitter output.

If the following procedure is adopted instead of that outlined under Transmitter Alignment in the August issue, more positive control will result.

Open link 2 and set VR2 to a maximum. This is to ensure that TR4 does not overheat during setting up with link 2 open. Insert current meter (0–50mA) in emitter of TR3 (between emitter connection and L1) and if a further meter (0–20mA) is available insert in place of link 1. The antenna should be connected.

Screw L3/L4 slug out to one end of the former, and observe that both TR3 and TR5 current is very small (<1mA). Commence screwing in the slug, and TR3 current will rapidly increase to a maximum (10–20mA), TR5 current will also increase. Further insertion of the slug (which should be at least $\frac{1}{2}$ in long) will cause a reduction in TR3 current but little change in TR5 current. Adjust the slug so that TR3 current is maintained at a maximum and stable state when S2 is repeatedly opened and closed.

Adjust C8 for a minimum "dip" in TR3 current. TR5 current should be 5–10mA.

Reconnect link 2 and set VR2 midway (100 ohm). Rotate VR1 so that TR3 current is a maximum. This will be less than when link 2 was open. The optimum maximum setting of L3/L4 should not have changed.

Remove meters and reconnect circuit. The transmitter is now aligned.



LOOK!

PRACTICAL!

VISUAL!

EXCITING!



a new 4-way method of mastering
ELECTRONICS
by doing — and — seeing . . .

1 ▶ **OWN and HANDLE a**

complete range of present-day **ELECTRONIC PARTS and COMPONENTS**

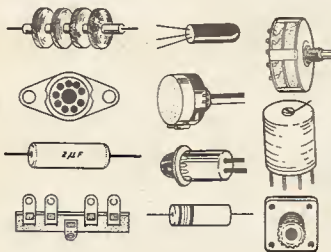

2 ▶ **BUILD and USE**

a modern and professional **CATHODE RAY OSCILLOSCOPE**

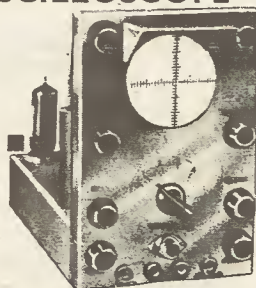

3 ▶ **READ and DRAW and**

UNDERSTAND CIRCUIT DIAGRAMS

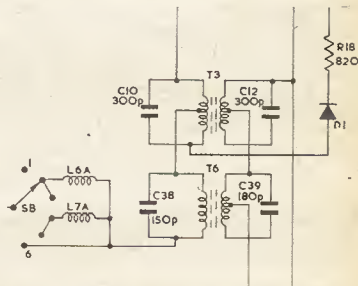

4 ▶ **CARRY OUT OVER 40 EXPERIMENTS ON BASIC ELECTRONIC CIRCUITS AND SEE HOW THEY WORK . . . INCLUDING . . .**

- VALVE EXPERIMENTS
- PHOTO ELECTRIC CIRCUIT
- A.C. EXPERIMENTS
- TRANSISTOR EXPERIMENTS
- COMPUTER CIRCUIT
- D.C. EXPERIMENTS
- AMPLIFIERS
- BASIC RADIO RECEIVER
- SIMPLE COUNTER
- OSCILLATORS
- ELECTRONIC SWITCH
- TIME DELAY CIRCUIT
- SIGNAL TRACER
- SIMPLE TRANSMITTER
- SERVICING PROCEDURES

This new style course will enable anyone to really understand electronics by a modern, practical and visual method—no maths, and a minimum of theory—no previous knowledge required. It will also enable anyone to understand how to test, service and maintain all types of Electronic equipment, Radio and TV receivers, etc.

FREE POST NOW
for
BROCHURE

or write if you prefer not to cut page

To: **BRITISH NATIONAL RADIO SCHOOL, READING, BERKS.** Please send your free Brochure, without obligation, to: we do not employ representatives

NAME..... BLOCK CAPS

ADDRESS..... PLEASE PE II



MORE TO CHOOSE FROM LESS TO PAY



This advanced design commutable Hi Fi mono/ stereo FM tuner comes in easy-to-assemble pre-fabricated units engineered to the highest standards of efficiency and performance. Valuable refinements include switchable A.F.C., automatic noise suppression, flywheel tuning, stereo indication light, excellent audio response. Sensitivity better than 5 microvolts. Stereo can be added later if so required. Inclusion of a world-famous Gortler I.P. amplifier ensures superb performance. Excellent chassis design made specially to fit the standard TRS Simplex cabinet system. Styled to match the TRS Stereo 4-4.

S.A.E. brings full details.

Total price (for mains operation) **£29.10.0** (Carriage 10/-).

A NEW DE-LUXE FM MONO/STEREO TUNER FROM TRS

- A.F.C. & A.G.C.
- Noise Limiter
- Chassis Ready Built
- pre-tuned

Kit to make MONO tuner inc. chassis and tuning assembly (p.p. 3/6) **15 gns.**
 Add-on Stereo Unit (p.p. 2/6) **10 gns.**
 Power Unit (p.p. 2/6) **£2.50**
 Simplex Cabinet (p.p. 2/6) **£1.17.6**



TRS STEREO 4-4 INTEGRATED AMPLIFIER

assembly. Stereo/Mono and Radio/PU switches. Amplifier Kit **£7.19.6** Complete kit inc. cabinet/ power pack/ DIN plugs and sockets (p.p. 2/6) **£12.10.0**
 T.R.S. Power Unit **£2.5.0** (p.p. 2/6)
 T.R.S. Simplex Cabinet, sockets (p.p. 2/6) **£12.10.0**
 4 prs. DIN plugs and sockets if purchased separately, 15/-.

A T.R.S. design based on newly developed Mullard 4 watt modules with BC108 pre-amp. Suitable for speakers from 3 to 15 ohms. Bass and treble cut/boost. Response—60 to 14kHz ±3dB. This excellently engineered layout requires only wiring between controls and modules. Complete with metal chassis and T.R.S. simplex teak-ended cabinet for instant

PLAYING UNITS BY GARRARD AND E.M.I.

LM3000 Record Player with 9T.A. Stereo Cartridge. **£10.5.0.**
 AT.60 Mk. II De-Luxe Auto-changer, die-cast turntable. Less cartridge. **£13.5.0.**
 SP.25 De-Luxe single record player, die-cast turntable. Less cartridge. **£11.19.6.**
 Brand new in makers cartons. Packing and carriage on any one of above 7/6.
GARRARD PLINTH W.B.I. In fine Teak for above units. (Packing and carriage

5/-) **65/-**.
 Clear-view rigid perspex cover (carriage 4/6), **62/6.**
CARTRIDGES FOR ABOVE—STEREO Sonotone 9T.A./HC Ceramic with diamond 49/8; Decca Deram with diamond 92/8; MONO Acoos GP91-1 21/-; Goldring MX2M 28/6.
E.M.I. 4-sp. single player, 10 1/2 in. T/table, separate arm and T/0 cart. **69/6** (p.p. 5/-).

MAKE A BOOKSHELF SPEAKER

With a set of matched speakers and cross-over from TRS. Comprises modern style high efficiency 5in. bass unit with special cone assembly, X-over and 2 1/2 in. tweeter for mounting into your own cabinet or baffle system. Smooth response from 80 to 20,000Hz. Loading up to 6 watts. Made by a world-famous manufacturer. A genuine bargain for only **79/6** (carr. 5/-).

RESISTORS—Modern ratings, full range 10 ohms to 10 megohms. 10% 1/4W, 44 each; 20% 1W, 6d each; 3W, 9d each; 5% Hi-stab, 1W, 5d each; 1W, 6d each; 1.2-10 meg. 10% 1/4W, 4d each; 1W, 5d each. 1% Hi-stab, 1W, 1/8 each (below 100Ω, 2/- each).
WIREWOUND RESISTORS—25Ω to 10kΩ 5W, 1/8 each; 10W, 1/9 each; 15W, 2/3 each.
CONDENSERS—Silver Mica. All values 2pF to 1,000pF, 6d. each. Ditto ceramics. 9d. Tub, 450V T.C.C. etc. 0.001-0.01 mF 10d. each; 0.1-350V 10d. each; 0.02-0.1mF 500V 1/- each. T.C.C. 350V 0.25, 1/3 each; 0.2, 2/- each.
CLOSE TOL. 5% MICAS—10% 5-500pF 9d; 600-5,000pF, 1/-; 1% 2-100pF 11d; 100-250pF, 1/2; 270-800pF, 1/4; 800-5,000pF, 2/-.
VEROBOARD—All standard sizes including 2 1/2 in. x 5 in. 3/8; 2 1/2 x 3 1/2; 3 1/2 x 5 in. 5/8; 3 1/2 x 3 1/2; 3/8; 2 1/2 in. x 1 1/2 in. 12/6. All accessories and tools in stock.
PEAK SOUND "CIR-KIT". Adhesive

copper circuit strip—60in. spool x 1/16in. 2/-, No. 3 Kit, special price 10/- (p.p. 1/-).
VOLUME CONTROLS—1 1/2 in. dia. Long spindles. Famous make. All values 5,000 ohms-2 Megohms. Guaranteed 12 months. Log or Linear tracks. Less Sw. 3/6; DP Sw. 5/-. Ditto Centre tapped 1 Megohm Log, 1 Megohm less Sw. 5/-. Twin ganged stereo controls 1 1/2 dia. long spindles. All values 5,000 ohms to 2 Megohms less Sw., ea. 8/6. ea. 10/6 to 2 Megohms with DP Sw., ea. 10/6.
STEREO BALANCE CONTROLS—Log/Anti-Log 5K, 1 Meg., 1 Meg., 2 Meg., ea. 9/6.

ORDERING—Send cash with order. Post and packing where not stated add 1/- per lb.; 1/9 1 lb.; 3/6, 2lb.; 5/-, 6lb.; 8/6, 10lb.; 8/-, 14lb.; over, 10/- S.A.E. with enquiries please.
LISTS—Eight large printed pages, packed with bargain offers including difficult to find lines. Send 6d. for latest copy.

TRS RADIO

COMPONENT SPECIALISTS EST. 1946

70 BRIGSTOCK ROAD, THORNTON HEATH, SURREY

Telephone: 9 a.m.—6 p.m. daily 01-648 2188 1 p.m. Weds.

A few doors from Thornton Heath Stn. (S.R. Victoria Section)

PRINTED CIRCUIT KIT

BUILD 40 INTERESTING PROJECTS ON a PRINTED CIRCUIT CHASSIS WITH PARTS and TRANSISTORS from your SPARES BOX

CONTENTS: (1) 2 Copper Laminate Boards 4 1/2" x 2 1/2". (2) 1 Board for Matchbox Radio. (3) 1 Board for Wristwatch Radio, etc. (4) Resist. (5) Resist Solvent. (6) Etchant. (7) Cleanser/Degreaser. (8) 16-page Booklet *Printed Circuits for Amateurs*. (9) 2 Miniature Radio Dials SW/MW/LW. Also free with each kit. (10) Essential Design Data, Circuits, Chassis Plans, etc. for 40 TRANSISTORISED PROJECTS. A very comprehensive selection of circuits to suit everyone's requirements and constructional ability. Many recently developed very efficient designs published for the first time, including 10 new circuits.

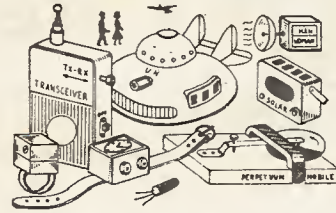

EXPERIMENTER'S PRINTED CIRCUIT KIT 8/6

Postage & Pack. 1/6 (UK)
 Commonwealth: SURFACE MAIL 2/- AIR MAIL 8/-
 Australia, New Zealand, South Africa, Canada.

(1) Crystal Set with biased Detector. (2) Crystal Set with voltage-quadrupler detector. (3) Crystal Set with Dynamic Loudspeaker. (4) Crystal Tuner with Audio Amplifier. (5) Carrier Power Conversion Receiver. (6) Split-Load Neutralised Double Reflex. (7) Matchbox Photocell Radio. (8) "TRI-RELEXON" Triple Reflex with self-adjusting regeneration (Patent Pending). (9) Solar Battery Loudspeaker Radio. The smallest 3 designs yet offered to the Home Constructor anywhere in the World. 3 Subminiature Radio Receivers based on the "Triflexon" circuit. Let us know if you know of a smaller design published anywhere. (10) Postage Stamp Radio. Size only 1.62" x 0.96" x 0.25". (11) Wristwatch Radio 1.15" x 0.80" x 0.55". (12) Ring Radio 0.70" x 0.70" x 0.65". (13) Bacteria-powered Radio. Runs on sugar or bread. (14) Radio Control Toner Receiver. (15) Transistor P.P. Amplifier. (16) Intercom. (17) 1-valve Amplifier. (18) Reliable Burglar Alarm. (19) Light-seeking Animal, Guided Missile. (20) Perpetual Motion Machine. (21) Metal Detector. (22) Transistor Tester. (23) Human Body Radiation Detector. (24) Man/Woman Discriminator. (25) Signal Injector. (26) Pocket Transceiver (Licence required). (27) Constant Volume Intercom. (28) Remote Control of Models by Induction. (29) Inductive-Loop Transmitter. (30) Pocket Triple Reflex Radio. (31) Wristwatch Transmitter/Wire-less Microphone. (32) Wire-less Door Bell. (33) Ultrasonic Switch/Alarm. (34) Stereo Pre-amplifier. (35) Quality Stereo Push-Pull Amplifier. (36) Light-Beam Telephone "Photophone". (37) Light-Beam Transmitter. (38) Silent TV Sound Adaptor. (39) Ultrasonic Transmitter. (40) Thyristor Drill Speed Controller.

PHOTOELECTRIC KIT

CONTENTS: 2 P.C. Chassis Boards, Chemicals, Etching Manual, Infra-Red Photo-transistor, Latching Relay, 2 Transistors, Condensers, Resistors, Gain Control, Terminal Block, Elegant Case, Screws, etc. In fact everything you need to build a Steady-Light Photo-Switch/Counter/Burglar Alarm, etc. (Project No. 1) which can be modified for modulated-light operation.

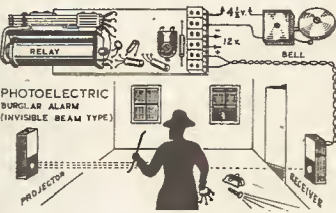

PHOTOELECTRIC KIT 39/6

Postage and Pack. 2/6 (UK)
 Commonwealth: SURFACE MAIL 3/6 AIR MAIL £1.00
 Australia, New Zealand S. Africa, Canada and U.S.A.
 Also Essential Data Circuits and Plans for Building

12 PHOTOELECTRIC PROJECTS. (1) Steady-Light Photo-Switch/Alarm. (2) Modulated-Light Alarm. (3) Long-Range Stray-Light Alarm. (4) Relay-less Alarm. (5) Warbling-Tone Alarm. (6) Closed-Loop Alarm. (7) Project Lamp Stabiliser. (8) Electronic Project Modulator. (9) Mains Power Supply. (10) Car Parking Lamp Switch. (11) Automatic Headlamp Dipper. (12) Super-Sensitive Alarm.

INVISIBLE BEAM OPTICAL KIT

Everything needed (except plywood) for building: 1 Invisible-Beam Projector and 1 Photocell Receiver (as illustrated). Suitable for all Photoelectric Burglar Alarms, Counters, Door Openers, etc.

CONTENTS: 2 lenses, 2 45-degree wooden blocks, Infra-red filter, projector lamp holder, building plans, performance data, etc. Price 19/6. Postage and Pack. 1/6 (U.K.). Commonwealth: Surface Mail 2/-; Air Mail 8/-.

JUNIOR PHOTOELECTRIC KIT

Versatile Invisible-beam, Relay-less, Steady-light Photo-Switch, Burglar Alarm, Door Opener, Counter, etc., for the Experimenter.

CONTENTS: Infra-Red Sensitive Photo-transistor, 3 Transistors, Chassis, Plastic Case, Resistors, Screws, etc. Full Size Plans, Instructions, Data Sheet "10 Advanced Photoelectric Designs". Price 19/6. Postage and Pack. 1/6 (U.K.). Commonwealth 2/-; Air Mail 4/-.

JUNIOR OPTICAL KIT

CONTENTS: 2 Lenses, Infra-red Filter, Lampholder, Bracket, Plans, etc. Everything (except plywood) to build 1 miniature invisible beam projector and photocell receiver. Price 10/6. Postage and Pack. 1/6 (U.K.). Commonwealth: Surface Mail 2/-; Air Mail 4/-.

PHOTOELECTRIC PARKING LAMP SWITCH

Automatically turns parking lamp on at dusk, off at dawn. Protects your car. Saves the battery. Miniature construction. Simply insert in parking lamp lead. Price: 27/6. Post and Packing 2/6 (U.K.).

THYRISTOR LIGHT DIMMER

Add a touch of luxury to your home. Adjust the light at parties, while watching TV, etc. Ideal for Children's bedroom. (100 watts max.) Price: 59/6. Post and Packing 2/6 (U.K.).

YORK ELECTRICS

333 YORK ROAD, LONDON, S.W.11

Send a S.A.E. for full details, a brief description and Photographs of all Kits and all 52 Radio, Electronic and Photoelectric Projects Assembled.

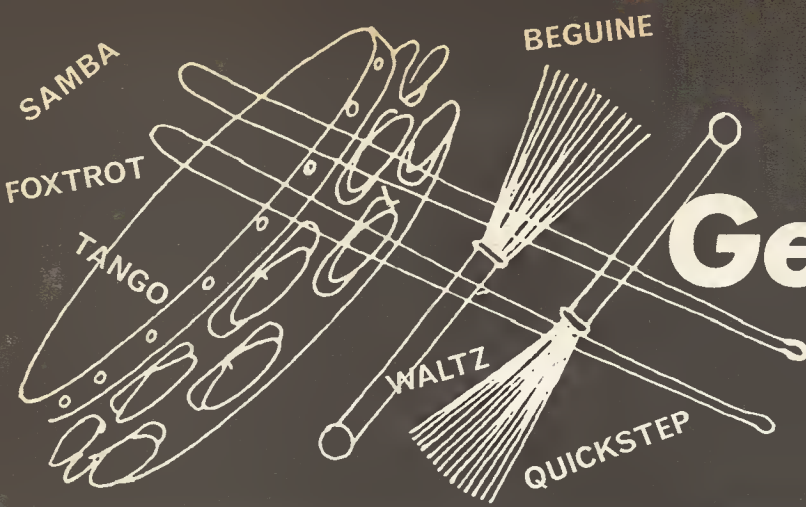

Rhythm Generator

By P. R. Allcock

Dip.Tech. (Eng.), C.Eng., M.I.E.E.

PULSE forming circuits and rhythm switch assembly were completed last month. In this second and final article operation of the sound generating circuits and their construction will be presented together with final wiring details.

SOUND GENERATION CIRCUITS

Fig. 10 shows the block diagram of the circuits involved in the sound generating half of the unit. Pulses from the two sets of differentiators are routed to the wipers of the rhythm selector switch S3. In selecting a dance tempo switch position pulses are steered to the associated sound forming circuits producing a rhythmic percussion pattern of high and low bongoes, bass drum and brushes as desired. As described in the last article these patterns are contained in the framework of the 6 or 8 pulse cycle produced from the twisted ring counter. The panel controls VR1 and S2 permit both control of tempo and extension of the rhythm pattern up to a maximum of 12 or 16 beats to the bar.

The noise generator produces a random combination of frequencies embracing the audio gamut. This is fed to two transistor gates which are separately triggered by pulses of different duration to produce long and short brush sounds after amplification. Fig. 11 gives the complete circuit of the various stages. With reference to this a more detailed description of operation follows.

HIGH BONGO

This sound is produced by feeding a pulse or pulses into the circuit comprising D35, R68, C34 and L2 the latter winding being encapsulated in an LA7 ferrite pot core. 700 turns of 36 s.w.g. enamelled wire are wound on to the bobbin the ends being taken out and soldered to the tags. The bobbin is then placed in the core assembly and the clamps tightened down. (Two should be wound for both bongo circuits.)

The coil inductance should be between $\frac{1}{2}$ and 1 Henry, and depending on the choice of parallel capacitor a wide range of bongo type sounds are possible. The circuit can be used to produce bongo or "scull" sounds.

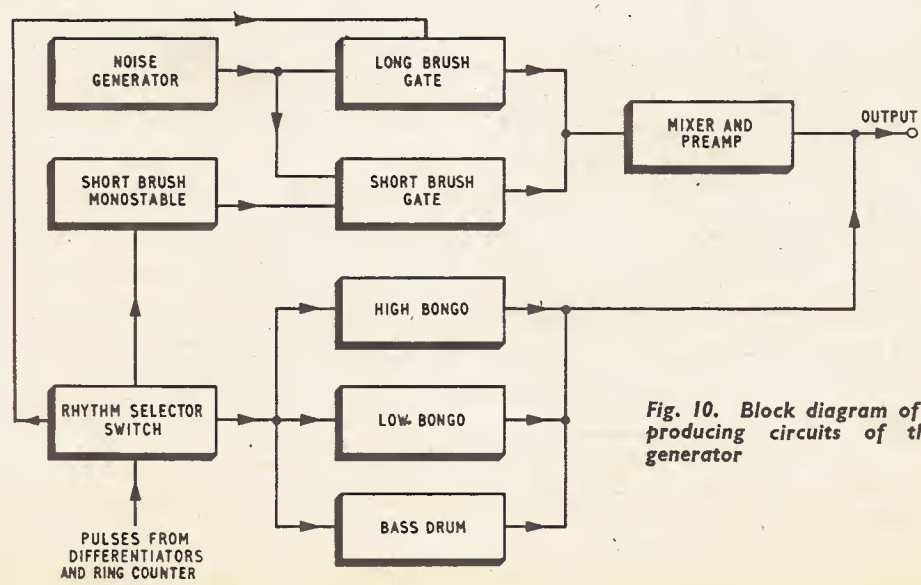

Fig. 10. Block diagram of the sound producing circuits of the rhythm generator

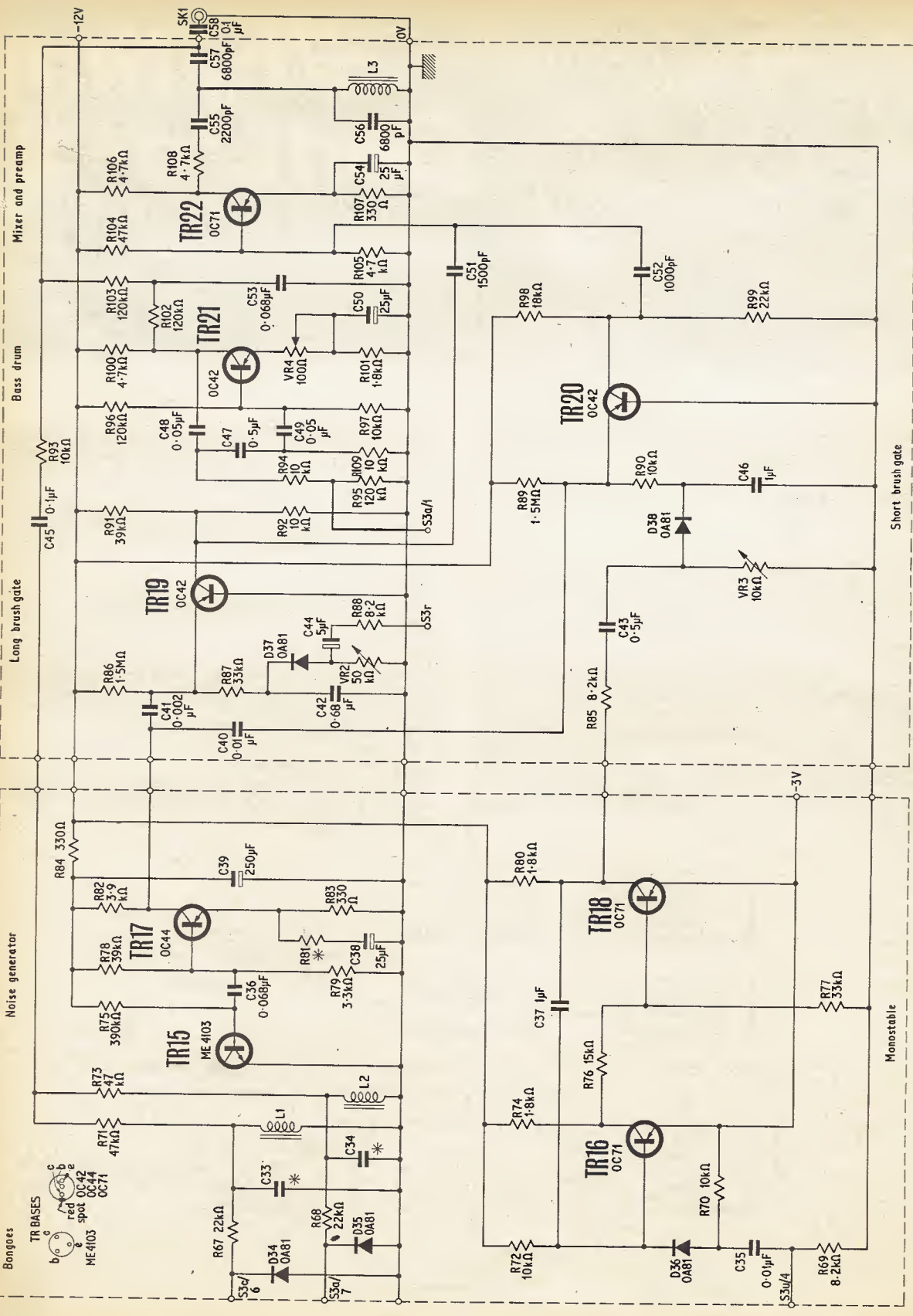

Fig. 11. Circuit diagram of noise generator and percussion elements



The capacitor is best selected by experiment to give the pitch of sound required. This in fact will be found to lie in the range of $0.1\mu\text{F}$ to $1\mu\text{F}$. In the prototype C34 was $0.1\mu\text{F}$ for high bongo.

LOW BONGO

Both bongo sounds are the result of pulse exciting a "ringing" circuit consisting of a parallel LC resonator. Since the coil inductances of both circuits are designed to be identical pitch variation will depend on the value of the capacitor used. In the prototype C34 was $0.25\mu\text{F}$ but this should be tailored by experiment.

NOISE GENERATING AMPLIFIER

The amplifier is conventional except for the input transistor TR15. The prototype uses the noise generated by a reverse-biased *pn* junction, but equal performance may be obtained with a noisy Zener diode.

The transistor used is a silicon planar type which has a maximum emitter-base reverse bias of 5V. When operating from a 12V supply the junction breaks down and acts like a Zener diode, the current being limited by resistor R75.

The amplifier transistor TR17 should preferably have a gain, or h_{fe} , in excess of 100, to give adequate noise output. Alternatively an extra stage of amplification could be added.

The output amplitude can be adjusted by inserting a feedback resistor R81 the value of which should be resolved by experiment. Lowering the value of this resistor increases the noise output.

MONOSTABLE PULSE GENERATOR

The monostable pulse generator has one stable and one semi-stable state. In its stable state TR16 is on and TR18 off. With the application of a positive trigger pulse, routed via S3, TR16 switches off and TR18 on; the circuit is now astable.

After a period determined by the C37, R72 time constant, the circuit reverts naturally to the stable state with TR16 on and TR18 off.

The monostable timing element determines the width of the positive output pulse appearing at the collector of TR18 and ensures that the short brush gate receives a constant duration input pulse irrespective of the tempo setting.

The triggering of the monostable is taken from either the clock pulse output, which gives a repetitive brush every beat, or one or more differentiator outputs via the rhythm switch S3.

SHORT BRUSH GATE

The short brush gate consists of a common base amplifier configuration. When a short brush sound is required on each beat the clock pulse generator provides positive pulses to D38 so gating TR20.

In the idle condition the gating circuit is held off by a small negative bias on the emitter. This bias should be just sufficient to prevent the noise signal from passing via the gate and this may be set by altering the value of R89. The panel mounted control VR3 enables muting of short brush sounds by setting to zero resistance.

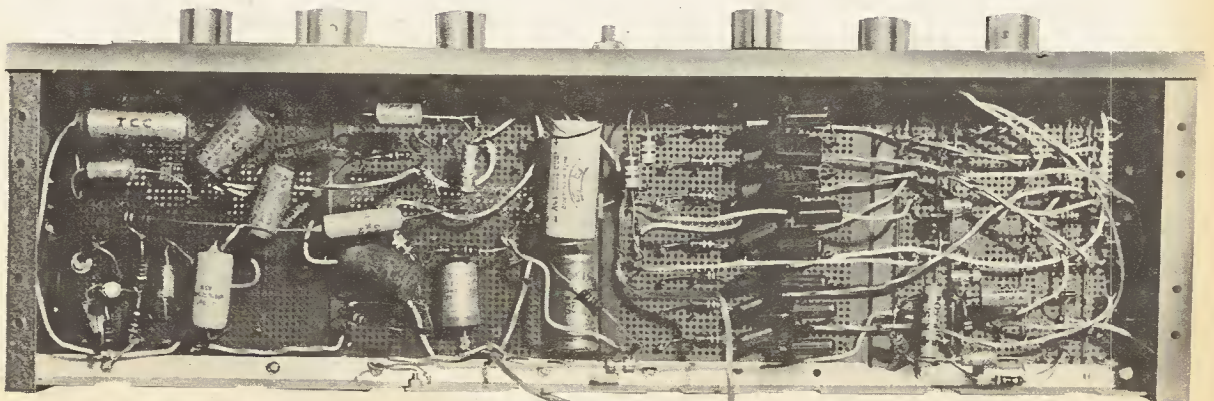

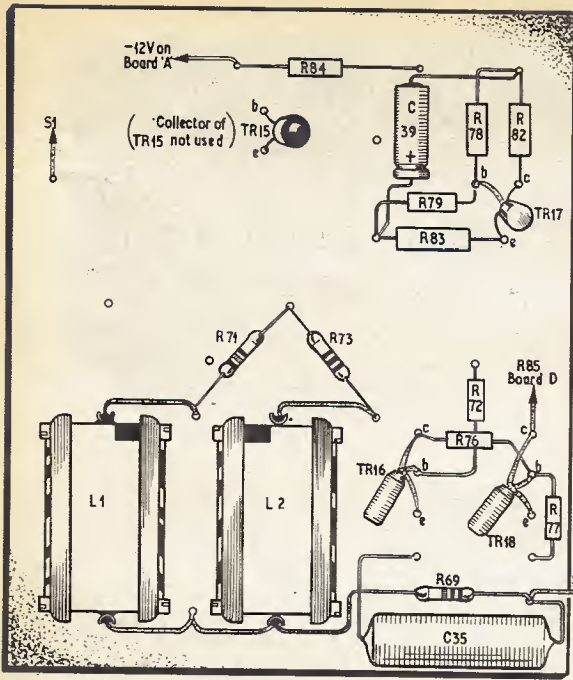

(a) topside view

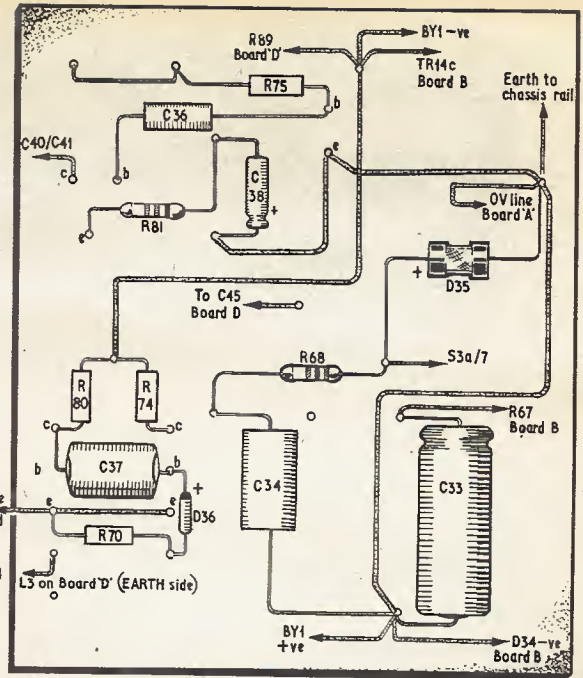

(b) underside view

Fig. 12. Component layout and wiring for noise and monostable generators and bongo circuits on board "C"

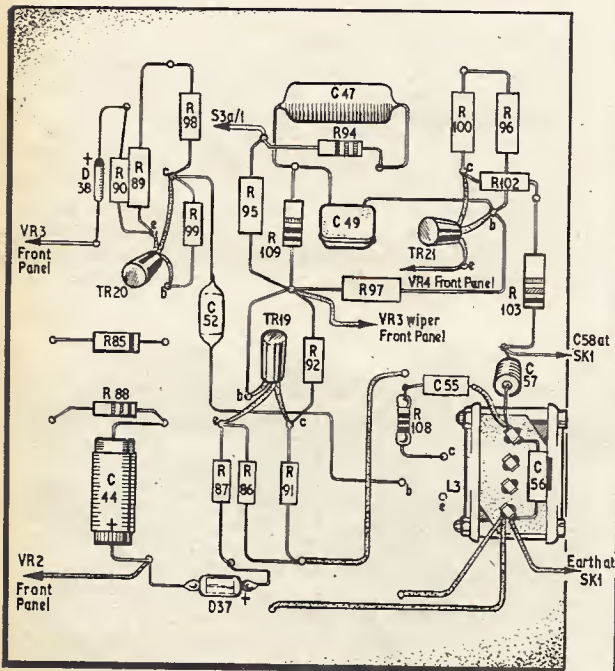

(a) topside view

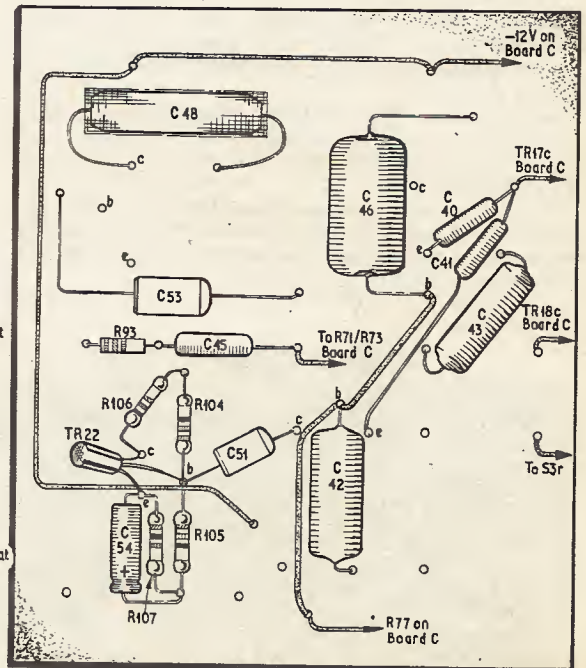

(b) underside view

Fig. 13. Component layout and wiring for brush gates, bass drum and pre-amplifier circuits on board "D"

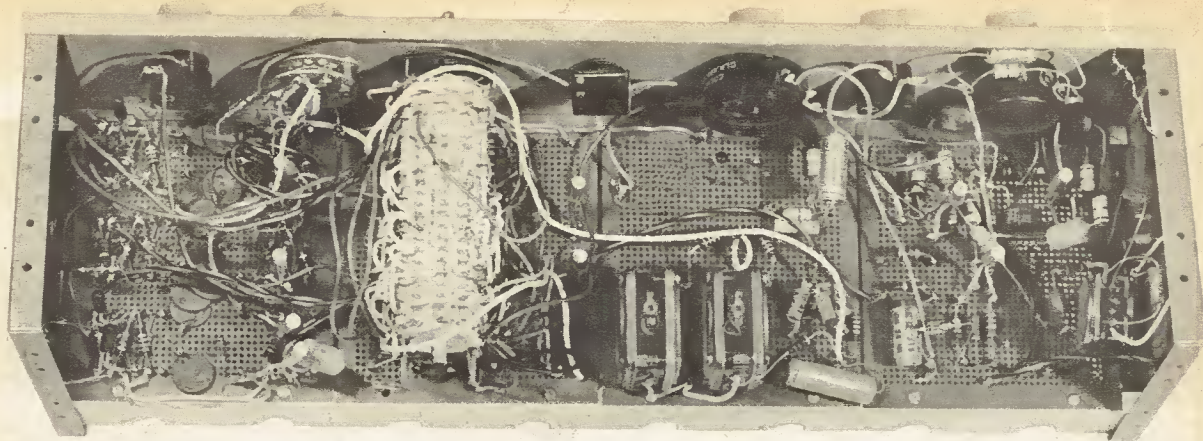

LONG BRUSH GATE

The long brush gate input is connected to the wiper of wafer S3r at the rhythm switch. This provides a selection of any one bistable output which may be applied to diode D37 for gating TR19.

As with the short brush gate, bias tailoring is by adjustment of the value of R86. It should be noted that the larger the noise input to the gates the lower the value of bias resistor needed. Panel control VR2 provides both muting by zero resistance setting and adjustment of noise pulse duration to suit personal requirement.

BASS DRUM

A fair imitation of a bass drum can be provided by the bongo circuit using a larger capacitance and so producing a low resonant frequency. However, a high Q coil is desirable and higher resistance values must be used to avoid the sound being too dead.

A better method is to employ a low frequency phase shift oscillator, TR21, which is set by means of VR4 so that the circuit cannot sustain continuous oscillation. The circuit now becomes a selective amplifier and the input pulse from S3a causes a transient disturbance, and the output obtained is similar to that for the bongo drum. VR4 can be set to give a much longer decay to the output and if set too low in value the circuit will oscillate continuously.

This particular circuit can be used to generate more realistic bongo drums than the resonant circuit given and if constructors wish to use this circuit for such sounds it is only necessary to select different values of capacitors for the feedback network to alter the frequency of operation. (It should be noted that R109 was omitted from the components list. This is normal rating, i.e. 10%, $\frac{1}{2}W$.)

BEAT EMPHASIS

For some rhythms it is desirable, for emphasis, to trigger both the bass drum and bongo drum circuit together on the same beat. This accentuation is provided by the wafer S3q.

Reference to Fig. 6, the rhythm switch wiring diagram given in the first article, shows that in the "Mambo" setting of the rhythm switch, connection is made to O1/B1 and this is passed to the drum circuit at wafer S3a via C32.

Since the wiper of this switch is also connected to the O1/B1 output via D17, a differentiator diode, the high bongo circuit is also triggered when the bistable 1 changes state so providing beat emphasis.

It should be emphasised that none of the switch wafers, S3a to S3p should be used to operate two sound circuits simultaneously as this would mean that these circuits would have a common input and would always sound together in other rhythm switch positions.

MIXER AND PREAMPLIFIER

The outputs from the two brush gates are amplified by a single stage amplifier TR22 which drives a resonant filter circuit C56, L3. This circuit gives a characteristic formant to the noise pulses to produce a more realistic imitation of the brush sounds.

The bass drum and bongo outputs are combined and together with the preamplifier brush signals require further amplification in a power amplifier. In the equipment used by the author, the extra amplification is provided by the power amplifier of an electronic organ, into which the rhythm unit is fitted.

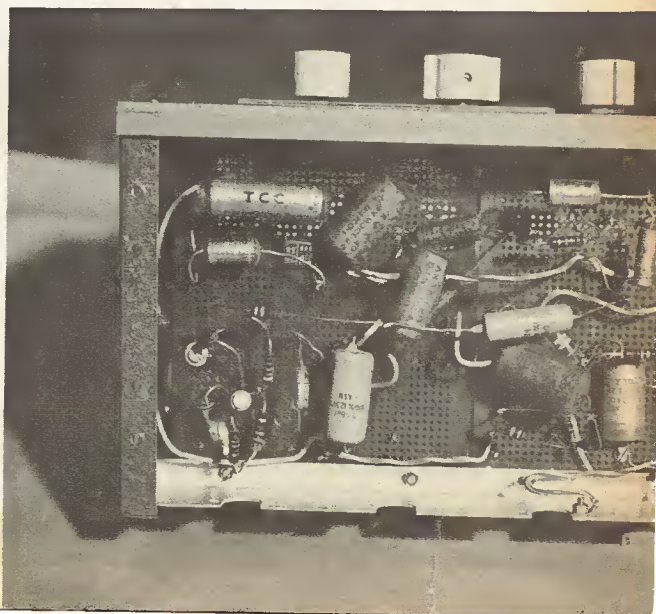

BOARD ASSEMBLY

Reference to Fig. 12a shows the topside of board C. Solder pins should be located at the positions indicated and components assembled and soldered to them.

With these attachments completed the board should be reversed and components assembled as in Fig. 12b.

Board D assembly, Figs. 13a and 13b should be completed and both boards laid temporarily aside.

RING COUNTER CHECK OUT

Constructors should first test the clock pulse generator and ring counter and rhythm patterns can be tried out.

During development the author decreased the speed of the clock pulse generator by using 20 μ F coupling capacitors for C1 and C2. This allows the counter operation to be examined in slow motion using a 20,000 Ω /volt voltmeter.

FLYING CONNECTIONS

After the boards are checked for proper function they should be attached to the rails of the chassis assembly (See Fig. 9) and inter board flying connections made. This operation should proceed through from board A to board D.

Next, flying lead connections to the switch bank S3 should be made, referring to Fig. 6. Sleeved lead lengths should be cut according to board location. Again connections should be systematic working from wafer S3a through to S3u.

The switch assembly should now be tightly bolted to the front panel and solder connections to the boards made.

With front panel control wiring completed and connection made to C58 at output socket SK1 the unit is ready for final testing. (C58, omitted from the components list, is a 0.1 μ F ceramic type.)

Before connection to an amplifier a further wiring check out should be undertaken.

SIMPLIFICATION

The equipment can be simplified, if required, by omitting the fifth bistable. This means that only one set of eight differentiators and associated switching wafers are required.

Because of this, TR13, TR14 and S2 in Fig. 4 can be omitted and the 10 kilohm differentiator resistors taken down to the -3V bias line. The bias line resistor R48 should be increased to about 150 ohms.

This simplification means that the maximum number of beats in any rhythm is six or eight. The "Bosa-Nova" rhythm requires a total cycle of 16 beats and so cannot be generated correctly with this reduced system.

No power supply circuit has been given as this will most likely be provided from existing sound equipment. The circuits will operate from less than 12 volts, but if the voltage is reduced too far the noise generating transistor will not be operating in a breakdown mode and the noise output will most certainly be inadequate. The supply used should be well smoothed to avoid hum on the output signal.

SOUND PROOF, INDEED!

Readers will be interested to learn that earlier this year the author demonstrated this Rhythm Generator before a meeting of the Electronic Organ Constructors Society. We understand the performance of this unit created quite an impression upon the audience—Ed. ★

MANCHESTER SHOW

OF the many electronics exhibitions held throughout the course of each year, few can compare with that of the Institution of Electronics, which took place, as usual, in the Lancaster Hall, Belle Vue, Manchester, in September. Immediately one is aware of the informal friendly atmosphere and helpful technical advice received on the various stands.

The lectures in the adjacent rooms are equally informal, and it is interesting to note the popularity in particular of the demonstration and talk on the Wyvern electronic church organ. This is a fine instrument with two manuals and 30-note radiating pedalboard.

COMPONENT SUPPLIES

Readers of PRACTICAL ELECTRONICS are frequently interested in obtaining small quantities of specialised electronic components, so our visit to the exhibition paid particular attention to this aspect. All too often one is told, when asking about supplies of "one off" orders: "Well we can, but . . ."

The sad tale is that some component specialists who handle products from several manufacturers just don't want to supply in "one off" quantities because overheads are high and the resulting profit margin is very nearly eliminated. The products are there but the problem is how to get them.

How about the retailers? Their job is to sell to the private consumer, the goods that *he* wants. If he wants a particular type of integrated circuit, or switch, or relay, or what have you, he should be able to walk into a shop and get it, either over the counter or on order. The retailer should have few problems—at least, that is what we deduce by talking to representatives of firms like Sasco, Jermyn Industries, Waycom, Newmarket, Mullard and so on. These companies, and others, supply in quantity to industry and the trade.

EDUCATIONAL AID

Of particular interest to educational establishments is the "Locktronics" circuit construction system. This is a base board with pillars and clips, on which can be mounted almost any combination of circuitry in the form of clip-on components. Link wires, junctions and crossovers are also supplied in this form. Each piece or component has the circuit symbol painted on its upper surface so that when complete the circuit diagram is shown.

A novel method of encapsulating dry reed switch relays has been employed by Electrothermal Engineering. These are called the "Flat Pack" range and are made in miniature and standard sizes (using single or multiple replaceable switch capsules) or in printed circuit style.

Model control enthusiasts will welcome the news of the Deac Universal constant current automatic electronic charger. This has been specially designed to handle 1 to 20 Deac cells in series connection up to 5Ah in capacity. Charge rate is adjustable in two ranges up to 50mA and 500mA. A charge timer is also incorporated so that the charger can be left unattended.

Deac introduced the new Varta 10/SD 1.6V control cell or "Third electrode cell battery" enabling the battery to be fully charged in one hour. A special charging unit or circuit can be supplied with this on application to the makers. ★

plug in
the smallest
soldering iron
available

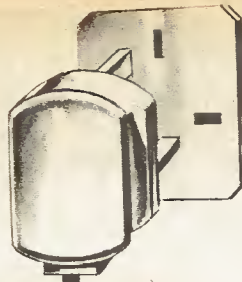

Complete precision soldering kit



This kit—in a rigid plastic "tool-box" — contains everything you need for precision soldering.

- Model CN 15 watts miniature iron, fitted $\frac{3}{16}$ " bit.
- Interchangeable spare bit, $\frac{5}{32}$ ".
- Interchangeable spare bit, $\frac{3}{32}$ ".
- Reel of resin-cored solder
- Felt cleaning pad
- Stand for soldering iron
- Space for stowage of lead and plug

PLUS 36-page booklet on "How-to-Solder"—a mine of information for amateur and professional.

From Electrical and Radio Shops or send cash **49/6** to Antex.

... pin-point precision soldering ... fingertip control ... bits that do not stick to shafts ... bits that slide over elements ... sharp heat at the tip ... reliable elements ... spares always available ...

in Europe, Africa, Asia, America ... ANTEX soldering irons are used by experts and amateurs alike; they have found out the advantages of Antex ...

you can too ... buy one in a shop or direct from us ... or ask for our catalogue first.

CN 15 watts. Ideal for miniature and micro miniature soldering. 18 interchangeable spare bits available from .040" (1mm) up to 3/16". For 240, 220, 110, 50 or 24 volts.

32/6

From Electrical and Radio Shops or send cash to Antex.

ACTUAL SIZE

G 18 watts. Ideal for miniature work on production lines. Interchangeable spare bits, 3/32", 1/8", 3/16", and 1/4". For 240, 220 or 110 volts. 32/6.

E 20 watts. Fitted with 1/4" bit. Interchangeable spare bits 3/32", 1/8", 3/16". For 240, 220, 110 or 24 volts. 35/-.

ES 25 watts. Fitted with 1/8" bit. Interchangeable bits 3/32", 3/16" and 1/4". Ideal for high speed production lines. For 240, 220, 110, 24 or 12 volts. 35/-.

F 40 watts. Fitted 5/16" bit. Interchangeable bits 1/4", 3/16", 1/8", 3/32". Very high temperature iron. Available for 240, 220, 110, 24 or 20 volts. 42/6.

Spare bits and elements for all models and voltages immediately available from stock.



Model CN240/2
15 watts - 240 volts
Fitted with nickel plated bit (3/32") and in handy transparent pack. From Electrical and Radio Shops or send cash to Antex.

31/-



PRECISION MINIATURE SOLDERING IRONS
made in England

Antex, Mayflower House, Plymouth, Devon
Telephone: Plymouth 67377/8. Telex 45296. Giro No. 345007.

To: Antex, Mayflower House, Plymouth, Devon

Please send me the Antex colour catalogue

Please send me the following irons

Quantity	Model	Bit Size	Volts	Price

I enclose cheque/P.O./cash value.....

NAME.....

ADDRESS.....

PE 12..... Telephone:.....

WIRECOMP ELECTRONICS SALE MART BARGAINS ★ BARGAINS BARGAINS

Fane Loud Speaker—Few Only

Type 183—18in. diam. 60 watts r.m.s. 15 ohms. Listed at £25.4.0.
SALE PRICE £16.19.6 P. & P. 10/-

Remote Control Transmitter

Designed for remote switching of famous make radiogram (export model). Output 27.2Mc/s. Fitted with 5 valves, crystals, etc. For use on 117 volts A.C. Size 12x8x5in. New and boxed. No circuit or data available.

SALE PRICE 29/6 P. & P. 5/-

Model A-1004 Plug-in FM Tuner

Self powered by 9v batt. 5 transistor. Covers 88-108 Mc/s. For use with tape recs., amps., wireless mics., etc. Size 5 1/4 x 2 3/8 x 1 1/8 in.

List price was £7.70 **SALE PRICE 85/-** P. & P. 2/6

Voice Actuated Microphone Model B-5001

Voice actuated microphone designed for use with tape recorders with facilities for remote control. Fitted with a three position switch allowing normal hand remote control, voice sensitivity action and off. Sound level required to operate the recorder can be adjusted. The microphone is self powered by one 9V (PP3 type) battery giving 6 to 10 hrs. operating time. 6 transistor circuit. Strong black plastic case. Length 7 1/4 in. Fitted with 2.5 and 3.5 mm. plugs for fitting polarised sockets. List price £8.19.6.

SALE PRICE 89/6 P. & P. 3/6

Push Button Two Band Car Radio

A high quality all transistor superhet car radio that really breaks the quality/price barrier. A unique feature of this set are the four M/W band station preselection buttons which you yourself set to your own four favourite stations—this is in addition to full M/W band cover over 535-1605 Kc/s and full L/W band cover over 150-300 Kc/s (IF frequency 455 Kc/s). Externally adjustable aerial trimmers ensure maximum output. Six transistor (including one drift type) and one diode circuit provides powerful 2W output. Adjustable for use on either positive or negative ground 12V systems (external line fuse fitted). Standard mounting size 6 1/2 x 5 1/2 x 2 1/2 in.—front panel 1/2 in. larger all round—finished in anodised aluminium with black push buttons. Complete with mounting brackets, full installation instructions and 2 baffle boards (for round or elliptical speaker). Fully guaranteed. Complete with 6 x 4 in. elliptical 8Ω dynamic speaker.

SALE PRICE £10.10.0 P. & P. 3/6

Crown Model TR-960C LW/MW/SW 9 Transistor Radio

Superb quality 9 transistor three band radio. Covers LW 150-350 Kc/s, MW 525-1605 Kc/s, SW 6-18 Mc/s. Fine tuning and tone controls. Illuminated dial. Telescopic aerial. Complete with simulated leather case, earpiece and 4 x 1 1/2 V U7 batteries.

List price was £11.10.0 **SALE PRICE £11.10.0** P. & P. 16 Gns.

DON'T DELAY—ALL ITEMS SUBJECT TO AVAILABILITY

100's and 100's of Other Bargains

There's something for everyone in our vast stocks of new, shop soiled and first-class reconditioned equipment—

RECORD PLAYERS ● HI-FI EQUIPMENT ● TELEVISIONS ● RADIOS ● TAPE RECORDERS, ETC., ALL BY WORLD FAMOUS MANUFACTURERS

COME AND LOOK TODAY

PERSONAL CALLERS TO:

48 TOTTENHAM CT. RD., W.1

Tel. 01-636 0647

MAIL ORDERS TO:

378 HARROW ROAD, PADDINGTON, LONDON, W.9

R.S.T. VALVE MAIL ORDER CO. BLACKWOOD HALL, WELLFIELD RD., S.W.16 Special 24 Hour Mail Order Service

AZ31	9/6	KT87	45/-	UCH42	10/6	1Q7GT	4/6	2N2904A	12/6	GEX541	15/-
BY100	5/6	KT81(7C5)		UCH81	6/9	20L1	17/-	2N2926	5/3	GEX941	3/6
CIG	20/-		15/-	UCL82	8/-	20P4	19/-	2N2819	15/-	GJ3M	3/6
CY30	16/3	KT81(GEC)		UCL83	10/-	20P5	18/-	2S002	20/-	GJ5M	3/6
DAF91	4/-		35/-	UF41	10/-	2Z24	6/3	2S003	12/-	GJ6M	3/6
DAF96	6/9	KT88	27/6	UF89	7/6	2Z26GT	7/-	2S004	11/-	GJ7M	3/6
DC090	12/6	KTW61	10/-	UL41	9/6	2Z26GT	8/6	2S005	48/-	HDS967	4/-
DF91	3/-	KTW92	10/-	UL84	7/-	30C15	20/-	2S006	20/-	HG5002	4/-
DF96	6/9	MYL4	17/6	UL87	7/-	30C17	14/-	2S012	50/-	JK9A	25/6
DH77	4/6	N78	15/-	UYR8	6/6	30C18	13/6	2S012A	55/-	JK10A	15/6
DK91	5/6	PC86	11/6	YP4B	25/-	30F5	14/-	2S013	20/-	JK10B	15/6
DK92	8/-	PC88	11/6	VR105/30	5/-	30FL1	16/-	2S018	60/-	JK19A	22/6
DK96	7/9	PC97	8/9	VR150/30	5/-	30FL12	16/-	2S108	60/-	JK21A	12/6
DL66	15/-	PC900	9/6	WV81	12/6	30FL14	13/6	2S301	12/6	K3S5A	5/-
DL92	4/9	PC84	6/3	Z69	15/-	30L15	15/3	2S320	9/-	MAT101	5/6
DL94	5/9	PC89	11/-	Z19	25/6	30L17	14/-	2S702	10/-	MAT120	7/9
DL96	7/6	PC189	29/-	Z39	25/6	30P12	12/-	48L	45/-	NKT128	6/-
DL810	12/6	PCF80	7/-	Z803U	15/-	30P19	13/-	AC107	10/-	NKT142	8/-
DL816	30/-	PCF86	9/-	OA2	6/3	30P1L	15/-	AC126	6/6	NKT211	6/-
DL910	30/-	PCF801	10/-	OB2	6/3	30P1L3	15/-	AC127	6/6	NKT214	4/-
DL4350	7/6	PCF802	10/-	OC3	5/6	30P1L4	15/-	AC128	7/6	NKT216	4/-
DY86	6/-	PCF806	12/6	OZ4	4/6	3BL6GT	7/-	AC130	7/6	NKT217	8/-
EB82	6/-	PCF82	7/9	B3GT	8/-	35V4	4/6	AC17	7/6	NKT218	6/-
EB83C	12/-	PCF83	9/3	IR5	5/6	3S24GT	5/6	AC18	5/3	NKT221	5/6
EB180F	17/6	PCL84	7/9	2D21	5/-	50C5	6/3	AC19	6/8	NKT223	6/-
E182CC	22/6	PCL85	9/3	2E26	20/-	50CD6G	31/-	AC120	5/3	NKT224	4/6
EAF6C80	7/-	PCL86	9/-	3A5	7/-	80	7/-	AC121	6/3	NKT225	3/6
EAF42	10/-	PENB4	20/-	3B28	40/-	85A1	25/-	AC122	3/6	NKT227	5/6
EB91	2/-	PEN45DD	3C45	65/-	85A2	7/3	AC128	4/6	NKT228	6/-	
EB3C3	7/-		12/-	4X150A	95/-	90A9	45/-	AD140	16/-	NKT251	5/-
EB041	9/9	FFL200	14/-	5R4GY	9/9	90AV	45/-	AD161	11/-	NKT265	9/6
EB030	4/6	PL36	10/-	5U4G	4/-	90C1	12/-	AF114	6/6	NKT274	5/-
EBF80	7/-	PL81	8/-	5V4G	4/-	90CG	25/-	AF115	6/6	NKT274	5/-
EBF83	8/3	PL82	7/3	5Y3GT	6/6	90CV	25/-	AF116	6/6	NKT282	8/-
EBF89	8/6	PL84	6/9	5Z4G	6/6	90C12	9/6	AF117	6/6	NKT404	12/6
EBL21	11/-	PL600	15/-	6J0L2	13/-	150B3	8/6	AF118	10/-	NKT452	12/6
EBL31	27/6	PX4	14/-	6AK5	4/6	801	6/6	AF125	6/3	NKT675	6/-
ECC33	15/-	PX25	12/6	6AK6	6/6	803	35/-	AF176	12/6	NKT676	5/-
ECC40	15/-	PY32	9/6	6AL5	3/-	807	7/-	AF186	17/6	NKT677	5/-
ECC81	3/9	PY33	9/6	6AM6	3/6	811	35/6	AF179	22/6	NKT678	6/-
ECC82	4/9	PY31	6/6	6AN8	10/-	813	75/-	AF180	7/6	NKT713	7/6
ECC85	6/-	PY82	6/-	6A04	4/-	866A	13/6	AS221	12/6	NKT777	8/-
ECC86	6/-	PY83	6/6	6A04	6/6	872A	5/6	AS223	30/-	OA5	3/-
ECC88	7/-	PY800	10/-	6AS6	6/0	5651	7/6	ATZ10	30/-	OA7	4/-
ECC89	6/6	PY801	10/-	6AS7	15/-	5654	8/6	AU110	39/6	OA10	3/-
ECC92	7/-	PZ30	10/-	6AT6	4/6	5657	7/6	BC108	7/6	OA7	2/-
ECH35	11/-	QV02/6	45/-	6AT6	6/6	5667	10/-	BC108	5/-	OA70	2/-
ECH42	11/-	QV03/10	45/-	6B4G	16/-	5691	25/-	BC109	7/6	OA79	2/6
ECH43	5/9		30/-	6BA6	5/-	5749	10/-	BCY31	13/6	OA81	2/6
ECH83	8/6	QV03/20	6/6	6BE6	5/-	5763	10/-	BCY33	7/6	OA85	2/6
ECL80	7/-		105/-	6BH6	7/6	5842	65/-	BCY34	6/6	OA86	5/6
ECL82	7/-	QV04/19	105/-	6B16	9/-	5963	10/-	BCY40	12/-	OA200	3/3
ECL83	10/3	QV06/40	105/-	6B8A	27/6	6037	10/-	BCZ11	5/-	OA202	4/3
ECL86	9/6		90/-	6BQA	7/-	6059	18/-	BDY11	27/6	OA210	7/6
EGL1000	30/-		90/-	6BR7	8/6	6060	6/6	BDY12	32/-	OA2200	11/-
EF9	20/-	QV6/10	70/-	6BR8	5/6	6061	12/-	BFY51	3/6	OA2201	10/-
EF37A	7/-		70/-	6BR8	5/6	6061	12/-	BFY52	4/6	OA2202	5/6
EF39	6/-	QS70/20	5/6	6B87	16/9	6062	14/-	BFY52	4/6	OA2204	8/6
EF41	10/-	QS75/20	5/6	6B86	14/9	6063	16/-	BSY27	9/6	OA2206	8/6
EF48	5/-	QS76/20	5/6	6B87	14/9	6064	7/-	BSY27	9/6	OA2208	6/6
EF86	6/9	QS83/3	7/3	6C4	2/9	6065	9/-	BSY28	5/-	OA2208	6/6
EF89	5/-	QS92/10	4/-	6CB6	5/-	6067	10/-	BSY51	7/6	OA2232	9/6
EF91	3/6	QS95/10	5/6	6CD6G	22/-	6080	25/-	BSY63	7/6	OA2234	10/-
EF92	2/6	QS108/45	15/-	6CH6	9/9	6096	8/6	BSY65	5/6	OA2235	10/-
EF98	15/-	QS150/15	6/-	6CL6	8/6	6146	25/-	BSY68	40/-	OA242	4/6
EF183	6/6	QS160/30	5/-	6DW4	16/-	9003	9/-	BTY98	19/6	OA2246	4/6
EF184	6/6	QS160/36	20/-	6DW4	16/-	9003	9/-	BTY95100R	£22.90	£22.90	4/6
EF80A	21/-		20/-	6DK6	9/-			TRANSISTORS	140/-	OA2292	9/6
EF60	10/-	QS150/45	20/-	6F23	13/6	IN21	3/6	BY100	5/-	OC16	20/-
EH90	7/6		20/-	6F24	12/-	IN22	5/-	BY114	5/-	OC19	7/6
EL33	12/6	QS150/50	20/-	6F25	12/-	IN429	12/6	BZ11	9/6	OC20	15/-
EL34	10/6		20/-	6F28	11/6	IN192	12/6	CC19	12/6	OC22	10/-
EL41	10/-	QS1200	7/3	6G3	2/6	IN3065	13/9	BY113	7/6	OC23	11/6
EL42	10/-	QV03-12	10/-	6J6	3/-	IS113	4/6	BZ118	15/-	OC24	15/-
EL81	7/9	QV04-7	12/6	6J7G	4/9	IS131	4/3	ODT131	13/6	OC25	9/-
EL84	4/9	QV05-25	7/-	6K7G	2/-	IS420R	12/6	CG64	2/6	OC26	2/6
EL85	7/6	QV06-20	25/-	6K8G	3/-	2152	4/3	CK707	2/6	OC28	12/-
EL86	7/6	R10	15/-	6L5G	7/6	20210	12/6	CS105	7/6	OC29	12/6
EL90	6/-	R17	8/-	6L7G	6/-	2G309	5/-	CV102	3/6	OC35	12/6
EL96	5/6	R18	7/6	6BSG7	5/-	2G381	5/-	CV103	3/6	OC36	12/6
EL360	22/-	R19	7/9	6SJM	7/-	2G382	5/-	CV425	3/6	OC41	6/-
EL500	20/6	RC5/300	80/-	6SLGT	4/9	2G401	5/-	CV226	20/-	OC42	5/-
EL821	6/-	S130	35/-	6SN7GT	4/6	2G402	6/-	CV258	25/-	OC43	9/-
EL822	16/-	S130P	35/-	6V6G	4/6	2G403	10/6	CV259	5/-	OC44	4/-
ELL80	20/-	SP41	3/6	6X4	3/6	2G414	6/-	CV219	2/6	OC44M	5/6
EM34	25/-	SP61	3/6	6X6G	4/6	2G415	6/-	CV284	2/6	OC45	3/6
EM80	7/6	STV280/40	6/-	6X8GT	6/-	2G416	6/6	CV1782	30/-	OC46M	4/-
EM81	7/9		25/-	7B6	11/6	2G417	6/-	CV1783	30/-	OC46	5/6
EM84	7/6	STV280/80	7B7	7/6	2N274	9/6	DD003	3/6	OC47	7/6	
EN32	25/-		85/-	7C5	15/-	2N274	9/6	DD190	9/9	OC37	16/-
EY61	7/6	SU2150	12/6	7C6	15/-	2N410	3/6	DD225A	7/6	OC38	17/6
EY83	8/6	U19	35/0	787	6/6	2N555	12/6	EW99	5/-	OC39	18/6
EY84	7/6	U24	24/-	7Y4	8/6	2N599	12/6	GET8	8/-	OC71	3/6
EY86	7/-	U25	13/6	10P13	15/6	2N606	11/-	GET16	7/3	OC72	5/-
EZ40	8/-	U26	13/6	11E3	42/-	2N697	12/6	GET20	10/-	OC73	7/6
EZ41	10/-	U191	15/-	12AC6	10/-	2N700A	12/6	GET38	3/6	OC74	6/-
EZ80	5/6	U201	16/9	12AD6	11/-	2N1040	20/-				

ELECTRONIC CONTROLLED PUMP

FOUND the conventional bi-metal strip type of thermostat, controlling the pump of a central heating installation, to be very inefficient despite the use of devices such as accelerators to prevent overshoot. My own produced actual temperature ranges of up to 5 degrees Fahrenheit so I decided to adapt Mr. Michaelis's Chemostat (August and September 1967 issues) to control the circulating pump.

The printed circuit board is made slightly longer to enable RLA, C13 and D6-9 to be mounted on the board. By slightly widening the board the positive connection may also be taken to diodes D6-9. The transformer need only have an 18V 1A output (the 6.3V winding is not necessary) as all the other relays and circuit breakers are not required. RLA should have contacts capable of carrying 5 amps at 250V. RLA1 contacts in the circuit diagram are connected as shown and RLA2 contacts are used to switch the circulating pump of the central heating. A 0.1 μ F capacitor and 100 ohm resistor in series was placed across RLA2 contacts to reduce the slight spark when the pump circuit was breaking. A blocking loop is included in this latter circuit, being a fish tank type thermostat set to about 75 degrees Fahrenheit. This acts as a safety control in the unlikely event of electronic failure of the main control.

The circuit board and transformer is mounted in a box 11in \times 5in \times 2 $\frac{1}{2}$ in (conveniently hidden away in the hall cloakroom), leaving only TR1, VR1, and the blocking loop thermostat to be placed in a small case mounted on the wall. The wall unit is thus no larger than the conventional bi-metal strip type unit. The only other variation to the circuit is to make VR1 15 kilohms instead of 100 kilohms, giving a temperature range of about 60 to 80 degrees Fahrenheit, which is a more suitable range for the purpose.

Components C and D3 must be very high quality with minimal leakage in order that sufficient voltage can be applied via R4 (4.7 megohms) to trigger the driver circuit. Also D4 was dropped to 4V to give the quoted figure of 8V at the base of TR7.

Switching control is now so good that, with a change-over down to nearly $\pm\frac{1}{2}$ degree Fahrenheit, room temperature never varies by more than $\frac{3}{4}$ degree Fahrenheit at the most. Because of this very much closer temperature control I estimate that I shall save the cost of the unit in one year's fuel bill.

G. R. Skeates,
Harrow, Middlesex.

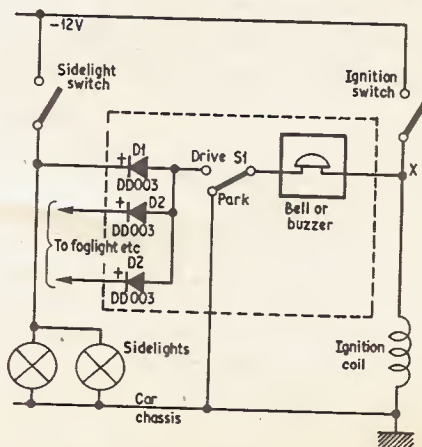

Fig. 1. Circuit diagram for a car lights alarm

UNLIMITED!

A selection of readers' suggested circuits. It should be emphasised that these designs have not been proven by us. They will at any rate stimulate further thought. This is YOUR page and any idea published will be awarded payment according to its merit.

CAR LIGHTS ALARM

THIS circuit was designed to overcome the annoying habit of continuously leaving the car sidelights on and, consequently, running down the battery.

The circuit, Fig. 1, gives an audible warning that the sidelights, foglight, etc. have been left on each time the ignition is turned off. It is basically a simple OR gate (D1, D2, D3) and an indicator. In the prototype a simple Woolworths' doorbell was used as the indicator.

When both sidelight and ignition switches are on, and S1 in the "Drive" position, -12V appears at both sides of D1 and the latter does not conduct, and no current flows through the indicator. If the ignition is now switched off, point X is grounded via the ignition coil causing D1 to conduct, allowing current to flow through the indicator, producing a suitable warning. If the lights are now switched off the indicator will cease to function.

When the sidelights are switched off and the ignition switch is on, D1 is reverse biased and no current is allowed to flow through the indicator. This prevents the alarm sounding when driving normally with the lights off.

On some occasion it will be necessary to leave the sidelights on when the ignition is off. To prevent the alarm operating continuously in this condition, S1 is switched to "Park". When the ignition is again switched on, the alarm will operate warning the driver to switch S1 back to the "Drive" position.

Any number of lights or auxiliary circuits can be monitored simply by adding further diodes to the gate as shown (D2, D3). For negative earth cars, the diodes should be reversed.

F. Cogger,
Sevenoaks, Kent.

COMPARISON TESTER FOR R.F. TRANSISTORS

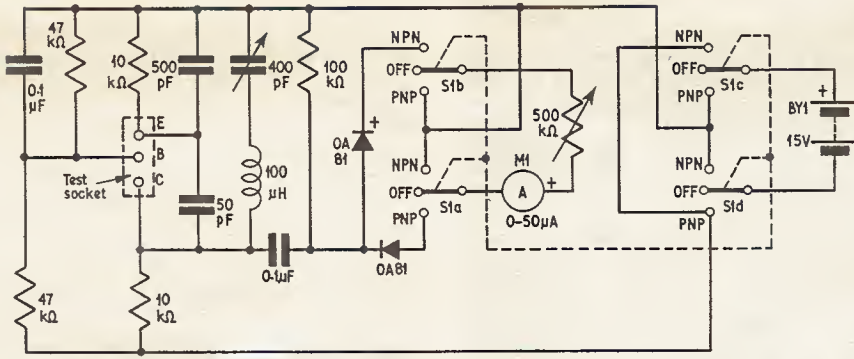

THE accompanying circuit was developed to check whether or not transistors were suitable for r.f. applications.

The components as shown cause the transistor under test to oscillate at approximately 3MHz. If the transistor is capable of oscillating at this frequency, the output will be detected and will be shown as a reading on the meter. The amount of this reading has no real importance, only that it is used as a comparison with a reading from a transistor known to be good.

The frequency at which the test transistor is made to oscillate can be varied by the preset capacitor in series with the 100μH choke. The meter can be built into the instrument, or it could be the 50μA range of a multimeter.

The preset potentiometer control is used to set the output reading to approximately mid-scale for an average transistor. Switch S1 is a 4-pole 3-way, key or rotary type.

R. D. McGilliuray,
New Zealand.

SCREEN WIPER DELAY

IF ANY readers are contemplating wiring a screen wiper delay unit to the BMC 1100 or 1300 models, it should be noted that these models have a set of contacts that short out the wiper motor when the wipers are switched off and returned to the parking position; this acts as a brake (Fig. 1.) If any of these delay circuits are used on these cars the thyristor will be destroyed.

The circuit of the wipers in these cars and a suggested circuit to avoid the destruction of the thyristor is given in Fig. 2.

This circuit breaks the shorting path before the thyristor fires and makes again before the contacts close to cut out the motor. It is necessary to incorporate a time delay (approximately 0.25sec) in the relay circuit to allow adequate braking of the motor.

R. End,
Sunningdale.

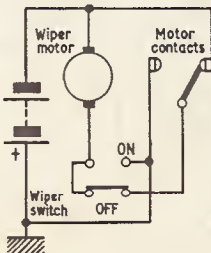

Fig. 1

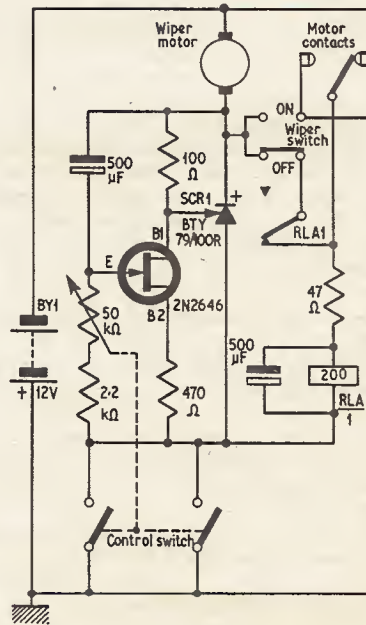

Fig. 2. Thyristor protection circuit diagram. The relay used is a GPO 3000 type with heavy duty N.C. contacts

TALK BACK SYSTEM

READERS might be interested in the intercom system described. Fig. 1 shows the circuit for a two-wire, two-way intercom, with call facility from either end: it consists of a fairly conventional amplifier preceded by a diode gate.

Under normal talk/listen conditions the diode is

A power supply with greater current capacity is required for this circuit than is required for Fig. 1, the quiescent consumption of the former being only about 5mA.

M. Tucker,
Ilford.

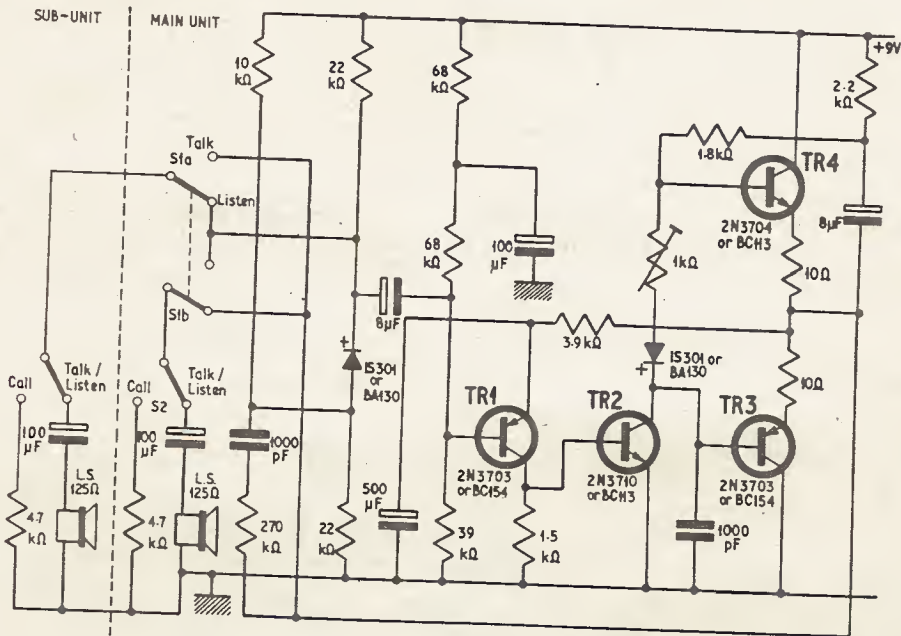

Fig. 1. Circuit diagram for a two-wire, two-way intercom, with call facility from either end

reverse biased and has no effect. When the appropriate call button is closed, however, the diode becomes forward biased and closes a positive feedback loop between output and input, generating an audible output at about 4kHz. Change in this frequency is achieved by altering the feedback capacitance.

The input transistor was selected to have a gain of at least 40 at 0.5mA collector current.

S.G.S. Fairchild devices, such as BC154 and BC113 may be used for the *pn*p and *np*n respectively and BA130 for the diodes.

The speakers were moving armature types, similar to those used in telephone receivers, but any unit from 75 ohms upwards could be used.

Fig. 2 shows the additional circuitry required for operating a number of sub-stations from one master, being just a lamp driving circuit, one being required for each sub-station. The 2N3703 was selected to have a gain of at least 40 at 3mA. A BC154 may be used here, but a BC115 or BC125 must be used for the *np*n.

The Zener diode may be omitted and the 39 kilohm resistor increased to 82 kilohms if lighting of the indicator lamp can be tolerated in the talk position of the main station.

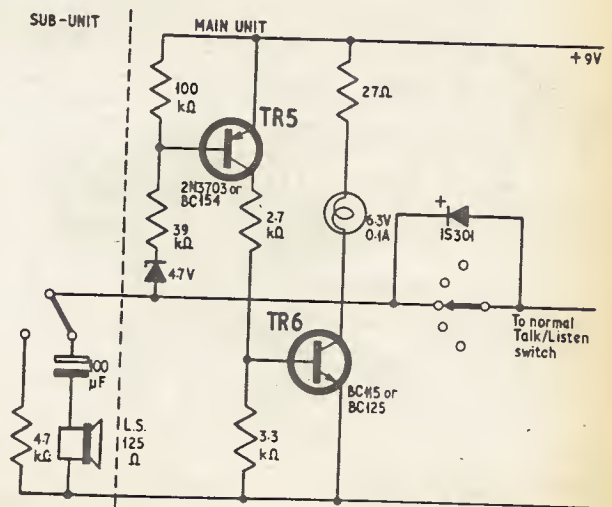

Fig. 2. Additional circuitry for operating a number of sub-stations from one main unit

Electronic STOCKMARKET

ELECTRONIC stockmarket is a game combining skill and chance in proportions such as to provide endless hours of amusement for all the family. Costing little over £7 in parts, it is simple to construct and can be depended upon to outlast many other conventional games, except, perhaps, chess.

The model illustrated accommodates four players or less, but extra players' positions can be accommodated on the board if required for an outlay of approximately 15s per position for components.

The game is designed to simulate very closely the thrills and hazards met in investing in the stockmarket proper. In the game, however, monetary gains and losses are substituted by changes in electrical charge on capacitors. These charges are checked by the players throughout the game so that each player can keep a

thrifty eye on his business "potentials" and "capacity"!

Briefly, each player makes intelligent transactions on 11 different market commodities, the individual "share" prices of which are constantly changing under the control of dice throws. A good memory is beneficial in playing, so that transactions will be made only on commodities whose shares have risen. This ensures that the player makes the most advantageous use of his transaction.

The ultimate object of the game is to build up one's cash (i.e. potential on "cash" capacitor) and to transfer it at intervals to a "bank" capacitor until the accumulated bank balance reaches a preset level, representing one "million". As soon as this point is reached, the player's "million" lamp starts flashing, so identifying the winning player.

By B. H. Bailly

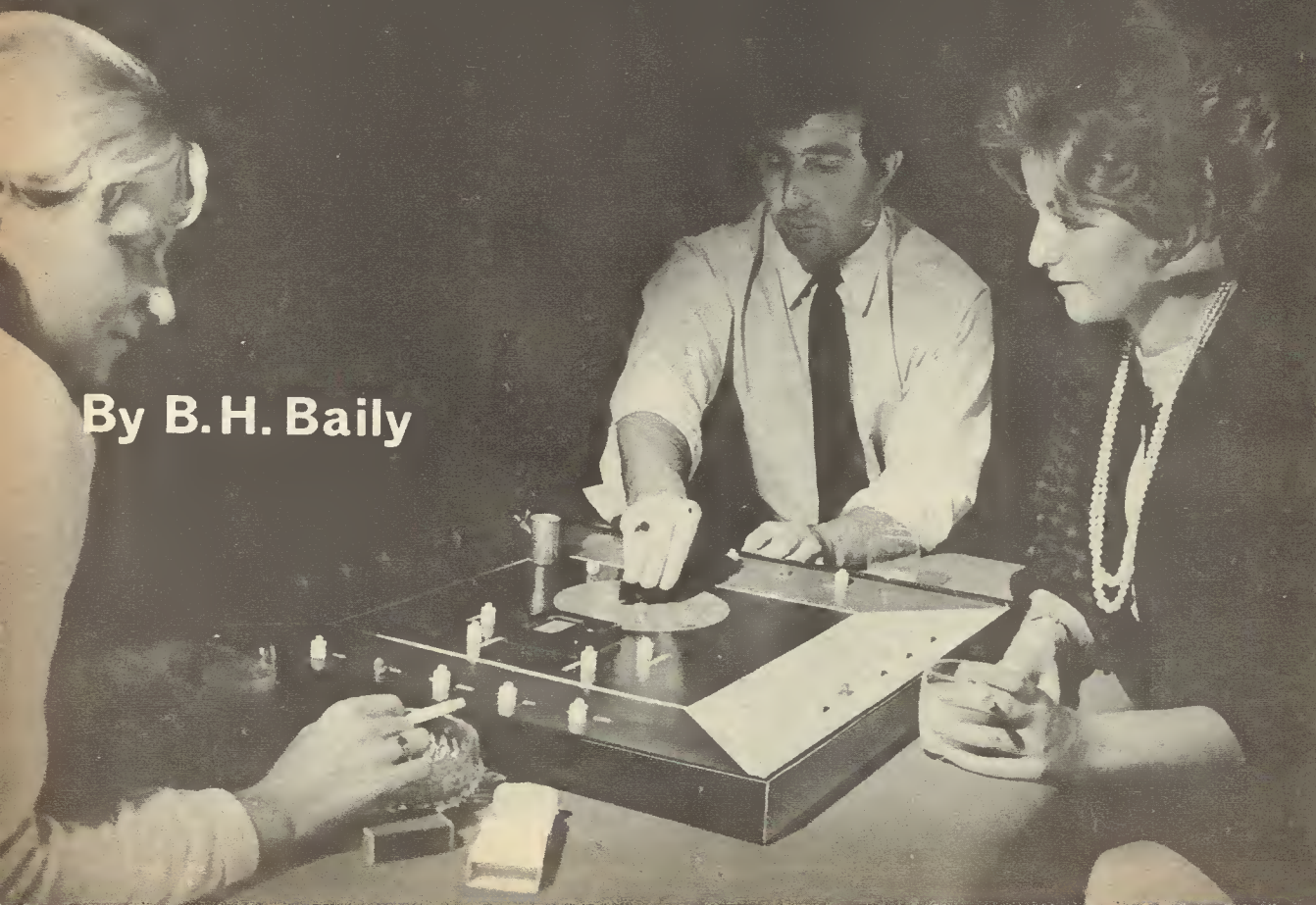

HAZARDS IN PLAY

The play is not as easy-going as may be indicated from the above, however, and deliberate hazards have been introduced to add interest to the game. For instance, if a player throws a "5", he is compelled to push his "bank raid" button. This at once puts a short-circuit across his "bank" capacitor and reduces all his accumulated bank savings to nil, leaving him with only his cash balance. Other dice throws affecting levels are as follows:

1. Demands that the shares of the selected commodity be brought "down"; press "shares down" button.

6. Raise the shares of the selected commodity, by the pressing of the "shares up" button. Players either gain or lose by transacting with commodities whose shares are up or down, respectively.

Shares are raised to a set high level by the "shares up" button, the actual level being preset by means of a preset potentiometer. Shares are lowered by the "shares down" button, which reduces the shares capacitor charge by a proportion of its original value only. A time constant is incorporated to make shares vary in their drop, if the down button is pressed twice within about 30 seconds.

A realistic "tax" system is incorporated which taxes or rebates players from time to time, according to their "financial" position.

PLAYERS' CONTROLS

The basic circuit is simple, see Fig. 1, and consists of three separate parts: a meter and associated emitter follower stage, the "Stock Exchange" capacitors and associated rotary selector switch and push-buttons, and finally the players' circuits.

The players' circuits are all identical, irrespective of the number of players accommodated. Each comprises a "cash" capacitor and a "bank" capacitor. The cash capacitor has push-buttons marked "check cash", "transact", and "cash to bank" to allow for the required functions.

The bank capacitor has a push-button marked "bank raid" which is connected so as to short-circuit the bank capacitor when the button is operated. A two-transistor level detecting and lamp-drive circuit monitors the bank capacitor potential at all times, and starts to flash the player's "million" lamp when it detects a certain minimum "winning" level in the player's bank.

CHECKING CHARGE LEVELS

The meter used in the prototype has an f.s.d. of $50\mu\text{A}$, but one of $100\mu\text{A}$ would do equally well provided that the series resistor is modified suitably.

Since the meter circuit is used to check charge levels on capacitors, the greater sensitivity used the better, or undue current drain would result through the base circuit of the meter circuit, so robbing the players of

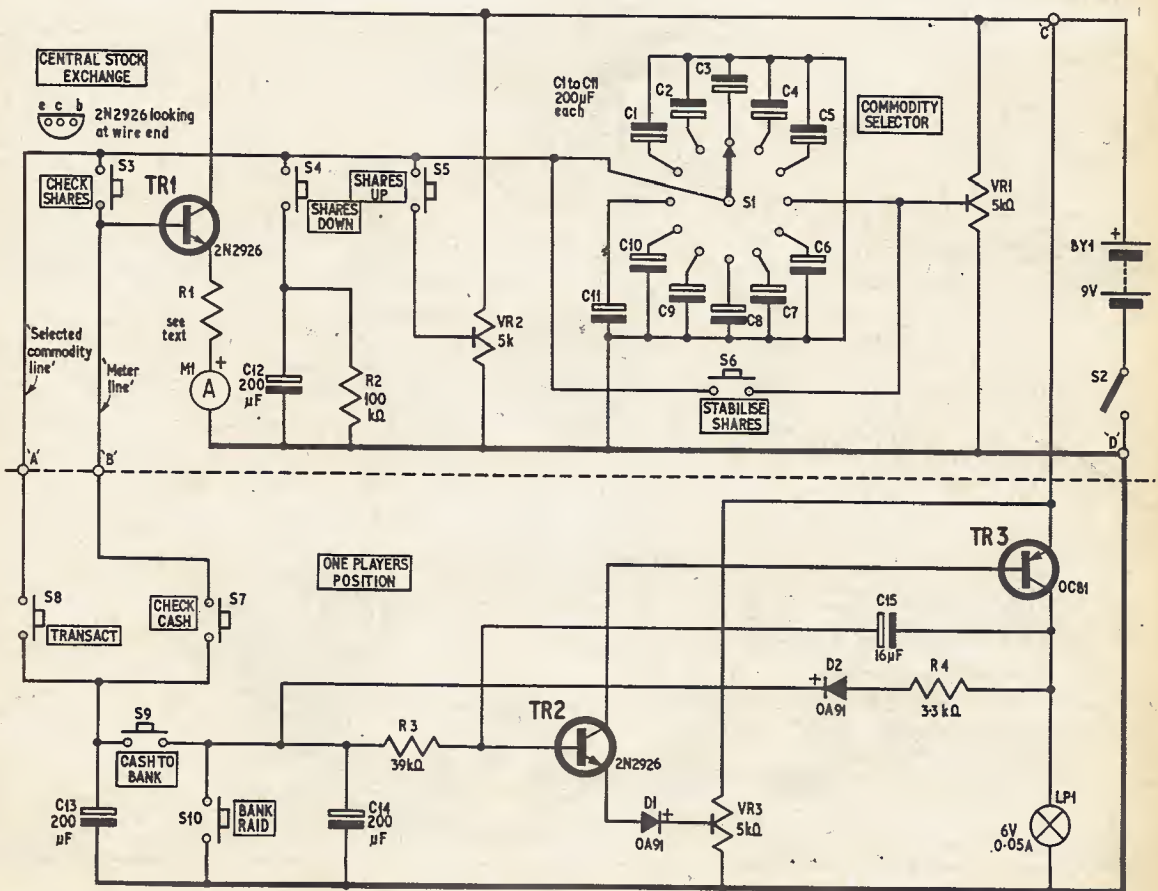

Fig. 1. Circuit diagram of the Central Stock Exchange and one Player's Position. Additional players' positions are connected similarly at "A", "B", "C" and "D"

BANK RAID

MILLION

CASH TO BANK

TRANSACT

CHECK GASH

Each player has four push button controls and a "million" lamp

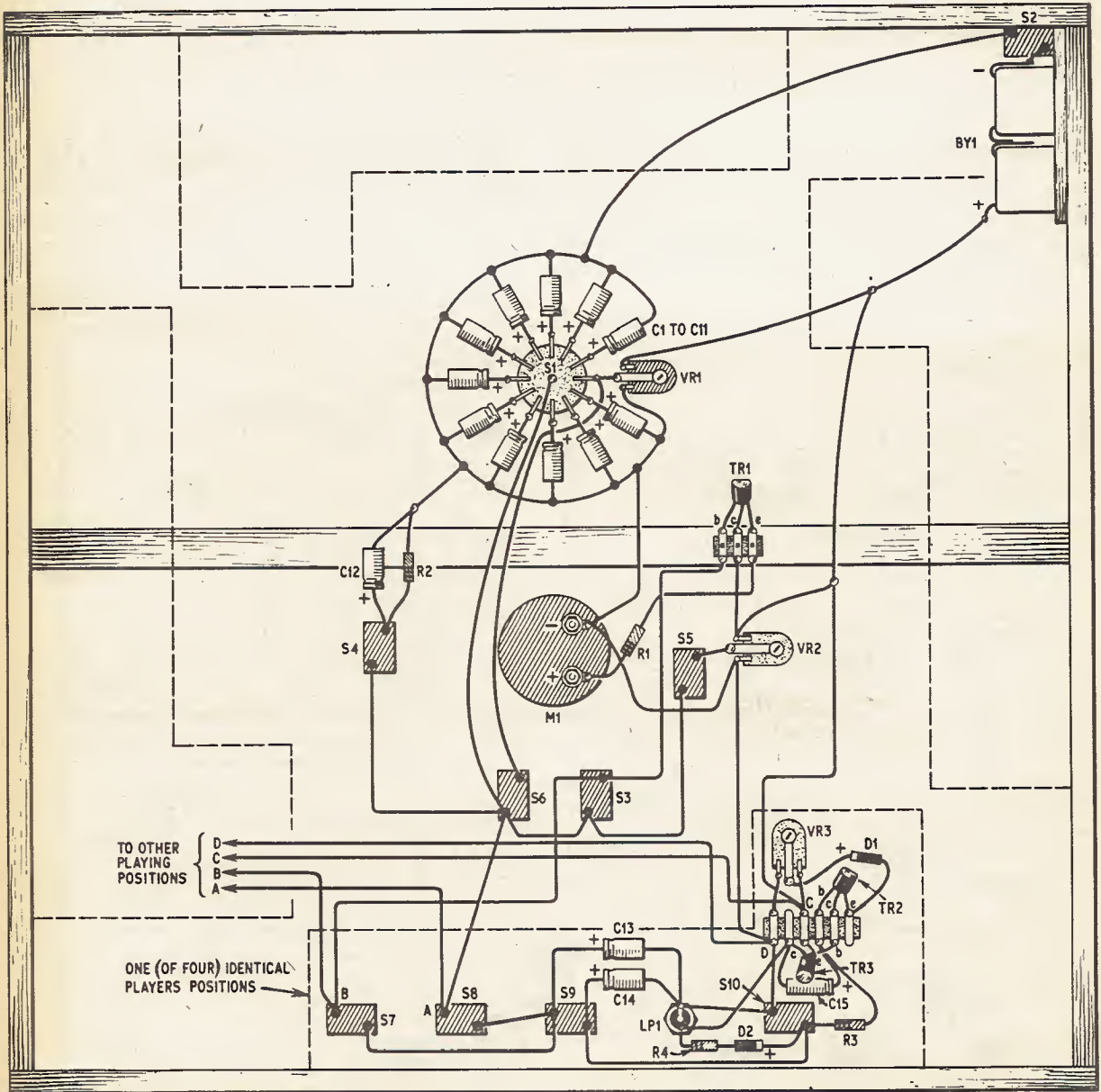

Fig. 2. Layout and wiring diagram of the Central Stock Exchange and one Player's Position. The player's position wiring within the dotted segment is repeated at the three other dotted positions. All players' positions are connected similarly at points "A", "B", "C" and "D"

part of their accumulated "cash". The transistor emitter follower circuit is designed to reduce this drain to a minimum, due to its characteristically high input impedance.

STOCK EXCHANGE COMMODITY SWITCH

The Stock Exchange is a simple common negative array of 11 200 μ F electrolytic capacitors, the positive terminals of which are connected to the stationary contacts of a 12-way single-pole rotary switch. The switch *must* be of the continuously rotating type, and it may be necessary to bend the stop on some types of switch to allow for this function.

COMPONENTS . . .

CENTRAL STOCK EXCHANGE

Resistors

R1 100k Ω if M1 is 50 μ A; 50k Ω if M1 is 100 μ A
R2 100k Ω

Potentiometers

VR1 5k Ω linear preset
VR2 5k Ω linear preset

Capacitors

C1 to C12 200 μ F elect. 10 or 12V (12 off)

Transistors

TR1 2N2926

Switches

S1 Single-pole 12-way rotary, continuous break before make type
S2 Single pole on/off toggle
S3 to S6 Push to make, release to break, Castelco type or similar push button switches (4 off)

Meter

M1 50 μ A or 100 μ A type MR65P (see R1 above)

Battery

BY1 4 $\frac{1}{2}$ V flat pack type 1289 (2 off)

Miscellaneous

Materials (hardboard and wood) to make the board according to requirements (see text)
Tag strips

PLAYER'S POSITION

One off each component referenced per player's position

Resistors

R3 39k Ω R4 3.3k Ω

Potentiometer

VR3 5k Ω linear preset

Capacitors

C13 200 μ F elect. 10 or 12V
C14 200 μ F elect. 10 or 12V
C15 16 μ F elect. 10 or 12V

Transistors and diodes

TR2 2N2926 TR3 OC81 DI, D2 OA91

Switches

S7 to S10 Push-to-make, release-to-break, Castelco type push button switches (4 off per position)

Lamp

LPI 6 to 8V 0.05 or 0.1A lamp in holder, panel indicator type

The twelfth stationary contact of the switch is taken to the wiper of a 5 kilohm preset potentiometer. This provides an arbitrary "tax" level, and the corresponding switch position is marked "tax". All other 11 positions of the switch pointer knob are marked with a set of stock-market commodities, e.g. "mining", "leather", "oil", etc. Ideas can be found in the financial pages of any national newspaper.

The Stock Exchange selector switch wiper is connected to a line termed the "selected commodity" line. It is to this line that each player connects his cash capacitor when transacting, in the hope of "milk-ing" the selected capacitor of some of its wealth. The line may also be connected to a preset high level via the "shares up" button, or to a discharged capacitor via the "shares down" button.

This reduces the selected capacitor's charge by about half, whether pushed once or more times, and also compensates for varying degrees of length of push, since the discharged capacitor has a long time constant resistor across it. All shares are stabilised at the commencement of a game by pushing the "stabilise shares" button and rotating the selector switch slowly. This levels all selected capacitors to the preset level of "tax".

PLAYERS' POSITIONS

The cash and bank capacitors of each player's position are connected by push-buttons to various lines as follows:

1. The "transact" button connects the cash capacitor to the selected commodity line.
2. The "check cash" button connects the cash capacitor to the common meter circuit, to allow the player to see his cash balance before and during transactions, etc.
3. The "cash to bank" button connects cash and bank capacitors together to allow high cash levels to be transferred to bank.
4. The "bank raid" button shorts out the bank capacitor.

All capacitors use a common "earth" or return line, and switching is achieved in the live lines.

The level detection and lamp drive circuit is simple, using a silicon 2N2926 transistor and a germanium OC81. Alternatively, two OC71's could be strapped in parallel for the second transistor. "Million" lamps should preferably be of 0.05A, but 0.01A types will serve since their use is intermittent during play.

CONSTRUCTION

The prototype was constructed on a hardboard sheet about 2ft square, supported underneath with wood battens to form a shallow inverted box. Controls and lamp holders were mounted through the hardboard, as was the meter, and all electronic circuits were built on single row strips of tag-board. These were later glued to the underside of the hardboard at convenient positions. All "floating" components were affixed by similar treatment.

Power lines from the batteries were attended to first, and this was followed by the wiring of basic lines, e.g. earth, selected commodity, transact, meter lines and so on. Wiring is quite a simple procedure if tackled in this manner. Note that all storage capacitors are 200 μ F 10 or 12 volt, and that they all have their negative ends connected to "earth".

THEORY OF OPERATION

Charges stored on capacitors are distributed and redistributed as the game progresses. Each transfer of charge is made from one capacitor to another, with the exception of "bank raid", "shares up" and "tax" operations.

Under normal play conditions "bank raid" occurs only occasionally to any one player, and the loss of potential to earth by this hazard is more than compensated for by the raising of selected shares by the "shares up" button. This effect is cumulative as the game progresses. Charges progress from the battery to the players' banks as follows:

- (a) Battery to selected commodity capacitor via "shares up" button.
- (b) Selected commodity capacitor to player's cash capacitor via his "transact" button.
- (c) Player's cash capacitor to his bank capacitor via "cash to bank" button.

At each transfer *a*, *b*, and *c* the charge (under the worst conditions) is halved, so that at each stage the original source is never completely depleted by a transfer. Note that there is a relatively long time constant on the "shares down" button capacitor. This adds interest to the game, in that if two "down" actions occur consecutively, the second results in less reduction of shares.

Initially, small charges may be transferred, but as charge builds up on a player's cash or bank capacitor, he has to note that he will only gain from an action in which he connects to a charge which is higher than his own—otherwise he will lose to the source. For instance, he may find himself buying shares instead of

selling them for cash. In this case the share price will rise at the expense of his cash balance.

For the same reason the game's taxman is considerate. If a player transacts with low cash balance, he will gain, but if he has more than the tax level, the latter will trim his balance down to size! As the rules explain, transaction with the taxman is compulsory when one's throw lands the selector switch to "tax".

PLAYING RULES

The suggested rules were compiled as a result of many trial games and have resulted in games lasting anything from 15 to 40 minutes, whilst giving dramatically exciting playing.

Before commencing a game, switch on the main battery switch, set "Stock Exchange" selector switch to "tax" and press "check shares" and "stabilise shares" buttons. Hold both down and slowly rotate the selector switch around all 12 positions. Stop on each position for about 3 seconds, or until the reading has stabilised to the tax level.

Next, ask each player to press his "bank raid" button, so that each starts without any bank balance.

With the selector back at tax position, ask each player *in turn* to press his "transact" button for about 3 seconds. This gives each player a starting cash potential equal to the tax level.

Stress to each player that he must never push any buttons out of turn, but to await his own turn of dice throw before doing anything.

The game is played by each player taking turns at throwing a dice. Dice throws are interpreted as in Table 1.

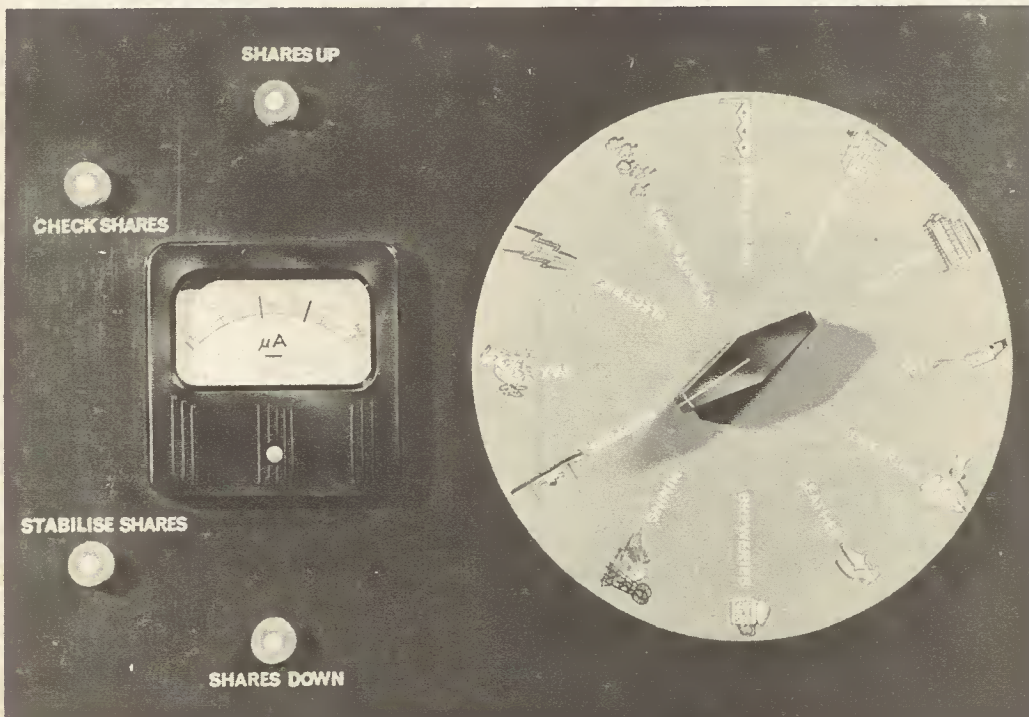

Close-up view of the Central Stock Exchange controls with meter

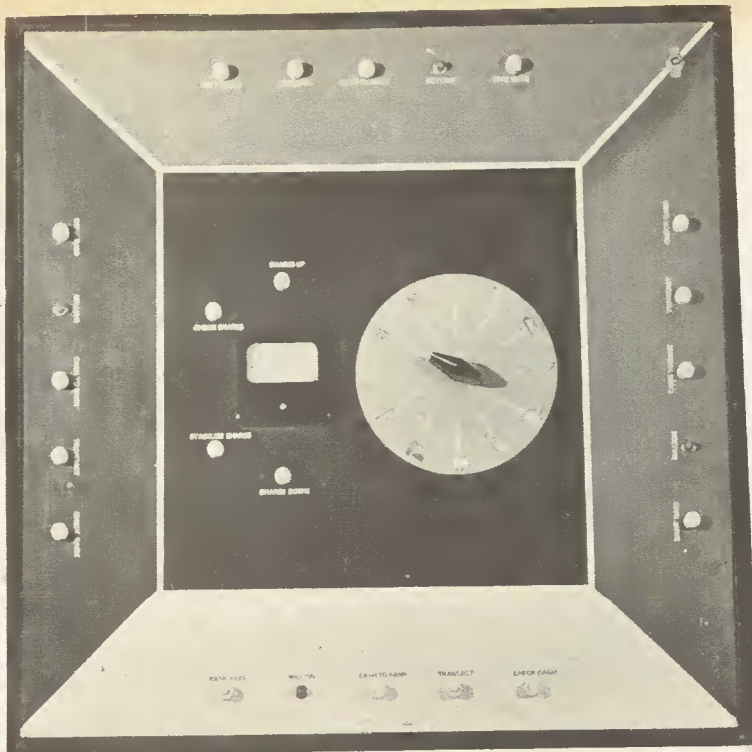

If, after moving the selector switch the required number of positions, it ends up pointing to "tax", the player *must* transact. He may watch what results by holding his "check cash" button down whilst transacting.

USE OF A CALLER

With the four-player version of this game, it is inevitable that the various labelling of share commodities will be read by some players better than by others. The prototype was labelled to be read from one position only, and this player was asked to move the selector, and to call out any share price changes as they occurred. He could be unofficially called the "stock broker's runner".

Table 1: DICE INTERPRETATION

Number thrown	Turn Selector Switch clockwise this number of positions	Other action by thrower
1	1	Press "shares down" button.
2	2	*Free choice of action unless switch lands on "tax".
3	3	Ditto.
4	4	Ditto.
5	1	Unless switch lands on "tax", must push own "bank raid" button.
6	1	Unless switch lands on "tax" push "shares up" button.

*Free Choice means that the player may press his "check cash" button to observe his cash balance, and choose whether he wishes to "transact" or put his cash to his bank by "cash to bank" button.

SUGGESTED LEVEL SETTINGS

The following levels were decided upon for the various presets, and were found by experiment to work out satisfactorily for normal lengths of play.

Shares Up Preset

Set to give hard over deflection on meter, but avoid turning to full 9 volt position. Press "shares up" and "check shares" buttons together with selector to any position but *not* "tax".

Tax Preset

Set selector switch to "tax" and press "check shares" button. Adjust to give half-scale deflection on meter.

Players' Positions "Million" Presets

Set selector switch to "tax" and hold down the "transact", "check shares", and "cash to bank" buttons together. Adjust preset to full 9 volt end and very slowly turn it back until "million" lamp flashes. Adjust very cautiously, since there is a delay in the lamp firing. Treat all positions similarly, and afterwards check each for final adjustment. The "million" lamps flash two or three times, and then remain on.

Length of Play Adjustment

The "shares up" preset will affect the length of play, as will the individual adjustment of the players' "million" presets. It may be necessary to make the players' "million" circuits fire at anything down to half of "tax" level. This is done by "inching" the "bank" capacitor up in small steps by repeated short depressions of the "transact" buttons, on "tax", with the "check cash" and "cash to bank" buttons held down on each position in turn. Alternatively the tax level could be reduced to half for the duration of the settings of the players' positions, and afterwards restored to half-scale.

The author has applied for Patent Rights on this Electronic Stockmarket game.

**2****SIGHT & TOUCH**

BIONICS

BY G.C. BROWN

M.S.H.A.A., A.M.R.S.H.

HAVING discovered the general lines upon which the conditioned reflex may be evoked, we can now utilise the knowledge to work out how we might synthesise it.

Examine the block schematic in Fig. 2.1. It will be seen that it has been drawn in the "black box" configuration; there are the two inputs S_s and S_n , and two outputs E_s and E_n . We now know that by application of input signals, reflex responses will appear at the output. Furthermore, we would expect to find evidence of a conditioned response to S_n at E_s , following the repeated combination of input S_n a short time prior to S_s . This pre-supposes that for S_n to remain effective up to the time S_s appears, it must be extended in time; put in another way, we need to include a short term memory for S_n .

A MEMORY DEVICE

When S_s makes its appearance for the first time, no *observable* reaction takes place; it is not until the input combination has occurred several times that an effect is elicited. Hence it would not be unreasonable to assume that some form of counting mechanism existed within the "black box", which had the ability to sum the number of times S_s had appeared just after S_n .

It would seem that this device therefore had the ability to exclude all reasonable possibilities for chance combinations of stimuli, by giving no output until an acceptable number of repetitions had occurred. We would then suppose that a gate (G2) would be opened by the summer which now allowed S_n to produce a conditioned response at E_s . (We might conceive of the summer as a type of long term memory). Once R_c has been established it will also be necessary to inhibit the normal response to S_n ; this is provided by gate G3.

DIFFERENTIATOR

Just to tidy up the "black box", a differentiator, and

another gate (G1), have been added. We need to know the *number* of times S_s has been applied, rather than the duration of its individual appearances; hence it is necessary to differentiate S_s prior to its summation with S_n . The extra gate has been included so that the short term memory can have a direct control over S_s once it has been differentiated.

The gates used here have been devised by the author to simplify explanation of the black boxes because their functions are largely analogue. Unlike the more normal logic gates which are either open or closed, these can be partly open, or partly closed. The cross-hatched gates are open until energised, and the remaining gates closed until energised.

INHIBITION SYNTHESIS

As yet, the black box has only fulfilled a few of its promises—it is to be expected that in addition to the excitation responses, we should be able to observe some aspects of inhibition too. A look at Fig. 2.2 will disclose that this should not be difficult to synthesise either.

Let us go back then, to where we investigated inhibition and ponder upon what we should expect to find inside the black box that could give rise to this phenomenon. As we only have two inputs available for stimulation, further distracting stimuli may of course be considered here as irrelevant. However, inhibition which is consequent upon application of S_n without S_s might be demonstrated. To accomplish this we need a further summer and two inhibit gates.

Assume that the "box" has been conditioned, and that S_n is being applied only, resulting in an output at E_s via G4 and G2. Seemingly, S_n would be passed via G5 to No. 2 summer, with the eventual result that G4 would be closed and hence inhibit further action for a while.

The design and construction of electronic "animals" or machines with artificial intelligence



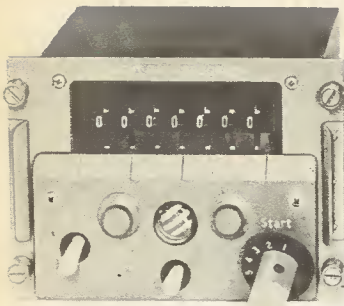

Digital display for the Plessey Flight data recorder

ESRO Satellite Checker

THIS second Elliott-Automation mobile satellite check-out station will exercise and test satellites from factory trials to launching for the European Space Research Organisation (ESRO).

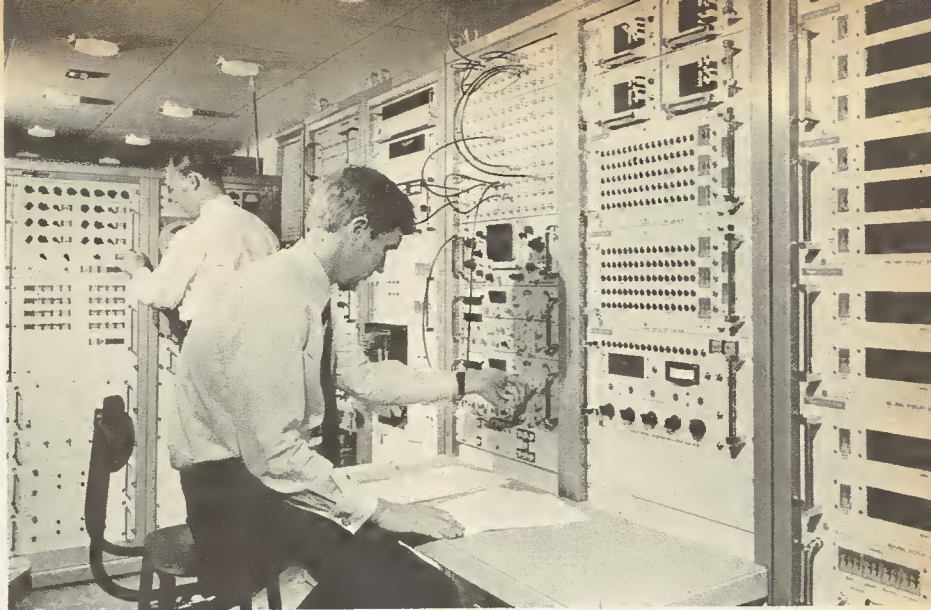

Phantom Reconnaissance Pod

THE latest McDonnell-Douglas Phantom F4M jet strike aircraft will carry a reconnaissance pod under the fuselage, which houses sideways and downwards looking radar, data converter for translating data into binary code for film storage, low level infra-red line scan equipment for ground close-ups, and cameras for day and night surveillance. The equipment has been developed by E.M.I. Electronics.



NORAMA ROUGH 1968

280,000-Channel Transceiver

A NEW military manpack transceiver, the Plessey B20 operates over the 2-30MHz range with 280,000 channels available in the a.m., c.w., and s.s.b. modes.



Nodding Heightfinder

THIS rather unusual looking scanner is the new Marconi "Heightfinder", part of the S600 series of radar equipment, designed for use in the C frequency band. It can be made static or transportable and will fold up for transportation. It is operated through a simple backwards and forward "nodding" action by computer control with height elevation angles between -5 and +55 degrees at velocities up to 45 degrees per second.



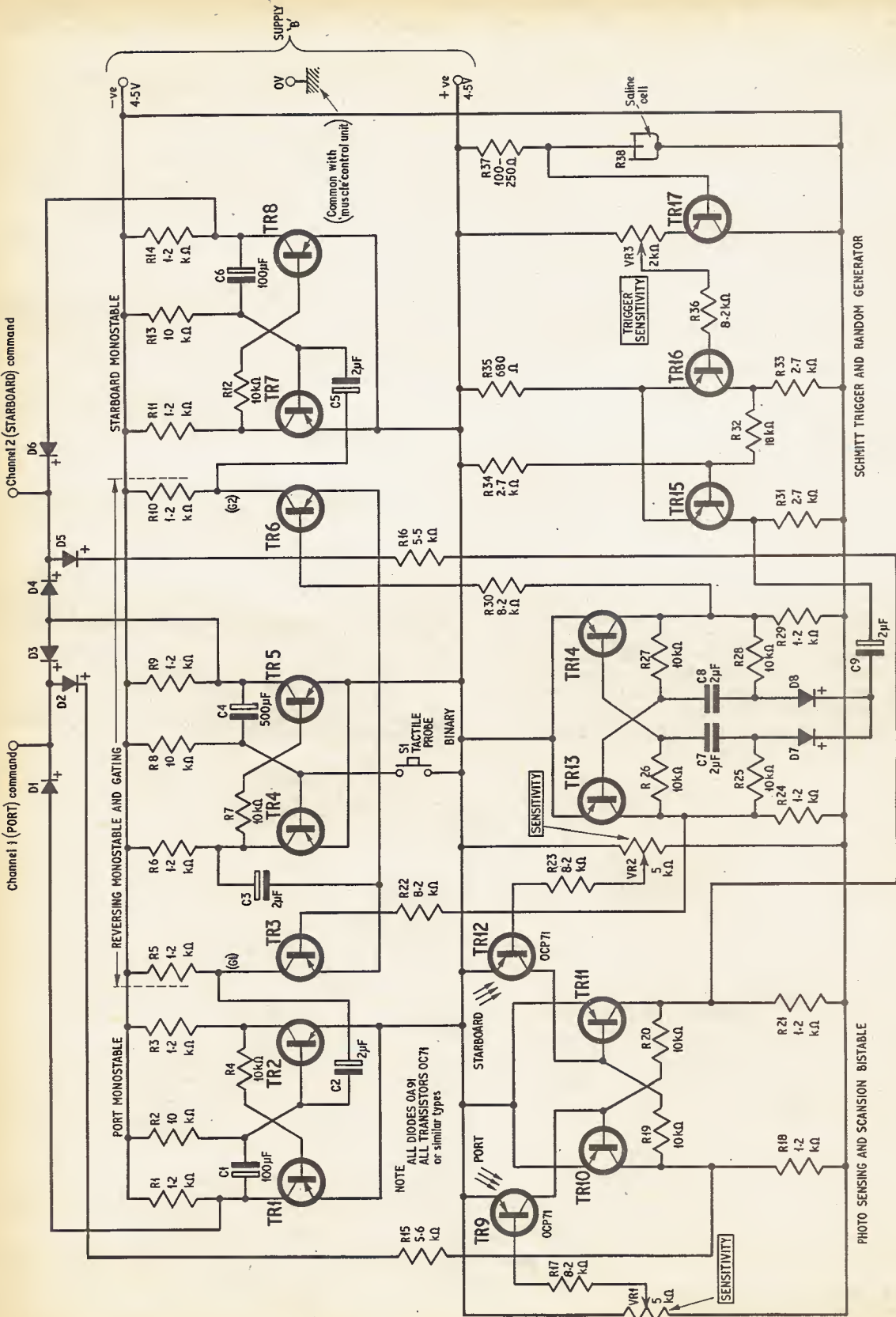

Fig. 2.4. Circuit diagram for the photo and tactile sensors and reflex sections of the system outlined in Fig. 2.3

DISINHIBITION SYNTHESIS

Using the same building bricks, disinhibition may also be included. On the assumption that R_c has been inhibited, if S_s is now presented, No. 2 summer will be cleared and G4 will then open again: the conditioned response will once more appear. As this summer has a decay characteristic, it follows that disinhibition will also occur with the passage of time.

Our "paper" model seems to function as we would wish. It appears to demonstrate simple learning, has the ability to store data in its memory, and shows certain preferences for particular meaningful combinations of stimuli. Readers here may object that we have built all this into the design: this, to a degree is correct but it must not be forgotten that this is true for a real live animal as well. After all, it is *endowed* with the equipment to learn, but these innate qualities cannot develop other than of the animal's own volition.

ELECTRONIC "GRAFTING"

The electronic counterpart of the learning aspects demonstrated by the black box model will be considered in the next article. However, in the meantime we must attend to the job of "grafting" in the sensory electronics, also the circuitry associated with scansion and reflexes. It must be remembered that most of the hardware is only temporary, so it would be as well to make provision for this in the "mobile breadboard" mentioned in Part 1 of this series.

Examination of Fig. 2.3 and 2.4 will familiarise the constructor with the circuitry being added to the existing breadboard. It will be noticed that we have effectively included two channels; one a combination of photo-sense and scansion, and the other dealing with tactile (or touch) stimuli. Although the building blocks used in the "animal" are fairly conventional, their interconnection and operation are a trifle unorthodox and so require some explanation. (The muscle control and motor drive circuits appeared in Fig. 1.2 last month.)

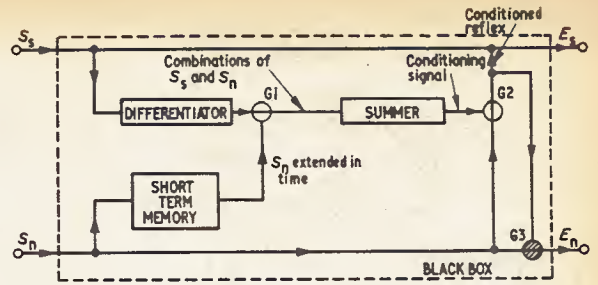

Fig. 2.1. Block diagram of a basic arrangement for synthesising conditional reflex action

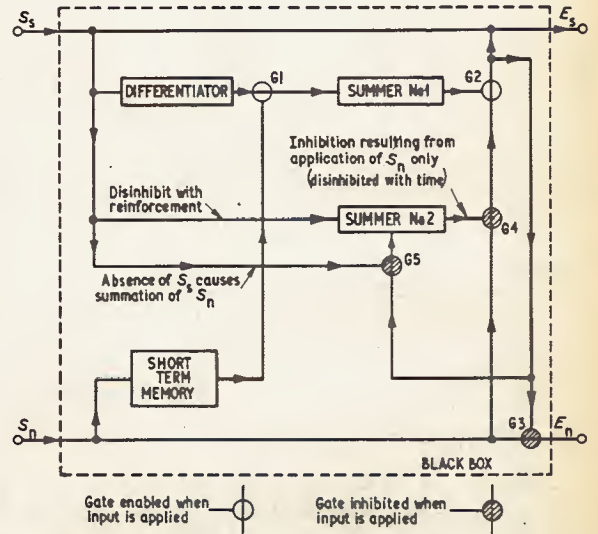

Fig. 2.2. The basic arrangement of Fig. 2.1 now developed to include inhibition synthesis

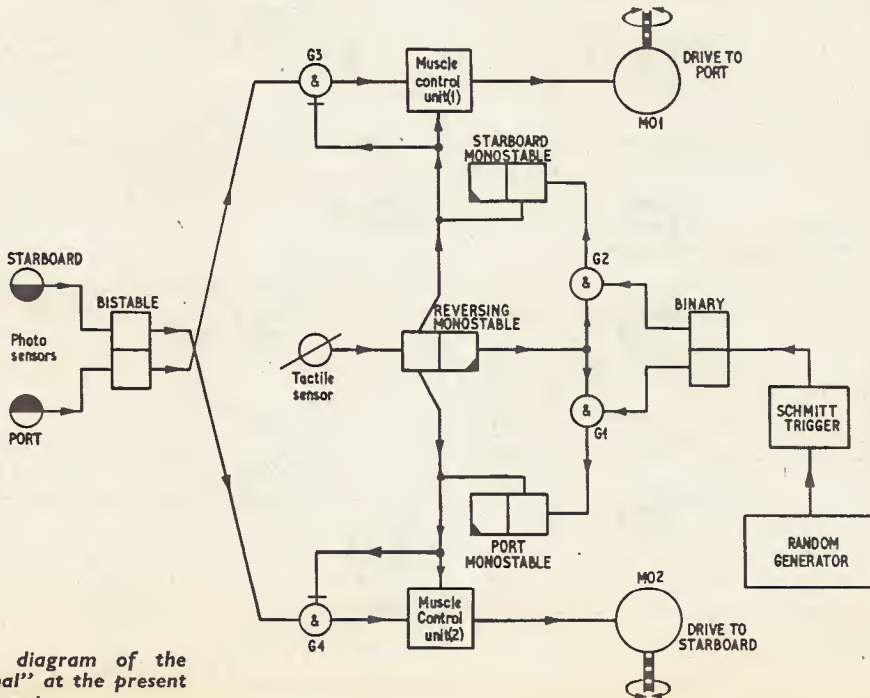

Fig. 2.3. Block diagram of the electronic "animal" at the present stage of development

later found necessary to introduce some randomness into the actual direction of turn. This was because there were occasions when if the "animal" experienced difficulties in extricating itself from a situation, a change of turn in the opposite direction often proved successful.

TOUCH SENSOR PROBE

In order to sense tactile stimuli, a probe system has been incorporated at the forward end of the "animal" (Fig. 2.5). This amounts to a simple pivoted affair, made from heavy gauge wire, and controlling a micro-switch or a pair of relay contacts. Upon contact with an obstacle in the "animal's" path, the probe will swing inwards to operate the switch, thereby generating a pulse.

The avoidance reaction is provided by three monostable flip-flops: one to provide the reversing characteristic, and the other two in order to produce turns.

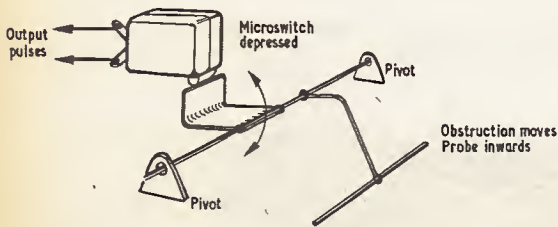

Fig. 2.5. A simple touch sensor probe

The pulse produced by the probe first triggers the reversing monostable, which causes the animal to move backwards; when the monostable flips back, a positive pulse will be fed to one or other "turn" monostables via either gate G1 or G2, resulting in the "animal" executing an appropriate turn. Once this final phase has been completed the "animal" will move in its normal forward direction.

RANDOM GENERATOR

The gates G1 and G2 are alternately switched in a random fashion under the control of a binary, driven via a Schmitt trigger, and a random generator. The design of the random generator posed quite a problem, for it was at first thought that the only basic prerequisite would be some form of white noise generator. However, it turns out that nearly all white noise generators produce pulse repetitions of too high an order (even after selecting pulses of only high amplitude). Eventually a relatively simple system was discovered that produced low occurrence pulses—this we shall use in our model.

The "noise" source (Fig. 2.6) is essentially a saline cell R38, consisting of two electrodes surrounded by a pad of cotton wool just saturated with a solution of ordinary table salt. The size of the container is not very important. It could be $\frac{1}{4}$ in to 1 in diameter, and about $\frac{1}{2}$ in to 1 in high.

When a current is passed through the cell, gassing occurs at the electrodes. Because the gas is given off rather irregularly, and because the "pockets" of gas surrounding the electrodes vary the dielectric of the cell, the current through it changes intermittently. These changes will produce a stream of pulses, each pulse varying in amplitude.

In the model we first amplify these pulses at TR17, then use the Schmitt to select those pulses with the highest amplitude. Finally the binary is switched by pulses from the Schmitt, resulting in G1 and G2 being enabled alternately. The "animal's" turning mode is thus quite random.

If during the "animal's" response to light it encounters an obstacle, the tactile sense will take priority and override or inhibit the photo reflex. This is brought about by interaction between the reflexes at diodes D1 to D6, the tactile response taking precedence due to the absence of resistors in the D3/D4, D1, and D6 lines.

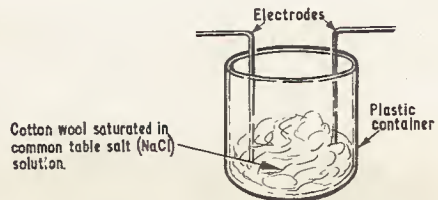

Fig. 2.6. A saline cell (R38) used as a random signal generator

SEPARATE POWER SUPPLIES

It should be noted that separate power supplies are utilised for the muscle control and reflex circuits. This is necessary since it is extremely likely that the motors will generate sufficient "noise" to interfere with the switching circuits. If the constructor intends using a common supply for both circuits, a very large measure of decoupling will be required in the muscle control circuit. In the recommended arrangement, the "OV" line is common to both circuits, i.e. Fig. 1.2 and Fig. 2.4.

In the present example a probe has been suggested for tactile sensing because this is a simple way of tackling the problem. However, other methods could be used as an alternative. The mercury switch is one example, but a more sophisticated scheme which we will consider in a later article makes use of the change in motor current accompanying increased mechanical loads. This concept will also open a vista of other interesting possibilities, but in the meantime we must be content with simplicity.

Anyhow, we now have a model that will respond to two kinds of stimuli. In the next article we will consider the design of the "learning" and "memory" electronics, and how they might be interconnected with existing functions.

To be continued

PHOTO SENSE AND SCANNING SYSTEMS

The photo sense and scanning systems have been designed to be positively photo-tropic; that is, light stimuli result in the "animal" moving towards, rather than away from, light. The circuit for this is a fairly simple arrangement comprising a pair of photo-transistors (photo-sensors) controlling a bistable flip-flop, which in turn feeds signals to the muscle control units mentioned in the previous article.

The photo-sensors are situated at the forward end of the "animal" and are located close together with their respective emitter areas facing port and starboard. In addition the areas of the sensors facing one another are painted black to prevent light pick up from the opposite side—this would otherwise result in an incorrect response.

Operation of the circuit is quite straightforward. Assuming that the supply has been switched on, but that the photo-sensors are not illuminated; then the bistable

short arcs when attracted to a source of illumination. In the absence of light the scanning mode is of course resumed.

LIGHT SENSITIVITY ADJUSTMENT

Sensitivity to light may be varied by adjustment of VR1 and VR2. These controls are necessary since TR9 and TR12 must not conduct during dark conditions. They are also of importance in preventing premature responses caused by ambient lighting conditions. The diodes D2 and D5 are included in the outputs of the bistable to maintain only negative or zero conditions, and also to prevent inter-action with other "forward" reflexes that could be added later.

There are obviously many ways in which the basic scanning configuration could be improved. One which might be considered would be to convert the bistable into a binary, and feed it with low occurrence pulses from a random generator similar to the type we shall be

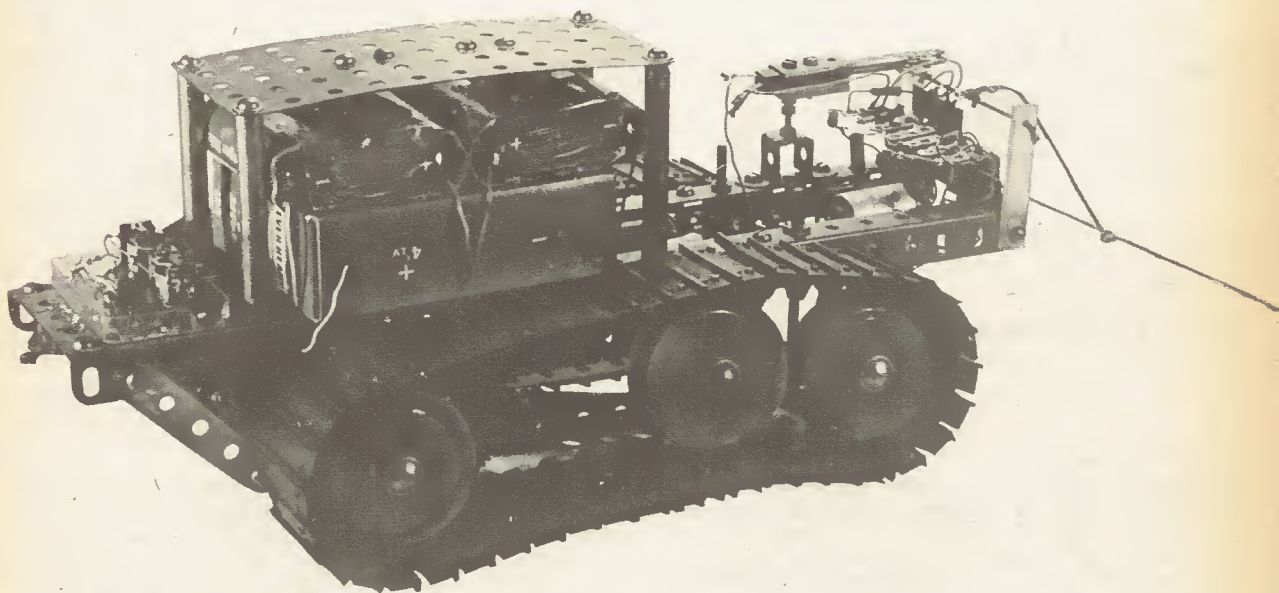

An electronic "animal" built by the author. This model uses a tracked drive. The tactile (touch) sensor probe and associated switch can be clearly seen

will be in one or other states—say TR10 switched off (collector negative) causing the muscle control units to drive the "animal" to port. It will therefore maintain a counter-clockwise movement, and thereby scan the field.

If during this scanning condition the starboard sensor encounters a light of sufficient strength, it will conduct, with the result that TR11 will be turned off and TR10 turned on. The port channel will now be inactive and the animal will turn to starboard homing on to the light.

When the light is encountered again, the bistable will switch once more causing a turn to port, and so on. The resulting gait of the "creature" will thus be cycloidal during scanning, and a rather wobbly line composed of

discussing for use in the tactile sense. The "animal", even in complete darkness, would then periodically change its direction of scanning, giving it a somewhat improved chance of locating a light source.

AVOIDANCE REACTION

Stimulation of the tactile sense has been designed to result in what might rightly be called an "avoidance reaction" (negatively tactile-tropic).

During its adventures, the "animal" is obviously going to meet a considerable number of obstacles in its path. With this in mind and after much trial and error, the best avoidance reaction found seemed to be that of a "reverse and turn" configuration. In addition it was

SINE WAVE TEST OSCILLATOR

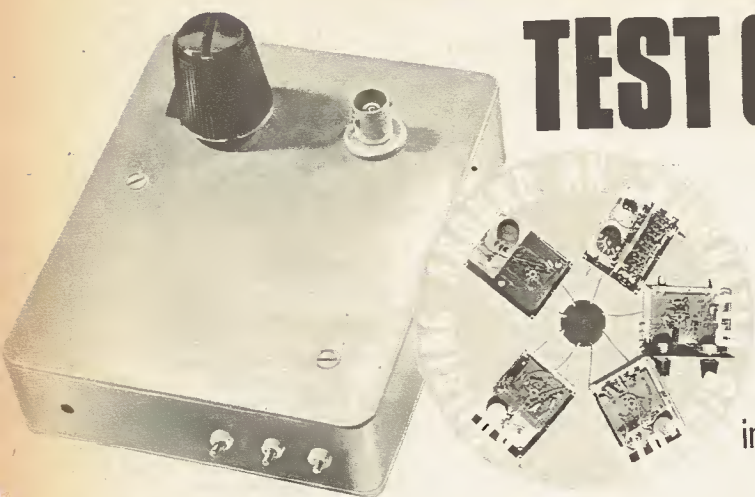

This is the fourth project
in our five-part series featuring the
integrated circuit linear amplifier Type SL701C

In the previous three articles we have considered, in effect, how we can use the Plessey SL701C integrated circuit for a.c. and d.c. amplification, but we have not yet used the circuit for signal generation. One simple circuit for generating a fixed frequency sine wave is dealt with this month, while the last of the practical circuits of this series (next month) deals with a fixed frequency square wave generator.

WIEN BRIDGE

Since the integrated circuit has both inverting and non-inverting inputs, a high input impedance, a low output impedance, and a high open loop gain, it can be used as the amplifier section of any of the well-known audio oscillators. Fig. 1 shows the Wien bridge oscillator circuit.

This network has zero phase shift and an attenuation of three times at a frequency given by:

$$f = \frac{1}{2\pi CR} \text{ Hz}$$

In the oscillator circuit a non-inverting gain of three times is needed for the amplifier, to complete the

positive feedback loop via the *C* and *R* network; while *R*2 and *R*3 provide negative feedback to maintain the gain at the required value of three times. A thermistor is normally used in the *R*2 position to provide automatic amplitude stabilisation. If the output of the amplifier tends to increase, more current passes through the thermistor and its resistance decreases, more negative feedback is applied around the amplifier, and the output is decreased. In this way the amplitude of the oscillator can be kept almost constant.

This circuit is used extensively as a variable frequency RC oscillator, since *R* can be made variable over a ten to one range with a double gang potentiometer, and the *C*'s can be switched.

Since the attenuation of the network is only three times at the oscillation frequency, its selectivity is not too good, and we would expect distortion to be in the order of 0.25 per cent. For a fixed frequency oscillator where we have no intention of attempting to switch components to cover a frequency range, we can with advantage use a much more selective network (even though it has more components) since we have a high gain available from our amplifier.

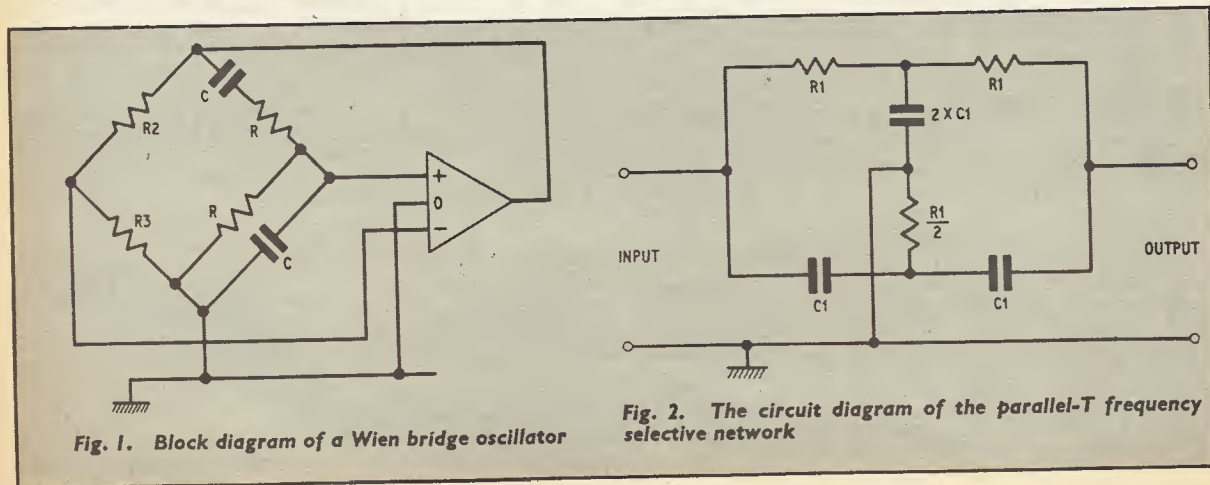

Fig. 1. Block diagram of a Wien bridge oscillator

Fig. 2. The circuit diagram of the parallel-T frequency selective network

MARKET PLACE

Items mentioned in this feature are usually available from electronic equipment and component retailers advertising in this magazine. However, where a full address is given, enquiries and orders should then be made direct to the firm concerned.

LIGHT DIMMER WITH SUPPRESSOR

The PH200 Dimlite lighting control from Photain Controls Ltd. incorporates a patented radio interference circuit which is believed to be the first of its kind to comply fully with the B.S.800 specification on radio interference.

Designed to fit a standard plaster depth switch box without modification it is easily fitted in place of most existing light switches. Installation is carried out by simply removing the

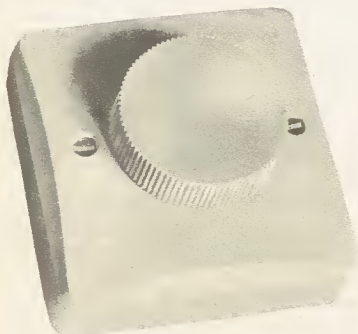

The PH 200 Dimlite from Photain Controls

front plate and connecting the lighting wires to the dimmer and screwing the unit to the recessed wall box.

The dimmer will control 200 watts of tungsten lighting load at 240V a.c. and measures $3\frac{1}{4}$ in \times $3\frac{1}{4}$ in \times $1\frac{1}{2}$ in. The unit incorporates an on/off switch and will vary the amount of the lighting from full brilliance down to 15 per cent of total load.

The cost of the PH200 Dimlite is £4 19s 6d and is available from Photain Controls Ltd., Randalls Road, Leatherhead, Surrey.

SOLDERING AND WIRE

A complete soldering kit for the home handyman and hobbyist has been marketed by Weller Electric Ltd. The kit, retailing at £2 1s 6d, contains a Marksman 25 watt soldering iron, two spare tips, a soldering aid—heat shunt, scraper and wire grip, and a coil of 60/40 solder.

Four standard interchangeable tips are available for the Marksman

range, comprising a cone tip, screw-driver tip, and chisel double-flat and single flat tips. Soldering tips are made from pre-tinned nickel plated copper and are simply screwed into the end when required.

An improved soldering iron is the Litesold 60 watt model from Light Soldering Developments Ltd. This iron is an improved version of the 55 watt model, which it replaces, and has a new style moulded nylon handle.

Other improvements feature spring collet mounting bit and the simplification of the element fixing arrangement.

The handle is also available in translucent nylon so that an internal indicator lamp can be installed to show when the iron is switched on, reducing the risk of accidental burns. This feature is to special order only.

A useful aid to the preparation of soldering is the Bib Model 6 wire stripper and cutter from Multicore Solders Ltd.

This new product, similar to other wire strippers manufactured by the same company, is sprung at the handle so that the tool automatically opens after an operation.

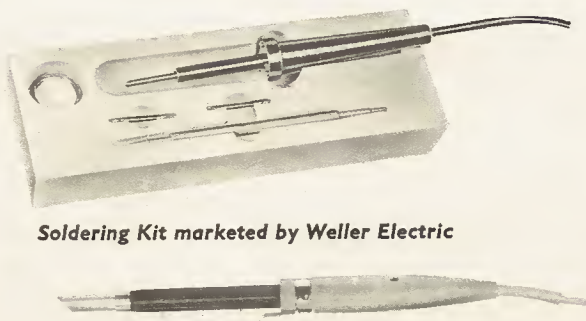

Soldering Kit marketed by Weller Electric

Litesold 60 watt iron from Light Soldering Developments



Bib Model 6 Wire Cutter and Stripper

The Model 6 enables the insulation to be easily removed from the ends of cables and flex, without nicking the wire. The aperture setting for different diameter wires is simply adjusted by a sliding screw in one of the handles. There are two cutting positions, one for normal flex, and the other on the tip for cutting wire after it has been connected to a tag or bolt. The handles are plastic covered and the tool is retained in the closed position by a handle slip ring.

The Bib Model 6 wire stripper retails at 8s 6d.

POWER TRANSISTOR

A safe-area power rating of 100W is the feature of the latest discrete-emitter power transistor BLY72 from SGS-Fairchild.

Discrete-emitter transistors are high performance power devices which instead of the usual single emitter, utilise a compound emitter made up of a multiplicity of discrete

emitter sites each linked to a common busbar by an integrated thin-film feedback resistor. This construction results in a claimed improved operating characteristics.

The BLY72 can be used for amplification or switching. Amplifier uses include r.f. communications, audio and servo amplifiers. Switching applications include inverters/converters, solenoid and relay drivers, and regulators.

Further details can be obtained from SGS-Fairchild Ltd., Planar House, Walton Street, Aylesbury, Bucks.

IC PACKAGE

An inexpensive new power plastic package for integrated circuits, the P20, has been introduced by Plessey Microelectronics of Swindon.

Planned eventually to accommodate a variety of chips, the P20 has already made its commercial debut in colour TV receivers. This encapsulation, which is particularly suited to commercial applications, will also be used for the fully integrated Plessey car radio, and 3 and 5 watt audio amplifiers, all due to appear later.

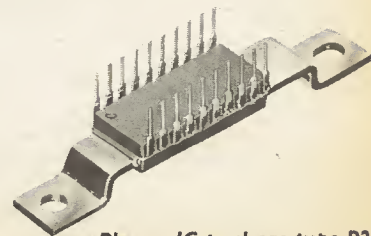

Plessey IC package type P20

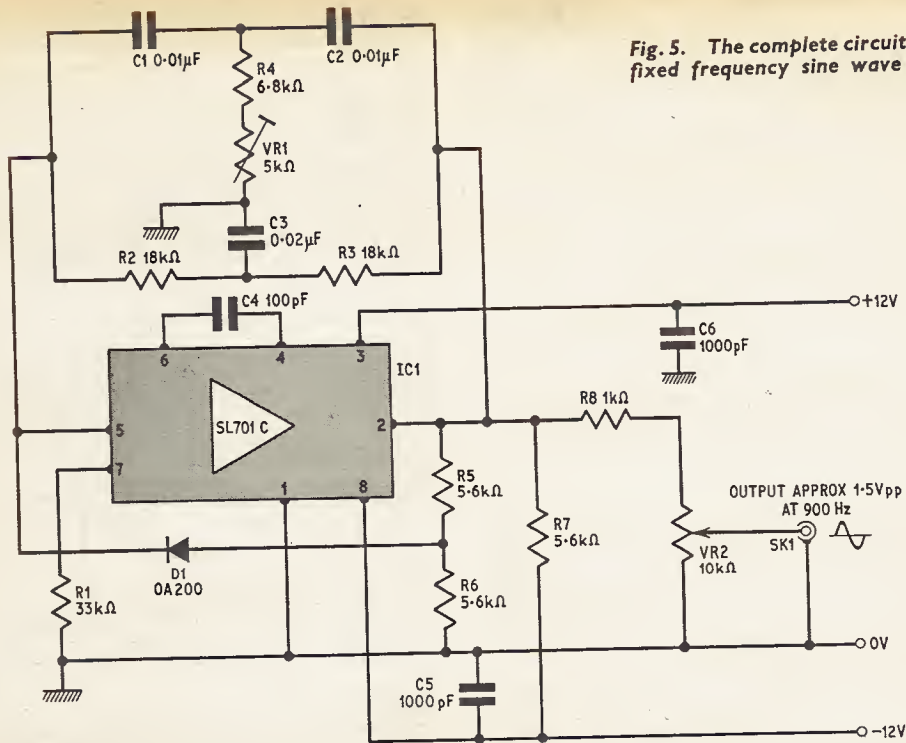

Fig. 5. The complete circuit diagram of the fixed frequency sine wave test oscillator

COMPONENTS . . .

Resistors

R1 33kΩ	R5 5.6kΩ
R2 18kΩ	R6 5.6kΩ
R3 18kΩ	R7 5.6kΩ
R4 6.8kΩ	R8 1kΩ

All 10%, ¼W carbon

Potentiometers

- VR1 5kΩ preset (Radiospares)
- VR2 10kΩ linear

Capacitors

- C1 0.01μF paper
- C2 0.01μF paper
- C3 0.02μF paper
- C4 100pF ceramic
- C5 1,000pF ceramic
- C6 1,000pF ceramic

Semiconductors

- IC1 Linear integrated circuit, d.c. coupled amplifier —SL701C. (Available direct from the makers: The Plessey Co. Ltd., Components Group, Cheney Manor, Swindon, Wiltshire. Price 18s)
- D1 OA200 or 1N14

Miscellaneous

- SK1 Coaxial socket
- Die-cast box 4½in × 3½in × 1in (Electroniques 46R.043A)
- Perforated s.r.b.p. 3½in × 2½in
- Three insulated feed-through terminals
- Control knob
- 22 s.w.g. plastics covered wire
- 6B.A. screws and nuts

A few figures will show why we can use a diode in this instance. If we assume that the diode conducts at 0.5V, then the output will be ±0.5V and if the network has a loss of 40dB, the amplifier input must be ±5mV. If the amplifier had a gain greater than 40dB the output would tend to build up, and if it reaches ±0.505V the diode conducts to feed back +5mV to reduce the input level, at this time, from -5mV to 0V. The diode only has to, in effect, clip 5mV off the output in order to completely reduce the input to zero. So our sine wave output is reduced from a possible ±0.505V to +0.5V and -0.505V and has a 1 per cent flat top.

In practice the onset of diode conduction is gradual, and we can adjust the network so that its loss is slightly less than the amplifier gain, and oscillations are maintained with a good waveform.

PRACTICAL CIRCUIT

For the values chosen:

$$f = \frac{1}{2\pi C_1 R_1} \text{ Hz} = \frac{1}{2\pi \cdot 0.01 \cdot 10^{-6} \cdot 18.10^3} \text{ Hz} = 900 \text{ Hz}$$

The complete circuit of the 900Hz oscillator is shown in Fig. 5. Positive feedback is applied via the network to the inverting input of IC1 (pin 5), and VR1 is a preset potentiometer to ensure that the bridge is unbalanced by the exact amount required to maintain oscillations. This control is adjusted from maximum towards minimum resistance until the circuit oscillates reliably, at this point the waveform is excellent. If the resistance is reduced still further the waveform becomes poor and the frequency departs from the theoretical value of 900Hz, but there is no difficulty in setting this control; especially if the waveform is observed on an oscilloscope.

PARALLEL-T NETWORK

The use of the parallel-T network of Fig. 2 to produce a null is well known. Without delving too much into the mathematics of this arrangement, we can see that there are two parallel, frequency selective paths between input and output. For the one path the time constant is:

$$t_1 = C1 \frac{R1}{2} \text{ secs}$$

For the other path the time constant is:

$$t_2 = R1.2C1 \text{ secs}$$

so that:

$$4t_1 = t_2 \text{ balance equation.}$$

For this arrangement, the null frequency is given by:

$$f = \frac{1}{2\pi C_1 R_1} \text{ Hz}$$

The depth of rejection at this frequency depends on the balance of components, obviously in practise (even if close tolerance components are used) the circuit *must* be unbalanced to some extent and only (say) 40dB of attenuation may be achieved at the null frequency. The gain characteristic is shown in Fig. 3 (a).

For the phase characteristics there are two possibilities, depending on the direction of unbalance. If $4t_1$ is greater than t_2 the phase characteristic returns through 0 degrees at f , as in Fig. 3 (b). If $4t_1$ is less than t_2 , the phase rotates through -180 degrees at f , and continues lagging to approach -360 degrees, as in Fig. 3 (c). The gain characteristics are identical, since we are talking in terms of *slight* unbalance.

We can use this network to form an oscillator by choosing the phase characteristic of Fig. 3 (c) and using the basic arrangement of Fig. 4. At low frequencies (below f) the resistive section provides an almost direct coupling between the output and input of the amplifier, and heavy negative feedback sets up our d.c. conditions. At f the network provides an extra 180 degree phase shift around the loop so that positive feedback occurs at this point and the circuit will oscillate provided that the attenuation of the parallel-T network is overcome by the gain of the amplifier.

For this circuit to work and give a reasonable waveform the degree of unbalance must be kept small, and the network attenuation will be large, so that a high gain amplifier is essential.

DIODE LIMITER

In Fig. 4 the diode D provides a large amount of negative feedback when the positive signal peak just brings the diode into conduction, and hence limits the signal output. Since the network has a high Q (good selectivity) this does not cause a distorted output waveform. The process can be likened to preventing the build up of oscillation of a swing. A child on a swing can move her legs with sufficient power just to cause oscillations to increase in amplitude, while a parent can maintain any desired peak to peak amplitude by applying a retarding force at one peak of the excursion only.

If we had used a less selective network (such as the Wien bridge) then the diode limiter would have to be replaced by a less drastic (non-clipping) arrangement (such as a thermistor) as the gain determining element in order to maintain distortion at an acceptable level.

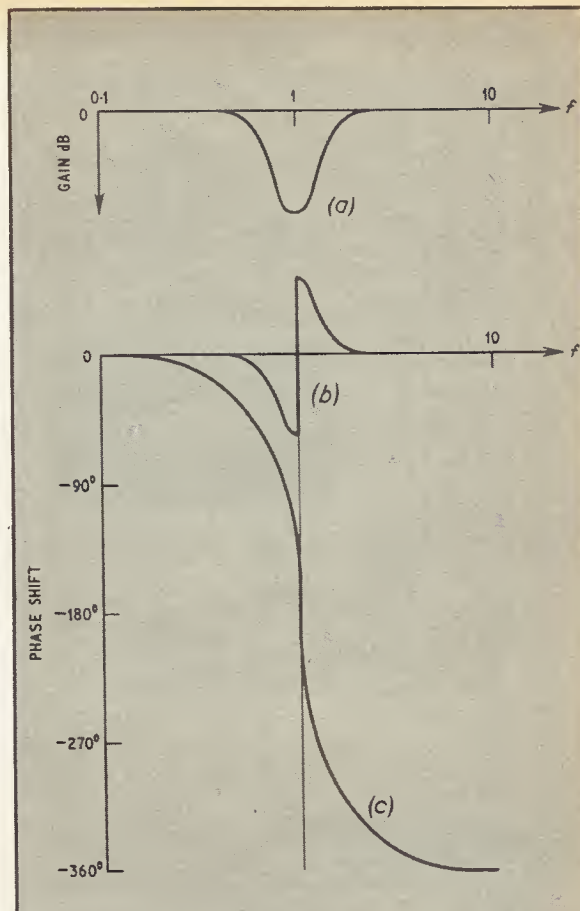

Fig. 3. The gain characteristic of the parallel-T network at point (a). The phase characteristic for one condition of unbalance of the network is given at point (b) and the other possible condition of unbalance is shown at point (c)

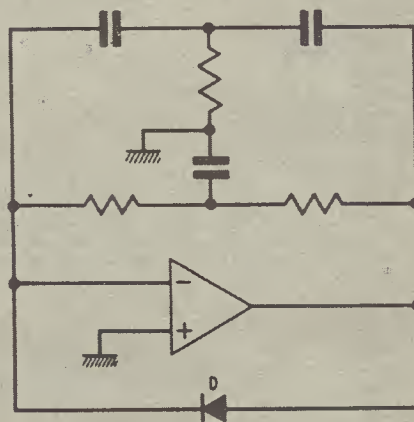

Fig. 4. The block diagram of a parallel-T oscillator

POLAR WIND

During September there was a symposium held in Washington on the Physics of the Magnetosphere. From the University of California at San Diego came Dr Peter Banks with an announcement of his discovery of a "polar wind". Some 300 or so scientists from all parts of the world attended this symposium to review the progress and assess what had been learned about the magnetosphere.

It is well known that the magnetosphere forms an invisible envelope that is shaped somewhat like a tear drop. The larger part is on the sunward side of the Earth and the tail extends outwards on the opposite side for some three million kilometres. It is forced into this shape by the solar wind which sets up tremendous forces along the Earth's magnetic field. This has been established by many observations which have been made of artificial satellites and records from satellites.



Now comes the discovery of this "polar wind" streaming out from the north and south poles of the Earth. It is in fact a portion of the Earth's atmosphere escaping into space. Though it consists of atmospheric electrons and atoms of oxygen, helium, nitrogen and hydrogen the loss of the Earth's atmosphere is negligible. There is no threat to the life supporting oxygen or other necessary constituents of the atmosphere. Once again the discovery has been confirmed by a satellite and this time it was *Explorer 31*.

It seems that the action results from the warming pressure of sunlight. This causes an expansion and the "polar wind" blows down the magnetic tail of the Earth and escapes through the magnetic field lines at the poles. An interesting comment was made by Dr I. A. Zhulin of the Soviet Union who suggested that here there was an opportunity to set up a solar-terrestrial warning system for passengers who will ride in supersonic transports. Such craft which will be flying at 20 miles altitude would be subject to the hazards of radiation from solar storms, auroral storms and residual radiation from the Van Allen belts. It should be noted that the U.S. is already

operating a solar-terrestrial warning system with headquarters at Boulder, Colorado.

ROUND THE MOON AND BACK

The U.S.S.R. successfully launched a space vehicle which under automatic control circumnavigated the Moon and returned to Earth to be safely recovered from a touch down in the Indian ocean. It seems certain that this was a test not only for the control systems but also for a vehicle some six tonnes in weight to be brought near to the moon. *Zond 5*, as it was called, was almost certainly one of the Voyus line of vehicles.

The previous test flight in near-Earth orbit of *Zond 4*, also a Voyus type of craft, was no doubt the beginning of a series of tests prior to sending a vehicle round the moon and back with one or more astronauts on board. The Voyus are known to have special facilities for automatic

docking and rendezvous techniques. Following the usual carefully planned method used by Soviet scientists in arranging the sequence of testing it would seem that an attempt to go on to the next step is imminent. This could mean that the margin between the U.S. and U.S.S.R. technology is very narrow. However the vital question of who will be first remains to be answered in the not too distant future.

A test flight of *Apollo 7* with three astronauts aboard in an Earth orbit practice mission was launched on October 11 and was equipped to allow for up to 11 days in orbit. It was arranged as an "open ended" flight, that is to say the astronauts were to remain in orbit as long as there was no malfunction which compelled the termination of the mission. Its 165 revolutions were successful; *Apollo 8* will follow in December and *Apollo 9* in the early part of 1969.

Dr Thomas O. Paine who succeeded James Webb as secretary of the National Aeronautics and Space Administration (NASA) said that the prospect of a lunar landing in late 1969 depends upon the success of the *Apollo* space vehicles 7, 8 and 9. *Apollo 8*, though capable of going round the moon and back, is at the moment scheduled as a repeat of

Apollo 7 and will be the first manned flight of the *Saturn-Five* moon rocket. *Apollo 9*, the first manned flight with full moonship complement (service, command and lunar landing modules) is scheduled for the first quarter of 1969 as a far out earth orbit flight, subject to what may happen in December. Dr Paine also had something to say about the requirements for a moon landing by the U.S.S.R.

"The U.S.S.R. problem was to develop a rocket with more than the 3.1 million pounds thrust vehicle they now had and there was evidence that they were doing this. The alternative for them was to assemble in an earth orbit the 50 tonnes or so of equipment needed with smaller rockets."

APOLLO 7

Though there is no information from the U.S.S.R. about their vehicles there is plenty from the U.S. about the *Apollo* craft. The arrangement of *Apollo 7* is in seven distinct parts with total height of 67m (224ft). At the bottom of the stack is the first stage of Saturn 1B rocket 24m high (80.2ft) and 6.5m in diameter (21.5ft) and weighing about 450,000 kilograms (almost a million pounds) when fueled. On this is a three rocket second stage, the S-4B. This is 17.5m high (58.4ft) and 6.5m (21.5ft) in diameter with a weight when fueled of 112,000 kilograms (250,000lb).

Then follows a ring 0.9m high and 6.25m (nearly 21ft) in diameter. This is the section which houses the instrument unit and contains the sophisticated electronic equipment for monitoring and controlling the vehicle from the moment of lift-off until its insertion into orbit.

Above the instrument unit is a conical section called the Spacecraft Lunar Module Adapter. This is 8.4m high (28ft) and has a bottom diameter of 6.7m (22ft) and tapers to a diameter of 3.9m (nearly 13ft). It is a container for the Lunar Module, the four-legged lunar landing vehicle. The Module has to be in this container to protect it from the atmosphere during launch since it is designed for operation in space.

On the first flight of *Apollo 7* the Lunar Module was not included, which reduced the weight of this section. Above this is the Service Module with a height of 6.6m (22ft) and a diameter of 3.9m (nearly 13ft). Above this again is the Command Module, the conical unit in which the astronauts lived between the time of launch and landing. This is 3.6m high and 3.9m in diameter at the bottom, tapering almost to a point at the top. Of the seven units only the Command Module returned to earth intact. The last one to be jettisoned was the Service Module which was not needed for re-entry.

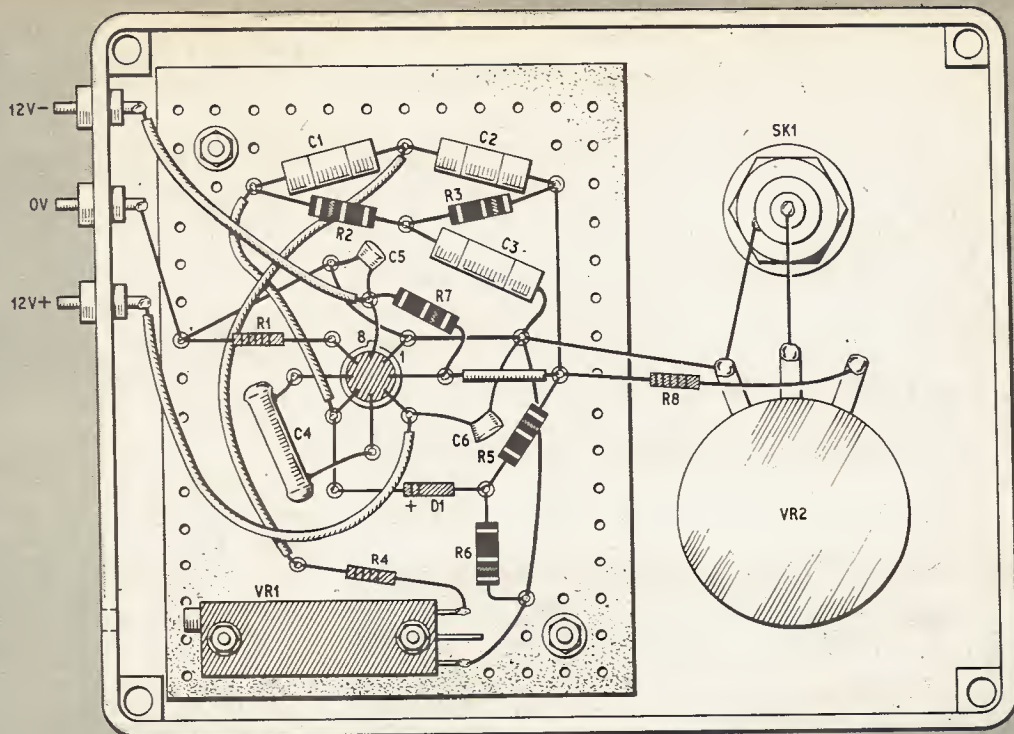

Fig. 6. Layout and wiring of the fixed frequency sine wave test oscillator

Since only a small amount of negative feedback is required to amplitude limit the oscillations, it is essential to use a silicon diode for this purpose as a germanium diode would have too high a leakage current and would not have a high resistance in the non-conducting state. The onset of diode conduction is lower than the 0.7V normally associated with the forward volt drop of a fully conducting silicon diode, so the diode is tapped down the output in order to maintain a reasonable output level of about 1V peak to peak. The output can be increased if required by decreasing the lower 5.6 kilohm resistor R6 to a value of 2.7 kilohm in order to provide the extra swing required.

Other fixed frequencies could be generated by altering the components for the T network, while maintaining the relationships outlined in the theoretical section of the article.

The level of signal applied to the output socket SK1 is controllable by the potentiometer VR2.

CONSTRUCTION

The construction is straightforward and on similar lines to previous articles. The s.r.b.p. board should be drilled for mounting in the case, and the soldering pins carefully inserted as indicated in Fig. 6. The integrated circuit IC1 and components should then be soldered in position. Particular care should be taken to avoid damage through excessive heat when soldering the IC.

The case should be drilled to receive the three power supply feed-through terminals, output socket SK1 and level control VR2. A small hole should be drilled in the side of the case to allow adjustment of the preset control VR1. The position of the hole should be ascertained by first laying the s.r.b.p. board in the case as a guide, and then marking the side of the box.

The board is secured in the die-cast box, using extra nuts or spacers to provide clearance between the metal and live points on the circuit board. Once the board has been mounted in the case, to complete the wiring of the unit all interconnecting leads and resistor R8 should be soldered in position.

ERRATUM

Switched Gain General Purpose Amplifier—Sept. 68, page 619. In Table 1 noise referred to the input should be in microvolts, i.e. 200 μ V and 24 μ V.

Next month: A fixed frequency Square Wave Test Oscillator

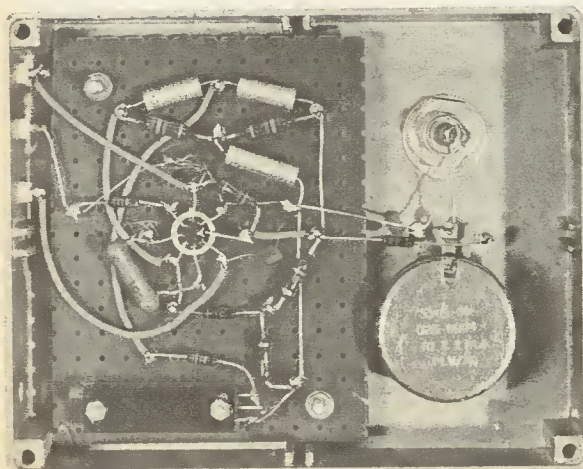

ELECTROVALUE

Rapid Mail Order Service UNBEATABLE VALUE IN NEW SEMICONDUCTORS

30 watt BAILEY AMPLIFIER complement
 MJ481 npn } matched pair output £2.19.0 40361 12/8; 40362 18/8; BC125 12/-;
 MJ491 pnp } BC126 12/-; BC107 2/9; BC109 2/8.
 40361 npn } matched pair drivers £1.10.3
 40362 pnp }
 Total for one channel £7.8.0 list; with 10% discount only £6.13.8.
 Total for two channels £14.16.0 list; with 15% discount only £12.11.8.

G.E. 2N2926 PLASTIC range: 18V 200mW:
 Red spot $\beta = 55$ to 110 2/8 Yellow spot $\beta = 150$ to 300 2/9
 Orange spot $\beta = 90$ to 180 2/8 Green spot $\beta = 235$ to 470 3/-
 2N2926, our choice of colour 2/2 each, 10 for 21/-.
 High reliability ceramic types available:
 CS2926 red 3/8; orange 4/-; yellow 4/8; CS2925 25V $\beta = 235$ to 470 5/-.

TEXAS SILECT range
 30V 300mA npn
 2N3704 $\beta = 90$ to 330 4/-
 2N3705 $\beta = 45$ to 165 3/8
 25V 200mA pnp
 2N3702 $\beta = 60$ to 300 4/-
 2N3703 $\beta = 30$ to 150 3/8
 small signal npn
 2N3707 low noise 4/6
 2N3711 $\beta = 180$ to 660 4/-
 small signal pnp
 2N4058 low noise 5/-
 2N4062 $\beta = 180$ to 660 4/3

BC107 SERIES
 300mW 300MHz IT T018
 BC107 45V $\beta = 125$ to 500 2/9
 BC108 20V $\beta = 125$ to 900 2/8
 BC109 20V $\beta = 240$ to 900 2/9

BC167 SERIES
 160mW 300MHz IT T092
 BC167 45V $\beta = 125$ to 500 2/3
 BC168 20V $\beta = 125$ to 900 2/-
 BC169 20V $\beta = 240$ to 900 2/3
 BC109 and BC169 are low noise.
 BC167, BC168 and BC169 are plastic.

FETs: MPF105 25V max., gm = 2 to 6mA/V, low noise 3/-
 2N3919 25V max., gm = 2 to 6mA/V, low noise 10/-.

Mini TRANSISTORS WITH MIGHTY SPECIFICATIONS
 2N4285 PNP hFE 35-150 @ 10mA. fT 7MHz min.
 2N4286 PNP 30V hFE over 100 @ 10mA to 1mA. fT 280MHz typ.
 2N4289 PNP 60V hFE over 100 @ 100 μ A to 1mA. fT 170MHz typ.
 2N4291 PNP 40V hFE over 100 @ 100 μ A complementary driver/output.
 2N3794 NPN 40V hFE over 100 @ 100mA
 2N4292 NPN 30V UHF, N.F. 6dB max @ 100MHz. fT 570MHz typ.
 B5001 Power, 14-3W @ 100°C base temp. Insulated base, T066 size. 35V, hFE over 100 @ 0.5A.
 Prices: 2N4285 to 2N4292, 2N3794, 3/3; B5001, 13/8.

*RECTIFIERS: 100V PIV 1A Type TS1, 2/-; 400V PIV 1A Type TS4, 2/9.
 850V PIV 1/2A Type BY238, 3/9; 1,000V PIV 1/2A Type 1N5054, 3/11.

FOR FURTHER DATA on the above semiconductors and many others, see our catalogue, price 1/- only, post free.

Zener diodes 3V to 27V 5% 400mW all preferred voltages, 4/8 each.

PEAK SOUND CIR-KIT No. 3 Pack, 12/6; adhesive copper strip, 5ft x 1/2 or 3/4 in, 2/-; 100ft x 1/2 or 3/4 in, 30/-; Perforated board 0.1in matrix 5in x 3 1/2 in, 4/-; 2 1/2 in x 3 1/2 in, 2/6; 2in x 3 1/2 in, 1/9.
 ALL PEAK SOUND PRODUCTS AS ADVERTISED

*SUPER QUALITY NEW RESISTORS

Carbon film high stab, low noise:
 1W 10% 1 Ω to 3 Ω } 1/10 doz., 14/6 per 100.
 1W 5% 3.9 Ω to 1M Ω }
 1/2W 10% 4.7 Ω to 10M Ω 1/9 doz., 13/6 per 100.
 1/2W 5% 4.7 Ω to 10M Ω 2/2 doz., 17/- per 100.
 1W 10% 4.7 Ω to 10M Ω 4d each, 3/3 doz., 25/10 per 100.
 1/6 less per 100 if ordered in complete 100's of one ohmic value. Please state resistance values required.

QUALITY CARBON SKELETON PRE-SETS: 100 Ω , 250 Ω , 500 Ω , 1k Ω , 2k Ω , 2.5k Ω , 5k Ω , 10k Ω , 20k Ω , 50k Ω , 100k Ω , 200k Ω , 250k Ω , 500k Ω , 1M Ω , 2M Ω , 2.5M Ω , 5M Ω , 10M Ω .

Available in horizontal or vertical mounting, 1/- each.
 ELECTROLYTICS, SUB-MIN., C426 range (μ F/V): 0.64/64, 1/40, 1.6/25, 2.5/16, 2.5/64, 4/10, 4/40, 5/64, 6.4/6.4, 6.4/25, 8/4, 8/40, 10/2.5, 10/16, 10/64, 12.5/25, 15/10, 16/40, 20/16, 20/64, 25/6.4, 25/25, 32/4, 32/10, 32/40, 32/64, 40/2.5, 40/16, 50/6.4, 50/25, 50/40, 64/4, 64/10, 80/2.5, 80/16, 80/25, 100/6.4, 125/4, 125/10, 125/16, 160/2.5, 200/6.4, 200/10, 250/4, 320/2.5, 320/6.4, 400/4, 500/2.5, 1/4 each.

ELECTROLYTICS, MINIATURE (μ F/V): 5/10, 10/10, 10/25, 25/10, 50/10, 50 each.
 25/25, 50/25, 100/10, 200/10, 1/- each, 50/50 2/-, 100/50, 2/8, 250 μ F 25V 2/8.

POTENTIOMETERS (short spindle): 100 Ω to 10M Ω lin. 5K Ω to 5M Ω log 2/3 each, Dual (long spindle): 10K, 25K, 50K, 100K lin or log, 10/8 each.

*ALL GOODS BRAND NEW *NO "SECONDS" OR SURPLUS

COMPONENT DISCOUNTS: 10% for total order value exceeding £3 list.
 15% for total order value exceeding £10 list.
 Post and Packing: up to £1-1/- Free on order over £1.

OVERSEAS ORDERS WELCOMED—Carriage at cost.

SEND 1/- for our catalogue containing data on 200 up-to-date semiconductors available from stock as well as many other components, also transistor equivalents table. Invaluable to every serious experimenter and designer. Everything at best possible prices.

Stores telephone No. EGHAM 5533 (STD 0784-3)

ELECTROVALUE

(Dept. P.E.12) 6 MANSFIELD PLACE, ASCOT, BERKS

Opportunity of a lifetime! Big price reductions on top quality knights-kits

Easy to build. Designed to highest specifications. Unbeatable quality and superb performance guaranteed.



KG980 Solid-State Stereo FM Receiver Kit

Silicon transistors. Control facilities for phono and tape. Extra-wide power bandwidth and response. 240V, 50Hz AC. Kit £35. 3. 6. Teak case extra £5. 15. 6. (inc. PT.) Tuning heart extra £7. 19. 0. (inc. PT.)



KG765A Solid-State Stereo FM-AM Tuner

Frequency response 1dB, 20-20,000 Hz. Hum and noise (f.m.) 55dB down. Outstanding in weak signal areas. Kit £34. 14. 2. Teak case extra £5 (inc. PT.) Tuning heart extra £10. 15. 4. (inc. PT.)



KG795 Stereo Tuner

F.M. \pm 1dB, 30-15,000 Hz. Hum and noise better than -50dB. Tuning range 88-108 MHz. Channel separation 30dB or more at 1kHz. Kit £34. 14. 2. Teak case extra £5. 7. 6. (inc. PT.) Tuning heart extra £6. 16. 0. (inc. PT.)



KG854 Stereo Amplifier

Advanced design. 14 transistors. 2 silicon diodes. Full controls. Response \pm 1dB, 20-25,000 Hz. Kit £42. 9. 0. Teak case extra £5 (inc. PT.)



KG964 Stereo FM-AM Receiver

For the perfectionist. Powerful 64-watt Hi-Fi Amplifiers. 46 semiconductors. Full controls. Factory assembled FM Front-end, FM-AM IF Circuits, transformers and coils. Response \pm 1dB, 20-20,000 Hz. Hum and noise 55dB. Kit £62. 8. 4. Teak case extra £8. 12. 7. (inc. PT.) Tuning heart extra £20. 1. 4. (inc. PT.)



KG790 Stereo AM-FM Tuner

22 Transistors. 14 diodes. Response \pm 2dB, 50 Hz to 15 kHz. Hum and noise -60dB. Range 87.5 to 108.5 MHz. Kit £55. 18. 2. Teak case extra £8. 9. 6. (inc. PT.) Tuning heart extra £20. 1. 4. (inc. PT.)

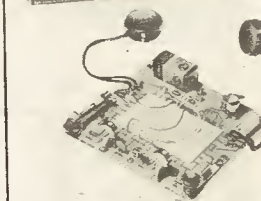

21 Circuit Transistor Lab. Kit

Complete with headphones and photocell. Great fun and instructive. Enables you to broadcast through any nearby radio; turn electric equipment on and off just by speaking! Kit £7. 19. 6. (inc. PT.)



KG275A CdS Exposure Meter Kit

Takes accurate readings even in moonlight. Covers ASA Speed Ratings 6 to 12,000; shutter settings 1/4,000 second to 30 minutes. Cine settings 4 to 128 frames per sec. Incident or reflected light readings. Kit £10. 7. 6. (inc. PT.) Hard case £2. 8. 3. (inc. PT.) extra. Soft case £1. 6. 5. (inc. PT.) extra.

Easy credit facilities available, ask for details.

New 960 page Hobbies Manual 12 Hobbies Sections • over 12,000 units & components for dozens of Hobbies 16/6

Please send me: Free Knight-Kits brochure
 The new Electronics Hobbies Manual. (16/6)
 Enclosed is a cheque/postal order for 16/6 (which includes the 5/- pp) made payable to Electronics (Prop. STC) Ltd.

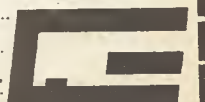

Name.....
 Address.....

knight-kit Quality built-in, built up by you. 
 Electronics (Prop. STC) Ltd., PE5
 Edinburgh Way, Harlow, Essex. **electroniques**

**Build yourself a quality
transistor radio
guaranteed results
backed by our
after sales service!**

roamer seven mk iv

SEVEN WAVEBAND PORTABLE AND CAR RADIO WITH A SUPER SPECIFICATION GIVING OUTSTANDING PERFORMANCE!
7 FULLY TUNABLE WAVEBANDS—
MW1, MW2, LW, SW1, SW2, SW3 AND TRAWLER BAND.



pocket five

MEDIUM WAVE, LONG WAVE AND TRAWLER BAND (to 50 metres approx.) PORTABLE WITH SPEAKER AND EARPIECE

Attractive black and gold case. Size 5½ x 1½ x 3¼in. Fully tunable over both Medium and Long Waves with extended M.W. band for easier tuning of Luxembourg, etc. All first grade components—7 stages—5 transistors and 2 diodes, supersensitive ferrite rod aerial, fine tone moving coil speaker, also Personal Earpiece with switched socket for private listening. Easy build plans and parts price list, 1/6 (FREE with parts).

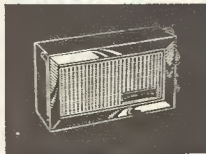

Total building costs
44/6 P. & P. 3/6

transona five

MEDIUM WAVE, LONG WAVE AND TRAWLER BAND (to 50 metres approx.) PORTABLE WITH SPEAKER AND EARPIECE

Attractive case with red speaker grille. Size 6½ x 4½ x 1½in. Fully tunable. 7 stages—5 transistors and 2 diodes, ferrite rod aerial, tuning condenser, volume control, fine tone moving coil speaker also Personal Earpiece with switched socket for private listening. All first grade components. Easy build plans and parts price list 1/6 (FREE with parts).



Total building costs
47/6 P. & P. 3/9

super seven

THREE WAVEBAND PORTABLE WITH 3in. SPEAKER

Attractive case size 7½ x 5½ x 1½in. with gilt fittings. The ideal radio for home, car or outdoors. Covers Medium and Long Waves and Trawler Band. Special circuit incorporating 2 R.F. Stages, push pull output, ferrite rod aerial, 7 transistors and 2 diodes, 3in. speaker (will drive larger speaker) and all first grade components. Easy build plans and parts. Price list 2/- (FREE with parts). (Personal Earpiece with switched socket for private listening 5/- extra.)



Total building costs
69/6 P. & P. 4/6

roamer six

SIX WAVEBAND PORTABLE WITH 3in. SPEAKER

Attractive case with gilt fittings, size 7½ x 5½ x 1½in. World wide reception. Tunable on Medium and Long waves, two short waves, Trawler Band Plus an extra M.W. band for easier tuning of Luxembourg, etc. Sensitive ferrite rod aerial and telescopic aerial for Short waves. All top grade components. 8 stages—6 transistors and 2 diodes including Micro-Alloy R.F. Transistors, etc. (Carrying strap 1/6 extra.) Easy build plans and parts price list 2/- (FREE with parts). Personal Earpiece with switch socket for private listening 5/- extra.)



Total building costs
79/6 P. & P. 4/6

Extra M.W. band for easier tuning of Luxembourg, etc. Built-in ferrite rod aerial for Medium and Long Waves. 5 Section 22in. chrome-plated telescopic aerial for Short Waves—can be angled and rotated for peak S.W. listening. Socket for Car Aerial. Powerful push-pull output. 7 transistors and two diodes including Micro-Alloy R.F. Transistors. Famous make 7 x 4in. P.M. speaker for rich-tone volume. Air spaced ganged tuning condenser. Separate on/off switch, volume control, wave change switches and tuning control. Attractive case with hand and shoulder straps. Size 8 x 7 x 4in. approx. First-grade components. Easy to follow instructions and diagrams make the Roamer 7 a pleasure to build with guaranteed results.

Total building costs
£5.19.6 P. & P. 7/6 Personal Earpiece with switched socket for private listening 5/- extra.

Parts price list and easy build plans 3/- (Free with parts).

NEW LOOK

melody six

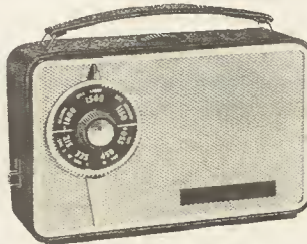

8 stages—6 transistors and 2 diodes. Covers Medium and Long Waves. Top quality 3in. Loudspeaker for quality output and also with Personal Earpiece with switched socket for private listening. Two R.F. Stages for extra boost. High "Q". Ferrite Rod Aerial. Push-pull output. Handsome pocket size case with gilt fittings. Size 6½ x 4 x 2in. Easy build plans and parts price list 2/- (FREE with parts).

Total building costs
69/6 P. & P. 4/3

RADIO EXCHANGE LTD

61 HIGH STREET, BEDFORD. Tel.: Bedford 52367

I enclose £..... please send items marked

ROAMER SEVEN ROAMER SIX

TRANSONA FIVE SUPER SEVEN

POCKET FIVE MELODY SIX

Parts price list and plans for.....

Name.....

Address.....

- Callers side entrance Stylo Shoe Shop.
- Open 10-1, 2.30-4.30 Mon.-Fri. 9-12.30 Sat.



BOOK REVIEWS

HI-FI IN THE HOME

By John Crabbe

Published by Blandford Press Ltd.
327 pages, 8½ in × 5½ in. Price 40s

Books on high fidelity sound reproduction are to be found in abundance, most of which give technical details of the equipment used. It is a welcome change, therefore, to find an author who has introduced this subject from an objective point of view—the aural appreciation of real music through an artificial medium. Concert-goers and record lovers alike can now read of the direct purpose of hi-fi at home in relation to something more than just a gimmick or status symbol.

The author, as a well-known journalist, is already recognised as a convincing authority, and has always taken great pains in promoting the theories behind hi-fi for the purpose of helping the music industry to find and maintain a truly appreciative audience.

One feels here that we are being carried through a "world tour" in the author's living room through the medium of recorded music during the last two chapters, having earlier discovered the association of music with electronics, and found how to assess the relative merits of commercial equipment for individual requirements.

Space here does not permit a comprehensive description of this book; no doubt one can imagine how much can be packed into 327 pages of small but clear type.

A glossary and bibliography are appended and no doubt will receive repeated reference. For the non-technical addicts, do not be deterred, for you will soon appreciate this adventure more fully having grasped its purpose. This book is recommended to all for its musical, technical, and literary merits.

M.A.C.

WORLD AT THEIR FINGERTIPS

By John Clarricoats, O.B.E., G6CL
308 pages, 8½ in × 5½ in. Price 12s 6d

RADIO COMMUNICATION HANDBOOK

Fourth Edition

710 pages, 10 in × 7½ in. Price 63s

AMATEUR RADIO TECHNIQUES

By J. Pat Hawker G3VA

160 pages, 9½ in × 7½ in. Price 12s 6d

All published by The Radio Society of Great Britain

MAYBE the recent exhibition has something to do with the sudden appearance of a number of books from the R.S.G.B.; anyhow, whatever the cause, "propagation" is seemingly not applicable only to radio waves!

Amateur radio is as old as radio itself. John Clarricoats is probably fully justified in describing Prof. D. E. Hughes as Britain's first radio amateur. In 1879 Hughes received signals in a telephone earpiece while walking in a London street some quarter of a mile from a primitive transmitter. This important episode is recalled in the opening chapter of *World at Their Fingertips* and from such historical beginnings the story of the amateur radio movement in this country is narrated through the 30 succeeding chapters.

The Radio Society of Great Britain grew from the London Wireless Club which was formed in 1913. The author is uniquely qualified to recount the significant events of the ensuing years, since he held office as the Secretary of the Society from 1930 until 1963. The birth pangs of the new organisation, the frequent tussles with officialdom about licences and operating conditions, and the achievements of individual amateurs in the developing hobby of

radio communication, all add up to a fascinating tale.

The R.S.G.B. has been constantly involved in politics, negotiating both with the home government and with international bodies on behalf of the radio amateur. Not surprisingly these activities and the personalities involved make up a considerable part of this story, and one is a little disappointed to be given just tantalisingly brief accounts of the important successes in radio communication and of the techniques and equipment employed by the various amateur stations concerned. However, an excellent selection of photographs do help make amends in this respect, for many of these are of great historical interest and show transmitting and receiving equipment used in epic making "contacts".

The phenomenal success of the R.S.G.B.'s first major publication *The Amateur Radio Handbook* is referred to in *World at Their Fingertips*. This handbook was eagerly seized upon as a valuable text book by the Services during the second world war, and was reprinted many times before being replaced by a third edition in 1961. Last September a fourth edition, now renamed the *Radio Communication Handbook* was published.

The pattern of that earlier book is still discernible in this greatly enlarged work but the subject matter reflects the immense technical changes and advances that have taken place over the years. It incorporates the combined efforts of a number of specialist contributors. The novice is catered for in the first chapter which deals with basic principles in a fairly elementary way; then follow further accounts of valves and semiconductors. Four chapters are devoted to receivers and transmitters (h.f. and v.h.f./u.h.f.), and these include practical designs for home construction; some are valve circuits and some use semiconductors. A chapter on single sideband transmission extends to over 100 pages—by far the longest chapter in the book—and indicates the completely up-to-date outlook of this work.

There is much more besides, but it will suffice here to add that anyone interested—as amateur or professional—in radio communication will hardly be able to resist acquiring a copy once they examine this excellently produced copious volume of technical information.

From a "combined op" to a solo effort. The name Pat Hawker is familiar to all readers of the R.S.G.B. Bulletin as the author of a lively series entitled "Technical Topics", first introduced in 1958.

Little of significance to the amateur seems to escape the eye of this diligent gleaner of technical news items. New components, circuits, and ideas are presented to his readers in an informal communicative style.

Under the title *Amateur Radio Techniques* is now presented, in paper back form, a selection from these items originally published over the past 10 years, together with some additional material. This book is a revised second edition of that published in 1965 under the title *Technical Topics for the Radio Amateur*. It contains over 350 circuit diagrams.

D.D.R.

WIRELESS WORLD DIARY 1969

Published by T. J. & J. Smith Ltd. in
conjunction with Iliffe Technical Publications Ltd.
79 pages of information plus diary section,
4½ in × 2½ in.

Price 6s 6d in rexine cover, 9s in leather cover

THIS well established diary maintains its aims in up-dating the information section to include current practices and is a useful condensed reference work for all branches of electronics. Of particular interest are the recent sections dealing with the PAL colour television system; stereo sound reception on BBC Radio 3, including a decoder circuit diagram; some transistor near equivalents and coding nomenclature. However, it is surprising to find, with a journal of this kind, that the circuit symbols in many cases still do not comply with British Standard specifications, particularly among semiconductor devices.

NEWS BRIEFS

Faraday Lecture

THIS YEAR'S Faraday Lecture arranged by the Institute of Electrical Engineers will be given by Mr P. E. Trier M.A., C.Eng., F.I.E.E., F.I.M.A., Director of Research and Development, Mullard Ltd., and Director of Mullard Research Laboratories. The subject is to be "Micro-electronics"—the Deputy Lecturer will be Mr E. T. Emms B.Sc., C.Eng., F.I.E.E., Head of the Mullard Central Application Laboratory.

The lecture will be delivered in 12 towns throughout Britain, and is intended to inform the general public, in straightforward language, about microelectronics. Mr Trier will cover the history, demand and physical principles of microelectronics and proceed to explain the technology for making microcircuits and the standards of the industry formed to meet the demand. Applications will be highlighted and described with the aid of models, demonstrations and films which are intended to introduce the subject in an enjoyable and entertaining way.

Members of the public are admitted (free) by ticket, obtainable (with details of dates and venues) on application to the Institute of Electrical Engineers, Savoy Place, W.C.2.

Golf Drive Measurement

ELECTRONIC equipment was used at the Alcan "Golfer of the Year" Championships for distance measurement of players' drives. The equipment used has a wide application in surveying and mapping. Drive distances can be measured within inches by transmission of microwaves from a "master" to a "remote" unit, mounted on a motorised golf cart. The equipment, which is made by Tellurometer (U.K.) Ltd., can provide instant readout and offers a means of measuring the tee-to-hole distances on any golf course with greater accuracy than conventional devices.

New Stock Market Computers

TWO COMPUTERS valued at almost £½ million will serve as the master systems of the Ultronic quotation service to stockbrokers from the United States to the Far East covering Canada, Europe and South America.

The two computers, supplied by Univac—a division of Sperry Rand—will be installed in a new computer centre in Mount Laurel, New Jersey. When installed, the incoming information from most major markets will be processed and transmitted to 26 satellite computer centres at high speed. From the centres the information is routed to some 2,000 brokerage offices in more than 400 cities. In-depth information on more than 8,000 individual stocks and commodities is available continuously.

Cheaper Printed Circuits

"NEW TECHNOLOGY" the MinTech news magazine reports on a new process for etching holes in the plastic insulation of printed circuit boards having two or more interconnected conducting layers. The process replaces costly mechanical methods and is based on the discovery of a new chemical action.

To permit the connection of integrated circuit packages and the interconnection of layers of conductors, holes are made in the p.c. board and the walls are plated with copper. The new process makes it possible to etch these holes, which are sometimes as dense as 100 per square inch. After etching the holes, the board is masked and plated with copper to form the conductors and connections through the walls of the holes.

I.T.A. Colour O.B. Vehicle

GRANADA Television have ordered a five-camera colour outside broadcast vehicle from EMI Electronics. The unit consists of three individually air conditioned areas for production, sound and vision control. Mixers for sound and vision are of modular solid state construction.

The new company of Thames Television has also been buying colour equipment from the same manufacturer. The orders include: 14 colour cameras and 10 video switching matrixes, each with 28 inputs and 5 outputs, for use in the new studio complex to be built for Thames Television at the Euston Centre, London.

Light Emission from Plankton

May Help Food Shortage

THE possibility that plankton might be used as a means of solving the universal food shortage has placed an increased importance on the study of its behaviour and environment. A comprehensive study into light emission by plankton is being carried out in the Firth of Clyde by the Scottish Marine Biological Association using special equipment made by Plessey.

A photo-multiplier light detector, which is considerably more sensitive than the human eye, is housed in a pressure-tight case from which signals are relayed via underwater cables to a research vessel. The signals are automatically recorded together with temperature and depth measurements.

Television Advisory Committee Reports

THE GOVERNMENT'S decision to adopt the PAL system of colour television and to authorise the duplication of BBC-1 and independent television programmes on u.h.f. with a definition standard of 625 lines were announced in 1966 and 1967. The technical considerations which led up to these decisions have now been published in the "Report of the Television Advisory Committee 1967", obtainable from Her Majesty's Stationery Office, price 2s 6d.

In 1962 the Government decided, on the advice of the Advisory and Pilkington Committees, to change to a 625-line standard system.

Since 1959 the Advisory Committee has been considering methods of changeover—methods of "overnight switch-over" and "duplication" were considered. The committee found that the final solution would have to be a mixture of the two methods and advised the Government that the work necessary for duplication should be put in hand at once, also that duplication should be continued until the residue of the public watching the 405-line standard was small enough to effect an "overnight switchover". The Committee also recommended the use of the PAL system in the United Kingdom for colour television.

In March 1966 the Government accepted the recommendations of the Committee and the first moves were made in the changeover. In December 1967 a full colour service began on BBC-2 using the PAL system.

Airborne Advertising

AN AIRCRAFT to be used as an advertising medium has been built by Slingsby Aircraft Ltd. The aircraft carries on its sides illuminated panels, consisting of a matrix of special tungsten lamps which can reproduce messages, nominally 50 words in length, whilst airborne.

The project is based on a memory system, supplied by Mullard, which accepts information from an electric typewriter; this information is stored so that messages can be reproduced at will. Logic circuitry converts the memory output into a suitable form to drive the thyristors which control the lamps. The messages are then flashed on alternate sides of the aircraft to save power.

LOOKING FOR SOMETHING DIFFERENT?

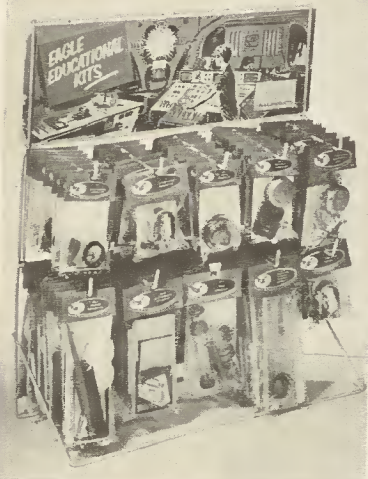

KA Series Educational Kits. 10 personal science adventures for the youngsters. Each a complete, easy, safe school tested project already over half a million in use by Students. Practical kits to observe and learn why motors turn, bells ring; how Firemen get pressure in a hose. Explore the power in a magnet; light bouncing from a mirror; how telegraph signals are formed; how to make scientific measurements. Verify basic physical laws by demonstration. A new world of practical education is opened with **EAGLE'S** fascinating KA Kits. Visit your **EAGLE Dealer** to inspect this exciting new range—such good value at 7/6 to 9/-.

FOR VERSATILITY RELIABILITY AND SOUND VALUE INSIST ON



Distributed by B. Adler & Sons (Radio) Ltd., Coptic Street, London, W.C.1



THE DORSET (600mW Output)

7-transistor fully tunable M.W.-L.W. superhet portable—with baby alarm facility. Set of parts. The latest modulated and pre-alignment techniques makes this simple to build. Sizes: 12" x 8" x 3".

MAINS POWER PACK KIT: 9/6 extra.

Price **£5.50** plus 7/6 p. & p. Circuit 2/6 FREE WITH PARTS.

THE ELEGANT SEVEN MK. III (350mW output)

7-transistor fully tunable M.W.-L.W. portable. Set of parts. Complete with all components, including ready etched and drilled printed circuit board—back printed for foolproof construction.

MAINS POWER PACK KIT: 9/6 extra.

Price **£4.96** plus 7/6 p. & p.

Circuit 2/6 FREE WITH PARTS.

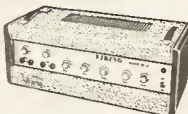
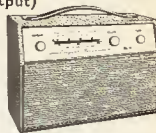

50 WATT AMPLIFIER A.C. MAINS 200-250V

An extremely reliable general purpose valve amplifier—with six electronically mixed inputs. Suitable for use with: mics, guitars, gram, tuner, organs, etc. Separate bass and treble controls.

Price **27 gns.** plus 20/- p. & p.

X101 10W SOLID-STATE HI-FI AMP WITH INTEGRAL PRE-AMP

Specifications: RMS Power Output (into 3 ohms speaker): 10 watts continuous (sine wave), 13 watts music power. Sensitivity (for rated output): 1mV into 3K ohms (0-33 micro-amp) Total Distortion (@ 1KHz): at 5 watts 0-35%, at rated output 1-5%. Frequency Response: Minus 3dB points 20Hz and 40KHz. Speaker: 3-4 ohms (3-15 ohms may be used). Supply voltage: 24V d.c. @ 800mA (6-24V may be used).

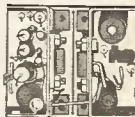

Control assembly: including resistors and capacitors.

1. Volume: PRICE 5/-.

2. Treble: PRICE 5/-.

3. Comprehensive bass and treble: PRICE 10/-.

The above 3 items can be purchased for use with the X101.

Power Supplies for the X101:

P101 M (for mono) 35/- plus 4/6 p. & p. P101 S (for stereo) 42/6 plus 4/6 p. & p.

Price **49/6**

plus 2/6 p. & p.

THE CLASSIC

Controls: Selector switch. Tape speed equalisation switch (3 $\frac{1}{2}$ and 7 $\frac{1}{2}$ i.p.s.). Volume. Treble. Bass. 2 position scratch filter and 2 position rumble filter.

Specification: Sensitivities for 10 watt output at 1KHz. Tape head: 3mV (at 3 $\frac{1}{2}$ i.p.s.).

Mag. P.U.: 2mV. Car. P.U.: 80mV. Radio: 100mV.

Aux.: 100mV. Tape/Rec. output: 100mV. Equalisation for each input

is correct to within ± 2 dB (R.I.A.A.) from 20Hz to 20KHz. Tone

control range: Bass ± 13 dB at 60Hz. Treble ± 14 dB at 15KHz. Total distortion: (for

10 watt output) < 1.5%. Signal noise: < -60dB. A.C. mains 200-250v.

Size 12 $\frac{1}{2}$ " long, 4 $\frac{1}{2}$ " deep, 2 $\frac{1}{2}$ " high. Teak finished case. Price **8 gns.** p. & p. 7/6.



THE RELIANT 10W SOLID-STATE HIGH QUALITY AMPLIFIER

Specifications: Output: 10 watts R.M.S. Sine-wave; 13 watts R.M.S. Music-power. Output impedance: 3 to 4 ohms. Inputs: 1. Xtal mic 10mV; 2. Gram/radio 250mV.

Tone controls: Treble control range ± 12 dB at 10KHz; Bass control range ± 13 dB

at 20Hz and 40KHz. Frequency response (with tone controls central): Minus 3dB points are

20Hz and 40KHz. Signal to noise ratio: better than -60dB. Transistors: 4 silicon

Planar type and 3 Germanium type. Mains input: 200-250V a.c. Size of chassis:

10" x 3 $\frac{1}{2}$ " x 2". A.C. Mains, 200-250V. For use with Std. or L.P. records, musical

instruments, all makes of pick-ups and mikes. Separate base and treble lift control

suit: Price 14/6 plus 1/6 p. & p. Crystal mike to suit: 12/6 plus 1/6 p. & p.

PRICE **£5.50** plus 5/- p. & p.

THE VISCOUNT

Integrated High Fidelity Transistor Stereo Amplifier

SPECIFICATIONS: Output: 10 watts per channel into 3 to 4 ohms speakers (20 watts mono). Input: 6 position rotary selector switch (3 pos. mono and 3 pos. stereo). P.U., Tuner, Tape and Tape Rec. Sensitivities: All inputs 100mV into 1.8M ohm. Frequency response: 40Hz-20KHz ± 2 dB. Tone controls: Tone controls flat (Baxandall type), separate bass and treble controls. Treble 13dB lift and cut at 15KHz. Bass 15dB lift and 25dB cut at 60Hz. Volume controls: Separate for each channel. AC Mains input: 200-240V. 50-60Hz. Size 12 $\frac{1}{2}$ " x 6" x 2 $\frac{1}{2}$ " in. teak-finished case. Built and tested.

PRICE **13 $\frac{1}{2}$ gns.** Postage & Packing 7/6 extra.

CYLDON U.H.F. TUNER

Complete with PC88 and PC86 Valves. Full variable tuning. New and unused. Size 4 $\frac{1}{2}$ " x 5 $\frac{1}{2}$ " x 1 $\frac{1}{2}$ ". Complete with circuit diagram. **35/-** plus 3/6 p. & p.



THREE-IN-ONE HI-FI 10 WATT SPEAKER

A complete Loud Speaker system on one frame, combining three matched ceramic magnet speakers with a low loss cross-over network. Peak handling power 10 watts. Impedance 15 ohms. Flux density 11,000 gauss. Resonance 40-60c/s. Frequency range 50c/s to 20Kc/s. Size 13 $\frac{1}{2}$ " x 8 $\frac{1}{2}$ " x 4 $\frac{1}{2}$ ". By famous manufacturer. List price £7. Our price 68/6 plus 5/- p. & p. Similar speaker to the above without tweeters in 3 and 15 ohms 39/6 plus 5/- p. & p.

Goods not despatched outside U.K. Terms C.W.O. All enquiries S.A.E.

RADIO & TV COMPONENTS (ACTON) LTD.

21d High Street · Acton · London W.3

323 Edgware Road · London W.2

ORDERS BY POST TO OUR ACTON ADDRESS PLEASE

THE DESIGNER'S GUIDE TO BRITISH TRANSISTORS

Comprehensive ratings, characteristics and test conditions of more than a thousand transistors. Comprehensive Equivalents List of 11 manufacturers by I. J. Kampel

Price 25/-

Postage 1/-

COLOR TV TROUBLESHOOTING PICT-O-GUIDE. 38/-. Postage 1/-.

COLOUR RECEIVER TECHNIQUES, by T. D. Towers. 35/-. Postage 1/-.

AN INTRODUCTION TO COUNTING TECHNIQUES AND TRANSISTOR CIRCUIT LOGIC, by K. J. Dean. 25/-. Postage 1/-.

TRANSISTOR POCKET BOOK, by R. G. Hibberd. 25/-. Postage 1/-.

ELECTRONIC DESIGNER'S HANDBOOK, by T. K. Hemingway. 63/-. Postage 2/-.

INTER. GEC TRANSISTOR MANUAL, 7th Ed. 21/-. Postage 2/-.

AMATEUR RADIO TECHNIQUES, R.S.G.B. 12/6. Postage 1/-.

RADIO VALVE DATA, by W. W. 9/6. Postage 1/-.

THE MODERN BOOK CO.

BRITAIN'S LARGEST STOCKIST of British and American Technical Books

19-21 PRAED STREET

LONDON, W.2

Phone: PADdington 4185

Closed Saturday 1 p.m.



IT'S A MUST OUR CATALOGUE JOIN THE THOUSANDS

OF SATISFIED CUSTOMERS SEND NOW FOR

OUR NEW 1968/69 illustrated catalogue NOW AVAILABLE
(send 2/- in stamps for your copy)

Catalogue contains prices and details of Amplifiers — Hi-Fi Tuners — Loudspeakers — Pick-ups — Playing Decks — Microphones — Test Meters — Hand Tools — Valves — Soldering Irons — Tape Recording Accessories, etc.

OFFICIAL SUPPLIERS TO MANY EDUCATION AUTHORITIES AND RESEARCH ESTABLISHMENTS

Usual Educational Discounts

ALPHA RADIO SUPPLY CO

103 Leeds Terrace, Leeds 7. Tel. 25187

VARIABLE VOLTAGE TRANSFORMERS

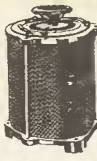

150 AMPS

1/2 AMP
£3.10.0.



PORTABLE TYPE
£9. 5. 0.

PRECISION INTERVAL TIMER

From 0-30 seconds (repetitive). Jewelled balanced movement. Lever re-set. Operates 230V. A.C. 5 amp. c/o Micro-switch. New. Price 17/6 plus 2/6 P. & P.



CONDENSERS 2,500 mfd 100v. 12/6 1/6 P. & P. 4,000 mfd 25v. 10/- 1/6 P. & P. 4,000 mfd 50v. 15/- 1/6 P. & P. 10,000 mfd 35v. 15/- 1/6 P. & P.

230 VOLT A.C. GEARED MOTORS

Type D15G 5 r.p.m. 1.7 lb. inch. £2/9/6, P. & P. 3/-. Type B16G 80 r.p.m. 26 lb. inch. £2/2/0, P. & P. 3/-. Type D16G 13 r.p.m. 1.45 lb. inch. £2/17/6, P. & P. 3/-.

SELENIUM BRIDGE RECTIFIERS

30.volt 3 amp., 11/-, 30.volt 5 amp., 16/-, plus 2/6 P. & P.

L.T. TRANSFORMERS

Type No.	Sec. Taps	Price	Carr.
1	30, 32, 34, 36 v. at 5 amps.	£4/5/0	6/-
2	30, 40, 50 v. at 5 amps.	£6/5/0	6/6
3	10, 17, 18 v. at 10 amps.	£4/10/0	4/6
4	6, 12 v. at 20 amps.	£5/17/6	6/6
5	17, 18, 20 v. at 20 amps.	£6/12/6	6/6
6	6, 12, 20 v. at 20 amps.	£6/5/0	7/6
7	24 v. at 10 amps.	£4/15/0	5/6
8	4, 6, 24, 32 v. at 12 amps.	£6/10/0	6/6

STROBE! STROBE! STROBE!

Build a Strobe Unit, using the latest type Xenon white light flash tube. Solid state timing and triggering circuit. 230/250V. A.C. operation.

ECONOMY KIT. Flash rate 1-36 flash per second. All components including Unijunction, thyristor, tube and circuit. £5/5/0 plus 3/6 P. & P.

INDUSTRIAL KIT. Ideally suitable for schools, laboratories, etc. Incorporates double wound transformer which isolates both tube and timing circuit from mains. Stabilized timing circuit and high power tube. £8/8/0 plus 6/- P. & P.

6 1/2" POLISHED REFLECTOR

Ideally suited for above Strobe kits. Price 8/6 post paid.

200/250V AC HORSTMAN 20A TIME SWITCH

2 on/off every 24 hours at any pre-set time. Fitted in metal case. 36 hr. spring reserve. Used but fully tested. Fraction of makers' price. £3.19.6 plus 4/6 P. & P.

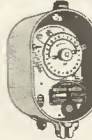

COPPER LAMINATE. Printed Circuit Board. Size 15 1/2" x 5 1/2" 3.9 each. 3 for 10/-. Post paid.



INSULATED TERMINALS Available in red, white, yellow, black, blue and green. New 17/- per doz. 2/- P. & P.

230/250V. A.C. SOLENOID

Heavy duty type, approx. 3 lbs. pull. Price: 17/6 plus 2/6 P. & P.



12/24V. D.C. SOLENOID

Approx. 8 oz. push. Price 8/6 plus 1/6 P. & P.

LIGHT SENSITIVE SWITCH

Kit of parts, including ORP12 Cadmium Sulphide PhotoCell, Relay, Transistor and Circuit, etc., 6-12 volt D.C. op. price 25/- plus 2/6 P. & P. ORP 12 including circuit, 10/6 each, plus 1/- P. & P.



A.C. MAINS MODEL Incorporates Mains Transformer, Rectifier and special relay with 3, 5 amp mains c/o contacts. Price inc. circuit 47/6 plus 2/6 P. & P.

LIGHT SOURCE AND PHOTO CELL MOUNTING

Precision engineered light source with focusible lens assembly and ventilated lamp housing, to take MBC bulb. Separate photo cell mounting assembly for ORP. 12 or similar cell. Both units are single hole fixing. Price per pair £2.15.0. P. & P. 3/6.



UNISELECTOR SWITCHES NEW

4 Bank 25 Way 24 v. D.C. operation £5.17.6 plus 2/6 P. & P. 8 Bank 25 Way 24 v. D.C. operation. £7.12.6 plus 4/6 P. & P.



MINIATURE UNISELECTOR SWITCH

3 banks of 11 positions plus homing bank. 40 ohm coil. 24-36 v. D.C. operation. Tested. 22/6, plus 2/6 P. & P.



DRY READ SWITCHES. New special offer of Dry Read Switches half amp. Contact. Size 1 1/2" x 1 1/2" 4 for 10/- Post Paid.

SPECIAL OFFER ELLIOT PEN RECORDER

V230 series movement 1ma fsd. resistance 1000 ohm. clockwork chart mechanism, chart speed of 12 inches per hr. with 36 hour continuous running time. Offered tested and in sound working order.



OUR PRICE ONLY £14.10.0
Carr. B.R.S. 15/-.

AVO MODEL 7X PANCLIMATIC

This Tropicalised Avo Model 7 Mk II is offered fully tested and in first class condition. Complete with carrying case, leads and instructions. Price £14.0.0 + 10/- reg. post.



RELAYS

Bulk purchase enables us to offer the following new SIEMENS, PLESSEY, etc. miniature plug in relays complete with base, at a fraction of maker's price.

Coil Ω	Working Voltage	Contacts	Price
280	6-12	2 c/o	14/6
280	9-18	4 c/o	15/6
700	12-24	2 c/o	12/6
700	16-24	4 c/o	15/6
700	16-24	4M 2B	12/6
1250	20-40	2 c/o H.D.	12/6
2500	30-50	2 c/o H.D.	12/6
5800	50-70	4 c/o	10/-
9000	40-70	2 c/o	10/-

H.D. Heavy Duty. POST PAID

A.C. CONTACTOR

2 make - 2 break (or, 2 c/o.). 15 amp. contacts. 230/240V. A.C. operation. Brand new. Price 22/6 plus 1/6 P. & P.



SERVICE TRADING CO

All Mail Orders—Also Callers—Ample Parking Space
57 BRIDGMAN ROAD, LONDON, W.4 Phone 995 1560
SHOWROOM NOW OPEN CLOSED SATURDAY

Personal callers only
9 LITTLE NEWPORT ST.
LONDON, W.C.2. Tel. GER 0576

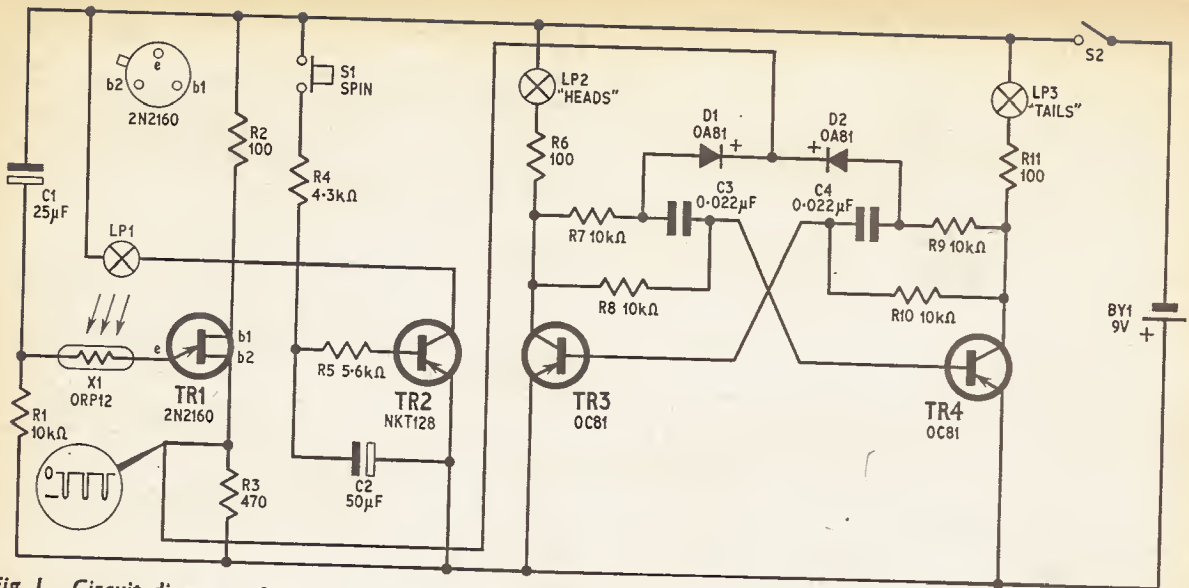

Fig. 1. Circuit diagram of u.j.t. pulse generator, timer and flip flop elements. To increase "spin" time the value of C2 may be increased

CONSTRUCTION

The components were assembled on a piece of Vero-board similar to that given away free in the October issue. Component mounting should follow that given in Fig. 2a. When soldering is completed layout should again be checked. Copper strips should then be cut as in Fig. 2b using a spot face tool or knife. If LP1 and X1 are attached to the board 20 s.w.g. wire should be used for a rigid fixture. An M.E.S. batten holder will prove suitable for holding this lamp, and can be screwed to the bottom of the box, inside. X1 is then suspended by the stiff wires

in close proximity to the lamp and facing it.

The small size and battery required permit a small housing to be used. No constructional details of this are given here but if anything prefabricated is used make sure that there are no gaps for unwanted light to come through as this will upset circuit action.

DECORATION

Decorating the box top where the lamps protrude is a matter of taste. The lamps should be labelled "heads" and "tails" and S1 "spin".

Panel lampholders come in a variety of transparent lens colours such as amber, blue, green or red and these can be used in addition to identify the coin faces.

COMPONENTS . . .

Resistors

R1 10kΩ	R7 10kΩ
R2 100Ω	R8 10kΩ
R3 470Ω	R9 10kΩ
R4 4.3kΩ	R10 10kΩ
R5 5.6kΩ	R11 100Ω
R6 100Ω	

All ½ watt ±10% carbon

Capacitors

C1 25µF elect. 15V	C3 0.022µF
C2 50µF elect. 15V	C4 0.022µF

Transistors

TR1 2N2160	TR3 OC81
TR2 NKT128	TR4 OC81

Light Dependent Resistor

X1 ORP12 (Mullard) 816

Diodes

D1, D2 OA81

Switches

S1 Miniature single pole push-to-make switch
S2 On/off toggle switch

Lamps

LP1, LP2, LP3 M.E.S. 6V 0.06A (3 off)

Battery

BY1 9 volts (type PP7)

Miscellaneous

M.E.S. Battenholder (1 off). Panel lampholders (2 off)

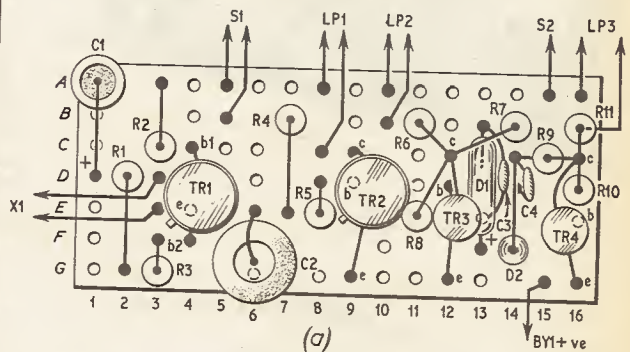
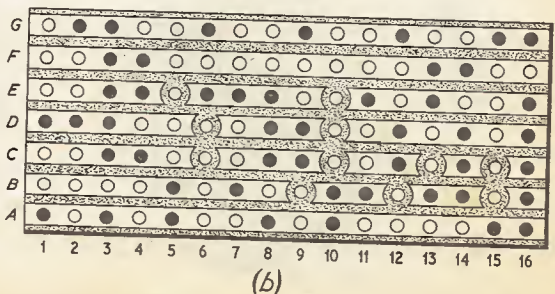

Fig. 2. The circuit board. (a) Component layout with connection details to other components



(b) Underside of board showing breaks in copper strips

FLIP FLOP

ELECTRONIC PARTY GAME

HERE is a novelty that should amuse the young over Christmas. It is a solid state version of the popular "heads or tails" game using neons which has already been described. Unfortunately that circuit, although simple, requires a battery supply of about 100 volts which is rather prohibitive when thinking in terms of portability.

The unit described in this article requires only 9 volts and the filament lamps present a better twinkling display when simulating a coin spin.

UNIUNCTION TRANSISTOR

TR1 is a unijunction transistor working as a relaxation oscillator, see Fig. 1. With S2 switched on the electrolytic capacitor C1 charges through R1. With the omission of the photoconductive cell X1, TR1 would normally fire when its peak point voltage appears at the capacitor. In unijunction devices this is a fixed percentage of the base-1 to base-2 voltage.

At this voltage the emitter to base-1 evinces a negative resistance characteristic, which means that the capacitor discharges although its voltage falls below the original peak point. The charge and discharge at C1 is reflected at R2 and R3 as positive and negative pulse trains. In dark conditions the high resistance of the light cell X1 holds off firing at TR1.

TIME DELAY

TR2 forms part of a time delay circuit the action of which is initiated by depressing the "Spin" push switch S1. This causes C2 to charge and the transistor to conduct, lighting the lamp LP1. With the release of S1, TR2 is maintained in conduction with the discharge of C2 through R5.

LP1 is arranged in close proximity to X1 and its light reduces the resistance of the cell to a few tens of ohms. The result is that TR1 conducts and its negative pulse output is taken off at R3 and applied to the diodes D1 and D2.

FLIP FLOP

The flip flop circuit containing TR3 and TR4 is the "coin" in the novelty. Each of its faces is represented by a lamp LP2 or LP3; a head or a tail.

With S2 depressed either TR3 or TR4 is switched on and its corresponding lamp lit. With the spin switch S1 depressed pulses arrive alternately "flipping" TR3 and TR4 into conduction and causing the lamp loads to light. After a period determined by the time delay the pulse train is cut short. The flip flop assumes a stable condition showing either a "head" or a "tail".

Building two complete circuits enables you to play that two coin variant of "odds" or "evens" which is calling for unmatching or matching coin faces to appear in the final combination.

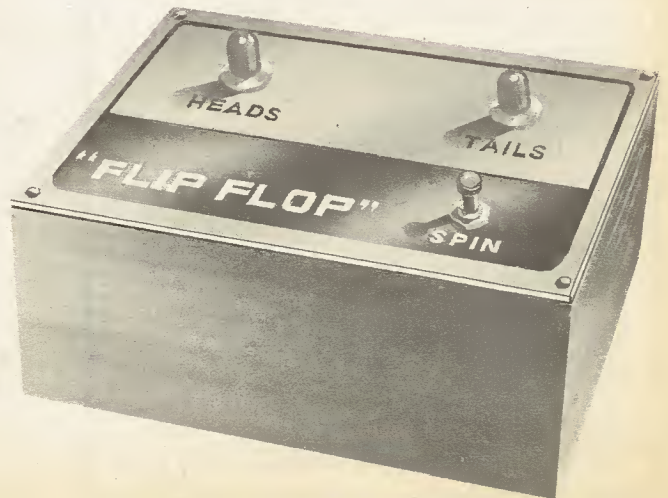
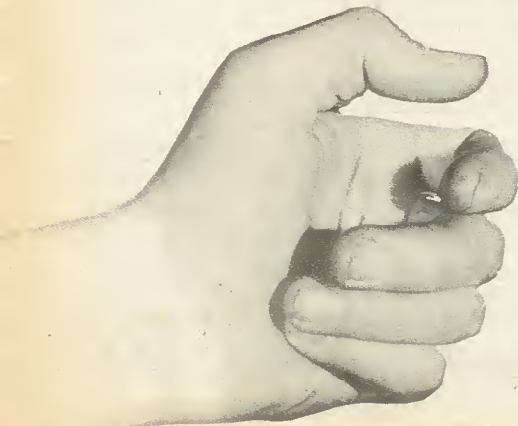
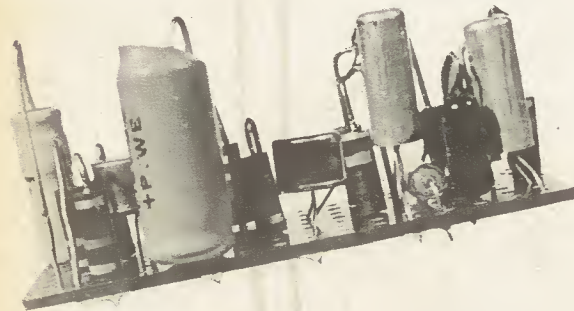



Some of the relay equipment for transmitting instructions to the trains

There is another code, 270 impulses per minute, which is used for re-starting a train after a signal to stop. This code permits the train to run at the same speed as the 180 code, a nominal 22 mph, but provision is made for the train to run at a controlled speed of 20 to 23 mph, with switching in of the motors or brakes.

A fourth code of 120 pulses per minute is also used, but this is in connection with the operation of signalling equipment only and is not picked up by the train.

The lines are divided into sections for the track circuiting purposes in the same way as for normal purposes, but the state of the track circuits ahead, showing whether the line is occupied, automatically determines the code to be fed to the track in any section.

The 125Hz frequency and the safety signalling code are checked by filter circuits before being passed to the appropriate relays.

The codes do not control normal braking, but they do operate a "trip valve" which makes an emergency brake application in the same way as the mechanical type. The trip valve is held in all the time when the train is running under the 420 (clear) code, but under the 180 (or 270) code it is fed through contacts on a mechanical governor driven from a trailer axle. This is arranged so that the valve will drop out if the speed exceeds 25 mph

The absence of any code causes the valve to drop out and it must be made operative again by pressing a reset button. It cannot be reset if the cause is still present.

Underside view of the front of the train showing the pick-up coils

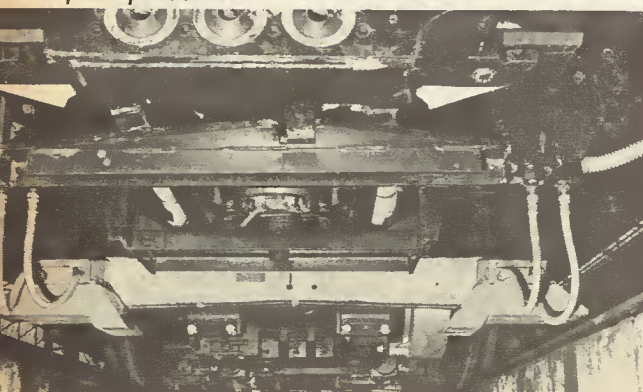

AUTOMATIC DRIVING SYSTEM

So far we have dealt with the safety signalling system, which over-rides commands related to the driving of the train. These command signals are given to the train by feeding audio frequency currents into 10ft sections of running rails, and are known as command spots. No special insulation is necessary for these sections.

The current used is produced by an electronic generator, and a frequency of 100Hz for 1 mph is used for spots or sections where specific train speeds are required, as in stopping a train at a station.

The automatic driver command signals are picked up by the separate induction coils, only one coil is used at a time, but with two coils available the "spot" can be placed on the most convenient running rail. The command signal frequency is detected and compared with a frequency produced by a generator mounted on the end of a motor on the train.

The train generator has a continuous output but the spot generator produces "bursts" of 127Hz at a time. A counter on the train starts as soon as a signal is received from the track and counts 127. No comparison is made unless this count is exactly right. If it is, a comparison is made with the train generator, which has been subject to simultaneous count. This comparison shows whether the train is moving faster or slower than the pre-determined speed and adjusts the braking of the train accordingly.

RUN-AND-COAST OPERATION

When the train operator closes the doors and presses the twin start button simultaneously, the train is receiving the 420 pulse code, provided the track is clear, and will move off under power. The train proceeds under power until it reaches the point at which power should be cut off, and here there is a command spot with a 15Hz frequency current passing through the track. This is a special frequency, outside the speed range of the train, which is recognised by a circuit in the train mounted equipment. This causes the supply to the motors to be cut off and the train then coasts.

The train will continue to coast, given a clear track, until it approaches a station, where it meets the first of a series of speed related frequency command spots to gradually slow the train down.

The first of the series of spots might dictate a speed of 35 mph and have a frequency of 3.5kHz, the impulses following each bringing the speed down by approximately 5 mph. The speed reduction is achieved by a comparison of the actual speed of the train, in terms of frequencies produced by a train mounted tachometer generator, with the frequencies received from the track. The brakes are applied as required until the speed drops to 4 mph, the braking is then "eased out" to give a smooth stop. The braking rate down to this speed is controlled by mercury retarder switches.

Command spots are also provided to control train speed where there are speed restrictions or signals.

TRACK SIDE EQUIPMENT

The provision of coded track circuits to operate the safety train equipment required special arrangement of the track circuits at those parts of the track involving junction work.

To give proper operation the track circuit current must always flow towards the front of an approaching train. Some of the track circuits associated with junctions have, therefore, been made reversible and are normally operated with two track relays.



DE LUXE PLAYERS

PORTABLE CABINET As illustrated. To fit standard 69/6 player or autochanger. RCS AMPLIFIER 3 WATT. Ready made and tested with UCL82 triode pentode valve and loud- 59/6 speaker. SUPERIOR AMPLIFIER. Built and tested. Better sound! Isolated AC Mains Transformer, 3 watt ECL82 triode pentode valve. Volume and tone controls with knobs. Quality 89/6 Loudspeaker.



Post 5/6 each item

STAIR PLAYERS MONO
 Star 9v. Battery
 45 rpm model £2.19.6
 EMI Junior £2.19.6
 Garrard SRP22 £6.19.6

AUTOCHANGERS MONO
 BSR Superslim £6.19.6
 BSR Transcription UA70 £12.19.6
 Stereo/Mono £12.19.6
 Garrard AT60 £12.19.6

All fitted LP 78 stylus and pickup circuit complete.

ALL LATEST GARRARD MODELS AVAILABLE. Send for our keenest quotation.

GARRARD TEAKWOOD BASE WB.1. Ready cut out for mounting 1000, 2000, 3000, SP25, AT60. GARRARD PERSEPEX COVER SP.1 for WB.1 EACH

PICK-UP ARM Complete with ACOS LP-78 Turnover GP67 and Stylus 25/-; GP67 15/-; Stereo Ceramic 35/-.

CRYSTAL MIKE INSERTS
 11 3in. 6/8; ACOS 13 2in. 8/8. BMS, 1' dia. 9/8
 MOVING COIL MIKE with Remote Control Switch 19/6

PORTABLE TRANSISTOR AMPLIFIER

Many uses, Intercoms, Baby Alarms, Guitar Practice, Telephone or Record Player Amplifier. ONE WATT OUTPUT. Wooden cabinet 12x9x4in. Rexine covered two tone grey. Four transistors, 7 4in. speaker. Volume control. Jack socket. Uses PP9 battery.

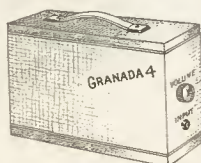

OUR PRICE 79/6 Post 5/6. Worth double

COLLARO BATTERY RECORD DECKS
 4 speed model 9v. operated. Complete with pick-up fitted crystal cartridge. Plays 7, 10, 12in. records. Fitted auto stop and start. Ideal for use with above 69/6 POST transistor amplifiers. OUR PRICE 69/6

THE ABOVE GRANADA AMPLIFIER AND PLAYER DECK STOP FREE IF PURCHASED TOGETHER

WEYRAD P50 - TRANSISTOR COILS
 RA2W 6 in. Ferrite Aerial Spruce Cores ... 6d.
 with car aerial coil ... 12/8 Driver Trans. LF24A ... 9/6
 Osc. P50/1AC ... 5/4 Printed Circuit, PC41 ... 9/8
 I.F. P50/2CC 470 kc/s ... 5/7 J.B. Tuning Gang ... 10/6
 3rd I.F. P50/3CC ... 6/- Weyrad Booklet ... 2/-
 Telescopic Chrome Aerials 6in. extends to 23in. 5/-

VOLUME CONTROLS 80ohm Coax 8d. yd.
 Long spindles. Midget Size 5 K. ohms to 2 Meg. LOC or LIN. I/S 3/- D.P. 5/- STEREO L/S 10/6, D.P. 14/6 5K. S.P. Edge type, 5d. Ideal 625 lines yd. 1/6

VEROBOARD 0.15 MATRIX
 2 1/2 x 5in. 3/8. 2 1/2 x 3 1/2in. 3/2. 3 1/2 x 3 1/2in. 3/8. 3 1/2 x 5in. 5/2.
 EDGE CONNECTORS 16 way 5/-, 24 way 7/6.
 PINS 28 per packet 3/4. FACE CUTTERS 7/6.
 S.R.B.P. Board 0.15 MATRIX 2 1/2in. wide 6d. per lin., 3 1/2in. wide 9d. per lin.; 5in. wide 1/- per lin. (up to 17in.).
 S.R.B.P. underlaid 1in. Board 10 x 8in. 3/-.

BLANK ALUMINIUM CHASSIS. 18 s.w.g. 2 1/2in. sides. 7x4in., 5/6; 9x7in., 6/6; 11x8in., 6/6; 11x7in. 7/6; 13x8in., 9/6; 14x11in., 12/6; 15x14in., 15/-.

ALUMINIUM PANELS 18 s.w.g. 12x12in. 6/6; 14x9in. 5/6; 12x9in. 4/6; 10x7in. 3/6; 8x6in. 2/6; 6x4in., 1/6

Q MAX CHASSIS CUTTER
 Complete: a die, a punch, an Allen screw and key
 1in. 18/-; 1 1/2in. 17/6; 1 3/4in. 19/6; 2in. 24/-; 2 1/2in. 44/3
 1in. 16/-; 1 1/2in. 19/6; 1 3/4in. 20/6; 2in. 29/-; 2 1/2in. 57/6
 3in. 16/9; 1 1/2in. 19/6; 1 3/4in. 21/6; 2in. 39/-; 1in. sq. 36/3

'SONOCOLOR' CINE RECORDING TAPE
 5" reel, 900' with LP strobe markings. also cine light deflector-mirror for synchronisation. 14/- each.

Tape Spools 2/6. Tape Splicer 5/-. Leader Tape 4/6.
 Reuter Tape Heads for Collaro models 2 track 21/- pair.
 UNIVERSAL TAPE CASSETTES Type C60. OUR PRICE 14/-.

"THE INSTANT" BULK TAPE ERASER AND RECORDING HEAD

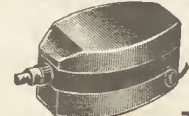

200/250 v. A.C. Leaflet S.A.E. Post 2/6 35/-
 Minimum Post and Packing charge 2/6.

RADIO COMPONENT SPECIALISTS 337 WHITEHORSE ROAD, WEST CROYDON

Written guarantee with every purchase. (Export: Send remittance and extra postage, no C.O.D.) Buses 133, 68 pass door. S.R. Stn. Selhurst. Tel. 01-684 1665

BARGAIN STEREO/MONO SYSTEM

Attractive Slimline PLAYER CABINET with B.S.R. UA25 Deck, 4 + 4 AMPLIFIER and TWO matched LOUD-SPEAKERS (Only 4 pairs of wires to join). Post 10/6 **£19.19.6**

NEW TUBULAR ELECTROLYTICS
 2/350V ... 2/3 100/25V ... 2- 8 680V ... 9/6
 4/350V ... 2/3 250/25V ... 2/6 16/600V ... 12/6
 8/450V ... 2/3 500/25V ... 4- 18+16/500V ... 7/6
 16/450V ... 3- 8+8/450V ... 3/6 32+32/250V ... 8/6
 32/450V ... 3/9 8+16/450V ... 3/9 50+50/350V ... 7/6
 25/25V ... 1/9 16+16/450V ... 4/6 60+100/350V ... 11/6
 50/50V ... 2- 32+32/350V ... 4/6 3000/30V ... 8/6

SUB-MIN. ELECTROLYTICS 1, 2, 4, 5, 8, 16, 25, 30, 50, 100, 250mF 15V 2/-; 500, 1000mF 12V 3/6; 2000mF 25V 7/-.

CERAMIC 500V 1pF to 0.01mF. 9D, Discs 1-1/2.
 PAPER 350V-0.1 9d. 0.5 2/6; 1mF 3-1/2 150V 3-1/2.
 500V-0.001 to 0.05 9d. 0.1 1/-; 0.5 3/6; 9/5 3/-.

SILVER MICA Close tolerance 1%, 5-500pF 1/-; 560-2200pF 2/-; 2.700-5.600pF 3/6; 6.800pF-0.01, mid 6/6; 365pF, miniatu-
 TWIN GANG, "0-0" 205pF 1/76pF 3/6; 365pF, miniatu-
 10/-; 500pF standard with trimmers, 9/6; 500pF
 midret less trimmers, 7/6; 500pF slow motion, standard 8/-.

SHORT WAVE, Single 10pF, 25pF, 50pF, 75pF, 100pF, 160pF, 5/6 each. Can be ganged. Couplers 9d each.

TUNING, Solid dielectric, 100pF, 300pF, 500pF, 4/6 each.

TRIMMERS, Compression 30, 50, 70pF, 1/-; 100pF, 150pF, 1/3; 250pF, 1/6; 800pF, 750pF, 1/8; 1000pF, 2/6.

250V RECTIFIERS, Selenium 1/6 wave 100mA 5/-; BY100 10/-.
CONTACT COOLED 1/6 wave 60mA 7/6; 85mA 9/6.
Full wave Bridge 75mA 10/-; 150mA 19/6; TV rectis. 10/-.

NEON PANEL INDICATORS 250v. AC DC 3/6.

RESISTORS, Preferred values, 10 ohms to 10 meg. 1/2 w., 3 w., 1 w., 20% 3d.; 1 1/2 w., 8d.; 2 w., 1/-; 3 w., 10% 6d.
HIGH STABILITY, 10 ohms to 10 meg., 2/-.
Diode 5/-, Preferred values 10 ohms to 22 meg., 9d.

5 watt 0.5 to 0.2 ohm 3/6 } 2/-
 10 watt 10 ohms to 6,800 ohms } 2/-
 15 watt 10 ohms to 6,800 ohms } 2/-

10K, 15K, 20K, 25K, 68K, 10W, 3/-

FULL WAVE BRIDGE CHARGER RECTIFIERS:
 6 or 12v. outputs, 1 1/2 amp 8/6; 2a, 11/3; 4a, 17/6.
CHARGER TRANSFORMERS, P. & P. 5-, Input 200, 250v.
 for 6 or 12v., 1 amp., 17/6; 2 amps., 21/-; 4 amps., 30/-.

WIRE-WOUND 3-WATT WIRE-WOUND 4-WATT
POTS, T. Y. Type. Values STANDARD SIZE POTS.
 10 ohms to 30 K. 4/6 LONG SPINDLE 7/6
 Carbon 30 K to 2 meg. 4/6 50 OHMS to 100 K.

VALVE HOLDERS, MOULDED 9d.; CERAMIC 1/- EACH.

NEW MULLARD TRANSISTORS 6/- each
 OC71, OC72, OC81, OC44, OC45, OC171, OC170, AF117.
 REPANCO TRANSISTOR TRANSFORMERS.
 TT45, Push Pull Drive, 9.1 CT. 6/-; TT48 Output, CTS:1.6/-;
 TT49, Interstage, 20.1, 6/-; TT52 Output 3 ohms, 4.5-1, 6/-.

TRANSISTOR MAINS POWER PACK, FAMOUS MAKE, FULLY SMOOTHED, FULL WAVE CIRCUIT 49/6
 9 Volt 500mA Size 5 3 1/2 x 2in.
TRANSFORMER ONLY, Size 2 1/2 x 1 1/2 in 9 volt 10/6

MAINS TRANSFORMERS

Post 5/- each

250-0-250 50 mA. 6.3 v. 2 amps, center tapped 19/6
 250-0-250 80 mA. 6.3 v. 3.5 a. 6.3 v. 1 a. or 5 v. 2 a. 30/6
 350-0-350 80 mA. 6.3 v. 3.5 a. 6.3 v. 1 a. or 5 v. 2 a. 35/-
 300-0-300 v. 120 mA. 6.3 v. 4 a. C.T.: 6.3 v. 2 a. 45/-
 MINIATURE 200 v. 40 mA. 6.3 v. 1 a. 12/8
 MIDGET 220 v. 45 mA., 6.3 v. 2 a. 12/8
HEATER TRANS. 6.3 v. 15 a. 6/6; 6.3 v. 4 a. 12/8
DiHo tapped sec. 1.4 v. 2, 3, 4, 5, 6.3 v. 1.3 amp. ... 12/8
GENERAL PURPOSE LOW VOLTAGE, Outputs 3, 4, 5, 6, 8, 9, 10, 12, 15, 18, 24 and 30 v. at 300 mA.
 1 amp., 6, 8, 10, 12, 16, 18, 24, 30, 36, 46, 48, 60, 35/-
 3 amp., 0-12 v. and 0-18 v. 19/6
AUTO TRANSFORMERS 0-15-230 v. Input/Output, 60w. 18/6; 150w. 20/-; 500w. 92/6; 1000w. 175/-.

COAXIAL PLUG 1.3, PANEL SOCKETS 1.3, LINE SOCKETS 2/-, OUTLET BOXES, SURFACE OR FLUSH 4/6.
BALANCED TWIN FEEDERS 1/- yd. 80 or 300 ohms.

CHROME SOCKET Std. open-circuit 2/6, closed circuit 4/6;
 Chrome Lead Socket 7/6, DIN 3-pin 1/6, 5-pin 2/1; Lead 3/6.
 Phono Plugs 1/-, Phono Socket 1/-, 2.5mm; 3.5mm 1/9
JACK PLUGS Std. Chrome 3/-; 2.5mm 1/9; 3.5mm 2/6; DIN 3-pin 3/6; 5-pin 5/-.

WAVE-CHANGE SWITCHES WITH LONG SPINDLES.
 2 p. 2-way, or 2 p. 6-way, or 3 p. 4-way 4/6 each.
 1 p. 12-way, or 4 p. 2-way, or 4 p. 3-way, 4/6 each.
 Wavechange "MAKITS" 1 p. 12-way, 2 p. 6-way, 3 p. 4-way,
 4 p. 3-way, 6 p. 2-way, 1 w. 12/-, 2 w. 17/-, 3 w. 22/-
 Additional waters 6/- each up to 12 max.
TOGGLE SWITCHES, sp. 2/6; sp. dt. 3/6; dp. 3/6; dp. dt. 4/6

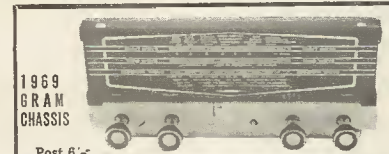

1969 GRAM CHASSIS
 Post 6/-
 Three Wavebands Five Valves: ECH81, EF89, Long, Med., Short, Gram. EBC51, EL84, EZ80.
 5 w. 3 ohm Chassis 13in. 7in. 5in. dial size 13in. x 4in. Two Pilot Lamps. Four Knobs. £10.19
 Aligned calibrated. Chassis isolated from mains DE LUXE STEREO GRAM CHASSIS V.H.F., MW, SW 19-50m. SW 60-180m. Magic eye, push buttons. £19.19
 6 valve plus rec. Size 15 7/8 x 6in. high.

BAKER MAJOR £8

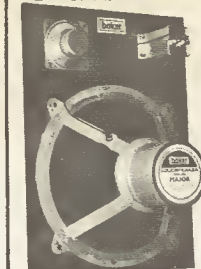

30-14,500 c.p.s., latest double cone, woofer and tweeter cone together with a special BAKER magnet assembly having a flux density of 14,000 gauss and a total flux of 145,000 Maxwells. Bass resonance 45 c.p.s. rated 20 watts. Voice coils available 3 or 8 or 15 ohms. Price £8, or Module kit, 30-17,000 c.p.s. with tweeter, crossover, baffle and instructions. £10.19.6

LOUDSPEAKER CABINET WADDING 18in wide, 2.6ft

BAKER "GROUP SOUND" SPEAKERS - POST FREE
 "Group 25" "Group 35" "Group 50"
 12in 2watt 6gns. 12in 3.5watt 8 1/2 gns. 15in 3watt 18gns.

ALL MODELS "BAKER SPEAKERS" IN STOCK

E.M.I. Cone Tweeter 3 1/2in square, 3-20kc/s. 10W 17/6. Quality Horn Tweeters 2-18kc/s. 10W 29/6. Crossover 16/6. LOUDSPEAKERS P.M. 3 OHMS 2 1/2in. 3in. 4in. 5in. 7 1/4in. 15/6 each; 8in 22/6; 6in 15/6; 10in 30/-; 12in. Double cone 3 or 15 ohm 35/-; 10 8in. 20/-; 8 6in. 21/-.

E.M.I. Double Cone 13in. 8in. 3 or 15 ohm models, 45/- or with twin tweeters, X-over and H D magnet 79/6.

SPECIAL OFFER! 8 ohm, 2 1/2in; 8 ohm, 2 1/2in, 2 1/2in; 15/6 EACH 25 ohm, 6 4in; 35 ohm, 3in; 15 ohm, 10 2 1/2in, 7 1/4in.

O.P. TRANS. EL84 etc. 4/6; MIKE TRANS. 50/- 3/9.

SPEAKER PRET Tysan various colours, 50in. wide, from 10/- ft.; 26in. wide from 5/- ft. SAMPLES S.A.E.

ALL PURPOSE HEADPHONES
 H.R. HEADPHONES 2000 ohms General Purpose 19/6
 H.R. HEADPHONES 2000 ohms Super Sensitive ... 35/-
 LOW RESISTANCE HEADPHONES 3-5 ohms ... 35/-
 DE LUXE PADDED STEREO PHONES 8 ohms ... 76/6

MINETTE AMPLIFIER



For All Record Players. A.C. Mains Transformer. Chassis size 7 x 3 1/2 x 4in high. Valves ECL82, EZ80. 12 month guarantee. Quality output 8 ohm matching Baffle offer complete with engraved control panel, valves, knobs, volume and tone controls, wired and tested. Post 5/6 **79/6**

ALL EAGLE PRODUCTS SUPPLIED AT LOWEST PRICES

BARGAIN AM TUNER, Medium Wave. 79/6
 Transistor Superhet. Ferrite aerial, etc.

BARGAIN DE LUXE TAPE SPLICER Cuts, trims, joins for editing and repairs. With 3 blades. 17/6

BARGAIN 4 CHANNEL TRANSISTOR MIXER. Add 12 musical highlights and sound effects to recordings. Will mix Microphone, records, tape and tuner with separate controls into single output. 59/6

BARGAIN FM TUNER 88-108 Mc/s Six Transistor. Ready built. Printed Circuit. Calibrated slide dial £6.19.6
 tuning. Size 6 x 4 2 1/2in.

BARGAIN 3 WATT AMPLIFIER, 4 Transistor Push-Pull Ready built, with volume control **69/6**

40-PAGE EAGLE CATALOGUE 5/- Post Free

★ RADIO BOOKS ★ (Postage 9d.)

Practical Transistor Receivers ... 5/-
 Practical Stereo Handbook ... 3/6
 Supersensitive Transistor Pocket Radio ... 5/-
 High Fidelity Speaker Enclosures and Plans ... 5/-
 Radio Valve Guide, Books 1, 2, 3, or 4 ea. 5/- No. 5 ea. 6/-
 Practical Radio Inside Out ... 4/6
 Shortwave Transistor Receivers ... 5/-
 Transistor Communication Sets ... 7/6
 Modern Transistor Circuits for Beginners ... 7/6
 Sub-Minature Transistor Receivers ... 6/-
 Wireless World Radio Valve Lists ... 9/6
 A glance valve equivalents ... 6/-
 Valves, Transistors, Diodes equivalents manual ... 10/6
 How to receive Foreign T.V. programmes on your set by simple modifications ... 5/-

SANGAMO 3 inch SCALE METERS 45/-
 Various calibrations/movements, 500 Microamp. 1 Milliamper; 50-0-500 Microamp, etc. S.A.E. for list.

POCKET MOVING COIL MULTIMETER 49/6
 0-1,000 A.C./D.C. ohms 0 to 100k, etc.

SUPERIOR MOVING COIL MULTIMETER 99/6
 0-2,500v. D.C. 20,000 ohms per volt, 0-1,000 A.C. Ohms 0 to 6 meg. 50 Microamps (Full list Meters S.A.E.)

BRAND NEW QUALITY EXTENSION LOUDSPEAKER
 Black plastic cabinet, 20ft. lead and adaptors. For any radio, intercom, tape recorder, etc. 3 to 15 ohm. PRICE 30/-
 Size: 7" x 5" x 3". Post 2/6



C.O.D. 5/- extra. Full List 1/-.

Take your Wellerchoice

LOW INITIAL COST

Marksman irons to cover all your soldering needs. 25W, 40W, 80W, 120W, 175W. Nickel-plated factory pre-tinned tips in stainless steel shanks.

INSTANT HEAT FOR RAPID SOLDERING

THE tool for intermittent work such as servicing. Working heat in a few seconds. The job is done in less time than it takes a normal iron to heat up. Expert dual-heat and Heavy Duty models.

TEMPERATURE CONTROL FOR RELIABILITY

For sophisticated production line soldering or to replace several conventional irons. No dry joints. Control of temperature without inhibiting performance. Mains or low voltage.

Send for full information

Weller Electric Limited

Redkirk Way, Horsham, Sussex

Tel: 0403. 61747

STEREOGRAM CABINET 219

An elegant Stereogram Cabinet in modern Veneered Mahogany and cloth covered Front Panel
BLACK LEATHERETTE SIDE PANELS
Dimensions: 52" x 17 1/2" x 12". Speaker positions for Twin 10" x 5" Speakers



OTHER MODELS—SEND FOR LIST

SPEAKERS 6/6

2"—75Ω. 2 1/2"—35Ω. P. & P. 2/6.

ACOS MICS. 35/- STANDARD

STICK MIC. 2gns. P. & P. 3/6.

ASSORTED CONDENSERS

10/- for 50. P. & P. 7/6.

ASSORTED RESISTORS

10/- for 50. P. & P. 4/6.

ASSORTED CONTROLS

10/- for 25. P. & P. 7/6.

TRANSISTORS

MULLARD MATCHED

OUTPUT KIT

9/- OC81D—2 OC81's.

P. & P. FREE.

FERRITE RODS 3/6

6", 8" x 3/8" complete with

LW/MW COILS. P. & P. FREE.

17in.—£11.10.0 Carr. 30/-

19in. SLIM-LINE FERGUSON 24 gns.

TWO-YEAR GUARANTEE
EX-RENTAL TELEVISIONS

FREE ILLUSTRATED LIST OF TELEVISIONS
17"—19"—21"—23"



WIDE RANGE OF MODELS
SIZES AND PRICES
DEMONSTRATIONS DAILY

TRANSISTOR CHASSIS DI 59/6

6 Transistors, LW/MW. Brand New. Famous British Manufacturer (LESS SPEAKERS). Size 7 1/2" x 3 1/2" x 4 1/2". P. & P. 4/6.

TRANSISTOR RECORD PLAYER CABINETS 19/6

P. & P. 7/6.

SINGLE PLAYER CABINETS 15/6

P. & P. 7/6.

TRANSISTOR CASES 19/6

Cloth covered, many colours. Size 9 1/2" x 6 1/2" x 3 1/2". P. & P. 3/6.

Similar cases in plastic 7/6.

AUTOCHANGERS £8.19.6

Garrard 3000 with Sonotone 9T H.C./D/S Stereo Cartridge.

VALVES SAME DAY SERVICE NEW! TESTED! GUARANTEED!

SETS 1R3, 1S3, 1T4, 3B4, 3V4, DAF91, DF91, DK91, DL92, DL94. Set of 4 for 17/6. DAF96, DF96, DK96, DL96, 4 for 26/-.

OZ4	4/6	12AX7	4/9	DK96	7/-	EL42	9/9	PEN30C15	1/-	UC85	6/6
1A7GT	7/6	12K3GT	7/6	DL35	5/-	EL84	4/-	PL20012	1/-	UCF30	8/3
1H5GT	7/3	12SN7GT6	6/-	DL92	5/9	EL90	5/-	PL36	9/6	UCH42	9/9
1N5GT	7/9	20F2	13/6	DL94	5/9	EL93	5/-	PL81	7/3	UCM91	6/6
1R5	5/8	20L1	16/9	DL96	5/9	EL95	5/-	PL82	6/6	UCM92	7/6
1S5	4/3	20P3	14/9	DY86	5/9	EM80	5/9	PL83	6/6	UCM93	9/9
1T4	2/9	20P4	18/6	DY87	5/9	EM81	6/9	PL84	6/3	UP41	9/9
3B4	5/9	30C1	8/9	EABC80	6/6	EM87	7/3	PL504	12/-	UF80	7/-
5U4G	4/6	30C15	13/6	EAF42	8/6	EY51	7/-	PL504	12/-	UF85	6/9
6Y3GT	5/9	30C17	12/6	EAF43	8/6	EY86	6/3	PL505	15/6	UF89	6/3
6Z4G	7/8	30C18	9/-	EB41	2/3	EZ40	7/6	PM84	7/9	UL41	9/6
6Z0L2	12/6	30F5	13/6	EB91	7/-	EZ41	7/6	PM85	10/6	UL84	8/6
6AL5	4/2	30FL1	12/6	EBF80	6/3	EZ81	4/6	PM86	10/-	UM84	7/6
6AM6	3/6	30FL14	12/6	ECC81	3/9	K781	8/9	PM87	10/-	UM84	7/6
6AQ5	4/9	30L1	6/-	ECC82	4/9	K781	15/-	PM88	5/3	UY41	7/-
6AT6	4/-	30L15	14/-	ECC83	4/9	N78	14/9	PM89	5/3	UY85	5/9
6AT6	5/8	30L17	13/-	ECC84	5/8	PC88	9/6	PM90	5/3	UY85	10/6
6BA6	4/8	30P4	12/-	ECC85	4/9	PC88	9/6	PM91	5/3	VP1321	21/-
6BD6	4/3	30P12	11/9	ECC86	4/9	PC88	9/6	PM92	5/3	Z77	3/6
6BJ6	7/-	30P19	8/-	ECC87	4/9	PC88	9/6	PM93	5/3	Z77	3/6
6BW6	13/-	30P12	12/-	ECC88	4/9	PC88	9/6	PM94	5/3	Z77	3/6
6C4	2/9	30PL13	14/6	ECC89	4/9	PC88	9/6	PM95	5/3	Z77	3/6
6F13	3/6	30PL14	15/-	ECC90	4/9	PC88	9/6	PM96	5/3	Z77	3/6
6F14	9/-	35L6GT	8/-	ECC91	4/9	PC88	9/6	PM97	5/3	Z77	3/6
6K7G	13/3	35W4	4/6	ECC92	4/9	PC88	9/6	PM98	5/3	Z77	3/6
6K8G	4/3	60C3	12/6	ECC93	4/9	PC88	9/6	PM99	5/3	Z77	3/6
6L18	6/-	AZ31	9/-	ECC94	4/9	PC88	9/6	PM100	5/3	Z77	3/6
6V6G	3/6	B729	12/6	ECC95	4/9	PC88	9/6	PM101	5/3	Z77	3/6
6V9GT	6/8	CC835	10/-	EF89	8/3	PCF82	6/-	PM102	5/3	Z77	3/6
6X4	3/6	CL33	18/6	EF41	9/6	PCF85	8/3	PM103	5/3	Z77	3/6
6X5GT	5/9	DAC32	7/3	EF80	5/9	PCF80	13/8	PM104	5/3	Z77	3/6
7B6	10/9	DAF91	4/3	EF85	5/6	PCF80	7/3	PM105	5/3	Z77	3/6
7B7	7/-	DAF96	5/-	EF86	5/3	PCF80	11/6	PM106	5/3	Z77	3/6
7C6	15/-	DF33	7/9	EF89	5/3	PCF80	12/6	PM107	5/3	Z77	3/6
7Y4	8/9	DF91	2/9	EF91	5/3	PCF80	12/6	PM108	5/3	Z77	3/6
10F1	8/6	DF96	6/-	EF183	5/9	PCF82	7/-	PM109	5/3	Z77	3/6
10P13	15/6	DH77	4/-	EF184	5/9	PCF82	7/-	PM110	5/3	Z77	3/6
12AT7	3/9	DK92	9/3	EL41	8/6	PCF82	7/-	PM111	5/3	Z77	3/6
12AU6	4/9	DK91	5/8	EL34	9/6	PCF82	7/-	PM112	5/3	Z77	3/6
12AU7	4/9	DK92	9/3	EL41	8/6	PCF82	7/-	PM113	5/3	Z77	3/6
						PCF82	7/-	PM114	5/3	Z77	3/6
						PCF82	7/-	PM115	5/3	Z77	3/6
						PCF82	7/-	PM116	5/3	Z77	3/6
						PCF82	7/-	PM117	5/3	Z77	3/6
						PCF82	7/-	PM118	5/3	Z77	3/6
						PCF82	7/-	PM119	5/3	Z77	3/6
						PCF82	7/-	PM120	5/3	Z77	3/6
						PCF82	7/-	PM121	5/3	Z77	3/6
						PCF82	7/-	PM122	5/3	Z77	3/6
						PCF82	7/-	PM123	5/3	Z77	3/6
						PCF82	7/-	PM124	5/3	Z77	3/6
						PCF82	7/-	PM125	5/3	Z77	3/6
						PCF82	7/-	PM126	5/3	Z77	3/6
						PCF82	7/-	PM127	5/3	Z77	3/6
						PCF82	7/-	PM128	5/3	Z77	3/6
						PCF82	7/-	PM129	5/3	Z77	3/6
						PCF82	7/-	PM130	5/3	Z77	3/6
						PCF82	7/-	PM131	5/3	Z77	3/6
						PCF82	7/-	PM132	5/3	Z77	3/6
						PCF82	7/-	PM133	5/3	Z77	3/6
						PCF82	7/-	PM134	5/3	Z77	3/6
						PCF82	7/-	PM135	5/3	Z77	3/6
						PCF82	7/-	PM136	5/3	Z77	3/6
						PCF82	7/-	PM137	5/3	Z77	3/6
						PCF82	7/-	PM138	5/3	Z77	3/6
						PCF82	7/-	PM139	5/3	Z77	3/6
						PCF82	7/-	PM140	5/3	Z77	3/6
						PCF82	7/-	PM141	5/3	Z77	3/6
						PCF82	7/-	PM142	5/3	Z77	3/6
						PCF82	7/-	PM143	5/3	Z77	3/6
						PCF82	7/-	PM144	5/3	Z77	3/6
						PCF82	7/-	PM145	5/3	Z77	3/6
						PCF82	7/-	PM146	5/3	Z77	3/6
						PCF82	7/-	PM147	5/3	Z77	3/6
						PCF82	7/-	PM148	5/3	Z77	3/6
						PCF82	7/-	PM149	5/3	Z77	3/6
						PCF82	7/-	PM150	5/3	Z77	3/6
						PCF82	7/-	PM151	5/3	Z77	3/6
						PCF82	7/-	PM152	5/3	Z77	3/6
						PCF82	7/-	PM153	5/3	Z77	3/6
						PCF82	7/-	PM154	5/3	Z77	3/6
						PCF82	7/-	PM155	5/3	Z77	3/6
						PCF82	7/-	PM156	5/3	Z77	3/6
						PCF82	7/-	PM157	5/3	Z77	3/6
						PCF82	7/-	PM158	5/3	Z77	3/6
						PCF82	7/-	PM159	5/3	Z77	3/6
						PCF82	7/-	PM160	5/3	Z77	3/6
						PCF82	7/-	PM161	5/3	Z77	3/6
						PCF82	7/-	PM162	5/3	Z77	3/6
						PCF82	7/-	PM163	5/3	Z77	3/6
						PCF82	7/-	PM164	5/3	Z77	3/6
						PCF82	7/-	PM165	5/3	Z77	3/6
						PCF82	7/-	PM166	5/3	Z77	3/6
						PCF82	7/-	PM167	5/3	Z77	3/6
						PCF82	7/-	PM168	5/3	Z77	3/6
						PCF82	7/-	PM169	5/3	Z77	3/6
						PCF82	7/-	PM170	5/3	Z77	3/6
						PCF82	7/-	PM171	5/3	Z77	3/6
						PCF82	7/-	PM172	5/3	Z77	3/6
						PCF82	7/-	PM173	5/3	Z77	3/6
						PCF82	7/-	PM174	5/3	Z77	3/6
						PCF82	7/-	PM175	5/3	Z77	3/6
						PCF82	7/-	PM176	5/3	Z77	3/6
						PCF82	7/-	PM177	5/3	Z77	3/6
						PCF82	7/-	PM178	5/3	Z77	3/6
						PCF82	7/-	PM179	5/3	Z77	3/6
						PCF82	7/-	PM180	5/3	Z77	3/6
						PCF82	7/-	PM181	5/3	Z77	3/6

The recently opened Victoria Line is the first new "tube" railway to be built under central London for over 60 years. Probably the most technically advanced railway in the world, this line relies heavily upon electronics for its automatic running



Electronics Underground

THE travelling habits of many thousands of London commuters underwent a major change on September 2, 1968. On this day the first fully automatic train pulled away from Walthamstow Central station, marking the opening of the first section of the new Victoria Line. The first section runs from Walthamstow Central to Highbury and Islington, the next section, due to commence running in December, is from Islington to Warren Street and the third section from Warren Street to Victoria will be completed in the early spring. A fourth section will be completed in 1970, which will extend the line to Brixton.

ROLE FOR ELECTRONICS

Apart from the enormous task of the tunnelling there was the task of station and train design to be considered. This is where electronics plays a starring role in the form of automatic trains, automatic ticket issuing, automatic passenger barriers, closed circuit television, and for the first time in this country the use of carrier wave equipment for intercommunicating with traffic regulators in control rooms and in other trains, whilst still running underground.

Most of the design of the complete system has been done by London Transport design departments in close consultations with subcontractors.

Tracking and coding equipment of the type used on the new line

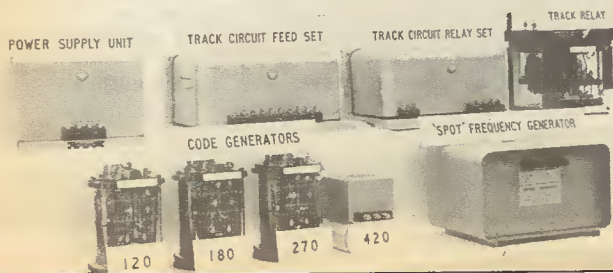

THE AUTOMATIC TRAIN

The first train fitted with automatic driving equipment to be tried in passenger service began way back in April 1963. Since then many exhaustive tests and experiments to ensure safety and reliability of running have been carried out.

Automatic driving apparatus incorporates two separate systems, the safety signalling system which ensures the safety of the train and its passengers, and the automatic driver signal command system. Both systems rely on electrical currents, either coded or of different frequencies, being picked up by induction coils mounted at the front of the train.

SAFETY SIGNALLING SYSTEM

The safety signalling system uses coded signals which take the place of the usual visual signalling system, although enough visual signals are provided to allow trains to proceed manually if any emergencies arise.

The basic principle of the system is that a train cannot run unless it is receiving a continuous series of coded pulses transmitted through the running track. The coded signals inform the train whether the track is clear or if another train is ahead. The train must receive one or other of the safety codes continuously. If a code ceases to be received then the brakes are automatically applied.

The safety signals are derived from mains current at 125Hz, which is interrupted into the necessary codes by means of pendulums swinging at different rates and operating electronic switches.

CODED SIGNALS

The codes used are: 420 impulses per minute, indicating that the track is clear for full speed running; and 180 pulse, which indicates that the train cannot proceed at more than 25 mph. Indications of the codes are given by lights in the cab for the information of the train operator.

caution ensures that no power will be supplied to the traction motors unless the air brakes are fully operative.

CLOSE RUNNING

A feature of the equipment is the provision of a 20kHz command spot which works in conjunction with a stop signal and is switched on and off with it. The purpose of this special command pulse, outside the train speed frequency, is to enable a train to approach an occupied section at reduced speed.

If a train is standing in a station under the protection of the home signal, the 20kHz pulse is automatically switched on. Any other train approaching receives this signal and is caused to make a service brake application so as to stop before reaching the signal itself. The train will re-start by itself as soon as the train ahead leaves the station and the signal is cleared, but will continue into the station at the reduced 20 to 23 mph speed until it comes to the braking points for the station stop.

The effect of the 20kHz spot is to cause the train to be stopped at a signal position before it runs on to a lower or no-code section when it would be stopped by means of the emergency trip valve. Full safety braking distances are incorporated in the positioning of the safety signalling equipment applying the codes to the tracks.

AUTOMATIC TICKET GATES AND FARE COLLECTION

In the new stations full use is made of automatic ticket issuing, automatic barriers and closed circuit television.

This automatic system has been developed to act as a deterrent to fraudulent travel and to cut costs.

Two types of gates are used—the four-door gate and the tripod turnstile. Entry and exit gates are worked by yellow tickets with magnetic tape backing on which the journey details are electronically encoded. When passengers place their tickets in the appropriate slot, these details are "read" electronically by the gates, which open only if the ticket is valid.

A high percentage of tickets sold in station booking halls will come from automatic machines including a

"Four-door" automatic collection gates, one of two types used on the Victoria Line

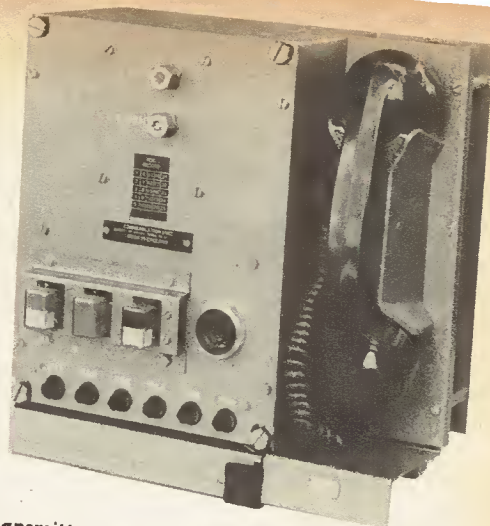

V.H.F. transmitter and receiver used on the new automatic trains

new multi-fare machine which has a range of 20 fares; this accepts any coin and gives change as necessary. Note changing machines will also be used at stations; these accept banknotes and, after checking electronically, deliver two shilling pieces as necessary.

CLOSED CIRCUIT TELEVISION

Closed circuit television, designed by Peto Scot Ltd., will help maintain a smooth flow of passengers to and from the trains.

Seventy-four cameras and 42 monitor sets and distributive equipment will be used between Walthamstow Central and Victoria to cover the 10½ mile, 12 station section of the new line.

At most stations on the new line an operations room, generally at ticket level, will be equipped with two 11in monitor screens on which the supervisor in charge will be able to select pictures from any of the cameras at his disposal. A microphone connected to loudspeakers on the platforms will enable him to make announcements to passengers.

Television also gives a visual link with all Victoria Line stations to the line controller. At the control centre at Cobourg Street, Euston, he will have two 19in monitors on which to pick up pictures from cameras on any of the station platforms throughout the whole system.

In the event of a delay to the service he will be able to see the effect of the trouble at a glance.

A two-way sound system, linked to the TV set-up, will enable the line controller to hear as well as see what is going on with the range of each camera, and to speak through the platform public address system if required.

For the train operators, monitor screens are sited on each platform opposite the point where the front of the train stops. These show the picture transmitted by the camera mounted at the opposite end of the same platform.

SUMMARY

Finally, the cost of the Victoria Line, which has a carrying capacity of equivalent to eleven motorways running across the heart of London, will be about £80 million and will have a rush hour capacity of 25,000 passengers an hour in either direction.

But is the money well spent? Will it ease the congestion and frayed tempers during rush hour? Only time will tell.





Short of a lead?

With a 3-pin DIN plug on one end and 3.5mm jack on the other? With the Goldring Screened Audio Lead Set, you've got it—instantly—at your finger tips. And 37 other different equipment-to-equipment connections



as well. With cable lengths of 20', 40', or 60' according to the combinations you use. All tidily and instantly to hand in a small neat storage box. There's no longer any need to have an unwieldy collection of dozens of different leads... and still be short of the right one! This new Goldring set will give you most of the connections you're ever likely to want—without searching for cables and plugs, without soldering, without waiting, without further expense. The Goldring Audio Lead Set, from your Hi-Fi dealer, is a real investment at **£3.6.0**

*Goldring are now marketing an extremely useful range of individually packed leads, plugs, sockets and connections for audio enthusiasts.

GOLDRING MANUFACTURING CO. (G.B.) LTD.,

G 486-488 High Road, Leytonstone, London, E.11.
Tel: Leytonstone 8343.

Samson's

(ELECTRONICS) LTD.

9 & 10 CHAPEL STREET
LONDON, N.W.1

01-723 7851 01-262 5125

CURRENT RANGE OF BRAND NEW L.T. TRANSFORMERS. FULLY SHROUDED (*excepted) TERMINAL BLOCK CONNECTIONS. ALL PRIMARIES 220/240V

No.	Sec. Taps	Amps	Price	Carr.
1A	25-33-40-50	15	£9 10 0	10/6
1B	25-33-40-50	10	£6 19 6	8/6
1C	25-33-40-50	6	£5 19 6	8/6
1D	25-33-40-50	3	£3 12 6	7/6
2A	4-16-24-32	12	£6 10 0	7/6
2B	4-16-24-32	8	£4 17 6	7/6
2C	4-16-24-32	4	£3 5 0	6/-
2D	4-16-24-32	2	£2 2 6	5/-
3A*	25-30-35	40	£14 17 6	15/-
3B*	25-30-35	20	£9 7 6	9/6
3C*	25-30-35	10	£6 10 0	7/6
3D	25-30-35	5	£3 15 0	6/6
3E	25-30-35	2	£2 15 0	6/6
4A*	12-20-24	30	£11 15 0	10/-
4B	12-20-24	20	£7 10 0	8/6
4C	12-20-24	10	£4 15 0	7/6
4D	12-20-24	5	£3 5 0	6/6
5A	3-12-18	30	£8 15 0	7/6
5B	3-12-18	20	£6 10 0	7/6
5C	3-12-18	10	£3 17 6	6/6
5D	3-12-18	5	£2 12 6	6/6
6A	48-56-60	2	£3 5 0	5/6
6B	48-56-60	1	£2 7 6	5/6
7A*	6-12	50	£9 7 6	9/6
7B	6-12	20	£5 10 0	7/6
7C	6-12	10	£3 10 0	6/6
7D	6-12	5	£2 10 0	5/6
8A	12-24	1	£1 9 6	5/6
9A	17-32	8	£5 12 6	5/6
10A	9-15	2	£1 5 0	5/6
11A	6-3	15	£2 5 0	5/6
12A	30-25-0-25-30	2	£3 5 0	5/6

NEW H.T. TRANSFORMERS
by Woden and Gardner. Primaries tapped 200-250V.

- (1) Secondaries 315-0-315V, 110m.a., 175-0-175V, 25m.a., 5V, 1-9A., 6-3V, 3-1A., 6-3V, C.T. 4A., 6-3V, C.T. 12A., 6-3V, 1A. "C" core. Table top connections. 50/- P. & P. 7/6.
- (2) 350-0-350V, 180m.a., 6-3V, 3A., 6-3V, 2A., 2 x 6-3V, 2A., 6-3V, 1A., 5V, 2-8A. 75/- P. & P. 10/6.
- (3) 350-0-350V, 25m.a., 6-3V, 1A., 6-3V 6A. 19/6. P. & P. 5/6.

AUTO TRANSFORMERS
240V-110V or 100V. Completely Shrouded fitted with Two pin American Sockets or terminal blocks. Please state which type required.

Type	Watts	Weight	Price	Carr.
1	80	2 1/2 lb	£1 17 6	4/6
2	150	4 lb	£2 7 6	5/-
3	300	6 1/2 lb	£3 7 6	6/-
4	500	8 1/2 lb	£4 15 0	6/6
5	1,000	15 lb	£6 12 6	7/6
6*	1,750	25 lb	£13 10 0	10/6
7*	2,250	30 lb	£16 10 0	12/6

* Completely enclosed in beautifully finished metal case fitted with two 2-pin American sockets, neon indicator, on/off switch, and carrying handle.

ISOLATION TRANSFORMERS
Amps. Price Carr.
All primaries and 1 £3 19 6 6/6
secondaries 220/ 2 £7 10 0 8/6
240V. Terminal 3 £8 19 6 10/6
block con- 4 £10 19 6 10/6
nections. Fully shrouded. *8 £17 10 0 15/-
(*excepted).

ADVANCE CONSTANT VOLTAGE TRANSFORMERS:
Input 190-260V, 50 cycles. Output 230V at 60 watts. Type M.T.161A. £4.15. P. & P. 7/6.

COMPUTER EXTRACTOR FANS
Manufactured by Papst. A.C. 220-240 volts. Complete with fibre-glass filter 3 1/2 in fan. Capacitor start. Ex equipment. Guaranteed in perfect order. Size: 28 x 5 x 5 in. 59/6, carr. 8/6.
FANS ONLY (ILLUSTRATED) 45/-, carr. 5/-.

DIGITAL HOUR METERS
6 figs. inc. 1/100ths, 1/1000ths, 40V a.c. but complete with transformer for 240V a.c. operation. All in plastic case. Size 6 1/2 x 6 1/2 x 3 in. Condition as new 45/- P. & P. 5/-.

Now! A FAST EASY WAY TO LEARN BASIC RADIO AND ELECTRONICS

Build as you learn with the exciting new TECHNATRON Outfit! No mathematics. No soldering—but you learn the practical way.

Now you can learn basic Radio and Electronics at home—the fast, modern way. You can give yourself the essential technical 'know-how' sooner than you would have thought possible—read circuits, assemble standard components, experiment, build... and enjoy every moment of it. B.I.E.T.'s Simplified Study Method and the remarkable new TECHNATRON Self-Build Outfit take the mystery out of the subject—make learning easy and interesting.

Even if you don't know the first thing about Radio now, you'll build your own Radio set within a month or so!

and what's more, **YOU'LL UNDERSTAND EXACTLY WHAT YOU ARE DOING.** The Technatron Outfit contains everything you need, from tools to transistors... even a versatile Multimeter which we teach you how to use. You need only a little of your spare time, the cost is surprisingly low and the fee may be paid by convenient monthly instalments. You can use the equipment again and again—and it remains your own property.

You LEARN—but it's as fascinating as a hobby.

Among many other interesting experiments, the Radio set you build—and it's a good one—is really a bonus; this is first and last a teaching Course. But the training is as rewarding and interesting as any hobby. It could be the springboard for a career in Radio and Electronics or provide a great new, spare-time interest.

A 14-year-old could understand and benefit from this Course—but it teaches the real thing. Bite-size lessons—wonderfully clear and easy to understand, practical projects from a burglar-alarm to a sophisticated Radio set... here's your chance to master basic Radio and Electronics, even if you think you're a 'non-technical' type. And, if you want to carry on to more advanced work, B.I.E.T. has a fine range of Courses up to A.M.I.E.R.E. and City and Guilds standards.

Send now for free 132-page book. Like to know more about this intriguing new way to learn Radio and Electronics? Fill in the coupon and post it today. We'll send you full details and a 132-page book —'ENGINEERING OPPORTUNITIES'—Free and without any obligation.



BRITISH INSTITUTE OF ENGINEERING TECHNOLOGY

Dept. 371B, Aldermaston Court, Aldermaston, Berkshire.

To: B.I.E.T., Dept. 371B, ALDERMASTON COURT, ALDERMASTON, BERKS.

I would like to know more about your Practical Radio & Electronics Course. Please send me full details and FREE 132-page book.

name.....

address.....

.....age.....

POST THIS COUPON NOW!

Look What's New from HEATHKIT

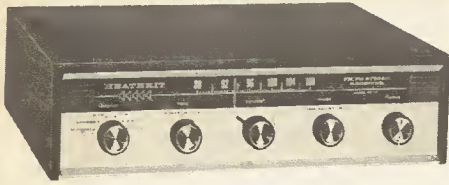

Low-cost FM Stereo Receiver, AR-17

Kit K/AR-17

£39.0.0

P.P. 10/6

Cabinet walnut or teak finish **£3.10.0** extra

28 transistor, 7 diode circuit, 14 watts music power, 10 watts r.m.s. from 25-35,000Hz @ ± 1 dB. Automatic stereo indicator light. Adjustable phase control. Complete front panel controls. Flywheel tuning. Factory assembled and aligned FM front-end. Circuit board assembly. Compact 10 $\frac{3}{8}$ " deep \times 3" high \times 12" wide. Use free standing with Heathkit cabinet optional extra.

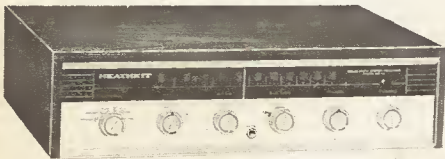

Quality FM Stereo Receiver, AR-14

Kit K/AR-14

£54.0.0

P.P. 13/6

Cabinet walnut or teak finish **£4.10.0** extra

31 transistor, 10 diode circuit can deliver ± 1 dB, 15 to 50,000Hz at 10 watts per channel (20 watts total) 15 watts per channel 1HF music power (30 watts total). Wide-band FM/FM stereo tuner plus two preamps, two power amplifiers. Compact only 3 $\frac{3}{8}$ " high \times 15 $\frac{1}{2}$ " wide \times 12" deep. Install in a wall, free standing or in Heathkit cabinet optional extra. 210-240V 50Hz a.c.



Low-cost FM Mono Receiver, AR-27

Kit K/AR-27

£22.10.0

P.P. 10/6

Cabinet walnut veneered **£3.10.0**

13 transistor, 6 diode circuit. 7 watts music power. ± 1 db, 25 to 60,000Hz at 6 watts. Input connectors for phono and aux. Complete front panel controls. Flywheel tuning, factory pre-aligned FM tuner. Circuit board assembly. Compact bookshelf size. Install in a wall, free standing or in cabinet optional extra. 210-240V 50Hz a.c. operation.



Solid-State Volt-ohm-Milliammeter, IM-25

Kit K/IM-25

£48.10.0

P.P. 10/6

9 a.c. and 9 d.c. ranges 150mV up to 1,500V f.s. 7 resistance ranges, 10 ohms centre scale with multipliers $\times 1$, $\times 10$, $\times 100$, $\times 1k$, $\times 10k$, $\times 100k$ and $\times 1$ Meg. . . . measures from 1 ohm to 1,000Mohms. 11 current ranges from 15 μ A full scale to 1.5A full scale. 11Mohm input impedance d.c. 10Mohm input impedance a.c. 6" 200 μ A meter. Internal battery power or 120/240V a.c. 50Hz supply. PCB construction.

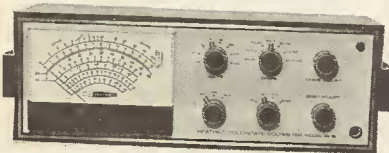

Solid-State Volt-ohm Meter, IM-16

Kit K/IM-16

£28.8.0

P.P. 10/6

8 a.c. and 8 d.c. ranges 0-5V to 1,500V f.s. 7 ohm-meter ranges with 10 ohms centre scale with multipliers $\times 1$, $\times 10$, $\times 100$, $\times 1k$, $\times 10k$, $\times 100k$ and $\times 1$ Meg. . . . 11Mohm input on d.c., 1Mohm on a.c. Internal battery power or 120/240V a.c. 50Hz supply.



Solid-State Low Voltage Power Supply, IP-27

Kit K/IP-27

£46.12.0

P.P. 10/6

0.5 to 50V d.c. with better than ± 15 Millivolts regulation. Four current ranges 50mA; 150mA, 500mA, and 1.5 amperes. Adjustable current limiter: 30 to 100% all ranges. Panel meter for output voltage or current.

SEE HEATHKIT MODELS IN LONDON, Tottenham Court Road. BIRMINGHAM, St. Martin's House. GLOUCESTER, factory

This special trackside equipment has been installed in special "relay rooms". The equipment transmits instructions to the train in the form of electrical impulses which are fed to the running rails and picked up by the induction coils on the train; they are then passed to the "brain", which is a box of electronic equipment and electrical relays housed in special compartments on the train. The impulses convey commands to the train which operate the electrical circuits. These in turn actuate the brakes or the motors so that the train can accelerate, coast, and brake accordingly.

The impulses having been pre-set to give the most efficient running section by section over the line, act as automatic check points to ensure that the speed is dropping correctly to halt the train in proper alignment with the platforms regardless of its passenger load.

CAB DESIGN

Automatic train operation has involved considerable changes in the cab as compared with that of a standard train. The train operator has a folding seat on the rear bulkhead on the near side, with the more important controls and dials grouped on a desk in front of him.

Immediately in front of the operator and duplicated on both sides of the cab are the twin push-button switches used for starting the train—the only driving control required in normal automatic working.

For use when the train is being operated manually, as in entering the depot or in the event of a failure of the automatic system, there is a combined traction/brake controller to the left of the desk. The handle is pushed forward for motoring and pulled back for braking. On the right hand side is a switch for selecting manual (forward or reverse) or automatic driving, or "off".

To operate the train when no signalling codes are being fed to the track, the train operator must first raise a "slow manual" flag switch on the off-side of the cab which restricts speed to approximately 10 mph. When signalling codes are being picked up by the train the train operator can drive in manual control at up to 25 mph.

Cab of the Victoria line train. The operator's desk, with controls for manual operation when required, is on the front wall of the cab, with other controls and switches on the desk in the right foreground



DOOR CONTROL AND DRIVING LIGHTS

There are two other controls in regular use—the near and off-side door controllers. These are levers moving through 90 degrees and can be worked while the operator is looking, from the cab drop window, back along the train. To protect against inadvertent opening of the doors, the door controllers cannot be operated until a lock has been depressed.

As automatic train operation is used, there are few of the colour-light signals, which, on a standard Tube line, act as points of visual reference to drivers. Because of their absence, the new trains have been fitted with headlights which will light up the tunnel for some distance ahead, giving a visual relationship between the movement of the train and its surroundings.

An unusual item in the cab is an emergency calling light switch. When switched on from the operator's position, a light on the outside of each cab acts as a breakdown calling light. The light at the front of the train acts as a repeater to show the operator that the rear call light is also functioning.

COMMUNICATION SYSTEM

Each train cab is fitted with a v.h.f. transmitter and receiver, supplied by Nelson Tansley Ltd., with an aerial mounted on the front of the train. Fitted with a telephone handset and selector panel there are three positions on which the operator selects Public Address, Intercommunication, or inter-train communication.

Selection of inter-train communication position by depressing an associated push button will, after alerting the called train, enable a normal two-way radio-telephone conversation to take place. This enables the operators of the two trains to speak to each other before coupling so that the man in the following train can be told the nature of the fault in the train ahead.

This avoids the risk of, say, an electrical fault being inadvertently transmitted from the disabled train to the one behind as the couplers make contact. Means are provided for isolating the electrical connections in these circumstances.

Selecting Public Address on the selector panel enables train operators to convey information and/or instructions to passengers via six loudspeakers in each coach. This facility will normally only be used when the train is stationary.

Carrier wave equipment is also fitted, operating via the conductor rails, to allow the train operator to speak to the Central Control Room and vice versa. The carrier wave system operates whether the train is moving or not.

STARTING THE TRAIN

Each train has a one-man crew who is called a train operator. He travels in the front cab and can switch over to manual control at any time in the event of a failure of any part of the automatic system. He uses a control in the cab to open doors at station stops, and to close them again he must carry out two safety procedures before the train will commence its journey. They are, that he must close the cab drop window and press twin start buttons simultaneously; this way no train can be sent on its journey without an operator. The twin starting buttons are also provided so that a fault in one wire cannot cause a false start.

Interlocking devices ensure that the train cannot start until all doors are properly closed and unless the 420 code is in operation. Indicator lights are provided near the buttons to show the train operator whether these conditions have been fulfilled. An additional pre-

DUXFORD ELECTRONICS (PE)

97/97A MILL ROAD, CAMBRIDGE

Telephone: CAMBRIDGE (0223) 63687

(Visit us—at our new Mail Order, Wholesale & Retail Premises)

MINIMUM ORDER VALUE 5/-

C.W.O. Post and Packing 1/-

DISCOUNT 10% over £2
15% over £5

CERAMIC DISC CAPACITORS (Hunts.). 500V ±20%; 100, 220, 330pF. —20%, —80%; 470, 680, 1,000pF. 5d each.

ELECTROLYTIC CAPACITORS (Mullard). —10% to 50%.

Subminiature (all values in μ F)					
4V	8	32	64	125	250
6.4V	6.4	25	50	100	200
10V	4	16	32	64	125
16V	2.5	10	20	40	80
25V	1.6	6.4	12.5	25	50
40V	1	4	8	16	32
64V	0.64	2.5	5	10	20
Price	1/6	1/3	1/2	1/-	1/2
Small (all values in μ F)					
4V	800	1,250	2,000	3,200	4,000
6.4V	640	1,000	1,600	2,500	3,200
10V	400	640	1,000	1,600	2,000
16V	250	400	640	1,000	1,250
25V	160	250	400	640	800
40V	100	160	250	400	500
64V	64	100	160	250	320
Price	1/6	2/-	2/6	3/-	3/-

POLYESTER CAPACITORS (Mullard)

Tubular, 10%, 160V: 0.01, 0.015, 0.022 μ F, 7d. 0.033, 0.047 μ F, 8d. 0.068, 0.1 μ F, 9d. 0.15 μ F, 11d. 0.22 μ F, 1/- 0.33 μ F, 1/3. 0.47 μ F, 1/6. 0.68 μ F, 2/3. 1 μ F, 2/8.

400V: 1,000, 1,500, 2,200, 3,300, 4,700pF, 6d. 6,800pF, 0.01, 0.015, 0.022 μ F, 7d. 0.033 μ F, 8d. 0.047 μ F, 9d. 0.068, 0.1 μ F, 11d. 0.15 μ F, 1/2. 0.22 μ F, 1/6. 0.33 μ F, 2/3. 0.47 μ F, 2/8.

Modular, metallised, P.C. mounting, 20%, 250V: 0.01, 0.015, 0.022 μ F, 7d. 0.033, 0.047 μ F, 8d. 0.068, 0.1 μ F, 9d. 0.15 μ F, 11d. 0.22 μ F, 1/- 0.33 μ F, 1/5. 0.47 μ F, 1/8. 0.68 μ F, 2/3. 1 μ F, 2/9.

POLYSTYRENE CAPACITORS: 5%, 160V (unencapsulated): 10, 12, 15, 18, 22, 27, 33, 39, 47, 56, 68, 82, 100, 120, 150, 180, 220, 270, 330, 390, 470, 560, 680, 820pF, 5d. 1,000, 1,500, 2,200pF, 6d. 3,300, 4,700, 5,600pF, 7d. 6,800, 8,200, 10,000pF, 8d. 15,000, 22,000pF, 9d.

1%, 100V (encapsulated): 100, 120, 150, 180, 220, 270, 330, 390, 470, 500, 560, 680, 820pF, 1/- 1,000, 1,200, 1,500, 1,800, 2,200, 2,700, 3,300, 3,900pF, 1/3. 4,700, 5,000, 5,600, 6,800, 8,200, 10,000, 12,000, 15,000pF, 1/6. 18,000, 22,000, 27,000, 33,000, 39,000pF, 1/9. 0.047, 5,000, 0.056 μ F, 2/- 0.068, 0.082, 0.1 μ F, 2/3. 0.12 μ F, 2/9. 0.15, 0.18 μ F, 3/- 0.22 μ F, 4/- 0.27, 0.33 μ F, 5/- 0.39 μ F, 5/9. 0.47, 0.51 μ F, 6/3.

JACK PLUGS (Screened): Heavily chromed, $\frac{1}{2}$ in Standard: 2/9 each. Side-entry: 3/3 each. Standard (Unscreened): With black, grey, white, red, blue, green or yellow covers, 2/3 each.

JACK SOCKETS ($\frac{1}{2}$ in Plug): With black or white bezel and chrome nut, 2/9 each. Available with: Break/Break, Make/Break, Break/Make, Make/Make contacts.

POTENTIOMETERS (Carbon): Long life, low noise, $\frac{1}{2}$ W at 70°C. $\pm 20\% \leq \Delta M, \pm 30\% > \Delta M$. Body dia., $\frac{1}{2}$ in. Spindle, 1in $\times \frac{1}{16}$ in. 2/3 each. Linear: 100, 250, 500 ohms, etc., per decade to 10M. Logarithmic: 5k, 10k, 25k, etc., per decade to 5M.

SKELTON PRE-SET POTENTIOMETERS (Carbon): Linear: 100, 250, 500 ohms, etc., per decade to 5M. Miniature: 0.3W at 70°C. $\pm 20\% \leq \Delta M, \pm 30\% > \Delta M$. Horizontal (0.7in \times 0.4in P.C.M.) or Vertical (0.4in \times 0.2in P.C.M.) mounting, 1/- each. Submin. 0.1W at 70°C. $\pm 20\% \leq \Delta M, \pm 30\% > \Delta M$. Horizontal (0.4in \times 0.2in P.C.M.) or Vertical (0.2in \times 0.1in P.C.M.) mounting, 10d each.

RESISTORS (Carbon film), very low noise. Range: 5%, 4.7 Ω to 1M Ω (E24 Series): 10%, 10 Ω to 10M Ω (E12 Series). $\frac{1}{2}$ W (10%), 1 $\frac{1}{2}$ d (over 99, 1 $\frac{1}{2}$ d), 100 off per value 12/-, $\frac{1}{2}$ W (5%), 2d (over 99, 1 $\frac{1}{2}$ d), 100 off per value 13/9. $\frac{1}{4}$ W (10%), 2d (over 99, 1 $\frac{1}{2}$ d), 100 off per value 13/9. $\frac{1}{4}$ W (5%), 2 $\frac{1}{2}$ d (over 99, 2d), 100 off per value 15/6.

SEMICONDUCTORS: OA5, OA81, 1/9. OC44, OC45, OC71, OC81, OC81D, OC82D, 2/- OC72, 2/3. OC170, OC171, 2/6. AF115, AF116, AF117, 3/- OC73, 3/3. OC140, 4/3.

SILICON RECTIFIERS (0.5A): 170 P.I.V., 2/9. 400 P.I.V., 3/- 800 P.I.V., 3/3. 1,250 P.I.V., 3/9. 1,500 P.I.V., 4/-.

SWITCHES (Chrome finish, Silver contacts): 3A 250V, 6A 125V. Push Buttons: Push-on or Push-off (with white, black, green or red buttons) 5/-. Toggle Switches: SP/ST, 3/3. SP/DT, 3/6. SP/DT (with centre position) 3/9. DP/ST, 4/3. DP/DT, 5/-.

PRINTED CIRCUIT BOARD (Vero). 0.15in Matrix: 3 $\frac{1}{2}$ in \times 2 $\frac{1}{2}$ in, 3/3. 5 $\frac{1}{2}$ in \times 2 $\frac{1}{2}$ in, 3/11. 3 $\frac{1}{2}$ in \times 3 $\frac{1}{2}$ in, 3/11. 5in \times 3 $\frac{1}{2}$ in, 5/6. 0.1 Matrix: 3 $\frac{1}{2}$ in \times 2 $\frac{1}{2}$ in, 4/- 5in \times 2 $\frac{1}{2}$ in, 4/6. 3 $\frac{1}{2}$ in \times 3 $\frac{1}{2}$ in, 4/6. 5in \times 3 $\frac{1}{2}$ in, 5/3.

RECORDING TAPE (Finest quality MYLAR—almost unbreakable). Standard Play: 5in, 600ft, 7/6. 5 $\frac{1}{2}$ in, 850ft, 10/6. 7in, 1,200ft, 12/6. Long Play: 3in, 225ft, 4/- 5in, 900ft, 10/6. 5 $\frac{1}{2}$ in, 1,200ft, 13/- 7in, 1,800ft, 18/-.

Send S.A.E. for May, 1968 Catalogue

NEW F.M. STEREO TUNER £25

Range 87 to 107 MHz Black crackle finish metal case with cast front escutcheon. Case size 13in. \times 7in. \times 3in. high. Mains transformer. Metal Rectifier and Valves ECC85, EF89, EF80, ECC82 as cathode follower. EM84 tuning indicator, 2 \times AF117 and 2 diodes. A really fantastic performer. Price £25, tax paid and carr. paid. MONO VERSION as above but less stereo decoder £17.17.0 tax and carr. paid. Terms available this item.

"SUPER SIX" L.W. and M.W. TRANSISTOR RADIO KIT Mark 2. Complete set parts £4.2.6 (6/- post). PP6 batt. 2/9 extra. Instructions and list 2/- (free with kit), Superhet; ferrite rod; wooden cab. 9 $\frac{1}{2}$ \times 7 $\frac{1}{2}$ \times 3in. Celestion 4in. speaker, 6 transistors, diode, etc.

RADIOGRAM CHASSIS unused but very slightly tarnished. Size 13 $\frac{1}{2}$ \times 5 $\frac{1}{2}$ \times 7in. Dial 13 \times 4in. gold and brown. Controls beneath dial, Tone, Volume/on/off, MW/LW/Gram. Tuning. Ferrite rod aerial. Valves UY85 rect., UCL82, UBFS9, UCH81. Limited quantity. £7.7.0, carr. paid.

EX GOVERNMENT AVO METER Model 7. Excellent condition, fully checked, with leather carrying case. List price new over £29. Our price £18. Carr. paid.

CLEAR PLASTIC PANEL METERS D.C. Type KA/38C. 1 $\frac{1}{2}$ in. sq. 50 microA 80/- 500 microA 27/8; 1mA (S-meter) 27/8; 5mA 27/8; 100mA 25/-; 300V 27/8. Post 1/6d.

6 PUSH-BUTTON STEREOGRAM CHASSIS

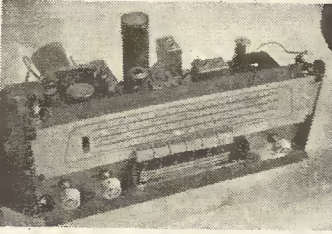

M.W.; S.W.1; S.W.2; V.H.F.; Gram: Stereo Gram Two separate channels for Stereogram with balance control. Also operates with two speakers on Radio. Chassis size: 15 \times 7 \times 6 $\frac{1}{2}$ in. high. Dial silver and black 15 \times 3in. 190-650M; 18-51M; 60-187M; VHF 86-100 Mc/s. Valves: ECC85, ECH81, EF89, 2 \times ECL56, EM84, and Rect. Price £19.19.0, carr. paid or £6.18.0 deposit and 5 monthly payments of 66/6. Total H.P. price £20.15.6. STEREO DECODER £7.10.0 extra.

GLADSTONE RADIO

66 ELMS ROAD, ALDERSHOT, Hants.

(2 mins. from Station and Buses). FULL GUARANTEE. Aldershot 22240 CLOSED WEDNESDAY AFTERNOON. CATALOGUE 1/-.

ALL ITEMS FULLY BUILT UNLESS OTHERWISE STATED

NEW



INSTANT
CIRCUIT
SYSTEM

Better than
anything
you have
ever used before



This is the quicker, cheaper, tidier and more efficient way to make a modern flat-board circuit. Unique "Cir-kit" adhesive copper strip and special matrix board enable you to work to professional standards with ease. Soldering is easier too, so are modifications. That is why "Cir-kit" is also widely used in labs., industry and by experimenters. A 5ft. spool, $\frac{1}{16}$ in. wide costs only

2/-

"Cir-kit" 0.1in. Matrix Board is available in 3 sizes: 5 \times 3 $\frac{1}{2}$ in., 4/-; 2 $\frac{1}{2}$ \times 3 $\frac{1}{2}$ in., 2/6; 2 \times 3 $\frac{1}{2}$ in., 1/9.

"Cir-kit" and other Peak Sound products, i.e. Stereo Amplifier Kit, Mini-Speaker Kit, etc. are obtainable from good high-fidelity stockists. JUST OUT—The authorised "Peak Sound" version of the revolutionary Baxandall loud speaker system. S.A.E. for details. In case of difficulty, please send direct, adding 4d. to value of order to cover cost of postage. TRADE ENQUIRIES INVITED. AT THE R.S.G.B. EXHIBITION, Horticultural Hall, Westminster Oct. 2-5

"Cir-kit" is an exclusive speciality designed and made by
PEAK SOUND (HARROW) LTD.

32 St. Jude's Road, Englefield Green, Egham, Surrey

Telephone: EGHAM 5316

BI-PRE-PAK LIMITED

TRANSISTORS PRICE

AC107	3/-	OC170	3/-
AC126	2/4	OC171	4/-
AC127	2/4	OC200	3/6
AC128	2/4	OC201	7/-
ACY17	3/-	2G301	2/6
AF114	4/-	2G303	2/6
AF115	3/6	2N711	10/-
AF116	3/6	2N1302-3	4/-
AF117	3/6	2N1304-5	5/-
AF118	3/6	2N1306-7	6/-
AF119	3/6	2N1308-9	8/-
AF186	10/-	2N3844A	5/-
AF139	10/-	Power Transistors	
BFY50	4/-	OC20	10/-
BSY25	7/6	OC20	10/-
BSY26	3/-	OC23	10/-
BSY27	3/-	OC25	8/-
BSY28	3/-	OC26	5/-
BSY29	3/-	OC28	7/6
BSY95A	3/-	OC35	5/-
OC41	2/6	OC36	7/6
OC44	1/11	AD149	10/-
OC45	1/9	2N2287	20/-
OC71	2/6	Diodes	
OC72	2/6	AA742	2/-
OC73	3/6	OA95	2/-
OC81	2/6	OA70	1/9
OC81D	2/6	OA79	1/9
OC83	4/-	OA81	1/9
OC139	2/6	OA73	2/-
OC140	3/6	IN914	1/6

EXCITING NEW PAKS

FOR AMATEURS, PROFESSIONALS, FACTORIES, ORGAN BUILDERS, AND THOSE PEOPLE THAT JUST USE LARGE QUANTITIES OF TRANSISTORS.

XA PAK

Germanium PNP type transistors, equivalents to a large part of the OC range, i.e. 44, 45, 71, 72, 81, etc.

PRICE £5 PER 1000

XB PAK

Silicon TO-18 CAN type transistors NPN/PNP mixed lots, with equivalents to OC200-1, 2N706a, BSY27/29, BSY95A.

PRICE £5.50 PER 500

PRICE £10 PER 1000

XC PAK

Silicon diodes miniature glass types, finished black with polarity marked, equivalents to OA200, OA202, BAY31-39 and DK10, etc.

PRICE £5 PER 1000

ALL THE ABOVE UNTESTED PACKS HAVE AN AVERAGE OF 75% OR MORE GOOD SEMICONDUCTORS. FREE PACKS SUSPENDED WITH THESE ORDERS. ORDERS MUST NOT BE LESS THAN THE MINIMUM AMOUNTS QUOTED PER PACK.
P/P 2/6 PER PACK (U.K.)

PRE-PAKS

Selection from our lists

No.	Description	Price
B1	50 Unmarked Trans. Untested	- 10/-
B2	4 Photo Cells Inc. Book of Instructions	- 10/-
B6	17 Red Spot AF Transistors	- 10/-
B6A	17 White Spot RF Transistors	- 10/-
B9	1 ORP 12 Light Sensitive Cell	- 9/-
B53	25 Sil. Trans. 400 Mc/s Brand New	- 10/-
B54	40 " " NPN To 5 Trans Voltage	- 10/-
B55	40 " " NPN To 18 & Gain Fallouts	- 10/-
B56	40 " " NPN/PNP All Tested	- 10/-
B68	10 Top Hat Recs. 750 M/A 100-800 PIV	- 10/-
B69	20 Diodes. Gld-Bnd. Germ Sil. Planer	- 10/-
B74	5 Gld-Bnd. Diodes. 2-OA9, 3-OA5	- 10/-
B75	3 Comp. Set. 2G371, 2G381, 2G39A	- 10/-
C2	1 Unijunction Transistor 2N2160	- 15/-
C32	6 Top Hat Recs. IS100 Type	- 15/-
C35	3 Unijunction Transistor - to 2N2160	- 15/-
A1	7 Silicon Rectifiers BY100 Type	- 20/-
A3	25 Mixed Marked and Tested Transistors	- 20/-
A21	5 Power Transistors 1-AD149/1-OC26 and 3 others	- 20/-

AND MANY MORE

FREE!

PACKS OF YOUR OWN CHOICE UP TO THE VALUE OF 10/- WITH ORDERS OVER £4

BRAND NEW PAK • JUST RELEASED

REPLACES OUR VERY POPULAR B.39 PAK. BRAND NEW SHORT LEAD COMPONENTS ALL FACTORY MARKED AND MOUNTED ON PRINTED CIRCUIT PANELS.

80 TRANSISTORS & DIODES ALL 10/-
50 HIGH TOLERANCE RESISTORS
20 VARIOUS CAPACITORS FOR

PLEASE STATE WHEN ORDERING PAK P.I. 2/- P. & P. WITH THIS PAK.

TRANSISTORS ONLY 1/- EACH

SILICON • PLANAR • N.P.N. • P.N.P

All these types available

2N929	2N706	2S131	2S103	2N696	2N1613	2S733	BFY10
2S501	2N706A	2S512	2S104	2N697	2N1711	2N726	2S731
BC108	2N3011	2S102	2N2220	2N1507	2N1893	2N2484	2S732

All tested and guaranteed transistors—unmarked. Manufacturers over runs for the new PRE-PAK range.

NEW UNMARKED UNTESTED PAKS

25	BSY95A NPN Silicon	TRANSISTORS 10/-
10	OC45—OC81 Mull. Glass Type	TRANSISTORS 10/-
25	BSY26-27 NPN Silicon	TRANSISTORS 10/-
10	10 Watt Silicon All Voltages	ZENERS 10/-
25	BFY50-1-2 NPN Silicon	TRANSISTORS 10/-
10	4 amp. Stud. Silicon	RECTIFIERS 10/-
25	BC107-8-9 NPN Silicon	TRANSISTORS 10/-
40	1N914-6 OA200/202 Sub. Min. Silicon	DIODES 10/-
150	Min. Germ. High Quality	DIODES 10/-
25	2N706 A NPN Silicon	TRANSISTORS 10/-

PRE-PAK. N.605 POWER TRANSISTOR EQUIVALENT TO NKT301-2-3-4

5/- each

COMPLIMENTARY SET NPN/PNP GERM. TRANS. 2/6 pair

Make a Rev. Counter for your Car. The "TACHO BLOCK". This encapsulated block will turn any 0-1mA meter into a perfectly linear and accurate rev. counter for any car. State 4 or 6 cylinder. **20/- each**

FREE CATALOGUE AND LISTS for:—

ZENER DIODES
TRANSISTORS, RECTIFIERS
FULL PRE-PAK LISTS
& SUBSTITUTION CHART

MINIMUM ORDER 10/- CASH WITH ORDER PLEASE. Add 1/- post and packing per order. OVERSEAS ADD EXTRA FOR AIRMAIL.

THERE IS ONLY ONE
BI-PRE-PAK LTD
BEWARE OF IMITATIONS

FIRST EVER LOGIC KITS

Learn for yourself how computers work, even make one for yourself. Full instructions for a noughts and crosses machine, binary counters, timers, etc. L1. 5gns. L2. 10gns. Introducing the Norkit range. Norkit Junior £8. Norkit Senior £16.

Details Free
Free Paks suspended with Logic Kit Orders.

FREE! A WRITTEN GUARANTEE WITH ALL OUR SEMICONDUCTORS

BI-PRE-PAK LTD

DEPT. A, 222-224 WEST ROAD, WESTCLIFF-ON-SEA, ESSEX
TELEPHONE: SOUTHEND (0702) 46344

Practical Electronics Classified Advertisements

The pre-paid rate for classified advertisements is 1/3 per word (minimum order 15/-), box number 1/6 extra. Semi-displayed setting £4.2.6 per single column inch. All cheques, postal orders, etc., to be made payable to PRACTICAL ELECTRONICS and crossed "Lloyds Bank Ltd." Treasury notes should always be sent *registered post*. Advertisements, together with remittance, should be sent to the Classified Advertisement Manager, PRACTICAL ELECTRONICS, George Newnes Ltd., 15/17 Long Acre, London, WC2, for insertion in the next available issue.

HOLIDAYS

HOLIDAY FOR BOYS 14/16 years August 1969, specialising in engineering, electronics, photography. Tuition and practical work including go-karting. 11 days—£14.10.0. Write for free brochure: INTER-SCHOOL CHRISTIAN FELLOWSHIP, 47 Marylebone Lane, London W.1.

WANTED

NEW VALVES WANTED. Popular TV and Radio types. Best cash price by return. DURHAM SUPPLIES, 367F Kensington Street, Bradford 8, Yorkshire.

WANTED. Practical Electronics, Urgently require to buy copies any of the following issues:—November, December 1964; November, December 1966; June, August 1967. BOORMAN, 31 Marlborough Crescent, Sevenoaks, Kent

SITUATIONS VACANT

A.M.I.E.R.E., A.M.S.E. (Elec.), City & Guilds, G.C.E., etc., on "Satisfaction or Refund of Fee" terms. Wide range of Home Study Courses in Electronics, Computers, Radio, T.V., etc. 132-page Guide—FREE. Please state subject of interest. BRITISH INSTITUTE OF ENGINEERING TECHNOLOGY (Dept. 124K), Aldermaston Court, Aldermaston, Berks.

ARE YOU PRACTICAL AND FED UP WITH YOUR PRESENT JOB?

We require a number of junior and senior engineers with drive and initiative for:—

Circuit design—development and prototype construction, etc.: Electro-mechanical drafting—printed circuit/chassis layouts, etc.: Production line test and inspection engineers: Production line fault finders.

Excellent prospects and full training given, day release considered. Salary up to £1,400 depending on experience and qualifications.

Send full details in writing of experience to date and present salary to:—

Mr. B. C. Johnson,
Solid State Controls Limited,
Brunel Road,
Acton, W.3,
London.

SITUATIONS VACANT (continued)

Wanted for production line Testers and Fault Finders with experience of alignment of Radio Receivers. Average weekly wage including bonus £18 to £24 per week, depending upon experience and skill.

Apply to:

Mr. W. Eddington
Fidelity Radio Ltd.
6 Olaf Street
London, W.11

Telephone No.:

PARK 0131 - Ext. 54

V.H.F. TEST ENGINEERS

URGENTLY REQUIRED—Test Engineers to align and test our wide range of VHF Radio-Telephone equipment.

These positions are particularly suitable for those having experience in TV or Radio servicing or Ex-Service personnel having similar training.

Excellent working conditions, good salary, free pension and life assurance scheme, etc.

Write or telephone the Chief Inspector—TODAY.

DYMAR ELECTRONICS LIMITED
Colonial Way, Radlett Road
Watford, Herts

Telephone: Watford 21297/8/9

Build Your Own HEATHKIT Electronics!

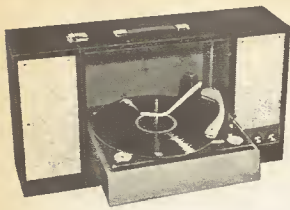

Stereo Record Player SRP-1

Total price KIT K/SRP-1
£28.6.0 P.P. 10/6

- Automatic Playing of 16, 33, 45 and 78 rpm records
 - All transistor circuitry ensures cool instant operation
 - Dual sapphire stylus for LP's and 78's
 - Plays mono as well as stereo records
 - Compact, with easy-to-carry handle for suitcase portability
 - Detachable speaker enclosure for best stereo separation
 - Two 8" x 5" speakers
 - Operates on 220-250V ac supply.
- A portable STEREO record player for the home!** The all-transistor amplifiers give a total high-power output of 3 watts r.m.s. . . . uses two large, high efficiency 8" x 5" speakers for crisp, bold sound. With the new Heathkit SRP-1 you can now enjoy the stirring realism of stereophonic sound in any room of your house.

Stereo Tape Recorder STR-1 Fully Portable—Own Speakers

KIT K/STR-1
£58.0.0 P.P. 10/6



- 1 track stereo or mono record and playback at 7 $\frac{1}{2}$, 3 $\frac{3}{4}$ and 1 $\frac{1}{2}$ ips
- Sound-on-sound and sound-with-sound capabilities
- Stereo record, stereo playback, mono record and playback on either channel
- 18 transistor circuit for cool, instant and dependable operation
- Moving coil record level indicator
- Digital counter with thumbwheel zero reset
- Stereo microphone and auxiliary inputs and controls, speaker/headphone and external amplifier outputs . . . front panel mounted for easy access
- Push-button controls for operational modes
- Built-in stereo power amplifier giving 4 watts rms per channel
- Two 8" x 5" speakers
- Operates on 230V.

Here's the Car Radio for You—Luxury Motoring with the CR-1

Total Price KIT K/CR-1
£14.12.0 P.P. 4/6 incl. Speaker



- Superb Long and Medium Wave entertainment wherever you drive
- Complete your motoring pleasure with this compact, high performance radio
- 8 Latest semi-conductors (6 transistors, 2 diodes)
- For 12 volt positive or 12 volt negative earth systems
- Powerful output (4 watts)
- Pre-assembled and aligned tuning unit
- Push-button tone and wave change controls
- Positive manual tuning
- Easy circuit board assembly
- Instant operation, no warm-up time
- Tastefully styled to harmonise with any car colour scheme
- High quality output stage will operate two loudspeakers if desired.

Shortwave 4-Band Receiver, GR-64E

KIT K/GR-64E
£22.8.0 P.P. 9/-



- 4 bands - 3 shortwave bands cover 1 MH/z to 30 MH/z, plus 550 KH/z to 1620 KH/z AM broadcast band
- Built-in 5" permanent magnet speaker for a big, bold sound
- Illuminated 7" slide-rule dial with extra logging scale
- Easy to read lighted bandspread tuning dial for precise station selection
- Relative signal strength indicator aids pin-point station tuning
- 4-valve superhet circuit plus two silicon diode rectifiers
- Variable BFO control for code and SSB transmissions
- Built-in external antenna connections
- Built-in AM rod antenna
- Fast, simple circuit board construction assures stability
- Handsome 'low-boy' styling
- Headphone jack for private listening.

Compact Slim-Line Speaker System—the Berkeley

KIT K/Berkeley
£21.4.0 P.P. 13/6



- Beautiful walnut veneered, fully finished cabinet
- Two specially designed speakers
- New compact 'slim line' size
- Build it in an evening
- Professional attractive styling
- Use one for mono and a pair for stereo
- Outstanding performance at a low price
- Shelf or floor standing
- Use vertical or horizontal
- Designed to harmonise with modern or traditional decor
- The two loudspeakers, 12" low resonance unit and 4" Mid/High frequency ceramic unit, both specially designed for this type of cabinet, give extremely enjoyable high quality reproduction over a very wide frequency range.

An Ideal Beginner Kit—Portable radio UXR-1

KIT UXR-1 Colour Case
£12.8.0 P.P. 4/6

KIT UXR-1 Leather **£13.8.0** P.P. 4/6

- 6 transistor, 1 diode circuit
- Large 7" x 4" speaker for crystal clear tone
- Choice of case in colours and brown real leather
- Long and Medium waveband coverage
- Pre-aligned IF transformers ensure first-time performance
- Fast, easy, printed circuit board construction



Portable radio UXR-2

KIT K/UXR-2 Leather
£15.10.0 P.P. 6/-

- 7 transistor, 3 diode circuit
- Large 7" x 4" elliptical speaker for 'big-set' sound
- Battery economiser-circuit
- Push buttons for Long/Medium and Tone
- Double-tuned IF stage for greater sensitivity and selectivity
- Output for personal phone
- Output for tape-recorder
- Choice of brown or black, real leather case and handle.

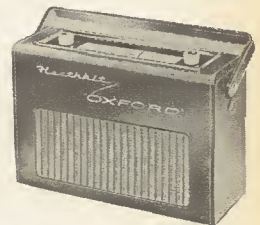

FREE! CATALOGUE

Describe these and many more kits and ready-to-use models for Stereo, Hi-Fi, Domestic Radio, Record Players, Tape Recorder, Amateur Radio, Short-Wave, Test, Educational, Home and Hobby. Save money with Heathkit models. Mail coupon or write to Daystrom Ltd., Gloucester, Tel: 29451.

DAYSTROM LTD., Dept. P.E.12
GLOUCESTER Tel. 29451

Enclosed is £ _____, plus packing and carriage.

Please send model (s) _____

Please send FREE Heathkit Catalogue.

Name _____ (Please Print)

Address _____

City _____

Prices and specifications subject to change without notice.

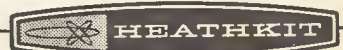

TECHNICAL TRAINING by ICS IN RADIO, TELEVISION AND ELECTRONIC ENGINEERING



First-class opportunities in Radio and Electronics await the ICS trained man. Let ICS train YOU for a well-paid post in this expanding field. ICS courses offer the keen, ambitious man the opportunity to acquire, quickly and easily, the specialized training so essential to success. Diploma courses in Radio/TV Engineering and Servicing, Electronics, Computers, etc. Expert coaching for:

- * C. & G. TELECOMMUNICATION TECHNICIANS' CERTS.
- * C. & G. ELECTRONIC SERVICING.
- * R.T.E.B. RADIO AND TV SERVICING CERTIFICATE.
- * RADIO AMATEURS' EXAMINATION.
- * P.M.G. CERTIFICATES IN RADIOTELEGRAPHY.

Examination Students Coached until Successful.
NEW SELF-BUILD RADIO AND ELECTRONIC COURSES
Build your own 5-valve receiver, transistor portable, signal generator, multi-meter and valve volt meter—all under expert guidance.

POST THIS COUPON TODAY and find out how ICS can help YOU in your career. Full details of ICS courses in Radio, Television and Electronics will be sent to you by return mail.

MEMBER OF THE ASSOCIATION OF BRITISH CORRESPONDENCE COLLEGES

**INTERNATIONAL
CORRESPONDENCE
SCHOOLS**

**A WHOLE WORLD
OF KNOWLEDGE
AWAITS YOU!**

International Correspondence Schools
(Dept. 152), Intertext House, Parkgate Road,
London, S.W.11.

NAME
Block Capitals Please

ADDRESS

..... 12.68

Wanted for Factory Service Department Engineers with experience on Transistor Radios, Tape Recorders and Record Players. A substantial individual bonus is available for fast workers. The present average bonus being earned is £6. 10. 0. per week, but there is no limit.

Call or write to:

Mr. Savvides
Service Department
Fidelity Radio Ltd.
6 Olaf Street
London, W.11
PARK 0131 - Ext. 28

Telephone No.:

MISCELLANEOUS

PRINTED CIRCUITS made to your negatives or transparent master positives. 1 board to 250 boards. We will produce master to your circuit diagram if required. BIDEFORD GRAPHIC ARTS, Torridge Hill, Bideford, North Devon. Telephone Bideford 4991.

MISCELLANEOUS (continued)

CALL OR SEND for list from the most interesting shop in Lancashire. Electrical Mechanical and Electronic Goods. ROGERS, 31 Nelson Street, Southport.

MISCELLANEOUS (continued)

RHYTHM MODULES. Build your own rhythm box—simply, cheaply. Realistic sound guaranteed. S.A.E. for details. D.E.W. LTD., 254 Ringwood Rd., Ferndown, Dorset.

BUILD IT in a DEWBOX quality cabinet 2in x 2 1/2in x any length. DEW LTD., Ringwood Road, Ferndown, Dorset. S.A.E. for leaflet. Write now—right now.

ARTIFICIAL LIFE

Well almost, because the NEW range of projects include: an electronic 'animal' which LEARNS, and a device capable of REPRODUCING itself!! Other projects SURE TO INTRIGUE YOU are an audio transmitter/receiver which has quite an amazing range and requires NO LICENCE; also a machine which recognizes itself, and an electronic dog whistle, etc., etc. HOSTS OF EASY-TO-CONSTRUCT projects. SEND 2/6 for your list—NOW!

To: 'BOFFIN PROJECTS'
incorporating
BIONIC DESIGNS
4 CUNLIFFE RD.
STONELEIGH, EWELL, SURREY

**NEW! ADD
EXCITING! STEREO EFFECTS**



TO YOUR LISTENING...
"NEW DIMENSIONS" gives fabulous Big Hall 3-dimension effect to all music. PLUS adjustable echo, vibrato and tone. BATTERY 9v. model for radio, tape or player. Speaker 25/- extra. **8 gns.**
CAR VERSION for 6v. or 12v. + or - earth. 10 gns. including rear speaker. 5/- post and ins. either model.
Send S.A.E. for full details direct from manufacturers—NOW!

D.E.W. LTD.
P.E., 254 Ringwood Road, Ferndown, Dorset

SERVICE SHEETS

SERVICE SHEETS. RADIO, TELEVISION, TAPE RECORDERS, 1925-1968, by return post, from 1/- with free fault-finding guide. Catalogue 6,000 models, 2/6. Please send stamped addressed envelope with all orders/enquiries. HAMILTON RADIO, 54e London Road, Bexhill, Sussex.

SERVICE SHEETS, Radio, TV, 5,000 models. List 1/6. S.A.E. enquiries. TELRAY, 11 Maudland Bank, Preston.

**C. & A. SUPPLIERS
SERVICE SHEETS**

T.V., RADIO, TRANSISTORS, TAPES, ETC.
Only 5/- each, plus S.A.E.
(Uncrossed P.O.'s please, returned if service sheets not available.)
**71 BEAUFORT PARK
LONDON, N.W.11
MAIL ORDER ONLY**



KONTAKT 60

FOR INACCESSIBLE CONTACTS—More than just a cleaner. KONTAKT 60 guarantees perfect cleaning of contacts chemically in accordance with today's technology.

KONTAKT offers the following advantages:—

1. Dissolves oxides and sulphides the safe way without attacking contact substances.
2. Contains carefully selected solvents which do not attack plastics whereas they do dissolve resinified contact greases and dirt.
3. Contains *no silicone*.
4. Contains a light lubricant in order to avoid the contact paths being corroded.
5. Prevents further oxidation setting in.
6. Prevents "creep" currents.

Because of these outstanding properties KONTAKT 60 is one of the best and most popular contact cleansing agents in the world.

Users include: Rolls Royce Ltd., C.E.G.B., South of Scotland Electricity Board, Trinity House Workshops, Kolster Brandes, Mullard, Plessey Cos., etc.

OTHER KONTAKT PRODUCTS ARE:

- 70 Protective Lacquer
- 72 Insulating Spray
- 75 Cold Spray For Fault Location
- 80 Special Siliconized Polish
- 100 Antistatic Agent For Plastics
- 101 Dehydration Fluid

Write for full details of above complete range of Kontakt products to:—

SPECIAL PRODUCTS DISTRIBUTORS LIMITED

81 Piccadilly, London, W.1 01-629 9556

*Young Men
Get going
Get out and
about
Get with a
Career—at
BURROUGHS*

Burroughs are looking for young men aged 18-25 with get going potential. Young men who want to get out and work in freedom on their own initiative. It could be you. We want you to become an advanced Burroughs Technician so that you can ensure our machines are kept up to Burroughs standards of perfection. Our business is big business. We manufacture and market business equipment that ranges from simple adding machines to some of the world's largest computer systems.

You will be trained for the job and put on the road to promotion. All you need is enthusiasm and G.C.E. 'O' levels in 5 subjects and/or some O.N.C. study or experience in electro-mechanical devices.

A good initial salary will be paid, rapidly rising with training and experience.

EXCLUSIVE OFFER

KITS for Transformerless Amplifiers, ZENER DIODES, ASSORTMENTS of Capacitors, Potentiometers, Carbon Film Resistors and branded new ORIGINAL TRANSISTORS

(Except from our SPECIAL OFFER B/1968)

KIT No. 7 for high quality, high power A.F. transformerless amplifier 6 transistors 20W only 59/-
 Supply voltage 30V
 Working current 40-1,300mA
 Loud-speaker connection 4 ohm
 Input voltage at max. vol. 20mV
 Input resistance 2Kohm
 Frequency range 20Hz-20KHz

Printed circuit panel for KIT No. 7 13/-
 The circuit diagram and the parts list are enclosed with every KIT
ZENER DIODES 1W 4-3, 5-6, 6-2, 6-8, 7-5, 8-2, 9-1, 10, 11, 12V 2/4 each

ASSORTMENTS of ELECTRONIC COMPONENTS
ORDER No.:
DIO 3 100 p. germanium diodes sub-miniature 13/4
TRA 1 50 p. different transistors 13/4
ZE 101 10 p. zener diodes different values 250mV-1W 22/6
ELKO 1 30 p. 1/2f. Electrolytic capac. sub-min, good sel. 16/-
KER 1 100 p. disk-, tubular-and pearl capac. 20 val. x 5 12/6
KON 1 100 p. plastic foil condens. 20 val. x 5 good sel. 12/6
Ein 1 10 p. adjust. potentiom. ohm values good select. 8/6
WID 1-1/8 100 p. carbon film resist., axial, 1/2V 20 val. x 5 12/-
WID 1-1/2 100 p. carbon film resist., axial, 1/2V 20 val. x 5 12/-
BRAND NEW ORIGINAL TRANSISTORS

equi.
 AC 153 AC 128 1/4 AF 144 = AF 116 1/9
 AC 188K AC 178 2/- AF 27 = AC 127 1/6 AF 149 = AF 117 1/4
 AD 136 2/3 AF 142 = AF 114 2/- RF 107 = BC 107 1/6
 AD 150 OC 26 3/6 AF 143 = AF 115 1/9 2N 706 = BSY 62 1/6

All goods BRAND NEW of HIGH QUALITY, fully guaranteed. NET Prices
 Subject to prior sale.
 Our deliveries are ex stock Zurich/Switzerland by air-mail C.O.D. Postage and packing will be charged at self-costs.
 Please request our complete free SPECIAL OFFER B/1968.
 We shall be very pleased to receive your trial order:



EUGEN QUECK

**CH-8810 HORGEN
Switzerland**

**Ingenieur-Büro
Import-Export
Bahnhofstr. 5**

FILL THIS IN NOW FOR A NEW FUTURE

I HAVE THE QUALIFICATIONS YOU ASK FOR and am interested in a career with Burroughs Machines Limited.

Please send me a preliminary application form

NAME _____

ADDRESS _____

Please print clearly and send to:

**J. A. R. DAKIN
BURROUGHS MACHINES LTD
HEATHROW HOUSE
BATH ROAD, CRANFORD
HOUNSLOW, MIDDLESEX**



CAPACITORS

Mullard Miniature, Small and Large Electrolytics.
Mullard Miniature Metallised Polyester and Film Polyester.
Polystyrene, Ceramic Plate and 1% silver mica.

For further information of all our stocks write sending 3/6 for our bright new catalogue (or 6d. for individual data sheets) or call—

STUDENT ELECTRONIC SERVICES, 196 Regent Road, Salford 5. Tel. 061-872 5187.

WE ARE BREAKING UP COMPUTERS

COMPUTER PANELS (as shown) 2in x 4in 8 for 10/-, P. & P. 2/- with min for 30 transistors, 100 for 65/- + P. & P. 6/6; 1,000 for £30 + carr.

PANELS with 2 power transistors sim. to OC28 on each board + components. 2 boards (4 x OC28) 10/-, P. & P. 2/-.

NPN GERMANIUM TO5 1 WATT POWER TRANSISTORS on small heat sink on 2in x 4in panel. 5 for 10/-, P. & P. 2/-.

POWER TRANSISTORS sim. to 2N174 ex-eqpt., 4 for 10/-, P. & P. 2/-.

POWER TRANSISTORS sim. to 2N174 ON Finned Heat Sink (10D) 4 for £1, P. & P. 3/-.

LONG ARM TOGGLE SWITCHES ex eqpt. SPST 13/6 doz., DPDT 22/6 doz., DPST 17/- doz. P. & P. all types 2/- doz.

TRANSISTOR COOLERS TO5 7/6 doz., TO3 18/- doz. P. & P. 2/-.

OVERLOAD CUT OUTS. Panel mounting in the following values... 5/- each. 1, 1 1/2, 2, 3, 4, 5, 7, 8 amp. P. & P. 1/6.

MINIATURE GLASS NEONS, 12/6 doz. P. & P. 1/6.

NEW MIXED DISC CERAMICS. 150 for 10/-, P. & P. 2/-.

LARGE CAPACITY ELECTROLYTICS 4 1/2in, 2in diam. Screw terminals.

All at 6/- each + 1/6 each P. & P.
4,000mF 72V d.c. wkg.
5,000mF 55V d.c. wkg.
6,300mF 72V d.c. wkg.
1,500mF 150V d.c. wkg.
16,000mF 25V d.c. wkg.
25,000mF 12V d.c. wkg.

Send 1/- stamps for list.

KEYTRONICS, 52 Earls Court Road London, W.8. Mail order only

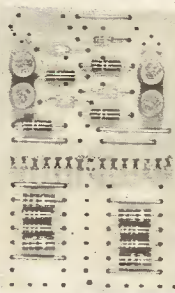

BRAND NEW MINIATURE ELECTROLYTICS, 15 volt, 2, 6, 8, 10, 15, 20, 30, 40, 50, 100 mfd, 8/6 dozen, 30 for £1. The C. R. SUPPLY CO., 127 Chesterfield Rd., Sheffield, SS ORN.

TRANSISTOR PANELS

New boxed, size 9in x 6in x 1 1/2in with "Valvo" transistors type OC45 or similar, with full length leads, also an equal number of OA85 diodes, H/5 resistors, etc. Built on perforated board in a metal frame.

Panel of 20 transistors, diodes, etc. 20/-
30—25/- 60—40/-
40—30/- 70—45/- Postage 2/- per panel.
50—35/- 80—50/-

TRANSISTOR CAPACITORS (ELECTROLYTIC)

500mF 4V 64mF 40V 16mF 25V
320mF 10V 50mF 10V 10mF 25V
250mF 4V 30mF 10V 6.4mF 64V
200mF 10V 25mF 25V 4mF 64V
20mF 12V 1mF 25V

1/- each. 9/- per doz. Min. order 10/-
COMPUTER PANELS with 40 sil. pnp or npn transistors, Diodes and res., 22/6 Post Paid.

COMPUTER PANELS (Flip-Flop) with 8-2G371 with diodes, 7/6; without diodes, 5/-.
Panel with 16-OC84, etc. 10/-
" " 8-OC43 or GET875 & OA81 7/-
" " 50-OA81 6/-

Postage 6d per panel

TEST CARDS. 6 transistors 20 for 20/-
ELECTROLYTICS 25,000 @ 12V, 16,000 @ 12V, 15,000 @ 10V, 10,000 @ 30V, 4,000 @ 60V, 3,000 @ 80V, 2,000 @ 50V, 1,200 @ 180V, 8/6 Post Paid.

ZENER DIODES—2.4, 2.7, 3.6, 4.75, 5.25, 5.75, 6.2, 6.8, 7.5, 13, 15, 16, 18, 20, 27, 30, 33 volts. 3/6 each, mostly 1 watt.

POLYSTYRENE CAPACITORS 350V: 180, 270, 330, 390, 470, 560, 680, 820F. 1,800, 2,200, 2,700, 3,300, 5,600, 6,800, 8,200
125V: 1,200, 1,500, 1,800, 2,200, 2,700, 3,300, 3,900, 4,700, 5,600, 6,800, 8,200, 0.015. 80pF ceramic 200pF S.M. any selection 2/- doz. 4.40pF trimmers 4/- doz.

BRAND NEW BOXED CHASSIS containing 2-OC35, 2-OC29 12 WW resistors 30/-, Postage 1/6.

NEW CROSS RADIO
6 OLDHAM ROAD, MANCHESTER 4

COMPONENT SALE

1,000's of components for disposal following cancelled and changed contracts.

OVER 500 TYPES OF CAPACITOR—Electrolytic, tantalum, polyester, paper at knock down prices (e.g. 12.5mfd 40V at 6d, 16mfd 10V at 9d.).

Also large quantities of semi-conductors, variable voltage transformers, etc.

These are all brand new and unused at unrepeatable prices.

Send 6d in stamps and address for lists.

O AND M SERVICES (PEI2)
ELM HOUSE, BARTON CLOSE
WHITEFIELD, LANCs.

TAPE HEADS

BSR BRAD 39/6 pair
2 TRACK

MICHIGAN REC./PLAY
HIGH IMP. 45/-

BSR MALL 39/6 pair
4 TRACK

BOGEN ERASE
UL218/6 27/6
4-TRACK

REUTER - COLLARO
ERASE 15/-
4-TRACK

COSMOCORD ERASE
T.E.2/9 15/-
4-TRACK

F.M. WIRELESS MICROPHONE

94-104Mc/s. Transistorised. Operates from 9V battery. Complete with additional secret tie clip microphone. List £12/10/- ONLY £6.15.0
These cannot be operated in U.K.

TRANSISTORISED FM TUNER

6 TRANSISTOR HIGH QUALITY TUNER. SIZE ONLY 6in x 4in x 2 1/2in 3 I.F. stages. Double tuned discriminator. Ample output to feed most amplifiers. Operates on 9V battery. Coverage 88-108Mc/s. Ready built ready for use. Fantastic value for money £6.12.6

FM MULTIPLEX STEREO ADAPTOR

Printed circuit biscuit, 4 trans., 6 diodes 9V with full instructions £5.2.6

LOUDSPEAKERS

12" 20 watt, 15 ohm.
TWIN CONE £57.0

12" 25 watt, 15 ohm.
GUITAR SPEAKER £57.0

FULL RANGE HIGH COMPLIANCE, 8" 16 ohm, 15 watt, 30-20K £5.18.0

10" 10 watt, 15 ohm.
CERAMIC - MAGNET 42/-

6 1/2" 16 ohm, 5 watt, 30-18K £5.0.0

CHARGER TRANSFORMER.
4 Amp. 2/6/12 volt 24/6

4" 16 ohm, 5 watt, 40-16K £3.3.0

MULTIMETERS 32/- from

REFLEX CONE TYPE WATERPROOF SPK. 5 watt, 3 ohm. 300-16,000c/s PA

LOUDSPEAKERS 2" 9/6
40 ohm, 21" 80 ohm.
12" TWIN CONE 10 watt PEAK 15 or 35/-
3 ohm.
TWEETER 16 ohm 28/9

4 Music Relay £3.10.0

CROSSOVER NETWORK 14/-

SUPER SILICON RECT. T.V., etc., 1,200 PIV 800mA, 5/-; or complete with instr. resistor, condenser, 6/8; 400 PIV HW 6A, 6/-; 200 PIV HW 6A, 6/-, No cheap rubbish.

Stamped envelope for full selection and bargain offers in Walkie-Talkies, Radios, Baby Alarms, Intercoms, Walkie-Talkies, Recorders, Sineclir, DULCI, and Eagle Lists. UNDER £1-P. & P. 6d., £2-£3-1/6d. over £3 Post Free. C.O.D. 3/6. MAIL ORDER ONLY.

DURHAM SUPPLIES
367 F, KENSINGTON STREET
BRADFORD 8, YORKSHIRE

RECORDING TAPES

Fully Guaranteed
7" STD 1,200' 7/3
7" L/P 1,800' 12/3
7" D/P 2,400' 19/-
5 1/2" STD 900' 6/6
5 1/2" L/P 1,200' 9/-
5 1/2" D/P 1,800' 14/9
5" STD 600' 5/3
5" L/P 900' 7/3
5" D/P 1,200' 10/9
3" D/P 185' 2/3
4" D/P 300' 4/-
7" D/P Concord 3,000' 33/6
Spools: 8 1/2" 6/3, 7" 2/6, 5 1/2" 2/3, 5" 2/3, 4" 2/-, 3 1/2" 1/9, 3" 9d., 2 1/2" 1/10.

CASSETTE TAPES

C-60 15.6, C-90 21/6

SPEAKERS (3 ohm)

8" x 5" 19/6,
7" x 4" 15/6,
3" 9/6, 5" 14/6,
8" 25/6, 12" 39/6.

A. MARSHALL & SON (LONDON) LTD

28 Cricklewood Broadway, London, N.W.2
P.E. 20 Tel. 01-452 0161/2

IN914	2/-	2N3708	4/-	BFX13	6/6	NKT261	4/6
IN-16	1/6	2N3709	4/-	BFX29	15/-	NKT262	4/6
IS120	2/6	2N3710	4/6	BFX84	8/-	NKT264	4/6
IS130	2/6	2N3711	4/6	BFX85	10/-	NKT271	4/6
IS132	2/6	2N3819	10/-	BFX86	8/-	NKT403	15/-
2N696	5/-	AC107	6/-	BFX87	10/-	NKT405	15/-
2N697	5/-	AC126	4/-	BFX88	8/-	NKT763	6/6
2N706	3/-	AC127	3/-	BFY50	5/6	NKT763	6/6
2N706A	3/-	ACY17	5/-	BFY51	4/6	NKT764	5/-
2N929	6/6	ACY18	5/-	BFY52	5/6	NKT767	3/-
2N930	6/6	ACY19	5/-	BSX19	5/6	NKT713	5/6
2N1302	4/6	ACY20	4/6	BSX20	5/6	NKT781	6/-
2N1303	4/6	ACY21	5/-	BSX21	8/-	OC26	7/6
2N1304	5/6	ACY22	4/6	BSX76	4/6	OC28	7/6
2N1305	5/6	AD140	8/6	BSY26	4/6	OC35	7/6
2N1306	6/6	AD149	8/6	BSY27	4/6	OC36	7/6
2N1307	6/6	AD161	7/6	BSY28	4/6	OC44	3/6
2N1308	8/6	AD162	7/6	BSY29	4/6	OC45	2/6
2N1309	8/6	AF114	5/-	BSY38	4/6	OC71	2/6
2N1613	6/6	AF117	5/-	BSY39	4/6	OC72	2/6
2N1711	6/6	ASY26	4/6	BSY40	4/6	OC74	4/6
2N1712	6/6	ASY27	4/6	BSY95A	4/6	OC75	4/6
2N2369A	8/6	ASY28	6/6	BY100	4/6	OC81	4/6
2N2904	8/6	ASZ21	4/6	BY210	9/-	OC83	5/-
2N2905	8/6	BC107	3/6	BYZ11	7/6	OC170	6/-
2N2905A	8/6	BC108	3/6	BYZ12	6/6	OC171	6/-
2N2906	8/6	BC109	3/6	BYZ13	5/6	OC200	5/6
2N2926	3/6	BCY33	5/6	MAT100	6/6	OC201	5/6
2N3053	7/6	BCY34	4/6	MAT101	6/6	OC202	8/6
2N3055	19/6	BCY38	5/6	MAT120	6/6	OC207	8/6
2N3702	4/6	BCY39	6/6	MAT121	6/6	OAB1	1/9
2N3703	4/6	BCY70	6/6	MPF102	9/-	OA91	1/6
2N3704	5/6	BCY71	10/6	MPF103	9/-	OA200	2/-
2N3705	4/6	BCY72	6/6	MPF104	9/-	OA202	2/-
2N3706	4/6	BF115	6/6	MPF105	9/-		
2N3707	4/6	BFX12	6/6				

COMPONENTS

Veroboard
3 1/2" x 2 1/2" 3/6;
3 1/2" x 3 1/2" 4/3;
Cutter 9/-;
3 1/2" x 5" 5/6;
17" x 3 1/2" 16/-;
5" x 2 1/2" 4/3.

Resistors:
1/2 w. 4d; 1/2 w. 5d;
1 w. 6d; 2 w. 1/-;
3 w. 1/6; 5 w. 2/0.

RCA ICs:
CA3019 30/-
CA3020 30/-
Data Sheets 2/- ea.

Electrolytics:
15V 1mF up to 100MFD 1/6, 25V 25MFD or 50MFD 1/6, 100MFD 2/9, 250MFD 2/9, 500MFD 3/9.

Presets:
STD Horizontal or Vertical 1/6.
Fairchild I.Cs.
L900 11/-
L914 11/-
L923 14/-

Livered Micas—
1/- per order.
Send 6d stamp for complete list.

ARE YOU . . . ? THE CIVILIAN TECHNICIAN WE NEED TO SUPPORT THE ROYAL NAVY OF THE 1970's

In other words, DO YOU—

- Have an ONC or an equivalent qualification in Electrical or Electronic engineering.
- Seek a varied career associated with modern engineering techniques and equipment.
- Desire a place in the salary scale £1,347 per annum on entry rising to £1,565 by four annual increments, with the prospect of promotion to the highest posts of the Technical Class with salary of £2,390.
(There is a separate scale for those under 25 or requiring further experience.)
- Wish to serve initially in London, Slough, Bath, Copenacre (Wilts.), Portland, Portsmouth, or the main shipbuilding areas — with the opportunity of transfer to other parts of the country later.

IF SO:—

Write for application form to:

Superintendent of Production Pool (Naval) (30/5)
Room 93, Empire Hotel
BATH, SOMERSET BA1 5AB

SITUATIONS VACANT (continued page 914)

EDUCATIONAL

STUDY RADIO, TELEVISION AND ELECTRONICS with the world's largest home study organisation. City & Guilds; R.T.E.B., etc. Also practical courses with equipment. No books to buy. Write for FREE Prospectus to ICS (Dept. 577), Intertech House, London, SW11.

ENGINEERS. A technical certificate or qualification will bring you security and much better pay. Elem. and adv. private postal courses for C.Eng., A.M.I.E.R.E., A.M.S.E. (Mech. & Elec.), City & Guilds, A.M.I.M.I., A.I.O.B. and G.C.E. exams. Diploma courses in all branches of Engineering—Mech., Elec., Auto, Electronics, Radio, Computers, Draughts., Building, etc. For full details write for FREE 132-page guide. BRITISH INSTITUTE OF ENGINEERING TECHNOLOGY (Dept. 125K), Aldermaston Court, Aldermaston, Berks.

EDUCATIONAL (continued)

RADIO OFFICERS see the world! Sea going and shore appointments. Trainee vacancies during 1969. Grants available. Day and Boarding students. Stamp for prospectus. WIRELESS COLLEGE, Colwyn Bay, Wales.

GET INTO ELECTRONICS—big opportunities for trained men. Learn the practical way with low-cost Postal Training, complete with equipment. A.M.I.E.R.E., R.T.E.B., City & Guilds, Radio, T/V, Telecoms., etc. For FREE 100-page book, write Dept. 856K, CHAMBERS COLLEGE, 148 Holborn, London, E.C.1.

BOOKS AND PUBLICATIONS

MAKE YOUR OWN TALKIES. An introduction to electronic tape/film synchronisation, with an explanation of the "Carol" Cinesound system, modifying equipment, filming in sync., etc. Price 7/6, post free (refundable against purchase of your "Carol" Cinesound equipment). Contronics Ltd., Deepcut, Camberley, Surrey.

BOOKS AND PUBLICATIONS

(continued)

SURPLUS HANDBOOKS

19 set Circuit and Notes 6/6 P.P. 6d
1155 set Circuit and Notes 6/6 P.P. 6d
H.R.O. Technical Instructions ... 5/6 P.P. 6d
38 set Technical Instructions ... 5/6 P.P. 6d
46 set Working Instructions ... 5/6 P.P. 6d
88 set Technical Instructions ... 7/- P.P. 6d
BC. 221 Circuit and Notes 5/6 P.P. 6d
Wavemeter Class D Tech. Instr. 5/6 P.P. 6d
18 set Circuit and Notes 5/6 P.P. 6d
BC.1000 (31 set) Circuit & Notes 5/6 P.P. 6d
CR.100/B.28 Circuit and Notes 10/- P.P. 9d
R.107 Circuit and Notes 7/- P.P. 6d
A.R.88D. Instruction Manual ... 18/- P.P. 6d
62 set Circuit and Notes 6/6 P.P. 6d
52 set Sender & Receiver Circuits 7/6. post free
Circuit Diagrams 5/- each post free.
R.1116/A, R.1224/A, R.1355, R.F. 24, 25, & 26.
A.1134, T.1154, CR.300, BC.342, BC.312,
BC.348, J.E.M.P. BC.624. 22 set.
Resistor Colour Code Indicator... 2/6 P.P. 6d
S.A.E. with all enquiries please.
Postage rates apply to U.K. only.

Instructional Handbook Supplies

Dept. P.E., Talbot House, 28 Talbot Gardens
Leeds 8

FOR SALE

TIME SWITCHES, 14 day clock, once on once off every 24 hours, reconditioned and fully guaranteed. 5 amp Horstmann 32/6, 15 amp Venner 42/6. P. & P. 4/6. A. R. BATCHELOR (P.E. Dept.), 4 Park Road, Bromley, BR1 3HP.

5 TON FACTORY CLEARANCE. Radio, TV, elec. components in 27s. 6d. mixed parcels. Post free. Example: resistors, condensers, pots, speakers, coax, coils, fibre washers, valves, over a dozen different types, tuning knobs, grommets, sleeving IFS, Paxalin, wire, rectifiers. Lots of other items. Pot luck. Postal orders to—P. L. NEWTON, 16 Shallcross Crescent, Hatfield, Herts.

ILLUSTRATED CATALOGUE No. 17 Manufacturers' Surplus and New Electronic Components including Semiconductors. 3/- post free. ARTHUR SALLIS LTD., 28 Gardner Street, Brighton.

OSCILLOSCOPE, Cossor D/B d.c. amplifiers, stabilised supplies, perfect condition £24, O.N.O. 117/3 Herrick Road Saltley Birmingham 8.

HIGH GLOSS METALLIC

HAMMERED ENAMEL

MAKES FANTASTIC DIFFERENCE TO PANELS

say hundreds of enthusiastic users 'Crackle' pattern appears like mag on wood and metal. No undercoat. Air dries 15 min. to hard glossy finish.

Heat, liquid and scratchproof. **BRUSH OR SPRAY-ON** and Dk. Blue; Bronze; Silver; Green; Black. Send for Free list, or 8/- (+ 1/9 post) for trial pt. TIN, colour samples and instructions. Send NOW.

FINNINGSPECIALITY PAINTS Dept. P.E. STOCKSFIELD. Tel. 2280 Northumberland.

BRASS, STEEL, LIGHT ALLOY, STAINLESS STEEL TUBE. Bar Material, Tools, Mechanical, Electrical, plus Assorted Lots. Send S.A.E. for latest Cat. of 1,000 items. K. R. WHISTON, Dept. BPE, New Mills, Stockport.

MORSE MADE EASY !!

FACT NOT FICTION. If you start RIGHT you will be reading amateur and commercial Morse within a month (normal progress to be expected).

Using scientifically prepared 3-speed records you automatically learn to recognise the code RHYTHM without translating. You can't help it, it's as easy as learning a tune. 18 W.P.M. in 4 weeks guaranteed.

For details and course C.O.D. ring S.T.D. 01-860 2896 or send 8d. stamp for explanatory booklet to:

GC3CHS/H, 45 GREEN LANE, PURLEY, SURREY

TRANSISTOR SUBSTITUTION HANDBOOK

AMERICAN, JAPANESE, BRITISH,
ETC. NEW 8th EDITION. 16/-.
P. & P. 1/3.

MODERN DICTIONARY OF ELECTRONICS by Graf. 3rd ed. 70/- P. & P. 4/6.

F.E.T. CIRCUITS by Turner. 25/- P. & P. 1/3.

SYNCHROS AND SERVOS by Brite. 35/- P. & P. 1/3.

TELEVISION TAPE FUNDAMENTALS by Ennes. 40/- P. & P. 1/6.

SOLID STATE POWER SUPPLIES by Lytel. 20/- P. & P. 1/3.

SILICON CONTROLLED RECTIFIERS by Lytel. 21/- P. & P. 1/3.

RADIO COMMUNICATIONS HANDBOOK by R.S.G.B. 63/- P. & P. 4/6.

TAPE RECORDER SERVICING MECHANICS by Schroder. 21/- P. & P. 1/3.

BASIC THEORY AND APPLICATION OF TRANSISTORS by U.S. Army. 14/6 P. & P. 1/3.

ELECTRONIC MUSICAL INSTRUMENT MANUAL, new 5th ed. by Douglas. 55/- P. & P. 3/6.

F.M. MULTIPLEXING FOR STEREO by Feldman. 30/- P. & P. 1/3.

ELECTRONIC GAMES AND TOYS YOU CAN BUILD by Buckwalter. 24/- P. & P. 1/3.

CRESCENT RADIO LTD.

(electronic component specialists)

For all regular components try

40 Mayes Road, Wood Green, N.22

For surplus components and equipment try

11 Mayes Road, Wood Green, N.22

THREE TRANSISTOR RADIO KIT

For you to make on a ready made printed circuit board. Gives good loudspeaker reception on the medium wave. Price includes postage and full set of instructions. Complete Kit 39/6 each.

SOLID STATE ELECTRONIC SPEED CONTROL UNIT

For A.C. motors or incandescent lights up to 5 amp rating all tested and guaranteed 27/6 each

EX COMPUTER PANELS

Guaranteed components on each board at least Three Transistors and Three Diodes plus various resistors and capacitors. Ideal for the Experimenter interested in transistor components 3/- each

UNMARKED AND UNTESTED TRANSISTORS

50 transistors in each parcel 10/6 for 50

SPECIAL COMPONENTS AT BARGAIN PRICES

Midget Relays 500 ohm 9V 5/- each

Ex Govt. headphones complete with microphone 12/6 each

Transistor Earpieces 8 ohm matching 1/6 each

Rev. Counters for tape recorders, etc. 6/- each

10mF 12V midget electrolytic capacitors 9d each

12mF 25V midget electrolytic capacitors 1/- each

Midget Knife switches 1/6 each

Fluorescent Starters Standard size 40 watt 1/6 each

100mF plus 32mF 300V Electrolytic capacitors 1/9 each

With our new premises in Mayes Road we can now offer an even wider selection of components for the home constructor and enthusiast.

Why not send 1/6 for our new catalogue. Please include postage with order.

Limited number VOX High quality 10" Speaker Cabinets with provision for amplifier. Finished in Black with gold trim. Brand new. £7 each.

TIMER UNIT consisting of standard mains input transformer 200/240 V 50 cycle; output 18 V 4 amp (conservative) GEC bridge rectifier; detachable accurate 1 sec timer sub-chassis with transistor STC type TS2, 2 x 12AU7, one 500 ohm relay heavy duty contacts 2 make; lamps, fuse switch, etc., etc., in case size 10 x 10 x 5". Ideal for battery charger, one second timer, transistor power supply, etc.

Tested and guaranteed working £3.10.0. P & P 15/-. Untested, but complete £2.10.0. P & P 15/-.

TRANSISTOR OSCILLATOR variable frequency 40 c/s to 5 kc/s 5 volt square wave o/p; for 6 to 12 V D.C. input. Size 1 1/2 x 1 1/2 x 1 1/2". Not encapsulated. Brand new. Boxed 11/6 each.

Brand new unmarked transistors. Types OC71 and OC44. Tested and guaranteed 10d each. Min. order 2/6.

Callers welcome. Cash with order.

CHILTMead LTD.

22 Sun Street, Reading, Berks.

Tel. Reading 65916 (9 a.m. to 10 p.m.)

INTERCOM/BABY ALARM

Three-way fully transistorised. Built-in buzzer and volume control. 52/6

Ideal for home, office, workshop. Wall or desk mounting. Complete full instructions, connecting wire, battery, etc.

RECORD PLAYER AMP.

As fitted to most popular record players. Our Bargain Price 59/6 only. Fully built and tested. EL84 output. 230-240V mains operated. 2 controls -vol.,-tone on flying lead. P/p. 3/6.

AMPLIFIER

4V transistorised, mains operated amplifier. Complete, ready built with integral power supply (240V). All on printed panel. Professional performance, high standard of reliability. Offered at a fraction of normal retail price. 79/6 plus 5/- p/p.

SONOTONE

9TA-HC diamond STEREO CARTRIDGE 47/6 plus 2/6 p/p. DIA. STYLI

● BARGAIN — Speakers, Hi-Fi — The Baker Selhurst Stalwart, 12in round, 15 watt rating, 12,000 lines gauss, 3 or 15 ohms, response 45-13,000c/s. Bass resonance 40-50c/s, solid aluminium chassis. Our price £4.19.6.

Brand new, 12 months' unconditional guarantee. P.P. 6/6.

● BARGAIN — Speakers, Hi-Fi — The Baker Selhurst Guitar Group 25, 12in round 25 watt rating, 12,000 gauss, 15 ohms, response 30-10,000c/s, solid aluminium chassis, heavy duty cone. Our price £4.19.6.

Brand new, 12 months' unconditional guarantee. P.P. 6/6.

BARGAIN—CHANGER DECKS AT LOWEST PRICES EVER

Plinth WB1	GARRARD 1025	£7.19.6
£2.15.0	GARRARD 2025	£8.9.6
Cover SPC1	GARRARD SP25 Mk. II	£11.15.0
£2.15.0	GARRARD AT60 Mk. II	£12.10.0
	GARRARD 3500 with SON.	
	9TA-HC dia. stereo cartridge	£10.9.6

Post and packing on all above 10/-.

BUDGET HI-FI SYSTEM YOU WON'T FIND A BETTER BARGAIN—ANYWHERE!

TELETON F2000 STEREO (MULTIPLEX) AM-FM TUNER AMP.	£35.8.11	C O M P L E T E	OUR PRICE
TELETON S1003 SPEAKER ENCLOSURES (PAIR)	£9.13.6		
GARRARD SP25, SONOTONE 9TA. DIAM. PLINTH TO MATCH	£22.1.4		
TOTAL	£67.3.9		59 GNS.
			FREE DELIVERY

EMI HI-FI SPEAKERS

13x8in. 39/6, p/p. 5/- 13x8in. plus 2 twr. 57/6, p/p. 7/6. 8x5in., 7x4in. 22/6, p/p. 3/6. Catalogue, full spec. on request. Distributors for EMI Sound.

Beautiful oiled teak enclosure

to suit EMI 13x8in. speakers. Retail value £8.15.0. Our low price ONLY 99/6 plus 8/- p/p.

TRIO

We have now been appointed Northern Stockist for the new outstanding range of Trio Hi-Fi Equipment. Examples:

● TK150T 13.5W + 13.5W Stereo Amplifier. Retail price £35.

● TK250T 20W + 20W Stereo Amplifier. Retail price £49.10.0.

Colour brochure with full details and specification on request.

BASF TAPE 3 1/2 OFF

	Standard	Long Play	Double Play
5"	600ft. 12/6	900ft. 17/-	1200ft. 27/6
5 1/2"	900ft. 17/-	1200ft. 21/6	1800ft. 36/-
7"	1200ft. 21/6	1800ft. 33/-	2400ft. 52/6

Thank you for reading our advertisement.

POST & PACKING 2/- OVER £5 FREE

Waldon Electronics, Atlas House, Chorley Old Rd., Bolton

BOLTON 25881

HEAT LIGHT SPEED CONTROL Unit



An Electronic unit capable of controlling electrical equipment up to 3,000 watts capacity. Fingertip control of all a.c./d.c. electrical equipment. Suitable for all types of lighting arrangements. Incandescent lamps. Spot lamps. Arc lamps. Floodlights. Makes an ideal dimming unit. Ideal for controlling all types of electric drills and up to 2 h.p. electric motors for all applications. Ideal for all types of electric heaters. Suitable for lathes and power tools. Contains the latest electronic switching devices and associated thyristor circuitry. Size 6 x 5 x 2in. Louvred metal case in pleasing hammer finish. Attractive front panel with matching socket and controls. Recommended price 25 gns. Huge purchase enable us to offer them at **£8.19.6**, carriage and insurance 10/-. C.O.D. if required.

AIRCRAFT— POLICE BAND BROADCAST REC.

A small transistorised receiver that will receive civil aircraft and police/ambulance broadcasts. Operates from a 9 volt battery that fits internally. 6 transistors. Robust metal cabinet size approx. 7 x 4 x 4in. Attractive front panel. Speaker or headphones output. Improved type of luxe model price **£9.10.0**, carriage 10/-. Few only. Brand new and unused.

TRAWLER TOP BAND RECEIVER KIT

This wonderful little set will provide hours of listening pleasure. Listen to the thrilling sound of an SOS at sea. Super for listening to the Hams at work. A printed circuit layout makes it simple to build in a short time. Fully comprehensive instructions. Employs the latest components and transistors. Complete down to the last detail. An ideal project for beginners. Price **£5/-**, Post 5/.

40 METRE BAND RECEIVER

These excellent receivers were made for the Government by a famous manufacturer. They will cover the complete amateur band, Aircraft, Marine and other Government Stations. It is a 5 valve superhet and works from standard dry batteries. Built in a robust metal case size 10 x 6 x 4in. Half moon calibration tuning dial. Phone or speaker output. Not new but in excellent condition. **£3.10.0**, carriage 10/-. Few only.

RUN LIGHTING, TELEVISION, DRILLS, etc., from a 12 Volt CAR BATTERY



A superbly designed **POWER CONVERTER (deluxe model)**. A 12 volt INPUT gives a 200/240 volt OUTPUT. Enables you to run up to 300 watt AC/DC TELEVISION, lighting and equipment. Thousands of uses. Indispensable to workshops. Ideal for lighting and power in your garage. The unit is contained in a compact louvred steel case. Complete with connecting leads, battery clips and full instructions. Ready to connect up and use. *Not to be confused With Heavy Duty Dynamotors.* Price only **£8.19.6**. Carr. 12/6. C.W.O. C.O.D. 3/6 ex. Callers welcome.

GLOBE SCIENTIFIC LTD
DEPT. P.E. 18, 24 CAWOODS YARD,
MILL STREET, LEEDS 9

240 VOLT ELECTRICITY ANYWHERE

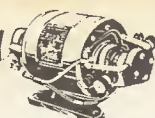

most brilliant performance ever from 12-volt Car Battery. BRILLIANT HEAVY DUTY 240 volt AMERICAN DYNAMOTOR with BIG 220 WATT OUTPUT. Marvellous for TELEVISION, ELECTRIC DRILLS, MAINS LIGHTING and ALL UNIVERSAL AC/DC MAINS EQUIPMENT. Marvellous for Fluorescent lighting. Thousands of uses. Tremendous purchase of this model makes fantastically low price possible.

ONLY **£4.19.6** each plus 10/6 delivery. C.O.D. with pleasure. **MONEY BACK** if not DELIGHTED. Please send S.A.E. for full illustrated details.

Dept. PE, STANFORD ELECTRONICS
Rear Derby Road, North Promenade
BLACKPOOL, Lancashire

UNIVERSAL BATTERY ELIMINATOR



Run all your transistor equipment direct from a.c. mains. The most economical way of running Transistor Radios, Hi-Fi Equipment, Record-Players, Amplifiers, etc. No more expensive batteries to buy. All the units are contained in an attractive case with a full set of accessories. MK 1 model—replaces all 9 volt batteries, i.e., PP3, PP4 PP5, PP6,, PP7, PP9 and all equivalents, or all 6 volt batteries, i.e., PPI and PP8 (please state which voltage). Now only **30/-** P. & P. 7/6. MK 2 model—this unique model has three outputs: 6 volts, 7½ volts and 9 volts and is ideal for cassette tape-recorders, price only **55/-**, P. & P. 5/- extra. Extra lead with DIN plug for Cassettes **6/6**. MK III—This unit is the same as the MK II version above with the added refinement that all the outputs are **STABILISED** making the unit most suitable for running Hi-Fi and Test Gear direct from the mains. Only **75/-**, P. & P. 5/-.

All units available from Dept. P.E.

GLOBE SCIENTIFIC LTD

DEPT. P.E. 18, 24 CAWOODS YARD,
MILL STREET, LEEDS 9

RECEIVERS AND COMPONENTS

(continued)

U.J.T.'s equiv. 2N2646, T1843 6/- each. Tested. P. & P. 6d per order. Data supplied, L.F.H. ELECTRONICS, 65 Flanders Mansions Flanders Road, London, W.4.

BARGAIN PARCELS of new surplus Electronic Components, 3/-, 5/-, 10/-, post free. DOLPHIN ELECTRONICS, 5 Pooles Way, Bria Close, Burntwood, nr. Lichfield.

R & R RADIO

51 Burnley Road, Rawtenstall
Rossendale, Lancs

Tel.: Rossendale 3152

VALVES BOXED, TESTED & GUARANTEED

BF80	3/-	PCC84	3/-	PY82	3/-
EBF89	3/6	PCF80	3/-	UJ91	4/6
ECC82	3/-	PCF82	3/6	U301	4/6
ECL80	3/6	PCL82	4/-	6F23	5/-
EF80	1/6	PCL83	4/-	10P14	3/-
EF85	3/-	PCL84	5/-	20P5	3/-
EF183	3/6	PL36	5/-	30F5	2/6
EF184	3/6	PL81	4/-	30L15	5/-
EY86	4/6	PL83	4/-	30P12	4/6
EL41	5/-	PY33	5/-	30C15	5/6
EZ40	4/6	PY81	3/6	30PL13	5/6
EBC41	4/6	PY800	3/6	30PL14	5/6

POST, ONE VALVE 9d. TWO TO SIX 6d.
OVER SIX POST PAID.

SPECIAL BARGAIN LOTS. NEW COMPONENTS. 70 assorted resistors/capacitors 10/-, P. & P. 1/-. BROWNS, 21 Goldington Avenue, Huddersfield, Yorks.

COMPONENTS

POSTAL SERVICE

* RECHARGEABLE BATTERIES

(Sealed DEAC Ni-Cad)

PP3 Equiv.: 9v. 37/- (p. & p. 2/-)
U2 Equiv.: 1.25v. 32/6 (p. & p. 2/-)
U7 Equiv.: 1.25v. 12/- (p. & p. 1/6)
U11 Equiv.: 1.25v. 26/- (p. & p. 1/6)



* BARGAIN PACK

100 Hi-Stab Resistors } 15/-
30 Silicon Diodes }
8 Silicon Top Hat Rectifiers

* ASSORTED RESISTORS—Hi-Stab. 300 off (5%, 10%, 1/2, 1/4 watt, worth £3) 15/- (P. & P. 1/6 per order) C.W.O.

S.A.E. for list of Industrial Components for the Home Constructor

ELMBRIDGE INSTRUMENTS LTD.
Island Farm Avenue, West Molesey, Surrey

COMPONENTS AT GIVE-AWAY PRICES. Digital Counters, Rev Counters, Thyristors, Transistors, Valves, Tool Bags, Track Heads, Recording Tape, Aerials, Intercoms, Microphones, Micro Switches, Etc. 6d. stamp only, to **DIAMOND MAIL ORDER PRODUCTS**, Prospect House, Canal Head, Pocklington, York. N04 2NW.

Single channel Radio Control at a price you can afford

RADIO CONTROL PRODUCTS

EXCELLENCE RANGE AND PERFORMANCE

TRANSMITTER—

- Crystal controlled tone Tx. 12v. operation. Silicon transistors. In smart blue anodised case with micro-switch.

Tx only **£6 - 5 - 0**



RECEIVER—

- Relayless weight 1½oz. Size 2½ x 1½ x ¾ in., working on 4.5 volts. In matching blue case.

Rx only **£4 - 5 - 0**

SUITABLE FOR MODELS OF ALL KINDS
ONLY **£10 - 10 - 0 COMPLETE**

Full off-the-shelf Guarantee, including crash damage, for 1 year

OBTAINABLE FROM

MODEL MART
3 COMBERTON ROAD
KIDDERMINSTER. Tel. 5879

OR DIRECT FROM

RADIO CONTROL PRODUCTS
38 FRANCHE ROAD
KIDDERMINSTER, WORCS.

ORGAN BUILDERS! SILICON N.P.N. TRANSISTORS. ALL INDIVIDUALLY TESTED IN PUBLISHED DIVIDER CIRCUIT! GOLD-PLATED LEADS FOR EASY SOLDERING! Unbeatable value at 1/6 each or £5/- per 100.

12 VOLT TRANSISTORISED FLUORESCENT LIGHT * 8 WATT 12in TUBE. Current drain only 700mA! Complete and tested £2/19/6 only! Or in kit form:

*Case	10/-
Transistor	10/-
Lamp holders—	pair	5/-
Condensers, etc.	3/-
Transformer	13/6
Tube	8/-

*Post and Packing 5/-.

TRANSISTORS

OC200, OC203, OC204, all at 2/- each. ASY22, 2N753, BSY28, BSY65, 2G344A, 2G345A, 2G345B, 2G371A, 2G378A, all at 1/6 each.

Transistors similar to OC44, OC71 and OC72, all 1/- each.

Unmarked, untested transistors, 7/6 for 50.

LIGHT SENSITIVE TRANSISTORS (similar OCP 71), 2/- each.

30 watt transistors (ASZ17), 10/- each.

DIODES. Very low leakage. Make excellent detectors, also suitable for keying electronic organs, 1/- each, 20 for 10/-.

RECTIFIERS

BY100, 800 p.i.v., 2/6 each, 24/- per doz., £7/10/- per 100, £50 per 1,000.

BYZ13, 6-amp, 400 p.i.v., available on same terms.

MULLARD POLYESTER CAPACITORS FAR BELOW COST PRICE!

0-001µF 400 volts	..	3d	0-15µF 160 volts	6d
0-0015µF 400 volts	..	3d	0-22µF 160 volts	6d
0-0018µF 400 volts	..	3d	0-27µF 160 volts	6d
0-0022µF 400 volts	..	3d	1µF 125 volts	1/-
0-01µF 400 volts	..	3d				

VERY SPECIAL VALUE! Small Silver-mica, Ceramic, Polystyrene Condensers. Well assorted. Mixed types and values. 10/- per 100, PAPER CONDENSERS, MIXED BAGS, 0-0001 to 0-5µF. 12/6 per 100.

RESISTORS! Give-away offer! Mixed types and values, 1/4 to 1/2 watt. 6/6 per 100, 55/- per 1,000. Individual resistors 3d each. Also 1/2 to 3 watt close tolerance. Mixed values. 7/6 100, 55/- 1,000.

WIRE-WOUND RESISTORS. 1 watt to 10 watts. Mixed bags only. 16 for 10/-.

RECORD PLAYER CARTRIDGES

ACOS

GP 67/2 Mono.	15/- complete with needles.
GP 91/3 Stereo Compatible	£11/-
GP 93/1 Stereo Ceramic	£15/-
GP 94/1 Stereo Ceramic	£15/-

Small pick-up arms complete with cartridge and needle, 10/- only.

TRANSISTORISED SIGNAL INJECTOR KIT R.F./I.F./A.F. 10/- only

TRANSISTORISED SIGNAL TRACER KIT 10/- only

TRANSISTORISED REV. COUNTER KIT 10/-

VEROBOARD

2 1/2in x 1in 0-15in matrix	1/6	17in x 2 1/2in 0-15in matrix	11/-
3 1/2in x 2 1/2in 0-15in matrix	3/3	17in x 3 1/2in 0-15in matrix	14/8
3 1/2in x 3 1/2in 0-15in matrix	3/11	3 1/2in x 2 1/2in 0-1in matrix	3/9
5in x 2 1/2in 0-15in matrix	3/11	3 1/2in x 3 1/2in 0-1in matrix	3/11
5in x 3 1/2in 0-15in matrix	5/6	5in x 2 1/2in 0-1in matrix	3/11
		5in x 3 1/2in 0-1in matrix	5/6

Spot Face Cutter 7/6. Pin Insert Tool 9/6. Terminal Pins 3/6—36.

MULTIMETERS. 20,000 ohms per volt.

Ranges: a.c. 1,000V, 500V, 100V, 50V, 10V.

d.c. 250mA, 2-5mA, 50µA.

d.c. 2,500V, 500V, 250V, 50V, 25V, 5V.

Resistance: 0/60kΩ and 0/6MΩ.

Special price £4/- only.

ELECTROLYTIC CONDENSERS

0-25µF 3 volt	4µF 4 volt	10µF 25 volt	64µF 9 volt
1µF 6 volt	4µF 12 volt	20µF 6 volt	100µF 9 volt
1µF 20 volt	4µF 25 volt	25µF 6 volt	320µF 4 volt
1-25µF 16 volt	5µF 6 volt	25µF 12 volt	320µF 10 volt
2µF 3 volt	6µF 6 volt	25µF 25 volt	400µF 6-4 volt
2µF 350 volt	8µF 3 volt	30µF 6 volt	
2-5µF 16 volt	8µF 12 volt	30µF 10 volt	All at 1/- each.
3µF 25 volt	8µF 50 volt	50µF 6 volt	
3-2µF 64 volt	10µF 6 volt	64µF 2-5 volt	20 assorted (our selection) 10/-.

SKELETON PRE-SET POTENTIOMETERS. 100Ω, 100KΩ, 200KΩ, 500KΩ.

SLIDERS. 680KΩ. 6d each.

SMALL TRANSISTOR OUTPUT TRANSFORMERS 2/6 each.

SMALL TRANSISTOR DRIVER TRANSFORMERS 2/6 each.

CRYSTAL LAPEL MICROPHONES 10/-.

TAPE RECORDER MICROPHONES 12/-.

Orders by post to: G. F. MILWARD, DRAYTON BASSETT, NEAR TAMWORTH, STAFFS.

Please include suitable amount to cover post and packing. Minimum 2/-.

Stamped addressed envelope must accompany any enquiries.

For customers in Birmingham area goods may be obtained from Rock Exchanges, 231 Alum Rock Road, Birmingham 8.

HIGH SPEED MAGNETIC COUNTERS (4 x 1 x 1in). 4 digit. 12/24/48V (state which) 6/6 each. P. & P. 1/-.

COPPER LAMINATE BOARD (8 1/2 x 5 1/2 x 1/8in). 2/6 each. 5 for 10/-.

RE-SETTABLE HIGH SPEED COUNTER (3 x 1 x 1in). 3 digit. 12/24/48V (state which) 32/6 each.

BULK COMPONENT OFFERS

- 100 Capacitors 50pF to 0.5µF.
- 250 Carbon Resistors 1/2 & 1W (Transistor types).
- 250 Carbon Resistors 1/2 & 1W.
- 100 Ceramic Capacitors 2—1,000pF.
- 25 Vitreous W/W Resistors (5%).
- 12 Precision Resistors (0.1% several standard values included)
- 25 Close Tolerance Caps. (2%).
- 12 Silicon Diodes 500 p.i.v. 750 m.a.
- 4 Silicon Rects. 400 p.i.v. 8 amp.
- 8 Silicon Rects. 100 p.i.v. 3 amp.
- 50 Silicon Trans. (2N706/708, BSY28/29, BCY41/42 types.) Unmarked, Untested.

ANY ITEM 12/6. ANY 5 ITEMS £2.10.0.

S.C.R.s. (Thyristors) CRS1/20 5/6; CRS1/40 7/6; CRS3/10 7/6; CRS3/30 8/6; CRS3/40 10/-; CRS3/50 12/6 each.

'9000' TYPE RELAYS (ex. new equip.) 10 for 25/- (our choice) P. & P. 5/-.

VENNER LIGHTWEIGHT ACCUMULATORS (1oz 1 1/2 x 1 1/2 x 1in). 1-5 Abr 12/6 each.

COMPUTER LOGIC BOARDS containing: 14 BCZ11, 2 trimpots, diodes, etc., 20/- each.

LIGHT DIMMER/SPEED CONTROL MODULES: 200 watt, 85/-; 500 watt, 45/-; 1,000 watt, 60/-.

RECORD LEVEL METERS (By Smiths), 1 1/2 x 1/2 in, 15/- each. P. & P. 2/6.

MINIATURE RELAYS (1oz, 1/2 x 1/2 x 1/2 in), 24V 1 c/o, 7/6 each. 12V, 10/- each.

P. C. CONNECTORS (13 way in-line), 4/6 pair.

LARGE CAPACITY ELECTROLYTICS: 100 + 400µF, 275V; 1,000µF, 50V; 2,500µF, 20V; 3,200µF, 16V; 5,000µF, 15V; 4/- each. 4,000µF, 90V; 5,000µF, 25V, 7/6 each. 5,000µF, 50V; 6,300µF, 63V; 10,000µF, 30V; 16,000µF, 15V; 25,000µF, 15V, 10/- each.

SPEAKER BARGAINS (E.M.I. 13 x 8in.) With two Tweeters and x/over, 15 ohm, 65/-; with Dual Cone, 15 ohm, 52/6; Single Cone, 3 or 15 ohm, 45/-; P. & P. 3/-.

FANE, 12in, 20watt (Dual Cone), 95/- P. & P. 5/-.

TWEETER (E.M.I. 8in), 15 ohm, 12/6.

CAR RADIO (3/5 ohm), 7 x 4in, 15/-; 8 x 5in, 17/6.

L.T. TRANSFORMERS. Prim 240V. SEC. 10/20/25V. and 3.5 amp, 20/-; P. & P. 5/-; 5 amp, model 25/-; P. & P. 5/-.

PATTRICK & KINNIE

81 PARK LANE, HORNCHURCH, ESSEX ROMford 44473

Burgess instant heat solder gun

Only the tip heats—but fast! About 7 seconds! Pre-focused lamp lights the job up. Exclusive full-length trigger on pistol grip eases finger fatigue. Finger-tight is right for screw-in tips — no pliers needed. Kit complete with conical tip, chisel tip, 6" extension barrel, double-ended probe, gun and solder. £4 12 6.



Full details and nearest stockist from:

Burgess Products Co Ltd, Sapcote, Leicester LE9 6JW



12in. DE-LUXE MKII £9

The exceptional quality and performance of the "De-luxe MKII" brings truly breathtakingly rich sound from a single loudspeaker, recreating the musical spectrum virtually flat from 25 to 16,000 c.p.s. The unit consists of the latest double cone, woofer and tweeter cone together with a special Baker "FERROBA" magnet assembly having a flux density of 14,000 gauss and a total flux of 150,000 Maxwells. Bass resonance 32-38 c.p.s. Rated 15 watts. Voice coils available 3 or 8 or 15 ohms. Suitable for any High Fidelity System. Design capability concept has programmed third generation hardware giving fantastically delightful sound at this amazing bargain price.



48 page Enclosure Manual 5/9 post paid. **Baker Reproducers Ltd**

Bensham Manor Road Passage, Thornton Heath, Surrey. 01-684 1665

BARGAIN PACKS!

- 4 **FT318 STC** Sil. Rectifiers New and Marked 800 pV 1/2 amp. Good substitute for BY100, etc... 13/-
- 4 **RAS310AF STC** Avalanche Rectifiers New and Marked 1,200 pV 1/2 amp 5A surge rated... 20/-
- 6 **GJ4M** New and Marked AEL Germanium Rectifiers 50 pV 1 amp... 10/-
- 4 **GP297/1** Sub-miniature power transistors Texas New and Marked... 10/-
- 3 **ZF16 STC** New and Marked 16V 300mW Zener Diodes... 10/-
- 1 Pair of **AD161 AD162 NPN PNP** Power Complementary Pair... 10/-
- 1 Pair of **AC128/AC176 NPN/PNP** Driver Complementary Pair... 15/-
- 1 Set **OC82D + 2 x OC82** Matched Pair New Mullard Marked... 10/-
- 4 **BSY95A STC** New and Marked Planar Transistors... 10/-
- 4 **BC108** Mullard Latest type Low noise planars New and Marked... 10/-
- 6 **NKT276** New and Marked Newmarket Audio General purpose transistor... 10/-
- 36 Square inches of 0-15 in Matrix Veroboard—the most popular pack of all—only from LST... 10/-
- 4 **NKT162** New and Marked Newmarket Switching Transistor... 10/-
- 2 **OC19** New and Marked Mullard Power Transistors... 10/-
- 5 **BA115** New and Marked Mullard Colour Television Diodes... 10/-
- 4 **2G371B** New and Marked Texas Audio Transistors... 10/-
- 4 **BYX38/600** Mullard New and Marked Power Studs 600 pV 2 1/2 amp... 16/-
- 1 "Designers Guide to British Transistors" New data book with over 1,000 types listed—Computer selected substitution chart. Just out from Publishers (add 2/6 this item post) 25/-

Postage and Packing by First Class Mail now 1/- minimum per order

TIS43A
Equivalent
+2N1646; BEN3000
UNIUNIJUNCTION 6/9d
including data

2N3819
Texas Field
Effect Transistor 10/-

FAIRCHILD uLogic
uL900 Buffer 1-6 7-12 12-
uL914 Dual Gate 11- 9/6 8/4
uL923 JK Flip Flop 14- 12/6 11/9
5 Page data details 2/6d

SL7010 Plessey Integrated Circuit 18/-

SCR 1 + 2pc IS113
For PE Drill Controller (July Issue) 10/- et

BC107/8/9 2/9d each

TD716 Tunnel Diode 12/-

SILICON RECT'S 4

FULLY TESTED GUARANTEED

PIV	200mA	750mA	2A	10A
50	6d	2/3	-	-
100	9d	1/6	2/3	4/6
200	11d	2/-	3/9	5/-
400	2/-	2/9	4/-	8/-
600	3/-	-	4/6	9/6
800	-	3/9	5/-	11/3
1,000	-	-	6/6	14/-

Post and Packing 9d Free Export Catalogue

LOOKING FOR QUALITY, VALUE & SERVICE? Write

STOP

2N3703	5/-	AF124	6/-	GET103	4/6	OC81D	3/-
2N3704	5/-	AF127	4/-	GET113	5/-	OC82	4/6
2N3705	6/-	AF139	15/-	GET114	4/-	OC82D	3/-
2N3706	4/6	AF239	12/-	GET115	9/-	OC83	4/6
2N3707	6/9	AF186	12/-	OA5	3/8	OC123	7/-
2N3708	3/9	AF211	10/8	OA47	1/6	OC139	8/-
2N3709	4/-	AF212	11/9	OA70	1/6	OC140	12/-
2N3710	5/-	AS272	5/8	OA79	1/6	OC149	12/-
2N3711	5/6	AS238	4/4	OA2379M	1/6	OC169	9/-
2N3053	8/-	AS276	5/8	OA81	1/6	OC170	4/-
2N3055	22/-	AS291	4/4	OA85	1/6	OC171	4/6
2N3057	29/-	AS221	11/-	OA90	1/6	OC200	6/6
2G301	4/9	AT210	30/-	OA91	1/6	OC201	10/-
2G302	3/9	AT210	39/6	OA95	1/6	OC202	18/4
2G306	9/6	BA115	2/8	OA200	2/-	OC203	8/-
2G308	6/9	BA138	3/-	OA202	2/-	OC204	8/-
2G309	10/-	BC107	4/3	OA210	6/4	OC205	9/-
2G319A	5/-	BC108	4/-	OA211	9/-	OC206	10/6
2G345B	3/-	BC109	4/3	OA220	3/6	OC207	7/6
2G374B	5/-	BC130	7/-	OA2202	3/6	ORP12	9/6
2G382	2/-	BC232	14/-	OA2207	7/-	ORP41	8/-
25002	4/-	BC233	4/8	OA2208	3/6	ORP63	9/-
25017	8/-	BC234	4/8	OA2241	3/6	SR631	7/4
25018	8/6	BC238	8/-	OA2242	3/6	SR636	10/8
25024	35/-	BC239	27/4	OA2243	6/-	SR638	12/-
25034	25/-	BC240	13/4	OA2246	2/6	SR639	15/-
25701	15/-	BC245	15/2	OA2249	3/6	CA26	8/3
AA111	2/-	BC270	10/-	OA2270	3/6	PS46A	6/-
AA130	2/6	BC271	8/8	OC25	5/6	VA65A	9/3
AC107	14/6	BC211	4/4	OC20	33/-	EC401	5/-
AC126	6/6	BD121	25/8	OC22	13/-	EC602	4/8
AC127	6/6	BD123	32/-	OC23	15/-	CI11E	18/-
AC128	7/4	BF164	7/6	OC24	10/-	CA60	9/-
AC176	7/6	BF113	4/6	OC25	6/8	CI11	45/9
AC187	12/-	BF229	11/-	OC26	12/-	CA45	32/-
AC188	12/-	BF550	6/-	OC28	12/-	EA403	3/6
ACV17	5/6	BF551	8/8	OC29	15/-	FB381	3/6
ACV18	3/4	BF552	4/-	OC30	7/-	BC113	9/-
ACV19	4/6	BF553	6/8	OC31	5/6	BC118	7/6
AC200	3/8	BSX76	3/8	OC36	13/-	BC125	14/-
AC21	4/-	BSY27	4/4	OC41	3/6	BC126	14/-
AC22	2/6	BSY95A	3/6	OC42	4/-	BC154	12/-
AD149	11/8	BT197/150R	3/4	OC43	5/-	BF152	13/6
AD161	7/6	BT197/150R	3/4	OC44	3/-	BU111	15/-
AD162	8/6	BYX20/200	9/-	OC45	3/-	MPF102	11/-
AD211	21/-	BYX20/200	9/-	OC71	3/6	MPF103	9/6
AD212	23/4	BYX36/100	2/-	OC72	4/6	MPF104	10/-
AD214	12/-	BYZ10	11/3	OC73	3/-	MPF105	10/6
AF114	4/8	BYZ12	4/8	OC75	5/-	MP481	27/-
AF115	4/8	BYZ13	5/4	OC76	5/6	MP491	30/2
AF116	4/4	BZ193/C24	12/8	OC77	7/8	40361	13/3
AF117	4/4	GT2702	6/-	OC81	8/-	40362	16/3

Post and Packing 9d Free Export Catalogue

LST COMPONENTS
7 COFFOLD ROAD
BRENTWOOD ESSEX
BRENTWOOD 7904
24 HOUR POSTAL SERVICE

PLEASE SEND 1988 CATALOGUE TO:
(Block Capitals)
I ENCLOSE 1/6 STAMPS

NAME _____
ADDRESS _____
_____ (PEA)

SPECIAL OFFER. A.C. relays, 250V coil, 3H/D contacts, 2m, 1B, 2 1/2" x 1 1/2". New, 25/- Transformers, 200/50 input, 12V out, about 5 amp, with input lead, switch, neon. Totally enclosed, new, 50/- + 5/- carr. 1/- P.O. for list of new/ex equipment. Scopes, SigGens, etc. **STOODLEY POSTAL ELECTRONICS**, Sedbury, Doctors Hill, Sheffield English, Romsey, Hants. SO50JW.

NOT SUBMIT

Let's get one thing clear from the start: our AX9 component kit is NOT for subminiaturists. But constructors who have discovered that mini t.r.f. receivers give mini performances will find a pleasant contrast in this one. It uses a 4in x 3in litz-wound ferrite aerial to provide a reasonable input signal, a high-gain low-noise two-stage r.f. amplifier to boost it, and a sensitive transistor detector with plenty of a.f. output. After that, one high gain a.f. stage with an output transformer gives a loud signal to the earphone, in fact, enough power for quiet-room loudspeaker reception. (You need a 3-8Ω speaker.) The AX9 is a component kit—no cabinet, but everything else, except the 9V battery. Amplified a.g.c., and positively no trick circuits. Even the preset reaction is optional. Four silicon transistors—with makers' emblems and numbers on them, 'Dilem' tuning capacitor, top-grade parts, tinned and drilled printed circuit. Buy one now, scrounge a bit of Formica for the front panel, and you could be listening to it at Xmas. Medium wave, easily adapted other bands (see our notes). Price £2 10s. 0d.

We sell low-cost high grade transistors' amplifier kits, etc. List 4d.

AMATRONIX LTD.
(PE) 396 SELSDON ROAD
SOUTH CROYDON, SURREY, CR2 0DE

ELECTRONIC STOCK MARKET

KIT OF MOST PARTS
ALSO 'REACTALYSER' AND WAA-WAA PEDAL. S.A.E. FOR LIST.
D.E.W. LTD., RINGWOOD RD. FERNDOWN, DORSET

TAPE RECORDERS, TAPES, ETC.
TAPES TO DISC—using finest professional equipment—45 r.p.m. 18/-. S.A.E. leaflet. DERBY, High Bank, Hawk Street, Carnforth, Lancs.

WENTWORTH RADIO

104 SALISBURY ROAD, HIGH BARNET Phone 01-449 3087

BARGAIN OFFERS

Min. Magnetic Earpieces	9d	NKT124	8/9
OC72	2/2	NKT212	5/-
OC45 Mullard	1/6	NKT213	6/-
OC201 Mullard	2/-	NKT214	3/9
AF116 Mullard	2/1	NKT215	4/9
		NKT241	5/-
		NKT274	4/-
		NKT275	4/-
		NKT713	5/3
		NKT717	8/3
		NKT773	4/9
		NKT0013	12/6
		25512	3/10
		25701	11/6
		253040	19/-

QUOTATIONS SENT ON REQUEST
ALL COMPONENTS SUPPLIED
DISCOUNTS ON BULK ORDERS

P. & P. 1/-

ENGLANDS LEADING COMPONENT & EQUIPMENT CENTRES

SOLID STATE-HIGH FIDELITY AUDIO EQUIPMENT

Audio Equipment developed from Dinsdale Mk.II—each unit or system will compare favourably with other professional equipment selling at much higher prices.

COMPLETE SYSTEMS FROM £15.5.0

THE FINEST VALUE IN HIGH FIDELITY—CHOOSE A SYSTEM TO SUIT YOUR NEEDS AND SAVE POUNDS

All units available separately.

SEND FOR 16 PAGE BROCHURE (No. 21) TODAY! DEMONSTRATIONS DAILY AT '303' EDGWARE ROAD



Acclaimed by everyone THE MAYFAIR ELECTRONIC ORGAN

A completely new development in portable electronic musical instruments and a new field for the home constructor. The 'MAYFAIR' produces a multitude of the most pleasing sounds with a wide range of tone colours suitable for classic or popular music. The organ is fully polyphonic, that is full chords can be played over the entire keyboard. Supplied as a kit of parts which includes 165 transistors, printed circuit panels, special fully sprung and depth of touch adjusted keyboard, attractive vinyl covered cabinet with carry handle. A complete detailed and illustrated construction manual is provided with circuits and full parts list. Cost can be spread by purchasing the components packet by packet. All parts supplied are fully guaranteed. Full after sales service.



A new source of construction for the keen electronics fan either amateur or professional. Once built the 'MAYFAIR' will then provide **TOTAL COST 99 Gns.** years of enjoyable entertainment.

ORGAN COMPONENTS
We carry a comprehensive stock of organ components for TRANSISTOR AND VALVE FREE PHASE designs.
Ask for BROCHURE 9

Deferred terms available.
COMPLETE KIT
Deposit **£29.19.0**
12 monthly payments of **£7**.
TOTAL £113.19.0

BUILT AND TESTED
Deposit **£36.8.0**
12 monthly payments of **£9**. Total **£144.8.0**

EXPORT ENQUIRIES INVITED

Call in. See it and play it yourself.



TRANSISTOR AMPLIFIER

INTEGRATED 7 WATT AMPLIFIER & PREAMPLIFIER—MAY

With full Bass Treble and Volume Controls
A brilliant new design suitable for home or portable installations. For use with magnetic and crystal/ceramic cartridges, radio tuners, microphones, tape head replay and auxiliary inputs. Output is for 3 to 16 ohm speakers.

It favours the user in so many ways—with fantastic power, with far greater adaptability, with freedom to operate it from batteries or mains power supply unit (the new FS.20 is ideal for this), hi-fi installations, electronic guitars and organs, P.A. installations, intercom, systems, etc. This true 7-watt amplifier is supplied ready built, tested and guaranteed.

For complete listening satisfaction. **FOR ONLY £8/10/0 P.P. 4/-**. (OPTIONAL MAINS UNIT FS.20 £2.62/2, P.P. 3.-) Illustrated Brochure No. 12.



BRITISH MADE CAR RADIOS

A fine precision engineered car radio that's perfect company for long hours on the road. So easy to install and operate—and the price is exactly right. Has quick push-frequency. Manual tuning facilities. Push-button control. Output of 31 watts ensures crisp, top quality sound even at high motoring speeds. Price includes 7" x 4" speaker, full accessories and instructions.

POSITIVE OR NEGATIVE EARTH **EASI-TUNE £12.12.0**. pp. 4/6
AUTOBahn MANUAL as the EASI-TUNE, but with a single MW/LW Push Button. **£10.10.0**. pp. 4/6

CAR AERIALS * 3-Section Single Hole Wing or Boot Mounting 19/6 Brochure 15
Multi Section fully disappearing type with locking device, single hole mounting 35/- Post free with Car Radio or pp. 2/6 separately.

BUILD THESE PRACTICAL DESIGNS

	LIST
I.C.F.M. TUNER	£5.2.6. 40B
Switched F.M. Tuner	£3.17.6. 39B
Fluorescent Camping Light	£3.2.6. 43

Let us have your enquiries for parts for current PW and PE designs. S.A.E. PLEASE.



NEW MODELS NOMBREX TRANSISTORISED Test Equipment

MODEL	PRICE	Leaflet
22 Power Supply	£ 4	0 22
30 Audio Generator	19 10	0 24
31 R.F. Generator	12 10	0 25
32 C.R. Bridge	10 10	0 26
33 Inductance Bridge	20 0	0 29

Send for descriptive illustrated Brochure.



DO IT YOURSELF MW/LW PORTABLE

New printed circuit design with full power output. Fully tunable on both mw/lw bands. 7 transistors plus diode, push-pull circuit. Fitted 5 inch speaker, large ferrite aerial and Mullard transistors. Easy to build with terrific results. All local and Continental stations.
TOTAL COST £6.19.6. P.P. 4/6
Send for Brochure 1



MULLARD 7 WATT AMPLIFIER WITH VOLUME CONTROL

Suitable 7" x 4 inch 3 ohm speaker 17/6
Ideal for Portable Record Players, Inter-Comms, Baby Alarms etc. pp.
For 9 Volts operation. **45/-** 3/6d.

ITS SO EASY TO BUILD TO PROFESSIONAL STANDARDS

To get the best out of your MAGNAVOX STUDIO Matic DECK Type 363, you need a MARTIN RECORDAKIT. This comprises a special high quality 6 valve amplifier and pre-control knob—in fact everything needed down to the last screw FOR MAKING A SUPERB TAPE RECORDER, which, when built, will compare favourably with instruments costing twice as much, yet you need no experience or technical skill to bring this about. THE INSTRUCTIONS MANUAL MAKES BUILDING EASY AND SUCCESS ASSURED.



TWO TRACK Deck, Amplifier, Cabinet and Speaker. Complete kits with MICROPHONE 7 in 1, 200 ft. tape, spare spool. Today's value **£55**. OUR PRICE **36 gns.**
FOUR TRACK Deck, Amplifier, Cabinet and speaker. Complete kits with MICROPHONE 7 in 1, 200 ft. tape, spare spool. Today's value **£60**. OUR PRICE **39 gns.**

ALL UNITS AVAILABLE SEPARATELY. P.P. 2/6. Both models. ASK FOR BROCHURE 6.

VHF FM SUPERHET TUNER MKII

* 5 MULLARD TRANSISTORS & 4 DIODES * 300 Kc/s BANDWIDTH * PRINTED CIRCUIT CONSTRUCTION * HIGH FIDELITY REPRODUCTION MONO AND STEREO * MATCHES VHF FM MK II EQUIPMENT
A popular VHF FM Tuner now used throughout the country for quality reception of mono and stereo, with the decoder stereophonic broadcasts. There is no doubt about it—VHF FM gives the real sound. Excellent stability, economically priced.
TOTAL COST £6.19.6.
DECODEY £5.19.6.
(CABINET 20/- EXTRA) ASK FOR LEAFLET 3.



TRANSISTORS, RECTIFIERS, ZENERS, SCR'S, TUNNEL DIODES, FIELD EFFECT TYPES, VALVES, CRYSTALS

New 1968 32-page Booklet
Price 1/- Post Paid
Circuits with Data, Details and Prices of over 2000 different types.
This booklet is a must for every enthusiast.
MANUFACTURERS — DISTRIBUTORS.
We also publish a QUANTITY, SEMI-CONDUCTOR BULLETIN.
Please write to us for your copy.

NEW—MALLORY LONG LIFE MERCURY BATTERIES

50% OFF LIST PRICES
* RM12 1.35 volts 3600 m/ah OUR PRICE 5/-, each Size 2" x 4" dia.
RM625 10.35 volts 350 m/ah Pack of 8. Size 2 1/2 x 1 1/2 dia. OUR PRICE 10/-, each
Easily split into eight 1.35V cells.
These cells are ideal for any application where SMALL SIZE HIGH CAPACITY and LONG LIFE are required. QUANTITY QUOTATIONS WRITE OR PHONE EXTN. 2.

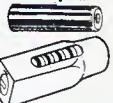

GARRARD DECKS



BRAND NEW All below list price

	£	s.	d.
2025 Mono/Stereo	8 19 6
300 LW with STAHC	9 19 6
SP25 Mk II	12 12 0
LAB90 Mk II	25 0 0
AT60	10 19 6
AT60 Mk II	13 19 6
40 Mk II	11 10 0
3500 Mono/Stereo 401	14 10 0
AP75	27 15 0
SL65	21 10 0
SL65	13 10 0
SL75	16 19 6
SL85	32 10 0
A70 Mk II	39 10 0

Send for illustrated brochures 16, 17
Complete range of accessories available

TRANSISTORS—SEMICONDUCTORS

COMPLETELY NEW 1968 LIST OF 1000 types available from stock. Send for your FREE COPY TODAY. (List No. 36)
S.C.R.'s from 5/-
Field Effect Transistors from 9/6
Power Transistors from 5/-
Diodes and Rectifiers from 1/6

HI-FI equipment to suit EVERY POCKET

Ask for Hi-Fi Stock List Leaflet 16.17
VISIT OUR NEW HI-FI CENTRE at 309 EDGWARE RD.



for all leading makes
AMPLIFIERS
TUNERS
DECKS
SPEAKERS
MICROPHONES
SYSTEMS
ALL WITH DISCOUNTS
IT WILL PAY YOU TO PAY US A VISIT!

Fully Illustrated CATALOGUE

COMPLETELY NEW 9th EDITION (1968)
The most COMPREHENSIVE—CONCISE—CLEAR—COMPONENTS CATALOGUE
Complete with 10/- worth discount vouchers FREE WITH EVERY COPY.
* 32 pages of transistors and semi-conductor devices, valves and crystals.
* 200 pages of components and equipment.
* 65 pages of microphones, decks and Hi-Fi equipment.



6,500 ITEMS
300 BIG PAGES
Send today 8/6 Post Paid

HENRY'S RADIO LTD



303 Edgware Road, London, W.2. Mail Order Dept.
all types of Components, Organ Dept. (01) 723-1008/9
309 Edgware Road, London, W.2. High Fidelity Sales, P.A. and Test Equipment, Record Decks (01) 723-6963

SAT. 9 a.m.—6 p.m. THURS. 9 a.m.—1 p.m.

The Mini 3 Receiver...

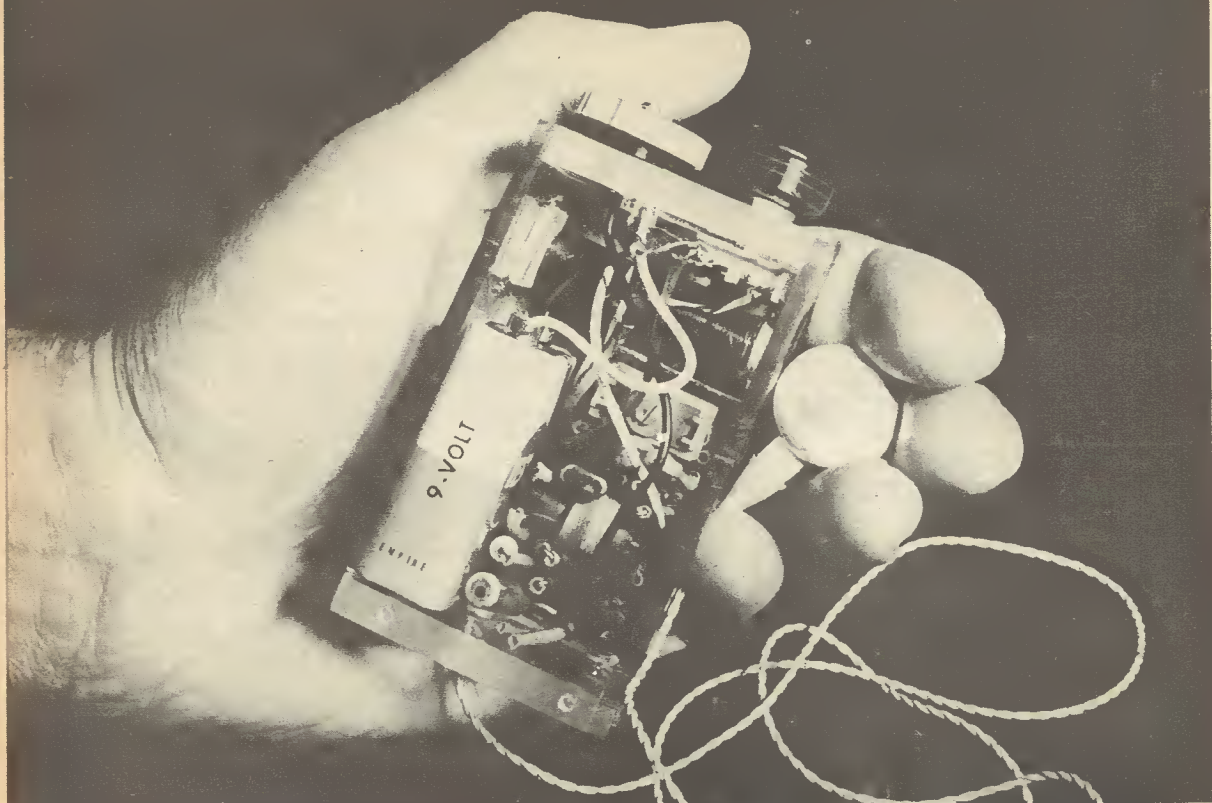

Plus 8-page **AUDIO SUPPLEMENT**

providing a detailed guide to:—

- **AUDIO SERVICING**
- **TEST EQUIPMENT**
- **WORKSHOP PRACTICE**

PRACTICAL WIRELESS

How-to-Make Features:

THE MINI 3

A 3-transistor 5-stage reflex receiver.

PYRAMID RECORD DECK

A battery-operated turntable and TRANSISTOR T.R.F. TUNER — both constructional projects in the PYRAMID series. Plus many other projects and regular features.

OUT NOW — 3s.

VALUABLE NEW HANDBOOK FREE TO AMBITIOUS ENGINEERS

Have you had your copy of "Engineering Opportunities"?

The new edition of "ENGINEERING OPPORTUNITIES" is now available—without charge—to all who are anxious for a worthwhile post in Engineering. Frank, informative and completely up to date, the new "ENGINEERING OPPORTUNITIES" should be in the hands of every person engaged in any branch of the Engineering industry, irrespective of age, experience or training.

On 'SATISFACTION OR REFUND OF FEE' terms

This remarkable book gives details of examinations and courses in every branch of Engineering, Building, etc., outlines the openings available and describes our Special Appointments Department.

WHICH OF THESE IS YOUR PET SUBJECT?

ELECTRONIC ENG.

Advanced Electronic Eng.—
Gen. Electronic Eng.—
Applied Electronics—
Practical Electronics—
Radar Tech.—
Frequency Modulation—
Transistors.

ELECTRICAL ENG.

Advanced Electrical Eng.—
General Electrical Eng.—
Installations—
Draughtsmanship—
Illuminating Eng.—
Refrigeration—
Elem. Elec. Science—
Elec. Supply—
Mining Elec. Eng.

CIVIL ENG.

Advanced Civil Eng.—
General Civil Eng.—
Municipal Eng.—
Structural Eng.—
Sanitary Eng.—
Road Eng.—
Hydraulics—
Mining—
Water Supply—
Petrol Tech.

RADIO & T.V. ENG.

Advanced Radio—
General Radio—
Radio & TV Servicing—
TV Engineering—
Telecommunications—
Sound Recording—
Automation—
Practical Radio—
Radio Amateurs' Examination.

MECHANICAL ENG.

Advanced Mechanical Eng.—
Gen. Mech. Eng.—
Maintenance Eng.—
Diesel Eng.—
Press Tool Design—
Sheet Metal Work—
Welding—
Eng. Pattern Making—
Inspection—
Draughtsmanship—
Metallurgy—
Production Eng.

AUTOMOBILE ENG.

Advanced Automobile Eng.—
General Auto. Eng.—
Auto. Maintenance—
Repair—
Auto. Diesel Maintenance—
Auto. Electrical Equipment—
Garage Management.

WE HAVE A WIDE RANGE OF COURSES IN OTHER SUBJECTS INCLUDING CHEMICAL ENG., AERO ENG., MANAGEMENT, INSTRUMENT TECHNOLOGY, WORKS STUDY, MATHEMATICS, ETC.

Which qualification would increase your earning power?
A.M.I.E.R.E., B.Sc.(Eng.), A.M.S.E., A.M.I.P.E., A.M.I.M.I., A.R.I.B.A., A.I.O.B., A.M.I.Ex., A.R.I.C.S., M.R.S.H., A.M.I.E.D., A.M.I.Mun.E., C.ENG., CITY & GUILDS, GEN. CERT. OF EDUCATION, ETC.

BRITISH INSTITUTE OF ENGINEERING TECHNOLOGY
316A ALDERMASTON COURT, ALDERMASTON, BERKSHIRE

THIS BOOK TELLS YOU

- ★ HOW to get a better paid, more interesting job.
- ★ HOW to qualify for rapid promotion.
- ★ HOW to put some letters after your name and become a key man . . . quickly and easily.
- ★ HOW to benefit from our free Advisory and Appointments Depts.
- ★ HOW you can take advantage of the chances you are now missing.
- ★ HOW, irrespective of your age, education or experience, YOU can succeed in any branch of Engineering.

132 PAGES OF EXPERT CAREER - GUIDANCE

PRACTICAL EQUIPMENT

Basic Practical and Theoretical Courses for beginners in Electronics, Radio, T.V., Etc., A.M.I.E.R.E. City & Guilds Radio Amateurs' Exam. P.T.E.B. Certificate P.M.G. Certificate Practical Electronics Electronics Engineering Practical Radio Radio & Television Servicing Automation

INCLUDING TOOLS

The specialist Electronics Division of B.I.E.T. NOW offers you a real laboratory training at home with practical equipment. Ask for details.

B.I.E.T.

You are bound to benefit from reading "ENGINEERING OPPORTUNITIES"—send for your copy now—FREE and without obligation.



POST COUPON NOW!

TO B.I.E.T., 316A ALDERMASTON COURT, ALDERMASTON, BERKSHIRE.

Please send me a FREE copy of "ENGINEERING OPPORTUNITIES." I am interested in (state subject, exam., or career).

NAME

ADDRESS

WRITE IF YOU PREFER NOT TO CUT THIS PAGE

THE B.I.E.T. IS THE LEADING INSTITUTE OF ITS KIND IN THE WORLD

Published about the 15th of the month by GEORGE NEWNES LIMITED, Tower House, Southampton Street, London, W.C.2, at the maximum price shown on the cover. Printed in England by THE CHAPEL RIVER PRESS, Andover, Hants. Sole Agents—Australasia: ZEALAND; GORDON & GOTCH (A/Sia) Ltd.; South Africa and Rhodesia: CENTRAL NEWS AGENCY LTD.; East Africa: OFFICE SUPPLIES LTD. Subscription rate including postage for one year: To any part of the World £2 2s. 0d.