

PRACTICAL

ELECTRONICS

JUNE 1968

PRICE 2/6



MULTI CHANNEL RADIO CONTROL SYSTEM FOR Model Boat

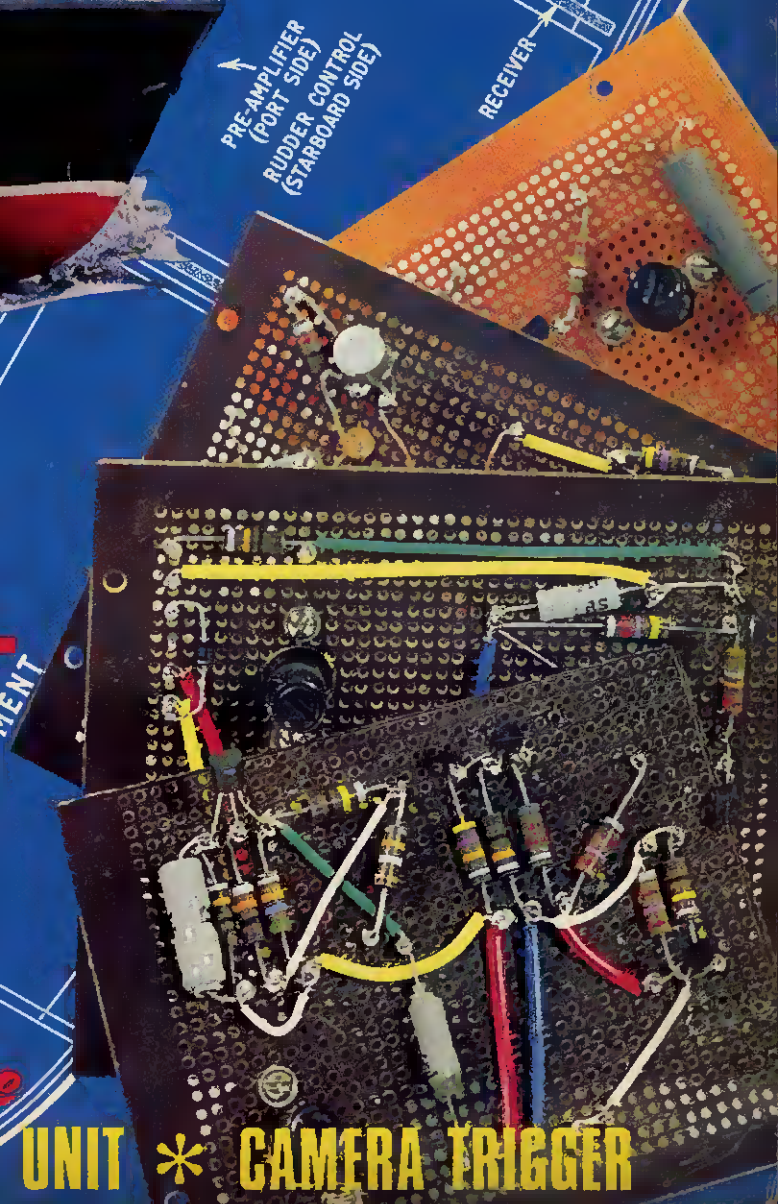

Also in this issue

DRUMMER'S WHOOSH UNIT * CAMERA TRIGGER

ADCOLA

PRODUCTS LIMITED
(Regd Trade Mark)

SOLDERING EQUIPMENT

for the

DISCRIMINATING ENTHUSIAST

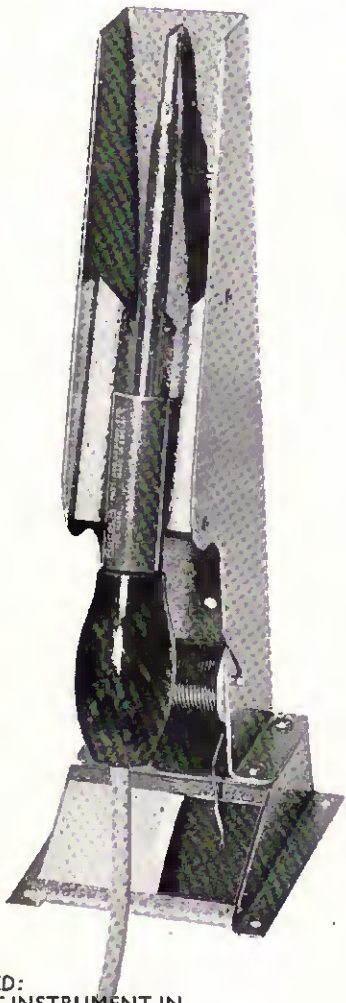

ILLUSTRATED:
L64 $\frac{3}{16}$ " BIT INSTRUMENT IN
L700 PROTECTIVE SHIELD

APPLY DIRECT TO:
SALES & SERVICE DEPT.
ADCOLA PRODUCTS LTD.
ADCOLA HOUSE
GAUDEN ROAD
LONDON, S.W.4
TELEPHONE 01-622 0291

**TWO-YEAR GUARANTEE
EX-RENTAL TELEVISIONS**

FREE ILLUSTRATED
LIST OF TELEVISIONS
17"-19"-21"-23"



WIDE RANGE OF MODELS
SIZES AND PRICES
DEMONSTRATIONS DAILY

£19

STEREOGRAM CABINET

An elegant Stereogram Cabinet
in modern Veneered Mahogany
and cloth covered Front Panel

BLACK LEATHERETTE SIDE PANELS

Dimensions: 52" x 17 $\frac{1}{2}$ " x 12"

Speaker positions for Twin
10" x 5" Speakers



OTHER MODELS—SEND FOR LIST

17in.—£11.10.0

3 Star Guarantee

★ Tube ★ Valves

★ Components Carr. 30/-

**TRANSISTOR CHASSIS
59/6**

6 Transistors, LW/MW, Tele-
scopic Aerial, Brand New,
Famous British Manufacturer,
(LESS SPEAKERS) P. & P. 4/6.

**SINGLE PLAYER
CABINETS 19/6.** P. & P. 7/6.

TRANSISTOR CASES 19/6.
Cloth covered, many colours.
Size 9 $\frac{1}{2}$ " x 6 $\frac{1}{2}$ " x 3 $\frac{1}{2}$ ", P. & P. 3/6.
Similar cases in plastic 7/6.

**RADIOGRAM CABINETS
ONLY £5.19.6**



An attractive discreetly
designed space saving
cabinet in natural grained
polyestered sapele. Press-
drop flap for autochanger
and record storage com-
partment. 10" x 5" speaker
position. Complete with
legs. Dim. 29 $\frac{1}{2}$ " H x 14 $\frac{1}{2}$ " D
x 29" W. Carr. Ins. 25/-.

DUKE & CO. (LONDON) LTD.
821/3 Romford Road, Manor Park, E.12
Phone 01-478 6001-2-3 Stamp for Free List.

BRAND NEW PARMEKO HT TRANSFORMERS

Pri tapped 200-250V. Sec. 500-0-500V, 250mA, 6.3V 4A, 6.3V 3.5A, 6.3V 4A, 5V 3.5A. Metal cased table top connections. Fraction of maker's price £4.15.0; carr. 10/-.

BRAND NEW TWICKENHAM HEAVY DUTY L.T. TRANSFORMERS

Pri tapped 110, 220, 235, 250V. Sec. No. 1, 55V 24A. Sec. No. 2, 14V 10A. Sec. No. 3, 60V 2A 11-0-0V 2A. Tropicaly finished—terminal connections. Fraction of maker's price £9.19.6; carr. 15/-.

HEAVY DUTY L.T. TRANSFORMERS

Pri 220-240V. Sec. 12V, 90A, Flying lead connections. £13.19.6; carr. 10/6. Pri tapped 190, 210, 230, 250V. Sec. 55V, 50A £18.10.0; carr. 15/-.

L. T. SUPPLY UNITS TYPE S.E.S.

A.C. input 220-240V d.c. Output 12 or 24V 10A continuous rating. Selenium full wave bridge rectification. 3 inch scale ammeter, neon indicator, housed in strong metal case. Size 17 x 7 x 6 $\frac{1}{2}$ in. £14/10/-; carr. 15/-.

VARIABLE D.C. SUPPLY UNITS TYPE SE.4.

0-48V, 10A continuous from 240V a.c. Silicon full wave bridge rectification, isolated transformer with Variac controlled primary 3 inch scale voltmeter and ammeter. Neon indicator. Housed in strong metal case. Size 17 x 7 x 6 $\frac{1}{2}$ in. £29/10/-; carr. 15/-.

ADVANCE COMPONENTS LTD.

Stabilised low voltage power supply units. Type DC3. Input 200-215-230-245V. Output 12V, 1.25A at 55°C, stabilised within $\pm 1\%$ at full load with supply voltage variation up to $\pm 5\%$. Ripple less than 1.5% R.M.S. of total output. Supplied brand new. £5.10.0; carr. 10/-.

WONDERFUL OFFER!

SCOTCH MAGNETIC TAPE. Type 3M 459. $\frac{1}{2}$ in 3,600 feet. Suitable for video. Brand new in maker's sealed cartons. List Price £18/10/-. Our Price £3/19/6. P.P. 5/-.

SPECIAL OFFER OF BLOCK CAPACITORS

BRAND NEW IN MAKER CARTON

G.E.C. 8mF 600V d.c. wkg. at 71°C. Six for 29/6. Carr. 7/6. S.T.C. 5mF 400V a.c. wkg., three for 17/6. Carr. 7/6. 5-25mF 600V a.c. wkg., three for 22/6. Carr. 7/6. Aerovox 1mF 600V d.c. wkg., six for 12/6. P.P. 4/6. T.M.C. 2mF 100V d.c. wkg., six for 7/6. P.P. 4/6.

SAMSON'S (ELECTRONICS) LTD.

9-10 Chapel Street,
London, N.W.1

Tel: PADDington 7851
AMBassador 5125

Lasky's Radio

DON'T MISS THIS!

HAVE YOU GOT YOUR LASKY'S CATALOGUE FREE Second Great Reprint Issue Now Ready. Just send your name, address and 1/- for post only.

SPECIAL INTEREST ITEMS!

DESIGNED ESPECIALLY TO REPLAY PHILIPS CASSETTE SYSTEM

THE FANTAVOX TAPE CASSETTE PLAYER

This machine is the first of its type and is designed specifically to replay pre-recorded tape cassettes made for the PHILIPS and other cassette systems. The cassette is simply slipped into the machine and is immediately ready to play. Each cassette gives over 40 minutes play (two tracks), no loss of time in rewinding—simply turn cassette over. Constant tape speed 1 1/2 i.p.s. Only two controls off/play and vol. Fully transistorised, powerful vol., built in speaker, socket for personal earpiece. Operates on 6 penlight batteries. Very attractively styled shockproof plastic cabinet size 6 1/2 x 4 1/2 x 2 1/2 in with wrist strap. Complete with earpiece and batteries. There are now over 200 music-cassette titles available: jazz, pop, shows and classics. This machine allows you to play the music of your choice anywhere—anytime.



LASKY'S PRICE £7.9.6 Post 5/-

CROWN MODEL TRF-6 AM/FM 9 TRANSISTOR RADIO

Unbelievably small for an AM/FM receiver—the Crown is only 4 1/2 in x 2 1/2 in x 1 1/2 in. Super sensitive 9 transistor superhet circuit with directionless stabilised reception. AM cover: MW 335-1,600kc/s, FM cover: 88-108Mc/s. Superb tone reproduction. 2 1/2 in FM speaker. Precision tuner. 6 section (14 in) telescopic aerial—clips into side when not in use. Output 280mW max. Beautifully styled and finished cabinet in black plastic with silver metal trim. Operates on one 3V battery. Complete with leather purse, ear-piece and battery. List Price 12/ 6 Gns.



SCOOP Price £7.19.6 Post 2/6

MODEL C-1000 MILI TESTER

A really tiny meter with "big" meter performance. Brief Specification: Movement sensitivity 400µA. D.C. volts ranges: 0-10, 60, 250, 1,000 volts, + 3% fcd at 1K Ω P.V. A.C. volts ranges: 0-10, 60, 250, 1,000 volts + 4% fcd at 1K Ω P.V. D.C. current: 0-1,100mA. Resistance range: 0-100K Ω. Size 2 1/2 in x 3 1/2 in x 1 in.



Lasky's Price 39/6 Post 2/6

AUDIO GENERATOR Model TE-22

A new factory tested and calibrated low distortion sine wave and Square wave Audio Generator suitable for use with most oscilloscopes. Brief Specification: frequency range—sine wave 20c/s to 200kc/s in four switched ranges 20-200c/s, 200c/s to 2kc/s, 2-200kc/s, 20-200kc/s. (Two scales 10-90 and 20-200 on etched circular dial with hair-line cursor.) Square wave range 60c/s to 30kc/s (read on same scales as sine waves). Frequency response 100/120V or 20/240V, 50/60c/s a.c. Distortion less than 2%. Output voltage: load impedance 1M Ω, 7V (max.), load impedance 10k Ω, 5V (max.). Variable output amplitude control. Valve line-up: 6BM8, 12AT7, 6X4. Power requirements 100/120V or 20/240V, 50/60c/s a.c. Strong metal cabinet size 7 x 10 1/2 x 6 1/2 in, finished in grey crackle with leather carrying handle. Power "on" pilot light fitted. Complete with test leads and instruction book.

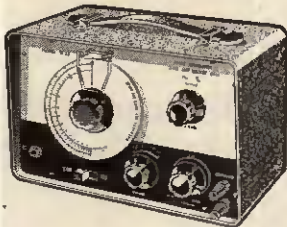

Lasky's Price £15.0.0 Post 5/-

Branches

207 EDGWARE ROAD, LONDON, W.2 Tel.: 01-723 3271
Open all day Saturday, early closing 1 p.m. Thursday

33 TOTTENHAM CT. RD., LONDON, W.1 Tel.: 01-636 2605

Open all day 9 a.m.—6 p.m. Monday to Saturday

152/3 FLEET STREET, LONDON, E.C.4 Tel.: FLEet St. 2833

Open all day Thursday, early closing 1 p.m. Saturday

ALL MAIL ORDERS AND CORRESPONDENCE TO: 3-15 CAVELL ST., TOWER HAMLETS, LONDON, E.1 Tel.: 01-790 4821

MOTORING PLEASURE

"EASI-TUNE" AM/FM MAJOR V.H.F. CAR RADIO

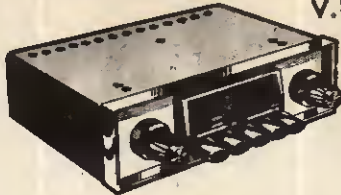

A completely new British made AM/FM car radio that brings the HIFI quality of FM transmissions to your car (ALL the new local stations) PLUS medium waveband cover 160-570m and long waveband cover 1,150-2,000m (FM cover: 8-108Mc/s with automatic. A.F.C.). Features five EASITUNE push buttons for wave

change and instant selection of three of your favourite medium wave stations, plus full manual tuning. Nine transistor and four diode circuit gives immediate reception, powerful 3W output and superior performance at high speed. Other features include illuminated dial, red "on" indicator, tone control. Strong metal case size 7 1/2 x 2 x 5 1/2 in (fits all standard cut-outs). Very handsome appearance, silver/black/chrome finish. For 12V positive or negative earth operation. Complete with 7 1/2 in. speaker, baffle board, universal mounting kit and instruction manual.

LASKY'S PRICE 23 Gns. Post FREE

NEW ANOTHER "EASI-TUNE" CAR ENTERTAINER

THE STEREO-TONE STEREO TAPE CASSETTE CAR PLAYER

Another British first—right on time, right up-to-date the latest in travelling pleasure. Plays ALL the new great range of PHILIPS Musicassettes with over 250 titles now available—giving YOU the choice of music for your journey (each cassette gives up to 48 min continuous play). The Stereo-Tone is compact, easy to fit and styled to enhance any car. Incorporates the well proven Philips tape play mechanism and a specially developed 12 transistor amplifier giving 2 1/2 W output per channel with sharp stereo separation. Controls include on/off with indicator, single control for start/stop, fast forward and rewind, sep. volume, bass, treble and stereo balance controls. Tape loading and change are super easy—the Stereo-Tone slides out from its vibration free mounting for inserting or turning cassette over then pushes back for obstruction free operation. The Stereo-Tone cabinet is made from high quality scratch proof CYCLOCAC plastic in dark grey with silver control panel with black knobs. Size only 9 1/2 x 5 1/2 x 3 1/2 in. Tape speed 3 1/2 i.p.s. with transistor motor regulator. Operates on all 12V positive or negative earth systems. Complete with two loudspeakers, baffle boards, leads, etc., simple (four screw fixing) mounting assembly AND one Free Musicasset of your choice.

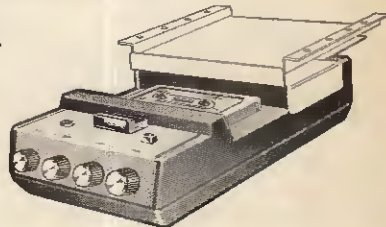

LASKY'S PRICE £29.0.0 Post FREE

TWO BAND TRANSISTOR CAR RADIO BARGAIN! MODEL CR-62

A new high quality imported all transistor superhet car radio that really breaks the quality/price barrier. A unique feature of this set are the four M/W band station selection buttons which you yourself set to your own four favourite stations—this is in addition to full M/W band cover over 535-1,000kc/s and full L/W band cover over 160-300kc/s (IF frequency 480kc/s). Externally adjustable aerial trimmers ensure maximum output. Six transistor (including one drift type) and one diode circuit provides powerful 2W output. The set is adjustable for use on either positive or negative ground 12V systems (external line fuse fitted). Standard mounting size 6 1/2 x 6 1/2 x 2 1/2 in—front panel 1/2 in larger all round—finished in anodised aluminium with black push buttons. Complete with mounting brackets, full installation instructions and two baffle boards (for round or elliptical speaker). Fully guaranteed.

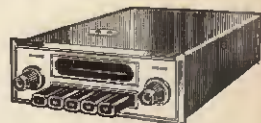

LASKY'S PRICE £9.19.6 Post 5/-

6 x 4 in elliptical 8 Ω dynamic speaker 17/6 extra—Post FREE.

SPECIAL OFFER—LOCKING CAR AERIAL Model S8003 five section 402 extension heavy chrome telescopic wing mounting type with unique locking device to protect the antenna when closed. Complete with mounting bracket, lead and plug and two "keys". **LASKY'S SPECIAL PRICE 39/6** Post Free with the Royal CR-02. Post 2/6.

High Fidelity Audio Centres

42 TOTTENHAM CT. RD., LONDON, W.1 Tel.: 01-580 2573

Open all day Thursday, early closing 1 p.m. Saturday

118 EDGWARE ROAD, LONDON, W.2 Tel.: 01-723 9789

Open all day Saturday, early closing 1 p.m. Thursday

PP3 Eliminator. Play your pocket radio from the mains! Save £a. Complete component kit comprises 4 rectifiers—mains dropper resistances, smoothing condenser and instructions. Only 6/6 plus 1/- post.

MINIATURE WAFER SWITCHES

4 pole, 3 way—2 pole, 3 way—4 pole, 3 way—2 pole, 4 way—3 pole, 4 way—2 pole, 6 way—1 pole, 12 way. All at 8/6 each, 36/- dozen, your assortment.

WATERPROOF HEATING ELEMENT

26 gauge length 50W. Self-regulating temperature control. 10/- post free.

A.E.I. FRACTIONAL H.P. MOTOR. 200/250V 50/60 c/s enclosed continuous rating 1/40 h.p. Ex. equip., perfect order. 19/6 plus 4/8.

A.C. FAN. Powerful mains motor with 6 1/2 in. blade. Ideal blow or extract. 17/6 plus 3/8.

1.2V NICKEL CADMIUM CELLS. Dia. 3/4 in. by 1/2 in. thick (approx.). 3/6 each. Charger for two cells 12/6.

OIL THERMOSTAT. Teddington type T.B.B. with capillary tube and sensor adjustable by knob (not supplied) controls 1 h.p. motor or up to 15 amp. resistive load. 9/6.

5 PUSH SWITCH. One push operates mains on/off switch the other four operate various on/off and change/over switches. 2/6.

QUICK CUPPA

Mini Immersion Heater, 300W, 200/240V. Boils full cup in about two minutes. Use any socket or lamp holder. Have at bedside for tea, baby's food, etc. 19/6, post and insurance 1/8.

NO SOLDERING POCKET 3

Lots of fun to build and good results when finished. Complete kit with detailed instructions and crystal earpiece. Batteries 1/2 extra—25 value only 19/6, plus 3/- post and ins.

DRILL CONTROLLER

Electronically changes speed from approximately 10 revs. to maximum. Full power at all speeds by finger-tip control. Kit includes

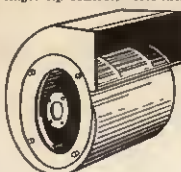

all parts, case, everything and full instructions 19/6 plus 2/6 post and insurance. Or available made up 32/6. Plus 2/6 post and ins.

CENTRIFUGAL FAN

Centrifugal blower or extractor by Torrington. very low noise but large capacity air flow, designed for central heating and air conditioning, ideal also for fume extraction over cooker, duct type outlet, 200/600V 50 c/s motor. £3.19.8. Post and insurance 7/8.



THIS MONTH'S SNIP

Full-Fi 12in. loudspeaker. This is undoubtedly one of the finest loudspeakers that we have ever offered, produced by one of this country's most famous makers. It has a die-cast metal frame and is strongly recommended for Hi-Fi loud and Rhythm Guitar and public address. Flux Density 11,000 gauss—Total Flux 44,000 Maxwell; Power Handling 15 watts r.m.s.; Cone Moulded fibre; Freq. response 30-10,000 c/s; Input Impedance 15 ohms; Main resonance 60 c/s; Chassis Diam. 12in.—12 1/2in. over mounting lugs; Baffle hole 11in. diam.; Mounting holes 4—Holes 1/2 in. diam. on pitch circle 1 1/2 in. diam.; Overall height 4 1/2 in. A 25 speaker offered for only £3.9.6 plus 7/6 post and insurance.



INFRA-RED BINOCULARS



These infra-red binoculars when fed from a high voltage source will enable objects to be seen in the dark, provided the objects are in the rays of an infra-red beam. Each eye tube contains a complete optical lens system as well as the infra-red cell. These optical systems can be used as lenses for TV cameras—light cells, etc. (details supplied). The binoculars form part of the Army night driving (Tabby) equipment. They are unused and believed to be in good working order but sold without a guarantee. Price £3.17.6, plus 10/- carr. and ins. Handbook 2/6.

MAINS MOTOR

Precision made—as used in record decks and tape recorders—ideal also for extractor fans, blower, heater, etc. New and perfect. Snip at 9/6. Postage 2/- for first one then 1/- for each one ordered. 12 and over post free.



MAINS TRANSISTOR POWER PACK

Designed to operate transistor sets and amplifiers. Adjustable output 6V, 9V, 12V up to 500mA (class B working). Takes the place of any of the following batteries: PP1, PP3, PP4, PP6, PP7, PP9 and others. Kit comprises: mains transformer, rectifier, smoothing and load resistor, condensers and instructions. Real snip at only 16/6 plus 3/8 postage.

Where postage is not definitely stated as an extra then orders over £3 are post free. Below £3 add 2/8. Semiconductors add 1/- post. Over £1 post free. S.A.E. with enquiries please.

GARRARD AUTO RECORD PLAYER Model 3000



This is one of the latest products of the World's most experienced maker of fine record reproducers. Its superior features include—automatic playing of up to 8 mixed size records—stopping and starting without rejecting—manual playing—pick-up pivots to give low stylus pressure—large diameter turntable for max. stability. Adjustments include pick-up height—pick-up/dropping position and stylus pressure. Size is 19 1/2 x 11 in. clearance 4 1/2 in. above, 2 1/2 in. below. Fitted with the very superior ceramic stereo cartridge type 9TAHC with diamond stylus which is listed at over £4. Price complete £10.9.6, carr. and insurance 7/8.

ELECTRONICS (CROYDON) LIMITED

(Dept. P.E.) 102/3 TAMWORTH RD., CROYDON, SURREY (Opp. W. Croydon Stn.) also at 266 LONDON ROAD, CROYDON, SURREY S.A.E. with enquiries please

MARTIN IS HIGH FIDELITY

plus

ADD-ON-ABILITY
THRILLING POWER
DEPENDABILITY
GENUINE ECONOMY

How would you like to start with a simple amplifier, say, and add to it until it became a fully stereo twenty watt amplifier with FM tuner and facilities to take the most sensitive low output pickups ever made? With Martin Audiokits it's easy, for with these superbly engineered all-transistor prefabricated units, success is built in from the start and you build to your own preferred plan. IT'S A MONEY SAVING SCHEME, TOO.

Details from:—

MARTIN ELECTRONICS LTD., 155 High Street, Brentford, Middlesex. ISLeworth 1161

To MARTIN ELECTRONICS, 155 High Street Brentford, Middlesex

I have not had your leaflets before. Please send them on AMPLIFIERS FM TUNER RECORDAKITS (Tick as required)

NAME.....

ADDRESS.....

PE 6

PARKERS SHEET METAL FOLDING MACHINES HEAVY VICE MODELS

With Bevelled Former Bars

No. 1. Capacity 18 gauge mild steel x 36in. wide £12.10.0
No. 2. Capacity 18 gauge mild steel x 24in. wide £7.5.0
No. 3. Capacity 16 gauge mild steel x 18in. wide £7.5.0
Also new bench models, Capacities 48in. x 18 gauge £40. 36in. x 18 gauge £25. 24in. x 16 gauge £24. Carriage free.

End folding attachments for radio chassis. Tray and Box making for 36in. model, 5/6 per ft. Other models 3/6. The two smaller models will form flanges. As supplied to Government Departments, Universities, Hospitals. One year's guarantee. Money refunded if not satisfied. Send for details.

A. B. PARKER, Folding Machine Works, Upper George St., Heckmondwike, Yorks. Heckmondwike 3997

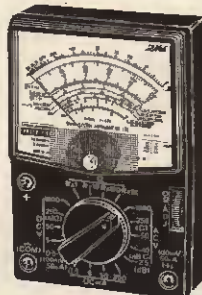

SANWA MULTI TESTERS

USED THROUGHOUT THE WORLD, SANWA'S EXPERIENCE OF 30 YEARS ENSURES ACCURACY, RELIABILITY, VERSATILITY. UNSURPASSED TESTER PERFORMANCE COMES WITH EVERY SANWA

6 Months' Guarantee * Excellent Repair Service
Model P-1B £3 7 6
Model JF-5D £5 10 0
Model U-50D £7 5 0
Model 360-YTR £17 6 0
Model 380-CD £13 5 0

Please write for illustrated leaflets of these Sanwa Meters

SOLE IMPORTERS IN U.K. QUALITY ELECTRONICS LTD.

47-49 HIGH STREET, KINGSTON-UPON-THAMES, SURREY Tel: 01-546 4585

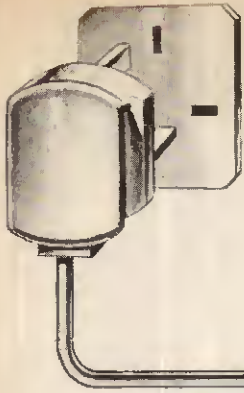

**plug in
the smallest
soldering iron
available**

When you buy a British made Antex miniature soldering iron you are buying a specialised precision instrument that has proved its success in the majority of leading companies in the electronics industries throughout the World. These are professional irons for the man who wants the ultimate in precision soldering. The versatility and accuracy of an Antex iron will give you fingertip control over any soldering problem. Send for your Antex iron now. Or you may have our colour catalogue. Simply complete the coupon.

CN 15 watts. Ideal for miniature and micro miniature soldering. 18 interchangeable spare bits available from .040" (1mm) up to 3/16". For 240, 220, 110, 50 or 24 volts.

From Electrical and Radio Shops or send cash to Antex.

32/6

Complete precision soldering kit

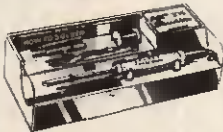

This kit—in a rigid plastic "tool-box" — contains everything you need for precision soldering.

- Model CN 15 watts miniature iron, fitted 3/8" bit.
- Interchangeable spare bit, 5/32".
- Interchangeable spare bit, 3/32".
- Reel of resin-cored solder
- Felt cleaning pad
- Stand for soldering iron
- Space for stowage of lead and plug

PLUS 36-page booklet on "How-to-Solder"—a mine of information for amateur and professional.

From Electrical and Radio Shops or send cash to Antex. **49/6**

G 18 watts. Ideal for miniature work on production lines. Interchangeable spare bits, 3/32", 1/8", 3/16", and 1/4". For 240, 220 or 110 volts. 32/6.

E 20 watts. Fitted with 1/4" bit. Interchangeable spare bits 3/32", 1/8", 3/16". For 240, 220, 110 or 24 volts. 35/-.

ES 25 watts. Fitted with 1/8" bit. Interchangeable bits 3/32", 3/16" and 1/4". Ideal for high speed production lines. For 240, 220, 110, 24 or 12 volts. 35/-.

F 40 watts. Fitted 5/16" bit. Interchangeable bits 1/4", 3/16", 1/8", 3/32". Very high temperature iron. Available for 240, 220, 110, 24 or 20 volts. 42/8.

Spare bits and elements for all models and voltages immediately available from stock.

Actual size



PRECISION MINIATURE SOLDERING IRONS

Antex, Grosvenor House, Croydon, CR9 1QE
Telephone 01-686 2774

To: Antex, Grosvenor House, Croydon, CR9 1QE

Please send me the Antex colour catalogue

Please send me the following irons

Quantity	Model	Bit Size	Volts	Price
.....
.....
.....
.....

I enclose cheque/P.O./cash value.....

NAME.....

ADDRESS.....

Telephone.....

P.F. 4

VARIABLE VOLTAGE TRANSFORMERS



INPUT 230/240v. A.C. 50/60—
OUTPUT VARIABLE 0-260v.
BRAND NEW
Keenest prices in the country.
All Types (and Spares) from
1 to 50 amp. from stock.

SHROUDED TYPE
1 amp, £5. 10. 0. 2.5 amps,
£6. 15. 0. 4 amps, £9. 0. 0.
5 amps, £9. 15. 0. 8 amps,
£14. 10. 0. 10 amps, £18. 10. 0.
15 amps, £21. 0. 0. 20 amps,
£25. 0. 0. 25 amps, £37. 0. 0.
37.5 amps, £72. 0. 0. 50 amps,
£92. 0. 0.

OPEN TYPE (Panel Mounting)
1/2 amp, £3. 10. 0. 1 amp, £5. 10. 0.
2 1/2 amps, £6. 12. 6.

PORTABLE TYPE
1.5 amp, portable fitted metal case,
voltage meter, lamp, switch, etc. £9.5.0.
Similar to above 2.5 amp. £11.7.6.

450
AMPS

1 AMP

£3.10.0.

PORTABLE TYPE
£9. 5. 0.

100 WATT POWER RHEOSTATS (NEW)

AVAILABLE IN THE FOLLOWING VALUES

1 ohm, 10 a.; 5 ohm, 4.7 a.; 10 ohm, 3 a.;
25 ohm, 2 a.; 50 ohm, 1.4 a.; 100 ohm, 1 a.;
250 ohm, 7 a.; 500 ohm, 4.5 a.; 1,000 ohm,
280 mA.; 1,500 ohm, 230 mA.; 2,500 ohm, 2 a. Diameter
3 1/2 in. Shaft length 3/4 in., dia. 3/8 in. All at 27/6 each.
P. & P. 1/6.

50 WATT. 1/5/10/25/50/100/250/500/1,000/1,500/2,500
ohm, 21/- P. & P. 1/6.

25 WATT. 10/25/50/100/250/500/1,000/1,500/2,500
ohm, 14/6 P. & P. 1/6.

VENNER ELECTRIC TIME SWITCH

200-250 v. A.C. 20 amp. contacts twice on,
twice off, at any manually pre-set time.
Spring reserve (in case of power cut) fully
tested £3/9/6. P. & P. 4/6. Or complete
in weatherproof metal case (illustrated)
£3/19/6, plus 4/6 P. & P. Can be supplied
with solar dial, on at dusk—off at dawn.
Prices as above.



INSULATED TERMINALS

Available in red, white, yellow, black, blue
and green. New 17/- per doz. 2/- P. & P.

230/250V. A.C. SOLENOID
Heavy duty type, approx. 3 lbs. pull. Price:
17/6 plus 2/6 P. & P.

12/24V. D.C. SOLENOID
Approx. 8 oz. push. Price 8/6 plus 1/6 P. & P.

PRECISION INTERVAL TIMER
From 0-30 seconds (repetitive). Jewelled
balanced movement. Lever re-set.
Operates 230V. A.C. 5 amp. c/o Micro-
switch. New. Price 17/6 plus 2/6 P. & P.

CONDENSERS 2,500 mfd 100v. 12/6 1/6 P. & P.
4,000 mfd 25v. 10/- 1/6 P. & P. 4,000 mfd 50v. 15/-
1/6 P. & P. 10,000 mfd 35v. 15/- 1/6 P. & P.

CONSTANT VOLTAGE TRANSFORMER
Input 185-250 v. A.C. Output 230 v. A.C.
Capacity 250 watt. Attractive metal case.
Fitted red signal lamp. Rubber feet.
Weight 17 lb. Price £11/10/0. P. & P. 15/-

SELENIUM BRIDGE RECTIFIERS
30 volt 3 amp., 11/-, plus 2/6 P. & P.
30 volt 5 amp., 16/-, plus 2/6 P. & P.

RADIO ALTIMETER

This precision instrument, built
to highest Ministry specification, is based on a 24 v. D.C.
LOW INERTIA Integrating Motor. The Motor, fitted
with gold brushes and drawing only 800 microamp at
24 v. D.C., drives two precision pots with platinum
wipers through close tolerance gear-trains, including
miniature slipping clutch, combined with two sub-
miniature pots for calibrating the electrical bridge
circuit. The 3 in. calibrated dial, with a number
aperture indicating one rev. per revolution of pointer
with maximum of 5 revs. gives an effective scale length
of approx. 30 in. Offered at fraction of Manufacturer's
price, 32/6. P. & P. 6/-.

LIGHT SENSITIVE SWITCH

Kit of parts, including ORP12 Cad-
mium Sulphide Photocell, Relay,
Transistor and Circuit, etc., 6-12
volt D.C. op. price 25/- plus 2/6
P. & P. ORP 12 including circuit,
10/6 each, plus 1/- P. & P.

A.C. MAINS MODEL Incorporates
Mains Transformer, Rectifier and special
relay with 3, 5 amp mains c/o contacts.
Price inc. circuit 47/6 plus 2/6 P. & P.

LIGHT SOURCE AND PHOTO CELL MOUNTING

Precision engineered
light source with focusable-
lens assembly and ventilated
lamp housing, to take MBC bulb. Separate
photo cell mounting assembly for ORP 12
or similar cell. Both units are single hole
fixing. Price per pair £2.15.0. P. & P. 3/6.

**RESETTABLE HIGH SPEED
COUNTER.** 4 figure, 1,000 ohm coil,
36-48 v. D.C. operation. £3/10/- P. &
P. 1/6. 3 figure, 24 v. D.C. £1/12/6.
P. & P. 1/6.

DRY READ SWITCHES. New
special offer of Dry Read Switches half
amp. Contact. Size 1 1/2 x 1/2. 4 for 10/-
Post Paid.

MINIATURE UNISELECTOR SWITCH
3 banks of 11 positions plus
homing bank. 40 ohm coil.
24-36 v. D.C. operation.
Tested, 22/6, plus 2/6 P. & P.

COMPACT HEAVY DUTY 6v. D.C. RELAY
2 change over, 30 ohm coil, 7/6 each.
P. & P. 1/6. 3 for 20/- Post paid.

NICKEL CADMIUM BATTERY
Sintered Cadmium Type 1-2 v. 7AH.
Size: height 3 1/2 in., width 2 1/2 x 1 1/2 in.
Weight: approx. 13 oz. Ex-R.A.F.
Tested, 12/6. P. & P. 2/6.

SANWA MULTI RANGE METERS

New Model U50D Multi tester,
20,000 OPV, mirror scaled with overload
protection. Ranges—d.c. volts: 100mV,
0-5 v., 5 v., 250 v., 1,000 v.; a.c. volts:
2-5 v., 10 v., 50 v., 250 v., 1,000 v.; D.C.
current: 5 mA, 0-5 MA, 5 MA, 50MA,
250 MA. Complete with battery and test
probe. £7/5/0 post paid. Three other
models available from stock. Descriptive
leaflet on request.

THYRISTOR 400 pIV, 5 amp., 14/6
THYRISTOR 400 pIV, 8 amp., 28/6

220/240 v A.C. COOLING UNIT
2,300 r.p.m. 6" blade size.
Smooth powerful motor.
All metal construction.
Continuously rated.
Individually tested.
Offered at fraction of
maker's price. £2.15.0.
P. & P. 7/6

SANGAMO WESTON
Dual range voltmeter. 0-5
and 0-100 v. D.C. FSD 1 m/a.
In carrying case with test
prods and leads, 32/6, P. &
P. 3/6.

A.C. CONTACTOR
2 make + 2 break (or, 2
c/o). 15 amp. contacts.
230/240V. A.C. operation.
Brand new. Price 22/6 plus
1/6 P. & P.

20 Amp LEVER MICRO SWITCH
Brand new lever operated
Micro Switch. 20 amp A.C.
c/o contacts. Price 4/6 each
plus 1/6 P. & P. 5 for £1
Post Paid.

ELECTRONIC BROKERS LIMITED

SYNCHRONOUS TIMING MOTORS BY HAYDON (illus.),
a high quality d.c. motor, 40oz
torque at 3 r.p.m. 3 r.p.m. 12V,
2 r.p.m. 6V, 1 r.p.m. 28V, 1/12
r.p.m. 12V, 1/12 r.p.m. 30V,
1/15 r.p.m. 24V, 1/60 r.p.m.
28V, 1/120 r.p.m. 28V. List £7.
£3.3.0.



OUR PRICE

HYSTERESIS CLUTCH MOTOR with integral
clutch allowing the motor to drop out of
engagement with the gear train, thereby faci-
ilitating easy resetting when used in timers or in
conjunction with a light spring. 6oz torque at
1 r.p.m. 240V, 50c/s. L = left, R = right.
15 r.p.m. L; 8 r.p.m. R and L; 6 r.p.m. L;
4 1/2 r.p.m. L; 3 r.p.m. L; 2 1/2 r.p.m. R and L; 2 1/4
r.p.m. L; Also 120V, 50c/s; 2, 1 1/2, 1 1/4, 1 1/2
1/2 r.p.m. L. Price 25/-.

HIGH TORQUE INDUCTION MOTOR MP 10.
Useful for cycle timers. Motorised valves,
advertising display unit. 30oz/in at 1 r.p.m.
2-5 watts. 240 volts, 50 cycles. 60 r.p.m.,
30 r.p.m., 20 r.p.m. Right, 6 r.p.m., 4 r.p.m.,
3 r.p.m., 2 r.p.m., 1 1/2 r.p.m., 1 r.p.m.; also
120V, 50 cycles, 20 r.p.m. List 35/- OUR
PRICE 15/-.

LOW TORQUE HYSTERESIS MOTOR MA23
(illus.) ideal for instrument
chart drives, extremely quiet,
useful in areas where ambient
noise levels are low. Having a
high starting torque a rela-
tively high inertia load can be
accelerated. 6oz/in at 1 r.p.m. 240
volts, 50 cycles, 10 r.p.m. R;
1 r.p.m. R and L; 2 r.p.m. R; 3 r.p.m. R;
4 r.p.m. R; 5 r.p.m. R; 6 r.p.m. R; 7 r.p.m. R;
8 r.p.m. R; 9 r.p.m. R; 10 r.p.m. R; also
1 1/2 r.p.m., 2-2 way friction, 25/-.



HYSTERESIS REVERSIBLE MOTOR. In-
corporating two coils. Each coil when energised
will produce opposite rotation of the output
shaft. 240 volt, 50 cycle. 15 r.p.m., 6 r.p.m.,
3 r.p.m., 2 r.p.m., 1 1/2 r.p.m., 1 r.p.m., 120 volts,
60 cycles, 8 r.p.m. 80/- reduced to 30/-.

DELAY TIMER BN42 consisting of D.P.D.T.
relay, a pilot duty switch, a clutch motor and an
actuator. 240 volt, 50c/s 10min., 13-5sec.,
120sec. £4.4.0.

CYCLE TIMER (illus.). Repeats
a set cycle or sequence of
switching operations as long as
the motor circuit is energised.
1min., 2min., 3min., 4min.,
5min. 35/-.



REPEAT CYCLE TIMERS V3CB. Incorporating
a timing motor which drives one or more cams
to actuate microswitches in a definite sequence
for set periods of time. 8 microswitches. One
minute or 2 minutes. £5.5.0.

PROGRAMME TIMERS. 240
volts—50 min., 30 min., £4.4.0.
DP11 RESET TIMERS (illus.).
240V, 50 cycles, 6sec., 45/-.



PEN RECORDERS
Elliott Bros. 3-7/8983. A single Pen Recorder.
5mA complete with Sweep and Recording Unit
Type 1168A. Voltage range 0-5V, 0-10V,
0-25V. £27.10.0.

Southern Instruments Two Pen Recorder.
Complete with Amplifier and 4-speed gearbox,
£89.

Kelvin & Hughes Two Pen Recorder, £89.
Two pens actuated mechanically by 6kΩ S.P.S.T. Relay Deviation
0-1 in. Chart width 1-3 in.
Driven by Synchronous Motor
Sangamo Weston 57 Motor 3 rev.
per hr. £27.10.0.



*It should be noted a wide range
of chart speeds can be achieved by the replace-
ment of the motor.

**Portable Single Pen Recorder by Record
Electrical** (illus.). 3 in
chart, sensitivity 500mA.
Coil res. 4-53kΩ. Fully
interchangeable gears avail-
able to make a wide range
of chart speeds. 200/250V.
Size 8 x 11 x 6 in. Brand
new, comp. with chart and
ink. List over £100. OUR
PRICE £49.10.0.



Elliott Portable Single Pen Recorder. 3 1/2 in
chart. Sensitivity 500mA. 1 and 6 in per hr.
£29.10.0.

ELECTRONIC BROKERS LTD.
8 BROADFIELDS AV., EDGWARE
MIDDLESEX
TEL: 01-958 9842

SERVICE TRADING CO

All Mail Orders—Also Callers—Ample Parking Space
57 BRIDGMAN ROAD, LONDON, W.4 Phone 995 1560
SHOWROOM NOW OPEN CLOSED SATURDAY
Personal callers only
9 LITTLE NEWPORT ST.
LONDON, W.C.2. Tel. GER 0576

S.B.—Superb Bargains Every Month

The greatest High Fidelity Bargains ever offered

STEREO AMPLIFIER, 13½ gns. only. Retail value 27 gns. A Fully Transistorized High Fidelity Stereo Amplifier complete in free standing case. Switched input facilities. Socket (1) tape or crystal P.V. (2) radio tuner. (3) ceramic P.U.-mike. Controls: Volume, Bass, Treble, Balance, Input Selector Switch, Stereo/Mono Switch. Facia plate rigid perspex with black/silver background and matching knobs.

Output 6 watts per channel (R.M.S.) 12 watts Mono. Free response to 3dB, 20-20,000c/s bass boost approx. 10-12dB. Treble out 2-16dB approx. Negative feedback—18dB over main amp.

12 months' unconditional guarantee. P./P. 6/-.

● **BARGAIN—High Fidelity Stereo Amplifier.** Our Price 7 gns. only. Retail value 16 gns. Complete in free standing case. Ideal for crystal or ceramic P.U., Tape, Radio, Tuner. Fully integrated. Rigid perspex facia plate black/silver matching knobs. **Output 4 watts per channel R.M.S. 12 months' unconditional guarantee.** P./P. 5/6.

● **BARGAIN—High Fidelity Mono Amplifier.** Our price 7 gns. only. Retail value 14 gns. Providing excellent results at all output levels and complete in free standing case. Frequency response: 30 20,000c/s - 2dB. Sensitivity: 5mV (max.). Harmonic distortion: 0.5% at 1,000c/s. Output: 3-8-15 ohms. Input: Mike, Gram, Radio, Tuner, Tape Recorder. Input selector: facia rigid perspex black/silver with matching knobs. **Output 6 watts R.M.S. (certified). 12 months' unconditional guarantee.** P./P. 5/6.

● **BARGAIN—CHANGER DECKS AT LOWEST PRICES EVER**

Garrard 1,000-1,025	£6.5.0	P./P. 7/6
2,000-2,025	£6.15.0	P./P. 7/6
3,000-3,500	£8.19.6	P./P. 7/6
AT/60 Mk II	£12.10.0	P./P. 8/6
SP25 Mk. II	£10.15.0	P./P. 8/6
LAB80 Mk. II	£23.10.0	P./P. 10/6
SRP22	£4.10.0	P./P. 5/6
B.S.R. UA/25	£6.5.0	P./P. 7/6

Plinths to suit all the above. Beautifully styled and first grade manufacture, £2.5.0. P./P. 5/-.

● **BARGAIN—A superb Mains Tuner.** Our price 6 gns. only. Retail value 12 gns. A.M. superhet transistor unit with own ferrite aerial. Simply add to any of our amplifiers for outstanding results. **12 months' unconditional guarantee.** P./P. 5/6.

● **BARGAIN—F.M. Mains Operated Tuner.** Our price 8 gns. only—16 gns. value. 6 transistor S/M horizontal dial, 2 I.F. stages, coupled double tuned discriminator terminating in I.F. Ample output for all amplifiers. **12 months' unconditional guarantee.** P./P. 5/6.

● **BARGAIN—L.W., A.M.—F.M., Mains Operated Tuner.** Our price 16 gns. only. Retail value 30 gns. Fully transistorized. Output 5mV—exceptional sensitivity and selectivity on all bands. L.W. 180-360RC/s, A.M. 600-1,400c/s, F.M. 88-108Mc/s. This unit is complete with aerials, three-band horizontal dial. **12 months' unconditional guarantee.** P./P. 6/6.

● **BARGAIN—Record Player Amplifiers, 47/6 only.** EL84 output. Two controls, flying panel, a.c. mains operated. 230-240V. Now inc. chassis, fully built and tested. **12 months' unconditional guarantee.** P./P. 2/6.

● **BARGAIN—Record Player Amplifier Unit, 52/6 only.** Complete with valves (UCL 82) output. Fully built and tested, mounted on board with 5in round speaker. Knobs supplied, all leads attached ready for instant connection to your turntable. **12 months' unconditional guarantee.** P./P. 3/6.

● **BARGAIN—Record Player Cabinets.** Our price 52/6 only. Retail value 4 gns. Strongly built wooden frame, two-tone gilt fittings, carrying handle, suitable for any amplifier, ample space for speaker. Matching Garrard or B.S.R. cut out board supplied free of charge. P./P. 5/-.

● **BARGAIN—Speakers—Standard, 5in round, 7 X 4in elliptical, 8in round, all 3 ohms.** Our price 15/-, P./P. 2/6.

● **BARGAIN—Speakers, Hi-fi—E.M.I. 8** 5in elliptical, 12,000 lines gauss, Alcomay magnet, rating 5 watts, 3 or 15 ohms. Sold elsewhere at 50/-, Our price 27/6.

● **BARGAIN—Speakers, Hi-fi—E.M.I. 13** 8in elliptical, 13,000 lines gauss, Alcomay magnet, rating 10 watts, 3 or 15 ohms. Sold elsewhere at £4.0.0, Our price 47/6.

Brand new, 12 months' unconditional guarantee, P./P. free.

● **BARGAIN—Speakers, Hi-Fi—The Baker Selhurst De-Luxe** Scialart, 12in round, 15 watt rating, 12,000 lines gauss, 3 or 15 ohms, response 45-13,000c/s. Bass resonance 40-50c/s, solid aluminium chassis. Our price £4.19.6.

Brand new, 12 months' unconditional guarantee. P./P. 6/6.

● **BARGAIN—Speakers, Hi-Fi—The Baker Selhurst Guitar** Group 25, 12in round, 25 watt rating, 12,000 lines gauss, 15 ohms, response 30-10,000c/s, solid aluminium chassis, heavy duty cone. Our price £4.19.6.

Brand new, 12 months' unconditional guarantee. P./P. 6/6.

Cartridges—All Bargain Prices

Sonotone—9TA/H.C. Sapphire (Stereo)	£2.0.0
Sonotone—9TA/H.C. Diamond (Stereo)	£2.5.0
Sonotone 2T/Ceramic H/C (Mono)	£1.2.0
Acos GP91/3 (Mono)	£1.0.0
E.R. S.M.B. Crystal (Mono)	£1.0.0
E.R. S.M.B. Ceramic (Mono)	£1.0.0
E.R. S.M.B.X. Ceramic (Stereo)	£1.5.0
T.C.B. H. (Mono)	£1.0.0
T.C.B. M. (Mono)	£1.0.0
C.I. Stereo	£2.2.0

All cartridges are supplied with fixing brackets and screws at no extra cost. P./P. on all above 2/6.

● **BARGAIN—"Phillips" Intercom System.** Our price 59/6 only. Retail value £6.6.0. This equipment is ideal for baby alarm, office, home and hundreds of other uses. Absolutely brand new in handsome presentation case containing all leads, etc. **12 months' unconditional guarantee.** P./P. 3/6.

● **BARGAIN—car radios.** Our price 9 gns., retail value 16 gns. Negative or positive earth (switched), famous brand name, fully transistorized (12V), medium and long waves, chromium escutcheon. Speaker and fitting kit supplied at no extra cost. **12 months' unconditional guarantee.** P./P. 7/6.

● **BARGAIN—car aerials.** Our price 22/6 only, retail value 37/6. Heavy chrome plate, retractable. A snip—buy while stocks last. Brand new in maker's package.

● **BARGAIN—Slimline T.V. receivers** in mint condition, 17, 19, 21in, checked complete and working but less I.F. strip. Our price £9.10.0 only. I.F. strips supplied at 45/- if required. Fitting charge for I.F. strip if requested £2.2.0. P./P. T.V. set 30/-, P./P. I.F. strip 5/-, If purchased together 30/-, Personal collection advised otherwise despatch at customer's risk.

● **BARGAIN—Car Radio Portable.** Our price 4½ gns. only, retail value 7½ gns. Single wave band (medium), fully transistorized, ideal for home or car. A beautiful radio, the performance has to be heard to be believed. **12 months' guarantee.** P./P. 4/6.

Free with this radio, suitable window mounting car aerial.

● **BARGAIN—Diodes.** Our price £1.0.0 for 750 in 750 lots only—assorted.

OUR HIGH FIDELITY EQUIPMENT IS NOT ADVERTISED DUE TO SPACE LIMITATIONS. IN STOCK ALL FAMOUS BRAND NAMES—LEAK, WHARFEDALE, ROGERS, THORENS, RADON, WYE.

UP TO 15% DISCOUNT AGAINST RECOMMENDED RETAIL PRICE

S. B. ELECTRONICS

ATLAS HOUSE

CHORLEY OLD ROAD

BOLTON

BOLTON 25881

LANCS

true to specification

SINCLAIR DESIGNS

Q.14 COMPACT HIGH-FIDELITY LOUDSPEAKER



- Size 9½in x 9½in x 4½in deep plus detachable base. ● 15 ohms impedance
- Up to 14 watts loading. ● Smooth response between 60 and 16,000Hz
- British manufacture

When Sinclair Radionics decided to design and manufacture a new loudspeaker, it was required from the start that its performance should be worthy of today's best high fidelity standards and be so reasonably priced that the greatest numbers could afford it. By using ultra-low resonant materials to form its acoustically contoured housing, outstandingly brilliant performance resulted. Furthermore, the unusual form of the Q.14 meant it could be used as a free-standing shelf speaker, as a wall-corner sound radiator or flush mounted singly or in multiple units on a flat surface such as a wall. The correctness of the design of the Q.14 has amply proven itself since within a few months of its introduction, it is already amongst the four most demanded loudspeakers irrespective of price. Independent laboratory tests have already shown that the Q.14 has amazingly good performance characteristics. As a judge of good sound yourself, your ear will confirm this instantly. At its price, there is nothing to stop you changing to Sinclair at once.

The Q.14 is finished in matt black with solid aluminium bar embellishment on the front. Supplied in strong fitted carton and sent post free under money back guarantee if you are not satisfied.

£7.19.6

IDEAL FOR 2.12 MONO AND STEREO SYSTEMS

sinclair

**SINCLAIR RADIONICS LTD., 22 Newmarket Road,
Cambridge**

Phone OCA-352996

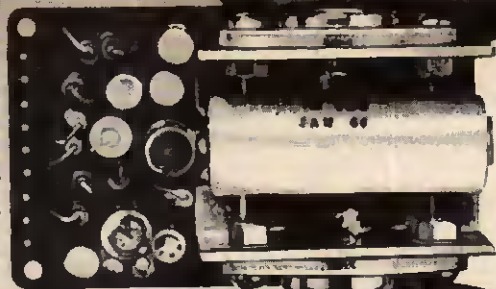

SINCLAIR Z.12

COMBINED 12 WATT AMPLIFIER AND PRE-AMP

No constructor's transistor amplifier has ever achieved such success as the Sinclair Z.12. It favours the user in so many ways—with fantastic power-to-size ratio, with far greater adaptability, with freedom to operate it from batteries or mains power supply unit (the new PZ.4 is ideal for this) and with the opportunity to obtain superb stereo reproduction for very little outlay. Countless thousands of Z.12s are in use throughout the world in hi-fi installations, electronic guitars and organs, P.A. installations, intercom, systems, etc. This true 12-watt amplifier is supplied ready built, tested and guaranteed together with the Z.12 manual which details a number of control circuits enabling you to match the Z.12 to your precise requirements. For complete listening satisfaction, use your Z.12 system with Q.14 loudspeakers. It assures superb quality with substantial savings.

Built, tested
and
guaranteed.

89/6

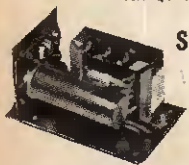

SINCLAIR PZ.4 STABILISED MAINS POWER UNIT

A heavy duty stabilised power supply unit of advanced design developed specially for systems using one or more Z.12s. For running from standard A.C. Mains supplies, the PZ.4 delivers 18V. D.C. at 1.5A. Supplied built, tested and guaranteed.

99/6

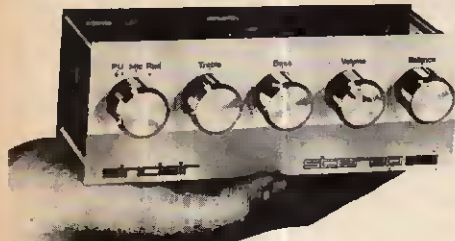

SINCLAIR STEREO 25

- Input switch in/Treble/Bass/Volume/Balance Controls
 - Sensitivity for 10 watts into 1.5 ohms per channel
Mic.—2mV into 30K ohms
P.U.—3mV into 50K ohms
Radio—20mV into 4.7K ohms
 - Equalisation correct to within ± 1 dB, RIAA curve, 50-20,000 Hz.
 - 6 $\frac{1}{2}$ x 2 $\frac{1}{2}$ x 2 $\frac{1}{2}$ ins. plus knobs. Aluminium front.
- Ready built and tested. **£9.19.6**

SINCLAIR MICROMATIC

the
world's
smallest
radio



No increase in price

Prices for this fantastically tiny, powerful receiver remain the same in spite of increased purchase tax so that the Sinclair micromatic is not only the most original and efficient set of its kind ever produced, it is the best value too. As easy to take with you as your wrist watch. Includes superb magnetic ear-piece, tunes over M.W., and plays anywhere.

Complete kit of parts inc. earpiece, case, aluminium front panel, etc. **49/6**

Ready built with earpiece tested and guaranteed. **59/6**

Walkley Mercury Cell (2 required) each 2/9.

YOUR SINCLAIR GUARANTEE

Should you not be completely satisfied with your purchase when you receive it from us, your money will be refunded in full at once and without question.

**FULL SERVICE FACILITIES
AVAILABLE TO ALL
SINCLAIR CUSTOMERS**

To: SINCLAIR RADIONICS LTD., 22 NEWMARKET ROAD, CAMBRIDGE

Please send POST FREE

.....
.....
.....

NAME

ADDRESS

For which I enclose cash/cheque/money order

PE.6

LIND-AIR (OPTRONICS) LTD.

*London's
Leading
Component
Shops*

ALL POST
ORDERS TO
Dept. P.E. 668
25 Tottenham
Court Road
London, W.1

25 & 53 TOTTENHAM COURT ROAD, LONDON, W.1. Tel. 01-580 4534/7679

Open 9-6 p.m. Monday to Saturday inclusive. Open Thursday until 7 p.m.

UNREPEATABLE BARGAINS



FANE 122/17.
12in in 25 WATT
HEAVY DUTY
E.T. FI
LOUD
SPEAKERS WITH
high efficiency
Ferrite magnet.
17,000 gauss. Imp. 3-5 ohms. Brand new
and guaranteed. List Price £12. **LIND-
AIR PRICE £8.10.6.** P. & P. 7/6.



**E.M.I. COMBINATION
LOUD SPEAKERS** 13
x 8 1/2in. Elliptical with
3 1/2in dia. Tweeter. Imp.
8 ohms. Power handling
10 watts. Brand new and
guaranteed. List price
£25.5.0. **LIND-AIR
PRICE 99/6.** P. & P. 7/6.
(Also available without
tweeter 59/6. P. & P.
7/6.)



**FANE 801
TWEETERS**
Imp. 3-5 ohms. 17,000
gauss. 12 watt. Brand new
and guaranteed. List price
£3.15.0. **LIND-AIR PRICE 59/6.** P. & P. 3/6.

GOODMANS SPEAKER BARGAINS:
5in 3 ohms, 15/6; 6in 3 ohms, 29/8; 8in
3 ohms, 42/8; 10in 3 ohms, 65/6; 10in x 6in
3 ohms, 32/6; Tweeter, 19/6. P. & P. 3/6
per Speaker.

STEREO HEADPHONES



Enjoy Stereo Sound as
you have never heard it
before. **MODEL TTC
61111** as illustrated.
Soft padded earphones.
Adjustable headband.
Impedance 8 ohms per
phone. Frequency range
25-18,000c/s. With 5ft.
lead. Price 69/6. P. & P.
4/6. Other similar types
available. **AKAI A5888.**
8 ohms. £8.6.0. **CORAL
E102** 16 ohms. £5.10.0.

EAGLE SEL. 16 ohms, 79/6. **T.T.C. Stereo-
scope** 8 ohms, 49/6. P. & P. 4/6 each.

AUTO TRANSFORMERS

Input 0-200, 220, 240V
Output 110V.

50W	£11.7.6	1,000W	£9.2.0
75W	£17.0.0	1,500W	£15.15.0
100W	£25.0.0	2,000W	£18.10.0
150W	£25.15.0	3,000W	£25.10.0
200W	£35.0.0	4,000W	£34.18.0
300W	£45.0.0	0-30V, 1A	30/-
400W	£49.10.0	0-30V, 1A	17/6
600W	£59.6.0	0-30V, 2A	37/6
800W	£69.8.0	0-30V, 3A	42/-

Post extra

MAINS TRANSFORMERS

Input 200/250V 50c/s.

24V	3A	£2.12.0	24V	8A	£5.5.0
24V	5A	£3.15.0	24V	12A	£5.15.0

Post extra.
Mains and Output Transformer lists available
on request.

**EXTENSION
TELEPHONES
ONLY**
37/6 P. & P. 3/6.

Complete with lead, automatic dial numbered
1-10 and internal bell. Guaranteed perfect
working order. Made by famous manufacturer
to G.P.O. Specification.

SEE OPPOSITE

GARRARD DECKS



3000 with Sonotone 9TAHC Stereo Cartridge	£9.19.6
3000 with Sonotone 9TAHC Diamond Stereo Cartridge	£10.19.6
AT60 MKII less cartridge	£13.19.6
AT60 MKII with Decca Derman Stereo Cartridge	£18.14.6
SP.25 MKII less cartridge	£11.19.6
SP.25 MKII with Decca Derman Stereo Cartridge	£18.14.0
AP.75 less cartridge	£24.3.11
L.A.B.80 MKII less cartridge	£24.19.0

All plus P. & P. 12/6

Mono Cartridge 17/6 extra.
Stereo Cartridge 22/6 extra.

2-3 WATT AMPLIFIER

An ideal basis for building your own portable
record player. Just add speaker and
turntable, and you will have an above-
average model for a mere fraction of the
cost. 2-3 watt printed circuit with
control panel on flying lead. ON, OFF,
TONE CONTROL AND VOLUME.
colourful escutcheon. Bimlar valves:
E280, ECL82 and composite installation
booklet. Price **85/-** P. & P. 3/6.



BARGAIN OFFER! FANTAVOX CASSETTE TAPE PLAYER



Specially designed to replay the well known and
popular Musicassettes prerecorded tape cassettes
offering a wide choice of all types of music from pop
to classical. Up to 40 minutes of quality repro-
duction through built-in speaker. Simple on/off play
and volume controls. Fully transistorised operating
on six penlight batteries. Modern compact styling
with earpiece socket and wrist strap. Size 6 1/2
x 4 1/2 in.

LIND-AIR PRICE, £9.19.6. Carr., Pkg. and
Ins. 3/6.

TRANSISTOR F.M. TUNER

SAVE £2.2.0!

6 Transistor FM tuner. Frequency range 88-
108Mc/s. Size 6 x 4 1/2 in. Ready built for
use with most amplifiers, 9V battery operation.
Complete with instructions. **LIST PRICE 29/6.**

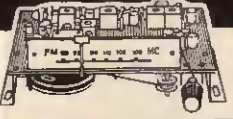

LIND-AIR PRICE 7 gns. P. & P. 4/6.

MULTIPLY ADAPTOR
for above for Stereo Radio
Reception **£5.19.6** extra

LINEAR AMPLIFIERS



Latest a.c. Mains Models offering highest quality
at modest cost.

LT90. All Transistor 12 watts Stereo. Inputs for
Tuner, Gram, Mike, Separate Bass, Treble,
Balance and Volume Controls **£15.15.0.** Carr. 7/6.
Teak case **£3.10.0** extra.

PTA 15 (as illus.). All Transistor, 15 watts Mono.
Inputs for Tuner, Gram, Mike, Guitar, Bass, Treble
and two volume controls, **£15.15.0.** Carr. 7/6. Teak
case **£3.10.0** extra. **LT45.** 2 Valve 5 watts Mono.
Inputs for Tuner, Gram, Bass, Treble and volume
controls, **£8.10.0.** Carr. 7/6. Metal cover 18/- extra. Full details sent on request.

9 in 1 ELECTRONIC KIT



Built nine different projects from one
basic kit—simple instructions, no techni-
cal knowledge required for you to build a
Police Siren, Metronome, Morse Code
amplifier, Electronic Messenger, WT
Transmitter, Radio Telephone, One-
transistor Radio Two-transistor Radio,
Electronic Music Kit. Completely safe-
operated on 9V PP3 battery. Hours of
fun for boys and girls of all ages. Complete
with all parts and simple step by step
instructions. **ONLY 69/6.** P. & P. 3/6.

MULTIMETERS

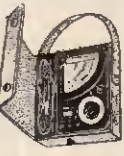

MODEL TTC.1001.
20,000 O.P.V. with
overload protection;
d.c. volts, 5, 25, 125,
500, 2,000V; a.c.
volts, 10, 50, 250,
100V; d.c. mA
250mA-50A. With
probe and carrying
case. **ONLY 85/-**
P. & P. 3/6.



MODEL TTC.
1030. 50,000
O.P.V.; d.c.
volts, 0-3, 12,
60, 120, 300,
600, 1,200V;
a.c. volts, 0-30,
120, 600,
1,200V; d.c. mA
0-0.3-300.
With probe
and carrying
case. **ONLY**
£11.19.6. P. &
P. 3/6.

MOTOR BARGAINS



Ideal for model
makers,
players,
decks, etc.

6.3 d.c. Motor.
10,000 r.p.m. at
280mA. 1 1/2in x
1 1/2in dia. Shaft 1/8in
long x 3/64in dia.
9.6. P. & P. 2/6.

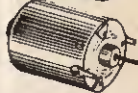

**9V d.c. Gram deck
replacement motor.**
2 1/2in x 1 1/2in dia.
Shaft 1/8in long x
3/32in. 17/6. P. & P.
2/6.

SYNCHRONOUS CLOCK MOTORS

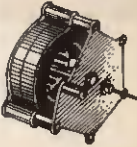

Heard for 40 revolu-
tions per hour.
230V 50 cycle, with
mounting flanges.
Size approximately
1 1/2in deep x 2 1/2in
diameter. **ONLY 22/6.** P. & P. 2/6.

SELECTOR DRIVE

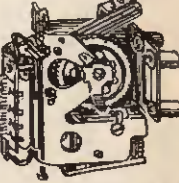

Numerous
applications
Electro-
magnet and
brass tooth
wheel.
A
switch wiper
and contacts
are coupled to
this and
arranged to
be on for 10
pulses and off
for 15. An
Auxiliary contact is normally on but off
1 in every 25. Complete with suppressor,
resistors, plus series contact for continuous
operation. Great window display, switching
lamps, models, etc. 12V or 24V d.c. Brand
new and boxed. 12.8. P. & P. 2/6.

1/8 H.P. MAINS MOTOR

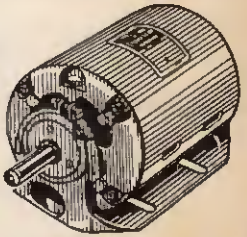

Made by Crompton Parkinson. Single phase
1/8 h.p. Motor. 230/250V. 50 cycles. 1.3 amps.
1 1/2 x 1 1/2 in dia. Overall size less spindle approx.
8 x 6 in. Perfect condition. A bargain for the
work bench. **ONLY 79/6.** Carr. 20/- (1 h.p.
Motor also available, 99/6. Carr. 29/-).

DELAY ACTION TIME SWITCH



Made by
Smiths. A.c.
operation
200 / 250V.
Double pole.
Will give time
delays from
0-10 minutes.
Size 2 1/2in dia. x
2 1/2in long inc.
1 1/2in x 3/16in dia. spindle. **BARGAIN PRICE**
17/6. P. & P. 2/6.

MULTIMETERS for EVERY purpose!

MODEL AS-100D. 1000Ω/VOLT 5in., mirror scale. Built-in meter protection. 0/3/12/60/120/300/600/1,200V. d.c. 0/8/36/120/360/600V. a.c. 0/10/40/80/300MA/12 Amp. 0/2K/200K/2M/2000KΩ. -20 to +17dB. £12.10.0. P & P 3/6.



NEW MODEL 500.30.000 O.P.V. with overload protection. Mirror scale. 0/0.5/2.5/10/25/100/250/500/1,000V. d.c. 0/2.5/10/25/100/250/500/1,000V. a.c. 0/50μA/5/80/800mA. 12 amp. d.c. 0/60/K/6. Meg. 60megohm £8.17.6. Post paid.

MODEL TE-12. 20,000 O.P.V. 0/0.6/30/120/600/1,200/3,000/6,000V. d.c. 1/8/30/120/600/1,200V. a.c. 0/60μA/5/80/800mA. 0/6K/600K/6meg/60. Megohm 50PF. 2 MFD. £5.18.6. P & P 3/6.

MODEL TE 80. 20,000 O.P.V. 0/10/50/100/500/1,000V. a.c. 0/6/20/50/250/500/1,000V. d.c. 0-50μA. 5/50/500MA. 0/6K/60K/600K/6 Meg. £4.17.6. P & P 3/6.

TE-51. NEW 80,000Ω/VOLT MULTIMETER. 0/6/30/120/1,200V. a.c. 0/3/10/60/100/500/1,000/3,000V. d.c. 0/60μA/12/300mA. d.c. 0/60K/6 Megohm. 85V. P & P 2/6.

MODEL PT-34. 1,000 O.P.V. 0/10/50/250/500/1,000V. a.c. and d.c. 0/1/100/500mA. d.c. 0/100K/500K. P & P 3/6.

MODEL AP-105. 50KΩ/Volt. Mirror scale, built-in meter protection. 0/3/3/12/60/120/300/600/1,200V. d.c. 0/8/30/120/300/600/1,200V. a.c. 0/30μA/5/60/300MA/12 Amp. 0/10K/1M/10M 10M Ω -20 to +17 dB. £8.10.0. P & P 3/6.

TE-65 VALVE VOLTMETER. High quality instrument with 28 ranges. D.c. volts 1.5-1,500V A.c. volts 1.5-1,600V Resistance up to 1,000 MΩ. 220/240V a.c. operation. Complete with probe and instructions. £17.10.0. P & P 6/-. Additional Probes available: R.F. 35/- H.V. 42/6.

GARRARD DECKS
Brand new and guaranteed.
1025 with cartridge £7.10.0.
LAB80 Mk.11 less cart. £23.10.0.
LAB80 Mk.11 less cart. with WB2 Base, £27.10.0.
401 Transcription less cart. £27.6.0.
Carr. 7/6 each

2-WAY RADIOS
Super quality. Brand new and guaranteed.
3 transistor £6.15.0 pr.
4 transistor £6.19.6 pr.
5 transistor £7.19.6 pr.
6 transistor £8.12.6 pr.
6 transistor De Luxe £12.10.0 pr.
10 transistor £22.10.0 pr.
13 transistor 500mW £31.10.0 pr.
Post extra These cannot be operated in U.K.

SINCLAIR EQUIPMENT
Z12 12 watt amplifier, 89/6.
P24 Power Supply Unit, 99/6.
Stereo 25 Presamp., 49.19.6.
Q14 Speakers, 27.19.6.
Micromatic Radio Kit, 49/8.
Bull 59/6.
Micro FM Radio Kit, 45.18.6.
ALL POST PAID

MODEL TE-10A. 200kΩ/Volt, 5/25/50/250/500/2,500V. d.c. 10/50/100/500/1,000V. a.c. 0/50μA/2.5 mA/250 mA d.c. 0/6K/6megohm. -20 to +22dB. 10-0, 100 mfd. 0-100-0-1 mfd. 69/6. P & P 2/6.

MODEL TE-70. 30,000 O.P.V. 0/3/15/60/300/600/1,200V. d.c. 0/6/30/120/600/1,200V. a.c. 0/30μA/3/30/300mA. 0/16K/160K/1-6M/16megohm. £5.10.0. P & P 3/6.

MODEL 250J. 2,000 O.P.V. 0/10/50/250V. d.c. 0/10/50/500/2,000V. a.c. 0/2megohm. 0/250 mA. 49/6. P & P 2/6.

LAFAYETTE
57 Range Super 50,000 O.P.V. Multimeter. D.c. Volts 125V-1000V. A.c. Volts 1.5V-1000V. D.c. Current 25μA-10 Amp. Ohms. 0-15 Meg Ω. dB. -20 to +81dB. Overload Protection. £12.10.0. Carr. 3/6.

MODEL ZQM TRANSISTOR CHECKER
It has the fullest capacity for checking on A, B and Ico. Equally adaptable for checking diodes, etc. Spec: A: 0.7-0.9967. B: 8-200. Ico: 0-50 microamps 0-5mA. Resistance for diodes 200Ω-1MΩ. Supplied complete with instructions, battery and leads. £5.19.6. P & P 2/6.

HOSIDEN DH04S 2-WAY STEREO HEADSETS
Each headphone contains a 2½ in woofer and a 1½ in tweeter. Built in individual level controls. 25-18,000c/s. 80 mm with cable and stereo plug. £5.19.6. P & P 2/6.

F.M. WIRELESS MICROPHONES
04-104Mc/s. Transistorised. Operates from 9V battery. Complete with additional secret tie-clip microphone. List £12.10.0 ONLY £8.15.0. P & P 2/6. These cannot be operated in U.K.

TRANSISTORISED TWO-WAY TELEPHONE INTERCOM
Operative over amazingly long distances. Separate call and press to talk buttons. 2-wire connection. 1000's of applications. Beautifully finished in ebony. Supplied complete with batteries and wall brackets. £8.19.6. P & P 3/6.

CLEAR PLASTIC METERS
First grade quality Moving Coil panel meters available ex-stock. S.A.E. for illustrated leaflet. Discounts for quantity. Available as follows: Type MR 3SP, 1½ in square fronts.

100-0-100μA	25/-	200mA	25/-	150V d.c.	25/-
500-0-500μA	25/-	300mA	25/-	150V a.c.	25/-
1-0-1mA	25/-	500mA	25/-	300V d.c.	25/-
1mA	25/-	750mA	25/-	500V d.c.	25/-
2mA	25/-	1A d.c.	25/-	750V d.c.	25/-
5mA	25/-	2A d.c.	25/-	15V a.c.	25/-
10mA	25/-	5A d.c.	25/-	50V a.c.	25/-
20mA	25/-	3V d.c.	25/-	130V a.c.	25/-
100μA	35/-	50mA	25/-	10V d.c.	25/-
500μA	25/-	100mA	25/-	200V a.c.	25/-
600μA	27/6	150mA	25/-	50V d.c.	25/-
80-0-80μA	35/-				

'8' Meter 1mA 49/6
POST EXTRA. Larger sizes available—send for lists.

UNR-30. 4-BAND COMMUNICATION RECEIVER
Covering 500Kc/s-30Mc/s. Incorporates variable BFO for CW/SSB reception. Built in speaker and phone jack. Metal cabinet. Operation 220/240V. a.c. Supplied brand new guaranteed with instructions. £12.10.0. Carr. 7/6.



LAFAYETTE MODEL HA700 AM/CWSSB AMATEUR COMMUNICATION RECEIVER
8 valves, 5 bands incorporating 2 MECHANICAL FILTERS for exceptional selectivity and sensitivity. Frequency coverage on 6 bands 150-400Kc/s, 550-1,600Kc/s, 1.6-4.0Mc/s, 4.8-14.5Mc/s, 10-5-30Mc/s. Circuit incorporates R.F. stage, serial trimmer, noise limiter, B.F.O. product detector, electrical bandspread, 3 meter, slide rule dial. Output for phones, low to 2KΩ or speaker 4 or 8ohms. Operation 220/240V. a.c. Size 7.2 x 10 in. Supplied brand new and guaranteed with handbook. 38 GNS. Carr. 10/-. S.A.E. for leaflet.

LAFAYETTE MODEL HA-500 SSB/AM/CW 80 THROUGH 6 METER RECEIVER
New outstanding Ham Bands only receiver covering the 80/40/20/15/10/6 metre bands. Incorporates 10 valves, product detector, two mechanical filters, S. Meter, dual conversion on all bands, crystal calibrator, V.P.O. noise limiter, serial trimmer, 1Fs 2.898Mc/s, and 455Kc/s. Output 8ohms and 500ohms. Operations 220/240V. a.c. Supplied brand new and guaranteed with handbook 48 Gns. Carr. 10/-. 100Kc/s. crystal, 85/-.



LAFAYETTE LA-224T TRANSISTOR STEREO AMPLIFIER
19 transistors, 8 diodes, 1HF music power, 30W at 8Ω. Response 30-20,000 ±2dB at 1W. Distortion 1% or less. Inputs 3mV and 250mV. Output 3-16Ω. Separate L and R volume controls. Treble and bass control. Stereo phono jack. Brushed aluminium, gold anodised extended front panel with complimentary metal case. Size 10½ x 3½ x 7½ in. Operation 115/230V. A.V. 225. Carr. 7/6.



★TRANSISTORISED FM TUNER★
6 TRANSISTOR HIGH QUALITY TUNER. SIZE ONLY 6 x 4 x 2½ in. 12 P. stages. Double tuned discriminator. Ample output to feed most amplifiers. Operates on 9V battery. Coverage 88-108Mc/s. Ready built ready for use. Fantastic value for money. £6.7.6. P & P 2/6. Stereo multiflex adaptors 5 gns.

TRIO COMMUNICATION RECEIVER MODEL 9R-59DE
4 band receiver covering 550Kc/s to 30Mc/s. continuous and electrical band spread on 10, 15, 20, 40 and 80 metres. 8 valve plus 7 diode circuit. 4/8 ohm output and phono jack SSB-CW ● ANL ● Variable BFO ● 3 meter ● Sep. band spread dial ● 1F 445Kc/s ● audio output 1.5W. ● Variable RF and AF gain controls. 115/250V. a.c. Mains. Beautifully designed. Size: 7 x 15 x 10in. With instruction manual and service data. £37.10.0. Carriage 12/6.

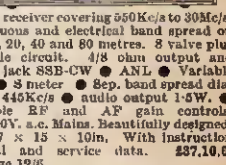

AMERICAN TAPE
First grade quality American tapes. Brand new. Discount on quantities.

3in. 225ft. L.P. acetate	7/6
3in. 600ft. T.P. mylar	19/-
5in. 600ft. std. plastic	9/6
5in. 900ft. L.P. acetate	10/-
5in. 1,200ft. D.P. mylar	15/-
5in. 1,800ft. T.P. mylar	22/6
5in. 1,200ft. L.P. acetate	12/6
5in. 1,800ft. L.P. mylar	15/-
5in. 1,800ft. D.P. mylar	22/6
5in. 2,400ft. T.P. mylar	39/6
7in. 1,200ft. std. acetate	12/6
7in. 1,800ft. L.P. acetate	15/-
7in. 2,400ft. D.P. mylar	25/6
7in. 3,000ft. T.P. mylar	45/-

Postage 2/-, Over £3 post paid.

MAGNAVOX 363 3-SPEED TAPE DECKS
4-track £18.10.0. Carriage Extra.

COSSOR DOUBLE BEAM OSCILLOSCOPES
Type 1035 general purpose a.c. coupled. Type 1049 L.F. a.c. coupled. £35 each. Carr. 90/-.

RECORDING HEADS
Beater 4-track. An fitted to Collored Mk. IV and Studio Decks. High imp. record myl back, low imp. erase. Brand new. 18/6 pair. MINIFLUX 4-track set of 3. 28/6. COSMOCORD with mounting plate. TRI-500 P/W record/replay 65/-, TRI-120 P/W record/replay 65/-, TEL 1-6 P/W Brass 20/-. Post extra.

G.W. SMITH & CO (RADIO) LIMITED

Phone: GERRARD 8204/9155
Cables: SMITHEX LESQUARE
3-34 LISLE STREET, LONDON, W.C2

OPEN
9 a.m. to 6 p.m. every day Mon. to Sat. Trade supplied.

LOOK!

PRACTICAL!

VISUAL!

EXCITING!



a new 4-way method of mastering
ELECTRONICS
by doing — and — seeing . . .

1 ▶ OWN and HANDLE a

complete range of present-day **ELECTRONIC PARTS** and **COMPONENTS**

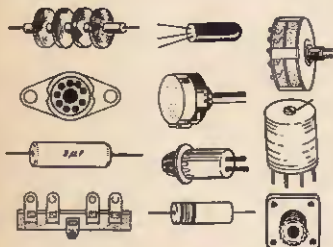

2 ▶ BUILD and USE

a modern and professional **CATHODE RAY OSCILLOSCOPE**

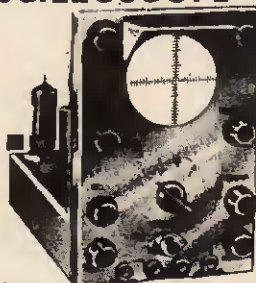

3 ▶ READ and DRAW and

UNDERSTAND CIRCUIT DIAGRAMS

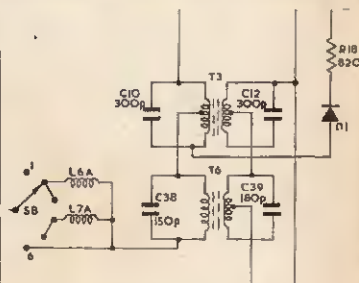

4 ▶ CARRY OUT OVER 40 EXPERIMENTS ON BASIC ELECTRONIC CIRCUITS AND SEE HOW THEY WORK . . . INCLUDING . . .

- VALVE EXPERIMENTS
- TRANSISTOR EXPERIMENTS
- AMPLIFIERS
- OSCILLATORS
- SIGNAL TRACER
- PHOTO ELECTRIC CIRCUIT
- COMPUTER CIRCUIT
- BASIC RADIO RECEIVER
- ELECTRONIC SWITCH
- SIMPLE TRANSMITTER
- A.C. EXPERIMENTS
- D.C. EXPERIMENTS
- SIMPLE COUNTER
- TIME DELAY CIRCUIT
- SERVICING PROCEDURES

This new style course will enable anyone to really understand electronics by a modern, practical and visual method—no maths, and a minimum of theory—no previous knowledge required. It will also enable anyone to understand how to test, service and maintain all types of Electronic equipment, Radio and TV receivers, etc.

FREE POST NOW
for
BROCHURE

or write if you prefer not to cut page

To: **BRITISH NATIONAL RADIO SCHOOL, READING, BERKS.** Please send your free Brochure, without obligation, to: we do not employ representatives

NAME..... BLOCK CAPS

ADDRESS..... PLEASE PE 6

THE AIR FORCE AND ELECTRONICS

THE fiftieth anniversary of the Royal Air Force is a fitting occasion to recall the close relationship that has always existed between this Service and the branch of technology we now know as electronics. Their histories are closely interwoven. The needs of air defence were chiefly responsible for the sudden growth of electronics.

When the R.A.F. was formed in 1918 wireless communication was already established, but still rather a novelty. Fortunately, government advisers on defence matters anticipated important future developments in the use of electro-magnetic waves, and a Radio Research Board was set up in that very same year. Thus was brought into being the nucleus of the official machinery which later facilitated consultations with persons such as R. Watson-Watt, destined to become the father of radar.

Once the feasibility of locating aircraft by radio had been demonstrated, many of the finest brains from universities, the radio industry, and government scientific departments were harnessed to the task of converting this idea to a practical reality. As is now well known, the first chain of R.D.F. stations was installed around the coasts of Britain well before the outbreak of war in 1939.

Furthermore, as we now realise, the door leading to a future "electronics" era was dramatically pushed open by these heroic backroom efforts of scientists, physicists, and engineers in the late 30's.

In amateur circles there is to be found an especial regard for the Royal Air Force. No other service depends so heavily upon signals and other branches of electronics. In 1939 hundreds of radio amateurs entered the R.A.F., some to perform signal duties, others to be assigned to special training on the secret R.D.F. equipment. Subsequently, thousands of other men and women from all walks of life became initiated into the strange world of radio—or the even stranger one of radar—during those war years.

Many of these ex w/op's and radar mechanics have retained their interest and have applied this fortuitously acquired knowledge to good effect in Civvy Street. The current general awareness of electronics, and the adoption of this subject as a useful and intellectually stimulating recreation by a great many lay persons, are in large measure due to the training and experience provided by the armed forces, and the R.A.F. in particular.

Today the future pattern of the Royal Air Force is the subject of much speculation. The move from manned aircraft to remotely controlled missiles can only mean a greater preponderance of electronic devices and systems. Whatever changes take place, the role of electronics is bound to be pre-eminent.

F. E. Bennett—*Editor*

THIS MONTH

CONSTRUCTIONAL PROJECTS

RADIO CONTROL SYSTEM FOR MODEL BOATS	398
CAMERA TRIGGER	414
P.E. ANALOGUE COMPUTER	429
DRUMMER'S WHOOSH	443

SPECIAL SERIES

NUCLEONICS FOR THE EXPERIMENTER—8	417
TRANSISTOR AMPLIFIER DESIGN—5	422

GENERAL FEATURES

EPOXY RESINS	410
INGENUITY UNLIMITED	420

NEWS AND COMMENT

EDITORIAL	397
POINTS ARISING	409
SPACEWATCH	413
ELECTRONORAMA	428
MARKET PLACE	447
READOUT	448

*Our July issue will be published on
Friday, June 14*

MULTI CHANNEL RADIO CONTROL SYSTEM

FOR MODEL BOATS.....

THE relatively simple transistorised multi-channel control system described here was designed specifically for controlling a 34in model diesel powered Vosper R.A.F. Crash Tender. Circuit and constructional details are given for the radio transmitter, receiver and control arrangements, including those for rudder and throttle actuator mechanisms. No special tools are required other than perhaps a power hand drill, although a multi-range meter is desirable and an oscilloscope is an advantage. The overall model with electronics will appeal to the do-it-yourself modeller who has a certain amount of electronics knowledge.

SINGLE OR MULTI-CHANNEL?

Undoubtedly the simplest control arrangement is "single-channel" operation in which only one item of information is transmitted at any one time. This can be quite effective, although special operating techniques may have to be evolved, particularly when high speed models are used, so that function selection is not unduly delayed.

In the case of model aircraft, the flying technique for single channel working differs completely from normal multi-channel practice. Therefore, it would seem to be a very natural progression to the more versatile "multi" techniques, which enable simultaneous movements of various controls to be made, particularly if the cost of such a system could be kept low.

AIRCRAFT OR BOAT?

The scope of "multi" aircraft control can be very rewarding, but the following points were the decisive factors in selecting a boat for using the control system described.

Cost of the installation

A boat or land vehicle control system need not be as complex as its aircraft counterpart, a four-channel system being usually quite adequate for controlling a boat, even at high speed. Surface vehicles are not seriously affected by equipment weight, size, or power consumption restrictions generally imposed by an aircraft of practical proportions.

This gives the home constructor much more scope to use materials and components which are readily available, rather than to have to purchase the relatively expensive, compact, and lightweight items generally required for aircraft control. There is no particular

need to miniaturise the circuitry or actuators; with a boat of 34in overall length, lack of space is not a problem to be encountered here.

Loss or damage

In the experimental stages, particularly with home-built equipment in the hands of newcomers to model control, there is a very real risk of damage, or even a complete write-off, in the case of a powered aircraft, as a direct result of some form of loss of control.

Adequate operating facilities

Unless one joins a club it is difficult to find suitable large open spaces for aircraft flying without undue aerial hazards. It must be remembered that a powered aircraft in free flight at speed is potentially a dangerous projectile and serious personal injury has been known to occur to spectators. There are still plenty of smooth stretches of water to be found of quite sufficient size for putting a boat through its paces without risk of annoyance to anyone. Most marine diesels are equipped with silencers to reduce noise.

The effective working range of the transmitter/receiver combination described in this article is about a quarter of a mile. In practice, this was found to be more than adequate, because even at 200 yards distance it becomes difficult for the operator to ascertain the boat's position and attitude in the water.

BASIC ARRANGEMENT

The basic scope for control of a boat is probably less than that for an aircraft, and in order to justify the selection of a "multi" system, a high-speed planing hull was selected, capable of good manoeuvrability at speed. Because of the low power/weight ratio achieved with electric propulsion, an ample size of diesel engine was chosen as the power unit. This was installed in an "Aerokits" R.A.F. Crash Tender available in kit form in plywood. The 34in model is used.

This boat is ideal for an installation of this type, the hull being conveniently divided, by bulkheads, into five compartments (see maker's plans). It is very wise if an internal combustion engine is used, to keep one compartment amidships reserved for the engine, fuel tank, and perhaps throttle gear, as these miniature engines tend to become dirty, exuding a mixture of soot and unburnt fuel—the penalty for throttling a diesel engine.



PART ONE

By E.J. PEPPER C.Eng. M.I.E.E.

The bow compartment (No. 1) (see maker's plans) is sealed off and filled with buoyancy material; No. 2 compartment (wheelhouse) is used as the main electronics area, as this is readily accessible but is well protected and well clear of any spray that might occur at speed. This compartment accommodates the radio receiver, preamplifier, and both control motion panels.

The receiving aerial plugs into a socket fixed to the deck adjacent to No. 2 compartment. No. 3 compartment is the engine room with throttle control and fuel tank. No. 4 houses the battery, relays, and the isolator switches. No. 5 compartment is occupied fully by the steering actuator and the actuator supply battery. It is probably a good idea to mark these compartments on the plans.

If polyurethane foam is inserted ahead of bulkhead B1, holes of about 1in square should be made in the bulkhead.

The second compartment houses the four perforated s.r.b.p. modules: the receiver (aft), the pre-amplifier (port side), rudder control (starboard side), and throttle control (forward). These four modules are easily recognised in the circuit diagram, each being indicated by a hatched line box (see Fig. 2). The complete circuitry in the boat is shown; the transmitter will be described later.

TWO BASIC SYSTEMS

There are two basic systems of control in general use, and there are also two main ways by which the control intelligence can be made to actuate the controlled member (see Fig. 1).

Progressive control

Progressive control is usually simplest, but less precise, being in principle an "open loop" arrangement of integration where the controlled member will move at more or less constant rate in the desired direction until it is checked.

Proportional control

This is a true "closed loop" servo position control. The simplicity of the system to be described stems from the fact that it permits simultaneous transmission of one progressive system and one proportional system, the former being used to actuate the throttle, i.e. commands "close", "open", and "hold", the latter to steer the boat.

The rudder assumes the angular position corresponding to that set up on the steering "wheel" on the transmitter unit, regardless of the load conditions on the rudder. To achieve this it is necessary to feed back the rudder position to the controller by means of a potentiometer (VR2) ganged to the rudder shaft.

CONTROL PRINCIPLE

The two controls, rudder and throttle, may be operated individually or simultaneously, and the principle of operation may be readily understood from Fig. 3. The transmitted 27MHz carrier is 100 per cent modulated by a square wave of adjustable mark/space ratio to correspond to rudder control, and at three pre-selected fundamental frequencies to provide throttle control.

The appropriate frequency (110Hz, 600Hz, 400Hz), corresponding to "increase", "decrease", and "hold" throttle respectively, can be selected by a centre biased three-position key on the transmitter, without affecting the pre-set mark/space ratio. The mark/space ratio of the square wave is variable from 1 : 10 to 10 : 1 for

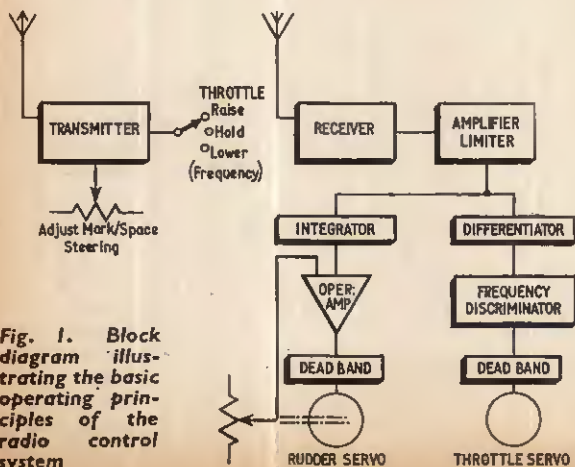

Fig. 1. Block diagram illustrating the basic operating principles of the radio control system



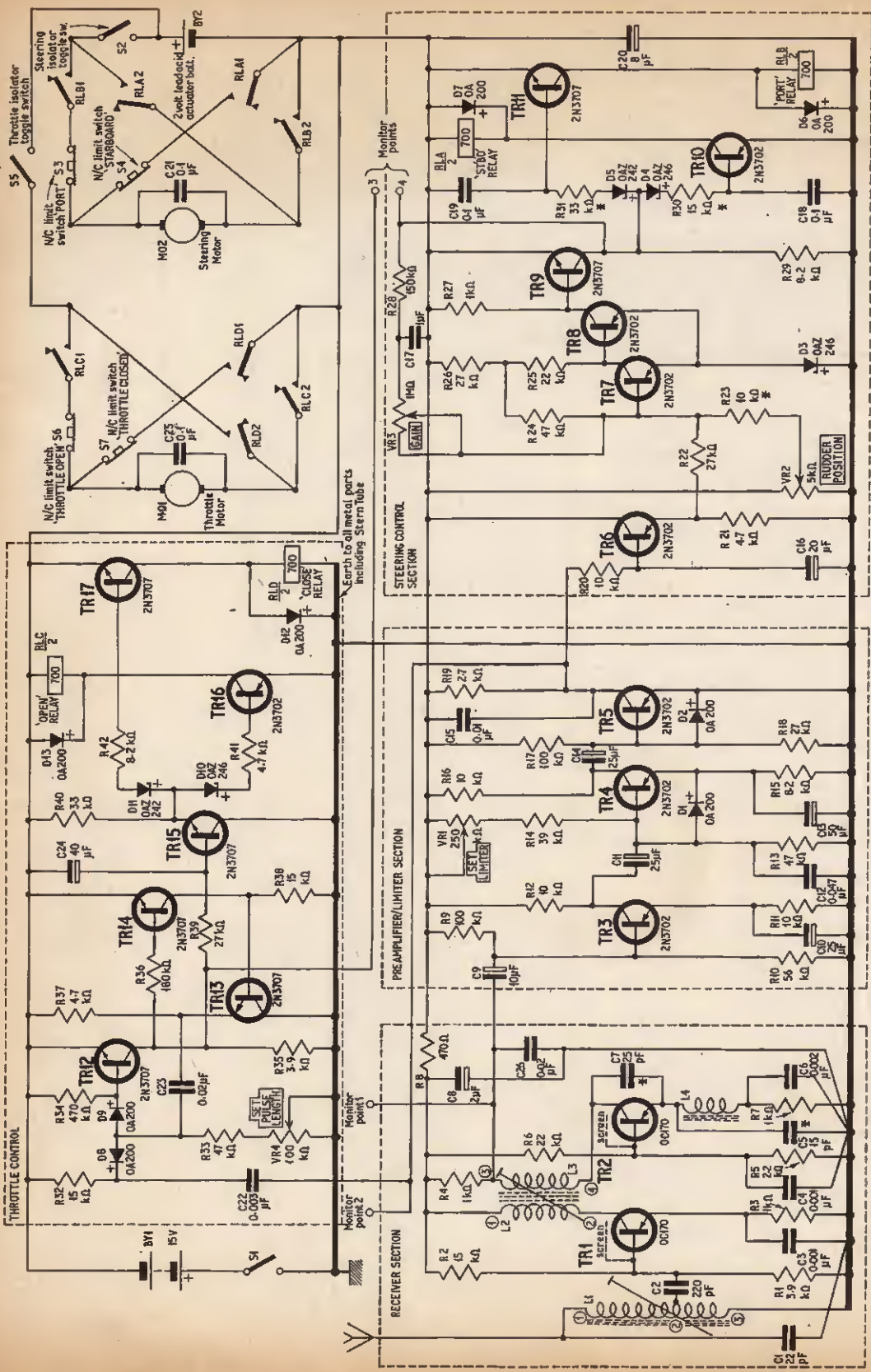
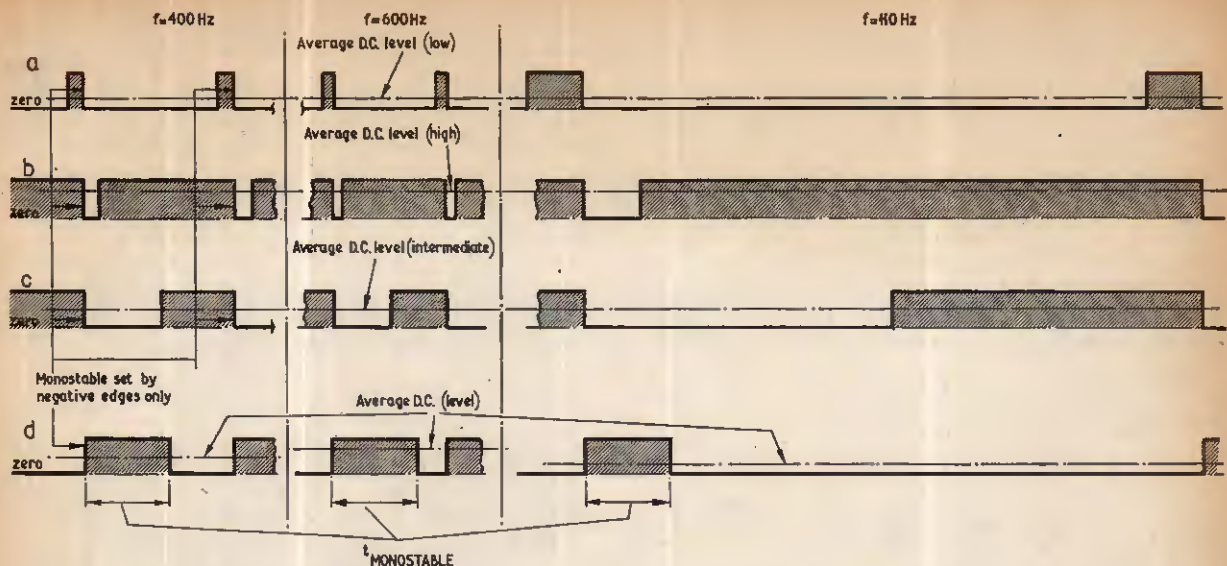

Fig. 2. Complete circuit diagram of the electronics in the boat. Each section is divided into shaded areas to show the individual panels



(a) Steering control waveforms Port Rudder (b) Steering control waveforms Starboard Rudder (c) Steering control waveforms Rudder Amidships (d) Corresponding Throttle control waveforms
 $f=400\text{Hz}$ 'HOLD' throttle (Intermediate D.C. level) $f=600\text{Hz}$ 'CLOSE' throttle (High D.C. level) $f=90\text{Hz}$ 'OPEN' throttle (Low D.C. level)

NOTES:

- (1) The D.C. level of the Rudder waveforms does not change with frequency (2) The Throttle waveform is not affected by change of Rudder Mark/Space ratio

Fig. 3. Steering and throttle control waveforms

any selected frequency and is set by the steering wheel control on the transmitter, a ratio of 1 : 1 corresponding to "rudder straight".

After detection by the receiver, the square wave signals are converted to d.c. levels which in turn actuate relays. These control the d.c. motors which rotate, in the appropriate direction, the actuator lead screws.

The general description of the system will now be followed by a more detailed account of the various functional units. However, it is emphasised at this stage that general information on constructing the boat is excluded since it is outside the scope of this magazine. It is expected that the constructor will acquire the boat kit with instructions through a retailer.

A kit of accessories for this model is available through retailers from Keil Kraft. The electronics are not generally available in complete kit form; constructors will find that all electronic parts are obtainable through the usual retailers.

RADIO RECEIVER

It is an undisputed fact that, because of their selectivity performance, superheterodyne receivers are to be preferred to t.r.f. types; nevertheless super-regenerative receivers can give excellent results and are undeniably simple. If the constructor has no intention of becoming involved in active competition work, where a superhet could offer advantages, he would probably do well to compromise and go for a super-regenerative receiver, which is simple and inexpensive while offering adequate performance.

At the high transmission frequency used, it would have been very difficult to have achieved adequate r.f. amplification with a conventional tuned radio frequency (t.r.f.) receiver, whereas the super-regenerative receiver is capable of providing tremendous amplification, provided that faithful reproduction of the modulation signal is not an important criterion.

As we are dealing with "clipped" rectangular waveforms the effects of signal distortion are of little consequence.

The principle of the super-regenerative receiver is to employ large amounts of positive feedback, to increase the overall gain or sensitivity. This "regeneration", or "reaction" as it was once known, is arranged to render the circuit alternatively oscillatory and non-oscillatory at a fairly rapid rate.

In ordinary t.r.f. receivers, the amount of regeneration possible is limited by the tendency towards instability, leading to continuous oscillation or "howl". The super-regenerative receiver makes full use of this phenomenon, and sufficient positive feedback is applied to ensure that self-oscillation will definitely occur.

TR2 is the super-regenerative detector stage and regeneration is applied via C7 from collector to emitter from the tuning coil L3.

As self-oscillation is assured, the strong resulting a.c. level is rectified by the base/emitter junction of TR2 to provide a d.c. bias signal. This bias builds up progressively on C4 and C6 such that the gain of TR2 progressively reduces until the transistor cuts off, and oscillation ceases.

The charges on C4 and C6 immediately begin to leak away after cut-off occurs, and ultimately TR2 will again commence to conduct, the current and gain increasing until oscillation again ensues, when the





process repeats itself. The time constants C4-R5 and C6-R7 are selected, such that the periodic bursts of oscillation (referred to as "squegging") occur at some low radio frequency, which is not particularly critical, and will be found to increase with the antenna

signal strength, normally being between about 30-100kHz. This is well out of the signal modulation frequency range, and can be filtered out after detection.

It can be seen, therefore, that there is a substantial portion of time in each period of "squegging" when the gain of the receiver is exceptionally high, but when self-oscillation does not exist. The gain during this period is far higher than could be achieved, with stability, in any single stage "conventional" t.r.f. receiver.

RECEIVER CONSTRUCTIONAL DETAILS

COMPONENTS . . .

Resistors

R1 3.9k Ω	R4 1k Ω	R6 22k Ω
R2 15k Ω	R5 2.2k Ω	R7 1k Ω
R3 1k Ω		

All 10%, $\frac{1}{4}$ watt carbon

Capacitors

C1 22pF ceramic	*C5 15pF ceramic
C2 220pF mica	C6 0.002 μ F mica
C3 0.001 μ F mica	*C7 25pF ceramic
C4 0.001 μ F mica	C8 2 μ F elect. 25V
C26 0.02 μ F polyester (additional squegging filter)	

*C5 and C7 may be altered in value so that the dust core in L2/3 is about mid travel for optimum tuning

Transistors

TR1, TR2 OC170 or OC171 (2 off)

Coils

L1 12 turns 28 s.w.g. enam. wire close wound on Neosid $\frac{1}{4}$ in polystyrene former with adjustable core. Tapping is taken 2 turns from the "earthy" end of the winding.

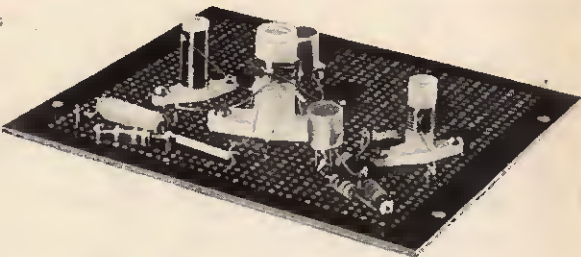

L2/3 $\frac{3}{8}$ in Aladdin former with dust core. L3 wound first—9 $\frac{1}{2}$ turns 28 s.w.g. enam. wire close wound.

L2 2 turns 28 s.w.g. enam. wire wound on top of L3 at "TR1 collector" end

L4 R.F. choke, 38 s.w.g. enam. wire in single layer on $\frac{1}{2}$ in Neosid former with dust core

Miscellaneous

Aerial, 14 in whip type made from 20 s.w.g. brass or nickel silver wire with wander or banana plug fitted to one end. Socket for aerial. Plain or perforated copper clad s.r.b.p. sheet (see Text) 4in x 4in. Pins for perforated board

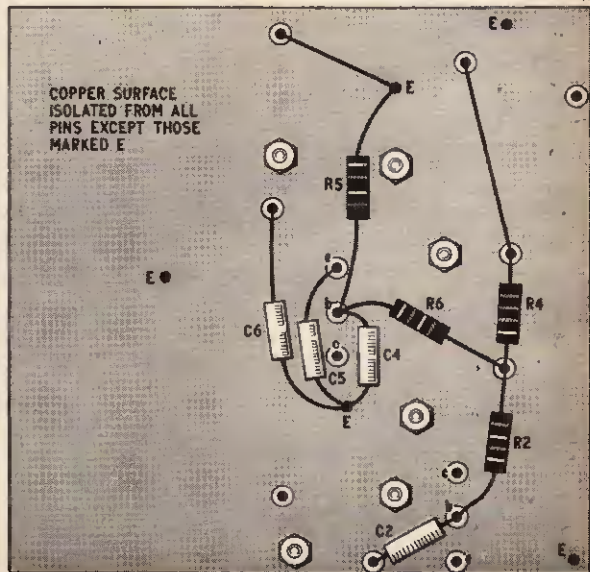
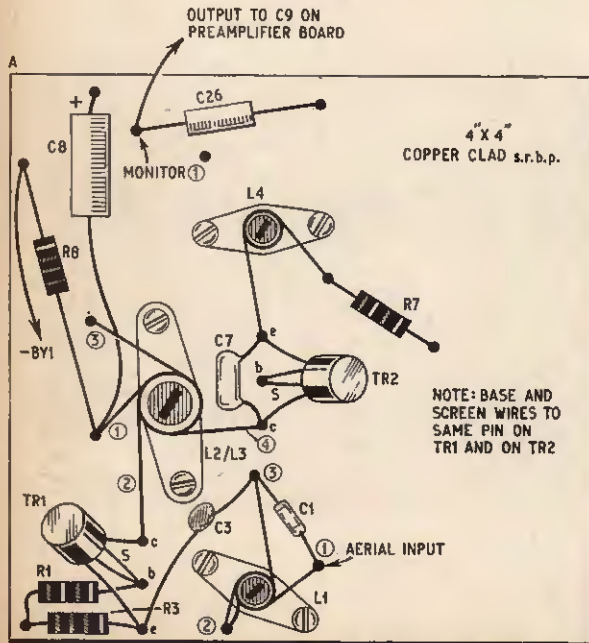

Fig. 4. Component layout and wiring of the receiver panel

Because of the fact that TR2 operates very close to its cut-off point, its characteristic is non-linear, and it is this non-linearity which provides the essential characteristic for detection of the modulation of the carrier. Therefore, TR2 performs the dual role of high gain r.f. amplifier and detector.

If no signal is being received, then self-oscillation is induced at a higher level of collector current, or gain, and hence any circuit noise is greatly amplified in the absence of a carrier. It is because of this inherent

characteristic that the super-regenerative receiver is affectionately referred to by some as a "rush-box".

The selectivity of a super-regenerative receiver is inherently poor, and hence is prone to receive simultaneous transmissions, on neighbouring frequencies, from other model control operators in the vicinity. This undesirable feature is to some extent offset by the tendency of the circuit to "latch on" to the strongest signal present, and suppress any weaker signals received.

PREAMPLIFIER CONSTRUCTIONAL DETAILS

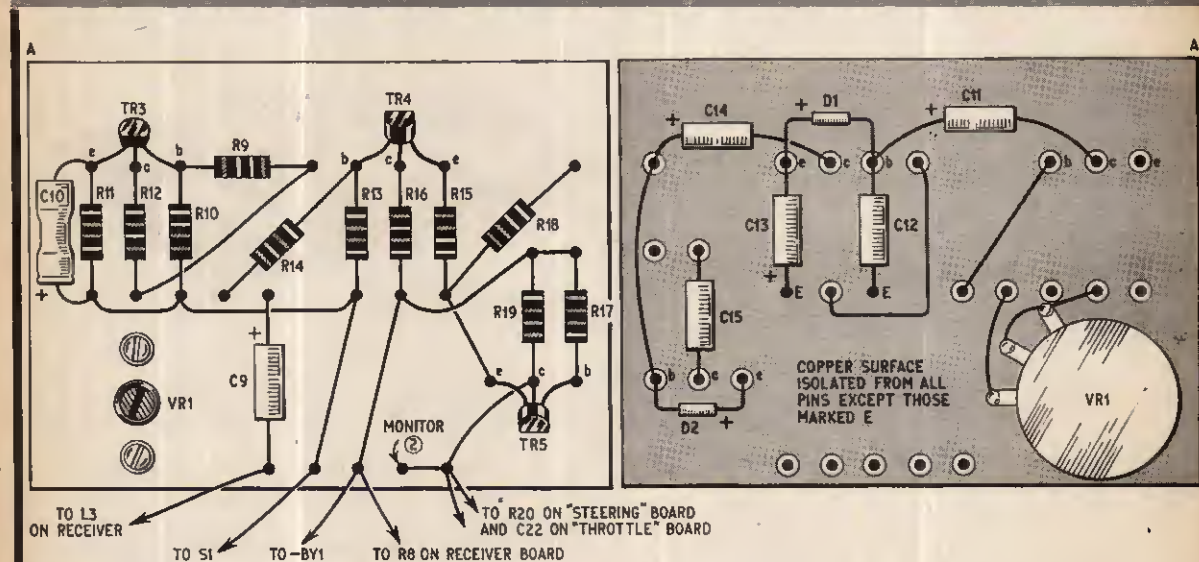

Fig. 5. Component layout and wiring of the preamplifier panel

COMPONENTS . . .

Resistors

R8 470 Ω	R12 10k Ω	R16 10k Ω
R9 100k Ω	R13 47k Ω	R17 100k Ω
R10 56k Ω	R14 39k Ω	R18 27k Ω
R11 10k Ω	R15 8.2k Ω	R19 2.7k Ω

All 10%, $\frac{1}{4}$ watt carbon

Potentiometer

VR1 250k Ω carbon min. preset

Capacitors

C9 10 μ F elect. 12V	C13 50 μ F elect. 6V
C10 25 μ F elect. 12V	C14 25 μ F elect. 12V
C11 25 μ F elect. 12V	C15 0.01 μ F paper
C12 0.047 μ F paper	

Transistors and Diodes

TR3, 4, 5 - 2N3702 or 2N3703 (3 off)
D1, 2 1S44 or 1S130 or OA200

Miscellaneous

Plain or perforated s.r.b.p. sheet (see text) 4in \times 3in
Pins for perforated board

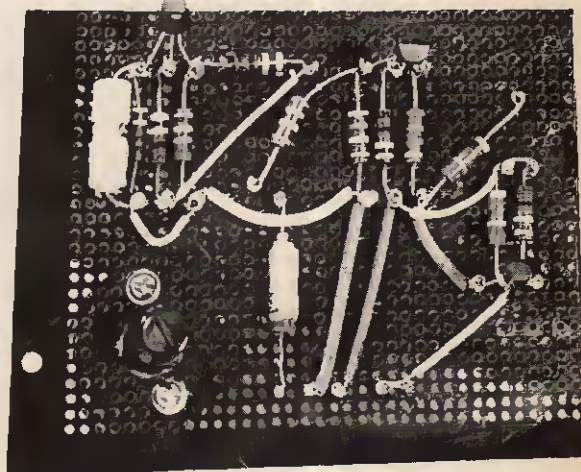



The "squegging" action of the receiver can cause unwanted r.f. radiation from a receiving antenna connected directly to the input. Indeed, the initial experiments, performed in an attic workshop, caused considerable interference to television receivers via

aerials in the immediate vicinity. This was eliminated and a 6dB gain achieved by fitting an r.f. stage TR1.

This acts as a buffer between the "squegging" detector TR2 and the antenna, and is merely a class A amplifier biased by R1 and R2 in the base, and R3 and C3 in the emitter circuit, for stable operation. The output at the collector is loosely coupled by L2 to L3.

The effect of the antenna loading is reduced on the detector stage, thereby increasing its performance,

STEERING CONTROL CONSTRUCTIONAL DETAILS

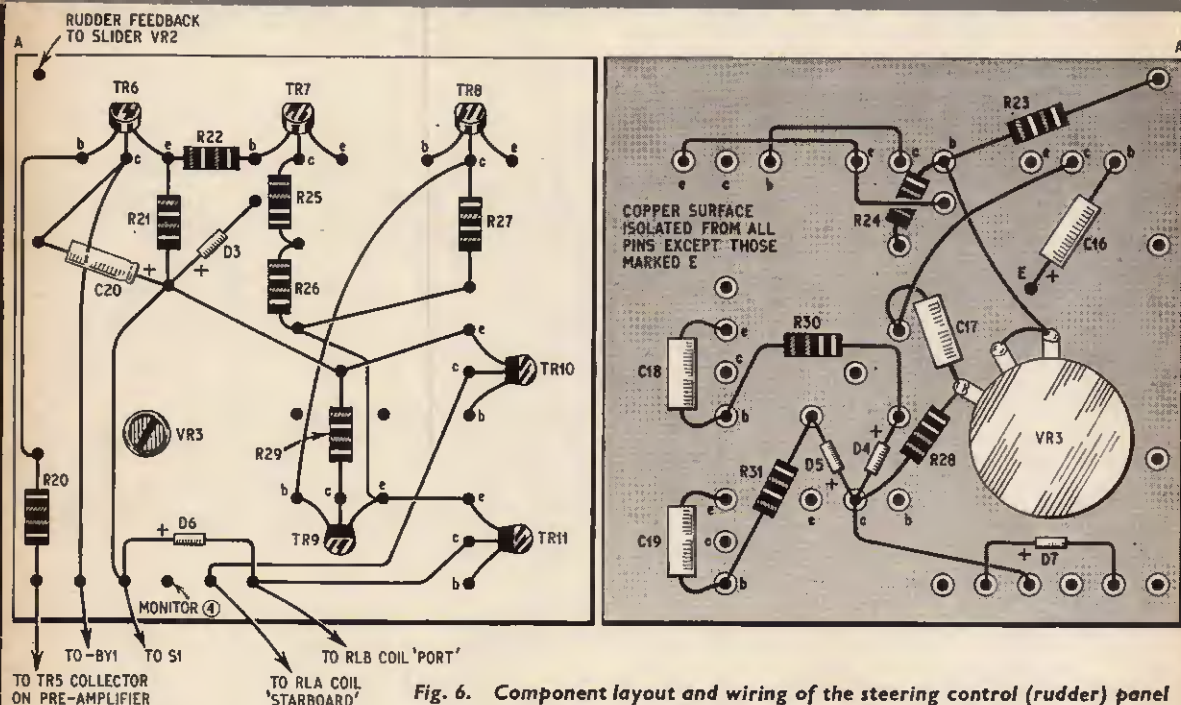

Fig. 6. Component layout and wiring of the steering control (rudder) panel

COMPONENTS . . .

Resistors

R20	10k Ω	R24	47k Ω	R28	150k Ω
R21	4.7k Ω	R25	22k Ω	R29	8.2k Ω
R22	27k Ω	R26	27k Ω	*R30	15k Ω
*R23	10k Ω	R27	1k Ω	*R31	33k Ω

All 10%, $\frac{1}{2}$ watt carbon

* R23, R30, and R31 may require adjustment on test

Potentiometers

VR2 5k Ω linear carbon or wirewound min.
VR3 1M Ω carbon min. preset

Capacitors

C16	20 μ F elect. 16V	C19	0.1 μ F paper
C17	1 μ F tantalum or paper 12V	C20	8 μ F elect. 25V
C18	0.1 μ F paper	C21	0.1 μ F paper

Transistors and Diodes

TR6, 7, 8, 10	2N3702 or 2N3703 (4 off)
TR9, 11	2N3707 (2 off)
D3, 4	Z8-2 (Brush) or OAZ246 (Mullard)
	Zener diodes (2 off)
D5	Z5-6 or OAZ242 Zener diode
D6, 7	IS44, IS130, or OA200 (2 off)

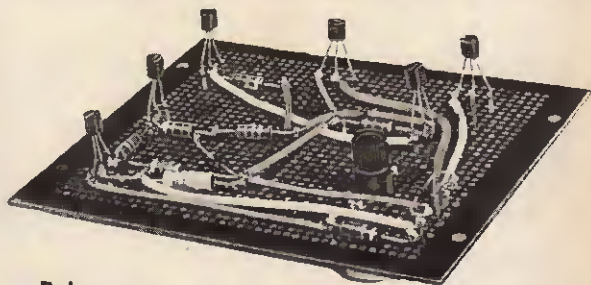

Relays

RLA, RLB 12V 700 Ω type MH2 with two changeover sets of 1A contacts (Keyswitch) or type 4190GD (S.T.C.) (2 off) (Normal open pair of contacts used)

Switches

S2 Single pole toggle
S3 } Part of Drive System, see Part 2
S4 }

Miscellaneous

MO2 Motor 3V 6,000-7,000 rev/min (Ripmax Orbit type 505)
Plain or perforated s.r.b.p. sheet 4in \times 4in. Pins for perforated board

whilst the antenna loading circuit itself is flatly tuned by L1-C1 prior to amplification by TR1.

The high frequency "squegging" component at TR2 output is filtered out by C26.

PRE-AMPLIFIER

Satisfactory operation of the controls depends entirely on the preservation of a good rectangular waveform after detection by the receiver. This is effected by the use of a high gain pre-amplifier (which is normally saturated), together with a degree of noise rejection filtering. Due to the saturated condition of the amplifier, it is quite stable, and the limiting action is effective in removing the inherent noise generated by the super-regenerative circuit.

The pre-amplifier comprises TR3-TR5 in a circuit which is optimised to clip and square the full range mark/space ratio for minimum signal strength conditions, and provides automatic d.c. restoration of the rectangular wave relative to the zero level for all signals.

Potentiometer VR1 is an optional preset control, which is fitted to the prototype, and can be adjusted to give optimum noise rejection at the limit of the working range of the transmitter. Some degree of noise rejection is provided by C12 and C15.

PROPORTIONAL RUDDER CONTROL

The resultant "clean" rectangular waveform appearing at TR5 collector contains an average d.c. component proportional to the mark/space ratio, but independent of the frequency. This component is extracted by the smoothing circuit R20 and C16 and buffered by emitter follower TR6, prior to being used as a "reference" voltage. This voltage is to be compared with a feedback reset voltage proportional to the actual rudder position as derived by VR2, which is driven mechanically by the rudder shaft, and is some fraction of the battery voltage.

The comparison is made at the input of the d.c. operational amplifier TR7, TR8, TR9, whose closed loop gain is controlled by VR3, the feedback potentiometer, to something around 15.

The quiescent state of the servo is that associated with an amplifier output of about half the battery voltage, when the input currents derived from the

IMPORTANT

Readers intending to construct this radio controlled model boat are advised that, before operating in the U.K., the appropriate "model control" licence must be obtained. This licence, which is allocated for model control only at 26.96 to 27.28MHz for a radiated power not exceeding 1.5 watts, can be obtained, upon payment of £1 (sterling), from the Radio Services Branch, G.P.O. Headquarters, St. Martins-le-Grand, London, E.C.1.

reference source and the feedback potentiometer are approximately equal. If, however, the reset voltage differs from that required to obtain this state by about 0.25 volt or so, the amplifier will drive hard to saturation or cut off depending on the polarity of the difference voltage.

A deadband circuit embodying Zener diodes D4 and D5 follows the amplifier, which inhibits operation of succeeding circuits until the "error" voltage exceeds about half that necessary to saturate the amplifier in either direction. This "error" voltage corresponds to about 5 degrees of arc of the steering control at the transmitter (270 degrees helm to helm) and is experienced as lost motion. The deadband, however, creates a definite quiescent state for the control, in which the rudder relays and actuator motor are not energised, and hence once the rudder "homes" to the selected position, current consumption falls to a very low level.

If a signal of more than 5 degrees helm is given then TR10 or TR11, as appropriate, conducts and the associated port or starboard relay is energised which in turn actuates the helm motor. When the rudder nears the selected equilibrium position, the amplifier "zeros" and the relay is released.

Limit switches are fitted at the extremes of lead screw travel which open the motor circuit for the direction selected, should hard helm be given.

The servo system is simply and effectively stabilised to one overshoot by the phase lead circuit in the feedback path (R28, C17).

Adjustment of the gain control VR3 will optimise the response, corresponding to minimum dead zone without any tendency to oscillate.

As the distance from the transmitter increases, some waveform degeneration is experienced which results in a slight "wander" of the rudder position. Similarly as the batteries run down, the relationship between

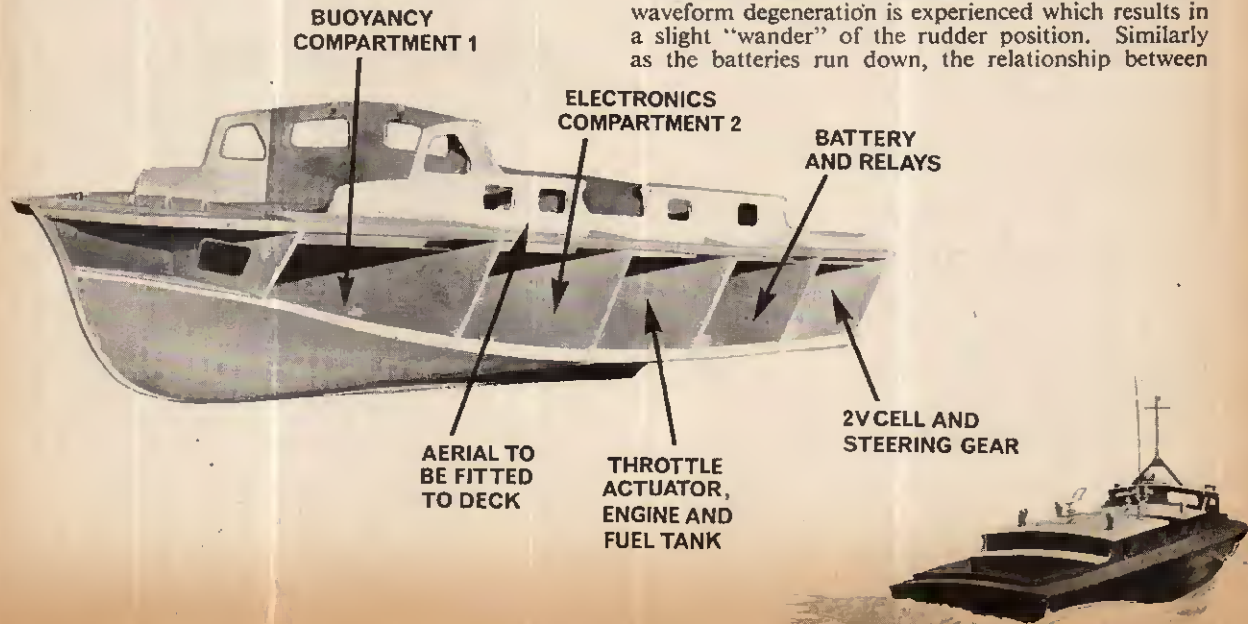



helm position and rudder position will be observed to change slightly. In practice these effects were not found to be severe enough to be embarrassing.

If desired, the effect of battery voltage deterioration affecting the rudder control

can be easily compensated for by merely rotating the rudder potentiometer body, with respect to its fixing bracket, slightly, say every half hour or so during operation.

PROGRESSIVE THROTTLE CONTROL

The output of TR5 is differentiated by C22 and R32 and fed to the throttle control circuit TR12-TR17.

THROTTLE CONTROL CONSTRUCTIONAL DETAILS

COMPONENTS . . .

Resistors

R32 15k Ω	R35 3.9k Ω	R39 27k Ω	R42 8.2k Ω
R33 47k Ω	R36 180k Ω	R40 3.3k Ω	
R34 470k Ω	R37 4.7k Ω	R41 4.7k Ω	
All 10%, $\frac{1}{4}$ watt carbon			

Potentiometer

VR4 100k Ω carbon min. preset

Capacitors

C22 0.003 μ F paper	C24 40 μ F elect. 16V
C23 0.02 μ F paper	C25 0.1 μ F paper

Switches

- S5 Single pole toggle
- S6 } Part of Drive System, see Part 2
- S7 }

Transistors and Diodes

- TR12, 13, 14, 15, 17 2N3707 (5 off)
- TR16 2N3702 or 2N3703
- D8, 9, 12, 13 1544 or OA200 (4 off)
- D10 Z8.2 or OAZ246 Zener
- D11 Z5.6 or OAZ242 Zener

Relays

- RLC, RLD 12V 700 Ω type MH2 with two changeover sets of 1A contacts (Keyswitch) or type 419GD (S.T.C.) (2 off)
- Normal open pair of contacts used

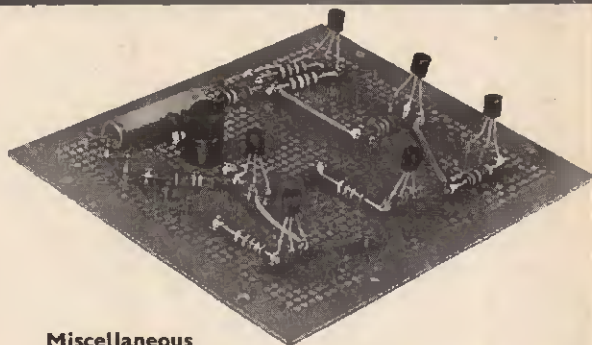

Miscellaneous

- M01 Motor, miniature for throttle control with a short shaft (Kell Kraft)
- Plain or perforated s.r.b.p. sheet 4in \times 4in
- Pins for perforated board

OTHER ITEMS FOR ELECTRONICS

Switch

- S1 Single pole toggle

Batteries

- BY1 15V made up from 12 nickel cadmium cells connected in series (Deac 1.25V, 225mAh)
- BY2 2V 1.6Ah lead acid cell

Components for mechanical actuators given next month

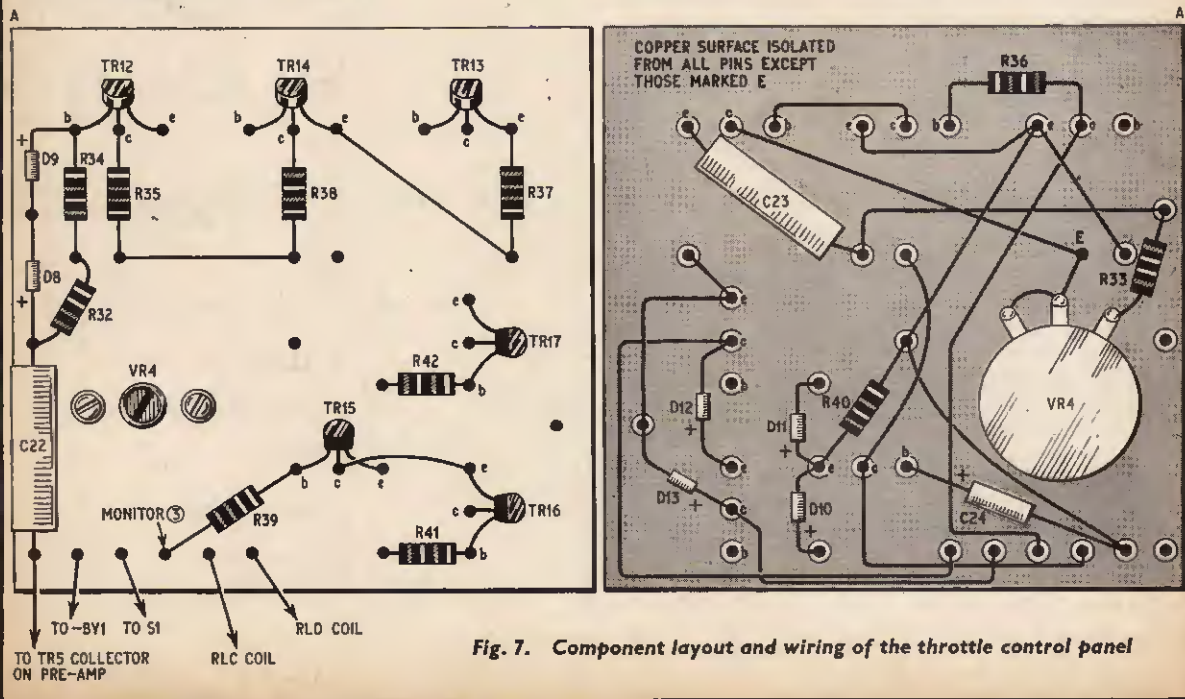

Fig. 7. Component layout and wiring of the throttle control panel

Build Your Own Heathkit Electronics

A kit for every interest — Home Workshop — Hi-Fi — Radio — Test — Amateur

Latest STEREO TAPE RECORDER, STR-1



Fully portable—own speakers

Kit £58. 0. 0 incl. P.T. P.P. 10/6

Ready-to-use £70. 6. 0 incl. P.T. P.P. 10/6

FOR THIS SPECIFICATION

1/2 track stereo or mono record and playback at 7 1/2, 3 1/2 and 1 1/2 ips. Sound-on-sound and sound-with-sound capabilities. Stereo record, stereo playback, mono record and playback

on either channel. 18 transistor circuit for cool, instant and dependable operation. Moving coil record level indicator. Digital counter with thumb-wheel zero reset. Stereo microphone and auxiliary inputs and controls, speaker/headphone and external amplifier outputs... front panel mounted for easy access. Push-button controls for operational modes. Built-in stereo power amplifier giving 4W rms per channel. Two high efficiency 8" x 5" speakers. Operates on 230V a.c. supply.

Versatile recording facilities. So easy to build—so easy to use.

Latest STEREO AMPLIFIER, TSA-12

12 x 12 watts output

Kit £30. 10. 0 less cabinet P.P.10/6

Ready-to-use £38 (incl. cab.) P.P 10/6

Cabinet £2. 5. 0 extra



FOR THIS SPECIFICATION

17 transistors, 6 diode circuit. ±1dB, 16 to 50,000Hz at 12W per channel into 8 ohms. Output suitable for 8 or 15 ohm loudspeakers. 3 stereo inputs for Gram, Radio and Aux. Modern low silhouette styling. Attractive aluminium, golden anodised front panel. Handsome assembled and finished walnut veneered cabinet available. Matches Heathkit models TFM-1 and AFM-2 transistor tuners.

Full range power... over extremely wide frequency range. Special transformerless output circuitry. Adequately heat-sinked power transistors for cool operation—long life, 6 position source switch.

High-performance CAR RADIO, CR-1



Superb long and medium wave entertainment wherever you drive. Complete your motoring pleasure with this compact outstanding unit.

8 Latest semiconductors (6 transistors, 2 diodes). For 12V positive or 12V negative earth systems. Powerful output (4W). Preassembled and aligned tuning unit. Push-button tone and wave change controls. Positive manual tuning. Easy circuit board assembly. Instant operation, no warm-up time. Tastefully styled to harmonise with any car colour scheme. High quality output stage will operate two loudspeakers if desired. Can be built for a total price.

KIT (less speaker) £12.18.6 incl. P.T. P.P. 4/6

Ready-to-use £19.12.6 (less speaker) P.P. 4/6

Latest Portable Stereo Record Player, SRP-1

Automatic playing of 16, 33, 45 and 78 rpm records. All transistor—cool instant operation. Dual LP/78 stylus. Plays mono or stereo records. Suitcase portability. Detachable speaker enclosure for best stereo effect. Two 8in x 5in special loudspeakers. For 220-250V a.c. mains operation. Overall cabinet size 15 1/8 x 3 1/2 x 10 1/2 in.



Compact, economical stereo and mono record playing for the whole family—plays anything from the Beatles to Bartok. All solid-state circuitry gives room filling volume.

KIT £28.6.0 incl. P.T. P.P. 10/6

Ready-to-use £35.4.0 P.P. 10/6

A wide range of SPEAKER SYSTEMS



SSU-1

HI-FI SPEAKER SYSTEM. Model SSU-1. Ducted-port bass reflex cabinet "in the white". Two speakers. Vertical/horizontal models with legs, Kit £12. 14. 6 P.P. 12/- Without legs, Kit £12. 0. 0 incl. P.T. P.P. 7/6



Berkeley

The BERKELEY SLIM-LINE SPEAKER SYSTEM, fully finished walnut veneered cabinet for faster construction. Special 12" bass unit and 4" mid/high frequency unit. Range 30-17,000Hz. Size 26" x 17" only 7 1/2" deep. Modern attractive styling. Excellent value.

Kit £19. 10. 0. P.P. 13/6

Ready-to-use £24. 0. 0. P.P. 13/6

Transistor Portables

UXR-1, now available in Modern coloured cases or leather.

6 transistor, 1 diode circuit. 7 x 4in. speaker. LW and MW coverage. Case: brown leather, or colours navy blue, coral pink, lime green. Please state 2nd choice.

Kit £12. 8. 0. incl. P.T. Colour

Kit £13. 8. 0. incl. P.T. Leather P.P. 4/6



UXR-1

UXR-2, choice of black or brown real leather cases.

7 transistor, 3 diode circuit. Battery saving circuitry. LW and MW coverage. Pushbutton wave change. Slide rule tuning.

Kit £15. 10. 0. incl. P.T. Leather P.P. 6/-



UXR-2

SEE HEATHKIT MODELS AT:

GLOUCESTER

Factory and Showroom, Bristol Road.

LONDON

233 Tottenham Court Road, W.1.

BIRMINGHAM

17-18 St. Martin's House, Bull Ring.

Demonstrations by arrangement.

Deferred terms available over £10 (U.K. only).

Prices quoted are Mail Order prices.

Send for Latest FREE Catalogue 36 pages, many models in Colour

Please address all enquiries to

DAYSTROM LTD., Dept. P.E.5, GLOUCESTER

Please send me FREE CATALOGUE

Full details of model(s).....

NAME.....

ADDRESS.....

Prices and specifications subject to change without prior notice

HEATHKIT

ELECTROVALUE

FAST MAIL ORDER SERVICE

Mini TRANSISTORS WITH MIGHTY SPECIFICATIONS

Low cost, Plastic encapsulated, Silicon

2N4285 pnp high reverse base-emitter voltage rating.
 BV_{ceo} BV_{ceo} BV_{ceo} all over 35V. f_T = 7MHz minimum.
 hFE 35 to 150. I_c = 10mA. V_{ce(sat)} 0.5V max. I_c = 10mA. I_b = 1mA.
 2N4286 npn high gain hFE = 100 min. I_c = 10mA. I_b = 1mA. I_c = 1mA.
 BV_{ceo} over 30V. BV_{ceo} over 25V. f_T = 280MHz typ. I_c = 1mA.
 2N4289 pnp high gain hFE = 100 min. I_c = 100mA. I_b = 1mA.
 BV_{ceo} over 60V. BV_{ceo} over 45V. f_T = 170MHz typ. I_c = 2mA.
 2N4291 pnp large signal high gain hFE = 100 to 300. I_c = 100mA. V_{ce} = 10V.
 BV_{ceo} over 40V. BV_{ceo} over 30V. V_{ce(sat)} = 1.5V max. I_c = 100mA.
 I_b = 10mA.
 2N4292 npn UHF, low noise. f_T = 570MHz typ. I_c = 2mA. V_{ce} = 5V.
 hFE = 50 typ.
 BV_{ceo} over 30V. BV_{ceo} over 15V. N.F. 6dB max. I_c = 1mA. f = 100MHz.
 2N3794 npn large signal high gain (complementary to 2N4291)
 BV_{ceo} over 40V. BV_{ceo} over 20V. hFE = 100 min. I_c = 100mA.
 All of the above are rated at 500mA max I_c, 200mW max. at 25°C.
 Size 0.175 x 0.090 x 0.090in high. Lead arrangement: in-line.
 B5001 POWER type on TO66 size base, npn high gain. Collector isolated from mounting surface (500V insulation). Dissipates 14.3W max. at T_c = 100°C and V_{ce} = 10V. V_{ce} (max) = 35V, I_c (max) = 3A, I_b (max) = 1A. T_j (max) = 150°C. hFE = 100 to 175. I_c = 0.5A (yellow selection). V_{ce(sat)} = 1.2V max. I_c = 1A, I_b = 50mA.

The seven types above are offered at the following low prices: 2N4285 to 2N4292, 2N3794 3/3 each; B5001 (yellow) 13/6.

PEAK SOUND PRODUCTS

CIR-KIT No. 3 Pack 12/6; adhesive copper 5ft x 1/8in or 1/16in 2/-; 100ft x 1/8in or 1/16in 30/-; Perforated board 0.1in matrix 5in x 3 1/2in, 4/-; 2 1/2in x 3 1/2in 2/6.

TRANSISTORISED STEREO AMPLIFIER AND PRE-AMP SAB-8

Complete kit of this very popular amplifier
 16 watts total output £10.10.0
 Power supply kit 43
 Cabinet 43

15% DISCOUNT on whole order and post free when purchasing an SAB-8!

EXTRA VALUE IN SEMICONDUCTORS

Silicon: many types in stock including:
 BC107, 45V, 8 125-900, 2/9 BC167, 50V, 8 125-500, 2/6
 BC108, 20V, 8 125-900, 2/6 BC168, 20V, 8 125-900, 2/-
 BC109, 20V, 8 240-900, 2/9 BC169, 20V, 8 240-900, 2/3
 BC109 and BC169 are low noise types, BC167, BC168 and BC169 are plastic.

Best value for:
 High Power: 2N3055, 115V, 100V, 16/6; 2N3054, 90V, f_T 25MHz typ, 4/1.
 Field Effect: MPF105, gm 2 to 6mA/V, 8/6; 2N3819, 13/-.
 VHF and fast switching: BSX20, f_T 600MHz, 4/6.
 High gain: 2N3390, 8 400-1250, 6/-.
 Low Noise: 2N3707, 4/6; 2N3391A 5/6; 2N4058 (pnp), 5/-.
 Sub-Miniature: BC122, 30V, 50mA, 80mV, 250MHz, 1 x 1.5 x 2mm, 6/6.
 Low cost: 2N2926, 18V, 120MHz, 2/3 (our colour selection).
 Also: 2N3702, 2N3704, 4/- each; BFY50, 5/3.
 Germanium: many types in stock including RF, VHF: NKT603F, 6/3;
 NKT613F, 5/9; NKT677F, 4/5.
 Low-noise: 2G308, 6/9; 2G309, 7/9; NKT275, 3/8.
 Still running well: 2N1302, 2N1303, 3/6; 2N1304, 2N1305, 4/-; 2N1306, 2N1307, 6/-; 2N1308, 2N1309, 7/11.
 High Power: NKT403, 14/10; 2N2147, 16/9; matching, 1/- pr.
 Complementary Output: AD161 (npn), 9/-; AD162 (pnp), 9/-.
 Silicon diodes:
 Low cost: 1S94, 30V, 75mA, 1/-; OA202, 150V, 160mA 2/-; BY238, 850V, 500mA 3/9; 1N5054, 800V, 1A 4/9; BY213, 200V, 6A, 6/9.
 Zener diodes: 400mW, 5%, 2.7V to 33V (E24 values), 5/3.
 Germanium diodes: OA47, 1/9; OA70, 1/6; OA81, 1/6; OA90, 1/3; OA91, 1/3; OA95, 1/3.

SUPER QUALITY NEW RESISTORS

Carbon film low noise high stabs:

Power	Range	Series	Per doz.	Per 100
1/8W 5%	5Ω to 330kΩ	E24	1/10	14/6
1/8W 10%	1Ω to 47Ω	E12	4 + 3d	resistor
1/8W 5%	390kΩ to 1MΩ	E12	1/10	14/6
1/4W 10%	4.7Ω to 10MΩ	E12	1/9	13/6
1/2W 5%	4.7Ω to 10MΩ	E24	2/2	17/-
1W 10%	4.7Ω to 10MΩ	E12	3/3	25/10

1/6 per 100 less in complete 100's of one ohmic value. 1W type 4d each. Please state value required.
 Quality Carbon Skeleton Pre-sets: 100Ω, 250Ω, 500Ω, 1kΩ, 2kΩ, 2.5kΩ, 5kΩ, 10kΩ, 20kΩ, 25kΩ, 50kΩ, 100kΩ, 250kΩ, 500kΩ, 1MΩ, 2MΩ, 2.5MΩ, 5MΩ, 10MΩ. Available in horizontal or vertical mounting, 1/- each.
 Low cost volume controls: 100Ω to 10MΩ 1in, 5kΩ to 5MΩ 1/2, 2/3 each.
 Log stereo: 100kΩ, 250kΩ, 500kΩ, 1MΩ, 2MΩ, L.S., 9/-; D.P. sw. 12/6.
 Ceramics: 100, 220, 470, 1,000, 2,200, 4,700pF, 500V, 5d; 0.01, 0.02, 0.05μF, 50V, 5d.
 Electrolytics: 5, 10, 25, 50μF, 10V, 9d; 5, 10μF, 25V, 9d; 100, 200μF, 10V, 1/-; 25, 50μF, 25V, 1/-.
 Sub-min C426 range (μF/V): 10/2.5, 8/4, 6.4/6.4, 4/10, 2.5/16, 1.6/25, 1/40, 0.6/64
 40/2.5, 32/4, 25/6.4, 16/10, 10/16, 6.4/25, 4/40, 2.5/64 ... 1/8 each
 500/2.5, 400/4, 320/2.5, 320/6.4, 250/4, 200/6.4, 200/10, 160/2.5, 125/4, 125/10, 125/16, 100/6.4, 80/2.5, 80/16, 80/25, 64/4, 64/10, 50/6.4, 50/25, 50/40, 40/16, 32/10, 32/40, 32/64, 25/25, 20/16, 20/64, 16/40, 12.5/25, 10/64, 8/40, 5/64 ... 1/4 each

EVERYTHING BRAND NEW NO SURPLUS FAST DELIVERY
 DISCOUNTS: 10% over £3, 15% over £10.
 SEND 1/- for 1968 CATALOGUE— invaluable to every electronics enthusiast and professional laboratory alike.
 Postage 1/- under £1, post free £1 and over.

ELECTROVALUE

6 MANSFIELD PLACE, ASCOT, BERKS

FANTASTIC BARGAINS

SONOTONE
 SOLENT
 2 SPEAKER
 HI-FI

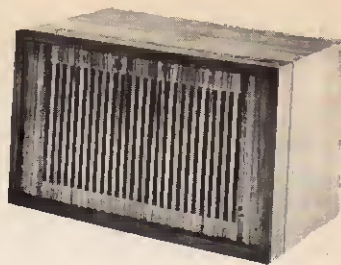

SYSTEMS

● LIST £18 EACH

SPECIAL OFFER

11 gns. EACH POST 9/-

- Impedance 8 ohm. Power input up to 12 watts.
- Suitable for valve or transistor amplifiers.
- Frequency response 40c/s to 20 k/cs.
- Scandinavian style cabinet.
- Small attractive size 14 x 9 x 8 1/2.
- On permanent demonstration.
- Reviewed by Hi-Fi News, The Gramophone, etc.

Send large s.a.e. for FREE Leaflets and Test Reports available from our Showrooms.

J. J. FRANCIS LTD.
 123 ALEXANDRA ROAD
 LONDON, N.8 BOW 1662

LEE ELECTRONICS
 400 EDGWARE ROAD
 PADDINGTON 5521

FAULT LOCATION

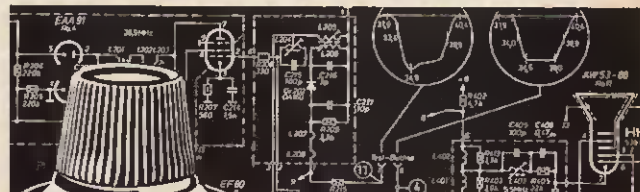

KONTAKT "Cold Spray 75"

For rapid and effective fault location.

Non-toxic, non-inflammable, Cold Spray 75 is a chemically inert coolant capable of producing temperatures of down to -42 centigrade. It can also be used to prevent heat damage during soldering processes, for the rapid freezing of small articles for biological and technical purposes and the prompt location of hairline cracks and other faults in temperature dependent components.

Other Kontakt produces:

Kontakt 60 and Kontakt 61 for relay contact cleaning; Plastic Spray 70, transparent protective lacquer; Insulating Spray 72; Kontakt WL, Spray Wash; Antistatic Spray 100, Antistatic agent for plastics; Politur 80, Polish and cleaner; Fluid 101, Dehydrating Fluid.

Details from U.K. distributors:

Special Products Distributors Ltd.

81 Piccadilly, London, W.1.

Tel. 01-629 9556

The negative-going edges are used to set a monostable multivibrator TR12, TR13 and TR14, whose quasi-stable pulse length is preset by VR4 such that it is approximately one half-period of the centre "hold" frequency, 400Hz, equal to 1.25ms.

The monostable output therefore comprises a 1 : 1 mark/space ratio for this condition, and has an average d.c. component after smoothing (R39, C24) of about half the battery voltage (7V). Neither Zener diode (D10, D11) conducts, thereby depriving TR16 and TR17 of drive; hence, neither throttle relay is energised.

It can be seen that as the monostable is only influenced by negative-going edges, and there is only one such pulse per cycle, the output d.c. level will be unchanged as the mark/space ratio of TR5 output varies over its full range.

If, however, the transmitted frequency is raised to 600Hz ("close throttle") the quasi-stable period of the monostable becomes nearly equal to one complete period of the signal frequency and TR12 is not conducting for a high percentage of time. The monostable output average d.c. component assumes a positive voltage, approaching that of the battery, and D11 conducts, operating the "throttle close" motion relay via TR17.

The throttle motor will continue to rotate until the frequency is restored to a lower level, or the limit switch on the lead screw is operated. If the frequency selected is 110Hz then TR12 remains in its stable state (conducting) for relatively long periods of time, with an average d.c. output voltage of about 1 volt to earth. This results in conduction of D10 and operation of the "throttle open" relay RLC via TR16.

The monostable is of a special design which permits rapid recharging of the timing capacitor C23 at the end of a quasi-stable period. This ensures that the monostable is ready to re-enter an accurate quasi-stable period with the minimum delay in the stable state (about 5 per cent), thus guaranteeing good separation between the "hold" and "throttle close" signals.

The "open throttle" discrimination is determined by the cut-off condition of TR15 (about 1.5 volts) as a result of TR16 base current. The "open throttle" frequency need only be low enough to create the cut-off condition, any further frequency reduction only results in unnecessary chatter of RLC.

The frequency allocations for throttle control functions are deliberately made to provide a fail-safe feature. It is obviously desirable that the throttle should be closed to minimum (tick-over) should the transmitter fail or the boat get out of range. Contrary to initial expectation, loss of signal does not produce the effect of frequency reduction to d.c. conditions, i.e. zero frequency.

The noise level of the super-regenerative circuit rises enormously if the carrier is removed, and becomes sufficient to trigger the monostable continuously, giving a high positive output from TR12. It is wise, therefore, to associate this condition with the "throttle close" command.

In a similar manner the random noise pattern generated under weak signal conditions results in an approximately "average" mark/space ratio of unity on the rudder control. As a result the rudder assumes a position roughly amidships. The slow speed straight-ahead attitude adopted by the vessel was very comfortable during trials when the transmitter was deliberately switched off.

At this point it will be realised that, had the modulating frequency of the transmitter been made infinitely variable instead of being switched, which could be readily achieved by variation of the charging potentials of the transmitter multivibrator capacitor, the throttle control could have been an independently actuated simultaneous position control, in a manner similar to that used on the rudder. However, it was decided not to do this on the prototype both to preserve simplicity, and to explore the possibilities of both systems.

BOARD CONSTRUCTION

Perforated s.r.b.p. boards were used throughout for the electronic assemblies and layouts were not found to be critical although it is desirable to keep lead lengths as short as possible in the 27MHz portions.

The receiver panel is actually a peg-board manufactured from s.r.b.p. and copper laminate (unetched printed circuit material) the copper acting as an earth plate, being cut away round the plated pegs used for connections to components. This is easily done by countersinking the $\frac{1}{8}$ in peg holes with a $\frac{3}{16}$ in drill prior to insertion of the pegs.

The entire receiver section is mounted on an unetched s.r.b.p. card 4in \times 4in fitted with isolated pegs, and soldering components straight down to the copper ground plane as required. The receiver layout is not particularly critical provided that lead lengths are kept to a minimum and the "earthy" end of certain capacitors are taken to a common point on the ground plane as shown.

So far as the other three assemblies are concerned, there is no special need for using copper clad board (as shown in the diagrams) and a plain type of s.r.b.p. board can be used here if preferred.

Full layout and wiring details for the boards are given in the illustrations (Figs. 4 to 7).

Next month : Actuator construction and installation of drive system and power supply.



PRACTICAL TRANSISTOR CIRCUITS (April 1968)

The loudspeaker should be connected between C3+ and the -9V line in the complementary symmetry circuit; R6 should be connected between C3+ and TR2 base; C2 should be connected in parallel with R3.

SOUND EFFECTS : WIND AND RAIN (April 1968)

Capacitor numbering in the wiring diagram (Fig. 5) should be amended as follows: C1 to C7 should read C7 to C13 in sequence; likewise C8 to C13 should read C1 to C6. In the components list R1 to R7 inclusive should be 2.7k Ω .

FLUORESCENT CAMPING LIGHT (March 1968)

Modification for pre-heating the lamp electrodes was published in the May 1968 issue. It has been found that in this modified circuit (page 375) the capacitor C2 is no longer required and should be deleted. The lamp will then give maximum output when switch S1 is turned to position 3.

EPOXY RESINS

And some of their applications
in the electronics industry

By P. A. Dunn, CIBA (A.R.L.) Ltd.

THE technique of protecting components by enveloping them in a "block" or film of moisture-resistant material was in use long before the development of the present-day potting or casting resins. For many years, components such as capacitors have been encapsulated in wax or bitumen, while transformers and other wound components have been impregnated using vacuum or dipping methods.

These processes, however, give very little mechanical protection to the components. Moreover, should any local overheating occur, thermoplastic materials such as wax and bitumen will melt and drain away. Another method is to hermetically seal components in a metal can, the leads being made through glass-metal seals, which are subsequently soldered. This method, however, is expensive.

Epoxy resins, introduced to this country about 18 years ago, have brought new concepts of design to the electrical and electronics industries and the ease with which intricate high performance components can now be formed with these resins has given a new freedom to design engineers.

APPLICATIONS

Probably the most well known use of epoxy resins is as adhesives and they are widely used as such in the electronic and electrical industries. Gramophone rotors are bonded to shafts, ceramic insulators are bonded to metal, nickel iron laminations are bonded together to form stators, etc. They are also used to bond the lids of car batteries and to bond iron powder in the manufacture of iron dust cores.

A wirewound resistor receiving a coating of epoxy resin by the fluidised bed technique

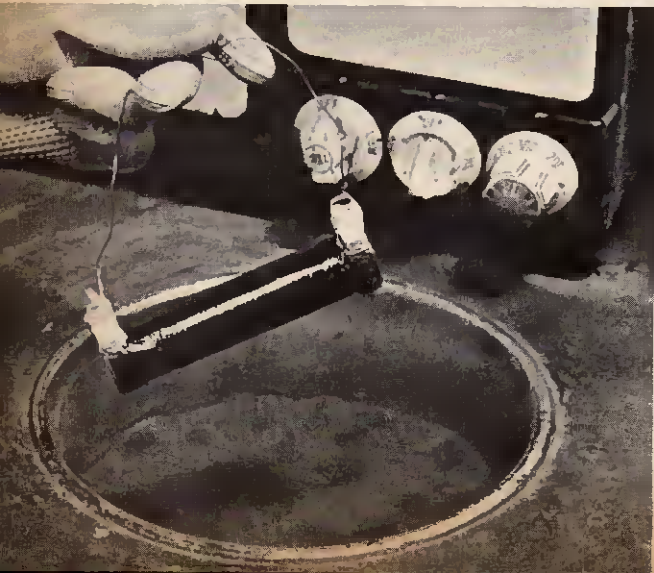

CIRCUIT BOARDS

When reinforced with, for example, glass cloth, epoxy resins can be formed into structures having a high strength-to-weight ratio, excellent electrical properties over a wide range of temperatures, great dimensional stability under varying conditions, and good chemical resistance, etc. Pre-impregnated sheets of epoxy glass cloth, pressure moulded to form printed circuit boards, are rapidly supplanting conventional s.r.b.p. ("Paxolin") in high quality equipment.

CHOICE OF INGREDIENTS

Chemically the resins are derived from epichlorohydrin and diphenylol propane. By varying the ingredients and certain phases of the manufacturing process a series of resins may be produced ranging from rather viscous liquids to hard solids. In the uncured state the resins are thermoplastic with poor mechanical strength. They are converted into hard, tough and substantially infusible materials of high molecular weight, by reaction with a suitable hardener. A wide range of chemical hardeners may be employed and since the hardener takes part in the reaction, the properties of the cured product are not only affected by the type of resin selected, but also markedly by the type of hardener employed.

Some epoxy resin and hardener mixtures will cure at room temperature, while others require processing at elevated temperatures. The ratio of hardener to resin in each case is fixed within narrow limits and departure from the optimum ratio entails loss in performance. The choice of hardener can affect the application viscosity of the mixture, the pot-life and the rate of cure. In general, therefore, pot-life and rate of cure can be varied only by choice of hardener, and not by change of resin : hardener ratio. There are, however, some formulations in which a small and variable addition of an accelerator may be used to adjust the pot-life and cure time of a slow acting resin-hardener system.

FILLING AND COLOURING

The many combinations, and permutations of the several basic epoxy resins and the greater number of hardeners can be extended by even further modifications. The viscosity may be reduced by solvents, plasticisers, and diluents. Some diluents and plasticisers are reactive and can be combined into the final cured product. Diluents and plasticisers reduce viscosity or impart resilience at the expense of strength at elevated temperatures. Inert fillers may be added to the epoxy resin systems for opacity, cheapness, to improve hardness, wear resistance, thermal conductivity, electrical and mechanical properties, to increase viscosity or reduce the co-efficient of expansion or possible exothermic reaction.

Commonly used fillers are silica, mica, chalk, asbestos, glass, and synthetic fibres, etc. Epoxy resins can be dyed, pigmented and pastes of colouring matter dispersed in liquid epoxy resin are available.

Although the number of possible combinations of resin, hardener, plasticiser, filler, and dyestuff is very great and the number of possible applications is equally large, resin formulations for specific purposes are commercially available. At the same time, the ingredient resins and hardeners are available for those who prefer to exercise wider choice or to derive their own formulations.

EPOXY POWDERS

Although much of the early work with epoxy resins in the electrical and electronic industries involved the use of liquid epoxy resins, more recent techniques make use of the resin systems in powder form.

Epoxy moulding powders consist essentially of a partially cured resin-hardener mixture in powder form. In use they are very free-flowing and may be easily moulded round delicate inserts, while thin sections of resin may be moulded round large metal inserts without difficulty. They cure rapidly on the application of heat and pressure with negligible after-shrinkage. As with other forms of epoxy resin, the absence of volatile matter during the curing operation is of particular value.

The moulding powders have a shelf life of some months and are usually stored at temperatures below 25 degrees C. After processing, they possess high insulation strength, excellent dimensional stability, good heat resistance, low water absorption, and good resistance to tracking. They maintain their dimensional stability at elevated temperatures and in adverse climates.

Epoxy moulding powders have been widely adopted for the fabrication of bobbins, relay bases and connectors, and for the protection and insulation of transformers, silicon diodes, ferrite cores, and metal film resistors.

FLUIDISED BED COATING

In the fluidised bed coating technique the powder, based on an epoxy resin system, is placed in a container with a porous base plate. Air is passed through the plate which causes the powder to become fluid. The component requiring protection is pre-heated and placed in the powder which becomes molten with the heat and adheres to the component. The time of

immersion in the powder and the pre-heat temperature of the component determines the thickness of the coating. Subsequent cure may or may not be required depending upon the resin system used. By suitable masking techniques, the protective or insulating film can be placed where required, as for example, in the slots of rotors, eliminating the need for slot liners. The absence of solvents, as may be present in normal coating systems, leads to the elimination of solvent bubbling and solvent entrapment during processing, etc.

Apart from application by the fluidised bed technique, powders can be applied by electrostatic spraying techniques or by processes involving the advantages of both techniques.

"E-PAK" TECHNIQUES

A technique recently introduced to the U.K. and particularly applicable to the packaging of diodes and transistors uses moulded cases and pre-formed pellets of epoxy resin, appropriate in shape and size to the component being protected. As supplied the pellets are dry, non-toxic, and easy to handle. Cure temperature, viscosity, and other physical properties may be varied to meet the requirements of productivity. As in the case of moulding powders and fluidised bed powders, etc., the epoxy pellet in the "E-Pak" process, as it is called, is not fully cured and under the influence of heat it melts, fills the moulded housing containing the components, then sets to form a high strength solid.

LIQUID RESINS

In the same way that an electronic component can be dipped into a fluidised bed powder, it may be protected by dipping into a liquid epoxy resin system. In this case, however, the component is usually at room temperature. The liquid epoxy resin system is formulated to give a thixotropic characteristic so that the resin will not flow from the component during cure. Where the specified requirements are not too high, this system probably offers the cheapest method of encapsulation. It is necessary, however, to take steps to ensure control over the thickness of the coating, since, should this vary, variable performance under high humidity may be obtained and there may also be a tendency for the thinner coatings to crack at low temperatures.

Liquid resin epoxy systems are, however, normally employed by pouring the fluid uncured mixtures into moulds of metal, plaster, plastic or other material by simple gravity casting techniques. Indeed, the term

(right) Rank Pullin amplifier-transmitter units before and after encapsulation

(below) An epoxy cased transistor from the Mullard "Lock-fit" range

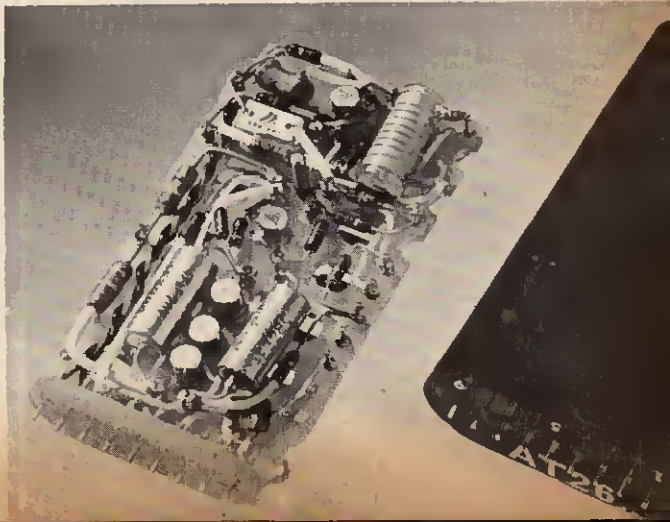
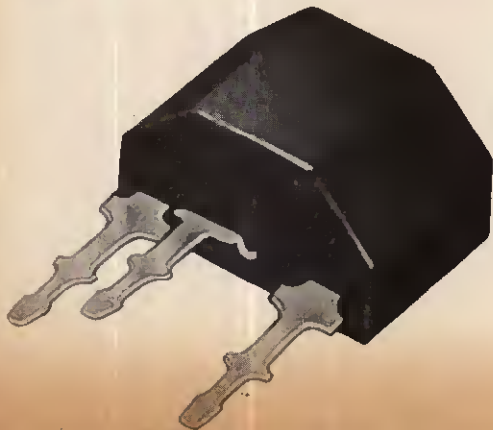

"casting" is normally employed to describe the general process, although it usually implies the production of an insulating or insulated component where the mechanical as well as the electrical properties of the material are important.

Potting, or encapsulation, implies the complete envelopment and embedment of a component or device in a protective mass of the resin, the object being not only to insulate, but also to protect the article being potted against vibration, shock, dust, ingress of moisture, chemical attack, insects, and other environmental hazards. It will be appreciated that such a technique gives a consistent resin thickness around the component being protected.

The basic casting methods are common to both the electronic and heavy electrical industries, but the products are usually different. Resins used for encapsulating electronic devices are usually designed to cure at low temperatures, for obvious reasons.

MECHANICAL REQUIREMENTS

In the case of magnetic materials, which are highly sensitive to pressure, such as some high permeability steels, it is often necessary to exclude contact with the encapsulation resin by making the core external to the casting, or by means of certain more specialised methods. Metal components can be enclosed within the cured epoxy resins, providing that the differences in thermal co-efficient of expansion are considered.

Both thermal contraction and the curing shrinkage may be further reduced by extending the resin mixtures with inert mineral fillers such as silica, mica, slate, and chalk, etc. The use of fillers also reduces possible exotherm, increases the thermal conductivity and reduces the cost. Fillers are invariably used in the production of large castings.

An automatic dispenser is used by Telegraph Condenser Co. for epoxy sealing of capacitors

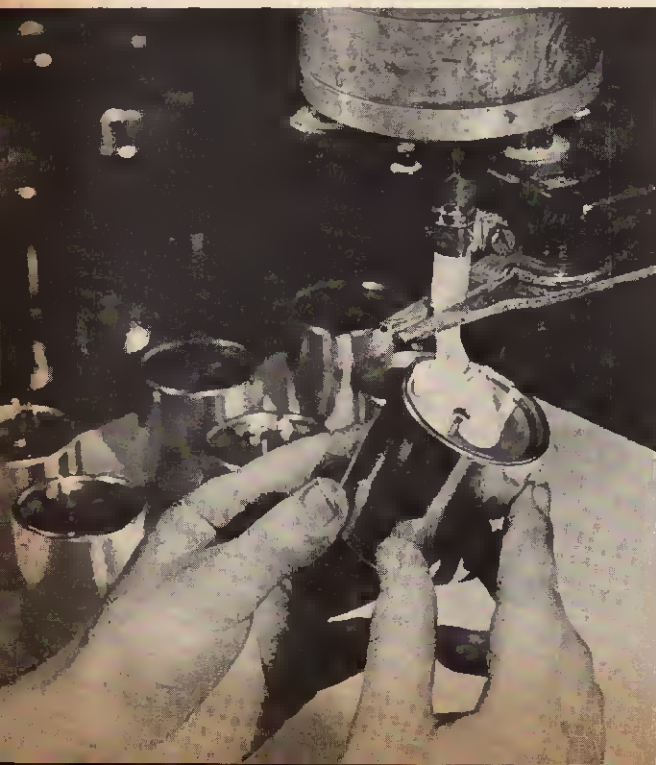

Pye of Cambridge use epoxy adhesives to bond the two halves of ferrite pot cores for telephone equipment

Liquid epoxy resin systems may be used to complete the existing closure, made of metal or insulating material, with which a component has been surrounded, by casting the epoxy resin in the container. For example, components may be placed in metal cans and sealed with a layer of epoxy resin and by this technique the need for relatively expensive sealed outlet bushings may be eliminated.

Certain other liquid epoxy resin systems are specially designed for impregnation. The usual technique is the straightforward vacuum impregnation used in industry, although when considered necessary, vacuum may be followed by pressure.

For the impregnation of windings of electrical machines, such as motors, dynamos, and syncros, liquid epoxy resin may be employed in the trickle impregnation process. Here the wound armatures or stators are exposed, while rotating, to a trickle of freshly prepared solvent-free epoxy resin mixture, for a fixed time at a constant temperature and at an appropriate angle. When the winding is completely filled with the epoxy resin, rotation is continued at a controlled temperature in the horizontal plane until the resin has gelled. Heat treatment may follow.

SOLUTIONS

Solutions of epoxy resins are also employed for impregnation and have advantages over more traditional systems. For example, they are used for the impregnation and bonding of "C-cores", where their adhesive properties are valuable.

Another major application of epoxy resins is their use in surface coatings. Epoxy based primers and finishes find wide application for the protection of refrigerators, washing machines, and the housings of many items of electrical and electronic equipment. ★

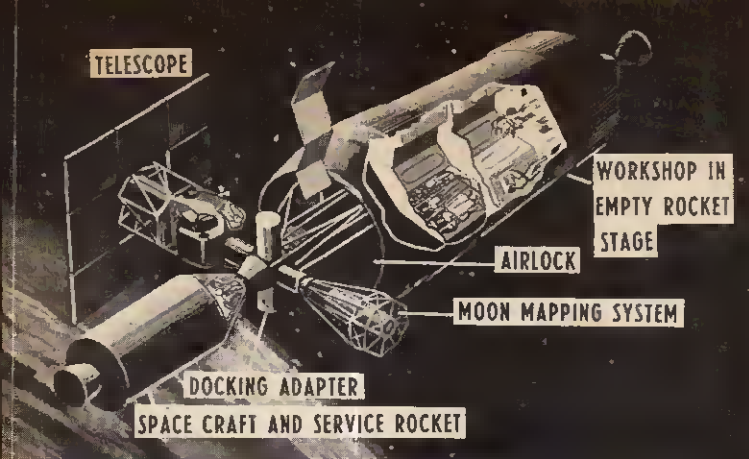

SPACEWATCH

Impression of United States Apollo space station

By Frank W. Hyde

FIRST ASTRONAUT

At the time of writing the sad news of the death of Yuri Gagarin was announced. He will go down in history as the first man in space and who marked the starting point of manned spaceflight. He was an unassuming and pleasant man who seemed quite unaffected by the publicity that his exploit brought him. He continued to lead the Russian cosmonauts though he did not make other spaceflights. This contrasts with the American "first men" who are no longer connected with spaceflight.

RUSSIAN MOON PROGRAMME

It is perhaps appropriate at this point to look a little more closely at the Russian Moon Programme. It has been thought that the general trend of Russia's efforts would be on the space platform technique. They had indicated this on a number of occasions when they gave small cocktail parties at the Soviet Embassy.

Since the successful remote manoeuvring of space vehicles it must be a possibility that Soviet technology has reached a point where they could be very close to the U.S.A. in point of time. The rumours of a special high thrust booster greater than *Saturn V* were circulating some time ago; such a booster could have a thrust in excess of 10⁹lb.

Possibly this has been once more achieved by the same techniques as in the past, namely the group or cluster method. It could be that a circumlunar project is being prepared in which case, if normal Soviet procedure is followed, there will be a first such attempt using dogs. It is rather significant that nine tracking ships came into operation in various parts of the world, some with large radomes aboard.

Such a network would be essential to any moon attempt which is manned. It is known that the astro-

nauts are having training for water landings, since a circumlunar attempt would probably require a landing somewhere on the equator.

VOICE OPERATED DEVICES

From time to time a certain Hungarian, Lazlo Telcs, has made headlines with his voice operated devices. Though some of these led to rather embarrassing incidents it did not minimise the importance of this development of electronic techniques.

A number of organisations have tackled this problem and now comes news from RCA that under contract for the American Air Force they have under development an advanced project for astronauts. The advantages of such a system are that the astronaut would have his hands free for tools, cameras, control of a personal jet system, etc. while being able to instruct other devices.

The technique of speech recognition has reached a stage where such variations as local dialectal differences can be accepted. There is a name for this type of recognition. The word "Phoneme" indicates the smallest part of speech sound that can be distinguished. The "f" in "fin" for example is one.

GROUND STATIONS

Cable and Wireless Ltd. will be setting up two new ground stations for public service. Scheduled to be in operation by May 1969 they will be constructed at Hong Kong and Bahrain. A contract has been placed with The Marconi Company covering the aerial structure and associated electronic equipment. The cost will be of the order of £2.1 million. The total cost to Cable and Wireless for this service will be about £3.5 million.

These two stations will operate through the *Intelstat 3* satellites. The aerial dishes will be 27 metres in diameter and will be mounted on 18 metre towers. They will be fully

steerable in order that they may follow satellites in any orbit.

The Hong Kong station will be concerned with the satellite over the Pacific and will be located on Stanley Peninsula. The Bahrain station situated at Abu Jajur will operate through the other satellite over the Indian Ocean. There will be a direct service from London to Japan, the U.S.A., Hawaii, Australia, Thailand, and the Philippines.

It is hoped by 1970 that another satellite *UK-4* will be launched. A design study has been completed. There would be a repeat of the experiments performed by *UK-3* with three new additions. Three of the previous experiments need to be repeated for they were spoiled to some extent by mutual radio interference. All three were in the low frequency range of the radio spectrum.

OPTICAL TELESCOPE IMPROVEMENTS

One of the problems in the optical field is getting enough area to gather the maximum amount of light since this determines limits of resolution. A recent successful system has now been developed which virtually makes a mirror ten times larger. This electronic system called the Boyd-Boksenburg Charge Image Reader is to be fitted to the new Isaac Newton Telescope at Herstmonceux.

The inventors were Prof. R. L. F. Boyd and Dr. A. Boksenburg of the Mullard Space Science Laboratory at University College London. The system has been patented and is on the production line.

Tested on the Isaac Newton Telescope it gave an effective mirror diameter of 2,500cm. The system uses a highly insulated electronic storage plate backed by a conducting plate on which the optical image is directly converted to a charge image by photo-emission. The image is "read" by the proximity of a vibrating probe. The distance between the probe and the plate is of the order of ten microns. The rapid change of capacitance results in an alternating current flow which is directly proportional to the quantity of charge. When amplified it results in a picture when the probe scans the area.

The method differs from ordinary television scanning in that the image is not destroyed during the scan and it is therefore possible to build up the picture element till it reaches a suitable value to be useful.

There are many great advantages to be derived from this device. A photographic image may take hours to expose where this method takes minutes, and in addition there is no grain to mar detail. Moreover the direct readout eliminates the processing of film and the attendant techniques, and not least avoids the uncertainty of the success of the exposure.



A LIGHT OPERATED CAMERA TRIGGER

By A. FOORD

THERE are frequent occasions when one would like to trigger some apparatus into operation without being present to operate it oneself. Examples of some applications are burglar alarms, counting circuits, photography, and so on.

In photography, a birdwatcher is a special case. All too often the bird, or indeed any animal, can be heard, but one has to wait patiently for some time before it will show its face. In the time it takes to set up a camera to photograph the subject, it could have vanished as unexpectedly as it appeared.

What is required, then, is some device that could be set up in the field ready to trigger the camera without undue loss of time. Such a device is described here and was designed to fulfil the following requirements, bearing in mind the use of the photo-electric principle of breaking a light beam.

1. To respond to the fast or slow movements of birds or animals.
2. To be unaffected by very slowly changing external light, such as daylight.
3. The distance between the light source and the triggering unit had to be as great as possible to avoid the animal scenting the photographer.
4. The unit should be lightweight, portable, and have low power consumption.

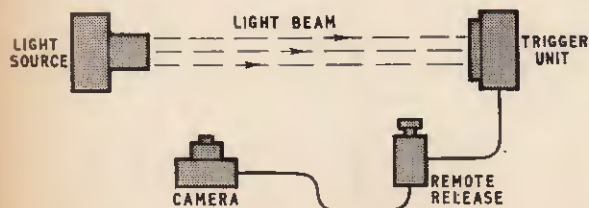

Fig. 1. Diagram of the camera trigger set-up

5. As most animals are sensitive to white light but not to red, a dark red filter was placed over the light source to render the beam inconspicuous.

SHADOW TRIGGER

The system used is illustrated in the block diagram Fig. 1. The complete circuit is given in Fig. 2. The drop in light intensity on the photocell, caused by the shadow of the subject, is used to trigger a monostable multivibrator. A low power lens, such as found in a watchmaker's eyeglass, was found to be suitable for directing the light onto the photocell, in this unit a phototransistor TR1. The eyeglass can be obtained quite easily through large well stocked toolmerchants.

Transistors TR2 and TR3 comprise the multivibrator, and TR4 operates the relay.

Consider at some instant that TR1 is illuminated. When the unit is switched on TR3 will conduct, since its base is returned via R7 to the negative rail. Thus TR3 collector-emitter voltage will be almost zero, and TR2 and TR4 will be cut off. The circuit will remain in this state indefinitely unless compelled to change by an externally applied signal. If the light beam is cut, a negative going pulse will be applied to TR2 base, making TR2 conduct and produce a positive pulse at its collector. This pulse is applied via C2 to the base of TR3, cutting it off. A negative pulse appears at TR3 collector and is applied to TR4 base; TR4 conducts to pull in the relay.

The circuit is now in the second of its two possible states: TR2 conducting, TR3 cut off, but will not remain in this state for long because C2 (which was charged up when it conducted the pulse from TR2 to TR3) immediately begins to discharge through R7 and the output circuit of TR2. As C2 discharges, TR3 base becomes less positive until TR3 conducts again. The circuit is now back in the stable state.

In brief, when the beam is interrupted, the unit changes from its stable state (TR3 conducting; TR2, TR4 cut off) to an unstable state (TR3 cut off; TR2, TR4 conducting) and operates the relay. The duration of the latter condition is given by $t = 0.69R_7C_2$ seconds.

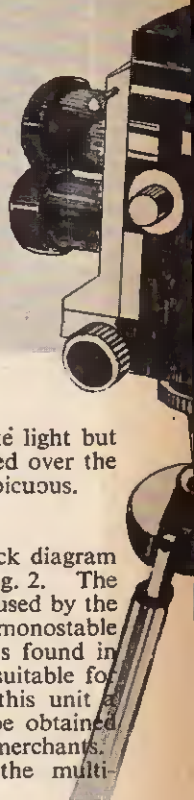

COMPONENTS . . .

Resistors

- R1 18k Ω
- R2 3.9k Ω
- R3 120k Ω
- R4 150k Ω
- R5 3.9k Ω
- R6 15k Ω
- R7 39k Ω
- R8 3.9k Ω
- R9 4.7k Ω

All 10%, $\frac{1}{2}$ watt carbon

Capacitors

- C1 8 μ elect. 15V
- C2 8 μ F elect. 15V
- C3 0.002 μ F paper or polyester

Transistors

- TR1 OCP71 (phototransistor)
- TR2, 3, 4 OC201 (3 off)

Diodes

- D1, 2, 3 OA81 (3 off)

Relay

- RLA 185 Ω 6V type MH2 (Keyswitch Relays)

Miscellaneous

- BY1 Battery 6 to 12V
- M1 Meter 0-1.5mA f.s.d.
- JK1, PL1 Jack with two break contacts and plug
- Sockets for wander plugs (2 off)
- S1 Single-pole, on/off, toggle switch
- Light source (bicycle lamp)
- Red filter (Ilford No. 608)
- Component tagboard, 10 pairs of tags
- Diecast box $6\frac{1}{2}$ in \times $4\frac{1}{2}$ in \times $2\frac{1}{2}$ in or similar
- Watchmaker's eyeglass
- Battery retainer and clips
- Insulation board, s.r.b.p., 4in \times 3in



The complete light operated camera trigger control

rectangular pulses generated at the collectors of TR2 and TR3 are sharp edged, so that the monostable changes state rapidly.

SIMPLE TO MAKE

The diode D1 may be any small signal type, while D3 prevents the high back e.m.f. from the collapsing magnetic field of the relay from damaging TR4. D2 is inserted to prevent damage if the battery connections are accidentally reversed. Relay RLA could be any 6V type requiring up to 30mA to operate it (see components list).

The construction used for the unit would vary according to the needs of the constructor; a diecast box is ideal for this to exclude unwanted light. Fig. 3 shows the tagboard wiring and tagboard component positions. The photograph shows the layout in the box, this will depend to a large extent on the focal length of the lens used. The one in the prototype has a 2in focal length.

For a lens of short focal length the phototransistor can be mounted on the back of the box as shown, with the lens mounted in a hole in the box lid. The trigger unit is connected to one of the remote camera releases available commercially, these usually consist of a solenoid released plunger, operated from a battery when a contact is made.

For the values shown the relay hold-in time is about 0.2 seconds. If this time is not sufficient (in any particular case) it may be increased by increasing the value of C2.

It is usually desirable for the unit to operate with the minimum of time lag, the addition of C3 gives appreciable feedback at high frequencies, and ensures that the

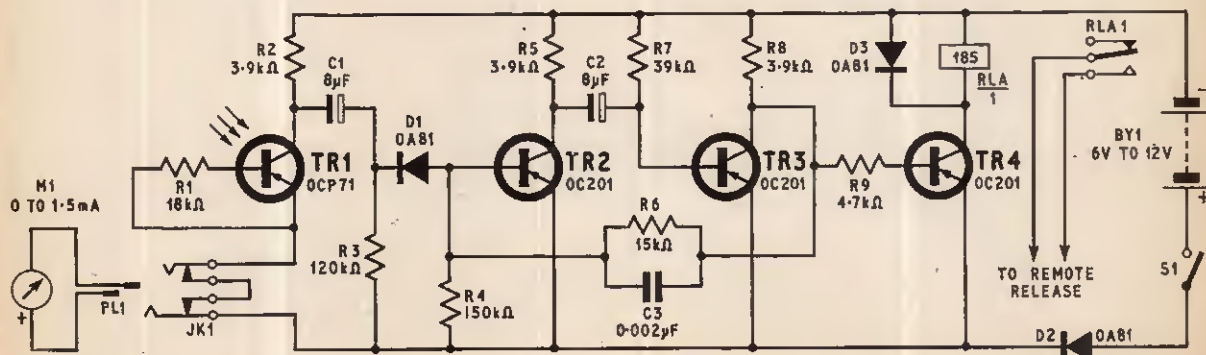

Fig. 2. Complete circuit of the trigger unit

The meter M1 in series with TR1 is for setting up, and is externally connected via a jack JK1, with break contacts to short the jack when not in use.

The phototransistor is mounted as shown in the photograph so that the emitter junction is facing the lens. This can be seen through the glass envelope and recognised as the side of the base (square piece) with the largest "blob".

SETTING UP PROCEDURE

Using an ordinary bicycle front lamp, reliable operation can be achieved with a beam length of over 40ft without the filter, and 20ft with the filter. The light source and trigger unit are mounted on camera tripods. The light source should not be run from a.c. supplies, otherwise unreliable operation will result.

Point the light source in the required direction and switch on. Arrange the trigger unit in the path of the light beam and switch on; the leads to the remote release should not be connected at this time.

Swing the trigger unit vertically and horizontally until M1 reads a maximum. Lock the trigger unit in this position; the light is now focused on TR1. For reliable operation M1 should read at least 0.5mA. There is no point in providing enough light to give more than 1mA current, so the intensity of the light source should be adjusted according to the range required.

Remove the meter from JK1. Now, by passing the hand through the light beam you should hear the click of the relay. The output sockets can be temporarily connected to an ohmmeter, or a series bulb and battery, to ascertain that the relay is actually switching. If all is in order, connect the remote release to the trigger unit and all is ready for photographing, provided the camera is aimed at the light beam, where the subject will be. ★

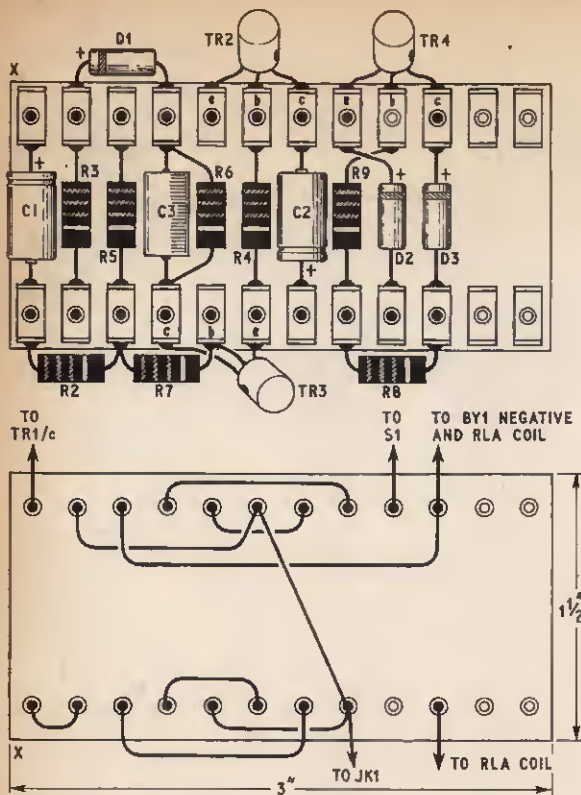
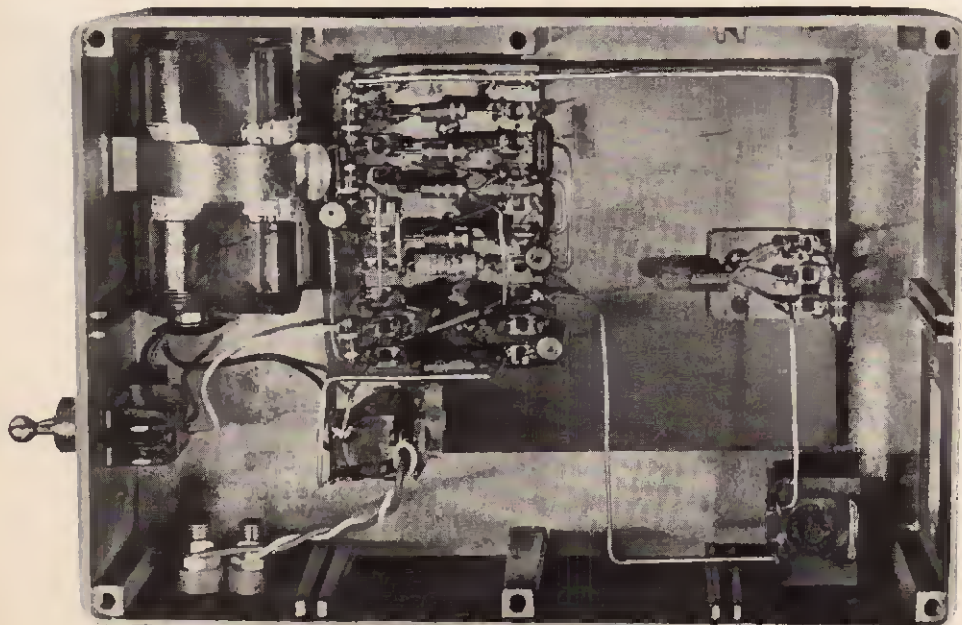

Fig. 3. Component layout and wiring of the tag board in the trigger unit



Interior view of the trigger unit showing layout of all components and interconnecting wires. Note the positioning of the phototransistor must line up with the lens mounted on the lid.

nucleonics

for the EXPERIMENTER

By M.L. Michaelis M.A.

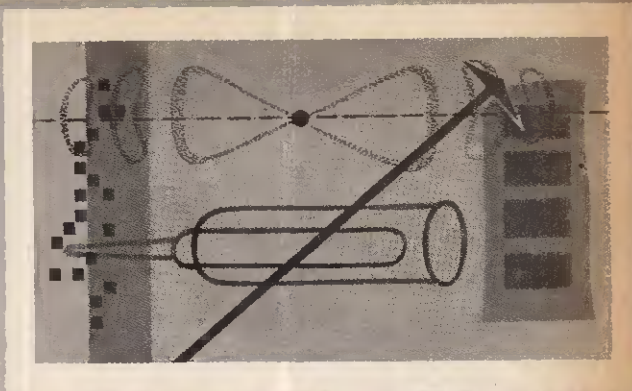

8—STRACE RADIATION METER (Continued)

LAST month the ratemeter module of the STRACE radiation meter unit, was described. Before going on to consider the other sub units which make up the complete unit, a few remarks concerning chart recording will be appropriate.

CHART RECORDING

The circuit of Fig. 7.1 illustrates all essential features of a modern ratemeter possessing high efficiency and excellent stability with respect to time and temperature. This circuit is eminently suitable for *chart recording*.

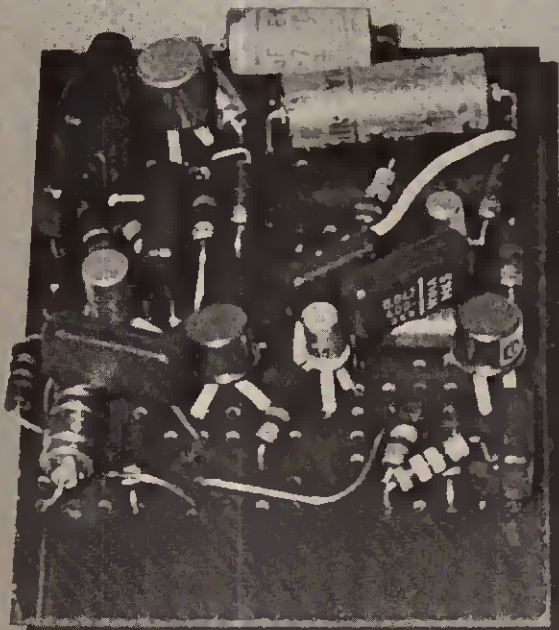

One of the pip generator modules of the STRACE Radiation Meter

The recommended chart recorder is the model "Metrawatt, Multiscript 3" obtainable from Messrs. Smiths Electric Clocks Ltd. This is a precision multimeter, which may also be used as such and possesses a scale and pointer in the usual arrangement. The pointer is a sharp knife-edge type and hovers above special pressure-sensitive waxed paper obtainable in rolls from the same makers. This paper carries the same scales across its width, and is driven forwards by a small mains synchronous motor, at a rate selectable with an internal lever. The motor at the same time drives a stirrup via a cam, causing the stirrup to drop onto the pointer once every two seconds. The knife-edge thereby strikes the waxed paper and makes a black mark. For chart-recording with the STRACE equipment, the Multiscript 3 should be set to the 1mA f.s.d. range and the paper speed lever to 20mm/hour.

Chart recording enormously enhances the scope of a ratemeter, for two important reasons. Firstly, the gradual decay of the activity of samples with short half-lives is thereby traced directly. It would be most inconvenient to sit and watch the panel meter for such purposes. Secondly, even when measuring long-life samples with insignificant decay over the time of recording, it is readily possible to draw a mean straight line through the residual random fluctuations of the recording. This leads to an effective statistical accuracy considerably better than the nominal design figure of 5 per cent for panel meter readings. In other words, chart recording brings the overall accuracy to a figure at least as good as the read-off accuracy of the chart recorder itself.

The long-term stability of the circuit of Fig. 7.1, when properly adjusted, is so good that the recordings are dead straight lines for days on end with no input pulses, or with a fixed input frequency from a crystal-controlled pulse generator, even if ambient temperatures and mains voltage fluctuate in the meantime. This zero-point stability is of course essential for reliable chart recording in the 2 per cent accuracy class.

ADJUSTMENTS

A source of standard pulse frequencies is required. These may be obtained from a crystal-controlled generator, or from any simple pulse generator (e.g. the Heathkit IG 82) which is tuned accurately to successive harmonics of the 50Hz mains by observing Lissajou figures on an oscilloscope.

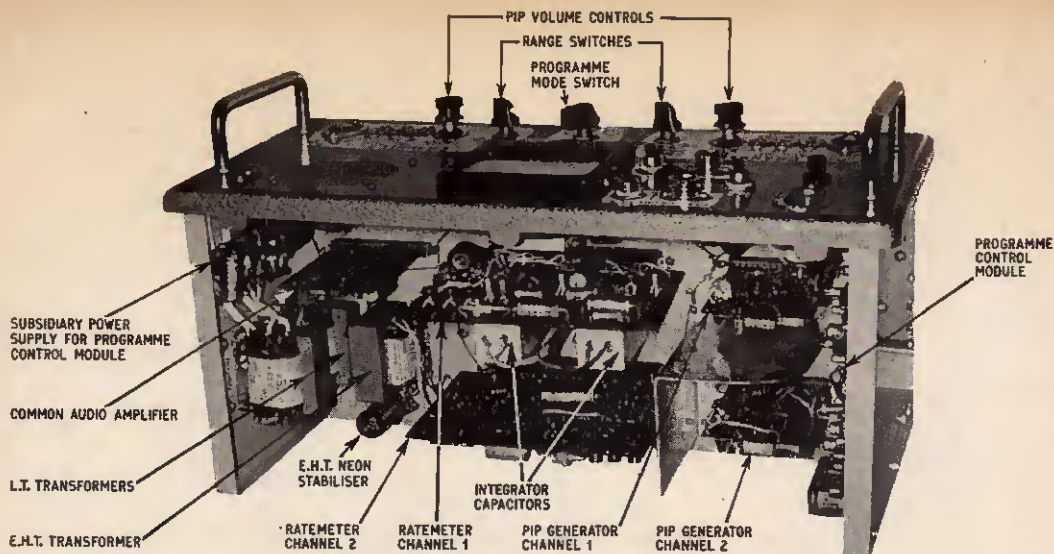

The STRACE Radiation Meter

First of all, switch to Range 1 and adjust VR3 for 10 per cent f.s.d. on meter and chart recorder. Then back-off both devices with their mechanical pointer setting screws, to give zero scale readings.

Now switch to range 4 and tune the pulse generator to the third harmonic of the mains (150Hz). Adjust VR5 to obtain meter reading 9,000 c.p.m. Then retune to 50Hz and correct with VR7, if necessary, to read exactly 3,000 c.p.m.

Repeat adjustment of VR5 and VR7 alternately until no further improvement.

Switch to range 3. Adjust VR6 for zero scale reading

with no input. Switch to range 1 and connect-up a G.M. counter detector unit without sample, i.e. counting solely the cosmic radiation background of about 40 c.p.m. Determine the true c.p.m. value by counting the pips in the loudspeaker (see below) and timing with a stopclock or watch with seconds hand. Adjust VR4 for correct reading. Wait at least 5 minutes between successive adjustments of VR4. Finally, feed positive pulses of 2V amplitude to PL2, or 5V amplitude to PL3, using pulse generator and oscilloscope. Adjust VR2 such that pulse expander just triggers, i.e. pips just audible in the loudspeaker.

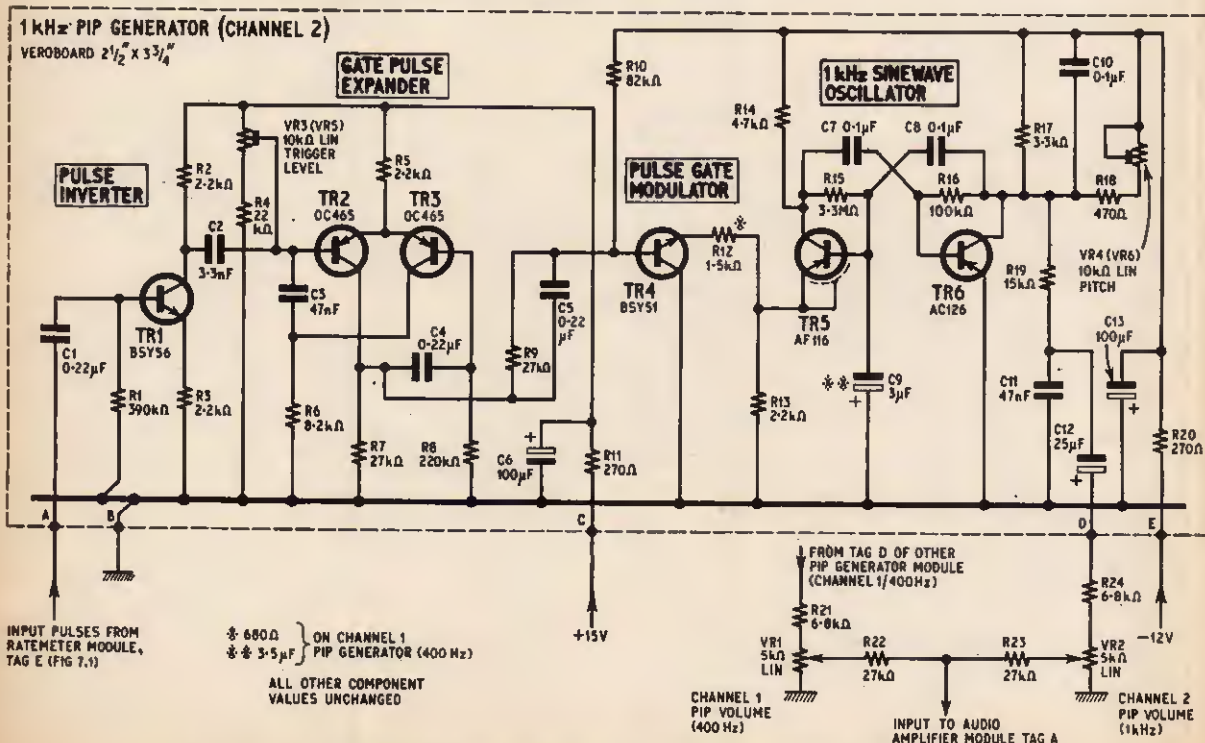
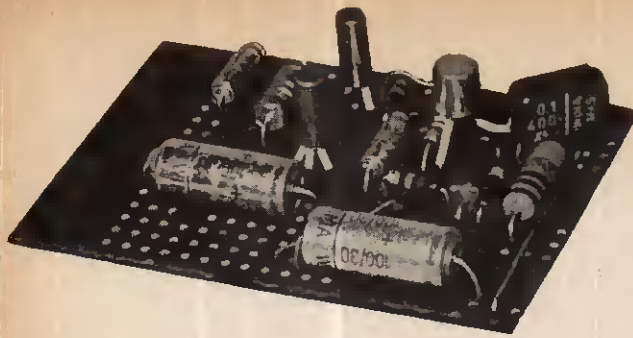

Fig. 8.1. STRACE RADIATION METER: circuit diagram of the pip generator module



The audio amplifier module of the STRACE Radiation Meter

Now to resume discussion of the remaining circuitry of the radiation meter.

THE PIP GENERATORS

Fig. 8.1 shows the full circuit of the pip generator module. The layout and semiconductor types are not critical, and it is possible to accommodate this circuit on a 2.5in x 3.75in piece of Veroboard.

We saw that the pulse integration time is 160 seconds ($40\mu\text{F} \times 4$ megohm) on ranges 1 and 2, so that individual pulses produce little or no visible change in the meter reading, and the final meter reading is not reached until about 10 minutes have elapsed. Some means of getting a rough immediate idea of the pulse rate is therefore essential, for selecting an appropriate range and for checking that the detectors are working correctly. This function is achieved acoustically, by making each pulse from the detector produce an audible pip in a small loudspeaker.

The STRACE radiation meter possesses two identical ratemeter channels according to Fig. 7.1, and thus also two pip generators according to Fig. 8.1. The latter differ only in the pitch of the pips they produce, so that the two channels can be distinguished when sounding

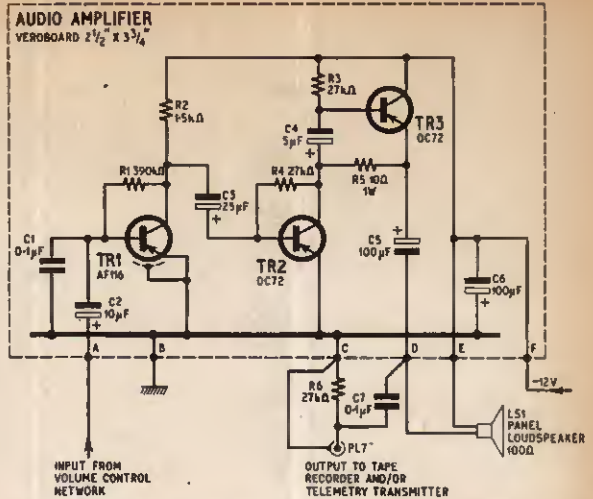

Fig. 8.2. STRACE RADIATION METER: Circuit diagram of the audio amplifier module

simultaneously in the loudspeaker. Channel 1 sounds 400Hz pips, whilst channel 2 sounds 1kHz pips. The components C9 and R12 in the respective pip generators are selected accordingly, and VR4,6 adjusted to give the respective pip pitches.

SINWAVE OSCILLATOR

The pump pulses from the ratemeter are also fed out via R18 of Fig. 7.1 to the pulse inverter TR1 of Fig. 8.1. This triggers another expander, which produces the much longer gate pulse for generating a pip of audible duration. This gate pulse drives the modulator TR4, which keys an RC sinewave oscillator of the suppressed-harmonic multivibrator type. This circuit keys very neatly to give accurate bursts of sinewave oscillation of about 20 cycles per burst.

continued on page 421

Fig. 8.3. STRACE RADIATION METER: Circuit diagram of the power supply section

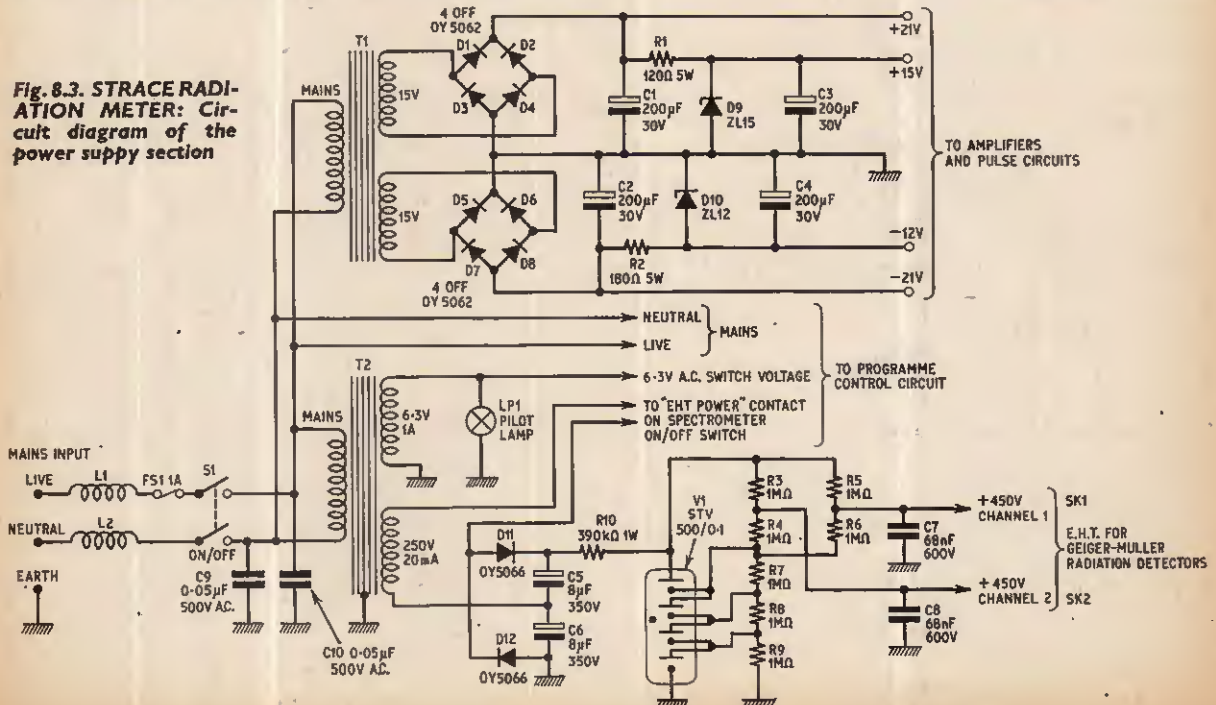



IN THIS feature we hope, from time to time, to be able to publish suggestions submitted by some of our readers on the possible improvement of projects previously described in PRACTICAL ELECTRONICS; short contributions on other subjects may be included. The aim is not to find fault or undermine the abilities or knowledge of our contributors. It may well be that the original article is *par excellence* but it could be improved or adapted to suit individual requirements. The views expressed by readers are not necessarily those of the Editor.

ADDING AN "X" AMPLIFIER AND SCRIBING THE GRATICULE

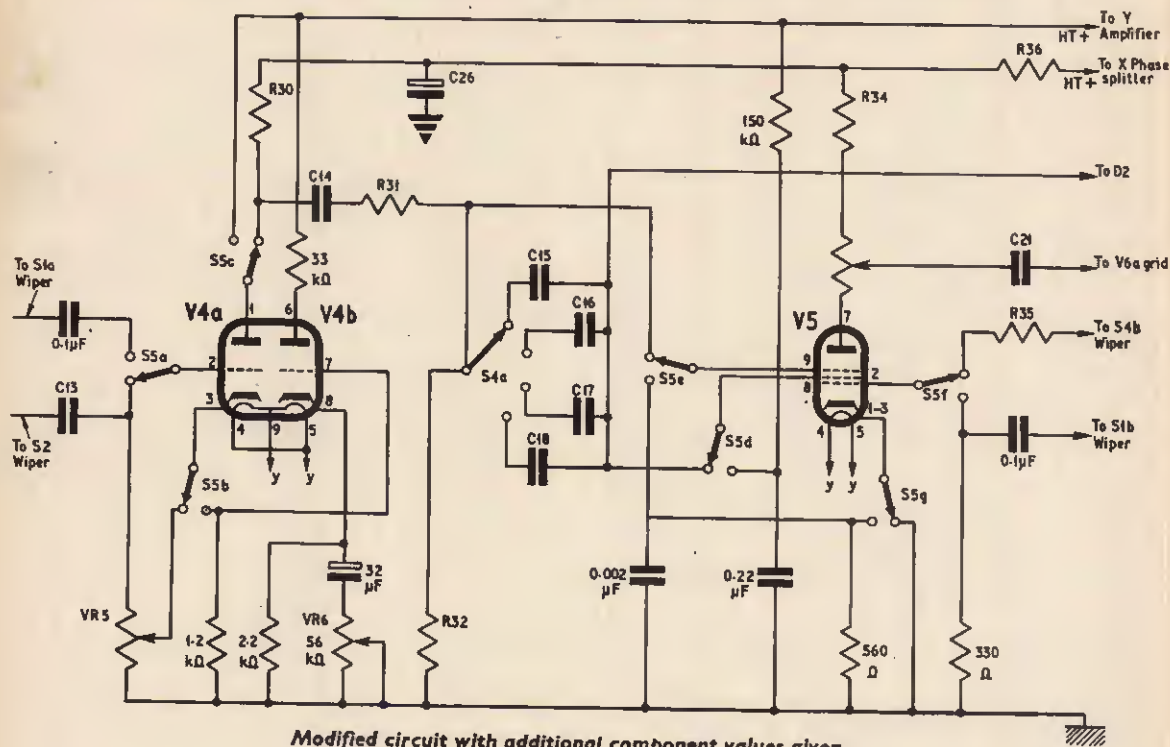

HERE is one suggestion for putting the spare valve to good use in the *Investigator Oscilloscope* (July 1967). Rather than add more valves the unused V4b is wired so that the timebase can be switched to bring in an X-amplifier in its place, using a 7-pole 2-way switch.

The circuit is simplified by the omission of the time base range and attenuator switches and several other components. The new X-amplifier is identical to the Y-amplifier and the setting of VR6 should be determined by trial and error.

Constructors wishing to build this unit are referred to *The Oscilloscope and its Applications* (March and April 1967) which covers the measurements that be undertaken using an X-amplifier instead of a timebase circuit.

And now another small addition to the *Investigator Oscilloscope* which might prove useful. When the lines on the perspex graticule are being scribed it will improve the accuracy of the reading taken if lines are scribed on *both* sides of the perspex.

This acts in the same way as the Mirror Scale on some of the more expensive multimeters, that is when the pointer and its image in the mirror coincide, then the eye is directly above the pointer and the reading is the most accurate in this position. The point where the image and pointer coincide is known as the position of no parallax. It is important to be directly above the reading to be taken because if the meter is being read from an extreme angle a considerable error is incurred.

To apply this method to the Oscilloscope the head should be moved about until the lines on the outside of the graticule coincide with those on the inside. Thus more accurate readings can be taken.

It might be found that the lines on the outside of the graticule may lose their layer of black wax with constant use so it may be advantageous to place another piece of perspex in the front of the graticule to preserve the lines.

I. W. Berry,
Huddersfield.

READERS may be interested in the following White Noise Generator circuits, having seen the article published in the January 1968 issue. The circuit in Fig. 1 was derived from the Bonanza Board *Simple Pre-amplifier* and *Treble Booster* described in the March 1966 issue. The components shown in dotted lines are those omitted from the original circuit, also the printed circuit board for the noise generator and the pre-amplifier are identical. All that is necessary to convert the pre-amplifier into a noise generator is the replacement of D1, the base-emitter bias diode, by a device having a poor reverse resistance in the region of 5 to 10 kilohms. Also it is important to omit the original diode bypass capacitor as this attenuates the high frequency output.

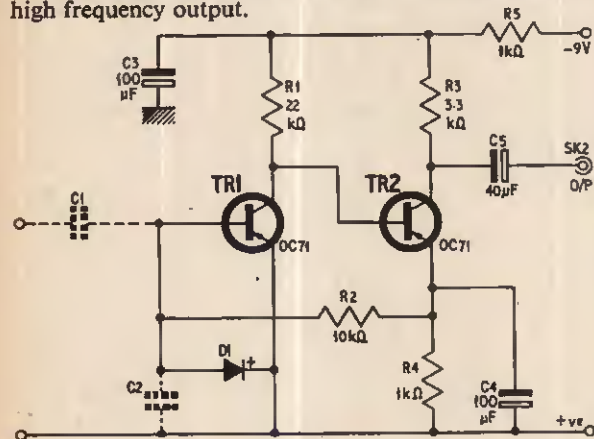

Fig. 1.

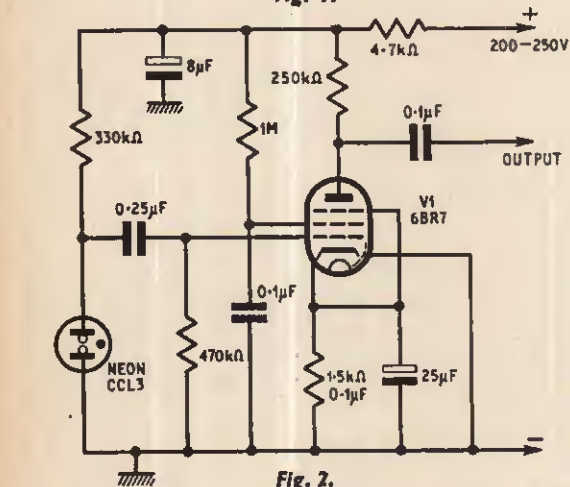

Fig. 2.

The circuit in Fig. 2 relies on the movement of heavy particles due to the ionised gas in a miniature neon indicator to produce white noise. The neon used may be of the type used as mains warning indicators provided that it has no integral series resistor. If construction of this circuit is contemplated it must be remembered that neons tend to be susceptible to mechanical shock when used in this application, and thus the unit gives best results if fitted with anti-vibration mountings.

S. A. Hardy,
Chippenham, Wiltshire.

Adjust VR3,5 such that triggering is secure. Then adjust VR4,6 to give correct pitch of the pips. If the oscillator bursts into continuous oscillation before correct pitch can be reached with VR4,6, judiciously increase the value of C9. Continuous oscillation also results if VR3,5 is turned too far towards R4, but this can be distinguished by its staccato form, as compared to a pure sinewave squeak if too low a value of C9 is the cause.

THE AUDIO AMPLIFIER

Fig. 8.2 shows the circuit of the common audio amplifier, using three readily available germanium transistors. TR1 is a driver stage for the series-push-pull output stage TR2, 3.

This simple circuit develops about 75mW output power and is thoroughly recommendable for monitoring purposes in general electronic equipment. Layout is again quite uncritical, and accommodation on a piece of 2.5in x 3.75in Veroboard, or even smaller, is a simple matter.

If a 100 ohm speaker is unobtainable, any other impedance may be fed from a suitable matching transformer (e.g. about 4.5 : 1 ratio step-down for a 5 ohm speaker). The exact ratio for the transformer is not critical, and a sub-miniature component is satisfactory.

Returning to Fig. 8.1, it is seen that the outputs of the pip generators are fed via respective front panel volume controls to the common audio amplifier. Either channel may thus be sounded alone at any desired volume, or both may be sounded together, whereby distinction is still possible by virtue of the different pitches. Both volume controls may be turned to zero when running the equipment on automatic chart recordings overnight, and noise is thereby undesirable.

It is of course equally possible to construct a radiation meter with only one ratemeter module, with or without a pip generator and audio amplifier. Or a single pip generator may be provided, which can be switched to either ratemeter module at will.

POWER SUPPLIES

Fig. 8.3 shows the power supply circuit providing all voltages for the circuits of Figs. 7.1, 8.1, and 8.2. The bridge rectifier and smoothing circuits with Zener diode stabilisation associated with TR1 are conventional.

D9 is a 15V power Zener diode and D10 a 12V power Zener diode. Both are rated for at least 750mW dissipation without cooling fin. The 250V winding of TR2 feeds a voltage doubler circuit for the e.h.t. supply for the specified G.M. counter detectors (450V stabilised). D11 and D12 may be any standard television silicon h.t. rectifier or other mains type.

V1 is a Noval-based Telefunken valve containing four miniature neon stabiliser sections of 125V running voltage each. Four separate neons or Zener diodes of equivalent rating may be used in series as alternatives.

The a.c. input to the e.h.t. rectifier circuit is switched via an extra contact on the scintillation spectrometer switch. Thus the G.M. counter detectors are automatically switched off when power is switched on to the scintillation detector/kick-sorter amplifier unit, and vice versa. The pulse cables of both types of detector units may be left connected to the radiation meter.

This completes our survey of the pulse processing circuits employed in a very typical analogue radiation meter. We have seen that two parallel channels are here provided. Professional equipments may use much greater numbers of parallel channels. These can be run on entirely independent experiments, but more commonly some form of coordination for a single composite experiment is required, since this is the only real justification for including more than one counting channel in a single equipment. The channel coordinating circuits are known as the *programme control* section of nucleonic equipment.

Next month: Programme control circuits.

Transistor Amplifier DESIGN

5 NEGATIVE FEEDBACK

By A. Foord

LAST month's article gave an outline of the theory of negative feedback principles. Continuing now with this subject, the virtual earth amplifier is described in relation to feedback; later on, negative feedback will be shown to have an influence in designing tone control networks.

VIRTUAL EARTH AMPLIFIER

For a "virtual earth" amplifier, an inverting amplifier is used and the output taken directly back to the input (see Fig. 5.1) via the feedback resistor R_2 . The open loop gain of the amplifier is \bar{A} where the bar indicates phase shift of 180 degrees. R_3 represents the input impedance of the amplifier; R_2 and R_1 determine the gain with feedback.

In the analysis we assume that R_2 and R_L do not load the output of the amplifier. Since the gain A is large, the voltage V at point A will be small (V_o/A) for practical values of V_o , so this point is often called a "virtual earth". The larger is A the smaller will be V . Taking into account the shunting effect of R_3 and the finite gain for A , the overall actual closed loop gain

$$G' = \frac{V_o}{V_i} = - \frac{R_2}{R_1} \times \frac{1}{1 + \frac{R + R_2}{AR}}$$

where R is R_3 and R_1 in parallel

$$R = \frac{R_1 R_3}{R_1 + R_3}$$

If A is large this simplifies to

$$\text{Ideal closed loop gain } G = \frac{V_o}{V_i} = - \frac{R_2}{R_1}$$

Provided A is large the gain is determined by the feedback resistors; taking a practical example we can compare the results between the actual and ideal formulae.

If $R_1 = 1 \text{ k}\Omega$ $R_2 = 10 \text{ k}\Omega$ $R_3 = 10 \text{ k}\Omega$ $A = 50$

(a) Using the accurate formula:

$$R = \frac{R_1 R_3}{R_1 + R_3} = \frac{10}{11} = 0.91 \text{ kilohms}$$

$$G' = -10 \times \frac{1}{1 + \frac{10.91}{50 \times 0.91}} = -8 \text{ times} \\ = 18 \text{ dB}$$

(b) Using the ideal formula:

$$G = -10 \text{ times} = 20 \text{ dB}$$

We aimed for a gain of 20dB and obtained 18dB, so that when A is only 5 times the required closed loop gain and R_3 is only ten times R_1 , the error in using the ideal formula is small, 2dB in this case. If A had been larger (say 100) the error would have been smaller, as we would expect from our theory on feedback in general.

It can be shown that the impedance at the virtual earth point A is given by:

$$Z_A = \frac{R_2}{A}$$

If $R_2 = 10 \text{ kilohms}$ and $A = 50$

$$Z_A = \frac{10^4}{50} = 200 \text{ ohms}$$

This low impedance at this point is another reason for calling this a "virtual earth". If we consider the complete amplifier including R_1 , then

$$Z_i \approx R_1$$

The output impedance of the amplifier (Fig. 5.2) without feedback is represented by Z_o' and could be of the order of 100 ohms if the last stage of the amplifier is an emitter follower. The output impedance with feedback is given by

$$Z_o = \frac{Z_o'}{A} \times \frac{R_2}{R_1} = 20 \text{ ohms}$$

The output impedance is reduced. The frequency response is improved by a factor of AR_1/R_2 at each end.

If the amplifier had its upper 3dB point at 6kHz then, if as before, $A = 50$, $R_1 = 1,000$, $R_2 = 10,000$ the 3dB down point is improved by $(50 \times 1)/10$ or 5 times, to become 30kHz. Similarly at the low end, the lower 3dB down point might be extended from 200Hz to 40Hz (Fig. 5.3).

SHUNT LOCAL FEEDBACK

The simplest method of applying this feedback is around a single common emitter stage, see Fig. 5.4. As one might expect, the effect of decreasing R_2 is to decrease the gain and increase the bandwidth of the overall response (Fig. 5.5).

It is desirable to make R_L high in order to increase the open loop gain of the amplifier, but unfortunately this means that R_L will be loaded by the next stage, so that it is not possible to predict closed loop gain by the above formula. By feeding R_L into an emitter follower, a better arrangement is possible, see Fig. 5.6a.

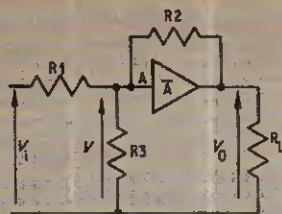

Fig. 5.1. Basic configuration to illustrate the "virtual earth" amplifier

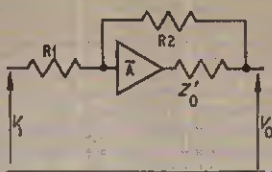

Fig. 5.2. Output impedance without feedback is Z'_0

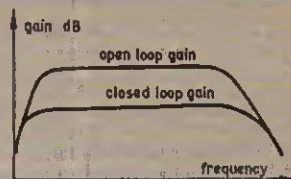

Fig. 5.3. Extended frequency response by using negative feedback

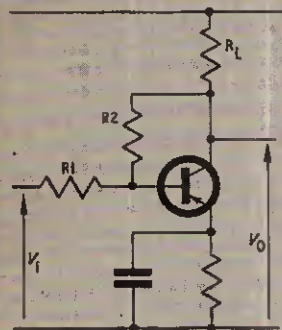

Fig. 5.4. Simplest form of negative feedback through R_2 , which is also used to bias the base

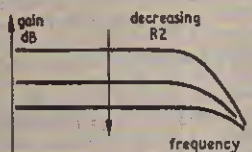

Fig. 5.5. Effect of decreasing the value of R_2 in Fig. 5.4 to increase bandwidth

The collector load of TR1 is no longer loaded by R_2 , the output impedance of the amplifier is already low and is further decreased by the feedback, and R_3 will not shunt the virtual earth point to any extent. The open loop gain V_0/V was about 300 times, which agrees with the similar figure obtained when using this amplifier previously for series local feedback.

$$\text{Closed loop gain} = \frac{R_2}{R_1} = \frac{39}{3.9} = 10 \text{ times} = 20\text{dB}$$

$$Z_i = 3,900$$

$$Z_o = 10 \text{ ohms}$$

$$\text{Maximum output} = 500\text{mV r.m.s. into } 1\text{k}\Omega$$

Without the capacitor across R_2 , the amplifier has a bandwidth of 60kHz; with 180pF across R_2 the bandwidth is restricted to about 22kHz (see Fig. 5.6b).

Since this amplifier needs to be fed from a source impedance low in comparison with R_1 , it can be fed either from an emitter follower or from the output of a similar circuit. These amplifiers can therefore be cascaded without interaction, the maximum output of 500mV into 1 kilohm is governed by the emitter current of TR2.

For a similar stage which presented a load of 3.9 kilohms a larger signal could be handled. If this amplifier needed to feed 500mV r.m.s. into a power amplifier which actually had a low impedance of the order of 1 kilohm, it might be better to reduce the emitter resistor of TR2 from 4.7k Ω to, say, 2.2k Ω so that there was no danger of the amplifier limiting.

The polarity of the input capacitor assumes that the amplifier is fed from a similar amplifier or an emitter follower.

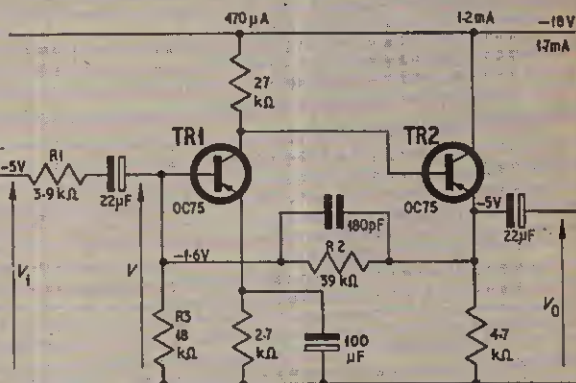

Fig. 5.6a. To avoid heavy loading of the amplifier stage an emitter follower is used

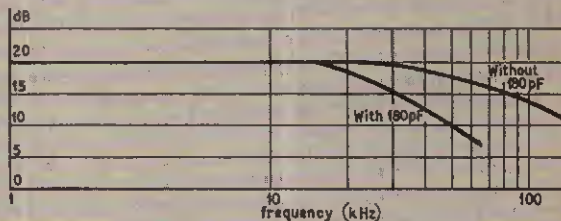

Fig. 5.6b. The feedback resistor R_2 can be shunted by a capacitor to reduce bandwidth

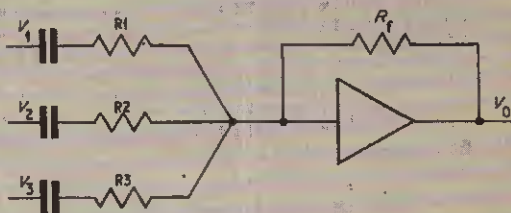

Fig. 5.7. Three inputs are mixed into the "virtual earth" point of the amplifier

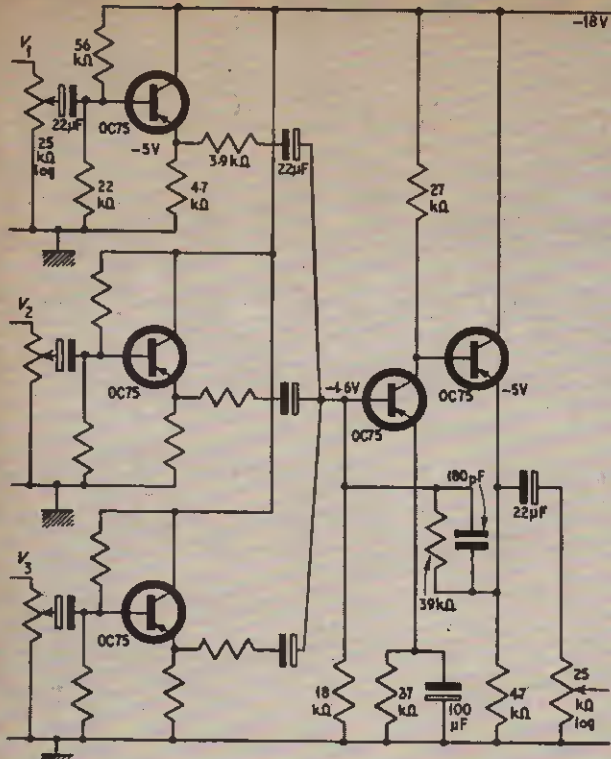

Fig. 5.8. A detailed circuit of the 3-channel mixer, each input being "buffered" from the others by an emitter follower

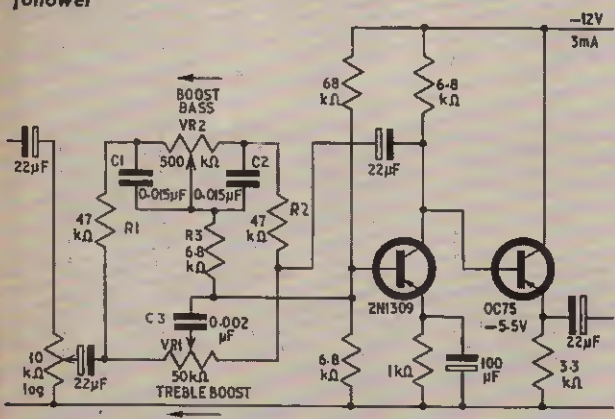

Fig. 5.9. A typical example of the Baxandall type of feedback tone control circuit for treble and bass boost and cut

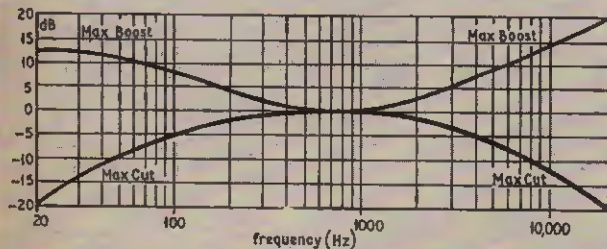

Fig. 5.10. Upper and lower limits of frequency response given by the Baxandall circuit

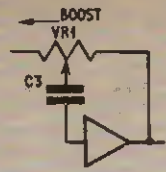

Fig. 5.11. Treble control

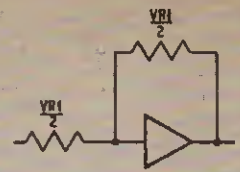

Fig. 5.12. Treble flat

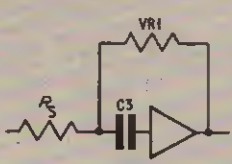

Fig. 5.13. Treble boost

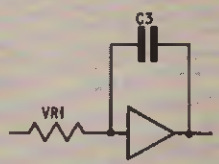

Fig. 5.14. Treble cut

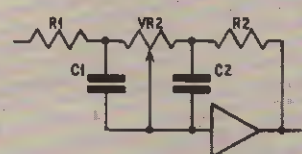

Fig. 5.15. Bass control

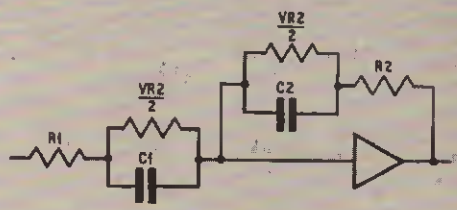

Fig. 5.16. Bass flat

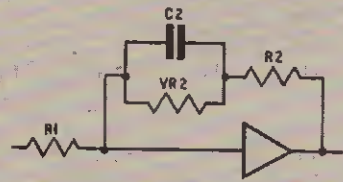

Fig. 5.17. Bass boost

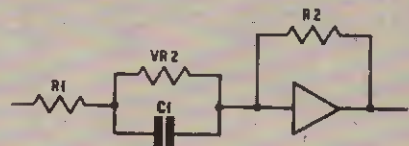

Fig. 5.18. Bass cut

Figs. 5.11 to 5.18. This series of diagrams shows the maximum, minimum and "flat" conditions of the Baxandall circuit

MIXING

Mixing can be achieved by adding extra inputs at the "virtual earth" point, Fig. 5.7.

$$V_o = R_f \times \left(\frac{V_1}{R_1} + \frac{V_2}{R_2} + \frac{V_3}{R_3} + \dots \right)$$

If $R_1 = R_2 = R_3 = R$. This becomes

$$V_o = \frac{R_f}{R} \times (V_1 + V_2 + V_3)$$

A practical audio mixing unit could be made up in this fashion (Fig. 5.8) for three or more inputs.

Input impedance = $8k\Omega$
 Maximum gain = 10 times = 20dB
 Maximum output = 500mV
 Frequency response 20Hz to 20kHz, $\pm 3dB$.

Each parallel input stage is identical.

FEEDBACK TONE CONTROLS

The virtual earth arrangement can be used with feedback and input networks that are frequency selective, providing tone controls of the well known Baxandall type (see Fig. 5.9). The performance of this circuit is given in Fig. 5.10, and was measured with the gain control at maximum, so that the tone controls were effectively fed directly from the previous stage, which had an output impedance of 250 ohms.

With the volume control at a lower level, the source impedance would be slightly higher (up to a maximum of $5k\Omega$) but this would not effect the response curves by more than a couple of dB or so, since the tone control network is made a high impedance network.

The 2N1309 was used here so that the open loop gain without feedback extended well outside the audio band. An OC75 (which has a lower cut-off frequency) could be used here, but the response on maximum treble boost might not be as great.

Slightly more bass boost can be obtained by reducing the 47 kilohm resistors to 22 kilohms. Performance: When no boost or cut is applied $\pm 3dB$, 20Hz-20kHz. Bass boost 12dB at 20Hz; cut 19dB at 20Hz. Treble boost 19dB at 20kHz; cut 19dB at 20kHz.

The overall gain is about unity at mid-band and will give a maximum output of 500mV into 1 kilohm. The circuit has been broken down into eight configurations in Figs. 5.11 to 5.18. Taking the treble section (Fig. 5.11) this can be divided into three conditions: flat (Fig. 5.12); boost (Fig. 5.13); cut (Fig. 5.14).

Secondly, the bass control in Fig. 5.15 gives equal source and feedback impedances (and hence unity gain) in the flat condition, Fig. 5.16. Feedback is reduced at low frequencies to give bass boost, Fig. 5.17. In the bass cut condition the input network increases in impedance from 1kHz towards 20Hz, and overall gain is reduced below unity, Fig. 5.18.

To ensure that the tone controls are not overloaded on peaks, it is preferable to place the volume control as early in the circuit as possible, so that the tone controls are operated at a low level, see Fig. 5.19.

VOLTAGE OUTPUT, SERIES INPUT NEGATIVE FEEDBACK

Apart from the virtual earth arrangement, there is another method of applying negative feedback over two stages: the voltage output, series input arrangement.

In this case (Fig. 5.20) the resistor R_2 enables a signal proportional to load voltage to be fed back,

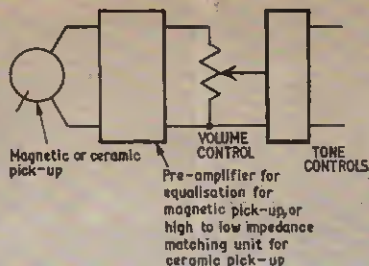

Fig. 5.19. Volume control is inserted before tone controls so that boost condition is not distorted

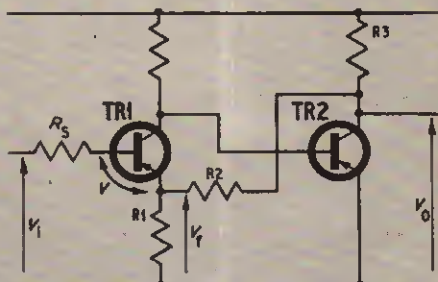

Fig. 5.20. Voltage output, series input negative feedback

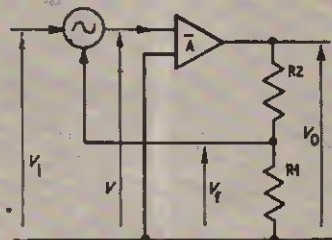

Fig. 5.21. Theoretical equivalent of Fig. 5.20

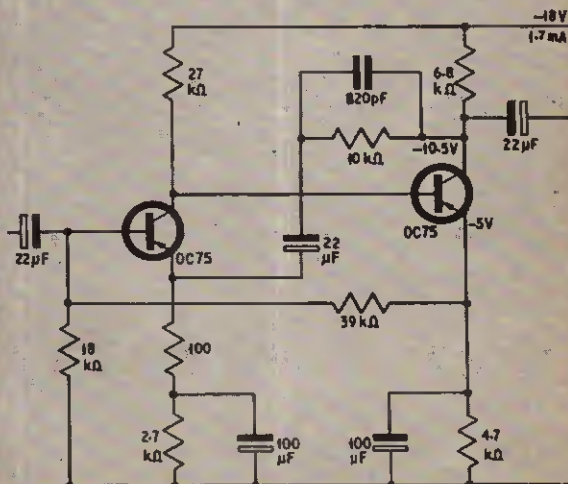

Fig. 5.22. Practical circuit of amplifier with voltage output, series input negative feedback

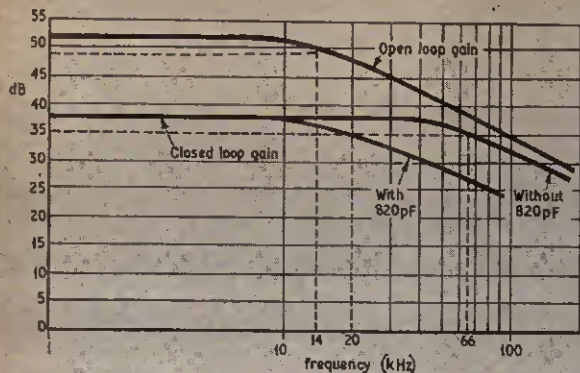

Fig. 5.23. Frequency response of circuit in Fig. 5.22 with and without shunt capacitor

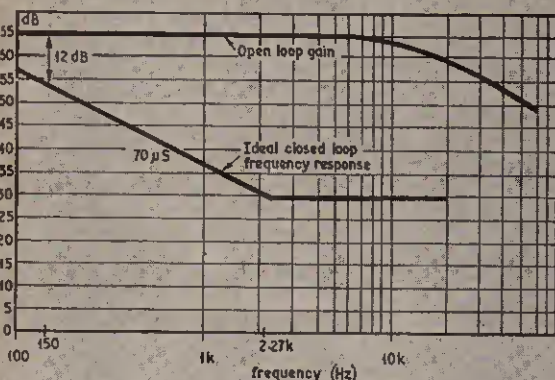

Fig. 5.25. Ideal tape replay characteristic compared with open loop gain response for 7 1/2 in/second

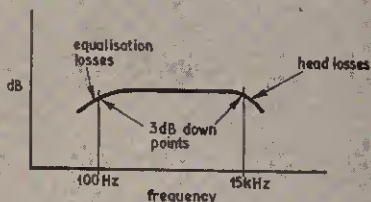

Fig. 5.26. Overall frequency response from tape replay head and amplifier

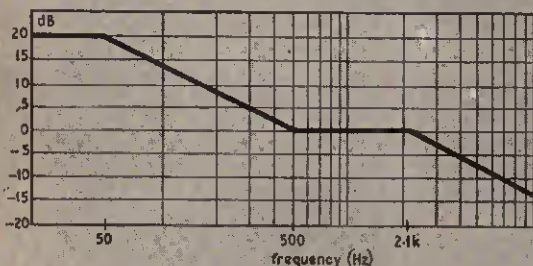

Fig. 5.27. R.I.A.A. microgroove replay characteristic

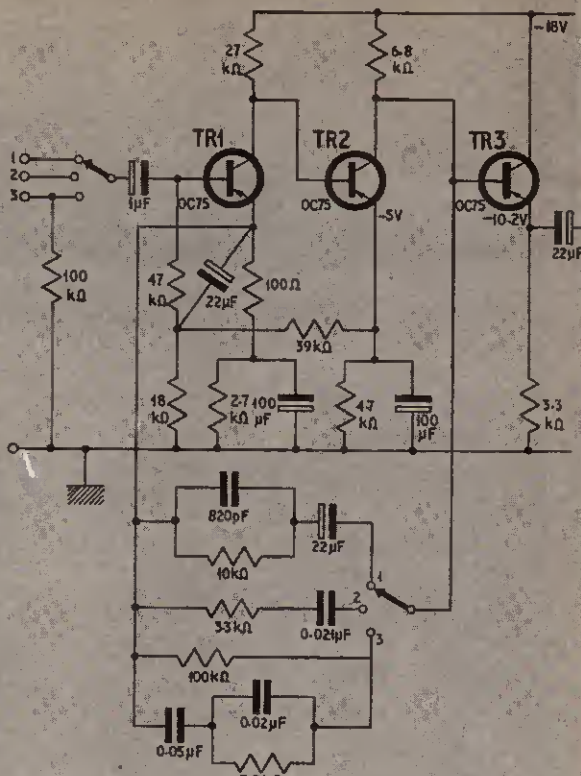

Fig. 5.24. Various tone correction characteristics are obtained with switched feedback paths. Position 1 for microphone, 2 for tape head replay, 3 for magnetic pick-up

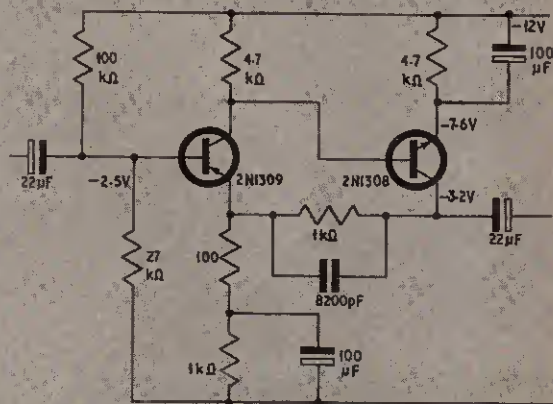

Fig. 5.28. Using an npn, pnp pair with fixed feedback

while R1 enables this feedback voltage to be applied in series with the input, Fig. 5.21.

This applied feedback increases the input impedance and decreases the output impedance. R1 should be kept low (less than 1 kilohm) since this applies local feedback to the first stage. The amount of output feedback = $B = R_2/(R_1 + R_2)$. Then gain with feedback

$$G = \frac{1}{B} = \frac{R_1 + R_2}{R_1} = 1 + \frac{R_2}{R_1}$$

provided $1 + (R_2/R_1)$ is much less than A in the usual way for negative feedback formulae.

If the gain with feedback is such that R_2/R_1 is much greater than unity, then $G = R_2/R_1$. Input impedance is given by

$$Z_1 = \beta_1 \beta_2 \times \frac{R_1 \cdot R_3}{R_2 + R_3}$$

this is shunted by the bias resistors at TR1 base. Output impedance is given by

$$Z_o = \frac{G}{\beta_1 \cdot \beta_2} \times [R_s + \beta_1 \cdot R_1]$$

$$Z_o = \frac{R_2}{\beta_2}$$

for a low source impedance R_s .

A typical circuit of this type is shown in Fig. 5.22, which has a frequency response as shown in Fig. 5.23.

Without feedback the input impedance $Z_1 = 5$ kilohms. Output impedance $Z_o = 6.8$ kilohms. Mid-band gain is 52dB and bandwidth 14kHz.

With feedback the gain is 38dB, which is what one might expect since the open loop gain is 52dB = 400 times, while the closed loop gain

$$G' = \frac{400}{1 + \frac{400}{5}} = \frac{400}{81} = 4.94 \approx 5 \text{ times} = 34 \text{ dB}$$

Ideal closed loop gain = 100 times = 40dB

Amount of feedback = 52 - 38 = 14dB

Input Impedance $Z_1 = 8.2$ kilohms

Output Impedance $Z_o = 200$ ohms

Maximum output is 150mV r.m.s. into 1k Ω , and 250mV r.m.s. for open circuit output.

Noise referred to input = 5 μ V r.m.s. for a 600 ohm source. Bandwidth is 66kHz, reducing to 20kHz with the 820pF capacitor in circuit. The response is 3dB down when the impedance of the capacitor is equal to 10 kilohms, in this case 19.4kHz.

The feedback must be operative until a frequency lower than the low frequency 3dB down point of the amplifier, otherwise we could obtain a peak in the closed loop response. This is deliberately done for tape equalisation, where a rising l.f. response is required. This feedback arrangement is widely used in pre-amplifiers since, by switching the feedback network, a wide variety of frequency selective characteristics can be obtained.

At the moment, the load is fed directly from the collector of TR2, which reduces the open loop gain. Feeding the load via an emitter follower increases the open loop gain to 65dB. For a tape head or magnetic pick-up input we require a high input impedance, but the high input impedance given by the negative feedback is masked by the shunting effect of the resistors biasing TR1.

Bootstrapping these resistors enables us to take full advantage of the high input impedance provided by negative feedback. The modified amplifier suitable for use with switched feedback is now as shown in Fig. 5.24.

Microphone Amplifier

As previously shown this will have a gain of about 40dB and a bandwidth of 20kHz. Input impedance is greater than 100 kilohms over the audio band.

Tape Amplifier

This has a gain of about 61 times (30dB) at 1kHz and an input impedance of 100 kilohms over most of the audio band, but the input impedance will drop at the low frequency end where it runs out of loop gain.

The ideal response for 7 $\frac{1}{2}$ in/second (70 μ s time constant) is shown in Fig. 5.25. Below 150Hz the amount of negative feedback is less than 12dB, so the equalisation is not going to be exact. This, coupled with the drop in input impedance would give an overall response out of the tape head, similar to that shown in Fig. 5.26

Magnetic pick-up

Here the mid-band gain is about 35dB, with R.I.A.A. equalisation. The input impedance is about 47 kilohms, which is recommended for most magnetic pick-ups, this falls to 30 kilohms at 20Hz, which is acceptable. The equalisation is within ± 2 dB of the required characteristic between 20Hz and 20kHz.

The straight line approximation of the theoretical curve is given in Fig. 5.27, which is referenced to 0dB at 1kHz. The 100 kilohm impedance has been increased from the theoretical value (about 47 kilohms) to allow for the finite open loop gain at low frequencies (65dB).

Summary

Inputs at 1kHz for an output of 250mV

Microphone. 2.5mV 100k Ω

Pick-up. 4.5mV 47k Ω

Tape. 4.0mV 100k Ω (7 $\frac{1}{2}$ in/sec and 70 μ s)

Maximum output: 250mV into 1k Ω

For a simple amplifier of fixed feedback, it can be advantageous to use an *npn*, *pn*p pair, as in Fig. 5.28. In this case

Maximum output = 250mV r.m.s.

Frequency response ± 3 dB 20Hz - 20kHz

Gain 10 times = 20dB

Input Impedance = 20k Ω

Output Impedance = 150 Ω

Next month: High input, low output impedance amplifiers and active filters

For Future Reference

- An index for volume three (January 1967 to December 1967) is now available price 1s 6d inclusive of postage.

Orders for copies of the Index *only* should be addressed to the Post Sales Department, George Newnes Ltd., Tower House, Southampton Street, London, W.C.2.

Official O.K. for Calibration Lab.

THE overworked National Physical Laboratory expects to be relieved of some time-consuming routine tasks following BCS (British Calibration Service) approval of the Ferranti Calibration Laboratory.

"Outsiders" can now obtain help in a wide range of measurements covering frequency, d.c. resistance, inductance, capacitance, a.c. and d.c. voltage, current, and power.

The calibration laboratory started at Ferranti's Moston works in 1940 and was transferred to its present site at Wythenshawe, Lancs., in 1954 to provide a service to the company's factories engaged in design and production of guided weapons.

It was later made available to all Ferranti factories in the Manchester area, and in 1963 was extended to other manufacturers and organisations engaged on government contracts by obtaining EID part III test house approval, which covers a variety of electrical and physical measurements.

The service was extended to all industries when the new BCS granted approval for d.c. and low frequency measurements.

Type from Tape

LANCASHIRE printing company, the Tinsling Printing Group, has ordered an Elliott-Automation computer typesetting system for its Prescot works.

The computer will automatically justify text (punched on special keyboards) and will produce complete pages in the form of punched paper tape. It also makes a record on magnetic tape for storage in case reprints are required.

The completed paper tape is fed to a Photon typesetting machine which produces a positive of each page for making litho printing plates.

Editing the book, and author's corrections, will also be easier and quicker because the computer adjusts the page make-up automatically to allow for alterations to the text during the proof-reading stage.

(below) the magnetic and paper tape units

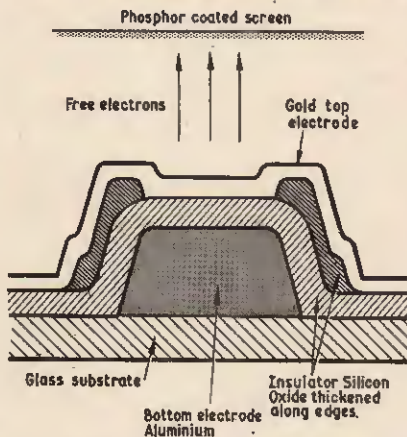
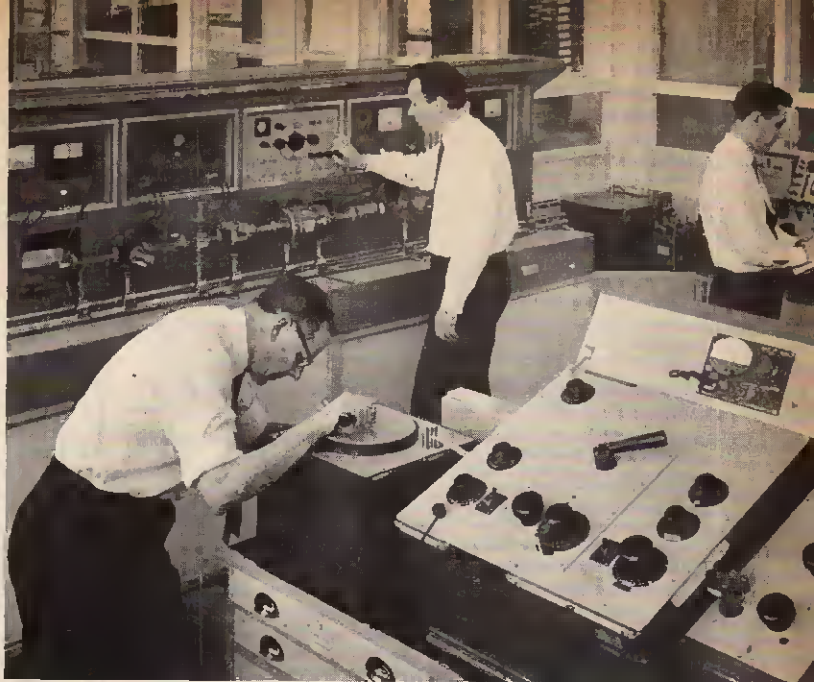

The point-source electron gun (above) can be matrixed to produce a detailed display

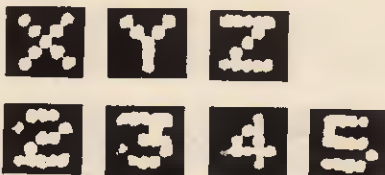

Semiconductor Picture Display

WHAT could be the beginning of a semiconductor version of a television tube was demonstrated at the Physics Exhibition by STL Research. The principle used relies on the electron tunnelling effect, already to be found in tunnel diodes.

The significant difference, though, is that electrons, after excitation in aluminium, are channelled through silicon oxide to a gold electrode.

Free electrons are then released into a vacuum to strike the phosphorescent coating on the display screen. The matrix (or raster) on the screen is made up from a series of tiny dots, each dot being related to its own semiconductor "gun".

Current experiments by STL have shown that good alphanumeric displays using 10 sq mm dots of activity are quite feasible and, in fact, could be developed on a commercial scale more economically than conventional methods.

The size of the dot can be made very much smaller (about 0.002in) to make up a fine screen matrix with a large regular pattern of dots. Reproduction by photo-optic and electronic systems of live or photographic pictures becomes a possibility. The major hurdle to be jumped here, of course, is the vastly increased numbers of lead-out wires, but sequential display of each "dot" would reduce this number to practical proportions.





ANALOGUE COMPUTER

PEAC

By
D. BOLLEN

THE PEAC basic equipment has now been dealt with and this month we commence a detailed description of the chief ancillary unit. Subsequent articles will cover the remaining two ancillary units.

Perhaps it should be repeated at this stage that the three ancillary units are purely optional add-on items. The additional facilities they each provide, are indicated in the PEAC Specification (January 1968, page 38).

PEAC UNIT "B"

UNIT "B" reinforces the facilities of UNIT "A", but does not introduce new computing circuit elements. A master potentiometer and a suitably scaled readout meter improve the accuracy and ease of handling of UNIT "A", while the integrator mode switching circuit opens up further possibilities in the solution of Calculus problems.

UNIT "B" FRONT PANEL

It may not be necessary to use hardboard for the front panel if a thick grade of plastic laminate is used, since the wooden surround in the box front gives plenty of support.

Prepare a 17½in × 8½in white laminate panel and establish hole centres with a sharp spike, from the drawings Fig. 6.1 and Fig. 6.2. Next, drill only the holes for all sockets, S7, S8, the meter mounting studs, and cut out a hole for the meter body with a fretsaw.

Beginning with the master potentiometer dial, draw a 300 degree arc of radius 2½in with a pencil compass (refer to Fig. 6.2). Divide the arc into 3-degree divisions with protractor and pencil. The accuracy of the master potentiometer will benefit from careful preparation of the dial. Draw in the dial arc and divisions with Indian ink.

Rub-on transfers are suitable for the dials of VR18 and VR19, and will save time, but make sure that the transfer gives main divisions spaced at 30-degree intervals, for a 1-10 calibration.

When dials are complete, drill holes to take the

spindles of VR18-VR20, S9 and S10. Draw in all ink lines, add transfer numerals, and varnish.

BOX CONSTRUCTION

Commence building the UNIT "B" box by cutting out two side panels from hardboard; they are shown in Fig 6.3. Fix ½in square softwood lengths *A*, *B*, *C*, and *D* to the inside of the side panels. Join the side panels together by means of horizontal lengths *E*, and *F*, using countersunk woodscrews and glue. Square up with the assembly placed on a flat surface.

Cover the box framework with hardboard top, bottom, and front strip panels, and, when firm, reduce overlapping edges with a rasp and sandpaper. Finish off the box with a layer of white plastic laminate, and paint exposed hardboard edges to match the UNIT "B" box.

MASTER POTENTIOMETER AND NULL METER

A d.c. voltmeter connected to the slider of a computing potentiometer will impose a small load, and when the voltmeter is removed the measured coefficient will increase slightly, to the extent of about 1½ per cent in the case of a 10V 20,000 ohms/volt meter, and a 10 kilohm potentiometer set with its slider near mid-track. One way of avoiding the error is to leave the voltmeter connected to the potentiometer after a coefficient reading has been taken, but this is seldom convenient.

Ideally, the instrument used to measure coefficients or computer voltages should impose no load at all, and this condition can be satisfied fairly easily by employing an accurately calibrated master potentiometer.

In Fig 6.4, a permanent load is placed on the coefficient potentiometer CP by the computing resistor R_{in} , thus causing a significant dial setting error. To find the true coefficient of CP, both potentiometers are supplied with a reference voltage of +10V, so that potentiometer coefficients of 0-1 will be multiplied by 10 to conform to a 0-10 dial calibration. When

COMPONENTS . . .

UNIT "B" FRONT PANEL

NOTE: All front panel controls are numbered consecutively, following on from UNIT "A", but internal sub-assemblies have individual component numbering.

Potentiometers

VR18 100k Ω carbon linear
 VR19 100k Ω carbon linear
 VR20 25k Ω wirewound, 3in., 25W instrument potentiometer. (G. W. Smith & Co. (Radio) Ltd., 3 Lisle Street, London, W.C.2)

Switches

S7 Miniature push button, push to make, one pole
 S8 Toggle, single pole changeover
 S9 4 pole, 3 way rotary
 S10 2 pole, 6 way rotary

Sockets

5 red, 3 black, 5 blue, 4 yellow, 4 white, and 2 green

Knobs

One Bulgin K403, 2 $\frac{3}{8}$ in knob with 3in skirt.
 Three Radiospares type PK 1 $\frac{1}{8}$ in knobs with pointers

Meter

M1 "Sew" MR85P, 100-0-100 μ A, internal resistance 1,000 Ω

Miscellaneous

Plastic laminate (thick) for front panel, 1 off, 17 $\frac{1}{2}$ in \times 8 $\frac{3}{4}$ in. Rub-on dial transfers and letters, black (Radiospares)

UNIT "B" MASTER POTENTIOMETER

Resistors

R1 200 Ω R3 47 Ω R5 820 Ω
 R2 820 Ω R4 47 Ω R6 200 Ω
 All 5%, $\frac{1}{2}$ W carbon film or metal oxide

Pre-set potentiometers

VR1-VR4 100 Ω wirewound (4 off) panel mounting type

Miscellaneous

16 s.w.g. aluminium sheet 6in \times 4in. Tag strip with three tags.

UNIT "B" READOUT METER

Resistors

R1 82k Ω 10% R3 7.5k Ω 5% All $\frac{1}{2}$ W, carbon
 R2 22k Ω 10% R4 1.2k Ω 10% composition

Pre-set potentiometers

VR1 22k Ω All miniature horizontal
 VR2 10k Ω mounting skeleton con-
 VR3 2.2k Ω struction
 VR4 1k Ω

Meter protection diodes

D1, D2 OC71 or similar "inverted" germanium transistor (2 off)

Miscellaneous

S.R.B.P. panel 2 $\frac{1}{2}$ in \times 2in.

UNIT "B" INTEGRATOR MODE SWITCH

Resistors

R1 10k Ω R4 4.7k Ω R7 27k Ω
 R2 10k Ω R5 27k Ω R8 4.7k Ω
 R3 1k Ω R6 1k Ω R9 10k Ω

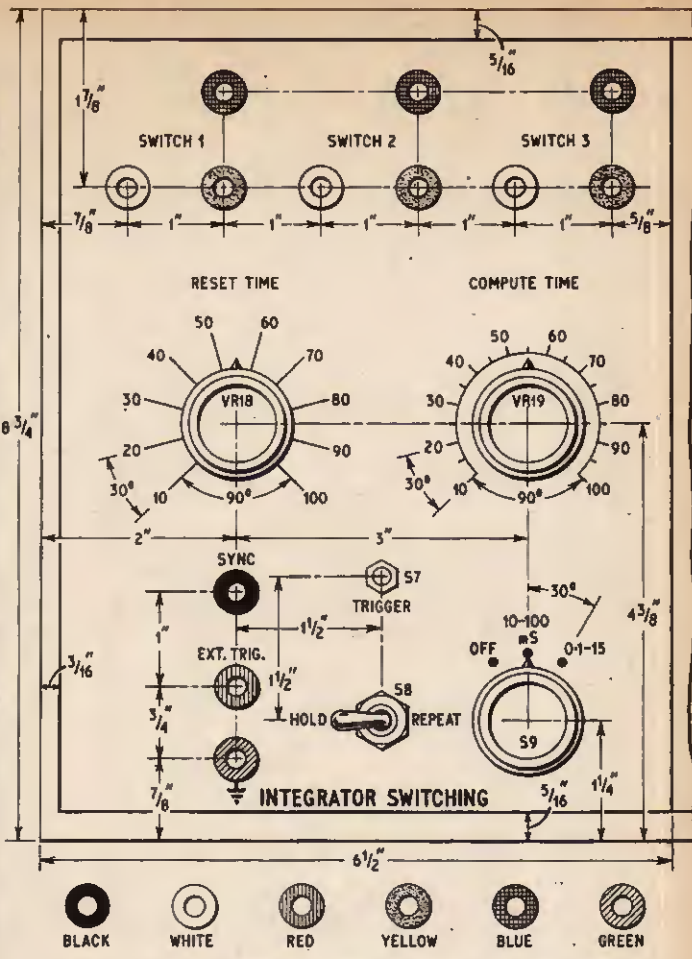

Fig. 6.1. UNIT "B" front panel, integrator switching section

R10 10k Ω R12 3.3k Ω R14 1k Ω
 R11 1k Ω R13 10k Ω R15 560k Ω
 All 10%, $\frac{1}{2}$ W carbon composition

Pre-set Potentiometers

VR1 10k Ω
 VR2 5k Ω Both vertical mounting

Capacitors

C1 1,000 μ F elec. 15V
 C2 1 μ F polyester 250V d.c. C6 1 μ F polyester 250V d.c.
 C3 1.4 μ F polyester 250V d.c. C7 1.4 μ F polyester 250V d.c.
 C4 14 μ F elec. 25V C8 14 μ F elec. 25V working
 C5 0.1 μ F polyester 250V d.c. C9 0.068 μ F polyester 250V d.c.
 (The values of C3, C4, C7, and C8 are approximate—see text)

Transistors

TR1-TR6 ACY28 or AC126.

Diodes

D1, D2 OA95 (2 off)
 D3-D14 1B30 (Radiospares) (12 off)

Reed Coils

RLA, RLB Miniature triple 12V Osmor type MT12V (2 off)

Reed Switches

RLA1-RLA3 Hamlin MRG2, 20-40AT (R.T.S. Ltd.,
 RLBI-RLB3 P.O. Box 11, Gloucester St. Cambridge) (6 off.)

Miscellaneous

S.R.B.P. panels: 1 off 6 $\frac{1}{2}$ in \times 2 $\frac{1}{2}$ in; 1 off 3in \times 2in.
 Small turret tags.

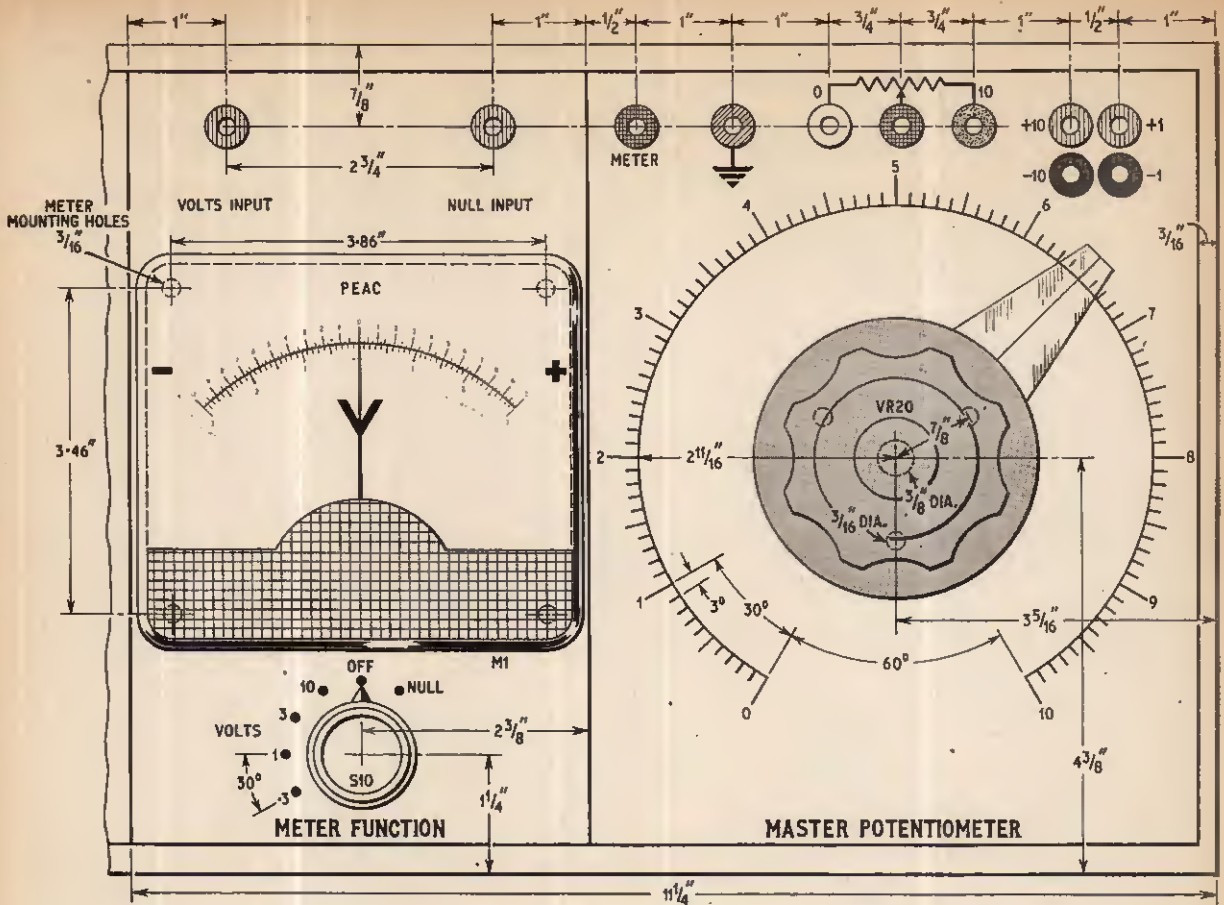

Fig. 6.2. UNIT "B" front panel, readout meter and master potentiometer

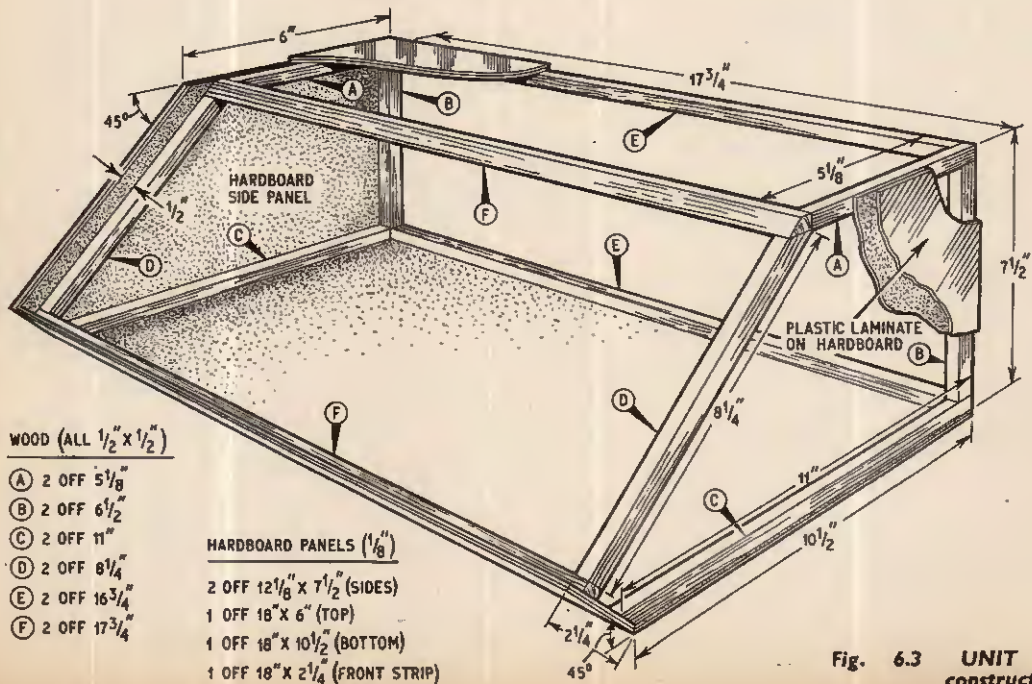

Fig. 6.3. UNIT "B" box constructional details

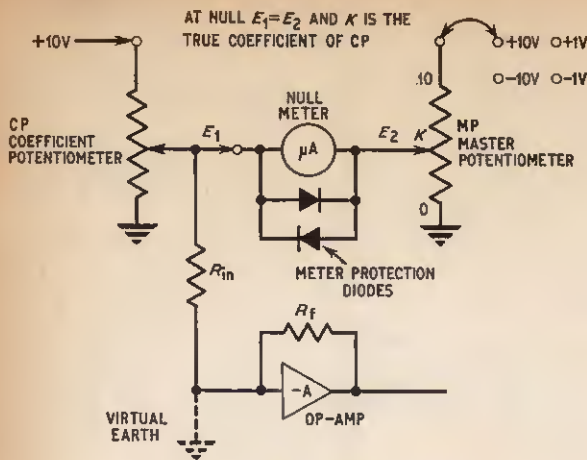

Fig. 6.4. Master potentiometer circuit for measuring coefficients

Fig. 6.5 (below). Circuit diagram of readout meter and master potentiometer

the voltage at the slider of CP is identical to the slider voltage of MP, no current flows through the null meter, and the true coefficient of CP can be read straight off the dial of MP.

Since no current flows at null point, no load is imposed, and the input resistance of the measuring circuit is virtually infinite. Meter protection diodes are included to preserve good meter sensitivity without allowing damaging currents to flow through the meter when the circuit is off balance.

READOUT METER AND MASTER POTENTIOMETER CIRCUITS

One meter movement serves for null indication and voltage measurement. Considering first the readout meter circuit Fig 6.5a, miniature pre-set resistors VR1-VR4 will permit calibration of each meter range to an external voltage standard, and also help to eliminate discrepancies between ranges.

The way in which meter protection diodes D1 and D2 are wired may be unfamiliar to the reader, so some explanation is called for. If a transistor is operated "inverted", that is with collector-emitter polarities reversed, it will exhibit a very low "on" resistance when the base is near emitter potential. With base connected straight to emitter, the transistor therefore becomes a diode with lower than normal forward resistance, and yet will still offer a high resistance

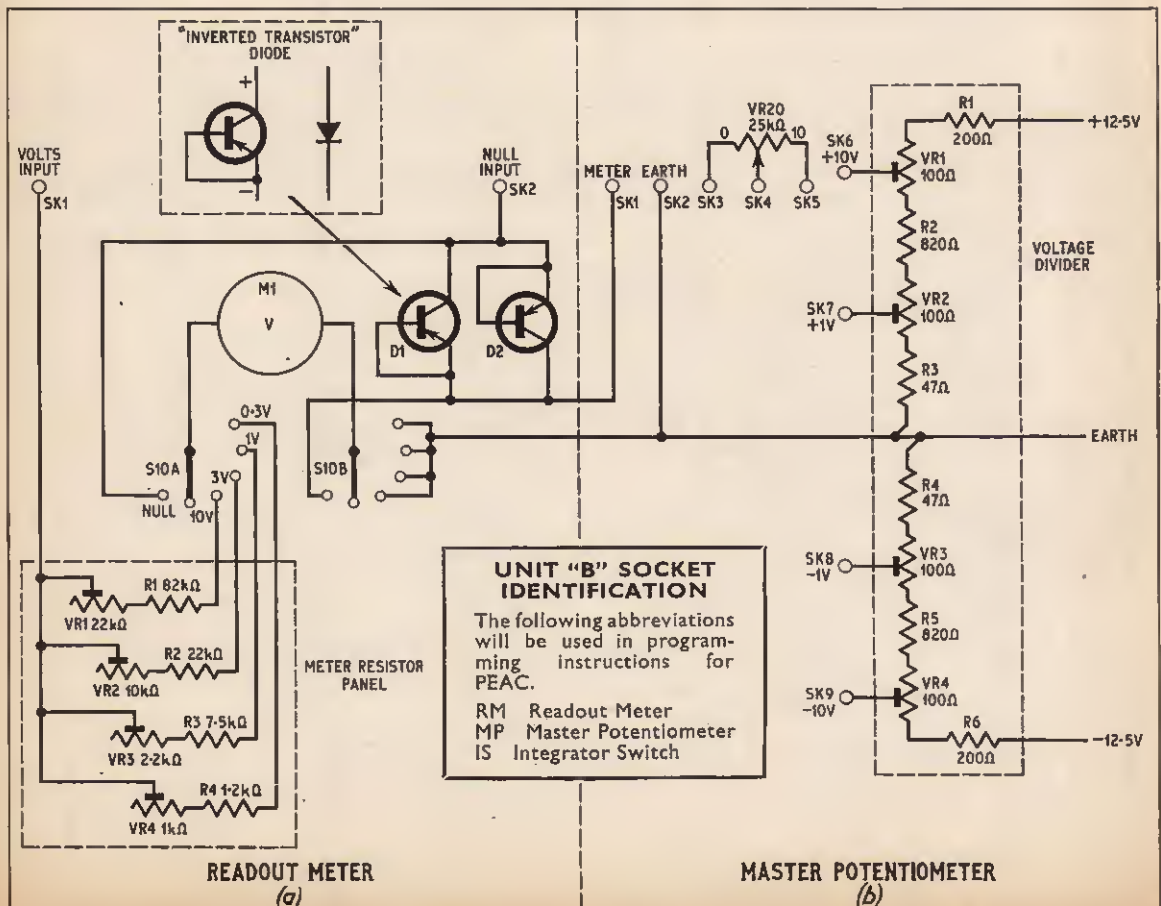



THE ELECTRONIC COMPONENTS CATALOGUE THAT SETS THE STANDARD

Used and
acclaimed by:-

**SCIENTISTS
ENGINEERS
TECHNICIANS
TEACHERS &
STUDENTS**

This edition of the Home Radio Catalogue is the result of ten years of careful selecting, compiling and indexing. It is the finest, most comprehensive we have ever produced—it has 256 pages, over 7,000 items listed and over 1,300 illustrations. With each catalogue we supply our unique Bargain list, Book Mark giving Electronic Abbreviations, an Order Form, an addressed envelope, and 5 vouchers each worth 1/- when used as directed. All this for only 7/6 plus 2/- post and packing. Send the attached coupon today, with your cheque or P.O. for 9/6.

Of course no catalogue is ever really finalised. As soon as we have one edition off the press, our researchers get busy finding out what is the latest in the world of Radio and Electronics—ready for the next printing.

Please write Name and Address in block capitals

NAME.....
ADDRESS.....
.....
.....

Home Radio (Mitcham) Ltd., Dept. PE, 187 London Road, Mitcham, CR4 2YQ.

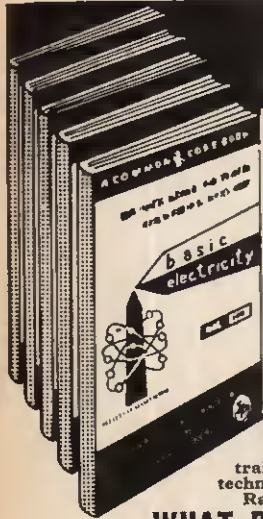

YOURS FREE FOR 7 DAYS

BASIC ELECTRICITY (5 vols.) BASIC ELECTRONICS (6 vols.)

You'll find it easy to learn with this outstandingly successful NEW PICTORIAL METHOD—the essential facts are explained in the simplest language, one at a time, and each is illustrated by an accurate, cartoon-type drawing. The books are based on the latest research into simplified learning

techniques. This has proved that the PICTORIAL APPROACH to learning is the quickest and soundest way of gaining mastery over these subjects.

TO TRY IT, IS TO PROVE IT

The series will be of exceptional value in training mechanics and technicians in Electricity, Radio and Electronics.

WHAT READERS SAY

"Man DIG THOSE MANUALS, I am at last with it." K. L., Oxford.

"Without doubt they are the easiest to follow books I have read, they will be used continuously from now on." J. W., Fife.

"I am delighted with them and consider them a most excellent set of books. They are all your other readers claim for them." G. P., Harrogate.

"I have viewed a number of such books in an effort to obtain the necessary knowledge suitable for the layman to understand easily, and find that only our own publication can do this, and does so very well indeed." D. F., Trowbridge.

A TECH-PRESS PUBLICATION.

POST NOW FOR THIS OFFER!

To The SELRAY BOOK CO., 60 HAYES HILL, BROMLEY BR2 7HP

Please send me WITHOUT OBLIGATION TO PURCHASE, one of the above sets on 7 DAYS FREE TRIAL, I will either return set, carriage paid, in good condition within 7 days or send the following amounts. BASIC ELECTRICITY 72/- Cash Price or Down Payment of 15/- followed by 4 fortnightly payments of 15/- each. BASIC ELECTRONICS 84/- Cash Price or Down Payment of 15/- followed by 5 fortnightly payments of 15/- each. This offer applies to UNITED KINGDOM ONLY. Overseas customers cash with order, prices as above.

Tick Set required (Only one set allowed on free trial.)

BASIC ELECTRICITY BASIC ELECTRONICS

Prices include Postage and Packing.

Signature.....
(If under 21 signature required of parent or guardian)

NAME.....
BLOCK LETTERS
FULL POSTAL
ADDRESS.....

reverse characteristic. The arrangement eliminates the need for a meter series resistor while still giving adequate protection.

In Fig. 6.5b, VR20 is a 3in instrument potentiometer of good linearity. The voltage divider network, composed of R1-R6 and VR1-VR4, taps off four standard voltages from the computer power supply, so that the master potentiometer will measure inputs of 0 to +1V, 0 to -1V, 0 to +10V, and 0 to -10V on its 0-10 scale. The accuracy of the master potentiometer, bearing in mind the 14in scale length, approaches that of a laboratory voltmeter.

FRONT PANEL AND MASTER POTENTIOMETER ASSEMBLY

Mount all sockets, potentiometers VR18-VR20, switches S7-S10, and meter, on the UNIT "B" front panel. Make up an aluminium bracket from the measurements given in Fig. 6.6, and glue it to the front panel, along with the small tag strip, in the position shown in Fig. 6.7. A hot soldering iron applied to the aluminium bracket will solidify the epoxy resin glue in a matter of minutes, sufficient to hold the bracket in place until the joint sets hard.

Rest the front panel inside-out on the UNIT "B" box front, to protect panel markings during assembly. Mount pre-set voltage divider potentiometers VR1-VR4 to the aluminium bracket, and then proceed with the

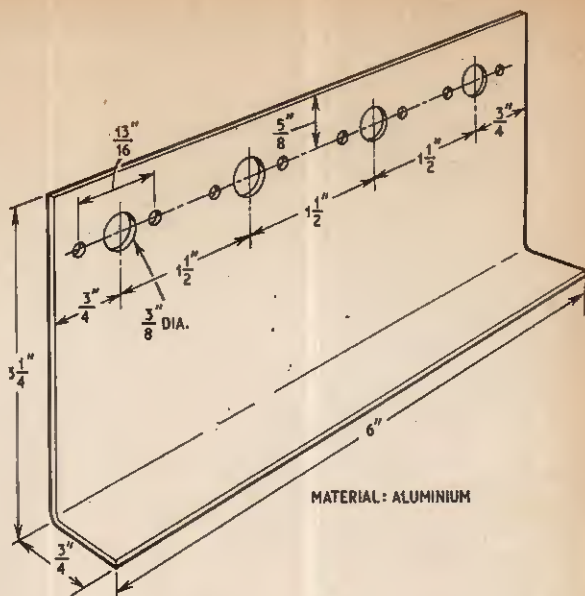

Fig. 6.6. Mounting bracket for pre-set potentiometers

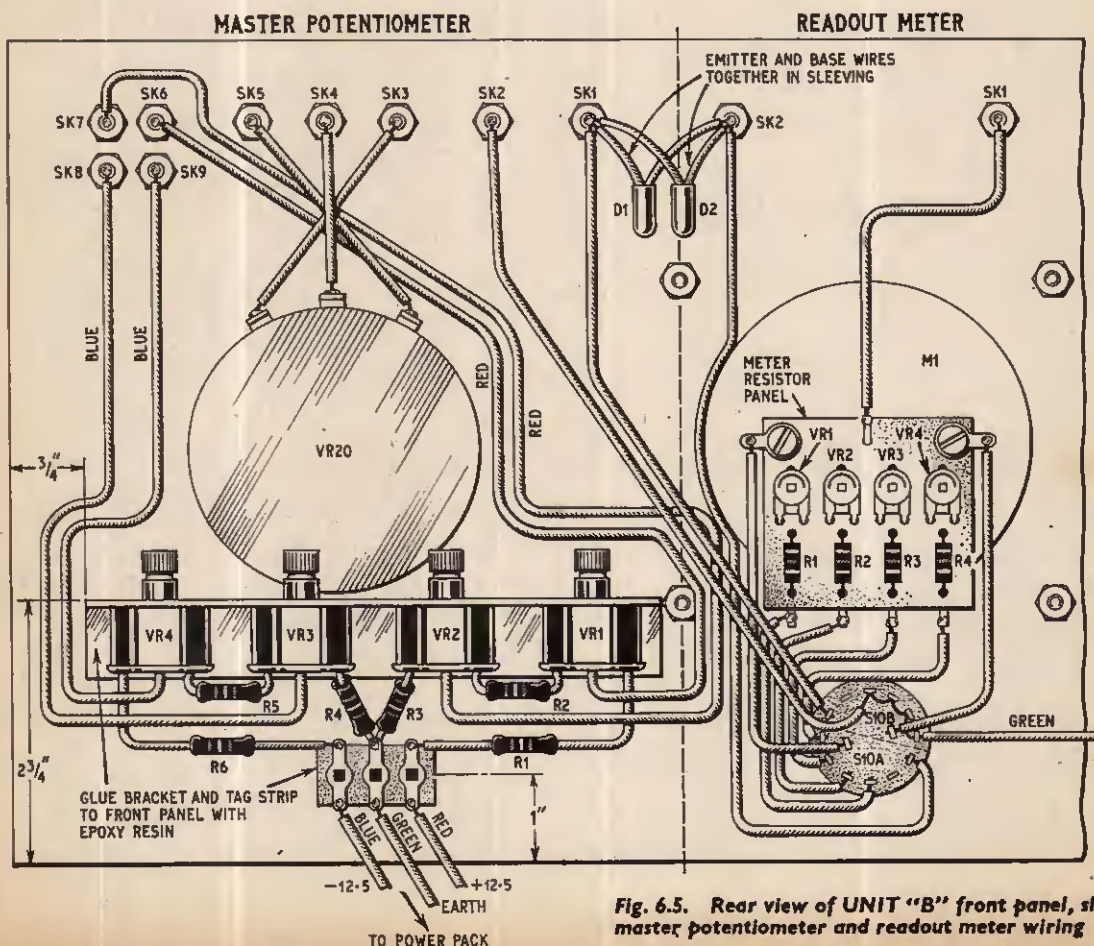

Fig. 6.5. Rear view of UNIT "B" front panel, showing master potentiometer and readout meter wiring

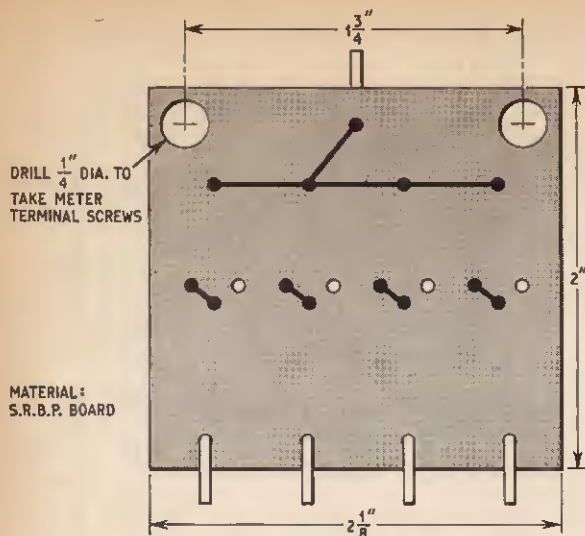

Fig. 6.8. Meter resistor panel, underside view

wiring of master potentiometer components, using 20 s.w.g. tinned copper wire and sleeving.

READOUT METER ASSEMBLY

Make up the meter resistor panel shown in Figs 6.7 and 6.8, and attach to the meter terminals. Solder D1 and D2 to MP/SK1 and RM/SK2, then complete S10 and resistor panel wiring.

As centre-zero voltmeters with 10-0-10 and 3-0-3 scale calibrations are not readily available, a scale will have to be made. Perhaps the most satisfactory way of fabricating a new and really accurate meter scale is to draw it two to four times full size, photograph it, and then have the resulting negative enlarged back to the original size on glossy photographic paper. The enlarging can be done commercially if the oversize drawing carries a thick black line to represent a length of 1in on the finished scale, just outside the scale perimeter.

When taking the photograph, ensure that the camera lens is in line with the centre of the scale card, and that the film plane is parallel to the surface of the oversize drawing, to prevent optical distortion.

Another tip, use white Formica for the drawing, as then mistakes in ink can be erased without leaving unsightly grey areas.

To remove the existing scale from the meter, prise off the transparent meter front, and carefully remove the scale card by undoing the two holding screws. Measurements can then be taken for preparing the oversize drawing.

To fit the new scale, cut out the photographic reproduction and paste it over the old scale, with edges and mounting holes of both scales properly registered.

SETTING UP MASTER POTENTIOMETER AND READOUT METER

With red, green, and blue p.v.c. covered wires, connect the master potentiometer tag strip (Fig 6.7) to the solder tags on the power pack output terminals. Also, temporarily link the rear of MP/SK2 to the green earth wire. Rotate VR20 spindle fully clockwise and patch MP/SK2 to SK3, MP/SK5 to SK6, MP/SK1 to SK4, and link RM/SK2 to VS1/SK1. Switch on the computer and S6, and adjust VS1 for an exact +10V. Now obtain a null on the readout meter by setting VR1 on the voltage divider bracket, from the back of UNIT "B" box.

Repeat for VR2 with an input of +1V by transferring the patching lead plug from MP/SK6 to SK7, and again for VR3, SK8, with an input of -1V, and VR4, SK9, with an input of -10V.

After that, while still nulling with a -10V input, rotate VR20 spindle slightly clockwise, until the meter pointer just begins to move away from zero. Place the large knob on VR20 spindle, with the transparent plastic cursor aligned with the "10" division, and tighten the grub screw. Set VR20 cursor to the "5" division and check for null with an input of -5V. It may be necessary to slightly re-position VR20 knob on the spindle, and trim VR1-VR4 again to minimise errors.

Calibration of the readout meter is straightforward. Apply a selection of known voltages to RM/SK1 and

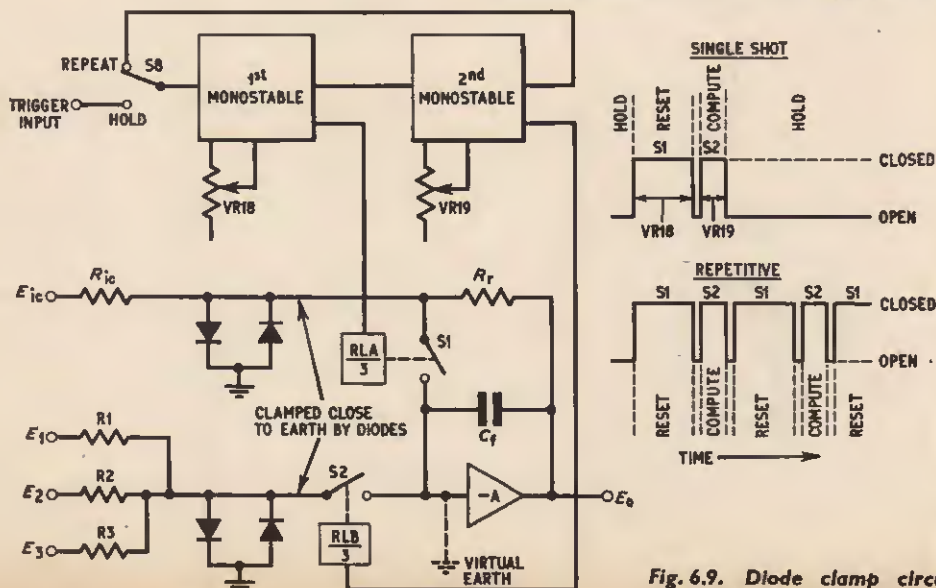
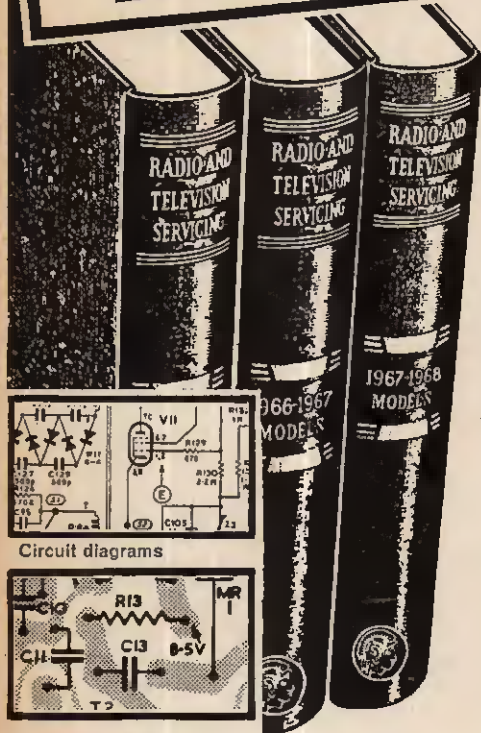

Fig. 6.9. Diode clamp circuit, showing principle of operation

Nearly 1,700 Circuits and Diagrams plus full repair data for 800 POPULAR MODELS

Great New
Edition



1968 RIGHT BACK TO 1965

RADIO & TV SERVICING

Big time-saving repair library
to step up your earnings

Now off the Printing Presses—a great new edition of RADIO & TV SERVICING, to save your time, to boost your earning-power. Packed with CIRCUITS, REPAIR DATA and vital information, it covers all the popular 1965-1968 TVs, Radios, Grams, Record Players and Tape Recorders—including latest data on COLOUR TV. Thousands of sets of previous editions sold. Now you can examine this big NEW edition free for a week. 3 handsome volumes—over 1,500 pages written by a team of research engineers—there's no other publication like it. Speeds up repair work for year after year. Hurry—send no money—simply post this coupon below... There can be no reprint once stocks are sold and there's absolutely no obligation to buy under this free trial offer.

**FULL DATA & CIRCUITS
FOR REPAIR OF**

● TELEVISIONS including

COLOUR TV

● RADIOS, RADIOGRAMS

● CAR RADIOS

● RECORD PLAYERS

● TAPE RECORDERS

SERVICING DATA FOR ALL THESE MAKES

Alwa, Alba, Baird (including colour TV), Beogram, Beolit, Bush, Carousel, Cossor, Dansette, Decca, Defiant, Dynaport, Dynatron, Eddystone, Ekco, Elizabethan, Ever Ready, Ferguson, Ferranti, Fidelity, G.E.C. (including colour TV), Grundig, H.M.V., Kolster-Brandes, Hitachi, Invicta, McMichael, Marconiphone, Masteradio, Motorola, Murphy, National, Newmatic, Pam, Perdio, Peto-Scott, Philips (including colour TV), Portadyne, Pye, Radiomobile, R.G.D., Regentone, Roberts' Radio, Sanyo, Sharp, Smith's Radiomobile, Sobell (including colour TV), S.T.C., Sony, Standard, Stella, Stereosound, Teletron, Thorn, Trans Arena, Ultra, Van Der Molen, World Radio.

PLUS LATEST DEVELOPMENTS IN RADIO AND TELEVISION

Including—Integrated Tuners, Stereo Multiplex Broadcasting—The Zenith-G.E. System. Receiver, Decoder and adjustments, Aerial, etc. Colour TV Receivers, Colour TV Test Card F, Servicing Transistor Equipment, Chemical Aids to Servicing, Batteries and Rechargeable Cells, Sound-on-Sync., Double Line Sync., Silicon Transistors, etc.

Sent to your home post paid on

7 DAYS FREE TRIAL

Absolutely no obligation to buy

OVER 1,500 PAGES, PACKED WITH CIRCUITS, COMPONENT LAYOUT DIAGRAMS, PRINTED PANEL DIAGRAMS, TABLES AND WAVEFORM GRAPHS.

Handsomely bound in rich maroon and gold.

To: Buckingham Press Ltd., 18/19 Warren Street, London, W.1

Please send Radio and TV Servicing—3 volumes without obligation to buy if you accept my application. I will return the books in 8 days or post:

Tick (✓) Full cash price of £12, or
here 15/- dep. and 16 monthly payments of 15/-.
If you are under 21 your father must fill up coupon.

Full Name.....
(Block letters)

Address.....

County.....

Occupation.....

Signature.....

Credit price £12.15s. For Eire & N.I. send £12 with coupon. Elsewhere overseas add 10/- P. & P.

Please tick (✓) here
The address on left is
my/our properly
Rented
unfurnished
Furnished accom
Temporary address
If none of the above
please answer here

RV3/3670

Circuit diagrams

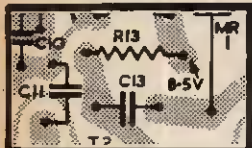

Printed panel diagrams



Component layout diagrams

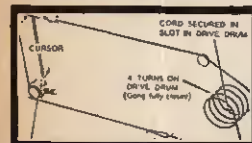

Drive-cord diagrams

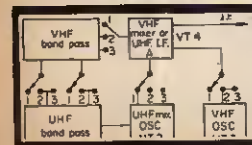

Block diagrams

MOVING COIL MULTIMETER TK 25. 49/6
 0-1,000, A.C./D.C., ohms 0 to 100k, etc.
SUPERIOR MOVING COIL MULTIMETER. 99/6
 0-2,500V, D.C. 20,000 ohms per volt, 0-1,000V, A.C.
 Ohms 0 to 6 meg, 50 Microamps. (Full List Meters S.A.E.)

NEW MULLARD TRANSISTORS
 OC71 8/-, OC78 6/-, OC81D 6/-, OC81 6/-, AP115 8/-;
 AP114 8/-, OC44 6/-, OC45 6/-, OC171 6/-, OC170 6/-;
 AP117 8/-, OC28 12/6; AD140 15/-; OC35 15/- Holders 1/-;
REPARCO TRANSISTOR TRANSFORMERS
 TT45, Push Pull Driver 9/10T
 TT46, Push Pull Output CT 6/1
 TT49, Interstage, etc. 4.5/1
 TT52, Output 3 ohms 20/1
TRANSISTOR MAINS ELIMINATORS. FAMOUS MAKE
FULLY SMOOTHED, FULL WAVE CIRCUIT. 49/6
 9 VOLT, 600mA, Size 6" x 8" x 3"
DITTO TRANSFORMER ONLY. Size 2 1/2" x 1 1/2" x 10/8

WEYRAD P50 — TRANSISTOR COILS
 BA2W 6 in. Ferrite Aerial Spare Cores 6d.
 with car aerial coil.....12/6
 Driver Trans. LEDT4..... 9/6
 Osc. P50/1AG..... 5/4
 Printed Circuit, FCA1..... 9/8
 I.F. P50/2C..... 5/7
 J.B. Tuning Gang..... 10/6
 3rd I.F. P50/3C..... 5/1
 Weyrad Booklet..... 2/-
 Telescopic Chrome Aerials 6in. extends to 29in. 5/-

Volume Controls
LONG SPINDLES. MIDGET
 SIZE 5 K. ohms to 2 Meg.
 LOG or LIN. V. 8/3/-, D.P. 5/-
STEREO LOG 8/8, D.P. 14/6.
 5 K. R.P. Edge Type 5/-

80 Ohm Coax 8d. yd.
SEMI-AIR SPACED
 40yd. 20/-; 60yd. 30/-;
FRINGE LOSS 1/6 yd.
 Ideal 825 lines

COAXIAL PLUG 1/8. PANEL SOCKETS 1/8. LINE SOCKETS
ETS 2/-, OUTLET BOXES, SURFACE OR FLUSH 4/6.
BALANCED TWIN 1/8. 20 or 300 ohms.
CAR AERIAL PLUGS 1/8. SOCKETS 1/8; LINE SOCKETS 2/-

SELCOL TRANSISTOR AMPLIFIER ONE WATT POWER OUTPUT



Portable Cabinet size 18 x 4 x 3in. Rated 7 x 5in. speaker. Volume Control, Standard Jack Socket. Uses PP9 Battery. Will increase volume and performance of Transistor Radios, Record Players, Tape Recorders, etc. Ideal for guitar practice. **WORTH DOUBLE!**
 PRICE **79/6** POST 5/6

MAINS TRANSFORMERS Post. 5/- each
 250-0-250 80 mA. 6.3 v. 3.5 a. 6.3 v. 1 a. or 5 v. 2 a. 20/-
 350-0-350 80 mA. 6.3 v. 3.5 a. 6.3 v. 1 a. or 5 v. 2 a. 25/-
 300-0-300 v. 120 mA. 6.3 v. 4 a. C.T.: 6.3 v. 2 a. 45/-
 MINIATURE 500 v. 20 mA. 6.3 v. 1 a. 12/6
 MIDGET 220 v. 45 mA. 6.3 v. 2 a. 17/6
 HEATER TRANS. 9.3 v. 11 a., 9/6; 9.3 v. 4 a. 12/6
 DITTO tapped sec. 1.4 v., 2.3, 4.5, 6.3 v. 1 amp. 12/6
GENERAL PURPOSE LOW VOLTAGE. Outputs 3, 4, 5, 6, 8, 9, 10, 12, 15, 18, 24 and 30 v. at 2 a. 30/-
 1 amp. 8, 9, 10, 12, 15, 18, 20, 24, 30, 36, 40, 48, 60, 35/-
AUTO TRANSFORMERS 0-12-220 v. Input/Output, 80w. 13/6; 150w. 30/-; 600w. 92/6; 1000w. 175/-

CRYSTAL MIKE INSERTS
 1 1/2 x 1/2 in. 6/8; ACOS 1 1/2 x 1/2 in. 8/8. BMS. 1" dia. 9/8
MOVING COIL MIKE with Remote Control Switch 19/6
ALL PURPOSE HEADPHONES
 H.R. HEADPHONES 2000 ohms 19/6
 H.R. HEADPHONES 2000 ohms Super Quality 25/-
 LOW RESISTANCE HEADPHONES 3-5 ohms 35/-

RESISTORS. Preferred values, 10 ohms to 10 meg. 1 w., 1/2 w., 1 w., 20% 3d., 11 w. 8d.; 2 w. 1/-; 4 w. 10% 8d.
HIGH STABILITY. 1/2 w., 15% 10 ohms to 10 meg., 2/-
 Ditto 5% Preferred values 10 ohms to 88 meg., 9d.
 5 watt } 0.5 to 8.2 ohm 3 w. } 2/-
 10 watt } **WIRE-WOUND RESISTORS** } 2/-
 10 ohms to 6,800 ohms }
 10K, 15K, 20K, 25K, 33K, 10W. 3/-

SPEAKER FRET YUKAN various colours. 52in. wide, from 10/- ft.; 26in. wide from 5/- ft. SAMPLES S.A.E.
EXPANDED METAL Gold or Silver 12 x 12 in. 6/-.
VEROBOARD 0.15 MATRIX
 2 1/2 x 5in. 2/6d., 2 1/2 x 3 1/2 in. 5/2d., 3 1/2 x 3 1/2 in. 3/8d.
EDGE CONNECTORS 18 way 5/-; 24 way 7/8.
PINS 26 per packet 3/4d. FACE CUTTERS 7/8.
S.R.B.P. Board 0.15 MATRIX 2 1/2 in. wide 6d. per lin.; 3 1/2 in. wide 9d. per lin.; 5 in. wide 1/- per lin. (up to 17in.)
BLANK ALUMINIUM CHASSIS. 18 s.w.g. 2 1/2 in. sides, 7 x 4in. 5/8; 8 x 7in. 6/6; 11 x 3in. 6/6; 11 x 7in. 7/6; 13 x 9in. 9/8; 14 x 13in. 12/8; 15 x 14in. 15/-
ALUMINIUM PANELS 18 s.w.g. 12 x 12in. 6/6; 14 x 7in. 5/8; 12 x 5in. 4/8; 10 x 7in. 3/8; 8 x 6in. 2/6; 6 x 4in. 1/6.

THE INSTANT BULK TAPE ERASER AND RECORDING HEAD DEMAGNETISER
 200/250 v. A.C. Leaflet S.A.E. **35/-**



ALL EAGLE PRODUCTS
EAGLE AM TUNER. Medium Wave. Transistor Superhet. Ferrite aerial, etc. **79/6**
EAGLE DE LUXE TAPE SPLICER Cuts, trims, joins for editing and repairs. With 5 blades. **17/6**
EAGLE 4 CHANNEL TRANSISTOR MIXER. Add manual highlights and sound effects to recordings. Will mix Microphone, records, tape and tuner with separate controls into single output. **59/6**
EAGLE DYNAMIC MICROPHONE. Impedance 600 ohms/50K. 70-12,000 cps. Universal mounting, stick, hand or stand. Professional quality. **£6.16.0**
EAGLE FM TUNER 88-108 Mc/s Sine Transistor. Ready built. Printed Circuit. Calibrated slide dial tuner. Size 6" x 8" x 2 1/2". **£8.10.0**
EAGLE 3 WATT AMPLIFIER. 4 Transistor Push-Pull Ready built, with volume control **69/6**
40-PAGE EAGLE CATALOGUE 5/- Post Free

★ RADIO BOOKS ★ (Postage 8d.)
 High Fidelity Speaker Enclosures and Plans 5/-
 Transistor Superhet Commercial Receivers 7/6
 Mullard Audio Amplifier Manual 8/8
 Radio Valve Guide, Books 1, 2, 3, or 5 each 5/-
 Practical Radio Inside Out 4/6
 Transistor Audio Amplifier Manual Book 1, 3/6; Book 2, 5/-
 Shortwave Transistor Receivers 6/-
 Transistor Communication Sets 6/-
 International Radio Stations List 2/8
 Modern Transistor Circuits for Beginners 7/8
 Sub-Miniature Transistor Receivers 5/-
 Wireless World Radio Valve Data 8/8
 At a glance valve equivalents 6/-
 Valves, Transistors, Diodes equivalents manual 10/8

WIRE-WOUND 3-WATT **WIRE-WOUND 4-WATT**
POTS, T.V. Type. Values **STANDARD SIZE POTS.**
 10 ohms to 30 K., 3/3, **LONG SPINDLE VALUES**
 Carbon 30 K. to 2 meg., 5/-, **50 OHMS to 100 K., 7/6.**

VALVE HOLDERS. MOULDED 6C: CERAMIC 1/- EACH.
SCREWING CANS 1/-; VALVE BASE PLUGS 2/8.
SANGAMO 3 inch SCALE METERS 45/- ea.
 Various calibrations and movements. 100 Microamp;
 1 Milliamp 50-60 Microamps, etc., S.A.E. for list.

BRAND NEW QUALITY EXTENSION LOUDSPEAKER
 Black plastic cabinet, 20ft. lead and adaptors. For any radio, intercom, tape recorder, etc. 8 to 15 ohm. **POT 30/-**
 Size: 7 1/2" x 8 1/2" x 3" **2/6**



RETURN OF POST DESPATCH Minimum Post and Packing charge 2/6. **C.O.D. 5/- extra. Full List 1/-.** **CALLERS WELCOME**
RADIO COMPONENT SPECIALISTS **337 WHITEHORSE ROAD, WEST CROYDON**
 Written guarantee with every purchase. (Export: Send remittance and extra postage, no C.O.D.) Buses 133, 68 pass door. S.R. Stn. Selhurst. TEL. 01-884-1665

NEW RANGE BBC 2 AERIALS
 AD U.H.F. aerials now fitted with tilting bracket and 4 element grid reflectors.
Loft Mounting Arrays, 7 element, 37/6.
 11 element, 45/-; 14 element, 52/6, 18 element, 60/-; Wall Mounting with Cranked Arm, 7 element, 46/-; 11 element, 57/-; 14 element, 75/-; 18 element, 82/6. **Mast Mounting with 2in. clamp, 7 element, 42/6; 11 element, 55/-; 14 element, 62/-; 18 element, 70/-.** **Chimney Mounting Arrays, Complete, 7 element, 72/6; 11 element, 80/-; 14 element, 87/6; 18 element, 95/-.** Complete assembly instructions with every unit. **Low Loss Cable, 1/6 yd. U.H.F. Pre-amps from 75/-.** State clearly channel number required on all orders.
BBC · ITV AERIALS
BBC (Band 1). Telescopic loft, 25/6; External S/D, 30/6; "H", £2.15.0.
ITV (Band 3). 3 element loft array, 30/-; 5 element, 45/-; 7 element, 50/-; Wall mounting, 3 element, 47/6. 5 element, 52/6.
Combined BBC/ITV. Loft 1+3, 40/-; 1+5, 50/-; 1+7, 60/-; Wall mounting 1+3, 37/6; 1+5, 47/6; Chimney 1+3, 67/6; 1+5, 75/-.
VHF transistor pre-amps, 75/-.
COMBINED BBC1 · ITV · BBC2 AERIALS
 1+3+9, 70/-; 1+5+9, 80/-; 1+5+14, 90/-; 1+7+14, 100/-; Loft mounting only. Special leaflet available.
F.M. (Band 2). Loft S/D, 15/-; "H", 22/6, 3 element, 55/-; External units available. Co-ax cable, 8d. yd. Co-ax plugs, 1/4. Outlet boxes, 5/-; Diplexer Crossover Boxes, 13/6. C.W.O. or C.O.D. P. & P. 5/-; Send 6d. stamps for illustrated lists.
CALLERS WELCOME
OPEN ALL DAY SATURDAY
K.V.A. ELECTRONICS (Dept. P.E.)
 27 Central Parade, New Addington
 Surrey—CRO-OJB
 LODGE HILL 2246

MATERIALS FOR THE RADIO CONTROL DEVICES IN THIS ISSUE AVAILABLE FROM TELERADIO
Specialists in Radio Control Systems
 Send S.A.E. for breakdown price lists of the components required, quoting P.E./RC/68
TELERADIO ELECTRONICS
 325-7 FORE STREET
 EDMONTON, LONDON, N.9
 01-807 3719



NEW 1968 Edition RADIO AMATEUR HANDBOOK
 45/- by A.R.R.L. Postage 4/-
WORLD RADIO T.V. HANDBOOK, 1968 ed. 42/-. Postage 1/-.
MULLARD DATA BOOK, 1968. 3/6. Postage 6d.
RADIO AND AUDIO SERVICING HANDBOOK, by G. J. King. 30/-. Postage 1/6.
MATHEMATICS FOR RADIO AND ELECTRONICS TECHNICIANS, by Ing. F. Bergtold. 50/-. Postage 1/6.
RCA TRANSISTOR MANUAL. 20/-. Postage 1/-.
Inter GEC. S.C.R. MANUAL 4th ed. 25/-. Postage 2/-.
COLOUR TELEVISION PAL SYSTEM, by G. N. Patchett. 40/-. Postage 1/-.
TRANSISTOR POCKET BOOK by R. G. Hibberd. 25/-. Postage 1/-.

THE MODERN BOOK CO.
 BRITAIN'S LARGEST STOCKISTS
 of British and American Technical Books
 19-21 PRAED STREET
 LONDON, W.2
 Phone: PADdington 4185
 Closed Saturday 1 p.m.

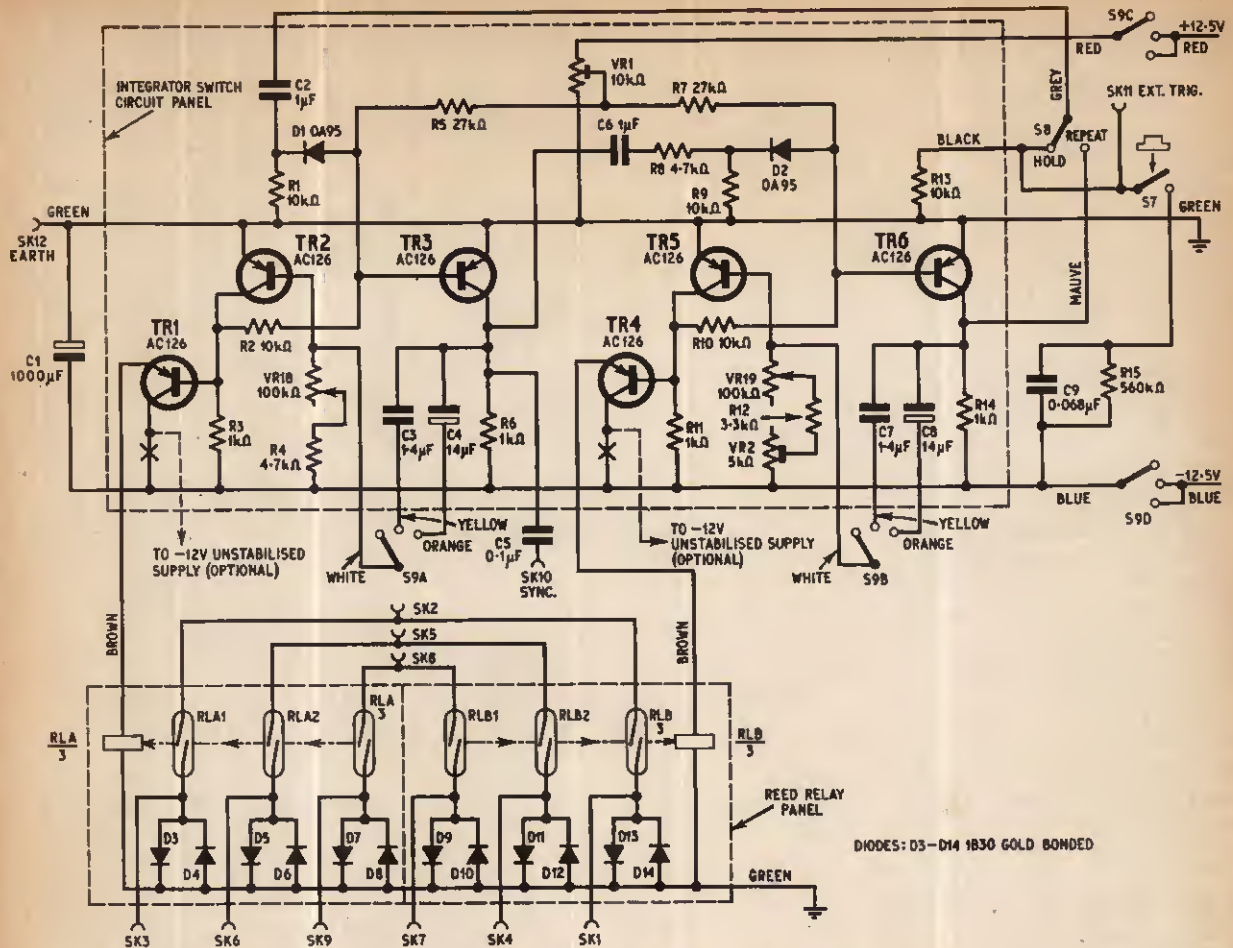

Fig. 6.10. The complete circuit diagram of the integrator switch

adjust VR1-VR4 on the resistor panel for optimum accuracy on each range.

INTEGRATOR MODE SWITCHING

The simplest type of integrator switch employs a mechanical relay with several sets of contacts, driven by an astable multivibrator, and this system is used for small demonstration and educational analogue computers. The relay is arranged to "gate" the inputs of several amplifiers simultaneously.

The PEAC integrator switch goes a stage further, with reed relays for a "clean" switching action at high speeds, full initial condition facilities, and a circuit based on two independently timed monostable multivibrators.

Referring back to the basic integrator switch shown in Fig. 1.2c, two changeover switches S1 and S2 are opened and closed in a pre-determined sequence, governed by an external timing circuit. It is important to ensure that integrating amplifier input resistors are not left floating when they are disconnected from the virtual earth summing junction, as this could seriously disturb input and other computer voltages, hence the presence of S1 and S2 earthed contacts.

DIODE CLAMPS

To eliminate the need for expensive reed switches with changeover contacts, diode clamps can be used instead of an earthed contact, see the alternative

amplifier circuit of Fig. 6.9. The diodes do not interfere with the normal working of the integrator, but will nevertheless hold resistor junctions close enough to earth to prevent load variations when S1 and S2 are open, and this modification more than halves the cost of switching components.

In the block diagram of Fig. 6.9, the 1st monostable—controlled by VR18—determines the period of closure of S1. When S1 opens after a timed interval, a pulse is delivered to the input of the 2nd monostable, thus closing S2. S2 will remain closed for an interval controlled solely by VR19.

For "single shot" operation, a trigger pulse applied to the 1st monostable input, when S8 is switched to "hold", will initiate the closure of S1 (reset) and bring the integrating amplifier to its initial condition.

As soon as S1 opens, S2 closes (compute) and connects input resistors to the summing junction. At the end of the compute period, S1 and S2 are both open (hold), the monostables are quiescent, and the amplifier output voltage is held steady by the action of capacitor C_r . The next computer run is started by another trigger pulse applied to the 1st monostable input.

Repetitive operation is achieved by passing the output pulse from the 2nd monostable back to the input of the 1st monostable, when S8 is switched to "repeat". S1 and S2 are then made to open and close alternately, and the "hold" facility is deleted.

The method of inserting an initial condition voltage is as follows. When S1 is closed the reset resistor R_r is connected between the amplifier output and summing junction, and can therefore be regarded as a feedback resistor in parallel with C_r .

As long as S1 remains closed, R_{ic} will be acting as an input resistor, so that

$$E_o = - E_{ic} \frac{R_r}{R_{ic}}$$

and $E_o = - E_{ic}$ when $R_r = R_{ic}$. R_{ic} and R_r are disconnected from the amplifier summing junction when S1 opens, but C_r will "remember" the initial condition voltage and hold the amplifier output steady prior to the application of compute voltages when S2 closes.

INTEGRATOR SWITCH CIRCUIT

The complete circuit of the integrator switch is shown in Fig 6.10. The 1st monostable consists of TR2 and TR3, with RLA actuated by emitter follower TR1. VR18 continuously covers two ranges given by C3 (10-100ms), and C4 (0.1-1s). Components associated with the 1st monostable input are C2, R1, and D1.

The 2nd monostable is almost identical to the 1st. TR4 drives RLB, C7 and C8 offer the same timing range coverage as C3 and C4, and input components are C6, R8, R9, and D2. However, more care is taken to establish the correct values for 2nd monostable timing capacitors C7 and C8, and VR2 allows precise calibration of the "fast end" of the VR19 timing scale, so that compute intervals can be determined by a reasonably accurate dial setting.

VR1 establishes the working point of both monostables, to achieve reliable operation at all dial settings. S7 is a push button on the front panel for starting a "single shot" computer run. Full control of an oscilloscope trace, from UNIT "B" front panel, can be realised by suitable connection to the integrator switch circuit. With S8 switched to "hold", the mode sequence can be triggered repetitively, with a variable hold interval, by the oscilloscope timebase output or by a separate oscillator. Consistent synchronisation of the trace, with continuous or single-sweep timebases, is made possible by linking IS/SK10 to an appropriate oscilloscope input

A SEPARATE SUPPLY

The load capacity of the existing stabilised power supply can be improved by wiring the collectors of TR1 and TR4 (shown dotted in Fig. 6.10) to a separate -12V unregulated supply, which can be housed inside the UNIT "B" box, and in this event C1 could be omitted from the Fig. 6.10 circuit, as it merely serves to prevent current pulses from flowing in the negative stabilised supply line during relay switching.

RLA and RLB consist of two triple-switch coils, catering for the needs of three integrating amplifiers. A duplicate relay panel could be added later, by wiring relay coils in parallel, to increase the switching capacity to six amplifiers.

CORRECTION

In Fig. 5.7, the captions for the first and second oscillographs (top row, left and centre) should be transposed.

Next month: Assembly and setting up of the Integrator Switch; practical examples in the use of this section. Introduction of UNIT "C" Function Generator.

next month!

Build this DRILL SPEED CONTROLLER

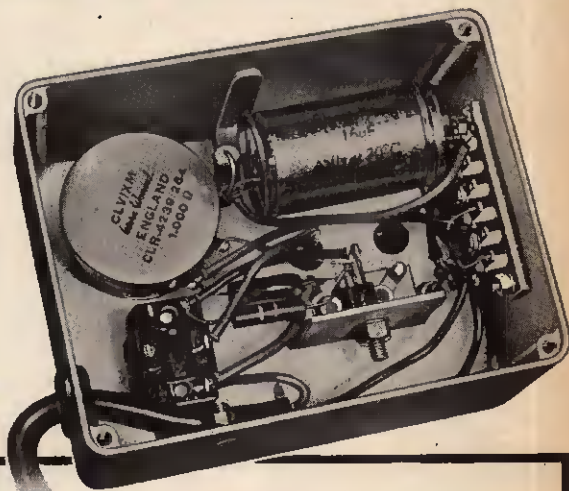
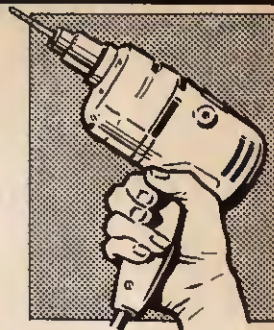

An invaluable accessory giving controlled drill speed at constant power. Easy to build from full instructions in next month's issue. This small, compact unit incorporates a simple thyristor circuit, providing smooth variation of drill speed by finger-tip control.

ALSO MULTI-CHANNEL RADIO CONTROLLED MODEL BOAT

The second part of this feature contains details of the electro-mechanical drive system and the power supply

WAA-WAA

A modern effects unit for electronic guitars

PRACTICAL ELECTRONICS

JULY ISSUE ON SALE FRIDAY JUNE 14

Order your copy now!

Budding technician?

In just 15 months, the Army could set you up for life!

Think it over. In just 15 months, you could have completed an Army course in electronics. You'd have trained with the most modern equipment and now you'd be handling it as though it was second nature. You'd be earning nearly £14 a week—with all your food and accommodation thrown in. And you'd be looking forward—in about eight months time—to promotion to corporal and the pay rise that goes with it. It's a great life all right. And if you're between 17-23 it's wide open to you. Get the facts by filling in the coupon or calling at your local Army Careers Information Office (address from any Post Office).

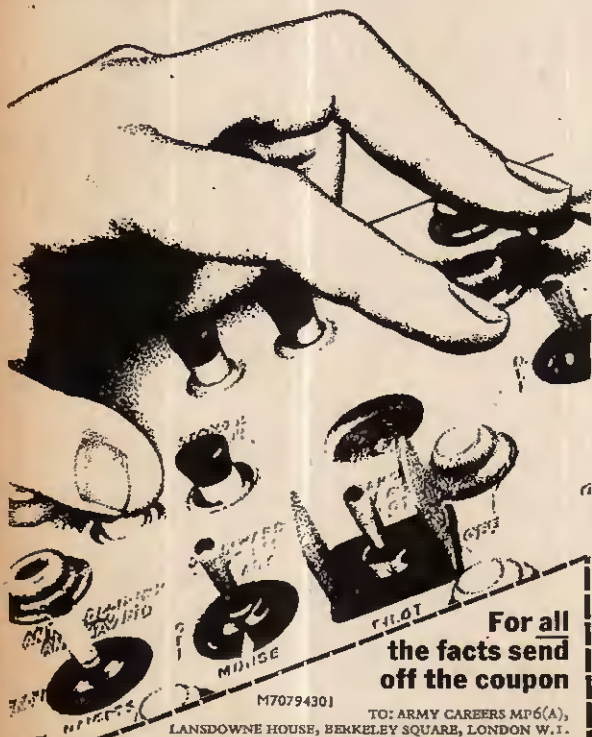

For all the facts send off the coupon

M70794301

TO: ARMY CAREERS MP6(A),
LANSDOWNE HOUSE, BEKKELEY SQUARE, LONDON W.1.
PLEASE SEND ME THE LATEST FREE ARMY LEAFLET.

NAME.....
ADDRESS.....
TOWN.....
COUNTY..... DATE OF BIRTH.....

(You must be a resident in the U.K., aged 15 for Junior Entry, 17 or over for the Regular Army.)



S-DeC

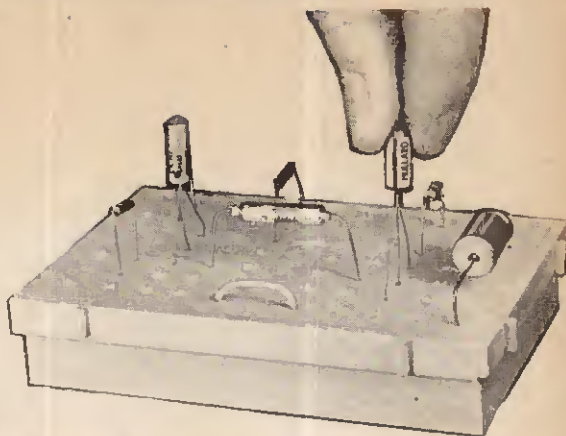

BREADBOARDING

SINGLE DeCs. One S-DeC with Control Panel, Jig and Accessories for solderless connections to controls, etc., with booklet 'Projects on S-DeC' giving construction details for a variety of interesting circuits 29/6 + 6d. P. & P.

4-DeC KIT. Four S-DeCs with two Control Panels, Jigs and Accessories and the booklet 'Projects on S-DeC' all contained in a strong, attractive plastic case. Ideal for the keen enthusiast and professional user £5.17.6 + 2/6d. P. & P.

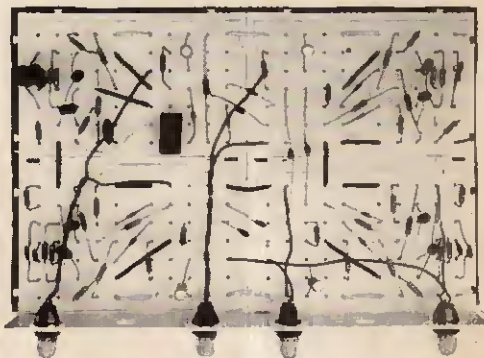

Four-stage binary counter using the 4-DeC Kit

★ S-DeC AVAILABLE FROM ELECTRONIQUE DEALERS AND LEADING SUPPLIERS

In case of difficulty in obtaining from a retailer post this form:
Please send me S-DeCs kits and 4-DeC kits for which I enclose P.O./Cheque/Money Order value £...../...../.....

NAME

ADDRESS

To: S.D.C. PRODUCTS (Electronics) LTD.
THE CORN EXCHANGE, CHELMSFORD, ESSEX

ORGAN BUILDERS! N.P.N. Sil. Planar Transistors. All Tested, 1/6 each or £5.0.0 per 100.

TRANSISTOR BARGAIN SALE! NEW STOCK AT UNBEATABLE PRICES!

OC44, OC45, OC81D now only 1/6 each! £6.0.0 per 100
 OC71, OC72 equivalent 1/- each! £5.0.0 per 100
 ASY22 Switching Transistors 2/6 each! £10.0.0 per 100

2N763 N.P.N. Silicon Planar, 300mW, 250Mc/s. High speed switching .. 2/6 each!
 88Y28 N.P.N. Silicon Planar, Epitaxial, 300mW, 300Mc/s .. 2/6 each!
 88Y48 N.P.N. Silicon Planar, Epitaxial, 800mW, 100Mc/s .. 2/6 each!
 AFZ12 P.N.F. Germanium Alloy Diff. low noise V.H.F. amplifier .. 2/6 each!

Complete sets of transistors for radio:
 2G344A/2G345A/2G345B/2G371A/2G378A/2G378A + diode .. 10/- only!
 GET120, 2 watts. Heat sink included .. 2/6 each!
 Transistor Driver Transformers .. 2/6 each!
 Transistor Output Transformers (suitable for our kits above) .. 2/6 each!
 OC28 .. 5/- each!
 BY213, 6 amp rectifiers. **SPECIAL REDUCED PRICE! ONLY 2/6 each; 24/- doz.;**
 £7.10.0 per 100; £50.0.0 per 1,000.

Light sensitivity transistors similar to OC71 .. 2/- each!
 UNMARKED, UNTESTED TRANSISTORS TO CLEAR .. 7/4 for 50!
 Silicon diodes. Make excellent detectors. Also suitable for keying electronic organs.
 1/- each; 20 for 10/-.

BY100 type rectifiers. **SPECIAL REDUCED PRICE! ONLY 2/6 each; 24/- doz.;**
 £7.10.0 per 100; £50.0.0 per 1,000.

ELECTROLYTIC CONDENSERS FANTASTIC SELECTION!

0.25µF .. 3 volt	4µF .. 3 volt	50µF .. 9 volt
1µF .. 50 volt	8µF .. 3 volt	64µF .. 2.5 volt
1µF .. 300 volt	8µF .. 6 volt	64µF .. 9 volt
1.25µF .. 15 volt	8µF .. 360 volt	100µF .. 3 volt
2µF .. 3 volt	8µF .. 450 volt	100µF .. 6 volt
2µF .. 9 volt	8µF .. 50 volt	100µF .. 9 volt
2µF .. 70 volt	8µF .. 276 volt	150µF .. 12 volt
2µF .. 180 volt	10µF .. 25 volt	150µF .. 3 volt
2µF .. 350 volt	16µF .. 150 volt	200µF .. 4 volt
2.5µF .. 16 volt	20µF .. 3 volt	200µF .. 2.5 volt
2.5µF .. 25 volt	20µF .. 6 volt	250µF .. 9 volt
3µF .. 3 volt	20µF .. 9 volt	250µF .. 2.5 volt
3µF .. 25 volt	25µF .. 15 volt	320µF .. 9 volt
3.2µF .. 6.4 volt	25µF .. 8 volt	360µF .. 2.5 volt
3.2µF .. 64 volt	25µF .. 12 volt	360µF .. 10 volt
4µF .. 4 volt	25µF .. 15 volt	360µF .. 2.5 volt
4µF .. 12 volt	25µF .. 25 volt	400µF .. 15 volt
4µF .. 25 volt	30µF .. 6 volt	400µF .. 4 volt
4µF .. 94 volt	30µF .. 10 volt	500µF .. 6 volt
4µF .. 100 volt	30µF .. 3 volt	500µF .. 2.5 volt
5µF .. 6 volt	40µF .. 6.4 volt	640µF .. 2.5 volt
5µF .. 25 volt	40µF .. 6.4 volt	

All at 1/- each. Mixed Packets of 20 (our selection) 10/-.

PAPER CONDENSERS

0.001µF .. 500 volt	0.02µF .. 600 a.c.	0.25µF .. 350 volt
0.001µF .. 1000 volt	0.02µF .. 350 volt	0.5µF .. 300 volt
0.002µF .. 500 volt	0.1µF .. 350 volt	0.5µF .. 500 volt
0.005µF .. 700 volt	0.1µF .. 700 volt	

All at 15/- per 100. 3/- per dozen. Mixed Bags of 100 (our selection) 10/-.

MULLARD POLYESTER CAPACITORS. ALL HALF PRICE

0.0025µF 400 volts .. 4d	0.15µF 160 volts .. 7d
0.0018µF 400 volts .. 4d	0.22µF 160 volts .. 7d
0.0015µF 400 volts .. 4d	0.27µF 160 volts .. 8d
0.001µF 400 volts .. 4d	0.055µF 125 volts .. 7d
0.01µF 400 volts .. 4d	1µF 125 volts .. 1/8

65pF Tubular pulse ceramic .. 6d each

VERY SPECIAL VALUE! Silver Mica, Ceramic, Polystyrene Condensers. Well assorted. Mixed types and values, 10/- per 100.

RESISTORS. Give-away offer! Mixed types and values, 1/2 to 1 watt, 5/6 per 100 or 55/- per 1,000. Individual values, 3d each.

Also 1/2 to 3 watt close tolerance. Mixed values, 7/8 per 100; 55/- per 1,000.

WIRE-WOUND RESISTORS. 1 watt, 3 watt, 6 watt, 6d each, 7 watt and 10 watt 9d each or 20 mixed types 10/-.

CONNECTING WIRE. THIN, P.V.C. INSULATED.
 10yd, 1/-; 100yd, 7/8; 500yd, 25/- (post 4/8); 1,000yd, 40/- (post 6/-).

VALVES. BRAND-NEW AND BOXED. ROCK-BOTTOM PRICES!

DY87 .. 8/9	LY86 .. 6/9	PCL86 .. 8/5
EABC80 .. 7/4	BY87 .. 6/9	PFL200 .. 11/8
OC82 .. 7/4	2ABC80 .. 7/1	PL86 .. 10/1
OC83 .. 7/4	PC87 .. 6/9	PL81 .. 8/5
ECL80 .. 7/1	PC84 .. 7/4	PL83 .. 8/5
ECL86 .. 8/5	PC89 .. 10/8	PL84 .. 6/8
EF80 .. 7/1	PCP80 .. 8/5	PL500 .. 12/5
EF85 .. 7/1	PCP86 .. 10/7	PY32 .. 9/-
EF183 .. 9/5	PCL82 .. 8/5	PY81 .. 6/9
EF184 .. 9/5	PCL84 .. 8/5	PY82 .. 4/9
EY51 .. 6/9	PCL85 .. 8/5	PY800 .. 6/9

A further 10% discount will be given on lots of 50 of any one type.

RECORD PLAYER CARTRIDGES
 Acos GP87/29 Mono, 15/-; Acos GP91/26C Stereo compatible, 20/-; Acos GP94/1 Stereo, 25/-. All with needles.

Transistorised Signal Injector Kit—10/-.
Transistorised Signal Tracer Kit—10/-.

VEROBOARD. All sizes in stock.

2 1/2in x 1in 0.15 matrix .. 1/3	17in x 3 1/2in 0.15 matrix .. 14/8
2 1/2in x 3 1/2in 0.15 matrix .. 3/3	
3 1/2in x 3 1/2in 0.15 matrix .. 3/11	5in x 2 1/2in 0.1 matrix .. 3/11
3 1/2in x 3 1/2in 0.15 matrix .. 3/11	3 1/2in x 3 1/2in 0.1 matrix .. 3/9
3 1/2in x 6in 0.15 matrix .. 6/6	6in x 3 1/2in 0.1 matrix .. 3/2
17in x 3 1/2in 0.15 matrix .. 11/-	3 1/2in x 3 1/2in 0.1 matrix .. 3/11

SPECIAL OFFER!
 Outer and 5 Boards 2 1/2in x 1in, 6/9. Cutter only, 7/6. Pin Insert Tool, 9/6. Terminal Pins. Packet of 36, 3/6.

BARGAIN OFFER!
 Few only Multimeters, 1,000Ω per volt, 45/-; 20,000Ω per volt, 80/-.

Orders by post to:—
G. F. MILWARD, 17 PEEL CLOSE, DRAYTON BASSET, Staffs.
 Please include suitable amount to cover postage. Stamped addressed envelope must be included with any enquiries.
 For customers in the Birmingham area goods may be obtained from Rock Exchanges, 231 Alum Rock Road, Birmingham 8. (All Post orders to Drayton.)
MINIMUM ORDER 10/-

SHORT WAVE ONE VALVE RECEIVER KIT 39/6 + 2/6 P.P.

PEAC ANALOGUE COMPUTER KIT IN STOCK

UNIT 'A' COMPLETE £26.0.0 + 15/- P.P.

Punched aluminium panels and case for above £4.17.6 + 5/- P.P.

CLUBMAN Mk. I KIT COMPLETE £6.17.6 + 5/- P.P.

Without metal work £4.12.6 + 2/6 P.P.

CLUBMAN Mk. II KIT COMPLETE £10.17.6 + 5/- P.P.

Without metal work £8.12.6 + 4/6 P.P.

EXPLORER KIT COMPLETE £4. 2.6 + 2/6 P.P.

STABILIZED POWER SUPPLY KIT 0.20V. 500ma COMPLETE £4.17.6 + 5/- P.P.

COMBINED AUDIO OSCILLATOR AND FREQUENCY METER £17 + 10/- P.P.

PORTABLE TEST UNIT KIT
FLUORESCENT CAMPING LIGHT IN STOCK

S.A.E. FOR TRANSISTORS, SEMICONDUCTORS, FULL LIST 700 TYPES

3 SILICON RECTIFIERS, BY100 TYPE 10/-
 10 MIXED MARKED TESTED TRANSISTORS 10/-
 40 UNMARKED UNTESTED TRANSISTORS NEW 10/-
 1 LIGHT SENSITIVE CELL ORP12 8/6
 25 MIXED UNMARKED TESTED TRANSISTORS 10/-
 2 TRANSISTOR COMP. PAIR AD161/162 16/- P.P. 1/-

OUR COMPONENTS CATALOGUE 5/- Post Paid with 10/- worth of discount vouchers.

OLRUS ELECTRONICS LTD.
748 HIGH ROAD, LEYTONSTONE
 (NEXT TO GREEN MAN)
LONDON, E.11. Tel. 01-989 2751
CALLERS WELCOME—CLOSED ALL DAY FRIDAY

★ CA 3020 (LINEAR I.C.) WIDE-BAND AMPLIFIER
 In 12-Lead to 5 Cases

COMPLETE WITH DATA SHEET 33/- EACH

ALUMINIUM DIECAST BOXES—Approx. dimensions: Type A 4 1/2 x 3 1/2 x 1 1/2 in. deep at 7/8 each. Type B 4 1/2 x 3 1/2 x 2 1/2 in. deep at 10/- each.

SURMINATURE TAGBOARDS—(1 1/2 in. wide), 6-way at 1/8. 18-way at 3/- each. **COAX. SOCKET**—Surface mounting, Nylon insulated, 1/8 each.

COAX. PLUG—Belling Lee Type L734, 1/4 each.

RESISTORS—CARBON FILM—1/2 watt, 5% 10 ohm to 10 Megohm, 3 1/2d each or 3/3 doz.

CARBON PRESET POTENTIOMETERS—Vertical or Horizontal mounting. 200 ohm to 2 Megohm. (Standard values) at 1/4 each.

MINIATURE CARBON POTENTIOMETERS—1 1/2 in. dia. x 1 1/2 in. deep; 1 1/2 in. dia. x 1 1/2 in. dia. x 5 Kohm to 2 Megohm 100Ω, and 5 Kohm to 1 Megohm, 1 1/2 in. at 3/- each or 2/8 each for 4 or more of the same value. (Standard values only.)

CAPACITORS—CERAMIC TUBULAR—(Standard Values) 4.7pF-0.01µF 5d each.

CAPACITORS—SILVER MICA—5pF-800pF 1/- each (Standard Values).

CAPACITORS—TANTALUM BEAD—A range of 36 miniature units, with values from 100pF/35v to 0.1µF/35v all values at 4/3 each.

BEEHIVE TRIMMERS—(3-30pF) at 2/6 each.

DIODES—0A70, 0A71, 0A78, 0A81, 0A85, 0A81, 0A200, 0A202 at 2/- each.

TRANSISTORS—OC44, 5/8; OC45, 5/4; OC71, 3/8; OC72, 5/4; OC83, 4/-; OC170, 7/8; BC107, 3/11; BC108, 3/8; BC109, 3/11; BC150, 5/8; OC81Z, 10/-; AC127Z, 9/6; BSY55A, 8/6; NKT212, 4/4; NKT218, 3/11; NKT226, 3/11; NKT271, 3/4; NKT274, 8/4; NKT275, 4/8; NKT773, 4/8; 2G992, 4/-; 2G371, 2/10; 2N706, 3/8; 2N697, 6/-; 2N3003, 6/8; 2N3638, 5/8; 2N3702, 3/8; 2N3703, 4/-; 2N3704, 5/-; 2N3705, 4/6; 2N3706, 3/8; 2N3707, 4/6; 2N3708, 3/4; 2N3709, 3/8; 2N3710, 3/8; 2N3711, 4/8; 2N3819(FET), 14/8; 2N3820(FET), 20/-; 2N2648(UJT), 10/8; BR398(SCS), 10/8; A WIDE RANGE OF OTHER TYPES ARE IN STOCK, INCLUDING 2N2926 SERIES—All groups at 3/3 each (or, 2/6 each in multiples of 6).

Postage and packing is charged at 1/- in the £ (Minimum of 2/- per order).

M. R. CLIFFORD & COMPANY (COMPONENTS DEPT.),
209A, MONUMENT ROAD, EDGBASTON, BIRMINGHAM, 16.
 Terms: C.W.O. (or C.O.D.—over £3 only) Tel.: 021-454 6515



DRUMMER'S

Whoosh..Sh..Sh

By A. J. BASSETT

THE "cymbals" circuit with the white noise generator, described last month, can be adapted to give a "whoosh" effect to the sound of drum beats. A microphone is placed in close proximity to the drums; the signal from the microphone is passed through the "whoosh" unit. The effect produced can be tuned or filtered to give different pitches for each drum beat.

WHOOSH TRIGGER

The unit described incorporates its own microphone amplifier to give sufficient drive to trigger the whoosh into action. Referring to the circuit in last month's cymbals effects article, the signal is fed into C7 from the heavily driven amplifier shown in Fig. 1.

This amplifier cannot be used as an ordinary audio amplifier or pre-amplifier for normal listening purposes, as its output would be pulsed and highly distorted; however, it is very suitable in this case for providing a pulse drive to the cymbals circuit. This latter circuit is triggered to pass white noise from the P.E. White Noise Generator.

Refer to the block diagram on Fig. 2. The sound of the drum is picked up by the microphone, which is placed close to the drum skin. The signal passes to the high-output-swing amplifier via a volume-control VR2.

The output pulses from the amplifier then operate the cymbal circuit, whose output can be heard as a "whoosh" by connecting to a power amplifier. A single-pole push/push switch may be connected from the junction of D2, D3 to chassis, in order to mute the unit when effects are not required.

The cymbals filter circuit is altered to give a lower "whoosh" sound rather than a cymbal effect. This

alteration consists merely of increasing the values of C5 and C10 to $0.05\mu\text{F}$; C7 and C8 become $0.01\mu\text{F}$, and R10 is decreased to 1 megohm. Different values may be tried, thus altering the effect to your own personal preference. It is necessary to adjust the volume controls (both the sensitivity control VR2 and the volume control on your audio amplifier) after changing the capacitors, as they have a considerable effect on the output amplitude of the unit.

If VR2 is set too high, acoustic feedback can occur, resulting in a continuous "whoosh" effect from the loudspeakers. Therefore, VR2 is set a little lower, so that a tap on the drum is necessary before the "whoosh" effect is produced. Other sounds, for example, from an electric guitar or organ, should not be allowed to trigger the whoosh unit. Another measure, which may be necessary in order to avoid this continuous "whooshing" feedback is to position the loudspeakers well away from the drums.

MAKING THE MODS

To make this effects unit you will need the basic white noise generator and cymbals filter boards (see last month's article). Carry out the modifications to the cymbals filter board as detailed earlier; fit these two units into a chassis or other box $12\text{in} \times 4\text{in} \times 2\frac{1}{2}\text{in}$, leaving space for the new microphone amplifiers and possibly the 18V power supply.

The "manual pulse" push-button S1 and resistor R7 are not necessary and can be omitted if desired. The "pulse input" jack JK1 is not necessary either and can be transferred for use as the microphone input jack.

A muting push-button is fitted to the chassis and connected in parallel with D2 on the filter board.

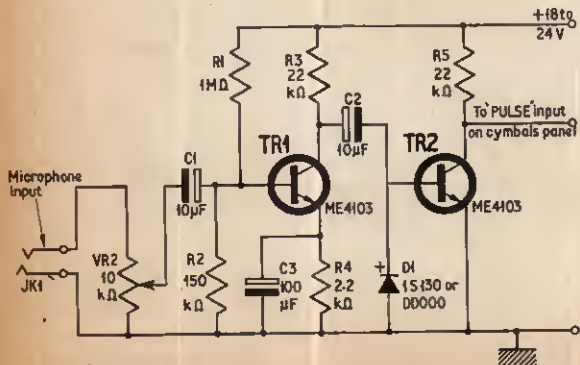

Fig. 1. Circuit diagram of the microphone amplifier

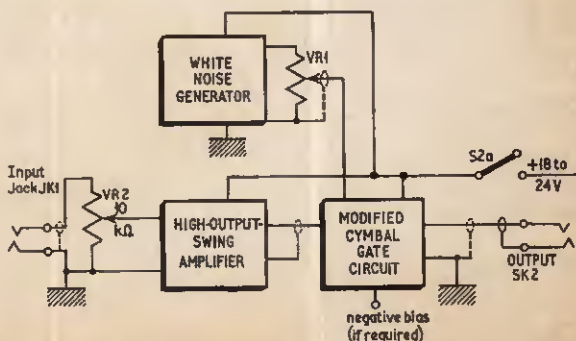

Fig. 2. Block diagram showing the interconnection of panels with jacks and controls



COMPONENTS...

MICROPHONE AMPLIFIER

Resistors

R1 1M Ω R3 22k Ω R5 22k Ω
 R2 150k Ω R4 2.2k Ω
 All 10% $\frac{1}{4}$ W carbon

Potentiometer

VR2 10k Ω log. carbon

Capacitors

C1 10 μ F elect. 15V
 C2 10 μ F elect. 15V
 C3 100 μ F elect. 10V

Transistors and Diode

TR1, TR2 ME4103 or C424
 D1 1S130 or DD000

Miscellaneous

Printed circuit board 2in \times 1 $\frac{1}{2}$ in

Other components are as given in the *Cymbals Effects Unit* article last month except:

Change C5 to 0.05 μ F C7 to 0.01 μ F
 C10 to 0.05 μ F C8 to 0.01 μ F
 R10 to 1M Ω

Delete S1 and R7

Add Single pole on/off switch in parallel with D2 (push on/push off)



Fig. 3. Printed circuit pattern (full size) for the microphone amplifier

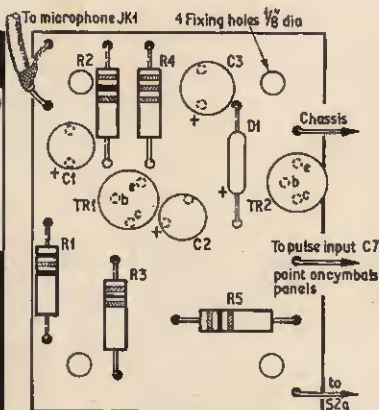

Fig. 4. Component layout on the printed circuit board

Next, the new panel incorporating components for amplifying the microphone signal is made up. The printed circuit pattern is shown full size in Fig. 3, while component layout is given in Fig. 4. Terminal points on the board can be either pins or direct connections to the copper through holes in the board.

All printed circuit boards can be glued on to foam rubber or plastics pads in the box so that the copper does not touch the metallic chassis; plain s.r.b.p. boards can be used here to separate the printed circuit boards from the metal.

TESTING THE EFFECTS UNIT

Connect the unit to a power supply of 18 to 24 volts, also a negative bias supply for the cymbal circuit. The power source may consist of either batteries or a mains power unit with smoothed output (as shown in last month's article). Connect also a power amplifier with loudspeakers (a guitar amplifier or public-address amplifier is suitable). All variable controls should be set initially to a low level. Temporarily connect the junction of R8, C8 (cymbals filter) to the positive supply and switch on.

By adjusting VR1 and the volume control of the audio amplifier, the sound of the white noise generator should come through in a filtered form; the controls should now be adjusted to give a fairly loud, continuous low-pitched

hissing effect. Remove the positive supply connection from the junction of R8, C8, and this sound should die away.

By adjusting VR2, you will find that sounds received by the microphone are transformed to give a whooshing effect from the loudspeaker. VR2 can be set so that only the loudest sounds have this effect, and if the microphone is mounted near to, and facing, the skin of a drum, only a tap on this drum will produce an output from the unit.

USING THE UNIT

The unit may be used with just one particular drum, which is the simplest arrangement. Alternatively, several different drums may be used, each with its own microphone. If a number of identical microphones are used, these may be simply connected in parallel using screened wire. Alternatively, an audio mixer unit may be used in place of VR2, to feed signals from a number of different sources to the input of the amplifier. The microphones used may be an inexpensive crystal type, or a moving-iron diaphragm unit.

In order to obtain a different "whoosh" sound from each drum, you may wish to build a separate "whoosh unit" for each drum, and feed the output from each unit to the power amplifier by way of a mixer unit. ★

BUILD YOURSELF A QUALITY TRANSISTOR RADIO—FULL AFTER SALES SERVICE!

THE MAGNIFICENT ROAMER 7 MK IV

SEVEN WAVEBAND PORTABLE AND CAR RADIO WITH A SUPER SPECIFICATION

- 7 FULLY TUNABLE WAVE BANDS—MW1, MW2, LW, SW1, SW2, SW3 and Trawler Band.
- Extra Medium waveband provides easier tuning of Radio Luxembourg, etc.
- Built in ferrite rod aerial for Medium and Long Waves.
- 5 Section 22 in. chrome plated telescopic aerial for Short Waves—can be angled and rotated for peak S.W. listening.
- Socket for Car Aerial.
- Powerful push-pull output.
- 7 transistors and two diodes including Philco Micro-Alloy R.F. Transistors.
- Famous make 7×4 in. P.M. speaker.
- Air spaced ganged tuning condenser.
- Separate on/off switch, volume control, wave change switches and tuning control.
- Attractive case with hand and shoulder straps. Size 9×7×4 in. approx.
- First grade components.
- Easy to follow instructions and diagrams make the Roamer 7 a pleasure to build with guaranteed results.

Total building costs
£5.19.6 P. & P. 7/6

Parts price list and easy build plans 3/— (FREE with parts).



TRANSONA FIVE



MEDIUM WAVE, LONG WAVE AND TRAWLER BAND PORTABLE

Attractive case with red speaker grille. Size 6½ × 4½ × 1½ in. Fully tunable. 7 stages—5 transistors and 2 diodes—ferrite rod aerial, tuning condenser, volume control, fine tone super dynamic 2½ in. speaker, all first grade components. Easy build plans and parts price list 1/6 (FREE with parts).

Total building costs
42/6 P. & P. 4/6

POCKET FIVE



MEDIUM WAVE, LONG WAVE AND TRAWLER BAND PORTABLE

Attractive black and gold case. Size 5½ × 1½ × 3½ in. Fully tunable over both Medium and Long Waves with extended M.W. band for easier tuning of Luxembourg, etc. All first grade components. 7 stages—5 transistors and 2 diodes—super-sensitive ferrite rod aerial, fine tone 2½ in. moving coil speaker, etc. Easy build plans and parts price list. 1/6 (FREE with parts).

Total building costs
39/6 P. & P. 4/6

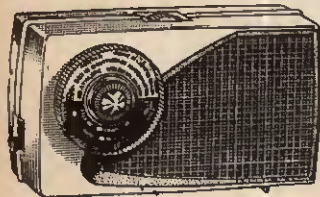

NEW MELODY MAKER SIX

3 WAVEBAND PORTABLE

8 stages—6 transistors and 2 diodes

Covers Medium and Long Waves and EXTRA M.W. BAND FOR EASIER TUNING OF LUXEMBOURG, etc. Top quality 3 in. Loudspeaker for quality output. Two RF stages for extra boost. High "Q" 6 in. Ferrite Rod Aerial. Approx. 350 milliwatts push-pull output. Handsome pocket size case with gilt fittings. Size 6½ × 3½ × 1½ in.

This amazing receiver may be built for only

69/6 P. & P. 4/6

Parts Price List and easy build plans 2/— (Free with parts).

ROAMER SIX



SIX WAVEBAND PORTABLE WITH 3 in. SPEAKER

Attractive case with gilt fittings, size 7½ × 5½ × 1½ in. World wide reception. Tunable on Medium and Long Waves, two Short Waves, Trawler Band plus an extra M.W. band for easier tuning of Luxembourg, etc. Sensitive ferrite rod aerial and telescopic aerial for Short Waves. All top grade components. 8 stages—6 transistors and 2 diodes including Philco Micro-Alloy R.F. Transistors, etc. (carrying strap 1/6 extra). Easy build plans and parts price list 2/— (FREE with parts).

Total building costs
79/6 P. & P. 4/6



SUPER SEVEN

THREE WAVEBAND PORTABLE WITH 3 in. SPEAKER

Attractive case size 7½ × 5½ × 1½ in. with gilt fittings. The ideal radio for home, car or outdoors. Covers Medium and Long Waves and Trawler Band. Special circuit incorporating 2 R.F. stages, push-pull output, ferrite rod aerial, 7 transistors and 2 diodes, 3 in. speaker (will drive larger speaker) and all first grade components. Price list 2/— (FREE with parts).

Total building costs
69/6 P. & P. 4/6

RADIO EXCHANGE Ltd

61a HIGH STREET, BEDFORD

Telephone: Bedford 52367

Callers side entrance Stylo Shoe Shop. Open 9-5 p.m. Saturday 9-12.30 p.m.

TWO SCOOPS FROM "KING'S" CONTINUOUS LOOP

(NEVER ENDING - NO REWINDING)

TAPE CASSETTE

**BULK PURCHASE
RIDICULOUS PRICE**

IDEAL BACKGROUND MUSIC - LANGUAGE COURSES, ETC. 200ft. HIGH QUALITY AMPEX TAPE. WILL FIT ALL TAPE RECORDERS. CANNOT BE REPEATED

NEARLY ALL GONE
HURRY! NOW ONLY 18/- EACH P&P 6d.

FULL CIRCUIT - INSTRUCTIONS - PARTS LIST TO BUILD YOUR OWN TELEPHONE ANSWERING/RECORD MACHINE - QUICK - AUTOMATIC TAKES 100's OF CALLS: **25/-** CHEAP TO BUILD. SEND NOW

7" AMPEX TAPE SPOOLS, ONLY 2/6

P. & P. 6d.

KING'S TELE-SERVICE CO.
105/107 DAWES ROAD, FULHAM, S.W.6
FULHAM 1668-2998

VALVES SAME DAY SERVICE NEW! TESTED! GUARANTEED!

SETS 1R5, 1S5, 1T4, 3V4, DAF91, DF91, DK91, DL92, DL94 Set of 4 for 17/8. DAF96, DF96, DK96, DL96, 4 for 26/-.

1A7GT 7/6	10P13 14/6	DK32 7/6	EF183 6/6	PCL85 8/6	UCH42 9/6
1R5GT 7/3	12A77 3/6	DK34 5/6	EF184 6/6	PCL86 8/6	UCH8 8/6
1N5GT 7/9	12AU6 4/9	DK92 9/6	EH90 8/6	PEN44 6/9	UCL82 7/6
1R5 5/6	12AU7 4/9	DK96 7/-	EL33 9/6	PEN36C15/-	UCL83 9/6
184 4/9	12AX7 4/9	DL33 8/9	EL41 9/6	PF120018/-	UF41 10/6
184 4/9	12K8GT 7/6	DI36 5/-	EL84 4/9	PL36 9/6	UF80 7/6
185 3/9	20F2 10/6	DL92 5/6	EL90 5/-	PL61 7/8	UF89 6/6
174 2/9	30L1 18/9	DL94 5/9	EL98 8/-	PL82 6/8	UL41 3/9
3A5 8/6	30P3 14/9	DL98 6/6	EM34 13/9	PL83 7/9	UL44 20/-
354 5/6	30P4 17/-	DY86 5/9	EM80 5/9	PL84 6/3	UL84 6/6
3V4 5/9	25U4G11/6	DY87 5/9	EM81 5/9	PL600 13/-	UY41 7/-
5U4G 4/6	30C10 11/6	EABO80 6/6	EM84 6/3	PK28 10/6	UY85 8/6
5Y4G 8/-	30C17 12/6	EAF42 8/6	EM87 7/6	PY32 10/6	VP43 10/6
5Y9GT 5/6	30C18 8/-	EB91 2/8	EY61 7/-	PY33 10/-	VF1821 21/-
6/80L2 11/9	30FL1 12/6	EBC33 7/6	EY86 6/3	PY80 5/3	Z77 3/6
6AL5 2/3	30FL14 12/6	EBF80 6/-	EZ40 7/6	PY81 5/3	
6AM6 3/6	30L15 14/-	EBF89 6/3	EZ41 7/6	PY82 5/-	
6AQ5 4/9	30L17 13/-	ECC81 3/9	EZ80 4/6	PY83 5/9	Transistors
6AT6 4/-	30P4 12/-	ECC82 4/9	EZ81 4/9	PY86 7/8	AC107 18/-
6B5 4/6	30P12 11/-	ECC83 7/-	KT61 8/9	PY801 8/9	AC127 6/-
8BE5 4/3	30P19 12/6	ECC84 5/6	KT81 15/-	R19 6/6	AD140 15/6
8BG6 15/-	30PL1 12/6	ECC85 4/9	N78 14/9	R20 12/9	AF102 18/-
8EJ8 6/9	30PL13 14/6	ECC86 7/9	PC86 9/6	U26 11/6	AF116 6/6
8C86 6/6	30PL14 14/6	ECC87 6/9	PC88 9/6	U28 11/6	AF117 5/-
8P13 8/6	35L6GT 8/-	ECC88 6/-	PC87 8/6	U47 13/6	AF118 3/6
8P14 8/-	35W4 4/6	ECH36 6/-	PC90 9/-	U49 13/6	AF124 7/6
6P23 12/6	35Z4GT 5/-	ECH42 10/-	PCC84 6/-	U52 4/6	AF125 7/6
6K7G 2/6	6083 12/6	ECH81 5/9	PCC89 10/6	U78 3/6	AF126 7/-
6K8G 4/8	A231 9/-	ECH84 7/3	PCC189 9/9	U191 11/-	AF127 7/-
6L18 6/-	B88 14/9	ECL50 6/9	PCF85 7/6	U801 13/6	OC22 2/6
6V6GT 6/6	CCH35 10/6	ECL82 6/9	PCF82 6/6	U801 13/6	OC26 9/6
6X4 3/6	DAC32 7/3	ECL86 8/3	PCF86 9/9	UABCS0 8/6	OC28 5/6
6X5GT 5/9	DAF91 12/6	EF59 3/9	PCF8011/6	UBA42 7/9	OC45 3/6
7B6 10/9	DAF96 8/-	EF41 9/6	PCF802 8/6	UBC41 7/9	OC71 3/6
7B7 7/-	DCC90 3/6	EF80 4/9	PCF805 9/9	UBP50 6/-	OC72 4/9
7C5 15/-	DF33 7/9	EF85 5/6	PCF80611/6	UBF89 6/9	OC76 6/9
7C6 8/9	DF91 3/9	EF86 5/6	PCF80812/6	UCL41 9/-	OC81 3/6
7H7 5/6	DF96 4/-	EF89 5/3	PCL82 7/3	UC92 5/-	OC81D 3/6
7Y4 6/6	DE77 4/-	EF91 3/6	PCL83 9/6	UC84 7/9	OC82 5/9
10P1 15/-	DH81 12/6	EF97 7/6	PCL84 7/6	UC85 6/9	OC82D 5/9
				UC86 8/3	OC170 5/-

READERS RADIO (I.F.E.)

85 TORQUAY GARDENS, REDBRIDGE, LONDON ESSEX Tel. 01-550 7441

Postage on 1 valve 9d. extra. On 2 valves or more, postage 6d. per valve extra. Any Parcel Insured against Damage in Transit 6d. extra.

4-STATION INTERCOM



£27/5/0

Solve your communication problems with this 4-Station Transistor Intercom system (1 master and 3 Subs), in de-luxe plastic cabinets for desk or wall mounting. Call/talk/listen from Master to Subs and Subs to Master. Ideally suitable for Business, Surgery, Schools, Hospital, Office and Home. Operates on one 9V battery. On/off switch. Volume control. Complete with 3 connecting wires each 66ft. and other accessories. P. & P. 7/6.

WIRELESS INTERCOM

No batteries - no wires. Just plug in the mains for instant two-way, loud and clear communication. On/off switch and volume control. Price 12 gns. P. & P. 7/6 extra

INTERCOM/BABY ALARM



Originally 8 gns.

Now only 65/-

Same as 4-Station Intercom for two-way instant communication. Ideal as Baby Alarm and Door Phone. Complete with 66ft. connecting wire. Battery 2/6. P. & P. 2/6.



TRANSISTOR TELEPHONE AMPLIFIER

Usualy 5/9

Why not boost efficiency with this incredible De-Luxe Telephone Amplifier. Take down long telephone messages or converse without holding the handset. A useful office aid. On/off switch. Volume control. Battery 3/6 extra. P. & P. 2/6. Full price refunded if not satisfied in 7 days.

WEST LONDON DIRECT SUPPLIES (P.E.S.)
169 KENSINGTON HIGH STREET, LONDON, W.8

HIGH SPEED MAGNETIC COUNTERS (4 x 1 x 1/2 in.). 4 digit. 12/24/48V. (state which) 8/6 each, P. & P. 1/-.

COPPER LAMINATE BOARD (3 1/2 x 5 1/2 x 1/4 in.). 2/8 each, 5 for 10/-.

RE-SETTABLE HIGH SPEED COUNTER (3 x 1 x 1/2 in.) 3 digit. 12/24/48V. (state which) 32/6 each.

BULK COMPONENT OFFERS

- 100 Capacitors 50pF to 5µF.
- 250 Carbon Resistors 1/2 & 1W. (Transistor types).
- 100 Ceramic Capacitors 2-1000pF.
- 25 Vitreous W/W Resistors (5%).
- 12 Precision Resistors (-1% several standard values included).
- 25 Close Tolerance Caps. (2%).
- 12 Silicon Diodes 500 p.i.v. 750 m.a.
- 4 Silicon Rects. 400 p.i.v. 3 amp.
- 8 Silicon Rects. 100 p.i.v. 3 amp.
- 50 Silicon Trans. (2N708/708, B5Y28/29, BCY41/42 types.) Unmarked. Untested.
- 50 Silicon Diodes 200 m.a. 100 p.i.v. Sub. Min.

ANY ITEM 10/-, ANY 5 ITEMS £2.

S.C.R.s. (Thyristors) CR81/20 5/6; CR81/40 7/6; CR83/16 7/6; CR83/30 8/6; CR83/40 10/-; CR83/60 12/6 each.

'3000' TYPE RELAYS (ex. new equip.) 10 for 25/- (our choice) p.p. 6/-.

PATRICK & KINNIE

81 PARK LANE
ROMFORD, ESSEX
ROMFORD 44473

BATTERY ELIMINATORS

The ideal way of running your TRANSISTOR RADIO, RECORD PLAYER, TAPE RECORDER, AMPLIFIER, etc. Types available: 9v; 7 1/2v; 6v; 4 1/2v (single output) 3/6 each, P. & P. 2/9. 9v + 9v; 6v + 6v; or 4 1/2v + 4 1/2v (two separate outputs) 42/6 each. P. & P. 2/9. Please state output required. All the above units are completely isolated from mains by double wound transformer ensuring 100% safety.

R.C.S. PRODUCTS (RADIO) LTD.
(Dept. P.E.), 31 Oliver Road, London, E.17

The ELECTRONIC MUSICAL INSTRUMENT MANUAL

New 5th Edition.

By Douglas. 55/- P. & P. 1/6.

COLOUR TV PAL SYSTEM, by Patchett. 40/- P. & P. 1/-.

F.E.T. CIRCUITS, by Turner. 25/- P. & P. 1/-.

TAPE RECORDER SERVICING MANUAL, by Hellyer. 63/- P. & P. 4/6.

ELECTRONIC COUNTING, by Mullard. 27/6 P. & P. 1/-.

SILICON CONTROLLED RECTIFIERS, by Lytel. 21/- P. & P. 1/-.

PRACTICAL OSCILLOSCOPE HANDBOOK, by Turner. 25/- P. & P. 1/-.

HAVING FUN WITH TRANSISTORS, by Buckwalter. 24/- P. & P. 1/-.

SOLID STATE POWER SUPPLIES AND CONVERTERS, by Lytel. 20/- P. & P. 1/-.

ELECTRONIC MOTOR CONTROL, by Lytel. 30/- P. & P. 1/-.

TRANSISTORS IN LOGIC CIRCUITS, by Altes. 16/- P. & P. 1/-.

Where possible 24-hour service guaranteed

UNIVERSAL BOOK CO.
12 LITTLE NEWPORT ST., LONDON, W.C.2
(Leicester Square Tube Station)

MARKET PLACE

Items mentioned in this feature are usually available from electronic equipment and component retailers advertising in this magazine. However, where a full address is given, enquiries and orders should then be made direct to the firm concerned.

COMPONENTS

The "Apollo" subminiature mercury switch available from Photain Controls Ltd., should prove very useful for trip or alarm circuits, and in a variety of other circuits such as communications, measuring and control equipment.

Very similar in appearance and size to a transistor, the switch consists of a robust metal housing and contains high purity mercury. One electrode is the metal outer casing and the other the centre lead. The contacts are sealed in glass and filled with gas. The load current is 0.3A at 110V.

When the switch is tilted at a minimum of 30 degrees from horizontal position the mercury moves and closes or opens the contacts, switching the supply on or off as required. When operating there is no clicking noise. Further details are available from Photain Controls Ltd., Randalls Road, Leatherhead, Surrey.

Now to lighting, the Mark-A-Lite is a small halfpenny size disc which glows continuously in the dark, yet needs no electricity, mains, battery or recharging. The back of the disc is self-adhesive and is useful for marking the position of any small item that could be a hazard, or for locating objects in darkness. Light switches, keyholes, car ignition switches and front panel controls, are just a few of the applications that come to mind.

The Mark-A-Lite costs 11s 4d and is available from Wrights Aviation Co. Ltd., 4 Melbourne Close, Morton, Middlesbrough, Yorkshire.

A new range of battery holders have just been announced by A. F. Bulgin & Co. Ltd., Bye Pass Road, Barking, Essex. These holders take U2 cells and equivalents. They are designed for front panel mounting, making it easy to replace exhausted batteries; all contacts are heavily plated to prevent corrosion.

The holder is fixed to a panel by four 6B.A. bolts, the front cap or contact being a push and twist type.

An r.f. microminiature coaxial connector by Thorn Special Products is available for matched impedance coupling of 50 ohm screened cables. It is made of gold plated copper alloy, with crimped connections, the connector being insulated with

p.t.f.e. The contact resistance is claimed to be less than 4 milli-ohms. This connector is supplied as a complete cable assembly, the pin and socket each being assembled with a 12in length of 50 ohm cable. Alternative lengths are available to order.

EQUIPMENT

Newmarket Transistors Ltd., have recently added a preamplifier to their range of "packaged circuit" modules. The PC10 is intended mainly for tape head amplification and is powered from a 9V supply. It has an input impedance of 150 ohms and output impedance of 3,300 ohms. The sensitivity is given as 150mV out at 1kHz for a 15mV input.

Readers thinking of purchasing a new multimeter may be interested in the Sanwa range available through Household Electrix Ltd., 47-49 High Street, Kingston-upon-Thames, Surrey.

The price of the Sanwa range of meters varies from £3 7s 6d to £13 5s.

One item not shown at this year's Audio Fair is the Dewtron New Dimensions sound effects amplifier.

Marketed at 8 guineas, plus 4s postage, by D.E.W. Ltd., Ringwood Road, Ferndown, Dorset, the unit provides adjustable echo, vibrato, spacial (reverberation) and tonal effects. The unit can be used with any domestic radio, record player, electronic musical instrument, or tape recorder having provision for an external speaker.

The effects amplifier creates a pseudo "stereo" effect if an extra speaker is used together with the existing appliance speaker. The power output is approximately 1 watt. Another version is obtainable for car radio use and is wired directly to the car battery.

AGENTS

Home Radio (Components) Ltd., 187 London Road, Mitcham, Surrey, have been appointed retail stockists of all Lektrokit components.

Over 150 individual items in the Lektrokit ranges are now available "off the shelf" and are all obtainable through the postal delivery service run by Home Radio.

Single cell or small quantities of Voltabloc rechargeable nickel-cadmium battery cells can now be purchased through Electroniques, Edinburgh Way, Harlow, Essex.

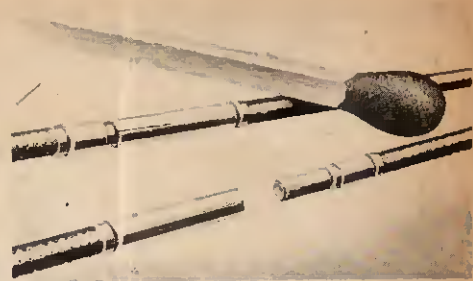

Microminiature coaxial connector produced by Thorn Special Products

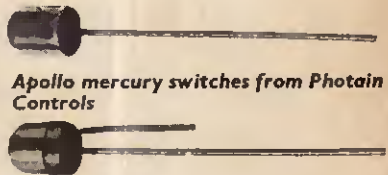

Apollo mercury switches from Photain Controls

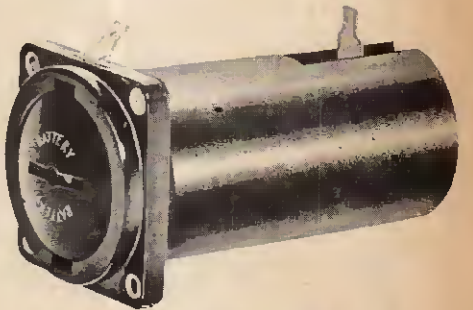

Panel mounting battery holder by A. F. Bulgin



Wright's Aviation Mark-A-Lite

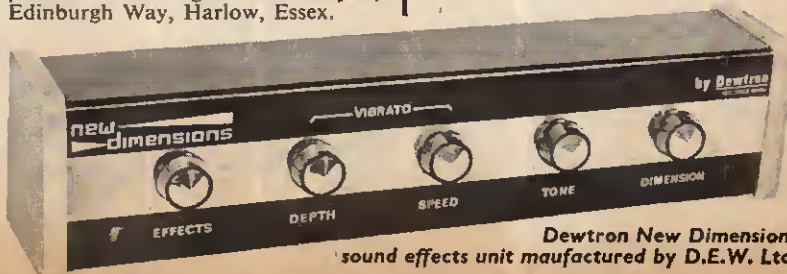

Dewtron New Dimensions sound effects unit manufactured by D.E.W. Ltd.

Readout —

A SELECTION FROM OUR POSTBAG

Thriving and active

Sir—About a year ago, a letter was published in your magazine, announcing the intention of forming a radio club in South London. The Addiscombe Amateur Radio Club was formed, having as its hard core several young people who wrote to us as a result of reading about us in P.E. Since those early days we have had many more members and visitors attracted by the publicity you have given us. The members have asked me, as secretary, to write to you with our thanks for the help and encouragement you have given to us, and doubtless to many other clubs who are struggling to get firmly established.

Thanks to P.E. the Addiscombe Club is now a thriving and active club.

S. V. Knowles, Hon. Sec.,
West Croydon,
Surrey.

Unsociable or mere handmaiden?

Sir—I wonder how many readers have stopped to think how Electronics, as an activity for Amateur enthusiasts, has never produced a social movement for the advancement of its aims and interests in a similar way, for instance, to the Amateur Radio Movement. It might be said that this lack of an effective Club or Society movement is due to the lack of incentive to co-operate with other fellow enthusiasts, which is essential in such activities as Amateur Radio.

It must mean that thousands of Electronics enthusiasts are working away on lonely projects, and that Electronics has no collective voice or recognisable unity as a hobby movement.

But, a closer look at my statement about lack of incentive above, shows that it does not hold water. There are a great number of Amateur Movements with strong collective organisations, the Amateur Astronomers, Model Engineers and Aero-modellers, to name just a few. None of these activities can claim an essential social element, like that necessary for Amateur Radio, yet they have strong society movements.

There might be more serious reasons for the lack I have been

discussing. Is it possible that, on the average, Electronics enthusiasts are an unsociable type of person anyway, rather dealing with gadgets and things than with people? They may have had a strong desire to retreat into their gadgetry world, over which they can keep a sense of power.

There is one further explanation, and that is the one that says Electronics has no separate existence. This means that the activities of the people engaged in electronics are catered for by other firmly established bodies. Therefore, Radio Amateurs constitute a vast number of electronics men. There is a large pool in the model control field. The Radio Astronomers make up another quite advanced group. The Photographer would build his timers and gadgets, without the need to go to an Electronics Club.

It would seem that Electronics is a handmaiden to other interests, in other words it has come too late and the prospects for any representative Society arising is bleak... or is it? There may be readers with other views, but the evidence would have to be strong!

R. F. Marchant,
Leyton, E.10.

"Phial"-ed

Sir—I would like to congratulate A. J. Nicholls on his approach to Electronic and Mechanical car protection (see Readout April issue). I feel though that his car is still dangerously vulnerable to theft.

The modern thief, having beaten the electronics and entered the car, thinks nothing of breaking or unhooking any mechanical device linking steering to a pedal.

I have made my car safer by arranging in addition, that the release of the handbrake, as the thief goes to drive away, breaks a glass phial and fills the car with tear gas. At this stage I felt my car was fairly secure until I realised that the thief might have a gas mask with him.

I have therefore arranged things further so that as soon as the car moves forward small bursting charges in the hubs blow off all four wheels.

Dr. R. Parfitt,
London, S.E.19.

You must have a thriving practice. We hope you don't charge a consulting fee?

Simplicity is the key

Sir—I have read your Editorial in the April issue of PRACTICAL ELECTRONICS with great interest.

As the Design Engineer of a small firm of Instrument Engineers I too have found that some of the circuits given in your magazine tend to be a little too sophisticated. Of course, if the aim is to generate an increased interest in electronic circuitry this is very fine. If, on the other hand, usefulness is the aim I would suggest that simplicity is the best policy.

Many manufacturers of instrumentation have the tendency to make their products with many "frills" built into them as sales gimmicks. For instance, I know of one s.c.r. control circuit containing no less than ten transistors. Compared with another (fool-proof and accurate) circuit produced by another firm that only employs three transistors.

There are numerous examples of this kind to be found in the industrial field. Believe me, the simpler a circuit can be made the less trouble in maintenance and reliability is to be expected.

Trusting that these remarks may interest your readers.

D. H. Heppell,
Warley.

Any square wire?

Sir—Can any reader suggest a source of SQUARE connecting-up wire, as used in the early 1920's?

This is urgently wanted by members of the Peterborough Radio and Electronic Society, in the making of "genuine 1922" wireless receivers for their "Radio Museum". Plenty of old components have been collected—but not a bit of SQUARE wire.

D. Byrne G3KPO,
Jersey House,
Eye, Peterborough.

Come and join us

Sir—We are writing to enquire if any of your readers in the Paddington area would be interested in visiting the Paddington and District Amateur Radio Society which meets every Thursday at 7.30 p.m.

The club promotes an interest in amateur radio and allied subjects. Lectures and film shows are amongst the itinerary together with a constructional evening, held on Wednesdays.

The Clubroom is in the Beauchamp Lodge Settlement, 2a Warwick Crescent, W.2.

The Club intends to hold several field days during the year and provide demonstration stations for local events.

M. M. Pawley G8AWV,
London, W.2.

BI-PRE-PAK LIMITED

TRANSISTORS PRICE

AC107	6/-	OC170	3/-
AC126	2/6	OC171	4/-
AC127	2/6	OC200	5/-
AC128	3/-	OC201	8/-
ACY17	5/-	2G301	2/6
AF114	4/-	2G303	2/6
AF115	3/-	2N711	10/-
AF116	3/-	2N1302-3	4/-
AF117	4/-	2N1304-5	5/-
AF118	3/6	2N1306-7	6/-
AF119	3/6	2N1308-9	8/-
AF178	10/-	2S303	2/6
BC211	5/-	Power Transistors	
BFY50	7/6	OC20	10/-
BSY25	3/-	OC23	10/-
BSY26	3/-	OC25	8/-
BSY27	3/-	OC26	5/-
BSY28	3/-	OC28	7/6
BSY29	3/-	OC35	5/-
BSY95A	3/-	OC36	7/6
OC41	2/6	GP826	40/-
OC44	1/11	2N2287	20/-
OC45	1/9	Diodes	
OC71	2/6	AAV42	2/-
OC72	2/6	OA10	2/6
OC73	5/-	OA70	1/9
OC81	2/6	OA79	1/9
OC81D	2/6	OA81	1/9
OC83	4/-	OA182	2/-
OC139	2/6	IN914	1/6
OC140	3/6		

EXCITING NEW PAKS FOR AMATEURS, PROFESSIONALS, FACTORIES, ORGAN BUILDERS, AND THOSE PEOPLE THAT JUST USE LARGE QUANTITIES OF TRANSISTORS.

XA PAK

Germanium PNP type transistors, equivalents to a large part of the OC range, i.e. 44, 45, 71, 72, 81, etc.

PRICE £5 PER 1000

XB PAK

Silicon TO-18 CAN type transistors NPN/PNP mixed lots, with equivalents to OC200-1, 2N706A, BSY27/29.

PRICE £5.50 PER 500
PRICE £10 PER 1000

XC PAK

Silicon diodes miniature glass types, finished black with polarity marked, equivalents to OA200, OA202, BAY31-39 and DK10, etc.

PRICE £5 PER 1000

ALL THE ABOVE UNTESTED PACKS HAVE AN AVERAGE OF 75% OR MORE GOOD SEMICONDUCTORS. FREE PACKS SUSPENDED WITH THESE ORDERS. ORDERS MUST NOT BE LESS THAN THE MINIMUM AMOUNTS QUOTED PER PACK.

P/P 2/6 PER PACK (U.K.)

PRE-PAKS

No.	Price
A1	6 Silicon rectifiers BY100 type - 20/-
A3	20 Mixed marked and tested trans. - 20/-
A13	25 New trans. & diodes marked & tested 20/-
A15	2 Power Comp. Parr. AD161/2 - 20/-
A17	3 Sil. stud recs. 6 amp. 400 PIV. BYZ12 - 20/-
A18	2 Sil. stud recs. 10 amp. 800 PIV. - 20/-

B1	50 Unmarked untested, trans., new Mixed Types - 10/-
B2	4 Solar cells, inc. Book of Instructions 10/-
B3	4 OA5 gold bonded, diodes Mullard - 10/-
B5	7 Matched set, OC44,45/81D/81 + diode - 10/-
B6	15 Red spot AF. trans. or white spot RF - 10/-
B8	2 Power trans. OC26/35 type - 10/-
B9	1 Light sensitive cell, ORP12 type - 9/-
B10	10 50V trans. germ. PNP latest type - 10/-
B44	1 Tunnel diode, AEY11, 1050 Mc/s - 10/-
B21	2 Sil. recs. 10 amp., 50-100 PIV - 10/-
B45	1 Power trans. ADY22/TK400A VCB60 IC 8 Amps. PNP - 10/-
B49	2 Power trans. GET 9 VCB64 IC 8 amp. germ. PNP - 10/-
B66	150—Germanium diodes, untested 10/-

C2	1 Unijunction, 2N2160 or 2N2646 - 15/-
C4	2 RF power trans., OC22 and BUY11 - 15/-
C15	4 Silicon PNP trans. in the 25300 Series 15/-
C31	4 Sil. recs. 800 PIV 2 amp. top hat - 15/-
C32	2 Power trans. TK400A/NKT404 VCB64 IC 8 amp. 70 amp. 400 PIV SCR special offer 15/- 70/-

INTEGRATED CIRCUITS (TEXAS)

SN7430 8 INPUT POSITIVE NAND GATE **19/6**

Make a Rev. Counter for your Car. The 'TACHO BLOCK'. This encapsulated block will turn any 0-1mA meter into a perfectly linear and accurate rev. counter for any State 4 or 6 cylinder. **20/- each**

FREE CATALOGUE AND LISTS for —

TANTALUM CAPACITORS, TRANSISTORS, RECTIFIERS & CIRCUIT DIAGRAMS, SUBSTITUTION CHART

MINIMUM ORDER 10/- CASH WITH ORDER PLEASE. Add 1/- post and packing per order. OVERSEAS ADD EXTRA FOR AIRMAIL.

THERE IS ONLY ONE **BI-PRE-PAK LTD** BEWARE OF IMITATIONS

FREE!
PACKS OF YOUR OWN CHOICE UP TO THE VALUE OF 10/- WITH ORDERS OVER £4

TRANSISTORS ONLY 1/- EACH

SILICON • PLANAR • N.P.N. • P.N.P

All these types available

2N929	2N706	2S131	2S103	2N696	2N1613	2S733	BFY10
2S501	2N706A	2S512	2S104	2N697	2N1711	2N726	2S73T
2N2411	2N3011	2S102	2N2220	2N1507	2N1893	2N2906	2S732

All tested and guaranteed transistors—unmarked. Manufacturers over runs for the new PRE-PAK range.

NEW UNMARKED UNTESTED PAKS

25	BSY95A NPN Silicon	TRANSISTORS 10/-
10	1000 PIV 1 amp. Min. Silicon	DIODES 10/-
25	BSY28-27 NPN Silicon	TRANSISTORS 10/-
10	10 Watt Silicon All Voltages	ZENERS 10/-
25	BFY50-1-2 NPN Silicon	TRANSISTORS 10/-
10	4 amp. Stud. Silicon	RECTIFIERS 10/-
25	BC107-8-9 NPN Silicon	TRANSISTORS 10/-
40	1N914-8 Sub. Min. Silicon	DIODES 10/-
50	Min. Germ. High Quality	DIODES 10/-
25	2N706 A NPN Silicon	TRANSISTORS 10/-

PRE-PAK, N.605 POWER TRANSISTOR EQUIVALENT TO NKT301-4 **5/- each**

TANTALUM CAPACITORS **4/- each**

FIRST EVER LOGIC KITS

Learn for yourself how computers work, even make one for yourself. Full instructions for a thoughts and crosses machine, binary counters, timers, etc. L1, 5gns. L2, 10gns. No need to purchase both kits, you can start with L2, which incorporates L1. Details free.

FREE! A WRITTEN GUARANTEE WITH ALL OUR SEMICONDUCTORS

BI-PRE-PAK LTD

DEPT. A, 222-224 WEST ROAD, WESTCLIFF-ON-SEA, ESSEX
TELEPHONE: SOUTHEND (0702) 46344

Practical Electronics Classified Advertisements

The pre-paid rate for classified advertisements is 1/3 per word (minimum order 15/-), box number 1/6 extra. Semi-displayed setting £4.2.6 per single column inch. All cheques, postal orders, etc., to be made payable to PRACTICAL ELECTRONICS and crossed "Lloyds Bank Ltd." Treasury notes should always be sent *registered post*. Advertisements, together with remittance, should be sent to the Classified Advertisement Manager, PRACTICAL ELECTRONICS, George Newnes Ltd., 15/17 Long Acre, London, WC2, for insertion in the next available issue.

SERVICE SHEETS

SERVICE SHEETS, Radio, TV, 5000 models. List 1/6. S.A.E. enquiries. TELRAY, 11 Maudland Bank, Preston.

RADIO TELEVISION, over 8,000 Models. JOHN GILBERT TELEVISION, 1b Shepherds Bush Rd., London, W.6. SHE 8441.

SERVICE SHEETS. RADIO, TELEVISION, TAPE RECORDERS, 1925-1968, by return post, from 1/- with free fault-finding guide. Catalogue 6,000 models, 2/6. Please send stamped addressed envelope with all orders/enquiries. HAMILTON RADIO, 54c London Road, Bexhill, Sussex.

WANTED

VALVES WANTED, brand new popular types boxed. DURHAM SUPPLIES (E), 175 Durham Road, Bradford 8, Yorkshire.

EDUCATIONAL

STUDY RADIO, TELEVISION AND ELECTRONICS with the world's largest home study organisation. I.E.R.E.; City & Guilds; I.T.E.B., etc. Also practical courses with equipment. No books to buy. Write for FREE Prospectus to ICS (Dept. 577), Intertext House, London, SW11.

ENGINEERS. A technical certificate or qualification will bring you security and much better pay. Elem. and adv. private postal courses for C.Eng., A.M.I.E.R.E., A.M.S.E. (Mech. & Elec.), City & Guilds, A.M.I.M.I., A.I.O.B. and G.C.E. exams. Diploma courses in all branches of Engineering—Mech., Elec., Auto, Electronics, Radio, Computers, Draughts., Building, etc. For full details write for FREE 132-page guide. BRITISH INSTITUTE OF ENGINEERING TECHNOLOGY (Dept. 125K), Aldermaston Court, Aldermaston, Berks.

GET INTO ELECTRONICS—big opportunities for trained men. Learn the practical way with low-cost Postal Training, complete with equipment. A.M.I.E.R.E., I.T.E.B., City & Guilds, Radio, T/V, Telecoms., etc. For FREE 100-page book, write Dept. 850K, CHAMBERS COLLEGE, 148 Holborn, London, E.C.1.

RADIO OFFICERS see the world! Sea going and shore appointments. Trainee vacancies in September. Grants available. Day and Boarding students. Stamp for prospectus. WIRELESS COLLEGE, Colwyn Bay, Wales.

SITUATIONS WANTED

A YOUNG ELECTRONICS enthusiast is looking for a position as a trainee technician in Radio, TV, etc. Prepared to work hard. Please reply: Box 11.

SITUATIONS VACANT



RADIO & TELEVISION SERVICING RADAR THEORY & MAINTENANCE

Vacancies regularly exist in industry for men with good knowledge of Radio TV and Radar. Our one-year day courses provide effective training. Shorter day courses available for men with experience. Write for details to:—

The Secretary, London Electronics College, 20 Penywern Road, Earls Court, London, S.W.5. Tel. 01-373 8721

A.M.I.E.R.E., A.M.S.E. (Elec.), City & Guilds, G.C.E., etc., on "Satisfaction or Refund of Fee" terms. Wide range of Home Study Courses in Electronics, Computers, Radio, T.V., etc. 132-page Guide—FREE. Please state subject of interest. BRITISH INSTITUTE OF ENGINEERING TECHNOLOGY (Dept. 124K), Aldermaston Court, Aldermaston, Berks.

YOUNG MAN required to assist in development department working on audio devices. Apply SELMER ELECTRONICS LTD., 40 Theobalds Road, W.C.1. Phone: 01-242 0141.

TECHNICAL TRAINING by ICS IN RADIO, TELEVISION AND ELECTRONIC ENGINEERING

First-class opportunities in Radio and Electronics await the ICS trained man. Let ICS train YOU for a well-paid post in this expanding field.

ICS courses offer the keen, ambitious man the opportunity to acquire, quickly and easily, the specialized training so essential to success. Diploma courses in Radio/TV Engineering and Servicing, Electronics, Computers, etc. Expert coaching for:

- * INSTITUTION OF ELECTRONIC AND RADIO ENGINEERS.
- * C. & G. TELECOMMUNICATION TECHNICIANS' CERTS.
- * C. & G. ELECTRONIC SERVICING.
- * R.T.E.B. RADIO AND TV SERVICING CERTIFICATE.
- * RADIO AMATEURS' EXAMINATION.
- * P.M.G. CERTIFICATES IN RADIOTELEGRAPHY.

Examination Students Coached until Successful.

NEW SELF-BUILD RADIO AND ELECTRONIC COURSES

Build your own 5-valve receiver, transistor portable, signal generator, multi-meter and valve volt meter—all under expert guidance.

POST THIS COUPON TODAY and find out how ICS can help YOU in your career. Full details of ICS courses in Radio, Television and Electronics will be sent to you by return mail.

MEMBER OF THE ASSOCIATION OF BRITISH CORRESPONDENCE COLLEGES

INTERNATIONAL CORRESPONDENCE SCHOOLS

**A WHOLE WORLD
OF KNOWLEDGE
AWAITS YOU!**

International Correspondence Schools
(Dept. 152), Intertext House, Parkgate Road,
London, S.W.11.

NAME
Block Capitals Please

ADDRESS



20 Penywern Road, Earls Court, London S.W.5. Tel. 01-373 8721

This Private School provides full and part day training in the following professional subjects

RADIO & TELEVISION SERVICING RADAR THEORY & MAINTENANCE RADIOTELEGRAPHY

MISCELLANEOUS

CALL OR SEND for list from the most interesting shop in Lancashire. Electrical Mechanical and Electronic Goods. **ROGERS**, 31 Nelson Street, Southport.

ARTIFICIAL LIFE

Well almost, because the NEW range of projects include: an electronic 'animal' which LEARNS, and a device capable of REPRODUCING itself! Other projects SURE TO INTRIGUE YOU are an audio transmitter/receiver which has quite an amazing range and requires NO LICENCE; also a machine which recognizes itself, and an electronic dog whistle, etc., etc. HOSTS OF EASY-TO-CONSTRUCT projects. SEND 2/6 for our list of 'BOFFIN PROJECTS'—NOW!

To: 'BOFFIN PROJECTS'
4 CUNLIFFE RD.
STONELEIGH
EWELL
SURREY

"PRACTICAL ELECTRONICS". Homecom. Rhythmic Effects Unit. Impact Counter. Fluorescent Camping Light. Glissandovibe. Spring Line Reverberation Unit. I.C. Tape Recorder. Combotron. Analogue Computer. Photographic Exposure Meter. Water Level Alarm. Fuzz Box. Yodeller Door Monitor. I.C. Gram Amplifier. Thyristor Power Controller. Transistor Millivoltmeter. Screenwiper Delay Unit. Investigator Oscilloscope. C.R.O. Trace Doubler. Light Operated Stopwatch. Proximity Detector. Photoflash Slave Unit. Integrated Stereo Amplifier and all constructional projects going back to Issue 1. Send s.a.e. for your choice of itemised price lists. **AJAX ELECTRONICS**, 18a Rumbold Road, Fulham, London, S.W.6.

BOOKS AND PUBLICATIONS

SURPLUS HANDBOOKS

19 set Circuit and Notes 5/6 P.P. 6d
1155 set Circuit and Notes 5/6 P.P. 6d
H.R.O. Technical Instructions 4/6 P.P. 6d
38 set Technical Instructions 4/6 P.P. 6d
46 set Working Instructions 4/6 P.P. 6d
88 set Technical Instructions 6/- P.P. 6d
BC. 221 Circuit and Notes 4/6 P.P. 6d
Wavemeter Class O Tech. Instr 4/6 P.P. 6d
18 set Circuit and Notes 4/6 P.P. 6d
BC.1000 (31 set) Circuit & Notes 4/6 P.P. 6d
CR.100/B.28 Circuit and Notes 9/6 P.P. 9d
R.107 Circuit and Notes 6/- P.P. 6d
A.R.88D. Instruction Manual 16/- P.P. 1/6
62 set Circuit and Notes 5/6 P.P. 6d
52 set Sender & Receiver Circuits 7/6. post free
Circuit Diagrams 4/- each post free.
R.1116/A, R.1224/A, R.1355, R.F. 24, 25, & 26.
A.1134, T.1154, CR.300, BC.342, BC.312.
BC.348, J.E.M.P. BC.624. 22 set.
Resistor colour code indicator, 2/- P.P. 6d.
S.A.E. with all enquiries please.
Postage rates apply to U.K. only.
Mail order only to:

Instructional Handbook Supplies
Dept. P.E., Talbot House, 28 Talbot Gardens
Leeds 8

TAPE RECORDERS, TAPES, ETC.

20% CASH DISCOUNT on most famous makes of Tape Recorders, Hi-Fi equipment, Cameras, etc. Join England's largest Mail Order Club now and enjoy the advantages of bulk buying. Send 5/- for membership card, catalogues, price lists and ask for quotation on any item. G.B.A. (Dept. A18), 370 St. Albans Road, Watford, Herts.

TAPES TO DISC—using finest professional equipment—45 r.p.m. 18/-. S.A.B. leaflet. DEKOY, High Bank, Hawk Street, Camforth, Lanes.

FOR SALE

BRASS, STEEL, LIGHT ALLOY, STAINLESS STEEL TUBE. Bar Material, Tools, Mechanical, Electrical, plus Assorted Lots. Send S.A.B. for latest Cat. of 1,000 Items. K. R. WHISTON, Dept. BPE, New Mills, Stockport.

ENTHUSIASTS! Discover the fascinating world of model railway signalling! Send for details of Conrad model railway control panels, 1/- post free from **COCKROBIN CONTROLS**, 36 Villiers Avenue, Surbiton, Surrey.

EXCLUSIVE OFFER

Further to our overwhelming response to our recent advert, we have acquired another consignment of extendable 4 core leads, extends from 1ft to 6ft 6in as supplied to G.P.O. for telephones. These have many applications in the field of amateur electronics, etc. These are offered to you at the unbeatable Price of 5/- each or 55/- for 12 Post Free.

PAXOLIN SHEETS

12ins x 12ins sheet
4/6d. or 1d. per sq.
inch cut to size. Post
Free.

PRINTED CIRCUIT BOARD

5ins x 15ins sheet
6/0d. or 1d. per sq.
inch cut to size. Post
Free.

Larger sizes available upon request

at Specially reduced prices.

Mason Trading Company
24 Stephen Street, Coventry

100 PAGE illustrated Catalogue No. 17 Government and manufacturers' electronic surplus, also new section of latest semi-conductors and miniature components. Credit voucher for 2/6 included. Price 3/- post free. **ARTHUR SALLIS LTD.**, 93 North Road, Brighton.

Operational Amplifiers for PEAC Analogue Computer, ready built on PC board, tested and guaranteed, 34/- each.

Kits available at 28/- post free.

WESTEK ELECTRONICS
10 Maple Lodge Close, Maple Cross
Rickmansworth, Herts.

FOR SALE (continued)

HIGH GLOSS METALLIC HAMMERED ENAMEL

MAKES FANTASTIC DIFFERENCE TO PANELS—say hundreds of enthusiastic users. "Crackle pattern appears like magic on wood and metal. No undercoat. Air dries 15 min. to hard glossy finish. Heat, liquid & scratch-proof. Lt. & Dk. Blue; Bronze; Silver; Green; Black. Send 10/- NOW for trial 1pt. Tin. Col. samples & instr'n. Post free.

FINNIGAN SPECIALTY PAINTS Dept. P.E.
STOCKSFIELD. Tel. 2280 Northumberland.

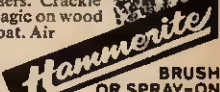

BRUSH OR SPRAY-ON

MORSE MADE EASY !!

FACT NOT FICTION. If you start RIGHT you will be reading amateur and commercial Morse within a month (normal progress to be expected).

Using scientifically prepared 3-speed records you automatically learn to recognise the code RHYTHM without translating. You can't help it, it's as easy as learning a tune. 18 W.P.M. in 4 weeks guaranteed.

For details and course C.O.D. ring S.T.D. 01-660 2896 or send 8d. stamp for explanatory booklet to:

6368/H, 45 GREEN LAKE, FURLEY, SURREY

RECEIVERS AND COMPONENTS

BARGAIN PARCELS of new surplus Electronic Components, 2/6, 5/-, 10/-, post free. **DOLPHIN ELECTRONICS**, 5 Holes Way, Briar Close, Burntwood, nr. Lichfield.

NEW PRICES ON NEW COMPONENTS

ELECTROLYTIC CAPACITORS (Mullard)
8uF/4V, 6.4uF/6.4V, 4uF/10V, 2.5uF/16V, 1.6uF/25V, 1uF/40V, 0.64uF/64V, 1/6, 32uF/4V, 25uF/6.4V, 16uF/10V, 10uF/16V, 6.4uF/25V, 4uF/40V, 2.5uF/64V, 1/3, 6.4uF/4V, 50uF/6.4V, 32uF/10V, 20uF/16V, 12.5uF/25V, 8uF/40V, 5uF/64V, 1/2, 125uF/4V, 100uF/6.4V, 64uF/10V, 40uF/16V, 25uF/25V, 16uF/40V, 10uF/64V, 1/-, 250uF/4V, 200uF/6.4V, 125uF/10V, 80uF/16V, 50uF/25V, 32uF/40V, 20uF/64V, 1/1, 400uF/4V, 320uF/6.4V, 200uF/10V, 125uF/16V, 80uF/25V, 50uF/40V, 32uF/64V, 1/2.

POLYESTER CAPACITORS (Mullard)
Tubular: 10%, 160V: 0.1, 0.015, 0.022uF, 7d, 0.033, 0.047uF, 8d, 0.068, 0.1uF, 9d, 0.15uF, 11d, 0.22uF, 1/-, 0.33uF, 1/3, 0.47uF, 1/6, 0.68uF, 2/3, 1uF, 2/8, 400V: 1,000, 1,500, 2,200, 3,300, 4,700pF, 6d, 6,800pF, 0.01uF, 0.015, 0.022uF, 7d, 0.033uF, 8d, 0.047uF, 9d, 0.068uF, 10d, 0.1uF, 11d, 0.15uF, 1/2, 0.22uF, 1/6, 0.33uF, 2/3, 0.47uF, 2/8.
Modular: metallised, P.C. mounting, 250V: 0.01, 0.015, 0.022uF, 7d, 0.033, 0.047uF, 8d, 0.068, 0.1uF, 9d, 0.15uF, 11d, 0.22uF, 1/-, 0.33uF, 1/5, 0.47uF, 1/8, 0.68uF, 2/3, 1uF, 2/9.

POLYSTYRENE CAPACITORS, 5%, 160V: 10, 12, 15, 18, 22, 27, 33, 39, 47, 56, 68, 82, 100, 120, 150, 180, 220, 270, 330, 390, 470, 560, 680, 820pF, 3d, 1,000, 1,500, 2,200, 6d, 3,300, 4,700, 5,600pF, 7d, 6,800, 10,000, 8d, 15,000, 22,000pF, 9d.

POTENTIOMETERS (Carbon), miniature, 1" x 1/2" spindle. Lin. 100 Horizontal to 10M, Log. SK to SKM, 2/3.

SKELETON PRE-SET POTENTIOMETERS (Carbon): Lin. 100Ω to 5MΩ horizontal and vertical P.C.M. mounting.

MINIATURE (0.3W), 1/-. **Submin. (0.1W)**, 10d. **RESISTORS (Carbon film)**: 5%, 10% over 1 MΩ. Range: 4.7Ω to 10MΩ.
Power Series Price (Over 99)
1W E24 2d ea. (1 1/2d ea.)
1/2W E24 2 1/2d ea. (2d ea.)
100 off per value: 1W, 13/9; 1/2W, 15/6.
C.W.O. P. & P., 1/-. Minimum order value 5/-.

DISCOUNT—10% over £2, 15% over £5.

Send S.A.E. for May 1968 Catalogue.

DUXFORD ELECTRONICS (PE)

DUXFORD, CAMBS.

Tel.: Sawston 3031

COMPONENTS

POSTAL SERVICE
*** RECHARGEABLE BATTERIES**
 (Sealed DEAC Ni-Cad)
 PP3 Equiv.: 9v, 37/- (p. & p. 2/-)
 U2 Equiv.: 1.25v, 32/6 (p. & p. 2/-)
 U7 Equiv.: 1.25v, 12/- (p. & p. 1/6)
 U11 Equiv.: 1.25v, 26/- (p. & p. 1/6)



*** BARGAIN PACK**
 100 Hi-Stab Resistors 15/-
 30 Silicon Diodes 15/-
 8 Silicon Top Hat Rectifiers 15/-

*** ASSORTED RESISTORS**—Hi-Stab, 300 ohm (5%, 10, 2, 5 watt, worth £3) 15/-
 (P. & P. 1/6 per order) C.W.O.

S.A.E. for list of Industrial Components for the Home Constructor

ELMBRIDGE INSTRUMENTS LTD.
 112 Farm Avenue, West Molesey, Surrey

RECORDING TAPES

Fully Guaranteed

7" D/P	2,400'	19/-
7" LP	1,800'	12/3
7" STD	1,200'	7/3
5 1/2" D/P	1,800'	16/5
5 1/2" LP	1,200'	9/-
5 1/2" STD	900'	6/6
5" D/P	1,200'	10/9
5" LP	900'	7/3
5" STD	600'	5/3
3" LP	185'	2/3
3" D/P	300'	4/-
7" D/P Concordia	3,000'	33/6

Spools: 8 1/2", 6 1/2"; 7", 2 1/2"; 5 1/2", 2 1/2"; 3", 9d.

Post and Packing up to 3 reels 2/9 otherwise 4/6.

OC22	8/-	OC202	6/6	BCY38	5/6	BYZ13	3/6	NKT734	5/9
OC23	8/-	OAS1	1/6	BCY39	5/9	GET102	4/-	NKT736	6/6
OC25	6/6	OAI82	2/-	BCY70	6/6	GET103	4/-	NKT773	5/6
OC26	6/6	OAA200	2/-	BCY71	10/6	NKT241	6/6	NKT781	6/-
OC28	6/6	OAA202	2/-	BCY72	6/6	NKT242	6/6	2N696	5/-
OC35	6/6	AC107	6/-	BFX29	15/-	NKT244	5/6	2N697	5/-
OC36	6/6	AC126	4/-	BFY19	5/-	NKT245	5/6	2N706	4/6
OC44	3/-	AC127	4/-	BFY19	5/6	NKT261	4/6	2N706A	4/6
OC45	2/6	AC171	4/-	BFY50	5/6	NKT262	4/6	2N708	5/-
OC46	3/-	AC178	4/-	BFY51	5/6	NKT264	4/6	2N2220	5/-
OC70	3/-	ACY19	4/-	BFY52	5/6	NKT271	4/6	2N2221	5/-
OC71	2/6	ACY20	5/6	BSY26	4/6	NKT603	6/6	2N2222	5/-
OC72	2/6	ACY21	5/6	BSY27	4/6	NKT604	6/6	2N2369A	8/7
OC74	4/-	ACY22	4/-	BSY28	4/6	NKT613	6/6	2N2411	6/6
OC75	2/6	AD140	4/-	BSY29	4/6	NKT677	6/6	2N3053	6/-
OC81	3/-	AD149	8/-	BSY38	4/6	NKT713	5/6		
OC81D	3/-	AF114	4/-	BSY39	4/6				
OC82D	3/-	AF116	4/-	BSY95A	4/6				
OC82	3/-	AF117	4/-	BY100	4/6				
OC83	4/-	AFZ12	5/6	BYZ10	9/6				
OC170	4/-	BCY33	5/6	BYZ11	8/-				
OC171	4/-	BCY34	5/6	BYZ12	6/6				

Send S.A.E. for complete list. P. & P. 1/-

A. MARSHALL & SON (London) LTD.
 28 Cricklewood Broadway, N.W.2
 Tel. 01-452 0161/2 Dept. P.E.19

VERO BOARDS: 3 1/2" x 2 1/2", 3/6; 3 1/2" x 3 1/2", 4/3; cutter, 9/-

DEE GEE: 30 watt Soldering Irons, 16/- each.

SPEAKERS: 3 ohm, 5", 1 1/2"; 8" 25/6; 12", 39/6; 7" x 4", 1 1/6; 3", 9/6.

RESISTORS: 1/2 watt, 6d; 3/4 watt, 6d.

ELECTROLYTICS: 15v 1 MFD up to 100 MFD, 1/6 each.

BI-PAK SEMICONDUCTORS 8 Radnor House KING OF THE PAKS SATISFACTION GUARANTEED
 93/97 Regent St SUPER PAKS—BRAND NEW
 (DEPT E) London W1 Untested Semiconductors

QUALITY-TESTED VALUE PAKS ★ BARGAINS

2	Drift Trans.	2N1225 Germ. PNP 100Mc's	...	10/-
2	Matched Trans.	OC44/45/81/81D	...	10/-
16	Red Spot AF Trans.	PNP	...	10/-
16	White Spot RF Trans.	PNP	...	10/-
5	Silicon Rects.	3A 100-400 PIV	...	10/-
2	10A Silicon Rects.	100 PIV	...	10/-
2	OC140 Trans.	NPN Switching	...	10/-
1	12A SCR	100 PIV	...	10/-
2	Sil. Trans.	25303 PNP	...	10/-
4	Zener Diodes	250mW 3-12V	...	10/-
2	200Mc's Sil. Trans.	NPN BSY26/27	...	10/-
3	Zener Diodes	400mW 33V 5% Tol.	...	10/-
4	High Current Trans.	OC42 Eqvt.	...	10/-
2	Power Transistors	I OC26 I OC35	...	10/-
5	Silicon Rects.	400 PIV 250mA	...	10/-
4	OC75 Transistors	Mullard Type...	...	10/-
1	Power Trans.	OC20 100V	...	10/-
4	OAA202 Sil.	Diodes sub-min.	...	10/-
2	Low Noise Trans.	NPN 2N929/30	...	10/-
1	Sil. Trans.	NPN VCB 100 ZT86	...	10/-
8	OAS1 Diodes	10/-
4	OC72 Transistors	Mullard Type...	...	10/-
4	OC77 Transistors	Mullard Type...	...	10/-
4	Metal Alloy Transistors	Mat. Type	...	10/-
4	Sil. Rects.	400 PIV 500mA	...	10/-
5	GET884 Trans.	Eqvt. OC44	...	10/-
5	GET883 Trans.	Eqvt. OC45	...	10/-
2	2N708 Sil. Trans.	300Mc's NPN...	...	10/-
5	GT4145 Germ. Trans.	PNP Eqvt. OC71	...	10/-
3	GT31 LF Low Noise Germ. Trans.	PNP	...	10/-
6	IN914 Sil. Diodes	75 PIV 75mA	...	10/-
8	OAS9 Germ. Diodes	Sub-min...	...	10/-
3	NPN Germ. Trans.	NKT773 Eqvt. AC130	...	10/-
2	OC22 Power Trans.	Germ.	...	10/-
2	OC25 Power Trans.	Germ.	...	10/-
2	OC73 Mullard Trans.	10/-
4	AC128 Trans.	NPN High Gain	...	10/-
4	AC127/128 Comp. pair	PNP/NPN	...	10/-
3	2N1307 PNP	Switching Trans.	...	10/-
7	CG62H Germ. Diodes	Eqvt. OA71	...	10/-
3	AF116 Mullard Type Trans.	10/-
12	Assorted Germ. Diodes	Marked...	...	10/-
4	AC126 Germ. PNP Trans.	10/-
1	ORP61	Photo-conductive cell	...	10/-

FREE One 10/- Pack of your own choice free with orders valued £4 or over.

UNIUNCTION
UT46, Eqvt. 2N2646, Eqvt. TI543, BEN3000
7/6 EACH

SIL. RECTS. TESTED
 PIV 750mA 3A 10A 30A
 50 2/- 3/- 4/6 9/6
 100 2/3 2/6 6/- 15/-
 200 2/6 4/6 6/6 20/-
 300 3/- 4/9 8/- 22/-
 400 3/6 6/- 9/- 25/-
 500 4/- 6/6 9/6 30/-
 600 4/3 7/- 10/- 37/-
 800 4/9 8/- 15/- 40/-
 1000 6/- 10/- 17/6 50/-

SCR'S
LOWEST PRICE LARGEST RANGE
 PIV IAMP 7A 16A 30A
 25 7/6 7/6 30/-
 50 7/6 8/6 10/6 25/-
 100 8/6 10/- 15/- 45/-
 200 12/6 15/- 20/- 55/-
 300 15/- 20/- 25/- 65/-
 400 17/6 25/- 35/- 80/-
 500 30/- 40/- 45/- 95/-
 600 ... 40/- 50/-

ORP12, ORP60 8/6 each

PRINTED CIRCUITS
EX-COMPUTER
 Packed with semiconductor and components. 8 boards give a guaranteed 30 trans and 30 diodes. Our price 8 boards 10/- Plus 2/- P. & P.

★ TESTED DEVICES ★

AC125	2/3	NKT773	4/-
AC176	5/6	NKT781	5/6
AF139	10/-	OC44	1/9
AFZ12	10/-	OC45	1/9
BC107	5/-	ST140	4/-
BC108	5/-	ST141	4/-
BC109	5/-	2N696	4/6
BCY33	5/-	2N697	5/-
BCY34	6/-	2N1090	4/9
BCZ10	5/-	2N1305	4/9
BCZ11	6/-	2N1147	15/-
BFY90	7/6	2N2894	8/-
BFY51	7/6	2N3819	15/-
BFY52	7/6	2N3820	25/-
MAT100	3/6	25302	5/-
MAT101	3/6	25303	4/-
MAT120	3/6	25304	4/-

Set of 4 trans. comp. with circuit and building inst. for radio. All boxed 5/- per set.

TRANSISTOR MANUAL BY G.E. INC.
 CIRCUITS, APPLICATIONS, CHARACTERISTICS, THEORY.
30/- EACH
 S.P. 2/6
S.C.R. MANUAL BY G.E. INC.
 L.A. S.C.R.'S, G.T. SWITCHES, THEORY, RATINGS, APPLICATIONS.
27/06
SILICON PLANAR TRANS. 1/- EACH NPN

INTEGRATED CIRCUITS
 Epoxy TO5 B lead
 100 914 Buffer @ 11/-
 100 914 Dual Gate @ 11/-
 100 923 J-K Flip Flop @ 14/-
 IC circuits data, 1/6 etc.

TAA263 21/-

6 VHF trans. 667 eqvt. AF116-117 10/-.

OCP71 8/6 each **IMPORTANT NOTICE** WE HAVE NOT CHANGED OUR NAME OR ALMGAMATED WITH ANY OTHER PAK FIRM. YOU CAN ONLY OBTAIN OUR ADVERTISED STOCK BY SENDING TO: C.W.O. please add 1/- p. & p. Min. Order 10/-

BI-PAK SEMICONDUCTORS, 8 RADNOR HOUSE, 93-97 REGENT ST., LONDON, W.1

BI-PAK GUARANTEE SATISFACTION OR MONEY BACK

IS130-30 FOR 10/-

TRANSISTORS EX STOCK

AC107	14/6	BYZ12	7/6	OC83	3/6
AC127	6/-	BYZ13	5/1	OC84	4/-
AC128	4/-	BY100	5/-	OC123	7/-
AC176	6/-	BYX20-200	8/-	OC139	12/-
ACY17	5/-	BZY93	12/-	OC140	12/-
ACY20	3/6	GET102	5/4	OC169	6/-
ACY21	4/-	GET103	4/4	OC170	4/-
ACY22	4/-	GET104	4/4	OC171	4/-
AD140	12/8	GET573	10/-	OC200	6/-
AD149	11/-	OA5	3/-	OC201	10/-
AD161	7/6	OA10	4/-	OC202	13/-
AD162	7/6	OA47	1/6	OC203	8/-
ADT140	12/6	OA70	1/6	OC204	11/-
AF102	16/-	OA73	1/6	OC205	10/6
AF114	4/9	OA79	1/6	OCP71	19/6
AF115	4/9	OA81	1/6	ORP12	9/-
AF116	4/9	OA85	1/6	ORP60	8/-
AF117	4/9	OA90	1/6	ORP63	9/-
AF186	13/-	OA91	1/6	ORP93	18/-
AF239	13/-	OA95	1/6	ORP90	19/6
AFZ11	10/-	OA200	2/-	MAT100	7/9
AFZ12	11/9	OA202	2/-	MAT101	8/6
ASY26	5/-	OC19	5/-	MAT120	7/9
ASY28	5/-	OC20	23/-	MAT121	8/6
ASY29	6/6	OC22	13/-	ST140	3/-
ASZ21	4/-	OC23	5/-	ST141	5/-
BA115	2/6	OC24	19/-	TAA262	29/6
BC107	4/3	OC25	7/-	1B40X10	19/-
BC108	4/-	OC26	12/-	2N1302	5/-
BC109	4/3	OC28	12/-	2N1303	5/-
BCY30	7/6	OC29	15/-	2N1304	6/-
BCY31	9/-	OC35	9/6	2N1305	6/-
BCY32	8/-	OC36	13/-	2N1306	8/-
BCY33	6/-	OC41	3/6	2N1307	8/-
BCY34	8/-	OC42	4/-	2N1308	10/6
BCY38	19/-	OC43	3/-	2N1309	10/6
BCZ40	2/6	OC44	3/-	2N1310	17/-
BCZ11	10/-	OC45	3/-	2N2160	14/9
BFY50	6/-	OC71	3/-	2N2646	10/-
BFY51	5/-	OC72	4/6	2N2926	3/-
BFY52	6/-	OC73	3/-	2N3528	19/-
BSX76	3/-	OC75	5/-	2N3819	11/-
BT79-400R	24/-	OC76	3/-	2N3926	6/3
BTY87-150R	23/-	OC81	3/-	UL900	11/-
BTY91-150R	35/-	OC81D	3/-	UL914	11/-
BTY87-500R	47/-	OC82	4/6	UL923	14/-
BYZ10	11/-	OC82D	4/3		



LST COMPONENTS
 7 COPTFOLD ROAD
 BRENTWOOD ESSEX
 BRENTWOOD 7904
 24 HOUR POSTAL SERVICE

GUARANTEE: All the above-listed semiconductor devices are Brand New, First Grade, and guaranteed. We will replace at no charge any device found to be faulty. Further: all devices carry the Manufacturer's name or Trade Mark, type number and batch number. We do not offer for sale devices often described as "new and tested" or bearing re-marked type numbers, these often have a short and unreliable life. **LST COMPONENTS**

WE ALSO STOCK:

- 20 watt Solid State Amplifier Kit—AF11 £8.8.0
- Solid State Pre-Amp for above, Complete £6.10.3
- Send now for details
- "S-Dec" Breadboards 29/6
- ½ and ¼ watt 5% Carbon Film Sub-Min. Resistors 4d each
- Skeleton Presets 1/6
- Mullard Sub-Min. Electrolytics and Polyester Capacitors
- Heat Sink for 2 X OC35, etc. 6/-
- Veroboard—All standard sizes
- Aluminium Chassis and Panels
- International Rectifier
- SEMICONDUCTOR CENTRE Stockists
- MULLARD & FAIRCHILD Integrated Circuits
- Handbooks of all types
- 40kc/s Transducers @ £5.18.0 pair with free circuits.
- "X"-Line Modules—Solid State—ready built and tested circuits

ALL THE ABOVE AND MUCH MORE IN OUR 1968 CATALOGUE

PLEASE SEND TO ME YOUR 34 PAGE CATALOGUE
 I enclose 1/6 stamps

NAME.....
 ADDRESS

.....
 BLOCK LETTERS PLEASE PE/6

DECADE COUNTER UNITS. Using 3-1 Cs and silicon transistors. Max. p.r.f. above 2MHz, B.C.D. output, reset-line, 2.4 x 1.5 x 0.7in, 85/- each inc. postage. R. MOUNT, Keldholme, Linton, Wetherby, Yorks.

STUDENT ELECTRONIC SERVICES
 194 Regent Road, Salford 5

We stock a wide range of Resistors ½ and ¼ watt.
 Buy individually OR try the S.E.S. Pre-Pack. Stocks now include Potentiometers—Log. and Lin.
 Enclose 6d. for complete price list.

RESISTORS

½ watt carbon film 5%
 All preferred values in stock from 10 ohms to 10 megohms 2d. each.
 Send S.A.E. for free sample

CAPACITORS

Mullard Miniature Metallised Polyester P.C. Mounting, all 250V D.C. working. 0.01mf, 0.022mf, 0.047mf, 0.1mf, 0.22mf, all at 6d. each

Hunts tubular 0.1mf 200V working at 3d. each

Send 6d. stamp for extensive list of low priced Electronic Components, Instruments and Equipment

Please include 1/- postage and packing on all orders under £1

Dept. P.E.12
BRENSAL ELECTRONICS LIMITED
 CHARLES STREET, BRISTOL 1

INTEGRATED AMPLIFIER RCA 3020 550mW class B amp. in T05 can. With data, 33/- List 3d. **AMATRONIX LTD.**, 306 Selsdon Road, Croydon, Surrey, CR2 0DE.

BRAND NEW ELECTROLYTICS, sub-miniature 15 volt, 8, 10, 30, 50, 100mF, 8/6 per doz. post 1/-. **The U.R. SUPPLY CO.**, 127 Chesterfield Road, Sheffield, S8 0RN.

COMPUTER PANELS

Eight assorted printed circuit panels with transistors, diodes, resistors, capacitors, etc. Guaranteed minimum 30 transistors. Ideal for Experimenters. 8 boards 10/-. POST FREE.
 100 Boards 65/- POST FREE
 1500+2000 MFD Electrolytics 25 volt DC wkg, 3/- each. 9d. P. & P.



KEYTRONICS, 52 Earls Court Road, London, W.8. Mail order only

R & R RADIO

51 Burnley Road, Rawtenstall
 Rossendale, Lancs
 Tel.: Rossendale 3152

VALVES BOXED, TESTED & GUARANTEED

EBF80	3/-	PCC84	3/-	PY82	3/-
EBF89	3/6	PCF80	3/-	UI91	4/6
ECC82	3/-	PCF82	3/6	U301	4/6
ECL80	3/-	PCL82	4/-	6F23	5/-
EF80	1/6	PCL83	4/-	10P14	3/-
EF85	3/-	PCL84	5/-	20P5	3/-
EF183	3/6	PL36	5/-	30F5	2/6
EF184	3/6	PL81	4/-	30L15	5/-
EY86	4/-	PL83	4/-	30P12	4/6
EL41	5/-	PY33	5/-	30C15	5/-
EZ40	4/6	PY81	3/6	30P13	5/6
EBC41	4/6	PY800	3/6	30P14	5/6

POST, ONE VALVE 9d. TWO TO SIX 6d. OVER SIX POST PAID.

TRANSISTOR CAPACITORS (ELECTROLYTIC)

500mfd 4V	64mfd 40V	16mfd 25V
320mfd 10V	50mfd 10V	10mfd 25V
250mfd 4V	30mfd 10V	6.4mfd 64V
200mfd 16V	25mfd 25V	4mfd 64V
100mfd 16V	20mfd 12V	1mfd 25V

1/- each, 9/- per doz. Min. order 10/-

TRANSISTOR PANELS—OC45 or equiv., 20 for 20/-, 30—25/-, 50—35/-, 70—45/-, 40—30/-, 60—40/-, 80—50/- Postage 2/- per panel

Brand new STC sil. EPT planar transistors 300 Mc/s 350 mV, all 2/- each. 2N743, 2N753, 2N916, BSY26, BSY28, BSY65, BSY18, BSY95A, BSY29

TRANSISTORS OC45, TK22C @ 1/- each. OC76, OC139, 2G302, OC81, OC44 @ 2/- each. GET120, OC83, 2N1308, OC72, NKT216 @ 4/- each. OC23, NKT452, NKT453 @ 6/- each. 10 watt heat sink drilled for power trans. 5/-, 1,000mfd 30V 4/-, 3,000mfd 10V 2/-, T.V. capacitors 100 + 200 + 400mfd 275V 7/6, 100 + 200mfd 300V 3/6.

W.W. POTS 5, 10, 25, 50, 100, 250, 500 ohms. 1k, 2k, 2.5k, 5k, 10k, 25k, 50k, 100k, not precise 2/- each. Min. order 5/-. Postage 1/-

ZENER DIODES—2.4, 2.7, 3.6, 4.75, 5.25, 5.75, 6.2, 6.8, 7.5, 9.1, 13, 15, 16, 18, 20, 27, 30, 33 volts. 3/6 each, mostly 1 watt

POLYSTYRENE CAPACITORS 350V: 180, 270, 330, 390, 470, 560, 680, 820pf. 1,800, 2,200, 2,700, 3,300, 5,600, 6,800, 8,200
125V: 1,200, 1,500, 1,800, 2,200, 2,700, 3,300, 3,900, 4,700, 5,600, 6,800, 8,200, 0.012, 0.015, 80pf ceramic 200pf 5M, any selection 2/- doz. 4-40pf trimmers 4/- doz.

BRAND NEW BOXED CHASSIS, containing 2—OC35, 2—OC29 12 WW resistors 30/-, Postage 1/6.

STEREO POTS. Less switch, single spindle. 1 meg + 1 meg log and 1 meg log + 1 meg rev log. 7/6 each.

NEW CROSS RADIO
 6 OLDHAM ROAD, MANCHESTER 4

STUDENT ELECTRONIC SERVICES

194 Regent Road, Salford 5

Constructional aids — including Assembly Stand (each individually made by craftsman).

LEKTROKIT—the biggest money and time saver since the safety pin!

Everything to construct a professional job, from a variety of boards, pins to chassis plates and rubber feet.

Special introductory kit in 2 sizes.

Write now for complete price list AND sample resistors, enclosing 6d.

SEMICONDUCTORS

All Brand New Mullard or Newmarket, No Rejects.
2N2926: Green β 235-470, 3/9; Yellow β 150-300, 3/6; Orange β 90-180, 3/3; Red β 55-110, 3/-.

ACV22	3/-	2N706	3/-
BC107	5/-	2N708	4/6
BC108	4/6	2N1132	12/6
BC109	5/-	OC71	3/-
BFY50	7/6	OA70	1/6
BFY51	5/6	OA81	1/6
BFY52	7/6	OA90	1/6
BSY95A	4/6	OA91	1/6
2N697	6/-	OA202	2/6

Resistors, $\frac{1}{2}$ watt carbon, all preferred values—3d each.
P. & P. 1/-, free on orders over 15/-. C.W.O.

Dept. P.E. W. W. Electronics
10 The Drive, Newcastle on Tyne, 7

**TRANSISTORS
1,000,000 FOR SALE**

BRITISH MANUFACTURERS SURPLUS

Owing to the reorganisation and expansion by the manufacturers of these transistors, it has been necessary to clear them as surplus to requirements. These devices would normally be tested several times into different groups, 50% would be used as good industrial transistors and a further 35% would make diodes. The remaining 15% would be disposed of as scrap rejects.

Offering these devices in varied quantities make them ideal for AMATEUR ELECTRONICS, RADIO HAMS and for EXPERIMENTAL USE IN SCHOOLS, COLLEGES and INDUSTRY.

All transistors are in mixed lots, mainly PNP but some NPN, all are Germanium type. Prices and quantities as follows:

	approx. count by weight	
100 pieces	10/-
300 "	25/-
500 "	40/-
1,000 "	60/-
10,000 "	£25

Large quantities by negotiation.
TERMS—CASH WITH ORDER, all goods sent by return. Please add 2/- towards Post & Packing orders up to £3, over £3, 5/-. Monthly accounts for Education Authorities, etc, on receipt of an Official Order.

EXPORT ENQUIRIES WELCOME
All correspondence, cheques, Postal Orders, etc., to:
DIOTRAN SALES, P.O. Box 5, 63 High Street, WARE, HERTS.
Tel.: WARE 3442

CHASSIS. Brand new 18in x 11 $\frac{1}{2}$ in, 18 gauge steel chassis with front panel, ready punched and stove enamelled silver hammer. Suitable for power supply, etc., 10/- each. 4/6 P. & P.

Brand new 10in x 5in, 16 gauge aluminium chassis, ready punched for two relays, tag strips, etc., 5/6 each. 2/- P. & P.

RELAYS. 1. Heavy duty type, suitable for use in cars, etc., 30 ohm coil, two sets of contacts, supplied on mounting bracket containing dropper resistor and input socket. 15/- each, 1/6 P. & P.

2. 3000 type, brand new, six pairs of change-over contacts. 200 ohm or 1,000 ohm coil, 10/- each. 1/- P. & P.

3. 600 type, 1,000 ohm coil, one set of contacts, 4/- each. 1/- P. & P.

CONSTRUCTING YOUR OWN RELAYS! Brand new and boxed relay contacts. Two pairs of change-over contacts per set, 3,000 type, four sets 10/-; medium power type, four sets 7/6. 1/- P. & P.

UNISELECTORS. Unused but soiled due to warehouse storage. 8 bank, 25 position, 75 ohm coil, 29/- each. 3/- P. & P. 4 bank (+ 1 shunting bank), 25 posn., 75 ohm coil, 19/- each. 3/- P. & P. 3 bank, 25 position, 12 ohm coil, 15/- each. 3/- P. & P.

PHOTOTRANSISTORS. OCP71 equivalents, 5/- each. P. & P. 6d. for £1 post free.

AVO VALVE TESTERS. Two only. Currently selling at £30, a bargain at £20 plus £1 carriage.

BUILDING YOUR OWN TAPE DECK?—TAPE REVERS UNIT? Professional quality 7/8in dia. rubber pinch rollers, with precision ground face and nylon bearing insert, suitable for any type of tape transport system, 2/- each. P. & P. 6d. Prices for larger quantities on application.

POSTAL SERVICE ONLY—REGRET NO CALLERS.

BEEJAY ELECTRONICS
106 REDDIPAC HEATH ROAD
SUTTON COLDFIELD, WARCS.

**CURSONS
TRANSISTORS
ALL GUARANTEED**

1/- each
BAY31, BAY50, DK10, OA70, OA81, OA200, OA10, OA90, OA91, OA259, IN914, IN916, JL102

2/- each
XA101, XA102, OC71, OC72, OC81, OC81D, OC44, OC45, GET16, FST3/1, ACY22, ASY57

3/- each
OC139, OC140, 2N706, 2N708, 2N2894, BY100, RAS310AF, 2N914, BSY26, BSY27, BSY95A, AFZ12

7/6 each
RAS508AF, CRS3/40, BLY10, BLY11, BUY10, BUY11, ADY22, ADY23, ADY24, OC22, OC26

ZENER DIODES

3.9v to 26v, $\frac{1}{4}$ w 3/- each, 1.5w 4/-, 7w 5/- each.

B. CURSONS S.A.E. NEW LIST
78 BROAD STREET
CANTERBURY
KENT

REPANGO Transistor Coils and Transformer. for the Constructor. Send stamp for lists **RADIO EXPERIMENTAL PRODUCTS LTD., 33 Much Park Street, Coventry.**

MICROMINIATURE MICROPHONES

Sensitive dynamic type. Will pick-up rustle of newspaper from 30 feet. Size 9 mm. X 9 mm. X 3.5 mm. Impedance 1 K Ω .

ONLY 28/6 Post free—C.W.O.

SHOWN FULL SIZE
MICRO DATA SYSTEMS
30 BAKER ST., LONDON, W.1

PHOTO ELECTRIC CONTROL SYSTEM

Comprises a light source unit with optional Infra Red filter and lens system to focus the light. Also a photo-electric Relay control unit. Both housed in metal cases for bench or wall mounting, sensitivity control, mains on-off switch. Working from 230/240V a.c. Mains. Can be used as a simple on-off switch by breaking the beam of light (invisible if Infra Red filter is used) and as such it will operate as a burglar alarm, or will open doors, etc. Also in conjunction with a counter or other equipment it will perform many functions in the factory or warehouse. **£9.19.6**

F.M. WIRELESS MICROPHONE
94-104Mc/s. Transistorised. Operates from 9V battery. Complete with additional secret clip microphone. List #19/10- ONLY **£6.15.0** These cannot be operated in U.K.

TRANSISTORISED FM TUNER
6 TRANSISTOR HIGH QUALITY TUNER. SIZE ONLY 6in x 4in x 2 $\frac{1}{2}$ in 8 I.F. stages. Double tuned discriminator. Ample output to feed most amplifiers. Operates on 9V battery. Coverage 88-108Mc/s. Ready built ready for **£6.17.6** use. Fantastic value for money

FM MULTIPLEX STEREO ADAPTOR
Printed circuit biscuit, 4 trans. 6 diodes 9V with full instructions **£5.19.6**

BSR TAPE HEADS MULTIMETERS from **32/-**
2 TRACK **39/6** pair

BSR TAPE HEADS LOUSPEAKERS 2 **9/6**
MALL 40 ohm, 2 $\frac{1}{2}$ " 80 ohm.
4 TRACK **39/6** pair 12" TWIN CONE 10 watt, 15 or 3ohm **95/-**

REFLEX CONE TYPE 95/-
WATERPROOF SPKR. 29/6
5 watt, 3 ohm, 200-16,000c/s PA **£4.5.0**
& Music Relay CROSSOVER NETWORK 17/-
& Music Relay 16 ohm

SUPER SILICON RECT. T.V., etc., 1,200 PIV 800mA, 6/-; or complete with instr. resistor, condenser, 7/6; 400 PIV HW 6A, 6/-; 200 PIV HW 6A, 6/-.

Stamped envelope for full selection and bargain offers in Multimeters, Radios, Baby Alarms, Intercoms, Walkie-Talkies, Rectifiers and Eagle Lists. UNDER £1—P. & P. 6d. OVER £1 post free. C.O.D. 3/6.

DURHAM SUPPLIES
175F, Durham Road, Bradford, 8, Yorkshire

ELECTRICAL



Best quality 3 core cable used. Fitted with unbreakable rubber plug and socket in either 13 amp., 5 or 15 (state choice). Will also extend your vacuum lead, hedge trimmer, mower, etc.

SOUTH WEST SUPPLIES (Dept. P1)
222 Fishponds Road, Bristol 5

DON'T MISS THIS OFFER



British Made Electric Soldering Iron, 6 months Makers Guarantee AND After Sales Service. 30 watts 230-250 volts or 200-220 volts, state choice, supplied with over 10ft. of 3-core pvc flex. This is a quality iron at the ridiculous low price of **ONLY 16/-** + 1/6 P.P. **SOUTH WEST SUPPLIES, 222 Fishponds Road, Bristol 5.**

COMMUNICATION RECEIVER TYPE GDx

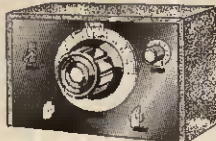

The Latest version of the T.R. GDx Series. The type 25/C improved model. A brand new fully transistorised receiver. Four complete ranges 550kc/s to 30mc/s covering all amateur bands, shipping bands and broadcast bands. It is a highly efficient double tuned superhet comprising R/F aerial tuning section, AVC and built in B.F.O. (tunable) for C.W. or S.S.B. reception. Ideal for mobile reception. Size only 9 x 7 x 6in. Operates from internal 9 volt battery. Gives a high quality reproduction. With speaker or headphone output. Hammer finished robust steel case of pleasing design, with all controls on well set out front panel. The set complete with handbook, 14 gns. Carriage 16/-. Headphones, 19/6 extra; P. & P. 3/6. ACCESSORIES: fitted S meter £2 extra. Stabilised miniature battery eliminator, 50/- P. & P. 5/-. De-luxe loudspeaker in matching metal cabinet £2.15.0: carriage 5/-.

HEAT LIGHT SPEED CONTROL Unit



MK V. 3,000 WATT MODEL. Finger tip control of all a.c./d.c. electrical equipment. Suitable for all types of lighting arrangements. Incandescent lamps, spot lamps, arc lamps. Floodlights. Makes an excellent dimming unit. Ideal for controlling all types of electric heaters. Electric blankets and electric irons. Will control the speed of all drills for all applications. Also lathes and power tools. Contains the latest electronic switching devices, and associated Thyristor circuitry. Size 6 x 5 x 2in. Louvered metal case in pleasing hammer finish. Attractive front panel with matching socket and control. Ample cable provided. Additional cable 3/6 per yard. The recommended price of the unit is 25 gns. Due to another bulk purchase we can offer them at only £8.10.0. carriage and insurance 10/-. C.O.D. 3/6 extra.

TWO WAY TALKIE PHONES. Ideal for indoor/outdoor Communication. Will work up to long distances. Clear reception. No G.P.O. licence required. Once complete set £2.10.0: carriage 10/-. Batteries 10/- extra. Special offer of Two complete sets plus batteries £6 post paid.

All orders to: Dept. P.E.11

GLOBE SCIENTIFIC LTD
24 CAWOODS YARD, MILL STREET
MARSH LANE, LEEDS 9 (LEEDS 35900)
Callers welcome. Open 7 days a week
New Component Centre opening 20th May
at this address.

CRESCENT RADIO LTD.

(electronic component specialists)
For all regular components try
40 Mayes Road, Wood Green, N.22
For surplus components and equipment try
11 Mayes Road, Wood Green, N.22
BARGAIN BOARD

7in X 5in board with the following components attached:

- 2 GERTZ transistors
 - 2 Mullard OA10 diodes
 - 2 Mullard OA5 diodes
 - 12 Midget 1W Resistors various values
 - 8 Midget Capacitors various values
- Including postage in Great Britain 4/- each
BARGAIN CHASSIS

- 1 Electrolytic capacitor 100 plus 100mF
- 1 Electrolytic capacitor 100mF or 150V
- 1 Electrolytic capacitor 8mF or 450V
- 1 0.12mF or 600V
- 2 Silicon Diodes
- 2 Pre set Pots (1) 500kΩ. (1) 2MΩ.
- 1 2mF 350V
- 5 mixed resistors
- 1 Transformer

- SPECIAL LINES**
- Airspeed capacitor 50pF with standard spindle 2/6 each
 - 8 ohm transistor earpieces 1/6 each
 - Heavy duty 1.25 ohm slider resistor 9d each
 - Double pole knife switches 1/6 each
 - G.P.O. 1,000 ohm relays 5/- each
 - 500 ohm midget relays, 9V 5/- each
 - 45 m/h Ferroxcube choke, L.A.3 size. 4/6 each
 - 00 gangs 208/176pF 4/6 each
 - 5kΩ midget transistor pot with S.P. switch 2/6 each
 - Twin transistor cooling clips OCB1 size 6d each
 - Black and satin chrome 1/4in. knobs, standard spindle 1/3 each
 - 1kg Bercostat pot 4/6 each
 - B.S.R. erase heads 5/- each
 - Mains indicators, yellow and green, 7in fixing 3/9 each

- VERO BOARD**
2 1/2 x 3 1/2in 0.15 pitch 2/- each
- TRANSISTORS**
- 2G339A 1/6 each
 - Matched pair 2G378B and 2G339B 3/6 each
 - 2G401 2/6 each
 - 2N711 2/6 each

With our new premises in Mayes Road we can now offer an even wider selection of components for the home constructor and enthusiast.

POSTAGE WITH ORDER PLEASE

AERIAL WIRE: Coils of 25 yd. Single Strand 2/8+ 6d P. & P.

- RELAYS:**
1. Miniature Plug-in Relays. 185 Coll. 4.6/18V. 3 Change over Contacts 18/6+ 1/8 P. & P.
 2. Miniature Plug-in Relays. 130 Coll. 4. Light Duty Contacts. 9/15V. 18/9+1/6 P. & P.
 3. 6V octal base A/O Relays. 2 pairs heavy duty contacts c/o. Complete with octal base. 28/-+ 1/6 P. & P.
 4. Single change over Relay. 875 Coll. 18V for printed circuit. 15/-+1/8 P. & P.
 5. Bases for Item 1 and 2. 8/9+6d P. & P. State whether wired or printed circuit.
- TEST METER:** 20 K per volt ITI-2. £8.9.6. PT34 small test meter £1.14.0+3/- P. & P. TAYLOR Jun. £10.10.0. AVO Minor £8.10.0, and many others.

LOUDSPEAKERS: 8 OHM 2" to 5" from 7/6 to 18/6 +1/8 P. & P.
Car Speakers 7" x 4" 12/6+2/- P. & P.

TRANSFORMERS: 250-0-250 sec. 60 MVA/6-3V. 18/9+3/6 P. & P.
250-0-250 sec. 100 MVA/6-3V. 30/6+3/6 P. & P.

TRANSFORMERS SUITABLE FOR SMALL POWER SUPPLIES: 5/11/17V at 4 amps. 27/8+3/8 P. & P. 3 to 30V tapped 2 amps. 30/-+3/6 P. & P. 0-9-15V. 1 1/2 amps. 18/6+3/- P. & P. 75W auto transformers. 10/6+2/6 P. & P.

OUTPUT TRANSFORMERS: Suitable for EL84, UL84 Singles. 6/6+2/6 P. & P. Midget Choke Output. 6/6 +2/6 P. & P.

CONDENSERS ELECTROLYTIC: 2, 4, 10, 16, 30, 50, 100 m.s.d. 15V. 1/6+4d. P. & P. each.

CARBON CONTROLS: 5 K to 2 M Lin. or Log. 3/6 +1/- P. & P. 5 K to 2 M Lin. or Log. with s/w. 8/2 +1/- P. & P.

EAR PIECES: 2.5 mm or 3.5 mm Magnetic 2/6. Crystal 2.5 mm, 3.5 mm. 5/6.

SINGLAIER PRODUCTS: All units and Mat. Trans.

TRANSISTORS: Popular Range OC44, OC45, OC71, OC72, OC81, OC82, all at 2/6.

POWER TRANSISTORS: OC24, 10/9, OC28 18/3, OC35, 13/6, ADT149, 15/-.

OSMOR RANGE of I.F.s, Coils, Driver & output trans.
ELECTRONIC KITS: Suitable for beginners £2.17.6.
Write or call for our free Components List.



BOTHWELL ELECTRIC SUPPLIES (Glassgow) LTD.
54 EGLINTON STREET,
GLASGOW, G.5. Tel. 041 SOUTH 2904.
Member of the Lander Group



TRANSISTOR BOOSTER 39/6

JUST PLACE NEAR RADIO —

The Dewtron Wave Trap for portables
★ Boosts Radio 1, Luxembourg, Pops etc.
★ Eliminates 'fading'
★ Extends battery life.
★ Replaces car aerial for portable sets.
★ 7-day refund trial. £2 post free.

D.E.W. LTD., P.E., RINGWOOD ROAD, FERNDOWN, DORSET.



ADD NEW DIMENSIONS TO YOUR LISTENING —

The revolutionary N.D. Effects Amplifier adds fabulous "Big Hall Stereo" effect to any transistor, radio, tape or player. Adjustable echo, vibrato and tone. Requires only speaker and PP3 battery 8 gns. + 4/- P. & P. Tubular speaker 25/- extra.
GAE VERSION 10 gns. with rear speaker.

BAR 3087

WENTWORTH RADIO

104 SALISBURY ROAD, HIGH BARNET

ACV15 4/6	BC100 5/-	NKT217 7/9	NKT612 4/11	OC45 1/8	OC170 2/6
ACV19 4/6	BCY31 10/9	NKT201 3/8	NKT675 4/2	OC70 5/-	OC171 8/6
ACV20 4/8	BFY50 7/-	NKT271 3/8	NKT676 4/2	OC71 1/8	OC172 4/8
ACV21 5/-	BXY36A 6/-	NKT273 3/8	NKT713 4/8	OC72 1/10	26971 3/3
ACV22 3/8					2N404 6/-
ACV23 8/9					2N596 4/6
ACV32 6/9					2N706A 4/6
ACV40 3/10					2N1302 3/9
AD140 8/8					2N1804 4/6
AF114 4/8					2N1305 4/6
AF116 2/8	MAT100 7/9	NKT274 3/8	NKT773 4/-	OC74 3/9	2N1307 7/-
AF117 2/8	MAT101 8/8	NKT304 11/-	OC35 8/8	OC76 3/9	29801 9/6
AF118 4/6	NKT1 4/11	NKT403 15/-	OC36 8/8	OC77 8/8	28512 4/6
BC107 4/9	NKT24 3/8	NKT401 12/-	OC44 1/11	OC78 1/8	29746A 8/8
BC108 4/9					295010 6/7

CASH WITH ORDER

P. & P. 9d.

VALUABLE NEW HANDBOOK FREE TO AMBITIOUS ENGINEERS

Have you had your copy of "Engineering Opportunities"?

The new edition of "ENGINEERING OPPORTUNITIES" is now available—without charge—to all who are anxious for a worthwhile post in Engineering. Frank, informative and completely up to date, the new "ENGINEERING OPPORTUNITIES" should be in the hands of every person engaged in any branch of the Engineering industry, irrespective of age, experience or training.

On 'SATISFACTION OR REFUND OF FEE' terms

This remarkable book gives details of examinations and courses in every branch of Engineering, Building, etc., outlines the openings available and describes our Special Appointments Department.

WHICH OF THESE IS YOUR PET SUBJECT?

ELECTRONIC ENG.
Advanced Electronic Eng.—
Gen. Electronic Eng.—*Applied Electronics—Practical Electronics—Radar Tech.—Frequency Modulation—Transistors.*

ELECTRICAL ENG.
Advanced Electrical Eng.—
General Electrical Eng.—
Installations—Draughtsmanship—Illuminating Eng.—Refrigeration—Elem. Elec. Science—Elec. Supply—Mining Elec. Eng.

CIVIL ENG.
Advanced Civil Eng.—
General Civil Eng.—
Municipal Eng.—Structural Eng.—Sanitary Eng.—Road Eng.—Hydraulics—Mining—Water Supply—Petrol Tech.

RADIO & T.V. ENG.
Advanced Radio—*General Radio—Radio & TV Servicing—TV Engineering—Telecommunications—Sound Recording—Automation—Practical Radio—Radio Amateurs' Examination.*

MECHANICAL ENG.
Advanced Mechanical Eng.—
Gen. Mech. Eng.—Maintenance Eng.—Diesel Eng.—Press Tool Design—Sheet Metal Work—Welding Eng.—Pattern Making—Inspection—Draughtsmanship—Metallurgy—Production Eng.

AUTOMOBILE ENG.
Advanced Automobile Eng.—
General Auto. Eng.—Auto. Maintenance—Repair—Auto. Diesel Maintenance—Auto. Electrical Equipment—Garage Management.

WE HAVE A WIDE RANGE OF COURSES IN OTHER SUBJECTS INCLUDING CHEMICAL ENG., AERO ENG., MANAGEMENT, INSTRUMENT TECHNOLOGY, WORKS STUDY, MATHEMATICS, ETC.

Which qualification would increase your earning power? A.M.I.E.R.E., B.Sc.(Eng.), A.M.S.E., A.M.I.P.E., A.M.I.M.I., A.R.I.B.A., A.I.O.B., A.M.I.E.C., A.R.I.C.S., M.R.S.H., A.M.I.E.D., A.M.I.Mun.E., C.ENG., CITY & GUILDS, GEN. CERT. OF EDUCATION, ETC.

BRITISH INSTITUTE OF ENGINEERING TECHNOLOGY
316A ALDERMASTON COURT, ALDERMASTON, BERKSHIRE

THIS BOOK TELLS YOU

- ★ HOW to get a better paid, more interesting job.
- ★ HOW to qualify for rapid promotion.
- ★ HOW to put some letters after your name and become a key man . . . quickly and easily.
- ★ HOW to benefit from our free Advisory and Appointments Depts.
- ★ HOW you can take advantage of the chances you are now missing.
- ★ HOW, irrespective of your age, education or experience, YOU can succeed in any branch of Engineering.

132 PAGES OF EXPERT CAREER - GUIDANCE

PRACTICAL EQUIPMENT

Basic Practical and Theoretic Courses for beginners in Electronics, Radio, T.V., Etc., A.M.I.E.R.E. City & Guilds Radio Amateurs' Exam. R.T.E.B. Certificate P.M.G. Certificate Practical Electronics Electronics Engineering Practical Radio Radio & Television Servicing Automation

INCLUDING TOOLS

The specialist Electronics Division of B.I.E.T. NOW offers you a real laboratory training at home with practical equipment. Ask for details.

B.I.E.T.

You are bound to benefit from reading "ENGINEERING OPPORTUNITIES"—send for your copy now—FREE and without obligation.



POST COUPON NOW!

TO B.I.E.T., 316A ALDERMASTON COURT, ALDERMASTON, BERKSHIRE.

Please send me a FREE copy of "ENGINEERING OPPORTUNITIES." I am interested in (state subject, exam., or career).

NAME

ADDRESS

WRITE IF YOU PREFER NOT TO CUT THIS PAGE

THE B.I.E.T. IS THE LEADING INSTITUTE OF ITS KIND IN THE WORLD

Published about the 15th of the month by GEORGE NEWNES LIMITED, Tower House, Southampton Street, London, W.C.2, at the recommended maximum price shown on the cover. Printed in England by THE CHAPEL RIVER PRESS, Andover, Hants. Sole Agents—Australia and New Zealand: GORDON & GOTCH (A/sia) Ltd.; South Africa and Rhodesia: CENTRAL NEWS AGENCY LTD.; East Africa: STATIONERY & OFFICE SUPPLIES LTD. Subscription rate including postage for one year: To any part of the World £1 16s. 0d.

SOLID HIGH FIDELITY AUDIO EQUIPMENT BRITISH MADE

POWER AMPLIFIERS — PRE-AMPLIFIERS/CONTROL UNITS — POWER SUPPLIES



MP3



SP4-A



SP6-2

16 PAGE BROCHURE ON REQUEST, No 21
All units sold separately.

● COMPLETE RANGE OF SUITABLE PLAYER DECKS, SPEAKERS AND TUNERS IN STOCK.—ASK FOR LATEST LIST 16 ●

- MP3 mono preamplifier/control unit **£6.19.6** p.p. 3/-
- SP4-A mono/stereo version of MP3 **£11.19.6** p.p. 4/6
- SP6-2 mono/stereo (takes mag. pick-up as well) **£15.10.0** p.p. 5/-
- MPA12/3 12 watt amplifier 3 — 6 ohm output **£4 10.0** p.p. 2/6
- MPA12/15 12 — 16 ohm 12 watt **£5.5.0** p.p. 2/6
- MPA25 25-30 watt amplifier for 7½-16 ohm speaker **£7.10.0** p.p. 3/6
- PS24/40 power supply for MPA12/3 & MPA12/15 **£3.12.6** p.p. 3/-
- MU24/40 choke version **£4.10.0** p.p. 3/6
- MU60 power supply for MPA25 **£4.17.6** p.p. 4/6

All systems complete with grey/silver panels and matching silver knobs.

Audio Equipment developed from Dinsdale Mk. II—each unit or system will compare favourably with other professional equipment selling at much higher prices. Brief details are below:

Complete suggested systems		Price
1A	MP3 + MPA12/3 + MU24	£15.5.0 p.p. 5/-
2A	MP3 + MPA12/15 + MU40	£18.0.0 p.p. 6/-
4	MP3 + (2) MPA12/15 + MU40	£21.8.6 p.p. 7/-
6	MP3 + MPA25 + MU60	£18.15.0 p.p. 7/-
8A	SP4-A + (2) MPA12/15 + MU40	£26.0.0 p.p. 8/6
10	SP6-2 + (2) MPA12/15 + MU40	£29.5.0 p.p. 8/6
12A	SP4-A + (2) MPA25 + (2) MU60	£35.10.0 p.p. 10/-
13	SP6-2 + (2) MPA25 + (2) MU60	£38.17.6 p.p. 10/-

THE FINEST VALUE IN HIGH FIDELITY—CHOOSE A SYSTEM TO SUIT YOUR NEEDS AND SAVE POUNDS

NEW! INTEGRATED 7 WATT AMPLIFIER AND PREAMPLIFIER — MA 7

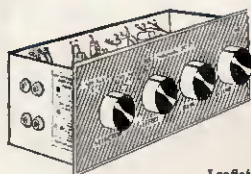

New design for 3 to 10 ohm speakers. Input for mag. zeal/ceramic pu's. Tape, tuner mic., etc. Battery operated or mains unit Full Treble/Bass controls. 8 transistor design.

PRICE **£8.10.0** P.P. 4/-

Leaflet on request (Mains int PS20 62/6. P.P. 3/-)



VHF FM TUNER. Ask for Brochures 3 and 4. 87/105 Mc/s Transistor Superhet. Geared tuning. Terrible quality and sensitivity. For valve or transistor amplifiers. 4 x 3½ x 3½in. Complete with dial plate. 5 Mullard Transistors, plus 4 diodes.

TOTAL COST TO BUILD **£6.19.6** P.P. 2/6



FM STEREO DECODER Brochure 4 7 Mullard Transistors. Printed Circuit Design with Stereo Indicator. For use with any valve or transistor FM. Uses pot cores to Mullard design and ger. and silicon transistors. As used by B.B.C. and G.P.O.

Complete Kit Price **£5.19.6** P.P. 2/6

Build a Quality TAPE RECORDER with MARTIN RECORDAKITS



363 DECK ★ TWO-TRACK. Deck £12.19.6, Amplifier £14.19.6. Cabinet and speaker 7 gns. Complete kits with MICROPHONE and 7in 1,200ft. tape, spare spool.

Today's Value £55 **32 gns.** P.P. 22/6

★ FOUR-TRACK. Deck £15.19.6. Amplifier £15.19.6. Cabinet and speaker 7 gns. Complete kits with MICROPHONE and 7in 1,200ft. tape, spare spool.

Today's Value £60 **35 gns.** P.P. 22/6

Ask for Brochure 6

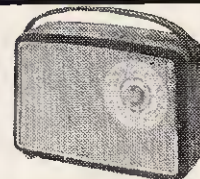

7-TRANSISTOR MW-LW SUPERHET PORTABLE NEW!

New printed circuit design with full power output. Fully tunable on both mw/lw bands. 7 transistors plus diode, push-pull circuit. Fitted 5 inch speaker, large ferrite aerial and Mullard transistors. Easy to build with terrific results. All local and Continental stations. Size 10 x 7 x 3½in.

TOTAL COST TO BUILD **£6.19.6** P.P. 4/6

Send for Brochure 1

TRANSISTOR P.M. STEREO DECODER Brochure 4 **£5.19.6**

MW/LW QUALITY TRANSISTOR RADIO TUNER Brochure 5 **£3.19.6**

TRANSISTOR CAR RADIO Send for Brochure 15



BRITISH MADE 6-Transistor MW/LW. 12 volt 3 watt output. Push-button wave-change. Boxed, ready to use with Speaker and Baffle. Car fixing kit and manufacturers' guarantee. Special Bargain Offer. Positive or Negative Earth. 5 Push-button de-luxe version **£10.10.0** P.P. 4/8.

£11.19.6. Positive or Negative Earth.

TRANSISTORS - SEMICONDUCTORS

COMPLETELY NEW 1968 LIST OF 1000 types available from stock. Send for your FREE COPY TODAY. (List No. 36)

- ★ B.C.R.'s from 5/-
- ★ FIELD EFFECT TRANSISTORS from 9/6
- ★ POWER TRANSISTORS from 5/-
- ★ DIODES AND RECTIFIERS from 2/-

30 page illustrated brochure as above including Valves and Quartz Crystals. 1/- post paid.

GARRARD DECKS ALL THE LATEST MODELS



COMPLETE RANGE IN STOCK FROM **£5.19.6**

Send for illustrated brochure 16 & 17

MAYFAIR PORTABLE



TOTAL COST TO BUILD **99 GNS.**

Ask for Brochure 9.

ELECTRONIC ORGAN

Also READY BUILT AND TESTED 128 gns. Deferred terms available. DEPOSIT £36.8.0 and 12 monthly payments of £9. Total £144.8.0. KIT OF PARTS Deferred terms: DEPOSIT £29.10.0 12 monthly payments of £7. TOTAL COST £113.10.0. ORGAN COMPONENTS We carry a comprehensive stock of organ components for TRANSISTOR AND VALVE FREE PHASE designs. Brochure 10.

EXPORT PRICES ON APPLICATION

- ★ Build this instrument stage by stage in your own home.
- ★ A truly portable instrument for all enthusiasts.
- ★ Fully TRANSISTORISED FOLKPHONIC. British design.
- ★ Call in for a DEMONSTRATION and see for yourself.

13 NOTE PEDAL KIT **£18.0.0** P.P. 10/-

BUILD THESE PRACTICAL WIRELESS DESIGNS

CLUBMAN LESS CHASSIS MK I 89/6 MK II 79/6 MK III 45/- List No. 41	L.C. F.M. TUNER Dec. 1967 99/6 Post 2/6 Including R.O.A. CA3014 List 40A	SWITCHED F.M. TUNER Aug. 1967 77/6 Post 2/6 List 39
--	---	---

CATALOGUE LATEST EDITION 240 pages, 6,000 items 1,000 illustrations

- ★ 25 pages of transistors and semiconductor devices, valves and crystals.
- ★ 150 pages of components and equipment.
- ★ 50 pages of microphones, decks and Hi-Fi equipment.

The most comprehensive—Concise—Clear components Catalogue in Gt. Britain. Complete with 10/- worth Discount Vouchers Free with every copy.

Send today **8/6** Post paid



303 EDGWARE ROAD LONDON W.2 PHONE: 01-723 1003/9

Open Mon. to Sat. 9 a.m.-6 p.m.
Thurs. 9 a.m.-1 p.m.

WE CAN SUPPLY FROM STOCK MOST OF THE PARTS SPECIFIED FOR CIRCUITS IN THIS MAGAZINE. SEND LIST FOR QUOTATION.

HENRY'S RADIO LTD.

