

PRACTICAL

ELECTRONICS

JANUARY 1968

PRICE 2/6

*** Introducing PEAC**

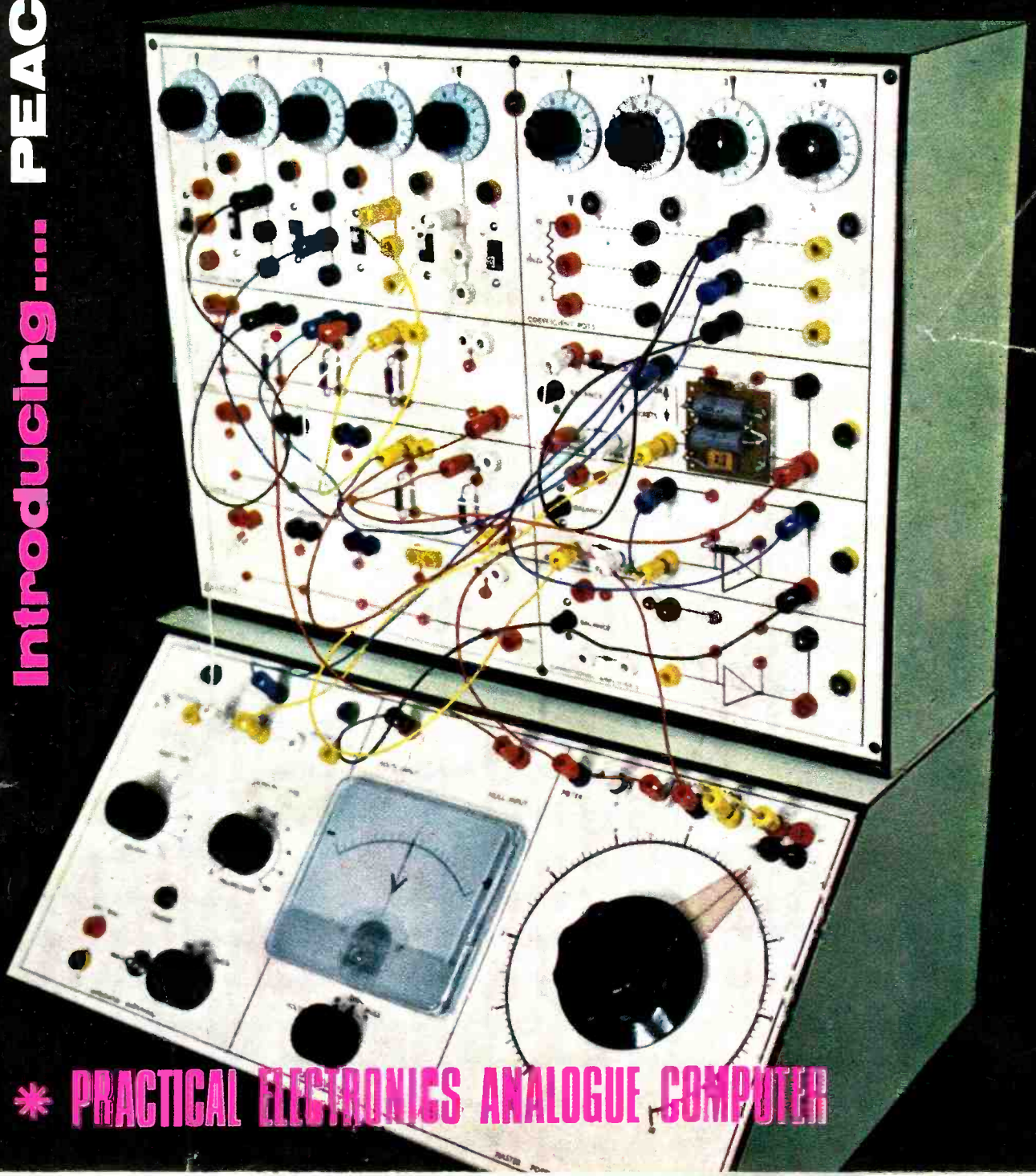

*** PRACTICAL ELECTRONICS ANALOGUE COMPUTER**

ADCOLA

PRODUCTS LIMITED
(Regd. Trade Mark)

SOLDERING EQUIPMENT

for the

DISCRIMINATING
ENTHUSIAST

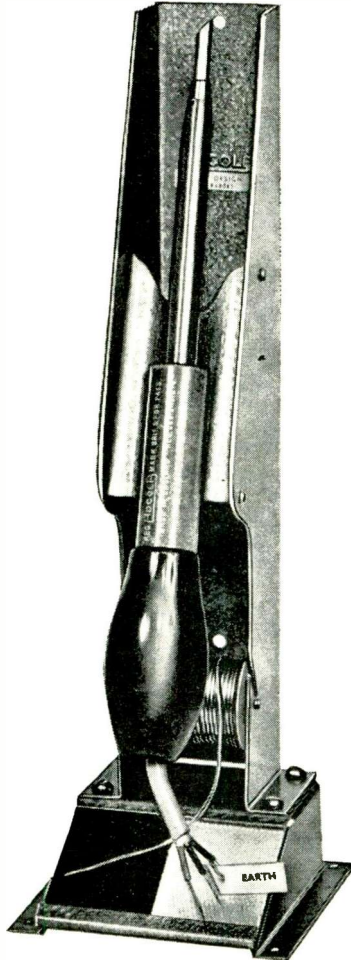

ILLUSTRATED:
L64 3/8" BIT INSTRUMENT IN
L700 PROTECTIVE SHIELD

APPLY DIRECT TO:

SALES & SERVICE DEPT.
ADCOLA PRODUCTS LTD.
ADCOLA HOUSE
GAUDEN ROAD
LONDON, S.W.4
TELEPHONE 01-622 0291

TRANSISTOR BARGAIN SALE! NEW STOCK AT UNBEATABLE PRICES!

OC44, OC45, OC81D now only 1/6 each! £6 per 100
OC71, OC72 equivalent 1/- each! £10 per 100
AS722 Switching Transistors 2/6 each! £10 per 100
2N753 NPN Silicon Planar, 300mW, 250Mc/s, High speed switching 2/6 each!
BSY28 NPN Silicon Planar, Epitaxial, 300mW, 300Mc/s 2/6 each!
BSY65 NPN Silicon Planar, Epitaxial, 800mW, 100Mc/s 2/6 each!
AFZ12 PNP Germanium Alloy Diff. low noise VHF amplifier 2/6 each!
Complete sets of transistors for radio:
2G34A/2J454/2G345B/2G371A/2G378A/2G378A + diode .. 15/- only!
OC44/OC45/OC45/OC81D/OC81 + diode .. 10/- only!
GET 897 2 watts. Heat sink included .. 2/6 each!
OC28 .. 5/- each!
BYZ13 6 amp. rectifier .. 2/6 each!
Light sensitive transistors similar to OCP71 .. 2/- each!
UNMARKED, UNTESTED TRANSISTORS TO CLEAR .. 7/6 for 50!
Silicon diodes. Make excellent detectors. Also suitable for keying electronic organs. 1/- each, 20 for 10/-
BY 100 type rectifiers. SPECIAL REDUCED PRICE! ONLY 2/6 each, 24/- doz., £7.10.0 per 100.

ELECTROLYTIC CONDENSERS! FANTASTIC SELECTION!

50µf 450V .. 1/3	20 + 4	275V .. 10d.
64µf 275V .. 1/3	32 + 32	275V .. 1/6
500µf 30V .. 1/2	8 + 8	450V .. 1/9
800µf 15V .. 1/2	8 + 16	450V .. 1/9
500µf 25V .. 10d.	50 + 50	275V .. 2/0
16/16/16 350V .. 2/2	40 + 40 + 20	275V .. 2/1
50/50/50 350V .. 2/7	100 100	50V .. 3/2
1,000µf 70V .. 3/2	12V 4/6	250µf 50V .. 10d.
100/200 275V .. 3/2	1,250µf 50V .. 4/-	12,500µf 30V .. 16/-
100/200/200/50 275V 4/-	150/350 300V .. 4/-	30,000µf 30V .. 25/-
3,000µf 35V .. 3/9	250/250 325V .. 4/-	1,000µf 15V .. 1/-
1,500µf 50V .. 4/-	2,000/2,000 25V .. 4/6	500µf 15V .. 10d.
0.25µf .. 3V 3.2µf 6.4V 8µf .. 50V 30µf .. 10V 250µf .. 9V		
1µf .. 6V 3.2µf .. 6.4V 8µf 275V 32µf 1.5V 320µf 2.5V		
1µf .. 10V 4µf .. 4V 10µf .. 6V 40µf .. 3V 350µf .. 9V		
1µf .. 15V 4µf .. 12V 10µf .. 10V 40µf 6.4V 350µf .. 10V		
1µf .. 50V 4µf .. 25V 10µf .. 12V 50µf .. 6V 400µf 2.5V		
1.25µf .. 16V 4µf .. 6.4V 10µf .. 25V 50µf .. 9V 500µf .. 4V		
2µf .. 3V 4µf .. 100V 12µf .. 3V 50µf .. 12V 500µf .. 6V		
2µf .. 9V 5µf .. 6V 12µf .. 20V 64µf 2.5V 640µf 2.5V		
2µf .. 70V 5µf .. 25V 16µf .. 30V 64µf .. 9V 750µf .. 12V		
2µf .. 150V 5µf .. 50V 16µf .. 150V 100µf .. 3V		
2µf 350V 5µf .. 70V 20µf .. 3V 100µf .. 6V		
1µf 350V 6µf .. 3V 20µf .. 6V 100µf .. 9V		
2.5µf .. 16V 6µf .. 12V 20µf .. 9V 150µf .. 12V		
2.5µf .. 25V 6µf .. 15V 20µf .. 15V 150µf .. 25V		
3µf .. 3V 6µf 150V 25µf .. 6V 200µf .. 3V		
3µf .. 12V 8µf .. 3V 25µf .. 12V 200µf .. 4V		
3µf .. 25V 8µf .. 6V 25µf .. 15V 200µf .. 16V		
8µf 450V 8µf .. 25V 25µf .. 25V 250µf 2.5V		
3.2µf .. 6V 8µf 350V 30µf .. 6V 250µf .. 12V		

PAPER CONDENSERS

0.001µf 500V	0.005µf .. 750V	0.1µf .. 350V	0.5µf .. 150V
0.001µf 1,000V	0.02µf .. 600a.c.	0.1µf .. 750V	0.5µf .. 350V
0.002µf 500V	0.02µf .. 350V	0.25µf .. 350V	0.5µf .. 500V

ALL AT 15/- per 100, 3/- per dozen.

MULLARD POLYESTER CAPACITORS—ALL HALF PRICE

0.0022µf 400V .. 4d	0.22µf 160V .. 7d
0.0018µf 400V .. 4d	0.27µf 160V .. 8d
0.0015µf 400V .. 4d	0.056µf 125V .. 7d
0.001µf 400V .. 4d	1µf 125V .. 1/6
0.01µf 400V .. 4d	68pf Tubular pulse ceramic .. 6d
0.15µf 400V .. 7d	120pf Disc pulse ceramic .. 6d

VERY SPECIAL VALUE! SILVER MICA, CERAMIC, POLYSTYRENE CONDENSERS

Well assorted. Mixed types and values. 10/- per 100.

RESISTORS

GIVE-AWAY OFFER! MIXED TYPES AND VALUES. 1/2 TO 1/2 WATT. 6/6 per 100 or 55/- per 1,000.

ALSO 1/2 to 3 watt close tolerance. Mixed values. 7/6 per 100. 55/- per 1,000.
WIRE-WOUND RESISTORS. 1 watt, 3 watt, 6 watt. 6d each, 7 watt and 10 watt 9d each.

CONNECTING WIRE, THIN, P.V.C. INSULATED

10yds 1/-; 100yds 7/6; 500yds 25/- (post 4/6); 1,000yds 40/- (post 6/-).

VALVES. BRAND-NEW AND BOXED. ROCK-BOTTOM PRICES!

DY 87 .. 5/10	PCF 80 .. 7/4
EABC 80 .. 6/1	PCF 86 .. 8/9
ECC 82 .. 6/5	PCL 82 .. 7/4
ECC 83 .. 6/5	PCL 83 .. 8/6
ECL 80 .. 6/2	PCL 84 .. 7/4
ECL 86 .. 7/4	PCL 85 .. 7/4
EF 80 .. 6/2	PCL 86 .. 7/4
EF 85 .. 6/2	PFL 200 .. 10/2
EF 183 .. 8/2	PL 36 .. 8/9
EF 184 .. 8/2	PL 81 .. 7/4
EY 51 .. 5/10	PL 83 .. 7/4
EY 86 .. 5/10	PL 84 .. 5/7
EY 87 .. 5/10	PL 500 .. 10/10
PABC 80 .. 6/2	PY 32 .. 7/10
PC 97 .. 5/10	PY 81 .. 5/10
PCC 84 .. 6/5	PY 82 .. 4/1
	PY 800 .. 5/10

A FURTHER 10% DISCOUNT WILL BE GIVEN ON LOTS OF 50 OF ANY ONE TYPE

RECORD PLAYER CARTRIDGES

Sonotone Mono 10/-; Acos Mono 15/-; Acos Stereo 20/-; Stereo Diamond 25/-.
All with needles

Signal Injector Kit—10/-; Signal Tracer Kit—10/-

VEROBOARD

1in. x 2 1/2in. 1/1; 2 1/2in. x 5in. 3/11; 2 1/2in. x 3 1/2in. 3/3; 3 1/2in. x 5in. 5/6;
3 1/2in. x 3 1/2in. 3/11. Terminal Pins, 36 for 3/-; Spot Face Cutter, 7/3.
Special Offer—Cutter and 5 boards, 2 1/2in. x 1in. 9/9.

LOUDSPEAKERS. 12in. Richard Allen, 37/6d. 12in. Bakers Guitar, £5.50. 3in., 4in., 5in. and 5in. x 3in., all at 10/- each; 8in. x 2 1/2in., 12/6; 2in. 80 ohm, 7/6.

EARPIECES. Magnetic or Crystal, 5/- each.

Orders by post to: G. F. MILWARD, 17 PEEL CLOSE, DRAYTON BASSETT, STAFFS.

Please include suitable amount to cover postage
Stamped addressed envelope must be included with any enquiries
For customers in Birmingham area goods may be obtained from Rock Exchanges, 231 Alum Rock Road, Birmingham 8. (All POST orders to Drayton)

LIND-AIR LTD (ELECTRONICS)

LONDON'S LEADING COMPONENT SHOPS

25 & 53 TOTTENHAM COURT RD. LONDON W.1.

TELEPHONE 01-580 4532/7879

Open 9 a.m.-6 p.m. Mon. to Sat. inclusive

GARRARD DECKS UP TO 25% UNDER LIST PRICE



Model 3000 with Monotone; STAHC Stereo cartridge. £29.9.6.
 AT60 Mk. I, less cart., £10.19.6.
 SP25 Mk. II, less cart., £12.19.6.
 LAB 80 Mk. II, less cart., £10.19.6.
 P. & P. 7/6 extra.
 Mono Cartridge, 12/6.
 Stereo Cartridge, 19/6. Pintha with perspex cover, 65/- (for LAB 80 8 gns.).
 Agents for Thorens Dual, Goldring—prices on request.

TRANSISTOR FM TUNER ONLY

£67.6 P. & P. 4/-

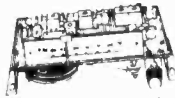

6 transistor, 88-108 Mc/s. 9v. operation. Complete. (Multiplex adaptor £5.19.6.)

2 WAY RADIOS

Midland (as illus.) 10 transistor, £18.19.0.
 Vantone 6 transistor, £8.15.0;
 Vantone 5 transistor, £6.15.0;
 Lafayette 2 channel long range, 65 gns.
 P. & P. 5/- each.
 These cannot be operated in U.K.



AIRCRAFT BAND RADIO



Sanyo Aircraft-Medium Wave portable radio, 9 Transistors, 2 diodes, 1 thermister, 4in x 2 1/2in oval speaker.
 Twin outlets for private earphones. 6 penlight batteries. Telescopic aerial. Leather carrying case and straps. ONLY £16.19.6. P. & P. 5/-.
 MANY OTHER RADIOS FROM 49/6.

LIND-AIR XMAS SCOOP!

COMPLETE HI-FI STEREO SYSTEM

ONLY 59 GNS.

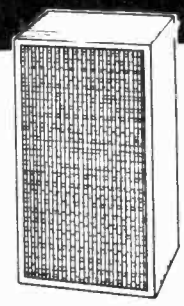
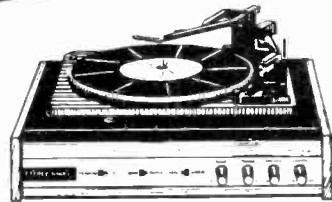
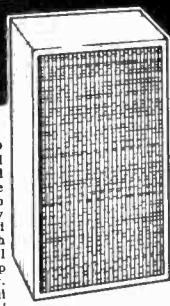

The Scoop of the year—32 all transistor 6 watts per channel stereo hi-fi system offering a performance equal if not better than similar systems costing up to double the price. Modern styling plus advanced circuitry using latest silicon transistors throughout. The famous Garrard 3000 Record Changer unit fitted lightweight tubular arm with Monotone 9 TAHC Stereo/Mono diamond cartridge will play all sizes of records. (4 speeds—78, 45 33 1/2, 16 2/3 r.p.m.). Will play up to 9 records automatically, also provision for manual play. Amplifiers and controls are mounted below record player and incorporate Bass, Treble, Volume and Balance controls and On/Off, Gram/Radio, Mono/Stereo slide switches. Two identical loudspeaker systems each incorporating separate bass speakers and high frequency units with crossover network provide full frequency reproduction and are complete with 10ft. leads and plugs for connection to amplifier. Peak finished matching units will fit easily on to bookshelves, room dividers or existing furniture. Brief spec.: Player/Amplifier unit, size 14 1/2 x 14 x 8 1/2 in. 200/250v. A.C. operation. Inputs for Radio Tuner/Tape Recorder, also outputs for Tape Recorder. Loudspeaker Systems. Size (each) 13 x 7 x 8 in. Supplied complete with instruction booklet ready to plug in and play. Send your order now or call and hear this marvellous Hi-Fi Stereo System. Only 59 gns. plus 20/- Carriage and Insurance. (Rosewood Finish 2 gns. extra).

MULTIMETERS

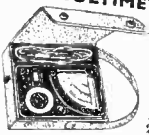

TTC1001 (as illustrated) £20.000 per V. £3.19.6.
 C1000, 1,000 Ω per V. £2.2.0; Caby N H 2 0 0. 20,000 Ω per V. £8.10.0; Caby B40, 4,000 Ω per V. £6.10.0; TMK600, 1030, 50,000 Ω per V. £9.19.6; TTC Model Model 1031, 100,000 Ω per V. £12.19.6. Also stockists of Avo, Nombrex, Eagle etc. Test equipment. P. & P. 3/6.

STEREO HEADPHONES



Selection from stock: TTC G1100, 16 Ω, £3.19.6; AKAI ASE25, 8 Ω, £3.19.6; Coral F102, 16 Ω, £4.19.6; Eagle BE1, 16 Ω, £3.19.6; TTC Stethoscope, 8 Ω, £2.9.6. P. & P. 4/6 each. Also stockists of Koss, Beyer, etc.

SINCLAIR AMPLIFIERS

Z.12 Amp. and Pre-amp. 89/8
 STEREO 25 Control 29.19.6
 PZ3. Power Supply 79/6
 P. & P. 2/6 each

SPECIAL OFFER

This coupon entitles you to receive 20/- special discount off any purchase over £15.



(Excluding Garrard Decks)
 ★★★★★★★★★★★★★★

Cut out and take along to one of our shops or enclose with your mail order. Valid up to December 31, 1967

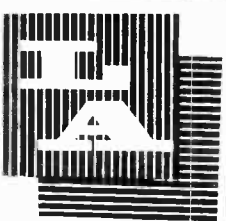

EFFICIENT MAIL ORDER SERVICE

For prompt despatch send your orders to Dept. PE168, 53 Tottenham Court Road, London, W.1.

HI-FI AMPLIFIERS — TUNERS — RECORD PLAYERS



FM TUNERS
FM-4U



TFM-IS

HI-FI FM TUNER. Model FM-4U. Available in two units. R.F. tuning unit (£2.15.0 incl. P.T.) with I.F. output of 10.7 Mc/s and I.F. Amp. unit and valves (£13.13.0). Total Price Kit **£16.8.0**

HI-FI AM/FM TUNER. Model AFM-1. Available in two units which, for your convenience, are sold separately. Tuning heart (AFM-T1—£4.13.6 incl. P.T.) and I.F. amplifier (AFM-A1—£22.11.6). Printed circuit board, 8 valves. Covers L.W., M.W., S.W., and F.M. Built-in power supply. Total Price Kit **£27.5.0**

STEREO DECODER SD-1. Available as extra for above models. Self-powered. Kit **£8.10.0**. Assembled **£12.5.0**

Hear the BBC stereo FM programmes on the **TRANSISTOR STEREO FM TUNER.** Elegantly designed to match the stereo Amplifier, AA-22U. Available in two units, sold separately, can be built for a Total Price:

Kit TFM-IS (STEREO) **£24.18.0** incl. P.T.
Kit TFM-IM (MONO) **£20.19.0** incl. P.T.

10W POWER AMP.
MA-12



20 + 20W STEREO AMP.
AA-22U



20+20W TRANSISTOR STEREO AMPLIFIER. Model AA-22U. Outstanding performance and appearance. Kit **£39.10.0** (less cabinet). Attractive walnut veneered cabinet **£25.0** extra. Assembled incl. cabinet, **£59.15.0**.

HI-FI MONO AMPLIFIER. Model MA-12. 10W output, wide freq. range, low distortion. Use with control unit.
Kit **£12.18.0** Assembled **£16.18.0**

HI-FI CABINETS. Full details available. MALVERN: Kit **£18.1.0**. GLOUCESTER: Kit **£18.10.0**.

DE LUXE STEREO AMPLIFIER. Model S-33H. De luxe version of the S-33 with two-tone grey perspex panel, and high sensitivity necessary to accept the Decca Deram pick-up. Kit **£15.17.6** Assembled **£21.7.6**

HI-FI STEREO AMPLIFIER. Model S-99. 9+9W output. Ganged controls. Stereo/Mono gram, radio and tape inputs. Push-button selection. Printed circuit construction. Kit **£28.9.6** Assembled **£38.9.6**



Enjoy Yourself While You Save

RADIOS

Complete your motoring pleasure with this outstanding car radio, Model CR-1



Will give you superb LW and MW entertainment wherever you drive. Tastefully styled to harmonise with any car colour scheme. 8 latest semi-conductors (6 transistors, 2 diodes) for 12V positive or negative

earth systems. Powerful output (4 watts) will drive two loudspeakers. Pre-assembled and aligned tuning unit. Available for your convenience in two units. Can be obtained for a Total Price: Kit (excl. L.S.) **£12.17.0** incl. P.T. 6" x 4" 3 $\frac{1}{2}$ " loudspeaker **£14.5.**



Oxford

"OXFORD" LUXURY PORTABLE Model UXR-2. Specially designed for use as a domestic or personal portable receiver. Many features, including solid leather case. Kit **£14.18.0** incl. P.T.



UXR-1

TRANSISTOR PORTABLE. Model UXR-1. Pre-aligned I.F. transformers, printed circuit. Covers L.W. and M.W. Has 7" x 4" loudspeaker. Real hide case. Kit **£12.11.0** incl. P.T.



GC-1U

JUNIOR EXPERIMENTAL WORKSHOP. Model EW-1. More than a toy! Will make over 20 exciting electronic devices, incl.: Radios, Burglar Alarms, etc. 72 page Manual. The ideal present! Kit **£7.13.6** incl. P.T.

"MOHICAN" GENERAL COV. RECEIVER for Amateur or Short Wave listening. Send for leaflet. Model GC-1U. Kit **£37.17.6** Assembled **£45.17.6**

Prices quoted are Mail Order, retail prices slightly higher

WELCOME TO OUR HEATHKIT CENTRES

LONDON—233 Tottenham Court Road, W.1

Opens Mon.-Fri. 9 a.m.-5.30 p.m. Sat. 9 a.m.-1 p.m.

BIRMINGHAM—17-18 St. Martin's House, Bull Ring

Tue.-Sat. 9 a.m.-6 p.m. Thurs. 9 a.m.-8 p.m.

Demonstrations of models by arrangement

TEST INSTRUMENTS

Our wide range includes:

3" LOW-PRICED SERVICE OSCILLOSCOPE. Model OS-2. Compact size 5" x 7 $\frac{1}{2}$ " x 12" deep. Wt. only 9lb. "Y" bandwidth 2 c/s-3 Mc/s \pm 3dB. Sensitivity 100mV/cm T/B 20 c/s-200 kc/s in four ranges, fitted mu-metal CRT Shield. Modern functional styling. Kit **£23.18.0** Assembled **£31.18.0**

5" GEN.-PURPOSE OSCILLOSCOPE. Model 10-12U. An outstanding model with professional specification and styling. "Y" bandwidth 3 c/s-4.5 Mc/s \pm 3dB. T/B 10 c/s-500 kc/s. Kit **£35.17.6** Assembled **£45.15.0**

DE LUXE LARGE-SCALE VALVE VOLTMETER. Model IM-13U. Circuit and specification based on the well-known model V-7A but with many worth-while refinements. 6" Ernest Turner-meter. Unique gimbal bracket allows operation of instrument in many positions. Modern styling. Kit **£18.18.0** Assembled **£26.18.0**

AUDIO SIGNAL GENERATOR. Model AG-9U. 10 c/s to 100 kc/s, switch selected. Distortion less than 0.1%. 10V sine wave output metered in volts and dB's. Kit **£23.15.0** Assembled **£31.15.0**

VALVE VOLTMETER. Model V-7A. 7 voltage ranges d.c. volts to 1,500. A.C. to 1,500 r.m.s. and 4,000 peak to peak. Resistance 0.1 Ω to 1,000M Ω with internal battery. D.C. input resistance 11M Ω . dB measurement, has centre-zero scale. Complete with test prods, leads and standardising battery. Kit **£13.18.6** Assembled **£19.18.6**.

MULTIMETER. Model MM-1U. Ranges 0-15V to 1,500V a.c. and d.c.; 150 μ A to 15A d.c.; 0.2 Ω to 20M Ω 4 $\frac{1}{2}$ " 50 μ A meter. Kit **£12.18.0** Assembled **£18.11.6**

R.F. SIGNAL GENERATOR. Model RF-1U. Up to 100 Mc/s fundamental and 200 Mc/s on harmonics. Up to 100mV output. Kit **£13.18.0** Assembled **£20.8.0**

SINE/SQUARE GENERATOR. Model IG-82U. Freq. range 20 c/s-1 Mc/s in 5 bands less than 0.5% sine wave dist. less than 0.15 μ sec. sq. wave rise time. Kit **£25.15.0** Assembled **£37.15.0**

TRANSISTOR POWER SUPPLY. Model IP-20U. Up to 50V, 1.5A output. Ideal for Laboratory use. Compact size. Kit **£35.8.0** Assembled **£47.8.0**



OS-2



VVM, IM-13U



V-7A



RF-1U



IG-82U

Prices and specifications subject to change without notice

TAPE DECKS — CONTROL UNITS

NEW! STEREO AMPLIFIER, TSA-12

12 × 12 watts output

Kit £30.10.0 less cabinet

Assembled £42.10.0

Cabinet £2.5.0 extra



FOR THIS SPECIFICATION

- 17 transistors, 6 diode circuit
- ± 1dB, 16 to 50,000 c/s at 12 watts per channel into 8 ohms
- Output suitable for 8 or 15 ohm loudspeakers
- 3 stereo inputs for Gram, Radio and Aux.
- Modern low silhouette styling
- Attractive aluminium, golden anodised front panel
- Handsome assembled and finished walnut veneered cabinet available
- Matches Heathkit models TFM-1 and AFM-2 transistor tuners.

Full range power . . . over extremely wide frequency range. Special transformerless output circuitry. Adequately heat-sinked power transistors for cool operation—long life. 6 position source switch.

FULL SPECIFICATION SHEET AVAILABLE



TRUVOX DECK

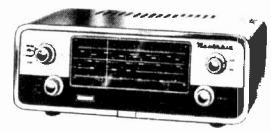

AM/FM TUNER

TRUVOX D-106 and 108 TAPE DECKS. High quality stereo/mono tape decks. **D106**, ½ track, £39.15.0 **D108**, ¼ track, £39.15.0

TRANSISTOR INTERCOM. Models XI-1U and XIR-1U. A time-saving device for office, shop or for the home. Master unit XI-1U will operate up to 5 remote stations. Master, XI-1U Kit £11.9.6 Assembled £17.9.6. Remote, XIR-1U Kit £4.9.6 Assembled £5.18.0. Send for full specification leaflet.

MONO CONTROL UNIT. Model UMC-1. Designed to work with the MA-12 or similar amplifier requiring 0.25V or less for full output. 5 inputs. Baxandall type controls. Kit £9.2.6 Assembled £14.2.6

STEREO CONTROL UNIT. Model USC-1. Push-button selection, accurately matched ganged controls to 1dB. Rumble and variable low pass filters. Printed circuit boards. Kit £19.19.0 Assembled £27.5.0

Build Your Own Electronics



SPEAKER SYSTEMS

AVON HI-FI PERFORMANCE 'MINI' SPEAKER KIT. A compact, bookshelf size, 7½" wide × 19½" high × 8½" deep, speaker with beautiful walnut veneered fully-finished cabinet, wide frequency response, special 6" bass, 3" HF units and crossover network. Cabinet Kit £8.18.0. Speaker Kit £4.18.0. Total Price Kit £13.16.0 incl. P.T.



SSU-1

HI-FI SPEAKER SYSTEM. Model **SSU-1.** Ducted-port bass reflex cabinet "in the white". Two speakers. Vertical horizontal models with legs, Kit £12.12.0, without legs, Kit £11.17.6 incl. P.T.

Many other models in range. See latest catalogue for details.

NEW! STEREO TAPE RECORDER, STR-1

½ track stereo or mono record and playback at 7½, 3½ and 1½ ips. Sound-on-sound and sound-with-sound capabilities. Stereo record, stereo playback, mono record and playback on either channel. 18 transistor circuit for cool, instant and dependable operation. Moving coil record level indicator. Digital counter with thumb-wheel zero reset. Stereo microphone and auxiliary inputs and controls, speaker headphone and external amplifier outputs . . . front panel mounted for easy access. Push-button controls for operational modes. Built-in stereo power amplifier giving 4 watts rms per channel. Two high efficiency 8 in. by 5 in. speakers. Operates on 230v A.C. supply.



Kit £45.18.0
Assembled price on request

NEW MODELS!

Portable Stereo Record Player, SRP-1

Automatic playing of 16, 33, 45 and 78 rpm records. All transistor—cool instant operation. Dual LP/78 stylus. Plays mono or stereo records. Suitcase portability. Detachable speaker enclosure for best stereo effect. Two 8" × 5" special loudspeakers. For 220-250v A.C. mains operation.

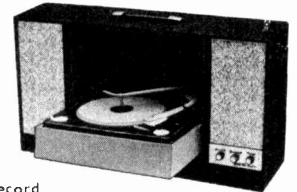

Compact, economical stereo and mono record playing for the whole family — plays anything from the Beatles to Bartok. All solid state circuitry gives room filling volume.

Kit £27.15.0 incl. P.T. Assembled price on request.

Transistorised AM-FM Stereo Tuner

In the same attractive styling as our well-known AA-22U Stereo Amplifier. Features 18 transistor, 3 diode circuit. AM-LW/MW, FM Stereo and Mono tuning. Stereo indicator light. AFC, AGC. Pre-assembled and aligned FM unit. Separate AM and FM circuit boards. Self-powered. Handsome, finished walnut veneered cabinet. (Optional extra).



Comprising: Model AFM-2T RF Tuning Unit. Kit £7.17.6 including P.T. AFM-2A IF Amp. and power supply kit £24.9.6. Cabinet £2.5.0 extra.

TOTAL PRICE KIT £32.7.0 incl. P.T.

LOW-COST TRANSISTOR STEREO AMPLIFIER KIT TS-23.

A really low priced unit yet incorporates all essential features for good reproduction from gramophone, radio and other sources, 3 watts for channel output (15 ohms). Kit £17.15.0. Beautiful walnut veneered cabinet £2.0.0 extra.



FREE!
36 page Catalogue.
SEND FOR YOUR
COPY
NOW!

Over 150 models shown,
many in Full Colour

To **DAYSTROM LTD., Dept. P.E.1, Gloucester**

Without obligation please send me

FREE BRITISH HEATHKIT CATALOGUE.....

FULL DETAILS OF MODEL(S).....
(Please write in BLOCK CAPITALS)

NAME

ADDRESS

(Tick here)

Please send FREE catalogue to my friend.

NAME

ADDRESS

P.E.1

RADIONIC

**INDISPENSABLE ALIKE TO:
STUDENT
TEACHER
AMATEUR EXPERIMENTER**

Clear, simple, versatile, this rugged system can build almost any electronic circuit. Ideal for the experimenter, the teacher, and the complete beginner. Already used by well over 1,000 schools in the U.K.

Selected by the Council of Industrial Design for all British Design Centres. Featured in Sound and Television broadcasts.

Beautifully engineered; battery operated; no soldering; no prior knowledge needed. Results guaranteed by our technical department. People say:

"I can only describe the results as brilliant, absolutely brilliant."
"You have opened up a new world."
"Nothing could paint the picture clearer than building these sets."
"The kit has been used by my son (aged 10) with complete success."
"Most impressive—a stroke of genius whoever devised it."

UNIQUE! Our "No soldering" printed circuit board for superhet portable. Simply insert components and tighten nuts.

- No. 1 Set £5.18.6. 14 Circuits (Earphone)
- No. 2 Set £6.19.6. 20 Circuits (Earphone)
- No. 3 Set £10.19.6. 22 Circuits (7 x 4in. Loudspeaker output)
- No. 4 Set £14.19.6. 26 Circuits (Include 6 Transistor and reflex superhets)

Prices (Post Free)

(Plus P.T. increases of 1/8; 1/11; 3/1; 4/2d respectively)

Full details from:

RADIONIC PRODUCTS LIMITED
STEPHENSON WAY, THREE BRIDGES
CRAWLEY, SUSSEX

Tel.: CRAWLEY 27028

(Trade Enquiries invited)

RADIO & ELECTRONIC CONSTRUCTION SYSTEM

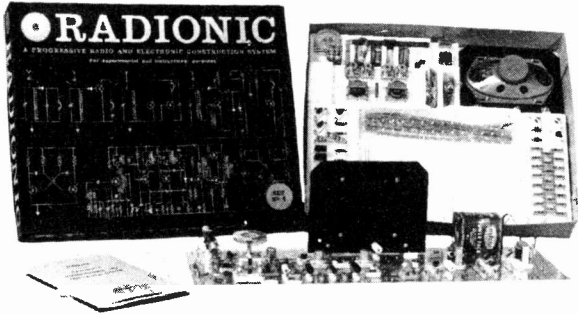

A No. 4 SET and 6-TRANSISTOR SUPERHET

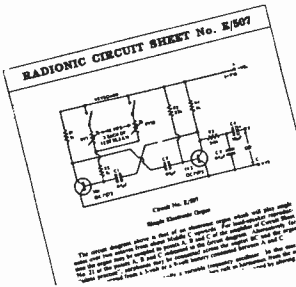

Theoretical Circuit

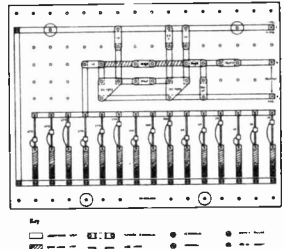

Practical Layout

Our 'E' Series of basic electronic circuits is available separately. (See E/507 above). Send for details of E/508 computer.

ERSIN



5 CORE SOLDER

for quick,
easy, reliable
soldering

Contains 5 cores of non-corrosive flux, instantly cleaning heavily oxidised surfaces. No extra flux required. Ersin Multicore Savbit Alloy also reduces wear of copper soldering iron bits.



SIZE 5 HANDY SOLDER DISPENSER
Contains 12 ft. coil of 18 s.w.g. Ersin Multicore Savbit Alloy. 2/6 each.



SIZE 15 SOLDER DISPENSER
Contains 21 ft. coil of 60/40 Alloy, 22 s.w.g. Ideal for small components, transistors, diodes, etc. 3/- each.



SIZE 12
Ideal for home constructors. Contains 102 ft. of 18 s.w.g. Ersin Multicore Savbit Alloy on a plastic reel. 15/- each.



BIB MODEL 8 WIRE STRIPPER AND CUTTER
Strips insulation cleanly and quickly, fitted with unique 8 gauge wire selector. Plastic handles: 9/6 each.

From Electrical and Hardware shops. If unobtainable, write to:
Multicore Solders Ltd., Hemel Hempstead, Herts.

TWO SCOOPS FROM "KING'S"

CONTINUOUS LOOP
(NEVER ENDING - NO REWINDING)

TAPE CASSETTE

BULK PURCHASE

RIDICULOUS PRICE

IDEAL BACKGROUND MUSIC - LANGUAGE COURSES, ETC. 200ft. HIGH QUALITY AMPEX TAPE. WILL FIT ALL TAPE RECORDERS.

CANNOT BE REPEATED.

HURRY! SEND FOR YOURS.

HURRY! NOW ONLY 16/- EACH

FULL CIRCUIT - INSTRUCTIONS - PARTS LIST TO BUILD YOUR OWN TELEPHONE ANSWERING MACHINE: SIMPLE - QUICK - EASY - AUTOMATIC. TAKES 100's OF CALLS: **25/-** CHEAP TO BUILD. SEND NOW

KING'S TELE-SERVICE CO.
105/107 DAWES ROAD, FULHAM, S.W.6
FULHAM 1668-2998

Lasky's Radio

DON'T MISS THIS!

GREAT NEWS!

THIS YEAR LASKY'S CELEBRATE THEIR 35th ANNIVERSARY

35 Great Years of service to you based on fair prices and value

To celebrate our success and your satisfaction we are publishing a 12-page, fully illustrated colour "35th Birthday Pictorial" Catalogue

Printed in large 16 x 11 in. modern magazine format—the "Birthday Pictorial" contains thousands of different items from our vast stocks of Radio, Hi-Fi, TV, Test Gear, Components, Communications and other equipment.

PLUS AND many bargain offers and prices exclusive to Lasky's in addition every copy of the "Birthday Pictorial" is numbered and automatically enters you in our great "Birthday Draw" with over £100 in Gift Vouchers to be won.

All goods shown in the "Birthday Pictorial" are available over the counter from any of our branches—by post to any address in the U.K. or overseas—bringing the benefits of shopping at Lasky's to you in your home.

PUBLICATION DATE — NOVEMBER. Make sure of your copy **NOW**—just send your name, address and a 4d. stamp for postage.

A MUST FOR EVERY ELECTRONICS HOBBYIST AND HI-FI ENTHUSIAST!



COMMUNICATION RECEIVERS

NOW AVAILABLE FOR THE FIRST TIME IN GREAT BRITAIN—TWO NEW TRIO RECEIVERS

MODEL JR-500SE

This high performance receiver is made especially to cover the amateur bands and utilises a crystal controlled double heterodyne circuit for extra sensitivity and stability. **Brief spec.:** Covers all the amateur bands in 7 separate ranges between 3.5 and 29.7 Mc/s. Circuit uses 7 valves, 2 transistors and 5 diodes plus 8 crystals; output 8 and 500 ohm and 500 ohm phone jack. **Special features:** Crystal controlled oscillator • Variable BFO • VFO • AVC • ANL • 8 meter • SSB-CW • Stand-by switch • Special double gear dial drive with direct reading down to 1 kHz • Remote control socket for connection to a transmitter. Audio output 1 watt. For use on 115/250V a.c. Mains. Superb modern styling and control layout—finished in dark grey. Cabinet size 7 x 13 x 10 in. Weight 18 lb. Fully guaranteed, complete with instruction manual and service data. **LASKY'S PRICE £61.19.0** Carriage and Packing 12/6.



MODEL 9R-59DE

Brief spec.: 4 band receiver covering 550 Kc/s to 30 Mc/s continuous and electrical band spread on 10, 15, 20, 40 and 80 metres. 8 valve plus 7 diode circuit. 4/8 ohm output and phone jack. **Special features:** SSB-CW • ANL • Variable BFO • 8 meter • Sep. band spread dial • IP frequency 455 Kc/s • Audio output 1.5W • Variable RF and AF gain controls. For use on 115/250V a.c. Mains. Beautifully designed control layout finished in light grey with dark grey case, size 7 x 15 x 10 in. Weight 19 lb. Fully guaranteed, complete with instruction manual and service data. **LASKY'S PRICE £36.15.0** Carriage and Packing 12/6.



SPECIAL INTEREST ITEMS!

NEW VOICE ACTUATED MICROPHONE

MODEL B 5001

This new voice actuated microphone is designed for use with tape recorders with facilities for remote control. The microphone is fitted with a three position switch allowing normal hand remote control, voice sensitivity action and off. The degree of voice or sound level required to operate the recorder can be adjusted. The microphone is self powered by one 9V (FP3 type) battery giving 6 to 10 hrs. operating time. Super sensitive 8 transistor circuit. Strong black plastic case. Length 7 1/2 in. Designed for hand held use or laying flat. Fitted with 2.5 and 3.5 mm. plugs for fitting polarised sockets.

LASKY'S PRICE £6.19.6 Post 3/6.



OUTSTANDING BARGAINS!

TRANSISTOR FM TUNER CHASSIS

Fully tunable—range 88 to 108 Mc/s. Completely wired on printed circuit. 10.3 Mc/s. IF. 6 transistors and 3 diodes. Slow motion tuning drive. Size 8 1/2 x 4 x 2 1/2 in. Operates from any 9V d.c. source. Full data and circuit supplied.

LASKY'S PRICE £6.10.0 Post 5/- extra.

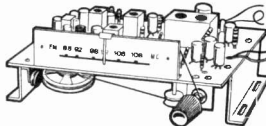

MULTIPLEX ADAPTOR

Now you can enjoy stereo sound with the FM Tuner above. **Brief spec.:** MPX input sensitivity 100mV. Output 100mV. Self powered by a 9V battery. 4 transistor and 6 diode circuit. Size 5 1/2 x 2 x 2 1/2 in. Also suitable for use with other FM tuners with MPX input.

LASKY'S PRICE 99/6 Post 5/-

PACKAGE PRICE IF BOUGHT TOGETHER £11 Post 5/-.

Branches

207 EDGWARE ROAD, LONDON, W.2 Tel.: 01-723 3271

33 TOTTENHAM CT. RD., LONDON, W.1 Tel.: 01-636 2605

Open all day Saturday, early closing 1 p.m. Thursday

152/3 FLEET STREET, LONDON, E.C.4 Tel.: FLEet St. 2833

Open all day Thursday, early closing 1 p.m. Saturday

ALL MAIL ORDERS AND CORRESPONDENCE TO: 3-15 CAVELL ST., TOWER HAMLETS, LONDON, E.1 Tel.: 01-790 4821

CONSTRUCTORS BARGAINS

LASKY'S MINIATURE TRANSISTOR AMPLIFIER MODULES

Incorporating the very latest circuitry to provide high sensitivity and good quality in conjunction with extreme small size and compactness. High quality Newmarket transistors used throughout. All designed to operate on 9V miniature battery. Add 1/- on each for post & packing

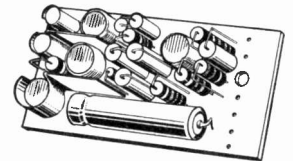

TYPE LRPC 1. 3 transistor. Input sens. 50 mV., output 150 mW, output imp. 40 Ω, size 2 x 1 x 1 1/2 in. **PRICE 27/6**

TYPE LRPC 4. 5 transistor. Input sens. 150 mV, output 330 mV, output imp. 15 Ω, size 2 1/2 x 1 1/2 x 2 in. **PRICE 18/6**

TYPE LRPC 5. 6 transistor. Input sens. 8mV, output 3W, output imp. 3 Ω, size 5 1/2 x 1 1/2 x 1 in. **PRICE 59/6**

TYPE LRPC 9. High to low impedance matching pre-amp.—input imp. 1 megohm, output imp. 2 k/ohms. Size 1 1/2 x 1 1/2 x 2 in. **PRICE 10/6**

TYPE LRPC 10. Magnetic tape replay pre-amp. designed so that a 450 mH head can be matched into any of the audio amplifier modules listed above. Size 2 1/2 x 1 1/2 x 2 in. **PRICE 10/6**

TYPES LRPC 9 and 10 are ideal for use with LRPC 1, 4 and 5 and are available at the reduced price of 7/6 each if bought with the LRPC 4.

FULLY INCAPSULATED MODULES

Special function modules — all one size 1 1/2 x 1 x 1 1/2 in. Complete with detailed function and installation instructions. Send S.A.E. for data.

TYPE PA-1. Public address amp. for use with carbon, crystal or Dynamic microphones. 3 Ω output imp. **PRICE 30/-**

TYPE GR-1. Gramophone amplifier—provides sufficient power to fill average room. 3 Ω output imp. **PRICE 30/-**

TYPE CO-1. Morse code practice oscillator — for use with morse key and 3 Ω speaker. **PRICE 20/-**

TYPE MT-1. Metronome module—provides audible and visual beat from 30 to 240 beats per minute (for use with 3 Ω speaker or ind. lamp). **PRICE 22/6**

High Fidelity Audio Centres

42 TOTTENHAM CT. RD., LONDON, W.1 Tel.: 01-580 2573

Open all day Thursday early closing 1 p.m. Saturday

118 EDGWARE ROAD, LONDON, W.2 Tel.: 01-723 9789

Open all day Saturday, early closing 1 p.m. Thursday

CHRISTMAS BARGAINS!

GEE'S SPECIAL OFFER! TAPE

Attractively boxed.
Guaranteed. Brand new.

5in. Std.	600ft.	8/6
7in. Std.	1,200ft.	12/6
5in. L.P.	900ft.	10/-
5 1/2in. L.P.	1,200ft.	12/6
7in. L.P.	1,800ft.	15/-
4in. D.P.	600ft.	9/-
5in. D.P.	1,200ft.	15/-
5 1/2in. D.P.	1,800ft.	22/6
7in. D.P.	2,400ft.	25/-
3in. T.P.	600ft.	12/6
4in. T.P.	900ft.	15/-
5in. T.P.	1,800ft.	30/-
5 1/2in. T.P.	2,400ft.	40/-
7in. T.P.	3,600ft.	50/-

P. & P. 2/6 per order.

GARRARD MODEL A70

Three-speed record changer complete with attractive metal plinth and including Sonotone 9TA Stereo pick-up head. Ready wired for connection to existing Hi-Fi Amplifier. Brand new in original packing. Listed over £28.



GEE'S PRICE 18 Gns. CARR. PAID

AUTOMATIC WIRE STRIPPER

● Simple to use. ● Strips any size wire. ● A must for every home workshop. **35/-**
P. & P. 5/-.

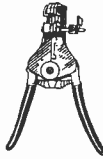

STEREO HI-FI HEAD SET Model ST 3R



Provides perfect stereo. Freq. res. 25-17,000 c.p.s. 8 ohms per channel. Feather soft ear cushions and headband, 8ft. lead with stereo jack plug and remote control box with separate volume control for each earphone.

92/6
P. & P. 2/6

FANTAVOX COMMUNICATIONS RECEIVER HE.50

4 wavebands 540kc/s to 30 Mc/s. Exceptionally sensitive circuit. Extra large easy to read dial with Bands pre ad tuning. "8" meter for fine tuning. Built-in speaker and telescopic aerial. BFO. Phone output socket. Stably switch, etc. A.C. 200/250V.



Gee's Price **Only 15 gns.**
P. & P. 10/-



NEW MODEL U-500 MULTI-TESTER, 20,000 O.P.V. MIRROR SCALED WITH OVERLOAD PROTECTION. Ranges: D.C. volts: 100 mV., 0.3 v., 5 v., 250 v., 1,000 v. A.C. volts: 2.5 v., 10 v., 50 v., 250 v., 1,000 v. D.C. current: 5 μA., 0.5 mA., 5 mA., 50 mA., 250 mA. Size: 5 1/2" x 3 1/2" x 1 1/2". Complete with batteries and test leads. **£5.15.0**

SEND 1/- FOR ILLUSTRATED CATALOGUE OF TAPE AND AUDIO ACCESSORY BARGAINS

'TELETON 701' FABULOUS 7 TRANSISTOR MAINS OR BATTERY TAPE RECORDER



Wonderful performance from either 110/240v. A.C. Mains or 4 x 1.5 v. batteries. Uses 5" spools, twin track, two speeds 1 1/2 and 3 1/2 i.p.s. piano key controls, built in dynamic speaker. Complete with tape, mike, telephone pick up, earphone, direct recording lead, mains lead and plug, batteries and instruction book. Fully guaranteed.

GEE'S SPECIAL PRICE £21

Carr. 10/6

AUTOMATIC AERIAL - ADDS LUXURY TO ANY CAR!

Today's value 15 gns. Tamper proof electrically operated car radio aerial, 4 section telescopic, extends automatically to 48in. and retracts to 1in. at the flick of a switch. Depth below wing 15in. Robustly made, heavy chrome finish 12V d.c. operation. Quickly and easily fitted, supplied with cable, switch and all fixing parts.



OUR PRICE £7-19-6 P&P 5/-

GEE'S RADIO

15 LITTLE NEWPORT STREET LONDON, W.C.2. GER. 6794/1453

Open 9 a.m.-6 p.m. Monday-Friday, 1 p.m. Saturday Adjoining Leicester Square Tube

STOP READING start building start SW listening

For only £28.6.2d. you can build this exciting, instructive Short Wave Receiver. The Star Roamer kit looks and sounds professional a beautifully finished charcoal grey cabinet and matching front with ham type operating features and performance. The perfect introduction to radio construction and ham techniques - the perfect gift for enthusiast and novice alike.

Like all Knightkits the Star Roamer is available from Electroniques on convenient credit terms. It is fully guaranteed and for any construction problem our friendly Service Department is ready to advise and assist.

Send for the FREE Knightkit 64-page brochure. It gives full details and performance specification on the Star Roamer and dozens of other unusual electronic kits. No real enthusiast can afford to be without a copy.



Please send me your FREE brochure K37 giving full details on the Knightkit range. Send to ELECTRONIQUES (Prop. STC) Limited, Edinburgh Way, Harlow, Essex.

NAME
ADDRESS



knight-kit

Quality built in, built up by you



electroniques

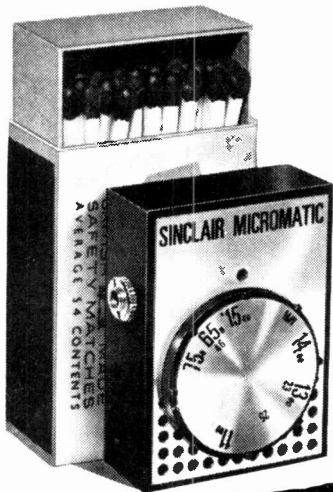

SINCLAIR MICROMATIC

the world's smallest radio set

Down in price!

and

UP IN LISTENING QUALITY



BY BUYING
THE
COMPLETE
KIT

Originally 59/6 complete with earpiece, solder and instructions in pack, the Micromatic Kit now costs

49/6



BY BUYING A
READY BUILT
SET

Originally 79/6, the Micromatic ready built, tested and guaranteed complete now costs

59/6

FOR IMMEDIATE
DELIVERY

2 Long-life Mercury Cell Batteries for either of above, each 1/10d.

With sales and export orders for the Sinclair Micromatic breaking all records, we have changed over to new production methods to meet the ever-increasing demand for the world's smallest radio set. This has enabled us to effect dramatic economies because of the large quantities of materials involved. At the same time, we have appreciably improved the set's quality. We now supply a magnetic earpiece which matches perfectly to the powerful output of the Micromatic, and what was superb performance before, now sounds better than ever. Now that your Micromatic costs you less (49/6 kit; 59/6 built), you can afford not only to have one for yourself, but give them as gifts. But be quick. At the new prices, everyone is going to want the Micromatic. Order yours now.

- PLAYS ANYWHERE
- FANTASTIC POWER AND RANGE
- FULLY GUARANTEED
- $1\frac{4}{5} \times 1\frac{3}{10} \times \frac{1}{2}$ in.

NOW SUPPLIED WITH A DE-LUXE
MAGNETIC EARPIECE

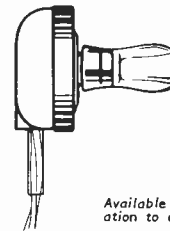

This new finely engineered magnetic earpiece has great sensitivity and covers a very wide frequency range. It provides exceptional clarity and quality and is of robust construction. Each one is individually checked before despatch.

Available separately with instruction for adaptation to existing Micromatic Sets, post free **15/-**

FULL SERVICE FACILITIES AVAILABLE WHEN YOU BUY THE KIT AND BUILD IT YOURSELF

sinclair

Order form and more Sinclair designs

SEE PAGES 2 AND 3 SINCLAIR ADS



SINCLAIR

Q.14

A no-compromise high-fidelity loudspeaker of outstanding quality

- ACOUSTICALLY CONTOURED SOUND CHAMBER
- MAXIMUM LOADING IN EXCESS OF 14 WATTS
- BRILLIANT TRANSIENT RESPONSE
- 15 OHMS IMPEDANCE
- AN ALL-BRITISH PRODUCT

Price need no longer stop you enjoying the best possible high-fidelity loudspeaker reproduction nor is size any longer a problem. (These considerations are of utmost importance to every audio enthusiast for stereo.) In the Sinclair Q.14 you will find a loudspeaker of such superb quality and so compactly and attractively styled that you will want to change over to Sinclair immediately you hear it. This is no ordinary loudspeaker. A vast amount of money, time and research have gone into producing a design which proves beyond question that good reproduction does not have to be expensive. Users of the Z.12 for instance, know that full well, and coupling the Q.14 to this Sinclair amplifier assures the keen listener of superb audio reproduction.

The Sinclair Q.14 has been tested in an independent laboratory and shows exceptionally smooth response between 60 and 16,000c/s with well sustained output both below and above these readings. Its remarkable transient response ensures clean-cut separation between instruments, voices, etc. The unusual shape of the sealed, seamless pressure chamber allows the Q.14 to be conveniently positioned on shelves, in wall corners, or flush mounted in assemblies of one or more units.

Try the Q.14 in your own home now. If you are not satisfied send it back and your money plus the cost of posting your Q.14 to us will be refunded in full.

£6.19.6

POST FREE ANYWHERE IN THE UK

sinclair

**SINCLAIR RADIONICS LTD., 22 Newmarket Road,
Cambridge**

Phone: OCA3 52996

SINCLAIR Z.12

12 WATT INTEGRATED HIGH FIDELITY AMPLIFIER AND PRE-AMP

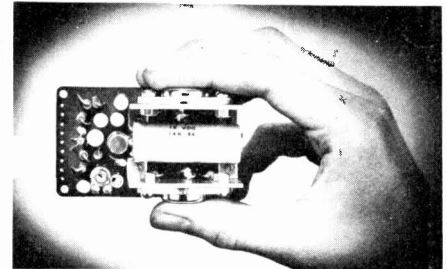
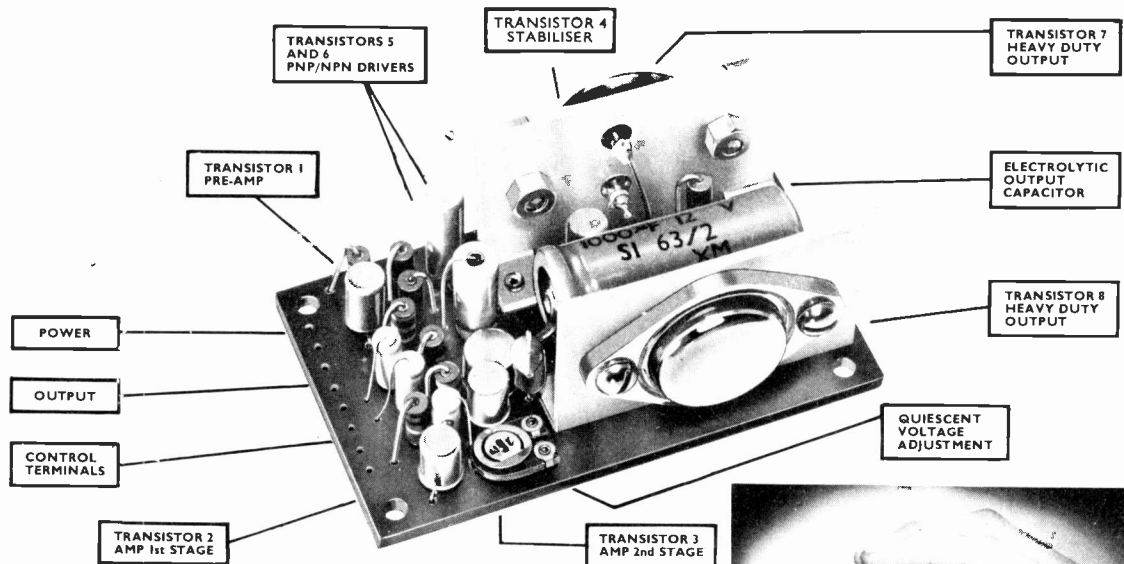

TECHNICAL DETAILS

- Class "B" ultra-linear output.
- RESPONSE 15-50,000 c/s \pm 1dB.
- Suitable for 3, 7.5 or 15 Ω speakers. Two 3 Ω speakers may be used in parallel.
- INPUT—2mV into 2k Ω .
- Signal to noise ratio better than 60dB.
- Use two for stereo.

12 WATTS R.M.S. OUTPUT CONTINUOUS SINE WAVE (24W PEAK) 15 WATTS MUSIC POWER (30W PEAK)

- 3 x 1 $\frac{3}{4}$ x 1 $\frac{1}{4}$ in.
- IDEAL FOR BATTERY OPERATION
- 15-50,000c/s \pm 1dB

PZ.3 Mains Supply Unit for Z.12 and Stereo 25 **79/6** users.

The embodiment of power, efficiency, reliability and economy. Nothing could be better than this fine amplifier for use with space-saving plinth-mounted motor and pick-up assemblies. Equally, its light weight makes the Z.12 ideal for guitar amplifier or electronic organ. It operates efficiently on any power supply between 6 and 20V. d.c. The pre-amp of this 8-transistor masterpiece will accept the outputs of pick-up, radio and microphone, etc. Full details for matching control and selector switching circuits are in the manual supplied with each unit. The Z.12 is now in use all over the world and is the accepted standard for all hi-fi needs.

BUILT, TESTED AND GUARANTEED.

89/6

ALL ITEMS POST FREE • SATISFACTION OR MONEY BACK GUARANTEE • PROMPT DELIVERY

SINCLAIR MICRO FM 7 TRANSISTOR DUAL PURPOSE FM TUNER/RECEIVER

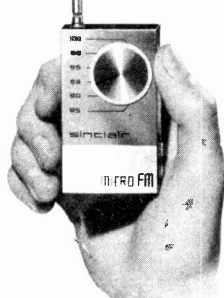

Low I.F. makes alignment unnecessary when built. Tunes 88-108 Mc/s. The telescopic aerial suffices for good reception in all but poorest areas. Signal to noise ratio—30dB at 30 microvolts. One outlet leads to amplifier or recorder the other allows set to be used as a pocket portable. Complete kit with earpiece and instructions. **£5.19.6**

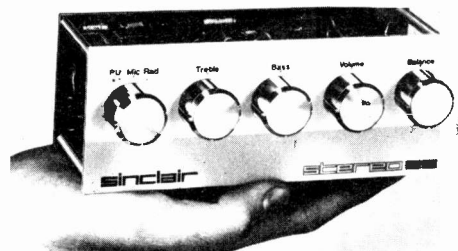

SINCLAIR STEREO 25
For use with two Z.12s or any hi-fi stereo system. Frequency response 25c/s to 30kc/s \pm 1dB. Switched inputs for P.U. Radio, Microphone, etc. Equalisation correct to within \pm 1dB on RIAA curve from 50 to 20,000c/s. 6 $\frac{1}{2}$ in. x 2 $\frac{1}{2}$ in. x 2 $\frac{1}{2}$ in. plus knobs. Built, tested and guaranteed **£9.19.6**

Please quote P.E.12 if you want to write your order instead of cutting out the coupon.

GUARANTEE

If you are not completely satisfied when you receive your purchase from us, your money will be refunded at once in full and without question.

SINCLAIR RADIONICS LTD., 22 NEWMARKET ROAD, CAMBRIDGE

Please send

NAME

ADDRESS

for which I enclose cash/cheque/money order value £ s. d.

P.E.12

Adamin

MODEL 15

MICRO SOLDERING INSTRUMENT



● EXTREME VERSATILITY

Range of 8 interchangeable bits, from 3/64" (.047") to 3/16", including new non-wearing PERMATIPS.

● ULTRA-SMALL SIZE

Length 7 1/8". Weight 1/2 oz. Max. handle dia. 7/16".

● EXTRA-HIGH PERFORMANCE

Heating time 90 secs. Max. bit temp. 390°C. Loading 15 watts—equals normal 30/40 watt iron.

● ALL VOLTAGES

The ADAMIN range includes five other models (5, 8, 12, 18 and 24 watts), Thermal strippers (PVC and PTFE) and a De-Soldering Tool. Please ask for colour catalogue A/37.



LIGHT SOLDERING DEVELOPMENTS LTD.

28 Sydenham Rd., Croydon, CR9 2LL
Telephone 01-688 8589 & 4559

COMPONENTS BY POST

MINIATURE CARBON TRACK POTENTIOMETERS. 1" dia. x 1" deep; 1/2" dia. spindle. Available in the following values: 5K, 10K, 25K, 50K, 100K, 250K, 500K, 1M, and 2M Ohm-LOG. Also: 5K, 10K, 25K, 50K, 100K, 250K, 500K, 1M Ohm-LIN. Available less switch @ 3/- each or with switch @ 5/- each.

MINIATURE TWIN-GANG POTENTIOMETERS @ 9/- each (less switch). 50K-50K LIN or LOG; 100K-100K LIN only; 250K-250K LOG only; 500K-500K LIN or LOG; 1M-1M LOG only; 2M-2M LIN only.

MINIATURE HI-STAB. CARBON FILM RESISTORS. 1/2 watt. 5% Tolerance. 10mm x 3.8mm dia. 10 ohm to 10 Megohm. 3/3 per doz. (min. quantity).

ALUMINIUM DIECAST BOXES—with divider slots. Dimensions: length 4 1/2" x width 3 1/2" x depth 1" —Type A @ 7/6 each; 4 1/2" x 3 1/2" x 2" —Type B @ 9/6 each; 6 1/2" x 4 1/2" x 2" —Type C @ 13/3 each; 8 1/2" x 5 1/2" x 2" —Type D @ 18/3 each; 10 1/2" x 6 1/2" x 2" —Type E @ 22/- each.

JACK PLUGS AND SOCKETS by BENDAR INSTRUMENT. JPS400 Fully screened 1" dia. 2 contact plug with cable clamp, 5/- each; JPS300 Fully screened 1" dia. 3 contact plug with cable clamp, 11/- each; JS01A Standard panel mounting 2 contact socket. D/c type, 3/6 each; JS00AO Standard panel mounting 3 contact socket. D/c type, 4/6 each; CC300 Fully screened 3 contact IN-LINE female free socket. 5/6 each. All the above items are available with "screw-lock" facility at 1/6 extra.

DIODES, TRANSISTORS, RECTIFIERS, SCR's, PHOTOCELLS, etc. All semiconductors are guaranteed to be Brand New FIRST GRADE items only.
 OA47, OA70, OA79, OA81, OA85, OA91, OA95, OA200, OA202, all at 2/6 each. OC44, 5/8; OC45, 5/-; OC71, 4/7; OC72, 5/8; OC75, 5/4; OC83, 4/7; OC140, 16/3; OC170, 8/9; OC171, 7/8; ACY18, 4/8; ACY19, 5/-; ACY20, 4/8; ACY21, 5/2; ACY22, 3/-; ACY40, 3/4; BC107, 4/6; BC108, 4/3; BC109, 5/3; BFY50, 5/8; BBY95A, 5/6; 2G371, 2/10; 2G374, 3/8; 2G302, 4/-; 2G414, 5/6; 2G416, 4/9; 2G417, 4/8; 2N697, 5/6; 2N706, 3/9; 2N2147, 16/6; 2N3638, 5/9; 2N3702, 3/9; 2N3703, 4/-; 2N3704, 5/-; 2N3705, 4/8; 2N3706, 3/9; 2N3707, 4/6; 2N3708, 3/4; 2N3709, 3/3; 2N3710, 3/3; 2N3711, 4/8; 2N3904, 6/-; 2N3906, 6/-; 2N4124, 4/8; 2N4126, 4/6; 3N84, 24/-; 2N2646, 10/6; BY100 0-75A @ 800V. P.I.V., 5/3 each; BY103 0-5A @ 800V. P.I.V., 6/3 each; BY114 0-65A @ 450V. P.I.V., 4/3 each; BY130 0-8A @ 450V. P.I.V., 3/6 each; BYX10 0-2A @ 800V. P.I.V., 4/8 each; BYX22/400 1-0A @ 400V. P.I.V., 5/6 each; BYZ10 and 16 6-0A @ 800V. P.I.V., 15/3 each; BYZ11 and 17 6-0A @ 800V. P.I.V., 12/9 each; BYZ12 and 18 6-0A @ 400V. P.I.V., 10/- each; BYZ13 and 19 4-2A @ 200V. P.I.V., 7/3 each; BYZ24 0-5A @ 50V. P.I.V., 3/9 each.

FET'S. 2N3820 @ 20/- each (RF and AF general purpose); MPF 102 @ 8/6 each (RF applications); MPF 103, 104, 106 @ 8/- each (AF and RF general purpose); 2N3819, now only 14/3 each, ex-stock.

For all of your general purpose AF and RF applications calling for a silicon $n-p-n$ transistor, use the 2N2926—NOW AT REDUCED RATES YET AGAIN.
 2N2926 Red h/c, 55-110, 3/- each, 32/3 per doz.; 2N2926 Orange 90-180, 3/3 each, 35/- per doz.; 2N2926 Yellow 150-300, 3/6 each, 37/9 per doz.; 2N2926 Green 235-470, 3/9 each, 40/6 per doz.; Packs of 25 mixed types, 66/-.

Postage and Packing is charged at 1/- in the £ (minimum 2/- per order).

M. R. CLIFFORD & COMPANY (Components Dept.),
 209A MONUMENT ROAD, EDGBASTON, BIRMINGHAM 16
 Terms: C.W.O. or C.O.D. Tel.: 021-454 0615

Jason

KITS

UNREPEATABLE SNIPS

★ 9 Gns. ★

GARRARD AT6 MK II 59/-

GARRARD SRP12 (110/230V) 49/-

COLLARO 9 VOLT 4 SPD. HEAVY TIT. ABOVE LESS CARTRIDGES Mono. Cart. add 12/6 Stereo Ceramic Cart. add 19/-

★ TAPE ★

We offer you fully tennilised polyester/nylon and P.V.C. tapes of identical quality hi-fi, wide range recording characteristics as top grade tapes. Quality control manufacture. They are truly worth a few more coppers than acetate, sub-standard, jointed or cheap imports. TRY ONE AND PROVE IT YOURSELF.

Standard		Long	
3in 150ft	2/3	3in 225ft	2/9
4in 300ft	4/8	4in 450ft	5/6
5in 900ft	7/8	5in 900ft	10/6
5 1/2in 900ft	10/6	5 1/2in 1,200ft	13/-
7in 1,200ft	12/6	7in 1,800ft	18/6

Double		Triple	
3in 300ft	4/-	4in 900ft	13/-
4in 600ft	8/-	5in 1,800ft	25/-
5in 1,200ft	15/-	5 1/2in 2,400ft	24/-
5 1/2in 1,800ft	19/-	7in 3,600ft	44/-
7in 2,400ft	27/-	Quadruple 3in 600ft	8/6

Postage 1/- reel. Post Free less 5% on three reels. Quality and Trade enquiries invited. NOTE: Large tape stocks at all branches.

TECHNICAL TRADING

All Mail Orders to Brighton

★ London—10 Tottenham Court Rd Tel: MUS 2639
 ★ Portsmouth—350-352 Fratton Rd. Tel: 22034
 ★ Southampton—72 East St. Tel: 25851
 ★ Worthing—132 Montague St. Tel: 2585
 ★ Brighton—Devonian Court, Park Crescent Place
 All Mail Order (24-hour Rabophone) Brighton 680722

AUTOCHANGE PORTABLE CABINETS
 As used on 18gus record player. Due to fortunate purchase we offer complete with motor board and all fittings at only **49/-**

PLEASE NOTE. A wide range of cabinets to callers at all branches.

100 HI-STABS 9/6
 1% to 5% 100Ω to 5mΩ

CO-AX low loss, 8d. yd. 25 yds. 18/6, 50 yds. 30/-
 25/-; BHC2 H/D fringe 1/6 yd. 25 yds. 30/-

100 RESISTORS 6/6
 SIZES 1-5 watt

MICROPHONE CABLE. Highest quality, black, grey, white, 1/- YD.

100 CONDENSERS 9/6
 Miniature Ceramic, Silver, Mica, etc. 3pF to 5μF. LIST VALUE OVER 24.

SILICON H.T. RECTIFIERS
 Guaranteed performance. Top makes. Tested 250V working
 120mA (3 for 6/6) 2/9
 500mA (3 for 18/6) 7/6

Please note Postage extra on all items

FREE FLOG LIST No. 2
 Scores Special Bargains
 Send S.A.E. or call at any Branch for yours



The latest Eagle range is greater than ever!

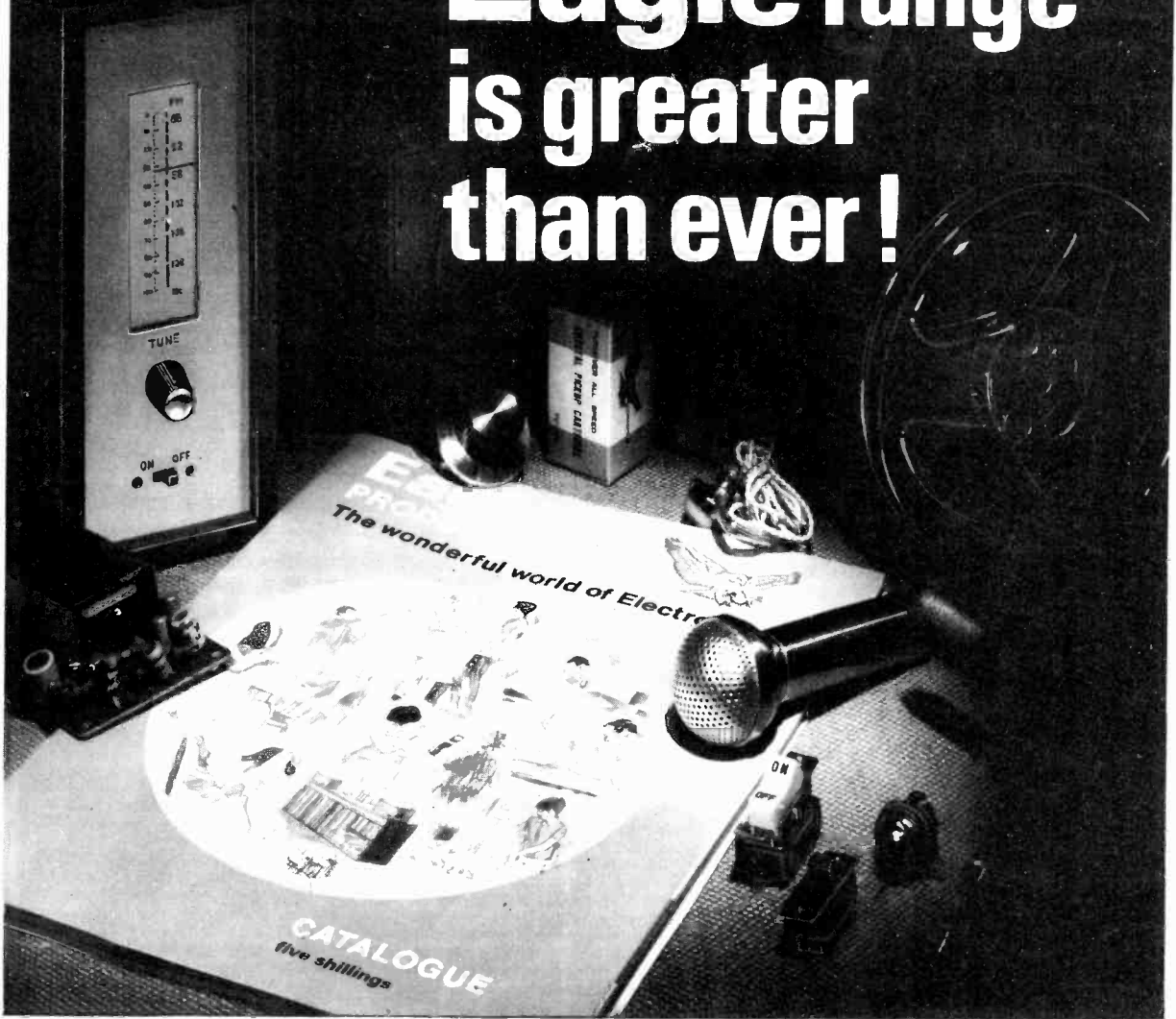

It's now ready—the new Eagle Catalogue presenting 'The Wonderful World of Electronics'. Hundreds of items for the Radio Hobbyist, Hi-Fi Enthusiast, Serviceman, Do-it-Yourself, etc. The widest ever choice of sensibly priced Electronic Components, Audio and Tape Accessories, Educational Projects, Home Lighting, Intercoms, Hi-Fi Amplifiers, Tuners, Tape Recorders, Loudspeakers and Speaker Systems, all of which are fully illustrated together with technical specifications. There's something for everyone in Eagle's Wonderful World of Electronics so send for your copy now or call in at one of the 6,000 Eagle Stockists today.

To: EAGLE PRODUCTS, Dept. P.E.1
Coptic Street, London, W.C.1.

Please send me catalogue of the entire "Eagle" range. I enclose 5/-.

Name

Address

SUB LASER!

OPTOELECTRONICS

from PROOPS

A new science project combining the fascination of optics with electronics . . . the new field of OPTOELECTRONICS

These new devices offer features which can be exploited in an extremely wide field of applications. Their outstanding modulations and switching capabilities, coupled with completely solid state circuit design and small physical size make them ideally suited to such purposes as short distance speech and data links, remote relay controls, safety devices, burglar alarms, batch counters, level detectors, etc.

DEMONSTRATIONS

of these devices operating as SPEECH LINK and ON/OFF LINK are being given daily at our only address

52 TOTTENHAM COURT ROAD
LONDON, W.1

MGA100



28/6
each
Post Free

TYPE MGA100 General Purpose Gallium Arsenide Light Source
A filamentless, Gallium Arsenide infra-red emitter, only 5.54mm dia. and 8.1mm long. Features a robust cylindrical package coaxial with the beam, facilitating optical alignment and heat-sinking.
Supplied complete with suitable lenses, full Technical Data and Application Sheets, including Line of Sight Speech Link.

MSP3



85/-
each
Post Free

TYPE MSP3 Solid State Photo Receiving Device
An ultra-sensitive infra-red and visible light detector, this device is a complete silicon photo-electric receiver with a peak spectral response at 9.500A. Size only 6.4mm dia. and 25.4mm long, yet absolutely complete, the device will generate sufficient power to drive an external relay. Chiefly intended for use in optical links based on Gallium Arsenide Light Sources, they are equally suitable for systems based on visible light. Features a robust cylindrical package coaxial with the incident light facilitating optical alignment and heat-sinking.
Supplied complete with suitable lenses, full Technical Data and Application Sheets, including Line of Sight Speech Link.

31F2



28/6
each
Post Free

TYPE 31F2 Micro-miniature Infra-Red Detector
Extremely small photo diodes of silicon npn passivated planar construction and suitable for Punched Card Readers, Counters, Film Sound Track, etc.
Supplied complete with suitable lenses, full Technical Data and Application Sheets, including Line of Sight Speech Link.

52 Tottenham Court Road, London, W.1
Telephone: LANgham 0141 (01-580 0141)

PROOPS BROTHERS LIMITED

MARTIN IS HIGH-FIDELITY

PREFERRED FOR RELIABILITY, QUALITY, ADD-ON-ABILITY AND ECONOMY



F.M. TUNER

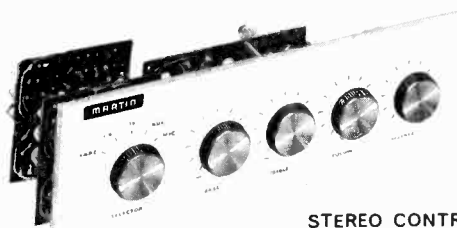

STEREO CONTROL ASSEMBLY

You can do so much with MARTIN kits. The system of using pre-fabricated transistorised units which can be interlinked in a variety of ways enables you to assemble the combination of your choice and then extend it unit by unit until you possess a full stereo gramophone and radio assembly. When new units are produced, they can be added to existing equipment very easily with the advantage that you can continue to use equipment you already have,

so that your installation is always up to date. Most important of all is the power and quality which MARTIN Audiokits give you. Their sturdy construction assures compactness without sacrifice to quality or efficiency. They offer excellent value, are very easily installed and will give years of unfailing service. That is why people prefer MARTIN — it's simple to instal, good to listen to, and looks completely professional.

NO OTHER KITS GIVE YOU THIS

MARTIN AUDIOKITS are available for Mono, and can be doubled up for stereo, or as complete stereo units. 3 ohm and 15 ohm systems are available. There is a special pre-amp for low output pick-ups and escutcheon panels to suit the arrangement you choose. The tuner is styled to match.

- 5-stage input selector £2.7.6
- Pre-amp/ tone controls £3.2.6
- 10 watt amp. (3 ohms) £5.12.6
- 10 watt amp. (15 ohms) £6.12.6
- Mains power supply £2.15.0
- F.M. Tuner £12.19.3

AMPLIFIER SYSTEMS • TUNERS • RECORDERS

From Radio and Hi-Fi Stockists

MARTIN ELECTRONICS LTD. 154/5 HIGH STREET, BRENTFORD MIDDLESEX. ISLeworth 1161/2

Trade enquiries invited

MARTIN ELECTRONICS

154 High Street, Brentford, Middlesex
Please send Recordakit/F.M. Tuner/Audiokit Hi-Fi Leaflets. (Strike out items not wanted)

Name

Address

PE168

BUILD YOURSELF A QUALITY TRANSISTOR RADIO—FULL AFTER SALES SERVICE!

THE MAGNIFICENT ROAMER 7 MK.IV

SEVEN WAVEBAND PORTABLE AND CAR RADIO WITH A SUPER SPECIFICATION

- 7 FULLY TUNABLE WAVE BANDS—MW1, MW2, LW, SW1, SW2, SW3 and Trawler Band.
- Extra Medium waveband provides easier tuning of Radio Luxembourg, etc.
- Built in ferrite rod aerial for Medium and Long Waves.
- 5 Section 22 in. chrome plated telescopic aerial for Short Waves—can be angled and rotated for peak S.W. listening.
- Socket for Car Aerial.
- Powerful push-pull output.
- 7 transistors and two diodes including Philco Micro-Alloy R.F. Transistors.
- Famous make 7x4 in. P.M. speaker.
- Air spaced ganged tuning condenser.
- Separate on/off switch, volume control, wave change switches and tuning control.
- Attractive case with hand and shoulder straps. Size 9 x 7 x 4 in. approx.
- First grade components.
- Easy to follow instructions and diagrams make the Roamer 7 a pleasure to build with guaranteed results.

Total building costs

£5.19.6

P. & P. 5/6

Parts price list and easy build plans 3/— (FREE with kit).



TRANSONA FIVE



MEDIUM WAVE, LONG WAVE AND TRAWLER BAND PORTABLE

Attractive case with red speaker grille. Size 6 1/2 x 4 1/2 x 1 1/2 in. Fully tunable. 7 stages—5 transistors and 2 diodes—ferrite rod aerial, tuning condenser, volume control, fine tone super dynamic speaker, all first grade components. Easy build plans and parts price list 1/6 (FREE with kit).

Total building costs
42/6 P. & P. 3/6

POCKET FIVE



MEDIUM WAVE, LONG WAVE AND TRAWLER BAND PORTABLE

Attractive black and gold case. Size 5 1/2 x 1 1/2 x 3 1/2 in. Fully tunable over both Medium and Long Waves with extended M.W. band for easier tuning of Luxembourg, etc. All first grade components, 7 stages—5 transistors and 2 diodes—super-sensitive ferrite rod aerial, fine tone 2 1/2 in. moving coil speaker, etc. Easy build plans and parts price list 1/6 (FREE with kit).
POCKET FIVE Medium and Long Wave version with miniature speaker ONLY 29/6. P. & P. 3/6.

Total building costs
39/6 P. & P. 3/6

MELODY SIX



TWO WAVEBAND PORTABLE WITH 3in. SPEAKER

Handsome leather-look case, size 6 1/2 x 3 1/2 x 1 1/2 in. with gilt trim and hand and shoulder straps. Fully tunable over both Medium and Long Waves. Incorporates pre-tagged circuit board, 8 stages—6 transistors and 2 diodes—ferrite rod aerial, push-pull output, wave change slide switch, tuning condenser, volume control, 3in. moving coil speaker, etc. Easy build plans and parts price list 2/— (FREE with kit).

Total building costs
59/6 P. & P. 3/6

MELODY MAKER 6

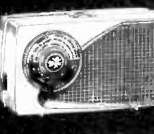

THREE WAVEBAND PORTABLE WITH 3in. SPEAKER

Smart pocket size case, 6 1/2 x 3 1/2 x 1 1/2 in. with gilt fittings. Fully tunable over both Medium and Long Waves with extra M.W. band for easier tuning of Luxembourg, etc. 8 stages—6 transistors and 2 diodes—top grade 3in. speaker, 2 R.F. stages for extra boost, high "Q" ferrite rod aerial. Easy build plans and parts price list 2/— (FREE with kit).

Total building costs
69/6 P. & P. 3/6

ROAMER SIX



SIX WAVEBAND PORTABLE WITH 3in. SPEAKER

Attractive case with gilt fittings, size 7 1/2 x 5 1/2 x 1 1/2 in. World wide reception. Tunable on Medium and Long Waves, two Short Waves, Trawler Band plus an extra M.W. band for easier tuning of Luxembourg, etc. Sensitive ferrite rod aerial and telescopic aerial for Short Waves. All top grade components, 8 stages—6 transistors and 2 diodes including Philco Micro-Alloy R.F. Transistors, etc. (carrying strap 1/6 extra). Easy build plans and parts price list 2/— (FREE with kit).

Total building costs
79/6 P. & P. 3/6

SUPER SEVEN



THREE WAVEBAND PORTABLE WITH 3in. SPEAKER

Attractive case size 7 1/2 x 5 1/2 x 1 1/2 in. with gilt fittings and carrying strap. The ideal radio for home, car or outdoors. Covers Medium and Long Waves and Trawler Band. Special circuit incorporating 2 R.F. stages, push-pull output, ferrite rod aerial, 7 transistors and 2 diodes, 3in. speaker (will drive larger speaker) and all first grade components. Price list 2/— (FREE with kit).

Total building costs
69/6 P. & P. 3/6

RADIO EXCHANGE Ltd

61a HIGH STREET, BEDFORD

Callers side entrance Barratt's Shoe Shop. Open 9-5 p.m. Saturday 9-12.30 p.m.

Telephone: Bedford 52367



Well here's a pretty how-d'ye-do!! The Old Chap is lost, to-night of all nights, and that stubborn old Rudolph airing his navigational knowledge. Let's hope he finds his bearings before the morning!

If you find yourself lost in the maze of components required for your next project the surest way to find the way out is to get a copy of that invaluable guide, the *Home Radio Catalogue*. Surprise surprise, although the Catalogue has been enlarged and improved every year, the price remains at **7/6 plus 2/- postage and packing**. So if you want some interesting Christmas reading send the coupon and p.o. or cheque without delay. Oh! and by the way, every catalogue contains **5 vouchers**, each worth **1/-** if used as directed.

*The Directors and
Staff of Home Radio
wish you all a*
MERRY CHRISTMAS
and a
HAPPY NEW YEAR

Please write your Name and Address in block capitals

Name.....

Address.....

Home Radio Ltd., Dept. PE, 187 London Rd., Mitcham, Surrey
CR4 2YQ

YOURS TO EXPLORE

PARTY time approaches, so here is a simple quiz for you, but don't worry, there are just two questions (and we give the answers too!)

(1) What single piece of equipment or apparatus best typifies the advanced state of the electronic art today?

(2) Name the earliest (and simplest) piece of electronic apparatus of practical value to be put into the hands of the ordinary man.

The first is very easy. Science fiction and James Bond gadgets apart, we think you will plump for the computer.

The second is perhaps a trifle more difficult, and certainly less immediately obvious the younger you are. When you *do* think about it, however, there is no doubt that the "crystal set" radio receiver was the founder member of the great family of electronic apparatus we are familiar with today.

"... *Tall oaks from little acorns grow.*" That early crystal diode or "detector" was a prolific ancestor. A veritable technological forest now exists some 60 years after the first acorn was planted. "Crystal set to computer" just about sums it up.

This "forest" is growing still, and it is becoming rather difficult for the amateur to explore alone: so many different paths each offering rival attractions. Some individuals prefer to keep to the well trodden paths, others are more venturesome and are eager to explore and seek out the less frequented parts of the forest.

We do our best to help, guide, and encourage all in their various pursuits. To this end, gadgets of wide and popular appeal figure prominently in our pages, as do high quality equipments for home entertainment. But in addition, the more serious, scientific minded reader is offered opportunities to exercise his abilities and acquire further knowledge through more advanced and ambitious projects. This is illustrated by our recently introduced series "Nucleonics for the Experimenter" and now by the appearance in this issue of the Practical Electronics Analogue Computer.

Back to that little acorn. As the forester seeds the ground for the future, we likewise have the novice very much in mind. And what is more suitable and appropriate than a crystal set as a very first project? To be honest, we can't say that the beginner of 1968 will have quite as much excitement as his counterpart of the cat's whisker twiddling days, but that's progress for you!

To all readers—whatever their particular interests, whether they participate in electronics for sheer pleasure and relaxation, or primarily for utilitarian or serious experimental purposes—the editorial staff of PRACTICAL ELECTRONICS wish a very happy and constructive new year.

F. E. Bennett—*Editor*

THIS MONTH

CONSTRUCTIONAL PROJECTS

I.C. TAPE RECORDER	16
COMBOTRON	21
SHAVER ADAPTOR	35
P.E. ANALOGUE COMPUTER	36
WHITE NOISE GENERATOR	44
SINE TO SQUARE WAVE CONVERTER	57

SPECIAL SERIES

NUCLEONICS FOR THE EXPERIMENTER—3	62
-----------------------------------	----

GENERAL FEATURES

INGENUITY UNLIMITED	24
HOLOGRAPHY	28
CROSSWORD PUZZLE	42
DETERMINING VOLTAGE AMPLIFICATION	54

BEGINNERS

SEMICONDUCTOR BASICS—2	48
CRYSTAL RECEIVER	51

NEWS AND COMMENT

EDITORIAL	15
POINTS ARISING	42
ELECTRONORAMA	43
MARKET PLACE	46

*Our February issue will be published on
Friday, January 12*

THIS article describes a mains operated tape recorder using the latest techniques in linear integrated circuits. For ease of wiring and the obvious advantage of being able to monitor the recording from the tape during the recording process, the design has been based upon a three head system. The three-speed tape deck is a readily available unit and may be purchased from many radio dealers. This unit comes complete with two heads (record/replay and erase). A third replay head may be ordered at the same time to fit into the space provided.

The replay characteristics of the final tape recorder follow the recommendations laid down by the C.C.I.R. at all speeds and the reproduction of pre-recorded tapes is of a very high quality. The full output power of 1 watt is more than sufficient to fill a large room and at this level the distortion is held to within less than 4 per cent. The signal/noise ratio, when related to the full output power, is better than 48dB and the hum level better than 52dB down at $7\frac{1}{2}$ in/second. Tone correction is available in the form of treble lift and cut using one control only to perform both these functions in the replay condition.

As most recording equipments include a speaker, considerable thought was given to including a speaker in this unit but, due to the inability to maintain a reasonable size and at the same time take full advantage of the sound output quality, it was thought that most readers could use a separate speaker which may be part of an existing hi fi set-up.

The tape recorder was designed as an immobile unit to blend in with the more modern style of furnishing, therefore the addition of a speaker unit as a separate item should present no serious problems. A recommended size for the speaker in question would be in the order of 8 inches and may be housed in an enclosure to suit the reader's taste and pocket.

REPLAY AMPLIFIER

From Fig. 1, it may be seen that the replay amplifier is in no way connected to the recording chain and, for the constructor who may wish to build the unit as a replay device only, can omit the recording amplifier in it's entirety without affecting the replay function.

The pre-amplifier function is performed by the integrated circuit type TAA263 which has been described in the article *IC Gram Amplifier* in the October 1967 issue, so no further description of the internal characteristics of this device is necessary.

The signal from the replay head X1 is fed directly to the input of the integrated circuit, amplified and fed out to the volume control via C2 and R7. The d.c. working point of the pre-amplifier is established by R1, R2, and R3; the a.c. gain is set to the required level by the resistance capacitance network R5 and C4.

In order to promote some of the treble lift required to meet the C.C.I.R. replay specification, further decoupling of the a.c. negative feedback is achieved by the inclusion of R4 and C3 which forms a frequency selective network.

INTEGRATED CIRCUIT TAPE RECORDER

A QUALITY TAPE RECORDER IN MODERN BOOKSHELF STYLE USING
TWO LINEAR INTEGRATED CIRCUITS IN A SIMPLE CONSTRUCTION

SPECIFICATION

TAPE SPEEDS
AMPLIFIERS
FREQUENCY RESPONSE

POWER OUTPUT (Replay)
DISTORTION

SIGNAL-TO-NOISE RATIO

RECORDING LEVEL
INDICATOR

INPUTS: Microphone
Pick-up or Radio

$7\frac{1}{2}$, $3\frac{3}{4}$, $1\frac{7}{8}$ inches per second

Separate record and replay amplifiers
Overall, 50Hz to 10kHz ± 3 dB at $7\frac{1}{2}$ in/sec
Replay, 50Hz to 12kHz ± 3 dB at $7\frac{1}{2}$ in/sec

1 watt into 15 Ω load

Better than 2.5% total harmonic distortion at 500mW output

Better than 48dB at peak recording level

VU level meter 1mA f.s.d.

100-600 Ω , 500 μ V (moving coil type)

220k Ω , 400mV (crystal or ceramic pick-up)

The more experienced constructor may notice the lack of any form of bass lift in the replay amplifier. This may be readily explained by considering the fact that under open-circuit conditions a tape head will provide a voltage characteristic that falls at the rate of 6dB per octave toward the bass frequencies. However, as the impedance of the head falls in a similar fashion, it can be shown that a constant current output may be obtained, and it is this constant current that is fed into the very low input impedance of the pre-amplifier, which presents a constant voltage output across the output load R18.

The main amplifier comprises TR1, 2, and 3 connected as a directly coupled configuration thus maintaining excellent stability of the d.c. and a.c. operating points. The stability is brought about by the a.c. and d.c. negative feedback that is applied to the base of TR1 via R9 and VR2.

In order to avoid shorting out some of the negative feedback by the collector load of the previous stage, varying as the volume control slider is moved, R7 has

been included in almost identical fashion but the treble lift components have been omitted and the gain is set as before by decoupling the negative feedback applied by R15 and R17.

The output from the pre-amplifier is fed to the record volume control via C11 and R20 and subsequently to the base of TR4. R20 has been included to isolate R18 from the base circuit of TR4, with R21 and C15 forming a treble lift network at the upper frequencies to compensate partially for recording losses. The collector of TR4 is decoupled by C16 so that bias frequency leakage is not superimposed on the collector output signal.

The majority of the treble compensation is achieved by the network C18 and R26 ensuring that the overall response of the system is flat between 50Hz and 10kHz. R27, which is in series with the output to the recording head, helps to prevent bias flowing back into the collector load, which is now effectively a short circuit at bias frequency, thus ensuring an adequate supply of bias for the recording head.

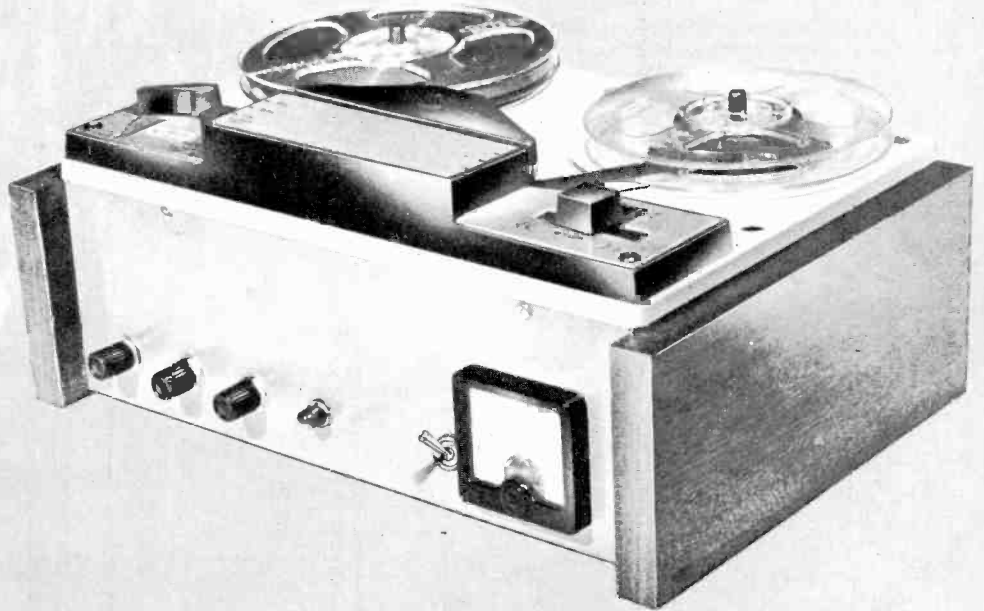

By R. HIRST

been included in the slider of the potentiometer. D1 and R11 hold down the bases of the output transistors, working in class C operation, to prevent thermal runaway.

The tone control provides both treble lift and cut in the following manner: With the slider of VR1 at the junction of C6, the a.c. negative feedback applied via R9 and VR2 is shorted to the negative rail at the upper frequencies, therefore the amplifier has more gain at any frequency shorted out by C6.

When the slider of VR1 is at the other end of its travel, that is to say at C7, more negative feedback is applied to the base of TR1 by the shunting effect of C7, giving a total variation of 12dB in output at 10kHz. This is quite adequate to compensate for the lack of switched treble equalisation at the three speeds.

RECORD AMPLIFIER

Fig. 1 also indicates the record amplifier configuration, where an integrated circuit similar to that contained in the replay amplifier, is used as a pre-amplifier.

The level of the recording signal is indicated by M1 which is in the collector of TR5. This stage is not biased in the normal manner but relies upon the incoming signal from the record amplifier, via R25 and VR5, being rectified by the base-emitter junction of TR5.

The advantage of this type of circuit lies in the very small range of level that is presented to the meter. The scale from 2 to 8 represents a change in output level of only 6dB. While this condition allows for very accurate setting of levels, some disadvantage may be encountered in the initial use of such a system due to the relatively small movement of the meter at an average signal level. C20 is included in the base circuit to prevent the meter reading from being affected by any bias leakage.

The action of the pointer may be damped to suit personal preference and the existing damping capacitor C21 gives a rather fast action but a value in the order of 100 μ F may be more suited for programme material of a wide dynamic range.

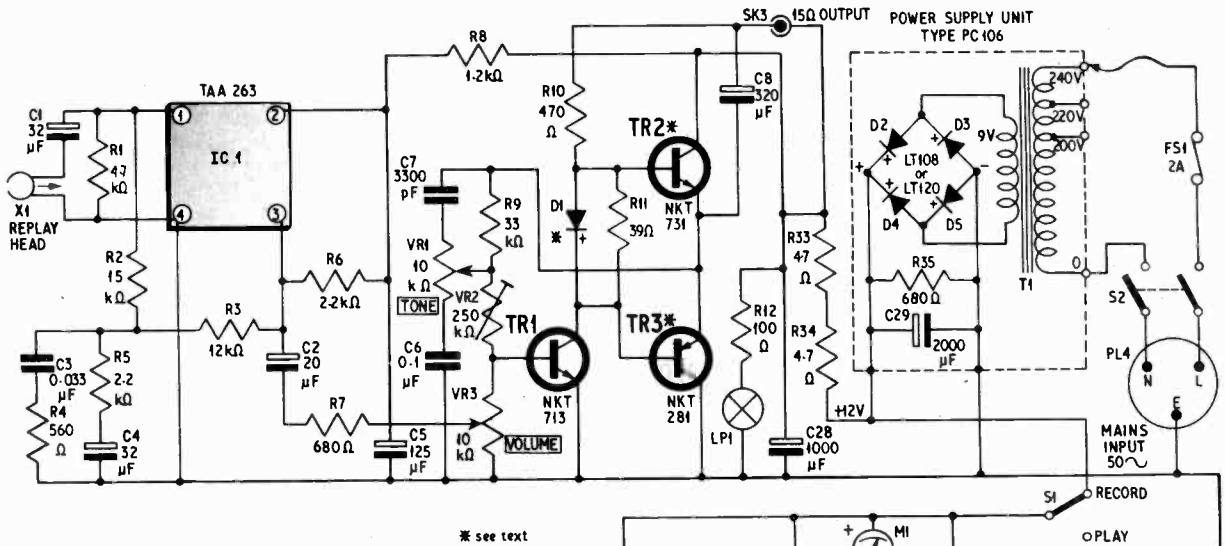
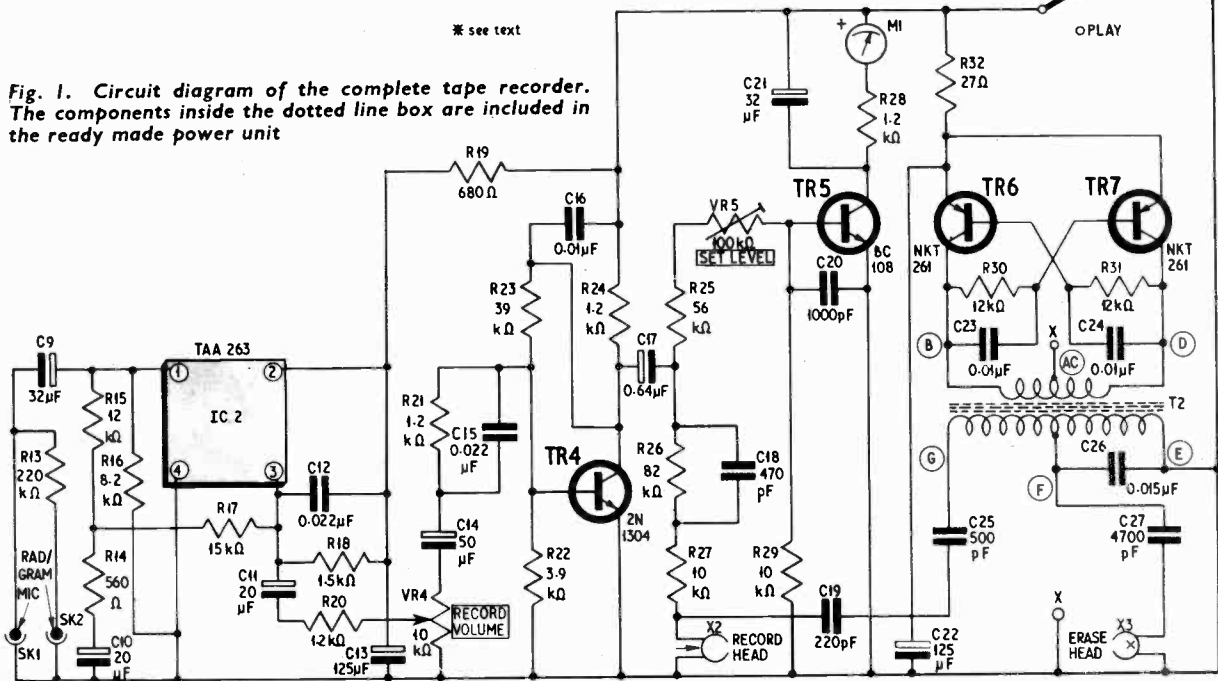

Fig. 1. Circuit diagram of the complete tape recorder. The components inside the dotted line box are included in the ready made power unit



OSCILLATOR

The bias oscillator is of the push-pull variety being biased in class D. The coil is wound on a ferrite core and presents an output of excellent waveshape and symmetry at a frequency of 50kHz. The output winding is tapped to feed the erase head and at this point the coil is tuned to promote the correct operating frequency.

The series capacitor C27 tunes the erase head to minimise the load on the oscillator and a value of 4,700pF matches this particular erase head. Bias for the recording head is fed via C25 and C19 to the junction of R27 and the record head.

The value of C19 is such as to ensure that 220µA of bias flows through the record head. Some slight delay in the decay time of the oscillator is brought about by the inclusion of R32 and C22, thus reducing the risk of saturating the record head due to sudden spikes when discontinuing the supply by reverting to the replay condition.

The recorder is changed from the replay position to record by virtue of a switch S1 mechanically linked to the function lever on the tape deck. Recording cannot commence until this switch is operated, so there is no risk of the bias frequency partly erasing a pre-recorded tape. To simplify construction only one set of contacts on the switch wafer has been used and these remove the positive supply from the record amplifier and the oscillator.

POWER SUPPLY

The tape recorder was designed to function from a 15 volt source of supply capable of delivering at least 400mA without the voltage falling to less than 12 volts. A ready made unit available on the market was used at a very modest cost, but alternative components can be used.

The only addition to the power supply unit was in the form of a series resistor and capacitor to smooth any remaining ripple. Two 4.7 ohm resistors were

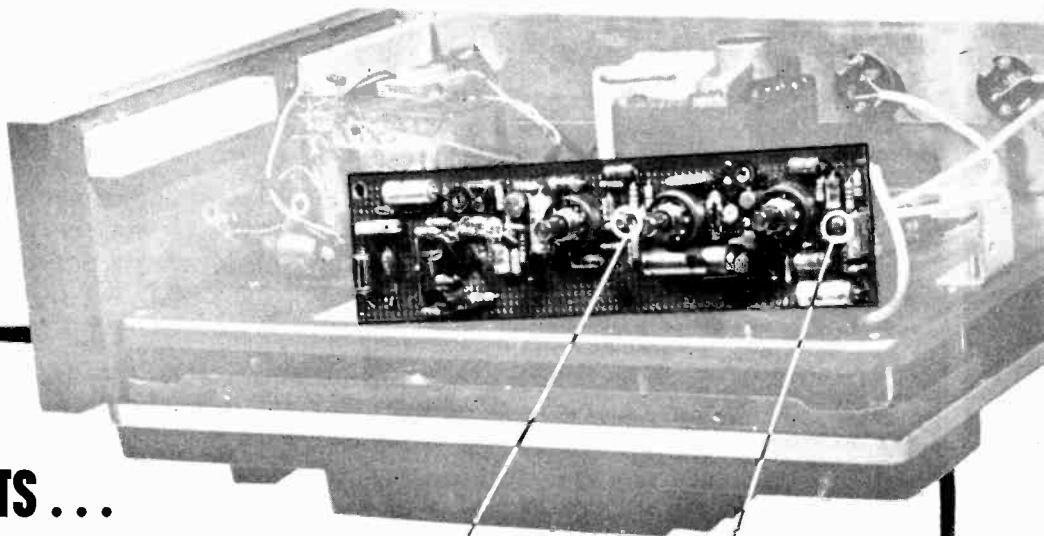

COMPONENTS . . .

Resistors

R1	4.7k Ω	R14	560 Ω	R27	10k Ω
R2	15k Ω	R15	12k Ω	R28	1.2k Ω
R3	12k Ω	R16	8.2k Ω	R29	10k Ω
R4	560 Ω	R17	15k Ω	R30	12k Ω
R5	2.2k Ω	R18	1.5k Ω	R31	12k Ω
R6	2.2k Ω	R19	680 Ω	R32	27 Ω
R7	680 Ω	R20	1.2k Ω	*R33	4.7 Ω
R8	1.2k Ω	R21	1.2k Ω	*R34	4.7 Ω
R9	33k Ω	R22	3.9k Ω	*R35	{ 680 Ω or as supplied in power unit (see below)
R10	470 Ω	R23	39k Ω		
R11	39 Ω	R24	1.2k Ω		
*R12	100 Ω	R25	56k Ω		
R13	220k Ω	R26	82k Ω		

All 10%, $\frac{1}{4}$ W high stab. carbon except that
 *R12 is 10%, $\frac{1}{2}$ W. R33, R34, R35 are 5%, $\frac{1}{2}$ W.

Potentiometers

VR1	10k Ω log. carbon miniature
VR2	250k Ω linear preset sub-miniature skeleton
VR3	10k Ω log. carbon miniature
VR4	10k Ω log. carbon miniature
VR5	100k Ω log. preset sub-miniature skeleton

VR1, VR3, VR4 to have tags on rear (Iskra type P6)
 (Obtainable through retailers only from Guest Electronics, Nicholas House, Brigstock Road, Thornton Heath, Surrey)

Capacitors

C1	32 μ F elect. 4V	C17	0.64 μ F elect. 64V
C2	20 μ F elect. 16V	*C18	470pF poly. 125V
C3	0.033 μ F poly. 160V	C19	270pF poly.
C4	32 μ F elect. 4V	C20	1,000pF disc ceramic
C5	125 μ F elect. 10V	C21	32 μ F elect. V4
C6	0.1 μ F poly. 160V	C22	125 μ F elect. 10V
C7	3,300pF poly. 160V	C23	0.01 μ F poly. 160V
C8	320 μ F elect.	C24	0.01 μ F poly. 160V
C9	32 μ F elect. 4V	C25	500pF poly.
C10	20 μ F elect. 16V	C26	0.015 μ F poly. 160V
C11	20 μ F elect. 16V	C27	4,700pF poly.
C12	0.022 μ F poly. 160V	C28	1,000 μ F elect. 12V
C13	125 μ F elect. 10V	C29	{ 2,500 μ F elect. 25V or as supplied in power unit (see below)
C14	50 μ F elect. 6.4V		
*C15	0.022 μ F poly. 160V		
C16	0.01 μ F poly. 160V		

* See text for alternative values at other tape speeds

Transformers

- T1 Mains transformer: Pri. 0-200, 220, 240V; sec. 0-8, 13V 400mA (type PS12/4) or transformer supplied in power unit (see below)
 T2 Oscillator coil wound on ferrite pot core assembly type LA2103 (see text) (Mullard)

IC2

IC1

Transistors

TR1	NKT713	} Matched to include D1
TR2	NKT731	
TR3	NKT281	
TR4	2N1304	
TR5	BC108	
TR6	NKT261	
TR7	NKT261	

Integrated Circuits

IC1, IC2 TAA263 (Mullard) (2 off)

Diodes

D1 Matched to TR2 and 3 (Newmarket)
 D2-5 LT108 or LT120 12V 1A selenium bridge rectifier or rectifier supplied in power unit (see below)

Power Supply Unit (optional)

PC106 (Newmarket)
 Ready made unit incorporates R35, C29, D2-5, and T1

Meter

M1 0-1mA f.s.d. scaled VU Meter or scaled 0-10 (type MR2P)

Sockets with Plugs

SK1-3 Phono socket (3 off)
 SK4 Mains chassis mounting miniature plug type P360

Tape Heads

X1 Replay head (extra head type MNI55 with spring and screw) (B.S.R.)
 X2 Record head } Supplied with tape deck
 X3 Erase head }

Miscellaneous

Tape deck, 3-speed, type TD10 (B.S.R.)
 Perforated s.r.b.p., 0.1in matrix 7 $\frac{1}{2}$ in \times 2in
 Aluminium sheet, 18 s.w.g. 12in \times 4in (2 off)
 Veneered chipboard 9in \times 4in (2 off), or as required for case
 FS1 Fuse and fuseholder 2A
 LPI 10V or 12V bulb with wire ends (Hivac)
 S1 Single-pole, on/off, wafer (see text)
 S2 Double-pole, on/off, toggle

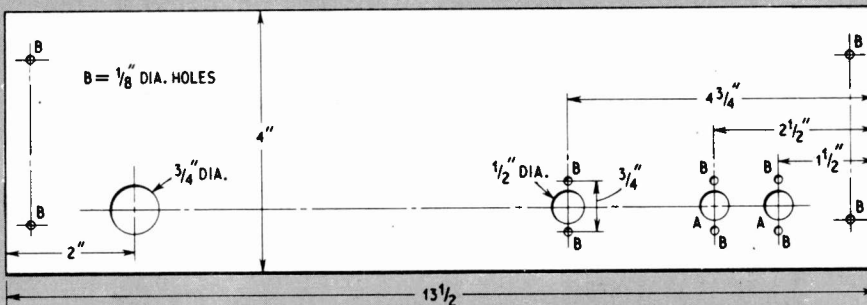

Fig. 3a. Back panel drilling details; 18 s.w.g. aluminium sheet is used

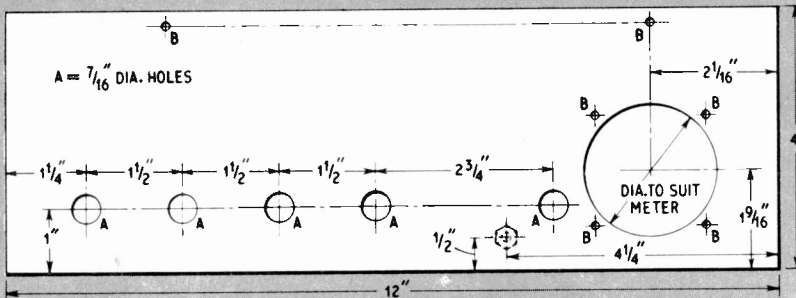

Fig. 3b. Front panel drilling details also in aluminium sheet. Do not cut the holes for the meter until this component has been obtained as the sizes will depend on the item chosen

chosen as they were easier to obtain than one of 9.4 ohms. The mains supply is connected to the transformer at the appropriate mains tap; the resultant d.c. voltage is visually indicated by LP1 which is a 10 volt "pea" bulb taking something in the order of 40mA. Resistor R12 is included to reduce the supply voltage to this level. The bulb rating is not critical; any type can be used provided that R12 is adjusted to suit the voltage rating of it. Current rating should be as low as possible.

OSCILLATOR COIL

The oscillator coil is simple to wind by making a suitable nut and bolt arrangement to fit into an ordinary hand drill. The former is clamped between a nut and the face of the chuck of the drill and two washers will assist in establishing an even fitting. The primary is wound in a bifilar fashion (i.e. both halves wound together to achieve perfect matching). The preparation of the wire is shown in Fig. 2a; the method of winding is also indicated.

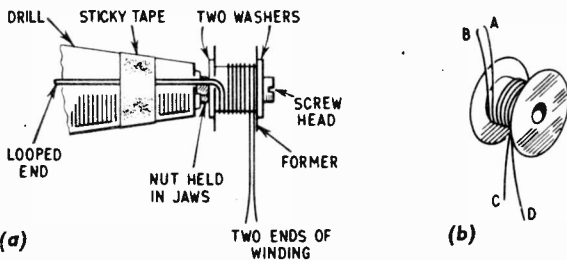

Fig. 2. Primary winding of the oscillator coil. Both halves are wound together

Primary: 6 + 6 turns of 24 s.w.g. enamelled copper wire, bifilar wound (see Fig. 3)

Secondary: 42 turns of 36 s.w.g. plus 48 turns of 40 s.w.g. enamelled copper wire, layer wound

Once the primary has been wound, which incidentally forms one layer only, a single layer of thin plastics tape may be used to hold it in position. When the coil is finally assembled the looped end is cut to form two terminations A and B. One of these cut ends is checked to see which of the other wires C or D at the further end of the coil forms a complete circuit when measured on an ohmmeter.

When this is established A and D should form one circuit and B and C the other. Now twist A and C together which will form the centre tap of the coil and B and D will go to the respective collectors of TR6 and TR7. This operation is shown in detail in Fig. 2b and it is important to observe the correct connections.

The secondary winding of the coil is wound in the more normal manner of layer or pile winding; that is to say, the whole of this winding is wound in the same direction and the tap is brought out to form a connection. The layers are wound on top of each other until the required number of turns has been made. Fit thin plastics sleeving on all lead-out wires. The finished bobbin should be covered with another layer of insulating material before being assembled in the outer ferrite core.

The two halves of the core were stuck together with a resin adhesive such as Araldite and held to the component board similarly. Care must be taken to ensure that the ends of the wires are tinned and cleaned well so as to make good soldered joints. This is not a difficult item to make as long as the instructions are followed exactly. Care must be taken not to damage the enamel insulation on the wire and not to chip the core.

The pot core assembly can be obtained through retailers who distribute Mullard components.

Next month the constructional and wiring details and setting-up procedure will be given

Amuse your friends or family with this fascinating party novelty

You can construct the robot or the game — either way it's fun!



The Combotron

Crack the combination and his eyes respond

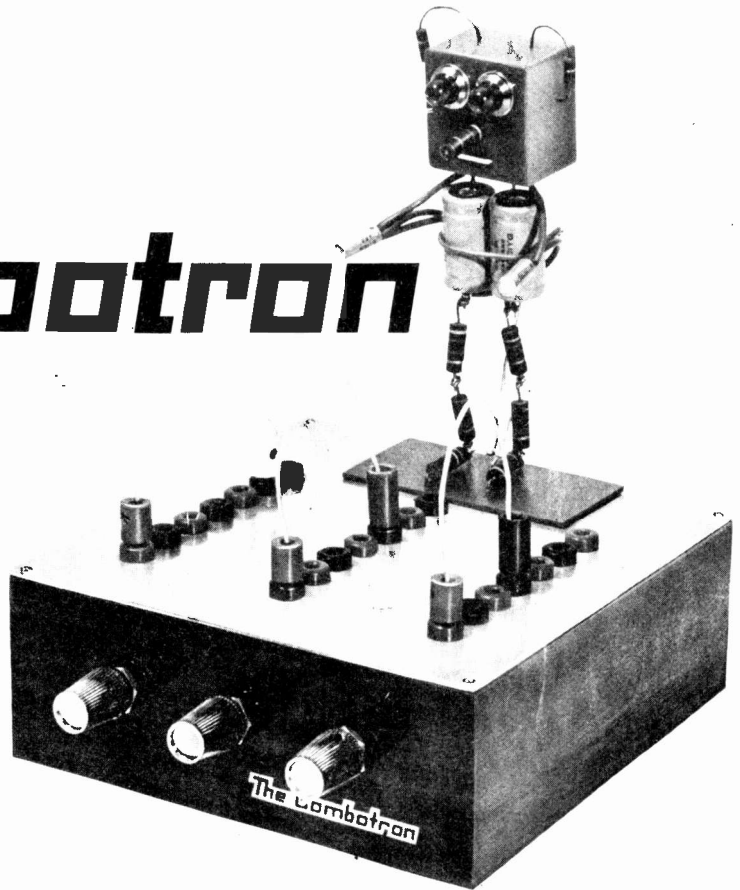

THIS is not a game where mental agility or high I.Q. may be demonstrated, but one of chance (with mathematical undertones) where boffin or dullard may compete on level terms.

The object of the game is to crack the circuit completing combination by random insertion of three jumper plugs. Each plug must be inserted into one of the line of sockets running vertically from its fixed termination point, i.e. "A", "B", and "C". If the circuit is successfully completed this winning combination will be indicated by the robot's eyes flashing.

Since many readers might only be interested in constructing the robot as a desk-top or sideboard novelty, its construction will be described separately but with simple add-on instructions if it is to be included in the game.

NUMEROUS COMBINATIONS

Examination of the circuit will show that random switching of S2, S3, and S4 presents a completely different set of plug combinations for each game and if the wiring of sockets to switch tags is equally random in the construction of the unit it should be virtually impossible to memorise winning combinations.

Since there are six sockets available to each jumper jack plug there are six possible inserts at each column of sockets to successfully complete the robot's supply line. It can be seen then that there are 6^3 combinations available by switch settings, or to generalise a formula, $c = x^n$ where c is the total number of combinations, x the number of switch ways and n the number of switches. This indicates that with more switch ways and sockets the game increases rapidly in complexity, and if you don't want to exhaust the patience of your friends or family you should restrict the game to the modest limits set out here.

BUILDING THE ROBOT

The robot is in essence a simple free running "multi", with its working parts contained entirely in its physical make up. The body and legs make up the timing components and the switching transistors the arms. The simplest order of construction was found to be from the head and progressively working downwards.

The head can be any small plastic box of sufficient size to house the small indicator lamps, but not too large to appear ungainly on the body. If the components are obtained first it is a simple matter to proportion the choice of box with the torso capacitors.

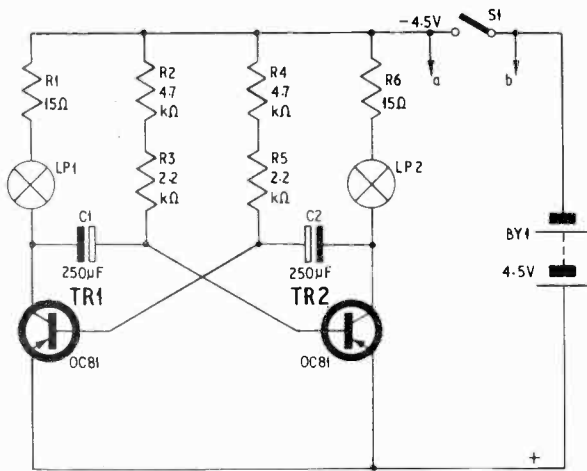

Fig. 1. The robot circuit. This is a free running multi-vibrator

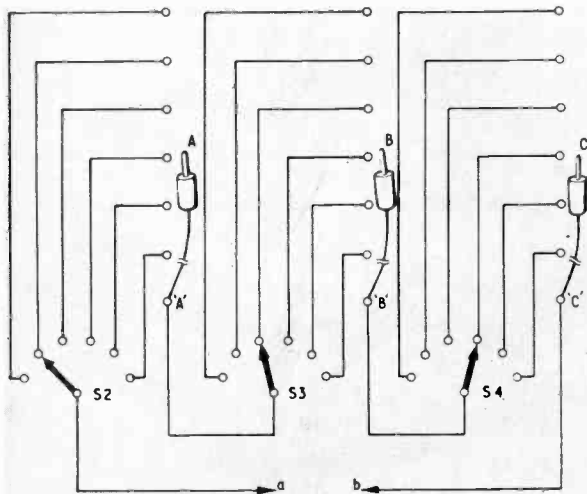

Fig. 3. The game circuitry.

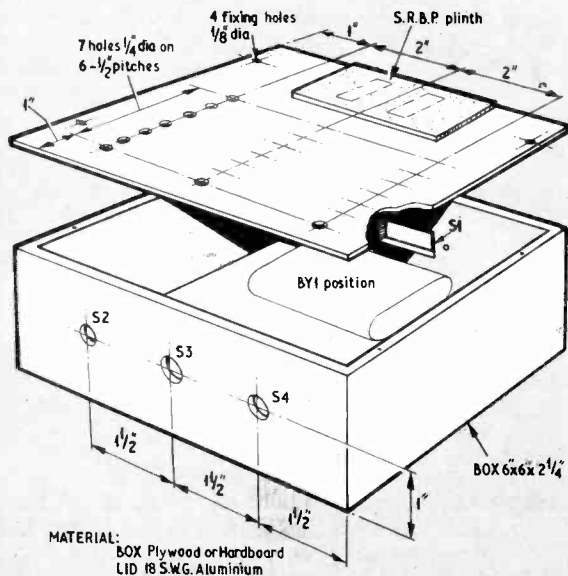

Fig. 4. Constructional details of box for the Combotron

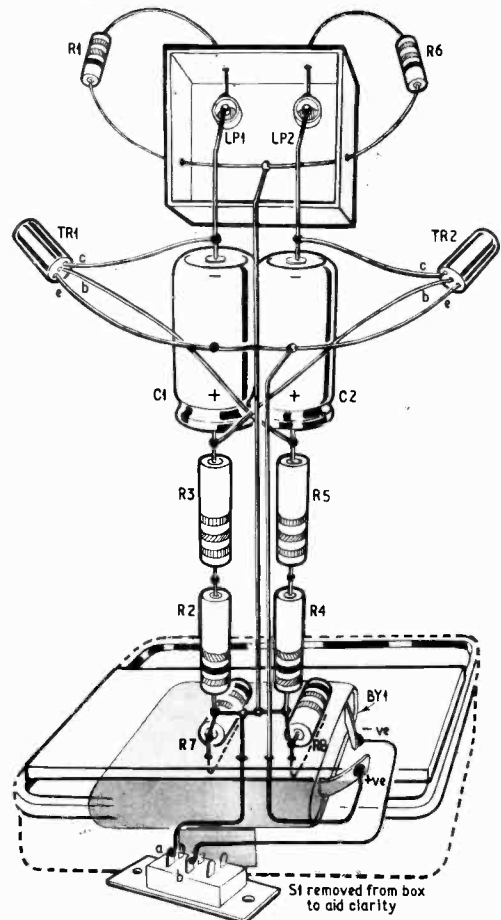

Fig. 2. The completed robot assembly. The "feet" resistors R7 and R8 have no circuit function. A rectangular piece of laminated plastics provides a plinth for the robot, and is mounted on the top of a 2oz tobacco tin

COMPONENTS . . .

Resistors

R1	15Ω 1/2W	R5	2.2kΩ 1W
R2	4.7kΩ 1W	R6	15Ω 1/2W
R3	2.2kΩ 1W	R7	} any value
R4	4.7kΩ 1W	R8	

Capacitors

C1, 2 250μF elect. 15V subminiature tubular (Radiospares) (2 off)

Transistors

TR1, 2 OC81 (Mullard) (2 off)

Lamps

LP1, 2 1.5V 0.16W subminiature 5mm tubular L.E.S. (Vitality Bulbs Ltd.)

Switches

S1 Slide switch s.p.s.t. (see text)
S2-4 Rotary switch, s.p. 8 way (Henry's Radio) (3 off)

Miscellaneous

21 4mm panel sockets; 6 plugs to suit (G. W. Smith)
Aluminium sheet 6in x 6in. Plywood for case.
4.5V flat battery

Holes should be drilled for the lamps LP1 and LP2 and these positioned. Using these as references, holes for the ear resistor leads, nose resistor, and mouth capacitor leads should be made with a No. 60 diameter drill.

A 1 watt resistor of any value, or a piece of sleeved wire, should be inserted at the nose position. One lead of the resistor is cut short with the other protruding into the box by approximately a $\frac{1}{2}$ inch. The ear resistors are then inserted, with one lead being soldered to their respective lamps and the other leads being wrapped round the projecting nose wire. For the mouth a small length of sleeved wire was inserted and retained on the other side of the box by twisting together the free ends with long nosed pliers.

The capacitor negative leads can now be fed through into the box and soldered at the unconnected lamp tags. The head construction is completed by joining a 5 inch length of sleeved wire to the three wires at the nose position and soldering this junction.

The 1 watt resistors making up the legs and feet should now be completed making sure that the joints are mechanically strong before soldering so providing a rigid support for the robot. The resistor wires at the feet should be left long at this stage.

The addition of the transistor arms is straightforward if care is taken with soldering. The base leads are extended by soldering a 2 inch piece of wire to their ends after which both are sleeved and joined to the capacitors. The emitters are then made common with a small piece of bare wire. An 8 inch piece of sleeved wire should be connected to its mid point for battery positive.

If it is not intended to incorporate the robot with the game it can be conveniently mounted on a 2oz tobacco tin using the feet wires, through holes drilled in the lid, both for retaining and connection to the slide switch S1 in Fig. 1. For added rigidity Araldite should be applied to bond the resistors and lid.

Finally the sleeved positive lead should be taken through a hole in the lid and connected to the $4\frac{1}{2}$ volt flat battery that will be housed in the tin (Fig. 2).

GAME SECTION

If the robot is to be used as an indicator with the game the game circuitry should be connected to points *a*, *b* in Fig. 1. The game circuitry thus forms a complex on/off, or combination, switch. The switch S1 can be retained as a master control, permitting the robot to be operated continuously for display purposes.

The socket panel used was a piece of 6in x 6in aluminium sheet. If the vertical rows of sockets are commenced about 1 inch from the panel edge with separation of a $\frac{1}{2}$ inch for sockets there will be ample space for the robot's attachment which will follow the same lines as detailed before.

A box for switch mounting and battery housing of dimension 6in x 6in x 2in should be constructed of plywood or hardboard. When drilling the switch holes these should be arranged slightly below the line of centre to offset any possibility of contact with sockets. Wiring of the sockets should be commenced and the leads plaited to their respective switch tags, making sure that the leads protrude by about 3 inches beyond the panel when the bunches are drawn taut.

With the robot attached to the panel wiring, wiring to the switch tags can be completed. This operation should be random for the reasons outlined previously. With battery connections made the game is complete. ★

Hey! Ever played a GLISSANDOVIBE?

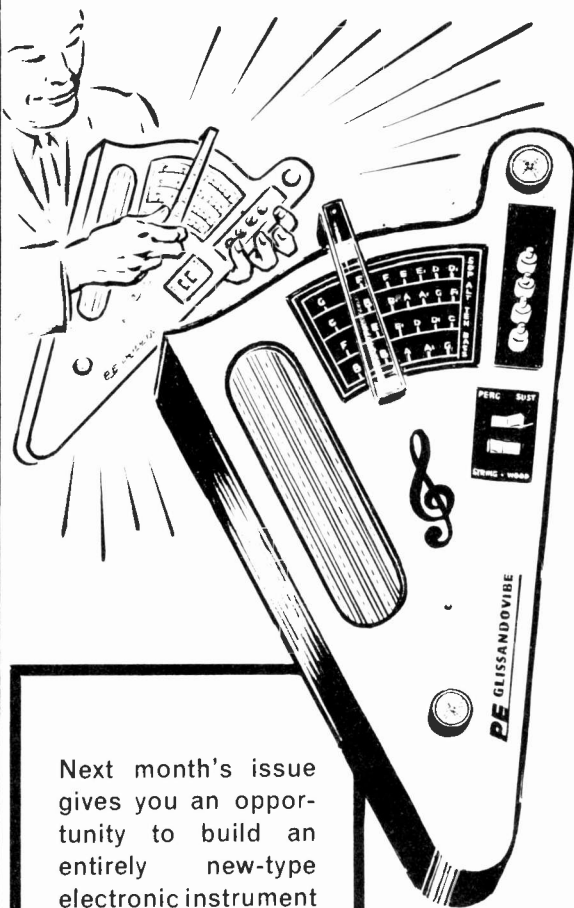

Next month's issue gives you an opportunity to build an entirely new-type electronic instrument that will bring hours of enjoyment. Designed for solo or group performance, with a frequency range of two octaves, the Glissandovibe puts glissando, vibrato, and percussive effects at your finger-tips. Make sure of the February issue now!

Also

CAR ANTI-THEFT ALARM

When fixed, immobilises the engine and gives external indication immediately the car is tampered with. Suitable also for motorcycles and other vehicles with a 12V supply.

PEAC

Second part of the Practical Electronics Analogue Computer series. Commencing construction of UNIT A.

FEBRUARY ISSUE ON SALE JAN 12

PRACTICAL ELECTRONICS

IN THIS feature we hope, from time to time, to be able to publish suggestions submitted by some of our readers on the possible improvement of projects previously described in PRACTICAL ELECTRONICS; short contributions on other subjects may be included. The aim is not to find fault or undermine the abilities or knowledge of our contributors. It may well be that the original article is *par excellence* but it could be improved or adapted to suit individual requirements. The views expressed by readers are not necessarily those of the Editor.

THE "MINI-CLIP"

THE necessity to protect semiconductor devices from overheating when soldering into circuit, needs no further elaboration to the average experimenter.

When making up transistor circuits, it is a fair assumption that the soldering-in process may well be a one-shot, "for all time" job. The usual pliers or crocodile-clip heat shunt, when soldering semiconductors, normally suffices.

However, for the experimenter who designs and builds, his budget may demand that components will be used many times over. After re-soldering many times, bending leads to effect the appropriate temporary connection, a transistor may start to complain. On the other hand, the novice may solder in a transistor with painstaking precautions, and then immediately solder many other components to the same terminal, with no thought for the device rapidly frying to death!

This novel gadget (which may be fitted and removed in seconds) will give threefold protection to semiconductors. It will provide a very good thermal shunt, give mechanical protection of the lead-out wires and seals, and by shorting all the leads together, protect against stray currents from a "leaky" soldering iron.

The Mini-clip is in essence, a miniature screw clip (Fig. 1). The transistor leads are placed between the "jaws" to within 5mm of the encapsulation and the clip screwed up. The leads are then held very firmly. On test, all three leads of a transistor were wrapped around the bit of a 25 watt iron for 3 to 5 minutes with the clip in place without the leads becoming dangerously hot. The leads below the clip may be bent at any angle and even pulled strongly with pliers without disturbing the transistor in any way.

After soldering, the clip is removed by unscrewing the jaws open to only half of the diameter of the encapsulation, the end plate may then be removed and the clip lifted off the transistor. Thus, the Mini-clip may be used in fairly confined spaces.

The dimensions given (Fig. 2) are for the "large size" (as seen in the photograph) which will accommodate the larger four-lead transistors. The dimensions may be considerably reduced for use with the small epoxy encapsulated devices now available. The prototype was made up from a small piece of brass (from a valence rail) about 2mm thick. The three pieces are cut and drilled as shown.

Fit the two 6 B.A. runners through the holes in the pressure plate, and locate their ends in the holes in the shoulder plate. Solder these screws in. Make up the thumb screw as in Fig. 2 and screw into the tapped hole. Fit the base-plate over the guide rails and the unit is then complete. Several of these clips may be constructed in an hour or so.

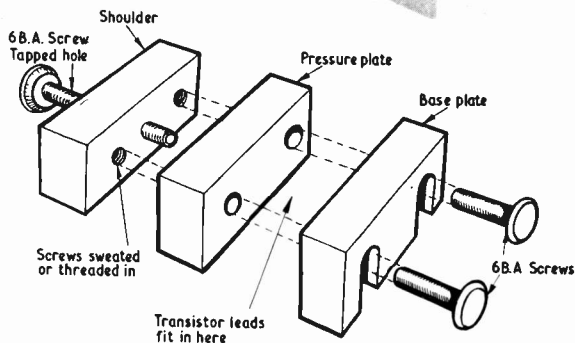
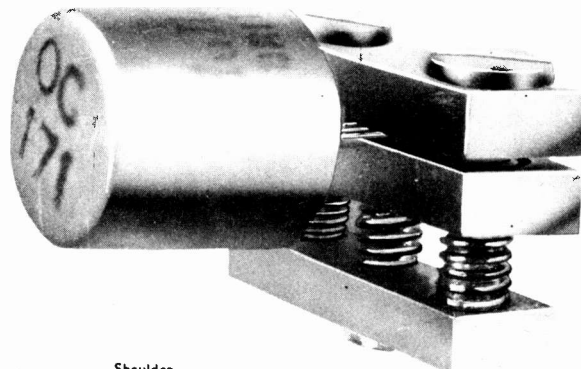

Fig. 1. Exploded view of the Mini-clip

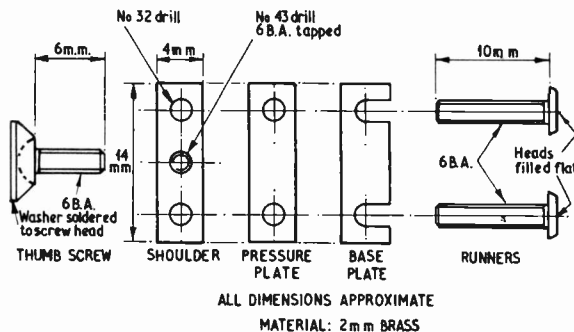

Fig. 2. Dimensions of the Mini-clip parts

It is essential to ensure that the faces of the plates which hold the transistor leads are perfectly flat and parallel, so that even pressure is exerted on all the leads.

Some transistors with tinned leads may have some irregularities on the surface which must be removed before screwing-up.

Don't forget to remove the Mini-clip before switching on for circuit testing!

D. S. Branston,
Birmingham, 14.

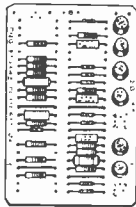

PRINTED CIRCUITS

Five assorted circuit boards with transistors, diodes, resistors, condensers, etc. Guaranteed minimum 20 transistors. Ideal for experimenters. 5 boards for 10/- P. & P. 2/-.



F.M. WIRELESS MICROPHONES

94-104Mc/s. Transistorised. Operates from 9V battery. Complete with additional secret tie-clip microphone. List £12.10.0 ONLY £8/15/0. P. & P. 2/6. These cannot be operated in U.K.

TE-800 20,000 VOLT GIANT MULTIMETER
6in full view meter. 2 colour scale. 0/2.5/10/250/1,000/5,000V a.c. 0/25/12.5/10/50/250/1,000/5,000V d.c. 0/50μA/110/100/500 mA 10A d.c. 20K/200K/2MΩ. £12/19/6. P. & P. 5/-.



NEW MODEL 500 30,000V d.p.v. With overvoltage protection, mirror scale 0.5/1.2/5/10/25/100/250/500/1,000V a.c. 0/50μA/5/50/300mA 12A d.c. 0/60hΩ/6/60MΩ. £8/17/8. Post Paid.

MODEL ZQM TRANSISTOR CHECKER

It has the fullest capacity for checking on A, B and Ico. Equally adaptable for checking diodes, etc. Spec: A: 0.7-0.9967. B: 5-200. Ico: 0-50 microamps 0-5mA. Resistance for diode 200Ω-1MΩ. Supplied complete with 9 instructions, batteries and leads. £5/19/6. P. & P. 2/6.



VARIABLE VOLTAGE TRANSFORMERS

Brand New—fully shrouded. Input 230V 50/60c/s. Output 0-260V

1A	£4.10.0
2.5A	£5.17.6
5A	£9.0.0
8A	£13.10.0
10A	£17.0.0
12A	£19.10.0
20A	£32.10.6

Post extra.



SILICON RECTIFIERS

200V P.I.V. 200mA	2/6
400V P.I.V. 5A	5/6
400V P.I.V. 3A	7/6
1,000V P.I.V. 5A	7/6
400V P.I.V. 6A	5/6
400V P.I.V. 8A	7/6
1,000V P.I.V. 650mA	6/6
800V P.I.V. 500mA	5/6
800V P.I.V. 5A	7/6
400V P.I.V. 500mA	3/6
70V P.I.V. 1A	3/6
150V P.I.V. 165mA	1/-
150V P.I.V. 25A	19/6
700V P.I.V. 100A	49/6
400V P.I.V. 3A (S.C.R.)	7/6
100V P.I.V. 5A (S.C.R.)	13/6
200V P.I.V. 5A (S.C.R.)	15/6
400V P.I.V. 5A (S.C.R.)	17/6

Discounts for quantities. Post extra.

★ TRANSISTORISED FM TUNER ★

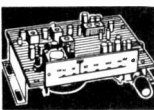

6 TRANSISTOR HIGH QUALITY TUNER. SIZE ONLY 4in x 2in. 3 I.F. stages. Double tuned discriminator. Ample output to feed most amplifiers. Operates on 9V battery. Coverage 88-108Mc/s. Ready built ready for use. Fantastic value for money. £8/10/0. P. & P. 2/6.



AVOMETERS

Supplied in excellent condition fully tested and checked. Complete with prods, leads and instructions. Model 47A £9.19.6 Model 8 £18. Model 9 £20. P. & P. 7/6 each.

TE22 SINE SQUARE WAVE AUDIO GENERATORS



Sine: 20c/s to 200 kc/s on 4 bands. Square: 20c/s to 30kc/s. Output impedance 5,000 ohms, 200/250V a.c. Supplied brand new and guaranteed with instruction manual and leads. £15. Carr. 7/6.

TE-20RF SIGNAL GENERATOR



Accurate wide range signal generator covering 120kc/s - 260 Mc/s on 6 bands. Directly calibrated Variable R.F. attenuator. Operation 200/240V a.c. Brand new with instructions £12/10/0. P. & P. 7/6. S.A.E. for details.

LAFAYETTE TE-46 RESISTANCE CAPACITY ANALYSER

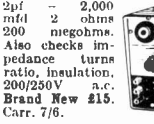

2μf - 2,000 μf/1 - 2 ohms 200 megohms. Also checks impedance turns ratio, insulation. 200/250V a.c. Brand New £15. Carr. 7/6.

ARF-100 COMBINED AF-RF SIGNAL GENERATOR



AF. SINE WAVE 20-200,000 c/s. Square wave 20-30,000 c/s. 0/3V. **HIGH IMP. 21V** P/P 600Ω 3-8V P/P. 100kc/s-300 Mc/s. Variable R.F. attenuation int/ext. modulation. Incorporates dual purpose meter to monitor AF output and % mod. on R.F. 220/240V a.c. £27/10/0. Carr. 7/6.

TE-65 VALVE VOLTMETER



High quality instrument with 28 ranges. D.c. volts 1.5-1,500V. A.c. volts 1.5-1,500V. Resistance up to 1,000 MΩ. 220/240V a.c. operation. Complete with probe and instructions. £15. P. & P. 6/-. Additional Probes available: R.F. 35/- H.V. 42/6.

Catalogue of Electronic Components and Equipment

G.W. SMITH & CO. (LONDON)

Send today 5/- P&P 1/-

CATALOGUE

- ★ ELECTRONIC COMPONENTS
- ★ TEST EQUIPMENT
- ★ COMMUNICATIONS EQUIPMENT
- ★ HI-FI EQUIPMENT

We are proud to introduce our first comprehensive catalogue of Electronic Components and Equipment. Over 150 pages fully illustrated, listing thousands of items, many at bargain prices. Free discount coupons with every catalogue. Everyone in electronics should have a copy.

50μA 32/6
100μA 27/6
500μA 25/6
1mA 22/6
5mA 22/6
10mA 22/6
20mA 22/6
50mA 22/6
100mA 27/6
500μA 25/6
50-0-50μA 29/6

CLEAR PLASTIC PANEL METERS

First grade quality Moving Coil panel meters available ex-stock. S.A.E. for illustrated leaflet. Discount for quantity. Available as follows: Type MR 38P. 1 21/32in square fronts.

100-0-100μA 27/6	200mA 22/6	100V d.c. 22/6
500-0-500μA 22/6	300mA 22/6	150V d.c. 22/6
10mA 22/6	500mA 22/6	300V d.c. 22/6
1mA 22/6	750mA 22/6	500V d.c. 22/6
2mA 22/6	1A d.c. 22/6	750V d.c. 22/6
5mA 22/6	2A d.c. 22/6	15V a.c. 22/6
10mA 22/6	5A d.c. 22/6	150V a.c. 22/6
20mA 22/6	3V d.c. 22/6	150V a.c. 22/6
50mA 22/6	10V d.c. 22/6	300V a.c. 22/6
100mA 27/6	20V d.c. 22/6	300V a.c. 22/6
500μA 25/6	150mA 22/6	50V d.c. 22/6
50-0-50μA 29/6	50V d.c. 22/6	"S" Meter 1mA

POST EXTRA. Larger sizes available—send for lists. 29/6

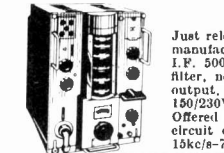

ADMIRALTY B.40 RECEIVERS

Just released by the Ministry. High quality 10 valve receiver. manufactured by Murphy. Coverage in 5 bands 650kc/s-30Mc/s. I.F. 500kc/s. Incorporates 2 R.F. and 3 I.F. stages, bandpass filter, noise limiter, crystal controlled B.F.O., calibrator, I.F. output, etc. Built-in speaker, output for phones. Operation 150/230V a.c. Size 19in x 13in x 16in. Weight 114 lb. Offered in good working condition, £22.10.0. Carr. 30/-. With circuit diagrams. Also available B.41 L.F. version of above, 15kc/s-700kc/s. £17.10.0, carr. 30/-.

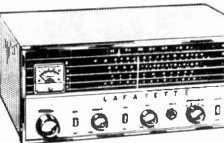

HAM-1, 4 BAND COMMUNICATION RECEIVER

4 wavebands covering 535 kc/s. to 30 Mc/s. 5 valve superhet circuit. Incorporated "S" meter B.F.O., BANDSPREAD TUNING, BUILT-IN 4in SPEAKER, FERRITE AERIAL AND EXTERNAL TELESCOPIC AERIAL. Operation 220/240V a.c. Supplied brand new with handbook. £15.15.0. Carr. 10/-.

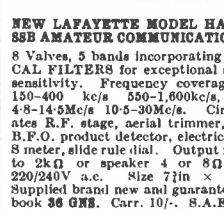

NEW LAFAYETTE MODEL HA-700 AM/CW/SSB AMATEUR COMMUNICATION RECEIVER

8 Valves, 5 bands incorporating 2 MECHANICAL FILTERS for exceptional selectivity and sensitivity. Frequency coverage on 5 bands 150-400 kc/s 550-1,600kc/s, 1.6-4.0Mc/s, 4.8-14.5Mc/s 10-6-30Mc/s. Circuit incorporates R.F. stage, aerial trimmer, noise limiter. B.F.O. product detector, electrical bandspread, 83 meter, slide rule dial. Output for phones, low to 2KΩ or speaker 4 or 8Ω. Operation 220/240V a.c. Size 7in x 13in x 10in. Supplied brand new and guaranteed with handbook 36 GNB. Carr. 10/-. S.A.E. for leaflet.

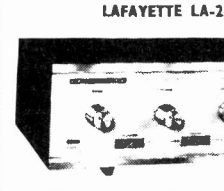

LAFAYETTE LA-224T TRANSISTOR STEREO AMPLIFIER

10 transistors, 8 diodes, 1HF music power, 30W at 8Ω. Response 30-20,000 ± 2dB at 1W. Distortion 1% or less. Inputs 3MV and 250MV. Output 3-16Ω. Separate L. and R. volume controls. Treble and bass control. Stereo phone jack. Brushed aluminium, gold anodised extruded front panel with complementary metal case. Size 10 1/2 x 3 1/2 x 7 1/2 in. Operation 115/230V a.c. £25. Carr. 7/6.

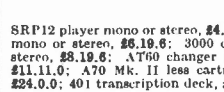

GARRARD DECKS

SRP12 player mono or stereo, £4.4.0; 1000 changer mono or stereo, £5.15.6; 2000 changer mono or stereo, £6.19.6; 3000 changer mono or stereo, £7.19.6; AT6 Mk. II mono or stereo, £11.11.0; AT60 changer mono or stereo, £10.10.0; AT60 Mk. II mono or stereo, £11.11.0; A70 Mk. II less cartridge, £12.12.0; LAB80 Mk. II changer less cartridge, £24.0.0; 401 transcription deck, £27.0.0. All plus 5/- P. & P.

G.W. SMITH & CO. (RADIO) LIMITED

Phone: GERRARD 8204/9155
Cables: SMITHEX LESQUARE
3-34 LISLE STREET, LONDON, W.C.2

BI-PRE-PAK LIMITED

TRANSISTORS PRICE

AC107	6/-	OC170	2/6
AC126	2/6	OC171	4/-
AC127	2/6	OC200	5/-
AC128	3/-	OC201	8/-
AC117	5/-	2G301	2/6
AF114	4/-	2G303	2/6
AF115	3/-	2N711	10/-
AF116	3/-	2N1302-3	4/-
AF117	4/-	2N1304-5	5/-
AF118	3/6	2N1306-7	6/-
AF119	3/6	2N1308-9	8/-
AF178	10/-	2S303	2/6
BCZ11	5/-	Power Transistors	
BFY50	15/-	OC20	10/-
BSY25	10/-	OC23	10/-
BSY26	5/-	OC25	8/-
BSY27	5/-	OC26	5/6
BSY28	5/-	OC28	7/6
BSY29	5/-	OC35	5/-
BSY95A	5/-	OC36	7/6
OC41	2/6	GF826	40/-
OC44	1/11	2N2287	20/-
OC45	1/9	Diodes	
OC71	2/6	AA42	2/-
OC72	2/6	OA10	2/-
OC73	5/-	OA70	1/9
OC81	2/6	OA79	1/9
OC81D	2/6	OA81	1/9
OC83	4/-	OA182	2/-
OC139	2/6	IN914	1/6
OC140	5/-		

BRAND NEW UNTESTED TRANSISTORS!

SAVE £'s TEST THEM YOURSELF

WE TELL YOU WHAT TYPES THEY ARE

DON'T TAKE CHANCES ON UNKNOWN LOTS

PRE-PAKS

No.	Price
A1	6 Silicon rectifiers BY100 type - 20/-
A3	20 Mixed marked and tested trans. - 20/-
A13	25 New trans. & diodes marked & tested 20/-
A15	2 Power Comp. Pair. AD161/2 - 20/-
A17	3 Sil. stud recs. 6 amp. 400 PIV BYZ12 - 20/-
A18	2 Sil. stud recs. 10 amp. 800 PIV - 20/-

B1	50 Unmarked untested, trans., new Mixed Types - 10/-
B2	4 Solar cells, inc. Book of Instructions - 10/-
B3	4 OAS gold bonded, diodes Mullard - 10/-
B5	7 Matched set. OC44,45/81D/81 + diode - 10/-
B6	15 Red spot AF. trans. or white spot RF - 10/-
B8	2 Power trans. OC26/35 type - 10/-
B9	1 Light sensitive cell. ORP12 type - 9/-
B10	10 50V trans. germ. PNP latest type - 10/-
B44	1 Tunnel diode, AEY11. 1050 Mc/s - 10/-
B21	2 Sil. recs. 10 amp., 50-100 PIV - 10/-
B45	1 Power trans. ADY22/TK400A VCB60 IC 8 Amps. PNP - 10/-
B49	2 Power trans. GET 9 VCB64 IC 8 amp. germ. PNP - 10/-
B50	2 Light sensitive cells ORP60 type - 10/-

C2	1 Unijunction, 2N2160 or 2N2646 - 15/-
C4	2 RF power trans., OC22 and BUY11 - 15/-
C15	4 Silicon PNP trans. in the 2S300 Series - 15/-
C31	4 Sil. recs. 800 PIV 1/2 amp. top hat - 15/-
C32	2 Power trans. TK400A/NKT404 VCB64 IC 8 amp. - 15/-

FREE!
PACKS OF YOUR OWN CHOICE UP TO THE VALUE OF 10/- WITH ORDERS OVER £4

TRANSISTORS ONLY 1/- EACH
SILICON • PLANAR • N.P.N. • P.N.P.

All these types available

2N929	2N706	2S131	2S103	2N696	2N1613	2S733	2N2904
2S501	2N706A	2S512	2S104	2N697	2N1711	2N726	2S731
2N2411	2N3011	2S102	2N2220	2N1507	2N1893	2N2906	2S732

All tested and guaranteed transistors—unmarked.
Manufacturers over runs for the new PRE-PAK range.

F.E.T.'s FIELD EFFECT TRANSISTORS
2N3822 'N' Channel 4 lead 15/-

Make a Rev. Counter for your Car. The 'TACHO BLOCK'. This encapsulated block will turn any 0-1mA meter into a perfectly linear and accurate rev. counter for any car. State 4 or 6 cylinder. **20/- each**

FREE CATALOGUE AND LISTS for: —
TANTALUM CAPACITORS, TRANSISTORS, RECTIFIERS & CIRCUIT DIAGRAMS, SUBSTITUTION CHART

MINIMUM ORDER 10/- CASH WITH ORDER PLEASE. Add 1/- post and packing per order. OVERSEAS ADD EXTRA FOR AIRMAIL.

THERE IS ONLY ONE BI-PRE-PAK LTD BEWARE OF IMITATIONS



FIRST EVER LOGIC KITS
Learn for yourself how computers work, even make one for yourself. Full instructions for a noughts and crosses machine, binary counters, timers, etc. L.1. 5gns. L.2. 10gns. No need to purchase both kits, you can start with L.2. which incorporates L.1.
Details Free.

NEW UNMARKED UNTESTED PAKS

25	BSY95A NPN Silicon	TRANSISTORS 10/-
10	1000 PIV 1 amp. Min. Silicon	DIODES 10/-
25	BSY26-27 NPN Silicon	TRANSISTORS 10/-
10	10 Watt Silicon All Voltages	ZENERS 10/-
25	2N1131-32 PNP Silicon	TRANSISTORS 10/-
10	4 amp. Stud. Silicon	RECTIFIERS 10/-
25	BC107-8-9 NPN Silicon	TRANSISTORS 10/-
40	1N914-6 Sub. Min. Silicon	DIODES 10/-
50	Min. Germ. High Quality	DIODES 10/-
25	2N706 A NPN Silicon	TRANSISTORS 10/-

PRE-PAK, N.605 POWER TRANSISTOR EQUIVALENT TO NKT301 **5/- each**
TANTALUM CAPACITORS **4/- each**

FREE! A WRITTEN GUARANTEE WITH ALL OUR SEMICONDUCTORS

BI-PRE-PAK LTD DEPT. A, 222-224 WEST ROAD, WESTCLIFF-ON-SEA, ESSEX
TELEPHONE: SOUTHEND (0702) 46344

TAPE STOP FOIL DEVICE

AN inexpensive auto-stop for a tape recorder is a useful addition to any machine. The one that appeared in the Tape Recorder Auto-Switch article in the January 1967 issue uses a 12V relay and suggests insulating a spare guide bollard. This is not possible on many tape decks (such as the B.S.R. TD2) and may appear at first sight to be more difficult than fitting a photocell. This is the principle described here that can be made for under £1.

To provide a pillar with two insulated contacts, a 3.5mm jack plug was mounted on the deck. This is arranged to switch a 6V relay which is powered via a rectifier from the 6.3V heater winding of the tape recorder mains transformer.

A latching circuit may be incorporated as shown in Fig. 1. This enables shorter lengths of stop foil to be used. S1 is a "reset" switch, releasing the relay.

If the recorder uses solenoid operated brakes, a latching circuit is not required. Two additional refinements are then worth adding: pause and remote pause. The circuit is given in Fig. 2, S2 being the pause control and S3 a remote start/stop. It is not considered worthwhile adding these extra facilities to a deck in which the brakes would be uncontrolled, due to the time taken for the drive mechanism to slow down.

The diode and smoothing capacitor may be mounted directly on to the tags of the relay. All mains contacts on the relay must be heavy duty types rated at 250V a.c.

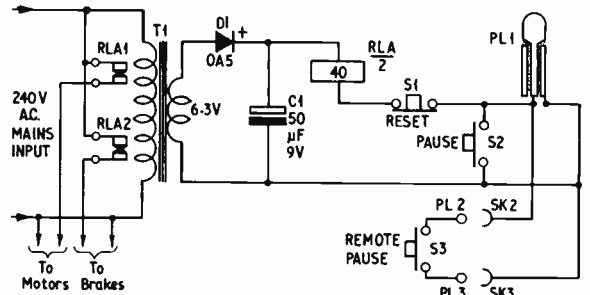
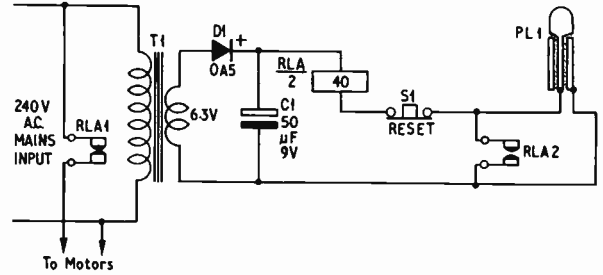

5A. The Omron type MK2/40 ohms is available from Keyswitch Relays Ltd., 120 Cricklewood Lane, London, N.W.2.

P. M. Delaney,
Poole,
Dorset.

STOPPING MODEL TRAINS

MY model locomotive controller was built in rather a hurry several months ago; however I have since drawn up a complete circuit and included a modification to obtain a more realistic performance. It appears to be usual practice for children to reduce the output voltage from maximum to zero instantaneously as the train approaches a station. A locomotive with magnetised wheels running on steel track comes to an immediate stop.

Speed versus voltage was plotted and found to be a linear function, therefore if the voltage could be made to fall in an exponential manner the above defect would be overcome. A time constant at the input to the compound emitter follower gives the desired results, as shown below.

With the switch in position A the circuit performs as before; this position is used for shunting, etc.

When starting the train a similar set of conditions occurs although the waveform is not as ideal for starting, it is a reasonable compromise. The output voltage is quite often increased from zero to 10 volts

instantaneously, causing the train to lurch away from the station. With the switch in position B acceleration is more gradual.

A note regarding construction may be of interest especially when the safety of small children is considered.

The mains transformer and fuses are housed in a separate unit, this being situated near the mains supply socket. An 8ft length of three core lead connects the 18-0-18V supply to the controller.

One side of the output is connected to earth so that the 100mA fuse in the primary can prevent a dangerous rise in output voltage should the transformer insulation become faulty.

This arrangement eliminates high voltage mains from the train set but also provides a low voltage secondary for the operation of "point" solenoids, etc.

G. H. Baker,
Romford,
Essex.

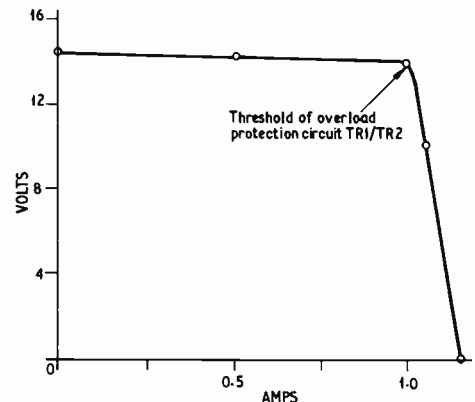
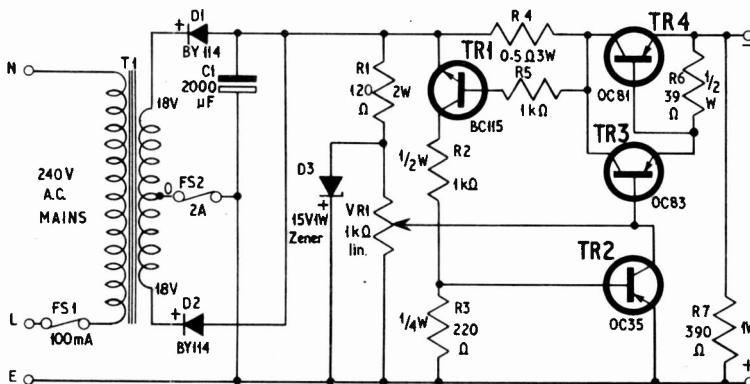

HOLOGRAPHY has been exciting a great deal of comment in the scientific circles during recent years. In the popular press this comment has tended to take the line of optimistic suggestions about three-dimensional "snap-shot" cameras, cinema, and television. While holography is potentially capable of providing these and other fascinating devices, it is scarcely out of its infancy.

Five years ago the recently invented laser was being described as "a solution in search of a problem". Holography, a thriving offspring of laser research, is today in very much the same situation. In this article we shall discuss how holograms are made, the theory behind them, and some of their applications.

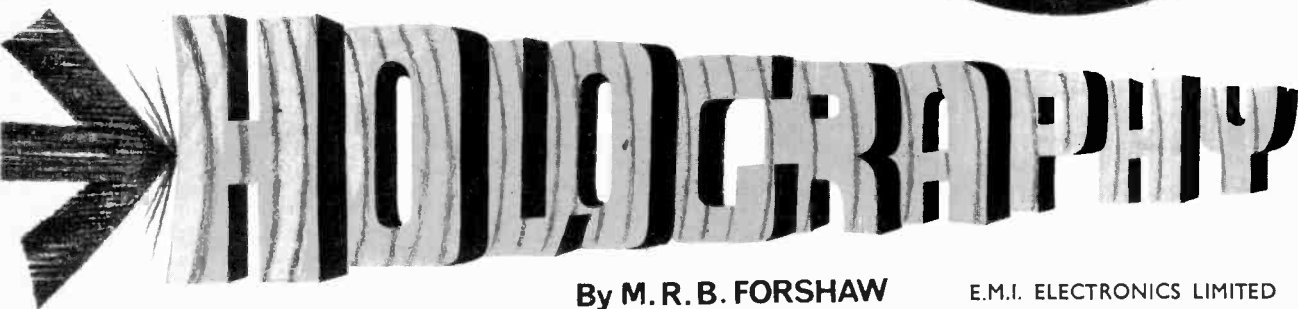
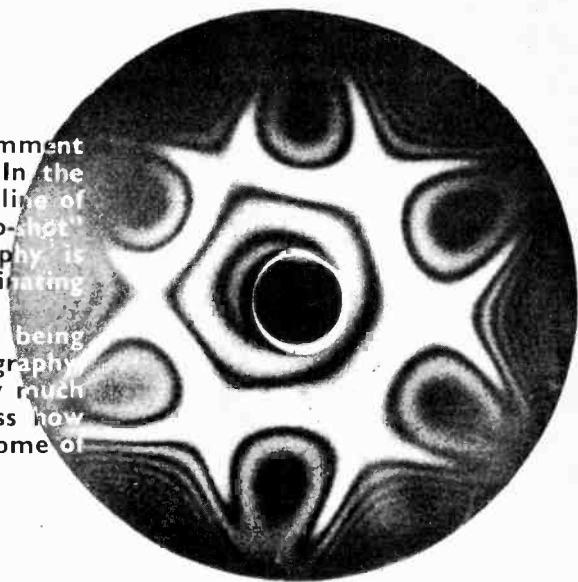

By M. R. B. FORSHAW

E.M.I. ELECTRONICS LIMITED

Fig. 1. Under the ordinary room lighting the hologram looks like an ordinary photographic plate, with little or no visible detail upon it

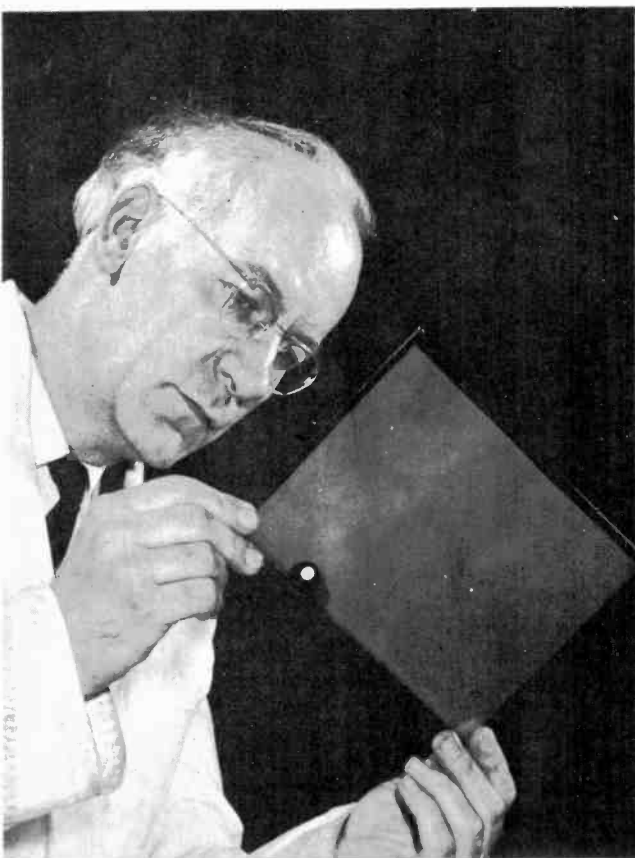

WHEN SEEN in ordinary room lighting, a hologram looks like an unexposed photographic plate, with a uniform layer of grey or "milky" emulsion on it (Fig. 1). No sign of an image, three-dimensional or otherwise, can be seen.

Suppose now that we take a helium-neon gas laser, which emits a continuous pencil beam of red light. If this narrow beam (a few millimetres in diameter) is passed through a lens, the laser light is focused to a point and then diverges. When this diverging cone of light falls on the hologram most of it passes straight through, but a fraction of the light is scattered by the emulsion. The result of this scattered light is a red image which appears to lie behind the surface of the hologram.

Fig. 2 shows how the camera is focused on the image of a toy horse, which lies behind the out-of-focus hologram frame. The hologram becomes a window, through which one can see the impressively substantial scene on the other side. In some way the hologram has recorded information about the distance to the various parts of the scene, which an ordinary two-dimensional photograph fails to do.

Instead of using a laser to illuminate the hologram, suppose that a "point" source of white light is used; a quartz-iodine car headlamp bulb is a convenient approximation to such a point source. The image which results is usually unrecognisable; a spectrally dispersed rainbow of colours is all that results. Putting a red gelatine filter over the white light enables us to recognise the image on the other side of the plate, but the finer details of the scene are blurred or indistinguishable.

The purpose of this second experiment is to show that monochromatic (single frequency) light gives the

best reconstruction from a hologram: the helium-neon gas laser is a near-ideal source of such monochromatic light. A tolerable reconstruction can be obtained with a non-laser source (the white light and red filter) if it is nearly monochromatic.

A laser is not only the best source for *viewing* holograms: it is also the most suitable source for making them. One can make holograms with a non-laser source such as a mercury arc (the first ever holograms were made by Professor D. Gabor in 1947 using mercury lamps) but the results are visually unimpressive and nowadays nearly all holograms are made with laser sources. The reason for this is explained later.

MAKING HOLOGRAMS

Making a hologram is a relatively simple process. Fig. 3 illustrates one holographic "camera" layout which has proved convenient and adaptable. Light from the laser is split into two beams by the beam splitter—a piece of ordinary unsilvered glass. Most of the light passes straight through this glass plate and is reflected from the plane mirror M1. This reflected light passes through the lens L1 which illuminates the object O. The light scattered from the object then falls directly on the hologram.

The rest of the laser beam is reflected from the beam splitter, bounces off mirror M2 and is expanded by lenses L2 and L3 to a wide collimated beam of light which also illuminates the hologram. This second beam is called the "reference" beam, and it is the interaction between the reference beam and the light scattered from the object which affects the photographic plate and produces the hologram. To make the hologram one simply switches the laser on for the required exposure, perhaps ten seconds, and then develops the photographic plate in the normal way.

There are,snags, of course. For reasons which will become clear all the apparatus has to be kept stationary to within one-tenth of a wavelength of light during the exposure. This is done by mounting everything on a firm table, with foam rubber under the table to isolate the equipment from shocks.

Very fine grain photographic plates must be used if wide angle scenes are to be recorded. The photographic plates most often used in holography have this extremely fine grain, but only at the expense of film speed. For comparison, an ordinary fine grain film, with a film speed of about 100 ASA, will resolve up to 50 lines per millimetre. The special holographic plates can

resolve up to 5,000 lines per millimetre, but their speed is only 0.03 ASA.

After the plate has been developed, processed, and dried, it is then illuminated by the "reference" source by itself (the objects having been removed in the meantime) and the three-dimensional image is seen as in Fig. 2.

PRINCIPLES

The underlying principle of holography can be expressed quite briefly. Like radiowaves and microwaves, light is an electromagnetic wave phenomenon.

If two waves, A from the object and B from the reference source, have exactly the same wavelength, then they are said to be mutually coherent. They are able to interfere with one another and produce a stationary wave pattern which is recorded by the photographic plate as a detailed fringe structure (see Fig. 4). This photographic plate, with the fringe pattern recorded upon it, is the hologram. If the photographic plate is illuminated by the reference wavefront B, then the recorded fringe pattern behaves like an optical diffraction grating and diffracts (scatters) some of the light. This diffracted light has exactly the same form as wavefront A (the object wave). The reconstructed object thus "appears" once more in its original position.

If the object and reference waves A and B are not monochromatic (i.e. if they contain more than one wavelength) then interference still occurs but each wavelength lays down its own interference pattern and the resulting average fringe structure recorded in the hologram becomes blurred or disappears completely. This is why monochromatic lasers have to be used to make holograms.

It was mentioned earlier that, in order to make a good hologram, all the equipment had to be kept steady to within a fraction of a wavelength. This stationary condition prevents the recorded fringes from being smeared out and lost. This blurring of the recorded fringes can be turned to good use.

As an example, suppose that halfway through the recording of a metal plate (simulating a bridge), we were to load it with a model car (see Fig. 5). The mirror behind the model car provides a plan, as well as a side view of the bridge. The bridge will deflect under the load and some of the interference fringes recorded by the hologram will be blurred. These fringes, once destroyed, cannot reconstruct their

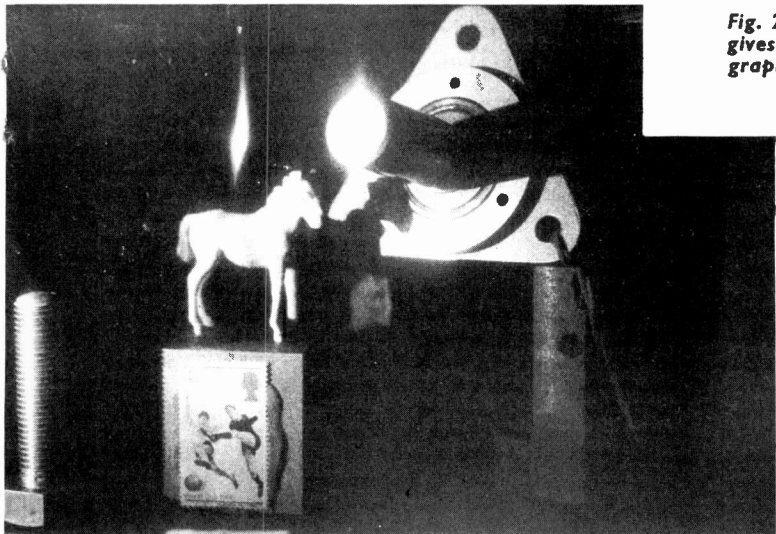

Fig. 2. Illumination of the hologram with red laser light gives a three-dimensional image lying behind the photographic plate



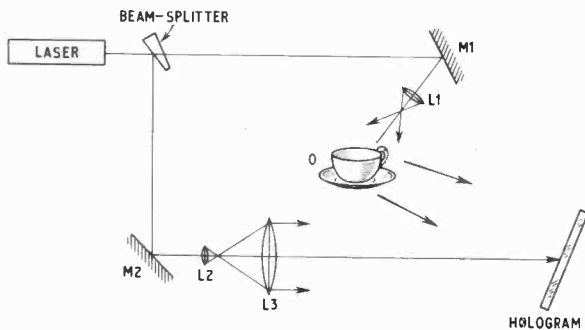
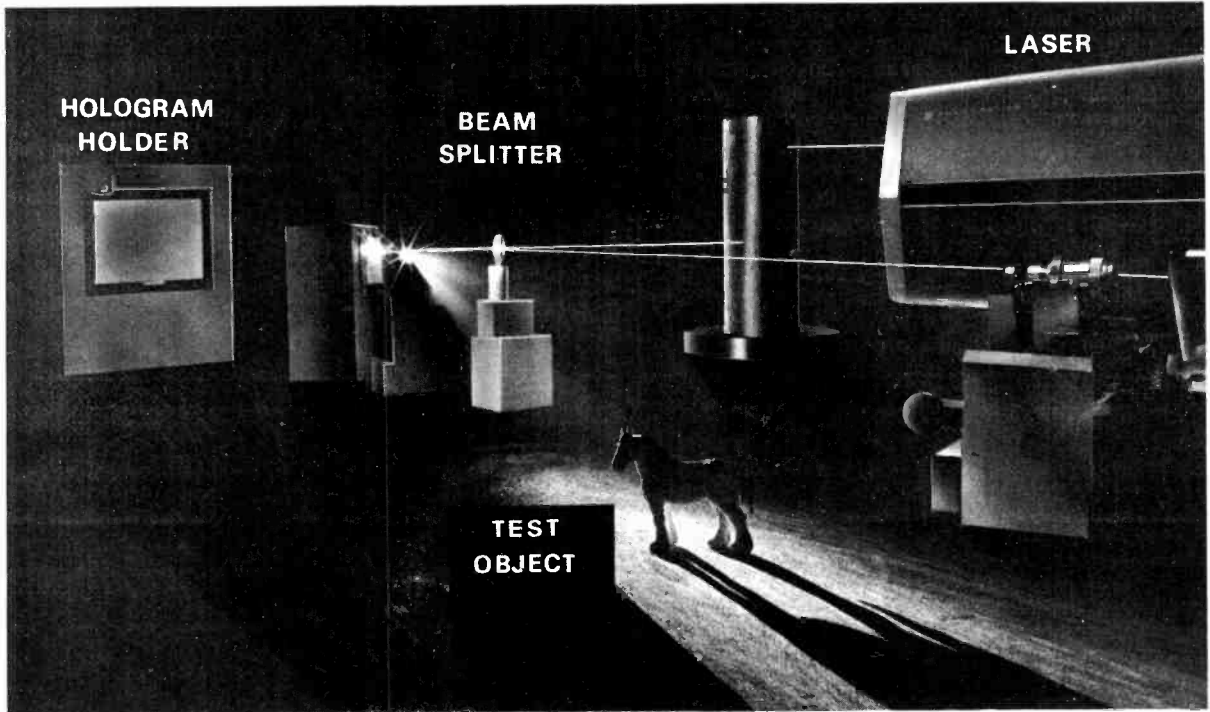

Fig. 3. The apparatus required for making a hologram

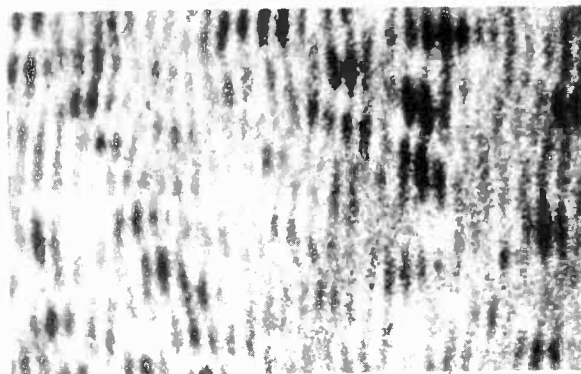

Fig. 4. Enlargement of part of a hologram (about 1,000 lines per millimetre)

corresponding images, and parts of the bridge will be invisible in the reconstructed image. Fig. 6 shows how different parts of the bridge have been deflected by varying amounts. The deflection can be calculated quite readily because each dark ring in the picture represents a deflection of one half wavelength of light.

Almost any sort of small movement or vibration can be detected by this technique which is called holographic interferometry. It is used very successfully in wind tunnels to obtain three dimensional pictures of the air flow patterns round aircraft models. It can be used to measure stress in mechanical structures, to measure thermal expansion or "creep", or to measure the amplitude of vibration of objects such as quartz crystals or loudspeaker cones.

Fig. 7 shows a holographic image of a loudspeaker diaphragm undergoing small periodic oscillations; each dark zone represents about one half of a wavelength of light flexure of the diaphragm. This is a measurement which is readily made using holography. There is no need to touch the object in any way while making the measurement, and so the vibration is unaffected by the measurement.

INTERFERENCE PATTERNS

Another interesting facet of holographic interferometry is the production of "live" interference patterns. Take as an example the bridge shown earlier, but without disturbing the apparatus during the exposure. If the hologram is developed and put back in exactly its original position, then on looking through the hologram we see the original object and its holographic image superimposed. If the object and image are perfectly aligned, nothing unusual is seen, but if the bridge is now loaded by the toy car then "live" interference patterns are seen. These are similar in appearance to those in Fig. 6, but can vary as the car is moved along the bridge. "Real-time" measurements can be made in preference to the "frozen" patterns shown in Fig. 6.

Numerous other applications are being investigated in laboratories throughout the world—three-dimensional microscopy, pattern recognition devices, holograms made with microwaves and ultrasonic waves, and a variety of experiments concerned with the use of holograms in visual display systems. Work on the last item includes the development of a new type of hologram which, despite the remarks in the opening paragraphs, can be viewed with unfiltered white light sources.

This last type of hologram is called a reflection hologram, or sometimes a "white light" hologram. The "camera" arrangement used to make reflection holograms differs from that shown in Fig. 3. Instead of the object and reference beams converging onto the same side of the photographic plate, as in Fig. 3, they fall on opposite sides of the plate. The resulting interference pattern recorded in the emulsion differs from that in an "ordinary" hologram as Fig. 8 shows. Closely spaced layers of silver, half a wavelength of light apart, are stacked through the thickness of the emulsion. Even though the emulsion is very thin (about 1.5×10^{-3} cm) several dozen layers can still be registered.

These reflection holograms require a different viewing technique from that used for ordinary "transmission" holograms. Fig. 9 compares the two viewing methods. Ordinary, transmission holograms require a laser, mercury lamp, or other monochromatic source for viewing. Reflection holograms, as their name implies, are viewed by reflection and give a single-colour image with any "point" white light source, such as a car headlamp or torch bulb—even sunlight gives a recognisable image.

There are two main reasons why reflection holograms are not more widely used. First, the reconstructed images are not very bright; second, a colour change occurs between recording and viewing, that is to say a reflection hologram made with *red* laser gives a *green* image.

The explanation of the faintness and colour change of the image is as follows. When we shine white light onto the reflection hologram, most of it passes straight through the thin emulsion, but light which has a wavelength corresponding to the spacing of the silver

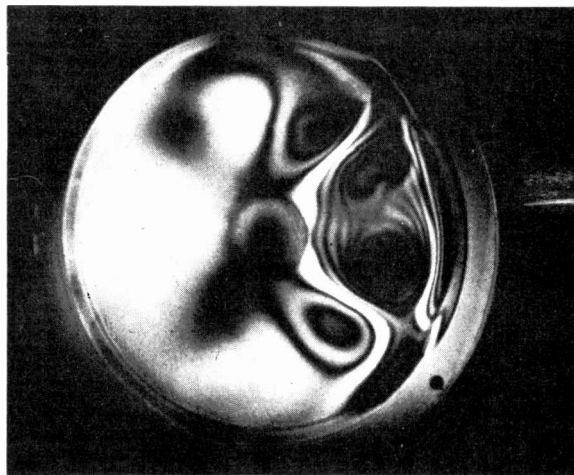

Fig. 7. Holographic interferometry shows that this faulty loudspeaker diaphragm is only vibrating over half its surface. The heading photograph at the beginning of this article shows the holographic image of a 40cm sonic transducer, designed for underwater operation, while the transducer was vibrating. The brightest regions correspond to the stationary nodal regions

layers (see Fig. 8) is selectively reflected. The action of the stacked layers is to pick out a narrow band of wavelengths and reflect them towards the viewer, as indicated in Fig. 9. Because the emulsion is so thin, not much of the light is reflected and so the image is very faint.

The change in colour between making and viewing the hologram is due to the leaching of the silver salts from the emulsion during the fixing stage. The emulsion shrinks on drying, and the layers which were originally half the wavelength of red light apart contract to a spacing of half the wavelength of green light—we therefore see a green image. By dampening the emulsion the correct colour can be recovered temporarily before the gelatine dries out once more.

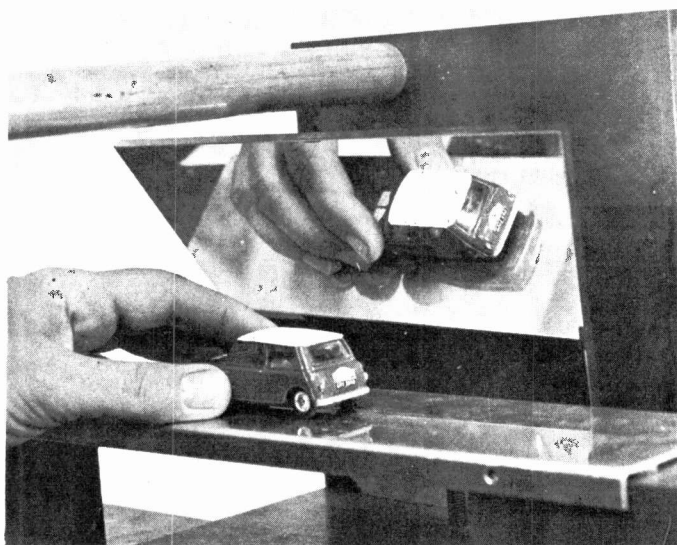
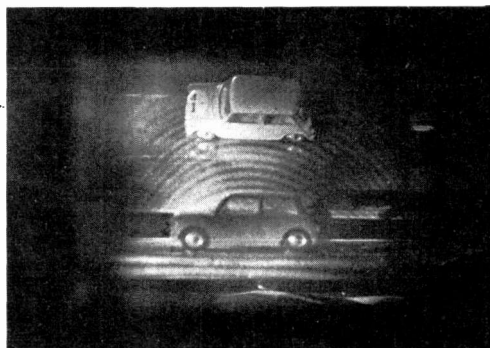

Fig. 5 (left). A toy car is placed on the "bridge" halfway through the holographic exposure

Fig. 6 (below). The holographic image shows how the weight of the car has deflected the bridge—each dark semi-circle represents half a wavelength of light deflection



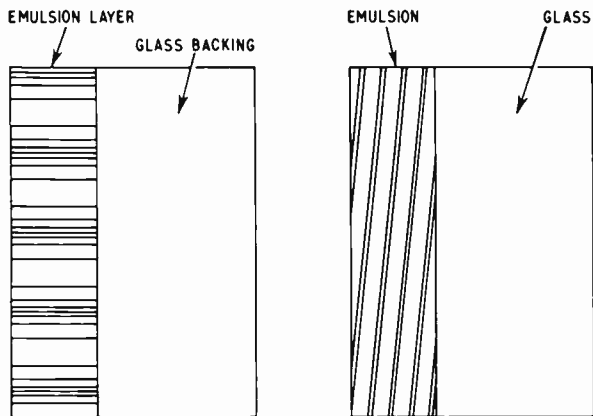

Fig. 8. The interference fringes layed down in a reflection hologram (right) differ from those recorded in an ordinary "transmission" hologram

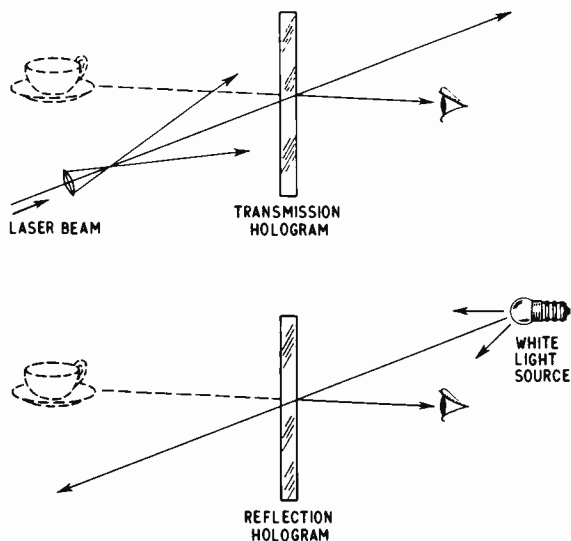

Fig. 9. Viewing transmission holograms and reflection holograms

You may have noticed that the images recorded in the holograms are of small objects, no more than a foot or so across. This is not due to a shortage of laser light. The reason is that even lasers are not sufficiently monochromatic but emit light with a narrow, but finite bandwidth. Referring to Fig. 3, the object light travels from the beam splitter, via M1, L1 and the object, to the hologram. If this object light gets out of step with the reference light, travelling via M2 L2 L3, by more than six inches or so, then it turns out that we are unable to record any interference fringes on the hologram—the two beams are said to be mutually incoherent. It is possible to make sufficiently monochromatic lasers to look at large objects, but a lot of light is lost in reducing the bandwidth.

The other problem in making holograms, that of keeping the equipment stationary during the exposure,

can be overcome by the use of pulsed lasers. A pulsed ruby laser can be made to emit a 10 nanosecond burst of light. Moving objects can thus be "frozen", and holograms have been made of bullets travelling at hundreds of feet a second.

FUTURE DEVELOPMENTS

We can now look to the future and see how holography may develop. At the present time most effort seems to be going into interferometric applications, where small object movements require measuring. Various workers in the U.S.A. have made multi-colour reflection holograms—by using different coloured lasers in making the hologram a multi-coloured image can be obtained. A lot of work has still to be done however, before other than very small objects can be imaged in colour.

Projects such as holographic television are even less developed. At least two big problems remain unsolved—the nature of the "television tube", and the large bandwidths required. If we recall that a hologram is a "window" through which we look at the scene beyond, then it is clear that the "window-frame" has to be quite large in order not to intrude on the viewer. Since the picture has to change at about 25 frames per second, we must "read in" the hologram onto the screen at this rate, and also erase it. Unfortunately, an ordinary television tube cannot be used to project holograms, and the possible alternatives, such as the existing Eidophor projection television system, simply do not have the image resolution required.

This brings us to the other problem, that of bandwidth. Suppose that our hologram window is one foot square. The required fringe detail in the hologram is about 1,000 lines per mm (see Fig. 4)—thus the number of "picture points" required is about 10^{11} . To project this at a rate of 25 frames per second requires the enormous electrical bandwidth of 2.5 tera-cycles per second. Despite the possibilities of bandwidth compression techniques, it is evident that an acceptable holographic television system is still a number of years away.

There is, however, no need for gloom about the prospects for holography. After a protracted infancy, from 1947 to 1964, the last three years have shown considerable improvements in equipment and technique, and this progress is still continuing—the future prospects for holography look distinctly inviting. ★

PRACTICAL ELECTRONICS

● BINDERS

Easi-binders with a special pocket for storing blueprints and data sheets, etc., are available price 14s 6d inclusive of postage. State whether "Vol. 1", "Vol. 2", "Vol. 3" or "Vol. 4" is required.

Orders should be addressed to the Binding Department, George Newnes Ltd., Tower House, Southampton Street, London, W.C.2.

CURRENTLY FITTED TO OVER 100 MODELS BY MAJOR MANUFACTURERS

BRING YOUR RECORD PLAYER UP TO DATE WITH

Sonotone **TCL**

HIGH FIDELITY STEREPHONIC CERAMIC CARTRIDGES

Sonotone 9TA SERIES. Superior quality cartridges offering extremely high compliance for a cartridge with dual styli. Tracking weights as low as 1-3 gm. allow reproduction from heavy modulated records without distortion on most changers. Standard $\frac{1}{4}$ " fixing centres. Prices: Sapphire £2.18.10. Tax paid. Diamond £3.16.7. Tax paid. Other types available. Send for leaflet.

metrosound

metrosound manufacturing co. ltd.
bridge works, wallace road,
london, n.1. tel. 01-226 8641/2/3



TRANSISTOR STEREO 8 + 8

A really first-class Hi-Fi Stereo Amplifier Kit. Uses 14 transistors giving 8 watts push-pull output per channel. (16 W mono). Integrated pre-amp with Bass, Treble and Volume controls. Suitable for use with Ceramic or Crystal cartridges. Output stage for any speakers from 3 to 15 ohms. Compact design, all parts supplied including drilled metal work, Cir-Kit board, attractive front panel, knobs, wire, solder, nuts, bolts—no extras to buy. Simple step by step instructions enable any constructor to build an amplifier to be proud of.

Brief Specification: Freq. response ± 3 db 20-20,000 c/s. Bass boost approx. to +12 db. Treble cut approx. to -16 db. Negative feedback 18 db over main amp. Power requirements 25 V at 0.6 amp.

PRICES

Amplifier Kit	£9.10.0	P. & P. 4/6
Power Pack Kit	£2.10.0	P. & P. 4/-
Cabinet (as illus.)	£2.10.0	P. & P. 5/6

(Special offer—£14.10.0. Post Free if all above ordered at same time.)

Circuit diagram, construction details and parts list (free with kit) 1/6 (S.A.E.)

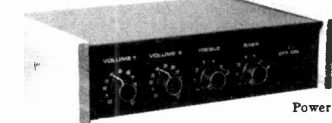

STEREO AMPLIFIER

Incorporating 2 ECL86s and 1 EZ80, heavy duty, double wound mains transformer. Output 4 watts per channel. Full tone and volume controls. Absolutely complete.

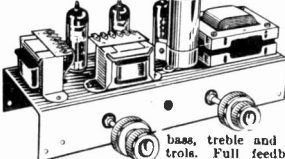

ONLY £4.19.6
P. & P. 8/-
Super Deluxe version with ECL86 valves, sep. bass, treble and balance controls. Full feedback. 8 gs. P. & P. 8/-.

3-VALVE AUDIO AMPLIFIER MODEL HA34

Designed for Hi-Fi reproduction of records. A.C. Mains operation. Ready built on plexiglass heavy gauge metal chassis, size 7 1/2 in. w. x 4 in. d. x 4 1/2 in. h. Incorporates ECC83, EL84, EZ80 valves. Heavy duty, double wound mains transformer and output transformer matched for 3 ohm speaker, separate Bass, Treble and volume controls. Negative feedback line. Output 4 1/2 watts. Front panel can be detached and leads extended for remote mounting of controls. Complete with knobs, valves, etc., wired and tested for only **£4.5.0**. P. & P. 6/-.

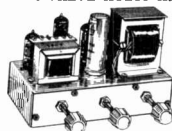

HEL "FOUR" AMPLIFIER KIT. Similar in appearance to HA34 above but employs entirely different and advanced circuitry. Complete set of parts, etc. 7/6. P. & P. 6/-.

LATEST COLLARO MAGNAVOX 363 STEREO TAPE DECK. Three speeds, 4 track, takes up to 7in. spools. **£12.10.0**, Plus 7/6 Carr. & Ins. (Tapes extra). **QUALITY PORTABLE TAPE RECORDER CASE.** Brand new. Beautifully made. Only 4/6. P. & P. 8/6. **Dual Purpose Bulk Tape Eraser and Tape Head Demagnetiser 35/-**. P. & P. 3/-.

4-SPEED RECORD PLAYER BARGAINS

Mains Models. All brand new in maker's original packing.

SINGLE PLAYERS

B.S.R. TU/12	£3.8.6.	Carr. 5/6
GARRARD SP25 De Luxe	£10.18.6.	Carr. 5/6
B.S.R. G/7 with unit mounted pickup arm.	£4.18.8.	Carr. 5/6

AUTO CHANGERS

Latest B.S.R. UA25 Super slim	£6 2 6	Carr. 6/6 on each.
GARRARD 1000 with Hi-Fi cart.	£6 19 6	
GARRARD 2000 £7 10 0; GARRARD 3000	£5 15 0	
LATEST GARRARD AT60 Mk. II	£12 0 0	

All the above units are complete with mono head and sapphire stylus or can be supplied with compatible stereo head for 12/6 extra.

BRAND NEW CARTRIDGE BARGAINS! ACOS GP69-1 MONO CARTRIDGE. For E.P. and L.P. Complete with stylus. **ONLY 12/6**. P. & P. 1/-.
SONOTONE STAEIC Compatible Stereo Cartridge with diamond stylus 50/- or with sapphire stylus 40/- P. & P. 1/- each.

QUALITY RECORD PLAYER AMPLIFIER

A top-quality record player amplifier employing heavy duty double wound mains transformer, ECC83, EL84, EZ80 valves. Separate Bass, Treble and Volume controls. Complete with output transformer matched for 3 ohm speaker. Size 7 1/2 in. w. x 3 in. d. x 6 in. h. Ready built and tested. **PRICE 69/6**. P. & P. 6/-.
ALSO AVAILABLE mounted on board with output transformer and speaker ready to fit into cabinet below. **PRICE 89/6**. P. & P. 7/6.

DE LUXE QUALITY PORTABLE R/P CABINET

Uncut motor board size 14 1/2 in. x 12 in. clearance 2in. below, 4 1/2 in. above. Will take above amplifier and any B.S.R. or GARRARD Autochanger or Single Player Unit (except AT60 and SP25). Size 18 in. x 15 in. x 8 in. **PRICE £3.8.6**. P. & P. 9/6.

VYNAB AND BEXINE SPEAKER AND CABINET FABRICS app. 54in. wide. Usually 35/- yd., our price 13/6 per yd. length. P. & P. 2/6. (min. 1yd.) S.A.E. for samples.

BRAND NEW 3 OHM LOUDSPEAKERS

5in., 12/6; 6 1/2 in., 15/-; 8in., 22/6; 10in., 27/6; 7in. x 4in. 16/-; 10in. x 8in., 27/6.
E.M.I. 8in. x 8in. with high flux magnet 21/-.
E.M.I. 13 1/2 in. x 8in. with high flux ceramic magnet, 42/- (15 ohm 45/-). P. & P. 2/-; 6 1/2 in. x 8in. 2/6, 10in. x 12in. 3/6 per speaker.

BRAND NEW. 12in. 15w. H/D Speakers, 3 or 15 ohm. Current production by well-known British maker. Offered below list price at 89/6. P. & P. 5/-.
Guitar models: 25w. 85.5.0; 35w. 23.8.0.
E.M.I. 9 1/2 in. HEAVY DUTY TWEETERS. Powerful ceramic magnet. Available in 3, 8 or 15 ohms 15/- P. & P. 2/6.

85 OHM SPEAKERS

3 1/2 in. 12/6; 7 x 4 in. 21/- P. & P. 2/- per speaker.

HIGH GAIN 4 TRANSISTOR PRINTED CIRCUIT AMPLIFIER KIT

Type TAI
● Peak output in excess of 1 1/2 watts.
● All standard British components.
● Built on printed circuit panel size 6 x 3in.
● Generous size Driver and Output Transformers.
● Output transformer tapped for 3 ohm and 15 ohm speakers.
● Transistors (GET 114 or 81 Mullard OC81D and matched pair of OC81 o/p).
● 9 volt operation.
● Everything supplied, wires, battery clips, solder, etc.
● Comprehensive easy to follow instructions and circuit diagram 2/6 (Free with Kit). All parts sold separately. **SPECIAL PRICE 45/-**. P. & P. 3/-. Also ready built and tested. 52/6. P. & P. 3/-.

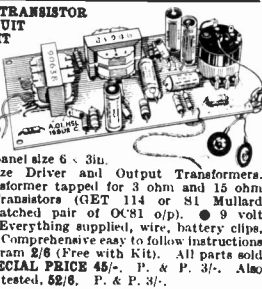

10 1/4 WATT HI-FI AMPLIFIER KIT

A stylishly finished monaural amplifier with an output of 14 watts from 2 EL84s in push-pull. Super reproduction of both music and speech, with negligible hum. Separate inputs for mike and gram allow records and announcements to follow each other. Fully shrouded section wound output transformer to match 3-15Ω speaker and 2 independent volume controls, and separate bass and treble controls are provided giving good lift and cut. Valve line-up 2 EL84s, ECC83, EF86, and EZ80 rectifier. Simple instruction booklet 2/6. (Free with parts.) All parts sold separately. **ONLY £7.9.8**. P. & P. 8/6. Also available ready built and tested complete with std. input sockets, **£9.5.0**. P. & P. 8/6.

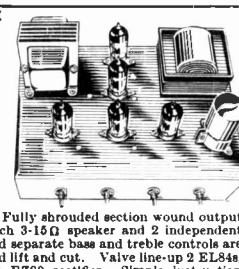

MAINS TRANSFORMER.

For transistor power supplies. Pri. 200/240v. Sec. 9-C: 9v. at 500 mA. 11/- P. & P. 2/6.

MAINS TRANSFORMER.

For transistor power supplies. Tapped pri 200-250v. Sec. 40-0-40 at 1 amp (with electrostatic screen) and 6.3v. at 5 amp for dial lamps etc. Drop thro' mounting. Stack size 1 1/2 in. x 3 1/2 in. 27/6. P. & P. 4/6.

MATCHED PAIR OF 2 WATT TRANSISTOR DRIVER AND OUTPUT TRANSFORMERS.

Stack size 1 1/2 x 1 1/2 in. Output taps tapped for 3 ohm and 15 ohm output. 10/- pair plus 2/- P. & P.

7-10 watt OUTPUT TRANSFORMERS to match pair of ECL 86's in push-pull to 3 ohm output.

ONLY 11/- P. & P. 2/6.

10-12 watt OUTPUT TRANSFORMERS.

Size 2 1/2 in. x 2 in. Clamp fitting. For two EL84's in push-pull. State 3 or 15 ohm impedance. 12/6. P. & P. 2/6.

VIBRATORS.

Large selection of 2, 4, 6, 12, 24 and 32 Volt. Non-synch. 8/6; Synch. 10/- P. & P. 1/6 per vibrator. S.A.E. with all enquiries.

ACOS HIGH IMPEDANCE CRYSTAL STICK MIKES.

Listed at 42/-. Our price, 21/- P. & P. 1/6.

ACOS CRYSTAL MIKES.

High imp. For desk or hand use. High sensitivity, 18/6. P. & P. 1/6.

SPECIAL OFFER! MOVING COIL MIKE.

Fitted on/off switch for remote control. High quality. High or Low impedance. (State imp. reqd.)

BARGAIN PRICE 30/-

P. & P. 2/6.

FM/AM TUNER HEAD

Beautifully designed and precision engineered by Dornier and Wadsworth Ltd. Supplied ready fitted with twin '0005 tuning condenser for AM connection. Preamplified FM section covers 86-102 Mc/s. I.F. output 107 Mc/s. Complete with ECC85 (6L12) valve and full circuit diagram of tuner head. Another special bulk purchase enables us to offer these at 27/6 each. P. & P. 3/-. Order quickly! Limited number also available with precision geared 3:1 reduction drive. 30/- P. & P. 3/-.

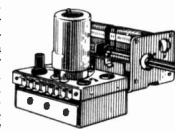

MATCHED PAIR AM/FM I.F.'s.

Comprising 1st I.F. and 2nd I.F. discriminator. (465 Kc/s/10.7 Mc/s). Size 1 1/2 in. x 2 1/2 in. H. Will match above tuner head. 11/- pair. P. & P. 2/-.

TURRET TUNERS

by famous maker. Brand new and unused. Complete with PCC84 and PCF80 valves 34-38 Mc/s IF. Biscuits for Channel 1 to 5 and 8 and 9. Circuit diagram supplied. **ONLY 25/-** each. P. & P. 3/9.

GORLER P.M. TUNER HEAD.

88-100 Mc/s 10.7 Mc/s I.F. 15/- Plus 2/- P. & P. (ECC85 valves, 8/6 extra).

6-WAY NON-TANGLE TELEPHONE CABLE.

Latest spring back coil type, extends 12in. to 4ft. 6in. **ONLY 6/-** each. P. & P. 1/6.

S.T.C. SILICON AVALANCHE HALF-WAVE RECTIFIERS.

Type RAS. 608 AF, 6 amps. 960 P.I.V. 1in. long x 1/2 in. dia. approx. List 50/- OUR PRICE 8/6. Post Free.

NEON A.C. MAINS INDICATOR.

For panel mounting, cut out size 1 1/2 x 1 1/2 in. deep inc. terminal. White case with lens giving brighter light. For mains 200/250v. 2/6 each. P. & P. 6d. (6 or more post free).

HARVERSON SURPLUS CO. LTD.

170 HIGH ST., MERTON, S.W.19 01-540 3985

Open all day Saturday Early closing Wed., 1 p.m.

A few minutes from South Wimbledon Tube Station. (Please write clearly)
OVERSEAS P. & P. CHARGED EXTRA. S.A.E. with all enquiries

SHAVER ADAPTOR

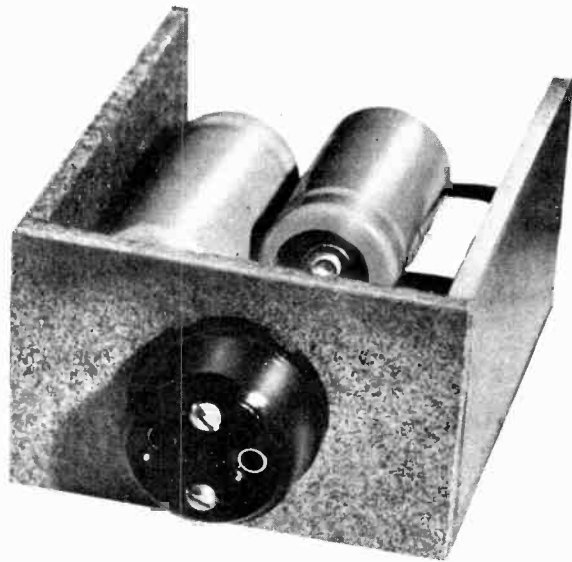

By
S.F. HANNAFORD



THE voltage doubler described here was built to enable a 200–240 volt a.c./d.c. electric shaver to be used on 100–115 volt a.c. mains when travelling abroad. The output is 200–240 volt d.c. depending on the input voltage. The razor was found on test to take 60 to 70mA at 240 volts, the output of the voltage doubler being ample for this as the rectifiers are rated at 500mA at 250 volts. The circuit is shown in Fig. 1.

The 16 μ F 150 volt working capacitors were used because of their small size, but are not as easy to obtain as the higher voltage types; these may be used instead but will make the unit more bulky.

CONSTRUCTION

The two capacitors are soldered to a six-way tag strip and arranged side by side, with the positive of one capacitor joined to the negative of the other, see Fig. 2. Where the ends of the capacitors are soldered to one tag a lead from the 110–115 volt flex should also be soldered on to the same tag.

The rectifiers are soldered to the opposite ends of the capacitors together with the output leads. It is important to observe the polarities of the rectifiers and capacitors. When soldering, a pair of pliers should be used to act as a heat shunt from the leads.

The other ends of the rectifiers are soldered together on to the tagstrip and the remaining 110–115 volt lead is soldered to this junction point.

Once all the wiring to the tag strip is completed it should be fitted in a small hardboard, or similar material, case. A large diameter cardboard roll would be ideal. The output leads can be wired to a socket bolted to the end of the case or can be the actual shaver leads.

It is advisable that the components be mounted in an insulated case, but if a metallic case is used, this must be connected to earth. *The 240V output terminals must not be connected to the mains supply.* ★

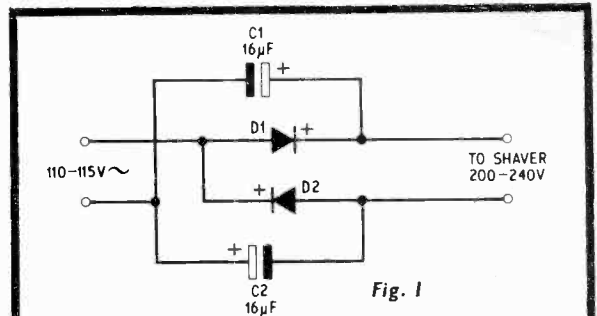

Fig. 1

COMPONENTS . . .

Capacitors

C1, C2 16 μ F elect. 350V (2 off)

Diodes

D1, D2 REC51A (Radiospares) (2 off)

Miscellaneous

Six-way tag strip. Plug and socket. Hardboard for case, see text

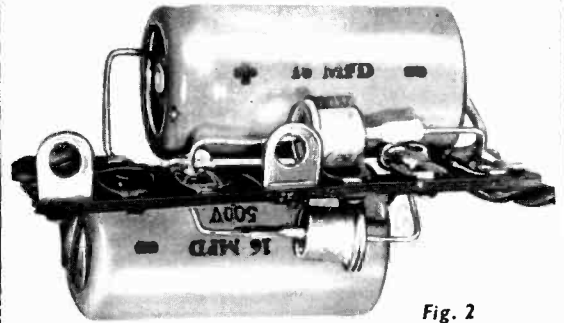

Fig. 2

Introducing.....

PEAC

A low cost, general purpose analogue computer of modern design, intended for the amateur or student.

A useful tool which is capable of solving complicated problems at high speed.

Can be used as a model to simulate mechanical systems and electronic networks.

Extends enormously the scope of the amateur experimenter.

This series of articles will explain in detail the design, construction, and operation of PEAC.

ANALOGUE

MOST of the publicity afforded to computers favours digital equipment. However, digital methods tend to be disproportionately expensive for small installations. On the other hand, although analogue equipment is ideally suited to limited, low-cost applications, it was not until the silicon transistor had become firmly established, and enough practical published information was available, that a start could be made on designing analogue computing equipment to yield a reasonable standard of performance in the lowest possible price range.

A WORTHWHILE PROJECT

No doubt many readers will think that construction of a true computer could involve them in a great deal of time, money, and effort. They might also believe that an average understanding of mathematics would not be sufficient to equip them to operate a computer effectively. However, the amount of time and money spent building PEAC need be no more than is consumed by a home constructed hi fi outfit of normal proportions and performance, and the computer will solve even simple problems a great deal faster than the human mind or slide rule, once it has been programmed to do so.

In fact, a general purpose computer can find application in almost every sphere of technical activity, and is particularly useful in the electronic workshop, to the point of becoming indispensable after a short period of use.

UNIT CONSTRUCTION

PEAC is arranged in the form of units, and is organised in such a way that reasonably advanced computations may commence upon completion of the first unit, UNIT "A". The cost of building UNIT "A", based upon typical retail prices at the time of writing,

will not be much above £25, and yet it will solve algebraic polynomial equations, simultaneous linear equations, simple differential equations, and can also be used to simulate the behaviour of many elementary mechanisms and electronic networks.

UNIT "A" is designed primarily to satisfy a minimum user requirement, for experimental and educational work, but it also serves as a convenient starting point for the addition of further units to expand the computer to almost any desired degree of capability and complexity. The additional facilities provided by the add-on UNITS "B", "C", and "D" are described in the specification. See also the block diagram, Fig. 1.1.

A comprehensive PEAC installation, equipped with a function generator and multiplier, and with full integrating facilities for the fast solution of a range of differential equations, might finally cost around £60: not a lot to pay for an item of workshop equipment which can solve electronic formulae in 10ms, and which may also be employed as a variable waveform generator, 18 input high quality audio mixer, variable characteristic high Q audio filter, large inductance or capacitance simulator, d.c. or a.c. millivoltmeter, and many other things besides.

COMPARISON BETWEEN ANALOGUE AND DIGITAL COMPUTERS

Although popularly regarded as an inaccurate machine of limited usefulness, the analogue computer is to be found in the Polaris missile, spacecraft, aircraft, large scale chemical processes, and many automated production lines, quite apart from basic research work, where flexibility and ease of working are often considered to be more important than extreme accuracy. The analogue computer is, in most cases, very much faster than its digital counterpart, and can offer far more in the way of general facilities for a given outlay.

The time taken to solve a problem on an analogue computer is independent of problem length. All circuits operate in parallel, simultaneously. A typical solution might be arrived at in 20ms, and this solution can then be repeated at the rate, say, of 25 solutions per second. In human terms the solution is virtually immediate and continuous, therefore, any adjustments made to problem parameters (terms of an equation) while the computer is working will be immediately reflected in the solution readout. This rapid response allows the operator to quickly gain an insight into the workings and structure of a problem.

In contrast, digital computers perform many mathematical operations in a pre-determined and comparatively lengthy sequence, which bears little obvious relationship to the structure of the problem, but they do offer the very high degree of accuracy essential for calculations involving money or very precise data.

The computer of the future will undoubtedly combine the best of both worlds with analogue and digital equipment in hybrid form.

ANALOGUE METHODS

The statement that an aeroplane is a machine for solving sets of differential equations is not very far removed from the truth. If the aeroplane did not solve its equations correctly it would not be able to fly at all. Almost all relationships or events can be described mathematically, or in turn be represented by an analogy. A model aeroplane in a wind tunnel solves, by analogy, roughly the same equations which govern the behaviour of the real aeroplane, although in much simpler and less expensive fashion.

An analogy of a physical or mathematical process could be achieved by a system of gears, pulleys, and levers; or by the controlled flow of gases or liquids. But in the last couple of decades electronic methods of simulation and equation solving have become almost universal, because of the accuracy, availability, and adaptability of standard electronic components.

The main purpose of the analogue computer is to allow a model to be set up quickly and easily, to simulate the behaviour of a full scale system, and at

COMPUTER

By
D. BOLLEN

The Practical Electronics Analogue Computer is of flexible design. The basic equipment is UNIT "A". Computing facilities may be extended by the addition of further units: "B", "C" and "D", in accordance with user requirements. This photograph shows UNIT "A" standing on UNIT "B"

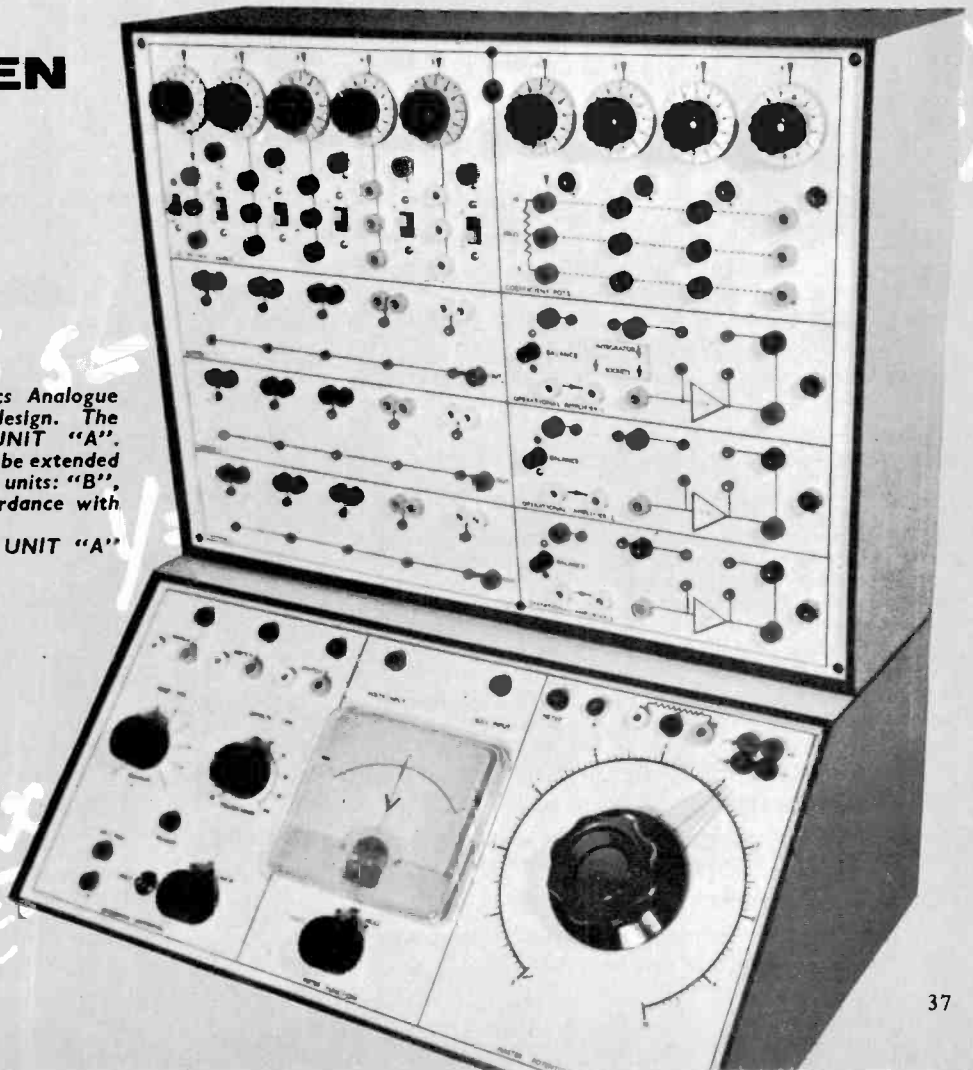

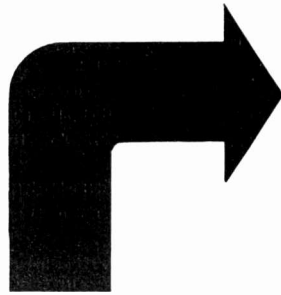
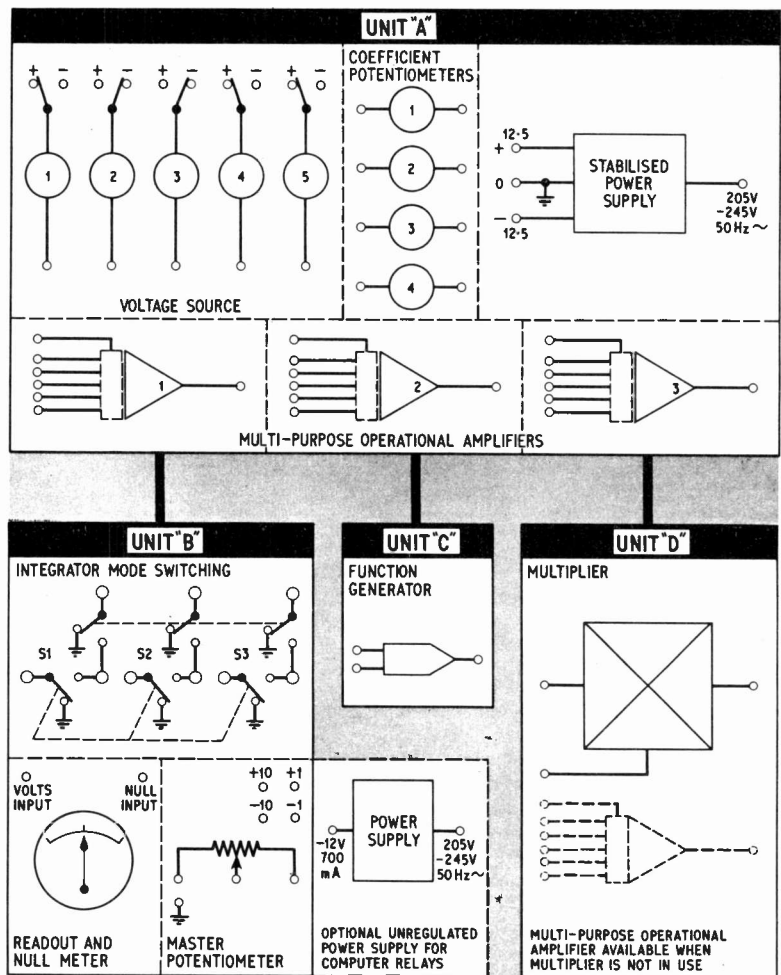
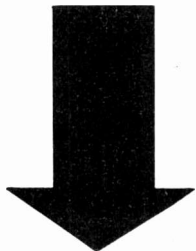

Fig. 1.1 Block diagram of

PEAC



SPECIFICATION



UNIT "A"

POWER SUPPLY

Input 205V—245V 50Hz. Output $\pm 12.5\text{V}$ d.c. Voltage regulation better than 1% for loads of 0—200mA, and 2% for 0—300mA. Total ripple 2mV. Complete short circuit protection.

AMPLIFIERS

Three multi-purpose operational amplifiers, each with five silicon transistors. Open loop voltage gain greater than 5,000. Output $\pm 10\text{V}$ at 5mA. Current demand (average) 40mA. Equivalent input drift under normal room conditions better than $\pm 0.5\text{mV}$ per hour. Unity gain frequency response within 1% for 0—10kHz, and 5% for 0—25kHz. Typical noise and hum at output 3mV.

VOLTAGE SOURCE

Five independent outputs, each continuously variable in three steps giving $\pm 0-0.1\text{V}$, $\pm 0-1\text{V}$, and $\pm 0-10\text{V}$. Dial setting accuracy better than 3% of full scale between dial divisions 1—10. Total current demand 50mA.

COEFFICIENT POTENTIOMETERS

Four 10 kilohm 270° potentiometers. Dial setting accuracy better than 5% of full scale between dial divisions 1—10.

SUMMING NETWORKS

Three five-input summing networks provided with voltage check sockets, and plug-in computing components.

UNIT "B"

MASTER POTENTIOMETER

25 kilohm 300° wirewound, 25 watt. Two voltage measuring ranges $\pm 0-1\text{V}$ and $\pm 0-10\text{V}$. Scale length 14in. Accuracy better than $\pm 0.5\%$ of full scale.

READOUT METER

Centre zero 100—0—100 μA , calibrated 0—0.3V, 0—1V, 0—3V, and 0—10V. Accuracy better than $\pm 2\%$ of full scale.

INTEGRATOR SWITCHES

Provision for three or more Integrating amplifiers. Compute times ranging from 10ms—1s. Single shot or repetitive mode with "hold" facility. Current demand around 65mA.

UNIT "C"

FUNCTION GENERATOR

Diode function generator for parabolic and other functions. Typical accuracy 2%. Frequency response to several kHz.

UNIT "D"

MULTIPLIER

Four quadrant multiplication of two or more variable voltage inputs. Also incorporates an operational amplifier which may be used on its own to supplement the amplifiers of UNIT "A". Frequency response generally better than 0—50Hz. Approximate current demand around 75mA.

the same time solve the equation which represents the system. Sometimes the computer will be used just for solving equations or, alternatively, as a working model only, depending on the nature of the problem. The advantage of the electronic computer is that it will do each, or both at the same time, with ease.

The computer is set up, or "programmed", for a particular task by inserting computing components, i.e. resistors and capacitors, into sockets on the front panel. This procedure will be described in full detail in due course.

ANALOGUE COMPUTER CIRCUITS

In the electronic analogue computer, the analogy is created fundamentally by manipulating sets of d.c.

voltages. There is nothing to prevent a.c. voltages being used—in fact they often are—except that a.c. measurement techniques are generally less accurate at low levels than d.c. However, when simulating dynamic processes with d.c. voltages, the computer will be handling a voltage which varies with time. In this context it is more appropriate to regard a waveform, even if it is a pure sine wave, as a d.c. voltage varying with time according to a formula which describes the nature of the waveform.

The main computing element is the "operational amplifier". As far as operational amplifiers are concerned, the decibel is much too coarse a unit to use for the measurement of frequency response, so amplitude linearity is usually expressed as a percentage variation over a fairly restricted range of audio frequencies. In some cases, for example, an operational amplifier and its attendant circuits will be expected to respond to inputs from d.c. to 5kHz with an accuracy of a fraction of 1 per cent, and up to 10kHz at no worse than 1 per cent.

COMPUTING ELEMENTS

The majority of problems can be solved by the varied application of only five analogue elements, but the size of the problem to be handled will in turn depend on the quantity of elements available, and hence on the overall size of the computer.

The five computing elements are shown in Fig. 1.2, together with their conventional symbols and generalised functions. The symbols are used as a kind of shorthand when drawing up a computer programme.

The first thing to note about the simplified circuit diagrams of Fig. 1.2 is that the common earth return is often completely ignored. Computer supply voltages are usually positive and negative in relation to an earthed centre tap. Since the input and output terminals of each

computing element are arranged to be very close to earth potential in the absence of an input voltage, it is feasible to take the earth rail for granted and regard all circuits as having only two terminals, instead of the usual four.

Although the symbol and function of each of the elements of Fig. 1.2 are common to all analogue computers, the actual circuit design and choice of components will naturally vary from one computer to another. For example, the time-division multiplier of Fig. 1.2e is only one among many possible circuit configurations for achieving multiplication of independent variables. Alternative approaches include the Hall effect, the servo, logarithmic, and quarter square multipliers.

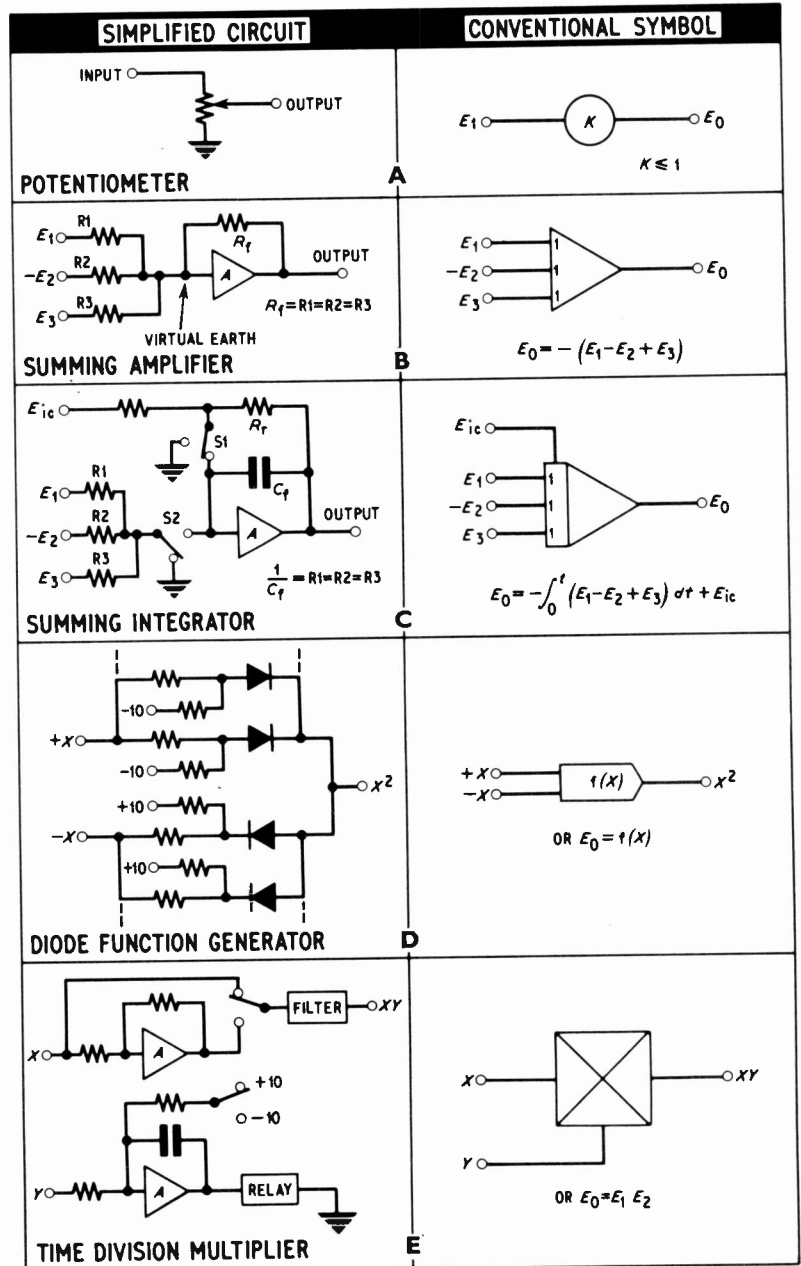

Fig. 1.2 Analogue computing elements

It is proposed to examine computing elements in greater detail when they are dealt with individually at a later stage, but in the meantime a brief survey will suffice.

COMPUTING POTENTIOMETER

The potentiometer of Fig. 1.2a may be used for multiplying a variable voltage (often called a machine variable) by a constant of less than unity.

Example: potentiometer input 1.5 volts. Slider set exactly half way along resistance track, corresponding to a constant of 0.5. Output voltage E_o therefore equals 1.5×0.5 , or 0.75. As set, the potentiometer will multiply any input voltage by 0.5.

When incorporated in the feedback loop of an operational amplifier, the potentiometer will divide a machine variable by a constant smaller than 1. The fact that potentiometer constants are less than unity is no real disadvantage. It is a simple matter to either increase input voltages by a factor of ten, or increase the gain of an operational amplifier ten times, to bring the potentiometer constant above unity. Like the slide-rule, it is simply a matter of deciding in advance where the decimal point should be.

SUMMING AMPLIFIER

The summing amplifier of Fig. 1.2b uses a high gain operational amplifier with several inputs to achieve addition and subtraction of machine variables. When the operational amplifier has a voltage gain equal to several thousand, input voltages will be accurately summed together, without unwanted interaction. The summing junction SJ is at "virtual earth", a way of saying that SJ will never be more than a few millivolts above or below earth potential, and is also, to all intents and purposes, shunted by a resistance of only a few ohms. Compared with input resistors R_1 - R_3 , the SJ shunt resistance is very low indeed, a condition necessary for accurate summing of voltages.

A definite relationship exists between resistors R_1 - R_3 , and feedback resistor R_f , and if these resistors are arranged to plug into the amplifier, many problem conditions can be met by "ringing the changes" on preferred values of fixed resistor, including multiplication by a constant as well as addition.

If a voltage E_1 is applied via resistor R_1 (in Fig. 1.2b) of the summing junction SJ, the output voltage E_o will

This photograph shows UNIT "A" being used to simulate a tuned LC circuit, consisting of an inductance of 5H in series with a capacitance of 5 μ F. The oscilloscope is displaying phase shift within the simulated circuit at the resonant frequency of 31Hz, and the trace also gives an indication of the damping factor or "Q" of the circuit

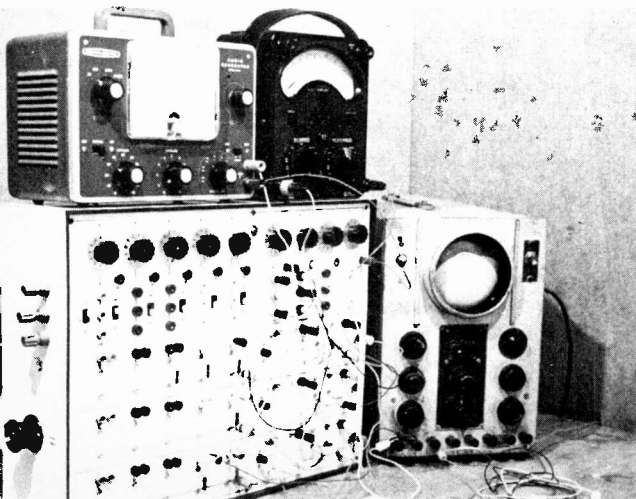

be $-E_1 \frac{R_f}{R_1}$. The operational amplifier is designed to

invert an input voltage, hence the minus sign in front of this expression. The ratio between input resistor and R_f holds good for each input.

Example: apply three input voltages $E_1 = 5$, $E_2 = -3.5$, and $E_3 = 2$ to the summing junction via $R_1 = 10$ kilohm, $R_2 = 2$ kilohm and $R_3 = 100$ kilohm. Let the feedback resistor $R_f = 10$ kilohm. The relationship between voltages and resistances will be

$$E_o = - \left(E_1 \frac{R_f}{R_1} - E_2 \frac{R_f}{R_2} + E_3 \frac{R_f}{R_3} \right) \text{ Substituting values}$$

$$E_o = - \left(5 \frac{10}{10} - 3.5 \frac{10}{2} + 2 \frac{10}{100} \right) = (5 - 3.5 \times 5) + 0.2,$$

therefore $E_o = 12.3$.

In the above example, the summing amplifier has not only summed negative and positive inputs, but has also multiplied E_2 by 5, and E_3 by a constant of 0.1, merely by selection of appropriate values of input resistor.

SUMMING INTEGRATOR

The summing integrator is used for the detailed investigation of time dependent variables, and for the solution of problems involving calculus.

The integrator of Fig. 1.2c is based on the inverting operational amplifier, with capacitor C_f acting as the feedback component. The output from a single integrator, in response to a steady voltage input, is a linear ramp voltage which increases with time at a rate dependent on choice of input resistor, feedback capacitor, and input voltage. Once again, precise relationships must exist between computing components and voltage, but now time is introduced as an additional analogue variable.

The action of electronic integration is best explained by a working example, and reference should be made to the diagram of Fig. 1.3a.

Example: a fairly sluggish motor car accelerates from rest at a steady rate of 20ft/second/second. Examine the progress of the motor car during the first four seconds of its motion. The computer is set up to operate in "real time", that is to say, the time actually occupied by the motor car when accelerating. The problem layout of Fig. 1.3a shows a computing potentiometer "A" coupled to the input of Integrator "1", which in turn feeds Integrator "2". Voltmeters are connected into circuit to display the three parameters of interest. Potentiometer "A" is first adjusted so that its dial reads 2, corresponding to multiplication by the constant 0.2, to represent 20ft/s² scaled down to yield a voltage of appropriate magnitude for the integrators to handle. The output from the potentiometer is a steady voltage analogue of a steady rate of acceleration.

As soon as switch S3 is closed to the +V position, the velocity and distance meter pointers will start to move in a manner analogous to the motion of the motor car. Velocity will increase linearly with respect to time, while distance will be displayed as an accelerating pointer movement. Integrator "2" computes distance (s) as a voltage function of the square of time, in terms of $s = \frac{1}{2}at^2$.

With the problem of Fig. 1.3a, acceleration, velocity, and distance are immediately available to the computer operator as dial and meter readings. He can vary acceleration just by turning the dial of the potentiometer.

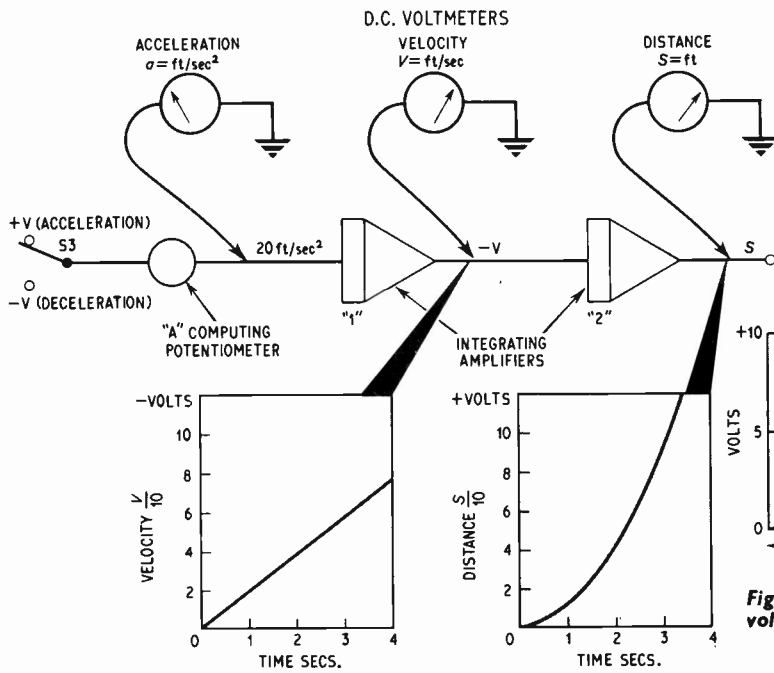

Fig. 1.3a (left). The use of integrators is illustrated in this diagram. In this example the rate of acceleration, velocity, and distance covered by a motor car are computed and can be read off the potentiometer dial and meter scales

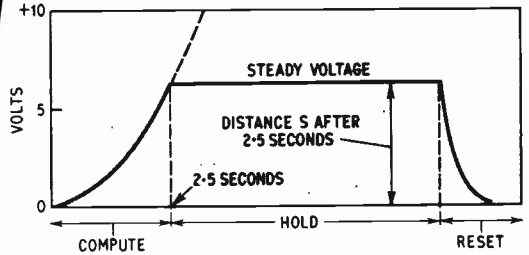

Fig. 1.3b. Arresting a computation to give a steady voltmeter reading

meter. If switch S3 is moved to the $-V$ position, the car will decelerate and stop.

COMPUTE, HOLD AND RESET

It is obviously inconvenient to take readings from voltmeters when pointers are on the move, and it is impossible to do so if time t is very short, as with fast events, or when the computer is speeded up to some fraction of real time. The sequence governing switches S1 and S2, in Fig. 1.2c, is therefore arranged to provide three facilities, called "compute", "hold", and "reset".

The purpose of the "hold" facility is to allow a steady meter reading to be taken at any point on the voltage/time curve output of an integrator. The high gain introduced by the operational amplifier effectively

multiplies the capacitance of C_f when the integrator input is disconnected from input resistors and reset resistance R_r . With amplification, C_f becomes the equivalent of a very large capacitor which is capable of holding a charge for a relatively long time. In practice, the ability of an integrator to "hold" or store a voltage will also depend on low amplifier drift.

Fig. 1.3b shows graphically the effect of compute, hold, and reset modes, when applied to the distance curve of Fig. 1.3a. In this case, it is necessary to halt the computation after an elapsed time of 2.5s, and obtain a value for distance in the form of a steady meter reading.

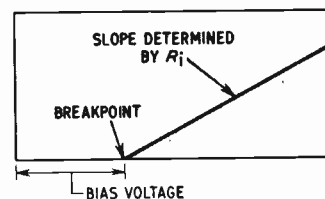
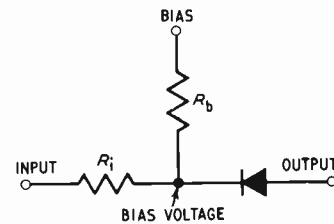
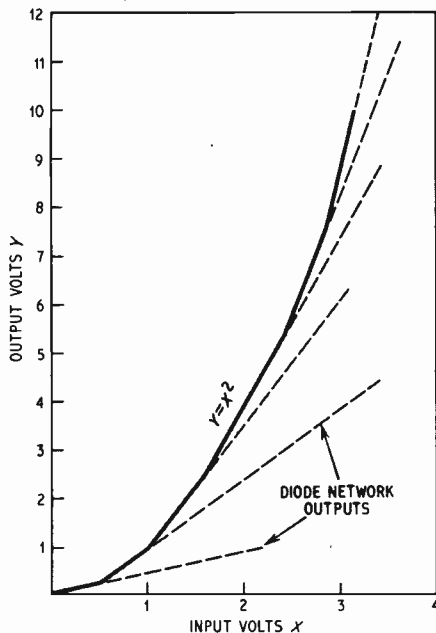
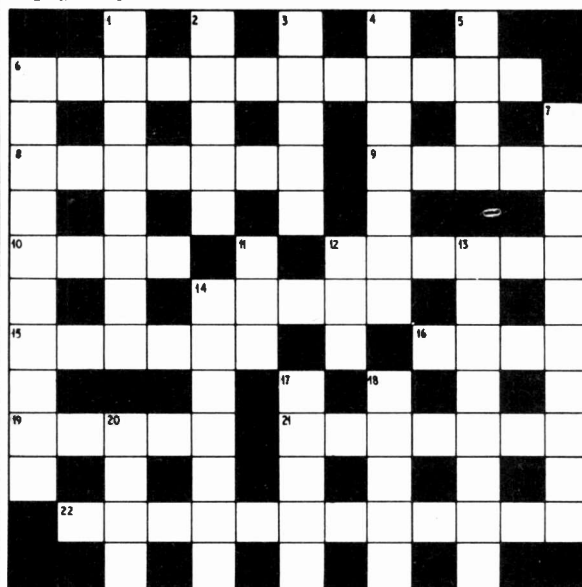

Fig. 1.4a (left). Illustrating how a mathematical function can be constructed from a series of straight line tangents Fig. 1.4b (above). A single diode network and its output characteristic

CROSSWORD . . .



CLUES

Across

6. An integral part of the Wheatstone Bridge (9, 3)
8. One million megohms (7)
9. Dye (5)
10. An electrode of 11 down (4)
12. He patented the incandescent filament lamp (6)
14. A thousand start to consume the poet (5)
15. Nonsense and knaves could be so described (6)
16. β (anagram) (4)
19. Adipose (5)
21. Electronic effect favoured by some instrumentalists (7)
22. It fixes a valve's working point (8, 4)

Down

1. This describes "j" (8)
2. "Flip-flop" is one in the language of electronics (5)
3. Zurich Banker? (5)
4. Special forms of procedure (7)
5. A Schmitt trigger would hardly fire this gun (4)
6. Well known operational amplifier (10)
7. This radar valve gets Norman confused (10)
11. Semiconductor with circuit applications similar to a valve (abbr.) (3)
12. Greek letter (3)
13. Below the audio range (8)
14. Would this attenuate a batsman's scoring? (4, 3)
17. He shows a lot of self control (5)
18. Denary equivalent of binary 0111 (5)
20. These numbers are integrally divisible by two (4)

Solution next month



ANTI-DAZZLE DRIVING MIRROR (December 1967)

Transistor types in components list should read as follows:

TR4 XA701 or 2N1304

TR5 XC141 or OC35

The second type mentioned in both cases is the more recent type of transistor and is the preferred choice.

The compute mode is initiated by opening S1 and closing S2 (Fig. 1.2c). After 2.5seconds, S2 automatically opens and the amplifier input is left floating, with C_I still connected between input and output and holding a stored charge. A meter coupled to the integrator output will show the distance travelled after 2.5s of acceleration.

The "hold" period can occupy several tens of seconds, and is usually at the discretion of the operator. To begin a new computer run, S1 is closed, discharging C_I through R_r , thus resetting the integrator output to zero. The input E_{Ic} in Fig. 1.2c, is to allow an initial condition to be applied to the integrator, as in the case of a motor car which does not start from rest, but is already in motion when it accelerates. When computing and resetting times are shorter than about 1s, voltmeter answers will appear to be given at the instant of pressing the button which initiates the S1, S2 cycle.

The above description relates to a "single shot" computer run, where the operator adjusts, takes a reading, adjusts, and so on. In the repetitive mode, the hold facility is ignored and the computer keeps on repeating the answer curve, for display on an oscilloscope, chart recorder, or XY plotter.

DIODE FUNCTION GENERATOR

In many computer applications it is necessary to generate a voltage which varies according to some non-linear function not provided by normal operational amplifier techniques. The diode function generator of Fig. 1.2d will allow a mathematical function to be constructed from a series of straight line tangents, as shown in Fig. 1.4a.

Each straight line characteristic is obtained from a single diode-resistor network, and when the outputs from several networks are summed together a complete function will result. The shape of the final approximated curve is determined by adjustment of the network resistors. Apart from powers of x, and other functions, roots are achieved by placing the function generator in the feedback loop of an operational amplifier.

A single diode network appears in Fig. 1.4b, and the slope of its output characteristic can be varied by adjustment of R_1 . The diode breakpoint (the voltage at which the diode starts to conduct) is dependent on the value of R_b .

MULTIPLIER

The computing potentiometer will multiply a variable by a constant, but special techniques must be used to multiply one variable by another variable. The process employed in modern computers is akin to modulation, where the gain of a circuit is controlled by an applied voltage.

The multiplier should yield a product of correct sign when multiplying negative or positive variables, and this is readily achieved with the self-excited time division circuit of Fig. 1.2e. The time division multiplier operates on the principle of modifying the mark-space and amplitude of a square wave in accord with two voltage inputs. The filter of Fig. 1.2e extracts the mean level of d.c. from the square waveform. An additional advantage of the Fig. 1.2e circuit is that it can be arranged to cater for more than two variables. For example, inputs X1, X2, and X3 multiplied by input Y.

Next month: Commencing the construction of UNIT "A".

ELECTRONORAMA

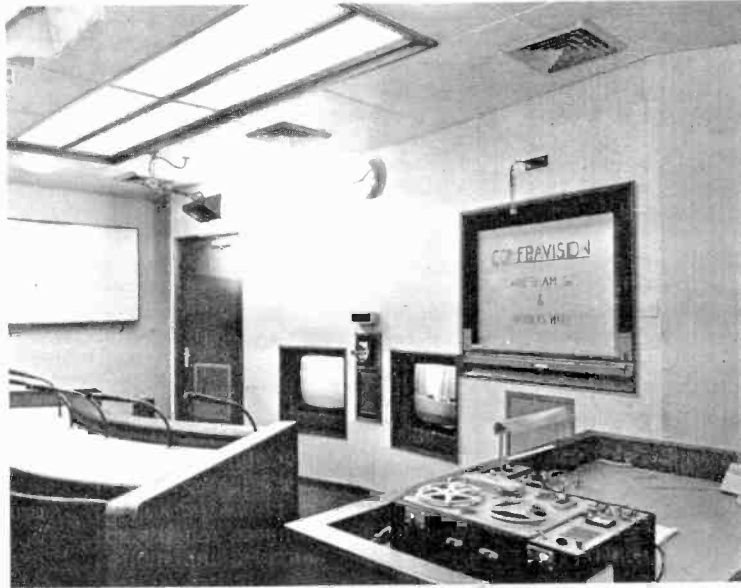
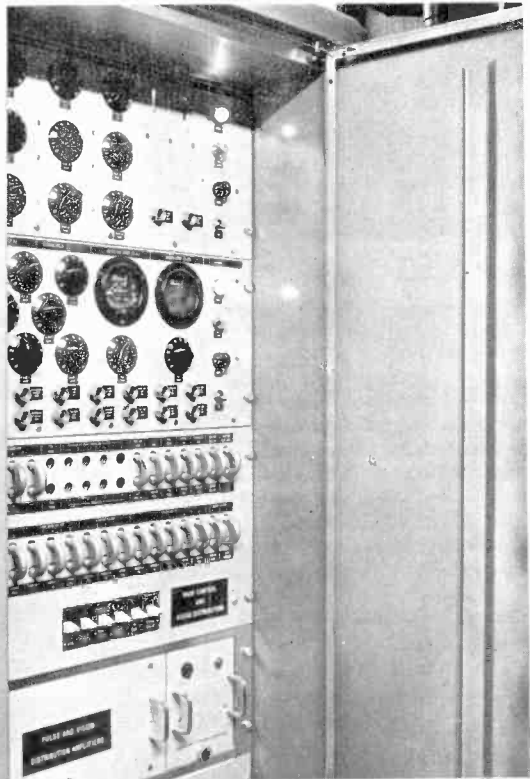

**"Confravision"
Launched**

CONFERENCES between two distant locations can now be conducted through the medium of closed circuit television. Following a demonstration of the system between Gresham Street in the City of London, and the Post Office Research Station at Dollis Hill, North-west London (about 10 miles apart), our correspondent joined the panel in the City and found that greater relaxation was experienced while conversing with the other panel over the television link. By the inclusion of "privacy" equipment, proceedings would be kept confidential; a scrambling code is brought into operation to obviate telephone tapping.

Logicon Controls Float Glass

AUTOMATIC control of float glass processing, involving cutting, snapping, squaring, and berthing has been installed at the Pilkington plant at St. Helens, Lancashire. Under automated control from AEI Logicon solid state electronic systems, the operation forms part of a continuous process in producing a continuous ribbon of glass which is cut into patterns of a required size. The glass is then trimmed and snapped before being conveyed into the warehouse.

Control of the speed of the plant is effected by adjustment to the frequency of the output. A mains standby transformer can be used to enable the plant to be run at constant speed from the mains supply. Signals from over 300 vane-operated magnetic proximity switches, which can detect the presence of glass, initiate the Logicon system controlling the various operations.

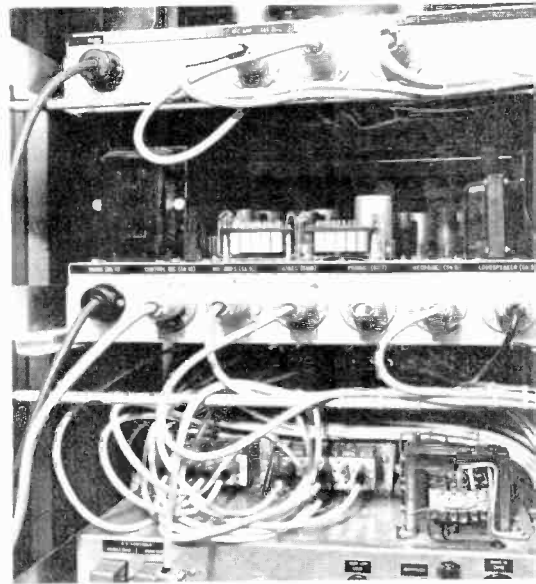
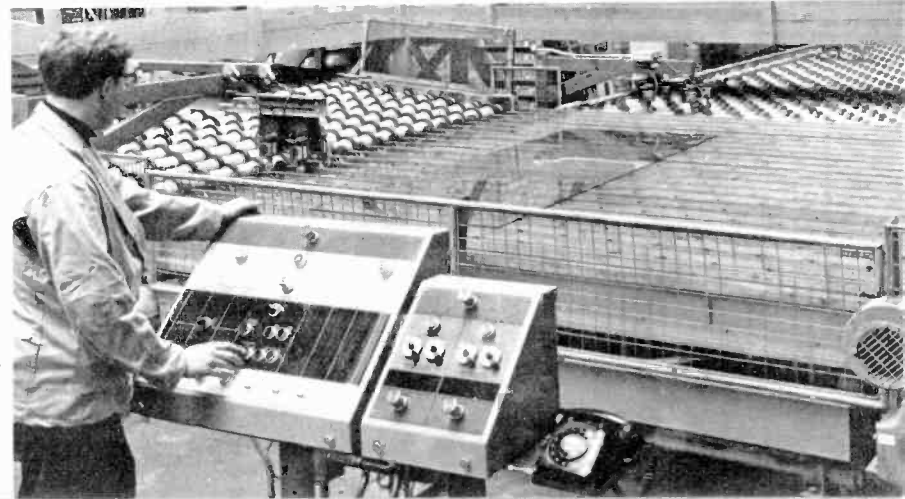

WHITE NOISE GENERATOR

By A.J. BASSETT

WHITE NOISE is a very special form of audible sound, in that it has no special pitch or waveform, but contains a random mixture of pitches and waveforms, covering the entire audio spectrum. This makes it a very interesting subject for the audio experimenter, who can, from a given sample of white noise, electrically or acoustically filter out and make use of sounds of any desired pitch, or within any chosen passband. It is also possible to adjust the envelope waveform of a given sample of white noise, either before or after filtering.

By means of these manipulations, it is possible to produce a wide range of very interesting sound effects, many of which are of practical use in making electronic music. Some examples of these effects are: steam locomotive; heavy surf; wind effects; cymbals; rhythmic wood-blocks; and an effect very loosely termed "phasing", which finds considerable favour as a "psychedelic audio experience". More about these special effects will come later.

The circuit of the white noise generator operates from a power supply of 18 to 24 volts, although a 9 volt battery can be used, as described later, and gives rather less output. Construction is based on a standard P.E. *Bonanza Board* printed circuit as shown on the full size pattern in Fig. 2a.

HIGH LEAKAGE DIODE

Electrical power is fed to diode D1 through resistor R1. The diode is reverse biased, but passes quite a considerable leakage current with the result that a random output or white noise output is produced at the junction. The way in which this happens is described in considerable detail in various textbooks. The output from the diode is at a fairly low level, so is fed via C2 to a high gain transistor stage TR1, which amplifies the white noise output to a more useful level. This output is available from the collector of TR1, and is fed to the output connection point through the coupling capacitor C4.

CONSTRUCTION

Obtain the components listed except diode D1, and resistor R1, which are mentioned later in the text, and solder to the printed circuit board in the positions shown in Fig. 2b. Connect also the link wires shown. Connect the circuit to the power-source (a suitable power supply unit was given in the *Spring Line Reverberation Unit* last month) or a 9 to 18 volt dry battery. The voltage across TR1 (collector to emitter) should be about half the supply voltage. If it is not near this value, change the transistor or select a different value for R3 accordingly.

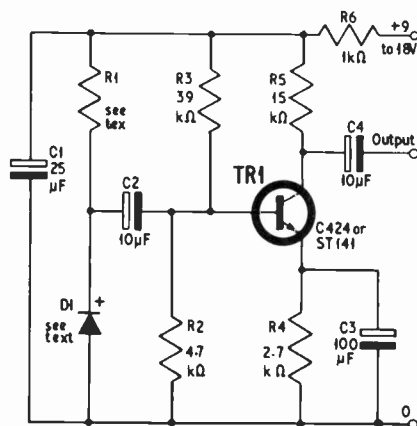

Fig. 1. Circuit diagram of the white noise generator

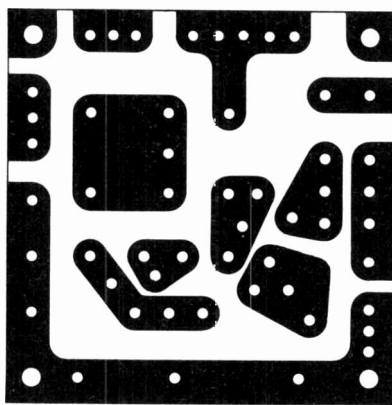

Fig. 2a. Printed circuit pattern of the "Bonanza Board"

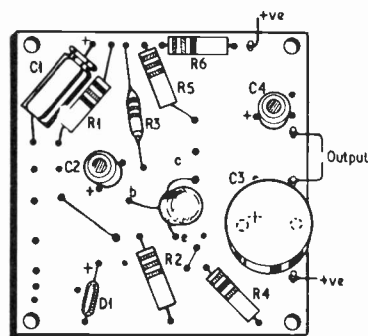

Fig. 2b. Final layout of components on the printed circuit board

COMPONENTS . . .

Resistors

R1	see text	R4	2.7k Ω
R2	4.7k Ω	R5	15k Ω
R3	39k Ω	R6	1k Ω
All 10%, $\frac{1}{4}$ watt carbon			

Capacitors

C1	25 μ F elect. 25V
C2	10 μ F elect. 25V
C3	100 μ F elect. 12V
C4	10 μ F elect. 25V

Transistor and Diode

TR1	C424 (S.G.S. Fairchild) or ST141 (Sinclair)
D1	Point contact diode (see text)

Miscellaneous

Printed circuit board (see Fig. 2)
Potentiometer 1M Ω for diode
selection (see text)
Crystal earpiece for testing (see
text)

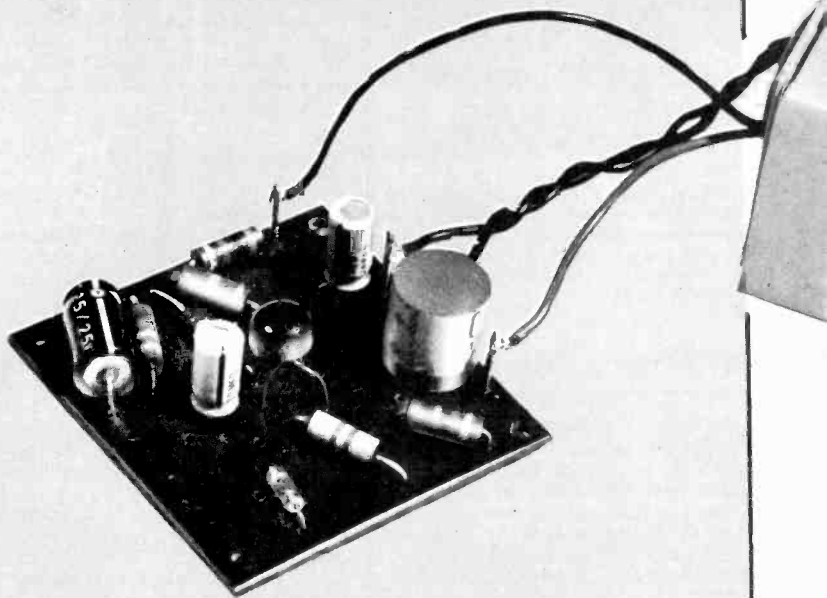

The diode used by the author is a miniature glass-encapsulated unmarked germanium point-contact type intended for use in a crystal radio set in place of the old-fashioned "cat's whisker" and galena crystal. These diodes are often so very leaky in the reverse direction that they may be said to have no definite peak inverse voltage rating! This leakage is put to good use in this white noise generator. The diode is cheap to buy and is usually found at component surplus suppliers for about 6d to 1s.

Various types of crystal diodes were tried by the author, but those which produced the most noise were unbranded, and the best way to obtain a suitable diode appears to be to buy a few and select one which generates a considerable noise level. (It has been said that almost any crystal diode can be caused to generate more noise, by passing a very heavy current through it for only a few seconds, so that it glows like a dimly lit bulb. The author did not need to try this process, as there were many diodes in the spares box which were very noisy already.)

SELECTING A DIODE

In order to select the most suitable diode from a number which may be to hand, carry out the following experiment. Connect in place of R1 a 3.3 kilohm resistor in series with a 1 megohm potentiometer (see Fig. 3). Connect in place of D1 two short flying-leads with crocodile clips attached, so that diodes can be quickly tested and passed on.

The easiest way to check the diodes is to listen to the noise output by connecting the output of the generator to a crystal earpiece or an audio amplifier. Other methods are by means of a signal strength meter or an oscilloscope.

Check the diodes in turn, adjusting the potentiometer in each case for highest noise output. If you connect a diode wrong way round so that it is forward biased, no harm will be done, but the noise level is not so great when connected this way. If you are using the higher supply voltage (18 volts or above), it

is worth using the emitter junction of a C424 transistor as a noise generator diode, with R1 set at 100 kilohms; this does not work well at lower voltages.

The white noise will, in most cases, be heard as a steady hissing or rushing sound, but some diodes are uncertain, with intermittent fading effects. These should be rejected; a diode giving a loud, steady output should be chosen.

When you have chosen a diode, remove the 3.3 kilohm resistor and the potentiometer without altering its setting, and measure the total resistance. Choose a fixed resistor of the nearest standard value and solder in place as R1. Solder the diode in place as D1.

The white noise generator should now be ready for use. ★

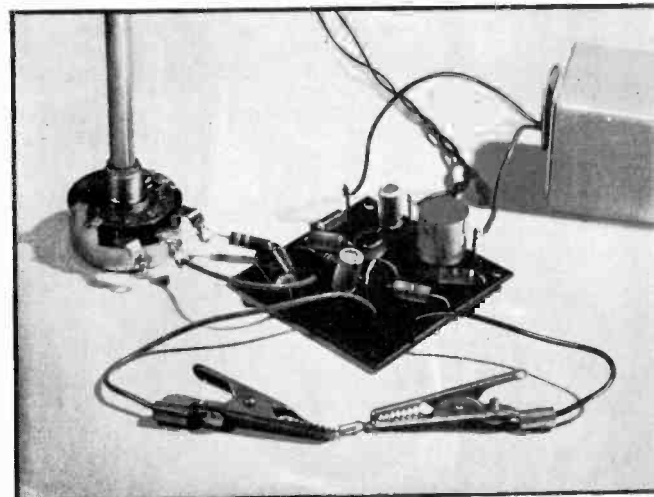

Fig. 3. Set up the module for finding the most suitable diode and adjust the potentiometer to given optimum bias and noise output

MARKET PLACE

Items mentioned in this feature are usually available from electronic equipment and component retailers advertising in this magazine. However, where a full address is given, enquiries and orders should then be made direct to the firm concerned.

SEMICONDUCTORS

The case for the use of monolithic circuits in the audio field is now beginning to make an increasing impact and will surely be generally accepted in time, just as the transistor is now firmly established.

The MC1554G monolithic circuit from Motorola Semiconductor Products Inc., is a high performance audio amplifier of one watt output with a harmonic distortion of 0.4 per cent over a frequency range of 20Hz to 20,000Hz.

The input impedance is 10k Ω and the output impedance is 0.2 Ω . The low output impedance is optimised for driving a 16 Ω load, usually found in audio and servo applications.

Housed in a 10-pin metal can, this device needs to be powered by a 16 volt d.c. supply; the drain current is only 15mA d.c. with a zero signal input.

Further details and nearest retailer of the MC1554G can be obtained from Motorola Semiconductor Products Inc., York House, Empire Way, Wembley, Middlesex.

Three new silicon npn transistors announced by Mullard have been designed for mobile f.m. transmitters that operate from a 13.8 volt supply. Types BLY34 and BLY55 are intended as drivers, but can also be used in the output stages of small v.h.f. transmitters. Type BLY36 is intended for use in the output stage of larger v.h.f. transmitters.

SGS-Fairchild have announced price reductions over their whole range of silicon planar devices. In some cases these reductions are over 50 per cent. We hope that these reductions will be passed on to the public by retailers.

SHOPPING GUIDE

Now to items that would make suitable gifts!

Something that will hold the interest of younger people, and the serious designer will also find useful, is the S-Dec "breadboarding" system marketed by S.D.C. Products (Electronics) Ltd.

A single unit or "building block" consists of two panels with seven parallel rows of phosphor bronze double-leaf spring contacts. Each row has five connecting holes, drilled in the panel, which are linked electrically.

To make up circuits, component leads are simply pushed into the panel holes and can be removed quite easily for any circuit alterations. If more than one unit is required, they can be joined together by keys and keyways on the four walls of the boxes.

S-Dec costs 29s 6d each unit and further details can be obtained from S.D.C. Products (Electronics) Ltd., Pump Lane, Springfield, Chelmsford, Essex.

Items for the workshop include a set of three tools: 5in engineers' pliers; 5in diagonal cutters; and 5½in long-nosed pliers, produced as a set in a p.v.c. wallet by Elliott-Lucas Ltd.

Bib Home Electrician's Kit by Multicore Solders Ltd. contains virtually every item needed to carry out minor electrical repair work in the home.

The kit costs 14s 6d and contains a Bib Model 8 Wirestripper and Cutter; three flex shorteners; Ersin multicore tape solder, which can be melted with a match; insulating tape; fuse wire rated at 5 and 15 amps; and a screwdriver with a blade designed to suit all plugs in general use.

A riveter's skill is brought within everyone's reach with the "Pop"

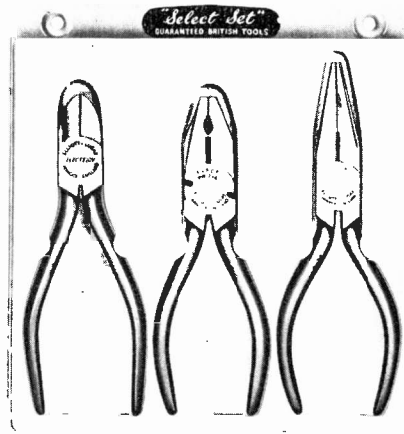

"Select Set" from Elliott-Lucas Ltd



Fidelity HF36 Stereo Record Player



"Pop" Rivet Kit marketed by United Marketing (Leicester) Ltd

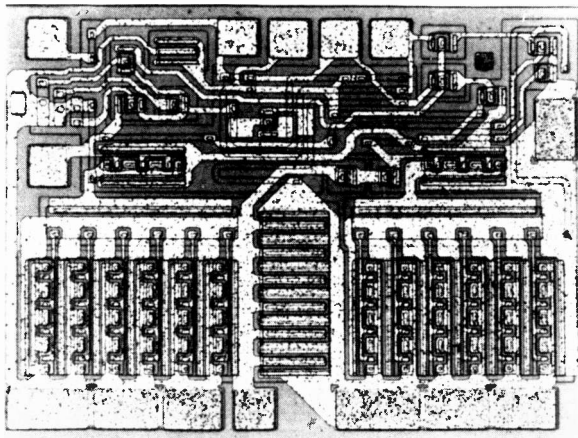

The MC1554G One Watt Audio Amplifier from Motorola



Simoniz Ltd. Fire Extinguishers

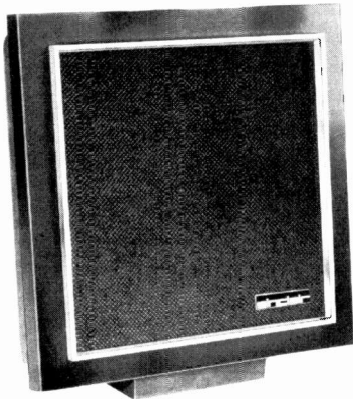

Sinclair Q14 Loudspeaker

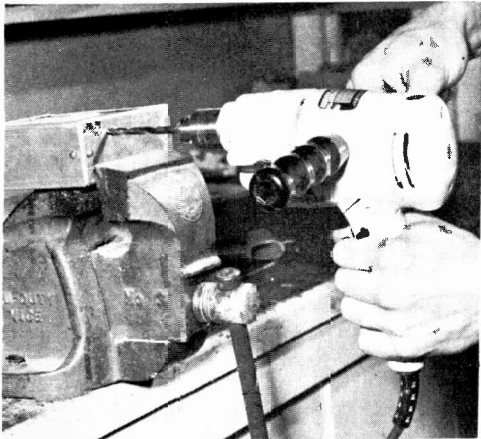

D520 Two-Speed Drill from Black and Decker

rivet kit and should prove most helpful in the workshop. Marketed by **United Marketing (Leicester) Ltd.**, it is priced at 39s 11d and contains a riveting tool; a supply of rivets in three lengths; washers; a 3.3mm drill bit; and an instruction leaflet. A feature of the kit is that it can be used where only one side of the work is accessible and a nut and bolt cannot be used.

Finally, two items that are invaluable in the home workshop.

First, a fire extinguisher should always be kept handy. **Simoniz Ltd.** are offering two in a Christmas pack at 55s. Weighing only 11lb it is claimed that this extinguisher will snuff out a car engine fire in five seconds and a television fire just as quickly.

Secondly, a power tool has numerous uses for the many cabinet making and chassis drilling jobs that are always needed when making any equipment.

Both the **Black and Decker D500** and **D520** models have $\frac{1}{8}$ in chucks, and retailing at £5 10s and £8 19s 6d respectively, are always welcome gifts.

The two-speed model **D520** is particularly useful for low speed drilling with high torque, such as required for drilling steel sheet and masonry. Maximum recommended hole sizes are $\frac{1}{8}$ in for steel and masonry and $\frac{3}{16}$ in in hardwood at the slow drill speed of 900 r.p.m. The drill can be used to cut larger holes for components up to 1in diameter if used with a "holesaw".

The presentation of audio equipment can cost from a few shillings to several pounds. For example, there is the **Bib Tape Head Maintenance Kit** for 12s 6d or the **Fidelity HF36** console stereo record player at 45gns.

The **Fidelity HF36** is finished in fine teak veneer and is fully transistorised. The turntable is a Garrard four speed auto/manual type, taking eight records on auto. Four watts output per channel is fed to two 8in speakers in acoustically designed chambers.

The new **Sinclair Q14** loudspeaker at £6 19s 6d measures only $9\frac{1}{2}$ in \times $9\frac{1}{2}$ in \times $4\frac{1}{2}$ in and is claimed to produce a smooth level response between

60Hz to 16,000Hz. The full frequency range is claimed to be 45Hz to 18,000Hz and it can handle 14 watts r.m.s. at 1,000Hz. The impedance of the speaker is 15 ohms.

The demand for tape recorders has steadily increased over the years, so a tape recorder spool or accessory may be another useful gift.

Mastertape (Magnetic) Ltd. are now producing their 5in, $5\frac{1}{2}$ in, and 7in reels in a strong black polypropylene box in the form of a book, with grained front and back covers. The spine has the brand names and a label printed in a colour which identifies the type, reel size and length of recording, i.e. red for standard play, yellow for long play, etc. Prices range from 20s 6d for a 5in spool of standard play tape to £5 for a 7in spool of triple play tape. The "books" also contains a printed card index and tape clip.

The 4in, 5in, $5\frac{1}{2}$ in, and 7in Synchronotape spools are available from **Adastra Electronics Ltd.**, 167, Finchley Road, London, N.W.3, and include a 12-page guide to playing times and speeds, editing and storage hints, technical data and a recording log for individual tabulation of recordings. Coupons are given with these spools enabling a tape splicer to be purchased at half price.

The care and maintenance of tape recorders is important if good service and reproduction is to be maintained throughout the life of the recorder. So at 12s 6d the **Bib Size E Tape Head Maintenance Kit** is a worthwhile consideration for those who really care about tape recorder maintenance; others need encouragement, too!

The kit consists of a bottle of instrument cleaner; cleaning tissues; applicator and polishing tools and sticks; double-ended brush and a five-page instruction booklet.

NOTE

In the **G.S.P.K. (Electronics) Ltd.** advertisement (December 1967) for their **Printed Circuit Kit**, the price was incorrectly given as being £1. The correct price is £1 5s 0d plus 3s 6d postage and packing.

Bib Home Electrician's Kit by Multicore Solders Ltd

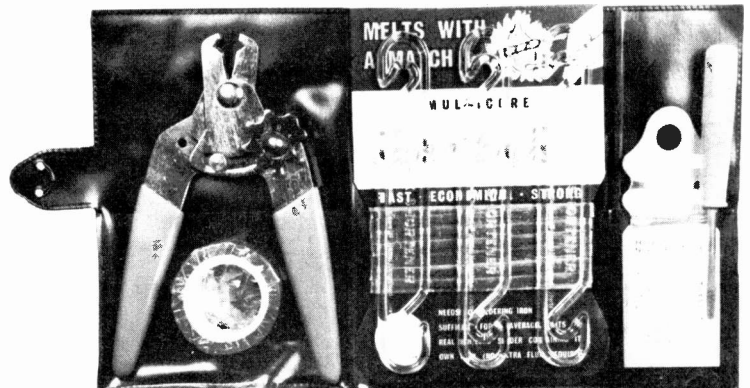

SEMICONDUCTOR BASICS

2-DIODE PROPERTIES

By G. J. KING

LAST MONTH'S article described how semiconductors are formed from carefully prepared crystalline materials. Now, going a little deeper this month, the actual crystal structure will be shown to have specific properties.

A common crystal for semiconductors is germanium which, in its pure state, has a very low conductivity. However, its conductivity rises steeply with increase in temperature and above 100 degrees C it is so high that current control becomes a bit of a problem.

TWO MAIN TYPES

Germanium is extracted from flue ash formed from the burning of Northumberland coal. In this state it is an oxide containing a great deal of impurity and, for semiconductor applications, it has to undergo a purifying process called "zone refining". Here the germanium ingot is placed in a radio frequency heating field in such a way that only a small part is affected, producing a molten zone. This is arranged to "sweep" along the ingot from one end to the other, and because the impurities are concentrated in the molten zone they are, in effect, "swept" out of the crystal to one end. After several sweeps the heavily contaminated end is cut off the ingot, leaving the bulk of pure crystal.

Silicon is another common semiconductor material. This has a lower electrical conductivity (more resistance to current flow) than germanium, and is thus more suitable for high power devices than germanium. It can also be used at higher temperatures without posing the current control and heating problems of germanium.

Pure germanium has a resistivity of about 60 ohm-centimetres, while pure silicon is much higher, rising to about 60,000 ohm-centimetres. The controlled addition of impurities, referred to last month, reduces the resistivity of the pure crystals to about 2 ohm-centimetres at room temperature. Fig. 2.1 shows the scale of resistivities of pure germanium and silicon relative to copper at one end of the scale and glass at the other end.

CRYSTAL LATTICE

The structure (called crystal lattice) of pure crystal materials is composed of atoms which are effectively bound to their partnering atoms by the pairing of their outer or *valence* electrons. This gives so-called electron-pair bonds, as shown in Fig. 2.2. Because each of the four valence electrons per atom is linked to the electrons of an adjacent atom, no electrons are available for the conduction of electricity (there are no current carriers), which is why a pure crystal has such a high resistance.

However, partial collapse of the lattice occurs when the crystal is heated owing to the result of thermal

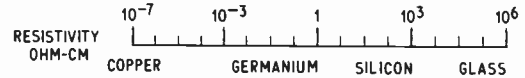

Fig. 2.1. Scale of resistivities of pure germanium and silicon relative to copper and glass

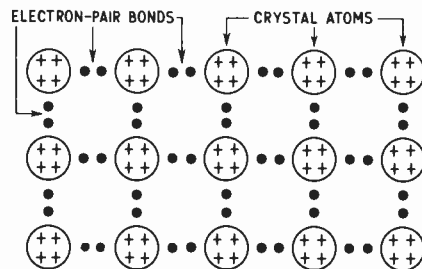

Fig. 2.2. Construction of a crystal lattice, showing the atom crystals and the electron-pair bonds

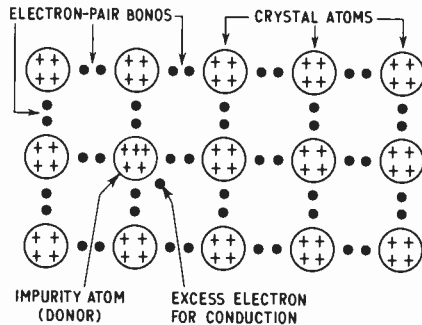

Fig. 2.3. N-type semiconductor material. The excess electron for current conduction is given by the impurity atom, which has five electrons against the four of the crystal atoms

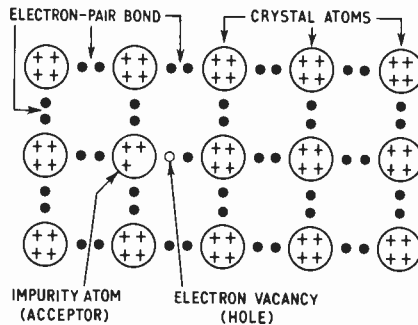

Fig. 2.4. P-type semiconductor material. The electron vacancy (hole) is given by the impurity atom, which has three electrons against the four of the crystal atoms

energy. This releases electrons from the bonds, making them available for current conduction, which lowers the crystal's resistance.

If heated crystal is arranged to pass an electric current, more heat is generated due to normal power dissipation. This allows even more current to flow and the effect, which is cumulative, eventually results in the destruction of the lattice. Germanium is more influenced by temperature rise than silicon.

Fig. 2.3 shows what happens in the lattice when an infinitesimally small amount of impurity is added to give *n*-type material. The impurity atom fits into the lattice, but because it has one more electron than the atoms of the crystal this becomes available for current carrying. The diagram shows that the crystal atoms each have four electrons, while the impurity atom has five electrons. Four are used for the bonding into the lattice and the excess one for conduction.

Fig. 2.4 shows what happens when an impurity atom is added to the crystal to produce *p*-type material. Here the impurity atom has only three valence electrons and, while these pair-up with the electrons of adjacent crystal atoms, one of the bonds in the lattice cannot be completed because the impurity atom lacks the final valence electron. This gives rise to the so-called hole, or positive current carrier, explained last month.

It will be appreciated now that holes encourage conduction by electrons, since they provide a "channel" in the semiconductor material through which electrons can flow. A hole, for instance, exerts an attractive force on any electron, and if this is one liberated from a crystal atom it may combine with the hole, but will have left a hole behind it. This process is continuous within the crystal, thereby constituting a flow of positive current carriers, as shown in Fig. 1.4 last month.

The impurities added to the pure crystal to give it *n*- and *p*-type characteristics are called respectively donor and acceptor atoms, the first giving negative current carriers and the second positive current carriers (i.e. electrons and holes).

PN JUNCTION

When *p*- and *n*-type materials are brought close together and effectively diffused at their junction, the well-known *pn* junction diode effect is achieved. This is illustrated in Fig. 2.5. Contrary to expectation, electrons do not flow from the *n*-type material into the *p*-type material to neutralise the holes.

As soon as holes flow from the *p*-type and electrons from the *n*-type material, the *n*-type develops a positive charge and the *p*-type a negative charge, because the *p*- and *n*-type materials are electrically neutral. These charges inhibit any further interchange of electrons and holes across the junction.

A "charge barrier" is, in fact, developed across the junction, and is often referred to as "potential barrier", "space-charge", "transition region", and "depletion layer". All these terms mean the same thing—the charge developed across the junction due to the initial interchange of holes and electrons.

It should be understood that the electric charge exists only across the junction, and it cannot be measured by connecting a voltmeter between the *p*- and *n*-type materials, but it can be represented by an imaginary battery connected within the two crystals at the junction, as shown in Fig. 2.6.

JUNCTION BIASING

This depletion layer has a fundamental effect on the action of the two materials so united when an external supply is connected. Suppose an external source of electricity is connected across the *p*- and *n*-type materials with a polarity that will counteract the potential developed across the junction. This is shown in Fig. 2.7a. A potentiometer, connected so that this source can be varied upwards from zero, and a means of measuring the current flowing, should show that very little current flows when the voltage is first applied, but after a certain small value, the current rises fairly steadily as the voltage is increased.

The initial slow start is due to the external supply overcoming the potential across the junction, and from then onwards the "barrier" is broken and electrons in the *p*-type material, near the positive terminal of the supply, break their electron-pair bonds and enter the supply, thereby producing new holes.

Simultaneously, electrons from the negative terminal of the supply enter the *n*-type material and diffuse towards the junction. Excess electrons from the *n*-type then flow across the depletion layer and move, via the holes in the *p*-type, towards the positive terminal of the battery. This flow continues as long as the external supply is connected, and it is called forward current flow due to forward biasing of the junction.

When the external supply polarity is reversed, giving reverse biasing of the junction (as shown in Fig. 2.7b) the potential within the material across the junction is effectively reinforced—it becomes wider. This is because the free electrons in the *n*-type are attracted

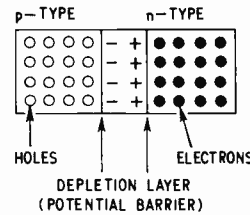

Fig. 2.5. Showing the union of *p*- and *n*-type semiconductors. Observe the negative charge on the *p*-type side of the junction and the positive charge on the *n*-type side

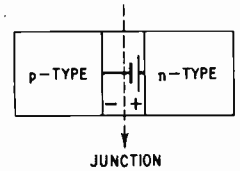

Fig. 2.6. The potential barrier can be represented by an imaginary battery

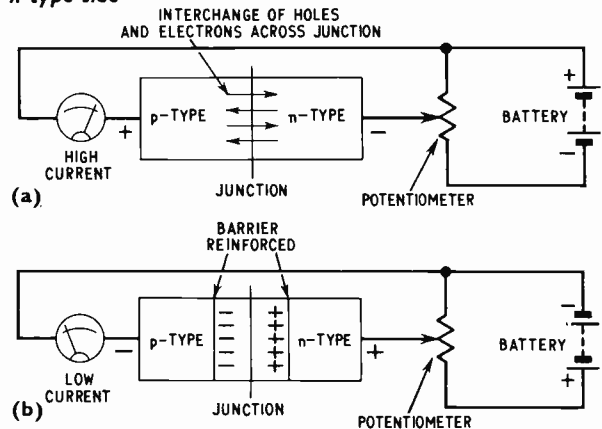

Fig. 2.7. Junction biased for forward current (a) and for reverse current (b)

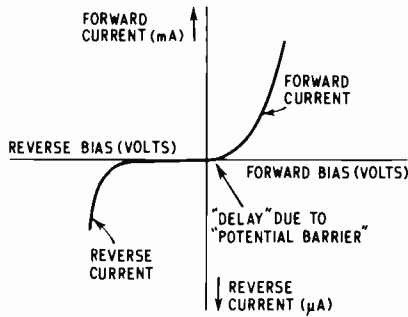

Fig. 2.8. Forward and reverse characteristics of a typical semiconductor diode

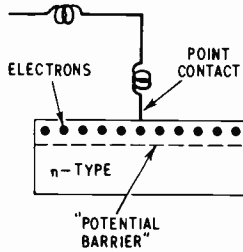

Fig. 2.9. Basic point-contact diode action. Note the formation of a depletion layer or "potential barrier"

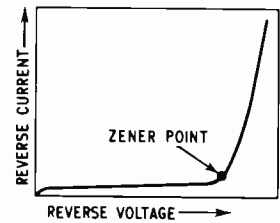

Fig. 2.10. Breakdown of the reverse characteristic gives the Zener effect

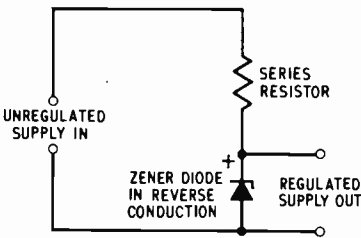

Fig. 2.11a. Voltage stabilisation using a Zener diode

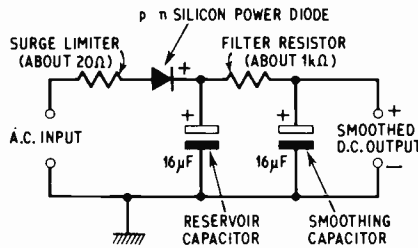

Fig. 2.11b. Junction diode rectifier circuit

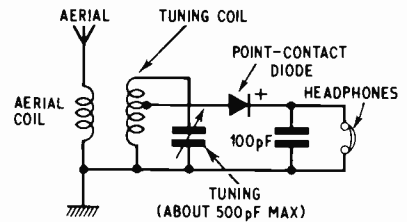

Fig. 2.11c. Simple crystal receiver using a point-contact diode

towards the positive terminal, away from the junction, while the electrons from the negative terminal of the supply enter the *p*-type and diffuse towards the junction, filling the holes as they approach the junction. Current flow is then extremely small, it being called reverse current.

Fig. 2.8 shows the forward and reverse characteristics. In the forward-bias region, current rises swiftly as the voltage is raised, while in the reverse-bias region the current is much lower (being microamperes as opposed to milliamperes and amperes in the forward direction).

The reverse current is caused by minority carriers due to the impossibility of obtaining absolute purity in the basic crystal, and being considerably aggravated by temperature increase, releasing current carriers due to thermal energy.

The "diode effect" can also be created by introducing, say, a piece of *n*-type material, into the surface of which is embedded a pointed piece of wire called a cat's whisker. This is after the style of the old crystal detector used in radio receivers of yesteryear. *N*-type material, for instance, has a surface layer of electrons and an adjacent layer of positively charged donor atoms. These produce a potential barrier or depletion layer similar to that of a junction diode as shown in Fig. 2.9.

This type of construction is called a point-contact diode, and is adopted extensively for small low capacitance diodes for radio detection and similar, low power applications.

The junction type of diode is used more for power rectification applications and for voltage stabilisation, using the Zener effect explained below.

ZENER DIODES

If a diode is reverse biased with increasing voltage, there comes a point when the current rises very rapidly. This is called the reverse breakdown voltage or Zener

voltage, after the name of the engineer who discovered it. In normal applications diodes are not subjected to such reverse stresses, but for stabilisation applications special diodes have been developed to work at and beyond reverse breakdown potentials. One name for these is the Zener diode.

If such a diode is reverse biased from a supply through a series resistor, the voltage applied to a load circuit from across the diode will remain fairly constant in spite of changes in load current. Further, the voltage will hold constant even though the input voltage may alter. Fig. 2.10 shows why this happens.

Here the current curve rises sharply at the breakdown point, so that if the load takes an increasing current, the current in the series resistor tends to increase likewise. This is prevented, however, by the diode passing a small Zener current, thereby holding the current in the series resistor constant. Fig. 2.11a shows how the Zener diode is used in a circuit.

VARIABLE CAPACITANCE DIODES

The depletion layer of a *pn* junction diode has a value of capacitance determined by the effective width of the depletion layer. The greater the width, the smaller the capacitance. Therefore, when unbiased, the capacitance is determined by the diode's design, but as the reverse bias is increased, the capacitance falls since the width of the depletion layer increases.

This basic principle is exploited in the variable capacitance diode which is used for remote tuning of radio and television circuits, for automatic frequency correction in radio, television and f.m. receivers, for parametric amplifiers and for hosts of other applications.

Figs. 2.11b and 2.11c show respectively applications of the junction diode as a power supply rectifier and the point-contact diode in a simple radio receiver, the up-to-date version of the crystal set.

Crystal Receiver

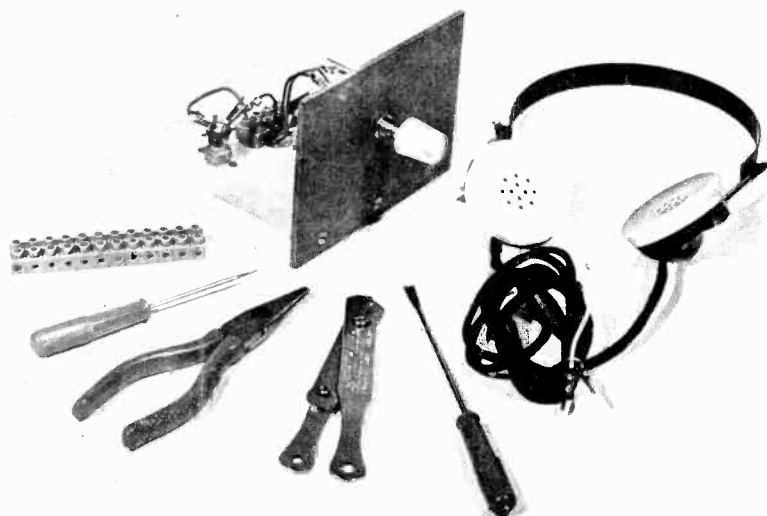

While the Semiconductor Basics series (introduced last month) is running, it is intended to publish each month a simple constructional item for the real beginner, based on the particular semiconductor device currently under discussion.

As our opening project, the semiconductor diode is presented in a modern version of the crystal set to illustrate its ability to function as a signal rectifier.

A few words in general about these special beginners projects . . .

A non-soldering method of construction has been adopted throughout this series. The method used has the virtue of being simple and inexpensive, and even the youngest novice need have no fear to embark upon the building of these electronic circuits. Careful reading of the text and close study of the illustrations is all that is required.

The only tools needed are: a pair of long-nosed pliers; an electrician's small screwdriver, a larger one for fixing the terminal strip and front panel; a wire stripper; and drills and saw for making the baseboard and front panel.

Components specified in all these projects are readily available from the usual retailers; in case of local difficulty, components can be ordered from various firms specialising in mail order service who advertise in this magazine. (Copy out the full description given in the Components List).

The approximate cost of components will be stated for each project. This figure will be based upon brand new "top" prices. The actual cost could well be somewhat lower if the reader is prepared to do some "shopping around".

EARLY crystal sets were very elaborate "instruments" with the crystal detector taking pride of place on a highly polished ebonite top panel, itself mounted on an oiled-wood box about 9 in square and 6 in deep. This panel also carried a large tuning knob and a very scientifically-constructed tuning coil; and there were large, instrument-type brass terminals for aerial, earth, and headphones.

Today's crystal set works on exactly the same principles as the first ever made 40-odd years ago; but it can take advantage of the incredible developments in components since those early days, particularly so far as the crystal detector and tuning coil are concerned.

THE CIRCUIT

The circuit of our constructional item is given in Fig. 1, which is very straightforward, indeed. The coil L1 picks up the signals from the aerial. This coil is tuned by the variable capacitor VC1. When the resonant frequency of the combination L1, VC1 matches the frequency of the required signal a large r.f. signal voltage is developed across the tuned circuit. This is the "carrier" voltage of the transmission, while its "envelope" carries the audio information, as shown at a and b in Fig. 2.

A pair of headphones connected directly across this "tuned-in" r.f. voltage would fail to respond in spite of the presence of audio information on the envelope because of the symmetrical nature of the wave. One half cycle would cancel out the other, and the net result would be no movement of the diaphragm. However, by rectifying the wave (this is where the crystal detector—or diode—comes in), the asymmetrical

PE BEGINNERS PROJECT

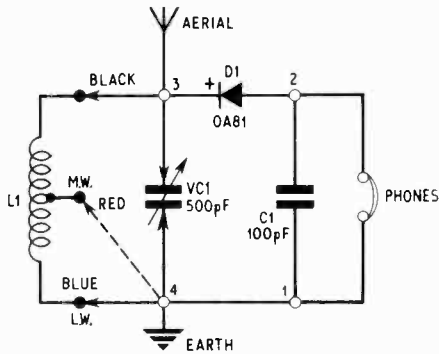

Fig. 1. Circuit of the crystal set. The numbered circles represent the terminal strip connections; arrow heads represent crocodile clips

COMPONENTS . . .

Capacitors

C1	100pF	Mica
VC1	500pF	Solid dielectric variable tuner (Dilecon)

Diode

D1	OA81	Germanium diode (Mullard)
----	------	---------------------------

Coil

L1	DRX1	Dual range crystal set coil (Repenco)
----	------	---------------------------------------

Miscellaneous

- Headphones, high resistance, Eagle SF20 (Electroniques)
- One 12-way plastics terminal strip (see text)
- Wooden baseboard 5in x 5in x 1/2in
- Hardboard front panel 3 3/4in x 5in
- Woodscrews for mounting coil, terminal strip and front panel to baseboard
- Four miniature crocodile clips
- One knob
- Plastic covered, single core copper wire (Woolworths)

TOTAL COST £1 10s 6d

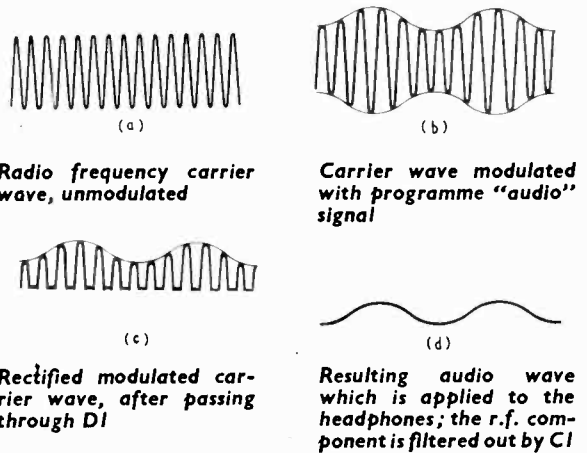

Fig. 2. These waveforms illustrate the process of "detection"

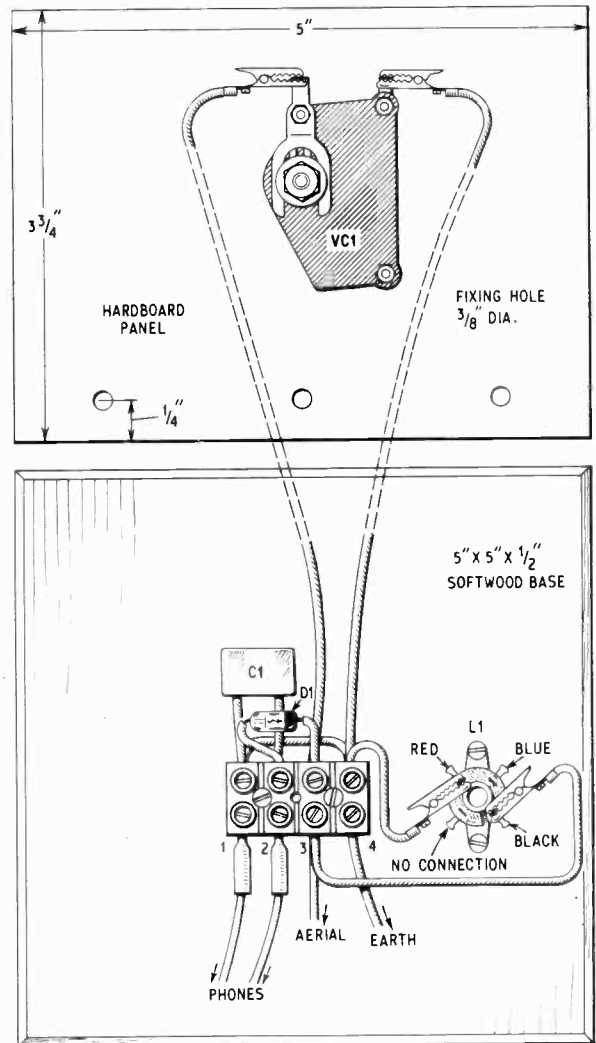

Fig. 3. Constructional and wiring details. The front panel has been laid flat for clarity

waveform of Fig. 2c is produced. Capacitor C1, across the headphones, by-passes the r.f. carrier wave and leaves only the audio information, Fig. 2d, which operates the headphones.

GOOD AERIAL ESSENTIAL

It will be appreciated that the phones are powered by the *actual transmitter signal* as picked up by the aerial, so it is essential that the latter be very efficient. This means a long outdoor aerial, as high as possible. A good earth connection is also needed; this supplements the aerial. An earth connection can be made to a cold water pipe, or to a metal spike inserted into the ground. *Do not use gas mains, hot water, or radiator pipes for this purpose.*

WAVE BAND SWITCHING

L1 is a dual band coil. The whole winding is used for long waves; the top section only for medium waves. To change from long to medium wave remove the crocodile clip from the blue tag and fit to the red tag.

Any kind of tuning knob can be used fitted to the tuning capacitor VC1. Slow-motion tuning is not necessary for the selectivity of this kind of set is not great. The headphones which should have a resistance of about 2,000 ohms (not less than 1,000 ohms) are connected direct to the terminal strip (1 and 2).

CONSTRUCTION

The first stage in construction is to measure and cut a baseboard 5in by 5in from any $\frac{1}{2}$ in thick softwood. The hardboard front panel measuring $3\frac{1}{2}$ in \times 5in is cut and drilled as shown in Fig. 3 and screwed to one of the edges of the baseboard with three $\frac{1}{2}$ in No. 6 countersunk wood screws. The variable capacitor VC1 and coil L1 should next be mounted on the front panel and baseboard, respectively, in roughly the positions indicated in the photos and Fig. 3.

Once the capacitor and coil have been secured in position the next step is to wire-up the four-way terminal strip which has been cut from the 12-way strip (the remainder of this strip will be used in later projects). The strip can be cut with a sharp pocket knife, or a Junior hacksaw.

It is best to wire the terminal strip *before* mounting on the baseboard and the terminal screws should not be tightened up until all component wires for that particular terminal have been positioned. Each wire should be given a slight pull to ensure it has made contact and is held fast by the screw once it has been tightened. Refer to Fig. 1 and Fig. 3 for connections.

When the terminal strip has been wired-up, four miniature crocodile clips should be fixed to the four leads which connect the tuning capacitor and coil to the terminal block.

Once the crocodile clips have been fixed to the four leads the terminal clips should be checked and screwed on to the baseboard by two $\frac{1}{4}$ in No. 4 countersunk wood screws. The four crocodile clips should be attached to the capacitor VC1 tags and coil L1 tags as shown in Fig. 3. The clips should not be allowed to short out on each other.

Finally, once the wiring has been carefully checked, the aerial, earth and headphones should be connected as indicated in Fig. 3. As stated earlier it is important to have a good aerial *and* earth if the Crystal Receiver is to give good results.

Next month: A transistor audio amplifier



All circuit components for constructing the crystal receiver

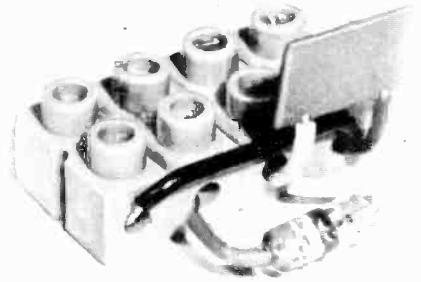

Mounting the capacitor, diode and link wire between terminals. Avoid sharp bends close to components

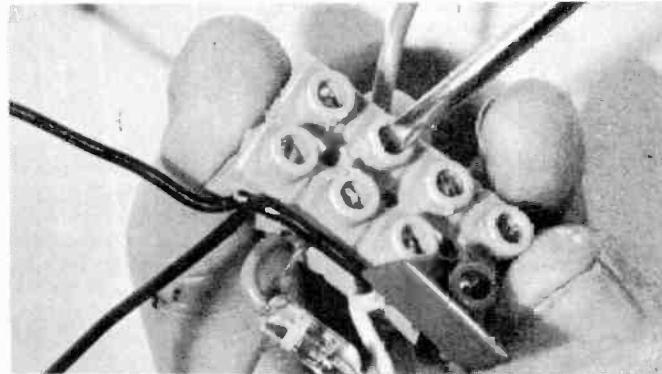

Fixing the connecting wires to the block. When the wires have been fixed the block should be mounted on the baseboard

The completed receiver

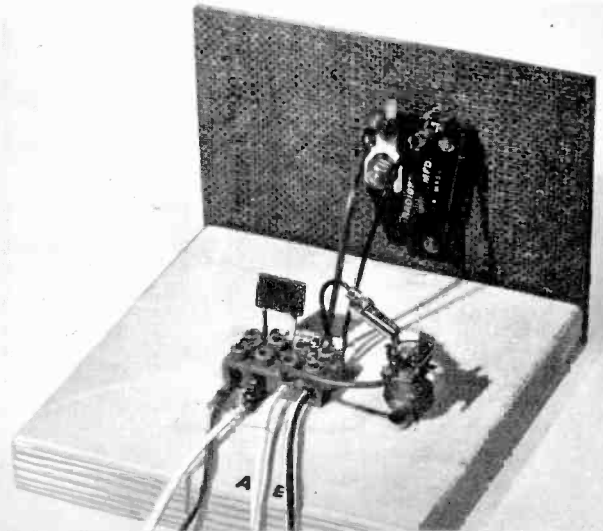

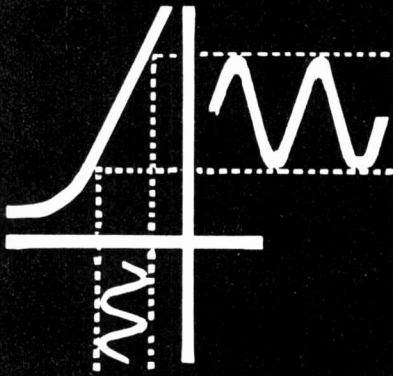

DETERMINING VOLTAGE AMPLIFICATION

By G.R. WILDING

QUITE frequently when designing, modifying or constructing valve audio amplifiers and the a.f. stages of receivers, it is desired to know the voltage amplification effected by each stage so that the output stage can be correctly loaded from the applied input.

Furthermore, if it is necessary to include a pre-amplifier to boost low level signals to any desired degree, determination of the gain required will indicate what type of valve and load resistor to use.

It is quite a simple matter, and always interesting and informative to calculate valve amplification, using one of three separate formulas.

VALVE STAGE GAIN

The most commonly used is

$$A = \frac{\mu R_L}{r_a + R_L}$$

where A is the amplification or stage gain obtained, μ is the valve amplification factor, r_a the valve anode impedance (both obtained from manufacturers' charts), and R_L is the value of the anode load resistor employed.

Thus to give an actual example, suppose an ECC40 triode was incorporated in a pre-amplifier to boost a low voltage microphone input, what magnification would it give with a load resistor of 39 kilohms, and what voltage would appear across the load resistor, for transmission to a later stage, if the input is only 0.2V?

$$A = \frac{\mu R_L}{r_a + R_L} = \frac{30 \times 39 \times 10^3}{(11 + 39)10^3} = \frac{1170}{50} = 23.4$$

With an input of 0.2V, there would be an a.c. voltage of $0.2 \times 23.4 = 4.68$ developed across the anode load resistor.

Thus the theoretical amplification factor of 30 was not equalled in practice, and although an increase in R_L would increase gain beyond the 23.4 realised, the full figure can never be quite attained.

In Fig. 1 it can be seen that a loaded valve amplifier can be regarded as a perfect signal generator of amplification factor μ , in series with a resistor r_a equal to its own impedance, and R_L equal to its effective load, so that the total gain developed is divided between the two resistors relative to their proportional values.

COUPLING COMPONENTS

The formula given ignores the effect of the coupling capacitor and grid leak resistor of the succeeding stage, which are virtually shunted across the load resistor, thereby reducing it in effective value.

This is because in most instances the following grid resistor has a value greatly in excess of the load resistor and will only reduce its value by a trifling amount. If R_L is in the region of 200 kilohms or more, the effect of even a 500 kilohm grid leak will be appreciable. Ignoring the capacitive reactance $1/\omega C$ of the coupling capacitor, the effective value of the load resistor becomes

$$R_L = \frac{R_L \times R_g}{R_L + R_g}$$

where R_g is the grid leak resistance.

continued on page 69

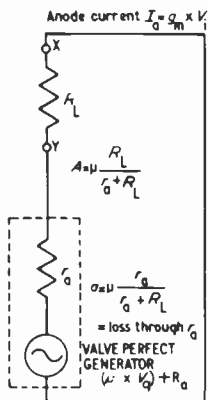

Fig. 1

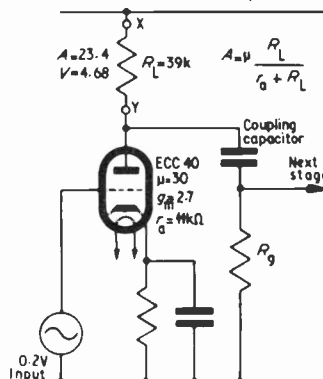

Fig. 2

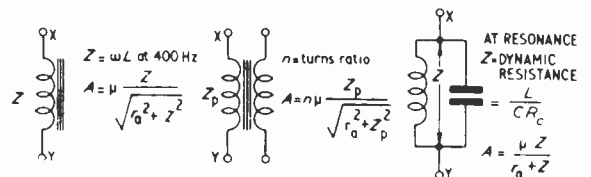

Fig. 3

Fig. 1. Theoretical circuit of a valve considered as a perfect generator. The ratio of $R_L/(r_a + R_L)$ determines the proportion of μ obtainable from the static characteristics

Fig. 2. Actual valve circuit where the stage gain A is calculated for different types of anode load R_L

Fig. 3. Alternative types of anode load with the appropriate formulae for calculating the stage amplification



**This gun
for SALE!**

**FOR 'INSTANT HEAT'...SAFE
...EFFICIENT SOLDERING**

With a Weller 'Expert' Dual Heat Gun in hand you can successfully tackle any soldering job—from a small printed circuit up to sheet metal work! You get INSTANT HEAT at the press of a trigger—and tip is cool within 10 seconds of releasing trigger. Completely safe for operator...

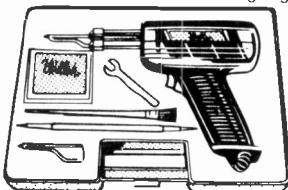

... and components Simple to use... speedy and accurate. Dual Heat 120-140 watts.

Expert Dual Heat Gun 66/- (Kit 89/6). Also available: Marksman Soldering Iron 29/- (Kit 38/-).

Manufactured by the world's largest makers of quality soldering tools.



Write for literature on Weller Soldering Equipment.

To: **WELLER ELECTRIC LIMITED**
Horsham, Sussex.
Telephone: Horsham 61747

**GOODMANS HIGH FIDELITY
MANUAL**



**A Guide to full
listening enjoyment**

The Manual is much more than a catalogue of Goodman's High Fidelity Loudspeakers—it contains informative articles, including advice on stereo, special beginners page, and full cabinet drawings. You'll find it interesting as well as informative.

**The Perfect Combination
MAXAMP 30**

TRANSISTORISED STEREOPHONIC HIGH FIDELITY AMP-LIFIER 15 + 15 watts · Silicon solid state · Integrated pre-amplifier
Negligible distortion · £49.10.0.

STEREOMAX

MATCHING AM/FM STEREOPHONIC FM TUNER

Transistorised · Outstanding specification · Stereo de-coder (optional)
£60.0.0. + £11.18 3. P.T. inc. Surcharge.

Both MAXAMP 30 and STEREO MAX have polished wood cases (10½" x 5½" x 7½" deep) in Teak or Walnut to order

Full specifications of the Maxamp 30 and Stereomax are given in the High Fidelity Manual — send the coupon for your FREE copy — or pay an early visit to your Goodmans dealer.

FREE

Please send Hi-Fi Manual together with name and address of my nearest Goodmans dealer.

Name.....

Address.....

P.E.1/68

GOODMANS LOUDSPEAKERS LTD

AXIOM WORKS · WEMBLEY · MIDDLESEX. Tel: 01-902 1200

EXCEL

in

ELECTRONICS

**Through this ICS
3-way Training Method:**

MASTER THE THEORETICAL SIDE

1

From basic principles to advanced applications, you'll learn the theory of electronic engineering, quickly and easily through ICS. That's because each course is set out in easy-to-understand terms.

MASTER THE PRACTICAL SIDE

2

ICS show you how to develop your practical abilities in electronic engineering—alongside your theoretical studies. It's the only sure way to success. All training manuals are packed with easy-to-follow illustrations.

MASTER THE MATHEMATICAL SIDE

3

To many this aspect is a bitter problem. Even more so because no electronic engineer is complete without a sound working knowledge of maths. But new ICS teaching makes mathematics easier to learn.

Wide range of courses available include:
Radio/T.V. Engineering and Servicing, Closed Circuit T.V., Electronics, Electronics Maintenance, Instrumentation and Servomechanisms, Telemetry, Computers, etc.

NEW! Programmed Course on Electronic Fundamentals
EXPERT COACHING FOR:

- INSTITUTION OF ELECTRONIC AND RADIO ENGINEERS
- CITY AND GUILDS TELECOMMUNICATION TECHNICIANS
- R.T.E.B. RADIO/T.V. SERVICING CERTIFICATE
- RADIO AMATEURS' EXAMINATION
- P.M.G. CERTIFICATES IN RADIOTELEGRAPHY

And there are practical "learn as you build" radio and electronics courses as well.

Member of the Association of British Correspondence Colleges

FOR **FREE HANDBOOK** POST THIS COUPON TODAY

I.C.S., Dept. 151, INTERTEXT HOUSE,
PARKGATE ROAD, LONDON, S.W.11

NAME

ADDRESS

OCCUPATION.....AGE..... 1/68

INTERNATIONAL CORRESPONDENCE SCHOOLS

EXPERIMENTER'S PRINTED CIRCUIT KIT

BUILD 40 INTERESTING PROJECTS on a PRINTED CIRCUIT CHASSIS WITH PARTS and TRANSISTORS from your SPARES BOX

CONTENTS: (1) 2 Copper Laminate Boards 4 1/2" x 2 1/2". (2) 1 Board for Matchbox Radio. (3) 1 Board for Wristwatch Radio, etc. (4) Resist. (5) Resist Solvent. (6) Etchant. (7) Cleanser/Degreaser. (8) 16-page Booklet Printed Circuits for Amateurs. (9) 2 Miniature Radio Dials 5V/PMW/LW. Also free with each kit. (10) Essential Design Data, Circuits, Chassis Plans, etc. for building.

40 TRANSISTORISED PROJECTS

A very comprehensive selection of circuits to suit everyone's requirements and constructional ability. Many recently developed very efficient designs published for the first time, including 10 new circuits.

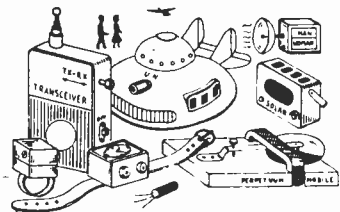

EXPERIMENTER'S PRINTED CIRCUIT KIT 8/6

Postage & Pack. 1/6 (UK)

Commonwealth:

SURFACE MAIL 2/-

AIR MAIL 8/-

Australia, New Zealand, South Africa, Canada

- (1) Crystal Set with biased Detector.
- (2) Crystal Set with voltage-quadrupler detector.
- (3) Crystal Set with Dynamic Loudspeaker.
- (4) Crystal Tuner with Audio Amplifier.
- (5) Carrier Power Conversion Receiver.
- (6) Split-Load Neutralised Double Reflex.
- (7) Matchbox or PhotoCell Radio.
- (8) "TRIFLEXON" Triple Reflex with self-adjusting regeneration (Patent Pending).
- (9) Solar Battery Loudspeaker Radio.
- (10) The smallest 3 designs yet offered to the Home Constructor anywhere in the World. 3 Subminiature Radio Receivers based on the "Triflexon" circuit. Let us know if you know of a smaller design published anywhere. (10) Postage Stamp Radio. Size only 1.62" x .95" x .75". (11) Wristwatch Radio 1.5" x .80" x .55". (12) Ring Radio .70" x .70" x .55". (13) Batteria-powered Radio. Runs on sugar or bread. (14) Radio Control Tone Receiver. (15) Transistor P/P Amplifier. (16) Intercom. (17) 1-valve Amplifier. (18) Reliable Burglar Alarm. (19) Light-Seeking Animal-Guided Missile. (20) Perpetual Motion Machine. (21) Metal Detector. (22) Transistor Tester. (23) Human Body Radiation Detector. (24) Man/Woman Discriminator. (25) Signal Injector. (26) Pocket Transceiver (Licence required). (27) Constant Volume Intercom. (28) Remote Control of Models by Induction. (29) Inductive-Loop Transmitter. (30) Pocket Triple Reflex Radio. (31) Wristwatch Transmitter/Wire-less Microphone. (32) Wire-less Door Bell. (33) Ultrasonic Switch/Alarm. (34) Seismic Car Alarm. (35) Quality Stereo Push-Pull Amplifier. (36) Light-Beam Telephone "Photophone". (37) Light-Beam Transmitter. (38) Silent TV Sound Adaptor. (39) Ultrasonic Transmitter. (40) Thyristor Drill Speed Controller.

PHOTOELECTRIC KIT

BUILD 12 EXCITING PHOTOELECTRIC DEVICES

CONTENTS: 2 P.C. Chassis Boards, Chemicals, Etching Manual, Cadmium Sulphide PhotoCell, Latching Relay, 2 Transistors, Condenser, Resistors, Gain Control, Terminal Block, Elegant Case, Screws, etc. In fact everything you need to build a Steady-Light Photo-Switch/Counter/Burglar Alarm, etc. (Project No. 1) which can be modified for modulated-light operation.

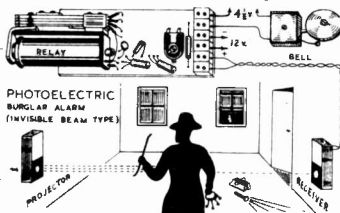

PHOTOELECTRIC KIT 39/6

Postage & Pack. 2/6 (UK)

Commonwealth:

SURFACE MAIL 3/6

AIR MAIL £1.00

Australia, New Zealand, S. Africa, Canada & U.S.A. Also Essential Data Circuits and Plans for Building

- 12 PHOTOELECTRIC PROJECTS. (1) Steady-Light Photo-Switch/Alarm. (2) Modulated-Light Alarm. (3) Long-Range Alarm. (4) Relay-Less Alarm. (5) Warbling-Tone Alarm. (6) Closed-Loop Alarm. (7) Protector Lamp Stabiliser. (8) Electronic Projector Modulator. (9) Mains Power Supply. (10) Car Parking Lamp Switch. (11) Automatic Headlamp Dipper. (12) Super-Sensitive Alarm.

INVISIBLE BEAM OPTICAL KIT

Everything needed (except plywood) for building: 1, Invisible-Beam Projector and 1 Photocell Receiver (as illustrated). Suitable for all Photoelectric Burglar Alarms, Counters, Door Openers, etc.

CONTENTS: 2 lenses, 2 mirrors, 2 45-degree wooden blocks, Infra-red filter, projector lamp holder, building plans, performance data, etc. Price 19/6. Postage and Pack 1/6 (UK). Commonwealth: Surface Mail 2/-; Air Mail 8/-.

LONG RANGE OPTICAL KIT 29/6 p.p. 1/6

Obtainable from larger electronic components distributors or direct from

EXPERIMENTAL ELECTRONIC ENG. KITS
YORK ELECTRICS, 333 York Road, London, S.W.11

Send a S.A.E. for full details, a brief description and Photographs of all Kits and all 52 Radio, Electronic and Photoelectric Projects Assembled.

R.S.T. VALVE MAIL ORDER CO.

144 WELLFIELD ROAD, STREATHAM, S.W.16
Special 24 Hour Mail Order Service

AZ31	9/-	EY81	7/-	QS150.45	68H6	7/-	50C5	6,9	OC16	20/-
CIC	12/-	EY83	8/6	20/-	6BJ6	7/-	60CD6G	31/-	OC19	17/6
DAF91	4/-	EY84	7/6	80	6BK4	27/6	80	0/-	OC20	16/6
DAF96	6/3	EY86	6/6	20	6BN6	7/6	85A1	25/-	OC24	15/-
DCC90	7/-	EZ41	8/-	80	Q1209	7/3	6BQ7A	7/-	OC25	11/-
DF81	3/-	EZ80	6/-	10	QV03-12	10/-	6BR7	8,6	90A4	46/-
DF86	5/-	GT1C	17/6	QV07-7	12/6	6B7	10	90A5	43/-	
DH3/91	80/-	GT1C	17/6	QV03-25	6BW6	7/-	90C1	12/-	OC29	16/6
DK91	5/-	GZ30	10/-	QV06-20	6BW7	9	90C2	25/-	OC35	11/6
DK92	8/-	GZ32	9/6	R10	15/-	6C4	2	90C2V	25/-	
DK96	7/-	GZ34	10/-	R17	8/-	6CB6	5	150B2	9/6	
DL66	15/-	GZ37	12/6	R18	7/6	6CD6G	20	150H3	8,6	
DL92	4/9	H63	8/-	R19	7/-	6CH6	6,9	801	6/-	
DL94	5/9	HL41DD	13/6	RG5-300	80/-	6CL5	8	803	35/-	
DL96	7/-	KT4V	12/6	300	26/-	6A4	19	805	50/-	
DL810	12/6	KT66	16/-	SI30P	25/-	6D4	15	807	7/-	
DL816	30/-	KT67	45/-	SP41	3/6	6DK6	9	813	75/-	
DL819	30/-	KT817C5	SP61	3	6FP23	13,6	866A	13,6		
DM70	5/-	10/-	STV280	40	6F24	12	872A	57/6		
DY86	6/-	KT81(GEC)	25	6F25	12	6651	7,6			
DY87	6/-	KT88	35/-	STV280	80	6F28	11,6			
EL84	12/6	KT88	25/-	160	6G5G	12	6672	7		
EL80F	17/6	KTW61	10/-	SU2150	12	6J6	3			
EL82CC	22/6	KTW62	10/-	SU2150A	12	6J7G	4			
EABC90	6/6	ML4	17/6	17V	35/6	6K7G	1			
EB91	3/-	N78	15/-	U24	24/-	6K8G	3			
EC63	7/-	PC86	8/6	U23	13/6	6L6G	7			
EBF90	6/6	PC88	8/6	U26	13/6	6Q7G	6			
EB98	6/6	PC87	7/6	U19	12/6	6G7	5			
EBL31	2/6	PC900	5/6	U01	15/-	68J7M	10			
ECL800	30/-	PC84	5/6	U04	10/9	68L7GT	4			
EC33	15/-	PC89	10/-	C801	17/-	68N7GT	4			
EC40	9/6	PCF80	6/3	UABC00	5	6V6G	4,6			
EC68	3/9	PCF86	8/-	UAF42	8/9	6X4	3,6			
EC82	4/9	PCL82	7/-	UCH21	8/6	6N3	4,6			
EC83	5/9	PCL83	8/6	UC82	8/6	6T7	7			
EC85	7/-	PCL84	8/6	UC81	25/-	6A4	10			
EC88	7/-	PCL85	8/6	UCL82	7/-	7C6	6			
ECF80	6/6	PCL86	8/6	UCL83	8/9	7H7	6			
ECF82	7/-	PENB4	20/-	UL41	8/9	7H7	17,9			
ECF35	11/-	PEN45DD	UL84	6/-	7Y4	7/6	6146	25		
ECH42	9/-	12/-	UY41	6/3	10P13	16/6	900	8		
ECH61	3/3	PFL100	14/-	UY85	5/-	11E23	42/-			
EC180	2/6	PL26	5/6	UP41	25/-	6Z4G	10			
ECL80	6/6	PL81	7/6	VR150/30	5/-	12AD6	11/-			
ECL82	6/3	PL84	6/6	VR150/30	6/-	12AE6	9,6			
ECL83	9/6	PL500	13/6	W81	6/-	12AH8	30			
ECL86	8/9	PX4	14/-	Z66	15/-	12AT6	6,6			
EF9	20/-	PX25	12/6	Z319	25/-	12AT7	3			
EF37A	7/-	PY32	8/6	Z759	23/-	12A1T	4			
EF39	6/-	PY33	8/6	Z801U	16/-	12AX7	6,9			
EF80	5/-	PY81	6/-	0A2	5/9	12BA6	5/6			
EF86	6/3	PY82	6/6	0B2	6/-	12BE6	5/6			
EF89	5/-	PY83	6/-	0Z4	4/6	12E1	17/6			
EF91	3/6	PY800	7/-	1B3GT	8/-	12K7GT	6/-			
EF92	2/6	PY801	7/-	2D21	5/-	12K8GT	8/-			
EF98	9/-	PZ30	10/-	2E26	20/-	12Q7GT	4/6			
EF182	6/6	QV02,6	10/-	2Q02,6	17/-	2N658	12/6			
EF184	6/-	QV03/10	3B28	40/-	20P4	15/-	AC107	9/-		
EF804	21/-	10/-	30	3C45	47/-	20P5	18/-			
EFF60	10/-	QV03/20	4X150A	96/-	2B24	6/3	AC128	6/6		
EL90	7/6	105/-	6R4GY	8/9	25Z6GT	7/-	ACY19	4/9		
EL33	12/6	QV04/15	5L4G	4/-	25Z8GT	8/6	ACY20	4/9		
EL34	9/6	105/-	5V4G	8/-	30C15	13/6	ACY21	4/9		
EL41	8/6	QV06/45	5V3GT	2/6	30C17	14/-	AD140	15		
EL42	8/6	90/-	5Z4G	5/-	30C18	13/6	AF114	7/-		
EL81	7/9	QV5/10	6/30L2	13/-	30F5	14/-	AF115	7/-		
EL84	4/3	70/-	6AK5	4/6	30F11	16/-	AF116	7/-		
EL85	7/6	Q870/20	5/6	6AK6	6/6	30F12	16/-			
EL86	7/6	Q875/20	5/6	6AL5	3/-	30FL14	13/6			
EL360	22/-	Q875/60	6AM6	3/6	30L15	15/-	NK7211	3/-		
EL820	6/-	20/-	6A8	10/-	30L17	14/3	NK7214	4/-		
EL84	8/6	Q883/3	6AQ6	4/6	30P12	13/6	NK7216	7/6		
EL822	16/-	Q892/10	4/-	6AQ5	5/6	30P19	13/-			
EL880	20/-	Q895/10	5/6	6AS6	6/0	30PL1	15/-			
EM34	12/6	Q8108/45	15/-	6A87	15/-	30PL13	15/-			
EM80	7/-	Q8150/15	8/-	6AT6	4/-	30PL14	15/-			
EM84	7/-	Q8150/30	0/-	6B4G	16/-	35L6GT	5/9			
EN82	20/-	Q8150/36	6BA6	4/6	35W4	4/9	NK767	5/-		
EY01	7/-	20/-	6BE6	4/6	45Z4GT	6/6	NK7713	7/6		

All valves brand new and boxed. Postage 6d. valve.
OPEN DAILY TO CALLERS 9 a.m.—5.45 p.m. No early closing
C.W.O. Tel: 01-769 0199 & 1649 No C.O.D.

SEND S.A.E. FOR LIST OF 2,000 TYPES

The SUPER 6

L.W. and M.W. TRANSISTOR RADIO

- ★ 6 transistors and diode. ★ 350mW. ★ Superhet.
- Ferrite rod aerial. ★ Wooden cabinet, 11" x 7 1/2" x 3 1/2"
- ★ Vinyl covered. ★ 6 x 4 in. speaker. ★ Booklet 8/-.
- ★ Free with kit. ★ Lining up service. ★ All parts supplied separately. Write for list. S.A.E. please. P.P.9 required (3/9 with kit).

COMPLETE SET OF PARTS ONLY £4.00

OR FULLY BUILT £6.17.6 Tax & Carr. Paid (PLUS 6/- POST)

NEW 6 PUSHBUTTON STEREOGRAM CHASSIS

M.W.; 8.W.1; 8.W.2; VHF; Gram; Stereo Gram. Two separate channels for Stereo Gram with balance control. Also operates with two speakers on Radio. Chassis size 16" x 7" x 6 1/2" high. Dial cream and red 16" x 3". ECC85; ECH81; EF89; 2 x ECL86; EM84 and Rect. 190-650M; 18-61M; 60-187M; 86-100 Mc/s. Price £19.19.0 carr. paid or £6.18.0 deposit and 5 monthly payments of 66/6 Total H.P. price £20.15.6. Decoder can be fitted at £6.0 extra.

GLADSTONE RADIO

(2 mins. from Station and Buses.)
CLOSED WEDNESDAY AFTERNOON

66 ELMS ROAD
ALDRSHOT, HANTS.

Aldershot 22240
CATALOGUE 6d.

SINE TO SQUARE WAVE CONVERTER

By A. FOORD

SINCE a square wave contains many harmonics as well as a basic frequency, square wave testing of an audio amplifier is more representative of actual operating conditions on speech and music than mere sine-wave testing. The circuit shown in Fig. 1 can be used to convert a sine wave to a square (or rectangular) wave.

SCHMITT TRIGGER

This circuit, commonly known as a Schmitt trigger, is a two stage amplifier with positive feedback via R5, this resistor being common to both TR1 and TR2. It has two stable states: TR1 conducting and TR2 off, and TR1 off with TR2 conducting—depending on the amplitude of the input. Due to the positive feedback the circuit switches rapidly from one state to the other, and can be used to produce a square or rectangular wave.

If TR1 is non-conducting, the base of TR2 is biased via R1, R2, and R3 at about +6.8V, and the emitter of TR1 and TR2 will be at +6.2V (0.6V base-emitter drop for silicon), so that for TR1 to be off (as was assumed) the input must be less than +6.2V. As the input approaches 6.2V a critical voltage is reached where TR1 begins to conduct, and positive feedback brings TR1 on rapidly and cuts TR2 off, so that a good rise time is achieved. If the input is now lowered below a similar critical value TR2 will conduct and TR1 will be cut off.

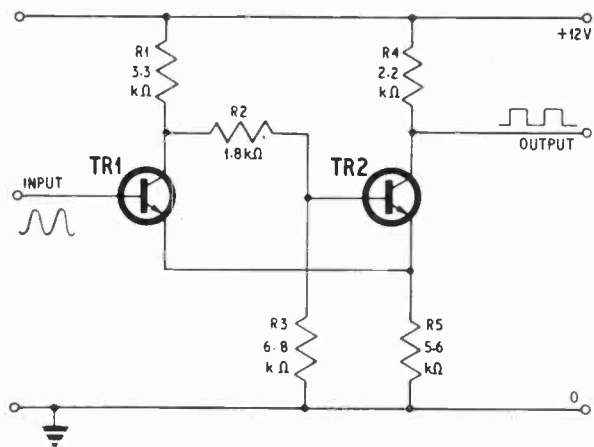
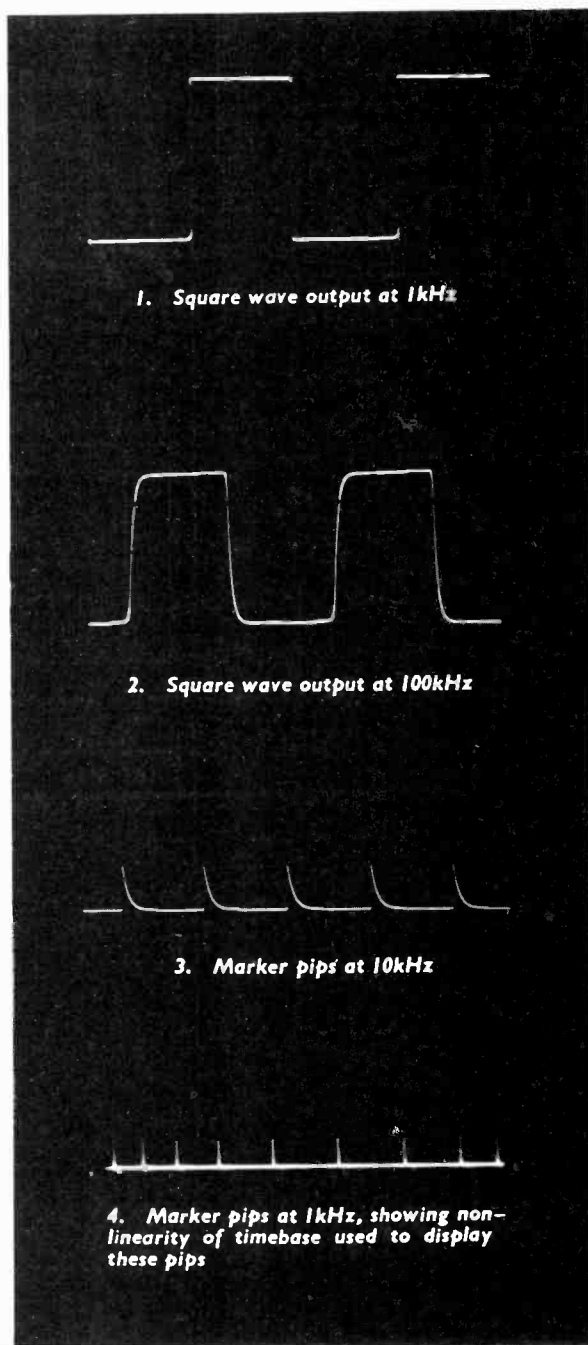

Fig. 1. The basic Schmitt trigger circuit



1. Square wave output at 1kHz

2. Square wave output at 100kHz

3. Marker pips at 10kHz

4. Marker pips at 1kHz, showing non-linearity of timebase used to display these pips

THE PRACTICAL CIRCUIT

The practical circuit has several additions, as will be seen by reference to Fig. 2. The 220 kilohm resistor R1 is used to bias TR1 on, and the signal cuts TR1 off. The addition of the two diodes D1, D2 prevents the base-emitter junction of TR1 from being reverse biased. (Transistors such as the OC71 have a reverse rating of about 10V, the much faster 2N2926's have a reverse rating of 5V, and the diodes prevent this from ever being exceeded; when the input falls below the trip voltage the emitter of TR1 is clamped to the base via a diode.)

Using a 6V supply the output achieved with this circuit was 1V peak to peak, for a 12V supply it was 2.5V peak to peak, and for a 15V supply it was 3V peak to peak. The results tabulated below and shown graphically in the photographs are for a 12V supply.

PERFORMANCE

Input impedance	2 kilohm
Input (for square-wave output)	1.5V pp sinewave at 1kHz
	2V pp sinewave at 100kHz
Output	2.5V pp square wave
Rise time	less than 1 μ s

The first photograph 1 shows the output at 1kHz. On this scale the rise time of 1 μ s is so fast that the vertical edges do not photograph. The second photograph shows the output at 100kHz. Here the rise and fall times are clearly visible (but the square wave is reasonably good, an amplifier of 300kHz bandwidth would noticeably degrade these edges!)

DIFFERENTIATING CIRCUIT

By adding a differentiating circuit as shown in the right hand portion of Fig. 2, this unit can be used to provide a variable time calibration for an oscilloscope.

For a 1kHz input this differentiator would give pips every 1ms. In use the pips would be displayed, and the oscilloscope time base varied to give a convenient calibration on a graticule (say, 1ms per cm). If the pips were removed and a signal displayed, time intervals could easily be measured. Those fortunate enough to own a double beam oscilloscope can of course display both signal and marker pips simultaneously.

The time constant chosen for the pips is a compromise; at 10kHz (photo 3) the pips are easily seen, but at 1 kHz (photo 4) the pips are very narrow compared with the interval. Photo 4 actually shows the poor timebase linearity of a simple oscilloscope (not the one used to take the other photo's!); the timebase is slightly cramped at the start and appreciably cramped at the end.

If the add-on circuit is used for markers it should be connected via a switch as shown in the diagrams since it loads the square wave and degrades its edges.

COMPONENTS . . .

Resistors

R1	220k Ω	R5	2.2k Ω
R2	3.3k Ω	R6	5.6k Ω
R3	1.8k Ω	R7	10k Ω
R4	6.8k Ω	R8	10k Ω

All $\pm 10\%$, $\frac{1}{2}$ W carbon

Capacitors

C1	10 μ F elect. 20V
C2	10 μ F elect. 20V
C3	1,000pF ceramic or paper

Transistors

TR1, 2 2N2926 yellow or green spot (2 off)

Diodes

D1, 3 OA81 (3 off)

Sockets

SK1-3 Coaxial socket (3 off)

Switch

S1 Single pole changeover, small slide type

Miscellaneous

Battery, 12V. Veroboard. Diecast box $4\frac{1}{2}$ in \times $2\frac{1}{2}$ in \times 1in. Two feed-through terminals. Spacers, screws and nuts, insulating material.

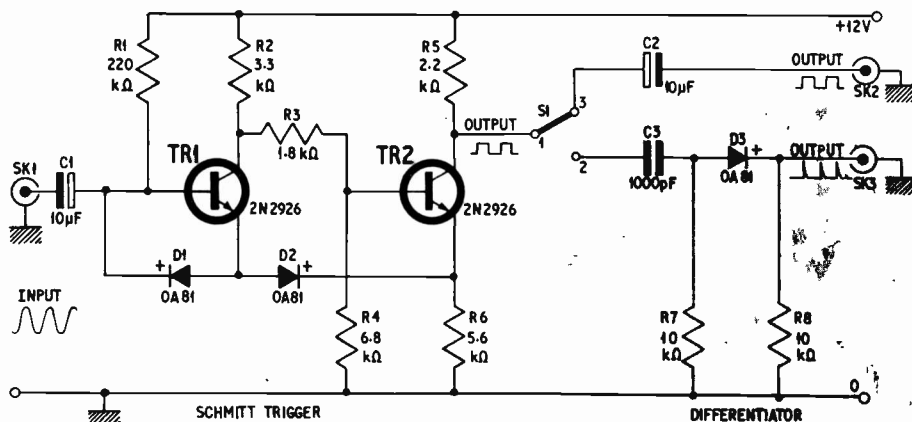

Fig. 2. Circuit diagram of the complete sine to square wave converter



POCKET MULTI-METER

Size 3 1/4 x 2 1/4 x 1 1/4 in. Meter size 2 1/4 x 1 1/4 in. Sensitivity 1000 O.P.V. on both A.C. and D.C. volts. 0-15, 0-150, 0-1000, D.C. current 0-150mA. Resistance 0-100k Ohm. Complete with test prods, battery and full instructions, 42/6. P. & P. 3/6. **FREE GIFT** for limited period only. 30 watt Electric Soldering Iron value 15/- to every purchaser of the Pocket Multi-Meter.

ANTI-THIEF CAR BURGLAR ALARM

The Melguard Safermatic consists of an electrical device housed in small metal box 4" x 2" x 1 1/2", which has been designed and developed to provide protection required by the average motorist at an economic cost. Using this system, an alarm and the immobilised condition is set automatically as soon as you park the car. Should you leave the key in the ignition, no one but you can drive the car away. Upon entering the vehicle the method of starting the car is by switching on the ignition, depressing two hidden switches and simultaneously operating the starter. Location of the switches is known only to you. Should the alarm be set off it can be stopped by following the normal starting procedure. For 12V operation. List price 79/6 our price 29/6 plus 2/6 P. & P. Full easy-to-follow instructions supplied.



EXTRACTOR FAN

AC Mains 230/230v complete with pull switch. Size 6" x 6" x 4". Price 27/6 plus 5/- P. & P.



3 to 4 WATT AMPLIFIER

3-4 watt Amplifier built and tested. Chassis size 7" x 3 1/4" x 1 in. Separate bass, treble and volume control. Double wound mains transformer, metal rectifier and output transformer for 3 ohms speaker. Valves ECC81 and 6V6. £2.5.0 plus 5/6 P. & P.

BSR MONARCH UAI6 With FULL-FI HEAD

4-speed, plays 10 records, 12in., 10in. or 7in. at 16, 33, 45 or 78 r.p.m. Intermixes 7in., 10in. and 12in. records of the same speed. Has manual play position; colour, brown. Dimensions: 12 1/2 x 10 1/2 in. Space required above baseboard 4 1/2 in., below baseboard 2 1/2 in. Fitted with Full-Fi-turn-over crystal head. £4.19.6. P. & P. 9/-.

Special offer ELEGANT SEVEN mk IIa

SPECIAL OFFER. Power supply kit to purchasers of 'Elegant Seven' parts, incorporating mains transformer, rectifier and smoothing condenser, A.C. mains 200/250 volts. Output 9v. 100 mA. 9/6 extra.

Buy yourself an easy to build 7 transistor radio and save at least £10.0.0. Now you can build this superb 7 transistor superhet radio for under £4.10.0. No one else can offer such a fantastic radio with so many de luxe star features.

- ★ De luxe wooden cabinet size 12 1/2" x 8 1/2" x 3 1/2".
- ★ Horizontal easy to read tuning scale printed grey with black letters, size 1 1/2" x 2".
- ★ High 'Q' ferrite rod aerial.
- ★ I.F. neutralisation on each separate stage.
- ★ D.C. coupled push pull output stage with separate A.C. negative feedback.
- ★ Room filling output 350mW.
- ★ Ready etched and drilled printed circuit board back printed for foolproof construction.
- ★ Fully comprehensive instructions and point to point wiring diagrams.
- ★ Car aerial socket.
- ★ Fully tunable over medium and long wave, 168-535 metres and 1250-2000 metres.
- ★ All components, ferrite rod and tuning assembly mount on printed board.
- ★ 5" P.M. Speaker.
- ★ Parts list and circuit diagram 2/6, free with parts.



ONLY £4.4.0

Plus 7/6 Post & Packing

BSR TAPE DECKS

200/250 v. A.C. mains
Type TD2 Tape 'speed 3 1/2" twin track—£6.19.6.
Type TD10 2-track, 3 speed, plus rev. counter—£7.19.6.
Type TD10 4-track, 3 speed, plus rev. counter—£9.5.0.
P. & P. on each 7/6.

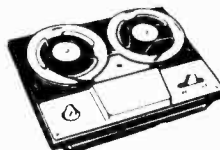

STAR SR 150 COMMUNICATION RECEIVER

Frequency range: 535 kc/s-30 Mc/s. 4 wavebands. 5 valve superhet. Incorporates BFO, bandspread tuning, "S" meter, external telescopic aerial and ferrite aerial. Built-in 4in. speaker. Easy-to-read dial. For 240v. A.C. operation. Complete, brand new, with full instruction manual. 15 gns. P. & P. 10/-.



NEW! DORSET 600 milli-watt solid state 7 transistor plus diode and thermistor Transistor Portable Radio plus Baby Alarm Facilities

Completely modulated high quality portable radio featuring complementary N.P.N. and P.N.P. output stage.

The comprehensive easy-to-follow drawings supplied make this the easiest-ever transistor radio set of parts, with the following features:

- Simple connections to only 6 tags on the R.F./I.F. module, 3 I.F. stages, osc. coil and 3 transistors which with their associated components are completely wired.
 - Only 4 connections on the A.F. module to complete the 4 transistor 600 milli-watt solid state amplifier.
 - Pre-aligned R.F./I.F. module built and tested.
 - A.F. module built and tested.
 - Fully tunable over M.W. and L.W. bands. M.W. 540-1640 Kc/s (557-183 metres). L.W. 150-275 Kc/s (2000-1100 metres).
 - Intermediate Frequency 470 Kc/s.
 - Sensitivity: M.W. at 1 Mc/s 10 microvolts plus or minus 3db. L.W. at 200 Kc/s 40 microvolts plus or minus 4db.
 - High Q internal ferrite rod aerial on both wavebands.
 - Finger tip controls.
 - Class "B" modulated output stage with thermistor controlled heat stabilization. Class "B" output stage ensures long battery life. Current drain is proportional to the output level. Total current drain of the receiver under no signal conditions is 10-12mA. At reasonable listening level 20-30mA.
 - Extension sockets for car aerial input, tape recorder output (independent of vol. control) and Ext. Speaker.
 - All components (except speaker) mount on the printed circuit board. Easy to follow instructions. Size of cabinet 12" long, 8" high and 3" deep.
- Circuit and parts list 2/6, free with parts.
- PRICE: £5.5.0** plus 7/6 P. & P.

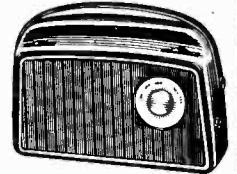

RADIO AND T.V. COMPONENTS (ACTON) LTD.

21D HIGH STREET, ACTON, LONDON, W.3

Shop hours 9 a.m. to 6 p.m. Early closing Wednesday Goods not despatched outside U.K. All enquiries stamped addressed envelope. Terms C.W.O.

Also at 323 EDGWARE ROAD, LONDON, W.2. PERSONAL SHOPPERS ONLY. All orders by post must be sent to our Acton address. Early closing Thursday.

Transistorised SIGNAL GENERATOR

Size 5 1/2" x 3 1/2" x 1 1/2". For IF and RF alignment and AF output, 700 c/s frequency coverage 460 Kc/s to 2 Mc/s in switched frequencies. Ideal for alignment to our Elegant Seven and Musette. Built and tested. 39/6. P. & P. 3/6.



FIRST QUALITY P.V.C. TAPE

5 1/2" Std. 850ft. ...	9/-	5"	L.P. 850ft. ...	10/6
7" Std. 1200ft. ...	11/6	3"	T.P. 600ft. ...	10/6
3" L.P. 240ft. ...	4/-	5"	T.P. 1800ft. ...	25/6
5 1/2" L.P. 1200ft. ...	11/6	5 1/2"	T.P. 2400ft. ...	32/6
7" L.P. 1800ft. ...	18/6	7"	T.P. 3600ft. ...	42/6
5 1/2" D.P. 1800ft. ...	18/6	4"	T.P. 900ft. ...	15/-

P. & P. on each 1/6, 4 or more post free

600mW SOLID STATE 4-TRANSISTOR AMPLIFIER

Features NPN and PNP Complementary Symmetrical Output Stage. The elimination of transformers ensures maximum efficiency and frequency response. Automatic heat compensation. Combined AC/DC feed back. Class B output stage, i.e. output power is proportional to total current consumption, this ensures long battery life. Under no signal condition (IQ) current drain is approx. 12mA at 9 volts (4mA in the output pair). Printed circuit construction, size: 2 1/2" x 4" x 1 1/2". Speaker output impedance 12 ohms. Output power 600mW at 5% distortion, 400mW at 2.5% distortion, 750mW at 10% distortion. Supply 9 volts. Total current consumption at a reasonable listening level approx. 35-40mA at full power (speech and music). average 65mA. Sensitivity for 50mW output is 10mV. Frequency response -3db points 90 c/s and 12 Kc/s. Price 15/- plus 1/- P. & P. 7" x 4" speaker to suit. 13/6 plus 2/- P. & P.

8-WATT 4-VALVE PUSH-PULL AMPLIFIER & Metal RECTIFIER

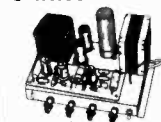

Size 9" x 6" x 1 1/2". A.C. Mains, 200-250 v. 4 valves. For use with Std. or L.P. records, musical instruments. All makes of pick-ups and mikes. Output 8 watts at 5 per cent of total distortion. Separate bass and treble lift control. Two inputs, with controls for gram. and mike. Output transformer tapped for 3 and 15 ohm speech coils. Built and tested. £4.4.0. P. & P. 11/- 8" x 5" Speaker to suit. Price 14/6 plus 1/6 P. & P. Crystal Mike to suit 12/6 plus 1/6 P. & P.

BARGAIN OPPORTUNITIES

FROM



LOUDSPEAKER OPPORTUNITIES

TRS ACOUSTIC ENCLOSURE

Teak finished, 21in high x 16in wide x 7in, cut to take tweeter and 8in or 10in speaker to order. Acoustically proportioned for finest possible audio quality. Supplied ready to take units. SUPERB VALUE AT ONLY **£4.15.0** Please add 7/6 as part of cost of packing and carriage.

E.M.I. elliptical 13 1/2in x 8in 3 ohm heavy duty 10W unit. Special price **55/-**

15 OHM SPEAKER UNITS

W.B. HF812 8" Unit	£4.10.0
8in FR.8 Dual concentric, 15W loading	£5.15.0
8in Goodman's Twin Axiette, 15W loading	£6. 0.0
10in Goodman's Axiom	£7. 5.0
8in Fane with 15000 line ceramic magnet and foam-surround cone suspension	£5.19.6
SINCLAIR Q.14 complete speaker 9 1/2in square. Fantastically good in stereo.	£6.19.6

GARRARD UNITS & PLINTHS

LM3000 Record Player with 9T.A. Stereo Cartridge. Brand new as from factory **£8.15.0**
 AT.60 Mk II De-luxe Auto-changer, die-cast turntable. Less cartridge **£11.19.6**
 SP.25 De-luxe single record player, die-cast turntable. Less cartridge **9j gas.**
 Packing and carriage on any one of above 7/6 extra.
 Garrard Plinth. Ideal mounting for the Garrard Units offered here. Will readily suit any hi-fi set-up. In fine Teak. Complete with useful soft plastic dust cover. Packing and carriage 5/- **75/-**
 Garrard clear-view rigid perspex cover (carriage 3/6) **57/6**
CARTRIDGE OFFER TO PURCHASERS OF ABOVE ITEMS—Ronette 105/S Stereo, 32/6; Sonotone 9TA/HC, 37/6; 9TA/HC with diamond 47/6; Decca Deram (with diamond), 79/6; TC8/M Crystal Mono, 25/-; 5NBO T/O Mono, 17/6; Acos G91-1 19/6.

TRS MULLARD AMPLIFIERS

STEREO 10-10

Valve amplifier to exact Mullard spec. With pre-amp tapped off p transformer 3 and 15p, all controls, H.T. and L.T. outlet, mono, stereo and speaker phase switching. Complete with escutcheon, knobs, plugs, etc. Ready built. **£20.0.0** (P. & P. 12/6)

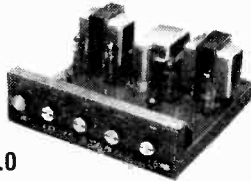

Kit form due shortly **£17.10.0** (P. & P. 12/6)

2 + 2 VALVE Pre-amp/Control Unit. Built, 13 gas.; kit, 10 gas. (P. & P. either 7/6)

3-3 MONO
 3 valve, 3W amplifier with controls, absolutely complete kit including panel, knobs, etc. **£7.10.0** (P. & P. 7/6)

5-10 MONO
 5 valve, 10W basic amplifier kit complete. (P. & P. 7/6) **£9.19.6**
 with passive control network and panel **£11.19.6**
 2 valve pre-amp kit **£6.12.6**

7 VALVE AM/FM RG REPLACEMENT CHASSIS

A superbly powerful high performance instrument for the keenest enthusiasts. Provides tuning on long, medium and F.M. wavebands. Excellent sensitivity. Permeability tuning on F.M. Large clear dial, A.V.C., good neg. feedback. Magic eye. 3W output. A.c. 200/250V. Circuit diagrams available. Aligned, tested and ready for use (Carr. and insurance 7/6). **£13.19.6** S.A.E. brings full details.

VEROBOARD—All standard sizes including: 2 1/2in x 6in, 3/8; 2 1/2in x 3 1/2in, 3/8; 3 1/2in x 6in, 5/8; 3 1/2in x 3 1/2in, 3/8; 2 1/2in x 17in, 1 1/2/8. All accessories and tools in stock.

RESISTORS—Modern ratings, full range 10 ohms to 10 megohms. 10% 1/4W, 4d each; 20% 1W, 6d each; 2W, 9d each; 5% Hi-stab, 1W, 5d each; 1W, 6d each; 1-2-10 meg, 10% 1W, 4d each; 1W, 5d each. 1% Hi-stab, 1W, 1/6 each (below 100 ohm, 2/- each).

WIREWOUND RESISTORS—25 ohm to 10k to 5W, 1/6 each; 10W, 1/9 each; 15W, 2/3 each.

CONDENSERS—Silver Mica. All values 2pF to 1,000pF, 6d each. Ditto ceramics. 9d Tub. 450V T.C.C., etc. 0-001-0-01uF, 10d each; 0-1-350V, 10d each; 0-02-0-1uF, 10d each; 1-100uF, 1/6 each; 0-5, 2/- each.

CLOSE TOL. 5/MICAS—10%, 5-500pF, 6d; 500-5,000pF, 1/-; 1% 2-100pF, 11d; 100-250pF, 1/2; 270-800pF, 1/-; 800-5,000pF, 2/-.

ALUMIN. CHASSIS—18g. Plain undrilled, folded four sides, 2in deep, 6in x 4in, 4/8; 8in x 6in, 5/9; 10in x 7in, 6/9; 12in x 6in, 7/8; 12in x 8in, 8/-, etc.

ALL SINCLAIR PRODUCTS STOCKED AS ADVERTISED

OUR NEW LISTS

feature more lines than ever at money saving prices. For latest issue please send

6d

Please include S.A.E. with all enquiries.

TRS RADIO COMPONENT SPECIALISTS

Established 1946

70 BRIGSTOCK ROAD, THORNTON HEATH, SURREY

Tel. 01-684 2188. Hours 9 a.m.—6 p.m. 1 p.m. Wednesdays
 A few doors from Thornton Heath Stn. (S.R. Victoria section.)

4-STATION INTERCOM



£6/9/6

Solve your communication problems with this 4-Station Transistor Intercom system (1 master and 3 Subs), in de-luxe plastic cabinets for desk or wall mounting. Call/talk/listen from Master to Subs and Subs to Master. Ideally suitable for Business, Burgery, Schools, Hospital, Office and Home. Operates on one 9V battery. On/off switch. Volume control. Complete with 3 connecting wires each 66ft. and other accessories. P. & P. 6/6.

WIRELESS INTERCOM

NO BATTERIES—NO WIRES. Just plug in the mains for instant two-way, loud and clear communication. On/off switch and volume control. Price 3 Gas. post paid.

INTERCOM/BABY ALARM



Originally 5/6
 Now 57/6

Same as 4-Station Intercom for two-way instant communication. Ideal as Baby Alarm and Door Phone. Complete with 66ft. connecting wire. Battery 2/6. P. & P. 3/6.

Transistor TELEPHONE AMPLIFIER



Usually 6/6
 Now 55/-

Why not boost business efficiency with this incredible De-Luxe Telephone Amplifier. Take down long telephone messages or converse without holding the handset. A useful office aid. On/off switch. Volume control. Battery 2/6 extra. P. & P. 2/6. Full price refunded if not satisfied in 7 days.

WEST LONDON DIRECT SUPPLIES (PE.10)
 169 KENNINGTON HIGH STREET, LONDON W.8

LOWEST PRICES YET!

SEMICONDUCTOR BARGAINS

BRAND NEW—GUARANTEED

OC22 5/-	OC171 2/6	GET113 4/-
OC23 9/-	OC200 4/6	GET116 8/-
OC26 5/-	OC202 7/-	GET118 4/6
OC28 4/6	OC205 7/6	GET119 4/6
OC30 7/6	BC107 4/6	GET573 4/6
OC35 6/6	BC108 4/3	GET587 4/6
OC36 7/6	BC109 5/-	GET373 4/-
OC38 10/-	BYZ12 6/6	GET887 4/6
OC44 2/-	BYZ13 6/6	GET889 4/-
OC46 1/9	BY100 3/-	GET890 4/-
OC46 3/-	ACY17 4/-	GET896 4/-
OC70 2/8	ACY18 4/-	GET897 4/-
OC71 2/-	ACY19 4/-	GET898 4/-
OC72 2/8	ACY20 4/-	2N297 5/-
OC75 3/-	ACY21 4/-	2N404 6/-
OC76 3/-	ACY22 4/-	AD140 8/-
OC77 3/-	ACY28 4/6	AD149 8/-
OC78 3/-	AFZ12 4/6	AF114 4/-
OC78D 3/-	BCY10 6/6	AF115 3/-
OC81 2/6	BCY12 6/6	AF116 3/-
OC81D 2/6	BCY33 6/6	AF117 2/6
OC82 2/3	BCY34 6/-	AF118 3/6
OC82D 3/-	BCY38 6/-	AF119 3/6
OC83 4/-	BCY39 6/-	AC107 4/-
OC84 4/6	BFY50 5/6	AC126 2/6
OC123 4/6	BFY51 5/6	AC127 3/-
OC189 4/-	BFY52 5/6	AC128 3/-
OC170 2/6	GET103 4/-	

MINIMUM ORDER 10/-

Postage 1/- per order

ACOS GP91/35C latest compatible mono turnover cartridge. Will track stereo records **25/-**

TITAN TAPES

27 HIGHVIEW AVENUE
 EDGWARE, MIDD.

TAPE RECORDER SERVICING MECHANICS

by H. Schroder

21/- Postage 1/-

ELECTRONIC COUNTING, Pub. Mullard. 27/6. Postage 1/-.

STRAIN GAUGES—Theory and Application, by T. Potma. 21/- Postage 1/-.

ELECTRICAL CONTRACTING AND ESTIMATING, by F. Hindler. 40/- Postage 1/-.

ELEMENTARY TELECOMMUNICATION PRINCIPLES, by R. N. Renton. 30/- Postage 2/-.

INTRODUCTION TO ELECTRONICS, by P. E. Gray. 30/- Postage 1/-.

BEGINNER'S GUIDE TO RADIO CONTROL, by R. H. Warring. 18/6. Postage 1/-.

TV FAULT FINDING. A Data Pub. 8/6. Postage 6d.

Inter: G.E.C. S.C.R. MANUAL 4th ed. 25/- Postage 1/6.

Inter: G.E.C. TRANSISTOR MANUAL 7th ed. 18/- Postage 2/-.

THE MODERN BOOK CO.

BRITAIN'S LARGEST STOCKISTS
 British and American Technical Books
 19-21 PRAED STREET
 LONDON, W.2

Phone: PADdington 4185

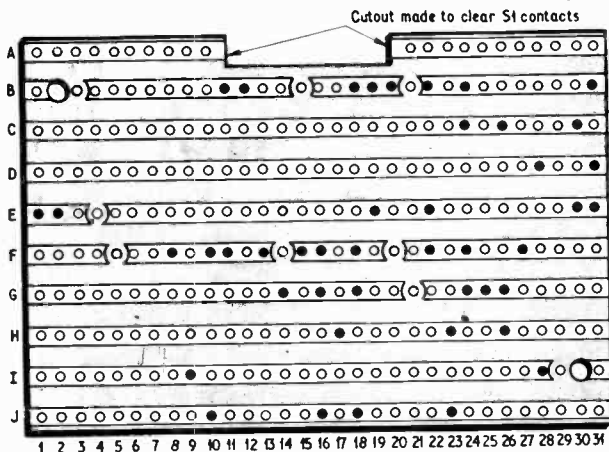

Fig. 3. Underside view of Veroboard

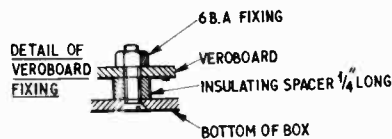

Fig. 5.

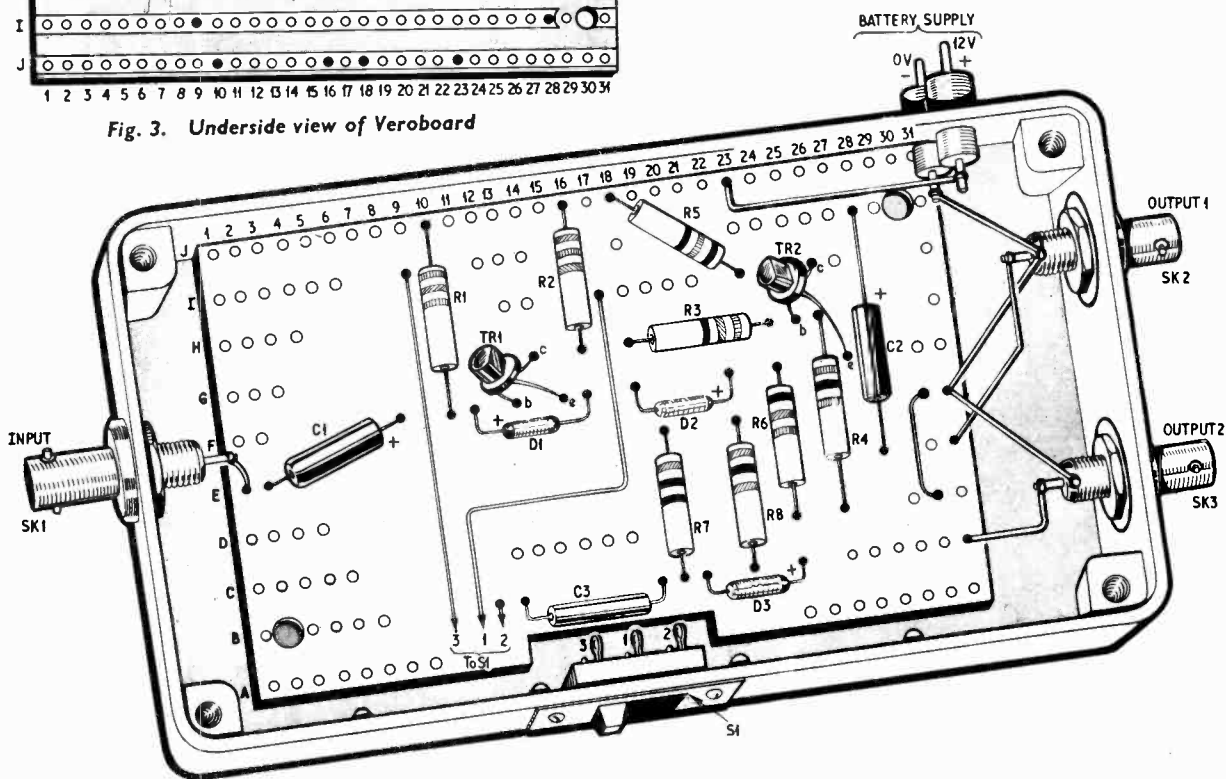

Fig. 4. The completed assembly of the converter

CONSTRUCTION

Full details of the construction of this sine to square wave converter appear in Fig. 3, Fig. 4 and Fig. 5. The equipment depicted here relates to the complete circuit given in Fig. 2. It should be noted that the model shown in the photograph is the simpler version, i.e. it does not include the differentiator; thus S1 is omitted and C2 is connected directly between TR2 collector and SK2.

Whichever version is built, it is a good idea to utilise a small diecast box as the housing, as illustrated. The circuit components are mounted on a piece of Veroboard which is prepared according to Fig. 3.

The diecast box is drilled to accommodate the coaxial sockets, switch S1, and feed-through battery supply terminals. Two holes are made in the bottom of the box for the 6 B.A. screws which secure the Veroboard in position (see Fig. 5). It is a wise precaution to cover the bottom of the case interior with a piece of insulating material to ensure complete isolation of case from circuit board and its connections.



nucleonics

for the EXPERIMENTER

By M.L. Michaelis M.A.

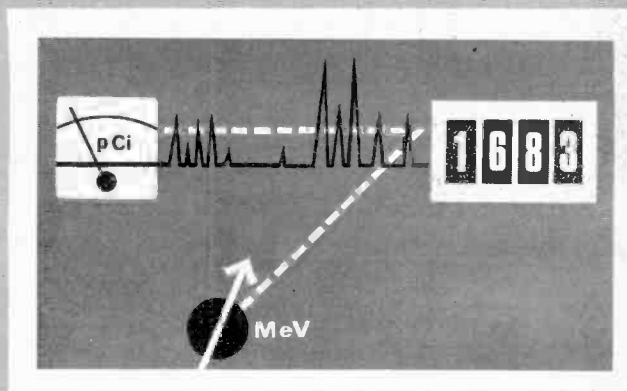

3—ESSENTIAL PARTS OF A NUCLEONIC EQUIPMENT; RADIATION DETECTORS (GAS IONISATION TYPES)

LAST month we introduced the subject of measuring nuclear radiation in a general way, and pointed out that electronic methods for such measurements can be explained most clearly on the basis of a typical equipment. Fig. 2.1 (last month) showed the complete block diagram of the equipment chosen for this purpose. This equipment, called STRACE, has been designed specially for this series of articles, and experienced readers will be able to construct all or parts of it from the theoretical circuits given in the course of discussions. However, our chief aim is to provide the general reader with a practical introduction to the electronic principles and methods of working with nucleonic equipment, as electronic devices for detecting and measuring nuclear radiation are called.

NUCLEONIC EQUIPMENT

Nuclear radiation is never a continuous stream such as water flowing out of a tap, but rather a series of disjointed and essentially independent events. Each such event is the emission of one or more gamma rays and/or particles from an unstable atom, whereby the emission process may be considered as instantaneous. Furthermore, the unstable atoms (radioactive atoms) do not influence each other in any way. In other words, the decay of a particular atom does not influence the point in time or the nature of the decay of any other atom in any way whatsoever.

Nucleonic equipment consists of three fundamental sections, see Fig. 3.1. The first section is the *radiation detector*. Its purpose is to produce a brief pulse of electric current in response to the nuclear radiation of interest. Since the decay of radioactive atoms and consequent appearance of nuclear radiation amounts to a random series of isolated events, all radiation detectors produce a random sequence of pulses as output. Random here refers to the time intervals between any two successive pulses, which are quite unpredictable. All that is predictable is a most probable interval, which means that if very many pulses are counted over a very long time (compared to the most probable interval), a more or less constant average rate (pulses per unit time) will be found. This average rate is a measure of the *activity* of the radioactive sample.

The conventional unit used for stating activities in nucleonics is the *curie*. One curie (symbol 1Ci) is the activity of 1 gram of pure radium, and was named after the discoverer of radium. The curie is a measure of the

number of disintegrating atoms per unit time, without taking account of the type or energy of the emitted radiations. One curie represents an average rate of 2.2×10^{12} atoms disintegrating per minute in the sample.

This is a very large, for amateur purposes immediately lethal, activity. It is thus convenient to employ sub-units, the commonest of which are the *pico-curie* (pCi) and the *nano-curie* (nCi) for studying small activities, e.g. under amateur and educational conditions.

1 pico-curie (pCi) = 10^{-12} curie = 2.2 atoms/minute
decaying on the long-term average

1 nano-curie (nCi) = 10^{-9} curie = 2,200 atoms/
minute decaying on the long-term average

Although legislation is not quite clear in all respects, amounts of 100nCi of individual radioactive substances generally represent the maximum quantities which are sold without special permits or precautions. For some substances, much smaller amounts already represent the "free" limit, where the nature of the emitted radiation entails increased biological hazards.

All radioactive substances involved in the course of this series for specific experiments are available in the UK from the Radiochemical Centre, Amersham, Bucks. Schools and legitimated responsible private persons can purchase the materials from this source without special permit for the required amounts, and no further precautions beyond those customary for highly poisonous chemicals are required in storage and use thereof.

RADIATION METER

Whereas the radiation detector, as first section of a nucleonic equipment, supplies a random sequence of individual pulses, the activity registering unit, as third section of the equipment, must indicate or record some steady reading corresponding to the average rate of arrival, i.e. the *mean repetition frequency* of the pulses.

The radiation meter unit, as second section of the equipment, between the radiation detector and the activity register, must perform the transformation from a random pulse sequence to a "d.c." output signal corresponding to the average repetition frequency of the pulses. In the simplest case, an ordinary moving coil meter can fulfil both functions, since the inertia of the pointer will give a more or less steady reading on any rapid sequence of

Everything You need to know about

RADIO, TELEVISION & ELECTRICAL REPAIRS

AMAZING 'KNOW HOW' BOOK

Brings You RIGHT UP TO DATE!

576
PAGES
OVER
470
ILLUSTRATIONS

REVISED AND ENLARGED—this essential handbook for the enthusiast, handyman or professional repairer, is packed with detailed information and easy-to-follow instructions on how to service radio and TV sets (including all-transistor and U.H.F. circuits), audio equipment and domestic appliances of every kind. Shows every step in fault tracing and the use of modern test gear, from simple meters to complex oscilloscopes. Also provides practical guidance on household electrical installation work. 576 pages. Over 470 illustrations. Mammoth value—Special Library Edition, superbly bound in Leathercloth, 50/-, or on easy terms; 13/- down and 3 monthly instalments of 14/- (total credit price 55/-). But first accept 7 Days' Home Trial Offer—without obligation!

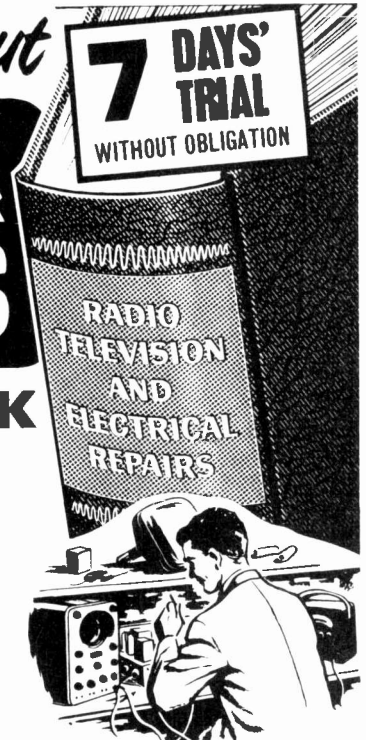

7 DAYS' TRIAL
WITHOUT OBLIGATION

COVERS ALL THE LATEST TECHNICAL ADVANCES!

U.H.F. TELEVISION

Here are basic circuits and full instructions to enable you to service modern sets—get perfect 625-line reception.

Getting the best from RADIO AND TELEVISION SETS

How to make adjustments and repairs in order to get the best possible performance from any set.

All you need to know about DOMESTIC INSTALLATIONS

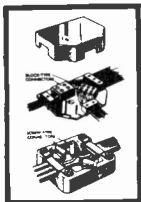

Learn from these helpful pages how to carry out modifications and extensions—with efficiency and safety! Complete guidance on lighting and power circuits, practical wiring work, safety regulations, cables, earthing, fuses, etc. Also Fluorescent Lighting, Time Switches and Thermostats.

Junction Boxes for Lead-covered Cables

WATER HEATING

All you should know about water heaters and how to install them and keep them in perfect working order. How to service FIRES and SPACE HEATERS.

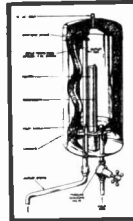

HOW TO MAINTAIN AND REPAIR DOMESTIC APPLIANCES

From irons, toasters, hair dryers, etc. to cookers, washing machines and refrigerators. Also covers the repair and rewinding of small motors.

SPECIAL SECTION ON COLOUR TELEVISION

Explains clearly and concisely the principles of all the main colour systems.

FAULT FINDING

This grand book is invaluable for tracing faults in radio and TV sets (both valve and transistor circuits). Deals fully with tools and bench work—shows how to make the best use of test instruments. Tells everything you want to know—from how to carry out preliminary tests to how to align tuned circuits.

Servicing DOMESTIC AUDIO EQUIPMENT

How to locate and rectify faults in hi-fi equipment (mono or stereo), record players, tape recorders, etc.

ACT NOW!

Simply complete form, indicating method of payment preferred, and post in a 3d. stamped unsealed envelope. Offer applies in U.K. only. Hurry, make sure of your copy.

ONE GREAT VOLUME covers:

Current, Voltage and Resistance, Coils, Capacitors and Tuning, Valves, Tubes and Transistors, Radio Components, Receiver Design Principles, Transistor-Radio Circuits, Valve-Radio Circuits, Valve-Television Circuits, Transistor-Television Circuits, Colour-Television Systems, Audio Amplifier Circuits, Audio Equipment and Gramophones, Tape Recorders, Radio and Television Aerials, Tools and Bench Work, Test Instruments and Their Use, Fault Tracing and Circuit Testing, Alignment of Tuned Circuits, Television Fault Tracing, Interference Suppression, Domestic Power Supply Circuits, Electrical Wiring Work, Fluorescent Lighting, Thermostats and Time Switches, Motor Repair and Rewinding, Small Appliances, Space and Water Heaters, Electric Cookers, Washing, Drying and Ironing Machines, Electric Refrigerators, Suction Cleaners and Floor Polishers.

SEND NO MONEY NOW!

To: Dept. NS35, Odhams Books Ltd., Basted, Sevenoaks, Kent.

WITHOUT OBLIGATION please send me, on 7 Days' Home Trial, Radio, Television and Electrical Repairs. Within 8 days I will either (a) send the Cash Price of 50/- (plus charge for postage and packing), or (b) send a down payment of 13/- (plus postage charge), followed by a 3 monthly payments of 14/- (Total Credit Price 55/-). Alternatively, I will return volume in good condition, postage paid, within 8 days.

Cross out words NOT applicable below:

I wish to pay by CASH/TERMS. I am (a) houseowner; (b) tenant in house or flat; (c) temporary resident; (d) single; (e) married; (f) over 21; (g) under 21.

PLEASE SIGN HERE

Your Signature

(Or, if you are under 21, signature of parent or guardian)

BLOCK LETTERS BELOW

NAME (Mr./Mrs./Miss)

Full Postal

ADDRESS.....

NS35/Jan.68

VARIABLE VOLTAGE TRANSFORMERS



4 50
AMPS

1 AMP
£3.3.0.



PORTABLE TYPE
£8. 10. 0.

INPUT 230/240v. A.C. 50/60—
OUTPUT VARIABLE 0-260v.
BRAND NEW Carriage Paid.
Keenest prices in the country.
All Types (and Spares) from
1/2 to 50 amp. from stock.
SHROUDED TYPE
1 amp, £4. 10. 0. 2.5 amps,
£5. 17. 0. 4 amps, £8. 7. 6.
5 amps, £9. 0. 0. 8 amps,
£13. 10. 0. 10 amps, £17. 0. 0.
12 amps, £19. 10. 0. 15 amps,
£22. 0. 0. 20 amps, £32. 10. 0.
37.5 amps, £65. 0. 0. 50 amps,
£85. 0. 0.
OPEN TYPE (Panel Mounting)
1/2 amp, £3. 3. 0. 1 amp, £4. 10. 0.
2 1/2 amps, £5. 12. 6.
PORTABLE TYPE
1.5 amp, portable fitted metal case,
voltmeter, lamp, switch, etc. £8. 10. 0.
P. & C. 10/-. Similar to above 2.5
amp, £9. 17. 6. P. & C. 10/-.

100 WATT POWER RHEOSTATS (NEW)

AVAILABLE IN THE FOLLOWING VALUES

1 ohm, 10 a.; 5 ohm, 4.7 a.; 10 ohm, 3 a.;
25 ohm, 2 a.; 50 ohm, 1.4 a.; 100 ohm, 1 a.;
250 ohm, .7 a.; 500 ohm, .45 a.; 1,000 ohm,
280 mA; 1,500 ohm, 230 mA; 2,500 ohm, .2 a. Diameter
3 1/2 in. Shaft length 3/4 in., dia. 3/16 in. All at 27/6 each.
P. & P. 1/6.



50 WATT POWER RHEOSTATS

1 ohm, 7a.; 5 ohm, 3a.; 10 ohm, 2.25a.; 25 ohm, 1.4a.;
50 ohm, .7a.; 100 ohm, .45a.; 250 ohm, .25a.; 500 ohm,
.15a.; 1,000 ohm, .08a.; 2,500 ohm, .04a.; all at 21/-.
P. & P. 1/6.

25 WATT POWER RHEOSTATS

10 ohm, 1.5a.; 25 ohm, .75a.; 50 ohm, .375a.; 100 ohm, .1875a.;
250 ohm, .09375a.; 500 ohm, .046875a.; 1,000 ohm, .0234375a.;
1.2a.; 2,500 ohm, .00586a.; all at 14/6. P. & P. 1/6.

PRECISION FLATPOT. Manufactured by M.E.C. 50K.
45 turn. Fly leads. All metal sealed construction.
10/6. P. & P. 1/6.

GENUINE NEW MULLARD

6 AMP. SILICON DIODES

NOT Rejects or Seconds
BYZ13 200 PIV 7/- BYZ12 400 PIV 8/-
BYZ11 600 PIV 9/- BYZ10 800 PIV 10/-

RESETTABLE HIGH SPEED

COUNTER. 4 figure, 1,000 ohm
coil, 36-48 v. D.C. operation, £3/10/-.
P. & P. 1/6. 3 figure, 24 v. D.C.
£1/12/6. P. & P. 1/6.

WE NOW STOCK

ONLY SANWA

The ultimate in test meters.
Four types from stock. Price
from £3.2.0. Full range of
spares and repair service available.
Descriptive leaflet on request.

NICKEL CADMIUM BATTERY

Sintered Cadmium Type 1-2 v. 7AH.
Size: height 3 1/2 in., width 2 1/4 x 1 1/4
in. Weight: approx. 13 oz. Ex-R.A.F.
Tested, 12/6. P. & P. 2/6.

INSULATED TERMINALS

Available in black,
red, white, yellow,
blue and green. New
15/- per doz. P. & P. 2/-.



DRY READ SWITCHES

New special offer of Dry Read Switches half amp.
Contact, Size 1 1/2 x 1/4. 4 for 10/- Post Paid.

CONSTANT VOLTAGE TRANSFORMER

Input 185-250 v. A.C. Output 230
v. A.C. Capacity 250 watt. Attractive
metal case. Fitted red signal
lamp. Rubber feet. Weight 17
lbs. Price £11.10.0. P. & P. 15/-.



LIGHT SENSITIVE SWITCH

Kit of parts, including ORP12 Cad-
mium Sulphide Photocell, Relay,
Transistor and Circuit, etc., 6-12
volt D.C. op. price 25/- plus 2/6
P. & P. ORP 12 including circuit,
10/6 each, plus 1/- P. & P.



A.C. MAINS MODEL Incorporates
Mains Transformer, Rectifier and special
relay with 3, 5 amp mains c/o contacts.
Price inc. circuit 47/6 plus 2/6 P. & P.

LIGHT SOURCE AND PHOTO CELL MOUNTING

Precision engineered
light source with focusible
lens assembly and ventilated
lamp housing, to take MBC bulb. Separate
photo cell mounting assembly for ORP 12
or similar cell. Both units are single hole
fixing. Price per pair £2.10.0. P. & P. 3/6.



UNISELECTOR SWITCHES

NEW 4 Bank 25 Way

Uniselector 25 ohm
coil. 12-24 v. D.C. operation
£4.17.6 plus 2/6 P. & P.

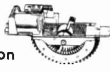

8 Bank 25 Way 24 v. D.C. operation.
£6.10.0 plus 4/6 P. & P.

USED 75 ohm coil 24 v. D.C.

6 Bank 25 position, 5 non-bridging 1
Bridging Wiper 35/- each. P. & P. 2/6.

MINIATURE UNISELECTOR SWITCH

3 banks of 11 positions plus homing bank.
40 ohm coil. 24-36 v. D.C.
operation. Tested, 22/6,
plus 2/6 P. & P.



COMPACT HEAVY DUTY 6v. D.C. RELAY

2 change over, 3 ohm coil. 7/6 each.
P. & P. 1/6. 3 for 20/- Post paid.

VENNER ELECTRIC TIME SWITCH

200-250 v. A.C. 20 amp. contacts twice on,
twice off, at any manually pre-set time.
Spring reserve (in case of power cut) fully
tested £3/9/6, P. & P. 4/6. Or complete
in weatherproof metal case (illustrated)
£3/19/6, plus 4/6 P. & P. Can be supplied
with solar dial, on at dusk—off at dawn.
Prices as above. Venner 14-day clockwork
time switch 5 amp 230 v. contact. 1 on/off
every 24 hr. Fitted in metal case with key
used but guaranteed 47/-, plus 3/- P. & P.

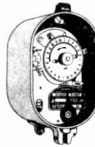

AIR BLOWER

Highly efficient blower unit fitted with totally
enclosed 200/250 v. A.C. 50 cycles. 1/8 h.p.
motor producing 2,800 r.p.m. outlet 2 1/2 x 1 1/2
used, but in first class condition and tested.
Price £3/15/-, P. & P. 7/6.



DOUBLE WOUND VARIABLE LT

TRANSFORMERS Fully isolated low tension
secondary winding. Input 230 v. A.C.
Output continuously variable 0-36 v. A.C.
0-36 Volt at 5 Amp. £8.10.0. P. & P. 8/6.
0-36 Volt at 20 Amp. £19.10.0. P. & C. 15/-.
Leaflets on request.

SLIDER RESISTANCE

200 ohm 1.25 amp., 37/6. P. & P. 3/6.
5 ohm 10 amp., 37/6. P. & P. 3/6.

PHOTO MULTIPLIER. Type CV337. This supersedes
type 931A. Complete with special P.T.F.E. base and divider
network. 57/6 incl. P. & P.

230 VOLT A.C., GEARED MOTORS

Type D15G 5 r.p.m. 1.7lb. inch, £2/9/6,
P. & P. 3/-. Type B16G 80 r.p.m. 26lb. inch,
£2/2/-, P. & P. 3/-. Type D16G 13 r.p.m.
1.45lb. inch, £2/17/6, P. & P. 3/-.

SELENIUM BRIDGE RECTIFIERS

30 volt 3 amp., 11/-, plus 2/6 P. & P.
30 volt 5 amp., 16/-, plus 2/6 P. & P.

new VARI-STAT, thermostatic soldering iron

High Production Model D
Miniature Iron 50 watt
Voltage 12-250 volt
Weight 1 3/4oz.
"Screw on" Bit sizes 3/32in., 1/8in., 3/16in.,
1/4in.
Our range also includes:
Standard Instrument Model 50W
Standard Instrument Model 70W
High Production Instrument Model 125W
Industrial Model 500W

PRICE
55/-

All these irons give excellent bit and element
life since the thermostat completely elimin-
ates overheating and controls reserve
heating capacity which makes possible con-
tinuous soldering without chilling of the bit.
The constant temperature makes these
irons ideal for printed circuit work.

CARDROSS ENGINEERING CO. LTD.,

Woodyard Road, Dumbarton.

Phone: Dumbarton 2655

SUPPLIERS OF ELECTRONIC EQUIPMENT TO.....

- * INDUSTRIAL RESEARCH ESTABLISHMENTS
- * RADIO ENTHUSIASTS
- * UNIVERSITIES & TECHNICAL COLLEGES

OFFICIAL SUPPLIERS TO MANY
EDUCATION AUTHORITIES
Usual Educational Discounts

OUR NEW 1967/8 illustrated catalogue NOW AVAILABLE

(Send 2/- in stamps for your copy)

INCLUDES

Valves, Transistors, Transformers; Loud-
speakers, Recording Tape, Coils, Resistors,
Condensers, Potentiometers, Chassis,
Rectifiers, Test Meters, Microphones,
Tools, Solder, etc.

DISTRIBUTORS OF EAGLE PRODUCTS
WHOSE NEW ENLARGED CATALOGUE

is now available 5/-

ALPHA RADIO SUPPLY CO.
103 Leeds Terrace, Leeds 7. Tel. 25187

SERVICE TRADING CO

All Mail Orders—Also Callers—Ample Parking Space
57 BRIDGMAN ROAD, LONDON, W.4 Phone 995 1560
SHOWROOM NOW OPEN CLOSED SATURDAY

Personal callers only
9 LITTLE NEWPORT ST.
LONDON, W.C.2. Tel. GER 0576

pulses. The simplest complete nucleonic equipment thus consists of a detector, a conventional amplifier and a moving coil meter.

The need to devise more refined radiation meter units, which provide a true "d.c." output, arises from the fact that we have to deal with rather slow pulse sequences in many cases. Intervals between successive pulses may be several seconds, or even hours in extreme cases. A better "storage" device than the sluggishness of a meter pointer is then obviously required. However, it is quite clear that any radiation meter unit is essentially a *frequency meter*.

The problems are twofold in this special case: firstly very low frequencies (down to small fractions of 1Hz) have to be dealt with, and secondly, the momentary frequency is quite irregular. The second problem is by far the more serious one. If the mean pulse rate is, say, 1Hz, pairs of pulses may appear at much shorter intervals. A frequency meter suitable for steady oscillator frequencies up to 1Hz, is thus quite unsuitable for determining the mean rate of random pulse sequences up to 1Hz. The steady-frequency resolution limit must be many times greater than the highest desired random pulse frequency measurement, otherwise missed pairs of rapidly consecutive pulses will lead to intolerable errors. It is possible to make quite good arithmetical corrections here, but it is always better to avoid the source of error by designing the radiation meter unit with adequate time interval resolution for the envisaged measurements.

ANALOGUE AND DIGITAL METHODS

The transformation from a random pulse input sequence to a "d.c." output reading corresponding to the mean pulse frequency, can be effected by two inherently different means. These are the *analogue* method and the *digital* method, a duality of possibilities for almost any basic computer function.

The digital method (Fig. 3.2) is theoretically the simpler, since it merely amounts to numerical counting of the individual pulses for a definite time determined by some form of stopclock. Each pulse from the radiation detector, after suitable amplification, is made to advance a cyclometer-type digital counter mechanism by one unit. The total number of clocked-up pulses must subsequently be divided by the time of running, to obtain the final activity reading.

This method of working is clearly the more advantageous, the smaller the mean pulse frequencies involved. For fast pulse rates, i.e. greater than 25 to 100Hz, mechanical counting mechanisms fail to respond sufficiently rapidly. It is then necessary to resort to digital electronic techniques, at least for pre-division of the pulse sequences (called *scaling*), and ultimately for the digital displays and registers themselves. This rapidly leads to extensive equipment, a disadvantage of digital methods.

The analogue method (Fig. 3.3), here also known as the *ratemeter* method, leads to a true d.c. output signal which can be displayed directly on a moving coil meter with scale calibrated in activity values. Individual pulses arriving from the radiation detector cause little or no visible change of the meter reading. Instead, each pulse is reshaped electronically to a standard form and then used to pump a definite quantity of electric charge into a large capacitor. A high-value leak resistor connected across the same capacitor continuously drains away the accumulated charge.

It is evident that the average voltage established across the capacitor by this process is directly proportional to the mean number of pulses arriving within the so-called integration time. The latter is the time constant, $C \times R$, where C is the capacitance of the capacitor and R is the value of the leak resistor connected across it. The practical difficulty with such equipment lies in the design of circuits with adequately large CR -values for very slow pulse rates.

A ratemeter circuit is evidently the more elegant in design and performance, the faster the pulse rates to be measured, since then quite small values of C and R suffice. We saw that the digital counter method suffers

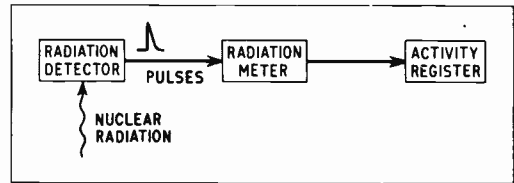

Fig. 3.1. The three essential sections of a nucleonic equipment for measuring nuclear radiation

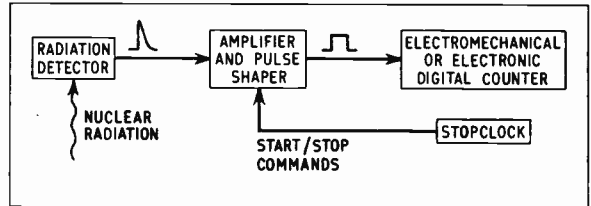

Fig. 3.2. Digital equipment for measuring nuclear radiation

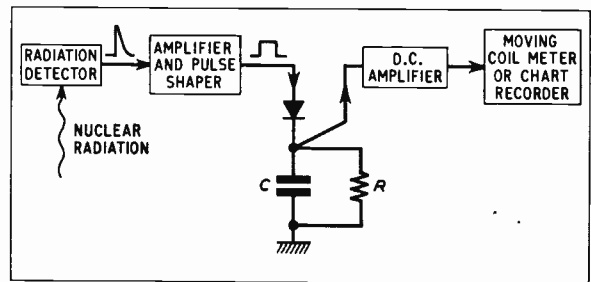

Fig. 3.3. Analogue equipment (ratemeter) for measuring nuclear radiation

increasing economic drawbacks just here. The ratemeter is thus favoured for measuring medium and high activities, and there has the advantage of simplicity and direct-reading. But its accuracy becomes increasingly poorer relative to the digital method, as still higher pulse rates are involved. This is because a moving coil meter can be read to an accuracy of little better than 1 per cent, whereas the read-off accuracy of a digital counter is theoretically unlimited, e.g. it is already 0.1 per cent when a thousand pulses have been clocked-up. For this reason, professional equipment makes extensive use of complex digital counting equipment for measuring fast pulse rates, in spite of the apparent suitability of a ratemeter on superficial considerations.

At the other extreme, the ratemeter is definitely ineffective for dealing with very low pulse rates, e.g. where only a very few pulses arrive per hour, as is the case in some professional studies of low alpha-activities. A digital counter is then eminently suitable and can be very simple for such low pulse rates, since only a conventional amplifier is required between the radiation detector and an electro-mechanical counting mechanism.

Summing up, we thus see that the ratemeter is preferable for all except the lowest counting rates, provided that no great demands are placed on read-off accuracy. If high demands are placed on read-off accuracy, the digital counter method is *always* essential, and it is the only practicable method for extremely low counting rates. These considerations make it quite clear that a general-purpose amateur nucleonic equipment should be designed around the ratemeter principle, as our STRACE equipment is. Nevertheless, we shall have recourse to amateur digital circuits in the course of this series, and will of course mention professional digital techniques at the appropriate points.

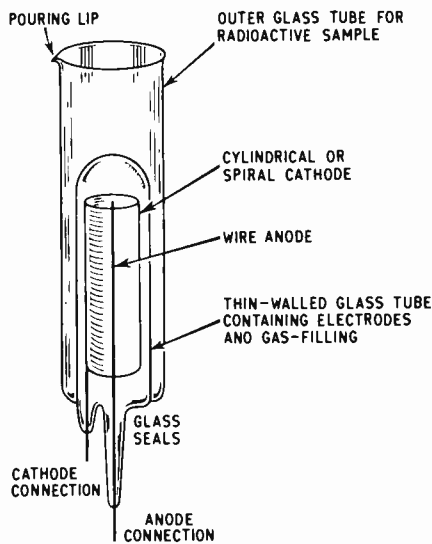

Fig. 3.4a. G.M. counter tube (Mullard MX124/01)

RADIATION DETECTORS

All radiation detectors are based on the exploitation of *ionisation* produced when nuclear radiation is absorbed by matter. Each radiation particle or quantum of gamma radiation dissipates its kinetic energy by dislodging electrons in the structure of the matter absorbing it. The absorbing matter may thereby be a gas, a liquid or a solid. It is convenient to consider radiation detectors according to this classification. A second parallel classification is concerned with the manner in which the ionisation is made to produce an electric current pulse, or some other effect.

THE GEIGER-MÜLLER TUBE

The gas-ionisation group of radiation detectors includes the most familiar device for detecting nuclear radiation, the Geiger-Müller counter tube, often simply referred to as a *Geiger counter* or G.M. tube.

The G.M. tube is a gas-filled diode with more or less cylindrical cathode surrounding a coaxial thin-wire anode, see Fig. 3.4a. The applied voltage is just not sufficient to cause a permanent discharge, but a temporary discharge immediately takes place when triggered-off by ionisation from a quantum or particle of nuclear radiation entering the active volume of gas between the cathode and anode. Two effects then quench the discharge again very rapidly. The first quenching effect is the large voltage drop at the anode as soon as discharge current flows, reducing the voltage across the tube below the level required to sustain a discharge.

The second quenching effect results from the inclusion of heavy or complex molecules in the gas filling, either as

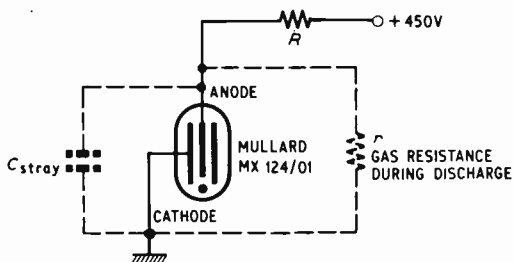

Fig. 3.4c. Voltage pulse at anode of G.M. counter tube (idealised)

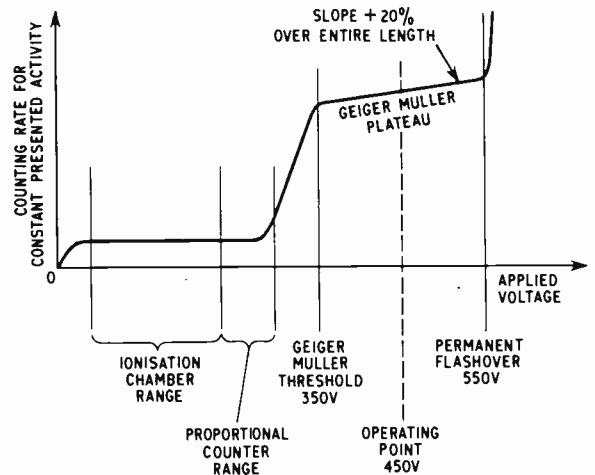

Fig. 3.4b. Detection efficiency characteristic for a G.M. counter such as that depicted in Fig. 3.4a

principal component (e.g. chlorine in so-called halogen G.M. tubes) or as admixture (e.g. alcohol vapour in argon-filled G.M. tubes). As soon as the electric discharge has built-up in the tube, the heavy vapour molecules are set spinning and vibrating instead of undergoing only ionisation. This removes energy from the ionisation process, so that the discharge can no longer be sustained.

This gas quenching effect is the more important one in modern G.M. counter tubes, and usually is able to quench the discharge even if the electrodes are connected directly to a low-impedance power supply, when the discharge no longer makes the tube voltage drop. However, G.M. tubes should never be operated in this manner, but always via large anode or cathode load resistors of several megohms. Unless otherwise specified by the makers, the total load resistance should be about 1 megohm per hundred volts of applied e.h.t. potential.

THE IONISATION CHAMBER

Two further gas-ionisation radiation detectors closely related to the G.M. tube are the *ionisation chamber* and the *proportional counter*.

Apart from differences in structural detail for practical versions, the only difference in principle lies in the lower applied voltage, see Fig. 3.4b. The ionisation produced by an absorbed particle or quantum of nuclear radiation is then unable to set off a full-scale discharge. When used as ionisation chamber, only a very small voltage (usually under 100 volts) is applied between the electrodes. This achieves no more than drawing-off the primary ionisation produced by the absorbed nuclear radiation.

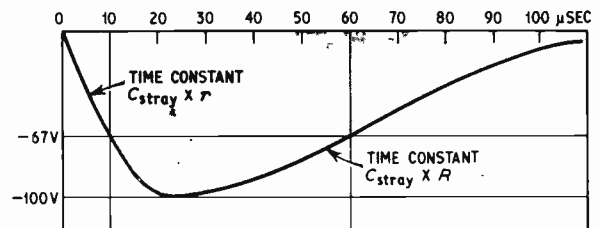

DE LUXE PLAYERS

4-Speed Mono Players 2-tone Cabinets 17" x 15" x 8 1/2". High flux loudspeaker and High Quality Amplifiers ready built. Quality output. Volume and Bass controls. Special instructions enable assembly in 30 minutes, only 5 wires to join. 12 months guarantee.

TO BUILD YOURSELF

Post 2/6 per item.
PORTABLE CABINET As illustrated. To fit standard player 69/6
RCS AMPLIFIER 3 WATT. Ready made and tested with UCL82 triode pentode valve and loudspeaker. 59/6
SINGLE PLAY MONO
 BSR TU9 23.7/6
 Garrard SRP22 24.19/6
 Garrard SP25 21.0/19/6
 Philips AG1016 212. 9/6
 Garrard A70 219.18/6
 Garrard LAB80 224.19/6
 Garrard 401 229.19/6
 All with mono cartridge (Stereo 12/6 extra)

SUPERIOR AMPLIFIER. Ready made and tested. Guaranteed better sound! Fully isolated AC Mains Transformer 4 watt output. ECL86 triode pentode valve. Volume and tone controls with knobs. Quality Loudspeaker. 89/6
AUTOCHANGE MONO
 BSR Superlim 45.19/6
 Garrard 1000 25.19/6
 Garrard 2000 26.19/6
 Garrard 3000 28. 9/6
 Garrard AT60 28. 9/6
 discact turntable £12.19/6
 All with mono cartridge (Stereo 12/6 extra)

GARRARD TEAKWOOD BASE WB.1 Ready cut for mounting 1000, 2000, 3000, SP25, AT60.
GARRARD PERSPEX COVER SPCL for WB.1. 58/-

A.18 TRANSCRIPTION TONE ARM with temp. plate and two plug-in shells. OUR PRICE 90/-
 Decca Demam Stereo Diamond Cartridge £4.10.0 extra, or Stereo Moving Coil Diamond 20-1500 c.p.s. 5 gns. extra.

Q MAX CHASSIS CUTTER

Complete: a die, a punch, an Allen screw and key
 lin. 14/8 lin. 15/9 lin. 18/- lin. 18/11 lin. 20/6 lin. 23/9 lin. 27/9 lin. 28/11 lin. 29/6 lin. 30/6 lin. 32/9 lin. 34/3 lin. sq. 31/6

ACOS XTAL GP67, 15/-, PICK-UP ARM Complete with ACOS LP-78 Turnover Head and Stylus 20/-, Stereo 30/-
SPEAKER FRET TYPEN various colours, 52in. wide, from 10/-; 26in. wide from 5/-; 11in. wide from 10/-; 11in. wide from 10/-; 11in. wide from 10/-; 11in. wide from 10/-
EXPANDED METAL GOLD or Silver 12" x 12in. 6/-

FULL WAVE BRIDGE CHARGER RECTIFIERS: 3 or 12 v. outputs, 1 1/2 amp., 8/9; 4 a., 11/3; 4 a., 17/6.
CHARGER TRANSFORMERS: P. & P. 2/6. Input 200/250 v. for 6 or 12 v., 1 1/2 amps., 17/6; 2 amps., 21/-; 4 amps., 25/-.

MOVING COIL MULTIMETER TK 25. 47/6
 0-1,000v. A.C./D.C. ohms 0 to 100k. etc.
MOVING COIL MULTIMETER EP10K. 79/6
 0-1,000v. A.C./D.C. ohms 0 to 3 meg. etc.
MOVING COIL MULTIMETER EP20K. 99/6
 0-2,500v. D.C. 20,000 ohms per volt. 0-1,000v. A.C. Ohms 0 to 6 meg. 50 Microamps. (Full list Meters S.A.E.)

NEW MULLARD TRANSISTORS

OC71 8/-; OC72 6/-; OC81D 6/-; OC81 6/-; AF15 8/-; AF14 8/-; OC44 6/-; OC45 6/-; OC71 6/-; OC70 6/-; AF17 6/-; OC28 12/6; AD140 15/-; OC35 15/-; Holders 1/-
REPANCO TRANSISTOR TRANSFORMERS
 TT45, Push Pull Input CT, 1CT, OC72, OC81D 6/-
 TT46, Push Pull Output CT, 1CT, OC72, OC81D 6/-
 TT49, Interstage, etc. 4.5-1 5/-
 FT52, Output 3 ohms 20:1 5/-
TRANSISTOR MAINS ELIMINATORS. FAMOUS "POWER MIT" 9 VOLT. SAME SIZE AS PP3 BATTERY. 45/-
FULLY SMOOTHED. 150mA. FULL WAVE CIRCUIT. 45/-
SPECIAL 9 VOLT. 500mA. POWER PACK. 49/6

WEYRAD P50 — Transistor Coils
 RA2V 6 in. Ferrite Aerial Spare Cores 20/- 6d.
 Driver Trans. LFDT4 9/6
 Oso. P50/ACAL 12/6
 Printed Circuit, PCAL 9/6
 J.B. Tuning Gang 10/6
 3rd I.F. P50/3CC 2/-

Volume Controls
 LONG SPINDLES. MIDGET SIZE 5K. ohms to 2 Meg. LOG or LIN. L/S 3/-, D.P. 5/-
STEREO L/S 10/6, D.P. 14/6.

80 Ohm Coax 6d. yd.
 Semi-air spaced Cable 100 yd. drum 50/- post free.
FRINGELOSS 1/6. yd.
 Ideal 625 lines

COAXIAL PLUG 1/-, PANEL SOCKETS 1/-, LINE SOCKETS 2/-. OUTLET BOXES, SURFACE OR FLUSH 4/6
BALANCED TWIN FEEDERS 1/-, 40 or 300 ohms
TELESCOPIC CHROME AERIALS. 6in. extends to 23in 9/6 each. CAR AERIAL PLUGS 1/6. Sockets 1/3.

SPECIAL PURCHASE!

STELLA BATTERY RECORD PLAYER

Amplifier and loudspeaker—all transistor—top performance of discs at 33, 45 and 78 r.p.m. LP xtal cartridge. Smart red or blue plastic cabinet. WORTH DOUBLE!
 OUR PRICE **£8.5.0.** P. & P. 5/-



RETURN OF POST DESPATCH

RADIO COMPONENT SPECIALISTS

Written guarantee with every purchase. (Export: Send remittance and extra postage, no C.O.D.) Buses 133, 68 pass door. S.R. Stn. Selhurst. Tel. 01-684-1665

MERRY CHRISTMAS

THE E.A.R. RECORD PLAYER CABINET
 Strongly built wooden cabinet covered in Blue and Grey leathercloth size 15" x 17" x 8 in. Motorboard 14 1/2" x 12 1/2" in. ready cut out for B.S.R. Monarch UA 12/14/15/16/25 decks. Gift fittings, strong carrying handle. Amplifier space size 14" x 7" x 3 in. is completely enclosed. The baffle board 59/6 is cut out for a 8 1/2 in. dia. speaker. P. & P. 5/6. PRICE

NEW TUBULAR ELECTROLYTICS		CAN TYPES	
2/350 v. 2/3	100/25 v. 2/-	8/600 v. 9/6	
4/350 v. 2/3	250/25 v. 2/6	16/600 v. 12/6	
8/450 v. 3/-	500/25 v. 4/-	18/18/500 v. 7/6	
16/450 v. 3/-	8-8/450 v. 3/6	32+32/450 v. 6/-	
32/450 v. 3/9	8-16/450 v. 3/9	50+50/350 v. 7/-	
25/25 v. 1/9	16+16/450 v. 4/3	60+100/350 v. 11/6	
50/50 v. 2/-	32+32/350 v. 4/6	100+200/275 v. 12/6	

SUB-MIN. ELECTROLYTICS 1, 2, 4, 5, 8, 16, 25, 30, 50, 100, 250 mfd. 15v. 2/6; 500, 1000 mfd. 12v. 3/6 2000 mfd. 25v. 9/6. CERAMIC. 500 v. 1 pF. to 0.01 mfd. 9d. Discs 1/-.

PAPER TUBULARS
 350v.-0.1 9d., 0.5 2/6, 1 mfd. 3/-, 2 1/2 4/6, 5 3/6.
 500v.-0.001 to 0.05 9d. 0.1 1/-, 0.25 1/6, 0.5 3/6.
 1,000v.-0.001, 0.002, 0.004, 0.01, 0.02, 1/6; 0.047, 0.1 2/6.
 E.H.T. CONDENSERS. 0.001mfd. 7kV. 6/6; 20kV. 10/6

SILVER MICA. Close tolerance (plus or minus 1 pF). 5 to 47 pF. 1/-; ditto 1/4 to 800 pF. 1/-; 1,000 to 5,000 pF. 2/-
TWIN GANG. "0-0" 208 pF. +176 pF. 10/6; 365 pF. miniature 10/-; 500 pF. standard with trimmers, 9/6; 500pF. midget less trimmers, 7/6; 500 pF. slow motion, standard 9/-; small 3-gang 500 pF. 18/9. Single "0-0" 365 pF. 7/6. Twin 10/6.
SHORT WAVE. 10 pF. 25 pF. 35 pF. 50 pF. 75 pF. 100 pF. 120 pF. 150 pF. each. Can be spaced. Complete 9d. each.
TUNING. Solid dielectric, 100 pF., 300 pF., 500 pF., 3/6 each.
TRIMMERS. Compression ceramic 30, 50, 70 pF. 9d. 100 pF., 150 pF. 1/3; 250 pF. 1/6; 600 pF. 750 pF. 1/9.
250v. RECTIFIERS. Selenium 1/6 wave 100mA 5/-, BY100 10/-
CONTACT COOLED 1/2 wave 60mA 7/6; 85mA 9/6.
Full 9v. 75mA 10/-; 150mA. 19/6; T.V. rectis. from 10/-.

NEW B.A.S.F. LIBRARY BOXED TAPE

7 in. L.P. 1,800 ft. 45/-; 7 in. D.P. 2,400 ft. 70/-
 60 min. Cassette C60 (For Philips, etc.) 17/6
 Spare Spools 2/6. Tape Splicer 5/-. Leader Tape 4/6.
REUTER Tape Heads for Colloredo models 2 track 21/- pair.

MAINS TRANSFORMERS

Post 2/6 each
 250-0-250 80 mA. 6.3 v. 3.5 a. 6.3 v. 1 a. or 5 v. 2 a. 25/-
 350-0-350 80 mA. 6.3 v. 3.5 a. 6.3 v. 1 a. or 5 v. 2 a. 29/6
 MT. 510/300-0-300 v. 120 mA. 6.3 v. 4 a. 29/6
 MINIATURE 200 v. 20 mA. 6.3 v. 1 a. 10/6
 MIDGET 220 v. 45 mA. 6.3 v. 2 a. 15/6
 SMALL 250-0-250 50 mA. 6.3 v. 2 a. 18/6
HEATER TRANS. 6.3 v. 1 a.; 8.3 v. 3 a.; 4 a. 10/6
 Ditts tapped sec. 1.4 v., 2.3, 4.5, 6.3 v. 1 1/2 amp. 10/6
GENERAL PURPOSE LOW VOLTAGE. Outputs 3, 4, 5, 6, 8, 9, 10, 12, 15, 18, 24 and 30 v. at 2 a. 25/-
 1 amp., 6, 8, 10, 12, 16, 20, 24, 30, 36, 40, 48, 60, 29/6
AUTO TRANSFORMERS 0-115-230 v. Input/Output, 60w. 18/6; 150w. 25/-; 500w. 92/6; 1000w. 175/-

CRYSTAL MIKE INSERTS

1 1/2" x 1/2" 6/6; ACOS 1 1/2" x 1/2" 8/6. ACOS 39, 1" dia. 12/6
MOVING COIL MIKE with Remote Control Switch 19/6

ALL PURPOSE HEADPHONES

H.R. HEADPHONES. 2000 ohms 12/6, 4000 ohms 15/-
 H.R. HEADPHONES 2000 ohms Super Quality 25/-
LOW RESISTANCE HEADPHONES 3-5 ohms. 25/-



Post 5/-
 Three Wavebands: Five Valves: CCH81, EF89, Long., Med., Short. Gram. EBC81, EL84, E280, 12-month guarantee. A.C. 200-250 v. Ferrite Aerial 5 watts 3 ohm. Chassis 19 1/2 in. 7 in. 5 in. dial size 1 1/2 in. x 4 in. Two pilot Lamps. Four Knobs. **£10.10**
 Aligned calibrated. Chassis isolated from mains
DE LUXE STEREO GRAM CHASSIS V.H.F., M.W. SW 19-50m. 60-180m. Magic eye, push buttons, 19.19
 6 valve plus rect. Size 15 1/2" x 7 1/2" x 6 1/2" inch

TAPE DECK AMPLIFIER FOR B.S.R., T.D.2, etc.

With Pre-Amplifier, Oscillator, all valves, "magic-eye" tuning indicator, 3 watt. 3 stage amplifier especially built for B.S.R. TD.2 Tape Deck. Bolts directly to tape deck chassis. Inputs for mike and radio/gram. Output 3-5 ohms. A.C. 200/250v. Ready built. PRICE 27.19.8. Carriage 5/6.

BLANK ALUMINIUM CHASSIS. 18 s.w.g. 2 1/2 in. sides. 7 x 4 in., 5 1/2 x 7 in., 6 1/2 x 11 x 3 in., 6 1/2 x 11 x 7 in., 7/6, 13 x 9 in., 9/6; 14 x 11 in., 12/6; 15 x 14 in., 15/-
ALUMINIUM PANELS 18 s.w.g. 12 x 12 in. 5/6; 14 x 9 in. 4/6; 12 x 8 in. 3/6; 10 x 7 in. 2/6; 8 x 6 in. 2/-; 6 x 4 in. 1/6.

'SONOCOLOR' CINE RECORDING TAPE

Superior quality. 5" reel, 900' LP with strobe markings also cine light deflector-mirror. Suitable all tape recorders and cine projectors. List 29/- OUR PRICE 14/- each. Post 2/6.

THE INSTANT BULK TAPE ERASER AND RECORDING HEAD DEMAGNETISER

200/250 v. A.C. Leaflet S.A.E. Post 2/6 **35/-**



BAKER MAJOR 'MODULE'

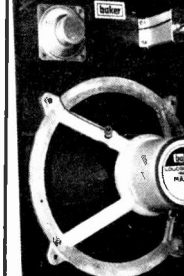

Ideal mono or stereo conversion of existing cabinets, furniture, etc. 12 inch Baker Major Full range speaker on 19" x 12 1/2" baffle board with 2 1/2" tweeter and crossover. Output 20 watts. Response 30-17,000 c.p.s. Impedance 15 ohms.

In kit form with instructions. **£10.19.6** or Fully assembled **£12.10.0**

Post Free
'Group 25' 'Group 35' 'Group 50'
 12in. 5gns. 12in. 8/6 15in. 18gns.
 25w. 35w. 50w.
 'BONDACOUST' Wadding for cabinet lining 15/- sq. yd.

E.M.I. CONE TWEETERS 3 in. square. 3-20kc/s. 10w. 17/6.
Quality Horn Tweeters 2-18kc/s. 10w. 27/6. Crossover 14/6.
LOUDSPEAKERS P.M. 3 OHMS: 2 in., 3 in., 4 in., 5 in., 7 in. x 4 in., 15/6 each; 8 in. 22/6; 6 in. 18/6; 10 in. 30/-; 12 in. 30/-; (15 ohms 35/-); 10 x 6 in. 30/-; 8 x 5 in. 21/-; E.M.I. Double Cone 1 1/2" x 8 in., 3 or 15 ohm models, 45/-
SPECIAL OFFER! 8 ohm. 2 in., 5 in., 8 ohm. 2 in., 2 in. 15/6
 25 ohm. 3 in., 8 x 4 in.; 35 ohm. 3 in., 5 in.; 7 x 4 in.

15/6 25 ohm. 3 in., 8 x 4 in.; 35 ohm. 3 in., 5 in.; 7 x 4 in.
JACK SOCKETS Std. open-circuit 2/6; close circuit 4/6
Chrome Lead Solder 7/6. DIN 3-pin 1/3, 5-pin 1/8; Lead 3/6.
Phono Plugs 1/-. Socket 1/6. **JACK PLUGS** Std. Chrome 3/6. 2.5mm.; 3.5mm.; 1/8; DIN 3-pin 3/6; 5-pin 5/-
WAVE-CHANGE SWITCHES WITH LONG SPINDLES. 2 p. 2-way, or 2 p. 6-way, or 3 p. 4-way 3/6 each. 1 p. 12-way, or 4 p. 2-way, or 4 p. 3-way, 3/6 each.
Wavechange "MAKITS" 1 p. 12-way, or 2 p. 6-way, 3 p. 4-way, 4 p. 3-way, 6 p. 2-way. Prices include click spindles, adjustable stops, spacers, etc., 1 waf. 10/6; 2 waf. 15/-; 3 waf. 19/6.
TOGGLE SWITCHES. sp. 2/-; sp. dt. 3/6; dp. 4/-.

DE LUXE TAPE SPLICER

Cuts, trims, joins for editing and repairs. With 3 blades. **14/6**

4 CHANNEL TRANSISTOR MICROPHONE MIXER. Add musical highlights and sound effects to recordings. Will mix Microphone, records, tape and tuner with separate controls into single output. **52/6**

DYNAMIC MICROPHONE

Dual impedance 600 ohm/50K. Universal Mounting. 70-12,000 cps. **£6.6.0**

AM TUNER MEDIUM WAVE

Three Transistor Superhet. Ready built. Printed Circuit. Ferrite Aerial. **79/6**
 Sizes 5 1/2" x 3 1/2" x 1 1/2". Ideal for Tape Recorders.

FM TUNER 88-108 Mc/s

Six Transistor. Superhet. Ready built. Printed Circuit. Calibrated slide dial **£6.19.6**
 tuning. Size 6" x 4" x 2 1/2".

3 WATT QUALITY AMPLIFIER

4 Transistor Push-Pull Ready built, with volume control **65/-**

★ RADIO BOOKS ★ (Postage 9d.)
 High Fidelity Speaker Enclosures and Plans 5/-
 Transistor Superhet Commercial Receivers 7/6
 Mullard Audio Amplifier Manual 8/6
 Radio Valve Guide, Books 1, 2, 3, or 4 5/- each 5/-
 Practical Radio Inside Out 4/6
 Transistor Audio Amplifier Manual Book 1, 3/6; Book 2, 6/-
 Shortwave Transistor Receivers 5/-
 Transistor Communication Sets 6/-
 International Radio Stations List 2/6
 Modern Transistor Circuits for Beginners 7/6
 Six-Transistor Transistor Receivers 5/-
 Wireless World Radio Valve Data 9/6
 At a glance valve equivalents 6/-
 Valves, Transistors, Diodes equivalents manual 10/6

RESTORERS. Preferred values. 10 ohms to 10 meg. 4 w. 1 w. 20 2/3 d.; 1 w. 8 d. 2 w. 1 1/2 w. 10 1/2 d. **HIGH STABILITY.** 1 w. 1 1/2 ohms to 10 meg. 2 d. Ditts 5%. Preferred values 10 ohms to 22 meg. 9d. 5 watt 0.5 to 8.2 ohm 3 w. 10 watt 10 ohms to 6,800 ohms 1/9 15 watt 10 ohms to 6,800 ohms 2/9

WIRE-WOUND RESISTORS

10K, 15K, 20K, 25K, 68K, 10W. 3-0.3 a., 1 K., 0.2 a., 1.2 K., 0.15 a., 1.5 K., 6/- each. **LINE CORD** 100 ohms lin. ft. twin plus resistance. 1/- 1/6

WIRE-WOUND 3-WATT WIRE-WOUND 4-WATT

POTS. T.V. Type. Values STANDARD SIZE POTS. 10 ohms to 30 K., 3/3, LONG SPINDLE VALUES Carbon 30 K. to 2 meg., 3/-, 50 OHMS to 100 K., 7/6.

VALVE HOLDERS.

Int. Oct. 6d. Mazda Oct. 6d.; B7G, B8A, B9G, B9A, Moulded 9d. Ceramic 1/-; B7G, B7A Cans 1/-; Valve base plugs B7G, B9A, Int. Oct., 2/6.

SANGAMO 3 inch SCALE METERS

Various calibrations and movements. 100 Microamp 55/-; 1 Milliamm 50/-, etc. Post 5/- extra. Send S.A.E. for list.

BRAND NEW QUALITY EXTENSION LOUDSPEAKER

Black plastic cabinet, 20lt. lead and adaptor. For any radio, intercom, tape recorder, etc. 3 to 15 ohm Size: 7 1/2" x 5 1/2" x 3" Post 30/- 2/6

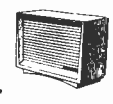

Post 1/6 unless otherwise stated. C.O.D. 5/- ex. List 1/-

337 WHITEHORSE ROAD, WEST CROYDON



Armstrong

high fidelity sound

series 27 TUNER-AMPLIFIERS for the BUDGET SYSTEM



- | | |
|--|----------|
| 127 STEREO TUNER-AMPLIFIER (illustrated) | £40.1.6 |
| 127M MONO TUNER-AMPLIFIER | £29.18.9 |
| 227M MONO TUNER-AMPLIFIER | £40.1.6 |
| OPTIONAL CASE, teak and vinyl hide | £3.15.9 |

Three tuner-amplifiers, identical in size and similar in styling, each with the same high performance AM-FM Tuner incorporated. The 227M provides 10 watts power output whilst the 127M, with 5 watts output, is designed for those whose power requirements are more modest. The 127 is the stereo version of 127M, having two amplifiers, each of 5 watts output. All three have similar facilities; pick-up and tape inputs; tape recording output, bass and treble tone controls.

For full details and technical specifications of all models, including the new series 400, plus list of stockists, post coupon or write mentioning 1PE68.

ARMSTRONG AUDIO LTD., WARLTERS ROAD, N.7
Telephone 01-607 3213

Name

Address

1PE68.

THREE HEADS ARE BETTER THAN TWO..

Two amplifiers are better than one...



Without these refinements it is impossible for a tape recorder to provide such facilities as Double Play, Sound-on-Sound and Direct Tape Monitoring—these are just some of the outstanding features incorporated in the WyndSOR Vanguard and when you study the complete specification (4 track—3 speeds—7in. spools—3 heads—Separate Record and Playback Amplifiers—Double Play—Sound-on-Sound—Detachable lid fitted 8in. speaker—Tape Monitoring—Push button controls—Recording meter and Playback indicator—Bass, treble, volume and record gain controls, etc.) you can see that we are offering an extraordinary recorder at an ordinary price.

59 GNS.

Ask your dealer to unveil the wonders of the Vanguard or write direct for full specification.

Complete with 1,800 ft. LP tape and tape manual. (Microphone, Headphones and Stereo tape pre-amp are available as optional extras.)

WYNSOR RECORDING CO. LTD. (Dept. PE12)

WyndSOR Works, Bellevue Rd., Friern Barnet, London, N.11. ENT 2226

SOLDERING ?

—you need the Antex
SOLDERING TOOL KIT

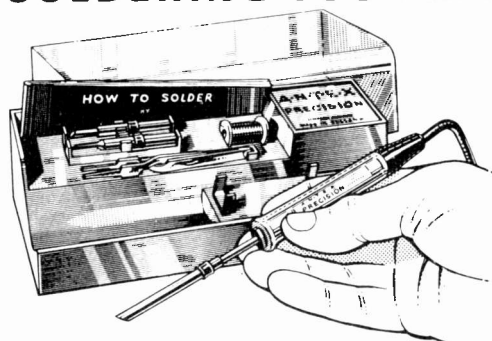

- Model CN240 15W Precision Iron with $\frac{3}{16}$ " bit,
- Two spare Interchangeable Bits ($\frac{3}{32}$ " and $\frac{3}{8}$ ")
- Reel of Solder ● Heat Sink ● Cleaning Pad
- PLUS 36-page booklet on "How-to-Solder"

49^{6d}

British made. From The Army & Navy Stores, Harrods, and Radio Shops, or if unobtainable locally, direct from:

ANTEX LTD

GROSVENOR HSE · CROYDON · CR91QE

Telephone: 01-686 2774

The resulting electric current will then be strictly proportional to the energy of the absorbed radiation, because this energy determines the number of gas atoms or molecules which the radiation particle can ionise before coming to rest. Ionisation chambers are thus useful for measuring particle energies as well as total activities.

A G.M. tube can measure only activities directly, since the current pulses it produces are all identical; a particle either causes a pulse or does not cause a pulse. The amplitude of the pulses produced by the ionisation chamber is, on the other hand, proportional to the particle energy. But it is extremely small, lying in the microvolt or millivolt range, so that very sensitive amplifiers and amplitude discriminators are required. On the other hand, very large volumes of gas can be employed without technical difficulties, so that radiations with a long range can be completely absorbed within the inter-electrode volume. Hence the term 'ionisation chamber'. Sizes up to many gallons are common in professional ionisation chambers.

THE PROPORTIONAL COUNTER

The proportional counter is intermediate in size and function between the ionisation chamber and the G.M. tube, and the applied voltage also lies intermediate, at one or several hundred volts. In this voltage range, primary ions produced by the radiation absorbed in the gas volume are accelerated on their way to the electrodes, producing secondary ionisation by collision with further gas molecules on the way.

The total anode current in the resulting pulse is thus much greater than for an ionisation chamber, but still requires considerable amplification in critical circuits. Proportionality is preserved between pulse amplitude and particle energy, because each primary ion produces a definite mean number of secondary ions, determined solely by the applied voltage.

G.M. TUBE OPERATION

Between the voltage range for proportional counter operation and the G.M. tube range, lies an indefinite region which is of little practical use. Above the G.M. threshold voltage, all particles entering the tube produce a large discharge pulse of fixed amplitude and duration, independent of the particle energy within the range known as the Geiger-Müller plateau. The upper limit of this plateau is the voltage at which a permanently sustained discharge takes place and rapidly destroys the tube.

The G.M. tube type of discharge is known as an avalanche discharge, because the multiplication of primary ionisation through collisions and other effects is cumulative, leading to complete breakdown of the insulation of the gas volume. This discharges the stray capacitance across the tube within a few microseconds, producing a corresponding voltage step across the anode or cathode load resistor, due to the current from the e.h.t. supply which immediately commences to recharge the stray capacitance. The voltage across the load resistor then drops exponentially as the recharge process proceeds, see Fig. 3.4c.

The time constant is thereby usually 30 to 100 microseconds (stray capacitance several pF, load resistance several megohms). This means that the G.M. tube cannot work faster than about 10kHz, which is a serious limitation in professional work. There is no advantage gained in working with smaller load resistors, because the so-called 'dead time' of the tube is also about 60 microseconds. It is the time taken for the quenching and de-ionisation process to be completed, and the sensitivity of the tube for a new particle to be restored.

The discharge of the stray capacitance at the start of the pulse takes place approximately down to the threshold voltage, so that the pulse amplitude is usually about 25 volts, a value which is easily handled by simple electronic circuits.

Next month: Other types of radiation detectors.

DETERMINING VOLTAGE AMPLIFICATION

continued from page 54

Similarly, if the load resistor should be of only medium value, but working into a succeeding stage of medium impedance, the normal

$$\frac{R_1 R_2}{R_1 + R_2}$$

formula for two resistors in parallel should be substituted for R_L only to obtain greater accuracy.

Of course, R_L need not necessarily be a resistor. It could be an a.f. choke, whose value would be determined by ωL at an average frequency handled, usually 400Hz, or the primary of an unloaded intervalve transformer which would also multiply the usual stage gain by its turns ratio.

As the impedance of a choke or untuned transformer primary winding is electrically at 90 degrees out of phase to the valve impedance, the formula must be altered so that they can be correctly related to each other so that A becomes

$$\frac{Z}{\sqrt{(r_a^2 + Z^2)}}$$

With a tuned circuit or transformer at resonance, its impedance or dynamic resistance L/CR_c behaves as a pure resistance and this figure merely replaces R_L in the formula.

FEEDBACK

Naturally, this and all other formulae presupposes that there is no negative feedback present in the stage which means that the cathode bias resistor must be effectively bypassed.

If no bypass capacitor is present the formula for stage gain then becomes

$$A = \frac{\mu R_L}{(\mu + 1) \times R_k + R_L + r_a}$$

Resolving this for the example already computed with a bypass capacitor shows a big decrease in gain.

ANODE LOAD

As well as being able to compute what the stage gain is, it is also convenient to decide what value of anode load resistor should be employed with any specified valve to obtain the exact degree of amplification required.

The static μ of the valve must naturally be comfortably in excess of that required to prevent the use of very high value resistors, which might bring the working point of the valve off the straight part of the I_a/V_g characteristic, and limit the grid input swing.

The formula is

$$R_L = \frac{A \times r_a}{\mu - A}$$

Thus, if it is required to obtain an amplification of just 20 from the same ECC40 triode, whose static μ is 30, the load resistor should be,

$$R_L = \frac{A \times r_a}{\mu - A} = \frac{20 \times 11}{30 - 20} = \frac{220}{10} = 22 \text{ kilohms}$$

An application of 0.2V to such a one-valve amplifier would therefore produce an a.c. voltage of $0.2 \times 20 = 4V$ across the anode load resistor.

With these two simple formulae therefore it is an easy matter to compute and arrange for any required degree of amplification.

★

Broadway ELECTRONICS

GARRARD 4 SPEED DECKS WITH CARTRIDGE:

Autochangers: AT6 Mk. II £8.19.6. 3000 £8.8.0. AT5 - Mono £8.10.0. P. & P. all changers 7/6.

TEAK FINISH WOODEN PLINTE:

With perspex cover. For Garrard 1000, 2000, 3000, AT60, SP25. Size 15 1/2" x 14 1/2" x 4" deep (7 1/2" deep inc. cover). 25 gns. P. & P. 6/6.

CARTRIDGES:

Stereo: EV26 25/-, GP83 15/-, Reuter STD/2 17/6. GP91/1 20/-, Mono Sonotone, 2T88 15/-, Acos, GP67 15/-, TC8 less bracket 18/6. P. & P. 1/- each.

B.S.R. 4 TRACK TAPE DECK 9gns. P. & P. 4/6.

MICROPHONES:

Xtal Hand Mikes:
BM3 and 200C 30/-, P. & P. 2/8. Stand for same 12/6. P. & P. 2/-, ACOS Mike 45, 21/-, ACOS Mike 40, 18/6. Dyn. Mike DM-391, 22/6, CM21 Xtal 12/6. CM20 Xtal, 9/6. Magnetic Hm 63C with remote control switch 15/-. Telephone Pick-up 10/6. P. & P. 1/-, Xtal Lapel Mike 7/6. Guitar Mike 12/6. P. & P. 1/-.

BARGAINS IN TRANSISTORS:

AC127, AF114, J15, 116, 117, 118, 119, OC169, 170, 171, 172, 200, 202, 203, 204, AC120, ACY40, ACY17, AF212, BCY10, 12, 33, 34, 38, 39; BFY50, 51, 52, 90, 5/6 each. P. & P. 6d. OA202 1/3. P. & P. 6d. OA2206, 208, 5/6. P. & P. 6d. OC72, 75, 82, 83, AAZ12, BY38, BCZ11, 3/6. OC71, 81, 31/-, R.F. Packs 1 OC44, 2 OC45 8/8, A.F. Packs 1 OC81D, 2 OC81 (Mullard), 8/6, GET113, Red Spot 2/-, OC26, 28, 29 9/6. ORP12 Light Cell 8/6. Diodes OA81 2/3, OA91, OA95 1/6. P. & P. 1/-.

TRANSISTOR ELECTROLYTICS:

1, 2, 4, 5, 8, 10, 16, 25, 32, 50, 100 mfd 15 volt working 1/3. P. & P. 1/-.
250 mfd DC 3/-, 500 mfd 12v DC 3/-, 500 mfd 25v DC 3/6. P. & P. 1/-.

RESISTORS: 1 watt 10%, from 4-7 ohm to 10 meg 5d. each, 4/- doz. P. & P. 1/- (minimum order 2/6).

PAPER CONDENSERS for Cross-Over Units 2 mfd 2/6. P. & P. 1/-.

4 AMP BATTERY CHARGERS £2.19.6. P. & P. 6/6.

PLANO KEY PUSH BUTTON SWITCHES, 7 button, inc. mains/off. 6 banks of 6 P.C.O. 8/6. P. & P. 1/-.

FERROX AERIAL ROD 6 1/2 in. 1/8. P. & P. 1/-.
10 x 1in. 3/-. P. & P. 1/-.

SPEAKER SYSTEMS

THE CAXTON COLUMN

This is a column cabinet. Size 22 1/2 x 5 x 6 1/2 in., fitted with 3 speakers. This will handle 10 watts and will improve the quality of any tape recorder or record player. Finished in wood grain cloth and sandstone Vynair. A real bargain at £3 plus 10/- P. & P.

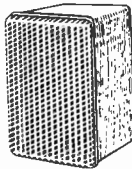

THE MILTON. A Hi-Fi Bookcase Cabinet. Size 9 x 5 x 6 in. with 5in. speaker. Finished in Teak cloth with black silk front. 30/-, P. & P. 3/6.



THE STEREO. A superior extension cabinet fitted with two 7 x 4 in. speakers. Size 16 x 9 x 8 1/2 in. Finished in fawn Vynair with natural teak ends. £3. P. & P. 5/-.

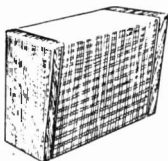

THE IMP. Extension Speaker Cabinet. Wedge shaped size 7 1/2 x 6 1/2 in. fitted with 7 x 4 in. speaker. Covered with attractive walnut with fawn Vynair front. Key-hole slot in back. Only 25/6. Post 2/6. Note: All cabinets new and made with 1/2 in. chipboard. All speakers ex TV reconditioned hi flux magnet. All carefully tested before despatch.

HAYDON SPEAKER SYSTEM
Size 16 1/2 x 15 x 7 1/2 in., fitted 12in. Speaker and volume control. Fabric covered. £4.17.6. P. & P. 10/-.

Stockists of ● Eagle Products ● Goodmans ● W.B. ● Wharfedale ● Bakers ● Tripletone ● Linear, all makes of amplifiers and speakers supplied. S.A.E. please. Trade terms to bona fide dealers.

SPEAKER ENCLOSURES

Tony Corner Cabinet 20 x 10 x 7 1/2 in. takes 10 x 6 in. speaker covered in Rexine and Vynair, 45/-, P. & P. 5/-.
Blake Cabinet size 18 x 24 1/2 x 9 1/2 in., fabric covered £4.10.0. P. & P. 10/-.

Haydon, 16 1/2 x 15 x 7 1/2 in. fabric covered suitable for 12in. speaker, 45/-, P. & P. 7/6.

Table top or wall mounting enclosure for 13 1/2 x 8 in. speakers 37/6. P. & P. 4/6.

Corner Cabinet in natural teak finish for 13 1/2 x 8 in. speaker also cut out for tweeter, £3.10.0. P. & P. 8/6.

Hi-Fi Bookshelf speaker enclosure foam lined, cabinet size 10 1/2 x 5 1/2 x 7 1/2 in. Teak finish, £3.0.0. P. & P. 3/6.

Woolfer for above £3.0.0. P. & P. 2/6. Tweeter 12/6. P. & P. 1/6. Condenser for crossover 2/6. Terminals 2/6 pair. P. & P. 1/-.

SPEAKERS:

Elac Heavy duty Ceramic Magnets 11,000 line, 10in. round 10 x 6 in. 3 ohm or 15 ohm, 42/6. P. & P. 3/6.

8in. round 15 or 3 ohm, 38/6. P. & P. 3/6. E.M.I. 13 1/2 x 8 in. 15 or 3 ohm, 42/6. P. & P. 3/6. E.M.I. Tweeter, 12/6. P. & P. 1/6. R.T.C. 12in. 20 watt 15 ohm Ceramic magnet £5.5.0. P. & P. 3/6. 8 x 6 in. Elliptical 30 ohm 30/-, P. & P. 3/6. 5in. round 30 ohm 17/6. P. & P. 2/6. 5 x 3 in. 15 ohm 17/6. P. & P. 2/6. 7 x 4 in. 35 ohm, 22/6. P. & P. 2/6. All other speakers supplied—Goodmans, Bakers, W.B., Wharfedale, Eagle, Tripletone.

PYE T.V. REMOTE CONTROL UNITS. Grey and Red plastic case. 2 white/silver knobs, 2 volume controls. 500K and 100K, small chasels. 7 yards 5-way cable with octal plug. Brand new, boxed. Only 5/6. P. & P. 1/-.

EARPIECES WITH CORD AND 3.5 mm. plug. 8 ohm magnetic, 3/-, 250 ohm 4/-, 160 ohm with clip, 6/6. Xtal 4/-, P. & P. 6d.

TRANSISTOR SPEAKERS 8 ohm 2in. 8/6; 3in. 10/6; 3 1/2 in. 12/6. P. & P. 1/-.

VYNAIR. Widths from 40"-54" 18/6 yd. off roll. Send 6d stamps for samples.

SPEAKER MATCHING TRANSFORMERS. 3, 7, 15 ohms, 8 watts 9/6. P. & P. 1/6.

PANEL LIGHTS, 6v Red, Blue, Green, Yellow, White (uses Lilliput bulbs) 3/- each. P. & P. 1/-.

NEON PANEL LIGHTS 200-250v 3/- each. P. & P. 1/-.

ROTARY SWITCHES: 2 pole Mains Switch 3/-, 1 pole 12 way, 2 pole 2 way, 3 pole 3 way, 3 pole 4 way, 4 pole 3 way, 3/6 each. P. & P. 1/-.

92 MITCHAM ROAD, TOOTING BROADWAY LONDON, S.W.17 Telephone 01-672 3984

(Closed all day Wednesday)

(four minutes from Tooting Broadway Underground Station)

YOURS FREE FOR 7 DAYS

The New 'Picture - Book' way of learning

- # BASIC
- ELECTRICITY (5 Vols)
 - ELECTRONICS (6 Vols)
 - ELECTRONIC CIRCUITS (2 Vols)
 - INDUSTRIAL ELECTRICITY (2 Vols)
 - SYNCHROS & SERVOMECHANISMS (2 Vols)

You'll find it easy to learn with this outstandingly successful new pictorial method—the essential facts are explained in the simplest language, one at a time; and each is illustrated by an accurate cartoon-type drawing.

The books are based on the latest research into simplified learning techniques. This has proved that the Pictorial Approach to learning is the quickest and soundest way of gaining mastery over these subjects.



"Times" Educational Review says: The volume can be thoroughly recommended as a training and revision course for T.V. engineers

—NOW READY—

BASIC TELEVISION Pt. 1.

Price 22/- inc. postage.

Complete in two parts, publication date of Pt. 2 to be announced later. Available on 7 days free trial, see coupon.

TO SELRAY BOOK CO.
60 HAYES HILL, HAYES, BROMLEY, KENT

Please send me Without Obligation to Purchase, one of the above sets on 7 Days Free Trial. I will either return set, carriage paid, in good condition within 7 days or send the following amounts. Basic Electricity 70/- Cash price or Down Payment of 15/- followed by 4 fortnightly payments of 15/- each. Basic Electronics 82/- Cash Price or Down Payment of 15/- followed by 5 fortnightly payments of 15/- each. This offer applies to U.K. only. Overseas customers cash with order.

Tick set required (only ONE set allowed on free trial)

- BASIC ELECTRICITY 70/- BASIC ELECTRONICS 82/-
 BASIC ELECTRONIC CIRCUITS 40/-
 BASIC INDUSTRIAL ELECTRICITY 40/- All prices include postage
 BASIC SYNCHROS & SERVOMECHANISMS 38/-
 BASIC TELEVISION PART 1 22/- PE12

Signature..... (If under 21, signature of parent or guardian)

NAME.....

FULL POSTAL ADDRESS..... BLOCK LETTERS BELOW

POST NOW FOR THIS OFFER!

3-PUSH SWITCH

For test meter, hi-fi amp, etc. 1st button operates mains on/off switch, the other two operate change-over switches. Knobs engraved On/Off, Bass, Treble, but engraving easily removed leaving clean surface for marking. 2/9 each, 24/- doz.



SATCHWELL OVEN THERMOSTATS

Type TO. With capillary tube and sensor. 20 amp a.c. type and as fitted to many cookers. Adjustable by control knob (not supplied). 12/6 each.

MAINS TRANSISTOR POWER PACK
Designed to operate transistor sets and amplifiers. Adjustable output 0V, 9V, 12V for up to 500mA (class B working). Takes the place of any of the following batteries: PP1, PP3, PP4, PP6, PP7, PP9, and others. Kit comprises: mains transformer, rectifier, smoothing and load resistor, condensers and instructions. Real snip at only 18/6, plus 3/6 postage.

FLOURESCENT CONTROL KITS

Each kit comprises seven items—Choke, 2 tube ends, starter, starter holder and 2 tube clips, with wiring instructions. Suitable for normal fluorescent tubes or the new "trilux" tubes for flash tanks and indoor plants. Chokes are super-silent, mostly resin filled. Kit A—15-20W, 19/6. Kit B—30-40W, 17/6. Kit C—80W, 17/6. Kit D—125W, 22/- . Kit E—65W, 19/6. Kit MF1 is for 6in, 9in and 12in miniature tubes, 19/6. Postage on Kits A and B 4/6 for one or two kits, then 4/6 for each kit ordered. Kits C, D and E, 4/6 on first kit then 3/6 for each kit ordered. Kit MF1 3/6 on first kit then 3/6 on each two kits ordered.

PHOTO ELECTRIC CONTROL SYSTEM

Comprises a light source unit with optional Infra Red filter and lens system to focus the light. Also a photo-electric Relay control unit. Both are housed in metal cases for bench or wall mounting and there is a sensitivity control as well as mains on-off switch. The outfit works from 230/240V a.c. Mains. Can be used as a simple on/off switch by breaking the beam of light (invisible if Infra Red filter is used) and as such it will operate as a burglar alarm, or will open doors, etc. Also in conjunction with a counter or other equipment it will perform many functions in the factory or warehouse. Price 29/19/6, plus postage and insurance 8/-.

SPECIAL BARGAINS

50 OHM 50 WATT WIRE WOUND POT-METER 8/6 each.

1 MEG MINIATURE. Pot-meter Morganite standard, 4in spindle, 1/- each, 9/- per dozen.

1 MEG MINIATURE. Pot-meter Morganite preset screwdriver control. 9d. each, 8/- per dozen.

PRE-SET 100K by Welwyn with intricate bakelite knob, 1/- each, 9/- per dozen.

100K POT-METER. Miniature type with double pole switch and standard 4in spindle, by Morganite. 2/- each, 18/- per dozen.

BLANKET-TYPE GLASS. Enclosed, normally closed circuit, will open should blanket overheat. 4/6 each.

THERMAL RELAY. Can be used to delay the supply of HT white heaters warm up, or will enable 15 amp. loads to be controlled by miniature switches or relays. Regular list price over £2, price 7/6 each.

SIEMENS HIGH SPEED RELAY. Twin 100 ohm coils. Platinum points changeover contacts—exquisite. 8/6 each.

TOGGLE SWITCH BARGAIN. 10 amp. 250V normal one hole fitting. 2/9 each, or 30/- per dozen.

ELECTRIC LOCK. 24V coil, but rewirable to other voltages. 4/6 each.

COMPRESSION TRIMMERS. Twin 100 pF. 1/- each, 9/- per dozen.

PRECISION WHEATSTONE BRIDGE. Opportunity to build cheaply. 100K wire wound pot. 15W rating, only 5/-.

SHEET PAXOLIN. Ideal for transistor projects. 12 panels, each 5in x 8in. 5/-.

3in FM LOUDSPEAKER. 3 ohm. 12/6. 80 ohm, 13/6.

TRANSISTOR FERRITE SLAB AERIAL with medium and long wave coils. 7/6 each.

SLIDE SWITCH. Sub miniature double pole change-over. 2/- each. 18/- per dozen.

Vacuum Cleaner Flex. Non-kinkable ribbed rubber, most pliable but very tough. 24/36 Cores. Normally 19p per yard, offered at £3 per 100 yard coil, post and insurance 8/6.

Sub-Miniature Silicon Diodes. General purpose type with gold-plated leads. 1/- each or 7/6 per dozen.

MESSAGE TAPES. 225ft Tape on 3in spools, normally 4/6 each. We offer 4 types for 12/6.

WHITE CIRCULAR FLEX. Ideal for lighting drops, twin made by BICC. Usually 8d yd., 100yd coil for 30/-, plus 6/- postage.

EDGEWISE CONTROL. Morganite, as fitted many transistor radios. 2K or 5K with switch. 2/6 each, or 24/- per dozen.

12V INVERTER. Full transistorised for operating a 20W fluorescent tube, size 6in long 1/- 12/6. Post and insurance 3/-.

CIRCULAR FLOURESCENT

Bring sunshine into your home. 150W of light but uses only 40W. Beautiful fittings with glass, non-plastic centre, fluorescent tube and choke control. Regular price £4/15/-. Special budget price 65/- plus 10/- carr. and ins. Please state colour of glass centre, white, pink, blue, red, black, yellow or cream. Also whether plug into lamp holder or ceiling mounting model 80W model 99/6. 10/- carr. and ins.

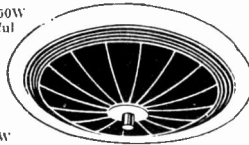

CASSETTE LOADED DICTATING MACHINE

Battery operated and with all accessories. Really fantastic offer, a British made £31 outfit for only 28/19/6, brilliantly designed for speed and efficiency—cassette takes normal spools drops in and out for easy loading—all normal functions—accessories include stethoscopic ear-piece—crystal microphone has on/off switch telephone pick-up—tape reference pad—DON'T MISS THIS UNREPEATABLE OFFER—SEND TO DAY 28/19/6, plus 7/6 post and insurance. Footswitch 18/6 extra. Spare Cassettes at 7/6 each, three for £1.

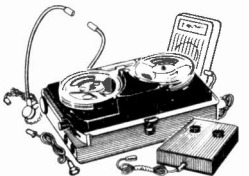

DRILL CONTROLLER



Electronically changes speed from approximately 10 revs to maximum. Full power at all speeds by fingertip control. Kit includes all parts, case, everything and full instructions. 19/8, plus 2/6 post and insurance. Or available made up 22/6.



750mW TRANSISTOR AMPLIFIER

4 transistors including two in push-pull input for crystal or magnetic microphone or pick-up—feed-back loops—sensitivity 5mV. Price 19/8. Post and insurance 2/6. Speakers: 3in, 12/6. 5in, 13/6. 6 x 4in, 14/6.



THIS MONTH'S SNIP

Non-flicker fluorescent lighting at silly price, famous A.E.I. (Mazda) instant start lighting transformer for 4ft 40W tube, listed at over £4. Two tube ends and two Terry clips to hold tube. Special snip price, only 14/6, plus 4/6 post and insurance—don't miss this tremendous bargain.

RADIO STETHOSCOPE

Easiest way to fault find—traces signal from aerial to speaker—when signal stops you've found the fault use it on Radio, TV, amplifier, anything—complete kit comprises two special transistors and all parts including probe tube and crystal earpiece, 29/6—twin stetoset instead of earpiece, 7/6 extra—post and ins. 2/6.



GARRARD AUTO RECORD PLAYER Model 2000

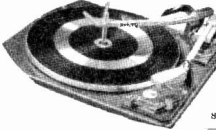

This is one of the latest products of the World's most experienced maker of fine record reproducers. Its superior features include—automatic playing of up to 8 mixed-size records—stopping and starting without rejecting—manual playing—pick-up pivots to give low stylus pressure—large diameter turn-table for max. stability adjustments include pick-up height—pick-up/dropping position and stylus pressure. Size is 13 1/2 x 11 1/2 clearances 4 1/2 in below—2 1/2 in below—fitted with latest hi-compliance cartridge for stereo—and mono L.P. and 78. Supplied complete with mounting template and an service sheet. Offered this month at the Special Snip price of £8/19/6, plus carriage and insurance.

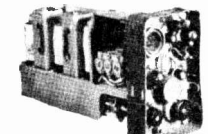

EX-WD BARGAIN Easily rebuildable to short wave radio
This is the 46 Receiver/Transmitter. It has a range of approx. 5 miles. Operates from dry batteries. Complete with six valves and in metal case. Size approx. 12 x 6 x 3 1/2 in. Complete but less crystal, not tested nor guaranteed. 19/8 plus 4/6 post and insurance. Should not be operated as a transmitter in the U.K.



SMALLEST TAP RECORDER AVAILABLE (6 1/2 x 2 1/2 x 1 1/2 in)
Will record or play back (into earphones) whilst still in your pocket. Uses standard tape which is re-usable indefinitely. Complete with batteries, ready to work, £8, plus 5/- post and insurance.

TUBULAR HEATERS

New and unused made by G.E.C.—rated at 60W per ft.—these are ideal in airing cupboards, bedrooms, offices, stores, greenhouses, etc., curtains or papers can touch them without fear of scorching or fire. Supplied complete with fixing brackets and available in the following sizes. 8ft, 30/-; 10ft, 36/-; 12ft, 42/-.

Prices which are about 1/2 list price includes carriage by B.R.S.

INFRA-RED HEATERS

Make one of these ideal type heaters. Suitable for bathroom, etc. They are simple to make from our easy-to-follow instructions—uses silica enclosed elements designed for the correct infra-red wave length (3 microns). Price for 750W element, all parts, metal casing as illustrated. 19/6, plus 3/6 post and insurance. Pull switch 3/- extra.

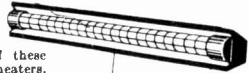

HI-FI SPEAKER BARGAIN

12in High fidelity loud-speaker. High flux permanent magnet type with either 3 or 15 ohm speech coil. Will handle up to 10W. Brand new by famous maker. Price 29/6. With built-in Tweeter 35/-, plus 3/6 post and insurance.



GEARED MOTOR

HALF REV. PER MINUTE
Made by famous Smith Electric, mains operated and quite powerful. Size 3 1/2 x 2 1/2 x 1 1/2 in deep. Secondary use as process timer. Internal switch can be made to break circuit within a period up to 2 min. 17/6. P. & P. 2/6 unless ordered with other goods.



DOOR INTERCOM



Know who is calling and speak to them without leaving bed, chair, etc. Outfit comprises microphone with call push-button connecting wire and master intercom. Simply plugs together.

Originally sold at £10. Special snip price 99/6, plus 3/6 postage.

GRAM MOTOR SNIP

4 speed, gram. motor with lightweight pick-up motor, electronically balanced and free from wow and flutter. Speed change by pushbutton—16, 33, 45, 78 r.p.m. Price 39/6, plus 4/6 post and insurance. DON'T MISS THIS TERRIFIC BARGAIN.

QUICK CUPPA

Mini Immersion Heater. 350W. 200/240V. Boils full cup in about two minutes. Use any socket or lamp holder. Have at bedside for tea, baby-food, etc., 19/6, post and insurance 1/6.

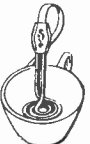

NO SOLDERING POCKET 3

Lots of fun to build and good results when finished—complete kit with detailed instructions and crystal earpiece (batteries 1/2 extra). £5 value only 19/6 plus 3/- post and insurance.



MULTI-RANGE TEST METER 1000 OPV

For checking car, electric, radio, TV, ignition systems, household lighting, etc. Measure a.c./d.c. volts; d.c. current. Resistance will last a lifetime, 39/8. P. & P. 3/6.



OZONE AIR CONDITIONER

For removing smells and generally improving oppressive atmosphere. In neat hammer finish box. Uses Philips ozone lamp and mains unit. Lamp easily replaceable. Only 39/6, plus 6/6 carr. and ins.

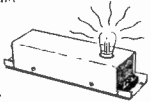

Where postage is not definitely stated as an extra then orders over £3 are post free. Below £3 add 2/9. Semi-conductors add 1/- post. Over £1 post free. SAE with enquiries please.

ELECTRONICS (CROYDON) LIMITED

(Dept. P.E.) 102/3 TAMWORTH ROAD, CROYDON, SURREY (Opp. W. Croydon Stn.)

also at 266 LONDON ROAD, CROYDON, SURREY S.A.E. with enquiries please

Practical Electronics Classified Advertisements

TAPE RECORDERS, TAPES, ETC.

GEE'S RECORDING TAPE and Audio Accessories (cost less! Send 1/- for illustrated catalogue. **GEE BROS. RADIO**, 15 Little Newport Street, London, W.C.2. Gerrard 6794.

TAPES TO DISC—using finest professional equipment—45 r.p.m. 18/-. S.A.E. leaflet. **DEROY**, High Bank, Hawk Street, Carnforth, Lancs.

20% CASH DISCOUNT on most famous makes of Tape Recorders, Hi-Fi equipment, Cameras, etc. Join England's largest Mail Order Club now and enjoy the advantages of bulk buying. Send 5/- for membership card, catalogues, price lists and ask for quotation on any item. **C.B.A.** (Dept. A18), 370 St. Albans Road, Watford, Herts.

HI-FI EQUIPMENT

WE have the exact speaker system to suit *YOUR* Hi-Fi requirements send **NOW** for full details of:

- (1) "BRIMHAM" loudspeaker systems
- (2) Loudspeaker cabinets for D.I.Y.

to

P. F. & A. R. HELME
(Dept. P.E.)
BUTCHER PASTURE, SUMMERBRIDGE
HARROGATE, YORKS.

MISCELLANEOUS

CALL OR SEND for list from the most interesting shop in Lancashire. Electrical, Mechanical and Electronic Goods. **ROGERS**, 31 Nelson Street, Southport.

"**PRACTICAL ELECTRONICS**" Water Level Alarm. Fuzz Box. Yodeller Door Monitor. Harmonic Distortion Meter. I.C. Gram Amplifier. Thyristor Power Controller. Transistor Millivoltmeter. Screenwiper Delay Unit. Electronic Stopclock. Transistor Test Set. Investigator Oscilloscope. Radio Servicing Aid. C.R.O. Trace Doubler. Bite Indicator. Light Operated Stopwatch. Field Strength Meter. Valve Voltmeter and Ohmmeter. Proximity Detector. Photoflash Slave Unit. Integrated Stereo Amplifier and all constructional projects going back to Issue 1. Send s.a.e. for your choice of itemised price lists. **AJAX ELECTRONICS**, 18a Rumbold Road, Fulham, London, S.W.6.

No. 10 PADDED MOVING COIL HEADPHONES AND MIKE

NEW CONDITION
HIGH QUALITY
HIGH IMPEDANCE
Bargain 13/-. Post Paid
S.A.E. for Lists of other Bargains
SALOP ELECTRONICS
9a GREYFRIARS ROAD, COLEHAM
SHREWSBURY, SHROPSHIRE

ELECTRONIC EQUIPMENT to buy, sell, or exchange, visit 31 Buckingham Street, Leicester. 8 tons available including the unusual, i.e. spectrum analysers, polarograph, electronic tube filling machine, decade potentiometer, transformer test sets, teleprinter and u.h.f. gear.

RATES: 1/3 per word (minimum 12 words). Box No. 1/6 extra.

Advertisements must be prepaid and addressed to Advertisement Manager, "Practical Electronics" 15/17 Long Acre, London, W.C.2

MISCELLANEOUS (continued)

PERSPEX, P.V.C. FABRICATIONS, cases, panels, etc. to specification for electronics industry. **WRAITHE BROTHERS LIMITED**, Velvet Street, Blackburn. Telephone 50505.



See the World famous
HEATHKIT
Electronic Kits
at
233 Tottenham Court Rd.
LONDON, W.1
Telephone 01-636 7349
Send for FREE Catalogue
Dept. TC-3

EDUCATIONAL

EDUCATIONAL

(continued)

ALDERMASTON COURT POSTAL TRAINING for B.Sc. (Eng.) Part 1, A.M.I.E.R.E., A.M.S.E., City & Guilds, G.C.E., etc. prepares you privately for high pay and security as Technician or Technologist. Thousands of passes. For details of Exams and Courses in all branches of Engineering, Building, Electronics, etc. (including latest information on C.Eng.), write for 132-page Handbook—FREE. Please state interest. **BRITISH INSTITUTE OF ENGINEERING TECHNOLOGY**, (Dept. 125K), Aldermaston Court, Aldermaston, Berks.

TELEVISION SERVICING RADIOTELEGRAPHY RADAR MAINTENANCE

Full and Part-day Training Courses
Apply:—Director, British School of Telegraphy,
20 Penywern Road, Earls Court, London, S.W.5

STUDY RADIO, TELEVISION AND ELECTRONICS with the world's largest home study organisation. I.E.R.E.; City & Guilds; R.T.E.B., etc. Also practical courses with equipment. No books to buy. Write for FREE Prospectus to ICS (Dept. 577), Intertext House, London, S.W.11.

CITY AND COUNTY OF BRISTOL BRISTOL TECHNICAL COLLEGE

Principal: E. Poole, B.Sc.(Eng.), C.Eng., M.I.Mech.E., M.I.Prod.E.

CAREERS IN RADIO AND RADAR

Marine Radio Officers

2-year full-time course for young men aged 16, upwards, leading to First and Second Class P.M.G. Certificates and B.O.T. Radar Maintenance Certificate.

Conversion Course (Second Class to First Class).

R.T. Courses (for Full or Restricted Licence).

Marine Electronic Maintenance Engineers Course (for qualified Marine Radio Officers).

Licensed Aircraft Radio Engineers

2-year full-time course for A.R.M.E. Licences, categories A and B, and six months courses for Radar Rating in association with the above.

Training given on the latest types of Marine and Aircraft Equipment in newly equipped Laboratories at

THE SCHOOL OF MARINE RADIO AND RADAR

Senior Lecturer-in-Charge: F. E. Bartrop

For details, write to:—

**The Registrar, BRISTOL TECHNICAL COLLEGE
ASHLEY DOWN, BRISTOL 7**

EDUCATIONAL

(continued)

GET INTO ELECTRONICS—big opportunities for trained men. Learn the practical way with low-cost Postal Training, complete with equipment. A.M.J.E.R.E., R.T.E.B., City & Guilds, Radio, T.V., Telecoms., etc. For FREE 100-page book, write Dept. 856K, CHAMBERS COLLEGE, 148 Holborn, London, E.C.1.

WANTED

VALVES WANTED. brand new popular types boxed. DURHAM SUPPLIES (E), 175 Durham Road, Bradford 8, Yorkshire.

SERVICE SHEETS

SERVICE SHEETS, Radio, TV, 5000 models. List 1/6. S.A.E. enquiries. TELRAY, 11 Maudland Bank, Preston.

RADIO TELEVISION, over 8,000 Models. JOHN GILBERT TELEVISION, 1b Shepherds Bush Rd., London, W.6. SHE 8441.

SERVICE SHEETS for all makes Radio, T.V., Tape Recorders, 1925-1967. Prices from 1/-, Catalogue 6,000 models, 2/6. Free fault-finding guide with all sheets. Please send stamped addressed envelope with all orders/enquiries. HAMILTON RADIO, 54 London Road, Bexhill, Sussex.

SERVICE SHEETS

4/- each, plus postage.

We have the largest supply of Service Sheets for all makes and types of Radios and Televisions, etc. in the country. Speedy Service.

To obtain the Service Sheet you require, please complete the attached coupon:

From:

Name:

Address:

To: **S.P. DISTRIBUTORS**

35/36 Great Marlborough Street, London, W.1

Please supply Service Sheets for the following:

Make:

Model No.: Radio/TV

Make:

Model No.: Radio/TV

Make:

Model No.: Radio/TV

also require the new 1967 list of

Service Sheets at 1/6 plus postage.

(please delete items not applicable)

enclose remittance of

which includes postage

MAIL ORDERS ONLY Jan. PE

SITUATIONS VACANT

TAPE RECORDER bench engineer required for Central Service Department tape recorder specialist company, situated East London (Upton Park). Some experience in tape recorder servicing essential. Interesting and varied work. 5 day week. MR. WILLIS, GRA. 2110.

SITUATIONS VACANT

(continued)

A.M.S.E. (Elec.), City & Guilds, G.C.E., etc., on "Satisfaction or Refund of Fee" terms. Wide range of Home Study Courses in Electronics, Computers, Radio, T.V., etc. 132-page Guide—FREE. Please state subject of interest. BRITISH INSTITUTE OF ENGINEERING TECHNOLOGY (Dept. 124K), Aldermaston Court, Aldermaston, Berks.

FED UP WITH YOUR PRESENT JOB?

We require a number of junior engineers with drive and initiative for:

Circuit design—development and prototype construction, etc.; Electro-mechanical drafting—printed circuit/chassis layouts, etc.; Production line test and inspection engineers; Production line fault finders.

Excellent prospects and full training given, day release considered. Salary up to £1,000 depending on experience and qualifications.

Send full details in writing of experience to date and present salary to:

Solid State Controls Limited
30/40 Dalling Road, London, W.6

ELECTRONIC WIREMAN with test experience. Used to transistor circuits, relay switching, printed circuit design, cable form layout, fault finding. Interesting work to suit ambitious personality. Applicant must be over 25 and offer at least "O" level G.C.E. passes or hold City & Guilds Telecommunications Technician Intermediate Certificate or equivalent technical qualification. Salary £962 p.a., rising to £1,104. Apply SHIELD PROTECTION LIMITED, 145 Farringdon Road, London, E.C.1. 01-278 1102.

SITUATIONS VACANT (continued)

RADIO TECHNICIANS

A number of suitably qualified candidates are required for unestablished posts, leading to permanent and pensionable employment (in Cheltenham and other parts of the U.K. including London). There are also opportunities for service abroad.

Applicants must be 19 or over and be familiar with the use of Test Gear, and have had practical Radio/Electronic workshop experience. Preference will be given to candidates who can offer "O" Level GCE passes in English Language, Maths and/or Physics, or hold the City and Guilds Telecommunications Technician Intermediate Certificate or equivalent technical qualifications. A knowledge of electro-mechanical equipment will also be an advantage.

Pay according to age, e.g. at 19—£828, at 25—£1,076.

Prospects of promotion to grades in salary range £1,159—£1,941. There are a few posts carrying higher salaries.

Annual Leave allowance of 3 weeks 3 days, rising to 4 weeks 2 days. Normal Civil Service sick leave regulations apply.

Application forms available from:

Recruitment Officer (RT/54)
Government Communications Headquarters
Oakley,
Priors Road
CHELTENHAM, Glos.

TECHNICAL TRAINING by ICS IN RADIO, TELEVISION AND ELECTRONIC ENGINEERING

First-class opportunities in Radio and Electronics await the ICS trained man. Let ICS train YOU for a well-paid post in this expanding field.

ICS courses offer the keen, ambitious man the opportunity to acquire, quickly and easily, the specialized training so essential to success. Diploma courses in Radio/TV Engineering and Servicing, Electronics, Computers, etc. Expert coaching for:

- INSTITUTION OF ELECTRONIC AND RADIO ENGINEERS.
- C. & G. TELECOMMUNICATION TECHNICIANS' CERTS.
- C. & G. SUPPLEMENTARY STUDIES.
- R.T.E.B. RADIO AND TV SERVICING CERTIFICATE.
- RADIO AMATEURS' EXAMINATION.
- P.M.G. CERTIFICATES IN RADIOTELEGRAPHY.

Examination Students Coached until Successful.

NEW SELF-BUILD RADIO AND ELECTRONIC COURSES

Build your own 5-valve receiver, transistor portable, signal generator, multi-meter and valve volt meter—all under expert guidance.

POST THIS COUPON TODAY and find out how ICS can help YOU in your career. Full details of ICS courses in Radio, Television and Electronics will be sent to you by return mail.

MEMBER OF THE ASSOCIATION OF BRITISH CORRESPONDENCE COLLEGES.

**INTERNATIONAL
CORRESPONDENCE
SCHOOLS**

**A WHOLE WORLD
OF KNOWLEDGE
AWAITS YOU!**

International Correspondence Schools
(Dept. 152), Intertext House, Parkgate Road,
London, S.W.11.

NAME
Block Capitals Please

ADDRESS

1.68

FOR SALE

100 PAGE illustrated Catalogue No. 17 Government and manufacturers' electronic surplus, also new section of latest semi-conductors and miniature components. Credit voucher for 2/6 included. Price 3/- post free. **ARTHUR SALLIS LTD.**, 93 North Road, Brighton.

P. WIRELESS, 1953-66; P. Television, 1953-66; R. Constructor, 1954-66 Issues. Must clear. Offers BOX No. 9.

HAMMERITE HAMMER PATTERN ENAMEL

AIR DRYING • **JUST BRUSH ON**

TRIAL TIN (covers 5 sq. ft.) **3/9** + 9d. post.

2 1/2 oz. tins 3/9, 1/2 pint [8]-1 pint 16/-; Carr. orders up to 5/-, 9d.; up to 10/-, 1/9; over 10/-, 3/-. Colours: blue, silver, black, bronze. No primer needed. Panel transfers, fireproof spray thinners. LIST FREE.

INDUSTRIALISTS SAVE TIME AND \$\$\$! (2 pints will do a Min!) **AMAZING RESULTS - JUST TRY IT!**

FINNIGAN SPECIALTY PAINTS (PE) Mickley Square, Stocksfield, Northumberland Tel.: Stocksfield 2280

BRASS, STEEL, LIGHT ALLOY, STAINLESS STEEL TUBE. Bar Material, Tools, Mechanical, Electrical, plus Assorted Lots. Send S.A.E. for latest Cat. of 1,000 items. **K. R. WHISTON**, Dept. BPE, New Mills, Stockport.

MORSE MADE !! EASY

FACT NOT FICTION. If you start **RIGHT** you will be reading amateur and commercial Morse within a month (normal progress to be expected). Using scientifically prepared 3-speed records you automatically learn to recognize the code **RHYTHM** without translating. You can't help it, it's as easy as learning a tune. 18 W.P.M. in 4 weeks guaranteed.

For details and course C.O.D. ring S.T.D. 01-660 2896 or send 8d. stamp for explanatory booklet to: **GSCHS/H, 45 GREEN LANE, PURLEY, SURREY**

RECEIVERS AND COMPONENTS

TIME SWITCHES. Reconditioned 14-day clock, once on once off every 24 hours. Fully guaranteed. 5A Horstmann 29/6—15A Venner 37/6. Postage 2/6. **A. R. BATCHELOR** (Dept. P.E.), 4 Park Road, Bromley, Kent.

HYSTABS

1/2 5% Carbon film low noise
12 preferred values per decade only
Your choice 3d. each, 2/3 doz., 17/- 100

W/E TCC 32 + 32µf n 300 V 4/6 each
W/E TCC 500µf m 30 V 2/9 each

C.W.O. P/P 2/- per Order. S.A.E. Gen. list.

CALDER RECORDINGS LTD.
Regent St., **HEBDEN BRIDGE, Yorkshire**

RECEIVERS AND COMPONENTS

(continued)

SEMICONDUCTORS

All Brand New. No Manufacturers' Rejects.

2N2926 Green β 235-470 3/9, Yellow β 150-300 3/6, Orange β 90-180 3/3, Red β 55-110 3/-.

ACY22 (Mullard) 3/9, OC71 (Mullard) 3/-.

Mullard diodes:
OA70, OA81, OA90, OA91 2/- each.
p.p. 1/-, free on orders for more than 15/- C.W.O.

WW ELECTRONICS
10 The Drive, Newcastle upon Tyne 7

FET's MPF105 suitable for 2N3819 applications, 10/-. Resistors 4 and 1/2 W 5% 4.7-Ω-4.7M Ω, 2d. each. Capacitors, rectifiers, etc. S.a.e. price list.—**STUDENT ELECTRONIC SERVICES**, 194 Regent Road, Salford 5.

FAMOUS No. 19 SET TRANS/RECEIVER

Covers 2-8Mc/s in 2 bands. 11 valve superhet transceiver including 807 P.A. Power reqs. L.T. 12v., H.T. rec. 275v., H.T. transmit 500v., D.C. Slightly used 45/-.

Selected condition 75/-. Carr. 15/- each. All 19 set ancillary parts available.

BRAND NEW RCA CANADIAN No. 29

Transmitter / Receiver 2-8 Mc/s., separate Manual tuning R.F. and Osc., also preset motor operated ditto. 2b miniature valves including 2/815's, 12/24v. d.c. operation.

In original packing, complete with all ancillary fittings. £22.10.0. Carr. 50/-

TELESCOPIC AERIAL MASTS. Tubular steel copperplated, spray finish, ring cam locking on each section provides for full or any height required. Suitable all fixings and base locations. Bottom section 1 1/2 in. diameter, 20ft. (4 section) Closed 5ft. 9in., Weight 16lbs., 60/-, Carr. 10/-, 24ft. (6 section) Closed 6ft. 6in., Weight 20lbs., 80/-, Carr. 10/-.

VHF COMMUNICATION RECEIVER I392

15 valve Superhet, Covering 95-155 Mc/s (2-3 metres Police, Aircraft and Amateur Broadcasts.)

Power required 240-250 v. at 80mA, 6.3v at 4 amps. Size 19x10x10in. £7.10.0. Carr. 15/-.

CREED 7B TELEPRINTERS. £15. Carr. 30/-.

ROTARY TRANSFORMER

12v. D.C. input, 250v. D.C. output at 125mA. Size 3 1/2x5 1/2in. Brand new, 17/6. P. & P. 5/-.

R.F. ANTENNA TUNER (A.T.U.)

Calibrated scale, ideal 160/80/40 metres. Few only. Brand new with instructions, 17/6. P. & P. 7/6.

A.J. THOMPSON (Dept. P.E.)

S.A.E. all enquiries—List 2/-

"Eiling Lodge" Codicote, Hitchin, Herts.
Phone: Codicote 242

RECEIVERS AND COMPONENTS

(continued)

REPANGO Transistor Coils and Transformer. for the Constructor. Send stamp for lists **RADIO EXPERIMENTAL PRODUCTS LTD.**, 33 Much Park Street, Coventry.

R & R RADIO

51 Burnley Road, Rawtenstall
Rossendale, Lancs
Tel.: Rossendale 3152

Boxed Valves	Fully Guaranteed
EF80 4/-	PCC84 5/- PY33 7/6
ECC82 4/-	PCF80 5/3 30P19 7/6
ECL80 6/-	PL81 5/- 30P4 7/6
EB91 2/-	PY81 5/- U191 7/6
EF85 5/-	PY800 5/- U301 7/6
EY86 5/6	PL36 7/6 PCL83 7/6

Postage: One valve 9d. extra. Two valves 6d. each extra. Three to Six valves 2d. each extra, over Six post paid. Speakers ex T.V. 5 inch round 3/6, 6 x 4 3/6, post 2/6, 8 inch round 6/6, post 4/6 for one or two.

Transistors
OC45 3/-, ACY27 4/-, ACY28 4/-, ACY30 10/-, 2N697 10/-, 2N706 3/-, AC128 2/6, G.E.C. Rect. 60 volt P.I.V. 1/-, Postage 6d. per order.

150 NEW ASSORTED Capacitors, Resistors Silvered Mica, Ceramic, etc. Carbon, Hystab, Vitreous, 1-20 watt, 12/6. Post Free. **WHIT-SALAM ELECTRICAL**, 18 Woodrow Close, Perivale, Middlesex.

RESISTORS

1/2 watt carbon film 5%
All preferred values in stock from 10 ohms to 10 megohms 2d. each.
Send S.A.E. for free sample

CAPACITORS

Mullard Miniature Metallised Polyester P.C. Mounting, all 250V D.C. working. 0.01mf, 0.022mf, 0.047mf, 0.1mf, 0.22mf, all at 6d. each

Hunts tubular 0.1mf 200V working at 3d. each

Send 6d. stamp for extensive list of low priced Electronic Components, Instruments and Equipment

Please include 1/- postage and packing on all orders under £1

Dept. P.E.6
BRENSAL ELECTRONICS LIMITED
CHARLES STREET, BRISTOL 1

VALUE FROM ELECTROVALUE NEW RESISTORS

1/2 W All values, 5-Ω to 330kΩ, carbon film low noise, 5% tolerance. 1/10 doz. mixed; 14/6 100 mixed; 13/- 100 of one ohmic value.

1/2 W All values, 4.7Ω to 10MΩ carbon film low noise, 10% tolerance. 2/1 1/9 doz. mixed; 13/6 100 mixed; 12/- 100 of one ohmic value.

1/2 W All values, 4.7Ω to 10MΩ, carbon film low noise, 5% tolerance. 2/1 doz. mixed; 16/- 100 mixed; 14/6 100 of one ohmic value.

All mixtures are to your specified values. Large quantities stocked.

Quality carbon Skeleton Pre-sets: 100Ω, 250Ω, 500Ω, 1kΩ, 2.5kΩ, 5kΩ, 10kΩ, 25kΩ, 50kΩ, 100kΩ, 250kΩ, 500kΩ, 1MΩ, 2.5MΩ, 5MΩ, 10MΩ.

All values available in horizontal or vertical mounting, 1/- each.

Volume controls: 100, 250, 500Ω etc. to 10MΩ linear, 2/6 each
5k, 10k, 25kΩ log. etc. to 5MΩ log, 2/6 each
5k, 10k, 25kΩ etc. to 2MΩ log, DF switch, 5/3 each

10% DISCOUNT OVER £3

Peak Sound Products
CIR-KIT No. 3 Pack, contains 12in x 6in board, 15ft x 1/2in strip, 6in x 4in copper sheet, 12/6.
Strip: 5ft x 1/2in or 3/4in 2/-; 100ft x 1/2in or 3/4in 30/-
Perforated board, 0.1in matrix, 5in x 3 1/2in 4/-; 2 1/2in x 3 1/2in 2/6; 2in x 3 1/2in 1/9

Transistorised Stereo Amplifier type SA8-8. Amplifier kit, £10/10/-. Descriptive leaflet only (refunded on purchase of amplifier) 1/6. Power supply kit £3/0/0. Cabinet £3/0/0.

10% DISCOUNT OVER £3

Mains neons, square, red, single hole fixing, 3/9 each. S-Decs 29/6.

NEW TRANSISTORS AND DIODES

Silicon
Ceramic, low noise, small signal amplifiers .. CS2926 Red 55-110 3/6
High reliability type, made in U.S.A. .. CS2926 Orange 90-180 3/9
Equivalent to the popular 2N2926 series .. CS2926 Yellow 150-300 4/-
Higher power rating, smart appearance .. CS2925 235-470 4/9

Low noise, high gain NPN: BC109 4/3; 2N3707 5/-, PNP: 2N4058 5/6.
General purpose high gain NPN: BC108 3/11; 2N2926 green 4/-.
AF driver NPN: BC107 4/3; 2N3704 4/-; 2N3415 6/-; BFY50 7/6; BFX85 10/9.
PNP: 2N3702 4/-; 2N3703 4/-; 40319 13/3; 40362 14/9.

High Power output: 2N3054 (planar) 26/-; 2N3055 £1; 40465 16/3.
Ultra high gain: NPN 2N3390 6/3; BC109C 4/6. UHF: 2N3663 11/3.
Field effect transistor: MPF105 10/- (equivalent to 2N3819). 10% DISCOUNT OVER £3

Germanium
Low noise AF PNP: NKT265 3/6; 2G308 6/9; 2G309 7/9.
General purpose switching PNP: ACY17 8/3; ACY18 5/-; ACY19 5/8; ACY20 4/9; ACY21 5/3; ACY22 3/6. NPN: ASY28 7/6; NKT773 5/3.
High Power PNP: NKT403 15/9; NKT405 13/9; 2N2147 15/9; 2N2148 11/9.

High Power Complementary matched pair: AD161/AD162 23/- pair.
Complementary matched driver pair: 2N1304/2N1305 8/6 pair.
Diodes: OA47, OA70, OA81, OA90, OA91, OA95 2/- each; OA202 3/-.

Fast Service 10% DISCOUNT OVER £3 Data supplied
Orders under £1 post 1/-, over £1 post free.

ELECTROVALUE, 6 Mansfield Place, Ascot, Berkshire



look at these values!

IOR SEMICONDUCTOR CENTRE BY MAIL

AC107	14/9	OC171	6/-	INTE-GRATED CIRCUITS	39/9
AC126	6/-	OC169	6/-	Fairchild	
AC128	4/-	OC200	6/-	uL900	9/6
AC176	6/-	OC201	15/-	uL914	9/6
ADT140	12/6	OC202	13/-	U1923	12/6
ACY17	5/-	OC203	8/6	5 page article on ICs	2/6
ACY20	3/6	OC204	11/-		
ACY21	4/-	OC205	10/6		
AF114	4/9	OC71	19/6		
AF115	4/9	ORP12	9/6		
AF116	4/9	ORP60	8/-		
AF117	4/9	2G374	5/-		
BA1731	4/-	2G381	5/-		
BC109	6/-	2N706	4/9		
BCY30	7/-	2N1302	5/-		
BCY31	13/-	2N1303	5/-		
BCY32	13/-	2N1304	6/-		
BCY33	6/-	2N1305	6/-		
BCY34	8/-	2N1306	8/-		
BCY38	10/-	2N1307	8/-		
BCY39	19/-	5T140	3/-		
BCY40	16/-	5T141	3/-		
BFY50	6/-	DIODES			
BFY51	6/-	OAS	2/6		
BSY95A	4/9	OA10	2/6		
BY100	5/-	OA70	1/6		
BYZ10	13/-	OA79	1/6		
BYZ12	7/6	OAB1	1/6		
BYZ13	5/6	OAB5	2/-		
GET103	4/4	OA90	3/-		
OC41	3/6	OA91	1/6		
OC42	4/-	OA200	4/-		
OC44	3/-	OA202	4/-		
OC45	3/-	POWER			
OC71	3/6	OC20	22/6	We stock most types of Mullard	
OC72	4/6	OC20	13/-	Newmarket	
OC73	3/3	OC23	25/-	Texas	
OC75	5/-	OC25	9/6	Sinclair	
OC76	4/-	OC26	12/-	S.T.C., etc.	
OC81	3/6	OC28	15/-	Quotations by return	
OC82	4/6	OC35	12/-	for types	
OC82D	4/6	OC36	14/-	not listed.	
OC83	4/-				

2N3819 fet. 15s!

BC107 & 8 5s

2N2646 ujt 12s

PLANAR SALE!!!

2N3707 npn 1/6

2N3702 npn 1/6

OC71 equiv. 9/6

TD716 tunnel diode+ data 12s

FAIRCHILD AF 11

20W SOLID STATE

AMPLIFIER KIT

£8.8.0d Complete

Includes Printed circuit board, Semiconductors, Resistors, capacitors, Heat sink and short circuit protection components. S.A.E. for details.

NOTE. All goods are new and to makers' ratings. We do not offer for sale re-marked transistors. All goods are subject to our usual money-back guarantee. Data sheets supplied if required cost 1/- extra.

The famous "International Rectifier Semiconductor Centre" now available by mail: L.S.T. Components are proud to announce their appointment as official stockists.

ZENERS: 1 Watt 3.9V-27V supplied with 24 page free book incl. 7/11 each

SELENIUM PHOTOCELLS: with free instructions and circuits, etc.

B2M photocell 0.2-0.4V 2mA ... 12/6 each
B3M photocell 0.2-0.4V 1.5-2.5mA ... 15/- each
S1M photocell 0.3-0.4V 10-16mA ... 19/- each
S4M photocell 0.3-0.4V 25-40mA ... 33/6 each

SOLAR DRIVE MOTOR: For use with photocells incl. free booklet and circuits ... 39/6 each

UNIJUNCTION: Type 2N2160 for transistor ignition/SCR Firing, etc. ... 14/9 each

SILICONE GREASE: For use with heat sink and power transistors 6.5gm tube ... 6/- each

SILICON CONTROLLED RECTIFIERS: SCRO1 to O4 each

SEND NOW FOR YOUR COPY OF THE "SEMICONDUCTOR CENTRE" PRICE LIST AND DETAILS OF THIS FASCINATING RANGE OF TOP QUALITY EXPERIMENTAL DEVICES. PRICE 6d (Stamp).

24 HOUR POSTAL SERVICE PLEASE NOTE: The listing above is only a small part of the range available

SUPER SAVE PACKS

1 pair 2N1304/5 NPN/PNP	10/-	4 SJ103 100piv 2A Stud	10/-
3 BC109 High gain NPN...	15/-	1 400piv 3A SCR Tested	9/-
3 2N2926 Planar state choice gain	10/-	2 12V 1W Zener diodes	10/-
4 BC113 Fairchild Planar...	10/-	1N202	10/-
20 Mixed new transistors Germanium and Silicon marked and tested	20/-	36 Square inches 0.15in Veroboard	10/-
20 Mixed new diodes Germanium and Silicon marked and tested	15/-	2 1,200V 1.5A Avalanche Rectifiers 5A surge rating RAS310AF	12/-
16 Red and White spot (8 Red, 8 white)	10/-	150 Assorted ceramic capacitors mainly colour coded—worth £££'s	10/-
4 OC16 equiv. (V30/30P)	10/-	2 OC81 matched + OC81D Mullard	7/-
2 25722 Texas 100V Silicon Limited quantity	15/-	2 OC45 + OC44 Mullard 4 inch length 100 Heat-sink for OC28/35 range power transistors plus mica washers and insulators	9/-
4 BY100 Brimar 800piv 750mA	13/-	3 TOS Transistor coolers	2/6
12 OA200 equivalents tested	6/-	3 Mullard OC71 brand new	9/-
12 OA202 equivalents tested	9/-	6 Valvo OC45 brand new	12/-
4 SL193 100piv 10A Stud diode	15/-		

L.S.T. COMPONENTS 23 NEW ROAD BRENTWOOD ESSEX

PURE SOLID STATE HIGH FIDELITY MODULES

SPA1. Silicon mono-stereo preamplifier. Inputs for magnetic/ceramic cartridges. Aux/tuner/tape, etc. Supplied tested on printed panel 2½in x 5in on brushed Al. fascia 9in x 3in with matching knobs. Output 500mV per channel. £6.19.6 per channel.

10W1. 10W pure comp. silicon amp. 10W RMS/8Ω. 15W/4Ω. F.R. 13Hz to 100 kHz. plus 0dB minus 3dB THD at 8W. RMS: 25Hz: 0-1%, 1kHz: 0-0.5%, 20kHz: 0-15%. I.M. dist. 0-1% at 8W. Low noise. Input 180mV/3,300Ω. Size 5in x 4in x 2in. Price fully tested, £6.19.6.

25W1. 25W pure comp. silicon amp. As above but rated at 25W RMS/8Ω, 30W RMS/4Ω. Price fully tested, £8.19.6.

FMT2. Two stage all silicon FM tuner head. 88 to 108 MHz. Output 10-7MHz. I.F. Built in AFC. Precision geared Gang. For valve or transistor amps. 2½in x 2½ x 1½in. Fully tested, £5.3.6.

FMT3. Three stage as above with AFC and AGC. Fully tested, £6.9.6.

FMF4. Four stage silicon I.F. amplifier. 10.7MHz I.F. input, with AFC and AGC. Preset A.M. rejection. Broad bandwidth. 5½in x 2in. Price, £5.19.6.

A new concept in amplifier design. Pure comp. silicon units on edge connected printed circuits and heat sink. 6½in x 2½in. Overall height 1in.
5WP. 5W RMS/8Ω. F.R. 20-20KHz at 4W. TH.D. 0-8%. 500mV I/P at 33kΩ. £5.7.6.
10WP. Specification as above, but 10W RMS into 8Ω. £5.15.6.
Field Effect Transistor Front End Version.
5WPF. As above but 150mV/2MΩ. £6.2.6.
10WPF. As above but 130mV/2MΩ. £6.17.6.

All modules are Guaranteed for twelve months. Money back if not delighted with results.

Power Supplies. 5W, £2.10.0; 10W, £2.15.0; 25W, £3.0.0; tuner or decoder, £2.2.6.

Guaranteed Transistors.

BRAND NEW TRANSISTORS

OC28	5/-	NKT211	4/9
OC35	10/-	NKT212	4/4
OC36	8/6	NKT213	4/6
OC41	2/3	NKT214	3/6
OC44	1/6	NKT215	3/6
OC45	1/9	NKT216	8/3
OC70	2/3	NKT217	7/9
OC71	2/-	NKT218	4/1
OC72	2/-	NKT219	4/7
OC81	2/3	NKT221	4/8
OC139	2/6	NKT222	4/-
OC140	4/6	NKT223	4/1
OC170	2/3	NKT224	3/6
OC171	2/6	NKT225	3/6
2N696	4/6	NKT226	8/9
2N697	5/-	NKT227	8/3
2N706	4/3	NKT228	4/1
2N2646	12/3	NKT601	5/9
2N2926	3/-	NKT612	4/8
2N3053	10/-	NKT613	4/9
2N3055	19/-	NKT675	5/-
NKT124	8/6	NKT675	4/-
NKT125	5/-	NKT676	4/1
NKT126	5/-	NKT677	4/1
NKT127	8/6	TK20C	2/-
NKT128	5/9	TK40C	2/-
NKT129	5/-	OA81	1/-
NKT141	5/9		
NKT142	5/-		
NKT143	4/9		

Modules P. & P. 3/- extra
Trans. P. & P. 9d. extra
Lists 9d. stamps
C.W.O. Airmail extra

ADROIT ELECTRONICS Lord Alexander House Waterhouse Street Hemel Hempstead, Herts

RECEIVERS AND COMPONENTS

(continued)

TRANSISTOR CAPACITORS (ELECTROLYTIC)

500mfd 4V	64mfd 40V	16mfd 25V
320mfd 10V	50mfd 10V	10mfd 25V
250mfd 4V	30mfd 10V	6.4mfd 64V
100mfd 16V	25mfd 25V	4mfd 64V
100mfd 16V	20mfd 12V	1mfd 25V

1/- each, 9/- per doz. Min. order 10/-

TRANSISTOR PANELS—OC45 or equiv.,
 20 for 20/-, 30—25/-, 50—35/-, 70—45/-, 40—
 30/-, 60—40/-, 80—50/- Postage 2/- per panel

Brand new 5TC sil. EPT planar transistors
 300 Mc/s 350 mW. all at 2/- each. 2N743,
 2N753, 2N916, BSY26, BSY28, BSY65, BSY18,
 BSY95A, BSY29

TRANSISTORS OC45, TK22C 1/- each.
 OC76, OC139, 2G302, OC81, OC44 2/- each.
 GET120, OC83, 2N1308, OC72, NKT216 4/-
 each. OC23, NKT452, NKT453 6/- each
 10 watt heat sink drilled for power trans. 5/-,
 5,000mfd 50V 6/6, 5,000mfd 25V, 4/6,
 1,000mfd 60V 5/-, 1,000mfd 30V 4/-, 3,000mfd
 10V 2/-, T.V. each, 10V + 200 + 400mfd
 275V 7/6, 100 + 200mfd 300V 5/6.

W.W. POTS 5, 10, 25, 50, 100, 250, 500 ohms,
 1k, 2k, 2.5k, 5k, 10k, 25k, 50k, 100k, not
 preset 2/- each. Min. order 5/-. Postage 1/-

ZENER DIODES—2.4, 2.7, 3.6, 4.75, 5.25,
 5.75, 6.2, 6.8, 7.5, 9.1, 13, 15, 16, 18, 20, 27, 30,
 33 volts. 3/4 each. Min. order 10/-

POLYSTYRENE CAPACITORS 350V: 180,
 270, 330, 390, 470, 560, 680, 820pF. 1,800, 2,200,
 2,700, 3,300, 5,600, 6,800, 8,200
 125V: 1,000, 1,200, 1,500, 1,800, 2,200, 2,700,
 3,300, 3,900, 4,700, 5,600, 6,800, 8,200, 0-012,
 0-015, 80pF ceramic 200pF S.M. any selection
 2/- doz. 4-40pF trimmers 4/- doz.

NEW CROSS RADIO
 6 OLDHAM ROAD, MANCHESTER 4

DUXFORD ELECTRONICS (PE)
DUXFORD, CAMBS.

C.W.O. P. & P. 1/-. Minimum order value 5/-.
 Trade enquiries invited.

CAPACITORS (Tubular, Axial Leads)

Polyester: 10%, 160V: 10,000 pF, 15,000pF, 6d,
 22,000pF, 7d, 33,000pF, 8d, 47,000pF, 68,000
 pF, 0.1µF, 9d, 0.15µF, 1/-, 0.22µF, 1/1, 0.33µF,
 1/3, 0.47µF, 1/6, 0.68µF, 1/10, 1µF, 2/6,
 400V: 1,000pF, 1,500pF, 5d, 2,200pF, 3,300pF, 4,700pF,
 6,800pF, 10,000pF, 6d, 15,000pF, 7d, 22,000pF,
 8d, 33,000pF, 9d, 47,000pF, 68,000 pF, 10d, 0.1µF,
 1/-, 0.15µF, 1/3, 0.22µF, 1/6, 0.33µF, 2/3, 0.47µF,
 2/9, 0.68µF, 3/9, 1µF, 4/6.

Polystyrene: 5%, 160V: 33pF, 39pF, 47pF, 56pF,
 68pF, 82pF, 100pF, 120pF, 150pF, 180pF, 220pF,
 270pF, 330pF, 390pF, 470pF, 560pF, 680pF, 820pF,
 4d, 1,000pF, 1,500pF, 2,200pF, 2,700pF, 3,300pF,
 3,900pF, 4,700pF, 5,600pF, 6d, 6,800pF, 8,200pF,
 10,000pF, 15,000pF, 22,000pF, 8d.

JACK PLUGS (Screened): Heavily chromed,
 jin. Standard: 2/9 each. Side-entry: 3/3 each.
 Standard (Unscreened): With black, grey, white, red,
 blue, green or yellow covers, 2/3 each.

JACK SOCKETS (jin Plug): With black or white
 bezel and chrome nut, 2/9 each. Available with:
 Break/Break, Make/Break, Break/Make, Make/Make
 contacts.

POTENTIOMETERS (Carbon): Long life,
 low noise. 1/4W at 70°C. 20% ± 1M, 30% ± 1M.
 Body dia. jin. Spindle, 1in x jin, 1/9 each. Linear:
 1k, 2.5k, 5k, etc., per decade to 10M. Logarithmic:
 5k, 10k, 25k, etc., per decade to 5M.

SKELETON PRE-SET POTENTIOMETERS
 (Carbon): Linear: 1k, 2.5k, 5k, etc., per decade
 to 5M.

Miniature: 0.3W at 70°C. ±20% ± 1M, ±30%
 > 1M. Horizontal (0.7in x 0.4in P.C.M.) or Vertical
 (0.4in x 0.2in P.C.M.) mounting. 1/- each.
 Submin. 0.1W at 70°C. ±20% ± 1M, ±30% >
 1M. Horizontal (0.4in x 0.2in P.C.M.) or Vertical
 (0.2in x 0.1in P.C.M.) mounting, 9d. each.

RESISTORS (Carbon film): High stability, very
 low noise. 1/4W at 70°C. Push Buttons: Push-on or
 Push-off (with white, black, green or red buttons)
 5/-. Toggle Switches: SP/ST, 3/3d. SP/DT, 3/6d.
 SP/DT (with centre position) 3/9d. DP/ST, 4/3d.
 DP/DT, 3/-.

SEND S.A.E. FOR FULL CATALOGUE

RECEIVERS AND COMPONENTS

(continued)

COMPONENTS

POSTAL SERVICE

*** RECHARGEABLE BATTERIES**
 (Sealed DEAC Ni-Cad)

PP3 Equiv.: 9v, 37/- (p. & p. 2/-)
 U2 Equiv.: 1.25v, 32/6 (p. & p. 2/-)
 U7 Equiv.: 1.25v, 12/- (p. & p. 1/6)
 U11 Equiv.: 1.25v, 26/- (p. & p. 1/6)

*** TRANSISTORS—Matched Output Kit:**
 OC81D and 2-OC81 9/6
 R.F. Kit: OC44 and 2-OC45 9/6
 OC44, 45, 70, 71, 72, 81 and 81D Equivalent,
 each 3/-

*** ASSORTED CAPACITORS—New Paper,**
 Polyester, Ceramic, Electrolytic, 100 off... 10/6

*** ASSORTED RESISTORS—Hi-Stab. 300 off**
 (5%, 10, 1, 1/2 watt, worth £3) 15/-
 (P. & P. 1/6 per order) C.W.O.

ELMBRIDGE INSTRUMENTS LTD.
 Island Farm Avenue, West Molesley, Surrey

JOHN'S RADIO (Dept. B)
 OLD CO-OP, WHITEHALL ROAD
 DRIFIELD, WEST SUSSEX
 Phone: Driffield 738

FAMOUS ARMY SHORT-WAVE TRANSRECEIVER
 MK. III

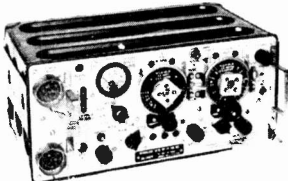

This set is made up of 3 separate units: (1) a two
 valve amplifier using a 6V6 output valve; (2) (some
 only, not built in the very latest models) a V.H.F.
 transceiver covering 229-241 Mc/s using 4 valves;
 in two switched bands, just below 2-4 Mc/s and
 4-8 Mc/s (approx. 160-37.5 metres) using 9 valves.
 For R.T., C.W. and M.C.W. The receiver is a super-
 heterodyne having 1 R.F. stage, frequency changer,
 two I.F. (465 kc/s) signal detector, A.V.C. and
 output stage. A B.F.O. included for C.W. or single
 side-band reception. T.X. output valve 807, other
 valves octal bases. Many extras, e.g. netting switch,
 quick flick dial settings, squelch, etc. Power re-
 quirements L.T. 12 volts, H.T. receiver 275 volts
 d.c., H.T. transmitter 600 volts d.c., size approx.
 17 1/2 x 7 1/2 x 1 1/2 ins. Every set supplied in new or
 as new condition in carton with book including
 circuits, only £4.10.0, or Grade 2 slightly used
 5/- carriage both 15/-.

A FULL KIT of brand new attachments for this
 set including all connectors, control box, headphones
 and mike, aerial tuning unit, co-axial lead, etc. at
 only 45/- carriage 5/-. WE MAKE A MAINS 200/250
 VOLT POWER UNIT in louvered metal case to plug
 direct into set power socket to run (1) receiver, 70/-
 post 5/- (2) TX and RX, £6.10.0 post 7/6. (3) 12
 VOLT D.C. P.U. for receiver, 50/- carriage 5/-. A
 charge of 10/- to unpack and test the receiver of
 these sets is made only if requested.

V.H.F. TRANSRECEIVER MK. 1/1



This is a modern self-contained tunable V.H.F.
 low powered frequency modulated transceiver for
 R.T. communication up to 8-10 miles. Made for the
 Ministry of Supply at an extremely high cost by well
 known British makers, using 15 midget B.O. 7
 valves, superhet incorporating E.F. amplifier,
 Double superhet and A.F.C. Slow-motion tuning
 with the dial calibrated in 41 channels each 200 kc/s
 apart. The frequency covered is 39-48 Mc/s. Also
 has built-in Crystal calibrator which gives pipe to
 coincide with marks on the tuning dial. Power
 required L.T. 4V, H.T. 180 volts, tapped at
 90 volts for receiver. Every set supplied complete
 with valves and crystals. New in carton, complete
 with adjustable whip aerial and circuit. Price
 £4.10.0, carriage 10/-. Headset or hand telephone
 20/-. Internal power unit stabilised for 200/250
 A.C. input, £6.10.0 extra.

RECEIVERS AND COMPONENTS

(continued)

RECORDING TAPES

Std. Play	L.P.	D.P.	E.R.
7" 1,200' 7/9	1,800' 12/-	2,400' 19/6	2/3
5 1/2" 900' 6/9	1,200' 8/9	1,800' 14/6	2/-
5" 600' 5/-	900' 7/3	1,200' 10/9	2/-
3" 185' 2/-	225' 2/9	300' 3/9	9d.

Post and packing, 2/9 per order

SEMICONDUCTOR BARGAINS

AC107 8/-	BY100 4/6	OC36 6/-
AC126 4/-	BYZ10 10/6	OC38 10/-
AC127 4/-	BYZ11 9/6	OC44 3/-
AC17 4/-	BYZ12 8/-	OC45 2/6
AC18 4/-	BYZ13 6/6	OC46 3/-
AC19 4/-	GET102 4/-	OC70 3/-
AC120 5/6	GET103 4/-	OC71 2/6
AC121 5/6	GET113 4/-	OC72 2/6
AC122 4/-	GET116 10/-	OC75 3/-
AD140 8/-	GET118 4/6	OC76 3/-
AD149 8/-	GET119 4/6	OC77 4/-
AF114 4/-	OA81 1/6	OC78 3/-
AF115 4/-	OA95 1/6	OC78D 3/-
AF116 4/-	OA182 2/-	OC81 3/-
AF117 4/-	OA200 1/-	OC81D 3/-
AF118 4/-	OA202 2/-	OC82 3/-
AF12 8/-	OC22 8/-	OC82D 3/-
BCY33 6/6	OC23 8/-	OC83 4/-
BCY34 6/6	OC24 8/-	OC84 4/6
BCY38 6/6	OC25 6/-	OC170 4/6
BCY39 6/6	OC26 6/-	OC171 4/6
OC28 5/6	OC28 5/6	OC202 6/6
BFY51 5/6	OC30 8/-	OC205 6/6
BFY52 5/6	OC35 6/-	

All fully tested and guaranteed. Discount for
 quantity orders on request
 Post and Packing, 1/- per order
 Money refunded in full if not satisfied

A. MARSHALL & SON (LONDON) LTD.
 28 Cricklewood Broadway, London, N.W.2
 (Dept. P.E.18) Tel. 01-452 0161

RADIO CONTROL RECEIVERS. New fabu-
 lous low priced units. Sensitive four tran-
 sistor design. For escapements, relays, lights,
 motors, etc. Requires only 4.5V. Size
 2 1/2 in x 1 1/2 in x 1/2 in, weight 1 1/2 oz. Fully guaran-
 teed. £3 19s. 6d. Matching transmitter now
 available. Price, £4 19s. 6d. RADIO
 CONTROL PRODUCTS, 38 Franche Road,
 Kidderminster.

CURSONS
TRANSISTORS
ALL GUARANTEED

1/- each

BAY31, BAY50, DK10, OA70,
 OA81, OA200, OA10, OA90, OA91,
 OA259, IN914, IN916, JL102

2/- each

XA101, XA102, OC71, OC72,
 OC81, OC81D, OC44, OC45,
 GET16, FST3/1, ACY22, ASY57

3/- each

OC139, OC140, 2N706, 2N708,
 2N2894, BY100, RAS310AF, 2N914,
 BSY26, BSY27, BSY95A, AFZ12

7/6 each

RAS508AF, CRS3/40, BLY10,
 BLY11, BUY10, BUY11, ADY22,
 ADY23, ADY24, OC22, OC26

ZENER DIODES

3.9v to 26v, 1/4w 3/- each, 1.5w 4/-,
 7w 5/- each.

B. CURSONS S.A.E.
NEW LIST
78 BROAD STREET
CANTERBURY
KENT

ELECTRICAL

240 VOLT ELECTRIC POWER FROM YOUR 12 volt or 6 volt CAR BATTERY
Run your mains AC/DC equipment direct from your car battery with this compact low battery consumption dynamo. Size only 5in. x 3in. Sturdy construction.



Converts a 12 volt input to a 240 volt output. Huge purchase enables us to offer them at only 39/6 each, post and packing 6/-. 6 volt input model only 35/-, post and packing 6/-. Thousands already sold.

COLLAPSIBLE AERIAL
IN 5 SECTIONS
CLOSED 13"
OPEN 5'-6"

A fully adjustable highly efficient whip aerial. Made to exacting specifications. Copper plated sections. Brass Base. An ideal aerial for TX/RX use. Easily adaptable for cars, scooters, walkie talkies, etc. Brand new in makers' boxes. Only 17/6 each, p.p. 2/6. Two aerials for 30/-, post & packing 2/6.

DEPT. P.E.6
GLOBE SCIENTIFIC LTD
24 CAWOODS YARD, MILL STREET
LEEDS 9
Callers welcome

BOOKS AND PUBLICATIONS

SURPLUS HANDBOOKS

19 set Circuit and Notes 4/6 P.P. 6d
1155 set Circuit and Notes 4/6 P.P. 6d
H.R.O. Technical Instructions ... 3/6 P.P. 6d
38 set Technical Instructions ... 3/6 P.P. 6d
46 set Working Instructions ... 3/6 P.P. 6d
88 set Technical Instructions ... 5/- P.P. 6d
BC. 221 Circuit and Notes 3/6 P.P. 6d
Wavemeter Class D Tech. Instr. 3/6 P.P. 6d
18 set Circuit and Notes 3/6 P.P. 6d
BC.1000 (31 set) Circuit & Notes 3/6 P.P. 6d
CR.100/B.28 Circuit and Notes 8/6 P.P. 9d
R.107 Circuit and Notes 5/- P.P. 6d
A.R.88D. Instruction Manual ... 15/- P.P. 1/6
62 set Circuit and Notes 4/6 P.P. 6d
52 set Sender & Receiver Circuits 6/-, post free
Circuit Diagrams 3/- each post free.
R.1116/A, R.1224/A, R.1355, R.F. 24, 25, & 26.
A.1134, T.1154, CR.300, BC.342, BC.312,
BC.348, J.E.M.P. BC.624. 22 set.
Resistor colour code indicator, 1/6 P.P. 6d.
S.A.E. with all enquiries please.
Postage rates apply to U.K. only.
Mail order only to:
Instructional Handbook Supplies
Dept. P.E., Talbot House, 28 Talbot Gardens
Leeds 8

The most accurate pocket size CALCULATOR in the world

The 66 inch OTIS KING scales give you extra accuracy. Write today for free booklet, or send 75/- for this invaluable spiral slide rule on approval with money back guarantee if not satisfied.

CARBIC LTD. (Dept. PE14)
54 Dundonald Road, London, S.W.19

OTIS KING SLIDE RULE
SAVES TIME AND MISTAKES IN ALL CALCULATIONS



FREE BOOKLET ON REQUEST

COCKTAIL/STEREOGRAM CABINET £25
STEREOGRAM CABINET £19
RADIOGRAM CABINETS ONLY £5.19.6



An elegant Stereogram Cabinet in modern Veneered Mahogany and cloth covered Front Panel
BLACK LEATHERETTE SIDE PANELS
Dimensions: 52" x 17 1/2" x 12"
Speaker positions for Twin 10" x 5" Speakers



Polished walnut veneer with elegant glass fronted cocktail compartment, padded. Position for two 10" elliptical speakers. Record storage space. Height 35 1/2", width 52 1/2", depth 14 1/2" Legs 1 gn. extra.

OTHER MODELS—SEND FOR LIST



An attractive discreetly designed space saving cabinet in natural grained polyestered sapele. Press-drop flap for autochanger and record storage compartment. 10" x 5" speaker position. Complete with legs. Dim. 29 1/2" H x 14 1/2" D x 29" W. Carr. Ins. 25/-

17in.—£11.10.0
3 Star Guarantee
★ Tube ★ Valves
★ Components Carr. 30/-

TWO-YEAR GUARANTEE EX-RENTAL TELEVISIONS
FREE ILLUSTRATED LIST OF TELEVISIONS
17"-19"-21"-23"
WIDE RANGE OF MODELS
SIZES AND PRICES
DEMONSTRATIONS DAILY



TWO-YEAR GUARANTEED TUBES 100% REGUNNED
14"—69/6 17"—89/6
21" and ALL SLIMLINE TUBES 99/6
EXCHANGE BOWLS. Carr. 10/6

TAPE RECORDER CABINETS 49/6
Dia. 16" x 12 1/2" x 7 1/2". Red and Grey. Cut out for BSR deck. P. & P. 7/6.



SINGLE PLAYER CABINETS 19/6. P. & P. 7/6.
TRANSISTOR CASES 19/6. Cloth covered, many colours. Size 9 1/2" x 6 1/2" x 3 1/2". P. & P. 3/6. Similar cases in plastic 7/6.

DUKE & CO. (LONDON) LTD. 621/3 ROMFORD ROAD
MANOR PARK, E.12
Phone: 01-478 6001-2-3 Liverpool Street—Manor Park 10 mins. Stamp for Free List.

WENTWORTH RADIO
104 SALISBURY ROAD, HIGH BARNET, HERTS. BAR 3087

Suppliers of High Quality Semiconductors

AD140 10/-	NKT124 8/5	NKT675 4/3	OC74 5/-
AF114 4/6	NKT125 5/4	NKT676 4/4	OC75 3/-
AF115 4/6	NKT126 5/2	NKT677 4/4	OC77 3/-
AF116 4/-	NKT127 8/11	NKT713 6/6	OC78 5/-
AF117 2/6	NKT128 6/-	NKT773 5/-	OC78D 5/-
AF118 5/9	NKT129 5/2	NKT774 5/-	OC81 2/6
BC107 7/10	NKT141 6/-	OC20 37/6	OC81D 2/6
BC108 7/6	NKT142 5/2	OC35 10/-	OC170 3/-
BSY26 13/6	NKT143 5/-	OC36 10/-	OC171 6/-
BSY27 12/9	NKT162 4/11	OC42 6/-	OC172 4/6
BSY95A 7/6	NKT163 4/11	OC44 2/6	OC200 3/6
MAT100 7/9	NKT164 4/11	OC45 2/6	OC201 7/-
MAT101 8/6	NKT211 5/-	OC70 5/-	OA81 1/3
MAT120 7/9	NKT212 4/7	OC71 2/6	OA91 2/-
MAT121 8/6	NKT213 4/9	OC72 2/6	OA95 1/-

BARGAIN OF THE MONTH
FANTASTIC!
OC72 AT 1/9d
12 OR MORE POST FREE

S.A.E. FOR LIST. CASH WITH ORDER. P. & P. 9d.

HIGH SPEED MAGNETIC COUNTERS (4 x 1 x 1in), 4 digit. 12/24/48V. (state which) 6/8 each, P. & P. 1/-.
COPPER LAMINATE BOARD (8 1/2 x 5 1/2 x 1/8 in), 2/8 each. 5 for 10/-.
RE-SETTABLE HIGH SPEED COUNTER (3 x 1 x 1 1/2 in), 3 digit. 12/24/48V. (state which) 32/6 each.

BULK COMPONENT OFFERS

100 Capacitors 50pF to .5µF.
250 Carbon Resistors 1/4 & 1/2W. (Transistor types).
250 Carbon Resistors 1/4 & 1W.
100 Ceramic Capacitors 2-1000pF.
25 Vitreous W/W Resistors (5%).
12 Precision Resistors (1% several standard values included).
25 Close Tolerance Caps. (2%).
12 Silicon Diodes 500 p.i.v. 750 m.a.
4 Silicon Rects. 400 p.i.v. 3 amp.
2 Silicon Rects. 100 p.i.v. 3 amp.
50 Silicon Trans. (2N706/708, BSY28/29, BCY41/42 types.) Unmarked, Untested.
50 Silicon Diodes 200 m.a. 100 p.i.v. Sub. Min.

ANY ITEM 10/-, ANY 5 ITEMS 22.

S.C.S.s. (Thyristors) CRS1/20 5/6; CRS1/40 7/6; CRS3/10 7/6; CRS3/30 8/6; CRS3/40 10/-; CRS3/50 12/6 each.
8000 TYPE RELAYS (ex. new equip.) 10 for 25/- (our choice) p.p. 5/-.

PATRICK & KINNIE, 81 Park Lane, Romford, Essex Romford 44473

NEW RANGE BBC 2 AERIALS

All U.H.F. aerials now fitted with tilting bracket and 4 element grid reflectors.

Loft Mounting Arrays, 7 element, 35/-, 11 element, 42/6, 14 element, 50/-, 18 element, 57/6. **Wall Mounting with Cranked Arm**, 7 element, 60/-, 11 element, 67/-, 14 element, 75/-, 18 element, 82/6. **Mast Mounting with 2in. clamp**, 7 element, 42/6; 11 element, 55/-; 14 element, 62/-; 18 element, 70/-.

Chimney Mounting Arrays, Complete, 7 element, 72/6; 11 element, 80/-; 14 element, 87/6; 18 element, 95/-.

Complete assembly instructions with every unit. **Low Loss Cable**, 1/8 yd. U.H.F. Pre-amps from 75/-. State clearly channel number required on all orders.

BBC · ITV AERIALS

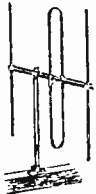

BBC (Band 1), Telescopic lofr, 21/-, External S/D, 30/-, "H", 22.10.0.

ITV (Band 3), 3 element lofr array, 25/-, 5 element, 35/-, 7 element, 45/-, Wall mounting, 3 element, 35/-, 5 element, 45/-.

Combined BBC/ITV, Loft 1+3, 41/3; 1+5, 48/8; 1+7, 58/9; Wall mounting 1+3, 58/8; 1+5, 63/8; Chimney 1+3, 63/8; 1+5, 71/3.

VHF transistor pre-amps, 75/-.

COMBINED BBC1-ITV-BBC2 AERIALS 1+3+9, 70/-, 1+5+9, 80/-, 1+5+14, 90/-, 1+7+14, 100/-. Special leaflet available.

F.M. (Band 2), Loft S/D, 12/6, "H", 30/-, 3 element, 52/6. External units available. Co-ax. cable, 8d. yd. Co-ax. plugs, 1/3. Outlet boxes, 4/6. Diplexer Crossover Boxes, 12/6. C.W.O. or C.O.D. P. & P. 5/-. Send 6d. stamps for illustrated lists.

CALLERS WELCOME

OPEN ALL DAY SATURDAY

K.V.A. ELECTRONICS (Dept. P.E.)

27 Central Parade, New Addington

Surrey—CRO-OJB

LODGE HILL 2266

CRESCENT RADIO LTD.

(electronic component specialists)

For all regular components try
40 Mayes Road, Wood Green, N.22

For surplus components
and equipment try
11 Mayes Road, Wood Green, N.22

Printed circuit board, 8in x 5in 1/11 each

SPECIAL LINES

6 x 3 transistor cabinet	3/- each
Transistor carry case 4 1/2in x 2 1/2in	9d each
2 1/2in 80 ohm loudspeaker	5/6 each
5in 25 ohm loudspeaker	9/6 each
8 ohm transistor earpieces	1/6 each
2in transistor slab aerial	2/9 each
Relay 500 ohm 9V Midget	5/- each
4 1/2V buzzer	1/6 each
Transistor power heat sinks	10d each
Miniature 5kΩ with switch (pot)	2/9 each
Twin transistor heat clips	6d each
50pF airspaced variable with spindle	2/- each
1 meg skeleton pre sets	2/- each
Rotary mains switch D.P.	4/6 each
12V 2A rectifiers	6d each
L.E.S. bulb holders	1/3 each
500mF 15V capacitor	1/6 each
16mF 275V capacitor	1/3 each
2MΩ lin pot	1/6 each
250kΩ pre set pot	1/6 each

SURPLUS TRANSISTORS

2G339A	1/6 each
Matched pair 2G378B and 2G339B	3/6 pair
2N1308	5/- each
PXA101	1/- each

PHOTOCONDUCTIVE CELLS

ORP12	10/- each
RPY28	7/6 each

With our new premises in Mayes Road we can now offer an even wider selection of components for the home constructor and enthusiast.

PLEASE INCLUDE POSTAGE WITH ALL ORDERS

FIRST-CLASS RADIO AND T/V COURSES ...

GET A CERTIFICATE!

After brief, intensely interesting study—undertaken at home in your spare time—YOU can secure a recognised qualification or extend your knowledge of Radio and T.V. Let us show you how:

FREE GUIDE

The New Free Guide contains 120 pages of information of the greatest importance to both the amateur and the man employed in the radio industry. Chambers College provides first rate postal courses for Radio Amateurs' Exam., R.T.E.B. Servicing Cert., C. & C. Telecoms., A.M.I.E.R.E. Guide also gives details of range of diploma courses in Radio T.V. Servicing Electronics and other branches of engineering, together with particulars of our remarkable Guarantee of

SUCCESS OR NO FEE

Write now for your copy of this invaluable publication. It may well prove to be the turning point in your career.

FOUNDED 1885—OVER
150,000 SUCCESSES

CHAMBERS COLLEGE

(Incorp. National Inst. of
Engineering) (Dept. 850F)

148 HOLBORN
LONDON, E.C.1

COMPUTER DICTIONARY AND HANDBOOK

By C. Sippl. 90/-, P. & P. 4/6

TRANSISTOR SPECIFICATION AND SUBSTITUTION HANDBOOK, by Techpress. 21/-, P. & P. 1/-.

TAPE RECORDER SERVICING MECHANICS, by Schroder. 21/-, P. & P. 1/-.

101 WAYS TO USE YOUR OSCILLOSCOPE, by Middleton. 21/-, P. & P. 1/-.

DIGITAL COMPUTERS, STORAGE AND LOGIC CIRCUITRY, 30/-, P. & P. 1/-.

PAL COLOUR T.V., by Mullard, Pal System and Circuits described. 12/6, P. & P. 1/-.

ELEMENTS OF TRANSISTOR PULSE CIRCUITS, by Towers. 35/-, P. & P. 1/-.

SILICON CONTROLLED RECTIFIERS, by Lytel. 21/-, P. & P. 1/-.

ELECTRONICS FOR YOUNG EXPERIMENTERS, by Pearce. 18/6, P. & P. 1/-.

SYNCROS AND SERVOS, by Training and Retraining Inc. 35/-, P. & P. 1/-.

TRANSISTOR ELECTRONIC ORGANS FOR THE AMATEUR, 18/-, P. & P. 1/-.

Where possible 24-hour service guaranteed

UNIVERSAL BOOK CO.

12 LITTLE NEWPORT ST., LONDON, W.C.2
(Leicester Square Tube Station)

TRANSISTOR SQUARE WAVE GENERATOR
Useful for signal tracing or Morse practice. Variable amplitude. Parts to build 11/- with circuit.

EAGLE MULTIMETERS

EP10K 67/6 p.p. 3/-; EP20K 75/- p.p. 3/-; EP30K 105/- p.p. 4/6; EP10KN 85/- p.p. 4/6; EP20KN 98/- p.p. 4/6; EP30KN 130/- p.p. 4/6, details on request.

FOOTBALL POOL COMPUTER CIRCUIT and three other analogue circuits, 4/6.

DIGITAL COMPUTER CIRCUIT

A simple digital Adder/Subtractor using switches and lamps only. A fascinating demonstration of Binary arithmetic. Full circuit, wiring diagram and notes on the Binary system, 3/6.

NOUGHTS AND CROSSES MACHINE CIRCUIT. Uses standard miniature switches and lamps only. This machine cannot be beaten. Full circuit, wiring diagram and instructions, 3/6.

PLANET INSTRUMENT CO.

25 (E) DOMINION AVENUE, LEEDS 7

BATTERY ELIMINATORS

The ideal way of running your TRANSISTOR RADIO, RECORD PLAYER, TAPE RECORDER, AMPLIFIER, etc. Types available: 9v; 7 1/2v; 6v; 4v (single output) 39/6 each. P. & P. 2/9. 9v + 9v; 6v + 6v; or 4 1/2v + 4 1/2v (two separate outputs) 42/6 each. P. & P. 2/9. Please state output required. All the above units are completely isolated from mains by double wound transformer ensuring 100% safety.

R.C.S. PRODUCTS (RADIO) LTD.
(Dept. P.E.), 11 Oliver Road, London, E.17

ELECTRONICS GALORE! IN THE dca CATALOGUE

THE CONVENIENT WAY TO SHOP FOR ALL YOUR ELECTRONIC NEEDS. EVERYTHING FROM SINGLE COMPONENTS TO COMPLETE EQUIPMENT ALL AT BEST VALUE PRICES.

SEND 2/6d. NOW FOR YOUR COPY TO:—
dca ELECTRONICS LIMITED
28 UXBRIDGE ROAD, EALING, W.5

The world's most versatile
and compact all band

JOYSTICK VARIABLE FREQUENCY ANTENNA

B.B.C. WORLD SERVICE—
Henry Hatch talking about the
JOYSTICK V.F.A.—“I couldn't
believe the wonderful signal.”

**DURHAM UNIVERSITY
EXPEDITION TO TUR-
KEY—**“We enjoyed excellent
radio reception at all times, due
of course to the JOYSTICK V.F.A.
used; because after all, A RADIO
IS ONLY AS EFFICIENT AS THE
AERIAL IT USES.”

—M. K. SARGINSON, B.Sc.

These are just two enthusiastic testi-
monies to the amazing efficiency of
this minute aerial!

Obtainable from the best radio
dealers—or direct from:

PARTRIDGE ELECTRONICS LTD.

(Dept. P.E.A.)
CAISTERHOUSE, PROSPECT ROAD
BROADSTAIRS, KENT

C.O.D. IMMEDIATE DESPATCH
Phone: THANET 62535 (STD 0843-62535)

BI-PAK SEMICONDUCTORS

(DEPT. E)

8 Radnor House
93/97 Regent St
London W.1

**NEW TESTED NO DUDS
SUPER PACKS FOR 1968**

PIV	LOWEST PRICE YET LARGEST RANGE EVER			
	1 AMP (TO-5 can)	7 AMP (STUD)	16 AMP (STUD)	30 AMP (STUD)
25	—	7/6	—	30/-
50	7/6	8/6	10/6	35/-
100	8/6	10/-	15/-	45/-
200	12/6	15/-	20/-	55/-
300	15/-	20/-	25/-	—
400	17/6	25/-	35/-	80/-
500	—	40/-	45/-	95/-
600	—	40/-	50/-	—

NEW SILICON RECTIFIERS TESTED

PIV	750 mA	3 AMP	10 AMP	30 AMP
50	2/-	3/-	4/6	9/6
100	2/3	3/6	6/-	15/-
200	2/6	4/6	6/6	20/-
300	3/-	4/9	8/-	22/-
400	3/6	6/-	9/-	25/-
500	4/-	6/6	9/6	30/-
600	4/3	7/-	10/-	37/-
800	4/9	8/-	15/-	40/-
1000	6/-	10/-	17/6	50/-

750 mA TOP-HAT TYPE 3, 10 and 30 A STUD TYPE

TRANSISTOR MANUAL BY G.E.

CIRCUITS, APPLICATIONS,
CHARACTERISTICS,
THEORY.

647 PAGES

30/-
EACH

INC. L.A. 5.C.R.'S.
G.T. SWITCHES,
THEORY, RATINGS,
APPLICATIONS.

P.P. 2/6

S.C.R. MANUAL BY G.E.

★ VALUE PACKS for '67 ★

	NEW	UNTESTED	
120 Glass Sub-Min.			GERM. DIODES 10/-
50 Mixed Germ.			TRANSISTORS 10/-
20 Mixed Volts			ZENERS 10/-
30 NPN, PNP, MIXED			SIL. TRANS. 10/-
60 200mA Sub-Min.			SIL. DIODES 10/-
20 Germ. 1 Amp.			RECTIFIERS 10/-
40 Like OC81, AC128			TRANSISTORS 10/-
10 2 Amp. Stud			SIL. RECT. 10/-
25 Sil. NPN, 200 Mc/s			TRANSISTORS 10/-
16 Top-Hat 750mA			SIL. RECT. 10/-
75 GERM. DIODES			GOLD BONDED 10/-
20 Like BAY50 charge storage			DIODES 10/-
10 50-400 PIV 1 Amp.			SCR's 20/-

Our vast stocks change daily with hundreds of Semiconductor bargains becoming available. Just send 2/6 to cover 3 months mailing of our latest stock lists, eqvt. charts, circuits, etc.

Minimum Order 10/-, CASH WITH ORDER PLEASE. Add 1/- postage and packing per Order. GUARANTEED by return postal service. Overseas add extra for Airmail.

40 SIL. PLANAR

NPN TRANS. Sim.
2N706/8 B5Y26/7
2N914 2S103/4

50 SIL. PLANAR

250mA DIODES
Sim. 1S121/130
OA200/202

30 MADT's PNP

METAL ALLOY DIFFUSED
Trans. Sim.
MAT 101/2 MA393

10 SIL. 1 AMP.

GLASS RECT.
200-800 PIV

30 GERM. ALLOY

AF TRANS. PNP
Sim. 2G300 Series
OC71/75 AC125/B

12 EPOXY 500mA

SIL. RECT.
100-600 PIV
Sim. BY101 BY130

30 FAST SWITCH

PLANAR DIODES
Sim. IN914/916
BAY31/38

ALL AT PER PAK

UNCODED DEVICES
10/-

QUALITY-TESTED VALUE PAKS NOW MORE FOR YOUR MONEY *

2 Drift Trans. 2N1225 Germ. PNP 100 Mc/s	10/-	12 Assorted Germ. Diodes Marked	10/-
6 Matched Trans. OC44/45/81/81D	10/-	4 AC126 Germ. PNP Trans.	10/-
16 Red Spot AF Trans. PNP	10/-	5 1 Amp Germ. Rect. 200 PIV	10/-
16 White Spot RF Trans. PNP	10/-	1 ORP61 Photo-conductive cell	10/-
5 Silicon Rects. 3 A 100-400 PIV	10/-	4 Silicon Rects. 100 PIV 750 mA	10/-
2 10 A Silicon Rects. 100 PIV	10/-	3 AF117 Trans. Mullard Type	10/-
2 OC140 Sil. Trans. NPN Switching	10/-	7 2CB1 Type Trans. PNP	10/-
1 12 A SCR 100 PIV	10/-	3 OC71 Trans. Mullard Type	10/-
3 Sil. Trans. 2S303 PNP	10/-	3 2N2926 Sil. Epoxy Trans.	10/-
4 Zener Diodes 250 mW 3-12 V	10/-	7 OC71 Type Trans.	10/-
3 200 Mc/s Sil. Trans. NPN B5Y26/27	10/-	2 GET9 Power Trans. 60 Vcb. 8 A	10/-
3 Zener Diodes 400 mW 33 V 5% Tol.	10/-	25 Trans. Heatsinks fit TO18, SO12, etc.	10/-
4 High Current Trans. OC42 Eqvt.	10/-	1 TK400A Power Germ. Trans. -ADY22	10/-
2 Power Transistors 1 OC26 1 OC35	10/-	2 2S701 Sil. Trans. Texas	10/-
5 Silicon Rects. 400 PIV 250 mA	10/-	2 Zener Diodes 22A150F. 15 V watt.	10/-
4 OC75 Transistors Mullard Type	10/-	3 1/2 Volt Zeners 400 mW	10/-
1 Power Trans. OC20 100 V	10/-	2 10 A 600 PIV Sil. Rects. IS425R	15/-
4 OA202 Sil. Diodes Sub-min	10/-	3 BC108 Sil. NPN High Gain Trans.	15/-
2 Low Noise Trans. NPN 2N929/30	10/-	2 Zener Diodes 25 V 18 and 22 V	15/-
1 Sil. Trans. NPN VCB 100 ZT86	10/-	1 2N910 NPN Sil. Trans. VCB100 80Mc/s	15/-
8 OAB1 Diodes (CV448)	10/-	2 1000 PIV Sil. Rect. 1.5 A RS310 AF	15/-
4 OC72 Transistors Mullard Type	10/-	3 High Volt. AF Trans. PNP AC17	15/-
4 OC77 Transistors Mullard Type	10/-	3 B5Y95A Sil. Trans. NPN 200 Mc/s	15/-
5 Metal Alloy Transistors Mat Type	10/-	3 OC200 Sil. Trans. Mullard	15/-
4 Sil. Rects. 400 PIV 500 mA	10/-	2 Sil. Power Rects. BYZ13	15/-
5 GET884 Trans. Eqvt. OC44	10/-	1 Sil. Power Trans. NPN100 Mc/s TK201A	15/-
5 GET883 Trans. Eqvt. OC45	10/-	6 Zener Diodes 3-15 V Sub-min	15/-
3 VHF Sil. Epoxy Trans. NPN 100 Mc/s	10/-	1 2N1132 PNP Epitaxial Planar Sil. Trans.	15/-
2 2N708 Sil. Trans. 300 Mc/s NPN	10/-	2 2N697 Epitaxial Planar Trans. Sil.	15/-
5 GT41/45 Germ. Trans. PNP Eqvt. OC71	10/-	4 Germ. Power Trans. Eqvt. OC16 Mullard	15/-
3 GT31 LF Low Noise Germ. Trans. PNP	10/-	1 Unijunction Trans. 2N2646 Eqvt. D5E29	15/-
6 IN914 Sil. Diodes 75 PIV 75 mA	10/-	2 Sil. Trans. 200 Mc/s 60Vcb ZT83/84	15/-
8 OA95 Germ. Diodes Sub-min IN69	10/-	1 Sil. Planar Trans. NPN 100 Mc/s B5Y25	15/-
3 NPN Germ. Trans. NK7773 Eqvt. AC130	10/-	1 Sil. Trans. IS104 150 Mc/s HFE 200 NPN	15/-
2 OC22 Power Trans. Germ.	10/-	2 SCRs 50 PIV 1 A TO-5 can	15/-
2 OC25 Power Trans. Germ.	10/-	1 Tunnel Diode IN375 (TD5) G.E.	15/-
2 OC73 Mullard Trans.	10/-	1 Unijunction Trans. 2N2160 TO5 can G.E.	15/-
4 AC128 Trans. PNP High Gain	10/-	2 Sil. Rects. 5 A 400 PIV Stud Type	15/-
2 AC127/128 Comp. pair PNP/NPN	10/-	2 Germ. Power Trans. OC28/29	15/-
10 Assorted Gold Bonded Diodes	10/-	1 10 A Sil. Stud Rect. 800 PIV	15/-
3 2N1307 PNP Switching Trans.	10/-	1 Tunnel Diode AEY11 1050 Mc/s STC	15/-
20 Germ. Diodes General Purpose	10/-	2 2N2712 Sil. Epoxy Planar HFE225 max.	20/-
7 CG62H Germ. Diodes Eqvt. OA71	10/-	6 BY100 Type Sil. Rects.	20/-
3 AF116 Mullard Type Trans.	10/-	25 Sil. and Germ. Trans. Mixed all Marked New	30/-

FREE One 10/- Pack of your own choice free with orders valued £4 or over **FREE**

Seasons Greetings from BI-PAK SEMICONDUCTORS and a Xmas "GIFT DOLLAR" value 5/- redeemable with all orders of One Pound or over. Cash in now and save 5/- on your next order. Not valid after 31st January 1968.

CUT ALONG DOTTED LINE

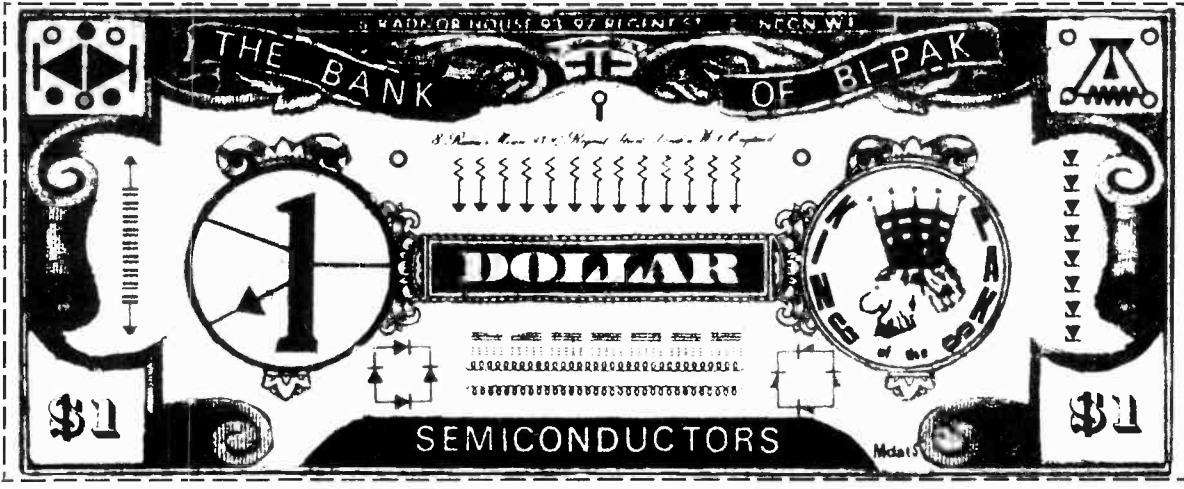

MARCONI AUDIO TESTER TYPE TF894

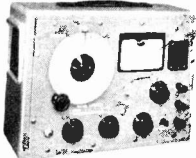

Size: 15in 11in 7in
Weight: 20lb

This directly calibrated AF oscillator from 50c/s to 12kc/s has a maximum output of 300mW into 600 ohm and is fitted with an output level meter and 600 ohm ladder attenuator of 0-50dB. An alternative 5,000 ohm outlet is provided and the level in each case is continuously variable. AF measurements: the voltmeter may be used for AF inputs (external) over the ranges of 0 to 80V in 4 ranges, providing a very useful facility. Supplied in excellent condition and working order for only £18.10.0. Power supply 240V a.c. (internal).

COSOR DOUBLE BEAM OSCILLOSCOPES TYPE 1035



Appearance as 1035.

An attractive end of contract run enables us to offer these fine professional scopes in perfect working order at only £25 each plus 25/- P. & P. Brief technical spec.: 4in flat face C.R.T.; bandwidth 20c/s to 10Mc/s; time base repetitive, triggered or single stroke 15µsec to 150msec; size 16in x 11in x 19in. Also Cosor 1049 DC Coupled DB Scope same size and appearance as 1035. Price £30 plus 25/- P. & P.

DIGITAL VOLTMETER



For the first time ever, we proudly present a three digit a.c./d.c. voltmeter for less than £100! Manufactured by the world famous Hawker Siddeley Group at its Gloucester Works, the Digimeter Type B.I.E. 2123 is a fully transistorised multi-range instrument possessing the following distinctive features:

Electrical Characteristics:
D.c. ranges: 10mV to 400V (for positive voltages).
Accuracy: the greater of $\pm 0.1\%$ of ± 1 digit.
A.c. ranges: 100mV to 250V r.m.s. in three ranges.

Accuracy: the greater of $\pm 0.5\%$ or ± 1 digit over the frequency range 30c/s to 10kc/s. Range change is manual.
Input impedance: D.c. 15M Ω on two lower ranges, 1M Ω on two higher ranges.
A.c.-a.c. coupled, approximately equivalent to a shunt impedance of 8K Ω in series with the parallel impedances 180K Ω and 550pF.
Input characteristics: Single ended, floating. The potential between terminal connected to 0V and earth should not exceed 400V d.c. or 250V a.c.
Input filter: 55dB attenuation at 50c/s.
Conversion time: 300msec.
Sampling rate: 1 reading per 2sec or manually controlled.
Power Supply: 100/120V; 200/250V 50c/s.
Mechanical Characteristics:
Dimensions: 10 $\frac{1}{2}$ in high x 7in wide x 13in deep.
Weight: 15lbs.
Display details: Three digit with decimal point indication. Character height 1in.
At the price we can offer these instruments no laboratory can afford to be without one! They are ideally suited to production and inspection applications. Brand new in manufacturer's packing. With Handbook. **£92.10.0**
Carriage extra at cost
IMMEDIATE DELIVERY!

SOLARTRON LABORATORY OSCILLOSCOPE TYPE 711/S2

This magnificent scope will take pride of place in any service dept., college or university, offered at one fifth of manufacturer's price, in perfect working order and excellent conditions, £80 plus carriage. Brief specification: bandwidth DC-7Mc/s; sensitivity 3mV/cm to 100V/cm; sweep velocity, 0.33cm/sec to 3.3cm/µsec; X expansion variable up to X 10; size 16in x 13in x 27in deep.

MARCONI AF ABSORPTION WATTMETER TYPE TF938/CT44

Designed to measure the power output of all audio equipment in the range of 10 micro watts to 6 watts in 3 ranges. Impedance 2.5 to 20k Ω switched in 11 ranges. Indication to large 5in meter, a small portable modern instrument. Price £25 plus P. & P. 12/6.

P. F. RALFE

Radio & Electrical Supplies

423 GREEN LANES, HARRINGAY LONDON, N.4. MOUNTVIEW 6939

SOLARTRON CALIBRATING UNIT AT203

Providing an output range 10V to 10V, in the frequency range of DC to 300kc/s. An extremely useful instrument of high accuracy for calibrating meters, and research work where the voltage output must be easily selected and of high standard. Offered in first class condition, fully tested, for 240V a.c. supply at £50.

SPECIAL OFFER OF COLVERN 10 TURN HELIPOSTS TYPES CLR26/1001/9

Values: 1,000 Ω and 100k Ω . Brand new stock. Price 30/-, P. & P. 1/6.

POWER RHEOSTATS

3 ohms 8-5A, 35/-, P. & P. 3/6.
7.5 ohms 5-5A, 35/-, P. & P. 3/6.
50 ohms 1-5A, 12/6, P. & P. 1/6.
3k Ω 75W, 12/6, P. & P. 1/6.
All heavy duty types Torodial wound on ceramic formers.

COMMUNICATION RECEIVER TYPE R209

Try some S.W.L. over the holidays with a really first class small portable receiver. Frequency range 1Mc/s to 20Mc/s in 4 ranges: function AM-FM-CW incorporates rock steady BFO for monitoring 5SB or teletype signals, aerial trimmer, Vernier drive for station selectivity, 2 aerial inputs, AF gain control, built in speaker and phones outlet, uses all miniature valves and the power requirements are 6V d.c. size 12in x 8in x 9in deep housed in moisture proof light alloy case, made to rigid ministry standards in excellent working condition only £15 plus 10/- P. & P.

AVOMETER MODEL 7

In first class condition and working order. Price £12.10.0. P. & P. 7/6. Also leather case for Model 7. Price 25/-, P. & P. 2/6.

TELEVISION MONITOR E.M.I. TYPE 306

Designed for close circuit TV operating on the 625 lines system with 19 inch picture tube, very latest model, in as new condition complete with specially designed portable trolley. Finish pale green enamel with stainless steel trim. Price £50, plus P. & P.

STC MOVING COIL STUDIO MICROPHONES TYPE 4035A

A limited quantity of these superb low impedance microphones for sale at approx. one third of makers price C/W type 4069A jack plug in as new little used condition. Price £7.10.0, P. & P. 3/6.

WESTON RF AMP METERS

Two inch flush round panel mounting, 25/- each.

Great for the home handyman and radio enthusiast. And for the hundred and one jobs around the house that need a really reliable soldering iron. Strongly made. Sensibly-sized. Extra long flex. Fully guaranteed for 6 months.

BUY YOURS TODAY!

Woolworth's larger stores stock them

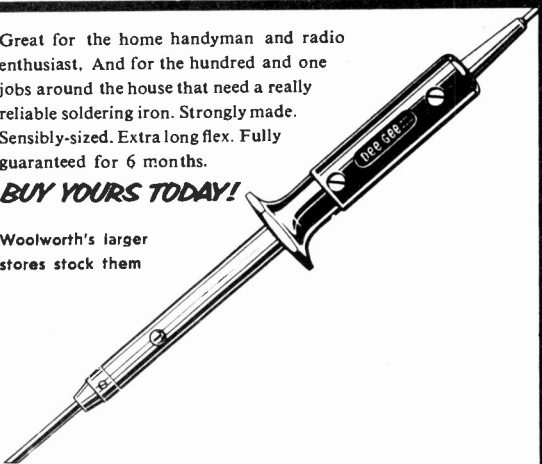

quick, accurate soldering with the Dee Gee high speed electric soldering iron

Sole makers:
DAVID GRIFFIN LTD.
HOLLAND WAY, BLANDFORD, DORSET

ONLY **16/-**

BUILD YOUR CIRCUITS ON VEROBOARD

—the Universal Wiring Board— obtainable from your local Retailer

Trade enquiries to:
NORMAN ROSE (ELECTRICAL) LTD.
8 St. Chad's Place, Gray's Inn Road, London, W.C.1

Technical enquiries to:
VERO ELECTRONICS LTD.
Industrial Estate, Chandler's Ford, Hants

BAKER MAJOR "MODULE"



A new Loudspeaker system featuring the famous 12 inch Baker Major Full range speaker on 19" x 12 $\frac{1}{2}$ " baffle board with 2 $\frac{1}{2}$ " tweeter and crossover. Output 20 watts. Response 30-17,000 c.p.s. Impedance 15 ohms. Ideal mono or stereo conversions of existing cabinets, furniture, etc.

£12.10.0 Post Free

Also available in kit form with instructions **£10.19.6**

Cabinet Plans and Catalogue Free

(Dept. P.E.25) **Baker Reproducers Ltd**

Bensham Manor Road Passage, Thornton Heath, Surrey. 01-684-1665

VALUABLE NEW HANDBOOK FREE TO AMBITIOUS ENGINEERS

Have you had your copy of "Engineering Opportunities"?

The new edition of "ENGINEERING OPPORTUNITIES" is now available—without charge—to all who are anxious for a worthwhile post in Engineering. Frank, informative and completely up to date, the new "ENGINEERING OPPORTUNITIES" should be in the hands of every person engaged in any branch of the Engineering industry, irrespective of age, experience or training.

On 'SATISFACTION OR REFUND OF FEE' terms

This remarkable book gives details of examinations and courses in every branch of Engineering, Building, etc., outlines the openings available and describes our Special Appointments Department.

WHICH OF THESE IS YOUR PET SUBJECT?

ELECTRONIC ENG.
Advanced Electronic Eng.—
Gen. Electronic Eng.—*Applied Electronics*—*Practical Electronics*—*Radar Tech.*—*Frequency Modulation*—*Transistors*.

ELECTRICAL ENG.
Advanced Electrical Eng.—
General Electrical Eng.—
Installations—*Draughtsmanship*—*Illuminating Eng.*—
Refrigeration—*Elem. Elec. Science*—*Elec. Supply*—
Mining Elec. Eng.

CIVIL ENG.
Advanced Civil Eng.—
General Civil Eng.—
Municipal Eng.—*Structural Eng.*—
Sanitary Eng.—*Road Eng.*—
Hydraulics—*Mining*—
Water Supply—*Petrol Tech.*

RADIO & T.V. ENG.
Advanced Radio—*General Radio*—*Radio & TV Servicing*—
TV Engineering—*Telecommunications*—
Sound Recording—*Automation*—
Practical Radio—*Radio Amateurs' Examination*.

MECHANICAL ENG.
Advanced Mechanical Eng.—
Gen. Mech. Eng.—*Maintenance Eng.*—
Diesel Eng.—*Press Tool Design*—
Sheet Metal Work—*Welding*—
Eng. Pattern Making—
Inspection—*Draughtsmanship*—
Metallurgy—*Production Eng.*

AUTOMOBILE ENG.
Advanced Automobile Eng.—
General Auto. Eng.—
Auto. Maintenance—
Repair—
Auto. Diesel Maintenance—
Auto. Electrical Equipment—
Garage Management.

WE HAVE A WIDE RANGE OF COURSES IN OTHER SUBJECTS INCLUDING CHEMICAL ENG., AERO ENG., MANAGEMENT, INSTRUMENT TECHNOLOGY, WORKS STUDY, MATHEMATICS, ETC.

Which qualification would increase your earning power?
A.M.I.E.R.E., A.M.I.Mech.E., A.M.S.E., A.M.I.C.E., B.Sc.,
A.M.I.P.E., A.M.I.M.I., A.R.I.B.A., A.I.O.B., A.M.I.Chem.E., A.R.I.C.S.,
M.R.S.H., A.M.I.E.D., A.M.I.Mun.E., C.ENG., CITY & GUILDS, GEN.
CERT. OF EDUCATION, ETC.

BRITISH INSTITUTE OF ENGINEERING TECHNOLOGY
316A ALDERMASTON COURT, ALDERMASTON, BERKSHIRE

THIS BOOK TELLS YOU

- ★ HOW to get a better paid, more interesting job.
- ★ HOW to qualify for rapid promotion.
- ★ HOW to put some letters after your name and become a key man . . . quickly and easily.
- ★ HOW to benefit from our free Advisory and Appointments Depts.
- ★ HOW you can take advantage of the chances you are now missing.
- ★ HOW, irrespective of your age, education or experience, YOU can succeed in any branch of Engineering.

132 PAGES OF EXPERT CAREER - GUIDANCE

PRACTICAL EQUIPMENT

Basic Practical and Theoretical Courses for beginners in Electronics, Radio, T.V., etc., A.M.I.E.R.E. City & Guilds Radio Amateurs' Exam. R.T.E.B. Certificate P.M.G. Certificate Practical Electronics Electronics Engineering Practical Radio Radio & Television Servicing Automation

INCLUDING TOOLS

The specialist Electronics Division of B.I.E.T. NOW offers you a real laboratory training at home with practical equipment. Ask for details.

B.I.E.T.

You are bound to benefit from reading "ENGINEERING OPPORTUNITIES"—send for your copy NOW—FREE and without obligation.

POST NOW!

TO B.I.E.T., 316A ALDERMASTON COURT, ALDERMASTON, BERKSHIRE.

3d. stamp if posted in an unsealed envelope.

Please send me a FREE copy of "ENGINEERING OPPORTUNITIES." I am interested in (state subject, exam., or career).

NAME

ADDRESS

WRITE IF YOU PREFER NOT TO CUT THIS PAGE



THE B.I.E.T. IS THE LEADING INSTITUTE OF ITS KIND IN THE WORLD

Published about the 15th of the month by GEORGE NEWNES LIMITED, Tower House, Southampton Street, London, W.C.2, at the recommended maximum price shown on the cover. Printed in England by THE CHAPEL RIVER PRESS, Andover, Hants. Sole Agents—Australia and New Zealand: GORDON & GOTCH (A/sia) Ltd.; South Africa and Rhodesia: CENTRAL NEWS AGENCY LTD.; East Africa: STATIONERY & OFFICE SUPPLIES LTD. Subscription rate including postage for one year: To any part of the World £1 16s. 0d.

Harper

NEW! SOLID STATE HIGH FIDELITY EQUIPMENT BRITISH MADE

POWER AMPLIFIERS—PRE-AMPLIFIERS—POWER SUPPLIES

We proudly present this new range of Audio Equipment developed from Dinadale Mk. II—each unit or system will compare favourably with other professional equipment selling at much higher prices. Brief details are below:—

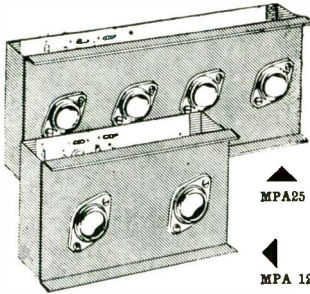
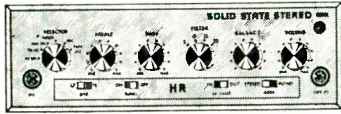

System	Comprising	Price
A	5 watt mono for 3/5 ohm speakers	£103.30
1	12 watt mono for 3 to 5 ohm speakers	£13.17.6
2	12 watt mono for 12 to 16 ohm speakers	£14.12.6
4	24 watt mono two channel for 12 to 16 ohm speakers	£20.15.0
8	20 watt mono/stereo for 12 to 16 ohm speakers	£24.0.0
9	24 watt mono/stereo for 3 to 5 ohm speakers	£26.15.0
14	40 watt mono/stereo for 7 1/2 to 16 ohm speakers	£29.10.0

COMPLETE FULLY ILLUSTRATED BROCHURE FREE ON REQUEST

All systems are complete with Dial Plate and Knobs. Units may be purchased separately.

THE FINEST VALUE IN HIGH FIDELITY — CHOOSE A SYSTEM TO SUIT YOUR NEEDS AND SAVE POUNDS



VHF FM TUNER
87/105 Mc/s Transistor Superhet. Geared tuning. Terrific quality and sensitivity. For valve or transistor amplifiers. 4 x 3 1/2 x 2 1/2 in. Complete with dial plate. 5 Mullard Transistors. Plus 4 Diodes. (Cabinet Assembly 20/- extra).
TOTAL COST TO BUILD **£6.19.6** P.P. 2/6

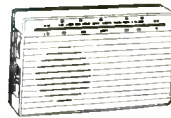

REGENT-6 MW/LW POCKET RADIO TO BUILD
6-Transistor superhet. Geared tuning. Push-pull speaker output. Moulded Cabinet 5 x 3 x 1 1/2 in. Phone socket.
TOTAL COST TO BUILD **£3.9.6** P.P. 2/6
Full tuning on both bands.



FM STEREO DECODER
7 Mullard Transistors. Printed Circuit Design with Stereo Indicator. For use with any valve or transistor FM. Uses pot cores to Mullard design and ger. and silicon transistors. As used by B.B.C. and G.P.O.
Complete Kit Price **£5.19.6** P.P. 2/6



AUTOBAN TRANSISTOR CAR RADIO Buy Now!
British Made 6-Transistor MW/LW. 12 volt 3 watt output. Push-button wave-change. Supplied built, boxed, ready to use with Speaker and Baffle. Car fixing kit and manufacturers' current guarantee. Special Bargain Offer. Positive or Negative Earth.
LIST PRICE 12 GNS. P.P. 4/6
Push-button version **9 gns.**
£11.19.6. Positive or Negative Earth

BUILD A QUALITY TAPE RECORDER WITH MARTIN RECORDAKITS



★ TWO-TRACK. Deck £10.10.0. Amplifier. £14.19.6. Cabinet and speaker 7gns. Complete kits with FREE 7in. 1,200ft. tape, spare spool.
Today's Value **27 gns.** P.P. 15/-
★ FOUR-TRACK. Deck £13.10.0. Amplifier £14.19.6. Cabinet and speaker 7 gns. Complete kits with FREE 7in. 1,200ft. tape, spare spool.
Today's Value **30 gns.** P.P. 15/-



7-TRANSISTOR MW-LW SUPERHET PORTABLE NEW!
New printed circuit design with full power output. Fully tunable on both mw/lw bands. 7 Transistors plus diode, push-pull circuit. Fitted 5 inch speaker, large ferrite aerial and Mullard transistors. Easy to build with terrific results. All local, and continental stations. Size 10 x 7 x 3 1/2 in.
TOTAL COST TO BUILD **£6.19.6** P.P. 4/6



MW/LW QUALITY TRANSISTOR RADIO TUNER
Fully tunable superhet with excellent sensitivity and selectivity. Output up to 1 volt peak. Complete with front panel, etc. 9 volt operated. For use with any amplifier or tape recorder.
TOTAL COST TO BUILD **£3.19.6** P.P. 2/6

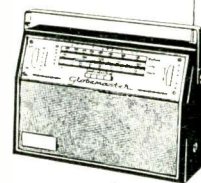

GLOBEMASTER
6-Mullard Transistors, 7 x 4in. speaker, very sensitive, excellent coverage. Full 3-wave-band tuning. Pushbutton wavechange. Superhet printed circuit. Black-chromed cabinet 11 x 7 1/2 x 3 1/2 in. (SW 17-50 metres). Ear/Record sockets. 1 watt push-pull output. WITH NEW DE-LUXE CABINET
TOTAL COST **£8.19.6** P.P. 4/6

TRANSISTORS

★ Largest range over 650 types
★ S.C.R.'s from 5/-
★ FIELD EFFECT TRANSISTORS from 9/6
★ POWER TRANSISTORS from 5/-
★ DIODES AND RECTIFIERS from 2/-
Send for Free List No. 36.
24 page Illustrated Brochure as above including Valves and Quartz Crystals. 1/- post paid.

GARRARD DECKS



COMPLETE RANGE IN STOCK
FROM **£4.19.6**
Send for Illustrated Brochure

BUILD THESE PW/PE DESIGNS

EXPLORER (less chassis) 62/6	ANTI-DAZZLE MIRROR 79/6
with drilled chassis and case 85/-	INTEGRATED CIRCUIT FM TUNER with CA3014 (27/8) 89/6
Thyristor Power Controller from 75/-	SWITCHED FM TUNER 75/-
SCREEN WIPER 38/6	STABILISED POWER SUPPLY 49/6

★ PRICES & PARTS LIST ON REQUEST (Post and Packing 2/6 extra)

MAYFAIR PORTABLE

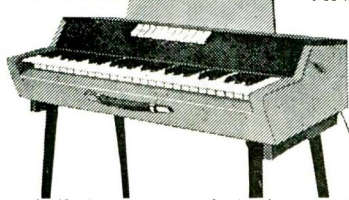

ELECTRONIC ORGAN

We regret to announce the untimely passing of MR. LEWIS W. ROCHE on Oct. 14th last—He will be sadly missed by his many friends and colleagues.

ORGAN COMPONENTS
We carry a comprehensive stock of organ components for TRANSISTOR AND VALVE FREE PHASE designs.

★ Build this instrument stage by stage in your own home.
★ A truly portable instrument for all enthusiasts.
★ Fully TRANSISTORISED POLYPHONIC, British design.
★ Call in for a DEMONSTRATION and see for yourself.
Also READY BUILT AND TESTED 128 gns. Deferred terms available.
DEPOSIT £36.8.0. and 12 monthly payments of £9. Total £144.8.0.

TOTAL COST 99 GNS.

CATALOGUE

LATEST EDITION
225 pages, 6,000 items
1,000 illustrations

- ★ 20 pages of transistors and semiconductor devices, valves and crystals.
- ★ 150 pages of components and equipment.
- ★ 50 pages of microphones, decks and Hi-fi equipment.

The most comprehensive—Concise—Clear components Catalogue in Gt. Britain. Complete with 10/- worth Discount Vouchers Free with every copy.

Send today **8/6** Post paid



HENRY'S RADIO LTD.



303 EDGWARE ROAD LONDON, W.2

PHONE: 01-723 1008/9
Open Mon. to Sat. 9 a.m.-6 p.m. Thurs. 9 a.m.-1 p.m.

WE CAN SUPPLY FROM STOCK MOST OF THE PARTS SPECIFIED ON CIRCUITS IN THIS MAGAZINE. SEND LIST FOR QUOTATION.

Full details on any advertised product FREE on request