

PRACTICAL

ELECTRONICS

DECEMBER 1967

PRICE 2/6

- * REAR VIEW SAFETY!
- * ANTI DAZZLE PROTECTION!

Hayes
**ELECTRONIC DEFLECTING
DRIVING MIRROR**



ADCOLA

PRODUCTS LIMITED
(Regd. Trade Mark)

SOLDERING EQUIPMENT

for the

DISCRIMINATING ENTHUSIAST

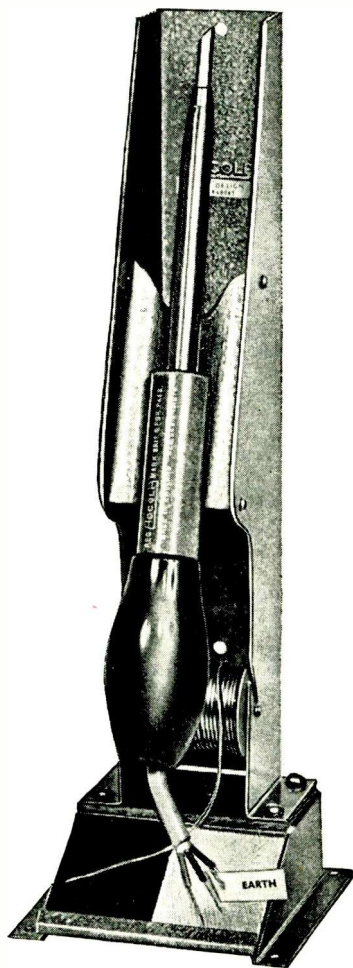

ILLUSTRATED:
L64 $\frac{1}{16}$ " BIT INSTRUMENT IN
L700 PROTECTIVE SHIELD

APPLY DIRECT TO:
SALES & SERVICE DEPT.
ADCOLA PRODUCTS LTD.
ADCOLA HOUSE
GAUDEN ROAD
LONDON, S.W.4
TELEPHONE 01-622 0291

TRANSISTOR BARGAIN SALE! NEW STOCK AT UNBEATABLE PRICES!

OC44, OC45, OC81D now only 1/6 each! £6 per 100
OC71, OC72 equivalent 1/- each! £3 per 100
45Y2 Switching Transistors 2/6 each! £10 per 100
2N753 NPN Silicon Planar, 300mW, 250Mc/s. High speed switching 2/6 each!
BSY28 NPN Silicon Planar, Epitaxial, 300mW, 300Mc/s 2/6 each!
BSY65 NPN Silicon Planar, Epitaxial, 800mW, 100Mc/s 2/6 each!
AFZ12 PNP Germanium Alloy Diff. low noise VHF amplifier 2/6 each!

Complete sets of transistors for radio:
2G344A/2G345A/2G345B/2G371A/2G378A/2G378A + diode ... 15/- only!
OC44/OC45/OC45/OC81D/OC81/OC81 + diode ... 10/- only!
Light sensitive transistors similar to OC71 ... 2/- each!
UNMARKED, UNTESTED TRANSISTORS TO CLEAR ... 7/6 for 50!
Silicon diodes. Make excellent detectors. Also suitable for keying electronic organs. 1/- each, 20 for 10/-.
BY 100 type rectifiers. SPECIAL REDUCED PRICE! ONLY 2/6 each, 24/- doz.

ELECTROLYTIC CONDENSERS! FANTASTIC SELECTION!

50µf 450V .. 1/3	20 + 4	275V .. 10d.
64µf 275V .. 1/3	32 + 32	275V .. 1/6
500µf 30V 1/2	8 + 8	450V .. 1/9
800µf 15V 1/2	50 + 50	275V .. 2/0
500µf 25V .. 10d.	40 + 40 + 20	275V .. 2/1
16/16/16 350V .. 2/2	100/100	50V .. 3/2
50/50/50 350V .. 2/7	10,000µf	12V .. 4/6
1,000µf 70V .. 3/2	1,250µf	50V .. 4/-
100/200 275V .. 3/2	150/350	300V .. 4/-
3,000µf 35V .. 3/9	250/250	325V .. 4/-
1,500µf 50V .. 4/-	2,000/2,000	25V .. 4/6
0.25µf .. 3V	3.2µf .. 6V	8µf .. 50V
1µf .. 10V	3.2µf .. 64V	8µf .. 275V
1µf .. 15V	4µf .. 4V	10µf .. 6V
1µf .. 40V	4µf .. 12V	10µf .. 10V
1µf .. 50V	4µf .. 25V	10µf .. 12V
1.25µf .. 16V	4µf .. 64V	10µf .. 25V
2µf .. 3V	5µf .. 100V	12µf .. 3V
2µf .. 9V	5µf .. 6V	12µf .. 20V
2µf .. 15V	5µf .. 25V	12.5µf .. 30V
2µf .. 50V	5µf .. 50V	16µf .. 30V
2µf .. 70V	5µf .. 70V	16µf .. 150V
2µf .. 150V	6µf .. 3V	20µf .. 3V
2µf .. 350V	6µf .. 12V	20µf .. 6V
1µf .. 350V	6µf .. 15V	20µf .. 9V
2.5µf .. 16V	6µf .. 150V	20µf .. 15V
2.5µf .. 25V	6.4µf .. 40V	25µf .. 6V
3µf .. 3V	8µf .. 3V	25µf .. 12V
3µf .. 12V	8µf .. 6V	25µf .. 15V
3µf .. 25V	8µf .. 25V	25µf .. 25V
8µf .. 450V	8µf .. 350V	30µf .. 6V
		30µf .. 10V
		30µf .. 25V

ALL AT
9/- per doz.
20 for 10/-
(our selection)

PAPER CONDENSERS

0.001µf 500V	0.005µf .. 750V	0.1µf .. 350V	0.5µf .. 150V
0.001µf 1,000V	0.02µf .. 600a.c.	0.1µf .. 750V	0.5µf .. 350V
0.002µf 500V	0.02µf .. 350V	0.25µf .. 350V	0.5µf .. 500V

ALL AT 15/- per 100, 3/- per dozen.

MULLARD POLYESTER CAPACITORS—ALL HALF PRICE

0.0022µf 400V	.. 4d	0.22µf 160V	.. 7d
0.0018µf 400V	.. 4d	0.27µf 160V	.. 8d
0.0015µf 400V	.. 4d	0.056µf 125V	.. 7d
0.001µf 400V	.. 4d	1µf 125V	.. 1/6
0.01µf 400V	.. 4d	68pf Tubular pulse ceramic	6d
0.15µf 400V	.. 7d	120pf Disc pulse ceramic	6d

VERY SPECIAL VALUE! SILVER MICA, CERAMIC, POLYSTYRENE CONDENSERS

Well assorted. Mixed types and values. 10/- per 100.

RESISTORS GIVE-AWAY OFFER! MIXED TYPES AND VALUES. 1/2 TO 1/2 WATT.

6/6 per 100 or 55/- per 1,000. ALSO 1/2 to 3 watt close tolerance. Mixed values. 7/6 per 100. 55/- per 1,000.

WIRE-WOUND RESISTORS. 1 watt, 3 watt, 6 watt. 6d each. 7 watt and 10 watt 9d each.

CONNECTING WIRE, THIN, P.V.C. INSULATED

10yds 1/-; 100yds 7/6; 500yds 25/- (post 4/6); 1,000yds 40/- (post 6/-).

VALVES. BRAND-NEW AND BOXED. ROCK-BOTTOM PRICES!

DY 87	.. 5/10	PCF 80	.. 7/4
EABC 80	.. 6/1	PCF 86	.. 8/9
ECC 82	.. 6/5	PCL 82	.. 7/4
ECC 83	.. 6/5	PCL 83	.. 8/6
ECL 80	.. 6/2	PCL 84	.. 7/4
ECL 86	.. 7/4	PCL 85	.. 7/4
EF 80	.. 6/2	PCL 86	.. 7/4
EF 85	.. 6/2	PFL 200	.. 10/2
EF 183	.. 8/2	PL 36	.. 8/9
EF 184	.. 8/2	PL 81	.. 7/4
EY 51	.. 5/10	PL 83	.. 7/4
EY 86	.. 5/10	PL 84	.. 5/7
EY 87	.. 5/10	PL 500	.. 10/10
PABC 80	.. 6/2	PY 32	.. 7/10
PC 97	.. 5/10	PY 81	.. 5/10
PCC 84	.. 6/5	PY 82	.. 4/1
		PY 800	.. 5/10

A FURTHER 10% DISCOUNT WILL BE GIVEN ON LOTS OF 50 OF ANY ONE TYPE

RECORD PLAYER CARTRIDGES

Sonotone Mono 10/-; Acos Mono 12/6; Acos Stereo 17/6. All with needles

Signal Injector Kit—10/- Signal Tracer Kit—10/-

Vero Board. All sizes in stock. Cutter and 5 boards 2 1/2in x 1in only 9/9

Orders by post to: G. F. MILWARD, 17 PEEL CLOSE, DRAYTON BASSETT, STAFFS.

Please include suitable amount to cover postage
Stamped addressed envelope must be included with any enquiries
For customers in Birmingham area goods may be obtained from Rock Exchanges, 231 Alum Rock Road, Birmingham 8. (All POST orders to Drayton)

S-DeC

the 'BREADBOARD' for the transistor age

TECHNICAL DATA

Insertion force 90 gm.wt.
 Withdrawal force 90 gm.wt.
 Resistance between adjacent holes 10m Ω
 Insulation resistance adjacent strips >10¹⁰ Ω
 Capacitance between adjacent strips 3pF.

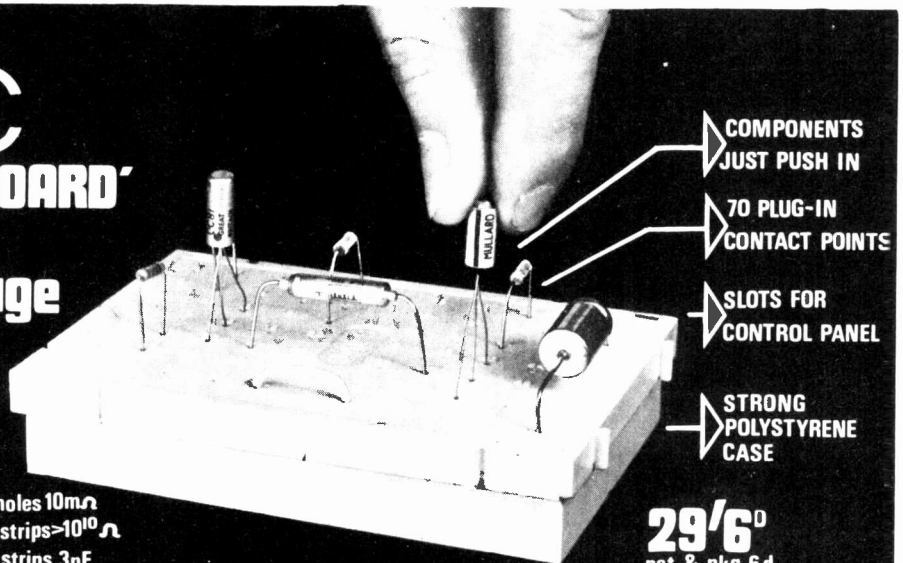

29/6^D
 pst. & pkg. 6 d.

Owing to the excellent demand for S-DeCs it is possible to give a free accessory kit with each S-DeC purchased from now on. I.e. combined kits are now 29/6 instead of 33/-.

INSTANT SUCCESS—already thousands of DeCs are in use in government and industrial development labs, universities, colleges and schools. S-DeC is fast becoming as important and fundamental a tool for electronics as the soldering iron.

- QUICK, FIRM, RELIABLE CIRCUIT ASSEMBLY
- LASTS INDEFINITELY—performance unchanged after 1,000 insertions
- PUTS AN END TO 'BIRDSNESTING'
- RE-USE COMPONENTS AGAIN AND AGAIN
- SAVES TIME, MONEY AND EFFORT

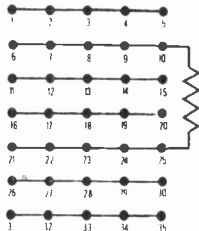

The diagram on the left shows one of the two panels of contacts on an S-DeC. The picture on the right shows a three stage audio amplifier mounted on an S-DeC. Instructions for assembling this amplifier are given in a booklet 'Construction Projects on S-DeC' which is given free with each DeC purchased. Other projects in the booklet are for a three transistor radio with diode detection, electronic flasher, light switch, divide by four logic circuit, morse practice set and VHF radio microphone.

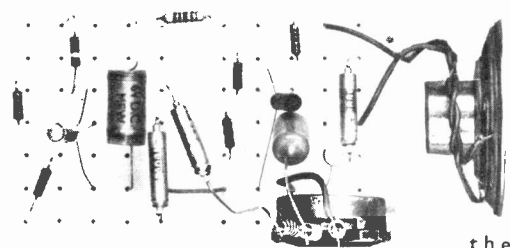

THE PROFESSIONAL "BREADBOARD" FOR DEVELOPMENT AND RESEARCH LABS, EDUCATION AND THE ENTHUSIAST.

Note the use of parts from the accessory kit—springs for solderless connection to the potentiometer AND the control panel which slots into the base of the DeC.

4-DeC KIT. FOUR S-DeC units with TWO Accessory Kits are supplied in an attractive plastic container. Makes storage of S-DeCs a simple matter. An economical way to buy your S-DeCs.

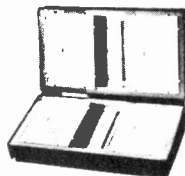

£6.12.6 value for £5.19.6 ONLY (post free).

CONTACT SYSTEM

The contacts are arranged in rows of five (numbered) which are joined together electrically as shown in the diagram. This arrangement is similar to that used in the popular printed wiring board so that the same methods of laying out circuits may be used. An S-DeC contains two of these 5 x 7 panels enabling most electronic building blocks to be accommodated. For very large circuits the decking can easily be enlarged by keying the units together forming a firm continuous area of decking of any desired size.

Components are simply pushed into the sockets where they are held securely by the double leaf spring phosphor-bronze contacts. This system ensures a good wiping action on insertion and withdrawal so giving a low resistance contact. Little force is required to push in or pull out the components but they are held firmly when inserted. Solderless connectors are provided in an accessory kit for use with controls. The controls are mounted on a panel which slots into the S-DeC base.

*** S-DeC NOW AVAILABLE FROM MOST LEADING SHOPS AND COMPONENT SUPPLIERS**

In case of difficulty in obtaining from a retailer post this form:

Please send me..... S-DeCs each containing a free accessory kit and.....4-DeC kits for which I enclose PO/Cheque/Money Order value £ / . / .

NAME

ADDRESS

**To: S.D.C. PRODUCTS (Electronics) LTD.
 PUMP LANE, SPRINGFIELD, CHELMSFORD**

CHRISTMAS BARGAINS!

GEE'S SPECIAL OFFER! TAPE

Attractively boxed.
Guaranteed. Brand new.

5in. Std.	600ft.	8.8
7in. Std.	1,200ft.	12.6
5in. L.P.	900ft.	10/-
5 1/2in. L.P.	1,200ft.	12.6
7in. L.P.	1,800ft.	15/-
4in. D.P.	600ft.	9/-
5in. D.P.	1,200ft.	15/-
5 1/2in. D.P.	1,800ft.	22.6
7in. D.P.	2,400ft.	25/-
3in. T.P.	600ft.	12.6
4in. T.P.	900ft.	15/-
5in. T.P.	1,200ft.	30/-
5 1/2in. T.P.	2,400ft.	40/-
7in. T.P.	3,000ft.	50/-

P. & P. 2/6 per order.

GARRARD MODEL A70



Three-speed record changer complete with attractive metal plinth and including Sunotone 9TA Stereo pick-up head. Ready wired for connection to existing Hi-Fi Amplifier. Brand new in original packing. Listed over £28.

GEE'S PRICE 18 Gns. CARR. PAID

AUTOMATIC WIRE STRIPPER

Simple to use. Strips any size wire. A must for every home workshop. P. & P. 5/-

35/-

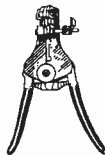

FANTAVOX COMMUNICATIONS RECEIVER HE.50

4 wavebands 540kc/s to 30 Mc/s. Exceptionally sensitive tuning circuit. Extra large easy to read dial with Bands pre set tuning. "S" meter for fine tuning. Built-in speaker and telescopic aerial. B.F.O. Phone output socket. Standby switch, etc. A.C. 200/260V.

Gee's Price Only 15 gns.
P. & P. 10/-



NEW MODEL U-500 MULTI-TESTER, 20,000 O.P.V. MIRROR SCALED WITH OVERLOAD PROTECTION.
Ranges: D.C. volts: 100 mV., 0.5 v., 5 v., 250 v., 1,000 v. A.C. volts: 2.5 v., 10 v., 50 v., 250 v., 1,000 v. D.C. current: 5 μ A., 0.5 mA., 5 mA., 50 mA., 250 mA. Size: 5 1/2" x 3 1/2" x 1 1/2". Complete with batteries and test leads. **£5.15.0**

SEND 1/- FOR ILLUSTRATED CATALOGUE OF TAPE AND AUDIO ACCESSORY BARGAINS

AUTOMATIC AERIAL - ADDS LUXURY TO ANY CAR!

OUR PRICE £7-19-6 P&P 5/-



Today's value 15 gns. Tamper proof electrically operated car radio aerial, 4 section telescopic, extends automatically to 48in. and retracts to 1in. at the flick of a switch. Depth below wing 16in. Robustly made, heavy chrome finish 12V d.c. operation. Quickly and easily fitted, supplied with cable, switch and all fixing parts.

PONY 9 TRANSISTOR Super 2-Way Radios

Edgna. VALUE FOR ONLY 16 gns. PAIR

Complete 2-way communication for Business, Home, Farms, Boating, etc. Brilliant design, beautifully finished. Built-in speaker microphone, 10 section telescopic aerial. Battery strength indicator. Size 6 1/2in. x 1 1/2in. x 2 1/2in. Complete with batteries, earphones, wrist straps. Cannot be operated in U.K.

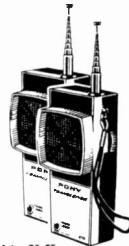

STEREO HI-FI HEAD SET Model ST 3R

Provides perfect stereo. Freq. res. 25-17,000 c.p.s. 8 ohms per channel. Feather soft ear cushions and headband, 8ft. lead with stereo jack plug and remote control but with separate volume control for each earphone.

92/6
P. & P. 2/6



GEE'S RADIO

15 LITTLE NEWPORT STREET LONDON, W.C.2. GER. 6794/1453

Open 9 a.m. - 6 p.m. Monday-Friday, 1 p.m. Saturday
Adjoining Leicester Square Tube

PEOPLE PREFER MARTIN

FOR RELIABILITY, FOR QUALITY, FOR ADD-ON-ABILITY, FOR ECONOMY



F.M. TUNER



STEREO CONTROL ASSEMBLY

MARTIN AUDIOKITS are available for Mono, and can be doubled up for stereo, or as complete stereo units. 3 ohm and 15 ohm systems are available. There is a special pre-amp for low output pick-ups and escutcheon panels to suit the arrangement you choose. The tuner is styled to match.

You can do so much with MARTIN kits. The system of using pre-fabricated transistorised units which can be interlinked in a variety of ways enables you to assemble the combination of your choice and then extend it unit by unit until you possess a full stereo gramophone and radio assembly. When new units are produced, they can be added to existing equipment very easily with the advantage that you can continue to use equipment you already have,

so that your installation is always up to date. Most important of all is the power and quality which MARTIN Audiokits give you. Their sturdy construction assures compactness without sacrifice to quality or efficiency. They offer excellent value, are very easily installed and will give years of unflinching service. That is why people prefer MARTIN - it's simple to instal, good to listen to, and looks completely professional.

AMPLIFIER SYSTEMS • TUNERS • RECORDERS

- 5-stage input selector £2.7.6
- Pre-amp/tone controls £3.2.6
- 10 watt amp. (3 ohms) £5.12.6
- 10 watt amp. (15 ohms) £6.12.6
- Mains power supply £2.15.0
- F.M. Tuner £12.17.6

MARTIN ELECTRONICS

154 High Street, Brentford, Middlesex
Please send Recordakit/F.M. Tuner/Audiokit Hi-Fi Leaflets. (Strike out items not wanted)

Name

Address

From Radio and Hi-Fi Stockists

Trade enquiries invited

MARTIN ELECTRONICS LTD. 154/5 HIGH STREET, BRENTFORD MIDDLESEX. 15Le worth 1161/2

PE 11



The latest Eagle range is greater than ever!



It's now ready—the new Eagle Catalogue presenting 'The Wonderful World of Electronics'. Hundreds of items for the Radio Hobbyist, Hi-Fi Enthusiast, Serviceman, Do-it-Yourself, etc. The widest ever choice of sensibly priced Electronic Components, Audio and Tape Accessories, Educational Projects, Home Lighting, Intercoms, Hi-Fi Amplifiers, Tuners, Tape Recorders, Loudspeakers and Speaker Systems, all of which are fully illustrated together with technical specifications. There's something for everyone in Eagle's Wonderful World of Electronics so send for your copy now or call in at one of the 6,000 Eagle Stockists today.

To: EAGLE PRODUCTS, Dept. P.E.12,
Coptic Street, London, W.C.1.

Please send me catalogue of the entire "Eagle" range. I enclose 5/-.

Name

Address

JASON KITS

★ TAPE ★

We offer you fully tensilised polyester/nylon and P.V.C. tapes of identical quality hi-fi, wide range recording characteristics as top grade tapes. Quality control manufacture. They are truly worth a few more coppers than acetate, sub-standard, jobbed or cheap imports. TRY ONE AND PROVE IT YOURSELF.

Standard		Long	
3in 150ft	2/8	3in 225ft	2/9
4in 300ft	4/6	4in 450ft	5/6
5in 900ft	7/8	5in 900ft	10/6
5 1/2in 900ft	10/6	5 1/2in 1,200ft	13/-
7in 1,200ft	12/6	7in 1,800ft	18/6

Double		Triple	
3in 300ft	4/-	4in 900ft	13/-
4in 600ft	8/-	5in 1,800ft	25/-
5in 1,200ft	15/-	5 1/2in 2,400ft	34/-
5 1/2in 1,800ft	19/-	7in 3,600ft	44/-
7in 2,400ft	27/-	Quadruple	

Postage 1/- reel. 3in 600ft 8/6
Post Free less 5% on three reels.

Quality and Trade enquiries invited.
NOTE. Large tape stocks at all branches.

TECHNICAL TRADING

All Mail Orders to Brighton

- ★ London—10 Tottenham Court Rd Tel. MUS 2639
- ★ Portsmouth—350-352 Fratton Rd. Tel. 22034
- ★ Southampton—72 East St. Tel. 25851
- ★ Worthing—132 Montague St. Tel. 2585
- ★ Brighton—Devonian Court, Park Crescent Place
All Mail Order (24-hour Rabophone)
Brighton 680722

UNREPEATABLE ★ SNIPS ★

GARRARD 9 Gns.
ATG MK II 59/-
GARRARD SRF12 (110/230V) 49/-
COLLARO 9 VOLT 49/-
4 SPD. HEAVY T.T.
LIGHT ARM (list £7) (p. & p. 5/-)
ABOVE LESS CARTRIDGES
Mono. Cart. add 12/6
Stereo Ceramic Cart. add 19/-

AUTOCHANGE PORTABLE CABINETS
As used on 18gms record player. Due to fortunate purchase we offer complete with motor board and all fittings at only **49/-**

PLEASE NOTE. A wide range of cabinets to entice at all branches.

100 HI-STABS 9/6
1% to 5% 100Ω to 5mΩ

CO-AX low loss, 8d. yd.
25 yds. 13/6, 60 yds. 25/-
BBC2 H/D fringe 1/8 yd. 25 yds. 30/-

100 RESISTORS 6/6
SIZES 1-3 watt.

MICROPHONE CABLE. Highest quality, black, grey, white, 1/- YD.

100 CONDENSERS 9/6
Miniature Ceramic, Silver, Mica, etc.
3pF to 5μF. LIST VALUE OVER £4.

SILICON H.T. RECTIFIERS

Guaranteed performance. Top makes. Tested 250V working.

120mA (3 for 6/8) 2/9

500mA (3 for 19/8) 7/6

Please note
Postage extra on all items

**FREE
FLOG LIST No. 2**

Scores Special Bargains
Send S.A.E. or call at any
Branch for yours



This gun for SALE!

FOR 'INSTANT HEAT'...SAFE ...EFFICIENT SOLDERING

With a Weller 'Expert' Dual Heat Gun in hand you can successfully tackle any soldering job—from a small printed circuit up to sheet metal work! You get INSTANT HEAT at the press of a trigger—and tip is cool within 10 seconds of releasing trigger. Completely safe for operator...

and components. Simple to use... speedy and accurate. Dual Heat 120-140 watts.

Expert Dual Heat Gun 66/- (Kit 89/6). Also available: Marksman Soldering Iron 29/- (Kit 38/-).

Manufactured by the world's largest makers of quality soldering tools.

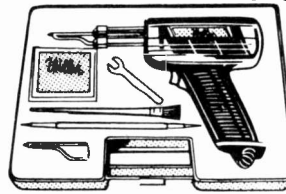

Write for literature on Weller Soldering Equipment.

To: WELLER ELECTRIC LIMITED
Horsham, Sussex.
Telephone: Horsham 61747

Weller

ALWAYS SWITCH ON WITH CONFIDENCE

This Knight-kit pocket multimeter, only slightly larger than a cigarette packet has dozens of uses. As well as helping build up your hobby projects it can be used to service radio and TV sets, Hi-Fi equipment and home appliances as well as checking for continuity in motors and testing home wiring. Start saving money immediately by doing all these jobs yourself, once you've built up this fantastic value kit.

The pocket multimeter is just one item from the Electroniques range of Knight-kit test equipment which includes oscilloscopes, a full-feature 57-range multimeter, signal generators, power supplies and a vacuum tube voltmeter—all available in kit form to save you money. Full details and specifications are to be found in a FREE 70-page brochure that also includes Hi-Fi gear and general interest electronic kits like a car engine fault analyser and a photographic exposure meter.

Knight-kits are easy and fun to build as well as being instructive. Credit terms are available and specifications fully guaranteed. For any problem, however small, our enthusiastic Service Department is ready to advise and assist—the only problem you ever have with Knight-kits is in convincing friends you built it yourself.

Features of the remarkable pocket multimeter include a two-colour 2 1/2 meter with 1mA full scale movement; 0.5-15-50-150-500 V dc; 0.1-10-100 mA dc; 0.15-50-150-500 V ac; 0-30 kΩ (1.2kΩ centre scale). The instrument is supplied complete with solder, test leads, battery and step-by-step instruction.



- 13-RANGE MULTIMETER THAT FITS IN THE POCKET
- READS VOLTAGE, CURRENT AND RESISTANCE WITH 1kΩ / VOLT DC SENSITIVITY
- A VITAL AID TO ALL YOUR PROJECTS FOR ONLY £5. 5. 0.

Please send me your FREE brochure K25 giving full details on the full range of Knight-kits
Send to ELECTRONIQUES (Prop. STC) Limited, Edinburgh Way, Harlow, Essex.

NAME _____

ADDRESS _____



knight-kit by
Quality Built-in, Built-up by you

electroniques

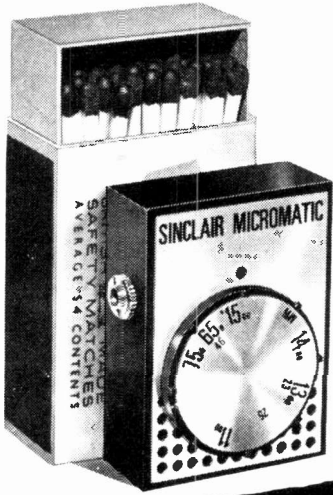

SINCLAIR MICROMATIC

the world's smallest radio set

Down in price!

and

UP IN LISTENING QUALITY



BY BUYING
THE
COMPLETE
KIT

Originally 59/6 complete with earpiece, solder and instructions in pack, the Micromatic Kit now costs

49/6



BY BUYING A
READY BUILT
SET

Originally 79/6, the Micromatic ready built, tested and guaranteed complete now costs

59/6

FOR IMMEDIATE
DELIVERY

2 Long-life Mercury Cell Batteries for either of above, each 1/10d.

With sales and export orders for the Sinclair Micromatic breaking all records, we have changed over to new production methods to meet the ever-increasing demand for the world's smallest radio set. This has enabled us to effect dramatic economies because of the large quantities of materials involved. At the same time, we have appreciably improved the set's quality. We now supply a magnetic earpiece which matches perfectly to the powerful output of the Micromatic, and what was superb performance before, now sounds better than ever. Now that your Micromatic costs you less (49/6 kit; 59/6 built), you can afford not only to have one for yourself, but give them as gifts. But be quick. At the new prices, everyone is going to want the Micromatic. Order yours now.

- PLAYS ANYWHERE
- FANTASTIC POWER AND RANGE
- FULLY GUARANTEED
- $1\frac{4}{5}$ x $1\frac{3}{10}$ x $\frac{1}{2}$ in.

**NOW SUPPLIED WITH A DE-LUXE
MAGNETIC EARPIECE**

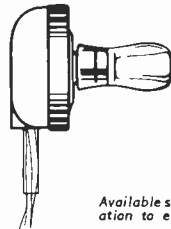

This new finely engineered magnetic earpiece has great sensitivity and covers a very wide frequency range. It provides exceptional clarity and quality and is of robust construction. Each one is individually checked before despatch.

Available separately with instruction for adaptation to existing Micromatic Sets, post free **15/-**

FULL SERVICE FACILITIES AVAILABLE WHEN YOU BUY THE KIT AND BUILD IT YOURSELF

sinclair

Order form and more Sinclair designs
SEE PAGES 2 AND 3 SINCLAIR ADS



SINCLAIR Q.14

A no-compromise high-fidelity loudspeaker of outstanding quality

- ACOUSTICALLY CONTOURED SOUND CHAMBER
- MAXIMUM LOADING IN EXCESS OF 14 WATTS
- BRILLIANT TRANSIENT RESPONSE
- 15 OHMS IMPEDANCE
- AN ALL-BRITISH PRODUCT

Price need no longer stop you enjoying the best possible high-fidelity loudspeaker reproduction nor is size any longer a problem. (These considerations are of utmost importance to every audio enthusiast for stereo.) In the Sinclair Q.14 you will find a loudspeaker of such superb quality and so compactly and attractively styled that you will want to change over to Sinclair immediately you hear it. This is no ordinary loudspeaker. A vast amount of money, time and research have gone into producing a design which proves beyond question that good reproduction does not have to be expensive. Users of the Z.12 for instance, know that full well, and coupling the Q.14 to this Sinclair amplifier assures the keen listener of superb audio reproduction.

The Sinclair Q.14 has been tested in an independent laboratory and shows exceptionally smooth response between 60 and 16,000c/s with well sustained output both below and above these readings. Its remarkable transient response ensures clean-cut separation between instruments, voices, etc. The unusual shape of the sealed, seamless pressure chamber allows the Q.14 to be conveniently positioned on shelves, in wall corners, or flush mounted in assemblies of one or more units.

Try the Q.14 in your own home now. If you are not satisfied send it back and your money plus the cost of posting your Q.14 to us will be refunded in full.

£6.19.6

POST FREE ANYWHERE IN THE UK

sinclair

SINCLAIR RADIONICS LTD., 22 Newmarket Road,
Cambridge
Phone: OCA3 52996

SINCLAIR Z.12

12 WATT INTEGRATED HIGH FIDELITY AMPLIFIER AND PRE-AMP

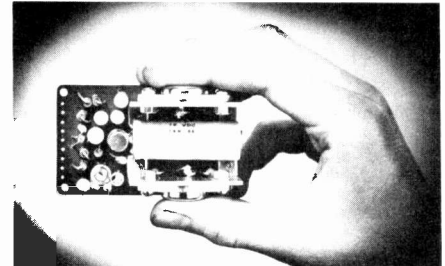
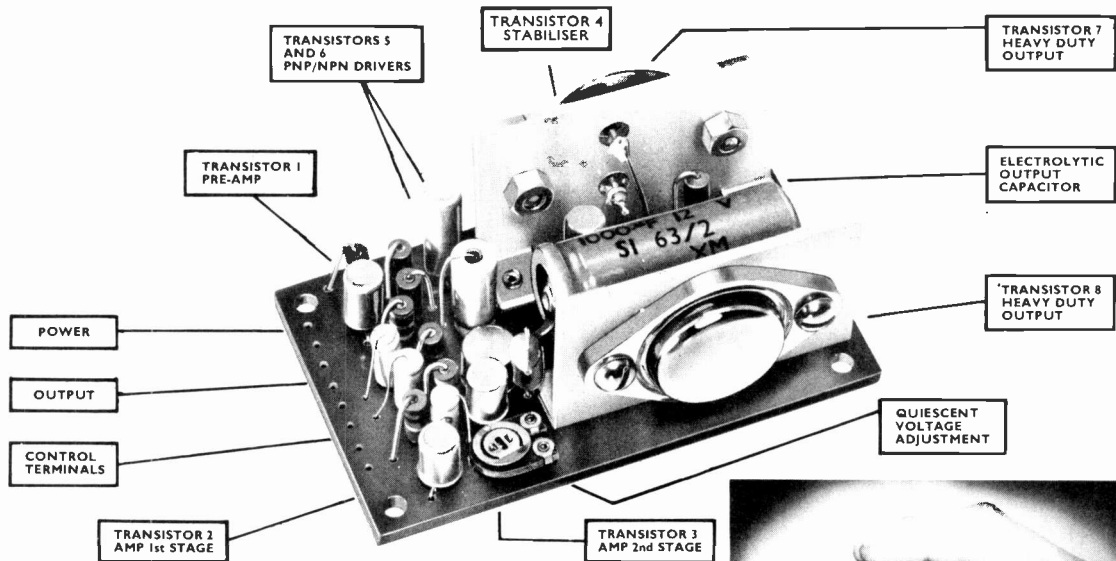

TECHNICAL DETAILS

- Class "B" ultra-linear output.
- RESPONSE 15-50,000 c/s \pm 1dB.
- Suitable for 3, 7.5 or 15 Ω speakers. Two 3 Ω speakers may be used in parallel.
- INPUT—2mV into 2k Ω .
- Signal to noise ratio better than 60dB.
- Use two for stereo.

BUILT, TESTED AND GUARANTEED.

89/6

12 WATTS R.M.S. OUTPUT CONTINUOUS SINE WAVE (24W PEAK) 15 WATTS MUSIC POWER (30W PEAK)

- 3 x 1 $\frac{3}{4}$ x 1 $\frac{1}{4}$ in.
- IDEAL FOR BATTERY OPERATION
- 15-50,000c/s \pm 1dB

PZ.3 Mains Supply Unit for Z.12 and Stereo 25 **79/6** users.

The embodiment of power, efficiency, reliability and economy. Nothing could be better than this fine amplifier for use with space-saving plinth-mounted motor and pick-up assemblies. Equally, its light weight makes the Z.12 ideal for guitar amplifier or electronic organ. It operates efficiently on any power supply between 6 and 20V. d.c. The pre-amp of this 8-transistor masterpiece will accept the outputs of pick-up, radio and microphone, etc. Full details for matching control and selector switching circuits are in the manual supplied with each unit. The Z.12 is now in use all over the world and is the accepted standard for all hi-fi needs.

ALL ITEMS POST FREE • SATISFACTION OR MONEY BACK GUARANTEE • PROMPT DELIVERY

SINCLAIR MICRO FM 7 TRANSISTOR DUAL PURPOSE FM TUNER/RECEIVER

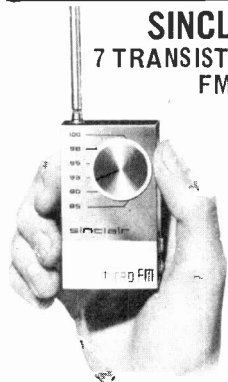

Low I.F. makes alignment unnecessary when built. Tunes 88-108 Mc/s. The telescopic aerial suffices for good reception in all but poorest areas. Signal to noise ratio—30dB at 30 microvolts. One outlet leads to amplifier or recorder the other allows set to be used as a pocket portable. Complete kit with earpiece and instructions. **£5.19.6**

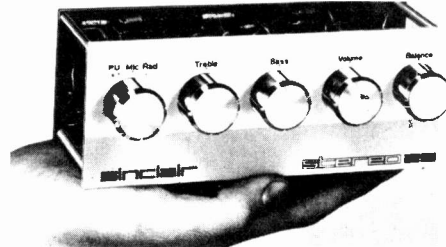

SINCLAIR STEREO 25
For use with two Z.12s or any hi-fi stereo system. Frequency response 25c/s to 30k/s \pm 1dB. Switched inputs for P.U. Radio, Microphone, etc. Equalisation correct to within \pm 1dB on RIAA curve from 50 to 20,000c/s. 6 $\frac{1}{2}$ in. \times 2 $\frac{1}{2}$ in. \times 2 $\frac{1}{2}$ in. plus knobs. Built, tested and guaranteed **£9.19.6**

Please quote P.E.12 if you want to write your order instead of cutting out the coupon.

GUARANTEE

If you are not completely satisfied when you receive your purchase from us, your money will be refunded at once in full and without question.

SINCLAIR RADIONICS LTD., 22 NEWMARKET ROAD, CAMBRIDGE

Please send

NAME

ADDRESS

for which I enclose cash/cheque/money order

value £.....s.....d.

P.E.12

BARGAIN OPPORTUNITIES FROM



VEROBOARD—All standard sizes including 2 1/2in x 5in 3/8; 2 1/2in x 3 1/2in 3/4; 3 1/2in x 5in 5/8; 3 1/2in x 3 1/2in 3/4; 2 1/2in x 1 7/8in 12/8. All accessories and tools in stock.

OUR NEW LISTS feature more lines than ever at money saving prices. Send 6d. for latest issue.

For a prompt reply send S.A.E. with your enquiries.

PEAK SOUND SA.88 SUPER STEREO AMP.
14 Transistor Kit builds into superb hi-fi amp. 8W per channel (16W mono) with integrated pre-amp to take high quality ceramic p.a. Unusually easy to build by following the instructions (16d. purchased separately and returned when kit is bought). This makes one of the best and most economical stereo transistor amps we have ever offered. All purchases backed by T.R.S. service facilities. When built and fitted in its special cabinet, the SA.88 equals the best in modern styling.
AMPLIFIER KIT (P/P 4/-) £9.10.0
POWER PACK KIT (P/P 4/-) £2.10.0
MODERN SLIMLINE WOOD CABINET £2.10.0 (P/P 5/-)
COMPLETE ASSEMBLY £14.10.0 post free if ordered at same time

GARRARD UNITS & PLINTHS

LM 3000 Record Player with 9T.A. Stereo Cartridge. Brand new as from factory ... 8 gns

AT.60 Mk II De-luxe Auto-changer, die-cast turntable. Less cartridge ... £11.19.6

SP.25 De-luxe single record player, die-cast turntable. Less cartridge ... 9; gns

Packing and carriage on any one of above 7/6 extra.

Garrard Plinth. Ideal mounting for the Garrard Units offered here. Will readily suit any hi-fi set-up. In fine Teak. Complete with useful soft plastic dust cover. Packing and carriage 5/- ... 75/-

Garrard clear-view rigid perspex cover (carriage 3/6) ... 57/6

Garrard Mono Cartridges when bought with any of the above from 15/-; Stereo from 25/-.

TRS MULLARD AMPLIFIERS

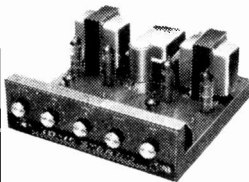

STEREO 10-10

Valve amplifier to exact Mullard spec. With pre-amp, tapped o/p transformer 3 and 15Ω all controls, H.T. and L.T. outlet, mono, stereo and speaker phase switching. Complete with escautcheon, knobs, plugs, etc. Ready built (p. & p. 12/6) **£20.0.0**

In kit form with chassis, knobs, plugs, etc. (p. & p. 12/6) **£17.10.0**

5-10 MONO

5 valve, 10W basic amp kit complete. **£9.19.6** (p. & p. 7/6) with passive control network and panel **£11.19.6**
2 valve pre-amp kit **£6.12.6**

3-3 MONO

3 valve 3W amplifier with controls, absolutely complete kit including panel, knobs, etc. (p. & p. 7/6) **£7.10.0**

RESISTORS—Modern ratings, full range 10 ohms to 10 megohms. 10% 1/4W, 4d each; 20% 1W, 6d each; 2W, 9d each; 5% Hi-stab. 1W, 5d each; 1W, 6d each; 1 2-10 meg. 10% 1W, 4d each; 1W, 5d each. 1% Hi-stab. 1W, 1/6 each (below 100Ω, 2/- each).

WIREWOUND RESISTORS—25Ω to 10kΩ 5W, 1/6 each; 10W, 1/9 each; 15W, 2/3 each.

CONDENSERS—Silver Mica. All values 2pF to 1,000pF. 6d each. Ditto ceramic, 6d. Tub. 450V T.C.C. etc. 0-001-0-01μF, 10d each; 0-1-350V, 10d each; 0-02-0-1μF, 500V, 1/- each. TCC 350V 0-25, 1/9 each; 0-5, 2/- each.

CLOSE TOL. MICAS—10% 5-500pF, 9d; 600-5,000pF, 1/-, 1%.
2-100pF, 11d; 100-250pF, 1/2; 270-800pF, 1/-; 800-5,000pF, 2/-.

TYGAN PRET or Vynair speaker fabric, 12in: 12in 2/-; 12in 18in 3/-; 12in 24in 4/-, max. width 48in.

BONDACOUST Speaker Cabinet Acoustic Wadding, approx. 1in thick 18in wide, any length cut 2/3 ft 6/- yd.

POSTAGE. Unless stated add 1/- on 1lb orders, 1/9 on 1lb, 3/8 on 2lbs, 5/- on 6lbs, 6/6 on 10lbs, 8/- on 14lbs. Over, 10/6.

7 VALVE AM/FM RG CHASSIS

A superbly powerful high performance instrument for the keenest enthusiasts. Provides tuning on long, medium and F.M. wavebands. Excellent sensitivity. Permeability tuning on F.M. Large clear dial, A.V.C., good neg. feedback. Magic eye. 3W output. A.C. 200/250V. Circuit diagrams available. Aligned, tested and ready for use (Carr. and ins. 7/6). S.A.E. **£13.19.6** brings full details.

TAPE & WALLET OFFER

With each reel of this tape we give you a strongly made library wallet in simulated leather with space for a reel each side. This is professional quality full frequency tape with metallized leader/stop foils.

5in reel, 900ft with wallet	12/6	7in reel, 1800ft with wallet	18/0
p. & p. 1/6 per reel		5 1/2in reel, 1200ft with wallet	17/6
		or 7in reel 1200ft with wallet	22/6

ALL SINCLAIR DESIGNS INCLUDING MICROMATIC KIT 49/6 (BUILT 59/6), Q.14 SPEAKER £6.19.6, Z.12 89/6.

TRS RADIO COMPONENT SPECIALISTS

Established 1946

70 BRIGSTOCK ROAD, THORNTON HEATH, SURREY

Tel.: 01-684 2188. Hours 9 a.m.—6 p.m. 1 p.m. Wednesdays
A few doors from Thornton Heath Station (S.R. Victoria section)

THREE HEADS ARE BETTER THAN TWO..

Two amplifiers are better than one...



Ask your dealer to unveil the wonders of the Vanguard or write direct for full specification.

Without these refinements it is impossible for a tape recorder to provide such facilities as **Double Play, Sound-on-Sound and Direct Tape Monitoring**—these are just some of the outstanding features incorporated in the WyndSOR Vanguard and when you study the complete specification (4 track—3 speeds—7in. spools—3 heads—Separate Record and Play-back Amplifiers—Double Play—Sound-on-Sound—Detachable lid fitted 8in. speaker—Tape Monitoring—Push button controls—Recording meter and Playback indicator—Bass, treble, volume and record gain controls, etc.) you can see that we are offering an extraordinary recorder at an ordinary price.

59 GNS.

Complete with 1,800 ft. LP tape and tape manual. (Microphone, Headphones and Stereo tape pre-amp are available as optional extras).

WYNSOR RECORDING CO. LTD. (Dept. PE11)

WyndSOR Works, Bellevue Rd., Friern Barnet, London, N.11. ENT 2226

SOLDERING ?

—you need the Antex SOLDERING TOOL KIT

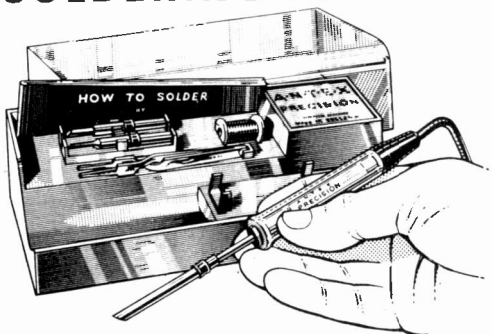

- Model CN240 15W Precision Iron with 3/16" bit.
- Two spare Interchangeable Bits (3/32" and 3/64")
- Reel of Solder ● Heat Sink ● Cleaning Pad
- PLUS 36-page booklet on "How-to-Solder"

49/6

British made. From The Army & Navy Stores, Harrods, and Radio Shops, or if unobtainable locally, direct from:

ANTEX LTD

GROSVENOR HSE · CROYDON · CR91QE

Telephone: 01-686 2774

A-Z

(MINUS X)

ALPHABETICALLY...

we can list the names

GEOGRAPHICALLY...

we can list the countries

All over the world students know that CREI HOME STUDY COURSES are supplying the answer to their need for advanced Technical Education in the field of Electronic Engineering Technology.

CREI PROGRAMMES ARE AVAILABLE IN:

- Electronic Engineering Technology
- Industrial Electronics for Automation
- Computer Systems Technology
- Nuclear Engineering
- Mathematics for Electronic Engineers
- Television Engineering
- Radar & Servo Engineering
- City & Guilds of London Institute :
- Subject 49 and Advanced Studies
- Subject No. 300

Write for free brochures to:

G.R.E.I. (London) (Dept. P.E. 6)

WALPOLE HOUSE, 173/176 SLOANEST., LONDON S.W.1

Telephone: Belgravia 8662

INTERNATIONAL DIVISION OF CAPITOL RADIO ENGINEERING INSTITUTE WASHINGTON D.C.

Please send me (for my information and entirely without obligation) full details of the educational programmes offered by your institute

Send details of the City & Guilds Programme

Name

Address

.....

.....

Electronics Experience

.....

.....

G.R.E.I. (LONDON) (DEPT. P.E.6), WALPOLE HOUSE, 173-176 SLOANE STREET, S.W.1

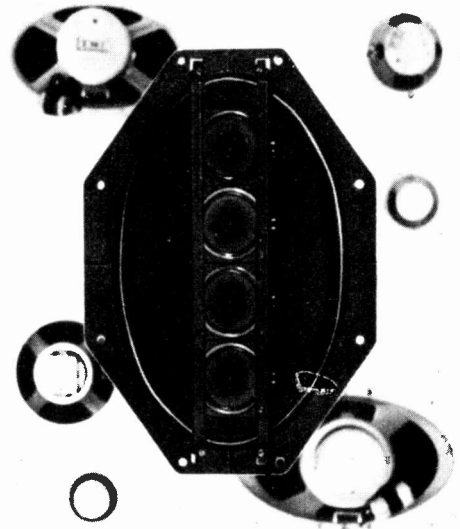

choice of professionals...
practical for enthusiasts
EMI SPEAKERS...

The quality of sound reproduction is vitally important to E.M.I. — the largest recording organization in the world. E.M.I. Matched Speaker Sets reproduce every detail of the original sound over the full audio spectrum, at high or low listening levels. E.M.I. Speakers are examples of the most advanced audio engineering at a realistic cost. For their size and price they give unrivalled response. With many unique features and innovations they range from the Type 250 set with a 5" woofer and Hi Fi unit for enclosures of 11" x 8" x 6", to the Type 950 set for which an enclosure of 3½ to 4 cu. ft. is required.

The EMISOUND Audio Advice Bureau places all our experience of sound reproduction at your service. Send us your problems and fill in the coupon for details of E.M.I. Speakers.

EMISOUND



**EMI SOUND PRODUCTS LTD
HAYES · MIDDLESEX
TEL: 01-573 3888**

Please send me details of EMI MATCHED SPEAKER SETS

Name

Address

Tel. No.

HI-FI AMPLIFIERS — TUNERS — RECORD PLAYERS



FM TUNERS
FM-4U



TFM-IS

HI-FI FM TUNER. Model FM-4U. Available in two units. R.F. tuning unit (£2.15.0 incl. P.T.) with I.F. output of 10.7 Mc/s and I.F. Amp. unit and valves (£13.13.0). Total Price Kit **£16.8.0**

HI-FI AM/FM TUNER. Model AFM-1. Available in two units which, for your convenience, are sold separately. Tuning heart (AFM-T1—£4.13.6 incl. P.T.) and I.F. amplifier (AFM-A1—£22.11.6). Printed circuit board, 8 valves. Covers L.W., M.W., S.W., and F.M. Built-in power supply. Total Price Kit **£27.5.0**

STEREO DECODER SD-1. Available as extra for above models. Self-powered. Kit **£8.10.0**. Assembled **£12.5.0**

Hear the BBC stereo FM programmes on the **TRANSISTOR STEREO FM TUNER.** Elegantly designed to match the stereo Amplifier, AA-22U. Available in two units, sold separately, can be built for a Total Price:

Kit (STEREO) **£24.18.0** incl. P.T.

Kit (MONO) **£20.19.0** incl. P.T.

10W POWER AMP. MA-12



9 + 9W STEREO AMP. S-99

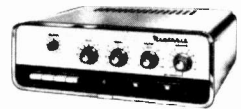

HI-FI MONO AMPLIFIER. Model MA-12. 10W output, wide freq. range, low distortion. Use with control unit.

Kit **£12.18.0** Assembled **£16.18.0**

HI-FI CABINETS. Full details available. MALVERN: Kit **£18.1.0**. GLOUCESTER: Kit **£18.10.0**.

DE LUXE STEREO AMPLIFIER. Model S-33H. De luxe version of the S-33 with two-tone grey perspex panel, and high sensitivity necessary to accept the Decca Derampick-up. Kit **£15.17.6** Assembled **£21.7.6**

HI-FI STEREO AMPLIFIER. Model S-99. 9+9W output. Ganged controls. Stereo/Mono gram, radio and tape inputs. Push-button selection. Printed circuit construction. Kit **£28.9.6** Assembled **£38.9.6**

TRANSISTOR MIXER. Model TM-1. A must for the tape enthusiast. Four channels. Battery operated. Similar styling to Model AA-22U Amplifier. Kit **£11.16.6** Assembled **£16.17.6**



Enjoy Yourself While You Save

RADIOS

Complete your motoring pleasure with this outstanding car radio, Model CR-1



Will give you superb LW and MW entertainment wherever you drive. Tastefully styled to harmonise with any car colour scheme. 8 latest semi-conductors (6 transistors, 2 diodes) for 12V positive or negative

earth systems. Powerful output (4 watts) will drive two loudspeakers. Pre-assembled and aligned tuning unit. Available for your convenience in two units. Can be obtained for a Total Price: Kit (excl. L.S.) **£12.17.0** incl. P.T. 6" x 4" 3 Ω loudspeaker **£1.4.5**.



Oxford

"OXFORD" LUXURY PORTABLE Model UXR-2. Specially designed for use as a domestic or personal portable receiver. Many features, including solid leather case. Kit **£14.18.0** incl. P.T.



UXR-1

TRANSISTOR PORTABLE. Model UXR-1. Pre-aligned I.F. transformers, printed circuit. Covers L.W. and M.W. Has 7" x 4" loudspeaker. Real hide case. Kit **£12.11.0** incl. P.T.

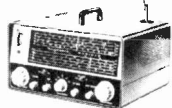

GC-1U

JUNIOR EXPERIMENTAL WORKSHOP. Model EW-1. More than a toy! Will make over 20 exciting electronic devices, incl.: Radios, Burglar Alarms, etc. 72 page Manual. The ideal present! Kit **£7.13.6** incl. P.T.

"MOHICAN" GENERAL COV. RECEIVER for Amateur or Short Wave listening. Send for leaflet. Model GC-1U. Kit **£37.17.6** Assembled **£45.17.6**

Prices quoted are Mail Order, retail prices slightly higher

WELCOME TO OUR HEATHKIT CENTRES

LONDON—233 Tottenham Court Road, W.1

Opens Mon.-Fri. 9 a.m.-5.30 p.m. Sat. 9 a.m.-1 p.m.

BIRMINGHAM—Open from Oct. 24th, 1967

17-18 St. Martin's House, Bull Ring

TEST INSTRUMENTS

Our wide range includes:

3" LOW-PRICED SERVICE OSCILLOSCOPE. Model OS-2. Compact size 5" x 7 $\frac{1}{2}$ " x 12" deep. Wt. only 9 $\frac{1}{2}$ lb. "Y" bandwidth 2 c/s-3 Mc/s \pm 3dB. Sensitivity 100mV/cm T/B 20 c/s-200 kc/s in four ranges, fitted mu-metal CRT Shield. Modern functional styling. Kit **£23.18.0** Assembled **£31.18.0**



OS-2

5" GEN.-PURPOSE OSCILLOSCOPE. Model 10-12U. An outstanding model with professional specification and styling. "Y" bandwidth 3 c/s-4.5 Mc/s \pm 3dB. T/B 10 c/s-500 kc/s. Kit **£35.17.6** Assembled **£45.15.0**

DE LUXE LARGE-SCALE VALVE VOLTMETER. Model IM-13U. Circuit and specification based on the well-known model V-7A but with many worth-while refinements. 6" Ernest Turner meter. Unique gimbal bracket allows operation of instrument in many positions. Modern styling. Kit **£18.18.0** Assembled **£26.18.0**



VVM, IM-13U

AUDIO SIGNAL GENERATOR. Model AG-9U. 10 c/s to 100 kc/s, switch selected. Distortion less than 0.1%. 10V sine wave output metered in volts and dB's. Kit **£23.15.0** Assembled **£31.15.0**



V-7A

VALVE VOLTMETER. Model V-7A. 7 voltage ranges d.c. volts to 1,500. A.C. to 1,500 r.m.s. and 4,000 peak to peak. Resistance 0.1 Ω to 1,000M Ω with internal battery. D.C. input resistance 11M Ω . dB measurement, has centre-zero scale. Complete with test prods, leads and standardising battery. Kit **£13.18.6** Assembled **£19.18.6**.



RF-1U

MULTIMETER. Model MM-1U. Ranges 0-1.5V to 1,500V a.c. and d.c.; 150 μ A to 15A d.c.; 0.2 Ω to 20M Ω 4 $\frac{1}{2}$ " 50 μ A meter. Kit **£12.18.0** Assembled **£18.11.6**

R.F. SIGNAL GENERATOR. Model RF-1U. Up to 100 Mc/s fundamental and 200 Mc/s on harmonics. Up to 100mV output. Kit **£13.18.0** Assembled **£20.8.0**

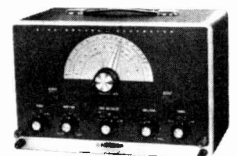

IG-82U

SINE/SQUARE GENERATOR. Model IG-82U. Freq. range 20 c/s-1 Mc/s in 5 bands less than 0.5% sine wave dist. less than 0.15 μ sec. sq. wave rise time. Kit **£25.15.0** Assembled **£37.15.0**

TRANSISTOR POWER SUPPLY. Model IP-20U. Up to 50V, 1.5A output. Ideal for Laboratory use. Compact size. Kit **£35.8.0** Assembled **£47.8.0**

Prices and specifications subject to change without notice

TAPE AMPLIFIERS — TAPE DECKS — CONTROL UNITS

**20 + 20W
STEREO
AMP.
AA-22U**



**GARRARD
PLAYER
AT-60**



20 + 20W TRANSISTOR STEREO AMPLIFIER. Model AA-22U. Outstanding performance and appearance. Kit £39.10.0 (less cabinet). Attractive walnut veneered cabinet £25.0 extra. Assembled incl. cabinet, £59.15.0

GARRARD AUTO/RECORD PLAYER. Model AT-60, less cartridge £14.12.10. With Decca Deram pick-up £19.7.4 incl. P.T. Many other Garrard models available, ask for Lists.

HI-FI MONO AMPLIFIER. Model MA-5. A general purpose 5W Amplifier, with inputs for Gram., Radio. Modern functional appearance. Kit £11.9.6 Assembled £15.15.0

TAPE PRE-AMPLIFIERS. TA-1M (MONO): Kit £19.18.0. Assembled £28.18.0. TA-1S (STEREO): Kit £25.10.0. Assembled £35.18.0. Will work satisfactorily with almost any tape deck.

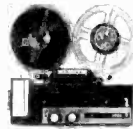

**TRUVOX
DECK**

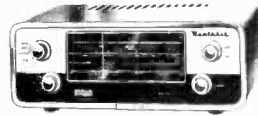

**AM/FM
TUNER**

TRUVOX D-106 and 108 TAPE DECKS. High quality stereo/mono tape decks. D106, 1 track, £39.15.0 D108, 1 track, £39.15.0

TRANSISTOR INTERCOM. Models XI-1U and XIR-1U. A time-saving device for office, shop or for the home. Master unit XI-1U will operate up to 5 remote stations. Master, XI-1U Kit £11.9.6 Assembled £17.9.6. Remote, XIR-1U Kit £4.9.6 Assembled £5.18.0. Send for full specification leaflet.

MONO CONTROL UNIT. Model UMC-1. Designed to work with the MA-12 or similar amplifier requiring 0-25V or less for full output. 5 inputs. Baxandall type controls. Kit £9.2.6 Assembled £14.2.6

STEREO CONTROL UNIT. Model USC-1. Push-button selection, accurately matched ganged controls to ±1dB. Rumble and variable low pass filters. Printed circuit boards. Kit £19.19.0 Assembled £27.5.0

Build Your Own Electronics



SPEAKER SYSTEMS

AVON HI-FI PERFORMANCE 'MINI' SPEAKER KIT. A compact, bookshelf size, 7 3/4" wide x 19 1/4" high x 8 1/2" deep, speaker with beautiful walnut veneered fully-finished cabinet, wide frequency response, special 6" bass, 3" HF units and crossover network. Cabinet Kit £8.18.0. Speaker Kit £4.18.0. Total Price Kit £13.16.0 incl. P.T.



HI-FI SPEAKER SYSTEM. Model SSU-1. Ducted-port bass reflex cabinet "in the white". Two speakers. Vertical horizontal models with legs, Kit £12.12.0, without legs, Kit £11.17.6 incl. P.T.

Many other models in range.

NEW! STEREO TAPE RECORDER, STR-1

1/2 track stereo or mono record and playback at 7 1/2, 3 1/2 and 1 1/2 ips. Sound-on-sound and sound-with-sound capabilities. Stereo record, stereo playback, mono record and playback on either channel. 18 transistor circuit for cool, instant and dependable operation. Moving coil record level indicator. Digital counter with thumb-wheel zero reset. Stereo microphone and auxiliary inputs and controls, speaker headphone and external amplifier outputs... front panel mounted for easy access. Push-button controls for operational modes. Built-in stereo power amplifier giving 4 watts rms per channel. Two high efficiency 8 in. by 5 in. speakers. Operates on 230V ac supply.



Kit £45.18.0.
Assembled prices
on request

NEW MODELS!

Portable Stereo Record Player, SRP-1

Automatic playing of 16, 33, 45 and 78 rpm records. All transistor—cool instant operation. Dual LP/78 stylus. Plays mono or stereo records. Suitcase portability. Detachable speaker enclosure for best stereo effect. Two 8" x 5" special loudspeakers. For 220-250V A.C. mains operation.



Compact, economical stereo and mono record playing for the whole family — plays anything from the Beatles to Bartok. All solid state circuitry gives room filling volume.

Kit £27.15.0 incl. P.T. Assembled price on request.

Transistorised AM-FM Stereo Tuner

In the same attractive styling as our well-known AA-22U Stereo Amplifier. Features 18 transistor, 3 diode circuit. AM-LW/MW, FM Stereo and Mono tuning. Stereo indicator light. AFC, AGC. Pre-assembled and aligned FM unit. Separate AM and FM circuit boards. Self-powered. Handsome, finished walnut veneered cabinet. (Optional extra).



Comprising: Model AFM-2T RF Tuning Unit. Kit £7.17.6 including P.T. AFM-2A IF Amp. and power supply kit £24.9.6. Cabinet £2.5.0 extra.

TOTAL PRICE KIT £32.7.0 incl. P.T.

LOW-COST TRANSISTOR STEREO AMPLIFIER KIT TS-23.

A really low priced unit yet incorporates all essential features for good reproduction from gramophone, radio and other sources, 3 watts for channel output (15 ohms). Kit £17.15.0. Beautiful walnut veneered cabinet £2.0.0 extra.



**FREE !
36 page Catalogue.
SEND FOR YOUR
COPY
NOW !**

Over 150 models shown,
many in Full Colour

To **DAYSTROMLTD., Dept. P.E.12, Gloucester**

Without obligation please send me

FREE BRITISH HEATHKIT CATALOGUE.....

FULL DETAILS OF MODEL(S).....
(Please write in BLOCK CAPITALS)

NAME

ADDRESS

Please send FREE catalogue to my friend.

NAME

ADDRESS

P.E.12

DO YOU KNOW...

THAT YOU CAN NOW OBTAIN...

4 SIZES OF 0.1" MATRIX VEROBOARD?



(FORMERLY ONLY AVAILABLE TO PROFESSIONAL USERS) for improved packaging density. Also compatible for use with TO5 and dual-in-line integrated circuits and miniature discrete components

AND

4 SIZES OF 0.15" MATRIX

... FROM YOUR USUAL RETAILER

TRADE ENQUIRIES TO:

NORMAN ROSE LTD., 8 St. Chad's Place, Gray's Inn Road, London, W.C.1

TECHNICAL ENQUIRIES TO:

VERO ELECTRONICS LTD., Industrial Estate, Chandler's Ford, Hants. SO5 3ZR

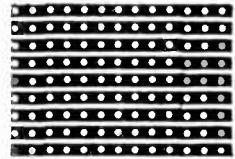

0.1" x 0.1" MATRIX

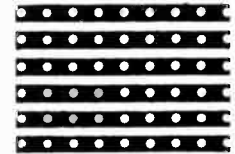

0.15" x 0.15" MATRIX

**WHEN THE SQUEEZE IS ON
THE PRESSURE IS OFF**

ESPI

**REVERSE ACTION
TWEEZERS
4 MODELS FOR THE
ELECTRICAL AND
ELECTRONICS
INDUSTRY**

K651—Stainless steel, anti-magnetic.
K652—Nickel silver alloy, anti-magnetic
—fine points.
K654—As 651 but coated with "Teflon"
for heat and chemical resistance.
K655—Extra fine points for micro-
miniature parts. Stainless steel.

Full details on request. Also range of
KONTAKT AEROSOL aids and Diacrom
range of diamonded spatulas, from:
U.K. Distributors:
**SPECIAL PRODUCTS
DISTRIBUTORS LIMITED**
81 Piccadilly, London, W.1
Tel. 01-629 9556

**FULCRUM PIN
W/ADJUSTABLE
TENSION
FEATURE-
REVERSES
TWEezer PINCH!**

No more dropping of tiny parts at critical moments with time loss and risk of damage.
Squeeze to pick up or release parts.
Uniform grip—adjustable to handle most delicate parts.

ERSIN



**for quick
easy faultless
soldering**

Containing 5 cores of non-corrosive flux, instantly cleaning heavily oxidised surfaces. No extra flux required. Ersin Multicore Savbit Alloy reduces wear of copper soldering iron bits.



**SIZE 5
HANDY SOLDER
DISPENSER**
Contains 12 ft.
coil of 18 s.w.g.
Ersin Multicore
Savbit Alloy.
2/6 each



SIZE 15
21 ft coil of 60/40
Alloy, 22 s.w.g. in
a dispenser. Ideal
for small compon-
ents, transistors,
diodes, etc.
3/- each



SIZE 12
Ideal for home
constructors
Contains 102 ft.
of 18 s.w.g. Ersin
Multicore Savbit
Alloy on a plastic
reel. 15/- each



**BIB MODEL 8
WIRE STRIPPER
AND CUTTER**
Strips insulation
without nicking
the wire, cuts
wire and splits
plastic twin flex.
Plastic cushioned
handles. 8/6 each

From Electrical or Hardware shops. If unobtainable write to
Multicore Solders Ltd., Hemel Hempstead, Herts.



Lasky's Radio

DON'T MISS THIS!

GREAT NEWS!

THIS YEAR LASKY'S CELEBRATE THEIR 35th ANNIVERSARY

35 Great Years of service to you based on fair prices and value

To celebrate our success and your satisfaction we are publishing a 12-page, fully illustrated colour

"35th Birthday Pictorial" Catalogue

Printed in large 16 x 11in. modern magazine format—the "Birthday Pictorial" contains thousands of different items from our vast stocks of Radio, Hi-Fi, TV, Test Gear, Components, Communications and other equipment.

PLUS AND many bargain offers and prices exclusive to Lasky's in addition every copy of the "Birthday Pictorial" is numbered and automatically enters you in our great "Birthday Draw" with over £100 in Gift Vouchers to be won.

All goods shown in the "Birthday Pictorial" are available over the counter from any of our branches—or by post to any address in the U.K. or overseas—bringing the benefits of shopping at Lasky's to you in your home.

PUBLICATION DATE — NOVEMBER. Make sure of your copy NOW—just send your name, address and a 4d. stamp for postage.

A MUST FOR EVERY ELECTRONICS HOBBYIST AND HI-FI ENTHUSIAST!



CONSTRUCTORS BARGAINS

NOW AVAILABLE FOR THE FIRST TIME IN GREAT BRITAIN—TWO NEW

TRIO RECEIVERS

MODEL JR-500SE

This high performance receiver is made especially to cover the amateur bands and utilises a crystal controlled double heterodyne circuit for extra sensitivity and stability. Brief spec.: Covers all the amateur bands in 7 separate Me/s. Circuit uses 7 valve

2 transistors and 6 diodes p as 8 crystals: output 8 and 500 ohm and 500 ohm phone jack. **Special features:** Crystal-controlled oscillator • Variable BFO • VFO • AVC • ANL • 8 meter • SSB-CW • Stand-by switch • Special double gear dial drive with direct reading down to 1 kHz • Remote control socket for connection to a transmitter. Audio output 1 watt. For use on 115/250V a.c. Mains. Superb modern styling and control layout—finished in dark grey. Cabinet size 7 x 13 x 10in. Weight 18lb. Fully guaranteed, complete with instruction manual and service data. **LASKY'S PRICE £61.19.0** Carriage and Packing 12/6.

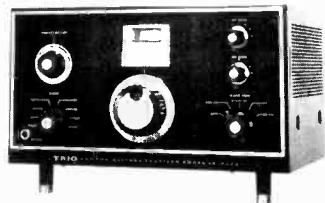

MODEL 9R-59DE

Brief spec: 4 band receiver covering 500 Kc/s to 30 Mc/s continuous and electrical band spread on 10, 15, 20, 40 and 80 metres. 6 valve plus 7 diode circuit. 408 ohm output and phone jack. **Special features:** SSB-CW • ANL • Variable BFO • 8 meter • Sep. band spread dial • IF frequency 455 Kc/s • Audio output 1.5W • Variable RF and AF gain controls. For use on 115/250V a.c. Mains. Beautifully designed control layout finished in light grey with dark grey case, size: 7 x 15 x 10in. Weight 19 lb. Fully guaranteed, complete with instruction manual and service data. **LASKY'S PRICE £36.15.0** Carriage and Packing 12/6.



SPECIAL INTEREST ITEMS!

NEW VOICE ACTUATED MICROPHONE

MODEL B 5001

This new voice actuated microphone is designed for use with tape recorders with facilities for remote control. The microphone is fitted with a three position switch allowing normal hand remote control, voice sensitivity action and off. The degree of voice or sound level required to operate the recorder can be adjusted. The microphone is self powered by one 9V (PP3 type) battery giving 6 to 10 hrs. operating time. Super sensitive 6 transistor circuit. Strong black plastic case. Length 7 1/2in. Designed for hand held use or laying flat. Fitted with 2.5 and 3.5 mm. plugs for fitting polarised sockets.



LASKY'S PRICE £6.19.6 Post 3/6.

BULK PURCHASE SCOOP!

STEREO AM/FM RADIOGRAM CHASSIS BY FAMOUS GERMAN MAKER



Long, medium and short wave bands coverage, plus VHF/FM multiplex. Piano key wave change, separate fly wheel tuning on AM and FM, bass, treble and balance controls, and magic eye tuning indicator. Ferrite rod aerial. The very latest printed circuitry. Output 5 watts per channel. Complete with multiplex decoder. 5 valves, line-up: ECC85, ECH801, ECC83, ELL80, EAF801. Full vision tuning scale, size: 21 x 6in. Overall dimensions: 21 x 6 1/2 x 8in. Made to very highest standards.

LASKY'S PRICE £38.6.6 Carriage and Packing 10/-.

ALSO AVAILABLE WITHOUT MULTIPLEX £33.12.0 C. & P. 8/6.

Branches

207 EDGWARE ROAD, LONDON, W.2 Tel.: 01-723 3271

33 TOTTENHAM CT. RD., LONDON, W.1 Tel.: 01-636 2605

Open all day Saturday, early closing 1 p.m. Thursday

152/3 FLEET STREET, LONDON, E.C.4 Tel.: FLEet St. 2833

Open all day Thursday, early closing 1 p.m. Saturday

ALL MAIL ORDERS AND CORRESPONDENCE TO: 3-15 CAVELL ST., TOWER HAMLETS, LONDON, E.1 Tel.: 01-790 4821

CONSTRUCTORS BARGAINS

LASKY'S MINIATURE TRANSISTOR AMPLIFIER MODULES

Incorporating the very latest circuitry to provide high sensitivity and good quality in conjunction with extreme small size and compactness. High quality Newmarket transistors used throughout. All designed to operate on 9v. miniature battery. Add 1/- on each for post & packing

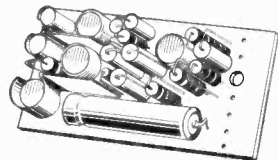

TYPE LRPC 1. 3 transistor. Input sens. 50 mV, output 150 mV, output imp. 40Ω, size 2 1/4 x 1 1/4in. **PRICE 27/6**

TYPE LRPC 4. 5 transistor. Input sens. 150 mV, output 330 mV, output imp. 15Ω, size 2 1/4 x 1 1/4in. **PRICE 18/6**

TYPE LRPC 5. 6 transistor. Input sens. 8mV, output 3W, output imp. 3Ω, size 5 1/2 x 1 1/2 x 1in. **PRICE 59/6**

TYPE LRPC 9. High to low impedance matching pre-amp.—input imp. 1 megohm, output imp. 2 k/ohms. Size 1 1/4 x 1 1/4 x 1in. **PRICE 10/6**

TYPE LRPC 10. Magnetic tape replay pre-amp. designed so that a 450 mH head can be matched into any of the audio amplifier modules listed above. Size 2 1/4 x 1 1/4 x 1in. **PRICE 10/6**

TYPES LRPC 9 and 10 are ideal for use with **LRPC 1, 4 and 5** and are available at the reduced price of 7/6 each if bought with the **LRPC 4**.

FULLY ENCAPSULATED MODULES

Special function modules — all one size 1 1/2 x 1 x 1 1/4in. Complete with detailed function and installation instructions. Send S.A.E. for data.

TYPE PA-1. Public address amp. for use with carbon, crystal or Dynamic microphones. 3Ω output imp. **PRICE 30/-**

TYPE GR-1. Gramophone amplifier—provides sufficient power to fill average room. 3Ω output imp. **PRICE 30/-**

TYPE CO-1. Morse code practice oscillator — for use with morse key and 3Ω speaker. **PRICE 20/-**

TYPE MT-1. Metronome module—provides audible and visual beat from 30 to 240 beats per minute (for use with 3Ω speaker or ind. lamp). **PRICE 22/6**

High Fidelity Audio Centres

42 TOTTENHAM CT. RD., LONDON, W.1 Tel.: 01-580 2573

Open all day Thursday, early closing 1 p.m. Saturday

118 EDGWARE ROAD, LONDON, W.2 Tel.: 01-723 9789

Open all day Saturday, early closing 1 p.m. Thursday

OH CALAMITY!!



Has he lost a vital component?

NO...MUCH WORSE!

He can't find his Home Radio Catalogue!!

With the evenings drawing in and the nights getting chilly, the radio enthusiast really gets down to planning his winter projects. And the thing he needs most, even before sorting out all his bits and pieces, is of course his precious Home Radio Components Catalogue. The dreadful scene above shows what happens if he can't find it! But soon a beautiful smile will break across his face as he remembers that for a mere nine and six he can get a new, up-to-date, greatly enlarged copy. And the smile will quickly broaden as he recalls that the catalogue contains five vouchers, each worth a shilling when used as directed. **Crisis over!**

If you have never been the proud possessor of a Home Radio Catalogue, or if you can't lay your hands on your old copy—don't tear your hair and stamp your feet. Simply fill in the coupon and post it today with your P.O. or cheque for 9/6 (7/6 + 2/- P. & P.)

Please send me latest Component catalogue. I enclose 9/6

NAME.....

ADDRESS.....

HOME RADIO (MITCHAM) LTD.

Dept. PE, 187 LONDON RD., MITCHAM, SURREY, CR4 2YQ

BEGINNERS, OLD AND NEW

TODAY's beginner in electronics has a decided advantage over the beginner of, say, five to ten years ago. Today the position of the semiconductor is clarified. No longer any doubt concerning its future prospects. The emergence of new forms of semiconductor continually increase the versatility of electronics in general. From a practical point of view, the newcomer to the hobby is destined to be 80 per cent or more a transistor man. So he can concentrate on solid state right from the start.

Looking back to before the transistor era, the beginner received his initiation into electronics through valve theory and practice. When the transistor first appeared on the scene it received a somewhat cool welcome. It seemed to some an intruder bent on bringing undue complications into a nicely ordered field. Attempts to describe the unfamiliar transistor action in terms analogous to valves proved helpful to some extent, but the artificial parallels and somewhat contrived comparisons with a device which is fundamentally so different also produced some added confusion.

The old adage concerning the difficulty of teaching an old dog new tricks applies here: and not only in the amateur field, for this very same problem has caused more than a little consternation amongst many of the older generation of professional engineers and technicians.

In contrast to all this, the youngster of today is well acclimatised to semiconductors. As soon as he takes an intelligent interest in technical affairs he is very quickly made aware of the solid state family whose members appear in many gadgets and equipment now commonplace in everyday life. He can approach this subject without any repudiation; it is natural to him, and there is no initial barrier to overcome because of long familiarity with valve operated equipment.

This month we launch a series entitled Semiconductor Basics. These articles will explain in a clear and non-mathematical manner the essential facts the beginner to electronics requires to know in order to make sensible use of semiconductor devices of various types. This series will also provide an excellent introduction to the subject for those who wish to pursue academic studies in this direction.

We conclude with a word to some of the "old dogs"—pardon the phrase. Perhaps they will forgive us for suggesting it, but careful reading of Semiconductor Basics should enable them to overcome any persisting aversion to the transistor and its associates. With confidence restored, they will then be able to get up to some "new tricks" just like the rest!

THIS MONTH

CONSTRUCTIONAL PROJECTS

SPRING LINE REVERBERATION UNIT	880
PROPORTIONAL SERVO SYSTEM	893
ANTI-DAZZLE DRIVING MIRROR	903
PHOTOGRAPHIC EXPOSURE METER	916

SPECIAL SERIES

MICROELECTRONICS—5	887
NUCLEONICS FOR THE EXPERIMENTER—2	922

GENERAL FEATURES

THE COLOUR RECEIVER	899
HIGH INPUT IMPEDANCE TECHNIQUES	910

BEGINNERS

SYMBOLS AND ABBREVIATIONS	912
SEMICONDUCTOR BASICS—1	913

NEWS AND COMMENT

EDITORIAL	879
THE 73 PAGE	896
MARKET PLACE	902
POINTS ARISING	906
SPACEWATCH	907
ELECTRONORAMA	908
DETACHED PARTICLES	933

*Our January issue will be published on
Friday, December 15*



SPRING LINE

FOLLOWING the concluding article last month on *Electronic Sounds and Music*, we present here the first of a number of constructional projects designed to give special effects to existing musical instruments or recorded electronic sounds. Full theoretical and practical information is given to enable the constructor to build up his own effects equipment.

This reverberation unit is inexpensive to build and, in addition to its applications in electronic music, can be used to add "dimension" to an electric guitar, organ and other musical instruments. It is also effective when used with a microphone, magnetic tape recorder, or record player. The sound impression given is of a large hall, but even if only used in a small room the instrumentalist may give the impression that he is playing in a huge cavern.

STRETCHED SPRING

The complete circuit of the unit is shown in Fig. 1, and consists of a 4-transistor audio power amplifier (TR5, 6, 7, 8) with which are associated two pre-amplifiers TR3, TR4. A mains power supply unit with electronic smoothing (TR1, 2) is used and two electromagnetic transducers operate in conjunction with a stretched spring to achieve the echo effect. These transducers (X1 and X2) are, in fact, a pair of spaced headphones.

The input signal is fed from the input socket (SK1) to the amplifier by way of VR1, TR4, and VR2. The audio output from the amplifier drives the "transmit" transducer X1, which sets up vibrations in a helical steel spring. This then acts as an acoustic delay line.

The mechanical vibrations in the spring are picked up by X2 causing its diaphragm to vibrate in sympathy at the other end of the spring line. The induced electrical signal is fed into transistor TR3 which amplifies it before being passed on to the output socket SK2 by way of potentiometer VR5, the "dimension" control.

Some of the output from the power amplifier bypasses the spring line, and is taken to the output socket by way of the volume control VR4. Here, it is mixed with the signal from the dimension control. The output will thus contain a variable degree of reverberation.

Some of the amplified reverberation signal from TR3 is fed back via VR3 (the "sustain" control) to the input of the power amplifier. This signal goes once again through the spring delay-line, producing further echoes and resulting in further prolongation of the decay period of the sound. The echoes are thus "sustained" over a longer period.

If VR3 is turned too high, the loop gain of the sustain feedback circuit will exceed unity, resulting in oscillation and a whistle appearing at the output. This may be counteracted by substituting a larger value for resistor R26, or by connecting an appropriate audio filter in the input lead of the power amplifier (at point marked *) in series with C11.

The amplifier circuit is fairly conventional and will operate from a power source in the region of 18 to 24 volts. Although it can be run from batteries, a mains power supply is incorporated in the unit to provide voltage consistency in operation.

The amplifier output is taken from a pair of medium power transistors, TR7, TR8 connected as a complementary push-pull output stage. The output point (junction of R17, R23, R24) is held at about half the supply voltage by heavy d.c. negative feedback applied through R15 and R17 to the emitter of TR5.

This voltage is set to the required value by selection of resistor R13, which supplies positive bias to the base of TR5. Negative feedback at audio frequencies passes through the same feedback loop. The amount of this feedback is determined by the value of resistor R16.

The pre-amplifiers TR3 and TR4 serve to raise the signal levels to a value suitable for the input of this main amplifier.

POWER SUPPLY

Mains transformer T1 supplies a secondary voltage of 17 volts which, when rectified by a full wave bridge rectifier (diodes D1, D2, D3, D4) supplies a d.c. output which charges C1 up to almost 24 volts. The current then passes to the output through an electronic filter circuit, comprising R1, R2, C2 and C3 in conjunction with transistors TR1 and TR2. This is a very effective smoothing circuit, necessary here because of the need to supply smooth d.c. to the power amplifier without introduction of mains hum, which could leak into subsequent amplifying circuits. The filter derives its effect from a capacitance multiplying action, in which the effective capacitance of C3 is multiplied by the very high gain provided by the transistors.

SURGE LIMITING

Also incorporated in the power supply circuit is a surge limiting feature, which limits the output current to a maximum of about 500mA. Diode D5 clamps the voltage on the base of TR2 to about 0.5V above the voltage on the positive output terminal.

The current through R3 causes a potential difference to appear across this resistor. When this current approaches the desired limiting value, the voltage across R3 will approach the same value as the voltage across D5. This would tend to cut off the current through TR2, and hence through TR1, as these are directly coupled, so limiting the total current output to the sum of the currents flowing in R3 and D5.

It will be seen, on examination of the circuit, that the value of resistor R3 is critical in determining the maximum current which may be drawn from the power supply. By alteration of the value of this resistor, the current can be limited to the desired maximum value for various applications of the power supply circuit.

REVERBERATION UNIT

By A. J. BASSETT

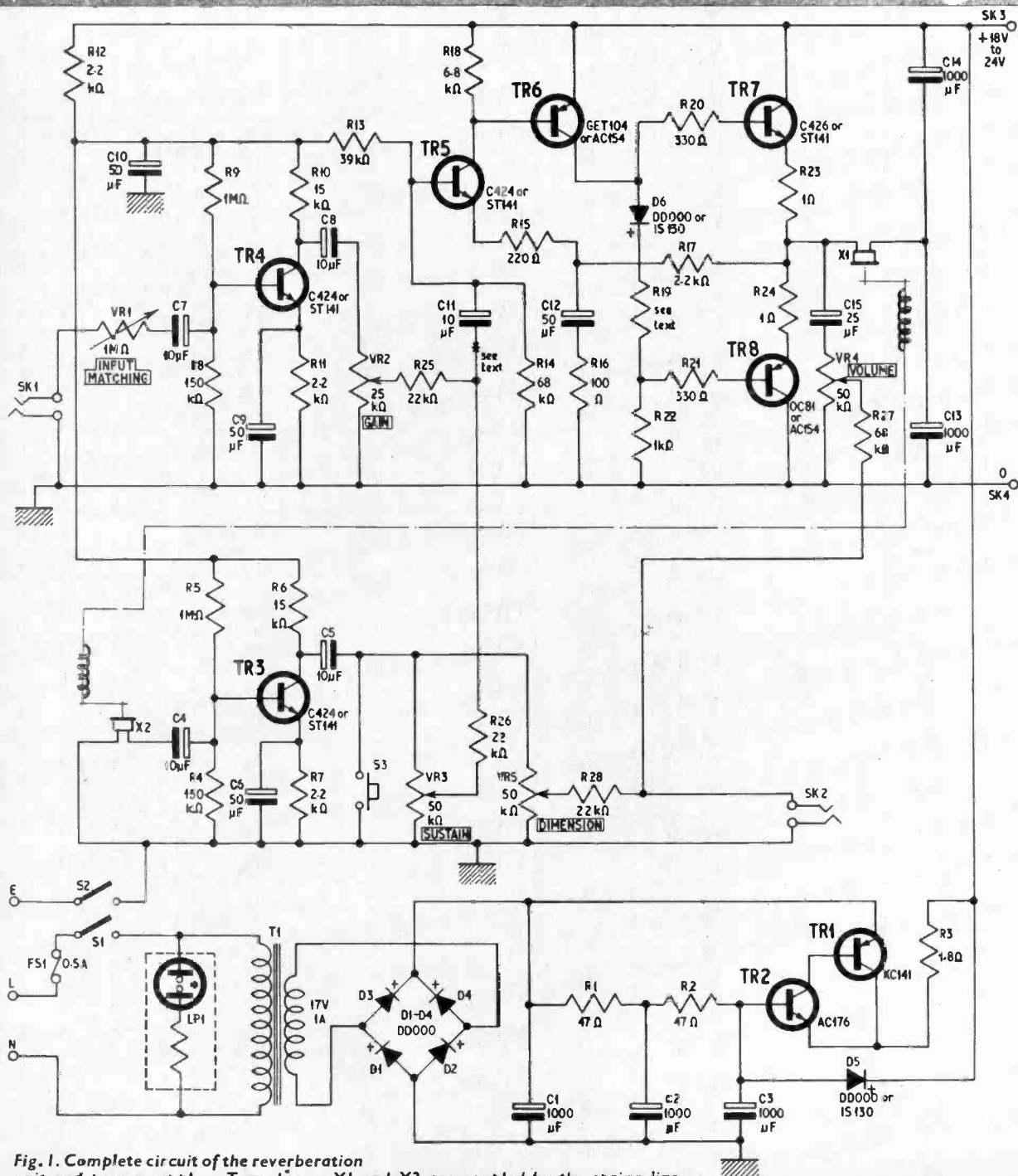

Fig. 1. Complete circuit of the reverberation unit and power supply. Transducers X1 and X2 are coupled by the spring line

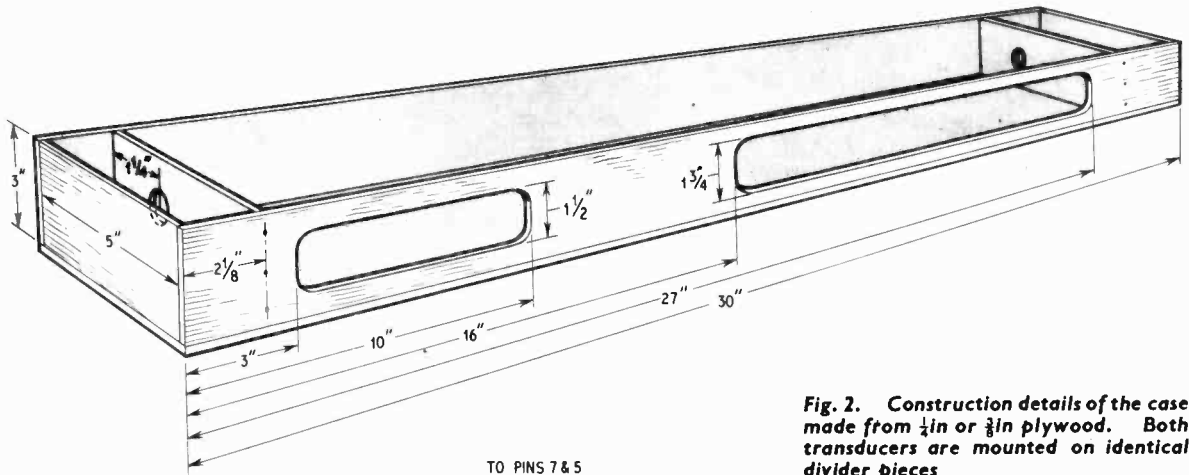

Fig. 2. Construction details of the case made from $\frac{1}{2}$ in or $\frac{3}{8}$ in plywood. Both transducers are mounted on identical divider pieces

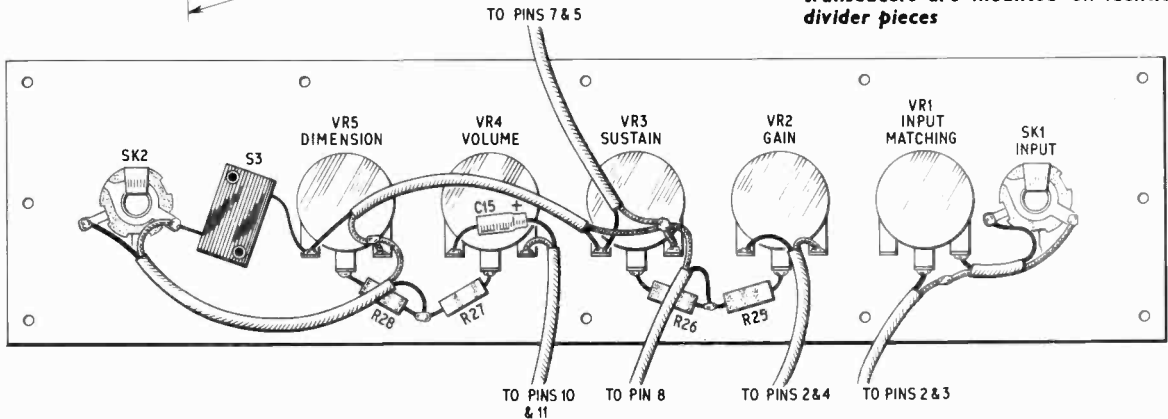

Fig. 3. Components and wiring on the amplifier control panel. Holes in the panel are drilled to size to suit components. Drawn here to half scale. Pin numbers refer to pin connections on the printed circuit layout below

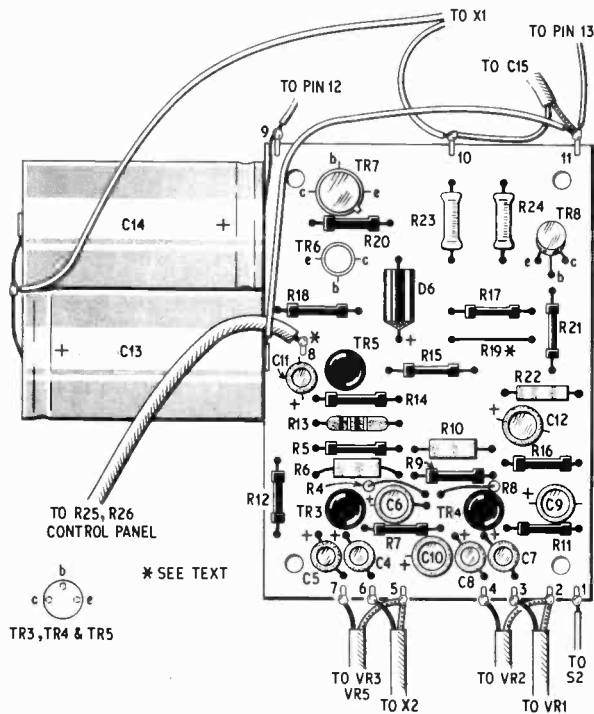

Fig. 4a (left). Component layout and wiring on the amplifier board. Connecting leads to the control panel have pin numbers. Pins 12 and 13 are on the power supply panel

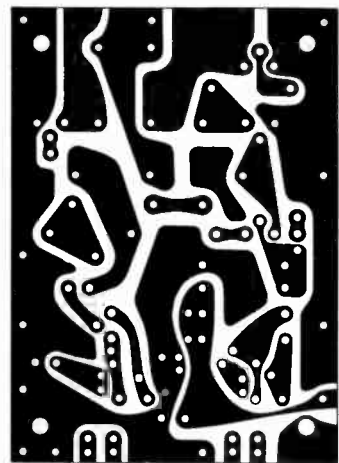
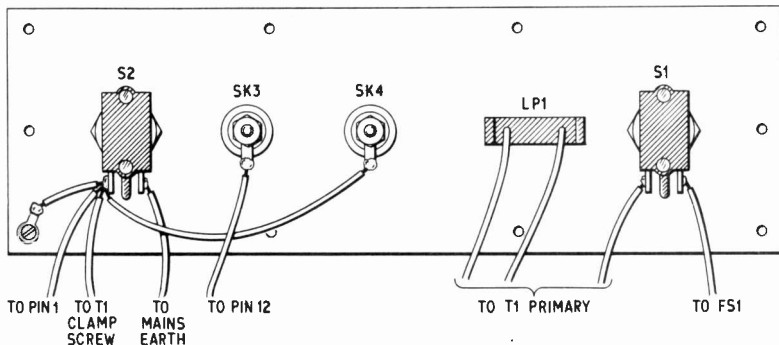

Fig. 4b (above). Printed circuit pattern for the amplifier panel drawn here half scale. The board can be etched by using a proprietary printed circuit kit

Fig. 5. Components and wiring on the power supply panel. Holes in the panel are drilled to size to suit components. Drawn here to half scale. The earthing connection from S2 to the soldering tag must also be connected to all pieces of foil lining the case. SK3 and SK4 are screw terminals for external supplies



Because of the very useful features of this power supply circuit it may be desirable for the experimenter to make use of it as an auxiliary supply, especially having regard to the fact that some future projects will operate from 18 to 24 volts. Therefore, the supply is connected to terminals on one of the control panels.

These terminals can be used as a low current source when the unit is plugged in to the mains, or as an alternative, they may be used for the purpose of running the reverberation unit from batteries, when connection to the mains would be inconvenient.

If it is required to use the power supply section by itself, without operating the reverberation section, a further switch cutting off the supply to the reverberation amplifier and pre-amplifiers can be inserted in the power output line.

POWER SUPPLY EARTHING SWITCH

The unit can be earthed either through its own mains supply connections, or through those of an external amplifier. If operating the unit with equipment which is not earthed, such as a battery powered amplifier, the earthing switch S2 earths the equipment via the mains earth wire, for safety and hum free operation.

If, on the other hand, the reverberation unit is connected to an amplifier which is already earthed, a severe hum level could be set up due to the formation of an "earth loop" via the two mains leads. In this case switch the earthing switch to its open-circuit position; the earth loop is broken, the hum level is much reduced, yet the equipment is safely earthed by the earth wire connection to the other apparatus.

WOODEN CASE

The wooden case is simple to make from $\frac{1}{4}$ in or $\frac{3}{8}$ in plywood; each piece is cut to size and glued with strong adhesive (see Fig. 2).

The headphone panels have $\frac{3}{8}$ in diameter holes and slots to accommodate connecting wire.

Cut the front panel as shown in Fig. 2 to accommodate the control panels. Cut out the control panels as Figs. 3 and 5 and screw to the wooden front panel.

All other wooden panels are cut to size and laid down in position on the bench ready for assembly. Before gluing the pieces together, apply a thin coat of impact adhesive to the inside surface of each piece and cover with aluminium cooking-foil. This foil should be in one complete piece for each piece of wood, with no joints. It will form an electrostatic screen on the inside of the cabinet and must be earthed via S2.

Assemble all the wood except the front panel and the lid using glue and panel pins, so producing the main structure of the cabinet. Whilst the glue is setting, proceed with other details of the construction.

PRINTED CIRCUIT BOARDS

Prepare and etch the printed-circuit panel designs shown in Figs. 4b and 6b. Glue the transistor heat sink on to the power supply printed board in the position shown (Fig. 6a), using Araldite epoxy resin. This may be set quickly by leaving in an oven at a low heat setting for 30 minutes, and allowing to cool in the oven with the door closed. It should not be cooled too rapidly or the adhesive may tend to crack.

Mount the components on to the amplifier board as shown in Fig. 4a. Resistor R19 in the author's amplifier was replaced by a link of copper wire, but a small value carbon resistor of a few ohms may be necessary in some instances to counteract crossover distortion.

When the printed board for the power supply circuit is cool, mount the components as shown in Fig. 6a. Bolt TR1 in place on the heat sink, using a little silicone grease to assist in heat conduction; make sure that the base and emitter leads do not touch the heat sink. A soldering tag may be fitted to

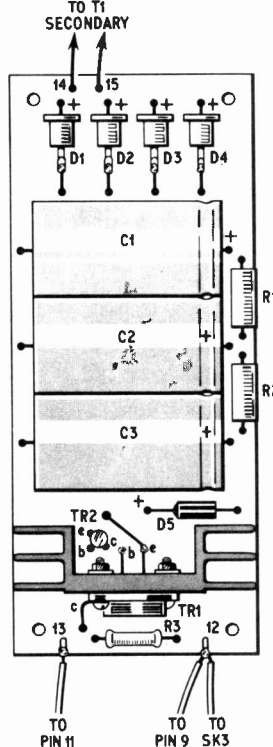

Fig. 6a (left). Layout of components on the power supply printed circuit board. Pins 9 and 11 are on the amplifier board

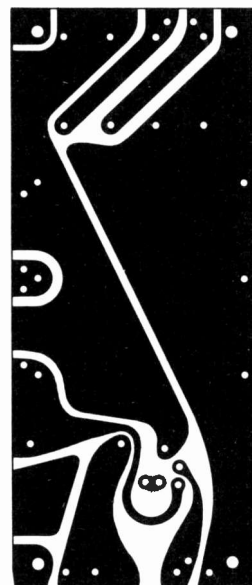

Fig. 6b (above). Printed circuit pattern drawn here half scale. Black areas are copper

COMPONENTS . . .

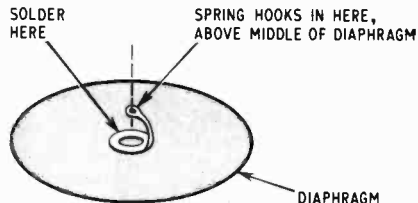
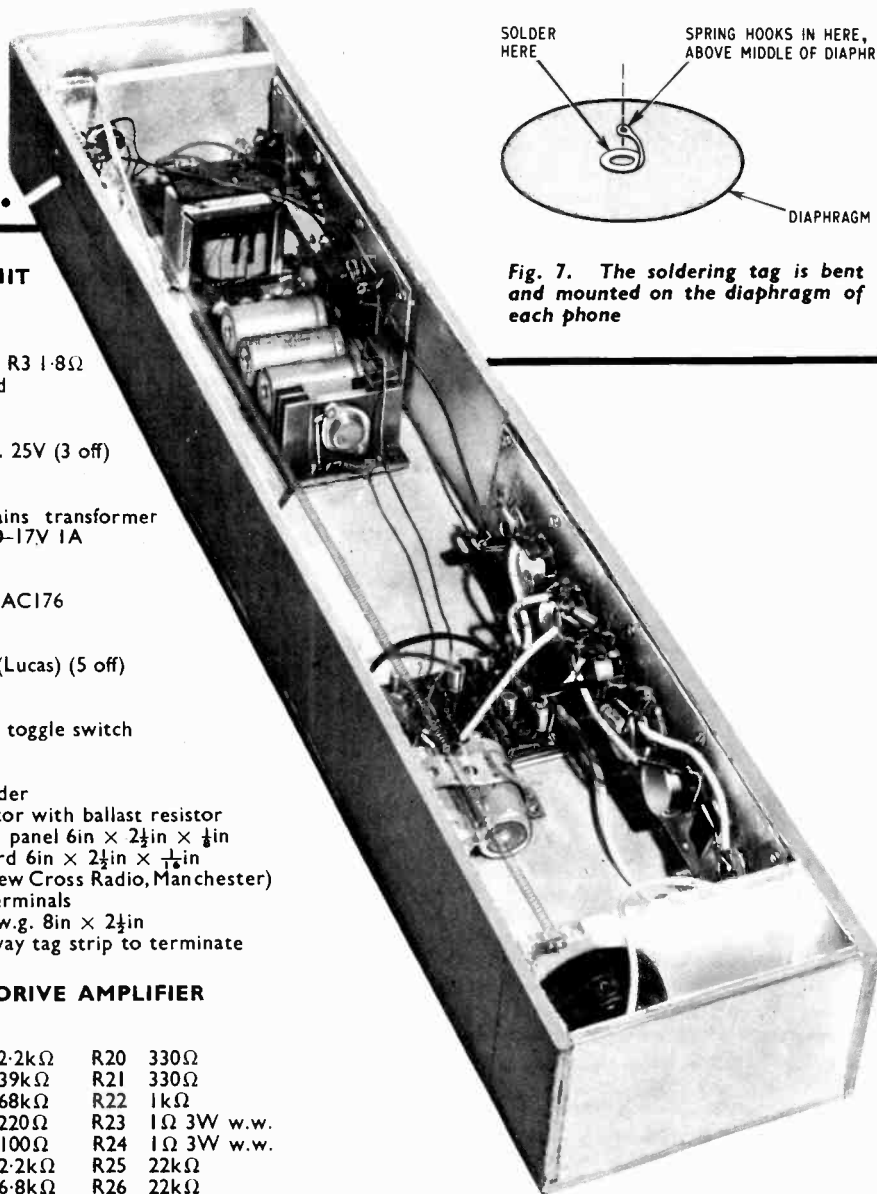

Fig. 7. The soldering tag is bent and mounted on the diaphragm of each phone

POWER SUPPLY UNIT

Resistors

R1 47 Ω R2 47 Ω R3 1.8 Ω
All 5%, 3W wirewound

Capacitors

C1, 2, 3 1,000 μ F elect. 25V (3 off)

Transformer

T1 Charger type mains transformer
Pri. 240V mains; SEC. 0-17V 1A

Transistors

TR1 XCI41 TR2 AC176

Diodes

D1, 2, 3, 4, 5 DD000 (Lucas) (5 off)

Switches

S1 Single pole, on/off, toggle switch

Miscellaneous

FS1 Fuse 0.5A with holder
LPI Neon panel indicator with ballast resistor
Printed circuit kit with panel 6in \times 2 $\frac{1}{2}$ in \times $\frac{1}{8}$ in
S.R.B.P. insulating board 6in \times 2 $\frac{1}{2}$ in \times $\frac{1}{16}$ in
Heat sink for XCI41 (New Cross Radio, Manchester)
Red and black screw terminals
Aluminium panel 18 s.w.g. 8in \times 2 $\frac{1}{2}$ in
Mains cable 3-core, 5-way tag strip to terminate

SPRING LINE DRIVE AMPLIFIER

Resistors

R4 150k Ω	R12 2.2k Ω	R20 330 Ω
R5 1M Ω	R13 39k Ω	R21 330 Ω
R6 15k Ω	R14 68k Ω	R22 1k Ω
R7 2.2k Ω	R15 220 Ω	R23 1 Ω 3W w.w.
R8 150k Ω	R16 100 Ω	R24 1 Ω 3W w.w.
R9 1M Ω	R17 2.2k Ω	R25 22k Ω
R10 15k Ω	R18 6.8k Ω	R26 22k Ω
R11 2.2k Ω	R19 see text	R27 68k Ω
		R28 22k Ω

All 10%, $\frac{1}{4}$ W carbon except R19, R23, R24

Potentiometers

VR1 1M Ω log carbon
VR2 25k Ω log carbon
VR3, 4, 5 50k Ω log carbon (3 off)

Capacitors

C4 10 μ F	C10 50 μ F
C5 10 μ F	C11 10 μ F
C6 50 μ F	C12 50 μ F
C7 10 μ F	C13 1,000 μ F elect. 25V
C8 10 μ F	C14 1,000 μ F elect. 25V
C9 50 μ F	C15 25 μ F elect. 25V

All electrolytic 15V except C13, C14, C15

Transducers

X1, X2 Moving diaphragm magnetic earphones, high impedance, d.c.r. 40 ohms (e.g. ex-Gov't type 4035B)

Transistors and Diode

TR3, TR4, TR5 C424 (S.G.S.-Fairchild)
or ST141 (Sinclair) (3 off)
TR6 GET104 or AC154 (Mullard)
TR7 C426 (S.G.S.-Fairchild) or ST141 (Sinclair)
TR8 OC81 or AC154 (Mullard)
D6 IS130 or DD000

Switch

SW3 Single pole, push on-push off press button switch

Miscellaneous

Printed circuit panel 3 $\frac{1}{2}$ in \times 2 $\frac{1}{2}$ in \times $\frac{1}{16}$ in
S.R.B.P. insulating board 3 $\frac{1}{2}$ in \times 2 $\frac{1}{2}$ in \times $\frac{1}{16}$ in
Aluminium panel 18 s.w.g. 12in \times 2 $\frac{1}{2}$ in
SK1, SK2 jacks
Helical steel tension spring 5 $\frac{1}{2}$ in long, $\frac{3}{16}$ in dia., 26 s.w.g.
Control knobs (Bulgin type K107) (5 off)
Single-core screened wire

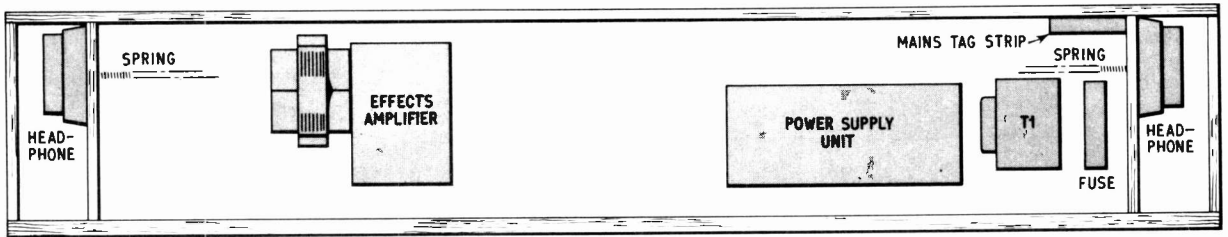

Fig. 8. Layout of units in the case

one of the brass screws at the same time, for subsequent connection of the collector of TR1 to the printed circuit board. After the collector, base, and emitter of TR1 have been wired to the printed circuit in this manner, fill the holes in the heat sink with polystyrene cement, or with Radiospares Sealing Compound, where the base and emitter leads come through. This will prevent lodging of dust in these spaces, which could lead to electrical unreliability if the dust contained metallic particles.

HEADPHONE TRANSDUCERS

Remove the front cover of each phone so as to gain access to the diaphragm. Find the exact centre of the diaphragm, and scrape away the varnish to expose a circle of clean metal about $\frac{1}{4}$ in in diameter. As this metal does not accept solder very easily, it is necessary to apply a thin layer of non-corrosive flux, and solder with a very hot iron or a solder-gun, giving a shallow pool of solder $\frac{1}{4}$ in diameter in the middle of the diaphragm.

A 4B.A. soldering tag which has been previously tinned and bent as shown in Fig. 6 is then soldered to the middle of each diaphragm so as to form an anchor-point for the spring. Cut a hole $\frac{1}{4}$ in diameter in the centre of the front cover of the phone, so that when it is re-assembled the soldering tag projects through this hole.

Each phone must now be mounted in its respective compartment at the ends of the cabinet. The headphones are mounted facing each other, with the tags projecting into the middle of the $\frac{1}{4}$ in hole in the wood. Roughen the front of the outer rim of the headphones with a file, and apply a ring of "Evo-Stik" impact adhesive to each phone. Immediately press it into place on the wood, so that a ring of adhesive is deposited there. Remove the phone from the wood and set it

Power supply section

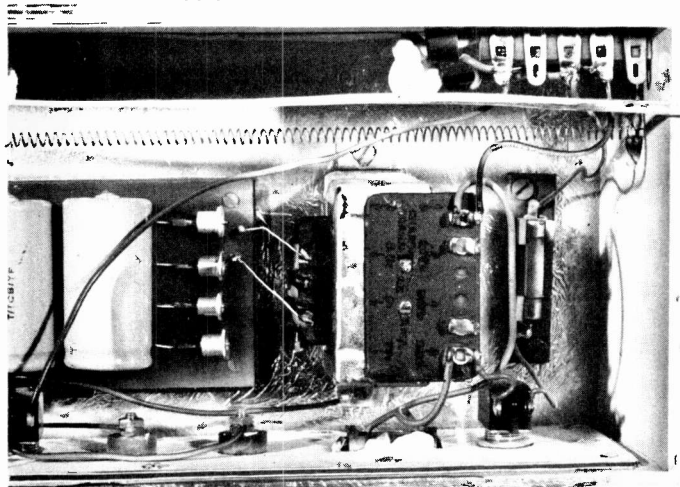

aside for a few minutes in accordance with the instructions on the adhesive package, making sure first that the adhesive on both wood and phone is evenly spread.

When the adhesive has become partly set (about 5 to 15 minutes according to temperature and thickness of the layer) press the phone firmly into place, when it should stick firmly in position.

Follow the same procedure for both phones so that when in position they face each other.

Hook the loop at one end of the spring into the small hole in one of the soldering tags, and stretch it evenly to hook into the other tag. Be very careful not to let the spring fly back when it is stretched, as it may break the diaphragm in one of the phones.

Fix the printed circuit boards in position in the cabinet with wood screws, using the insulated boards to separate the copper sides from the aluminium foil on the wood. Mount in position also the mains transformer, fuseholder, and capacitors C13, C14. Mount the potentiometers, switches, sockets, terminals, and neon indicator on the control panels.

Wire the unit according to the layout diagram in Fig. 6. All connections to the "signal and effects" control panel components should use screened wire with the screen connected to the common line to S2. The connection to the "receive" transducer X2 should also use screened wire.

The aluminium panels, foil, and the frame of the mains transformer should be connected to the common line to S2 using thick copper wire. The mains cable passes through a small hole in the rear panel, to a cable-clamp fastened inside, then terminated on the tag strip mounted in the box. Check that wiring and components are correct, then test as follows.

TEST THE POWER SUPPLY UNIT

Disconnect the positive power supply wire from the amplifier. Connect a 470 ohm 1 watt wirewound resistor across the output terminals. Plug into the mains and switch on. The output voltage of the power supply, measured across the terminals on the control panel should be slightly over 20 volts. Switch off, remove the 470 ohm resistor, and reconnect the amplifier.

TEST THE AMPLIFIER

Turn all controls to their minimum setting, and switch on again. The voltage at the junction of R23 and R24 should rise to about half the supply voltage. If it is more than, say, a couple of volts away from this value, switch off and change the value of R13 to bring this voltage nearer to its correct value.

Connect the unit to an external amplifier and loud-speaker via the output socket SK2, and plug in a microphone or other signal source at the input socket SK1. When adjusting the "gain" (VR2) and "volume" (VR4) controls, the signal should be heard through the loud-speaker. If the signal source is of high impedance, or

high output, adjust VR1 to give suitable matching, thus avoiding distortion at the input.

Check also the collector voltages of TR3, TR4, which should be in the region of 6 to 10 volts. It may be necessary to select transistors for these positions, or to alter the bias resistors R5 or R9 in order to achieve best results.

If crossover distortion is apparent from the amplifier, it may be necessary to use a higher value of resistor in place of R19, and in order to determine the best value, connect a 200 or 250 ohm potentiometer temporarily in this position, and gradually raise the value until the distortion is cleared. Be careful, as too high a value of resistor in this position will cause an excessive current to flow in the output transistors, causing them to overheat, and possibly to become damaged. The amount of current flowing through the entire amplifier (including pre-amplifiers) is about 15mA under quiescent conditions, rising to over twice this value for strong signals.

OBTAINING EFFECTS

Adjust the volume and gain controls so that the input signal is heard clearly through the loudspeaker. Carefully adjust "dimension control" VR5. If the reverberation switch S3 is in the open-circuit condition, varying degrees of reverberation should be obtained according to the setting of VR5. If, however, this control is set too high, acoustic feedback may occur as the unit is unavoidably somewhat microphonic.

The sustain control can be used to prolong the reverberation period, but, like the dimension control, should be used only moderately in order to avoid feedback problems.

REMOTE CONTROL

When the reverberation switch is operated, the reverberation effects should disappear and return according to the position of the switch. If it is desired to operate the unit from a remote switch, replace S3 by a standard audio jack socket into which a screened footswitch is plugged via a length of coaxial cable. If the "dimension" and "sustain" controls are deliberately set to obtain feedback, this may then be easily switched on and off for special effects.

ADVANTAGES AND DISADVANTAGES OF THIS TYPE OF UNIT

The use of headphones as transducers gives the advantage that the unit is much cheaper to construct than by other methods. Although the size of the unit is somewhat greater than that of some comparable commercial units, the author found that it is worthwhile to stretch the spring considerably in the interest of a better sounding effect.

The use of headphones gives the disadvantages of acoustic feedback, and colouration of the sound. This can be counteracted by replacing the entire spring assembly with a "Hammond Mk. IV" or similar mechanical system. The circuit given can be used with such a unit, and results are better, but a commercially built spring system must be obtained.

USE WITH OTHER EQUIPMENT

The reverberation unit can be used with most audio equipment, and with the *Fuzz Box* described in last month's issue gives a combined effect. It can also be used with the electronic sound sources to be described later for the production of electronic music and sound effects. ★

NEXT MONTH

What is
PEAC
?

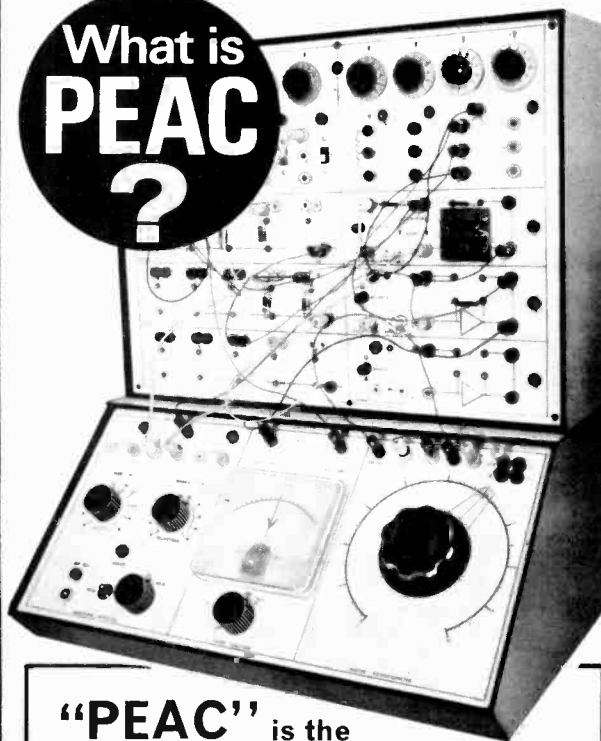

"PEAC" is the PRACTICAL ELECTRONICS ANALOGUE COMPUTER

Performance measurement of electronic circuits simulated by this computer

Extra value with better accuracy than commercial analogue computers costing up to twice as much

An exciting, interesting inexpensive project to build with a high order of flexibility

Can solve differential, algebraic, and simultaneous linear equations

* * *

Practical useful tool for the serious experimenter

Extensible by means of additional sub-units to solve complex problems

All circuits operated "in parallel"—up to 30 solutions per second

Colleges and schools will find PEAC a valuable instructional aid

PLUS TAPE RECORDER

with separate record and replay amplifiers using integrated circuits

PRACTICAL

JANUARY ISSUE ON SALE DEC. 15

ELECTRONICS

LAST month some typical digital integrated circuits were described, and it was established that with most types of digital circuitry a certain amount of standardisation occurs between different manufacturers. This month we look at the linear types of circuit that are available, and describe in detail a few of the more general purpose devices.

Linear circuits can be broadly classified as all those which are not digital, and include such types as amplifiers, detectors, oscillators, mixers, comparators, and even resistor networks. As any constructor will know there are many different basic designs which can be called on to perform these functions, and the natural result of this is that there is much less standardisation between manufacturers, and although there may be

many different types available no single unit is produced in anything like the same quantity as digital circuits. It follows immediately that linear integrated circuits, on the whole, are more expensive than their digital counterparts.

Cost, however, is purely relative, and in many instances the amateur will find that there is very little to choose between buying a ready made unit, and constructing his own at home—needless to say there is always an added risk in the latter that after building, the unit may or may not be satisfactory. At high frequencies, the integrated circuit really comes into its own, as it substantially reduces layout problems which directly leads to reductions in parasitic capacitance and inductance.

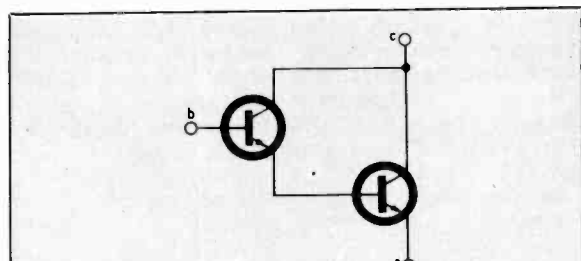

Fig. 21. Darlington pair

SUPER-ALPHA PAIR

Perhaps the most simple linear circuit is the super-alpha transistor pair, or Darlington pair. This is shown in Fig. 21. This compound unit can be considered as a single transistor having a very high base input impedance and a very high current gain. The effective gain of the unit is the product of gains of the two individual transistors it comprises. Current gain can be typically in excess of 600.

Many manufacturers offer this circuit as a device in its own right, and also in matched pairs which are commonly used for the input of differential amplifiers. In this case variations of temperature will not seriously affect the stability of the final amplifier as the transistors are integrated into a single chip, and temperature effects are self-cancelling.

As temperature effects do not greatly influence well designed integrated circuits, and capacitors are usually to be avoided for the reasons given in previous parts of this series, most circuits to be encountered are direct coupled. This is advantageous as it allows a far wider application for any particular circuit.

A comparatively simple circuit of this type, which utilises two Darlington pairs as a differential input is the Texas SN524A shown in Fig. 22. Either input may be used provided the other is strapped to earth through a suitable resistor for normal single input applications, or both may be used for differential, or comparative purposes. A point to note is that if single input is used there is a choice to be made between an inverted, or non-inverted output signal.

Most integrated circuit amplifiers have a facility for frequency characteristic modifications. This can take the form of an output point for a capacitor to set the top frequency roll-off (in this circuit pin 10), or outputs to allow external feedback circuits. In the case of the SN524A, negative feedback is obtained by an external network between pins 8 and 1. Positive feedback would occur if the non-inverting input (pin 5) was used.

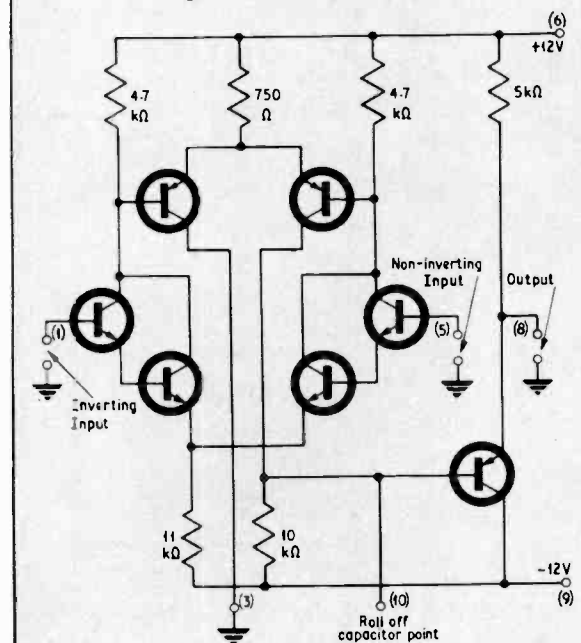

Fig. 22. Circuit of the SN524A differential amplifier

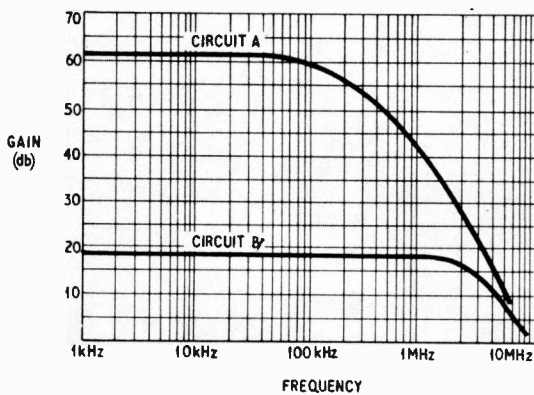

Fig. 23. Two possible circuit configurations using the SN524A with the frequency response of both

By careful selection of feedback it is possible to modify the overall characteristics of the amplifier quite considerably from one having very high gain at low frequencies to having medium gain at high frequencies. Two examples of this are shown for this circuit in Fig. 23.

Basic characteristics of this circuit are:

Voltage gain (no feedback)	63dB
Bandwidth (no feedback)	140kHz
Input impedance	1M Ω
Input offset voltage	12mV
Output impedance	200 Ω
Output voltage swing (max)	15V
Power dissipation	120mW

OPERATIONAL AMPLIFIER

Whilst the SN524A could be used (not necessarily to best advantage) without any external components, there is a family of circuits which rely solely on the addition of external components both to make a functional block, and also to modify parameters.

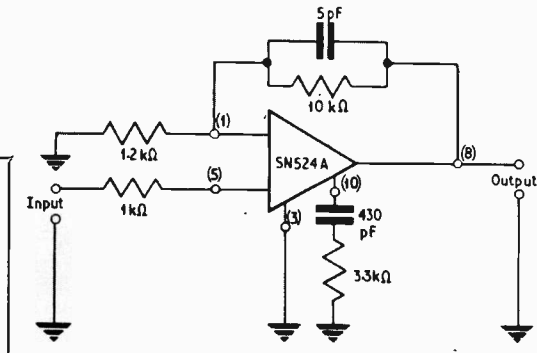
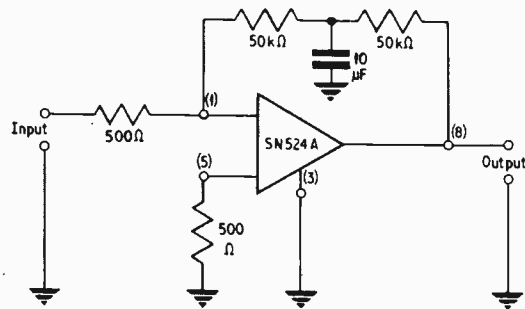

These amplifiers are called "operational" or instrumentation amplifiers, and are designed to allow the widest possible use of a standard integrated device.

Basically these circuits can be regarded as being a means of obtaining gain and nothing else. By suitable external circuitry it is possible to make oscillators, differential amplifiers, and all other types of amplifiers from these basic units. A typical example of an operational amplifier is the Plessey SL 751B shown in Fig. 24.

Note the basic similarity between this, and the previous circuit, but also the number of available terminations. An example of external circuitry required to form an amplifier having a gain of 40dB up to 400kHz is shown in Fig. 25.

Fig. 24. Circuit of the SL 751B operational amplifier. Pin connections for the flat-pack version are shown

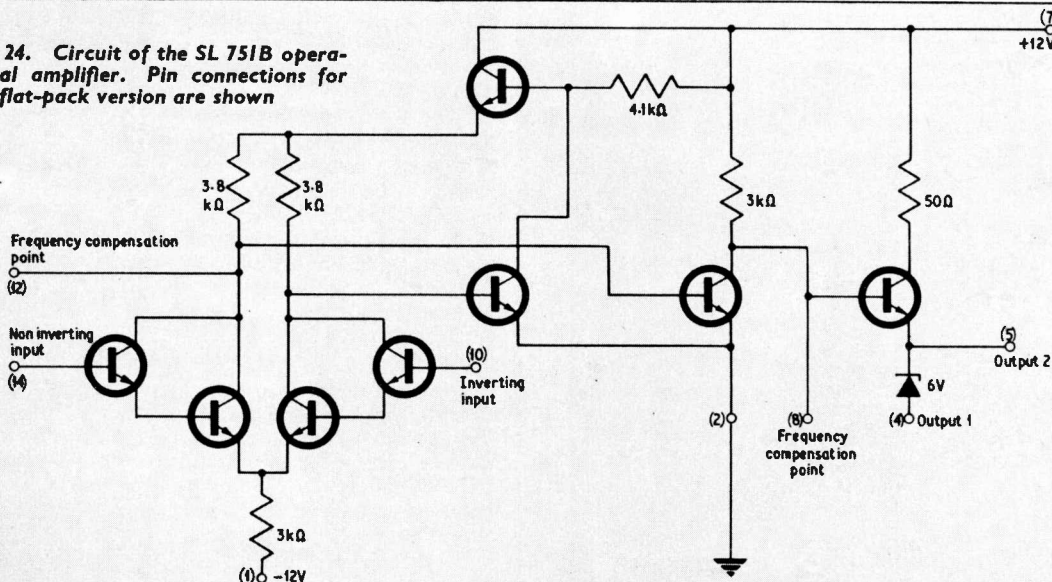

EXCEL in ELECTRONICS

Through this ICS 3-way Training Method:

1

MASTER THE THEORETICAL SIDE

From basic principles to advanced applications, you'll learn the theory of electronic engineering, quickly and easily through ICS. That's because each course is set out in easy-to-understand terms.

2

MASTER THE PRACTICAL SIDE

ICS show you how to develop your practical abilities in electronic engineering—*alongside* your theoretical studies. It's the only sure way to success. All training manuals are packed with easy-to-follow illustrations.

3

MASTER THE MATHEMATICAL SIDE

To many this aspect is a bitter problem. Even more so because no electronic engineer is complete without a sound working knowledge of maths. But new ICS teaching makes mathematics easier to learn.

Wide range of courses available include:

Radio/T.V. Engineering and Servicing, Closed Circuit T.V., Electronics, Electronics Maintenance, Instrumentation and Servomechanisms, Telemetry, Computers, etc.

NEW! Programmed Course on Electronic Fundamentals

EXPERT COACHING FOR:

INSTITUTION OF ELECTRONIC AND RADIO ENGINEERS
CITY AND GUILDS TELECOMMUNICATION TECHNICIANS
R.T.E.B. RADIO/T.V. SERVICING CERTIFICATE
RADIO AMATEURS' EXAMINATION
P.M.G. CERTIFICATES IN RADIOTELEGRAPHY

And there are practical "learn as you build" radio and electronics courses as well.

Member of the Association of British Correspondence Colleges

FOR **FREE** HANDBOOK POST THIS COUPON TODAY

I.C.S., Dept. 151, INTERTEXT HOUSE,
PARKGATE ROAD, LONDON, S.W.11

NAME

ADDRESS

OCCUPATION.....AGE.....12/67

INTERNATIONAL CORRESPONDENCE SCHOOLS



Box clever! GET MASTERTAPE IN THE TERRIFIC NEW TAPE BOOKS



The modern way to buy your recording tape. New Mastertape Tape Books are both practical and attractive—a one piece tape book in unbreakable black plastic with gold lettering and colour coded for standard, long, double and triple play covering the popular sizes of 5", 5½" and 7".

Standardise your personal tape library with Mastertape Tape Books—fine packs for a fine recording tape. Available now at your usual tape stockist.

mastertape

IN THE TERRIFIC NEW TAPE BOOKS

Manufactured in England by
Mastertape (Magnetic) Limited, Colnbrook, Slough, Bucks.

BUILD YOURSELF A QUALITY TRANSISTOR RADIO—FULL AFTER SALES SERVICE!

THE MAGNIFICENT ROAMER 7^{M+ IV}

SEVEN WAVEBAND PORTABLE AND CAR RADIO WITH A SUPER SPECIFICATION



- 7 FULLY TUNABLE WAVE BANDS—MW1, MW2, LW, SW1, SW2, SW3 and Trawler Band.
- Extra Medium waveband provides easier tuning of Radio Luxembourg, etc.
- Built in ferrite rod aerial for Medium and Long Waves.
- 5 Section 22 in. chrome plated telescopic aerial for Short Waves—can be angled and rotated for peak S.W. listening.
- Socket for Car Aerial.
- Powerful push-pull output.
- 7 transistors and two diodes including Philco Micro-Alloy R.F. Transistors.
- Famous make 7×4 in. P.M. speaker.
- Air spaced ganged tuning condenser.
- Separate on/off switch, volume control, wave change switches and tuning control.
- Attractive case with hand and shoulder straps. Size 9×7×4 in. approx.
- First grade components.
- Easy to follow instructions and diagrams make the Roamer 7 a pleasure to build with guaranteed results.

Total building costs
£5.19.6 P. & P. 5/6 Parts price list and easy build plans 3/- (FREE with kit).

TRANSONA FIVE

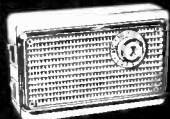

MEDIUM WAVE, LONG WAVE AND TRAWLER BAND PORTABLE

Attractive case with red speaker grille. Size 6½ × 4½ × 1½ in. Fully tunable. 7 stages—5 transistors and 2 diodes—ferrite rod aerial, tuning condenser, volume control, fine tone super dynamic speaker, all first grade components. Easy build plans and parts price list 1/6 (FREE with kit).

Total building costs
42/6 P. & P. 3/6

POCKET FIVE

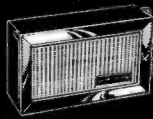

TWO WAVEBAND PORTABLE WITH 3in. SPEAKER

Attractive black and gold case. Size 5½ × 1½ × 3½ in. Fully tunable over both Medium and Long Waves with extended M.W. band for easier tuning of Luxembourg, etc. All first grade components, 7 stages—5 transistors and 2 diodes—super-sensitive ferrite rod aerial, fine tone 3in. moving coil speaker, etc. Easy build plans and parts price list. 1/6 (FREE with kit).
POCKET FIVE Medium and Long Wave version with miniature speaker ONLY 29/6. P. & P. 3/6.

Total building costs
39/6 P. & P. 3/6

MELODY SIX

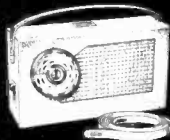

TWO WAVEBAND PORTABLE WITH 3in. SPEAKER

Handsome leather-look case, size 6½ × 3½ × 1½ in. with gilt trim and hand and shoulder straps. Fully tunable over both Medium and Long Waves. Incorporates pre-tagged circuit board, 8 stages—6 transistors and 2 diodes—ferrite rod aerial, push-pull output, wave change slide switch, tuning condenser, volume control, 3in. moving coil speaker, etc. Easy build plans and parts price list 2/- (FREE with kit).

Total building costs
59/6 P. & P. 3/6

MELODY MAKER 6



THREE WAVEBAND PORTABLE WITH 3in. SPEAKER

Smart pocket size case, 6½ × 3½ × 1½ in. with gilt fittings. Fully tunable over both Medium and Long Waves with extra M.W. band for easier tuning of Luxembourg, etc. 8 stages—6 transistors and 2 diodes—top grade 3in. speaker, 2 R.F. stages for extra boost, high "Q" ferrite rod aerial. Easy build plans and parts price list 2/- (FREE with kit).

Total building costs
69/6 P. & P. 3/6

ROAMER SIX



SIX WAVEBAND PORTABLE WITH 3in. SPEAKER

Attractive case with gilt fittings, size 7½ × 5½ × 1½ in. World wide reception. Tunable on Medium and Long Waves, two Short Waves, Trawler Band plus an extra M.W. band for easier tuning of Luxembourg, etc. Sensitive ferrite rod aerial and telescopic aerial for Short Waves. All top grade components, 8 stages—6 transistors and 2 diodes including Philco Micro-Alloy R.F. Transistors, etc. (carrying strap 1/6 extra). Easy build plans and parts price list 2/- (FREE with kit).

Total building costs
79/6 P. & P. 3/6

SUPER SEVEN



THREE WAVEBAND PORTABLE WITH 3in. SPEAKER

Attractive case size 7½ × 5½ × 1½ in. with gilt fittings and carrying strap. The ideal radio for home, car or outdoors. Covers Medium and Long Waves and Trawler Band. Special circuit incorporating 2 R.F. stages, push-pull output, ferrite rod aerial, 7 transistors and 2 diodes, 3in. speaker (will drive larger speaker) and all first grade components. Price list 2/- (FREE with kit).

Total building costs
69/6 P. & P. 3/6

RADIO EXCHANGE Ltd

61a HIGH STREET, BEDFORD

Telephone: Bedford 52367

Callers side entrance Barratt's Shoe Shop. Open 9-5 p.m. Saturday 9-12.30 p.m.

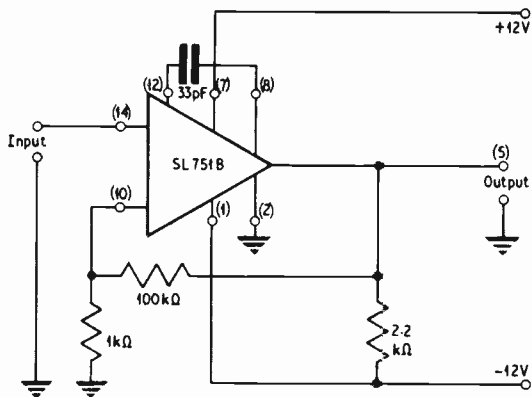

Fig. 25. The SL751B with added components to provide a 400kHz, 40dB amplifier

Fig. 26. Circuit of the ZBA1 single transistor stage. Pin connections for the TO-5 pack are shown

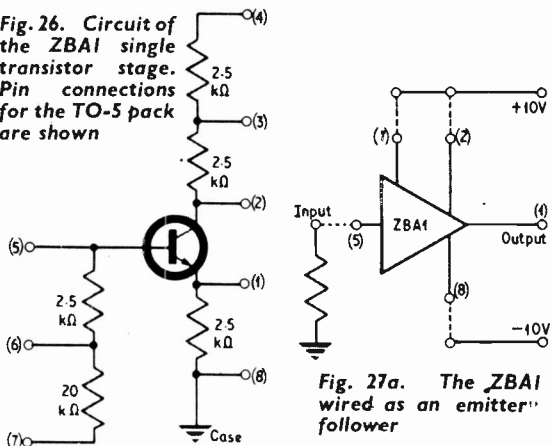

Fig. 27a. The ZBA1 wired as an emitter follower

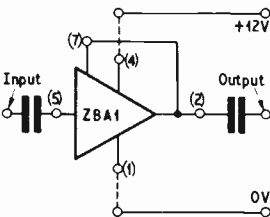

Fig. 27b. The ZBA1 wired as a common emitter audio amplifier

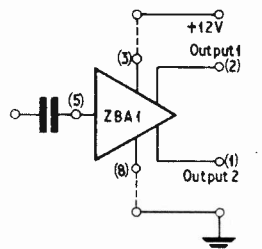

Fig. 27c. The ZBA1 wired as a phase splitter

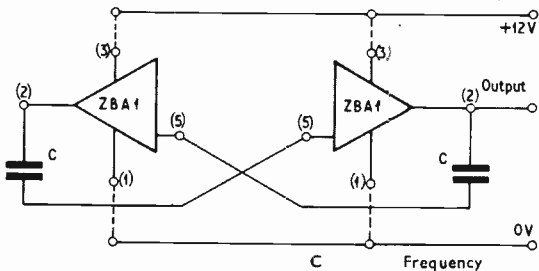

Fig. 27d. The ZBA1 wired as a free running multivibrator

C	Frequency
0.001 μ F	33kHz
0.0047 μ F	8kHz
0.01 μ F	2.5kHz
0.033 μ F	1.25kHz
3.3 μ F	10kHz

Whilst in some cases it is possible to obtain amplifiers having facilities for inductance tuned collectors, e.g. for conventional i.f. work, these inductors always have to be included as external components. A more modern approach is to use a transfilter or similar device in a negative feedback loop associated with amplifiers of the above types. For very narrow pass bands, or oscillators, a simple bridged-T RC network can be used in negative, or positive feedback respectively.

The above circuits are rather special as they are designed to make as much use as possible of integrated circuit techniques, but in some instances they may be over complicated. Although they are usually very well described with detailed circuitry in manufacturers' applications reports, they may present theoretical problems for the more inexperienced experimenter. There are, however, a number of conventional circuits available, and these range from simple single transistor stages to complete video amplifier stages.

SINGLE STAGE

An example of the single stage is the Ferranti ZBA1 shown in Fig. 26. A certain amount of redundancy is built into the chip because it is necessary to offer various choices of resistors for different loads and bias conditions, therefore more resistors are shown than one would normally encounter in a single stage. Fig. 27 shows the way in which this stage can be used to form

- an emitter follower,
- a common emitter audio stage,
- a phase splitter having two equal amplitude outputs 180 degrees out of phase, and
- a free running multivibrator oscillator which could be used as a test signal injector.

Typical characteristics of this circuit are as follows:

Supply voltage	6V
D.C. current gain	30 (min)
Current gain (at 10MHz)	5

A slightly more complex circuit is the ZLA10 wide-band amplifier shown in Fig. 28. Basically a two-stage, direct coupled amplifier, the unit has an 880 ohm feedback resistor built in, which can be used if wider

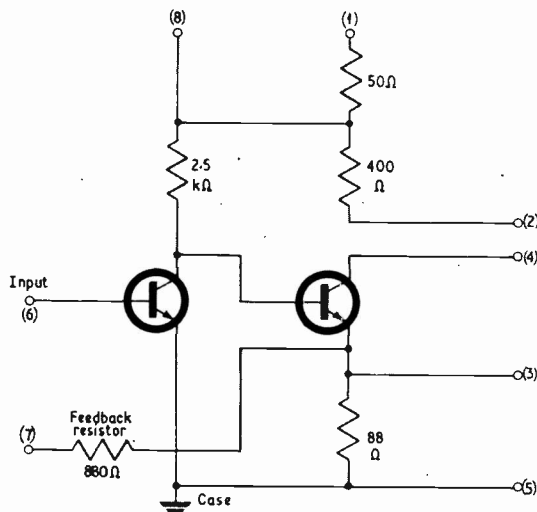

Fig. 28. Circuit of ZLA10 wide band amplifier. Pin connections for the TO-5 pack are shown

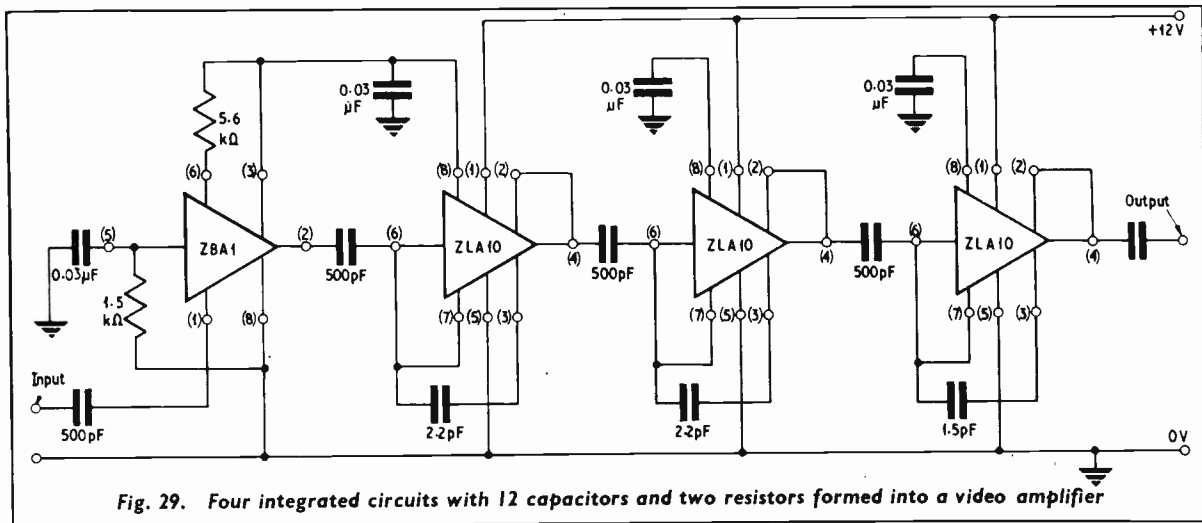

Fig. 29. Four integrated circuits with 12 capacitors and two resistors formed into a video amplifier

bandwidth at a lower gain is required. There is an optional open circuit collector which allows the use of external loads, e.g. an inductor, but under normal circumstances pin 4 would be short-circuited to pin 2 thus utilising the built-in load resistors.

Typical characteristics are:

Supply voltage	12V
Current gain	10
Upper frequency limit	120MHz
Output impedance	400Ω
Power dissipation	150mW

An example application utilising the ZLA10 and the ZBA1 is shown in Fig. 29. This circuit is a video amplifier having the input and output matched to 50 ohms thus making it ideal for use as a television video mixer panel amplifier. Suitable modifications could make it the basis of a home made television camera. In this application the ZBA1 is used as a grounded base stage having a low input impedance. Overall characteristics of the circuit are:

Input impedance	50Ω
Output impedance	50Ω
Voltage gain	52dB
Bandwidth	95MHz
Power consumption	430mW

In the space of this article it is impossible to describe all the various types of linear circuits that are available, but it is hoped that the outlines given will encourage experimentation. Most manufacturers are only too pleased to give help in the form of very detailed applications hints that deal explicitly with their own circuits.

To sum up the series it is obvious that the integrated circuit is well and truly here to stay, and is certainly well inside the price limit of the average experimenter. It only remains to make the best possible use of this new development, and as more use is made so the prices will fall.

DO's AND DON'Ts

Use the simplest possible circuit for a given application.

Try and use the most common circuits (these are the cheapest).

When using logic circuits stick to one type for a given application unless other types are stated as being directly compatible.

Avoid mixing package types (TO-5, flat-pack, and dual-in-line) unless it is unavoidable. Amateurs will find the dual-in-line, and TO-5 most easy to handle.

Make absolutely certain that the circuit board, or printed circuit is correctly wired before inserting the integrated circuits. It is extremely difficult to remove them without a special de-soldering tool.

Do not load more than the stipulated maximum fan outs on gate circuits.

Do not apply more than the specified supply voltage. Ensure that polarity of supply voltage is correct.

Make sure that there are no solder runs between pins of packages.

Do not apply soldering heat for more time than is necessary to make the joint.

In complex systems ensure that the dissipated heat can be removed.

Remember that it may be necessary to decouple between stages particularly in TTL, and all linear circuits.

DEVELOPMENTS

Where are integrated circuits likely to go from here? Already there are highly specialised techniques for manufacturing special types of circuit (e.g. the metal oxide semiconductor device). This particular technique could bring about the introduction of large scale integration in the space of the next year or two. It is already possible to buy 21-bit shift registers on a single chip.

S.T.C. have recently announced a new concept which they call DOFICS (Domain orientated functional integrated circuits). These will allow amplifiers and oscillators to operate by the control of waves of electrons through geometrically shaped pieces of semi-conducting material (the Gunn effect). If notches are introduced to the geometrical structure, pulses can be obtained at each notch, the number of pulses generated being proportional to the distance and speed of the wavefront. Here then is a very simple analogue-to-digital converter. A further possibility using this concept is the development of solid state replacements of the conventional cathode ray tube.

What the future holds is still a little obscure, but certainly there are going to be even more changes in techniques and applications in this rapidly expanding field. ★

Proportional Servo System

for MODEL CONTROL

By J. Tennant

THE availability of high frequency transistors has markedly changed radio control techniques. A few years ago, it was usual to employ the "bang-bang" system of control whereby the presence of the transmitter carrier frequency caused the receiver to operate a simple relay. This in turn supplied power to the coils of actuators or simple escapements worked by rubber bands and connected in ingenious ways to operate the model's controls sequentially.

The rudder of a boat, for example, could be turned to the right on full lock, released to a self-centred position then, after an interval, turned to the left on full lock. Skilled operation was necessary to make the model perform simple functions. Today, multi-channel proportional equipment enables an enthusiast to set such a ship's rudder at any angle between locks for any length of time, vary it at will, and simultaneously operate other controls.

BASIC SYSTEM

The servo system described here is intended for use with radio control equipment but is also suitable for other applications such as two-wire rotational control of indicators, volume controls and light mechanisms.

The carrier frequency of the transmitter 26.96 to 27.28MHz is modulated by an audio tone (or tones for multi-channel control) which is, in turn, proportionally controlled by one of several methods. The resulting output of the receiver is applied to a servo amplifier and motor.

It is arranged that a change of receiver output causes the motor to rotate turning a small potentiometer through a gear train until a voltage derived from the potentiometer equals and neutralises that from the receiver. A relatively large torque is obtained from the final gear which takes up a position "proportional" to that of a potentiometer control on the transmitter.

Although the price of a complete five- or six-channel servo proportional system is in the order of £100, some of the circuitry is identical to simple systems which could be converted subject to the addition of tone filters, discriminators, servo motors, and allied amplifiers.

The availability of small motors in the price range 2s to 5s suggested the thought that if such a motor were "doctored" to give reasonable reliability, and a gear train fitted, then all that would be necessary to produce a cheap servo would be the amplifier.

Equation must always be made between reliability and cost but if the motor is treated as having a distinct "life" a reasonable compromise is effected. The particular motor chosen for the first tests was rather large and suitable for boat work. It had a "start-to-run" load of 350mA on no load and an efficiency of approximately 30 per cent. Burrs on the armature

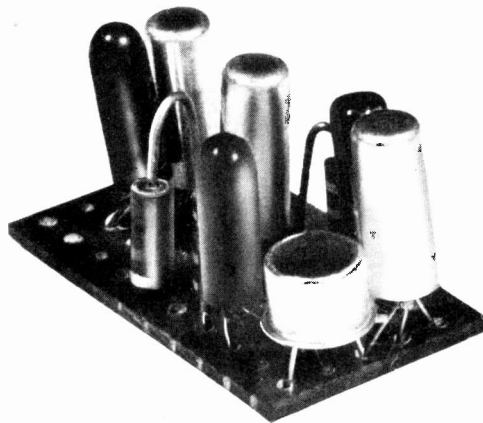

were removed, the pole pieces centred by packing and the spring commutator contacts treated with switch cleaning fluid.

A simple Meccano type gear train was fitted with a ratio of 50 : 1, the final gear being a push fit on a 10 kilohm potentiometer spindle acting as a clutch.

AMPLIFIER

The basic amplifier circuit used (Fig. 1) is similar to many existing designs. Equivalent transistors may be used and the resistor values are not critical, subject to certain effects common to servo systems which depend on the type of motor and gear ratio used. As a guide, consider the action of TR1, TR2, and TR3.

TR3 has to pass the full "stalled" load current of the motor. This is limited by the battery's internal resistance and by the voltage across the transistor (V_{BE}) and may be further reduced if necessary, by R_x which should be as low a value as possible to give the maximum running torque. TR3 is a *pnp* OC84 with an $I_{C(max)}$ (maximum current) of 1A and a current gain of at least 60. OC72, OC76 and OC77 are similar transistors having a current gain of 45, but an $I_{C(max)}$ of only 250mA.

The current into the base of TR3 is
$$\frac{I_{C(max)}}{\text{gain}} = \frac{1000}{60} = 16\text{mA}$$
 This is provided from TR2 which is an *npn* transistor with a gain of at least 80 (and an $I_{C(max)}$ of 400mA). TR2 and TR3 operate in the "bottomed" condition only, for short periods so "power" limitations may be ignored. TR1 is a *pnp* OC202 with a gain of at least 45. ($I_{C(max)} = 100\text{mA}$.)

Though high gain transistors have been chosen for best performance, less expensive ones may be used provided that $I_{C(max)}$ is not exceeded. It is possible to measure the gain of a transistor with a simple circuit, and it is often found that an individual cheap transistor has a higher gain than an expensive one that has a specified minimum gain.

Suppose point A (Fig. 1) is joined to 0V. If point B is made at least -0.7V (V_{BE}) then TR1 conducts developing a voltage across R_2 which turns on TR2 and TR3 causing the motor to run, the current passing from 0V (+ve) through the motor to -3V via TR3. The gear train turns VR1 in a direction so as to reduce the voltage between A and B, and so cut off TR1.

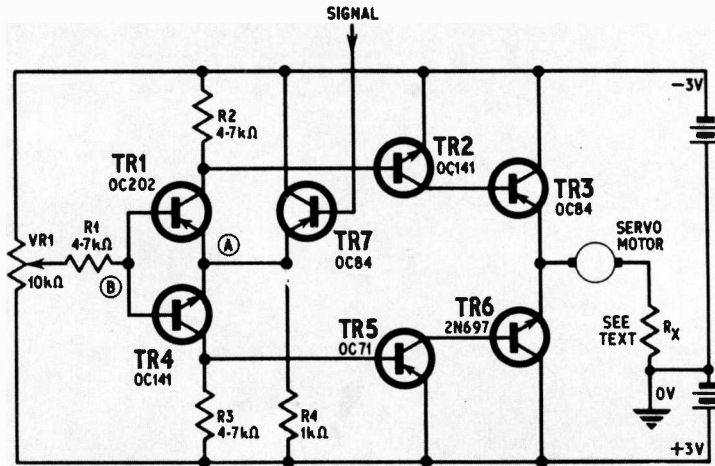

Fig. 1. Basic circuit of the servo amplifier on which the circuits in Figs. 2 and 3 are based

If the gear ratio was low and the motor large, "over-run" would be possible and the inertia would turn VR1 till TR4 conducted and the motor reversed.

The current now passes from +3V via TR6 through the motor to 0V (-ve).

The use of a small motor and a gear train prevents excessive over-run and the drive stops in a position with neither TR1 nor TR4 conducting. The "dead spot" corresponds to the sum of the turn-on V_{BE} voltages of TR1 and TR4. V_{BE} is dependent on collector current and by keeping this low (by means of R2 and R3) the nominal values of 0.3V and 0.7V are reduced to approximately 0.6V total.

The usual rotation of a potentiometer is 270 degrees. The "dead zone" is, therefore, $0.6/6 = 1/10$ of 270 = 27 degrees. This is satisfactory for most purposes but may be reduced by several means; boat modellers for example, may use a 12V battery across VR1 thus giving a dead zone of approximately 13 degrees.

AUXILIARY CIRCUIT

Fig. 2a indicates an auxiliary circuit in which the bases of TR1 and TR4 are only separated by the voltage across the diodes D1 and D2. This voltage varies with individual diodes and with current, but is approximately 0.3V for germanium types such as

OA70, OA10 and OA5. If TR1 is just conducting with a V_{BE} of 0.5V then the voltage at C is -0.5V relative to A. Point D is approximately 0.6V positive to C, or 0.1V positive to A. Changing the voltage at C by less than 0.2V positive will, therefore, cut off TR1 and turn on TR4, the dead zone being less than 9 degrees as before.

Fig. 2b shows the bases of TR1 and TR4 taken to separate wipers of the same potentiometer, the annular separation determining the "dead zone". This method is of particular interest since it is easily adjusted, and one method of mounting a potentiometer is to extract the disc of a miniature type and mount it on a gear shaft with "pigtail" ends and the wipers secured to the frame.

The signal voltage is applied to point A (low impedance) by means of an emitter follower TR7, which has a standing current of approximately 6mA in the inactive condition of the amplifiers. In practice the base of TR7 is directly connected to the discriminator circuits but for test purposes may be connected to a potentiometer as shown in Fig. 2c.

A signal voltage applied to point E from a relatively low impedance (e.g. a battery) causes the servo to act; if the signal is removed VR1 is rotated to the original position set by VR2. Thus VR2 may be used as a neutralising trim control.

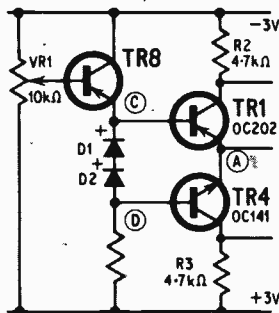

Fig. 2a. Modification to first stage with an extra transistor TR8

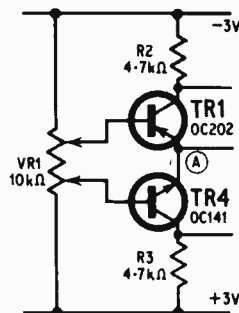

Fig. 2b. Two-wiper potentiometer to determine the dead zone

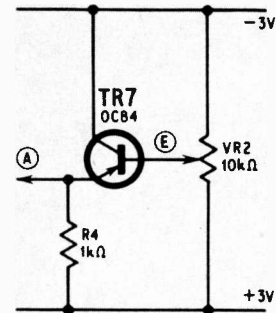

Fig. 2c. Test circuit around TR7 by connecting a d.c. source to the base

COMPONENTS . . .

Resistors

R1	4.7k Ω	R5	8.2k Ω
R2	4.7k Ω	R6	30k Ω
R3	4.7k Ω	R7	30k Ω
R4	1k Ω	Rx	(see text)

All 10%, $\frac{1}{8}$ or $\frac{1}{10}$ watt carbon
R6 and R7 selected from 33k Ω 10%

Potentiometers

VR1	10k Ω
VR2	10k Ω

Transistors and Diodes

TR1	OC202	TR4	OC141
TR2	OC141	TR5	OC71
TR3	OC84	TR6	2N697

D1 and D2 (see text)

Miscellaneous

Printed circuit board or Veroboard (see text)
Motor and gearing (see text)

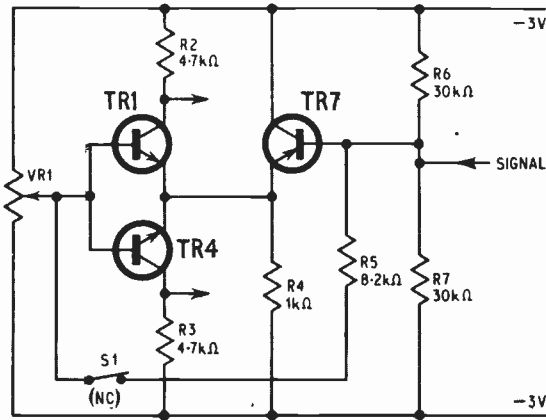

Fig. 3. Facility for injecting a d.c. signal to TR7 base and TR1 and 4 via R5

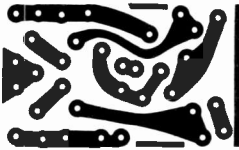

Fig. 4a. Printed circuit pattern (full size) for the amplifier in Fig. 1

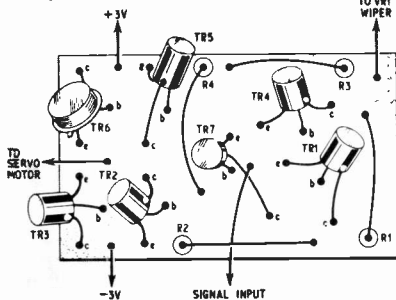

Fig. 4b. Component layout on the printed circuit board

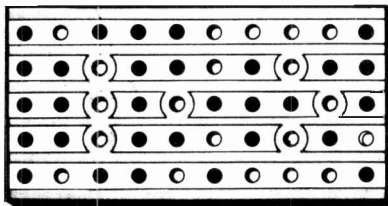

Fig. 5a. Veroboard is a simple method of making the amplifier unit

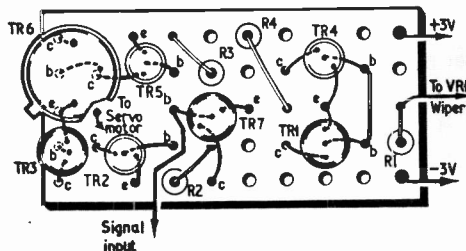

Fig. 5b. Component layout on the Veroboard of the amplifier in Fig. 1

Fig. 3 indicates the replacement of VR2 by R5 wired to VR1. In this case, on the removal of the signal voltage from point E, the servo stays in its last position, i.e. it does not neutralise at all. Provided there is little delay in the removal of the d.c. signal there is no reason why a number of servos (with corresponding tone filters, etc.) should not be operated in sequence as well as simultaneously. Not only does this give extreme versatility but it also allows for progressive development.

A system with, say, two simultaneous channels plus one non-neutralising (e.g. throttle) channel could be later developed to bi-simultaneous operation plus a number of non-neutralising channels.

Fig. 3 also shows R6 and R7 (approximately 20 kilohms) and switch S1. If S1 is opened with no signal present then the servo would rotate to the limit or to a given amount, depending upon the ratio of R6/R7. This could form part of any fail safe device.

CONSTRUCTION

For radio control work it is preferable to use a printed circuit board to keep the unit compact and lightweight (Fig. 4). The printed circuit board should be drilled with a No. 60 drill and resistors R1, R2, R3 ($\frac{1}{8}$ or $\frac{1}{10}$ watt) soldered in first.

Transistors TR1, 2, 4, 5, and 7 should be soldered in with a clean iron and with minimum lead length, using wiring pliers as wiring heat sinks, following the layout diagram. Transistors TR3 and TR6 do not normally require heat sinks. If prolonged use is contemplated or if substitutions are made heat sinks should be fitted and the "stalled" motor torque should not exceed the maker's maximum working rating.

If necessary a resistor R_x may be mounted on the motor to reduce the "stalled" current to within the rating of the transistors. This may take the form of two $\frac{1}{8}$ watt 5 ohm resistors in parallel.

For other users the amplifier may be built on Veroboard as illustrated in Fig. 5, layout not being critical, and two-wire control being obtained by using a remote variable resistance to shunt R6 or R7 in Fig. 3.

VR1 must be phased correctly by experiment and a simple friction clutch is recommended in the system to prevent the destruction of the driven potentiometer at its end stops.



the 73 page

by Jack Hum
G5UM

What of the Future?

"SAY HEART, what will the future bring?" The question recurs over and over again in that noble paean by John Ireland, "These Things Shall Be". Appropriately at the year end, traditional time for looking back over what has been achieved and ahead to what might be, the radio amateur may well ask himself "What will the future bring?"

On the one hand he sees his kind proliferating in such numbers that today there are almost half a million licensed amateur transmitting stations the world over, more than the tally of all the professional stations put together.

Intruders

On the other hand he is aware of constant pressure on his frequency space—and indeed encroachment upon it—by services that have no right to use it (a situation, one might add parenthetically, which is by no means accepted passively. The Radio Society of Great Britain's intruder watch, constantly vigilant, collects evidence of poaching stations to pass on to higher authority. Less officially, many written protests are known to have gone to Radio Peking — especially — against intrusion into amateur territory).

As he ponders "What will the future bring?" the transmitting amateur finds himself confronted by what is a world problem—too little space for the clamorous claimants for living room. Not that this is anything new: he more than any other user of the radio frequency spectrum has adapted himself to the exigencies of living under crowded conditions.

And when it comes to outside demands on his frequency space, he is well represented by strong national and international societies to champion his interests.

At times, though, he is saddened by what appears to him to be failure to use valuable frequencies to full advantage; commercial stations idling for hours on end "to keep a

channel warm", vast areas of v.h.f. completely blank, ostensibly required for "business radio" interests, and never show a signal.

Sideband

Of the many devices to which resourceful amateur radio has turned to make life more bearable, undoubtedly the most dramatic is the development of the single sideband suppressed carrier mode of transmission. At once this enormously increases a transmitter's talk-power (and therefore readability at great range), abolishes the heterodyne problem and permits greater occupancy of a given frequency space.

But these advantages are achieved at a price: in some countries less technologically based than our own the poor quality of single sideband transmissions needs to be heard to be believed, and in our own country there are many who, deploring what sounds to them to be the dehumanised "space noise" timbre of s.s.b., seek refuge in the v.h.f. regions where voices sound natural, and where "BBC quality" is still the standard.

Single sideband has a further disadvantage, say some: it cannot be readily resolved by the inquiring short wave listener whose graduation to transmitting status must come from what he hears through attending to the amateur bands. In the past, thousands have become transmitting amateurs through chance overhearing of conversations on the air.

"Very Highs"

"More single sideband", then, is one of the answers to the question "What will the future bring?" Another is: "More v.h.f.". And those who provide this particular answer are the enthusiasts who believe that the real future of amateur radio lies in developing the "very highs".

To examine what they are doing is to be convinced of the strength of their advocacy. For in no other area of amateur radio is so much forward-looking experimental work going on, both in the development of equipment and in its evaluation on the air.

Popularly, the metre-wavelengths extend from four metres and down. The band at 70.1 to 70.7MHz is the lowest of the v.h.f. allocations used by the British transmitting amateur. Then come the 144 to 146MHz and the 427 to 440MHz areas, customarily known as "Two" and "Seventy Cems" respectively, while centred upon 1,296MHz is the 23 centimetre band.

As might be expected, this order of frequency bands is also the order of difficulty presented to the individual in getting started on any of them.

Getting going on "Four" is easy, and "all-surplus" equipment may be pressed into service here. "Two" and "Seventy Cems", much more difficult, offer constant challenges to operators to develop their own equipment. As for 23 centimetres, approaching the microwaves, the problems are even more formidable, demanding for instance the construction of special parabolic aerial arrays.

Higher still in frequency, the true microwaves are already being essayed by the British experimentalist, and with encouraging results.

Although individually an amateur experimenter cannot be expected to match his results with those obtained in professional laboratories (most of them largely staffed with transmitting amateurs), what in fact is achieved by "loners" in the v.h.f. and u.h.f. field is truly astonishing.

Collectively, the mass of information yielded from the work of several thousand U.K. amateurs now equipped for metre-wave working adds much to the sum of knowledge of electronic communication, not the least in respect of how to "achieve the mostest with the leastest". Always the amateur is ready to show how impressive results can be achieved at economic cost.

Society's benefit from this work is, in both senses of the word, immeasurable.

What can be measured is a nation's electronic ascendancy: those with a large number of licensed transmitting amateurs remain the world's leaders, those with few lag far behind.



A picture to typify the ascendancy of v.h.f. work in amateur radio today. Two enthusiasts brave wild weather to establish a portable meterwave station on a lonely highspot during one of the R.S.G.B. contests of 1967.

Catalogue of Electronic Components and Equipment

CATALOGUE

- ★ ELECTRONIC COMPONENTS
- ★ TEST EQUIPMENT
- ★ COMMUNICATION EQUIPMENT
- ★ HI-FI EQUIPMENT

We are proud to introduce our first comprehensive catalogue of Electronic Components and equipment. Over 150 pages, fully illustrated, listing thousands of items many at bargain prices. Free discount coupons with every catalogue. Everyone in electronics should have a copy.

Send today
5/- P & P 1/-

CLEAR PLASTIC PANEL METERS

First grade quality. Moving Coil panel meters, available ex-stock. S.A.E. for illustrated leaflet. Discounts for quantity. Available as follows: Type MR. 28P. 1 21/32in. square fronts.

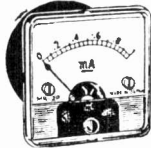

50μA	32/6
100μA	29/6
200μA	27/6
500μA	25/-
50-0-50μA	29/6

100-0-100μA	27/6	200mA	22/6	100V D.C.	22/6
500-0-500μA	22/6	300mA	22/6	150V D.C.	22/6
1-0-1mA	22/6	500mA	22/6	300V D.C.	22/6
1mA	22/6	750mA	22/6	500V D.C.	22/6
2mA	22/6	1A D.C.	22/6	750V D.C.	22/6
5mA	22/6	2A D.C.	22/6	15V A.C.	22/6
10mA	22/6	5A D.C.	22/6	50V A.C.	22/6
20mA	22/6	3V D.C.	22/6	150V A.C.	22/6
50mA	22/6	10V D.C.	22/6	300V A.C.	22/6
100mA	22/6	20V D.C.	22/6	500V A.C.	22/6
150mA	22/6	50V D.C.	22/6	"S" Meter 1A 29/6	

POST EXTRA. Larger sizes available—send for lists.

GARRARD RECORD PLAYERS

SRP12 Player mono £4.4.0; 1000 changer mono or stereo £5.15.6; 2000 changer mono or stereo £6.15.6; 3000 changer mono or stereo £7.19.6; SF25 Player mono or stereo £9.19.6; SF25 with cast turntable £10.19.6; AT60 Changer mono or stereo £10.10.0; AT60 Mk II Mono or Stereo £11.11.0; A70 less cartridge £10.19.0; LAB80 Mk II Stereo £25.0.0; 401 Transcription 26 gns. Brand new and guaranteed. All plus post and packing 5/-.

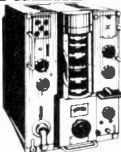

ADMIRALTY B.40 RECEIVERS

Just released by the Ministry. High quality 10 valve receiver manufactured by Murphy. Coverage in 5 bands 650 Kc/s-30 Mc/s. I.F. 500 Kc/s. Incorporates 2 R.F. and 3 I.F. stages, crystal bandpass filter, noise limiter, controlled B.F.O. calibrator, I.F. output, etc. Built-in speaker, output for phones. Operation 150/230 volt A.C. Size 19 1/2 x 13 1/2 x 16 in. Wght. 114 lbs. Offered in good working condition, £22/10/0. Carr. 30/-. With circuit diagrams. Also available B41 L.F. version of above. 15 Kc/s-700 Kc/s. £17/10/0. Carr. 30/-.

LAFAYETTE KT-340 COMMUNICATION RECEIVER SEMI-KIT

Build this wonderful receiver and save Pounds! Supplied semi-complete, main components ready mounted, R.F. Section already wired and aligned. Full and precise instructions supplied. Specification: 8 valves + rectifier, 4 bands covering 50 Kc/s-30 Mc/s. Incorporates 1 R.F. and 2 I.F. stages, "Q" multiplier, B.F.O., A.N.L., "S" meter, bandspread, aerial trimmer, etc. Operation 115/230v. A.C. Price 25 GNS. Carr. 10/-.

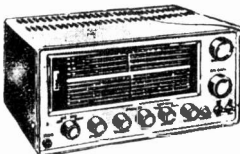

HAM-I. 4 BAND COMMUNICATION RECEIVER

4 wavebands covering 535 kc/s-30 Mc/s 5-valve superhet circuit. Incorporates 8 meter, B.F.O., BANDSPREAD TUNING, BUILT-IN 4in. SPEAKER, FERRITE AERIAL AND EXTERNAL TELESCOPIC AERIAL. Operation 220/240v. A.C. Supplied brand new with handbook. £15/15/0. Carr. 10/-.

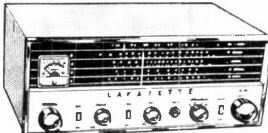

NEW LAFAYETTE MODEL HA-700 AM/CW/SSB AMATEUR COMMUNICATION RECEIVER

8 valves, 5 bands incorporating 2 MECHANICAL FILTERS for exceptional selectivity and sensitivity. Frequency coverage on 5 bands 150-400 kc/s, 550-1,600 kc/s, 1.6-4.0 Mc/s, 45-14.5 Mc/s, 10.5-30 Mc/s. Circuit incorporates R.F. stage, aerial trimmer, noise limiter, B.F.O., product detector, electrical bandspread, 8 meter, slide rule dial. Output for phones, low to 2KΩ or speaker 4 or 8 ohms. Operation 220/240 volt A.C. Size 7 1/2 x 15 1/2 x 10 in. Supplied brand new and guaranteed with handbook 36 GNS. carr. 10/-, S.A.E. for leaflet.



ALL ITEMS AVAILABLE AS PREVIOUSLY ADVERTISED

R.107 RECEIVERS

1-7-17.5 Mc/s. Mains or 12 volt D.C. operation. Perfect condition. £15. Carr. 30/-.

CALLERS WELCOME!

Open 9 a.m. to 6 p.m. every day Monday to Saturday. Trade supplied.

MARCONI TEST EQUIPMENT

TF144G STANDARD SIGNAL GENERATOR. 85 Kc/s-25 Mc/s. 200/250 v. A.C. £25. Carr. 30/-.
TF 320G "Q" METER. Brand new with access. £75.
T.F. 195 M. BEAT FREQUENCY OSCILLATOR. 0-40 Kc/s. 200/250 v. A.C. £20. Carr. 30/-.
All above offered in excellent condition fully tested and checked and offered at a fraction of original cost.

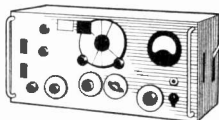

2-WAY RADIOS

Super quality. Brand new and guaranteed.

3 transistor	£8.15.0 pr.
4 transistor	£7.19.6 pr.
6 transistor	£8.4.0 pr.
6 transistor	£9.19.6 pr.
6 transistor De Luxe	£17.10.0 pr.
10 transistor	£22.10.0 pr.
13 transistor 500 MW	£31.10.0 pr.
13 trans. 1W	£35.0.0 pr. Post extra.

These cannot be operated in U.K.

SINCLAIR TRANSISTOR AMPLIFIERS

Z12 Amplifier 89/6; Z12 Power Pack 79/6; Stereo 25 Pre-Amplifier £9.19.6; Micro FM Radio Kits £5.19.6; Micro 6 Radio Kit 59/6; Micromatic Radio Kit 49/-; Ready built 59/6. Post paid.

COSSOR 1035 Mk III DOUBLE BEAM OSCILLOSCOPES

Latest model using miniature valves. Perfect condition. £45. Carr. 30/-.

LAFAYETTE HI-FI SOLID STATE STEREO AMPLIFIERS

Latest 1967 models now available. Outstanding performance from modern semiconductor. Provision for all types of inputs and outputs and comprehensive tone controls. Attractive metal case free standing units. DETAILS ON REQUEST.

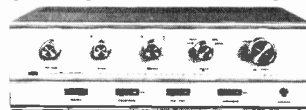

Model LA-224T, 30 watt £25. Carr. 7/6. Model LA-60T 60 watt £37.10.0. Carr. 7/6.

LAFAYETTE MODEL HA-500 SSB/AM/CW 80 THROUGH 6 METRE RECEIVER

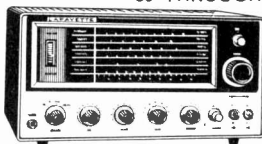

New outstanding Ham Bands only receiver covering the 80/40/20/15/10/6 metre bands. Incorporates 10 valves, product detector, two mechanical filters, "S" Meter, dual conversion on all bands, crystal calibrator, B.F.O., noise limiter, aerial trimmer, I.F.'s 2,608 Kc/s and 455 Kc/s. Output 8 ohms and 500 ohms. Operations 220/240 volt A.C. Supplied brand new and guaranteed with handbook. 42 gns. Carr. 10/- 100 Kc/s crystal 35/-.

★ TRANSISTORISED FM TUNER ★

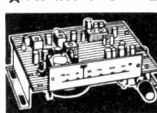

6 TRANSISTOR HIGH QUALITY TUNER. SIZE ONLY 6in. x 4in. x 2 1/2in. 3 I.F. stages. Double tuned discriminator. Ample output to feed most amplifiers. Operates on 9 volt battery. Coverage 88-108 Mc/s. Ready built ready for use. Fantastic value for money. £8.10.0. P. & P. 2/6.

VARIABLE VOLTAGE TRANSFORMERS

Brand New—fully shrouded. Input 230v. 50/60 c/s. Output 0-260 Volts.



1 Amp	£4.10.0
2.5 Amp	£5.17.6
5 Amp	£9.0.0
8 Amp	£13.10.0
10 Amp	£17.0.0
12 Amp	£19.10.0
20 Amp	£21.10.0

Post extra

TRANSISTORISED TWO-WAY TELEPHONE INTERCOM.

Operative over amazingly long distances. Separate call and press to talk buttons, 2-wire connection. 1000's of applications. Beautifully finished in ebony. Supplied complete with batteries and wall brackets. £5.19.6. P. & P. 3/6.

TYPE 13 DOUBLE BEAM OSCILLOSCOPES

5-5 Mc/s Bandwidth. Perfect condition. £22.10.0. Carr. 30/-.

NEW MODEL 500. 30,000 o.p.v. With overload protection, mirror scale. 0/5/1/2.5/10/25/100/250/500/1,000v. D.C. 0/2.5/10/25/100/250/500/1,000v. A.C. 0/50μA/5/50/500μA. 12 amp. D.C. 0/60K/6 Meg./60. Meg. £8/17/6 Post Paid.



MODEL ZQM TRANSISTOR CHECKER

It has the fullest capacity for checking on A, B and C. Equally adaptable for checking diodes, etc. Spec. A: 0.7-0.9967, B: 5-200, 100; 0-50 microamps, 0-5 mA. Resistance for diode 200Ω - 1 Meg. Supplied complete with instructions, battery and leads. £5/19/6. P. & P. 2/6.



RADIO ENGINEERS REQUIRED

Must be experienced and able to service all types of equipment, including Military receivers and test equipment. Well paid and permanent positions for suitable applicants. References required. Telephone or write for appointment.

G.W. SMITH & CO (RADIO) LIMITED

Phone: GERRARD 8204/9155
Cables: SMITHEX LESQUARE
3-34 LISLE STREET, LONDON, W.C.2

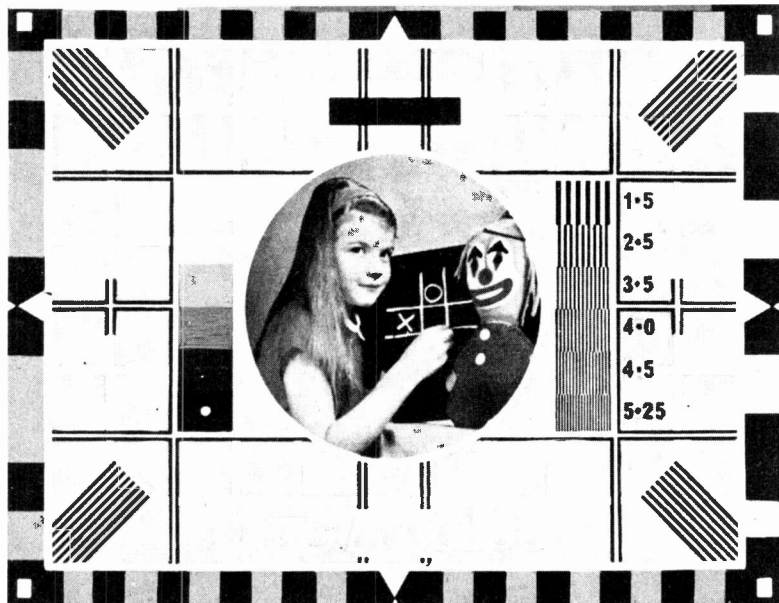

THE COLOUR RECEIVER

By W. Mizon

Part Two Setting-up Adjustments Procedure

COLOUR picture make-up in television receivers, described in Part 1 last month, is a delicate and precision operation. Naturally some care and special knowledge is necessary to achieve the best results when setting up. It is essential for engineers to be conversant with the setting-up procedure for the colour receiver, since these adjustments will be necessary for initial installations (to correct the effects of transporting the receiver itself) apart from routine service work once installed.

Experience gained from the practical application of these adjustments will be of great benefit for fault diagnosis apart from the satisfaction derived from a colour picture which has been correctly "set up".

Adjustments which are common to those normally encountered with monochrome receivers should be carried out first using a test card in the usual way. Picture height, width, linearity, centring, etc. are carried out on both 405 and 625-line operation, disregarding any colour which may be present on the monochrome picture obtained. During this initial setting-up procedure, two additional adjustments are required:

- (a) *Set E.H.T. Volts*—adjusted to give 25kV at zero beam current.
- (b) *Pincushion Correction*—adjusted for minimum bowing of the top and bottom horizontal lines.

This is followed by the "colour" picture adjustments.

PURITY

Purity is a term used to describe the individual primary colour raster or field displayed from the appropriate gun of the picture tube. A red field, for example, is "pure" when the red raster is uniform red, and not contaminated with blue or green. The three colour rasters or fields may be viewed individually by cutting off the output from the unwanted guns. A simple switch shunt circuit is shown in Fig. 9 and can be made up and used by the engineer to effect purity and convergence adjustments. However, colour receivers will incorporate a built-in switch for this purpose.

It will be remembered that the principal of the shadow mask within the tricolour tube is to ensure that the individual beams from each of the three guns will strike only those phosphor dots of the required colour.

The three beams are deflected from left to right and up and down as required for scanning by a deflection coil assembly, and the function of the purity adjustment is to ensure that the beams will enter the correct deflection centre. There are two adjustments which effect the purity.

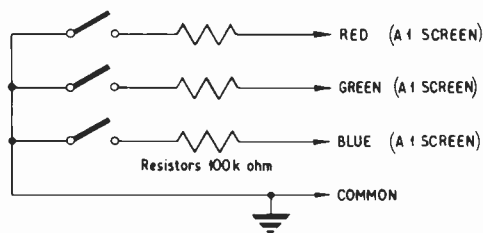

Fig. 9. Screen shunt to cut off selected guns in the picture c.r.t.

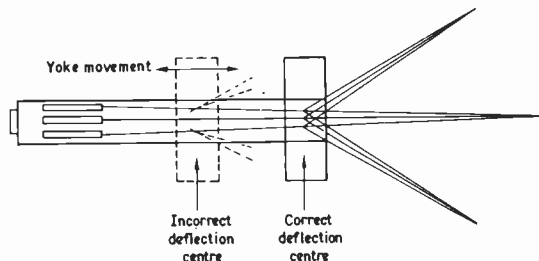

Fig. 10. Effects of deflection yoke position for purity adjustment

Firstly, the purity magnet which is similar in construction to the permanent magnet centring device normally encountered on conventional monochrome receivers. This is located on the neck of the tube behind the deflection coils and adjustment will affect purity in the centre of the picture.

Secondly, overall purity adjustment is achieved by the position of the deflection yoke along the neck of the tube (Fig. 10) and in conjunction with the magnetic field from the purity magnet, will ensure that the beams approach the correct centre.

However, these purity adjustments can be severely affected by stray magnetic fields which may result in magnetism of the steel parts of the chassis or even the steel shadow mask itself. These unwanted fields can be induced by heavy electric currents in nearby conductors, or the earth's magnetic field, and must be completely eliminated before purity adjustment is attempted.

Magnetic fields are neutralised or demagnetised by the use of a degaussing coil, a large coil of wire which is energised from the mains supply and, when placed near to and moved around the receiver, it eliminates the effects of nearly all the static magnetic fields including the earth's magnetic fields. Most colour receivers will incorporate an automatic degaussing coil within the receiver itself, but on the initial setting-up procedure a stronger degaussing source may have to be used externally.

PURITY ADJUSTMENT PROCEDURE

Place the receiver in the final viewing position and carry out the degaussing operation previously described.

Effect preliminary static convergence adjustments. (See under "Static Convergence".) This is a preliminary adjustment to be made before the purity adjustment, as there is some interaction between the purity and the static convergence magnets.

Switch off the blue gun and the green gun leaving a red raster on the cathode ray tube.

Loosen the clamp that secures the deflection yoke and slide back towards the tube base. This will upset the purity severely at the edges of the picture, but will have little effect at the centre of the screen. Adjust the purity magnet to obtain a pure red "blob" in the centre of the screen, and slide the yoke forward to obtain the optimum overall clear red raster. Compromise between these two adjustments for the best final result, then tighten the clamp.

Check the green purity in the same way by switching off the red and blue guns. Re-adjust if necessary.

Repeat this operation for blue purity by switching off the red and green guns.

GREY SCALE

The next step is to ensure that the output from the individual guns will give a uniform level of brightness for the red, blue and green content respectively. This adjustment is referred to as the grey scale, since these primaries in the correct proportion will yield white light, and subsequently gives the shades of grey normally encountered in a monochrome picture.

In most receivers the facilities for this adjustment will consist of three potentiometers which control the voltage applied to each A1 electrode (screen) of the individual guns, and will facilitate the brightness "cut off". As this adjustment is easier with the frame time base collapsed, receivers will incorporate a switch for this purpose. A further two "drive" controls will

facilitate the proportion of white light. These will adjust the grid potential on the "green" and "blue" grids, against the red which will be "fixed".

Finally a "background" control is used to effect bias on the chrominance output amplifiers and together with the controls previously mentioned will give the overall grey scale setting.

GREY SCALE ADJUSTMENT PROCEDURE

- (1) Switch to 625 lines (input black raster).
- (2) Set blue and green drive controls to mid-position, the background control down to minimum and the red, green, and blue screen controls to maximum.
- (3) Set the brightness control to mid-position and collapse the frame time base with the switch provided.
- (4) Turn the background control up until the red, green, and blue lines are just visible, then turn down the relevant screen control(s) to just extinguish the visible line(s). This procedure will ensure that at least one screen control will be at maximum.
- (5) Restore the frame scan (switch provided) and adjust the brightness control for a visible raster. Check neutral tint and adjust appropriate screen control if required.
- (6) Set the blue and green drive control to determine the proportions for the white content of the picture. Adjustment of these controls will effect the overall brightness which must be reset before the final result can be assessed.

A picture now received should be a true monochrome with the normal grey levels between black and white. Any odd traces of colour on this picture will be due to mis-convergence.

STATIC CONVERGENCE

The three electron beams must be made to converge so as to pass through the same hole in the shadow mask and fall only on the appropriate colour dot of a particular triad.

The beams are deflected simultaneously by a common deflector system, but each beam is individually controlled in density (current) by its own electron gun.

Convergence of the beams is in the first instance achieved by the application of weak magnetic fields, applied externally adjacent to the gun assembly and aligned with the internal pole pieces (Fig. 11a).

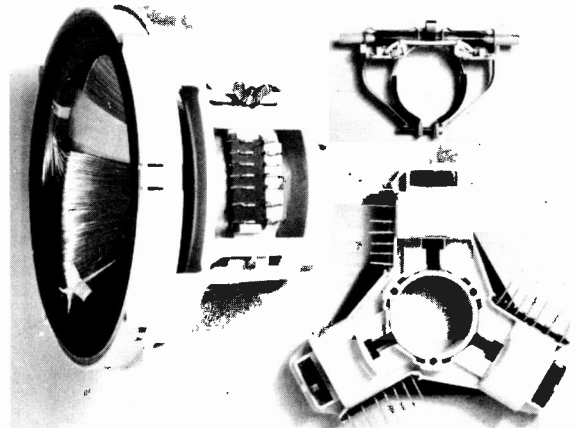

Mullard deflection and convergence yoke assembly for a shadow mask tube. Left, deflection coils; above right, blue lateral assembly; below right, convergence coil assembly.

It will be noted from this diagram that the arrangement of the external magnets will adjust the beams radially (Fig. 11b).

Radial adjustment, however, is not enough to ensure that all three beams will converge to a common point at the centre of the mask, at least one of the beams must be controllable in a second direction as well. The blue beam was selected for this purpose and is accordingly made to pass a second pair of pole pieces which, when energised by an external "blue lateral shift" magnet, displaces the beam horizontally. With these four magnets the beams can be made to converge near enough at the centre of the mask. This is known as static convergence. The use of a white cross-hatch signal generator will be essential for all convergence adjustments.

STATIC CONVERGENCE ADJUSTMENT

Connect a cross-hatch pattern generator and adjust the tuner (fine tuner) and brightness to obtain a clear steady cross hatch pattern on the screen.

Concentrating on the squares in the immediate centre vicinity of the screen, adjust the three static magnets and the blue lateral shift magnet to achieve the best possible line convergence.

DYNAMIC CONVERGENCE

The need for further convergence application will be readily understood if the spherical shape of the tube face and shadow mask is taken into consideration (Fig. 12). By virtue of the fact that this curvature will not coincide with the scanning motion of the three beams, which undergo different geometrical deformation. Therefore, while convergence may occur at the centre of the screen (static convergence) it will not occur at any point away from the centre. The colour rendering itself, that is the purity of colours, is not affected because the shadow mask will ensure that the three beams will always strike phosphor dots of the right colour. They may not, however, actually occur in the same triad.

This error in convergence must, of course, be avoided and hence the need for dynamic convergence. To ensure that convergence will occur at all points on the screen, a dynamic convergence signal is applied in conjunction with the magnets provided for static convergence. Whereas a direct current of the required polarity and strength is sufficient for the static convergence, we now require correction currents for each gun which are available at line and field frequencies.

These currents are essentially parabolic in waveform and are superimposed with a "sawtooth" current. Therefore, four such extra currents, variable in amplitude, are required for each gun: parabolic and

sawtooth waveforms at line frequency, and parabolic and sawtooth waveform at field frequency.

Together with the static convergence correction and the blue horizontal correction there are 16 controls to ensure optimum convergence over the whole area of the screen. As the colour receiver will be capable of receiving programmes on both 405 and 625-line transmissions, the field (dynamic control) will serve for both systems, but additional line controls at the 405-line frequency will be necessary.

DYNAMIC CONVERGENCE ADJUSTMENT

The procedure for this adjustment will vary according to the differences in manufacturing design. In all probability as many as 20 controls may be encountered and reference to a service manual will be essential to establish the exact function of each coil and potentiometer adjustment. Since the waveform at line frequency will differ between 405 and 625-line operation, adjustments must be carried out on both systems.

However, the ultimate requirement will be the same for all receivers, that is, to achieve convergence of the three beams in the overall area of the picture screen.

Apart from identifying the function of each control, the following procedure will apply:

Connect a cross-hatch pattern generator and adjust the tuner (fine tuner) and brightness to obtain a clear steady cross-hatch pattern on the screen.

Switch off the output from the blue gun. Dynamic convergence is in the first instance carried out with the red and green outputs only, thus producing a yellow hatch. Adjust the controls by reference to the service manual.

Switch on the blue gun, and adjust the controls by reference to the service manual. Final convergence will result in a white cross hatch.

During the procedure for dynamic convergence adjustments it will be necessary to revert back to the static adjustment to achieve ultimate overall convergence.

FINALLY

This two-part article is by no means exhaustive and is intended only to serve as a guide to the colour television engineer. It is not recommended that individual viewers attempt the setting-up unless they are fully conversant with colour techniques and also have the relevant receiver servicing manual. However, it is hoped that the reader will have gleaned some useful information to help in the general understanding of colour television receiving systems.

In Part I a millimicron was given as being a billionth of a meter. In American terminology this is correct, but in the U.K. it is a thousand-millionth (10^{-9}) meter.

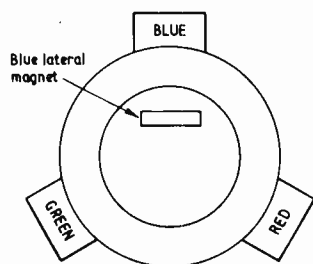

Fig. 11a. Convergence assembly mounted on the neck of the c.r.t. behind the deflection coils

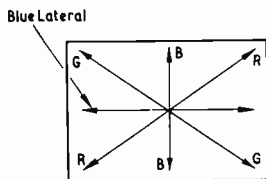

Fig. 11b. Direction of movement by adjustment of static magnets

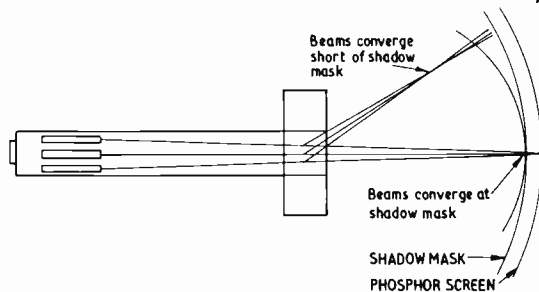

Fig. 12. Uncorrected beams showing the need for dynamic convergence

MARKET PLACE

Items mentioned in this feature are usually available from electronic equipment and component retailers advertising in this magazine. However, where a full address is given, enquiries and orders should then be made direct to the firm concerned.

SEMICONDUCTORS

Many companies have recently announced price reductions in their ranges of semiconductors, the latest being **Joseph Lucas (Electrical) Ltd.**, who announced a reduction of up to 30 per cent on one range and 25 per cent on their press-fit automotive rectifiers. Nearly all the large firms explain these reductions as being a result of better manufacturing processes and increased demand.

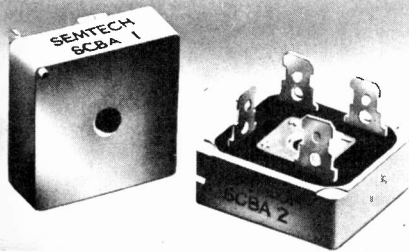

Semtech bridge rectifier

Another reason could be the gradual increase of Japanese transistors that are becoming more readily available at a competitive price. **Photain Controls Ltd.** have just been appointed U.K. distributors of Sanyo Electric Co. Ltd., of Japan, semiconductor components.

Further details of Sanyo Electric components can be obtained from Photain Controls Ltd., Randall's Road, Leatherhead, Surrey.

The Semtech "Alpac" is a high current power bridge rectifier enclosed in an aluminium case and available from most good retailers.

Ideal for use where space is limited they are marketed in this country by **Bourns (Trimpot) Ltd.**, and manufactured by the Semtech Corporation of California, U.S.A. They are available in ratings up to 25 amps, average rectified current from p.i.v. ratings of 50 to 600 volts.

SERVICING AIDS

The Iskra S6A multimeter, imported from Yugoslavia, is a handy portable instrument with a claimed accuracy of $\pm 2\frac{1}{2}$ per cent of f.s.d.

Measuring ranges include a.c. and d.c. voltage, direct current, resistance, capacitance, frequency, and decibels on a clear two-colour scale.

The meter is protected from overload by silicon diodes across the movement and by a glass fibre needle which is virtually unbreakable.

One of the advantages of the S6A is the use of multiple input terminals for range selection which produces a self-wiping action each time a different range is selected. This action reduces the contact resistance that is often evident in the more usual rotary switched range selectors.

Sensitivity is 20,000 ohms per volt d.c. and 4,000 ohms per volt a.c. Measuring ranges are 0.1, 2, 10, 50, 200, 500, 1,000 volts d.c. and 2, 10, 50, 250, 1,000 volts a.c. Direct current ranges are 50 μ A, 500 μ A, 5mA, 50mA, 500mA, and 5A. Resistance multipliers are $\times 1$, $\times 10$, $\times 100$, $\times 1,000$, $\times 10,000$. For resistance measurement up to 10 megohms a 3 volt battery can be accommodated inside the instrument; with mains input the range can be extended to 100 megohms.

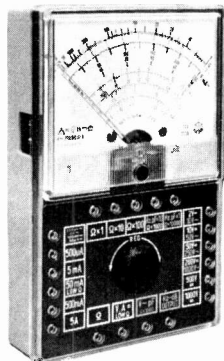

Iskra S6A multimeter

Capacitance measurements are also possible with an external a.c. supply with multipliers of pF $\times 1$ and pF $\times 10$ providing a range from 100pF to 0.5 μ F. By using the internal d.c. supply, and a simple conversion scale provided in the accompanying booklet, it is possible to extend the range to include electrolytic capacitors up to 150 μ F.

The 50Hz mains input also permits frequency measurements up to 50,500 Hz. This latter range may be further extended by a factor of 10 by the addition of an external capacitor.

The lowest scale provides decibel measurement for both power and voltage ratios.

The S6A multimeter is supplied in a plastics storage box complete with test probes and leads and can be obtained from **Guest Electronics Ltd.**, 78-86, Brigstock Road, Thornton Heath, Surrey, at a price of £10 5s 0d.

The Espi K651 is a new type of tweezer marketed by **Special Products Distributors Ltd.**, 81 Piccadilly, London, W.1.

The feature of this tweezer is the reverse action whereby the operator squeezes to pick up and squeezes to release objects. The points are precision ground, anti-magnetic, resistant to acid and many other chemicals and automatically exerts a uniform pressure on an object until released by the operator. The amount of tension exerted on an object is adjustable by a small fulcrum screw near the tip. The price of these tweezers is £1 3s 6d.

LITERATURE

Issued as part of the new 1968 Belling-Lee aerials catalogue, is a supplementary wall chart for aerials, masts, lashings and clamps. Measuring 23in \times 16in, copies of the wall chart are available separately from **Belling-Lee Ltd.**, Heysham Road, Netherton, Bootle 10, Lancashire.

Also available free from the above firm is a leaflet giving basic information about aerials for u.h.f. colour reception. The leaflet is entitled "Aerials for Colour Television" and gives typical questions and answers that are most likely to arise once the

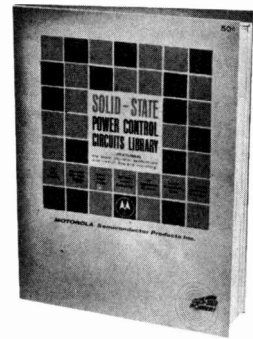

Motorola Solid State Circuits Guide

colour service is fully operational.

Motorola Semiconductor Products Division have compiled two new comprehensive guides entitled "R.F. Circuit Design Library" and "Solid State Power Control Circuits Library". Both guides contain actual circuit design and testing information from their own applications engineering staff.

The "R.F. Circuit Design Library" contains 150 pages and includes 10 application notes describing the use of basic r.f. design techniques, plus specific details for communications circuit designers.

Besides applications notes, there are sections on Whats and Whys about Y-Parameters, Systemising R.F. Power Design, R.F. Small Signal Design Using Admittance Parameters, and a 50-watt, 50MHz Solid State Transmitter.

The "Solid State Power Control Circuits Library" lists sections on S.C.R. Pulse Trigger, High Torque Motor Speed Control, Thyristor Trigger Circuits, and R.F.I. Suppression in S.C.R. Circuits.

ANTI DAZZLE

By D. Burn Ph.D.

ONE of the more irritating features of night driving is the dazzle caused by the reflections in the driving mirror of the headlights of following cars. Most drivers no doubt have their own methods of dealing with this problem; here is one solution that has the advantage of dealing with it automatically. The gadget to be described tilts the driving mirror upwards whenever a bright light falls on to a light-dependent resistor mounted behind the mirror. The whole unit is neat and compact and can be made for as little as £3.

SOLENOID SWITCH

The light operated circuit is ideally suited to this task and is arranged so that the mirror is tilted by means of a solenoid.

Solenoid switching stages present some rather special problems and careful design is necessary to ensure that they operate correctly. First, a fairly high current (1A or more) must be supplied, which means that it is desirable to use a power transistor. At the same time, it is essential that this transistor is fully switched on in order to avoid excessive power dissipation, and hence overheating. This is achieved by the addition of a driver stage which applies plenty of current to the base of the output transistor.

Although a fairly high current is required to actuate the solenoid, a relatively small current may suffice to keep it actuated. It is therefore necessary to ensure that the transistor is fully switched off. This is

achieved by applying a small negative potential to its emitter, so that in the off-state, the base-emitter junction is reverse biased.

When the solenoid is switched off, an inductive back e.m.f. of some several hundred volts appears across it, and hence across the output transistor. Since this pulse could cause the collector to become positive with respect to the emitter, with consequent damage to the transistor, it must be dissipated in a diode connected across the solenoid. The complete circuit is shown in Fig. 1.

The l.d.r. is arranged to form part of the bias network of an emitter follower circuit with a high input impedance. This is coupled by way of the sensitivity control VR2 to the Schmidt trigger TR2, 3. The potential divider formed by R9 and D2 applies the necessary potential to the emitter of the output transistor TR5. An increase in sensitivity can be obtained by connecting a 47 kilohm resistor between TR1 emitter and -12v line.

MIRROR BOX

The dimensions given in this article apply to the author's particular driving mirror, but they could be readily modified to suit a different size mirror. It should be mentioned however that several of the components are quite bulky and considerable care and ingenuity would be required to fit them all into a much smaller box. The general layout and construction will be evident from the photographs and drawings.

Fig. 1. Complete circuit of the solenoid tilting mirror powered by the 12V car battery or heavy duty dry battery

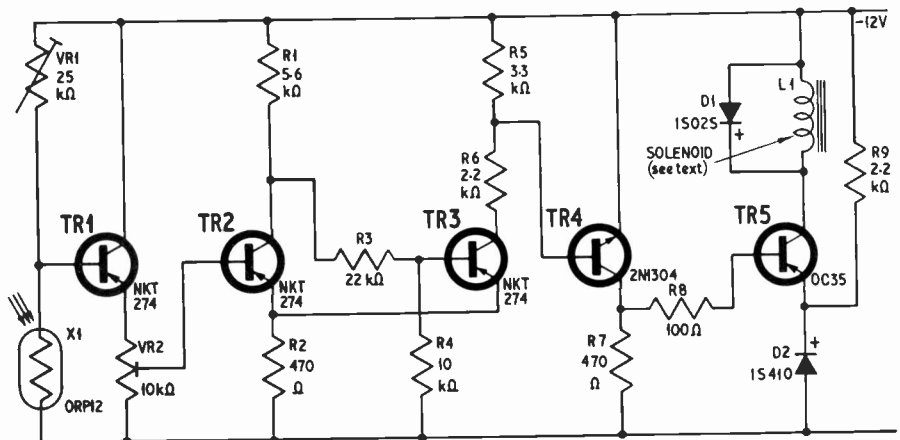

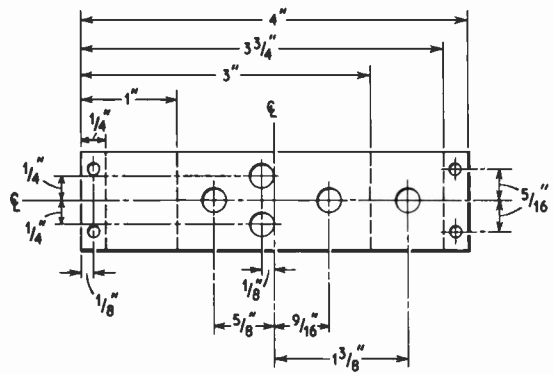
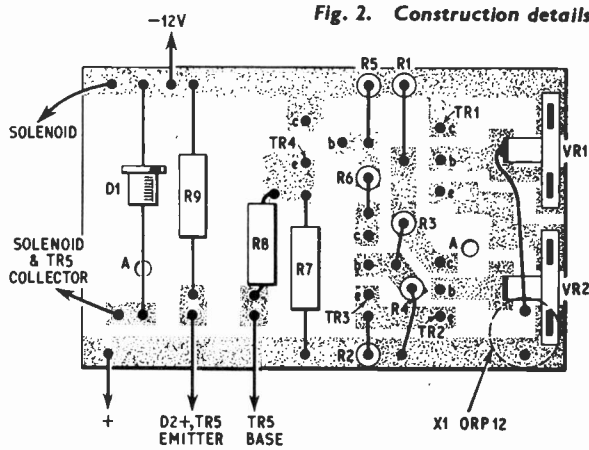
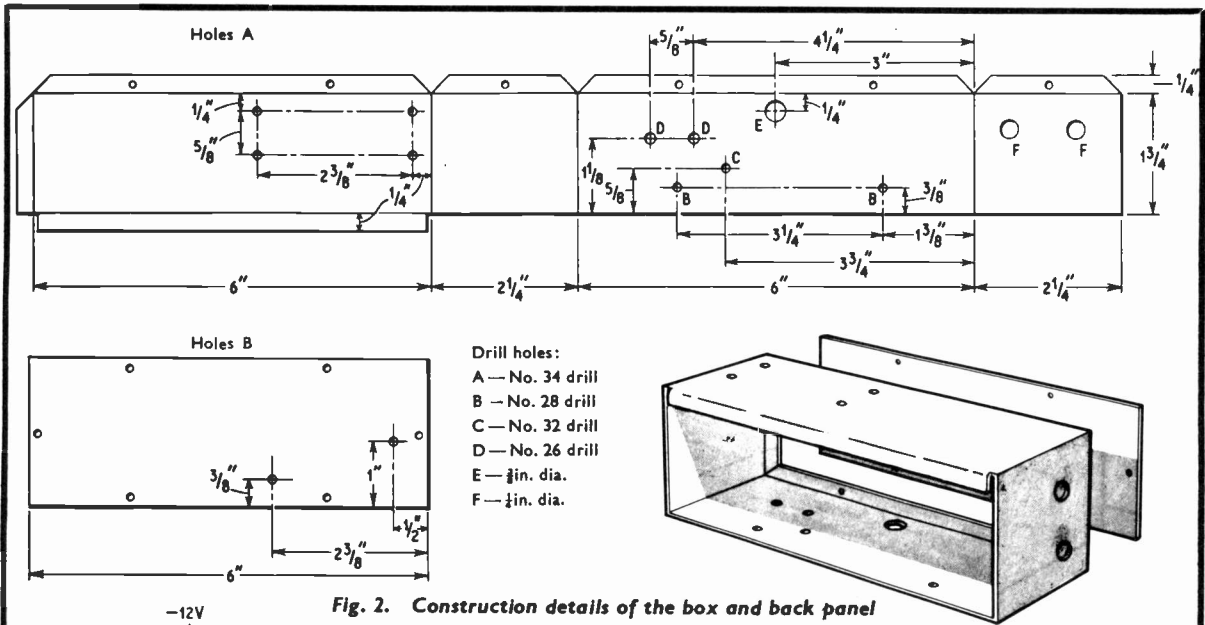

Fig. 3. Printed circuit pattern (dotted) and the components on the reverse side. Scale full size. Drill holes A with No. 32 drill

Fig. 4a. Cutting and drilling the bracket for TR5 and D2. Large holes $\frac{1}{4}$ in. dia.

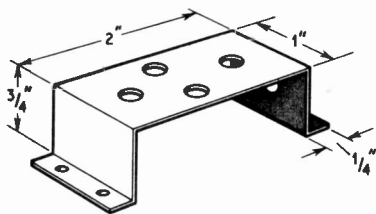
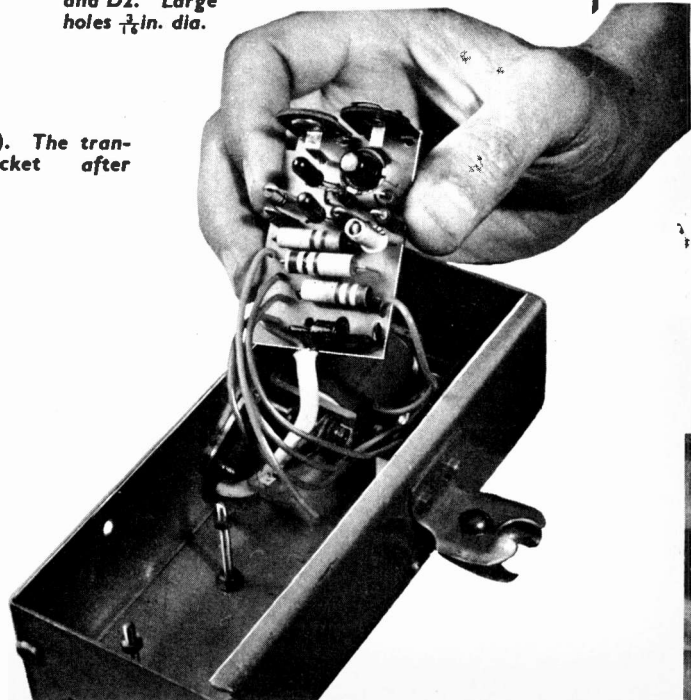
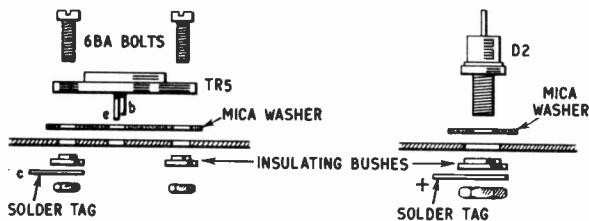

Fig. 4b (left). The transistor bracket after folding



The case is constructed from 18 s.w.g. aluminium, cut and bent as shown in Fig. 2. The back-plate is secured to the case with self-tapping screws.

The bulk of the electronics is mounted on a small printed circuit board Fig. 3, with the two potentiometers mounted on one edge. The l.d.r. is mounted on the back of the board opposite a hole scraped in the silvering of the mirror. The power transistor and diode are mounted on a separate bracket, using the usual mounting kits to ensure that they are electrically isolated from the case.

Fig. 4a shows the bracket used to mount the power transistor and diode, together with exploded views of the mounting method (Fig. 4c). It is fixed to the case with 6 B.A. bolts and nuts. The solenoid, mounted beneath it, is also secured with countersunk bolts.

The mirror is fixed with "Evo-stik" to a piece of 18 s.w.g. aluminium, cut and bent as shown in Fig. 5a. The lugs bent over the end of the mirror (see photograph) are not really necessary as the mirror is firmly held by the adhesive. The hinge, also formed from 18 s.w.g. aluminium, is cut and bent as shown, and forms a complete unit with the mirror. Two small helical springs are formed from 26 s.w.g. piano wire and mounted as shown in detail (see Fig. 5d); they serve to hold the mirror firmly in the normal driving position. The complete mirror assembly is fixed to the case with self-tapping screws through the hinge strips.

Probably the trickiest part to make is the linkage between the solenoid and the mirror. Various simple arrangements involving pieces of nylon thread were tried but proved unreliable. The rigid linkage shown in the photograph and Fig. 5e was then tried and found to be perfectly satisfactory. This linkage is

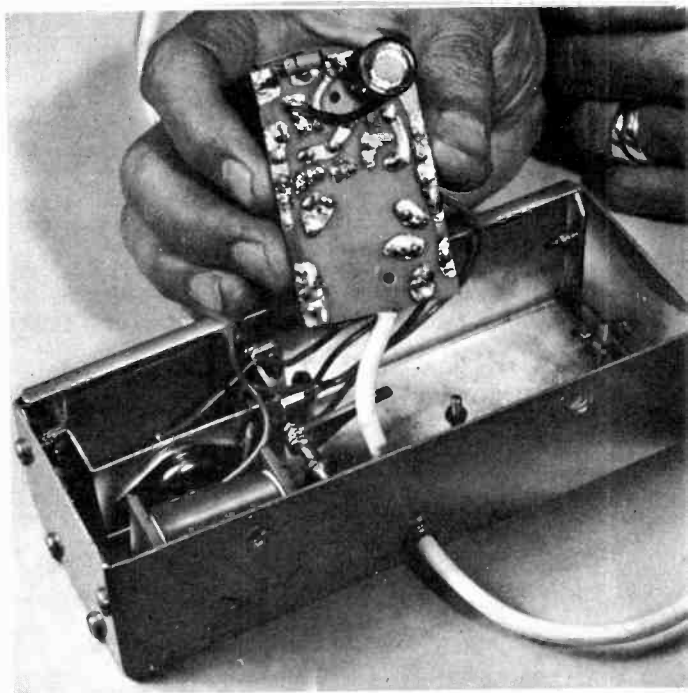

made from two shaped pieces of $\frac{1}{8}$ in brass sheet soldered to a short length of brass tubing, which is a loose fit on a 6 B.A. countersunk bolt; these levers are at approximately 90 degrees to one another. One of them is passed through a loop formed from 16 s.w.g. copper wire and fixed to the solenoid armature. The other is hooked behind a 6 B.A. bolt on the back of the mirror support.

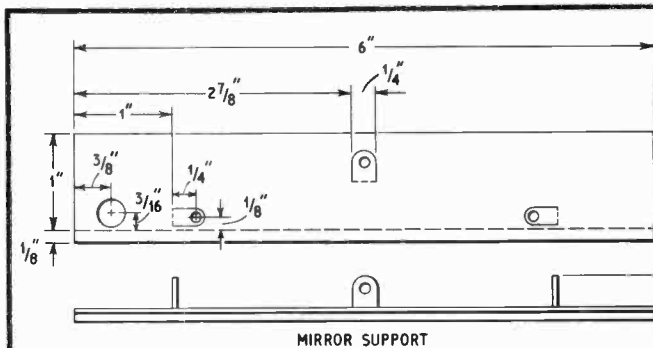

Fig. 5a. Construction of the mirror support. The three lugs are cut and bent at right angles to the plate

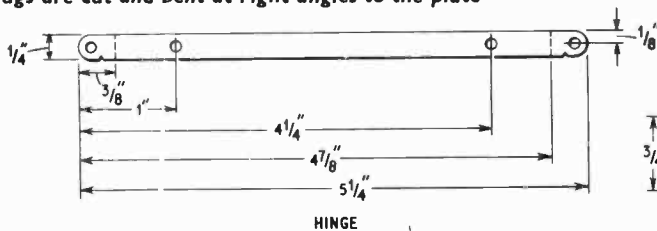

Fig. 5b. The hinge strip. All holes are 6 B.A. clear

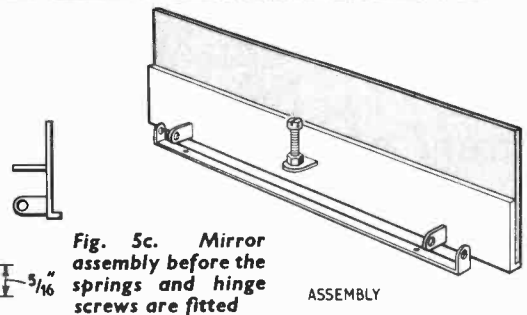

Fig. 5c. Mirror assembly before the springs and hinge screws are fitted

Fig. 5d. Hinge strips fitted with springs and 6 B.A. bolts

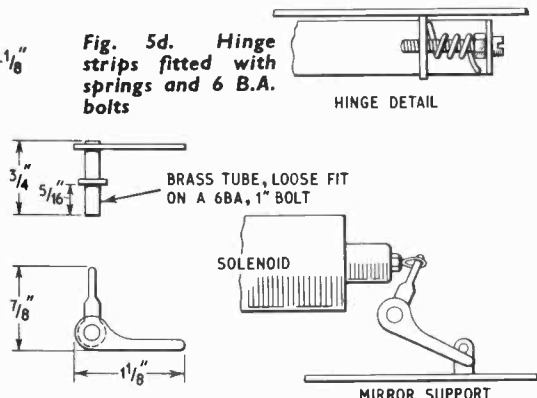
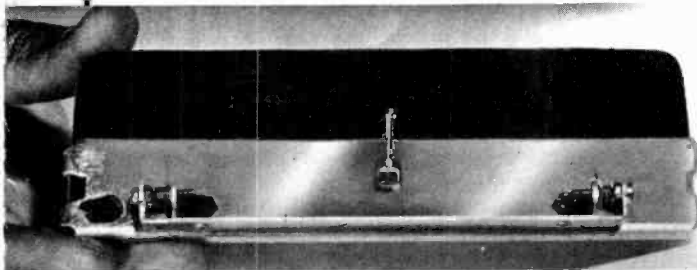

Fig. 5e. Cantilever linkage between the solenoid and mirror support



The printed circuit board is held in the case with two long 6 B.A. countersunk bolts as shown in Fig. 6. Fibre washers are used on the circuit side of the board to ensure that no part of the circuit is earthed to the case. The position of the nuts is adjusted so that the potentiometers just clear the case. Using the dimensions given, it will then be found that the l.d.r. is about $\frac{3}{8}$ in behind the mirror assembly, allowing enough room for the mirror to swing back into the "dipped" position.

FINISHING AND SETTING-UP

The unit is fixed in the car using the ball and socket assembly supplied with the mirror. Because of the considerable weight of the unit, the socket was placed on the top, as close to the point of balance as possible—this accounts for the rather lop-sided appearance. No dimensions are given here as the best way to find the correct position is by trial and error. Finally, the unit is given a coat of paint using an aerosol spray.

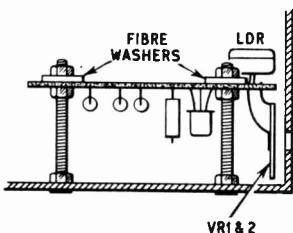
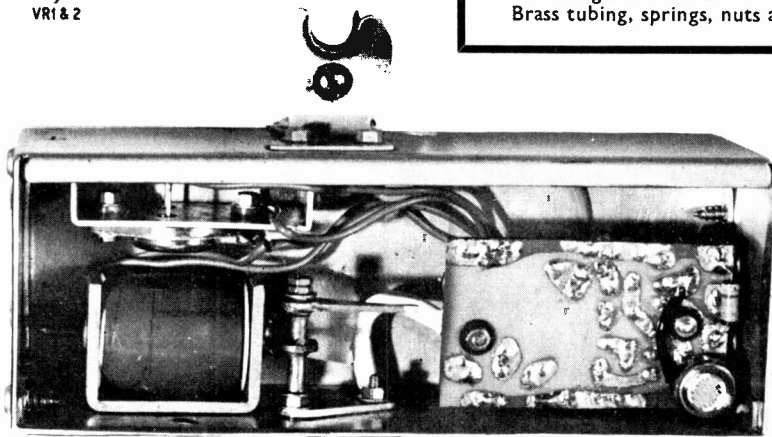

Fig. 6. Section view of the printed circuit board fitted on the bottom of the case so that the holes in the side line up with VR1 and VR2



COMPONENTS . . .

Resistors

R1	5.6k Ω	R4	10k Ω	R7	470 Ω	1 watt
R2	470 Ω	R5	3.3k Ω	R8	100 Ω	1 watt
R3	22k Ω	R6	2.2k Ω	R9	2.2k Ω	1 watt

All 10%, $\frac{1}{4}$ W carbon, except where stated

Potentiometers

VR1	25k Ω	carbon skeleton preset
VR2	10k Ω	carbon skeleton preset

Transistors

TR1, 2, 3	NKT274, NKT277 or OC71 (3 off)
TR4	XC701 or 2N1304
TR5	XAI41 or OC35

Diodes

D1	1S025 or ZR11	D2	1S410 or TM41
----	---------------	----	---------------

Photocell

X1	ORP12
----	-------

Solenoid

L1	Type 1, 12V d.c., pull action (Proop Brothers Ltd.)
----	---

Miscellaneous

Printed circuit etching kit
 Aluminium 18 s.w.g. 2ft \times 2 $\frac{1}{4}$ in
 Insulating kit for TR5
 Brass tubing, springs, nuts and bolts (see text)

Electricity is supplied to the unit via a two-cored cable passed through a rubber grommet in the bottom of the case. Since no part of the circuit is earthed, it may be used with positive or negative earth cars, the only precaution necessary being to observe the correct polarity. The unit is wired to the "dead" side of the sidelight switch, so that it automatically comes into operation when the lights are switched on, and no other switch is required.

The last operation is to put the mirror into place and this can be a little tricky. The mirror unit is first inserted under the lip at the top of the case. The mirror is then positioned as near to the case as possible and the linkage lever is guided behind the bolt at the back of the mirror. Finally, the mirror is pushed right into the case and the self-tapping screws are inserted.

The sensitivity controls are best adjusted with the help of a friend with another car. This car should be positioned 20 to 40 yards behind your car and the headlights turned on full, pointing straight into the driving mirror. The potentiometers are then adjusted until the solenoid operates.

If the headlights are now flashed on and off, the mirror should dip and return in step. Because the l.d.r. is mounted a little way behind the mirror, a directional effect is produced, and the unit will not respond to even quite bright lights unless they shine straight on to the mirror. ★



YODELLER DOOR MONITOR (November, 1967)

TR5 emitter and collector connections in Fig. 2 should be transposed to agree with the circuit diagram.



A scoop of lunar soil picked up by the mechanical digger on Surveyor III

SPACEWATCH

By Frank W. Hyde

DECADE OF PROGRESS

As this column goes to press a decade of progress is marked by the anniversary of the launching of the first artificial satellite. The memory of this occasion is an exciting one for those who were waiting for the momentous breakthrough that was to shatter the sceptics. For the writer it has a special significance, for the records made at the time confirmed predictions offered before the launch. There is, it must be confessed, a certain sense of satisfaction when the original tapes are replayed. Progress from that time has been very rapid and has resulted in a very wide field of discovery.

Apart from the manned spaceflights with the wealth of new knowledge accumulated (and it must be said the de-bunking of prophets of dire consequences) new techniques have evolved in the control of flights, the transmission of data, and the greatly increased understanding of the environs of the earth. The deep space probes have added to our knowledge of the moon and reached the stage of instrument landings with successful close up pictures of the surface. This alone has led to considerable rethinking and restudy from the earth of the rival theories of how craters came into being. The Soviet Union launched the first *Sputnik* which began the new age of astronomical discovery. The first orbiting probe to send back pictures of the hitherto unknown side of the moon was also a Russian success. It was shown that there was little difference in that hemisphere from the rest of the surface.

SOFT LANDINGS

The first soft landing on the moon again went to the credit of the Soviet Union. In February 1966 the

spacecraft *Luna 9* landed safely and some four minutes after touchdown pictures were being transmitted back to earth. The landscape was scanned and the signals were received by both British and Russian stations. The camera was arranged to give a panorama of 360 degrees. This was made at several different elevations of the sun above the lunar horizon and the results obtained enabled a mock-up of the landscape to be made.

Between two of the transmissions the craft slipped with the result that there was a change in inclination of several degrees of the camera. This was a fortunate event as it turned out. It meant that the stereo effect could be utilised to determine the distance of objects from the camera. In addition to the photographic results, radiation was detected on the surface amounting to 30 milliradions per day.

The second controlled soft landing was performed with *Surveyor I* which successfully touched down on the lunar surface on June 1, 1966, after a 63 hour 36 minute flight from Cape Kennedy. It landed at a velocity of 7.5 miles per hour at 2.45 degrees south of the lunar equator in the south-west portion of the Ocean of Storms (*Oceanus Procellarum*).

During the six weeks that followed the spacecraft's survey television camera took 11,150 high resolution pictures of the surface of the moon showing in some close-ups resolution of the order of about one fiftieth of an inch. The pictures showed that the surface at the landing was smooth and level. It was surrounded by a gently rolling surface studded with craters and littered with fragments. The tops of low mountains were visible beyond the horizon (about a mile at this point).

In contrast to this the next *Surveyor* crashed at about 6,000 miles per hour on the surface of the moon. *Surveyor III* was more successful though it bounced twice before coming to rest. It landed on the east wall of a crater 650 miles across in the Ocean of Storms. It was able to dig four trenches in the lunar surface and in the course of some 18 hours of work made bearing strength tests and penetration samplings. The operation of the television camera yielded some 6,315 pictures which included a solar eclipse as the earth passed in front of the sun, pictures of the lunar terrain, portions of the spacecraft, and the crescent earth.

The way is now paved by these experiments so that the astronauts who land will have preknowledge of the environment they will have to experience.

SPACE PROBES

All this was a quarter of a million miles from home but other probes went deeper. In 1962 the successful *Mariner* flight past Venus passed within 21,600 miles of the planet and measured cloud top temperature to be about 240 degrees F and the magnetic field to be negligible. The results of *Mariner V* will already be known when this article is in print.

The next significant event was the deep probe to Mars. The probe made its flight past Mars on July 14, 1965. The distance from the planet was between 7,000 and 10,000 miles. The pictures transmitted over distances that varied between 135 and 148 million miles were of excellent quality. The first conclusions were that there were not many craters visible though the fact that there were any at all was a major discovery not previously suspected. Subsequent analysis of the data showed that there were in fact many more craters than originally supposed. There were some three hundred well defined craters varying between 110 miles in diameter and 1.75 miles in diameter. There still remain other features not yet resolved because the positive identification is limited to about one per cent of the surface. There was evidence of a number of straight features which might be identified as part of the so-called canals. It was not possible to detect vegetation though variations of texture was observed. There were ridges, and depressions ranging from 100 to 200 miles in length and from two to seven miles in width. There were also signs of fracture zones in the crust. However the Martian surface shows marked deterioration of the craters compared with the moon and this is probably due to the fact that there is an atmosphere on Mars while there is none on the Moon. The wide daily fluctuations of temperature may also be responsible for the production of rubble created by the rapid expansions and contractions.



Newspaper Transmitted Across the Atlantic

A COMPLETE page of a newspaper, including pictures and words, was transmitted across the Atlantic on October 17 via satellite from London to San Juan, Puerto Rico. This was the first time that a newspaper page has been sent by satellite.

A complete page of the *Daily Express* was wrapped around a drum on the Muirhead transmitter (above) and a beam of light traversed the drum, illuminating a small square of the page. The drum revolved and the whole page was scanned in the form of a spiral. Light from a minute area of this square was reflected through a precision optical system and used to control the electrical output of a photocell. The amplitude of the output signal depends upon whether the scanning beam falls on white paper or print, including the dots in the half-tone pictures.

The signals were transmitted via a cable and microwave system to Goonhilly where they were directed to the *Early Bird* satellite. The receiver in Puerto Rico converted the signals back to "light" information for processing into printing plates.

Ballot Paper Counter



CUBIC CORPORATION of the U.S.A. have designed a ballot paper counter using 1,500 Motorola digital integrated circuits. Known as the Votronics ballot paper counter, it takes hand-fed papers up to 18in wide containing up to 299 voting positions. Perhaps we may see instant election results in the near future with same-day results in all cases.

ICs for Future Applications

THE Southampton works of Mullard concentrates its activities mainly in the manufacture of integrated circuits and semiconductor devices. The bulk of present production is on digital circuits but new fast types of EECL device are being made for use in the next generation of computers.

Among the new linear circuits is one that has the functions of five transistors and a diode and is the heart of an a.m./f.m. receiver up to and including the first audio stage. Variations of this device are expected to be produced for the sound channel of colour and monochrome television receivers. Our photograph (right) shows a bank of epitaxial reactors used in making integrated circuit slices.

Electronics in Business

THIS new audio teaching aid by Philips, shown at the Business Efficiency Exhibition, comprises four "source" dictating machines and a master tape recorder.

The teacher's control panel gives full control of up to a maximum of 60 students. Clear, easily understood directions are indicated on the panel.

The student control panel (inset below) includes a four position channel selector, volume control, and a socket into which the Stenolab headphones can be plugged. There is also an additional socket provided for teacher monitoring.

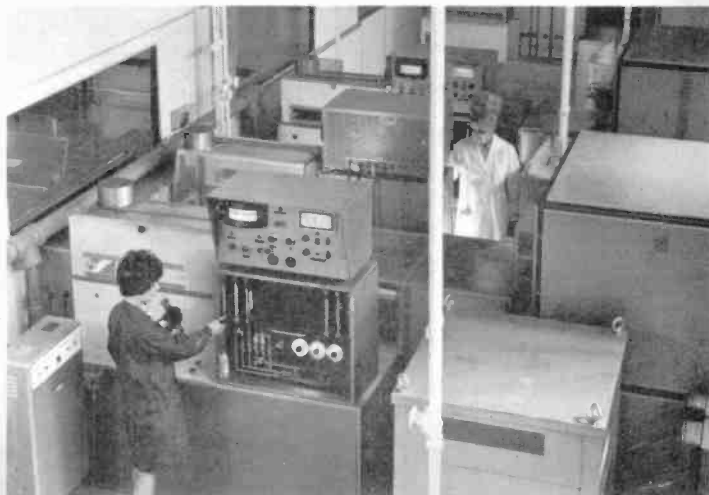



Integrated Circuit Regulator for Car Alternator

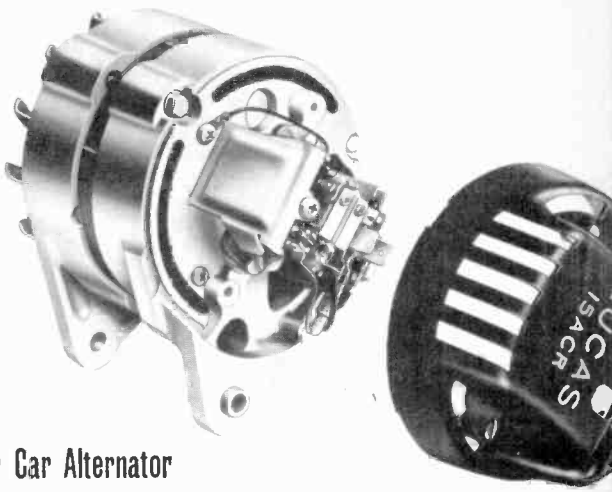

Lucas 15ACR alternator and regulator

A NEWCOMER to motor car electrical systems is designed for increasing the life and reliability of the battery charging system. The Lucas alternator 15ACR and the 8TR regulator replaces the old dynamo and is claimed to provide the battery with a continuous regulated voltage—irrespective of the load on the battery and engine running conditions.

This system (shown top right) occupies less space under bonnet than the old system. Instead of being a separate unit, as was the old electromechanical regulator, the new 8TR regulator is fitted inside the end cover of the alternator.

The comparison of size (far right) between these two shows a significant achievement in size reduction coupled with improved performance, due to development of a thick film integrated circuit regulator. Semiconductor silicon diodes are built in to the "finned" heat sink (just visible on the right of the alternator photo) with arrangements incorporated for simple plug-in connection.

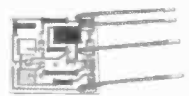

New 8TR integrated circuit regulator

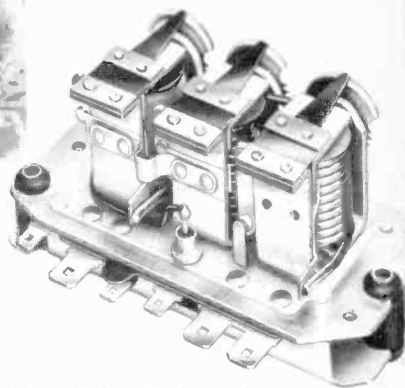

Old electro-mechanical RB340 regulator

The other three photographs show the manufacturing processes of Lucas semiconductor rectifiers. The silicon slice is diced and fitted with lead-out wires for small diodes. High current rectifiers are made by fitting the silicon dice on a thick metallic disc so that the connections are made through the disc and a central pin insulated from it. The picture (top left) shows the "top hat" cover being cold-pressed on to the disc periphery.

Rigid testing and polarity identification is carried out on the equipment shown in the centre of this page and below right. These two pictures show low current Zener devices and DD000 diodes. Polarity is indicated by placing the unencapsulated diodes on small racks. Connection through the lead-out wires is made to neons situated under the wires. Reverse positioning is carried out as necessary by the operator before being placed on the roller conveyor to the encapsulation fitters.



HIGH INPUT

IMPEDANCE

TECHNIQUES

By K.T. WILSON

How can a crystal pick-up be coupled into a transistor amplifier? Can a capacitance bridge work with transistor circuits? The answers to such questions as these depend on the input impedances which can be achieved with transistors. The impedance of a circuit element is a measure of how much electrical power is lost in it.

If a high impedance circuit is connected to a low one as in Fig. 1, then, as an a.c. current is passed through the combination, most of the power will be lost in the high impedance and very little will appear at the output across the low impedance. Sometimes this may be deliberate, as when using a volume control where the ratio of high to low can be varied.

If turned up the other way, then there is very little loss across the low impedance and the output across the high impedance is almost as large as the input.

TRANSISTOR IMPEDANCE

When using a transistor as an amplifier, the input is usually applied to the base, with the emitter earthed either directly or through a large capacitor. The input impedance of a transistor used in this way is rather low; if the source of the signal has a high impedance, then there will be very little signal left to go into the transistor.

This situation is even worse when feeding the input to the transistor through a capacitor, for the impedance of a capacitor varies with the frequency of the signal, being high for a low frequency signal and low for a high frequency signal. The opposite case holds for a choke, but this will not be discussed further as chokes are not so frequently found in transistor circuits.

If, then, a signal is fed through a capacitor into the base of a transistor, the amount of amplification obtained will vary with the frequency of the signal, being very low at low frequencies and rising to the amount we expected to get when we designed the circuit at high frequencies.

Sometimes this can be offset quite simply by using very large capacitors, and this is what is often done to couple two stages in an amplifier. The fact that very low frequencies will be amplified so much less is not a disadvantage providing that the lower limit is not too low; it may be 100Hz in an ordinary amplifier, rather lower in a hi fi amplifier.

NO CONTROL

In some cases, there may be no control over the impedance through which the transistor amplifier is fed. This is particularly so in the case of a crystal pick-up. If a crystal pick-up is coupled to a resistance (which is an impedance without any complications of frequency variation) and the output measured across the resistor at various frequencies, the result is exactly the same as it would be in the circuit of Fig. 2.

This circuit is termed the equivalent circuit of the arrangement, and the part enclosed by the dotted line is the equivalent circuit of the crystal pick-up. The capacitor is of rather a low value, about 2,000pF, so that if the pick-up is fed directly into the input of a transistor, there would be very little amplification at low frequencies.

This is the case, and special precautions have to be taken when using crystal pick-ups with transistor amplifiers. The whole trouble is that the input to the transistor is of low impedance and the circuit requires a high impedance.

The same sort of thing happens in the case of a bridge circuit, and is very much worse in the case of a potential divider circuit for measuring capacitance, such as is shown in part in Fig. 3.

All these troubles could be overcome if transistor circuits had a high input impedance. It is true that there are several other ways round the problem, but they all have their disadvantages.

The new field effect transistors known as MOSFETs have a very high input impedance, so high that the static

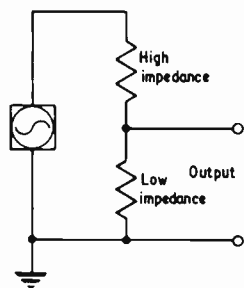

Fig. 1. A.C. potential divider or potentiometer

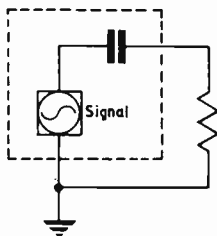

Fig. 2. A capacitive signal source connected to a resistive load

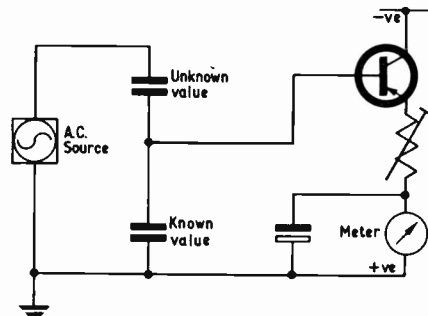

Fig. 3. An a.c. signal source with capacitive load

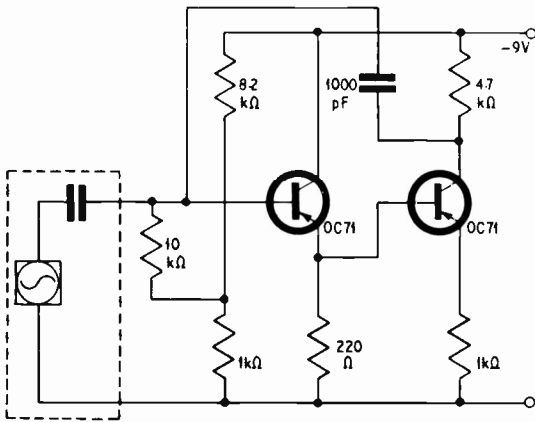

Fig. 4. Negative feedback applied over to stages to the input

electricity generated by rubbing the leads against an insulator cannot leak away, but will damage the transistor. Mosfets are very expensive, however, around £2 to £20 each, and hardly likely to be used at the moment in quantity except where nothing else will do.

It is possible, of course, to place a high resistance in series with the input. This has the disadvantage that the amplifier must now do more work, since the input signal is now so small; the increase in amplification required means more noise so that the signal-to-noise ratio suffers greatly.

Another method is to apply negative feedback to the input through a capacitor as shown in Fig. 4. This works by making the input impedance of the transistor amplifier seem like a capacitor as the equivalent circuit shows.

This can be a useful dodge where the input is fixed, as in the case of an amplifier, but is less useful with a variety of inputs, as the amount of amplification obtained depends on the capacitance of the source, and the feedback must be changed to resistive if a resistive input is to be used.

BEST SOLUTION

On the whole, the best solution is to use a high impedance input circuit of which several are known.

Most of these circuits use at least two transistors, but a useful improvement in input impedance can be obtained by using a simple emitter follower, as shown in Fig. 5. This is not good enough to be used with a crystal pick-up, but is very useful for isolation when two transistor units are coupled together. This circuit can be found as the last stage in pre-amplifiers or tuners.

The genuine high impedance circuits are usually of one of two types, the bootstrap type or the Darlington type. Taking the Darlington pair first, the name is derived from the combination of two transistors first investigated by Darlington, and shown in Fig. 6.

Two transistors connected in this way have a very high gain, and since the input impedance of an emitter follower circuit depends on the gain of the transistor, many designers have assumed that an emitter follower using a Darlington pair as a single transistor would have a very high impedance. In actual fact the impedance is

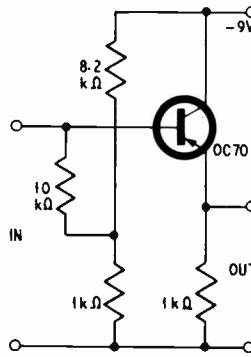

Fig. 5. Simple emitter follower with a high input impedance

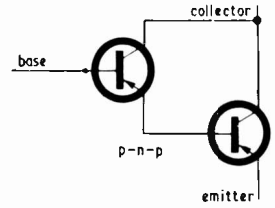

Fig. 6. Darlington pair using p-n-p transistors

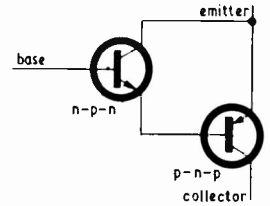

Fig. 7. Complementary Darlington pair

not particularly high, due to feedback in the transistors (internally); but many designs can be seen where it is confidently stated that the Darlington pair is used to increase the input impedance. The constructor building such a circuit can quite confidently replace the Darlington pair by a single emitter follower at some saving in cost.

A very different proposition is the circuit of Fig. 7, known as the complementary Darlington. It will be seen that one transistor of the Darlington pair is now an *npn* type. Such an arrangement avoids the difficulty of the internal feedback which makes the normal Darlington pair less useful.

This type of circuit can be used wherever a high impedance input is required, but it has two disadvantages: it requires one *npn* transistor, and any resistors used to bias the base of the first transistor will detract from the high input impedance, as they will be in parallel with the input.

BOOTSTRAP

These difficulties are avoided in the "bootstrap" circuit, at the expense of some extra circuit complications. The principle of the "bootstrap" circuit is shown in Fig. 8. If a signal is fed into a resistor of low value, and at the same time a signal of the same voltage is fed into the other end of the resistor, there will be no current through the resistor. This is another way of

continued on page 915

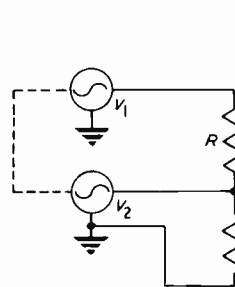

Fig. 8. Bootstrap principle. V_1 and V_2 produce the same waveform and the same voltage

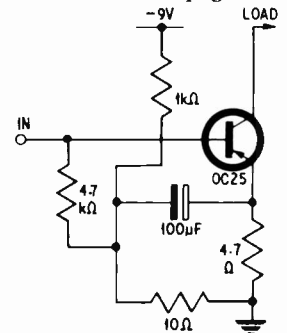

Fig. 9. Low bias resistance in a high impedance input

CIRCUIT SYMBOLS

WIRES CROSSING
Without connection



WIRES CROSSING
With connection

NOTE:
Not this

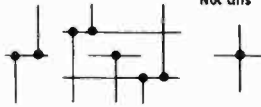

Transformer

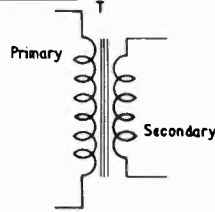

DIODE

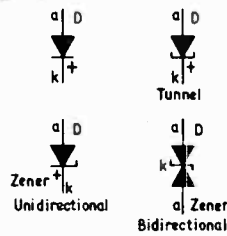

TRANSISTOR

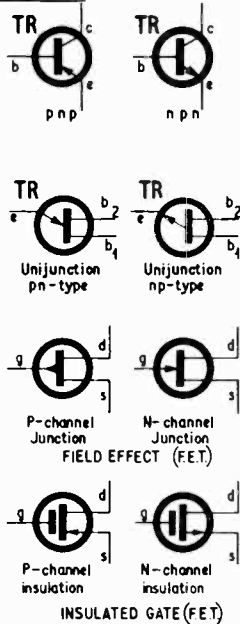

Thyristor

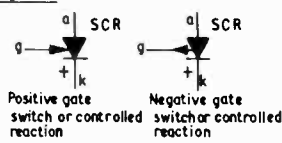

SWITCH (General symbol S)

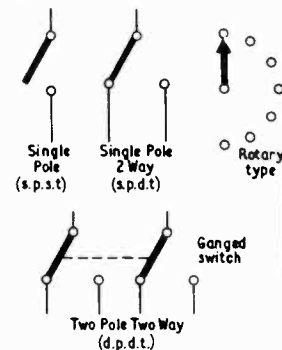

NOTE: Alternative description of switches given in brackets are:
s.p.s.t. single pole single throw
s.p.d.t. single pole double throw
d.p.d.t. double pole double throw

JACK

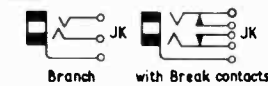

PLUG/SOCKET

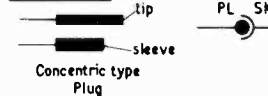

BATTERY

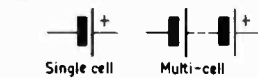

PICK-UP



FUSE



LAMP

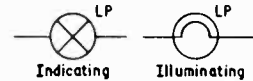

METER

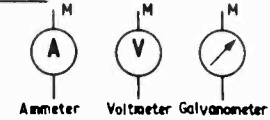

LOUDSPEAKER



HEADPHONES

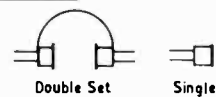

LIGHT DEPENDENT RESISTOR



THERMISTOR

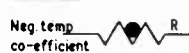

NEON LAMP



AERIALS

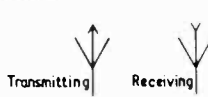

MICROPHONE

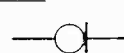

COMMON SYMBOLS AND ABBREVIATIONS

Unit abbreviations

A	amperes
dB	decibels
F	farads
H	henries
Hz	hertz (formerly cycles per second)
J	joules
V	volts
W	watts
Ω	ohms

Quantity abbreviations

C	capacitance (farads)
E	e.m.f. (volts)
f	frequency (hertz)
I	current (amperes)
L	inductance (henries)
P	power (watts)
R	resistance (ohms)
X	reactance (ohms)
Z	impedance (ohms)
λ	wavelength (metres)
α, β, h _{FE} , μ	amplification factor

Other abbreviations

a.m.	amplitude modulation
f.m.	frequency modulation
l.w.	long wave
m.w.	medium wave
s.w.	short wave
l.f.	low frequency
m.f.	medium frequency
h.f.	high frequency
i.f.	intermediate frequency
v.h.f.	very high frequency
u.h.f.	ultra high frequency

Semiconductors

e	emitter
b	base
c	collector
s	source
g	gate
d	drain
k	cathode
a	anode
b ₁	base one
b ₂	base two
sh	shield

Sub-multiples and multiples

p	pico	= × 10 ⁻¹²	μ	micro	= × 10 ⁻⁶	k	kilo	= × 10 ³
n	nano	= × 10 ⁻⁹	m	milli	= × 10 ⁻³	M	mega	= × 10 ⁶

SEMICONDUCTOR BASICS

1—INTRODUCTION

By G. J. King

THIS is the first of a series of articles written specially for beginners to electronics. As the large proportion of electronic circuitry involves the use of semiconductor devices, a straightforward and easily understood account is given of what semiconductor materials are and how they are put to good use.

Part 2 and all subsequent articles in this series will be accompanied by a special constructional article aimed at providing a practical demonstration of the operation of the particular semiconductor device under discussion.

CONDUCTORS AND INSULATORS

As implied by its name, a semiconductor is neither an insulator nor a good conductor of electric current. One of the best *practical* conductors is copper—a better one silver. All metals conduct electric currents to a fairly high degree, but some conduct them better than others. An elementary definition of an insulator is a substance through which an electric current cannot be persuaded to flow.

Again, there are various degrees of "insulation". Substances like glass, ceramic, mica and various plastics afford a good insulation against electricity, since materials like these are used to house electric and electronic elements and appear between the terminals of the devices. Hosts of other materials have the same property of insulation.

In some applications, the materials have to retain their insulating properties up to very high temperatures, such as the bars and blocks upon which are wound the elements of electric fires. Although some materials are adequate insulators for relatively low electric pressures, these same materials might be totally unsuitable for working at much higher pressures as present, for instance, in X-ray plant, oscilloscopes, and television equipment.

The pressure of electricity is measured in volts (signified by the capital letter V) or fractions of a volt, while the flow of current through the conductor is measured in amperes (signified by the capital letter A). The resistance offered to a flow of electricity by the conductor is measured in ohms (often signified by the greek omega Ω).

Why can electricity flow through conductors and not through insulators? This brings in the electron theory, but this will only be pursued here as far as essential to acquire a basic understanding of semiconductors.

PROPERTIES OF ATOMS

The smallest unit of any of nature's elements is the *atom*. This means that an element can be divided, sub-divided and sub-divided again many times over right down to its basic atom and still retain element identity. Further sub-division would then destroy its

identity and, indeed, possibly change it into two or more atoms of a different element!

It is not easy to appreciate just how small an atom really is, and various imaginary artifices are adopted in text books and by teachers to convey to the student some idea of its diminutiveness. It is rather like trying to assimilate the vastness of space. Anyway, as a rough measure, take a small blob of copper, about the size of a pin's head, and keep on dividing and subdividing this until you end up with 10^{18} bits; each bit would then be a copper atom! Happily, we do not have to be too subjective about dimensions.

Atoms have two main component parts, called the *proton* and *electron*. The former is about 2,000 times the mass of the latter. The number of protons and electrons determine the nature of the atom. The simplest case of an atom to take is hydrogen because this has just one proton and one electron. The proton is positively charged and the electron is negatively charged.

Now, there is a well known law about like charges repelling and unlike ones attracting, so one might expect the electron (of the hydrogen atom, for instance) to be stuck to its protonic partner. Actually, this is not so because the electron is revolving round the proton in exactly the same manner in which the Earth revolves round our Sun. In other words, the electron is in orbit round its proton, and the force that this motion creates on the mass of the electron balances out the electrically attractive force between them. A specific orbital path is thus established, as governed by the nature of the atom.

The centre of the atom, where the protons congregate in a cluster, is called the nucleus, and to maintain balance here, some atoms have inner-orbiting electrons. These are very closely associated with the nucleus and bonded in orbit very tightly to it. They are not easily moved and for this reason are called "fixed electrons".

Other atoms have electrons spinning round on outer orbits. These are called "free" electrons because they are not so tightly bound to the nucleus. They can dodge from the outer orbit path of one atom to that of another atom in the material. These so-called free electrons provide electric conductivity.

Some atoms are highly complex, but to illustrate the basic theme, Fig. 1.1a shows the simple hydrogen atom with one electron and one proton. In Fig. 1.1b the next complex atom, that of helium, with two free electrons orbiting its nucleus, is compounded of two protons. In Fig. 1.1c the carbon atom has six electrons in two orbits round its six-proton nucleus. A very complex atom is that of the metal uranium. This has a nucleus compounded of 184 protons with 92 fixed and 92 free electrons in complex orbits.

ELECTRON MOVEMENT

The essential difference, then, between conductors and insulators is that conductors have an abundance of free electrons while insulators' electrons are mostly tightly bonded to inner orbits. This implies, therefore, that an electric current is in some way related to a movement of electrons. This, indeed, is certainly the case; and electricity, in fact, is nothing more than a movement of electrons from point A to point B—that is, over a specific circuit.

Small random current "transients" are produced when free electrons dodge from atom to atom in a conductor. These random electron movements do not produce electricity in its known form, but the transients that they do create can be seen on the screen of an oscilloscope or, in fact, heard in a loudspeaker. In electronics they are known as the noise signal. Noise is the hiss heard when a receiver is tuned to a vacant channel.

Of course, the transient currents produced by these random electron movements have to be very considerably amplified before we can hear them in this way. On an oscilloscope screen they look like spiky pulses—the effect is known colloquially as "grass" by engineers.

Electricity in its more common form is due to an orderly movement of electrons. One can consider a conductor as a tube containing masses of electrons packed closely together, as shown in Fig. 1.2. Now, if one more electron is forced into one end, one will have to fall out at the other end. This is better visualised by assuming that the conductor has just one row of electrons with an extra one to spare. If this extra one is pushed in one end, the far one at the other end will fall out and this can be pushed in at the start again, thereby keeping up the flow—albeit, highly intermittent!

Actually, it is difficult to make electrons just fall into space from the end of a conductor (wire) and then get back into circuit again at the other end. We must have a complete circuit, and to keep the electrons moving we must have an electron pump of some sort (Fig. 1.3). The source of electricity is the "pump", so to speak. This might be a battery, generator or some other device to keep electrons in motion in a circuit.

In this context, electrons can be considered as current carriers. Actually, they constitute the current when they are in motion; but without them there would be no current carried, so it is perfectly proper to refer to them as current carriers. This term is used extensively in semiconductor parlance.

This brings up the question of how fast electricity travels. Some people tend to rate this with the velocity of light, which is wrong. True though it may be that the effect of electricity is felt immediately a switch is operated, this is only because electricity lies dormant, so to speak, in the conductors.

It is akin to the water supply to a house. Water falls from the tap immediately it is turned on: but this

almost zero time is not that taken for the water from the reservoir to arrive at the tap. Water—like electricity—is displaced along the pipe (conductor) and the pump (battery or generator) at the reservoir and keeps it flowing. The actual speed is relatively low.

Good conductors represent material in which the atoms have plenty of free electrons. And good insulators are materials in which the atoms have closely bound orbiting electrons. In such materials, any flow of electricity is due to electron current carriers, which are negative.

CRYSTALLINE SEMICONDUCTORS

Some semiconductors are based on a crystalline material in which there are virtually no free electrons in its purest form. Typical crystals for this application are germanium and silicon, and they are purified to a

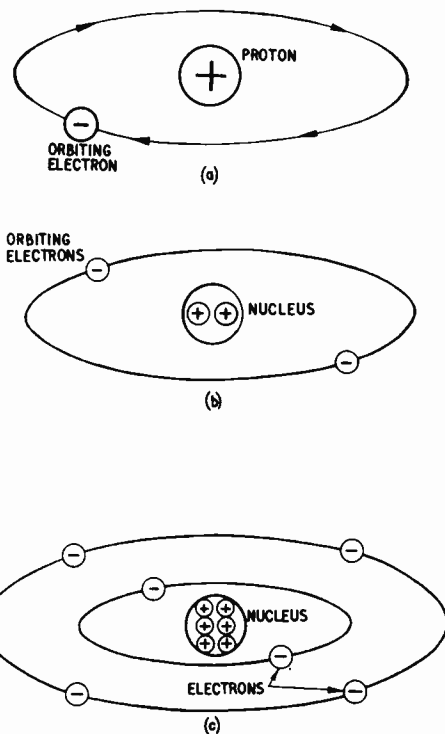

Fig. 1.1. Elementary representation of atoms (a) hydrogen, (b) helium, and (c) carbon

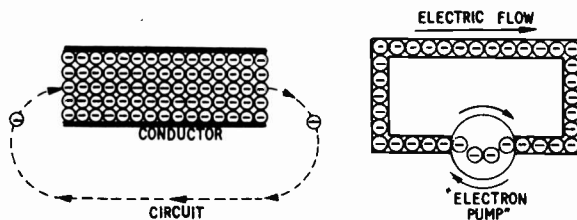

Fig. 1.2. A conductor can be considered as a tube full of electrons, a flow of electricity being a movement of the electrons which would occur by an electron entering at one end and leaving at the other

Fig. 1.3. An "electron pump" (battery or generator) keeps the electrons moving in a conductor, thus producing electric current

very high degree making them incredibly good insulators. They are then made into semiconductors with specific parameters by the controlled addition of impurities—from the electrical point of view.

If atoms of an impurity so added have more electrons than the atoms of the crystal, electrons are “let loose” in the material to serve essentially as current carriers. Since these are negative, this sort of semiconductor is called *n*-type (*n* for *negative*).

Impurity agents to provide excess electrons include arsenic and antimony. It should be appreciated at this juncture that the negative charge of the electrons is balanced by an equivalent positive charge in the nucleus of the impurity atoms.

To provide a semiconductor of different characteristics, impurity atoms such as aluminium, gallium, or indium are added. When these atoms get into the basic crystal structure they set up conditions which give an apparent shortage of electrons. In other words, there are positions for electrons which are not, in fact, present in the material. These electron vacancies or “holes”, as they are called, encourage electron flow through the material, for the electrons flowing through use the holes as “stepping stones” (Fig. 1.4).

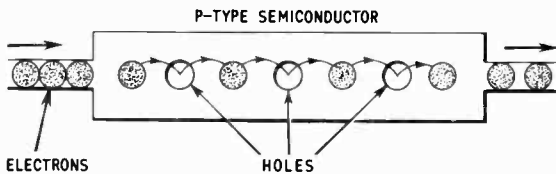

Fig. 1.4. Electrons can also move through material lacking in electrons but possessing spaces (holes) to accommodate electrons. In this case, electrons move through the material from hole to hole, as this diagram reveals. Since the electrons are moving from left to right in this drawing, the holes can be considered as moving from right to left in relation to the electrons

A hole in a crystal structure is considered to have a positive charge because it represents the absence of an electron, but as with *n*-type material, the net charge of the crystal as a whole is unchanged. Semiconductor materials which contain holes or positive charges are called *p*-type (*p* for *positive*). *p*- and *n*-type semiconductors are used extensively in diodes and transistors, as we shall see in later articles, but in addition to these there are many more kinds of semiconductor.

The resistivity of some materials is reduced or increased with temperature increase. These are called thermistors. Others drop substantially in resistance as the voltage across them increases. These are called voltage dependent resistors. Then there are others whose resistance falls as the intensity of light directed on to them increases. These are members of the photo-transistor and photoconductive family and light dependent resistor.

In all cases, the resistivity is reduced (i.e. the conductivity is increased) by the stimulus causing a change in the amount of free electrons available for conduction. That is, the number of current carriers is increased, whether these are electrons or holes.

Next month we shall be investigating semiconductor diodes, looking more at the crystalline make-up of the materials and seeing how it is that a diode easily passes electric current in one direction but not in the other.

HIGH INPUT IMPEDANCE TECHNIQUES

continued from page 911

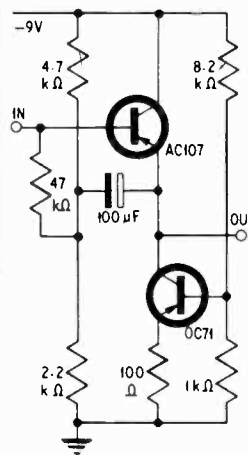

Fig. 10. Very high impedance circuit using two transistors

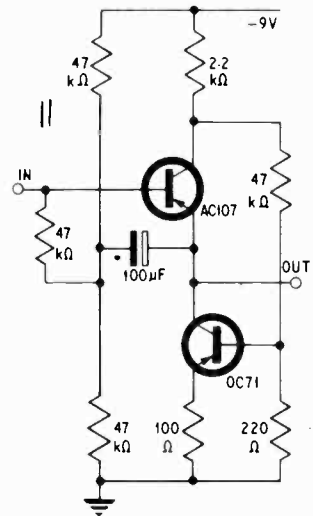

Fig. 11. Feedback applied to increase the apparent emitter load

saying that the resistor seems to have infinite impedance, although we know very well that the real impedance of the resistor is low.

It is rather difficult to feed the other end of the resistor with *exactly* the same waveform as is being fed into the “business end”, but for many purposes the voltage from the emitter of an emitter follower is good enough. Using this principle, a low value of resistance can be used to bias a power transistor for example, so that good thermal stability can be achieved, and yet the input appears as a high impedance to the signal, so that reasonably sized coupling capacitors may be used. Such a circuit is shown in Fig. 9.

To obtain the highest impedance, however, two transistors must be used, and two commonly used circuits are shown in Fig. 10. Their valve equivalents are well known to radar designers as improvements on the cathode follower principle. In each case the bias resistor has been “bootstrapped” to increase its apparent impedance, and the emitter load of the upper transistor which acts as an emitter follower, is formed by the lower transistor.

The lower transistor acts as if it were a high resistance as far as the signal is concerned (because the impedance at the collector of the transistor is high), but it does not restrict the current flowing in the same way that a “real” resistor would. This is one way of getting the best of both worlds.

The slightly modified version of this circuit, shown in Fig. 11, uses a feedback connection from the collector of the top transistor to the base of the bottom one to increase the apparent emitter load still further. Very high impedances can be obtained with this circuit.

Still higher impedances, of the order of 20 megohms upwards, can be obtained by elaborations of the circuits shown. It is to be hoped that this glimpse of the possibilities of high impedance circuits with transistors will encourage experimenters to try such circuits in such devices as potentiometer detectors, amplifiers for capacitance microphones and crystal pick-ups, proximity detectors and the like. ★

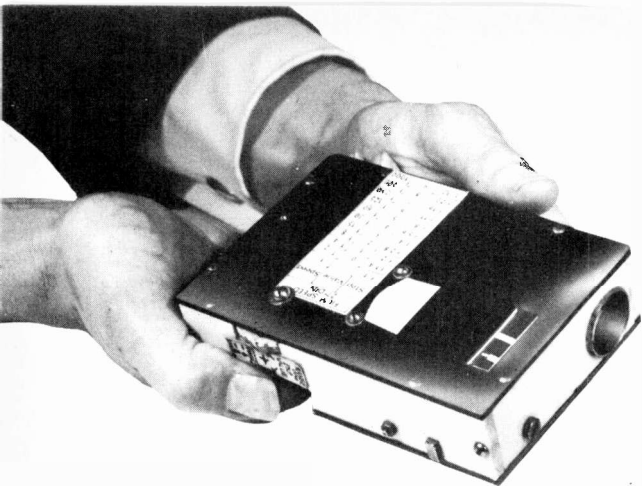

photographic EXPOSURE METER

By S. C. HOOSON

THE cadmium sulphide cell is of obvious interest to photographers since its resistance varies with the rate at which light energy falls on it. The cell recommended for use in this exposure meter (ORP12) varies in resistance from about 20 ohms to 10 megohms over the range of illumination which is of use in photography. Unfortunately the characteristics of individual cells differ, so that the meter must be calibrated for the particular cell it is using.

WHEATSTONE BRIDGE

The basic circuit is shown in Fig. 1. A Wheatstone bridge is used so that results do not depend on battery voltage. R_A and R_B are the ratio arms. By means of the switch S_2 the ratio of resistances R_A and R_B may be set to either of two different values, so providing the instrument with two ranges.

R_C is a variable resistance which is used to balance the bridge—the condition for balance being, of course, that $R_A/R_B = R_X/R_C$. Since the resistance R_X depends on the illumination of the cell, then the value of the resistance R_C needed for balance will indicate the illumination.

The author tried using a variable resistance for R_C , but found this unsatisfactory. In order to obtain a linear scale, appropriate resistance values were selected by a multi-way switch. This article will show how the values of these resistors may be calculated.

Construction of the exposure meter is fairly straightforward as dictated by the simplicity of circuit. The main criterion is the range switch which is a single-pole,

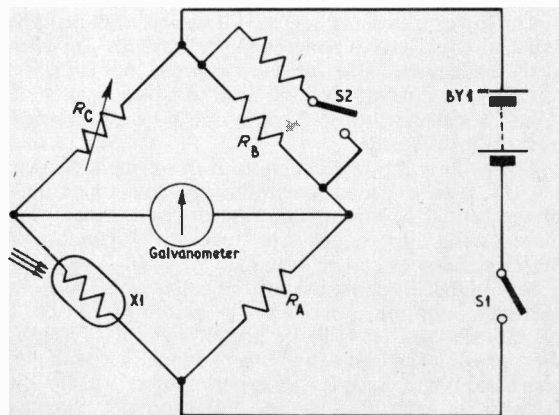
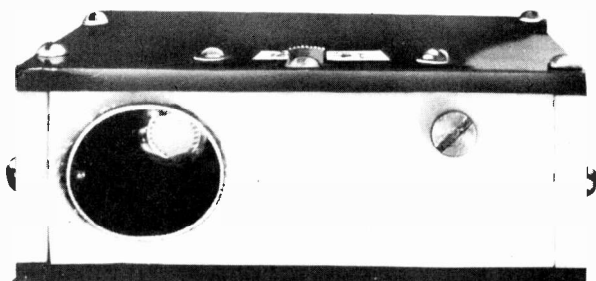

Fig. 1. Basic Wheatstone bridge circuit

18-way wafer with edge control. In the instrument described, only 11 ways are used. The overall size of this switch is $2\frac{3}{8}$ in \times $2\frac{3}{8}$ in \times $\frac{1}{8}$ in, so a case (the author's was in Perspex) of internal dimensions 3in \times $5\frac{1}{2}$ in \times 1in minimum should be able to house all the components comfortably (see Fig. 4).

All drilling and slot cutting should be done in the sides of the case before assembly, each side being fixed to the adjacent ones with glue or screws. The exact positions and sizes of holes will depend on the components used.

The range resistors are mounted directly on the selector switch, but space must be allowed to house the mercury cells in the corner by this switch. An insulating retainer is glued to adjacent sides of this corner to



keep the cells in position and insulate from the switch components. Similarly, the photo-cell tube should be wrapped in thin plastics sheeting to insulate from the nearby resistors and meter movement.

Wiring is straightforward and the circuit in Fig. 3 is used in the actual model. Insulated wiring is used as much as possible.

Before finally closing the lid (the part with the meter mounted on it) on the case, check all wiring and make sure that there is no risk of shorts.

The case should be made dust proof to protect the meter movement. Thin rubber or plastics sheet inserted at all case joints will help to achieve this.

MOUNTING THE CELL

Before making any measurements on the cell, it is essential to mount this component in its final form, since its resistance will depend on the acceptance angle it presents to the light source. It is recommended that a fairly narrow acceptance angle be used, since the meter may be used to measure the brightness of a small part of the scene, instead of giving an overall average brightness.

A metal or cardboard tube, of about 2½in in length and ¼in diameter forms a suitable container for the cell. A disc of s.r.b.p is cut to fit one end of the tube, two suitable holes are made in the disc, and the wire ends of the ORP12 pushed through the holes. The wires are then carefully bent over to anchor the cell. The disc is cemented to the end of the tube, with the cell inside the tube. The inside of the tube should be blackened with matt black paint.

An alternative, which can be easily obtained and provides a neat finished appearance, is a large cigar tube, which can be painted matt black.

The length of the tube controls the acceptance angle, a shorter tube giving a larger acceptance angle, but this may be altered to suit individual preference. It should be noted that the larger the acceptance angle, the less is the need for a sensitive meter in the bridge circuit.

CALIBRATING THE CELL

It is now necessary to find the resistance of the cell at a few known values of illumination, and for this it will be necessary to borrow a calibrated exposure meter, or light meter.

Arrange a sheet of white paper vertically, with both the cadmium cell and the exposed meter pointing at it, at a distance of about a foot. Connect the cell to a reliable ohmmeter, or other accurate resistance measuring device.

Set the film speed dial of the exposure meter to, say, 22 Din (125 ASA), and leave it at this setting. Readings are taken of the resistance of the cell, and of the exposure value readings on the exposure meter. This should be repeated a few times over a wide range of illumination of the white paper using daylight only.

A graph is now made, plotting the logarithm of the cell resistance against the exposure values. This will be found to be a straight line, as in Fig. 2. The calculation of the resistances for R_C and R_B is made from this graph.

CALCULATION OF RESISTANCES

A decision must now be made on the exposure values to be covered by each of the two ranges. Suitable values would be: Range 1, 0 to 10; Range 2, 8 to 18, and it is on this basis the calculation will be made. This requires a multi-way switch with 11 ways. The ranges may, of course, be extended or reduced to suit a switch with a different number of ways.

Tables 1 and 2 are now prepared, the third line of each table being obtained from the graph (Fig. 2). If the values of the resistances in the third line of each table are compared, it is found that their ratio is about

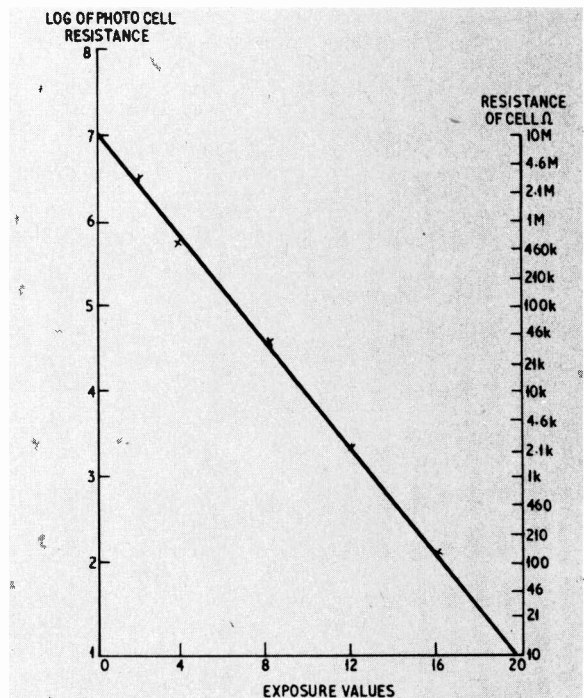

Fig. 2. Graph of photocell resistance against exposure values

300 : 1 (e.g. column 2 . . . 5 Megohms : 17 kilohms; and column 8 . . . 75 kilohms : 240 ohms, etc.).

Take the square root of this figure, 300, which is approximately 17. Line four of Table 1 is obtained by *dividing* line three by 17. Line four of Table 2 is obtained by *multiplying* line three by 17. Thus line four of each table should be the same, and this represents the value of the resistance needed for R_C for each switch position. The ratio of R_A/R_B must be either 17/1 or 1/17, depending on the position of S2.

Referring now to Fig. 4 which gives the complete circuit, it will be seen that the table of resistance values fulfils the above conditions (bearing in mind that line four of the tables gives the *total* resistance required for R_C at the various switch positions).

GENERAL CONSIDERATIONS

All the resistors should be 5 per cent tolerance or less and of high stability. It is worthwhile connecting R1 to R11 on the multi-way switch, and then checking with an ohmmeter that the resistance at each switch setting does in fact agree with line four of the tables.

Table 1: RANGE 1 VALUES

S3 switch position	1	2	3	4	5	6	7	8	9	10	11
Exposure value for range 1	0	1	2	3	4	5	6	7	8	9	10
Resistance of photocell (ohms)	10M	5M	2.5M	1.2M	600k	300k	150k	75k	36k	17k	9k
Resistance needed on selector S3 R_C (ohms)	600k	300k	150k	70k	34k	17k	8k	4k	2k	1k	500

Table 2: RANGE 2 VALUES

S3 switch position	1	2	3	4	5	6	7	8	9	10	11
Exposure value for range 2	8	9	10	11	12	13	14	15	16	17	18
Resistance of photo-cell (ohms)	36k	17k	9k	4k	2k	1k	460	240	120	60	30
Resistance needed on selector S3 R_C (ohms)	600k	300k	150k	70k	34k	17k	8k	4k	2k	1k	500

COMPONENTS ...

Resistors

R1	500Ω	R6	17kΩ	R11	500Ω
R2	1kΩ	R7	34kΩ	R12	3.6kΩ
R3	2kΩ	R8	85kΩ	R13	12Ω
R4	3.8kΩ	R9	150kΩ	R14	210Ω
R5	9.2kΩ	R10	300kΩ		

All 5%, 1/4W high stability, selected from nearest preferred values (see text)

Switches

- S1 Single-pole push-to-make (see text)
- S2 Two-pole on/off miniature slide switch
- S3 Single-pole, 18-way (Henry's type A)

Miscellaneous

- M1 500μA centre-zero meter
- X1 ORP12 (Mullard)
- BY1 3 × 1.35V Mallory cells
- Metal or cardboard tube for mounting CdS cell (see text). Plastics case (see text)

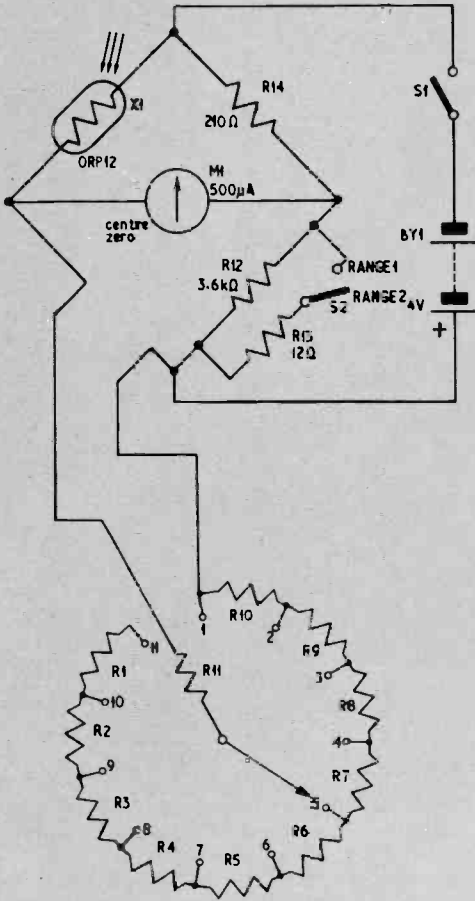

Fig. 3. Circuit diagram of the model described

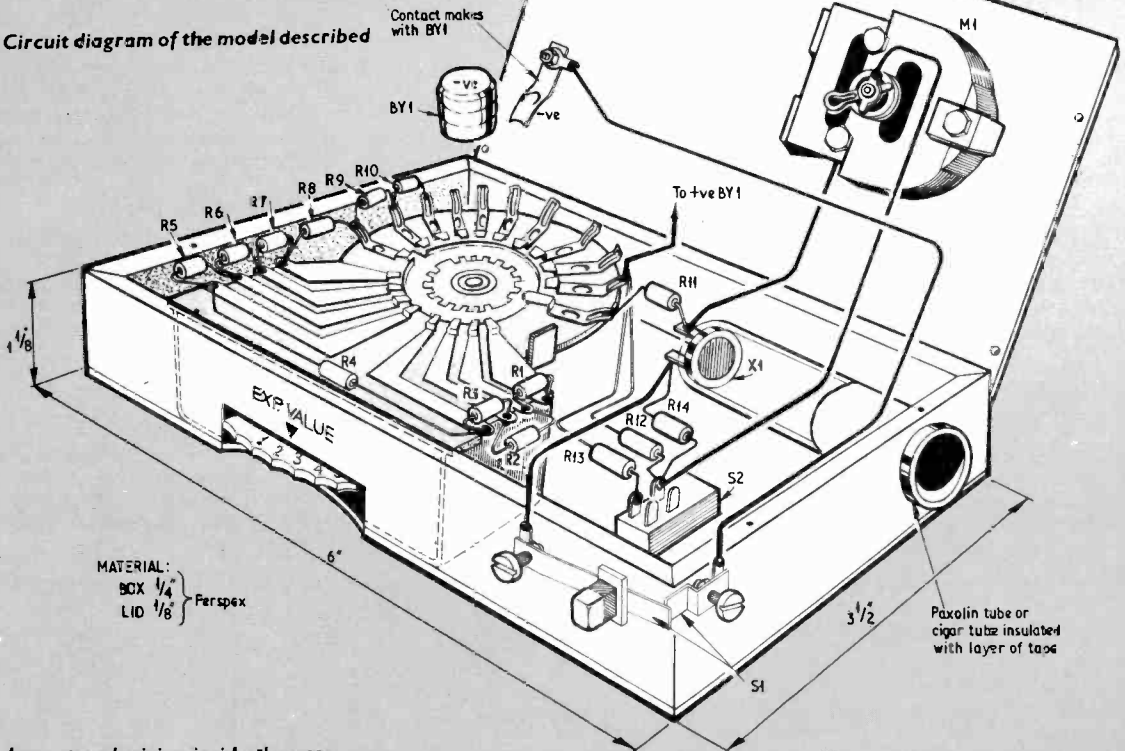

Fig. 4. Layout and wiring inside the case

DE LUXE PLAYERS

4-Speed Mono Players 2-tone Cabinets 17x15x8 1/2 in. High 8-oz loudspeaker and High Quality Amplifiers ready built. Quality output. Volume and Bass controls. Special instructions enable assembly in 30 minutes, only 5 wires to join. 12 months' guarantee.



TO BUILD YOURSELF

Post 2/6 per item.
PORTABLE CABINET
 As illustrated. To fit standard player or autochanger. **69/6**
RCS AMPLIFIER 3
 WATT. Ready made and tested with UCL82 triode pentode valve. **59/6**
SINGLE PLAY MONO
 BSR TU6736 £4.19.6
 Garrard SP22 £4.19.6
 Garrard SP25 £10.9.6
 Philips AG1018 £12. 9.6
 Garrard A70 £19.19.6
 Garrard LAB80 £24.19.6
 Garrard 401 £29.19.6

SUPERIOR AMPLIFIER.
 Ready made and tested. Guaranteed better sound! Fully isolated AC Mains Transformer 4 watt output. ECL86 triode pentode valve. Volume and tone controls with knobs. Quality Loudspeaker. **89/6**
AUTOCHANGE MONO
 BSR Superhim £5.19.6
 Garrard 1000 £5.19.6
 Garrard 2000 £6.19.6
 Garrard 3000 £8. 9.6
 Garrard AT60 £24.19.6
 diecast turntable £12.19.6

All with mono cartridge (Stereo 12/6 extra)
GARRARD TEAKWOOD BASE W.B.1 Ready cut for mounting 1000, 2000, 3000, SP25, AT80. **75/-**
GARRARD PERSEPE COVER SPCL for W.B.1. 58/-
A.18 TRANSCRIPTION TONE ARM with temp-plate and two plug-in shells. OUR PRICE **90/-**
 Decca Deram Stereo Diamond Cartridge £4.10.0 extra, or Stereo Moving Coil Diamond 20-18,000 c.p.s. 5 gns. extra.

Q MAX CHASSIS CUTTER

Complete: a die, a punch, an Allen screw and key
 1/4 in. 15/9 1/4 in. 18/- 1/2 in. 20/6 2 3/8 in. 37/9
 1/2 in. 14/9 1 in. 18/- 1 1/8 in. 18/6 1 1/4 in. 22/6 2 1/4 in. 44/3
 1 in. 15/6 1 1/2 in. 18/- 1 3/4 in. 20/- 2 in. 34/3 1 in. sq. 31/6

ACOS XTAL GP67, 15/-. PICK-UP ARM Complete with ACOS LP-78 Turnover Head and Styli 20/-; Stereo 30/-; SPEAKER FRET Tyan various colours, 5 1/2 in. wide, from 10/-; 26 in. wide from 5/- ft. SAMPLES S.A.E.
EXPANDED METAL Gold or Silver 12 x 12 in. 6/-.

FULL WAVE BRIDGE CHARGER RECTIFIERS:
 6 or 12 v. outputs, 1 1/2 amp., 8/9; 2 a., 11/3; 4 a., 17/8.
CHARGER TRANSFORMERS: P & P/6. Input 200/250 v. for 6 or 12 v., 1 1/2 amp.; 2 a., 2 amp.; 2 a., 4 amp.; 25/-.

MOVING COIL MULTIMETER TK 25. 0-1,000v. A.C./D.C., ohms 0 to 100k etc. **47/6**
MOVING COIL MULTIMETER EP10K. 0-1,000v. A.C./D.C., ohms 0 to 3 meg. etc. **79/6**
MOVING COIL MULTIMETER EP20K. 0-2,500v. D.C. 20,000 ohms per volt. 0-1,000v. A.C. Ohms 0 to 6 meg. 50 Microamps. (Full List Meters S.A.E.) **99/6**

NEW MULLARD TRANSISTORS
 OC71 6/-; OC72 6/-; OC81 6/-; OC81 6/-; AF115 8/-; AF114 8/8; OC44 6/-; OC45 6/-; OC171 6/-; OC170 6/-; AF117 6/-; OC28 12/6; AD140 15/-; OC85 15/-; Holders 1/-.

REPANCO TRANSISTOR TRANSFORMERS
 TT45. Push Pull Driver 9:1CT. OC71, OC81D 6/-
 TT46. Push Pull Output CT 8:1. OC72, OC81. 5/-
 TT49. Interstage, etc. 4.5:1 5/-
 TT52. Output 3 ohms 20:1 5/-

TRANSISTOR MAINS ELIMINATORS. FAMOUS "POWER MITE". 9 VOLT. SAME SIZE AS PP9 BATTERY.
FULLY SMOOTHED. 150mA. FULL WAVE CIRCUIT. 45/-
SPECIAL 9 VOLT. 500mA POWER PACK 49/6

WEYRAD P50A — Transistor Coils
 RA2W 8 in. Ferrite Aerial with car aerial coil. 12/6 Spare Cores. 6d.
 Driver Trans. LFDT4. 9/6
 Osc. P50/LAC. 5/4 Printed Circuit, PCA1. 10/6
 I.F.P50/2CC 470 kcs. 5/7 J.B. Tuning Gang. 9/8
 3rd I.F. P50/3CC. 6/- Weyrad Booklet. 2/-

Volume Controls
80 Ohm Coax 6d. Semi-air spaced Cable 100 yd. drum 50/- post free.
FRINGE LOSS 1/6. Ideal 625 lines.

COAXIAL PLUG 1/-. PANEL SOCKETS 1/-. LINE SOCKETS 2/-. OUTLET BOXES, SURFACE OR FLUSH 4/6.
BALANCED TWIN FEEDERS 1/- yd. 80 or 300 ohms.
TELESCOPIC CHROME AERIALS 1/6. extends to 23in. 6/6 each. **CAR AERIAL PLUGS 1/6.** Sockets 1/3.

SPECIAL PURCHASE!

STELLA BATTERY RECORD PLAYER
 Amplifier and loudspeaker—all transistor—top performance of discs at 33 1/3, 45 and 78 r.p.m. LP xtal cartridge. Smart red or blue plastic cabinet.



WORTH DOUBLE! OUR PRICE £8.5.0. P. & P. 5/-.

RETURN OF POST DESPATCH Post and Packing 1/6 unless otherwise stated. C.O.D. 5/- extra. Full List 1/-. CALLERS WELCOME RADIO COMPONENT SPECIALISTS 337 WHITEHORSE ROAD, WEST CROYDON

Written guarantee with every purchase. (Export: Send remittance and extra postage, no C.O.D.) Buses 133, 68 pass door. S.R. Stn. Selhurst. Tel. 01-684-1666

THE E.A.R. RECORD PLAYER CABINET

Strongly built wooden cabinet covered in Blue and Grey leathercloth size 15x17x8 in. Motorboard 14 1/2 x 12 1/2 in. ready cut out for B.S.R. Monarch UA 12/14/15/16/25 decks. Gilt fittings, strong carrying handle. Amplifier space size 14 x 7 x 3 in. is completely enclosed. The baffle board 59/6 is cut out for a 6 1/2 in. dia. speaker. P. & P. 5/6. PRICE

NEW TUBULAR ELECTROLYTICS	CAN TYPES
2/350 v. 2/3 100/25 v. 2/-	8/600 v. 9/6
4/350 v. 2/3 250/25 v. 2/6	16/600 v. 12/6
8/450 v. 2/3 500/25 v. 4/-	18+16/500 v. 7/6
16/450 v. 3/- 8+16/450 v. 3/6	32+32/450 v. 6/-
32/450 v. 3/8 8+16/450 v. 3/8	50+50/350 v. 7/6
25/25 v. 1/3 16+16/450 v. 4/3	60+100/350 v. 11/6
50/50 v. 2/- 32+32/350 v. 4/3	100+200/275 v. 12/6

SUB-MIN. ELECTROLYTICS 1, 2, 4, 5, 8, 16, 25, 30, 50, 100, 250 mfd. Lvs. 2/6; 500, 1000 mfd. 12v. 3/6 2000 mfd. 25v. 9/6. CERAMIC. 500 v. 1 pF. to 0.01 mfd., 9d. Discs 1/-.

PAPER TUBULARS
 350v.-0.1 9d. 0.05 2/6; 500 v. 2 mfd. 150v. 3/-.
 500v.-0.001 to 0.02 9d. 0.1 1/-. 0.25 1/8; 0.5 3/4.
 1,000v.-0.001, 0.0022, 0.0047, 0.01, 0.02, 1/6; 0.047, 0.1 2/6.
E.H.T. CONDENSERS. 0.001mfd. 7kV. 8/6; 20kV. 10/6

SILVER MICA. Close tolerance (plus or minus 1 pF.). 5 to 47 pF. 1/-; ditto 1 1/2; 50 to 800 pF. 1/-; 1,000 to 5,000 pF. 2/-.
TWIN GANG. "0-0" 208 9/6; 178 pF. 10/6; 365 pF. miniature 10/-; 500 pF. standard with trimmers, 9/6; 500pF. midjet less trimmers, 7/6; 500 pF. slow motion, standard 9/-; small 3-rank 500 pF. 18/9. Single "0" 365 pF. 7/6. Twin 10/-.
SHORT WAVE. Single 10 pF., 25 pF., 50 pF., 75 pF., 100 pF., 180 pF., 5/6 each. Can be ganged. Couplers 9d. each.
TUNING. Solid dielectric, 100 pF., 300 pF., 500 pF., 3/6 each.
TRIMMERS. Compressive, ceramic 9d., 50, 70, pF. 1/3; 100 pF., 150 pF., 1/3; 250 pF., 1/6; 600 pF., 750 pF., 1/9.

250v. RECTIFIERS. Selenium 1/6 wave 100mA 5/-; BY100 10/-.
CONTACT COOLED 1/. wave 60mA 7/6; 85mA 9/6.
 Full wave 75mA 10/-; 150mA 18/-; T.V. rects. from 10/-.

NEW B.A.S.F. LIBRARY BOXED TAPE

7 in. L.P. 1,800 ft. 45/-; 7 in. D.P. 2,400 ft. 70/-
 60 min. Cassette C60 (For Philips, etc.) 17/6
 Spare Spools 2/6. Tape Splicer 5/-. Leader Tape 4/6.
 Tape Heads: Coliario 2 track 28/6 pair. B.S.R. 4 track 99/6

MAINS TRANSFORMERS

250-0-250 80 mA. 6.3 v. 3.5 a. 6.3 v. 1 a. or 5 v. 2 a. 25/-
 350-0-350 80 mA. 6.3 v. 3.5 a. 6.3 v. 1 a. or 5 v. 2 a. 29/6
 MT. 510/300-0-300 v. 120 mA. 6.3 v. 4 a. 29/6
MINIATURE 500 v. 20 mA. 6.3 v. 1 a. 10/6
MIDGET 220 v. 45 mA. 6.3 v. 2 a. 15/6
SMALL 250-0-250 50 mA. 6.3 v. 2 a. 19/6
HEATER TRAP 6.3 v. 1 a. 8/6; 6.3 v. 4 a. 10/6
 DITTO tapered sec. 1.4 v., 2.3, 4.5, 6.3 v. 1 1/2 amp. 10/6
GENERAL PURPOSE LOW VOLTAGE. Outputs 3, 4, 5, 6, 8, 9, 10, 12, 15, 18, 24 and 30 v. at 2 a. 25/-
 1 amp., 6, 8, 10, 12, 16, 18, 20, 24, 30, 36, 40, 48, 60, 29/6
AUTO TRANSFORMERS 0-115-230 v. Input/Output, 60w. 18 6; 150w. 25/-; 500w. 92/6; 1000w. 175/-.

CRYSTAL MIKE INSERTS

1 1/2 in. 6/8; ACOS 11 x 1/2 in. 8/0
 MOVING COIL MIKE with Remote Control Switch 19 6

ALL PURPOSE HEADPHONES

MOVING COIL HEADPHONES 100 ohms (ex. Govt.) 12/6
 H.R. HEADPHONES 2000 ohms 12/6, 4000 ohms 15/-
 H.R. HEADPHONES 2000 ohms Super Quality 25/-

1988 GRAM CHASSIS

Post 5/-
 Three Wavebands: Five Valves: ECH81, EF89, Long., Med., Short. Gram. EC831, EL84, E280, 12-month guarantee. A.C. 200-250 v. Ferrite Aerial 5 watts 3 ohms. Chassis 13 1/2 in. x 7 in. x 5 in. ditto size 1 1/2 in. x 4 in. Two pair Lined, 500k Resistor. Aligned calibrated. Chassis isolated from mains **£10.10**
DE LUXE STEREO GRAM CHASSIS V.H.F. MW, SW 19-50m, SW 60-180m. Magic eye, push buttons. **£19.19**
 6 valve plus rect. Size 15 x 7 1/2 x 6 1/2 high

TAPE DECK AMPLIFIER FOR B.S.R., T.D.2, etc. With Pre-Amplifier. Oscillator, all valves. "magic-eye" tuning indicator, 3 watt, 3 state amplifier especially built for B.S.R. TD.2 Tape Deck. Bolts directly to tape deck chassis. Inputs for mike and radio gram. Output 3-5 ohms. A.C. 200/250v. Ready built. PRICE £7.19.6. Carriage 5/6.

BLANK ALUMINIUM CHASSIS. 18 s.w.g. 2 1/2 in. sides. 7x4in. 5/6; 9x7in. 6/6; 11x9in. 6/8; 11x7in. 7/8; 13x9in. 9/8; 14x11in. 12/6; 15x14in. 15/-.
ALUMINIUM PANELS 18 s.w.g. 12x12in. 5/6; 14x9in. 4/6; 12x8in. 3/6; 10x7in. 2/9; 8x6in. 2/6; 6x4in. 1/6.

ALL PURPOSE TRANSISTOR PRE-AMPLIFIER
 Gain 14: 1. 250v. or 8v. input. Ready built with Mu Metal input transformer. Pick-Up Tuners. Instructions and circuit supplied. Post 2/6. **15/-**

THE INSTANT BULK TAPE ERASER AND RECORDING HEAD DEMAGNETISER

200/250 v. A.C. Post 2/6 **53/-**
 Leaflet S.A.E.



BAKER MAJOR 'MODULE'



Ideal mono or stereo conversion of existing cabinets, furniture, etc. 12 inch Baker Major Full range speaker on 19" x 12" baffle board with 2 1/2" tweeter and crossover. Output 20 watts. Response 30-17,000 c.p.s. Impedance 15 ohms.

In kit form with instructions.
£10.19.6 or Fully assembled **£12.10.0**
 Post Free

'Group 25' 'Group 35' 'Group 50'
 12in. 5gns. 12in. 8gns. 15in. 18gns.
 25w. 35w. 50w.
 *BONDACOUST" Wadding for cabinet lining 15/- sq. yd.

Quality Horn Tweeters 2.18kcs. 10w. 27/6. Crossover 14/6. LOUDSPEAKERS P.M. 3 OHMS. 2 1/2 in. 3in. 4in. 5in. 7in. x 4in., 15/6 each; 8in. 22/6; 6in. 18/6; 10in. 30/-; 12in. 30/-; (15 ohms 35/-); 10 x 6in. 30/-; 8 x 5in. 21/-; E.M.I. Double Cone 13" x 8in., 3 or 15 ohm models, 45/-; SPECIAL OFFER: 8 ohm. 2 1/2 in., 5in.; 8 ohm. 2 1/2 in., 4 1/2 in.; 15 ohm. 3in., 8 x 4in.; 35 ohm. 3in., 5in. 7 x 4in.; EACH—ANY TYPE. 15 ohm. 3in., 5in., 7 x 4in. JACK SOCKETS 8 Sd. open-circuit 2/6, closed circuit 4/6; Chrome Lead Socket 7/6. DIN 3-pin 1/3, 5-pin 1/6; Lead 3/6; Phono Plugs 1/-. Socket 1/-. JACK PLUGS 5d. Chrome 3/6; 2.5mm.; 3.5mm. 1/9; DIN 3-pin 3/6; 5-pin 5/15. WAVE-CHANGE SWITCHES WITH LOW SPINDLES. 2 p. 2-way, or 2 p. 6-way, or 3 p. 4-way 3/6 each. 1 p. 12-way, or 4 p. 2-way, or 4 p. 3-way 3/6 each. WAVECHANGES "MAKITS" 1 p. 12-way, 2 p. 6-way, 3 p. 4-way. 4 p. 3-way, 6 p. 2-way. Prices include dielectric spindles, adjustable stons, spaces, etc., 1 water, 10/6; 2 water, 15/-; 3 water, 19/6. TOGGLE SWITCHES, sp. 2/-; sp. dt. 3/6; dp. 3/6; dp. dt. 4/-.

15/6 EACH—ANY TYPE. 15 ohm. 3in., 5in., 7 x 4in. JACK SOCKETS 8 Sd. open-circuit 2/6, closed circuit 4/6; Chrome Lead Socket 7/6. DIN 3-pin 1/3, 5-pin 1/6; Lead 3/6; Phono Plugs 1/-. Socket 1/-. JACK PLUGS 5d. Chrome 3/6; 2.5mm.; 3.5mm. 1/9; DIN 3-pin 3/6; 5-pin 5/15. WAVE-CHANGE SWITCHES WITH LOW SPINDLES. 2 p. 2-way, or 2 p. 6-way, or 3 p. 4-way 3/6 each. 1 p. 12-way, or 4 p. 2-way, or 4 p. 3-way 3/6 each. WAVECHANGES "MAKITS" 1 p. 12-way, 2 p. 6-way, 3 p. 4-way. 4 p. 3-way, 6 p. 2-way. Prices include dielectric spindles, adjustable stons, spaces, etc., 1 water, 10/6; 2 water, 15/-; 3 water, 19/6. TOGGLE SWITCHES, sp. 2/-; sp. dt. 3/6; dp. 3/6; dp. dt. 4/-.

DE LUXE TAPE SPLICER CUTS, trims, joins for editing and repairs. With 3 blades. **14/6**

4 CHANNEL TRANSISTOR MICROPHONE MIXER. Add musical highlights and sound effects to recordings. Will mix Microphone, records, tape and tuner with separate controls into single output. **52/6**

DYNAMIC MICROPHONE. Dual impedance 600 ohm/50K. Universal Mounting. 70-12,000 cps. **£6.6.0**

AM TUNER MEDIUM WAVE. Three Transistor Superhet. Ready built. Printed Circuit. Ferrite Aerial. Sizes 5" x 3" x 1 1/2". Ideal for Tape Recorders. **79/6**

FM TUNER 88-108 Mc/s. Six Transistor Superhet. Ready built. Printed Circuit. Calibrated slide dial tuning. Size 6" x 4" x 2 1/2". **£6.19.6**

3 WATT QUALITY AMPLIFIER. 4 Transistor Push-Pull Ready built, with volume control **65/-**

RADIO BOOKS 5/- (Postage 9d.)
 High Fidelity Speaker Enclosures and Plans 5/-
 Transistor Superhet Commercial Receivers 7/6
 Mullard Audio Amplifier Manual 8/6
 Radio Valve Guide, Books 1, 2, 3, or 4 each 5/-
 Practical Radio Inside Out 4/6
 Transistor Audio Amplifier Manual Book 1, 3/6; Book 2, 6/-
 Shortwave Transistor Receivers 5/6
 Transistor Communication Sets 2/6
 International Radio Stations List 6/6
 Modern Transistor Circuits for Beginners 7/6
 Sub-Miniature Transistor Receivers 5/-
 Wireless World Radio Valve Data 9/6
 A to Z glance valve equivalents 6/6
 Valves, Transistors, Diodes equivalents manual 10/6

RESISTORS. Preferred values, 10 ohms to 10 meg. 1 w. 1 w., 1 w., 20% 3d.; 1 w. 8d.; 1 w. 1/-; 1 w. 10% 6d.
HIGH STABILITY. 1 w. 19% 10 ohms to 10 meg., 2/-.
 DITTO 5%. Preferred values 10 ohms to 22 meg., 9d.
 5 watt 0.5 to 8.2 ohm 3/6 { 1/6
 10 watt WIRE-WOUND RESISTORS 1/9
 15 watt 10 ohms to 6,800 ohms { 2/-

10K, 15K, 20K, 25K, 68K, 10W, 3-
MAINS DROPPERS. Midget. With sliders.
 0.3 A. 1 K. 0.2 A., 1.2 K., 0.15 A., 1.5 K., 6/- each.
LINE CORD 100 ohms ft. twin plus resistance. 1/- ft.

WIRE-WOUND 3-WATT WIRE-WOUND 4-WATT
 POTS. T.V. Type. Values STANDARD SIZE POTS.
 10 ohms to 30 K., 3/3, LONG SPINDLE VALUES
 Carbon 30 K. to 2 meg., 3/-; 50 OHMS to 100 K., 7/6.

VALVE HOLDERS. Int. Oct. 6d. Mazda Oct. 6d., B7G, B8A, B8G, B9A, Moulded 9d. Ceramic 1/-, B7G, B9A Cans 1/-. Valve base plugs B7G, B9A, Int. Oct., 2/3.

60 ONLY—SANGAMO 3 inch SCALE LABORATORY MOVING COIL METERS
 Various calibrations and movements. 100 Microamp 55/-; 1 Milliamp 50/-, etc. Post 5/- extra. Send S.A.E. for list.

BRAND NEW QUALITY EXTENSION LOUDSPEAKER
 Cream plastic cabinet, 20ft. lead and adaptors. For any radio, intercom, tape recorder, etc. 3 to 15 ohm Size: 7 1/2 x 5 1/2 x 3" **Post 30/-**

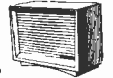

**See in the Dark
INFRA-RED BINOCULARS**



These infra-red binoculars when fed from a high voltage source will enable objects to be seen in the dark, providing the objects are in the rays of an infra-red beam. Each eye tube contains a complete optical lens system as well as the infrared cell. These optical systems can be used as lenses for TV cameras—light cells, etc. (details supplied). The binoculars form part of the Army night driving (Tabby) equipment. They are unused and believed to be in good working order but sold without a guarantee. Price £3/17/6, plus 10/- carr. and ins. Handbook 2/6.

ARMCHAIR CONTROL UNIT

Remote Control for Philips, Stella and Corsor TV sets but adaptable to most others, and to model control. Comprises 3 rock switches, two variable resistances and component including Mullard OA81—Knobs—10 way plug—11 ft. 7 way cable, etc., etc. List price £3/3/-, yours for only 12/6 plus 2/- post and insurance.

G.U.T RECORD PLAYER

BSR Record Player for normal mains operation. This is the famous BSR Model G.U.7. Four speeds with automatic stop. Plays any size of record and is complete with stereo cartridge and sapphire stylus. Special snip price this month 8/6 plus postage and insurance 6/6.

PP3 Eliminator. Play your pocket radio from the mains! Save 4s. Complete component kit comprises 4 rectifiers—mains dropper resistances, smoothing condenser and instructions. Only 6/6, plus 1/- post.

WATERPROOF HEATING ELEMENT
26 yards length. 70W. Self-regulating temperature control. 10/- post free.

HURSEAL AUTOMATIC TIME SWITCH
12 hour. 15A to control heating, lighting, radio, immersion heaters, etc. Regular price £4/4/- Limited quantity 39/6. P. & P. 3/-.

THERMOSTATS

Type "A" 15A for controlling room heaters, greenhouse, airing cupboards. Has spindle for pointer knob. Quickly adjustable from 30-80°F. 8/6, plus 1/- post. Suitable box for wall mounting 5/-, P. & P. 1/-.
Type "B" 15A. This is a 17in long rod type made by the famous Sunvic Co. Spindle adjusts this from 50-550°F. Internal screw alters the setting so this could be adjustable over 30° to 1,000°F. Suitable for controlling furnace, oven kiln, immersion heater or to make flame-start or the alarm. 8/6, plus 2/6 post and insurance.
Type "DP" We call this the Ice-stat as it cuts in and out at around freezing point. 2/3 amps. Has many uses, one of which would be to keep the loit pipes from freezing, if a length of our blanket wire (16 yds. 10/-) is wound round the pipes. 7/6. P. & P. 1/1.
Type "E" This is standard refrigerator thermostat. Spindle adjustments cover normal refrigerator temperatures. 7/6, plus 1/- post.
Type "F" Glass encased for controlling the temp. of liquid—particularly those in glass tanks, vats or sinks—thermostat is held (half submerged) by rubber sucker or wire clip—ideal for fish tanks—developers and chemical baths of all types. Adjustable over range 30° to 150°F. Price 18/-, plus 2/- post and ins.

MAINS TRANSISTOR POWER PACK
Designed to operate transistor sets and amplifiers. Adjustable output 6V, 9V, 12V for up to 500mA (class B working). Takes the place of any of the following batteries: PP1, PP3, PP4, PP6, PP7, PP9, and others. Kit comprises: mains transformer rectifier, smoothing and load resistor. 5,000 and 100mfd. condensers and instructions. Real snip at only 14/6, plus 3/5 postage.

Where postage is not definitely stated as an extra then orders over £3 are post free. Below £3 add 2/6. Semi-conductors add 1/- post. Over £1 post free. S.A.E. with enquiries please.

INFRA-RED HEATERS

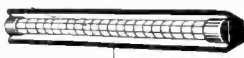

Make up one of these latest type heaters. Ideal for bathroom, etc. They are simple to make from our easy-to-follow instructions—uses silica enclosed elements designed for the correct infra-red wave length (3 microns). Price for 750W element, all parts metal casing as illustrated. 19/6, plus 3/6 post and ins. Pull switch 3/- extra.

CONTROL DRILL SPEEDS

DRILL CONTROLLER

Electronically changes speed from approximately 10 speeds, to max. Full power at all speeds by fingertip control. Kit includes all parts, case, everything and full instructions. 19/6, plus 2/6 post and insurance. Or available made up 32/6.

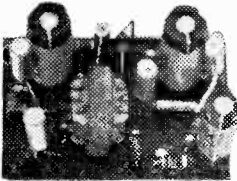

750mW TRANSISTOR AMPLIFIER

4 transistors including two in push-pull input for crystal or magnetic microphone or pick-up—feed-back loops—sensitivity 5mV. Price 19/6. Post and insurance 2/6. Speakers: 3in 12/6, 5in 13/6, 6 4in 14/6.

THIS MONTH'S SNIP INTERCOM BARGAIN

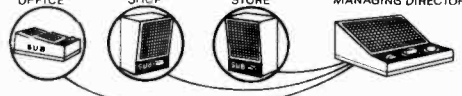

Will save time and improve efficiency. Ideal in home—office—shop—surgery, etc. Complete outfit comprises Master unit and three substations, each of which can call the master and have full two-way working. No wiring problems as subs fitted with 60ft twin flex and they plug into sockets. Also included is packet of staples—and a battery. Nothing else to buy—£4/19/6, plus 4/6 post and insurance.

GARRARD AUTO RECORD PLAYER Model 2000



This is one of the latest products of the world's most experienced maker of fine record reproducers. Its superior features include—automatic playing of up to 8 mixed size records—stopping and starting without rejecting—manual playing—pick-up pivots to give low stylus pressure—large diameter turntable for max. speed adjustments include pick-up height—pick-up drooping position and stylus pressure—size is 13 1/2 in. clearance 4 1/2 in. above, 2 1/2 in. below—fitted with latest hi-compliance cartridge for stereo—and mono. L.P. and 78. Supplied complete with mounting template and service sheet. Offered this month at the Special Snip price of £8/19/6 plus 7/6 carriage and insurance.

THE VECTRONOME CAPSTAN DRIVEN TAPE RECORDER

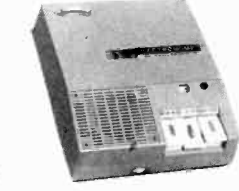

This is a truly portable, self-contained instrument with built-in microphone and loudspeaker using a 5-transistor amplifier with P.P. output and suitable for operation from mains or by chargeable batteries. Tape capacity is 25 minutes on easily changed spools. A tape position indicator gives quick reference to any part of dictation. Recording level is automatically preset during dictation and can be adjusted to suit operator. Interlock prevents unintentional erasures. Tape speed controlled by fly wheel driven capstan. Very portable in net case with carrying handle, overall size of which is approximately 6 1/2 x 7 1/2 x 2 1/2 in. Price, with tape, nickel cadmium rechargeable batteries and mains battery charger 28/19/6 (rather less than 3 original price). Postage and insurance 7/6. Unused and in perfect working order.

CIRCULAR FLUORESCENT

Brings sunshine into your home. 180 watts of light has uses only 40W. Beautiful fittings with glass, non-plastic centre, fluorescent tube and choke control. Regular price £4/15/-. Special budget price 65/-, plus 10/- carr. and ins. Please state colour of glass centre: white, pink, blue, red, black, yellow or cream. Also whether plug into lamp holder or ceiling mounting model. 80 watt model 99/6. 10/- carr. and insurance.

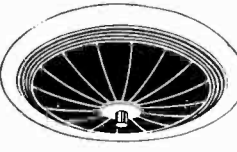

RADIO STETHOSCOPE

EASIEST WAY TO FAULT FIND—Traces signal from aerial to speaker—when signal stops you've found the fault. Use it on Radio, TV, amplifier, anything—complete kit comprises two special transistors and all parts including probe tube and crystal earpiece 29/6—twin stetosol instead of earpiece 7/6 extra. Post and ins. 2/6.



GEARED MOTOR



Half rev. per minute. Made by famous Smith Electric, mains operated and quite powerful. Size 3 1/2 x 2 1/2 x 1 1/2 in deep. Secondary use as process timer. Internal switch can be made to break circuit within a period up to 2 mins. 17/6. P. & P. 2/6 unless ordered with other goods.

MINIATURE WAFER SWITCHES



4 pole, 2 way—3 pole, 3 way—4 pole, 3 way—2 pole, 4 way—3 pole, 4 way—2 pole, 6 way—operate change-over switches. 38/- dozen. Your assortment.

BECKERSTAT

An Instant Thermostat. Simply push it into 15A wall socket and plug your fire or other appliance into it. Knob setting. Will save its cost in a season. Normally 39/6. We offer at 19/6. Plus 2/- post. 15A socket 4/6 extra.

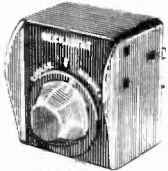

3-PUSH SWITCH

for test meter, hi-fi amp., etc. 1st button operates mains on/off switch, the other two operate change-over switches. Knobs engraved ON/OFF, Bass, Treble, but engraving easily removed leaving clean surface for re-marking 2/6 each. 24/- doz.

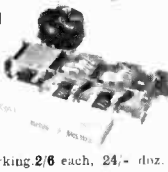

HI-FI SPEAKER BARGAIN

12in High Fidelity loudspeaker. High flux permanent magnet type with either 3 or 15 ohm speech coil. Will handle up to 10 watts. Brand new by famous maker. Price 29/6 With built-in tweeter 35/- plus 3/6 post and insurance.



TUBULAR HEATERS

New and unused made by G.E.C.—rated at 60 watts per ft.—these are ideal in airing cupboards, bedrooms, offices, stores, greenhouses, etc., curtains or papers can touch them without fear of scorching or fire. Supplied complete with fixing brackets and available in the following sizes. Prices which are about quarter of list price includes carriage by B.R.S. 6ft 30/-, 10ft 38/-, 12ft 42/-.

NO SOLDERING POCKET 3

Lots of fun to build and good results when finished—complete kit with detailed instructions and crystal earpiece (batteries 1/2 extra). £5 value only 18/6 plus 3/- post and insurance.

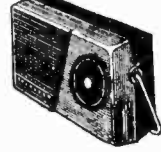

SUPPRESSOR CONDENSER



Stop your drill or other appliances interfering with you or your neighbours' radio or television. Simple instructions given. 1/6 each. 12/- dozen.

FLUORESCENT CONTROL KITS

Each kit comprises seven items—Choke 2 tube ends, starter, starter holder and 2 tube clips, with wiring instructions. Suitable for normal fluorescent tubes or the new "Grolux" tubes (for fish tanks and indoor plants). Chokes are super-insulated, mostly resin filled. Kit A—15-20w 19/6. Kit B—30-40w 17/6. Kit C—80w 17/6. Kit D—125w 22/-. Kit E—55w 19/6. Kit MF1 is for 6in, 9in and 12in miniature tubes—19/6. Postage on Kits A and B 4/6 for one or two kits then 4/6 for each two kits ordered. Kits C, D & E 4/6 on first kit then 3/6 for each kit ordered. Kit MF1 3/6 on first kit then 3/6 on each two kits ordered.

II RANGE TEST METER



For checking car electric, radio, TV, ignition systems, household lighting, etc. Measures a.d./d.c. volts, d.c. current. Resistance. Will last a lifetime. 39/6 P. & P. 3/6.

ELECTRONICS (CROYDON) LIMITED
(Dept. P.E.) 102/3 TAMWORTH RD., CROYDON, SURREY (Opp. W. Croydon Stn.)
also at 266 LONDON ROAD, CROYDON, SURREY. S.A.E. with enquiries please

Table 3: EXPOSURE TIMES FOR THREE FILM SPEEDS

FILM SPEED 15° DIN		
Stop	Value	Speed
f1	1	1
f1.4	2	1/2
f2	3	1/4
f2.8	4	1/8
f4	5	1/15
f5.6	6	1/30
f8	7	1/60
f11	8	1/125
f16	9	1/250
f22	10	1/500
f32	11	1/1000

FILM SPEED 21° DIN		
Stop	Value	Speed
f1	0	1
f1.4	1	1/2
f2	2	1/4
f2.8	3	1/8
f4	4	1/15
f5.6	5	1/30
f8	6	1/60
f11	7	1/120
f16	8	1/250
f22	9	1/500
f32	10	1/1000

FILM SPEED 27° DIN		
Stop	Value	Speed
f1		1
f1.4	0	1/2
f2	1	1/4
f2.8	2	1/8
f4	3	1/15
f5.6	4	1/30
f8	5	1/60
f11	6	1/125
f16	7	1/250
f22	8	1/500
f32	9	1/1000

A 10 per cent error is admissible, but if this is exceeded the addition of one or two extra resistors of suitable value will correct it.

Since the finished instrument should be as small as possible a small centre-zero galvanometer should be used. The author removed a movement from its case in order to save space. A sensitivity of 0.5mA is sufficient. Power requirements are met by a battery of three small Mallory mercury cells. These take up little room, and should last for years.

The switch S1 should be of the press-to-make type, and is best constructed from springy brass (as found on some batteries).

USE OF THE INSTRUMENT

In order to avoid awkward calculations, it is suggested that the following method be adopted.

The exposure values, as in line two of Tables 1 and 2, should be marked at the corresponding switch positions, using different colours to identify the two different ranges. Cards can now be prepared, one for each film speed which is likely to be used, and provision made for attaching the appropriate card to the meter. Examples of the cards are given in Table 3.

On the table appropriate to the speed of the film in use, each aperture (f5.6 etc.) and each time (1/30 sec etc.) is allocated a number, this number being in the centre column. The sum of the number representing the aperture and the number representing the time should be equal to the exposure value as read from the instrument.

In use, the meter is directed at the scene; the resistance range switch is adjusted to zero the meter as closely as possible (half values may be estimated). The value is read direct from the switch dial. Looking at the card for the appropriate film speed, the figures in the centre column opposite the chosen f stop and shutter speed must total this value for correct exposure.

For example, suppose the film speed is 15 Din, and the value from the dial is 9. Then combinations such as 1/5 second at f2.8; or 1/2 second at f8 are correct. Again, suppose the film speed is 27 Din (400 ASA) and the value from the dial is 14, then one possible correct exposure is 1/125 second at f22.

Because of the sensitivity of the CdS cell to red light, it is recommended that, when using the meter in tungsten light, the exposure value as given by the meter should be reduced by two before referring to the tables. If this is not done, there will be some under-exposure.

FURTHER REFINEMENTS

The instrument as described above will be found to be quite efficient. However, the reader may care to incorporate some of the following ideas.

If reversal colour film is regularly used, it is convenient to have a definite indication of half stops. This would require a switch with, say, 18 ways, and each range could then be arranged so that the exposure values increased in halves, i.e. 8, 8½, 9, 9½ and so on for successive switch positions.

On range 1, due to the large resistance of the cadmium cell, it may be found desirable to substitute a more sensitive meter, say a 100µA movement. If this is done, then S2 should be changed to a two-pole switch so that on switching S2 to range 2 a safeguarding resistance is switched in series with the meter. Alternatively it could be arranged that only one of the mercury cells is used on range 2. ★

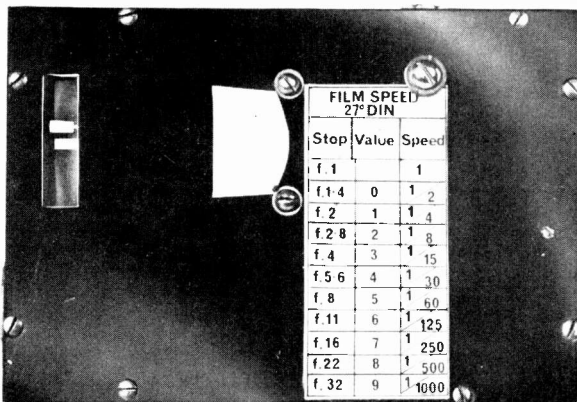

nucleonics

for the EXPERIMENTER

By M.L. Michaelis M.A.

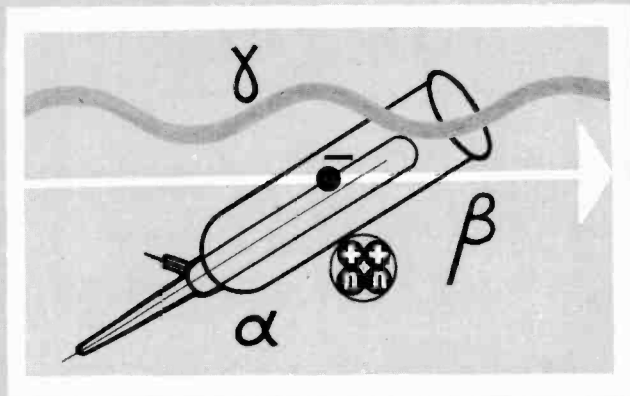

2—EVERYDAY APPLICATIONS OF NUCLEAR RADIATION; A COMPOSITE EQUIPMENT FOR THE AMATEUR

FOLLOWING the introductory discussion concerning the nature of nuclear radiations, it will be worthwhile now to look at some of the commonplace uses to which these radiations are applied in professional circles, before considering amateur activities in this field.

PRACTICAL APPLICATIONS

In certain respects, nucleonic equipment (electronic equipment for detecting and measuring nuclear radiation) represents a special branch of electronic computer techniques. However, the subject is by no means as specialised as one might suppose. Its topicality and extremely wide field is best borne out by the following summary of practical everyday applications of commercial nucleonic equipment.

INDUSTRIAL TECHNOLOGY

The range and relative absorption of nuclear radiations by matter are subject to well-established laws. Thus the thickness of sheet metal or plastic lamina in manufacturing processes may be monitored by using a radioactive substance on one side and a suitable radiation detector on the other side. The signals picked up by the detector can be used to derive automatic corrections for the settings of machine controls to maintain a constant desired thickness of the product.

A radioactive substance attached to a float in a liquid tank, in conjunction with a suitably mounted fixed detector, provides a reliable liquid level indicator. Again, such systems can be extended for automatic control of the liquid level or for the detection of leaks.

These are just two examples of countless technical applications of radioactive substances requiring nucleonic measuring equipment.

POWER ENGINEERING

We have seen that the binding energies of particles in the atomic nucleus are in the MeV-range, i.e. some millions of times greater than the binding energies of the outermost planetary electrons of an atom. The latter are involved in the chemical processes of conventional combustion fuels. The same weight of nuclear fuel can thus provide at least several millions of times as much energy as a combustion fuel. There is thus intense interest throughout the world in designing nuclear reactors (atomic piles) as a source of energy in competition to, and ultimately in place of, conventional fuels such as coal, oil, or water-power.

The special problems arising with nuclear reactors,

whether intended for large scale power production or for experimental purposes being immaterial in this respect, are largely twofold. Firstly, the very high capital cost of a complete nuclear reactor station is an important economic factor. Secondly, the nuclear radiations which are produced as inevitable byproducts, and in particular the radioactive waste substances, are lethal to human beings and life in general if not properly shielded and confined. A very extensive system of nucleonic detection and measuring equipment is thus an essential part of any nuclear power station.

GEOLOGICAL APPLICATIONS

Geological prospecting often makes use of probes containing a radioactive substance and a radiation detector, with a shield between them to prevent direct entry of radiations from the radioactive substance into the detector. The latter then responds only to the radiations from the radioactive substance which are scattered from the rock forming the walls of a test drilling into which the probe is lowered. It is possible to draw conclusions regarding the nature of these rocks deep down in the ground, from the intensity and spectral composition of the scattered radiations. This method is of great value, for example, in oil prospecting.

Out of the numerous other geological applications, apart from searching for deposits of radioactive minerals, we may consider just one further, quite different example.

Cosmic radiation produces a small proportion of a radioactive isotope of carbon, by forced modification of the nuclei of some atmospheric nitrogen atoms. This radioactive isotope of carbon is chemically identical to the ordinary inactive isotope of carbon, and thus participates in constant proportion in the biological and geological carbon cycle. All living matter and other substances containing carbon thus possess a very small specific radioactivity with a constant radiation intensity per unit weight of contained carbon, as long as they are still actively engaged in the carbon cycle.

Once carbonaceous matter is cut off from the carbon cycle, e.g. as coal, oil deposits or fossils deep down in the ground, the radioactive carbon isotope decays with time and is not replenished any longer. As a result, the specific radioactivity is progressively smaller with increasing geological age of the deposits. Sensitive electronic equipment for such measurements has proved a valuable aid for dating geological and archaeological discoveries.

OUR PRACTICAL CHRISTMAS OFFER TO YOU!

PRACTICAL ELECTRONICS PRESENTS
THE TRIED AND TRUSTED SWISS
KELEK 18ct. GOLD-PLATED WATCH

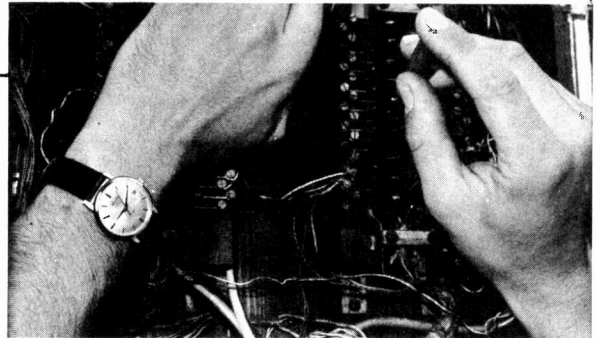

The **KELEK DE LUXE** 21-Jewel Lever, a watch of classic elegance with all the built-in qualities described below. *Plus automatic self-winding.* Yours for only **£10. 10s. 0d.**

The **KELEK** 17-Jewel Lever, beautifully designed, ultra-accurate and with all special features below. Yours for only **£7 7s. 0d.**

HERE'S the most practical present you can give to yourself—or to a friend—this Christmas... a superb quality watch. By special arrangement with a famous Swiss manufacturer of International repute, PRACTICAL ELECTRONICS has been able to obtain a supply of famous Kelek Wrist Watches and present two for you to choose from—as your Christmas gift to yourself. The special price of each is most attractive, you will agree, and your choice will be sent to you in a presentation box post free.

15 Special Features:

JEWEL LEVER MOVEMENTS. AUTOMATIC DATE CHANGE—Shows the date day-by-day, month-by-month. **PRESSURISED AND WATERPROOF TO 3 ATMOSPHERES**—If you unfortunately went swimming in yours it would still keep perfect time. **RUSTPROOF STAINLESS STEEL BACK**—Free from corrosion from dampness, rain, perspiration. **SHOCKPROOFED**—Eliminates the risks of knocks and shock. **ELECTRONICALLY TIME TESTED** in different positions to ensure accuracy in day-to-day wear and movement. **TEMPERATURE-COMPENSATED HAIR-SPRING**—Adapts itself to changes in climate. **GOLD PLATED • ANTI-MAGNETIC • UNBREAKABLE MAIN-SPRING • SWEEP SECOND HAND • DUSTPROOF COMPLETE WITH LEATHER STRAP and PRESENTATION BOX. 12 MONTHS INTERNATIONAL GUARANTEE WITH EVERY WATCH.**

How to get your watch

Complete the coupon below and write your name and full address twice where shown. Send coupon with postal order or cheque crossed “& Co.” and made payable to George Newnes Ltd. Write your name and address on back of remittance.

Post to:

PRACTICAL ELECTRONICS Watch Offer (PE/W1)
136 Long Acre, London, W.C.99

Christmas Delivery—Latest date for receipt of orders is December 6th, 1967. If gift is for an address other than your own, please address the label section accordingly on coupon. We regret that this offer is not available in Eire or overseas.

ORDER ON THIS FORM

PRACTICAL ELECTRONICS WATCH OFFER

Please send me the KELEK Watch indicated here

KELEK 17-Jewel Lever **£7 7s. 0d.** } Tick
KELEK DE LUXE 21-Jewel Lever **£10 10s. 0d.** } One

Cheque/P.O. No. Value £.....s.

Please check that coupon is complete with your name and address in two places, and that your remittance is correct.

NAME
(BLOCK LETTERS)

ADDRESS

..... (PE/W1)

LABEL WRITE IN BLOCK LETTERS

NAME

ADDRESS

..... (PE/W1)

If undelivered please return to:
PRACTICAL ELECTRONICS, 136 Long Acre, London, W.C.2

Broadway ELECTRONICS

GARRARD 4 SPEED DECKS WITH CARTRIDGE:
Autochangers: AT6 Mk. II £8.19.6. 3000 £8.8.0.
AT5—Mono £6.10.0. P. & P. all changers 7/6.

TEAK FINISH WOODEN PLINTH:
With perspex cover. For Garrard 1000, 2000, 3000, AT60, 8P25. Size 15 1/2" x 14 1/2" x 4" deep (7 1/2" deep inc. cover). £5 gns. P. & P. 6/6.

CARTRIDGES:
Stereo: EV26 25/-, GP83 15/-. Reuter STD/2 17/6. GP91/1 20/-. Mono Sonotone, 2TSS 15/-. Acos, GP17 15/-. TC8 less bracket 18/6. P. & P. 1/- each.

B.S.R. 4 TRACK TAPE DECK 9gns. P. & P. 4/6.

MICROPHONES:

Xtal Hand Mikes.
BM3 and 200C 30/-, P. & P. 2/6. Stand for same 12/6. P. & P. 2/-. ACOS Mike 45, 21/-. ACOS Mike 40, 18/6. Dyn, Mike DM-391, 22/6. CM21 Xtal 12/6. CM20 Xtal, 9/6. Magnetic Hm 63C with remote control switch 15/-. Telephone Pick-up 10/6. P. & P. 1/-. Xtal Lapel Mike 7/6. Guitar Mike 12/6. P. & P. 1/-.
BARGAINS IN TRANSISTORS:

AC127, AF114, 115, 116, 117, 118, 119, OC169, 170, 171, 172, 200, 202, 203, 204, AC120, ACY40, ACY17, AF212, RCY10, 12, 33, 34, 38, 39; BFY50, 51, 52, 90, 5/6 each. P. & P. 6d. OA202 1/3. P. & P. 6d. OA2206, 208, 5/6. P. & P. 6d. OC72, 73, 82, 83, AAZ12, BY38, BUZ11, 3/6. OC71, 81, 3/-. R.F. Packs 1 OC44, 2 OC46 8/6. A.P. Packs 1 OC81D, 2 OC81 (Mullard), 8/6. GET113, Red Spot 2/-. OC26, 28, 29 9/6. ORP12 Light Cell 8/6. Diodes OAN1 2/3. OA91, OA95 1/6. P. & P. 1/-.
TRANSISTOR ELECTROLYTICS:

1, 2, 4, 5, 8, 10, 16, 25, 32, 50, 100 mfd 15 volt working 1/3. P. & P. 1/-.
250 mfd DC 3/-, 500 mfd 12v DC 3/-. 500 mfd 25v DC 3/6. P. & P. 1/-.
RESISTORS: 1 watt 10%, from 4.7 ohm to 10 meg 5d. each, 4/- doz. P. & P. 1/- (minimum order 2/6).
PAPER CONDENSERS for Cross-Over Units 2 mfd 2/6. P. & P. 1/-.
4 AMP BATTERY CHARGERS £2.19.6. P. & P. 6/6.
PIANO KEY PUSH BUTTON SWITCHES, 7 button, inc. mains on/off. 6 banks of 6 P.C.O. 8/6. P. & P. 1/-.
FERROX ROD AERIAL 6 1/2 in. 1/9. P. & P. 1/-. 10 x 1/2 in. 3/-. P. & P. 1/-.
SPEAKER ENCLOSURES

Blake Cabinet size 18 x 24 1/2 x 9 1/2 in., fabric covered £4.10.0. P. & P. 10/-.
Haydon, 16 1/2 x 15 x 7 1/2 in. fabric covered suitable for 12in. speaker, 45/-. P. & P. 7/6.
Table top or wall mounting enclosure for 13 1/2 x 8in. speakers 37/6. P. & P. 4/6.
Corner Cabinet in natural teak finish for 13 1/2 x 8in. speaker also cut out for tweeter, £3.10.0. P. & P. 6/6.
Hi-Fi Bookshelf speaker enclosure foam lined, cabinet size 10 1/2 x 8 1/2 x 7 1/2 in. Teak finish, £3.0.0. P. & P. 3/6.
Woofer for above £3.0.0. P. & P. 2/6. Tweeter 12/6. P. & P. 1/6. Condenser for crossover 2/6. Terminals 2/6 pair. P. & P. 1/-.
SPEAKERS:

Elac Heavy duty Ceramic Magnets 11,000 line, 10in. round 10 x 6in. 3 ohm or 15 ohm, 42/6. P. & P. 3/6. 8in. round 15 or 3 ohm, 38/6. P. & P. 3/6. E.M.I. 13 1/2 x 8in. 15 or 3 ohm, 42/6. P. & P. 3/6. E.M.I. Tweeter, 12/6. P. & P. 1/6. R.T.C. 12in. 20 watt 15 ohm Ceramic magnet £5.5.0. P. & P. 3/6. 8 x 4in. Elliptical 30 ohm 30/-, P. & P. 3/6. 5in. round 30 ohm 17/6. P. & P. 2/6. 5 x 3in. 15 ohm 17/6. P. & P. 2/6. 7 x 4in. 35 ohm, 22/6. P. & P. 2/6. All other speakers supplied—Goodmans, Bakers, W.B., Wharfedale, Eagle, Tripletone.

PYE T.V. REMOTE CONTROL UNITS. Grey and Red plastic case. 2 white/silver knobs, 2 volume controls. 500K and 100K, small chassis. 7 yards 5-way cable with octal plug. Brand new, boxed. Only 5/6. P. & P. 1/-.
EARPIECES WITH CORD AND 3.5 mm. plug. 8 ohm magnetic, 3/-, 250 ohm 4/-. 180 ohm with clip, 6/6. Xtal 4/-. P. & P. 6d.
TRANSISTOR SPEAKERS 8 ohm 2in. 8/6; 3in. 10/6; 3 1/2 in. 12/6. P. & P. 1/-.
VYNAIR. Widths from 40"-54" 13/6 yd. off roll. Send 5d stamps for samples.
SPEAKER MATCHING TRANSFORMERS. 3, 7, 15 ohms, 5 watts 9/6. P. & P. 1/6.
PANEL LIGHTS. 6v Red, Blue, Green, Yellow, White (uses Lilliput bulbs) 3/- each. P. & P. 1/-.
NEON PANEL LIGHTS 200-250v 3/- each. P. & P. 1/-.
ROTARY SWITCHES: 2 pole Mains Switch 3/-. 1 pole 12 way, 2 pole 2 way, 3 pole 3 way, 3 pole 4 way, 4 pole 3 way, 3/6 each. P. & P. 1/-.
THE CAXTON COLUMN

SPEAKER SYSTEMS

THE CAXTON COLUMN

This is a column cabinet. Size 22 1/2 x 5 x 6 1/2 in., fitted with 3 speakers. This will handle 10 watts and will improve the quality of any tape recorder, or record player. Finished in wood grain cloth and sandstone Vynair. A real bargain at £3 plus 10/- P. & P.

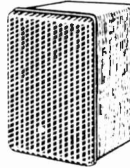

THE MILTON. A Hi-Fi Bookcase Cabinet. Size 9 x 5 x 6in. with 5in. speaker. Finished in Teak cloth with bold silk front. 30/-, P. & P. 3/6.

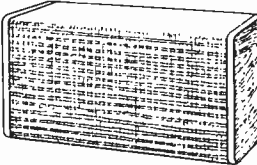

THE STEREO. A superior extension cabinet fitted with two 7 x 4in. speakers. Size 16 x 8 1/2 in. Finished in fawn Vynair with natur. a teak ends. £3. P. & P. 5/-.

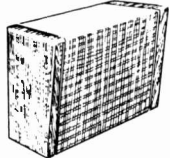

THE IMP. Extension Speaker Cabinet. Wedge shaped size 7 1/2 x 6 1/2 in. fitted with 7 x 4in. speaker. Covered with attractive walnut with fawn Vynair front. Key-hole slot in back. Only 25/6. Post 2/6. Note: All cabinets new and made with jpn. chipboard. All speakers ex TV reconditioned hi flux magnet. All carefully tested before despatch.

HAYDON SPEAKER SYSTEM

Size 16 1/2 x 15 x 7 1/2 in., fitted 12in. Speaker and volume control. Fabric covered. £4.17.6. P. & P. 10/-.

Stockists of ● Eagle Products ● Goodmans ● W.B. ● Wharfedale ● Bakers ● Tripletone ● Linear, all makes of amplifiers and speakers supplied. S.A.E. please. Trade terms to bona fide dealers.

92 MITCHAM ROAD, TOOTING BROADWAY LONDON, S.W.17 Telephone: BALHAM 3984

(Closed all day Wednesday)

(four minutes from Tooting Broadway Underground Station)

HI-FI
V.H.F.
SHORT WAVE
LISTENING
MEDIUM WAVE
DX
MARINE BAND

IF THESE ARE YOUR HOBBY — THEN YOU MUST GIVE YOUR RECEIVER A CHANCE TO SHOW WHAT IT CAN DO!

The world famous contest winning, top of the competition table "JOYSTICK" Variable Frequency Aerial has an UNFAIR ADVANTAGE over conventional aerials!!! How?

Because it behaves like an aerial that is MADE for the FREQUENCY on which you happen to be tuned... furthermore, it measures... JUST 7ft. 6ins. LONG!!!... and works beautifully in a small room or flat...

DON'T "SPOIL THE SHIP FOR A HA'PORTH OF TAR". Give your receiver a chance to show you what it can really do.

Send for free brochure and long list of stockists by return of mail to "THE AERIAL PEOPLE":—

PARTRIDGE ELECTRONICS LTD.
(Dept. PEL)
CAISTER HOUSE, PROSPECT ROAD
BROADSTAIRS, KENT

new VARI-STAT thermostatic soldering iron

High Production Model D
Miniature Iron 50 watt
Voltage 12-250 volt
Weight 1 3/4oz.
"Screw on" Bit sizes 3/32in., 1/8in., 3/16in., 1/4in.

PRICE
55/-

Our range also includes:
Standard Instrument Model 50W
Standard Instrument Model 70W
High Production Instrument Model 125W
Industrial Model 500W

All these irons give excellent bit and element life since the thermostat completely eliminates overheating and controls reserve heating capacity which makes possible continuous soldering without chilling of the bit. The constant temperature makes these irons ideal for printed circuit work.

CARDROSS ENGINEERING CO. LTD.,
Woodyard Road, Dumbarton.
Phone: Dumbarton 2655

20% DISCOUNT

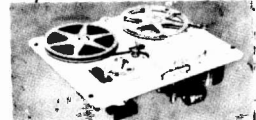

World famous WEARITE Series 6 Tape Decks 3 motors, 3 speeds, 2 heads plus space for extra head. BRAND NEW in Factory sealed cartons. 38 page Manual includes circuits.

MODEL 6A speeds 1 7/8, 3 3/4, 7 1/2 i.p.s.

Lists at £44.0.0d.

OUR PRICE carr. paid
£35.4.0d.

MODEL 6AH speeds 3 3/4, 7 1/2, 15 i.p.s.

Lists at £49.0.0d.

OUR PRICE carr. paid
£39.4.0d.

C.W.O. Allow 14/21 days for delivery.

UNILET PRODUCTS LTD.
Compton House,
New Malden, Surrey

Nucleonic equipment is of course required for prospecting for radioactive ores forming the raw materials for atomic reactor fuel production. The amateur can here participate to a limited extent, although this application is so well covered by professional circles and so limited in scope, that we do not consider it among the more interesting amateur applications of nucleonics to be sketched in this series of articles.

MEDICAL AND BIOLOGICAL APPLICATIONS

Nuclear radiations have an inherently destructive effect on living tissues, and under suitable circumstances cancerous tissues and other malignant growths are more sensitive than healthy tissue. Substances such as radium, and more recently cobalt-60 and others, are thus used extensively for cancer therapy.

Particle accelerators are here very effective competitors. These are electronic devices producing nuclear radiation beams by controlled electronic means instead of by spontaneous decay of radioactive atomic nuclei. Their great advantage lies in the better ability to aim the resulting radiation beams exactly at the desired spots, and the much greater achievable beam intensity.

The second medical application of radioactive substances is concerned with diagnosis and basic research rather than with therapy.

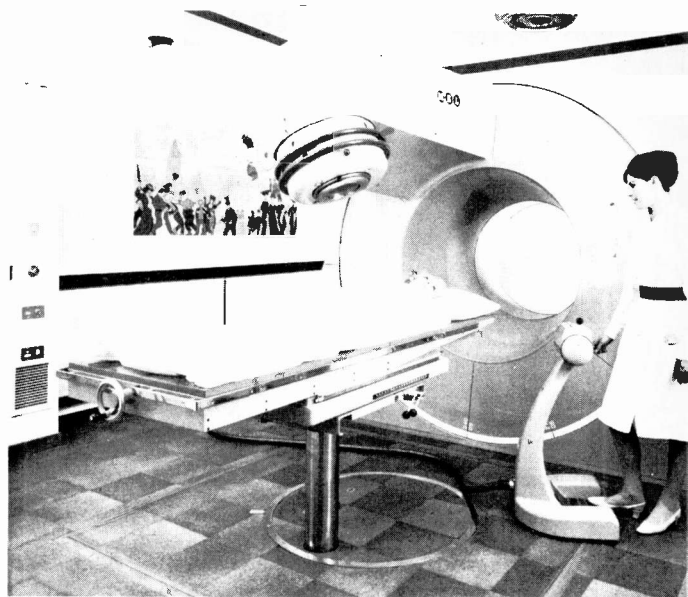

Medical Linear Accelerator SL75 (The M.E.L. Equipment Co. Ltd.)

High energy X-rays are produced by this equipment. The radiographer adjusts the position of the gantry carrying the X-ray head and the couch by means of the controls on the pedestal unit

are prohibited by safety legislation and for ethical reasons. Experienced medical supervision is essential here, and all large as well as many small hospitals nowadays maintain extensive radiation departments for diagnostic purposes and for essential medical research in this line. In some cases, use is made of the tendency of certain chemical elements to concentrate in certain organs, e.g. iodine in the thyroid gland or phosphorus in the brain and nervous system, to apply selective radiation therapy to these organs through the injection or oral administration of suitable radioactive isotopes.

RADIO-CHEMISTRY

The use of radioactive isotopes in chemical research and industry is termed radio-chemistry. Professionally speaking, this field is of immense importance. It is also possible here to carry out a wide range of interesting, instructive and quite safe experiments under private amateur or school conditions. These will be introduced later in this series of articles.

The principle of most of these methods is analogous to the biological tracer studies. If a known amount of a radioactive isotope is mixed with a given quantity of inactive isotopes of the same chemical element, then the fate of that

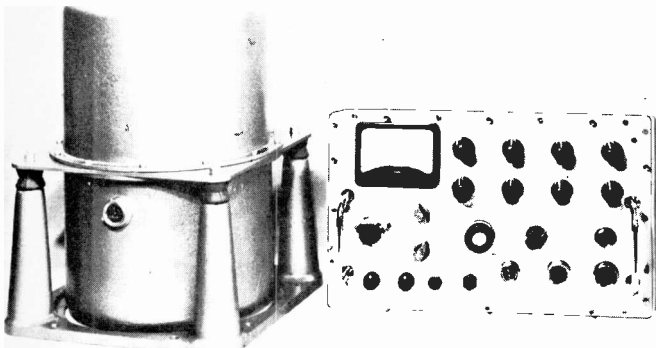

Scintillometer NE 8420 (Nuclear Enterprises (G.B.) Ltd.)

A transistor transportable multi-channel scintillometer for gamma ray spectrometry. The detector unit (left) contains a NaI crystal and photomultiplier and pre-amplifier. The control unit houses a pulse amplifier, single channel analysers, ratemeters, radiation level alarm, and stabilised power circuits.

This equipment is specially designed for airborne and airborne geological and geophysical survey, and operates from 12 or 24 volt d.c. supplies

If we introduce small amounts of a radioactive isotope of a particular chemical element into a human body or any other living organism, we can very conveniently follow the path and the rate of movement of that chemical element, as well as any tendency for accumulation in certain organs. The radioactive isotope behaves in every way identical to the ordinary inactive isotopes of the chemical element concerned, as far as biological and chemical processes are concerned, so that we here have a unique and very elegant method of studying biological metabolism without disturbing the natural system.

Electronic detection equipment for nuclear radiation can readily be made enormously more sensitive than living tissues to nuclear radiation, so that very small doses of radioactive substances, which are quite harmless to the living organisms, can be used for these so-called radioactive tracer studies.

Although amateur experiments would be possible in principle here, readers are emphatically warned that these

Hand and clothing monitors in use at Oldbury Nuclear Power Station (E.M.I. Electronics Ltd.)

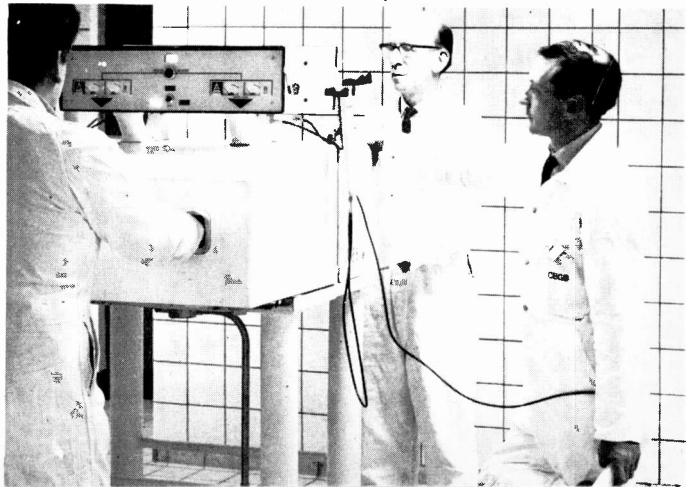

element in the course of complex chemical reactions can be followed with electronic radiation measuring equipment. This may prove quicker, more sensitive or more reliable than conventional methods of chemical analysis, but it also opens the way to some studies which are inherently impossible by other means. For example, the efficiency factors of standard separation processes in chemical analysis can be checked and determined directly, by comparing the radioactivity of the precipitated or otherwise separated material with the radioactivity of the residues of unseparated material.

Radiochemistry also overlaps the other fields already discussed, because chemical methods are employed to check and separate the complex radioactive products from a nuclear reactor to produce the individual radioactive isotopes for use as medical tracers, for radiation sources in prospecting and technology, etc. Many nuclear reactors are operated primarily for these radioactive products rather than for large-scale power generation. In this connection, it is appropriate to sketch the principle of a nuclear reactor. It is basically the same, regardless of whether the reactor is employed for power generation or for the production of radioactive isotopes.

We are here concerned with *nuclear fission*, which is a process of break-up of a heavy atomic nucleus (uranium, plutonium, etc.) into two roughly equal-size smaller nuclei, instead of by successive ejection of alpha and beta particles. Very few radioactive nuclei undergo spontaneous fission as a means of radioactive decay under normal circumstances. Large-scale nuclear fission is induced by exposing certain heavy nuclei to large ambient concentrations of neutrons. These bear no net electric charge and can thus easily penetrate the atomic nuclei. The chances for such encounters are made favourable simply by the large concentration of neutrons present.

As soon as a large atomic nucleus captures a roving neutron, it becomes violently unstable and splits into two almost equal fragments rather than mere alpha or beta emission decay. We already saw that the optimum ratio of neutrons to protons in an atomic nucleus is the greater, the more particles the nucleus contains. The result of fission of a heavy nucleus is thus to produce lighter nuclei with an enormous excess of neutrons. Some of these surplus neutrons are already liberated during the fission process, and maintain the ambient neutron concentration so that the fission process is self-sustaining. But many remain inside the fission products for the time being, adjustment taking place at some later moment through beta ray emission converting successive neutrons into protons.

Radioactive isotopes produced as fission products in a nuclear reactor are thus essentially beta ray emitters. In the majority of cases, a gamma ray accompanies the beta ray emission, because the latter at first leaves the product nucleus in an excited state.

The only essential difference between a nuclear explosive device and a nuclear reactor is that the fission process is uncontrolled and almost instantaneous for all nuclei present in the first case, whereas in the latter case, the fission process is moderated to proceed at a steady controlled rate. The fission products and liberated radiations are the same in both cases.

The study of fission products, whether from reactors or from nuclear explosions, thus calls for electronic equipment sensitive to beta and gamma rays. Alpha ray detection is here of little importance, because essentially only the residues of initial fissionable heavy nuclei which have escaped unchanged manifest alpha-radioactivity. It is readily possible to construct electronic equipment which is exclusively sensitive to alpha radiation in one case, or to beta and gamma radiation in the other case, so that studies of the fission efficiency of nuclear fuels and explosives are possible in this manner.

GAMMA RAY SPECTROSCOPY

Corpuscular radiations, i.e. beta and alpha rays, are emitted with a range of energies from any particular radioactive nucleus, so that specific correlation between emission energies and the type of nucleus concerned, e.g. for empirical analysis of radioactive mixtures, is somewhat difficult. The emission energies of gamma rays, on the other hand, are in most cases quite constant and specific characteristics of each particular radioactive nucleus.

As far as their corpuscular radiations are concerned, the radioactive nuclei may thus be likened to a broadband jamming transmitter, e.g. a former-day spark transmitter or a super-regenerative oscillator. The gamma radiations, on the other hand, may be likened to accurate crystal-controlled carrier frequencies, and this is more than an analogy because a gamma ray of clearly defined constant emission energy is indeed an electromagnetic wave of fixed (exceedingly high) frequency.

A gamma ray spectrometer is an electronic equipment capable of selective detection and intensity measurement of gamma radiation according to emission energy. Although it looks nothing like a radio receiver, it is one in principle, with a tuning range covering the frequencies equivalent to the emission energy range of interest. The range from 0.1MeV to 3.6MeV covers most important gamma ray

The U.K. Atomic Energy Authority's Radiochemical Centre at Amersham, Bucks, has since 1940, produced and distributed throughout the world, a comprehensive range of radioisotopes, radioactive sources and labelled compounds. (left) Laboratory for the development of new carbon-14 labelled compounds in the Organic Department. (right) View of shielded facility for processing minor isotopes

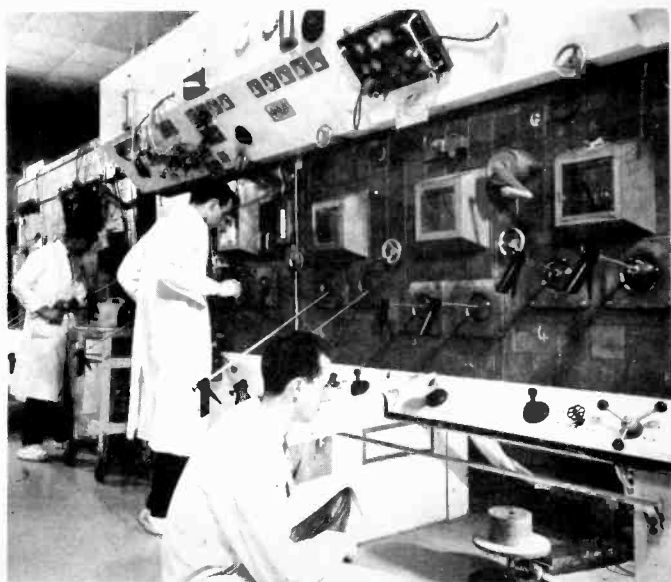

LOOK!

PRACTICAL!

VISUAL!

EXCITING!



a new 4-way method of mastering
ELECTRONICS
by doing — and — seeing . . .

1 ▶ OWN and HANDLE a

complete range of present-day **ELECTRONIC PARTS** and **COMPONENTS**

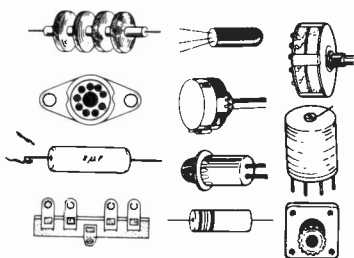

2 ▶ BUILD and USE

a modern and professional **CATHODE RAY OSCILLOSCOPE**

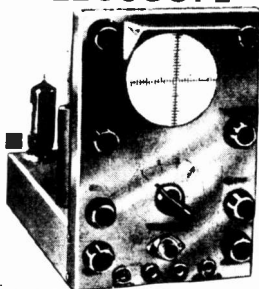

3 ▶ READ and DRAW and

UNDERSTAND
CIRCUIT DIAGRAMS

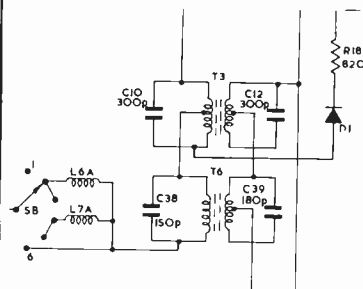

4 ▶ CARRY OUT OVER 40 EXPERIMENTS ON BASIC ELECTRONIC CIRCUITS AND SEE HOW THEY WORK . . . INCLUDING . . .

- VALVE EXPERIMENTS
- TRANSISTOR EXPERIMENTS
- AMPLIFIERS
- OSCILLATORS
- SIGNAL TRACER
- PHOTO ELECTRIC CIRCUIT
- COMPUTER CIRCUIT
- BASIC RADIO RECEIVER
- ELECTRONIC SWITCH
- SIMPLE TRANSMITTER
- A.C. EXPERIMENTS
- D.C. EXPERIMENTS
- SIMPLE COUNTER
- TIME DELAY CIRCUIT
- SERVICING PROCEDURES

This new style course will enable anyone to really understand electronics by a modern, practical and visual method—no maths, and a minimum of theory—no previous knowledge required. It will also enable anyone to understand how to test, service and maintain all types of Electronic equipment, Radio and TV receivers, etc.

FREE POST NOW
for
BROCHURE

or write if you prefer not to cut page

To: **BRITISH NATIONAL RADIO SCHOOL, READING, BERKS.** Please send your free Brochure, without obligation, to: we do not employ representatives

NAME

BLOCK CAPS

ADDRESS

PLEASE PE12

VARIABLE VOLTAGE TRANSFORMERS



PORTABLE TYPE
£8. 10. 0.



AMP

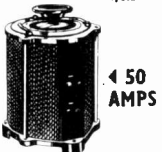

450 AMPS

INPUT 230/240v. A.C. 50/60—
OUTPUT VARIABLE 0-260v.
BRAND NEW Carriage Paid.
Buy direct from the importer,
keenest prices in the country.
All Types (and Spares) from
1/2 to 50 amp. from stock.
OPEN TYPE (Panel Mounting)
1/2 amp, £3. 3. 0. 1 amp, £4. 10. 0.
2 1/2 amps, £5. 12. 6.
SHROUDED TYPE
1 amp, £4. 10. 0. 2.5 amps,
£5. 17. 0. 4 amps, £8. 7. 6.
5 amps, £9. 0. 0. 8 amps,
£13. 10. 0. 10 amps, £17. 0. 0.
12 amps, £19. 10. 0. 15 amps,
£22. 0. 0. 20 amps, £32. 10. 0.
37.5 amps, £65. 0. 0. 50 amps,
£85. 0. 0.
1.5 amp. portable fitted metal case,
voltage meter, lamp, switch, etc. £8.10.0.
P. & C. 10/-.
Similar to above 2.5
amp. £9.17.6. P. & C. 10/-.

LIGHT SENSITIVE SWITCH

Kit of parts, including ORP12 Cadmium Sulphide Photocell, Relay, Transistor and Circuit, etc., 6-12 volt D.C. op. price 25/- plus 2/6 P. & P. ORP 12 including circuit, 10/6 each, plus 1/- P. & P.



A.C. MAINS MODEL Incorporates Mains Transformer, Rectifier and special relay with 3, 5 amp mains c/o contacts. Price inc. circuit 47/6 plus 2/6 P. & P.

LIGHT SOURCE AND PHOTO CELL MOUNTING

Precision engineered light source with focusable lens assembly and ventilated lamp housing, to take MBC bulb. Separate photo cell mounting assembly for ORP. 12 or similar cell. Both units are single hole fixing. Price per pair £2.10.0. P. & P. 3/6.



UNISELECTOR SWITCHES

NEW 4 Bank 25 Way
Uniselector 3 Bank + Homing 25 ohm coil. 12-24 v. D.C. operation £4.17.6 plus 2/6 P. & P.
8 Bank 25 Way 24 v. D.C. operation. £6.10.0 plus 4/6 P. & P.



USED 75 ohm coil 24 v. D.C.

6 Bank 25 position, 5 non-bridging 1 Bridging Wiper 35/- each. P. & P. 2/6.

MINIATURE UNISELECTOR SWITCH

3 banks of 11 positions plus homing bank. 40 ohm coil. 24-36 v. D.C. operation. Tested. 22/6, plus 2/6 P. & P.



COMPACT HEAVY DUTY 6v. D.C. RELAY

2 change over, 3 ohm coil. 7/6 each. P. & P. 1/6. 3 for 20/- Post paid.

100 WATT POWER RHEOSTATS (NEW)

AVAILABLE IN THE FOLLOWING VALUES
1 ohm, 10 a.; 5 ohm, 4.7 a.; 10 ohm, 3 a.;
25 ohm, 2 a.; 50 ohm, 1.4 a.; 100 ohm, 1 a.;
250 ohm, .7 a.; 500 ohm, .45 a.; 1,000 ohm,
280 mA; 1,500 ohm, 230 mA; 2,500 ohm, .2 a. Diameter
3 1/2 in. Shaft length 3 1/2 in. All at 27/6 each.
P. & P. 1/6.



50 WATT POWER RHEOSTATS

1 ohm, 7a.; 5 ohm, 3a.; 10 ohm, 2.25a.; 25 ohm, 1.4a.;
50 ohm, 1a.; 100 ohm, .7a.; 250 ohm, .45a.; 500 ohm,
.3a.; 1,000 ohm, .22a.; 2,500 ohm, .14a.; all at 21/-.
P. & P. 1/6.

25 WATT POWER RHEOSTATS

10 ohm, 1.5a.; 25 ohm, 1a.; 50 ohm, .75a.; 100 ohm, .5a.;
250 ohm, .3a.; 500 ohm, .2a.; 1,000 ohm, .15a.; 1,500 ohm,
.12a.; 2,500 ohm, .1a.; all at 14/6. P. & P. 1/6.

PRECISION FLATPOT. Manufactured by M.E.C. 50K,
45 turn. Fly leads. All metal sealed construction.
10/6. P. & P. 1/6.

GENUINE NEW MULLARD 6 AMP. SILICON DIODES

NOT Rejects or Seconds
BYZ13 200 PIV 7/- BYZ12 400 PIV 8/-
BYZ11 600 PIV 9/- BYZ10 800 PIV 10/-

RESETTABLE HIGH SPEED COUNTER. 4 figure, 1,000 ohm coil, 36-48 v. D.C. operation. £3/10/-.
P. & P. 1/6. 3 figure, 700 ohm coil, 24 v. D.C. £2/2/- P. & P. 1/6.

We have decided to provide our customers with only the finest in MULTIRANGE METERS, and therefore

now stock only **SANWA** the ultimate in test meters. Four types from stock. Price from £3.2.0. Full range of spares and repair service available. Descriptive leaflet on request.



NEW IMHOFS INSTRUMENT CASE

offered at approx. 1/3rd list price. Type 1. Width 20", Height 11", Depth 12 1/2", standard 19" recessed front panel. Fully ventilated. Streamlined handles. Hammer Blue finish. £5. Carriage B.R.S. 17/6. Type 2. Width 20 1/2", Height 14 1/2", Depth 16 1/2", less front panel. £4. B.R.S. 17/6.

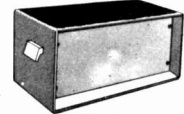

A.C. AMMETERS 0-1, 0-5, 0-10, 0-15, 0-20 amp. F.R. 2 1/2 in. dia. All at 21/- each.

A.C. VOLTMETERS 0-25 v., 0-50 v., 0-150 v., M.I. 2 1/2 in. Flush round all at 21/- each. P. & P. extra.
0-300 v. A.C. Rect. M-Coil 2 1/2 in. 29/-
0-300 v. A.C. Rect. M-Coil 3 1/2 in. Type W23 55/-

SLIDER RESISTANCE
200 ohm 1.25 amp., 37/6. P. & P. 3/6.
50 ohm 10 amp., 37/6. P. & P. 3/6.

PHOTO MULTIPLIER. Type CV337. This supersedes type 931A. Complete with special P.T.F.E. base and divider network. 57/6 incl. P. & P.

VENNER 14-DAY CLOCKWORK TIMESWITCH

5 amp. 230 v. contact 1 on/off every 24 h. Fitted in metal case with key. Used but guaranteed. 47/- plus 3/- P. & P.



INSULATED TERMINALS

Available in black, red, white, yellow, blue and green. New 15/- per doz. P. & P. 2/-.



THYRISTOR 400 piv. 3 amp. 9/6 post paid.
THYRISTOR 400 piv. 8 amp. 28/6 post paid.

CONSTANT VOLTAGE TRANSFORMER

Input 185-250 v. A.C. Output 230 v. A.C. Capacity 250 watt. Attractive metal case. Fitted red signal lamp. Rubber feet. Weight 17 lbs. Price £11.10.0. P. & P. 15/-.



DRY READ SWITCHES

New special offer of Dry Read Switches half amp. Contact. Size 1 1/2 x 1/2. 4 for 10/- Post Paid.

SUPER POWER MAGNET ex-W.D. Magnets, weighing only 4 lb. will lift well over 100 lb. Swivelled handle and keeper. Size 4 in. x 3 1/2 in. x 1 1/2 in. Packed in two's. Price 30/- per pair plus 7/6 C. & P.



MOVING COIL HEADPHONE AND MIKE

Soft rubber ear-pieces with M/C Mike fitted 5-way plug as on No. 19 set. New in makers packing, 16/6 plus 3/6 C. & P.

SERVICE TRADING CO

All Mail Orders—Also Callers—Ample Parking Space
57 BRIDGMAN ROAD, LONDON, W.4 Phone 995 1560
SHOWROOM NOW OPEN CLOSED SATURDAY
Personal callers only
9 LITTLE NEWPORT ST.
LONDON, W.C.2. Tel. GER 0576
Q7R

THE PRACTICAL AERIAL HANDBOOK

Radio and Television aerials: their design, erection and maintenance—Signal combining and splitting—Boosting of signals—Shared systems—Interference suppression.

by G. J. King

35/- Postage 1/6

Q & A ELECTRONICS, by C. Brown. 8/6. Postage 6d.

MATHEMATICS FOR RADIO & ELECTRONICS TECHNICIANS, by Dr. Ing Fritz Bergold. 50/- Postage 2/-.

INTER G.E.C. TRANSISTOR MANUAL, 7th ed. 18/- Postage 2/-.

RAPID SERVICING OF TRANSISTOR EQUIPMENT, by G. J. King. 30/- Postage 1/6.

TRANSISTOR POCKET BOOK, by R. C. Hibberd. 25/- Postage 9d.

WORLD RADIO TV HANDBOOK 1967. 32/- Postage 1/-.

BASIC THEORY & APPLICATION OF TRANSISTORS, by U.S. Dept. Army. 10/- Postage 1/-.

RADIO VALVE DATA, 8th ed. Compiled by "WW". 9/6. Postage 1/-.

THE MODERN BOOK CO.

BRITAIN'S LARGEST STOCKISTS
British and American Technical Books

19-21 PRAED STREET
LONDON, W.2
Phone: PADdington 4185



SUPPLIERS OF ELECTRONIC EQUIPMENT TO

- * INDUSTRIAL RESEARCH ESTABLISHMENTS
- * RADIO ENTHUSIASTS
- * UNIVERSITIES & TECHNICAL COLLEGES

OFFICIAL SUPPLIERS TO MANY EDUCATION AUTHORITIES
Usual Educational Discounts

OUR NEW 1967/8 illustrated catalogue NOW AVAILABLE
(Send 2/- in stamps for your copy)

INCLUDES
Valves, Transistors, Transformers, Loudspeakers, Recording Tape, Coils, Resistors, Condensers, Potentiometers, Chassis, Rectifiers, Test Meters, Microphones, Tools, Solder, etc.

DISTRIBUTORS OF EAGLE PRODUCTS
WHOSE NEW ENLARGED CATALOGUE
is now available **5/-**

ALPHA RADIO SUPPLY CO.
103 Leeds Terrace, Leeds 7. Tel. 25187

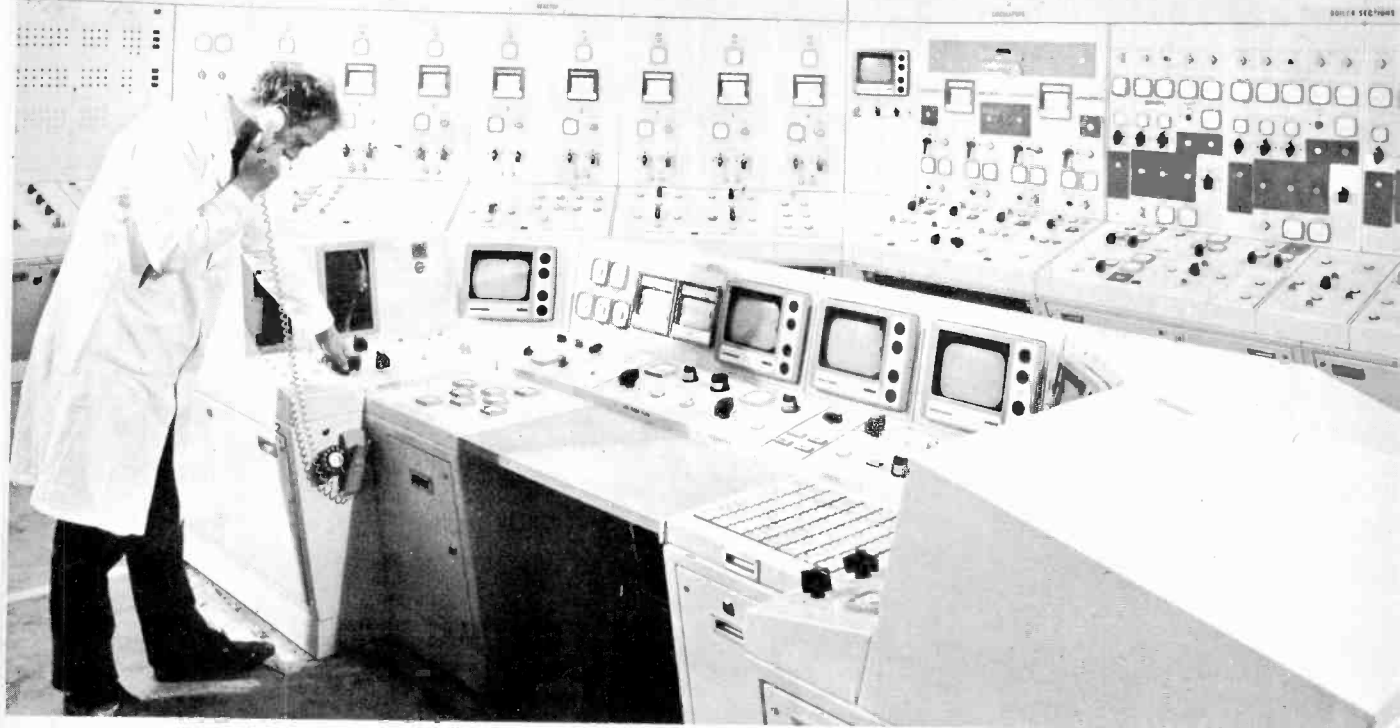

Central Control Room at Wylfa nuclear power station. This is the ninth and most powerful of Britain's first series of nuclear power stations.

A comprehensive computer controlled monitoring system is employed. This system includes English Electric Datapac digital and analogue scanners and Marconi TAC computers and tabular displays linked to cathode ray tubes

emissions accompanying radioactive decay processes, at least for amateur purposes, so that the practical gamma spectrometer design sketched in this series of articles covers this range.

We saw that gamma rays are produced as the means of dissipating the energy difference when an excited state of an atomic nucleus reverts to the ground state or to some interim state of lower energy.

Considered alone, these are processes of internal re-shuffle without gain or loss of particles. The clearly defined emission energies of gamma radiation imply that the nuclear structure involves well-defined energy states. Gamma ray spectroscopy is thus an important research tool for investigating nuclear structure, although this is beyond amateur practical work. However, the characteristic gamma ray energies for each radioactive nucleus which emits gamma rays at all, makes it possible to detect certain types of nuclei to the exclusion of others in a radioactive mixture.

Many interesting amateur experiments discussed later in this series make use of this elegant possibility. It must be pointed out that the gamma ray spectra, i.e. the energies at which gamma rays appear, are complex for very many radioactive nuclei. This is because the various energy levels through which an excited nucleus can finally reach the ground state often form an intricate and intermeshed system. In most cases the various paths are alternatives or a sequence of successive steps, so that each decaying individual nucleus produces only one gamma ray, with a certain one of the many possible energies determined by pure chance. Only the contributions of numerous decaying nuclei produce the complete spectrum of all characteristic energies for that type of nucleus.

The relative intensities (number of rays emitted per unit time) of the various gamma ray energies are thus determined by statistical chance, but are again extremely constant if an adequately large number of radioactive atoms of the species concerned is considered.

Nevertheless, some cases are known where all, or a large proportion of all decaying nuclei of the species produce two gamma rays of different energies essentially simultaneously. Cobalt-60 is here a notable example, and it permits certain instructive experiments on account of its gamma-gamma emission. The necessary quantities of cobalt-60

for these experiments are very small and safe, thus readily available to schools and responsible amateurs (from the Radiochemical Centre, Amersham, Bucks.). We will describe these experiments too, in due course.

We will conclude this article with a brief presentation of the electronic equipment which will form the theme of this entire series.

This photograph shows the complete "STRACE" equipment, consisting of five units and connecting cables. Fig. 2.1 shows the block diagram of this equipment which has been specially designed for amateur experimental purposes.

The two Geiger counter heads are the round black units standing on top of the radiation meter unit. The gamma ray spectrometer unit is standing to the right and the "chimney" on the upper side is the scintillation detector. The chart recorder unit is in the foreground

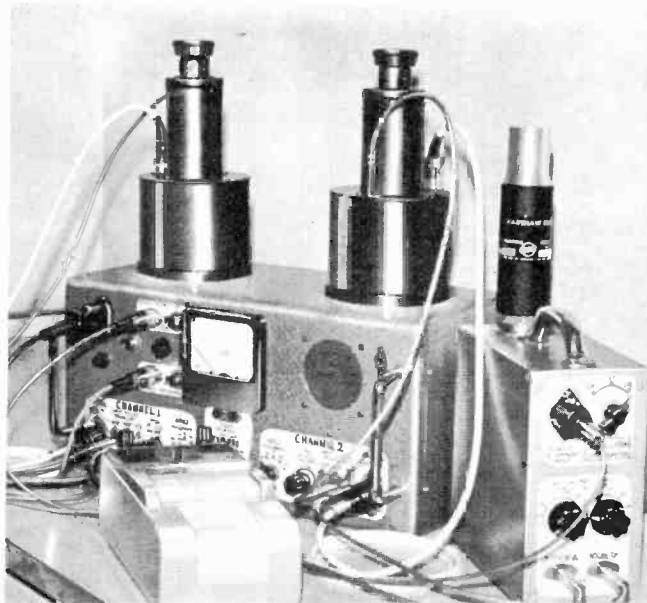

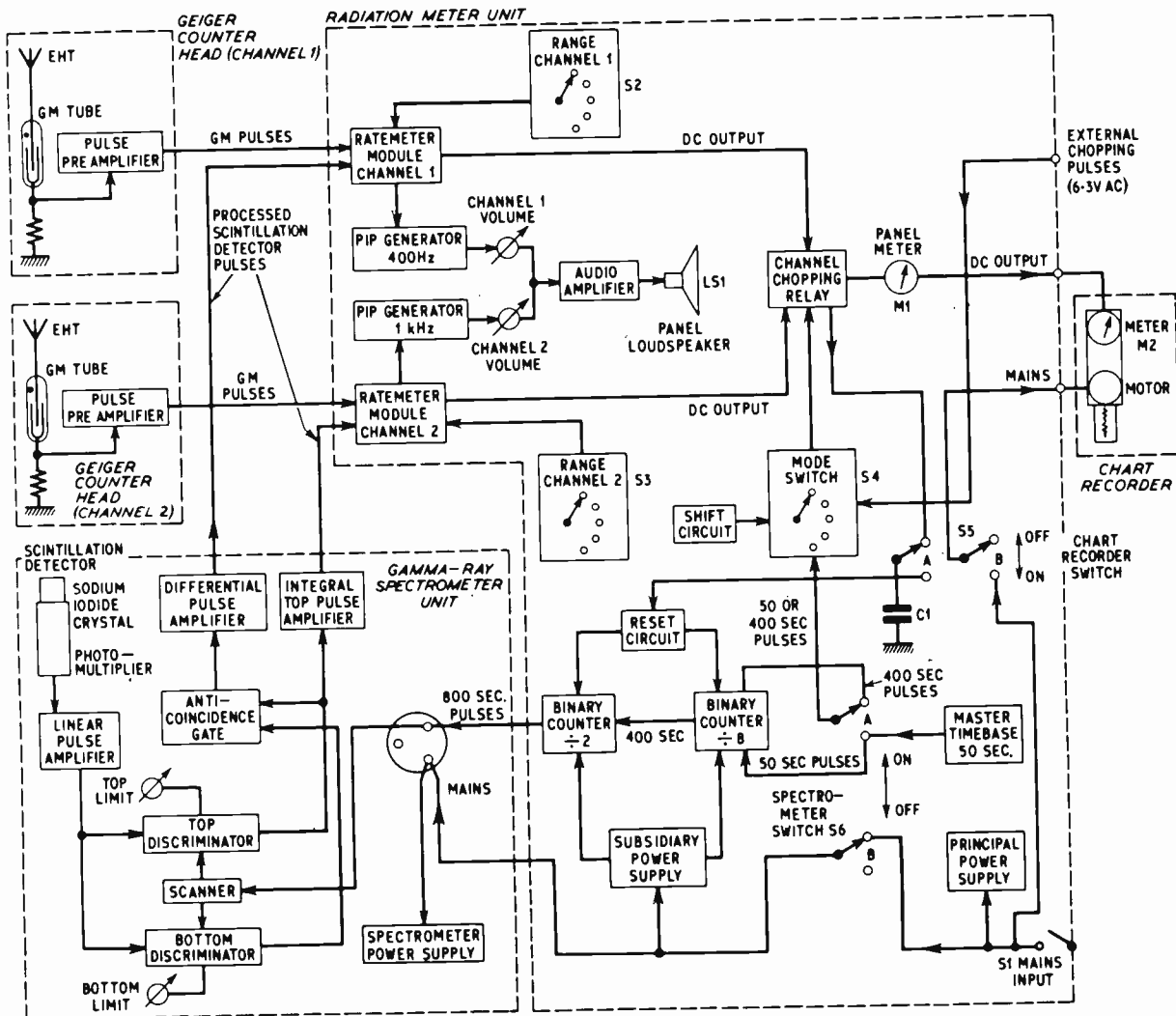

Fig. 2.1. Block diagram of STRACE

STRACE

The main aim of these articles is to acquaint the reader with the types of electronic circuitry required for nuclear radiation measurements involved in the applications discussed above, and to point out the scope of practical amateur constructional and experimental work in this fascinating field.

For this purpose, a composite equipment has been designed. See Fig. 2.1. This will enable all important types of nuclear radiation measurements, as far as the amateur is concerned, to be performed. Furthermore, this equipment embodies a very representative selection of all important types of nucleonic circuit bricks. Subsequent articles in this series will include theoretical circuits and photographs of the various sections of the equipment.

Most stages operate in Class C, i.e. they are normally resting cut off and are briefly keyed-on by each electric pulse produced in response to a nuclear radiation quantum sensed by the detector. The functions are thus less ones of amplification, but rather ones of pulse processing, shaping, and counting. The intensity of a nuclear radiation is expressed in terms of the number of quanta emitted per unit time, so that the essential computer functions of nucleonic equipment amount to plain counting and division by elapsed time. These functions, at least for amateur purposes, are not beset by the instability pitfalls associated

with high-gain amplifiers, so that within reason, component layout is pleasantly uncritical.

The systematic discussion of the full theoretical circuit of a specific equipment with brief references to common refinements found in advanced professional equipment, provides an intelligible theme for the reader seeking only general information. At the same time, more experienced readers will be quite able to construct the equipment from the theoretical circuits and photographs alone, with excellent prospects that it will work correctly immediately with any reasonable layout, or substitute components.

Furthermore, the modular presentation is such that readers can build any self-sufficient group of sections instead of the entire equipment, according to purse. We are deliberately aiming to stimulate enlightened experimental initiative rather than presenting finished blueprints with these articles, which are essentially descriptive.

We have called the composite equipment forming the descriptive basis of this series "STRACE" (Statistical Rate Computing Equipment), to express its functions. The nuclear radiation quanta are emitted according to the *statistical* laws of chance. The sequence is quite irregular, but the mean *rate* over a sufficiently long period of observation is an accurate measure of the radiation intensity.

Next month: The fundamental sections of a nucleonic equipment



POCKET MULTI-METER

Size 3 1/4" x 2 1/4" x 1 1/4". Meter size 2 1/4" x 1 1/4". Sensitivity 1000 O.P.V. on both A.C. and D.C. volts. 0-15, 0-150, 0-1000. D.C. current 0-150mA. Resistance 0-100kΩ. Complete with test prods, battery and full instructions, 42/6. P. & P. 3/6. **FREE GIFT** for limited period only. 30 watt Electric Soldering Iron value 15/- to every purchaser of the Pocket Multi-Meter.

ANTI-THIEF CAR BURGLAR ALARM

The Melguard Safermatic consists of an electrical device housed in small metal box 4" x 2" x 1 1/2", which has been designed and developed to provide protection required by the average motorist at an economic cost. Using this system, an alarm and the immobilised condition is set automatically as soon as you park the car. Should you leave the key in the ignition, no one but you can drive the car away. Upon entering the vehicle the method of starting the car is by switching on the ignition, depressing two hidden switches and simultaneously operating the starter. Location of the switches is known only to you. Should the alarm be set off it can be stopped by following the normal starting procedure. For 12V operation. List price 79/6 our price 29/6 plus 2/6 P. & P. Full easy-to-follow instructions supplied.



EXTRACTOR FAN

AC Mains 230/250v complete with pull switch. Size 6" x 6" x 4". Price 27/6 plus 5/- P. & P.

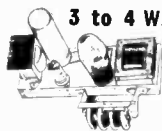

3 to 4 WATT AMPLIFIER

3-4 watt Amplifier built and tested. Chassis size 7 x 3 1/2 x 1 in. Separate bass, treble and volume control. Double wound mains transformer, metal rectifier and output transformer for 3 ohms speaker. Valves ECC81 and 6v6. £2.5.0 plus 5/6 P. & P.

BSR MONARCH UA16 With FULL-FI HEAD

4-speed, plays 10 records, 12in., 10in. or 7in. at 16, 33, 45 or 78 r.p.m. Intermixes 7in., 10in. and 12in. records of the same speed. Has manual play position; colour, brown. Dimensions: 12 1/2 x 10 1/2 in. Space required above baseboard 4 1/2 in., below baseboard 2 1/2 in. Fitted with Full-Fi-turn-over crystal head. £4.19.6. P. & P. 9/-.

Special offer ELEGANT SEVEN mk IIa

SPECIAL OFFER. Power supply kit to purchasers of 'Elegant Seven' parts, incorporating mains transformer, rectifier and smoothing condenser, A.C. mains 200/250 volts. Output 9v. 100 mA. 9/6 extra.

Buy yourself an easy to build 7 transistor radio and save at least £10.0.0. Now you can build this superb 7 transistor superhet radio for under £4.10.0. No one else can offer such a fantastic radio with so many de luxe star features.



ONLY £4.4.0

Plus 7/6 Post & Packing

- ★ De luxe wooden cabinet size 12 1/2" x 8 1/2" x 3 1/2".
- ★ Horizontal easy to read tuning scale printed grey with black letters, size 11 1/2" x 2".
- ★ High 'Q' ferrite rod aerial.
- ★ I.F. neutralisation on each separate stage.
- ★ D.C. coupled push pull output stage with separate A.C. negative feedback.
- ★ Room filling output 350mW.
- ★ Ready etched and drilled printed circuit board back printed for foolproof construction.
- ★ Fully comprehensive instructions and point to point wiring diagrams.
- ★ Car aerial socket.
- ★ Fully tunable over medium and long wave, 168-635 metres and 1250-2000 metres.
- ★ All components, ferrite rod and tuning assembly mount on printed board.
- ★ 5" P.M. Speaker.
- ★ Parts list and circuit diagram 2/6, free with parts.

BSR TAPE DECKS

200/250 v. A.C. mains

Type TD2 Tape speed 3 1/2 twin track—£6.19.6.

Type TD10 2-track, 3 speed, plus rev. counter—£7.19.6.

Type TD10 4-track, 3 speed, plus rev. counter—£9.5.0.

P. & P. on each 7/6.



STAR SR 150 COMMUNICATION RECEIVER

Frequency range: 535 kc/s-30 Mc/s. 4 wavebands. 5 valve superhet. Incorporates BFO, bandspread tuning, "S" meter, external telescopic aerial and ferrite aerial. Built-in 4in. speaker. Easy-to-read dial. For 240v. A.C. operation. Complete, brand new, with full instruction manual. 15 gns. P. & P. 10/-.

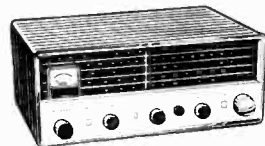

NEW! DORSET

600 milli-watt solid state 7 transistor plus diode and thermistor

Transistor Portable Radio plus Baby Alarm Facilities

Completely modularised high quality portable radio featuring complementary N.P.N. and P.N.P. output stage.

The comprehensive easy-to-follow drawings supplied make this the easiest-ever transistor radio set of parts, with the following features:

- Simple connections to only 6 tags on the R.F./I.F. module, 3 I.F. stages, osc. coil and 3 transistors which with their associated components are completely wired.
- Only 4 connections on the A.F. module to complete the 4 transistor 600 milli-watt solid state amplifier.
- Pre-aligned R.F./I.F. module built and tested.
- A.F. module built and tested.
- Fully tunable over M.W. and L.W. bands. M.W. 540-1640 Kc/s (557-183 metres). L.W. 150-275 Kc/s (2000-1100 metres).
- Intermediate Frequency 470 Kc/s.
- Sensitivity: M.W. at 1 Mc/s 10 microvolts plus or minus 3db. L.W. at 200 Kc/s 40 microvolts plus or minus 4db.
- High Q internal ferrite rod aerial on both wavebands.
- Class "B" modularised output stage with thermistor controlled heat stabilization. Class "B" output stage ensures long battery life. Current drain is proportional to the output level. Total current drain of the receiver under no signal conditions is 10-12mA. At reasonable listening level 20-30mA.
- Extension sockets for car aerial input, tape recorder output (independent of vol. control) and Ext. Speaker.
- All components (except speaker) mount on the printed circuit board. Easy to follow instructions. Size of cabinet 12" long, 8" high and 3" deep.

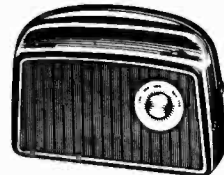

● Finger tip controls.

Circuit and parts list 2/6, free with parts.

PRICE: £5.5.0 plus 7/6 P. & P.



FIRST QUALITY P.V.C. TAPE

5 1/2" Std. 850ft. ... 9/-	5" L.P. 850ft. ... 10/6
7" Std. 1200ft. ... 11/6 3"	T.P. 600ft. ... 10/6
3" L.P. 240ft. ... 4/-	5" T.P. 1800ft. ... 25/6
5 1/2" L.P. 1200ft. ... 11/6	5 1/2" T.P. 2400ft. ... 32/6
7" L.P. 1800ft. ... 18/6	7" T.P. 3600ft. ... 42/6
5 1/2" D.P. 1800ft. ... 18/6	4" T.P. 900ft. ... 15/-

P. & P. on each 1/6, 4 or more post free

600mW SOLID STATE 4-TRANSISTOR AMPLIFIER

Features NPN and PNP Complementary Symmetrical Output Stage. The elimination of transformers ensures maximum efficiency and frequency response. Automatic heat compensation. Combined AC/DC feed back. Class B output stage, i.e. output power is proportional to total current consumption, this ensures long battery life. Under no signal condition (1Q) current drain is approx. 12mA at 9 volts (4mA in the output pair). Printed circuit construction, size: 2 1/2" x 8" x 8". Speaker output impedance 12 ohms. Output power 600mW at 5% distortion, 400mW at 2.5% distortion, 750mW at 10% distortion. Supply 9 volts. Total current consumption at a reasonable listening level approx. 35-40mA at full power (speech and music), average 65mA. Sensitivity for 50mW output is 10mV. Frequency response -3db points 90 c/s and 12 Kc/s. Price 15/- plus 1/- P. & P. 7" x 4" speaker to suit. 13/6 plus 2/- P. & P.

8-WATT 4-VALVE PUSH-PULL AMPLIFIER & Metal RECTIFIER

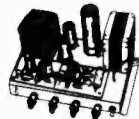

Size 9" x 6" x 1 1/4". A.C. Mains, 200-250 v. 4 valves. For use with Std. or L.P. records, musical instruments. All makes of pick-ups and mikes. Output 8 watts at 5 per cent of total distortion. Separate bass and treble lift control. Two inputs, with controls for gram. and mike. Output transformer tapped

for 3 and 15 ohm speech coils. Built and tested. £4.4.0. P. & P. 11/-. 8" x 5" Speaker to suit. Price 14/6 plus 1/6 P. & P. Crystal Mike to suit 12/6 plus 1/6 P. & P.

RADIO AND T.V. COMPONENTS (ACTON) LTD.

21D HIGH STREET, ACTON, LONDON, W.3

Shop hours 9 a.m. to 6 p.m. Early closing Wednesday. Goods not despatched outside U.K. All enquiries stamped addressed envelope. Terms C.W.O.

Also at 323 EDGWARE ROAD, LONDON, W.2. PERSONAL SHOPPERS ONLY. All orders by post must be sent to our Acton address. Early closing Thursday.

Transistorised SIGNAL GENERATOR

Size 5 1/2" x 3 1/2" x 1 1/4". For IF and RF alignment and AF output, 700 c/s frequency coverage 460 Kc/s to 2 Mc/s in switched frequencies. Ideal for alignment to our Elegant Seven and Musette. Built and tested. 39/6. P. & P. 3/6.

detached particles

JOHN VALENCE

CURRENT EXPENDITURE

The increased electricity charges will be making all domestic consumers economy conscious. Some of the pleasure derived from the red glowing element is going to be dampened for, at any rate, that member of the household who actually foots the bill. The cleanliness and convenience of electricity has always been bought at a cost—compared with other fuels—but the additional 15 per cent or so is a real blow, no mistake. Let us hope for a moderate winter!

Leaving aside the harsh economic facts of today, it is appropriate to give a little thought to the man initially responsible for the practical means for generating electrical power.

MICHAEL FARADAY

It is indeed particularly fitting around this time to recall Michael Faraday and his unparalleled contributions to technical and scientific progress: the centenary of his death was last September. Michael Faraday was in a sense the founder of the electrical industry—since his great experiments into the nature of electricity led to his discovery of electro-induction. Of the many debts modern society owes to this largely self-taught genius of the 19th century, that in respect of the discovery which gave us the dynamo is probably the greatest.

FUEL CELLS

The fact that Faraday's discovery could be put to practical use almost at once was due to the general availability of steam engines capable of providing the necessary rotary action. The state of contemporary technology assisted Faraday in this respect.

How different though in the case of one of his contemporaries. Just eight years following Faraday's discovery of electromagnetic induction, the principle of the fuel cell was discovered by W. G. Grove. Unfortunately for the latter, the technical problems of applying this discovery in an economical manner were

insurmountable. Thus a device which is potentially very much more efficient than the mechanically driven generator never materialised as a commercial proposition.

But if Grove was denied success and the attendant popular fame this would have aroused during his life time, it does seem that the latter part of the 20th century may make amends. Space exploration and military requirements have created an urgent need for a portable and highly efficient producer of electrical power. Research work into the possibilities of the fuel cell have been going on for several years now and there can be little doubt but that this will become a reality before long.

FOR THE HOME?

It has even been suggested that domestic supplies could be obtained from fuel cells and so eliminate the costly process of current distribution through the grid system.

In this event, since the output from a fuel cell is direct current, an electronic static inverter would be required in every home to convert this to the conventional 240 volt a.c. How shrewd therefore of the giant Associated Electrical Industries to enter the field of static invertors. A.E.I. are, of course, one of the largest makers of power station electrical generating plant!

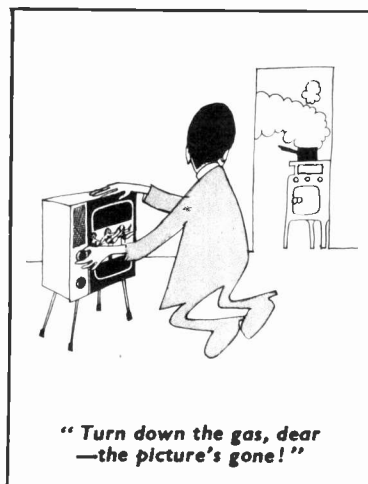

GAS MAINS

I can't leave this current topic without registering surprise at the lack of initiative by the Gas Board. This organisation often shows great enterprise, but we have heard no news of the exploitation of the thermoelectric effect. With all these developments in the field of semiconductor materials, isn't it about time Seebeck's discovery was put to good purpose? What better way of using all that North Sea gas than to heat up solid state thermo-electric generators by the gas ring? And what a crafty way in which to infiltrate the opposition's territory. Instant d.c. from high speed gas. Note the "d.c." again: so either way the *electronic* industry will be laughing.

Sober last thought on the subject. Will any of these technically exciting schemes result in a smaller bill for the householder? Your turn to laugh now.

SIR JOHN COCKCROFT

Some of my readers will be able to recall hearing the news of that epoch-making event when the atom was split for the first time. This was at Cambridge and the year, 1932. John Cockcroft and E. T. S. Walton in association carried out these wonderful experiments. The "gun" they devised for firing charged particles at the atom was the forerunner of the modern high energy particle accelerators.

Outside its atomic, or nucleonic, setting the "Cockcroft-Walton voltage multiplying circuit" has since become a classic electronic circuit and is widely used.

Sir John Cockcroft, master of Churchill College, Cambridge, who died last September, will be mainly remembered for his monumental work in atomic and nuclear physics. How closely these subjects are allied to electronics, and how frequently "pure" research leads to practical technological inventions, is well demonstrated in the example I have quoted above.

SAMSON'S ELECTRONICS LTD.

9-10 CHAPEL STREET, LONDON, N.W.1

Tel.: PAD 7851

Tel.: AMB 5125

DAWE AUDIO SWEEP OSCILLATOR AND CONTROLLER TYPE 443B

20c/s to 20Kc/s in a Single Sweep Logarithmic Scale Calibration. Accuracy $\pm 1\%$ $\pm 1c/s$. Power supply 110V and 200-250V. Dimensions: 19 x 12 x 13in. Supplied Brand New with Instruction Manual. Less than half Maker's Price. £125. Send 6d. Stamp for Data Sheet.

DAWE AUTOMATIC L.F. SWEEP OSCILLATOR

Type 444C. 5c/s to 5,000c/s in a Single Range. 6-in. dia. dial with Logarithmic Calibration over 216° of Arc. Fre. Accuracy $\pm 5\%$. Output continuously variable up to 10V. R.M.S. into a minimum Load Resistance of 10k Ω . Monitored on a Panel Voltmeter Power Supply. 110V and 200-240V. 50c/s. Dimensions: 19 x 18 x 9in. Supplied Brand New with Instruction Manual. Less than half Maker's Price. £100. Send 6d. Stamp for Data Sheet.

DAWE ANIMAL SONORAY TYPE 1803

Designed to give quick and accurate measurements of Back Fat Thickness, on live and dead pigs. Employs a Pulse Echo System, where High Freq. Vibrations, in the form of sound waves are transmitted into the animal by a Transducer, and Reflected on a 5-in. C.R. Tube. Brand New with Instruction Manual. Less than half Maker's Price. £150. Send 6d. Stamp for Data Sheet.

VARIABLE D.C. SUPPLY UNITS TYPE S.E.4

0-48V 10A, continuous from 240V a.c. Silicon full wave bridge rectification, isolated transformer with Variac controlled primary. 3in. scale voltmeter and ammeter. Neon indicator. Housed in strong metal case. Size 17 x 7 x 6 $\frac{1}{2}$ in. £29/10/0. Carr. 15/-.

WESTINGHOUSE L.T. SUPPLY UNITS

A.c. input tapped 250-250V d.c. output. Tapped 24-26V. Very conservatively rated at 8A. Also a separate tapped a.c. output of 6-10-6V 18A. Completely enclosed in metal wall mounting case. Size: 15 $\frac{1}{2}$ x 9 x 6 $\frac{1}{2}$ in. Brand new, £9/10/0. Carr. 15/-.

STABILISED L.T. SUPPLY UNITS

A.c. input 220-240V d.c. output two independent sections giving 24V 5A. Open unit built on Chassis. Size 26 x 7in. Brand new. Fraction of Maker's Price. £25. Ex Warehouse.

SPECIAL OFFER OF WODEN TRANSFORMERS BRAND NEW
No. 1. P.R.I. tapped 200-250V E.S. Sec. Tapped 8-15-25-28-30-33-35V 15A. Tropically finished table top connects. £3/17/6. Carr. 10/-. No. 2. P.R.I. 240V E.S. Sec. No. 1. 50V 4A. Sec. No. 2. 18-0-18V 1A. 35/-, P.P. 7/6. No. 3. P.R.I. tapped 200-250V E.S. Sec. 1. 315-0-315V 110mA. Sec. 2. 175-0-175 25mA. Sec. 3. 5V 1.9A. Sec. 4. 6-3V 3.1A. Sec. 5. 6-3V CT4A. Sec. 6-3V CT2A. Sec. 6-3V 1A. "C" Core table top connections. 30/-, P.P. 7/6.

COMPONENTS BY POST

MINIATURE CARBON TRACK POTENTIOMETERS. 1" dia. x 1" deep; 1" dia. spindle. Available in the following values: 5K, 10K, 25K, 50K, 100K, 250K, 500K, 1M, and 2M Ohms-LOG. Also: 5K, 10K, 25K, 50K, 100K, 250K, 500K, 1M Ohm-LIN. Available less switch @ 3/- each or with switch @ 5/- each.

MINIATURE TWIN-GANG POTENTIOMETERS @ 9/- each (less switch). 50K-50K LIN or LOG; 100K-100K LIN only; 250K-250K LOG only; 500K-500K LIN or LOG; 1M-1M LOG only; 2M-2M LIN only.

MINIATURE HI-STAB. CARBON FILM RESISTORS. 1/2 watt. 5% Tolerance. 10mm x 3.8mm dia. 10 ohm to 10 Megohm. 3/8 per doz. (min. quantity).

ALUMINUM DIECAST BOXES—with divider slots. Dimensions: length 4 $\frac{1}{2}$ " x width 3 $\frac{1}{2}$ " x depth 1"
—Type A @ 7/6 each; 4 $\frac{1}{2}$ " x 3 $\frac{1}{2}$ " x 2"—Type B @ 9/9 each; 6 $\frac{1}{2}$ " x 4 $\frac{1}{2}$ " x 2"
—Type C @ 13/8 each; 8 $\frac{1}{2}$ " x 5 $\frac{1}{2}$ " x 2"—Type D @ 18/3 each; 10 $\frac{1}{2}$ " x 6 $\frac{1}{2}$ " x 2"
—Type E @ 22/- each.

JACK PLUGS AND SOCKETS by RENDAR INSTRUMENT. JPS400 Fully screened 1" dia. 2 contact plug with cable clamp, 5/- each; JPS300 Fully screened 1" dia. 3 contact plug with cable clamp, 11/- each; J501A Standard panel mounting 2 contact socket, 0/6 type, 3/6 each; J300AO Standard panel mounting 3 contact socket, 0/6 type, 4/6 each; CC300 Fully screened 3 contact IN-LINE female free socket, 5/6 each.
All the above items are available with "screw-lock" facility at 1/6 extra.

DIODES, TRANSISTORS, RECTIFIERS, SCR's, PHOTOCELLS, etc. All semiconductor are Guaranteed to be Brand New FIRST GRADE Items only.
O47, OA70, OA79, OA81, OA85, OA91, OA95, OA200, OA202, all at 2/6 each. OC44, 5/3; OC45, 5/-; OC71, 4/7; OC72, 5/4; OC75, 5/4; OC83, 4/7; OC140, 16/8; OC170, 6/9; OC171, 7/8; ACY18, 4/8; ACY19, 8/-; ACY20, 4/8; ACY21, 5/2; ACY22, 5/-; ACY40, 3/4; BC107, 7/-; BC108, 5/8; BC109, 6/8; BFY60, 8/8; BS793A, 5/8; 2G371, 2/10; 2G374, 3/8; 2G302, 4/-; 2G414, 5/8; 2G416, 4/8; 2G417, 4/8; 2N697, 8/-; 2N706, 3/8; 2N2447, 16/6; 2N3538, 5/8; 2N3702, 3/8; 2N3703, 4/-; 2N3704, 5/-; 2N3705, 4/6; 2N3706, 3/8; 2N3707, 4/6; 2N3708, 3/4; 2N3709, 3/8; 2N4710, 3/8; 2N3711, 4/6; 2N3904, 6/-; 2N3906, 6/-; 2N4124, 4/6; 2N4126, 4/6; 3N84, 34/-; 2N2646, 10/6; BY100 0.75A @ 800V. P.I.V., 5/8 each; BY103 0.5A @ 800V. P.I.V., 6/8 each; BY114 0.55A @ 450V. P.I.V., 4/8 each; BY130 0.8A @ 450V. P.I.V., 3/6 each; BYX10 0.2A @ 800V. P.I.V., 4/8 each; BYX22/400 1.0A @ 400V. P.I.V., 5/6 each; BYZ10 and 15 600V. P.I.V., 4/8 each; BYZ11 and 17 60A @ 600V. P.I.V., 12/9 each; BYZ12 6.0A @ 800V. P.I.V., 15/8 each; BYZ13 and 19 4.2A @ 200V. P.I.V., 7/8 each; and 18 6.0A @ 400V. P.I.V., 10/- each; BYZ15 and 19 4.2A @ 200V. P.I.V., 7/8 each; MF234 0.5A @ 800V. P.I.V., 3/8 each; MF235 0.5A @ 800V. P.I.V., 3/8 each; MF236 0.5A @ 800V. P.I.V., 3/8 each; MF237 0.5A @ 800V. P.I.V., 3/8 each; MF238 0.5A @ 800V. P.I.V., 3/8 each; MF239 0.5A @ 800V. P.I.V., 3/8 each; MF240 0.5A @ 800V. P.I.V., 3/8 each; MF241 0.5A @ 800V. P.I.V., 3/8 each; MF242 0.5A @ 800V. P.I.V., 3/8 each; MF243 0.5A @ 800V. P.I.V., 3/8 each; MF244 0.5A @ 800V. P.I.V., 3/8 each; MF245 0.5A @ 800V. P.I.V., 3/8 each; MF246 0.5A @ 800V. P.I.V., 3/8 each; MF247 0.5A @ 800V. P.I.V., 3/8 each; MF248 0.5A @ 800V. P.I.V., 3/8 each; MF249 0.5A @ 800V. P.I.V., 3/8 each; MF250 0.5A @ 800V. P.I.V., 3/8 each; MF251 0.5A @ 800V. P.I.V., 3/8 each; MF252 0.5A @ 800V. P.I.V., 3/8 each; MF253 0.5A @ 800V. P.I.V., 3/8 each; MF254 0.5A @ 800V. P.I.V., 3/8 each; MF255 0.5A @ 800V. P.I.V., 3/8 each; MF256 0.5A @ 800V. P.I.V., 3/8 each; MF257 0.5A @ 800V. P.I.V., 3/8 each; MF258 0.5A @ 800V. P.I.V., 3/8 each; MF259 0.5A @ 800V. P.I.V., 3/8 each; MF260 0.5A @ 800V. P.I.V., 3/8 each; MF261 0.5A @ 800V. P.I.V., 3/8 each; MF262 0.5A @ 800V. P.I.V., 3/8 each; MF263 0.5A @ 800V. P.I.V., 3/8 each; MF264 0.5A @ 800V. P.I.V., 3/8 each; MF265 0.5A @ 800V. P.I.V., 3/8 each; MF266 0.5A @ 800V. P.I.V., 3/8 each; MF267 0.5A @ 800V. P.I.V., 3/8 each; MF268 0.5A @ 800V. P.I.V., 3/8 each; MF269 0.5A @ 800V. P.I.V., 3/8 each; MF270 0.5A @ 800V. P.I.V., 3/8 each; MF271 0.5A @ 800V. P.I.V., 3/8 each; MF272 0.5A @ 800V. P.I.V., 3/8 each; MF273 0.5A @ 800V. P.I.V., 3/8 each; MF274 0.5A @ 800V. P.I.V., 3/8 each; MF275 0.5A @ 800V. P.I.V., 3/8 each; MF276 0.5A @ 800V. P.I.V., 3/8 each; MF277 0.5A @ 800V. P.I.V., 3/8 each; MF278 0.5A @ 800V. P.I.V., 3/8 each; MF279 0.5A @ 800V. P.I.V., 3/8 each; MF280 0.5A @ 800V. P.I.V., 3/8 each; MF281 0.5A @ 800V. P.I.V., 3/8 each; MF282 0.5A @ 800V. P.I.V., 3/8 each; MF283 0.5A @ 800V. P.I.V., 3/8 each; MF284 0.5A @ 800V. P.I.V., 3/8 each; MF285 0.5A @ 800V. P.I.V., 3/8 each; MF286 0.5A @ 800V. P.I.V., 3/8 each; MF287 0.5A @ 800V. P.I.V., 3/8 each; MF288 0.5A @ 800V. P.I.V., 3/8 each; MF289 0.5A @ 800V. P.I.V., 3/8 each; MF290 0.5A @ 800V. P.I.V., 3/8 each; MF291 0.5A @ 800V. P.I.V., 3/8 each; MF292 0.5A @ 800V. P.I.V., 3/8 each; MF293 0.5A @ 800V. P.I.V., 3/8 each; MF294 0.5A @ 800V. P.I.V., 3/8 each; MF295 0.5A @ 800V. P.I.V., 3/8 each; MF296 0.5A @ 800V. P.I.V., 3/8 each; MF297 0.5A @ 800V. P.I.V., 3/8 each; MF298 0.5A @ 800V. P.I.V., 3/8 each; MF299 0.5A @ 800V. P.I.V., 3/8 each; MF300 0.5A @ 800V. P.I.V., 3/8 each; MF301 0.5A @ 800V. P.I.V., 3/8 each; MF302 0.5A @ 800V. P.I.V., 3/8 each; MF303 0.5A @ 800V. P.I.V., 3/8 each; MF304 0.5A @ 800V. P.I.V., 3/8 each; MF305 0.5A @ 800V. P.I.V., 3/8 each; MF306 0.5A @ 800V. P.I.V., 3/8 each; MF307 0.5A @ 800V. P.I.V., 3/8 each; MF308 0.5A @ 800V. P.I.V., 3/8 each; MF309 0.5A @ 800V. P.I.V., 3/8 each; MF310 0.5A @ 800V. P.I.V., 3/8 each; MF311 0.5A @ 800V. P.I.V., 3/8 each; MF312 0.5A @ 800V. P.I.V., 3/8 each; MF313 0.5A @ 800V. P.I.V., 3/8 each; MF314 0.5A @ 800V. P.I.V., 3/8 each; MF315 0.5A @ 800V. P.I.V., 3/8 each; MF316 0.5A @ 800V. P.I.V., 3/8 each; MF317 0.5A @ 800V. P.I.V., 3/8 each; MF318 0.5A @ 800V. P.I.V., 3/8 each; MF319 0.5A @ 800V. P.I.V., 3/8 each; MF320 0.5A @ 800V. P.I.V., 3/8 each; MF321 0.5A @ 800V. P.I.V., 3/8 each; MF322 0.5A @ 800V. P.I.V., 3/8 each; MF323 0.5A @ 800V. P.I.V., 3/8 each; MF324 0.5A @ 800V. P.I.V., 3/8 each; MF325 0.5A @ 800V. P.I.V., 3/8 each; MF326 0.5A @ 800V. P.I.V., 3/8 each; MF327 0.5A @ 800V. P.I.V., 3/8 each; MF328 0.5A @ 800V. P.I.V., 3/8 each; MF329 0.5A @ 800V. P.I.V., 3/8 each; MF330 0.5A @ 800V. P.I.V., 3/8 each; MF331 0.5A @ 800V. P.I.V., 3/8 each; MF332 0.5A @ 800V. P.I.V., 3/8 each; MF333 0.5A @ 800V. P.I.V., 3/8 each; MF334 0.5A @ 800V. P.I.V., 3/8 each; MF335 0.5A @ 800V. P.I.V., 3/8 each; MF336 0.5A @ 800V. P.I.V., 3/8 each; MF337 0.5A @ 800V. P.I.V., 3/8 each; MF338 0.5A @ 800V. P.I.V., 3/8 each; MF339 0.5A @ 800V. P.I.V., 3/8 each; MF340 0.5A @ 800V. P.I.V., 3/8 each; MF341 0.5A @ 800V. P.I.V., 3/8 each; MF342 0.5A @ 800V. P.I.V., 3/8 each; MF343 0.5A @ 800V. P.I.V., 3/8 each; MF344 0.5A @ 800V. P.I.V., 3/8 each; MF345 0.5A @ 800V. P.I.V., 3/8 each; MF346 0.5A @ 800V. P.I.V., 3/8 each; MF347 0.5A @ 800V. P.I.V., 3/8 each; MF348 0.5A @ 800V. P.I.V., 3/8 each; MF349 0.5A @ 800V. P.I.V., 3/8 each; MF350 0.5A @ 800V. P.I.V., 3/8 each; MF351 0.5A @ 800V. P.I.V., 3/8 each; MF352 0.5A @ 800V. P.I.V., 3/8 each; MF353 0.5A @ 800V. P.I.V., 3/8 each; MF354 0.5A @ 800V. P.I.V., 3/8 each; MF355 0.5A @ 800V. P.I.V., 3/8 each; MF356 0.5A @ 800V. P.I.V., 3/8 each; MF357 0.5A @ 800V. P.I.V., 3/8 each; MF358 0.5A @ 800V. P.I.V., 3/8 each; MF359 0.5A @ 800V. P.I.V., 3/8 each; MF360 0.5A @ 800V. P.I.V., 3/8 each; MF361 0.5A @ 800V. P.I.V., 3/8 each; MF362 0.5A @ 800V. P.I.V., 3/8 each; MF363 0.5A @ 800V. P.I.V., 3/8 each; MF364 0.5A @ 800V. P.I.V., 3/8 each; MF365 0.5A @ 800V. P.I.V., 3/8 each; MF366 0.5A @ 800V. P.I.V., 3/8 each; MF367 0.5A @ 800V. P.I.V., 3/8 each; MF368 0.5A @ 800V. P.I.V., 3/8 each; MF369 0.5A @ 800V. P.I.V., 3/8 each; MF370 0.5A @ 800V. P.I.V., 3/8 each; MF371 0.5A @ 800V. P.I.V., 3/8 each; MF372 0.5A @ 800V. P.I.V., 3/8 each; MF373 0.5A @ 800V. P.I.V., 3/8 each; MF374 0.5A @ 800V. P.I.V., 3/8 each; MF375 0.5A @ 800V. P.I.V., 3/8 each; MF376 0.5A @ 800V. P.I.V., 3/8 each; MF377 0.5A @ 800V. P.I.V., 3/8 each; MF378 0.5A @ 800V. P.I.V., 3/8 each; MF379 0.5A @ 800V. P.I.V., 3/8 each; MF380 0.5A @ 800V. P.I.V., 3/8 each; MF381 0.5A @ 800V. P.I.V., 3/8 each; MF382 0.5A @ 800V. P.I.V., 3/8 each; MF383 0.5A @ 800V. P.I.V., 3/8 each; MF384 0.5A @ 800V. P.I.V., 3/8 each; MF385 0.5A @ 800V. P.I.V., 3/8 each; MF386 0.5A @ 800V. P.I.V., 3/8 each; MF387 0.5A @ 800V. P.I.V., 3/8 each; MF388 0.5A @ 800V. P.I.V., 3/8 each; MF389 0.5A @ 800V. P.I.V., 3/8 each; MF390 0.5A @ 800V. P.I.V., 3/8 each; MF391 0.5A @ 800V. P.I.V., 3/8 each; MF392 0.5A @ 800V. P.I.V., 3/8 each; MF393 0.5A @ 800V. P.I.V., 3/8 each; MF394 0.5A @ 800V. P.I.V., 3/8 each; MF395 0.5A @ 800V. P.I.V., 3/8 each; MF396 0.5A @ 800V. P.I.V., 3/8 each; MF397 0.5A @ 800V. P.I.V., 3/8 each; MF398 0.5A @ 800V. P.I.V., 3/8 each; MF399 0.5A @ 800V. P.I.V., 3/8 each; MF400 0.5A @ 800V. P.I.V., 3/8 each; MF401 0.5A @ 800V. P.I.V., 3/8 each; MF402 0.5A @ 800V. P.I.V., 3/8 each; MF403 0.5A @ 800V. P.I.V., 3/8 each; MF404 0.5A @ 800V. P.I.V., 3/8 each; MF405 0.5A @ 800V. P.I.V., 3/8 each; MF406 0.5A @ 800V. P.I.V., 3/8 each; MF407 0.5A @ 800V. P.I.V., 3/8 each; MF408 0.5A @ 800V. P.I.V., 3/8 each; MF409 0.5A @ 800V. P.I.V., 3/8 each; MF410 0.5A @ 800V. P.I.V., 3/8 each; MF411 0.5A @ 800V. P.I.V., 3/8 each; MF412 0.5A @ 800V. P.I.V., 3/8 each; MF413 0.5A @ 800V. P.I.V., 3/8 each; MF414 0.5A @ 800V. P.I.V., 3/8 each; MF415 0.5A @ 800V. P.I.V., 3/8 each; MF416 0.5A @ 800V. P.I.V., 3/8 each; MF417 0.5A @ 800V. P.I.V., 3/8 each; MF418 0.5A @ 800V. P.I.V., 3/8 each; MF419 0.5A @ 800V. P.I.V., 3/8 each; MF420 0.5A @ 800V. P.I.V., 3/8 each; MF421 0.5A @ 800V. P.I.V., 3/8 each; MF422 0.5A @ 800V. P.I.V., 3/8 each; MF423 0.5A @ 800V. P.I.V., 3/8 each; MF424 0.5A @ 800V. P.I.V., 3/8 each; MF425 0.5A @ 800V. P.I.V., 3/8 each; MF426 0.5A @ 800V. P.I.V., 3/8 each; MF427 0.5A @ 800V. P.I.V., 3/8 each; MF428 0.5A @ 800V. P.I.V., 3/8 each; MF429 0.5A @ 800V. P.I.V., 3/8 each; MF430 0.5A @ 800V. P.I.V., 3/8 each; MF431 0.5A @ 800V. P.I.V., 3/8 each; MF432 0.5A @ 800V. P.I.V., 3/8 each; MF433 0.5A @ 800V. P.I.V., 3/8 each; MF434 0.5A @ 800V. P.I.V., 3/8 each; MF435 0.5A @ 800V. P.I.V., 3/8 each; MF436 0.5A @ 800V. P.I.V., 3/8 each; MF437 0.5A @ 800V. P.I.V., 3/8 each; MF438 0.5A @ 800V. P.I.V., 3/8 each; MF439 0.5A @ 800V. P.I.V., 3/8 each; MF440 0.5A @ 800V. P.I.V., 3/8 each; MF441 0.5A @ 800V. P.I.V., 3/8 each; MF442 0.5A @ 800V. P.I.V., 3/8 each; MF443 0.5A @ 800V. P.I.V., 3/8 each; MF444 0.5A @ 800V. P.I.V., 3/8 each; MF445 0.5A @ 800V. P.I.V., 3/8 each; MF446 0.5A @ 800V. P.I.V., 3/8 each; MF447 0.5A @ 800V. P.I.V., 3/8 each; MF448 0.5A @ 800V. P.I.V., 3/8 each; MF449 0.5A @ 800V. P.I.V., 3/8 each; MF450 0.5A @ 800V. P.I.V., 3/8 each; MF451 0.5A @ 800V. P.I.V., 3/8 each; MF452 0.5A @ 800V. P.I.V., 3/8 each; MF453 0.5A @ 800V. P.I.V., 3/8 each; MF454 0.5A @ 800V. P.I.V., 3/8 each; MF455 0.5A @ 800V. P.I.V., 3/8 each; MF456 0.5A @ 800V. P.I.V., 3/8 each; MF457 0.5A @ 800V. P.I.V., 3/8 each; MF458 0.5A @ 800V. P.I.V., 3/8 each; MF459 0.5A @ 800V. P.I.V., 3/8 each; MF460 0.5A @ 800V. P.I.V., 3/8 each; MF461 0.5A @ 800V. P.I.V., 3/8 each; MF462 0.5A @ 800V. P.I.V., 3/8 each; MF463 0.5A @ 800V. P.I.V., 3/8 each; MF464 0.5A @ 800V. P.I.V., 3/8 each; MF465 0.5A @ 800V. P.I.V., 3/8 each; MF466 0.5A @ 800V. P.I.V., 3/8 each; MF467 0.5A @ 800V. P.I.V., 3/8 each; MF468 0.5A @ 800V. P.I.V., 3/8 each; MF469 0.5A @ 800V. P.I.V., 3/8 each; MF470 0.5A @ 800V. P.I.V., 3/8 each; MF471 0.5A @ 800V. P.I.V., 3/8 each; MF472 0.5A @ 800V. P.I.V., 3/8 each; MF473 0.5A @ 800V. P.I.V., 3/8 each; MF474 0.5A @ 800V. P.I.V., 3/8 each; MF475 0.5A @ 800V. P.I.V., 3/8 each; MF476 0.5A @ 800V. P.I.V., 3/8 each; MF477 0.5A @ 800V. P.I.V., 3/8 each; MF478 0.5A @ 800V. P.I.V., 3/8 each; MF479 0.5A @ 800V. P.I.V., 3/8 each; MF480 0.5A @ 800V. P.I.V., 3/8 each; MF481 0.5A @ 800V. P.I.V., 3/8 each; MF482 0.5A @ 800V. P.I.V., 3/8 each; MF483 0.5A @ 800V. P.I.V., 3/8 each; MF484 0.5A @ 800V. P.I.V., 3/8 each; MF485 0.5A @ 800V. P.I.V., 3/8 each; MF486 0.5A @ 800V. P.I.V., 3/8 each; MF487 0.5A @ 800V. P.I.V., 3/8 each; MF488 0.5A @ 800V. P.I.V., 3/8 each; MF489 0.5A @ 800V. P.I.V., 3/8 each; MF490 0.5A @ 800V. P.I.V., 3/8 each; MF491 0.5A @ 800V. P.I.V., 3/8 each; MF492 0.5A @ 800V. P.I.V., 3/8 each; MF493 0.5A @ 800V. P.I.V., 3/8 each; MF494 0.5A @ 800V. P.I.V., 3/8 each; MF495 0.5A @ 800V. P.I.V., 3/8 each; MF496 0.5A @ 800V. P.I.V., 3/8 each; MF497 0.5A @ 800V. P.I.V., 3/8 each; MF498 0.5A @ 800V. P.I.V., 3/8 each; MF499 0.5A @ 800V. P.I.V., 3/8 each; MF500 0.5A @ 800V. P.I.V., 3/8 each; MF501 0.5A @ 800V. P.I.V., 3/8 each; MF502 0.5A @ 800V. P.I.V., 3/8 each; MF503 0.5A @ 800V. P.I.V., 3/8 each; MF504 0.5A @ 800V. P.I.V., 3/8 each; MF505 0.5A @ 800V. P.I.V., 3/8 each; MF506 0.5A @ 800V. P.I.V., 3/8 each; MF507 0.5A @ 800V. P.I.V., 3/8 each; MF508 0.5A @ 800V. P.I.V., 3/8 each; MF509 0.5A @ 800V. P.I.V., 3/8 each; MF510 0.5A @ 800V. P.I.V., 3/8 each; MF511 0.5A @ 800V. P.I.V., 3/8 each; MF512 0.5A @ 800V. P.I.V., 3/8 each; MF513 0.5A @ 800V. P.I.V., 3/8 each; MF514 0.5A @ 800V. P.I.V., 3/8 each; MF515 0.5A @ 800V. P.I.V., 3/8 each; MF516 0.5A @ 800V. P.I.V., 3/8 each; MF517 0.5A @ 800V. P.I.V., 3/8 each; MF518 0.5A @ 800V. P.I.V., 3/8 each; MF519 0.5A @ 800V. P.I.V., 3/8 each; MF520 0.5A @ 800V. P.I.V., 3/8 each; MF521 0.5A @ 800V. P.I.V., 3/8 each; MF522 0.5A @ 800V. P.I.V., 3/8 each; MF523 0.5A @ 800V. P.I.V., 3/8 each; MF524 0.5A @ 800V. P.I.V., 3/8 each; MF525 0.5A @ 800V. P.I.V., 3/8 each; MF526 0.5A @ 800V. P.I.V., 3/8 each; MF527 0.5A @ 800V. P.I.V., 3/8 each; MF528 0.5A @ 800V. P.I.V., 3/8 each; MF529 0.5A @ 800V. P.I.V., 3/8 each; MF530 0.5A @ 800V. P.I.V., 3/8 each; MF531 0.5A @ 800V. P.I.V., 3/8 each; MF532 0.5A @ 800V. P.I.V., 3/8 each; MF533 0.5A @ 800V. P.I.V., 3/8 each; MF534 0.5A @ 800V. P.I.V., 3/8 each; MF535 0.5A @ 800V. P.I.V., 3/8 each; MF536 0.5A @ 800V. P.I.V., 3/8 each; MF537 0.5A @ 800V. P.I.V., 3/8 each; MF538 0.5A @ 800V. P.I.V., 3/8 each; MF539 0.5A @ 800V. P.I.V., 3/8 each; MF540 0.5A @ 800V. P.I.V., 3/8 each; MF541 0.5A @ 800V. P.I.V., 3/8 each; MF542 0.5A @ 800V. P.I.V., 3/8 each; MF543 0.5A @ 800V. P.I.V., 3/8 each; MF544 0.5A @ 800V. P.I.V., 3/8 each; MF545 0.5A @ 800V. P.I.V., 3/8 each; MF546 0.5A @ 800V. P.I.V., 3/8 each; MF547 0.5A @ 800V. P.I.V., 3/8 each; MF548 0.5A @ 800V. P.I.V., 3/8 each; MF549 0.5A @ 800V. P.I.V., 3/8 each; MF550 0.5A @ 800V. P.I.V., 3/8 each; MF551 0.5A @ 800V. P.I.V., 3/8 each; MF552 0.5A @ 800V. P.I.V., 3/8 each; MF553 0.5A @ 800V. P.I.V., 3/8 each; MF554 0.5A @ 800V. P.I.V., 3/8 each; MF555 0.5A @ 800V. P.I.V., 3/8 each; MF556 0.5A @ 800V. P.I.V., 3/8 each; MF557 0.5A @ 800V. P.I.V., 3/8 each; MF558 0.5A @ 800V. P.I.V., 3/8 each; MF559 0.5A @ 800V. P.I.V., 3/8 each; MF560 0.5A @ 800V. P.I.V., 3/8 each; MF561 0.5A @ 800V. P.I.V., 3/8 each; MF562 0.5A @ 800V. P.I.V., 3/8 each; MF563 0.5A @ 800V. P.I.V., 3/8 each; MF564 0.5A @ 800V. P.I.V., 3/8 each; MF565 0.5A @ 800V. P.I.V., 3/8 each; MF566 0.5A @ 800V. P.I.V., 3/8 each; MF567 0.5A @ 800V. P.I.V., 3/8 each; MF568 0.5A @ 800V. P.I.V., 3/8 each; MF569 0.5A @ 800V. P.I.V., 3/8 each; MF570 0.5A @ 800V. P.I.V., 3/8 each; MF571 0.5A @ 800V. P

BI-PRE-PAK LTD.

DEPT. A
222-224 WEST ROAD
WESTCLIFF-ON-SEA, ESSEX
TELEPHONE: SOUTHEND (0702) 46344

TRANSISTORS PRICE		TRANSISTORS PRICE	
AC107	6/-	OC170	2/6
AC126	2/6	OC171	4/-
AC127	2/6	OC200	5/-
AC128	3/-	OC201	8/-
ACY17	5/-	2G301	2/6
AF114	4/-	2G303	2/6
AF116	3/-	2N711	10/-
AF117	4/-	2N1302-3	4/-
AF118	3/6	2N1304-5	5/-
AF119	3/6	2N1306-7	6/-
AF178	10/-	2N1308-9	8/-
BC211	5/-	2S303	2/6
BFY50	15/-	POWER TRANSISTORS	
BSY25	10/-	OC20	10/-
BSY26	5/-	OC23	10/-
BSY27	5/-	OC25	8/-
BSY28	5/-	OC26	5/-
BSY29	5/-	OC28	7/6
BSY95A	5/-	OC35	5/-
OC41	2/6	OC36	7/6
OC44	1/11	GP826	40/-
OC45	1/9	2N2287	20/-
OC71	2/6	DIODES	
OC72	2/6	AA42	2/-
OC73	5/-	OA10	2/-
OC81	2/6	OA70	1/9
OC81D	2/6	OA79	1/9
OC83	4/-	OA81	1/9
OC139	2/6	OA182	2/-
OC140	5/-	IN914	1/6

CHRISTMAS GIFT OFFER
REVOLUTIONARY - WAFER-THIN MAGNIFYING GLASS
IN CASE TO FIT YOUR POCKET . . . FREE . . . TO FIRST 500 ORDERS OF 50/- AND OVER
HURRY!!

BI **PRE-P** AK

PRE-PAKS

No.	Description	PRICE
A1.	6—Silicon rectifiers BY100 type	20/-
A2.	10—Relays mixed types and voltages	20/-
A3.	20—Mixed marked and tested trans.	20/-
A15.	2—Power Comp. Pair. AD161/2	20/-
A17.	3—Sil. stud recs. 6 amp. 400 PIV. BY212	20/-
A18.	2—Sil. stud recs. 10 amp. 800 PIV	20/-
B1.	50—Unmarked untested, trans., new	10/-
B2.	4—Solar cells, inc. Book of Instructions	10/-
B3.	4—OAS gold bonded, diodes Mullard	10/-
B5.	7—Matched set, OC44, 45/81D/81 diode	10/-
B6.	15—Red spot AF. trans. or white spot RF	10/-
B8.	2—Power trans. OC26/35 type	10/-
B9.	1—Light sensitive cell, ORP12 type	9/-
B10.	10—50V trans. germ. PNP latest type	10/-
B44.	1—Tunnel diode, AEY11, 1050 Mc/s	10/-
B21.	2—Sil. recs. 10 amp., 50-100 PIV.	10/-
B45.	1—Power trans. ADY22/TK400A VCB60 IC 8 amp. PNP	10/-
B49.	2—Power trans. GET 9 VCB64 IC 8 amp. germ. PNP	10/-

FREE PACKS OF YOUR OWN CHOICE UP TO THE VALUE OF 10/- WITH ORDERS OVER £4.

THERE IS ONLY ONE

"BI-PRE-PAK LTD."

BEWARE OF IMITATIONS

TRANSISTORS ★ ONLY 1/- EACH ★ TRANSISTORS SILICON ★ PLANAR ★ N.P.N. ★ P.N.P.

All these types available

2N929	2N706	2S131	2S103	2N696	2N1613	2S733	2N2904
2S501	2N706A	2S512	2S104	2N697	2N1711	2N726	2S731
2N2411	2N3011	2S102	2N2220	2N1507	2N1893	2N2906	2S732

All tested and guaranteed transistors — unmarked. Manufacturers over runs for the new PRE-PAK range.

NEVER WASTE MONEY ON UNTESTED PACKS OF SEMICONDUCTORS?

ALL THESE PRE-PAKS ARE TESTED AND GUARANTEED

40 PNP-NPN Silicon TRANSISTORS 10/-

40 Silicon Sub. Min. DIODES 10/-

40 NPN Silicon TRANSISTORS 10/-

75 Germanium Min. DIODES 10/-

25 NPN 400 Mcs. Silicon TRANSISTORS 10/-

10 Silicon 750mA Top Hat RECTIFIERS 10/-

40 NPN Silicon TO. 5. CAN TRANSISTORS 10/-

5 3 amp. Silicon 50-800 PIV. STUD RECS. 10/-

400-P.I.V. 10 AMP TRIACS AT

40/- EACH

PRE-PAK. N.605 POWER TRANSISTOR EQUIVALENT TO NKT301

5/- EACH

TANTALUM CAPACITORS

4/- EACH

★ PRE-PAKS

B45.	1—Power trans. ADY22/TK400A VCB60 IC 8 amp. PNP	10/-
B47.	10—Sil. stud recs. 3 amp. unmarked, untested	10/-
B49.	2—Power trans. GET 9 VCB64 IC 8 amp. germ. PNP	10/-
B50.	2—Light sensitive cells ORP60 type	10/-
C2.	1—Unijunction, 2N2160 or 2N2646	15/-
C4.	2—RF power trans., OC22 and BU111	15/-
C31.	4—Sil. recs. 800 PIV 3 amp. top hat	15/-
C32.	2—Power trans. TK400A/NKT404 VCB64 IC 8 amp.	15/-

FOR WHATEVER YOU LACK REMEMBER!! PRE-PAK

FREELISTS FOR CATALOGUE AND LIST FOR

NEW FROM THE U.S.A.

'TEXAS' INTEGRATED CIRCUITS

SN7360	Quadruple 2 input NAND/NOR gate	19/6
SN7430	8 Input positive NAND/GATE	21/6
SN7302	Dual J-K Flip Flop with preset	35/-

F.E.T.'s FIELD EFFECT TRANSISTORS

2N3822 "N" Channel 4 lead **15/-**

FIRST EVER LOGIC KITS. Learn for yourself how computers work, even make one for yourself. Full instructions for a noughts and crosses machine, binary counters, timers, etc. L.1. 5 gns. L.2. 10 gns. No need to purchase both kits, you can start with L.2. which incorporates L.1. DETAILS FREE.

MAKE A REV. COUNTER FOR YOUR CAR. THE "TACHO BLOCK". This encapsulated block will turn any 0-1mA meter into a perfectly linear and accurate rev. counter for any car. State 4 or 6 cylinder. **20/- each**

NO CONNECTION WITH ANY OTHER FIRM. MINIMUM ORDER 10/- CASH WITH ORDER PLEASE. Add 1/- post and packing per order. OVERSEAS ADD EXTRA FOR AIRMAIL.

— TANTALLIM CAPACITORS
TRANSISTORS
RECTIFIERS AND CIRCUIT
DIAGRAMS
SUBSTITUTION CHART

FREE A WRITTEN GUARANTEE WITH ALL OUR SEMICONDUCTORS
HAS FATHER XMAS IN HIS SACK — A PARCEL FOR YOU FROM BI-PRE-PAK

Practical Electronics Classified Advertisements

The pre-paid rate for classified advertisements is 1/3 per word (minimum order 15/-), box number 1/6 extra. Semi-displayed setting £4.2.6 per single column inch. All cheques, postal orders, etc., to be made payable to PRACTICAL ELECTRONICS and crossed "Lloyds Bank Ltd." Treasury notes should always be sent *registered post*. Advertisements, together with remittance, should be sent to the Classified Advertisement Manager, PRACTICAL ELECTRONICS, George Newnes Ltd., 15/17 Long Acre, London, WC2, for insertion in the next available issue.

TAPE RECORDERS, TAPES, ETC.

GEE'S RECORDING TAPE and Audio Accessories cost less! Send 1/- for illustrated catalogue. **GEE BROS. RADIO**, 15 Little Newport Street, London, W.C.2. Gerrard 6794.

TAPES TO DISC—using finest professional equipment—45 r.p.m. 18/-. S.A.E. leaflet. **DEROY**, High Bank, Hawk Street, Carnforth, Lancs.

20% CASH DISCOUNT on most famous makes of Tape Recorders, Hi-Fi equipment, Cameras, etc. Join England's largest Mail Order Club now and enjoy the advantages of bulk buying. Send 5/- for membership card, catalogues, price lists and ask for quotation on any item. C.B.A. (Dept. A18), 370 St. Albans Road, Watford, Herts.

SITUATIONS VACANT

SITUATIONS VACANT

(continued)

FED UP WITH YOUR PRESENT JOB?

We require a number of junior engineers with drive and initiative for:

Circuit design—development and prototype construction, etc.; Electro-mechanical drafting—printed circuit/chassis layouts, etc.; Production line test and inspection engineers; Production line fault finders.

Excellent prospects and full training given, day release considered. Salary up to £1,000 depending on experience and qualifications.

Send full details in writing of experience to date and present salary to:

Solid State Controls Limited
30/40 Dalling Road, London, W.6

SITUATIONS VACANT

(continued)

A.M.S.E. (Elec.), City & Guilds, G.C.E., etc., on "Satisfaction or Refund of Fee" terms. Wide range of Home Study Courses in Electronics, Computers, Radio, T.V., etc. 132-page Guide—FREE. Please state subject of interest. **BRITISH INSTITUTE OF ENGINEERING TECHNOLOGY** (Dept. 124K), Aldermaston Court, Aldermaston, Berks.

EXCELLENT position vacant, very good prospects for experienced Radio, T/V Engineer. Must have R.T.E.B. Certificate or equivalent. Exceptional accommodation facility available for successful applicant. Apply in confidence to Box No. 8.

RADIO TECHNICIANS

A number of suitably qualified candidates are required for permanent and pensionable employment (mostly in Cheltenham, but from time to time there are some vacancies in other parts of the U.K. including London). There are also opportunities for service abroad.

Applicants must be 19 or over and be familiar with the use of Test Gear, and have had practical Radio/Electronic workshop experience. Preference will be given to candidates who can offer "O" Level GCE passes in English Language, Maths and/or Physics, or hold the City and Guilds Telecommunications Technician Intermediate Certificate or equivalent technical qualifications.

Pay according to age, e.g. at 19—£812, at 25—£1,046 (highest age pay on entry) rising on 1/1/68 to—at 19—£828, at 25—£1,076.

Prospects of promotion to grades in salary range £1,159—£1,941. There are a few posts carrying higher salaries.

Annual Leave allowance of 3 weeks 3 days, rising to 4 weeks 2 days. Normal Civil Service sick leave regulations apply.

Application forms available from:

Recruitment Officer (RT)
Government Communications Headquarters
Oakley
Priors Road
CHELTENHAM, Glos.

EDUCATIONAL

RADIO OFFICERS see the world! Sea going and shore appointments. Trainee vacancies during 1968. Grants available. Day and Boarding students. Stamp for prospectus. **WIRELESS COLLEGE**, Colwyn Bay, Wales.

TECHNICAL TRAINING by **ICS** IN RADIO, TELEVISION AND ELECTRONIC ENGINEERING

First-class opportunities in Radio and Electronics await the **ICS** trained man. Let **ICS** train YOU for a well-paid post in this expanding field.

ICS courses offer the keen, ambitious man the opportunity to acquire, quickly and easily, the specialized training so essential to success. Diploma courses in Radio/TV Engineering and Servicing, Electronics, Computers, etc. Expert coaching for:

- INSTITUTION OF ELECTRONIC AND RADIO ENGINEERS.
- C. & G. TELECOMMUNICATION TECHNICIANS' CERTS.
- C. & G. SUPPLEMENTARY STUDIES.
- R.T.E.B. RADIO AND TV SERVICING CERTIFICATE.
- RADIO AMATEURS' EXAMINATION.
- P.M.G. CERTIFICATES IN RADIOTELEGRAPHY.

Examination Students Coached until Successful.

NEW SELF-BUILD RADIO AND ELECTRONIC COURSES

Build your own 5-valve receiver, transistor portable, signal generator, multi-meter and valve volt meter—all under expert guidance.

POST THIS COUPON TODAY and find out how **ICS** can help YOU in your career. Full details of **ICS** courses in Radio, Television and Electronics will be sent to you by return mail.

MEMBER OF THE ASSOCIATION OF BRITISH CORRESPONDENCE COLLEGES.

**INTERNATIONAL
CORRESPONDENCE
SCHOOLS**

**A WHOLE WORLD
OF KNOWLEDGE
AWAITS YOU!**

International Correspondence Schools
(Dept. 152), Intertext House, Parkgate Road,
London, S.W.11.

NAME
Block Capitals Please

ADDRESS

.....12.67

EDUCATIONAL

(continued)

ALDERMASTON COURT POSTAL TRAINING for B.Sc. (Eng.) Part 1, A.M.I.E.R.E., A.M.S.E., City & Guilds, G.C.E., etc. prepares you privately for high pay and security as Technician or Technologist. Thousands of passes. For details of Exams and Courses in all branches of Engineering, Building, Electronics, etc. (including latest information on C.Eng.), write for 132-page Handbook—FREE. Please state interest. BRITISH INSTITUTE OF ENGINEERING TECHNOLOGY, (Dept. 125K), Aldermaston Court, Aldermaston, Berks.

TELEVISION SERVICING RADIOTELEGRAPHY RADAR MAINTENANCE COMPUTER TECHNIQUES

Full and Part-time Training Courses

Apply:—Director, British School of Telegraphy, 20 Penywern Road, Earls Court, London, S.W.5

STUDY RADIO, TELEVISION & ELECTRONICS with the world's largest home-study organisation. I.E.R.E., City & Guilds, R.T.E.B., etc. Also practical courses with equipment. No books to buy. Write for FREE prospectus stating subject to I.C.S., Intertext House, Parkgate Road (Dept. 577), London, S.W.11.

GET INTO ELECTRONICS—big opportunities for trained men. Learn the practical way with low-cost Postal Training, complete with equipment. A.M.I.E.R.E., R.T.E.B., City & Guilds, Radio, T.V., Telecoms., etc. For FREE 100-page book, write Dept. 856K, CHAMBERS COLLEGE, 148 Holborn, London, E.C.1.

MISCELLANEOUS

MISCELLANEOUS (continued)

CALL OR SEND for list from the most interesting shop in Lancashire. Electrical, Mechanical and Electronic Goods. ROGERS, 31 Nelson Street, Southport.

DON'T READ THIS

unless you want to discover some **REALLY UNUSUAL CIRCUITS**: Devices like an experimental cyclic memory, a synthetic reflex animal, an electronic dog whistle, a machine which 'recognises' itself, etc., etc. **HOSTS** of **EASY-TO-CONSTRUCT** projects that are going to **FASCINATE YOU**. **SEND 2/6** for our list of "**BOFFIN PROJECTS**"—**NOW!**

To: "BOFFIN PROJECTS"
4 CUNLIFFE ROAD, STONELEIGH
EWELL, SURREY

"**PRACTICAL ELECTRONICS**" I.C. Gram Amplifier, Thyristor Power Controller, Transistor Millivoltmeter, Screenwiper Delay Unit, Electronic Stoplock, Transistor Test Set, Investigator Oscilloscope, Radio Servicing Aid, Enlargement Exposure Guide, Video Pattern Generator, C.R.O. Trace Doubler, Bite Indicator, Chemostat, Light Operated Stopwatch, Field Strength Meter, Valve Voltmeter and Ohmmeter, Proximity Detector, Photoflash Slave Unit, Integrated Stereo Amplifier and all constructional projects going back to Issue 1. Send s.a.p. for your choice of itemised price lists. **AJAX ELECTRONICS**, 18a Rumbold Road, Fulham, London, S.W.6.

MISCELLANEOUS (continued)

PERSEX, P.V.C. FABRICATIONS, cases, panels, etc. to specification for electronics industry. **WRAITHE BROTHERS LIMITED**, Velvet Street, Blackburn. Telephone 50505.



See the World famous
HEATHKIT
Electronic Kits

at
233 Tottenham Court Rd.
LONDON, W.1
Telephone 01-636 7349
Send for FREE Catalogue
Dept. TC-3

FOR SALE

100 PAGE illustrated Catalogue No. 17 Government and manufacturers' electronic surplus, also new section of latest semi-conductors and miniature components. Credit voucher for 2/6 included. Price 3/- post free. **ARTHUR SALLIS LTD.**, 93 North Road, Brighton.

AS NEW. Linear 10W amplifier, £9. S. SCARRATT, 10 Alice St., Darwen, Lancs.

BRASS, STEEL, LIGHT ALLOY, STAINLESS STEEL TUBE. Bar Material, Tools, Mechanical, Electrical, plus Assorted Lots. Send S.A.E. for latest Cat. of 1,000 items. K. R. WHISTON, Dept. BPE, New Mills, Stockport

CONTINUED OVERLEAF

FIVE COMPUTERS

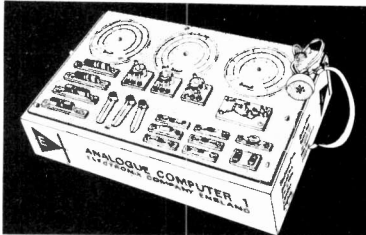

ANALOGUE COMPUTER 1. Anyone over 12 can now assemble his own Desk Top ANALOGUE COMPUTER for use as a Calculating, measuring and learning mini-computer. It is a rugged, ingenious and attractive Computer. Fully transistorised it runs on four batteries, computes heights of objects, solves mathematical problems, checks homework, measures capacitance, resistance and inductance. It teaches the fundamentals of Analogue Computer principles. Range of application limited only to the knowledge and ingenuity of the user—supplied complete with manual, large pictorial diagrams, all electronic parts blister-packed, including batteries, three aluminium dials for long wear. Beautifully engineered and constructed to last a life time. No soldering, no messing, all you need is a screwdriver to assemble and operate. £9 14s. 6d.

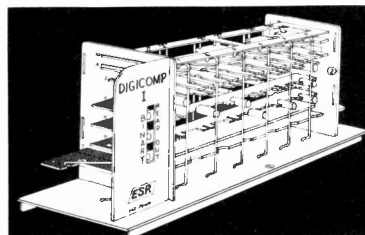

"**DIGI-COMP 1**" is world's first binary mechanical computer kit. This famous brain child of two Ph.D. scientists hardly needs any introduction as more than a million of these kits have already been sold to the public and educational establishments. Assemble and programme Digi-Comp 1 for 15 computer experiments and learn first hand what makes the giant computers tick. Supplied in kit form with 32-page clearly written manual and pictorial assembly diagrams. For those who want to learn more about binary arithmetic, boolean algebra, computer programming logical design there is a 50-page Advance Text Book based on Digi-Comp 1 experiments. Our replacement parts department is always able to supply broken or damaged parts at cost and ensure your full enjoyment of the kit. Digi-Comp only 59s. 6d. Digi-Comp with advance text book £3 10s. 0d.

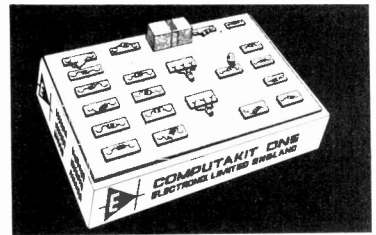

"**COMPUTAKIT-ONE**" is a revolutionary all-British design to teach the fundamentals of electronic techniques used in modern digital computers. Experiments cover properties of diodes and transistors, representation of data inside a computer, a clock circuit from a computer, circuits for storage and counting (the Flip-Flop), the principal logical gates (AND, OR, NOT, NOR, NAND). Part I of the handbook forms a general introduction to the computer hardware, with notes on careers in computers. Part II of the handbook covers in extensively illustrated pages the details of the experiments and circuits. Part III of the handbook gives a test which is examined and marked by the Education section of Electronix Limited. All electronic parts provided; no soldering required. Fully guaranteed for one year. Replacement parts always available. £7 19s. 6d.



DR NIM. Invented by a computer scientist Dr Nim is a remarkable teaching aid and computer toy based on digital computer principles and the ancient game of Nim. Supplied with 24-page manual which teaches simple binary addition and fundamentals of computers. Based on the fascinating game of "Nim", 42s. 6d.

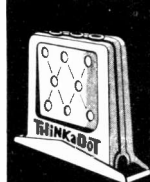

THINK-A-DOT. Computer toy that teaches. Think-a-Dot is a computer game so simple a child of four will be delighted with it and so intriguing a computer expert will enjoy programming it. Colour pattern appears on screen when a marble is dropped. Hundreds of variations based on computer logic and maths. Ideal for teaching computer logic and basis. Hours of guaranteed fun. 22s 6d.

ELECTRONIX LIMITED
Computer Products Division
Dept. P.E.12,
Champion Hill,
London, S.E.5

These computers are your ideal presents for Christmas. Send us your Christmas cards and messages with order, and we will do the rest. For sending gifts overseas please write for information. Prices quoted above include carriage and packing.

FOR SALE

(continued)

P. WIRELESS, 1953-66; P. Television, 1953-66; R. Constructor, 1954-66 Issues. Must clear. Offers BOX No. 9.

HAMMERITE HAMMER PATTERN ENAMEL

AIR DRYING • JUST BRUSH ON



TRIAL TIN (covers 5 sq. ft.) **3/9** + 9d. post.

2½ oz. tins 3/9, ½ pint (8-1) pint 16/-. (Carr.: orders up to 5/-, 9d.; up to 10/-, 1/9; over 10/-, 3/-). Colours: blue, silver, black, bronze. No primer needed. Panel transfers, fireproof spray thinners. LIST FREE. **INDUSTRIALISTS SAVE TIME AND \$\$\$'s** (2 pints will do a Mini)

AMAZING RESULTS - JUST TRY IT!
FINNIGAN SPECIALTY PAINTS (PE)
Mickley Square, Stocksfield, Northumberland
Tel.: Stocksfield 2280

FOR SALE. Marconi TF144G Sig. Gen., Corsor 1049 C.R.O. Buyer Collects, Liverpool area. Tel.: Howard 051-228 4130.

MORSE MADE !!

FACT NOT FICTION. If you start RIGHT you will be reading amateur and commercial Morse within a month (normal progress to be expected). Using scientifically prepared 3-speed records you automatically learn to recognise the code RHYTHM without translating. You can't help it, it's as easy as learning a tune. 18 W.P.M. in 4 weeks guaranteed. For details and course C.O.D. ring S.T.D. 01-660 2896 or send 8d. stamp for explanatory booklet to: **GSCHS/H. 45 GREEN LANE, PURLEY, SURREY**

WANTED

VALVES WANTED, brand new popular types boxed. **DURHAM SUPPLIES (E)**, 175 Durham Road, Bradford 8, Yorkshire.

HIGHEST prices paid for certain G.E.C. and other relays in any condition. Also wanted notched relay contacts. S.A.E. details **ELEY ELECTRONICS**, 112 Groby Road, Glenfield, Leicester.

ELECTRICAL

240 VOLT ELECTRIC POWER FROM YOUR 12 volt or 6 volt CAR BATTERY

Run your mains AC/DC equipment direct from your car battery with this compact low battery consumption dynamo. Size only 5in. x 3in. Sturdy construction.



Converts a 12 volt input to a 240 volt output. Huge purchase enables us to offer them at only 39/6 each, post and packing 6/-. 6 volt input model only 35/-. post and packing 6/-. Thousands already sold.

COLLAPSIBLE AERIAL IN 5 SECTIONS CLOSED 13' OPEN 5'-6"

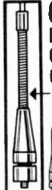

A fully adjustable highly efficient whip aerial. Made to exacting specifications. Copper plated sections. Brass Base. An ideal aerial for TX/RX use. Easily adaptable for cars, scooters, walkie talkies, etc. Brand new in makers' boxes. Only 17/6 each, p.p. 2/6. Two aerials for 30/-, post & packing 2/6.

DEPT. P.E.5, S. & R. SUPPLIES
24 CAWOODS YARD, MILL STREET LEEDS 9
Callers welcome

BOOKS AND PUBLICATIONS

SURPLUS HANDBOOKS

- 19 set Circuit and Notes 4/6 P.P. 6d
- 155 set Circuit and Notes 4/6 P.P. 6d
- H.R.O. Technical Instructions ... 3/6 P.P. 6d
- 38 set Technical Instructions ... 3/6 P.P. 6d
- 46 set Working Instructions ... 3/6 P.P. 6d
- 88 set Technical Instructions ... 5/- P.P. 6d
- BC. 221 Circuit and Notes 3/6 P.P. 6d
- Wavemeter Class D Tech. Instr ... 3/6 P.P. 6d
- 18 set Circuit and Notes 3/6 P.P. 6d
- BC.1000 (31 set) Circuit & Notes ... 8/6 P.P. 9d
- CR.100/B.28 Circuit and Notes 5/- P.P. 6d
- R.107 Circuit and Notes 15/- P.P. 1/6
- A.R.88D. Instruction Manual 4/6 P.P. 6d
- 62 set Circuit and Notes 4/6 P.P. 6d
- 52 set Sender & Receiver Circuits 6/- post free
- Circuit Diagrams 3/- each post free.
- R.1116/A, R.1224/A, R.1355, R.F. 24, 25, & 26.
- A.1134, T.1154, CR.300, BC.342, BC.312, BC.348,J.E.M.P. BC.624. 22 set.
- Resistor colour code indicator, 1/6 P.P. 6d.
- S.A.E. with all enquiries please.
- Postage rates apply to U.K. only.
- Mail order only to:
- Instructional Handbook Supplies**
Dept. P.E., Talbot House, 28 Talbot Gardens
Leeds 8

SERVICE SHEETS

SERVICE SHEETS, Radio, TV, 5000 models. List 1/6. S.A.E. enquiries. TELRAY, 11 Maudland Bank, Preston.

RADIO TELEVISION, over 8,000 Models. JOHN GILBERT TELEVISION, 1b Shepherds Bush Rd., London, W.6. SHE 8441.

SERVICE SHEETS for all makes Radio, T.V., Tape Recorders, 1925-1967. Prices from 1/-. Catalogue 6,000 models, 2/6. Free fault-finding guide with all sheets. Please send stamped addressed envelope with all orders/enquiries. HAMILTON RADIO, 54 London Road, Bexhill, Sussex.

SERVICE SHEETS

4/- each, plus postage.

We have the largest supply of Service Sheets for all makes and types of Radios and Televisions, etc. in the country. Speedy Service.

To obtain the Service Sheet you require, please complete the attached coupon:

From: Name:

Address:

To: **S.P. DISTRIBUTORS**
35/36 Great Marlborough Street, London, W.1

Please supply Service Sheets for the following:

Make:

Model No.: Radio/TV

Make:

Model No.: Radio/TV

Make:

Model No.: Radio/TV

also require the new 1967 list of Service Sheets at 1/6 plus postage. (please delete items not applicable) enclose remittance of which includes postage

MAIL ORDERS ONLY Dec. PE

RECEIVERS AND COMPONENTS

R & R RADIO

51 Burnley Road, Rawtenstall

Rossendale, Lancs

Tel.: Rossendale 3152

Boxed Valves	Fully Guaranteed
EF80 4/-	PCC84 5/- PY33 7/6
ECC82 4/-	PCF80 5/3 30P19 7/6
ECL80 6/-	PL81 5/- 30P4 7/6
EB91 2/-	PY81 5/- U191 7/6
EF85 5/-	PY800 5/- U301 7/6
EY86 5/6	PL36 7/6 PCL83 7/6

Postage: One valve 9d. extra. Two valves 6d. each extra. Three to Six valves 2d. each extra. over Six post paid. Speakers ex T.V. 5 inch round 3/6, 6 x 4 3/6, post 2/6, 8 inch round 6/6, post 4/6 for one or two.

Transistors
OC45 3/-. ACY27 4/-. ACY28 4/-. ACY30 10/- 2N697 10/-. 2N706 3/-. AC128 2/6, G.E.C. Rect. 60 volt P.I.V. 1/-. Postage 6d. per order.

JOHN'S RADIO (Dept. B)
OLD CO-OP, WHITEHALL ROAD
DRIFHLINGTON, BRADFORD
Phone: Drifhlington 732

FAMOUS ARMY SHORT-WAVE TRANSRECEIVER MK. III

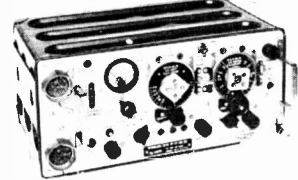

This set is made up of 3 separate units: (1) a two valve amplifier using a 6V6 output valve; (2) (some only, not built in the very latest models) a V.H.F. transreceiver covering 225-241 Mc/s using 4 valves; (3) the main short wave transmitter/receiver covering, in two switched bands, just below 2-4½ Mc/s, and 4½-8 Mc/s (approx. 160-37.5 metres) using 9 valves. For R.T., C.W. and M.C.W. The receiver is super-heterodyne having 1 R.F. stage, frequency changer, two I.F. (465 kc/s) signal detector, A.V.C. and single side-band reception. T.X. output valve 807, other valves octal bases. Many extras, e.g. netting switch, quick flick dial settings, squeel, etc. Power requirements L.T. 12 volts. H.T. receiver 275 volts d.c., H.T. transmitter 500 volts d.c., size approx. 17½ x 7½ x 11ins. Every set supplied in new or as new condition in carton with book including circuits, only £4.10.0, or (grade 2 slightly used 50/- carriage both 15/-)

A FULL KIT of brand new attachments for this set including all connectors, control box, headphones and mike, aerial tuning unit, co-axial lead, etc. at only 45/- carriage 5/- WE MAKE A MAINS 200/250 VOLT POWER UNIT in lowered metal case to plug into set power socket to run (1) receiver, 70/- post 5/-; (2) TX and RX, £8.10.0 post 7/6. (3) 12 VOLT D.C. P.U. for receiver, 50/- carriage 5/-.

A charge of 10/- to unpack and test the receiver of these sets is made only if requested.

V.H.F. TRANSRECEIVER MK. 1/1



This is a modern self-contained tunable V.H.F. low powered frequency modulated transreceiver for R.T. communication up to 8-10 miles. Made for the Ministry of Supply at an extremely high cost by well known British makers, using 16 midjet B.G. 7 valves, receiver incorporating R.F. amplifier. Double superhet and A.F.C. Slow-motion tuning with the dial calibrated in 41 channels each 200 kc/s apart. The frequency covered is 39-48 Mc/s. Also has built-in Crystal calibrator which gives pips to coincide with marks on the tuning dial. Power required L.T. 4½ volts, H.T. 150 volts, tapped at 90 volts for receiver. Every set supplied complete with valves and crystals. New in carton, complete with adjustable whip aerial and circuit. Price £4.10.0, carriage 10/-.

Headset or hand telephone 30/-.

Internal power unit stabilised for 200/250 A.C. input, £8.10.0 extra.

YOUR BASE FOR SEMICONDUCTOR BARGAINS!!

2N3819 FET 15/-

2N3528 SCR 18/-

2N1599 SCR 9/6

OCP71equiv. 9/6

BC107/8 5/-

NEW!! S-DEC
THE "BREADBOARD"
FOR THE
ELECTRONIC AGE
LASTS INDEFINITELY
RE-USE COMPONENTS
AGAIN AND AGAIN

IN STOCK AT L.S.T.

29/6 each
S.A.E. DETAILS

2N2646 UJT 12/6



24 hour postal service

L.S.T. COMPONENTS 23 NEW RD. BRENTWOOD, ESSEX. (tel: 7904)

AC126 6/-	BFY50 6/-*	OC36 14/-*	OC203 8/6*
AC128 4/-	BFY51 6/-*	OC41 3/6	OC204 11/-*
AC176 6/-	BFY52 6/-*	OC42 4/-	OC205 10/6
ADT140 12/6*	BSY95A 4/9*	OC44 3/-	OCP71 19/6
AF114 4/9*	BY100 5/-	OC45 3/-	ORP12 9/6
AF115 4/9*	OA5 2/6*	OC71 3/6	2G381 5/-
AF116 4/9*	OA10 2/6*	OC72 4/6	2N385A 15/-
AF117 4/9*	OA70 1/6	OC73 3/3	2N696 7/-*
AF118 9/-	OA79 1/6	OC75 5/-*	2N706 4/-
AF139 15/-	OAB1 1/6	OC76 4/-	2N1302 5/-
ACY17 5/-*	OAB5 2/-*	OC81 3/-	2N1303 5/-
ACY20 3/6*	OA90 3/-	OC81D 3/-	2N1304 6/-
ACY21 4/-*	OA91 1/6	OC81Z 9/-	2N1305 6/-
AD149 10/-*	OA200 4/-	OC82 4/6	2N1306 8/-
B3M 17/6	OA202 4/-	OC82D 4/6	2N1307 8/-
BAY31 4/-*	OC20 22/6*	OC83 4/-	2N2147 17/-
BAY38 6/-*	OC22 13/-*	OC84 6/-	2N2160 14/9
BC108 5/-	OC23 25/-*	OC139 12/-	2N2926 3/9
BC107 4/9*	OC25 9/6*	OC140 9/6	R53 23/-
BC109 6/-	OC26 12/-*	OC170 4/-	ST140 3/-*
BCY40 16/-	OC28 15/-	OC171 6/-	ST141 5/-*
BCY31 13/6*	OC29 15/-*	OC200 6/-*	V405A 13/-
BCZ11 10/-	OC35 12/-	OC202 13/-*	XA102 3/-*

Items starred—* are price reductions

Mullard output set 2 x OC81 + OC81D 7/-
Mullard RF set 2 x OX45 + OC44 8/6

P. & P. PLEASE ADD 9d.

QUOTATIONS BY RETURN FOR QUANTITY

TRANSISTORISED TRANSMITTERS 35/-

Have you sent for details of our "X" Line which contains these tiny transmitters, ready built and tested? Also, amplifiers, sirens, light flashers, metronome intercom, etc. "X" Line is not encapsulated, you can get inside! Send S.A.E. for details now.

BARGAIN PARCELS 10/- !!

- 3 2N2926 Planar transistors 10/-
- 4 BC113 Fairchild planar 10/-
- 2 25012 Silicon Power Tested 10/-
- 10 D1476—OC71, etc. equiv. New 10/-
- 36 square inches 15" Veroboard 10/-
- 4 100piv 3A Stud Rectifiers 10/-
- 2 20W min. power PNP GP297 stud mounted ideal for mini amps., etc. 10/-
- 16 Red & White spot (50/50 mixture) 10/-
- 1 Pair NPN/PNP 2N1304/5 10/-
- 2 1 Watt 12V Zener diodes 1N202 10/-
- 2 Thyristors 50piv 1 Amp Tested 10/-
- 2 10 Amp 400piv Stud rectifiers 10/-
- 4 BCY31 equivalent 25301 10/-
- 8 Sil. Rects. 100piv 75 Amp Tested 10/-
- 4 OC16 equiv. V30/30P Newmarket 10/-
- 2 Mullard OC19 Power transistors 10/-
- 150 Ceramic capacitors, assorted values mainly colour coded 10/-

MORE BARGAINS!

- 4 Brimar BY100 800piv 750mA 13/-
- 4 Mullard OA210 400piv 550mA 12/-
- 12 OA300 equivalents (1S1301) 6/-
- 12 OA202 equivalents (1S132) 9/-
- 3 BC109 High gain NPN Mullard 15/-
- 2 RAS310 1200piv 1 1/2 Amp Avalanche Rectifiers by STC 12/-

OUR NEW SHOP

7 COPTFOLD ROAD, BRENTWOOD
WHERE G3LST AND STAFF WILL BE PLEASED TO SOLVE YOUR COMPONENT PROBLEMS.

IF YOU CAN'T VISIT US SEND S.A.E. FOR FREE CATALOGUE

TRANSISTOR double tuned I.F. strips, 470kc/s 3AF117s, 4 x 1 1/2 x lin, 13/-, P.C. Osc. Boards 1AF117 M.W. Osc. coil 3 trimmers, etc., 2/9. Transistor Audio Transformers. Driver with split sec., 3/-. Driver and Output, 5/6 pair, 3/- each; suit OC81s, etc. sin. Ferrite Rod Aerials M and L.W., 4/9. Epicly-clip Drives, 1/6. GET573, 4/6. Matched pair OC10s, 8/6. 0.047µf 125V 12, 2/6; 100, 10/6. Transistor Capacitors 0.1µf 3d.; 5, 1/-; 15, 2/6; 100, 15/-; 390µf 9V, 100µf 6V, 50µf 15V, 6d, 1.000µf 18V 9d. 3 double tuned transistor L.F. Trans., 7/6. All items plus post, postal service only. S.a.e. for list. A. J. H. ELECTRONICS (G8AQN), 59 Waverley Rd., The Kent, Rugby, Works.

5 ton factory clearance radio, TV, elec. components in 15/- and 27/6 mixed parcels, post free. Example: resistors, condensers, pots, speakers, coil axle coils, fibre washers, valves, over dozen different types of tuning knob, gromets, sleeving, I.F.s, Paxalin, wire, rectifiers. Lots of other items. Pot luck. Postal orders, etc. to: P. L. NEWTON, 16 Shallcross Crescent, Hatfield, Herts.

150 NEW ASSORTED Capacitors, Resistors Silvered Mica, Ceramic, etc. Carbon, Hystab, Vitreous, 1-20 watt, 12/6. Post Free. WHIT-SAM ELECTRICAL, 18 Woodrow Close, Perivale, Middlesex.

COMPONENTS

POSTAL SERVICE

* RECHARGEABLE BATTERIES

(Sealed DEAC Ni-Cad)

PP3 Equiv.: 9v. 37/- (p. & p. 2/-)
U2 Equiv.: 1.25v. 32/6 (p. & p. 2/-)
U7 Equiv.: 1.25v. 12/- (p. & p. 1/6)
U11 Equiv.: 1.25v. 26/- (p. & p. 1/6)

* TRANSISTORS—Matched Output Kit: OC81D and 2-OC81 9/6
R.F. Kit: OC44 and 2-OC45 9/6
OC44, 45, 70, 71, 72, 81 and 81D Equivalent, each 3/-

* ASSORTED CAPACITORS—New Paper, Polyester, Ceramic, Electrolytic, 100 off ... 10/6

* ASSORTED RESISTORS—Hi-Stab. 300 off (5%, 1/10, 1/2, 1/4 watt, worth £3) 15/-

(P. & P. 1/6 per order) C.W.O.

ELMBRIDGE INSTRUMENTS LTD.
Island Farm Avenue, West Molesey, Surrey



TRANSISTOR PANELS

New boxed, size 9" x 6" x 1 1/4" with "Valvo" transistors type OC45 or similar, with full length leads, also an equal number of OAB5 diodes, H/S resistors, etc. Built on perforated board in a metal frame.

Panel of 20 transistors, diodes, etc. 20/-

30 — 25/- 60 — 40/-
40 — 35/- 70 — 45/- Postage 2/- per panel.
50 — 35/- 80 — 50/-

Brand new. Marked N.P.N. Sil. Ept. Planar Transistors. 300 mc/s. 350 MW. 20 v. 2N743, 2N753, 2N916, BSY26, BSY28, BSY65, BSY18, BSY29, BSY95A. All at 3/6 each.

ZENER DIODES

2.4v, 2.7v, 3v, 3.6v, 4.3v, 4.75v, 5.25v, 5.75v, 6.2v, 6.8v, 7.5v, 9.1v, 13v, 15v, 16v, 18v, 20v, 27v, 30v, 33v, mostly 1W at 3/6 each.

OC45 at 1/-. OC76, AF116, OC139, OC140 all at 2/-. TK22C at 1/-.
Polystyrene Capacitors, 350v. 680, 820, 1,800, 2,200, 2,700, 5,600, 6,800, 125v. 1,000, 1,200, 1,500, 1,800, 3,300, 3,900, 4,700, 8,200, 0-012, 0-015, 2/- dozen any selection. Heat Sinks 10W finned, 5/-. Electrolytics, 5,000 MFD, 50v. 6/6, 1,000 MFD, 60v. 5/-. 1,000 MFD, 30v. 4/-. 3,000 MFD, 10v. 2/-. Gold Bonded Diodes, 75v. P.I.V. 75mA. cards of 25, 10/-. Wire Wound Pots 5, 10, 25, 50, 100, 250, 500, 1k, 2k, 2.5k, 5k, 10k, 20k, 25k, 50k, 100k, not presets, 2/- each. OC23 6/-; NKT452 6/-. Minimum order 5/-, postage 1/-.

NEW CROSS RADIO

6 OLDHAM ROAD, MANCHESTER 4

RESISTORS

1/2 watt carbon film 5%

All preferred values in stock from 10 ohms to 10 megohms 2d. each
Send S.A.E. for free sample

CAPACITORS

Mullard Miniature Metallised Polyester P.C. Mounting, all 250V D.C. working. 0-01mf, 0-022mf, 0-047mf, 0-1mf, 0-22mf, all at 6d. each

Hunts tubular 0-1mf 200V working at 3d. each

Send 6d. stamp for extensive list of low priced Electronic Components, Instruments and Equipment

Please include 1/- postage and packing on all orders under £1

Dept. P.E.5

BRENSAL ELECTRONICS LIMITED
CHARLES STREET, BRISTOL 1

CONTINUED OVERLEAF

RECEIVERS AND COMPONENTS

(continued)

RADIO CONTROL RECEIVERS. New fabulous low priced units. Sensitive four transistor design. For escapements, relays, lights, motors, etc. Requires only 4-5V. Size 2 1/2 x 1 1/2 x 1/2 in. Fully guaranteed. **£3 19s. 6d.** RADIO CONTROL PRODUCTS, 38 Franche Rd., Kidderminster.

DUXFORD ELECTRONICS
DUXFORD, CAMBS.

C.W.O. P.&P. 1/-. Minimum order value 5/-.

CAPACITORS (Tubular, Axial Leads)
Polyester: -10%, 160V: 10,000 pF, 15,000pF, 22,000pF, 33,000pF, 47,000pF, 68,000 pF, 0.1µF, 9d. 0.15µF, 1/10, 0.22µF, 1/11, 0.33µF, 1/13, 0.47µF, 1/16, 0.68µF, 1/10, 1µF, 2/6, 1.0V: 4,000pF, 1,500pF, 5d, 2,200pF, 3,300pF, 4,700pF, 6,800pF, 10,000pF, 6d, 15,000pF, 7d, 22,000pF, 8d, 33,000pF, 9d, 47,000pF, 68,000 pF, 10d, 0.1µF, 1/1-, 0.15µF, 1/3, 0.22µF, 1/6, 0.33µF, 2/3, 0.47µF, 2/9, 0.68µF, 3/9, 1µF, 4/6.

Polystyrene: -5%, 160V: 33pF, 39pF, 47pF, 56pF, 68pF, 82pF, 100pF, 120pF, 150pF, 180pF, 220pF, 270pF, 330pF, 390pF, 470pF, 560pF, 680pF, 820pF, 1,000pF, 1,500pF, 2,200pF, 2,700pF, 3,300pF, 3,900pF, 4,700pF, 5,600pF, 6d, 6,800pF, 8,200pF, 10,000pF, 15,000pF, 22,000pF, 8d.

JACK PLUGS (Screened): Heavily chromed, 5in. Standard: 2/9 each. Side-entry: 3/3 each. Standard (Unscreened): With black, grey, white, red blue, green or yellow covers, 2/3 each.

JACK SOCKETS (4in Plug): With black or white bezel and chrome nut, 2/9 each. Available with Break/Break, Make/Break, Break/Make, Make/Make contacts.

POTENTIOMETERS (Carbon): Long life, low noise. 1/2W at 70°C. -20% ≤ ±1M, ±30% > 1M. Body dia., 1/2in. Spindle, 1/2in. 1/9 each. Linear: 1k, 2.5k, 5k, etc., per decade to 10M. Logarithmic: 5k, 10k, 25k, etc., per decade to 5M.

SKELTON PRE-SET POTENTIOMETERS (Carbon): Linear: 1k, 2.5k, 5k, etc., per decade to 5M.

Miniature: 0.3W at 70°C. -20% ≤ ±1M, -30% > 1M. Horizontal (0.7in x 0.4in P.C.M.) or Vertical (0.4in x 0.2in P.C.M.) mounting, 1/- each. Submin. 0.1W at 70°C. -20% ≤ 1M, -30% > 1M. Horizontal (0.4in x 0.2in P.C.M.) or Vertical (0.2in x 0.1in P.C.M.) mounting, 9d. each.

RESISTORS (Carbon film): High stability, very low noise. 1/2W at 70°C. Body 1/2in x 1/2in. Values in each decade: 10, 11, 12, 13, 15, 16, 18, 20, 22, 24, 27, 30, 33, 36, 39, 43, 47, 51, 56, 62, 68, 75, 82, 91 from 4.7Ω to 1M. -5%, 2d each. 1.2M, 1.5M, 1.8M, 2.2M, 2.7M, 3.3M, 3.9M, 4.7M, 5.6M, 6.8M, 8.2M, 10M. 10%, 2d each.

SILICON RECTIFIERS: 0.5A at 70°C (no heat sink required). 400 P.I.V., 2/9. 800 P.I.V., 3/-, 1.250 P.I.V., 3/6. 1,500 P.I.V., 3/9. 1.2A at 50°C (no heat sink required). 400 P.I.V., 5/6. 800 P.I.V., 7/-, 1,250 P.I.V., 7/6. 1,500 P.I.V., 8/3. 2.5A at 50°C (no heat sink required). 400 P.I.V., 6/-, 800 P.I.V., 7/6. 1,250 P.I.V., 8/3. 1,500 P.I.V., 11/3.

SWITCHES (Chrome finish, Silver contacts): 3A 250V, 6A 125V. Push Buttons: Push-on or Push-off (with white, black, green or red buttons) 5/-. Toggle Switches: SP/ST, 3/3d. SP/DT, 3/6d. SP/DT (with centre position) 3/9d. DP/ST, 4/3d. DP/DT, 5/-.
SEND S.A.E. FOR FULL CATALOGUE (Components, Kits, Hi-Fi Equipments, Turntables, Speakers).

TIME SWITCHES. Reconditioned 14-day clock, once on once off every 24 hours. Fully guaranteed. 5A Horstmann 29 6-15A Yenner 37 6. Postage 2 6. A. R. BATCHELOR (Dept. P.E.), 4 Park Road, Bromley, Kent.

RECEIVERS AND COMPONENTS (continued)

ADROIT ELECTRONICS

Lord Alexander House
Waterhouse Street
Hemel Hempstead, Herts

OC28	4/6	2N697	5/-	NKT211	4/9	NKT227	8/3	BRAND NEW GUARANTEED
OC35	10/-	2N706	4/3	NKT212	4/4	NKT228	4/1	
OC36	8/6	2N2646	12/3	NKT213	4/6	NKT601	5/9	
OC41	2/3	2N2926	2/6	NKT214	3/6	NKT612	4/8	
OC44	1/6	2N3053	10/-	NKT215	3/6	NKT613	4/9	
OC45	1/9	2N3055	19/-	NKT216	8/3	NKT674	5/-	
OC70	2/3	NKT124	3/6	NKT217	7/9	NKT675	4/-	
OC71	2/-	NKT125	5/-	NKT218	4/1	NKT676	4/1	
OC72	2/-	NKT126	5/-	NKT219	4/7	NKT677	4/1	
OC81	2/3	NKT127	8/6	NKT221	4/8	TK20C	2/-	
OC139	2/6	NKT128	5/9	NKT222	4/-	TK40C	2/6	
OC140	4/6	NKT129	5/-	NKT223	4/1	OAB1	1/-	
OC170	2/3	NKT141	5/9	NKT224	3/6			
OC171	2/6	NKT142	5/-	NKT225	3/6			
2N696	4/6	NKT143	4/9	NKT226	8/9			

Send 9d. stamps for complete lists Transistors, Rectifiers, Integrated Circuits, Etc.

Cash with order please. Postage 9d. Airmail extra

FAMOUS BRITISH R.107 RECEIVERS BY COSSOR

Frequency coverage 1.2-17 Mc/s. continuous in 3 switched bands. B.F.O., R.T., C.W., AF and R.T. Gain, Aerial Trimmer, Internal Speaker and two phone outputs. Internal power supply for 100,250v. A.C. mains also 12v. D.C. making this suitable for Ship, Mobile or Fixed Station. Excellent construction. Fully tested, complete and working. £15.0.0. Carr. 30/-.



BRAND NEW RCA CANADIAN No. 29

Transmitter / Receiver 2-8 Mc/s., separate Manual tuning R.F. and Osc., also preset motor operated ditto. 25 miniature valves including 2/815's, 12/24, d.c. operation. In original packing, complete with all ancillary fittings. £22.10.0. Carr. 50/-.

TELESCOPIC AERIAL MASTS. Tubular steel copperplated, spray finish, ring cam locking on each section provides for full or any height required. Suitable for all fixings and base locations. Bottom section 1 1/2in. diameter, 20ft. (4 section) Closed 5ft. 9in., Weight 16lbs., 60/-, Carr. 10/-, 34ft. (6 section) Closed 6ft. 6in., Weight 20lbs., 80/-, Carr. 10/-.

VHF COMMUNICATION RECEIVER I392

15 valve Superhet, Covering 95-155 Mc/s (2.3 metres Police, Aircraft and Amateur Broadcasts.) Power required 240-250 v. at 80mA, 6.3v at 4 amps. Size 19x10x10in. £7.10.0. Carr. 15/-.



All 19 Set and Accessories available. S.A.E. all enquiries—List 1/-

A.J. THOMPSON (Dept P.E.)
"Eiling Lodge" Codicote, Hitchin, Herts.
Phone: Codicote 242

FOR SALE Amateur selling up. Type 103 high speed oscilloscope complete all cables, etc. book, 10-20,000 µsec calibrated sweep, **£12 10s. 0d.** Hartley Type 13A oscilloscope, book, **£13 10s. 0d.** B.S.R. audio Sig. Gen. 0-16.5 k/c/s B.F.O. quality instrument, **£9 10s. 0d.** 9524B and 6097B new multiplier P.E. cells, **£3 15s. 0d.** each. TS-13-AP X Band Sig. Gen., **£18 10s. 0d.** Collins TC512 1.5-6 Mc/s 50 watt TX/RX, complete all cables and dynamotor, **£15 10s. 0d.** TF428 valve volt meter 1.5-150V, **£6 10s. 0d.** All items in first class condition. 24 Dover Rd., St Annes, Lancs.

RECORDING TAPES

Std. play	L.P.	D.P.	E.R.
7" 1,200'	7/9	1,800'	12/-
5" 900'	6/9	1,200'	8/9
5" 600'	7/3	900'	7/3
3" 185'	2/-	225'	2/9
		300'	3/9

Post and packing, 2/9 per order

SEMICONDUCTOR BARGAINS

OC22	8/-	OC83	4/-	AFZ12	8/-
OC24	8/-	OC84	4/6	BCY33	6/6
OC25	6/-	OC170	4/6	BCY34	6/6
OC26	6/-	OC171	4/6	BCY38	6/6
OC28	6/-	OAB1	2/-	BCY39	6/6
OC30	8/-	OAP5	2/-	BFY50	5/6
OC35	6/6	OA182	2/-	BY100	4/6
OC36	6/6	OA202	2/-	BFY51	5/6
OC38	10/-	AC107	8/-	BFY52	5/6
OC44	3/6	AC126	4/6	BY100	4/6
OC45	2/6	AC127	4/6	BYZ13	8/6
OC46	3/6	AC127	4/6	BYZ13	6/6
OC70	3/6	AC127	4/6	GET103	4/6
OC71	2/6	AC127	4/6	GET113	4/6
OC72	2/6	AC127	4/6	GET116	10/6
OC75	3/6	AC127	4/6	GET118	4/6
OC76	3/6	AC127	4/6	GET119	4/6
OC77	4/6	AD140	8/-	BYZ10	10/6
OC78	3/6	AD149	8/-	BYZ11	9/6
OC78D	3/6	AF114	4/6	GET102	4/6
OC81	2/6	AF115	4/6	OC202	6/6
OC81D	3/6	AF116	4/6	OC205	6/6
OC82	3/6	AF117	4/6	OA200	2/-
OC82D	3/6	AF118	4/6	OC23	8/-

All fully tested and guaranteed. Discount for quantity orders on request.

Post and packing, 1/- per order
Money refunded in full if not satisfied

A. MARSHALL & SON (LONDON) LTD.
28 Cricklewood Broadway, London, N.W.2
(Dept. P.E.) Tel: 01-452 0161

VALUE FROM ELECTROVALUE NEW RESISTORS

1/8 All values, 5 1/2 to 330kΩ, carbon film low noise, 5% tolerance. 1/10 doz. mixed; 1/4 100 mixed; 1/3- 100 of one ohmic value.
1/4 All values, 4.7Ω to 10MΩ, carbon film low noise, 10% tolerance. 1/9 doz. mixed; 1/3 100 mixed; 1/2- 100 of one ohmic value.
1/8 All values, 4.7Ω to 10MΩ, carbon film low noise, 5% tolerance. 2/- doz. mixed; 1/6- 100 mixed; 1/4 100 of one ohmic value.
All mixtures are to your specified values. Large quantities stocked.
Quality carbon Skeleton Pre-sets: 100Ω, 250Ω, 500Ω, 1kΩ, 2.5kΩ, 5kΩ, 10kΩ, 25kΩ, 50kΩ, 100kΩ, 250kΩ, 500kΩ, 1MΩ, 2.5MΩ, 5MΩ, 10MΩ.
All values available in horizontal or vertical mounting, 1/- each.
Volume controls: 100, 250, 500Ω etc. to 10MΩ linear, 2/6 each
5k, 10k, 25kΩ etc. to 5MΩ log, 2/6 each
5k, 10k, 25kΩ etc. to 2MΩ log, DP switch, 5/3 each

10% DISCOUNT OVER £3
Peak Sound Products
CIR-KIT No. 3 Pack, contains 12in x 6in board, 15ft x 1/2in strip, 6in x 4in copper sheet, 12/6.
Strip: 5ft x 1/2in or 1in 2/-; 100ft x 1/2in or 1in 30/-.
Perforated board, 0.1in matrix, 5in x 3 1/2in 4/-; 2 1/2in x 3 1/2in 2/6; 2in x 3 1/2in 1/9.
Transistorised Stereo Amplifier type SA8-8. Amplifier kit, £10/10/-. Descriptive leaflet only (refunded on purchase of amplifier) 1/6. Power supply kit £3/0/0.
10% DISCOUNT OVER £3
Mains neons, square, red, single hole fixing, 3/9 each.

NEW TRANSISTORS AND DIODES

Silicon
Ceramic, low noise, small signal amplifiers ... CS2926 Red 55-110 3/6
High reliability type, made in U.S.A. ... CS2926 Orange 90-180 3/9
Equivalent to the popular 2N2926 series ... CS2926 Yellow 150-300 4/-
Higher power rating, smart appearance ... CS2925 235-470 4/9
Low noise, high gain NPN: BC109 4/3; 2N3707 5/-; PNP: 2N4058 5/6.
General purpose high gain NPN: BC108 3/11; 2N2926 green 4/-; 2N3242A 8/3.
AF driver NPN: BC107 4/3; 2N3704 4/-; 2N3415 6/-; BFY50 7/6; BFX85 10/9.
PNP: 2N3702 4/-; 2N3703 4/-; 40319 13/3; 40362 14/9.
High Power output: 2N3054 (planar) 26/-; 2N3055 £1; 40465 16/3.
Ultra high gain NPN: 2N3390 6/3; BC109C 4/6. UHF: 2N3663 11/3.
Field effect transistor: MPF105 10/- (equivalent to 2N3819).
10% DISCOUNT OVER £3
Germanium
Low noise AF PNP: NKT265 3/6; 2G308 6/9; 2G309 7/9.
General purpose switching PNP: ACY17 8/3; ACY18 5/6; ACY19 5/8; ACY20 4/9; ACY21 5/3; ACY22 3/6. NPN: ASY28 7/6; NKT773 5/3.
High Power PNP: NKT403 15/9; NKT405 13/9; 2N2147 15/9; 2N2148 11/9.
High Power Complementary matched pair: AD161/AD162 23/- pair.
Complementary matched driver pair: 2N1304/2N1305 8/6 pair.
Diodes: OA47, OA70, OAB1, OA90, OA91, OA95 2/- each; OA202 3/-.
Fast Service: 10% DISCOUNT OVER £3. Post Free Over 10/-
ELECTROVALUE, 6 Mansfield Place, Ascot, Berkshire

RECEIVERS AND COMPONENTS

(continued)

REPANCO Transistor Coils and Transformer. for the Constructor. Send stamp for lists **RADIO EXPERIMENTAL PRODUCTS LTD.**, 33 Much Park Street, Coventry.

2N1302	NPN Ger.	25V 150mW	3MHz	4/6
2N1303	PNP Ger.	25V 150mW	3MHz	4/-
2N1304	NPN Ger.	20V 150mW	5MHz	4/3
2N1305	PNP Ger.	20V 150mW	5MHz	4/3
2N2926	NPN Si.	18V 200mW	120MHz	3/-
2N3702	PNP Si.	25V 300mW	100MHz	4/3
2N3704	NPN Si.	30V 300mW	100MHz	4/3
2N3055	NPN Si.	100V 65W	Power	19/6
2N3819	N-Channel FET	(Plastic)		19/6

P. R. COCKRAM
28 Royston Av., Byfleet, Surrey
C.W.O. P. & P. 6d. MAIL ORDER ONLY

CURSONS TRANSISTORS ALL GUARANTEED

1/- each

BAY31, BAY50, DK10, OA70, OA81, OA200, OA10, OA90, OA91, OA259, IN914, IN916, JL102

2/- each

XA101, XA102, OC71, OC72, OC81, OC81D, OC44, OC45, GET16, FST3/1, ACY22, ASY57

3/- each

OC139, OC140, 2N706, 2N708, 2N2894, BY100, RAS310AF, 2N914, BSY26, BSY27, BSY95A, AFZ12

7/6 each

RAS508AF, CRS3/40, BLY10, BLY11, BUY10, BUY11, ADY22, ADY23, ADY24, OC22, OC26

ZENER DIODES

3-9v to 26v, 1/4w 3/- each, 1-5w 4/-, 7w 5/- each.

B. CURSONS S.A.E. NEW LIST
78 BROAD STREET
CANTERBURY
KENT

HI-FI EQUIPMENT

We have the exact speaker system to suit YOUR Hi-Fi requirements send NOW for full details of:

- (1) "BRIMHAM" loudspeaker systems
- (2) Loudspeaker cabinets for D.I.Y.

to

P. F. & A. R. HELME
(Dept. P.E.)
BUTCHER PASTURE, SUMMERBRIDGE
HARROGATE, YORKS.

TRANSISTOR SQUARE WAVE GENERATOR
Useful for signal tracing or Morse practice. Variable amplitude. Parts to build 11/- with circuit.

EAGLE MULTIMETERS

EP10K 67/6 p.p. 3/-; EP20K 75/- p.p. 3/-; EP30K 105/- p.p. 4/6; EP10KN 85/- p.p. 4/6; EP20KN 98/- p.p. 4/6; EP30KN 130/- p.p. 4/6, details on request.

FOOTBALL POOL COMPUTER CIRCUIT and three other analogue circuits, 4/6.

DIGITAL COMPUTER CIRCUIT

A simple digital Adder/Subtractor using switches and lamps only. A fascinating demonstration of Binary arithmetic. Full circuit, wiring diagram and notes on the Binary system, 3/6.

NOUGHTS AND CROSSES MACHINE CIRCUIT. Uses standard miniature switches and lamps only. This machine cannot be beaten. Full circuit, wiring diagram and instructions, 3/6.

PLANET INSTRUMENT CO.
25 (E) DOMINION AVENUE, LEEDS 7

ELECTRONICS GALORE! IN THE dca CATALOGUE

THE CONVENIENT WAY TO SHOP FOR ALL YOUR ELECTRONIC NEEDS.

EVERYTHING FROM SINGLE COMPONENTS TO COMPLETE EQUIPMENT ALL AT BEST VALUE PRICES.

SEND 2/6d. NOW FOR YOUR COPY TO:-

dca ELECTRONICS LIMITED
28 UXBRIDGE ROAD, EALING, W.5

Please mention

PRACTICAL ELECTRONICS

when replying to

Advertisements

BATTERY ELIMINATORS

The ideal way of running your TRANSISTOR RADIO, RECORD PLAYER, TAPE RECORDER, AMPLIFIER, etc. Types available: 9v; 7 1/2v; 6v; 4 1/2v (single output) 39/6 each. P. & P. 2/9. 9v + 9v; 6v + 6v; or 4 1/2v + 4 1/2v (two separate outputs) 42/6 each. P. & P. 2/9. Please state output required. All the above units are completely isolated from mains by double wound transformer ensuring 100% safety.

R.C.S. PRODUCTS (RADIO) LTD.
(Dept. P.E.), 11 Oliver Road, London, E.17



PRINTED CIRCUIT KIT

YOUR OWN PRINTED CIRCUITS produced simply and inexpensively at home. No previous knowledge or experience necessary. Simple instructions provided. COMPLETE with all items necessary to produce FIRST CLASS CIRCUITS — No extra's to buy. GENEROUS quantities supplied. QUALITY is of the highest order. We must emphasise that all the parts in the kit are to highest industrial specifications. PRICE: £1, P. & P. 3/6 extra. Cash with order.

G.S.P.K. (Electronics) LTD.

HOOKSTONE PARK
HARROGATE - YORKSHIRE
Tel.: Harrogate 85415, 85258

HIGH SPEED MAGNETIC COUNTERS (4 x 1 x 1 in.), 4 digit. 12/24/48V. (state which) 6/8 each, P. & P. 1/-.

COPPER LAMINATE BOARD (8 1/2 x 5 1/2 x 1/8 in.). 2/6 each. 5 for 10/-.

RE-SETTABLE HIGH SPEED COUNTER (3 x 1 x 1 in.) 3 digit. 12/24/48V. (state which) 32/6 each.

BULK COMPONENT OFFERS

100 Capacitors 50pF to .5µF.
250 Carbon Resistors 1/4 & 1/2W. (Transistor types).
250 Carbon Resistors 1/4 & 1W.
100 Ceramic Capacitors 2—1000pF.
25 Vitreous W/V Resistors (5%).
12 Precision Resistors (-1% several standard values included).
25 Close Tolerance Caps. (2%).
12 Silicon Diodes 500 p.i.v. 750 m.a.
4 Silicon Rects. 400 p.i.v. 3 amp.
8 Silicon Rects. 100 p.i.v. 3 amp.
50 Silicon Trans. (2N706/708, BSY28/29, BCY41/42 types.) Unmarked, Untested.
50 Silicon Diodes 200 m.a. 100 p.i.v. Sub. Min.

ANY ITEM 10/- ANY 5 ITEMS £2.

S.C.R.s. (Thyristors) CRS1/20 5/8; CRS1/40 7/8; CRS3/10 7/6; CRS3/30 8/6; CRS3/40 10/-; CRS3/50 12/6 each.

'3000' TYPE RELAYS (ex. new equip.) 10 for 25/- (our choice) p.p. 5/-.

PATTRICK & KINNIE

81 PARK LANE
ROMFORD, ESSEX
ROMford 44473

WENTWORTH RADIO

104 SALISBURY ROAD, HIGH BARNET, HERTS

BAR.3087

Suppliers of High Quality Semiconductors

AF117	2/6
BC107	7/10
BC108	7/6
OC35	10/-
OC74	5/-
OC75	5/-
OC77	3/-
OC81D	2/6
OC170	3/-
OC171	4/6
OC172	4/6
OC280	3/-
MAT101	8/6
MAT120	7/9
MAT121	8/6

BARGAIN OF THE MONTH FANTASTIC!

OC71-1/8 OC44-1/11
OC81-1/9 OC201-2/6
OC45-1/11 AFI16-2/6

NKT212	4/7
NKT213	4/9
NKT214	3/9
NKT217	8/-
NKT218	4/4
NKT261	3/6
NKT265	3/6
NKT271	3/6
NKT274	3/6
NKT275	3/6
NKT612	4/11
NKT675	4/3
NKT676	4/4
NKT677	4/4
NKT773	4/4

S.A.E. FOR LIST. CASH WITH ORDER. P. & P. 9d.

BI-PAK SEMICONDUCTORS

(DEPT. E)

8 Radnor House
93/97 Regent St
London W.1

QUALITY-TESTED PAKS

NOW EVEN MORE FOR YOUR MONEY

2	Drift Trans. 2N1225 Germ. PNP 100 Mc/s.	10/-
6	Matched Trans. OC44/45/81/81D	10/-
16	Red Spot AF Trans. PNP	10/-
16	White Spot RF Trans. PNP	10/-
5	Silicon Rects. 3 A 100-400 PIV	10/-
2	10 A Silicon Rects. 100 PIV	10/-
2	OC139 Trans. NPN Switching	10/-
1	12 A SCR 100 PIV	10/-
3	Sil. Trans. 2S303 PNP	10/-
1	Assorted Computer Diodes	10/-
4	NPN Med. Speed Switching Trans.	10/-
4	Zener Diodes 250 mW 3-12 V	10/-
5	2G417 Trans. Eqt. AF117	10/-
3	200 Mc/s Sil. Trans. NPN BSY26/27	10/-
2	Bi-directional Trans. ASY66 PNP	10/-
3	Zener Diodes 400 mW 33 V 5% Tol.	10/-
4	High Current Trans. OC42 Eqt.	10/-
2	Power Transistors I OC26 I OC35	10/-
5	Silicon Rects. 400 PIV 250 mA	10/-
4	OC75 Transistors Mullard Type	10/-
3	NPN Silicon Trans. 70 Mc/s	10/-
1	Power Trans. OC20 100 V	10/-
4	OA202 Sil. Diodes 100 mW	10/-
2	Low Noise Trans. NPN 2N929/30	10/-
1	Sil. Trans. NPN VCB 100 ZT86	10/-
8	OA81 Diodes (CV448)	10/-
4	OC72 Transistors Mullard Type	10/-
4	OC77 Transistors Mullard Type	10/-
5	Metal Alloy Transistors Mat Type	10/-
4	Sil. Rects. 400 PIV 500 mA	10/-
5	GET884 Trans. Eqt. OC44	10/-
5	GET883 Trans. Eqt. OC45	10/-
2	GET20 Germ. PNP Trans. with Heat-sink	10/-
3	VHF Sil. Epoxy Trans. NPN 100 Mc/s	10/-
2	2N708 Sil. Trans. 300 Mc/s NPN	10/-
5	GT4145 Germ. Trans. PNP Eqt. OC71	10/-
3	GT31 LF Low Noise Germ. Trans. PNP	10/-
6	IN914 Sil. Diodes 75 PIV 75 mA	10/-
8	OA95 Germ. Diodes Sub-min IN69	10/-
3	NPN Germ. Trans. NKT773 Eqt. AC130	10/-
2	OC22 Power Trans. Germ.	10/-
2	OC25 Power Trans. Germ.	10/-
2	OC73 Mullard Trans.	10/-
4	AC128 Trans. PNP High Gain	10/-
2	AC127/128 Comp. pair PNP/NPN	10/-
10	Assorted Gold Bonded Diodes	10/-

FREE One 10/- Pack of your own choice free with orders valued £4 or over

6	TK22C Germ. Switching Trans.	10/-
3	2N1307 PNP Switching Trans.	10/-
20	Germ. Diodes General Purpose	10/-
7	CG62H Germ. Diodes Eqt. OA71	10/-
3	AF116 Mullard Type Trans.	10/-
12	Assorted Germ. Diodes Marked	10/-
1	30 Amp Power Rectifier 100 PIV	10/-
4	AC126 Germ. PNP Trans.	10/-
5	1 Amp Germ. Rect. 200 PIV	10/-
1	ORP61 Photo-conductive cell	10/-
4	Silicon Rects. 100 PIV 750 mA	10/-
3	AF117 Trans. Mullard Type	10/-
7	OC81 Type Trans.	10/-
3	OC171 Trans. Mullard Type	10/-
3	2N2926 Sil. Epoxy Trans.	10/-
7	OC71 Type Trans.	10/-
2	GET9 Power Trans. 60 VCB, 8 A	10/-
25	Trans. Heatsinks fit TO18, SO12, etc.	10/-
1	TK400A Power Germ. Trans. = ADY22	15/-
2	25701 Sil. Trans. Texas	10/-
2	BFY16 Sil. Trans. S	10/-
2	Zeners Z2A150F. 15 V 1 watt	10/-
3	BCY43 Sil. Trans. 100 mcs.	10/-
3	12 Volt Zeners 400 mW	10/-
2	GET571 Germ. Trans. = OC28	10/-
2	10 A 600 PIV Sil. Rects. IS425R	15/-
3	BC108 Sil. NPN High Gain Trans.	15/-
2	Zener Diodes 25 W 18 and 22 V	15/-
1	2N910 NPN Sil. Trans. VCB100 80Mc/s	15/-
2	1000 PIV Sil. Rect. 1-5 A RS310 AF	15/-
3	High Volt. AF Trans. PNP ACY17	15/-
3	BSY95A Sil. Trans. NPN 200 Mc/s	15/-
3	OC200 Sil. Trans. Mullard	15/-
2	Sil. Power Trans. NPN 500 Mc/s	15/-
1	Sil. Power Trans. NPN100 Mc/s TK201A	15/-
6	Zener Diodes 3-15 V Sub-min	15/-
1	2N1132 PNP Epitaxial Planar Sil. Trans.	15/-
2	2N697 Epitaxial Planar Trans. Sil.	15/-
4	Germ. Power Trans. Eqt. OC16 Mullard	15/-
1	Unijunction Trans. 2N2160 TO-5 can G.E.	15/-
2	Sil. Trans. 200 Mc/s 60Vcb ZT83/84	15/-
1	Sil. Planar Trans. NPN 100 Mc/s BSY25	15/-
1	Sil. Trans. IS104 150 Mc/s HFE 200 NPN	15/-
2	SCRs 50 PIV 1 A TO-5 can	15/-
1	Tunnel Diode IN3720 (TDS) G.E.	15/-
1	Unijunction Trans. 2N2160 TO-5 can G.E.	15/-
2	Sil. Rects. 5 A 400 PIV 250 mA	15/-
2	Germ. Power Trans. OC28/29	15/-
1	10 A Sil. Stud Rect. 800 PIV	15/-
1	Tunnel Diode AEY11 1050 Mc/s 5TC	15/-
2	2N2712 Sil. Epoxy Planar HFE225 max.	15/-
1	2N1257 PNP Sil. Planar TO-5 can	15/-
1	Sil. Power Trans. NPN 25721 85 W	15/-
6	BY100 Type Sil. Rects.	20/-
25	Sil. and Germ. Trans. Mixed all Marked New	30/-
10	New Power Trans. GEC replaces DC16/26/28	30/-
1	25024 Sil. Power Trans. NPN 100 V 100 W	30/-
1	Sil. Potted Bridge Rect. 800 PIV 2 A	30/-

BI-PAK EXCLUSIVE SILICON TRANSISTORS

300 Mc/s. NPN Planar Sim. 2N706
PRICE: 2/- 1/9 1/6 1/3 1/-
QTY: 1-24 25-99 99-499 500-999 1000 up

SILICON PLANAR DIODES 1/- (1-99); 10d. (100-499); 60 P.I.V. 200 mA. Sub-min. 9d. (500-999); 7d. (1000 up). ALL BRAND NEW - TESTED AND GUARANTEED. Full Data and List of possible Replacements available.

AF117	3/6	M	U	OA91	1/3
AF139	10/-	L	E	OA182	1/6
AF212	10/-	V	E	OA200	3/-
BC107	6/-	L	V	OA202	3/6
BC108	5/-	L	L	OC44	1/9
BFY50	10/-	D	I	OC45	1/9
BFY51	7/6	I	C	OC71	2/3
BFY52	10/-	C	E	OC73	3/-
OA5	1/9	R	S	OC76	2/3
OA9	1/10	D	E	OC81D	2/3
OA10	1/9	I	S	OC82D	2/3
OA47	2/-	BR	N	OC170	2/6
OA70	1/3	AN	W	OC200	4/-
OA79	1/9	D	E	OC201	7/6
OA81	1/6	NEW		ORP12	8/6

NEW SILICON RECTIFIERS TESTED

PIV	750 mA	3 AMP	10 AMP	30 AMP
50	2/-	3/-	4/6	9/6
100	2/3	3/6	6/-	15/-
200	2/6	4/6	6/6	20/-
300	3/-	4/9	8/-	22/-
400	3/6	6/-	9/-	25/-
500	4/-	6/6	9/6	30/-
600	4/3	7/-	10/-	37/-
800	4/9	8/-	15/-	40/-
1000	6/-	10/-	17/6	50/-

750 mA TOP-HAT TYPE 3, 10 and 30 A STUD TYPE

TRANSISTOR MANUAL BY G.E. INC.

CIRCUITS, APPLICATIONS, CHARACTERISTICS, THEORY. L.A. S.C.R.'S. G.T. SWITCHES, THEORY, RATINGS, APPLICATIONS.

647 PAGES EACH P.P. 2/6

S.C.R. MANUAL BY G.E.

★ VALUE PACKS for '67 ★

120	Glass Sub-Min.	GERM. DIODES	10/-
50	Mixed Germ.	TRANSISTORS	10/-
20	Mixed Volts	ZENERS	10/-
30	NPN, PNP, MIXED	SIL. TRANS.	10/-
60	200mA Sub-Min.	SIL. DIODES	10/-
20	Germ. 1 Amp.	RECTIFIERS	10/-
40	Like OC81, AC128	TRANSISTORS	10/-
10	2 Amp. Stud	SIL. RECT.	10/-
25	Sil. NPN, 200 Mc/s	TRANSISTORS	10/-
16	Top-Hat 750mA	SIL. RECT.	10/-
75	GERM. DIODES	GOLD BONDED	10/-
20	Like BAY50 charge storage	DIODES	10/-
10	50-400 PIV 1 Amp.	SCR'S	20/-

SCR'S (THYRISTORS) LOWEST PRICE YET

	1 AMP (TO-5 can)	7 AMP (STUD)	16 AMP (STUD)	30 AMP (STUD)
PIV	25	7/6	30/-	30/-
50	7/6	8/6	10/6	35/-
100	8/6	10/-	15/-	45/-
200	12/6	15/-	20/-	55/-
300	15/-	20/-	25/-	—
400	17/6	25/-	35/-	80/-
500	—	40/-	45/-	95/-
600	—	40/-	50/-	—

PLASTIC EPOXY 500 mA SIL. RECTIFIERS 400 PIV 2/6 each—replaces BY101. 800 PIV 3/- each—replaces BY100. Special quantity discount on 50 pieces or over.

Our vast stocks change daily with hundreds of Semiconductor bargains becoming available. Just send 2/6 to cover 3 months mailing of our latest stock lists, eqvt. charts, circuits, etc.

Minimum Order 10/-. CASH WITH ORDER PLEASE. Add 1/- postage and packing per Order. GUARANTEED by return postal service. Overseas add extra for Airmail.

4-STATION INTERCOM

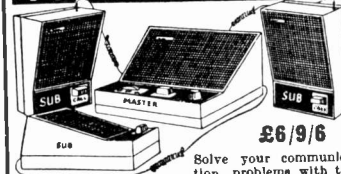

£6/9/6

Solve your communication problems with this 4-Station Transistor Intercom system (1 master and 3 Subs), in de-luxe plastic cabinets for desk or wall mounting. Call/talk/listen from Master to Subs and Subs to Master. Ideally suitable for Business, Surgery, Schools, Hospital, Office and Home. Operates on one 9V battery. On/off switch. Volume control. Complete with 3 connecting wires each 66ft. and other accessories. P. & P. 6/8.

WIRELESS INTERCOM
NO BATTERIES—NO WIRES. Just plug in the mains for instant two-way, loud and clear communication. On/off switch and volume control. Price 8 Gns. post paid.

INTERCOM/BABY ALARM



Originally 6 Gns. Now 57/-

Same as 4-Station Intercom for two-way instant communication. Ideal as Baby Alarm and Door Phone. Complete with 66ft. connecting wire. Battery 2/6. P. & P. 3/6.



Transistor TELEPHONE AMPLIFIER

55/-

Why not boost business efficiency with this incredible De-Luxe Telephone Amplifier. Take down long telephone messages or converse without holding the handset. A useful office aid. On/off switch. Volume control. Battery 2/6 extra. P. & P. 2/6. Full price refunded if not satisfied in 7 days.

WEST LONDON DIRECT SUPPLIES (PF/10)
169 KENSINGTON HIGH STREET, LONDON W.8

AERIAL WIRE: Coils of 25 yd. Single Strand 2/3 + 6d P. & P.

RELAYS:

1. Miniature Plug-in Relays. 150 Coil 4.5/15V. 2 Change over Contacts 13/6 + 1/6 P. & P.
2. Miniature Plug-in Relays. 130 Coil 4. Light Duty Contacts. 9/15V. 18/9 + 1/6 P. & P.
3. Heavy duty Car Alarm Relay 6 12V 3 c/o Contacts. 27/6 + 1/6 P. & P.
4. 6V metal base A7C Relays. 2 pairs heavy duty Contacts c/o. Complete with metal base. 25/- + 1/6 P. & P.
5. Single change over Relay. 875 Coil. 15V for printed circuit. 15/- + 1/6 P. & P.
6. Bases for Item 1 and 2. 3/9 + 6d P. & P. State whether wired or printed circuit.

TEST METER: Still available at reduced price of £15.8/6. 20 K per volt 171-2, and 200 H. TAYLOR Jun. and Minor.

Small robust Test Meter suitable for Field Service. 39/6 + 2/- P. & P.

LOUDSPEAKERS: 8" 2" to 5" from 7/6 to 13/6 + 1/6 P. & P.

Dual Cone Richard Allen, 3 and 15 s 29/6 + 3/- P. & P.

Car Speakers 7" 4" 13/6 + 2/- P. & P. 8" and 10" Richard Allen.

TEST LEADS: Pairs of Strong Test Leads 4 6 pin pr. TRANSFORMERS: 250-0-250 sec. 60 MVA 6.3V. 18/9 + 3/6 P. & P.

250-0-250 sec. 100 MVA 6.3V. 39/8 + 3/6 P. & P.

TRANSFORMERS SUITABLE FOR SMALL POWER SUPPLIES: 6/11/17V at 4 amps. 27/6 + 3/6 P. & P. 0-9-15V. 11 amps. 16/8 + 3/- P. & P. 7.5W auto transformers. 10/8 + 2/6 P. & P.

OUTPUT TRANSFORMERS: Suitable for DL86 Magnet. 6/8 + 2/6 P. & P. suitable for DL54/184 Singles. 6/8 + 2/6 P. & P. Midget Choke Output. 6/8 + 2/6 P. & P.

CARBON CONTROLS: 5 K to 2 M Lin. or Log. 3/6. 5 K to 2 M Lin. or Log. with W. 5/3 + 1/- P. & P. WEYRANG RANGE of 1Fs, Coils, Driver & output trs. EAR PIECES: 2.5 mho or 3.5 mho Magnetic 2/6. Crystal 2.5 mho/3.5 mho. 5/6.

SINGLAIER PRODUCTS: All units and Mat. Trans. TRANSISTORS: POPULAR RANGE. OC44. OC48. OC71. OC72. OC81. OC82. all at 2/8.

POWER TRANSISTORS: OC26. 20/9. OC28. 15/3. OC35. 13/6. AD1749. 15/-.

OSMOR RANGE of 1Fs, Coils, Driver & output trans. Write or call for our free Components List.

BOTHWELL ELECTRIC SUPPLIES (Glasgow) LTD. 64 EGLINTON STREET, GLASGOW, C.5. Tel. 041 5003 2904. Member of the Laundry Group.

BI-PAK GUARANTEE SATISFACTION OR MONEY BACK

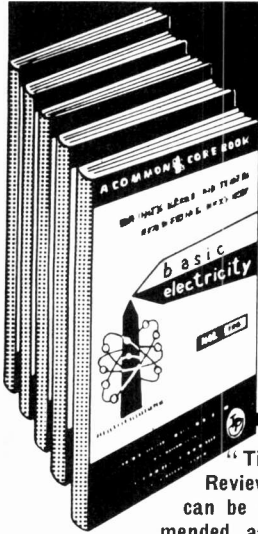

YOURS FREE FOR 7 DAYS

The New 'Picture - Book' way of learning

BASIC

- ELECTRICITY (5 Vols)
- ELECTRONICS (6 Vols)
- ELECTRONIC CIRCUITS (2 Vols)
- INDUSTRIAL ELECTRICITY (2 Vols)
- SYNCHROS & SERVOMECHANISMS (2 Vols)

You'll find it easy to learn with this outstandingly successful new pictorial method—the essential facts are explained in the simplest language, one at a time; and each is illustrated by an accurate cartoon-type drawing.

The books are based on the latest research into simplified learning techniques. This has proved that the Pictorial Approach to learning is the quickest and soundest way of gaining mastery over these subjects.

"Times" Educational Review says: The volume can be thoroughly recommended as a training and revision course for T.V engineers

—NOW READY—

BASIC TELEVISION Pt. 1.
Price 22/- inc. postage.

Complete in two parts, publication date of Pt. 2 to be announced later. Available on 7 days free trial, see coupon.

TO SELRAY BOOK CO.
60 HAYES HILL, HAYES, BROMLEY, KENT

Please send me Without Obligation to Purchase, one of the above sets on 7 Days Free Trial. I will either return set, carriage paid, in good condition within 7 days or send the following amounts. Basic Electricity 70/- Cash price or Down Payment of 15/- followed by 4 fortnightly payments of 15/- each. Basic Electronics 82/- Cash Price or Down Payment of 15/- followed by 5 fortnightly payments of 15/- each. This offer applies to U.K. only. Overseas customers cash with order.

Tick set required (only ONE set allowed on free trial)

- | | | | |
|---------------------------------------|--------------------------|------------------------|--------------------------|
| BASIC ELECTRICITY 70/- | <input type="checkbox"/> | BASIC ELECTRONICS 82/- | <input type="checkbox"/> |
| BASIC ELECTRONIC CIRCUITS 40/- | <input type="checkbox"/> | | |
| BASIC INDUSTRIAL ELECTRICITY 40/- | <input type="checkbox"/> | | |
| BASIC SYNCHROS & SERVOMECHANISMS 38/- | <input type="checkbox"/> | | |
| BASIC TELEVISION PART 1 22/- | <input type="checkbox"/> | | |
- All prices include postage PE12

Signature..... (If under 21, signature of parent or guardian)

NAME..... BLOCK LETTERS BELOW

FULL POSTAL ADDRESS.....

POST NOW FOR THIS OFFER!

"HAMMER FINISH" PAINT BY AMERICA'S LARGEST PAINT ORGANISATION PACKED IN GIANT ONE POUND SIZE AEROSOL CANS NOW AVAILABLE FOR THE FIRST TIME IN THE U.K. SUPERB FINISH ON METALS, PLASTIC, IN FACT ON ALL MATERIALS. ALREADY IN USE IN INDUSTRY IN THIS COUNTRY, JUST SPRAY ON FROM CLOG FREE CANS, PERFECT RESULTS, QUICK DRYING.

AVAILABLE IN THE FOLLOWING COLOURS: BLUE, SILVER, GOLD, COPPER, GREEN, GREY.

"WRINKLE FINISH," A GENUINE CRACKLE FINISH FROM AEROSOL CANS. PERFECT FOR ALL YOUR JOBS, 16oz. size can.

AVAILABLE IN THE FOLLOWING COLOURS: FIRE RED, FRENCH GREY, CELESTIAL BLUE, OPAL GREY, BRITISH BROWN, FOREST GREEN, NEPTUNE GREEN, TROPICAL TAN, JET BLACK, SMOKE SILVER.

PRICE PER TIN EITHER HAMMER OR WRINKLE FINISH 16.5d. post 1/-.

6 tins post free. Cash with order. OVER 150 finishes available, including fluorescent, epoxy's, etc.

TRADE AND RETAIL ENQUIRIES INVITED TO:

ILLBRONZE (U.K.) CO.
1063 STOCKPORT ROAD
MANCHESTER 19

Distributors in the U.K. for ILLBRONZE INC., CHICAGO, U.S.A.

CRESCENT RADIO LTD.
ELECTRONIC COMPONENT SPECIALISTS
40 Mayes Road, Wood Green, N.22

Telephone: BOWes Park 3206

- | TRANSISTORS | | | |
|------------------|----------|--------|----------|
| 2G339A | 1/6 each | 2N711 | 4/6 each |
| 2G378B+2G339B | | NKT277 | 3/6 each |
| matched pair 4/- | | NKT403 | matched |
| QC61 | 1/6 each | pair | 32/6 |
| AC127 | 3/- each | NKT773 | 5/2 each |
| NKT274 | 3/8 each | ST140 | 4/- each |
| 2N1308 | 5/- each | ST141 | 6/- each |
- SILICON RECTIFIERS**
- | | |
|-----------------------------|-----------|
| ZX68, 800 p.i.v. @ 2 amp | 10/- each |
| BY105, 800 p.i.v. @ 1.1 amp | 5/6 each |
- THYRISTOR**
- | | |
|------------------------|-----------|
| CR53/40 400 volt 3 amp | 12/- each |
|------------------------|-----------|

- ZENER DIODES**
- | | |
|-----------------|----------|
| Ferranti | |
| KS39/A 7.5 volt | 6/- each |
| KS41/A 9.1 volt | 6/- each |
- PHOTOCONDUCTIVE CELLS**
- | | |
|--------|-----------|
| RPY.28 | 7/6 each |
| ORP.12 | 10/- each |

- SPECIAL LINES**
- 4 x 2 1/2 inch Plastic Transistor Carry Case 9d. each
- Car Fuseholder complete with lead and clips 1/3 each
- Power Transistor Heat Sinks 1/- each
- 22 inch 80 ohm Loudspeaker 5/6 each
- 24 inch E.M.I. Tweeter 3 ohm 9/6 each
- 1 1/2 volt Buzzers 1/6 each
- 8 ohm Earpieces 1/6 each
- 1 1/2 inch Black with Satin Chrome Knobs 1/3 each
- Midget Varley Relay Type V.P. 4, 6 volt 52 ohm 7/6 each
- Midget Omron Relay Type 1051, 6 volt 120 ohm 7/6 each
- Mains Indicators RED, GREEN and YELLOW 3/9 each
- Govt. Surplus Morse Key with Cable and Jack Plug 5/6 each
- Transistor Extending Aerials 23 inch, 6/6 each; 28 inch, 7/6 each; 31 inch, 8/6 each
- Single Pole Toggle Switches (British) 2/- each
- British Standard Jack Plugs, Black and Grey, 2/6 each; Fully Screened, 3/- each
- British Standard Jack Sockets, Not Switched, 1/11 each; Switched, 2/6 each
- British 3.5 m/m Jack Plugs, Grey 1/9 each
- British 3.5 m/m Jack Plug, Fully Screened 2/- each
- We have a large stock of electronic components and feel that a visit to our premises would be to your advantage. Please include postage with orders.

NEW RANGE BBC 2 AERIALS

All U.H.F. aerials now fitted with tilting bracket and 4 element grid reflectors.

- Loft Mounting Arrays, 7 element, 35/-**
11 element, 42/6. 14 element, 50/- 18 element, 57/6. **Wall Mounting with Cranked Arm, 7 element, 60/-** 11 element, 67/- 14 element, 75/- 18 element, 82/6. **Mast Mounting with 2in. clamp, 7 element, 42/6; 11 element, 55/-; 14 element, 62/-; 18 element, 70/-**. **Chimney Mounting Arrays, Complete, 7 element, 72/6; 11 element, 80/-; 14 element, 87/6; 18 element, 95/-**. Complete assembly instructions with every unit. **Low Loss Cable, 1/6 yd. U.H.F. Pre-amps from 75/-**. State clearly channel number required on all orders.

BBC · ITV AERIALS

- BBC (Band 1)**. Telescopic loft, 21/- External S/D, 30/- "H", £2.10.0.
- ITV (Band 3)**. 3 element loft array, 25/- 5 element, 35/- 7 element, 45/- Wall mounting, 3 element, 35/- 5 element, 45/-
- Combined BBC/ITV**. Loft 1+3, 41/3; 1+5, 48/9; 1+7, 58/9; Wall mounting 1+3, 56/3; 1+5, 63/9; Chimney 1+3, 63/9; 1+5, 71/3.
- VHF** transistor pre-amps, 75/-.

COMBINED BBC1-ITV-BBC2 AERIALS

- 1+3+9, 70/- 1+5+9, 80/- 1+5+14, 90/- 1+7+14, 100/- Special leaflet available.
- F.M. (Band 2)**. Loft S/D, 12/6, "H", 30/- 3 element, 52/6. External units available. Co-ax. cable, 8d. yd. Co-ax. plugs, 1/3. Outlet boxes, 4/6. Diplexer Crossover Boxes, 12/6. C.W.O. or C.O.D. P. & P. 5/- Send 6d. stamps for illustrated lists.

CALLERS WELCOME
OPEN ALL DAY SATURDAY

K.V.A. ELECTRONICS (Dept. P.E.)
27 Central Parade, New Addington
Surrey—CRO-OJB
LODGE HILL 2266

THE NEW RICHARD ALLAN MID RANGE & TWEETER MODULE

(£9.7.10 inc. P.T.)

The Mid-range and Tweeter Module is a further development of the well established High Fidelity Module, and is similar to it in that it consists of 5" and 4" units mounted on a rectangular aluminium plate. However, different cone and magnet assemblies are utilised to suit the specialised purpose for which it is intended.

Ideal for adding to existing systems for extra sparkle, filling in the "hole in the middle," or including in new designs, the Mid-range Module is complete with crossover network and is fitted with a sensitivity control for ease of matching to various loudspeakers.

SPECIFICATION

Frequency Range

500-17,000 Hz.

Power Handling

For use with systems up to 20 watts.

Impedance

8 or 15 ohms.

Mid-range unit

5" dia. 12,000 lines, 1" pole.

Tweeter unit

4" dia. 10,000 lines, 1/2" pole

Size

11" x 6 1/2" x 2 1/2" deep

(28 x 16.5 x 6.4 cm.)

Weight

3 1/2 lbs. (1.6 Kg.)

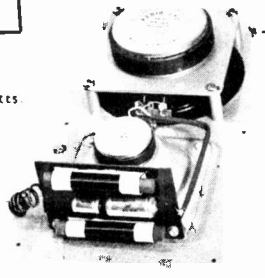

RICHARD ALLAN RADIO LTD.
BRADFORD RD., GOMERSAL, CLECKHEATON, YORKS.
Telephone: CLECKHEATON 2442

Richard Allan

XMAS COMPUTER PRESS-BUTTON PROBLEM SOLVER FOR 79/6

This is an Xmas project with a difference. Just think, with MAC-1 you can multiply and divide, do logs, trig, powers and square-roots, all at the touch of a button. The Experimental Instruction Manual lays down a simple step-by-step procedure for each of the computer's operations; and also relates MAC-1 to the wider problems of electronics, physics and mechanics.

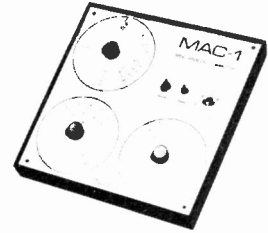

MAC-1 brings the world of computers to your own table-top; a high-speed electrical calculator that saves hours on many problems which are tedious by conventional methods.

MAC-1 is set in a wooden instrument-case and can be obtained built and ready-for-use at 79s. 6d. A complete kit is also available at 70s. 6d. (For either please add 6/- carriage.)

In addition to MAC-1, I-COR also have a number of other exciting computers. Just write to us, enclosing a 4d. stamp, and we will be pleased to send you our computer catalogue.

I-COR SYSTEMS

(File P.E.9)

4 MANOR ROAD, LONDON, N.16

metrosound

MANUFACTURERS OF THE LARGEST RANGE OF AUDIO ACCESSORIES IN GREAT BRITAIN

Exclusive and unique audio accessories designed to maintain and improve the quality of your listening enjoyment.

1. Klenszape Kit . 13/6	4. Metrostrobe . 12/6	7. Metrostyle Stylus Balance . 7/1	10. 45 r.p.m. Anti Slip Key . 3/-
2. Hi Fi Stylus Cleaning Kit . 7/1	5. Record Care Kit No. 3 . 5/6	8. Leader Tape or Stop Foil reel . 4/6	11. Metrosound Splicing Block . 9/-
3. Tape Recorder Cleaning Brush . 2/6	6. Merromat . 12/5	9. Metrosound Spirit Level . 6/-	12. Metrosound Lubrication Kit . 6/-

Also available—New Tape Editing Kit 27/-
From all leading dealers—look for the Metrosound display rack and serve yourself

metrosound manufacturing co. ltd., bridge works, wallace road, london, n.1. Tel 01-226 8641/2/3

'Questions and Answers on Electronics' is now available by post from George Newnes Ltd., Tower House, Southampton St., London, W.C.2 at 9s. 6d. or from your local bookseller at 8s. 6d.

The SUPER 6 L.W. and M.W. TRANSISTOR RADIO

★ 6 transistors and diode. ★ 350mW. ★ Superbet, Ferrite rod aerial. ★ Wooden cabinet, 11 x 7 1/4 x 3 1/4 in. ★ Vinyl covered. ★ 6 x 4 in. speaker. ★ Booklet 2/-, Free with kit. ★ Lining up service. ★ All parts supplied separately. Write for list. S.A.E. please. P.P.9 required (3/9 with kit).

COMPLETE SET OF PARTS ONLY £4.0.0

OR FULLY BUILT £8.17.8 Tax & Carr. Paid (PLUS 6/- POST)

NEW 6 PUSHBUTTON STEREOGRAM CHASSIS

M.W.; S.W.1; S.W.2; VHF; Gram; Stereo Gram. Two separate channels for Stereo Gram with balance control. Also operates with two speakers on Radio. Chassis size 16" x 7" x 6 1/4" high. Dial cream and red 16" x 3". ECC85; ECC181; EF89; 2 x ECL86; EM84 and Rect. 190-560M; 18-61M; 60-187M; 80-100 Mc/s. Price £19.19.0 carr. paid or £8.18.0 deposit and 8 monthly payments of 56/8 Total H.F. price £29.18.6. Carriage to N. Ireland 20/- extra.

GLADSTONE RADIO

(2 mins. from Station and Buses.)
CLOSED WEDNESDAY AFTERNOON

66 ELMS ROAD
ALDERSHOT, HANTS.
Aldershot 22240
CATALOGUE 6d.

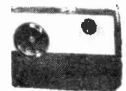

VALUABLE NEW HANDBOOK FREE TO AMBITIOUS ENGINEERS

Have you had your copy of "Engineering Opportunities"?

The new edition of "ENGINEERING OPPORTUNITIES" is now available—without charge—to all who are anxious for a worthwhile post in Engineering. Frank, informative and completely up to date, the new "ENGINEERING OPPORTUNITIES" should be in the hands of every person engaged in any branch of the Engineering industry, irrespective of age, experience or training.

On 'SATISFACTION OR REFUND OF FEE' terms

This remarkable book gives details of examinations and courses in every branch of Engineering, Building, etc., outlines the openings available and describes our Special Appointments Department.

WHICH OF THESE IS YOUR PET SUBJECT?

ELECTRONIC ENG.

Advanced Electronic Eng.—
Gen. Electronic Eng.—
Applied Electronics—
Practical Electronics—
Radar Tech.—
Frequency Modulation—
Transistors.

ELECTRICAL ENG.

Advanced Electrical Eng.—
General Electrical Eng.—
Installations—
Draughtsmanship—
Illuminating Eng.—
Refrigeration—
Elem. Elec. Science—
Elec. Supply—
Mining Elec. Eng.

CIVIL ENG.

Advanced Civil Eng.—
General Civil Eng.—
Municipal Eng.—
Structural Eng.—
Sanitary Eng.—
Road Eng.—
Hydraulics—
Mining—
Water Supply—
Petrol Tech.

RADIO & T.V. ENG.

Advanced Radio—
General Radio—
Radio & TV Servicing—
TV Engineering—
Telecommunications—
Sound Recording—
Automation—
Practical Radio—
Radio Amateurs' Examination.

MECHANICAL ENG.

Advanced Mechanical Eng.—
Gen. Mech. Eng.—
Maintenance Eng.—
Diesel Eng.—
Press Tool Design—
Sheet Metal Work—
Welding—
Eng. Pattern Making—
Inspection—
Draughtsmanship—
Metallurgy—
Production Eng.

AUTOMOBILE ENG.

Advanced Automobile Eng.—
General Auto. Eng.—
Auto. Maintenance—
Repair—
Auto. Diesel Maintenance—
Auto. Electrical Equipment—
Garage Management.

WE HAVE A WIDE RANGE OF COURSES IN OTHER SUBJECTS INCLUDING CHEMICAL ENG., AERO ENG., MANAGEMENT, INSTRUMENT TECHNOLOGY, WORKS STUDY, MATHEMATICS, ETC.

Which qualification would increase your earning power?
A.M.I.E.R.E., A.M.I.Mech.E., A.M.S.E., A.M.I.C.E., B.Sc.,
A.M.I.P.E., A.M.I.M.I., A.R.I.B.A., A.I.O.B., A.M.I.Chem.E., A.R.I.C.S.,
M.R.S.H., A.M.I.E.D., A.M.I.Mun.E., C.ENG., CITY & GUILDS, GEN.
CERT. OF EDUCATION, ETC.

BRITISH INSTITUTE OF ENGINEERING TECHNOLOGY
316A ALDERMASTON COURT, ALDERMASTON, BERKSHIRE

THIS BOOK TELLS YOU

- ★ HOW to get a better paid, more interesting job.
- ★ HOW to qualify for rapid promotion.
- ★ HOW to put some letters after your name and become a key man . . . quickly and easily.
- ★ HOW to benefit from our free Advisory and Appointments Depts.
- ★ HOW you can take advantage of the chances you are now missing.
- ★ HOW, irrespective of your age, education or experience, YOU can succeed in any branch of Engineering.

132 PAGES OF EXPERT
CAREER - GUIDANCE

PRACTICAL EQUIPMENT

Basic Practical and Theoretical Courses for beginners in Electronics, Radio, T.V., Etc., A.M.I.E.R.E. City & Guilds Radio Amateurs' Exam. R.T.E.B. Certificate P.M.G. Certificate Practical Electronics Electronics Engineering Practical Radio Radio & Television Servicing Automation

INCLUDING TOOLS

The specialist Electronics Division of B.I.E.T. NOW offers you a real laboratory training at home with practical equipment. Ask for details.

B.I.E.T.

You are bound to benefit from reading "ENGINEERING OPPORTUNITIES"—send for your copy NOW—FREE and without obligation.



POST NOW!

TO B.I.E.T., 316A ALDERMASTON COURT, ALDERMASTON, BERKSHIRE.

3d. stamp if posted in an unsealed envelope.

Please send me a FREE copy of "ENGINEERING OPPORTUNITIES." I am interested in (state subject, exam., or career).

NAME

ADDRESS

WRITE IF YOU PREFER NOT TO CUT THIS PAGE

THE B.I.E.T. IS THE LEADING INSTITUTE OF ITS KIND IN THE WORLD

Published about the 15th of the month by GEORGE NEWNES LIMITED, Tower House, Southampton Street, London, W.C.2, at the recommended maximum price shown on the cover. Printed in England by THE CHAPEL RIVER PRESS, Andover, Hants. Sole Agents—Australia and New Zealand: GORDON & GOTCH (A/Sia) Ltd.; South Africa and Rhodesia: CENTRAL NEWS AGENCY LTD.; East Africa: STATIONERY & OFFICE SUPPLIES LTD. Subscription rate including postage for one year: To any part of the World £1 16s. 0d.

NEW! SOLID STATE HIGH FIDELITY EQUIPMENT BRITISH MADE

POWER AMPLIFIERS—PRE-AMPLIFIERS—POWER SUPPLIES

We proudly present this new range of Audio Equipment developed from Dinsdale Mk. II—each unit or system will compare favourably with other professional equipment selling at much higher prices. Brief details are below:—

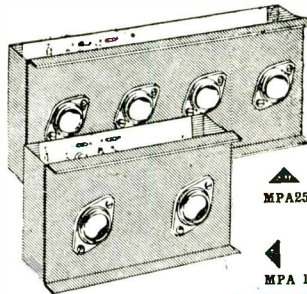

System	Comprising	Price
A	5 watt mono for 3/5 ohm speakers	£103.0
1	12 watt mono for 3 to 5 ohm speakers	£13.17.6
2	12 watt mono for 12 to 16 ohm speakers	£14.12.6
4	24 watt mono two channel for 12 to 16 ohm speakers	£20.15.0
8	20 watt mono/stereo for 12 to 16 ohm speakers	£24.0.0
9	24 watt mono/stereo for 3 to 5 ohm speakers	£26.15.0
14	40 watt mono/stereo for 7 1/2 to 16 ohm speakers	£29.10.0

COMPLETE FULLY ILLUSTRATED BROCHURE FREE ON REQUEST

All systems are complete with Dial Plate and Knobs. Units may be purchased separately.

THE FINEST VALUE IN HIGH FIDELITY—CHOOSE A SYSTEM TO SUIT YOUR NEEDS AND SAVE POUNDS



VHF FM TUNER
87/105 Mc/s Transistor Superhet. Geared tuning. Terrific quality and sensitivity. For valve or transistor amplifiers. 4" x 3 1/2" in. Complete with dial plate. 5 Mullard Transistors, Plus 4 Diodes. (Cabinet Assembly 20/- extra).
TOTAL COST TO BUILD £6.19.6 P.P. 2/6



REGENT-6 MW/LW POCKET RADIO TO BUILD
6-Transistor superhet. Geared tuning. Push-pull speaker output. Moulded Cabinet 5" x 3" x 1 1/2". Phone socket.
TOTAL COST TO BUILD £3.9.6 P.P. 2/6
Full tuning on both bands.



FM STEREO DECODER
7 Mullard Transistors. Printed Circuit Design with Stereo Indicator. For use with any valve or transistor FM. Uses pot cores to Mullard design and ger. and silicon transistors. As used by B.B.C. and G.P.O. Complete Kit Price £5.19.6 P.P. 2/-

TOURMASTER TRANSISTOR CAR RADIO Buy Now!



British Made 7-Transistor MW/LW. 12 volt 3 watt output. Push-button wave-change. RF stage. Supplied built boxed, ready to use with Speaker and Baffle. Car fixing kit and manufacturers' current guarantee. Special Bargain Offer. Positive Earth.
LIST PRICE 15 GNS. £17.19.6 P.P. 4/6
Push-button version £11.19.6. Positive or Negative Earth

BUILD A QUALITY TAPE RECORDER

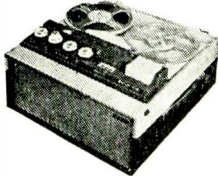

★ **TWO-TRACK.** Deck £10.10.0. Martin Amplifier £14.19.6. Cabinet and speaker 7gns. Complete kits with FREE 7in. 1,200ft. tape, spare spool.
Today's Value £45. 27 gns. P.P. 15/-

★ **FOUR-TRACK.** Deck £13.10.0. Martin Amplifier £14.19.6. Cabinet and speaker 7 gns. Complete kits with FREE 7in. 1,200ft. tape, spare spool.
Today's Value £50 30 gns. P.P. 15/-

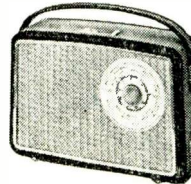

7-TRANSISTOR MW-LW SUPERHET PORTABLE NEW!
New printed circuit design with full power output. Fully tunable on both m/w/lw bands. 7 Transistors plus diode, push-pull circuit. Fitted 5 inch speaker, large ferrite aerial and Mullard transistors. Easy to build with terrific results. All local, and continental stations.
TOTAL COST TO BUILD £6.19.6 P.P. 4/-



MW/LW QUALITY TRANSISTOR RADIO TUNER
Fully tunable superhet with excellent sensitivity and selectivity. Output up to 1/2 volt peak. Complete with front panel, etc. 9 volt operated. For use with any amplifier or tape recorder.
TOTAL COST TO BUILD £3.19.6 P.P. 2/6

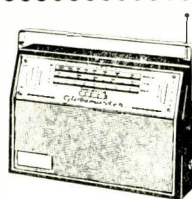

GLOBEMASTER

6-Mullard Transistors, 7 1/2 in. speaker, very sensitive, excellent coverage. Full 3-wave-band tuning. Pushbutton wavechange. Superhet printed circuit. Black-chromed cabinet 11" x 7 1/2" x 3 1/2 in. (SW 17-50 metres). Ear/Record sockets. 1 watt push-pull output.
TOTAL COST £8.19.6 P.P. 3/6

TRANSISTORS

★ Largest range over 650 types
★ S.C.R.'s from 5/-
★ FIELD EFFECT TRANSISTORS from 9/6
★ POWER TRANSISTORS from 5/-
★ DIODES AND RECTIFIERS from 2/-
Send for Free List No. 38.
24 page Illustrated Brochure as above including Valves and Quartz Crystals. 1/- post paid.

GARRARD DECKS



COMPLETE RANGE IN STOCK
FROM £4.19.6
Send for Illustrated Brochure

MAYFAIR PORTABLE

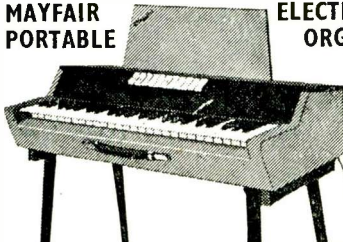

ELECTRONIC ORGAN

BELGRAVIA CONCERT ORGAN

DESIGNED BY L. W. ROCHE
Build this superb instrument in your own home. Complete details on request.

ORGAN COMPONENTS
We carry a comprehensive stock of organ components for TRANSISTOR AND VALVE FREE PHASE designs.

TOTAL COST 99 GNS.

- ★ Build this instrument stage by stage in your own home.
- ★ A truly portable instrument for all enthusiasts.
- ★ Fully TRANSISTORISED POLYPHONIC, British design.
- ★ Call in for a DEMONSTRATION.

Full details on all advertised products FREE on request

BUILD THESE PW/PE DESIGNS

EXPLORER (less chassis) 62/6 MUSIC BOX £4.19.6
with drilled chassis and case 85/- SOLID STATE IGNITION £6.19.6
THYRISTOR POWER CONTROLLER 39/6 SWITCHED FM TUNER 75/-
SCREEN WIPER 39/6 STABILISED POWER SUPPLY (Post and Packing 2/6 extra)

CATALOGUE

1967 EDITION
225 pages, 6,000 items
1,000 illustrations

- ★ 20 pages of transistors and semiconductor devices, valves and crystals.
- ★ 150 pages of components and equipment.
- ★ 50 pages of microphones, decks and Hi-Fi equipment.

The most comprehensive—Concise—Clear components Catalogue in Gt. Britain. Complete with 10/- worth Discount Vouchers Free with every copy.

Send today 8/6 Post paid



HENRY'S RADIO LTD.



303 EDGWARE ROAD
LONDON, W.2

PHONE: 01-723 1006/9
Open Mon. to Sat. 9 a.m.-6 p.m. Thurs.
9 a.m.-1 p.m.

WE CAN SUPPLY FROM STOCK
MOST OF THE PARTS SPECIFIED
ON CIRCUITS IN THIS MAGAZINE.
SEND LIST FOR QUOTATION.