

PRACTICAL

ELECTRONICS

JULY 1967

PRICE 216

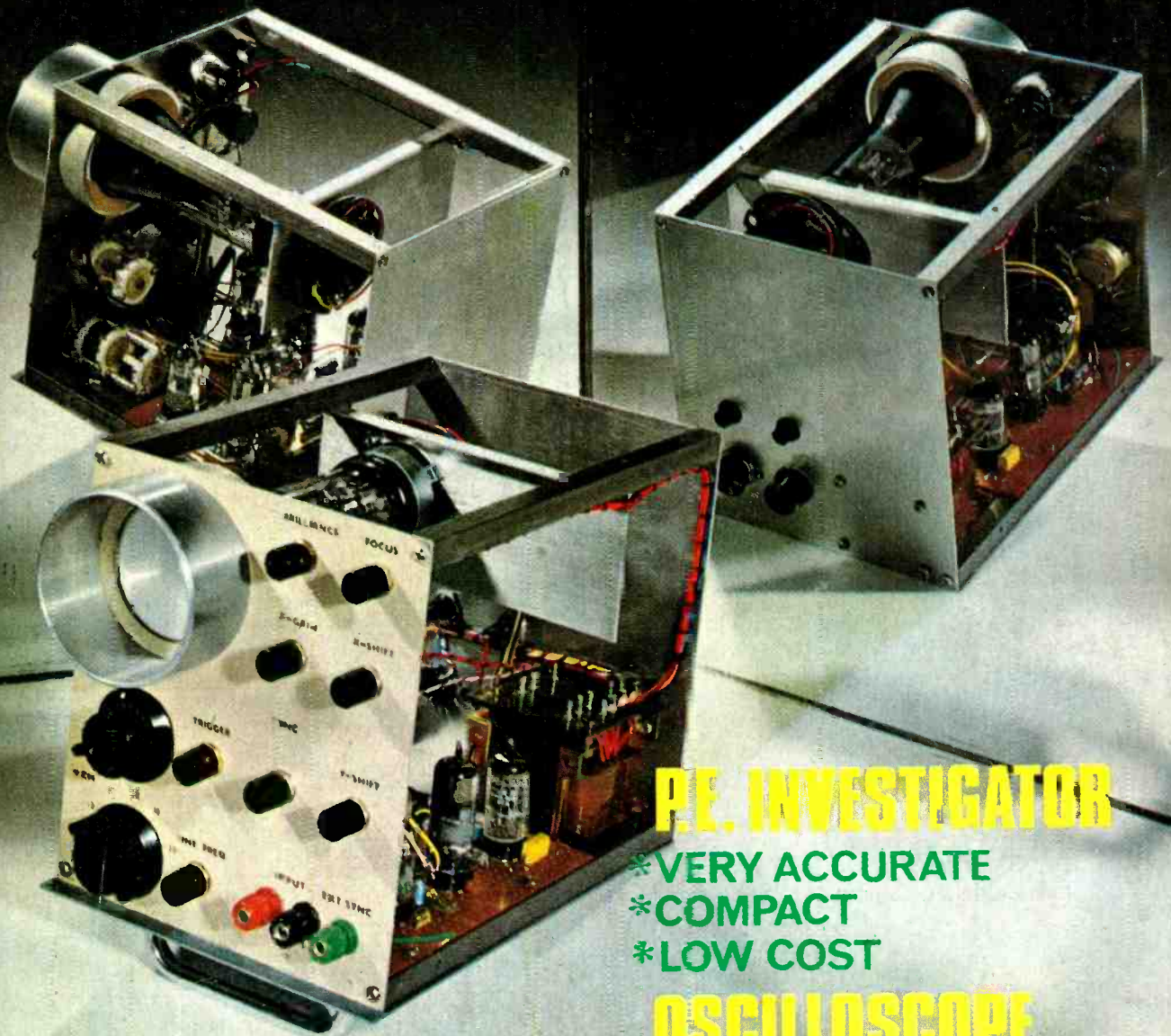

P.E. INVESTIGATOR

- * VERY ACCURATE
- * COMPACT
- * LOW COST

OSCILLOSCOPE

SPECIALLY DESIGNED FOR
THE AMATEUR CONSTRUCTOR

ADCOLA

PRODUCTS LIMITED
(Regd Trade Mark)

SOLDERING EQUIPMENT

for the

DISCRIMINATING ENTHUSIAST

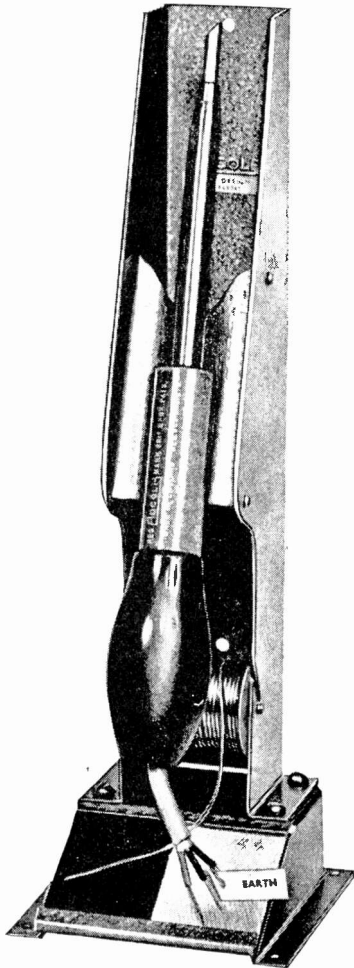

ILLUSTRATED:
L64 $\frac{3}{16}$ " BIT INSTRUMENT IN
L700 PROTECTIVE SHIELD

APPLY DIRECT TO:

SALES & SERVICE DEPT.
ADCOLA PRODUCTS LTD.
ADCOLA HOUSE
GAUDEN ROAD
LONDON, S.W.4
TELEPHONE: MACAULAY 0291/3

ELECTROLYTIC CONDENSERS

| | | | |
|---------------|---------------|--------------|---------------|
| 0.25uf. .3V. | 4uf. .4V. | 16uf. .150V. | 100uf. .3V. |
| 1uf. .10V. | 4uf. .12V. | 20uf. .3V. | 100uf. .6V. |
| 1uf. .15V. | 4uf. .25V. | 20uf. .6V. | 100uf. .10V. |
| 1uf. .40V. | 4uf. .100V. | 20uf. .9V. | 100uf. .12V. |
| 1uf. .50V. | 5uf. .6V. | 20uf. .15V. | 100uf. .15V. |
| 1uf. .350V. | 5uf. .25V. | 25uf. .6V. | 150uf. .12V. |
| 1.25uf. .16V. | 5uf. .50V. | 25uf. .12V. | 150uf. .25V. |
| 2uf. .3V. | 5uf. .70V. | 25uf. .25V. | 200uf. .3V. |
| 2uf. .9V. | 6uf. .15V. | 25uf. .30V. | 200uf. .4V. |
| 2uf. .10V. | 6uf. .15V. | 30uf. .6V. | 200uf. .16V. |
| 2uf. .15V. | 6.4uf. .40V. | 30uf. .10V. | 250uf. .2.5V. |
| 2uf. .70V. | 8uf. .3V. | 30uf. .15V. | 250uf. .9V. |
| 2uf. .150V. | 8uf. .6V. | 32uf. .1.5V. | 250uf. .15V. |
| 2.5uf. .16V. | 8uf. .50V. | 32uf. .25V. | 320uf. .2.5V. |
| 2.5uf. .25V. | 10uf. .6V. | 40uf. .3V. | 500uf. .4V. |
| 3uf. .3V. | 10uf. .10V. | 40uf. .6.4V. | 640uf. .2.5V. |
| 3uf. .12V. | 10uf. .12V. | 50uf. .6V. | 750uf. .18V. |
| 3uf. .25V. | 10uf. .25V. | 50uf. .9V. | 1000uf. .6V. |
| 3.2uf. .6V. | 12.5uf. .4V. | 64uf. .2.5V. | |
| 3.2uf. .6.4V. | 12.5uf. .40V. | 64uf. .9V. | |
| 3.2uf. .40V. | 16uf. .16V. | 64uf. .10V. | |
| 3.2uf. .64V. | 16uf. .30V. | 64uf. .40V. | |

All at 1/- each, 9/- per dozen. Mixed packet (our selection) 20 for 10/-, 200/100uf., 275V.; 200/200uf., 275V.; 125/300/50uf., 275V.; 5/- each or 3 for 10/-.

PAPER CONDENSERS

| | | | |
|------------------|------------------|----------------|---------------|
| 0.001uf. .500V. | 0.005uf. .750V. | 0.1uf. .350V. | 0.5uf. .150V. |
| 0.001uf. .1000V. | 0.02uf. .600A.C. | 0.1uf. .750V. | 0.5uf. .350V. |
| 0.002uf. .500V. | 0.02uf. .350V. | 0.25uf. .350V. | 0.5uf. .500V. |

All at 15/- per 100, or mixed packet (our selection) 50 for 10/-.

VERY SPECIAL VALUE! SILVER MICA, POLYSTYRENE, CERAMIC CONDENSERS

Very well assorted. Mixed types and values. 10/- per 100.

RESISTORS

Very small $\frac{1}{4}$ watt, 5% long leads, ideal for transistor work, 10/- for 50. $\frac{1}{2}$ watt assorted values including printed circuit types, 10/- for 100, 55/- per 1,000.

$\frac{1}{2}$ watt to 3 watt mixed values and types, 10/- for 100, 55/- per 1,000.

TO CLEAR: 10 Meg. 1/8th watt resistors, £1 per 1,000.

WIRE-WOUND 3 watt, 5 watt—6d each.

7 watt, 10 watt—9d each.

Most values, 1 Ω to 47K Ω .

TRANSISTORS

AFZ12, Screened V.H.F. oscillator transistors, 5/- each.

OC44, 45, 81D—2/6d each.

OC71 equivalent, 1/- each, £3 per 100.

Switching Transistors ASY22 (npn) or I.B.M. (npn), 6 for 10/-.

Car radio type Output Transistors type NKT405, 10/- each.

UNMARKED, UNTESTED TRANSISTORS—50 for 10/-.

LIGHT-SENSITIVE TRANSISTORS SIMILAR TO OCP71—2/- each.

TELEVISION VALVES. BRAND NEW AND BOXED

PCF80, 7/6; PL81, 7/6; PCL82, 7/6; PCL84, 7/6; PCC84, 6/6;

PY81, 6/-; ECC82, 6/6; PL36, 9/-; EY86, 6/-; PCL83, 9/-; PY33, 9/-; ECL80,

6/6; PCC89, 9/-.

Silicon diodes. Make excellent detectors. Also suitable for keying electronic organs. 1/- each or 20 for 10/-.

BY100 TYPE TELEVISION H.T. RECTIFIERS, SPECIAL PRICE 5/- each, 30/- dozen.

ORP12 light sensitive resistors, 9/- each.

TRANSISTOR BATTERY ELIMINATORS—same size as PP9, 30/-; PP6, 20/-.

BATTERY CHARGERS, with meter and fuse, 4 amp. 6/12V., 55/- each.

SOLO MODEL 615 Slim Pencil-bit Soldering Irons, 25/- each.

WELLER DUAL-HEAT SOLDERING GUN, 57/6.

NUTS, SCREWS and WASHERS, very useful assorted packs, 6/- each.

WALKIE-TALKIES (not for use in U.K.), £7/10/- pair.

SIGNAL INJECTOR, parts and circuit to make, 10/- only.

SIGNAL TRACER, parts and circuit to make, 10/- only.

MOTOR CAR REV. COUNTER (less 1mA meter), parts and circuit to make, 10/- only.

TRANSISTORS, COMPONENTS AND CIRCUIT to convert 1mA meter to 0 to 10 Meg. ohm meter, 10/-.

TRANSISTORISED RUMBLE AND SCRATCH FILTER (for improving reproduction of old records), all components and circuit, 30/-.

SINCLAIR. All products in stock including latest version of MICRO-6—World's smallest radio—and only 59/6!

NEEDLES FOR RECORD PLAYERS. HALF PRICE!

All types below at 3/6 each!

TCB1P; GC21P; GCBLP; BF40LP; GP67LP; GP37; GP59; TCB Stereo LP;

Studio O LP.

CARTRIDGES

SONOTONE MONO, 10/-; ACOS, 15/-; ACOS STEREO SAPPHIRE 12/6;

DIAMOND, 17/6. All complete with needles!

LAPEL MICROPHONES, Magnetic or Crystal, 10/- each.

TAPE RECORDER MICROPHONES, Fantastic value at 12/- each.

ACOS MIC. 45, 30/- Many others, both crystal and dynamic in stock.

THIN CONNECTING WIRE. 10yd., 1/-; 100yd., 7/6; 500yd., 25/-;

Post 4/6. 1,000yd., 40/-, Post 6/-.

LOUDSPEAKERS. 12in. Richard Allen, 37/6d., 12in. Bakers Guitar,

£5/5/-, 3in., 4in., 5in. and 5in x 3in., all at 10/- each; Bin. x 2 1/2in.,

12/6; 2in. 80 ohm, 7/6.

EARPIECES. Magnetic or Crystal, 5/- each.

VEROBOARD

2 1/2in. x 5in., 3/11; 2 1/2in. x 3 1/2in., 3/3; 3 1/2in. x 5in., 5/6; 3 1/2in. x 3 1/2in., 3/11.

Terminal Pins, 50 for 3/-; Spot Face Cutter, 7/3; Pin Insert Tool, 9/6.

Special Offer—Cutter and 5 boards, 2 1/2in. x 1in., 9/9.

ORDERS BY POST -TO G. F. MILWARD, 17 PEEL CLOSE, DRAYTON BASSETT, STAFFS.

PLEASE INCLUDE APPROPRIATE POSTAGE COSTS

No Enquiries without stamped addressed envelope

For customers in the Birmingham area, goods may be obtained from:

Rock Exchanges, 231 Alum Rock Road, Birmingham 8

PLEASE FILL IN THE COUPON FOR YOUR COPY OF **FREE** ★ **FLOG LIST**

WE HAVE TO URGENTLY MAKE ROOM IN OUR MAIN 13,000 SQUARE FEET BRIGHTON WAREHOUSE FOR THE SUPERB NEW RANGE OF JASON ELECTRONIC KITS AND EQUIPMENT THE FIRST OF WHICH WILL BE ARRIVING SHORTLY.

★ **A FEW
EXAMPLES!**

★ **QUANTITY
DISCOUNTS!**

★ **GUARANTEED!
NEW GOODS!**

★ **1/2 MILLION NEW
VALVES SURPLUS TO
OUR NORMAL
REQUIREMENTS OFFERED
FOR LIMITED TIME AT
SILLY PRICES. DAF96 4/-;
UCH 81 4/6; 6K8G 1/9; ECC85
3/9; PCF86 5/-; EF85 3/6;
832 9/-, ETC., ETC.**

1. Geloso 4000 Ω De Luxe Headphones Type H600 (Listed 3 Gns.) **19/6**
2. Geloso De Luxe Stethoset Headphones (Listed 3 Gns.) **19/6**
3. Geloso Desk Pen Mikes. Quality Xtal Mike with High Quality Ball Pen (Listed 6 Gns.) **19/6**
4. Toshiba Portable Record Player. 3 Speed with Variable Fine Speed Control, Ultra Modern Case, 200/250 V A.C., Excellent Volume and Quality (Listed 11 Gns.) **£6.19.0**
5. Raymor A.M./F.M. 9 tr. Radios. Japanese. Superior Quality Cabinet. Leather (Black) Finish. Model RMI01. Highly Recommended (List 11 Gns.). Not a Midget! Size 7 1/4" x 4 1/2" x 2 1/4" **7 1/2 Gns.**
6. Taya 8 Transistor Radiogram. Portable 2-Speed Player plus Medium Wave Transistor Radio. Size 10" x 6" x 3". Absolutely Complete to Xtal Cartridge and Batteries. (Normally £12). Limited Stocks **£7.19.0**
7. B.B.C. 2 Aerials, 5 to 22 Element Fringevision. De Luxe Finish, All with 6 Reflectors in Parabola for Peak Efficiency. For Callers Only. All Branches. **FROM 19/6**
8. Super Heavy Pointer Knobs. Black. Modern. (Normally 3/- each) **6 FOR 5/-**

AND 100's MORE!!!

SALES ALL BRANCHES COMMENCING 17th JUNE

JASON QUALITY ★ TAPE ★

We offer you fully tensilised polyester/nylon and P.V.C. tapes of identical quality hi-fi, wide range recording characteristics as top grade tapes. Quality control manufacture. They are truly worth a few more coppers than acetate, sub-standard, jointed or cheap imports. **TRY ONE AND PROVE IT YOURSELF.**

| Standard Play | | Long Play | |
|--------------------|--------------------|-------------|--|
| 3in. 150ft. 2/3 | 4in. 225ft. 2/9 | | |
| 4in. 300ft. 4/8 | 4in. 450ft. 5/8 | | |
| 5in. 600ft. 7/6 | 5in. 900ft. 10/8 | | |
| 6in. 900ft. 10/8 | 6in. 1,200ft. 13/- | | |
| 7in. 1,200ft. 12/6 | 7in. 1,800ft. 18/6 | | |
| Double Play | | Triple Play | |
| 3in. 300ft. 4/- | 4in. 900ft. 13/- | | |
| 4in. 600ft. 8/- | 5in. 1,800ft. 25/- | | |
| 5in. 1,200ft. 15/- | 5in. 2,400ft. 34/- | | |
| 6in. 1,800ft. 19/6 | 6in. 2,400ft. 44/- | | |
| 7in. 2,400ft. 27/- | | | |
| Quadruple Play | | | |
| 3in. 600ft. 8/8 | | | |

Postage 1/- reel

Post Free less 5% on three reels.
Quantity and Trade enquiries invited.
NOTE. Large tape stocks at all branches.

POST NOW FOR FREE "FLOG LIST"

To TECHNICAL TRADING CO., PARK CRESCENT PLACE, BRIGHTON
Please send free "Flog List", without obligation, to

NAME

ADDRESS

Block Capitals Please

OR WRITE IF YOU PREFER NOT TO CUT COUPON

PEV 7 67

Stockists of Leak, Quad, Chapman, Goulman, Armstrong, Tripletone, Linear, Rogers, Tricox, Ferrograph, Wharfedale, etc.
Post: 1 lb. 1/5, 1 1/2 lb. 2/8, 2 lb. 2/9, 4 lb. 3/3, 6 lb. 4/-, 14 lb. 5/8. All Mail Orders to Brighton please.

TECHNICAL TRADING

LONDON 10 Tottenham Court Road, W.1
Tel.: MUSEum 2639

BRIGHTON Park Crescent Place
Tel. 680722

PORTSMOUTH 350-352 Fratton Road
Tel. 22034

SOUTHAMPTON 72 East Street
Tel. 23851

WORTHING 132 Montague Street
Tel. 2585

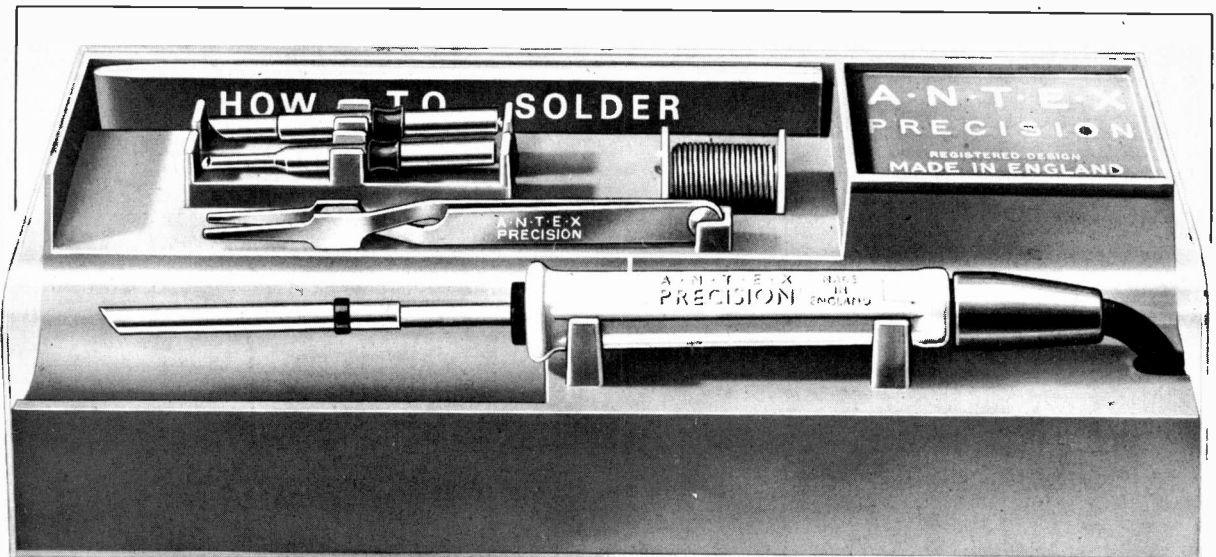

NEW!- Complete Precision Soldering KIT

This kit—in a rigid plastic "tool-box"—contains everything you need for precision soldering

- Model CN 15W. miniature iron fitted $\frac{3}{16}$ " bit
- Interchangeable spare bit, $\frac{5}{32}$ "
- Interchangeable spare bit, $\frac{3}{32}$ "
- Reel of Resin-cored solder
- Felt cleaning pad
- Stand for soldering iron
- Space for stowage of lead and plug
- Heat sink

49/6d.

PLUS 36-page booklet on "HOW-TO-SOLDER" for amateur and professional.

Lists of dealers available on request, or in case of difficulty order direct from Antex Ltd.

ANTEX Grosvenor House Croydon
CR9 1QE Phone 01-686 2774
*Send for the 16-Page ANTEX Main Catalogue

GOODMANS HIGH FIDELITY MANUAL

A Guide to full listening enjoyment

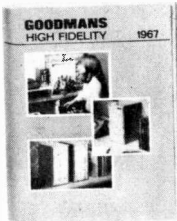

The Manual is much more than a catalogue of Goodman's High Fidelity Loudspeakers—it contains informative articles, including advice on stereo, special beginners page, and full cabinet drawings. You'll find it interesting as well as informative.

**The Perfect Combination
MAXAMP 30**

TRANSISTORISED STEREOGRAPHIC HIGH FIDELITY AMPLIFIER 15 + 15 watts · Silicon solid state · Integrated pre-amplifier · Negligible distortion - £49.10.0.

STEREOMAX

MATCHING AM/FM STEREOGRAPHIC FM TUNER

Transistorised · Outstanding specification · Stereo de-coder (optional) £60.0.0. + £11.18.3. P.T. inc. Surcharge.

Both MAXAMP 30 and STEREOMAX have polished wood cases (10½" x 5½" x 7½" deep) in Teak or Walnut to order.

Full specifications of the Maxamp 30 and Stereomax are given in the High Fidelity Manual—send the coupon for your FREE copy—or pay an early visit to your Goodman's dealer.

FREE Please send 'Hi-Fi Manual' together with name and address of my nearest Goodman's dealer.

Name

Address

PE 7

GOODMANS INDUSTRIES

AXIOM WORKS · WEMBLEY · MIDDLESEX. Tel: 01-902 1200

A Division of Radio Rentaset Products Ltd.

VIKING STEREO 4 + 4 DE-LUXE HIGH QUALITY AMPLIFIER

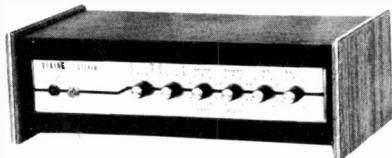

PRICE £13-17-0 COMPLETE

A high quality stereo amplifier, built to meet the requirements of budget Hi-Fi. Elegant styled cabinet in black rexine and woodgrained ends. Brushed aluminium panel, black and silver knobs. Quality components throughout. Ganged Bass and Treble controls, separate volume controls for each channel. Valves (Standard Model) 2 x ECL86 (De-Luxe Model) 1 x ECC83 (2) x ECL86. Output 3 ohms matching, suitable A.C. mains 230-240 volt. Cabinet size, 16½in. wide, 5½in. high, 8½in. depth. Full instructions and guarantee. Send for leaflet. S.A.E.

VIKING 10-12. A twelve watt amplifier for use on 230-240 volt A.C. mains. Inputs suitable Microphone, Record Player, Tuner, Tape Recorder, etc. Printed circuitry. Five Mullard valves, reliable components. Front panel contains 2 Input Jacks, 2 Volume Controls, 1 Tone, Neon and On/Off switch. Designed to fit into same type and size cabinet as Stereo. Fully guaranteed. Send S.A.E. for leaflet.

PRICE Complete with case £8-19-6 PLUS 12/6 P.P.

VIKING X.P.15 (Bass Model). A frustrated order offered at a fraction of cost (original price 39 gns.), 15 watts output. Suitable for 210-240 Volt A.C. mains. Attractive Black chassis with slotted Chromed steel top cover, size 15 x 7½ x 7in. 4 Input Jacks, 2 volume controls, 2 tone, 5 Mullard valves. Fully guaranteed. Send S.A.E. for leaflet.

Price Complete £12-19-6 plus 12/6 P. & P. and Ins.

L.P. TAPE BARGAIN

5½in. reels each containing 1,200ft. of top quality polyester recording tape (Limited quantity).

Price 3 reels for 35/- P.P. free.

Terms: C.W.O., C.O.D. Money back guarantee.

VIKING (ELECTRONICS) LTD. 37 HILLSIDE
STONEBRIDGE
LONDON, N.W.10

Telephone: ELG 3644

(MAIL ORDER ONLY)

Why

NOT BUILD ONE OF OUR PORTABLE TRANSISTOR RADIOS . . .

FIRST FOR PERFORMANCE, QUALITY & PRICE!

BACKED BY OUR SUPER AFTER SALES SERVICE

"A wonderful range of transistor radios using first grade components guaranteed results."

NEW ROAMER SEVEN Mk IV

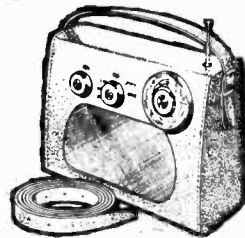

Amazing performance and specification

FULLY TUNABLE ON ALL WAVEBANDS

★ Now with PHILCO MICRO-ALLOY R.F. TRANSISTORS

● 9 stages—7 transistors and 2 diodes

Covers Medium and Long Waves, Trawler Band and three Short Waves to approx. 15 metres. Push-pull output for room filling volume from rich toned 7" x 4" speaker. Air spaced ganged tuning condenser. Ferrite rod aerial for M & L Waves and telescopic aerial for S Waves. Real leather-look case with gilt trim and shoulder and hand straps. Size 9" x 7" x 4" approx.

The perfect portable and the ideal car radio. (Uses PP7 batteries, available anywhere.)

★ **EXTRA BAND FOR EASIER TUNING OF LUXEMBOURG, etc.**

Total cost of parts now only **£5.19.6** P. & P. 5/6

Parts Price List and easy build plans 3/- (Free with kit)

NEW MELODY MAKER SIX

3 WAVEBAND PORTABLE. ● 8 stages. Six transistors and two diodes.

Covers Medium and Long Waves and extra Band for easier tuning of Luxembourg, etc. Top quality 3" Loudspeaker for quality output. Two RF stages for extra boost. High 'Q' 6" Ferrite Rod Aerial. Approx. 350 Milliwatts push-pull output. Handsome pocket size case with gilt fittings. Size 6 1/2" x 3 1/2" x 1 1/2" in. (Uses long-life PP6 battery). Carrying strap 1/6 extra.

This amazing receiver may be built for only

£3.9.6 P. & P. 3/6

Parts Price List and easy build plans 2/- (Free with kit)

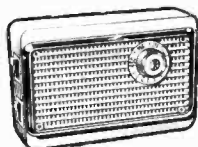
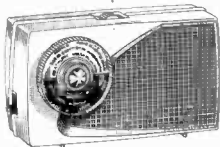

NOW WITH 3IN. SPEAKER ! NEW TRANSONA FIVE

"Home, Light, A.F.N. Lux. all at good volume" G.P., Durham

● 7 stages—5 transistors and 2 diodes

Fully tunable over Medium and Long Waves. Incorporates Ferrite rod aerial, tuning condenser, volume control, new type fine tone super dynamic 3 in. speaker, etc. Attractive case. Size 6 1/2" x 4 1/2" x 1 1/2" in. with red speaker grille. (Uses 1289 battery available anywhere.)

● **Extended M.W. band for easier tuning of Luxembourg etc.**

Total cost of all parts now only **42/6** P. & P. 3/6 Parts Price List and easy build plans 2/- (Free with kit)

POCKET FIVE NOW WITH 3in. SPEAKER!

● 7 stages—5 transistors and 2 diodes.

Covers Medium and Long Waves. On test Home, Light, Luxembourg and many Continental stations were received loud and clear. Designed round supersensitive Ferrite Rod Aerial and fine tone 3 in. moving coil speaker, built into attractive black and gold case. Size 5 1/2" x 1 1/2" x 3 1/2" in. (Uses 1289 battery, available anywhere.)

● **Extended M.W. band for easier tuning of Luxembourg etc.**

Total cost of all parts now only **42/6** P. & P. 3/6

Parts Price List and easy build plans 1/6 (FREE with Kit)



STOP PRESS!

Pocket 5. Med and Long wave version with miniature speaker

29/6 P. & P. 3/-



NEW ROAMER SIX

NOW WITH PHILCO MICRO-ALLOY R.F. TRANSISTORS

● 6 WAVEBAND !!

● 8 stages—6 transistors and 2 diodes

Listen to stations half a world away with this 6 waveband portable. Tunable on Medium and Long Waves, Trawler Band and two Short Waves.

Sensitive Ferrite rod aerial and telescopic aerial for short waves. Top grade transistors. 3-inch speaker, handsome case with gilt fittings. Size 7 1/4" x 5 1/4" x 1 1/4" in. (Carrying Strap 1/6 extra.)

★ **EXTRA BAND FOR EASIER TUNING OF LUX, ETC.**

Total cost of all parts now only **£3.19.6** P. & P. 3/6 Parts Price List and easy build plans 2/- (Free with kit)

TRANSONA SIX

● 8 stages—6 transistors and 2 diodes

This is a top performance receiver covering full Medium and Long Waves. High-grade 3in. speaker makes listening a pleasure. Push-pull output. Ferrite rod aerial. Many stations listed in one evening including Luxembourg loud and clear. Attractive case in grey with red grille. Size 6 1/2" x 4 1/2" x 1 1/2" in. (Uses PP4 battery available anywhere.) Carrying Strap 1/- extra.

● **Extended M.W. band for easier tuning of Luxembourg etc.**

Total cost of all parts now only **59/6** P. & P. 3/6 Parts Price List and easy build plans 1/6 (Free with kit)

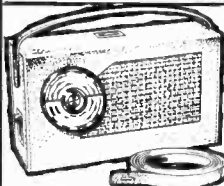

MELODY SIX

● 8 stages—6 transistors and 2 diodes

Our latest completely portable transistor radio covering Medium and Long Waves. Incorporates pre-tagged circuit board, 3in. heavy duty speaker, top grade transistors, volume control, tuning condenser, wave change slide switch, sensitive 6in. Ferrite rod aerial. Push-pull output. Wonderful reception of B.B.C. Home and Light, 208 and many Continental stations. Handsome leather-look pocket size case, only 6 1/2" x 3 1/2" x 1 1/4" in. approx. with gilt speaker grille and supplied with hand and shoulder straps.

Total cost of all parts now only **£3.9.6** P. & P. 3/6 Parts Price List and easy build plans 2/- (Free with kit)

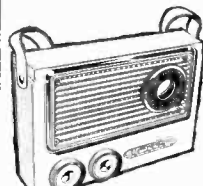

SUPER SEVEN

● 9 stages—7 transistors and 2 diodes

Covers Medium and Long Waves and Trawler Band. The ideal radio for home, car, or can be fitted with carrying strap for outdoor use. Completely portable—has built-in Ferrite rod aerial for wonderful reception. Special circuit incorporating 2 RF Stages, push-pull output, 3in. speaker (will drive large speaker). Size 7 1/2" x 5 1/2" x 1 1/2" in. (Uses 9v battery, available anywhere.)

Total cost of all parts now only **£3.19.6** P. & P. 3/6 Parts Price List and easy build plans 2/- (Free with kit)

Callers side entrance
Barratts Shoe Shop.

RADIO EXCHANGE Ltd

Open 9—5 p.m.
Saturdays 9—12.30 p.m.

61a HIGH STREET, BEDFORD. Phone: 52367

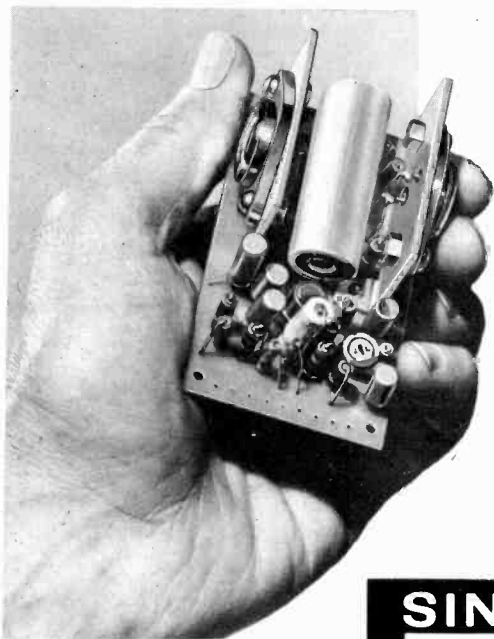

A masterpiece of power, compactness, quality and versatility

- 12 WATTS RMS CONTINUOUS SINE WAVE (24W PEAK)
- 15 WATTS RMS MUSIC POWER (30W PEAK)
- CAN BE RUN FROM BATTERIES
- SIZE 3in × 1¼in × 1in

SINCLAIR Z.12 12 WATT COMBINED HI-FI AMPLIFIER AND PRE-AMP

- Ultra-linear class B output and generous neg. feedback.
- Frequency response 15-50,000c/s ± 1dB.
- With unique manual of circuits.
- Output suitable for 3, 7.5 and 15 ohm loads.
- Two 3 ohm speakers may be used in parallel. Input—2mV into 2K ohms.
- Signal to noise ratio—better than 60dB.

BUILT, TESTED AND GUARANTEED **89/6**

Eight special H.F. transistors are used in the Z.12 to achieve results to compare favourably in every way with the costliest equipment you can buy. But the Z.12 is smaller, is more versatile and certainly saves you money. It is preferred not only for mono and stereo hi-fi, but it also enjoys enormous popularity fitted in electric guitars, used for P.A. and intercoms and many other instances where power and dependability are imperative. This superb amplifier with integrated pre-amp is supplied ready-built, tested and guaranteed together with the Z.12 manual which details matching, volume and tone control and selector switching circuits using one Z.12 in mono or two in stereo.

Technical Description

The Z.12 measures only 3in × 1¼in × 1¼in and weighs 3oz. 8 special transistors are employed in original circuitry developed by Sinclair Radionics own research team. The unit, which includes its own pre-amp, is ruggedly built. Two are ideal in stereo. This versatile amplifier can be powered by batteries or the PZ.3 12 volt car or other batteries.

SINCLAIR MICRO FM

7 TRANSISTOR COMBINED FM TUNER AND RECEIVER



Less than 3in × 1¼in × 2in. F.M. Superhet using pulse counting discriminator for superb audio quality. Low I.F. makes alignment unnecessary. Tunes 88-108Mc/s. The telescopic aerial suffices for good reception in all but poorest areas. Signal to noise ratio—30dB at 30 microvolts. Takes a standard 9V battery. One outlet serves for feeding to amplifier or recorder, the other allows set to be used as a pocket portable. Brushed and polished aluminium front, spun aluminium dial. A fascinating set to build which gives excellent reception by any standards. Complete kit inc. aerial, case, earpiece and instructions.

NEEDS NO ALIGNING

£5.19.6



SINCLAIR STEREO 15 PRE-AMP AND CONTROL UNIT

For use with two Z.12's or any good hi-fi stereo system. The front panel is elegantly styled in solid brushed and polished aluminium with well styled solid aluminium knobs. Frequency response 25c/s to 30kc/s ± 1dB connected to two Z.12's. Sensitivity Mic. 2mV into 50kΩ; P.U.—3mV into 50kΩ; Radio—20mV into 4.7kΩ. Equalisation correct to within ±1dB on RIAA curve from 50 to 20,000c/s. Size 6½in × 2½in × 2½in plus knobs.

BUILT, TESTED AND GUARANTEED

£9.19.6

Sinclair PZ.3. Transistorised mains power supply unit with ample output for two Z.12's and Stereo 25 together.

79/6

sinclair

SINCLAIR RADIONICS LTD., 22 Newmarket Rd., CAMBRIDGE

Telephone OCA3-52996

The smallest
set in the
World...



Actual Size

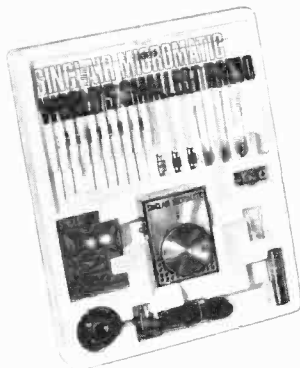

SINCLAIR MICROMATIC

There could not be a better time than NOW to enjoy using the Sinclair Micromatic. The performance of this British-designed and made 6-stage transistor set is fantastic. It assures reception from stations all round the dial and all round the clock with unsurpassed power and clarity, thanks to the unique new circuitry which this set incorporates. It plays virtually anywhere, indoors and out and you can enjoy your listening without ever disturbing the privacy of others nearby. You will particularly like the fine appearance of the Micromatic—it is completely professional inside and out and you can build it for yourself or buy it complete ready to play at once.

Technical description

6-stage receiver having two R.F. stages, a double diode detector and a powerful three stage A.F. amplifier, the output from which feeds into a specially matched high quality lightweight earpiece. The MICROMATIC has its own built-in ferrite rod aerial and uses vernier type tuning over the medium wave band. A.G.C. counteracts fading from distant stations. The beautifully styled case is faced with an artist designed aluminium front panel of outstanding elegance, with aluminium tuning dial to match.

Complete kit in new "see-for-yourself" pack, instructions and solder.

59/6

79/6

Built, tested and guaranteed with ear piece and batteries.

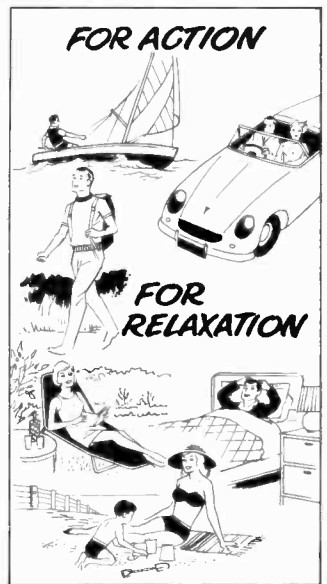

If you prefer not to cut this page, please quote PE.7 when writing your order.

Guarantee

Should you not be completely satisfied with your purchase when you receive it from us, your money will be refunded in full at once and without question. Full service facilities available to all purchasers.

SINCLAIR RADIONICS LTD., 22 NEWMARKET ROAD, CAMBRIDGE

Please send

NAME

ADDRESS

for which I enclose cash/cheque/money
order value £.....s.....d.

PE.7

RADIONIC

**INDISPENSABLE ALIKE TO:
STUDENT
TEACHER
AMATEUR EXPERIMENTER**

Unique and brilliantly simple. Hundreds of educational establishments—Universities, Technical Colleges, Schools, the Armed Forces—are already using Radionic for electronic instruction. Enthusiastic owners range from 9 to 82 years of age. Selected by the Council of Industrial Design for all British Design Centres. Featured in Sound and Television broadcasts.

The system is beautifully engineered from top quality British components. No soldering. No mains. No prior knowledge needed. Simply arrange components on perforated transparent panel, position brass connecting strip underneath, fix with 6BA nuts and circuit works with full efficiency. You can then dismantle and build another circuit. Your results are guaranteed by our Technical Department and News Letter Service. All parts available separately for conversion or expansion of sets.

UNIQUE! Our "No soldering" printed circuit board for superhet portable. Simply insert components and tighten nuts.
No. 1 Set £5.18.6. 14 Circuits (Earphone)
No. 2 Set £6.19.6. 20 Circuits (Earphone)
No. 3 Set £10.19.6. 22 Circuits (7 x 4in. Loudspeaker output)
No. 4 Set £14.19.6. 26 Circuits (include 6 Transistor and reflex superhets)
Prices (Post Free)
PLUS: P.T. Surcharge of 1/8d; 1/11d; 3/1d; 4/2d, respectively.)

Full details from:

RADIONIC PRODUCTS LIMITED
STEPHENSON WAY, THREE BRIDGES
CRAWLEY, SUSSEX

Tel.: CRAWLEY 27028

Trade Enquiries Invited

RADIO & ELECTRONIC CONSTRUCTION SYSTEM

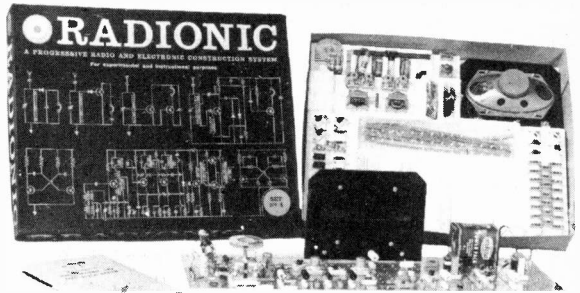

A No. 4 SET and 6-TRANSISTOR SUPERHET

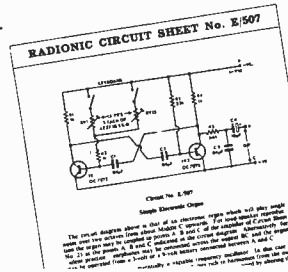

Theoretical Circuit

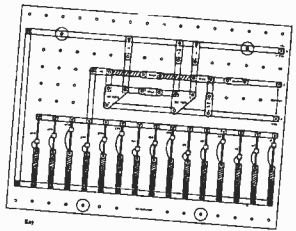

Practical Layout

Our 'E' Series of basic electronic circuits is available separately. Send for details of E/508, our do-it-yourself computer.

RADIOGRAM CABINETS 19 Gns.

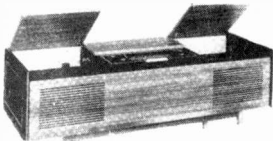

An elegant Stereogram Cabinet in modern Veneered Mahogany and Cloth covered Front Panel
BLACK LEATHERETTE SIDE PANELS
Dimensions : 52" x 17½" x 12"
Speaker positions for Twin 10" x 5" Speakers
OTHER MODELS—SEND FOR LIST

17 in. **TWO-YEAR GUARANTEE**
EX-RENTAL TELEVISIONS £11.10.0

3 star Guarantee ★ Tube ★ Valves ★ Components
Channels for all areas Insured Carriage 30/-

FREE ILLUSTRATED LIST

Slim line models
17" — 19" — 21" — 23"
A wide range of sizes, models and prices.

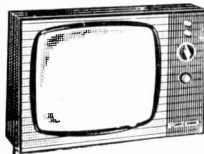

Demonstrations daily



TRANSISTOR CASES
7/6. 9½" x 6½" x 4½"
P. & P. 3/6.

TRANSISTOR CASES
19/6. Cloth covered, many colours. Size 9½" x 6½" x 3½"
P. & P. 3/6. Similar cases in plastic 7/6.

SINGLE PLAYER CABINETS 19/6.
P. & P. 7/6.

T.V. TURRET TUNERS 2/6. New Less Valves. Slim Models 5/-. Press Button Models 19/6. P. & P. 4/6.

TAPE RECORDER CABINETS 49/6
Dia. 16" x 12½" x 7½". Red and Grey. Cut out for BSR deck.
P. & P. 7/6.



DUKE & CO. (LONDON) LTD.
621/3 Romford Road, Manor Park, E.12
Phone: ILFord 600-1-2-3. Stamp for Free List.

Less than HALF list price!

SUPERB LUSTRAPHONE
MOVING COIL MICROPHONE

Guaranteed brand new in maker's box... offered at below cost, list price £3.7.6. Your opportunity while surplus stocks last. This high quality microphone is complete with 9ft. cable and standard co-axial plug.

ONLY
26/-

POST FREE IN U.K.

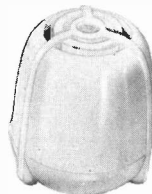

Frequency response 70-12,000 cycles/sec., sensitivity — 75 db (m). Medium impedance, nominal 600 ohms. Lead can be extended up to 100ft. without loss of quality. **FREE!** Circuit for low-cost transistor pre-amplifier for matching to high-impedance input.
RUSH YOUR ORDER NOW!

ANDREW MERRYFIELD LTD.

Dept. PL/805, 29 Wright's Lane, Kensington, London, W.8

Lasky's Radio

SPECIAL INTEREST ITEMS!

NEW! LASKY'S CLEAR PLASTIC PANEL METERS

Precision made in Japan by HIOKI. Each meter boxed and fully guaranteed with all fixing nuts and washers. Sizes are of front panel. Add 1/6 Post on each.

Type KR-52 3 x 2 1/2 in. (illustrated)
 1 mA DC 32/6 300 V DC 32/6
 5 mA DC 32/6 500 μA 37/6
 1 mA S Meter 39/6

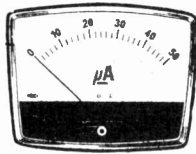

Type MK-38A 2 in. square
 1 mA DC 22/6 1 mA DC 36/-
 5 mA DC 22/6 5 mA DC 35/-
 300 V DC 22/6 300 V DC 35/-
 500 μA 27/6 500 μA 42/6
 1 mA S Meter 29/6 1 mA S Meter 39/6

Type MK-45A 1 1/2 in. square
 1 mA DC 25/- 1 mA DC 36/-
 5 mA DC 25/- 5 mA DC 35/-
 300 V DC 25/- 300 V DC 35/-
 500 μA 25/- 500 μA 39/6
 1 mA S Meter 35/- 1 mA S Meter 37/6

VEROBOARD — High grade laminated board with copper strips bonded to it and pierced with holes.

Boards
 42/1503 2 1/2 x 5 in. 3/11 Accessories
 43/1504 2 1/2 x 3 1/2 in. 3/3 Terminal pins — pkt. of 50 3/-
 45/1507 3 1/2 x 5 in. 5/6 Spot face cutter tool 7/3
 46/1508 3 1/2 x 3 1/2 in. 3/11 Pin inserting tool 9/6
 44/1505 3 1/2 x 17 in. 15/6 Post 6d. per item extra.
 Orders of 10/- and over post free.

UHF AND VHF T.V. TUNERS

Well known British makers' surplus stocks. Now available for the first time to the Home Constructor. Add 2/6 Post and Packing on each.

VALVE UHF MODEL (illustrated)
 In metal case size 4 x 6 x 1 1/2 in. Fully tunable — complete with PCC86 and PCC88 valves. LASKY'S PRICE 29/6. Without valves 7/6

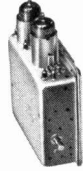

TRANSISTORISED VHF TUNER
 Sub-miniature turret fitted with 12 sets of coils and 3 Mullard AF102 transistors. In metal case size 3 x 1 1/2 x 2 1/2 in. LASKY'S PRICE 37/6
 Add 2/6 Post and Packing on each.

TELEVISION IF AMPLIFIERS

38 Mc/s. Contains a large number of components, 1F transformers, resistors, capacitors, etc., and the following valves: 2xPCC80, 1xEB91, EF80, EF183 and EF184. Overall size 1 1/2" x 3 1/2" x 4" deep. Ideal for servicemen and experimenters. This 1F amp. when used with the Valve model UHF Tuner (above) provides a suitable conversion for B.B.C.2. Circuit supplied.

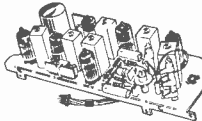

LASKY'S PRICE 29/6 Post 2/6

SPECIAL PACKAGE OFFER

Free standing table cabinet, size 17 1/2 x 9 x 6 1/2 in., finished in medium Mahogany. Scale marked 21 to 68 (UHF band). Designed to accept the above 1F Amplifier with space for a Valve UHF Tuner. Cabinet only 27/6. Post 3/6.



Special Package Offer 1F Amplifier, UHF Tuner with valves and Table Cabinet. PACKAGE PRICE 59/6 Post 6/-

EXPORT TTC B4002 FM WIRELESS MIC.

Highly sensitive — suitable for either static or mobile use. Signal can be picked up by any FM radio or tuner which receives frequencies between 96-104 Mc/s. over several hundred yards. Size only 3 x 2 1/2 x 1 in. (in leather case). Operates on one PP3 type battery. Complete with neck cord, clip-on dynamic extension mike (1/2 x 1/2 x 1/4 in.) and battery.



LASKY'S EXPORT PRICE 10 Gns. Post Free. Anywhere in the World.

TTC 13/500. More powerful version of above—size 7 1/2 x 1 1/2 x 1 1/2 in. Operates on one PP3 type battery. LASKY'S PRICE 12 Gns. Post Free. Anywhere in the World.
 These cannot be operated in the U.K. owing to G.P.O. regulations.

WATER TEMPERATURE THERMOSTATS

British made—orig. for use in high quality washing machine. Range adjustable between 114°F and 230°F. Rating 200/250 V.A.C., 20 amps (also D.C. up to 125 V.A.). Size 2 1/2 x 1 1/2 x 1 1/2 in. with 18 in. capillary tube and 6 in. bulb. Single hole fixing 3/16 in. spindle.

LASKY'S PRICE 15/- Post 2/-

CONSTRUCTORS BARGAINS

THE SKYROVER

De Luxe



7 transistor plus 2 diode superhet, 6 waveband portable receiver covering the full Medium Waveband and Short Waveband 31-94M and also 4 separate switched bandspread ranges, 13M., 16M., 19M. and 25M., with Band Spread Tuning for accurate Station Selection. The coil pack and tuning heart is factory assembled, and tested. Uses 4 U2 batteries. 5 in. Ceramic Magnet P.M. Speaker. Telescopic and Ferrite Rod Aerial. Tone Circuit, wood cabinet, size 11 1/2 x 6 1/2 x 3 in. covered with washable material, plastic trim and handle. Car aerial socket fitted.

Can be built for £8.19.6 Post H.P. Terms: 60/- deposit and 11 monthly payments of 12/9. Total H.P.P. £10.0.3. Data 2/6 extra: refunded if you purchase parcel. All parts avail. sep. Four U2 batt. 3/4 A simple additional circuit provides cover of the 1100/1500M Long Waveband. All components with construction data. Only 10/- extra Post Free.

PEAK SOUND SA-88 TRANSISTORISED STEREO AMP AND PRE-AMP KIT

A high quality 17 watt, 14 transistor High Fidelity Integrated Amplifier which anyone can easily build using the revolutionary Peak Sound "Cr-Kit" wiring system. Size assembled only 10 x 2 1/2 x 3 in. Complete kit with detailed construction data. LASKY'S PRICE £12.19.6 Post FREE. POWER SUPPLY KIT for the SA-88 £3.10.0 Post FREE.

LASKY'S MINIATURE TRANSISTOR AMPLIFIER MODULES

Incorporating the very latest circuitry to provide high sensitivity and good quality in conjunction with extreme small size and compactness. High quality Newmarket transistors used throughout. All designed to operate on 9v. miniature battery. Add 1/- on each for post & packing

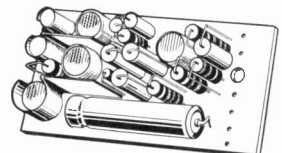

TYPE LRPC 1. 3 transistor. Input sens. 50 mV, output 150 mW, output imp. 40 Ω, size 2 x 1 x 1 1/2 in. PRICE 27/6

TYPE LRPC 4. 5 transistor. Input sens. 150 mV, output 330 mV, output imp. 15 Ω, size 2 1/2 x 1 1/2 x 1 1/2 in. PRICE 18/6

TYPE LRPC 5. 6 transistor. Input sens. 8mV, output 3W, output imp. 3 Ω, size 6 1/2 x 1 1/2 x 1 in. PRICE 59/6

TYPE LRPC 9. High to low impedance matching pre-amp. input imp. 1 megohm, output imp. 2 k/ohms. Size 1 1/2 x 1 1/2 x 1 1/2 in. PRICE 10/6

TYPE LRPC 10. Magnetic tape replay pre-amp. designed so that a 450 mH head can be matched into any of the audio amplifier modules listed above. Size 2 1/2 x 1 1/2 x 1 in. PRICE 10/6

TYPES LRPC 9 and 10 are ideal for use with LRPC 1, 4 and 5 and are available at the reduced price of 7/6 each if bought with the LRPC 4.

FULLY ENCAPSULATED MODULES

Special function modules — all one size 1 1/2 x 1 x 1 1/2 in. Complete with detailed function and installation instructions. Send S.A.E. for data.

TYPE PA-1. Public address amp. for use with carbon, crystal or Dynamic microphones. 3 Ω output imp. PRICE 30/-

TYPE GR-1. Gramophone amplifier—provides sufficient power to fill average room. 3 Ω output imp. PRICE 30/-

TYPE CO-1. Morse code practice oscillator — for use with morse key and 3 Ω speaker. PRICE 20/-

TYPE MT-1. Metronome module — provides audible and visual beat from 30 to 240 beats per minute (for use with 3 Ω speaker or ind. lamp). PRICE 22/6

SINCLAIR SUPER MINIATURE KITS

We stock the complete range. Write for details of package deals.
THE MICRO-6 miniature radio only 1 1/2 x 1 3/8 x 1 1/2 in. £2 19 6
THE MICRO-FM. (tuner/receiver) £5 19 6
THE MICROMATIC mini-radio Kit £2 18 6. Fully built £3 19 6
STEREO 25 pre-amp control unit fully built £9 19 6
THE Z-12 12 watt amplifier and pre-amplifier. Fully built and tested £4 9 6
PZ-3 power pack for Z-12 £3 19 6

TRANSISTORS ALL BRAND NEW AND GUARANTEED

GET 81, GET 85, GET 86 2/6; 873A, 874P 3/6; OC45, OC71, OC81D 4/8; OC 44, OC 70, OC 76, OC 81 5/6; pair (10/8); AF 117, OC 200 6/6; OC 42, OC 43, OC 73, OC 82D 7/8; OC 201, OC 204 15/-; OC 205, OC 206 19/6; OC28 24/6; OC 75 8/-.

TRANSFILERS By BRUSH CRYSTAL CO. Available from stock.

TO-01B 465 kc/s. ± 2 kc/s. TO-02D 470 kc/s. ± 1 kc/s. 9/6 EACH
 TO-01D 470 kc/s. ± 2 kc/s. TF-01B 465 kc/s. ± 2 kc/s.
 TO-02B 465 kc/s. ± 1 kc/s. TF-01D 470 kc/s. ± 2 kc/s. Post 6d.

Branches

207 EDGWARE ROAD, LONDON, W.2 Tel.: 01-723 3271

33 TOTTENHAM CT. RD., LONDON, W.1 Tel.: 01-636 2605

Open all day Saturday, early closing 1 p.m. Thursday

152/3 FLEET STREET, LONDON, E.C.4 Tel.: FLEet St. 2833

Open all day Thursday, early closing 1 p.m. Saturday

High Fidelity Audio Centres

42 TOTTENHAM CT. RD., LONDON, W.1 Tel.: 01-580 2573

Open all day Thursday, early closing 1 p.m. Saturday

118 EDGWARE ROAD, LONDON, W.2 Tel.: 01-723 9789

Open all day Saturday, early closing 1 p.m. Thursday

ALL MAIL ORDERS AND CORRESPONDENCE TO: 3-15 CAVELL ST., TOWER HAMLETS, LONDON, E.1 Tel.: 01-790 4821

Now Ready!

NEW 1967 EDITION OF Radio & TV Servicing

Up-to-the-minute repair data for 1966-1967 popular Televisions, Radios, Radiograms, Car Radios & Record reproducers.

You can't afford to be without this goldmine of money-spinning data for Radio and TV repair. It's packed with the Circuits, Diagrams, Alignment data and Repair hints you must have for the 1966-67 popular TVs and Radios. PLUS the very latest facts on COLOUR TV. Simply post coupon below to see this time-saving volume FREE for seven days WITHOUT OBLIGATION TO BUY.

It's a great Money-Maker!

496 PAGES

NEARLY 270 CIRCUITS

Over 290 printed panel diagrams, layout diagrams and waveform graphs.

Vital Repair hints, Circuits and Data for all these makes.

Alba - Baird - Bush - Cossor - Dansette - Decca - Defiant - Dynatron - Ekco - Ferguson - Farranti - Fidelity - G.E.C. Grundig - H.M.V. - Kolster-Brandes - Marconiphone - Masteradio - Murphy National - Pam - Perdio - Philips - Pye - R.G.D. - Regentone - Roberts' Radio - Sanyo - Sharp - Standard S.T.C. - Stella - Thorn - Ultra

You can also see on Free Trial
RADIO & TV SERVICING
(1965-66 Models)

If you missed seeing the 1966 edition of Radio and TV Servicing take advantage of this offer. There are only a limited number of these big 496-page volumes available. Full Servicing Data for nearly 300 POPULAR MODELS. Over 600 Circuits, Layout Diagrams, Drawings and Tables. When stocks are exhausted there can be no reprint. Hand wearing Rich Maroon Binding with Gold Lettering.

To see this volume on Free Examination tick (✓) coupon below.

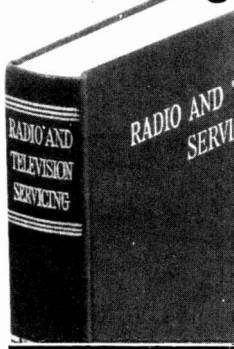

For the first time!
Big 32-page Section on
COLOUR TV (PAL System)

Compiled by
W. A. Montgomery, B.Sc.
Head of Advanced Development Group, Consumer Products Division, S.T.C.

This big new 32-page feature, packed with vital advance information on the PAL system, explains the basic encoding and decoding processes which will be in use when Colour Television is introduced to this country. You will find this new section of absorbing interest — essential reference for every TV and Radio repair workshop.

Strong maroon binding with gold lettering to match volumes previously published in this famous series.

It's yours on 7 days FREE Trial

the WyndSOR Vanguard ... the most versatile recorder at its price* offering so many outstanding features ...

- 4 track-3 speeds —7 in. spools
- Separate Record and replay amplifiers
- Double play
- Sound-on-Sound
- Detachable lid fitted 8" speaker
- Tape Monitoring facility



- Push button controls
- Recording meter and Playback indicator
- Straight through amplifier facility
- Bass, treble, volume and record gain controls
- Many other features

Before you buy an ordinary tape recorder write for full details of the Vanguard and other models.

* All British and full value for money at only 59 gns. inc. 1800 ft. LP tape and Tape manual. (less mike).

WYNDSOR RECORDING CO. LTD. (Dept. PE6)
WyndSOR Works, Bellevue Road, Friern Barnet, London, N.11. ENT. 2226

LOW-COST FIELD-EFFECT TRANSISTORS are now available, for immediate despatch, from 10/6 each.

These top quality junction field-effect transistors are now available at a price comparable with that of valves, for use in AF and RF applications where space and efficiency are at a premium.

Brief specifications of a few of the many devices held in stock, are given below. For further information on these and a great many others send 2/6 P.O. for a copy of our FET "DATA SUMMARY", which will be available in mid-May.

| Type | Channel | Package | BV (max.) Volts | I _{GSS} (max.) nA | I _{DSS} min. max. mA | f _s min. max. | C _{iss} max. | Price |
|----------|---------|---------|-----------------|----------------------------|-------------------------------|--------------------------|-----------------------|-------|
| MPF 104 | N | TO-92 | 25 | 1.0 | 1.0 5.0 | 1000/5000 | 7.0 | 10/6 |
| MFE 2094 | N | TO-72 | 50 | 0.1 | 0.4 1.4 | 350/700 | 6.0 | 26/3 |
| 2N 3819 | N | TO-92 | 25 | 2.0 | 2.0 20 | 2000/6500 | 8.0 | 14/- |
| 2N 3820 | P | TO-92 | 20 | 2.0 | 0.3 15 | 800/5000 | 32 | 24/- |
| 2N 3909 | P | TO-92 | 20 | 1.0 | 0.3 15 | 1000/5000 | 32 | 20/3 |

We can also supply hundreds of other semiconductors and a comprehensive selection of electronic components, some of which are listed below:

TRANSISTORS: AF 106, 8/3; AF 139, 12/6; OC 29, 25/6; OC35, 16/6; OCP71, 24/-; NKT 212, 4/3; NKT 218, 3/11; NKT 271, 3/4; NKT 274, 3/4; NKT 676, 4/-; NKT 773, 4/8; 2G 302, 5/4; 2N 706, 4/6; 2N 2147, 18/-; 2N 2646, 14/-; 2N 2926 (yellow), 4/3; 2N 3563, 6/3; 2N 3638, 8/-; 2N 3640, 11/8; 2N 3646, 8/3; 2N 3702, 7/-; 2N 3703, 8/-, etc.

DIODES AND RECTIFIERS: OA 91, 2/-; OA 95, 2/-; OA 200, 3/-; OA 202, 4/-; BYZ 11, 14/3; BYZ 12, 11/3; BYZ 13, 8/-; BZY 88/C6V2, 6/-, etc.

VARICAP DIODES: BA 110 (8-12pf) 5/9; BA 111 (45-65pf), 7/3; BA 112, (80-120pf), 12/9, etc.

RESISTORS: 1/2W Carbon film 5% 10 ohm-10 Megohm. 3 1/2, each.

CAPACITORS: Electrolytic from 1/5. Polyester from 9d. Polystyrene from 10d. Tantalum from 3/6. Silver Mica from 9d. Send us a list of your requirements for a competitive quotation.

TRANSFILTERS: Ceramic filters for use in transistor I.F. stages.

(INFORMATION ON REQUEST) TF-01D (470KHz), (Emitter Bypass), 7/-; TO-01D (470KHz) (Interstage Coupling), 8/9.

Please add 2/- postage and packing on all orders of £1 or less.

MAIL ORDER ONLY PLEASE

TERMS: C.W.O. or C.O.D.

M. R. Clifford & Company (Components Dept.)

209A Monument Road, Edgbaston, Birmingham, 16.

P.S.: Are you on our mailing list? If not, send 2/- P.O. and receive our current transistor price list (800/2) and amendment bulletin, and further information as it becomes available.

P.P.S.: We are now an ELECTRONICS DEALER which makes us a single supply source for almost every component need.

Buckingham Press Ltd., Headington Hill Hall, Oxford

Without obligation to buy, please send

RADIO & TV SERVICING

1966/67 Models

5/- dep. 10/- monthly for 8 months, paying subscription price of 85/-, Cash price in 8 days 80/-.

RADIO & TV SERVICING

1965/66 Models

5/- dep. 10/- monthly for 8 months, paying subscription price of 85/-, Cash price in 8 days 80/-.

Tick (✓) your choice above

If both titles kept 10/- deposit, then 10/- monthly for 16 months paying £8 10s. in all. Cash in 8 days £8.

If you accept this application I will either send deposit in 8 days, then the monthly payments (—or cash prices) in 8 days — or return the book(s).

If under 21 your father must fill in coupon.

Full Name (BLOCK LETTERS)

Address

Occupation

Signature

(Mr., Mrs., Miss)

Tick (✓) where applicable

The address on left is—

- My Property
- Rented unfurnished
- Parents' Home
- Furnished Accom.
- Temporary Address

R67/R66/2981



POCKET MULTI-METER

Size 3 1/2 x 2 1/4 x 1 1/2 in. Meter size 2 1/2 x 1 1/2 in. Sensitivity 1000 O.P.V. on both A.C. and D.C. volts. 0-15, 0-150, 0-1000. D.C. current 0-150mA. Resistance 0-100k Ohm. Complete with test prods, battery and full instructions, 42/6. P. & P. 3/6. **FREE GIFT** for limited period only. 30 watt Electric Soldering Iron value 15/- to every purchaser of the Pocket Multi-Meter

3 to 4 WATT AMPLIFIER

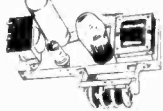

3-4 watt Amplifier built and tested. Chassis size 7 x 3 1/2 x 1 in. Separate bass, treble and volume control. Double wound mains transformer, metal rectifier and output transformer for 3 ohms speaker. Valves ECC81 and 6V6. £2.5.0 plus 5/6 P. & P. The above in Kit Form, £1.14.6 plus 5/6 P. & P.

CYLDON U.H.F. TUNER

complete with PC.88 and PC.86 Valves. Full variable tuning. New and unused. Size 4 1/2 x 5 1/2 x 1 1/2. Complete with circuit diagram. 35/- plus 3/6 P. & P.



8-VALVE STEREO RADIOGRAM CHASSIS

3-4 WATTS PER CHANNEL

By Famous Manufacturer

Superb new 8-valve chassis covering long, medium and short waves on AM, also VHF transmissions on FM. AM circuit's high sensitivity permits internal aerial for most stations. Well-known Gorder tuning heart in separate FM input. Tone and volume controls. Extra large illuminated dial. External AM and FM aerial inputs. Gram. pick-up socket. Standard 3 ohm speaker. 200/250 volts A.C. Size 17 x 7 x 5 1/2 in. deep. **£14. 14. 0** P. & P. £1

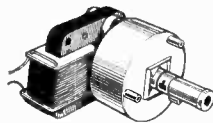

Type E MOTOR

Small A.C. mains motor 230/250 volts complete with gearbox, 6 r.p.m. Price 15/- plus 4/- P. & P. Similar to above motor but without gearbox. Price 9/6 plus 3/- P. & P.

SILICON RECTIFIERS

250 v. P.I.V. 750 milliamps. Six for 7/6, Post paid.

NEW Transistorised SIGNAL GENERATOR

Size 5 1/2 x 3 1/2 x 1 1/2. For IF and RF alignment and AF output, 700 c/s frequency coverage 460 Kc/s to 2 Mc/s in switched frequencies. Ideal for alignment to our Elegant Seven and Musette. Built and tested. 39/6. P. & P. 3/6.



TRANSISTOR INVERTOR

50 v. D.C. Input. Output 240 v. A.C. 40 watts incorporating transformers, choke, condensers and 2 Mullard OC28 in solid 16 gauge Aluminium Case. Size 15 x 6 x 2 1/2 by famous manufacturers. 19/6 plus 7/- P. & P.



40W FLUORESCENT LIGHT KIT

Incorporating GEC Choke size 8 1/2 x 1 1/2 x 1 1/2, 2 bi-pin holders, starter and starter-holder. 11/6. P. & P. 5/6.

Similar to above: 80 W. Fluorescent Light Kit incorporating GEC Choke size 1 1/2 x 1 1/2 x 1 1/2, 2 bi-pin holders, starter and starter holder 17/6. P. & P. 6/6.

Twin 40 W Choke instant start for 2 x 2 ft. tubes 17/6. P. & P. 5/6.



Special offer ELEGANT SEVEN mk IIa

SPECIAL OFFER. Power supply kit to purchasers of 'Elegant Seven' parts, incorporating mains transformer, rectifier and smoothing condenser, A.C. mains 200/250 volts. Output 9v, 100 mA. 7/6 extra.

Buy yourself an easy to build 7 transistor radio and save at least £10.0.0. Now you can build this superb 7 transistor superhet radio for under £4.10.0. No one else can offer such a fantastic radio with so many de luxe star features.

★ De luxe grey wooden cabinet size 12 1/2 x 8 1/2 x 3 1/2. ★ Horizontal easy to read tuning scale printed grey with black letters, size 1 1/2 x 2. ★ High 'Q' ferrite rod aerial. ★ I.F. neutralisation on each separate stage. ★ D.C. coupled push pull output stage with separate A.C. negative feedback. ★ Room filling output 350mW. ★ Ready etched and drilled printed circuit board back printed for foolproof construction. ★ Fully comprehensive instructions and point to point wiring diagrams. ★ Car aerial socket. ★ Fully tunable over medium and long wave, 168-535 metres and 1250-2000 metres. ★ All components, ferrite rod and tuning assembly mount on printed board. ★ 5" P.M. Speaker. ★ Parts list and circuit diagram 2/6, free with parts.



ONLY **£4.4.0**

Plus 7/6 Post & Packing

BSR Tape deck

AC 200/250 v., tape speed 3 1/2 twin track.

Special price £5.19.6

Post and packing 7/6



TRANSISTORISED 1 1/2 WATT AMPLIFIER

comprising 2AC 128, 20C 75 and 2 AA129 separate bass and treble volume controls. Complete with Power Supply AC mains 240 v. Size 7 1/2 x 3 1/2 x 2. Price 50/- plus 2/6 P. & P.

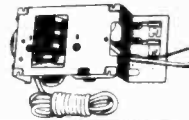

POWER SUPPLY KIT

A.C. MAINS 200-250 V

Incorporating "C" core type mains transformer, full wave metal rectification and smoothing condenser. Smooth output 250 v. 250 mA and 6.3v. 4 amp. for Heaters. 25/- P. & P. 9/6.

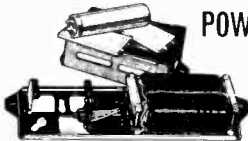

FIRST QUALITY P.V.C. TAPE

| | |
|------------------------------|------------------------------|
| 5 1/2" Std. 850ft. ... 9/- | 5" L.P. 850ft. ... 10/6 |
| 7" Std. 1200ft. ... 11/6 | 3" T.P. 600ft. ... 10/6 |
| 3" L.P. 240ft. ... 4/- | 5" T.P. 1800ft. ... 25/6 |
| 5 1/2" L.P. 1200ft. ... 11/6 | 5 1/2" T.P. 2400ft. ... 32/6 |
| 7" L.P. 1800ft. ... 18/6 | 7" T.P. 3600ft. ... 42/6 |
| 5 1/2" D.P. 1800ft. ... 18/6 | 4" T.P. 900ft. ... 15/- |

P. & P. on each 1/6, 4 or more post free



EXTRACTOR FAN

AC Mains 230/250v complete with pull switch. Size 6 1/2 x 4 1/2. Price 27/6 plus 5/- P. & P.

GEC DOORBELL

Complete with mains transformer 240v AC and bell push. Price 12/6 plus 5/6 P. & P.

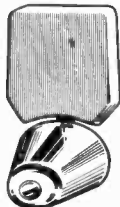

8-WATT 4-VALVE PUSH-PULL AMPLIFIER & Metal RECTIFIER

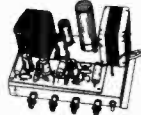

Size 9" 6" 1 1/2". A.C. Mains, 200-250 v. 4 valves. For use with Std. or L.P. records, musical instruments. All makes of pick-ups and mikes. Output 8 watts at 5 per cent of total distortion. Separate bass and treble lift control. Two inputs, with controls for gram. and mike. Output transformer tapped for 3 and 15 ohm speech coils. Built and tested. £4.4.0. P. & P. 11/-; 8" x 5" Speaker to suit. Price 14/6 plus 1/6 P. & P. Crystal Mike to suit 12/6 plus 1/6 P. & P.

GEC KETTLE ELEMENT

3,000W WITH AUTOMATIC EJECTION 200/240 v. size of hole required 1 1/2". List Price 32/- Our PRICE 15/- P. & P. 1/6.



RADIO AND T.V. COMPONENTS (ACTON) LTD.

21D HIGH STREET, ACTON, LONDON, W.3

Shop hours 9 a.m. to 6 p.m. Early closing Wednesday. Goods not despatched outside U.K.

All enquiries stamped addressed envelope. Terms C.W.O.

Also at

323 EDGWARE ROAD, LONDON, W.2

Early closing Thursday
PERSONAL SHOPPERS ONLY

All orders by post must be sent to our Acton Address

The Key to Your Success . . . HEATHKIT Manuals!

PRELIMINARY NOTES AND INSTRUCTIONS

UNPACKING YOUR KIT

Unpack your kit carefully and check each part against the Parts List. The component identification sheet will help locate items and acquaint you with the parts as you check them. Save the packing material until all parts are accounted for. If any parts are damaged or missing, complete the inspection slip and notify us promptly. The illustration shows a convenient way to arrange the parts. The leads of resistors and capacitors can be inserted in the edge of a corrugated cardboard box and their values can be written on the cardboard next to each component. Mounted resistors make handy trays for small parts.

COMPONENTS

The resistors in Heathkits have a tolerance of 1% unless they are designated otherwise in the Assembly Manual. All colour codes are quoted in both the Parts List and in the instruction slip. The colour code chart for resistors and capacitors will be found in the inside of the iron cover.

Capacitor values are given in pF (microfarad) and μ F (micro-microfarad). The unit pF (picofarad) is sometimes used in place of pF. Some manufacturers use the letter M for micro.

10 PARTS LIST

| PART No. | PARTS Per Kit | DESCRIPTION |
|---|---------------|--------------------------------------|
| Resistors (1/2 watt, 10% carbon) | | |
| (1) H-330C10 | 1 | 330 (Orange, Orange, Black) |
| H-220C10 | 1 | 220 (Red, Red, Brown) |
| H-56C10 | 3 | 5600 (Green, Blue, Brown) |
| H-100C10 | 1 | 1 K Ω (Brown, Black, Red) |
| H-220C10 | 2 | 2.2 K Ω (Red, Red, Yellow) |
| H-68C10 | 1 | 6.8 K Ω (Blue, Grey, Red) |
| H-100C10 | 3 | 10 K Ω (Brown, Black, Orange) |
| Capacitors (all types) | | |
| (2) 20-572 | 1 | 200 pF mica |
| (3) 21-599 | 2 | .01 μ F disc ceramic |
| (4) 21-584 | 3 | .01 μ F polyester |
| (5) 21-504 | 5 | 8 pF 12V electrolytic |
| (6) 21-562 | 1 | 1000-1000 μ F 25V electrolytic |
| Controls, Switches | | |
| (7) 10-367 | 1 | 10 K Ω control knob |

CHASSIS PARTS MOUNTING

Refer to Pictorial 5 for the following steps:

- (1) Locate the chassis and position it as shown.

NOTE: When mounting parts to the front panel take care not to damage the finish.

- (2) Refer to Detail 5A and mount the slide switches at locations 5A and 5B with the tags positioned as shown. Secure with 0.04" screws and nuts. **DO NOT USE LOCKWASHERS.**
- (3) Locate the 10K Ω control and the lamp bracket. Refer to Detail 5B and mount the lamp bracket and potentiometer at P.

Detail 5A

Detail 5B

PICTORIAL 5

FAULT FINDING CHART

| DIFFICULTY | POSSIBLE CAUSE |
|--|--|
| Decoder completely dead POWER lamp not on | <ol style="list-style-type: none"> 1. Open circuit mains supply lead. 2. Blown fuse. 3. Defective mains transformer. |
| No sound, POWER lamp on | <ol style="list-style-type: none"> 1. BUZZE switch in AD just position. 2. Open circuit or shorted output cables. 3. No 9V positive line. 4. Faulty silicon diode D1 or reversed. 5. Open circuit resistor R23. 6. Faulty filter capacitor, C22 or C23. 7. 5B all broke open circuit. |

WARRANTY OF PARTS

Daystrom Limited guarantees subject to the following terms to repair or replace free of charge any defective parts of this Heathkit (with the exception of cathode ray tubes and valves referred to hereunder) which fail owing to faulty workmanship or material provided the defective parts are returned to Daystrom Limited within 12 months from date of purchase —

1. This guarantee is given to and for the benefit of the original buyer only, and is and shall be in lieu of, and otherwise, as to quality or fitness for any purpose of the equipment, and in no event shall Daystrom Limited be liable for any loss of anticipated profits, damages, consequential or otherwise, injury, loss of time or other losses whatsoever incurred or sustained by the buyer in connection with the purchase, assembly or operation of Heathkits or components thereof.
2. No replacement will be made of parts damaged by the buyer in the course of handling, assembling, testing or operating Heathkit equipment.
3. The purchaser shall comply with the Replacements Procedure laid down in the relevant Heathkit Manual.
4. Daystrom Limited will not replace, repair or service instruments or parts thereof in which acid core solder or paste fluxes have been used and in such event this guarantee shall be completely void.

Note: The Cathode Ray Tubes and Valves forming part of the equipment are guaranteed by the respective manufacturers. It should be noted that this guarantee is given only in respect of faulty workmanship and/or material and does not cover misuse or consequential damage.

1 Helpful Guidance on Kit Building

Each Heathkit manual contains valuable tips for the kit-builder. Shows you . . . how to unpack and set-up the kit for easy building . . . how to identify components by size, shape and coding . . . how to mount parts, cut leads and position them. It even explains and illustrates how to solder properly 'point-to-point' and on printed circuit boards.

2 Detailed Parts List

Inside every Heathkit manual are descriptions and pictures of each and every part for easy identification while you are building your kit.

3 Simple Step-by-Step Procedure

Guides you through each assembly step. Tells you exactly what part to use, what to do, and how to do it. Covers kit construction, alignment and installation . . . nothing is left to chance. Written in non-technical, everyday language so that everyone can understand the instructions.

4 Large 'Exploded' Diagrams

Large illustrations and pictorials show precisely where each component goes and many detailed diagrams are generously sprinkled among the instructions to illustrate how various assemblies go together.

5 Operating Instructions

Cover the use of your kit under virtually any situation, and recommend appropriate accessories where necessary. Even dwell on operational theory, if required for use.

6 Fault Finding Chart and Service Information

In the unlikely event that you do run into trouble, there's an 'In Case of Difficulty' section and a 'Fault Finding Chart' that lists difficulties and possible causes to assist you in locating your problem. Also our staff of Technical Correspondents is at your service to answer any question about construction, accessories or kit selection.

7 Circuit Description and Diagrams

If you are technically inclined or interested in learning about electronics, you'll find the Circuit Description, Circuit Diagram and block diagrams both helpful and educational.

8 Heathkit Guarantee

Any model when assembled in accordance with the Instruction Manual must meet our published specification for performance or the purchase price will be cheerfully refunded.

Please direct your enquiries to DAYSTROM LTD., Dept. PE-7, Gloucester. Tel. 20217

HEATHKIT WORLD-FAMOUS ELECTRONIC EQUIPMENT

The Hi-Fi, Radio, Amateur Gear, Test Instruments *anyone* can build

Treat yourself to superb LW, MW entertainment with the
High-Performance Car Radio Kit, CR-1

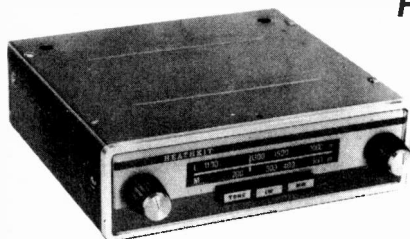

Complete your motoring pleasure with this small, compact, high-performance car radio. It can be fitted to any make of car having 12 volt positive or negative earth system. Tastefully styled in neutral grey with matching black knobs and chrome trim to harmonise with any car colour scheme.

Features include: Six-transistor, 2-diode circuit. Completely pre-assembled and aligned tuning unit. High sensitivity, combined with wide range automatic gain control (AGC), minimises fading under weak reception conditions. Easy-tune dial. Push button Long, Medium and Tone selection.

The car radio is available for your convenience, in two separate units; RF Amplifier Kit CR-1T £11.13.6 incl. P.T., IF/AF Amplifier Kit CR-1A £11.3.6.

TOTAL PRICE KIT (excluding Loudspeaker) £12.17.0 incl. P.T.
8" x 5" Loudspeaker Pt. No. 401-505 £1.16.1 incl. P.T.

The Transistor Amplifier you have been looking for!



Low-cost Stereo Amplifier Kit, TS-23
Breaks the price barrier in quality
Transistor Amplifier cost

Incorporates all the essential features for good quality reproduction from gramophone records, radio and other sources.

Its many features include: 3 watts rms (15Ω) each channel. Good frequency response for outstanding fidelity. Compact slim-line styling. Ganged BASS, TREBLE and VOL. controls, 6-position SELECTOR switch for programme sources. Attractive perspex two-tone front panel. 16 transistor, 4 diode circuit. Handsome fully-finished walnut veneered cabinet. Outputs for 8 or 15 ohm loudspeakers. Printed circuit boards. For free-standing or cabinet mounting.

Size 3½" x 13" x 8" deep.

PRICES: Amplifier Kit £17.15.0
Amplifier Kit and Cabinet £18.19.0

Walnut Veneered Cabinet
separate £2.0.0

Hi-Fi performance from a "Mini"
Speaker Kit
with the
"AVON"
BOOKSHELF
SPEAKER
SYSTEM

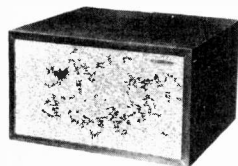

The challenge to our acoustic engineers was to design a speaker occupying the minimum space consistent with first class reproduction. The results of our efforts was this "AVON" compact unit of exceptional quality.

Features: Two special speakers 6½" BASS, 3" HF unit and crossover network. Good frequency response. Beautiful fully-finished walnut veneered cabinet, size only 7¼" x 13¼" x 8" deep.

Supplied in two units. Can be built for a total price.

Kit £13.16.0 incl. P.T.

NEW! Transistorised AM-FM Stereo Tuner

In the same attractive styling as our well-known AA-22U Stereo Amplifier. Features 18 transistor, 3 diode circuit. AM-LW/MW, FM Stereo and Mono tuning. Stereo indicator light. AFC, AGC. Pre-assembled and aligned FM unit. Separate AM and FM circuit boards. Self-powered. Handsome, finished walnut veneered cabinet. (Optional extra).



Comprising: Model AFM-2T RF Tuning Unit. Kit £7.17.6 including P.T. AFM-2A IF Amp. and power supply kit £24.9.6. **TOTAL PRICE KIT £32.7.0**
Cabinet £2.5.0 extra.

Many other models in wide range.

Prices quoted are Mail Order, Retail Prices slightly higher.

Full specification sheets of any model available upon request.

HEATHKIT



FREE!

32 page Catalogue
SEND COUPON FOR
YOUR COPY NOW!

Over 150 models: Hi-Fi, Audio
Speaker systems, Intercom, PA
Guitar amplifiers, Amateur Radio, Educational, Transistor radios, Test and service instruments. Many shown in full colour.

To:—

DAYSTROM LTD., Dept. P.E.7
GLOUCESTER, ENGLAND. Tel.: Glos. 20217

Please send me
FREE British Heathkit Catalogue

further details of model(s)

NAME

ADDRESS

MOST MODELS CAN BE SEEN AND DEMONSTRATED AT THE LONDON HEATHKIT CENTRE. 233 Tottenham Court Road, W.1 Tel: 01-636 7349.
Retail and Mail Order purchase can be made there.

**FULLY GUARANTEED
INDIVIDUALLY PACKED
VALVES**

| | | |
|-------------|------------|-------------|
| AC/HL 6/- | EB080 5/- | EL34 10/- |
| ACP4 6/- | EBF80 6/6 | EL36 10/- |
| AC6PEN 5/- | EBF83 7/6 | EL37 16/- |
| AL60 5/- | EBF89 6/9 | EL38 17/6 |
| ARR 5/- | EBL31 20/- | EL41 8/- |
| ARF3 3/- | EL42 4/- | EL42 8/- |
| ARF12 2/6 | EC53 12/6 | EL50 8/- |
| ATP4 2/8 | EC70 4/- | EL81 8/- |
| ATP7 5/6 | EC90 6/- | EL83 6/3 |
| AU7 55/- | EC91 3/- | EL84 4/3 |
| AZ31 9/- | ECC32 4/- | EL86 7/6 |
| B6H 16/- | ECC33 10/- | EL91 4/6 |
| B78 40/- | ECC81 4/- | EL96 5/- |
| BL63 10/- | FCC82 5/- | EM31 5/- |
| B84 8/- | ECC83 6/- | EM80 6/- |
| B86 20/- | ECC84 5/6 | EM81 7/- |
| B884 47/6 | ECC85 6/6 | EM84 6/3 |
| BY214 7/6 | EC91 4/- | ES174 8/6 |
| BZ134 16/- | ECC189 9/6 | ES208 6/6 |
| CC31 2/6 | ECF80 7/- | EY61 5/6 |
| CY31 6/6 | FCC82 7/- | EY86 6/6 |
| D1 1/8 | ECH35 12/6 | EY91 3/- |
| D41 3/3 | ECH42 9/- | EZ40 6/6 |
| D61 6/- | ECH81 5/- | EZ41 6/6 |
| D77 3/- | ECH83 7/6 | EZ80 6/6 |
| DA30 12/6 | ECL80 6/- | EZ81 8/- |
| DA100/120/- | ECL82 6/3 | FY6067 5/- |
| DAF96 6/- | ECL83 10/- | FY8061 5/- |
| DD41 4/- | ECL86 9/- | FY8063 4/- |
| DF73 5/- | EF36 3/6 | FW4/600 6/6 |
| DF91 3/- | EF37A 7/- | FW4800 8/6 |
| DF92 3/- | EF40 8/- | G50/2G 6/- |
| DF96 6/6 | EF41 6/6 | GM4 45/- |
| DK96 5/6 | EF69 2/6 | HL22 12/6 |
| DL83 8/- | EF62 6/- | GZ34 10/- |
| DL92 4/- | EF66 8/- | H30 3/6 |
| DL93 4/- | EF71 7/6 | HK64 22/6 |
| DL94 5/6 | EF72 5/- | HL2K 2/6 |
| DL96 7/- | EF73 5/- | HL23 6/- |
| DL810 6/- | EF74 4/- | HL23DD 5/- |
| DY86 7/6 | EP80 5/- | HL41 4/- |
| E80F 23/- | EF85 4/6 | HVR2 9/- |
| E88CC 12/- | EF86 6/6 | K3A 30/- |
| E90CC 10/- | EF89 5/6 | KT32 8/- |
| EA60 1/- | EF91 3/6 | KT33C 6/- |
| EA73 7/- | EF92 2/- | KT44 5/9 |
| EABC80 5/9 | EF95 5/- | KT33 14/- |
| EAC91 3/6 | EF96 5/- | KT66 16/- |
| EAF42 8/- | EF183 6/6 | KT67 25/- |
| EB34 1/6 | EF184 6/6 | KT71 5/- |
| EB91 3/- | EH90 7/6 | KT76 8/6 |
| EBC33 6/- | FL31 15/- | KT88 22/- |
| EBC41 8/6 | FL32 3/9 | KT241 6/- |

| | | |
|------------|-------------|-----------|
| KT263 5/- | MB4 5/- | ML6 6/- |
| OC3 8/6 | N78 15/- | NE17 7/- |
| OA2 5/9 | OB2 6/- | OB3 7/- |
| OC3 5/3 | OD4 5/3 | OD5A 5/- |
| P41 4/- | PC86 9/- | PC88 9/- |
| PC97 7/6 | PC900 12/- | PC834 5/6 |
| PCF80 6/3 | PCF82 6/6 | PCF84 8/- |
| PCF86 8/- | PCF89 8/6 | PCF90 8/6 |
| PCF902 9/6 | PCF905 11/- | PCL81 9/- |
| PCL82 7/6 | PCL83 7/6 | PCL84 7/6 |
| PCL85 8/6 | PE85 4/6 | PL262 6/6 |
| PL263 6/6 | PL264 6/6 | PL265 6/6 |
| PL266 6/6 | PL267 6/6 | PL268 6/6 |
| PL269 6/6 | PL270 6/6 | PL271 6/6 |
| PL272 6/6 | PL273 6/6 | PL274 6/6 |
| PL275 6/6 | PL276 6/6 | PL277 6/6 |
| PL278 6/6 | PL279 6/6 | PL280 6/6 |
| PL281 6/6 | PL282 6/6 | PL283 6/6 |
| PL284 6/6 | PL285 6/6 | PL286 6/6 |
| PL287 6/6 | PL288 6/6 | PL289 6/6 |
| PL290 6/6 | PL291 6/6 | PL292 6/6 |
| PL293 6/6 | PL294 6/6 | PL295 6/6 |
| PL296 6/6 | PL297 6/6 | PL298 6/6 |
| PL299 6/6 | PL300 6/6 | PL301 6/6 |
| PL302 6/6 | PL303 6/6 | PL304 6/6 |
| PL305 6/6 | PL306 6/6 | PL307 6/6 |
| PL308 6/6 | PL309 6/6 | PL310 6/6 |
| PL311 6/6 | PL312 6/6 | PL313 6/6 |
| PL314 6/6 | PL315 6/6 | PL316 6/6 |
| PL317 6/6 | PL318 6/6 | PL319 6/6 |
| PL320 6/6 | PL321 6/6 | PL322 6/6 |
| PL323 6/6 | PL324 6/6 | PL325 6/6 |
| PL326 6/6 | PL327 6/6 | PL328 6/6 |
| PL329 6/6 | PL330 6/6 | PL331 6/6 |
| PL332 6/6 | PL333 6/6 | PL334 6/6 |
| PL335 6/6 | PL336 6/6 | PL337 6/6 |
| PL338 6/6 | PL339 6/6 | PL340 6/6 |
| PL341 6/6 | PL342 6/6 | PL343 6/6 |
| PL344 6/6 | PL345 6/6 | PL346 6/6 |
| PL347 6/6 | PL348 6/6 | PL349 6/6 |
| PL350 6/6 | PL351 6/6 | PL352 6/6 |
| PL353 6/6 | PL354 6/6 | PL355 6/6 |
| PL356 6/6 | PL357 6/6 | PL358 6/6 |
| PL359 6/6 | PL360 6/6 | PL361 6/6 |
| PL362 6/6 | PL363 6/6 | PL364 6/6 |
| PL365 6/6 | PL366 6/6 | PL367 6/6 |
| PL368 6/6 | PL369 6/6 | PL370 6/6 |
| PL371 6/6 | PL372 6/6 | PL373 6/6 |
| PL374 6/6 | PL375 6/6 | PL376 6/6 |
| PL377 6/6 | PL378 6/6 | PL379 6/6 |
| PL380 6/6 | PL381 6/6 | PL382 6/6 |
| PL383 6/6 | PL384 6/6 | PL385 6/6 |
| PL386 6/6 | PL387 6/6 | PL388 6/6 |
| PL389 6/6 | PL390 6/6 | PL391 6/6 |
| PL392 6/6 | PL393 6/6 | PL394 6/6 |
| PL395 6/6 | PL396 6/6 | PL397 6/6 |
| PL398 6/6 | PL399 6/6 | PL400 6/6 |
| PL401 6/6 | PL402 6/6 | PL403 6/6 |
| PL404 6/6 | PL405 6/6 | PL406 6/6 |
| PL407 6/6 | PL408 6/6 | PL409 6/6 |
| PL410 6/6 | PL411 6/6 | PL412 6/6 |
| PL413 6/6 | PL414 6/6 | PL415 6/6 |
| PL416 6/6 | PL417 6/6 | PL418 6/6 |
| PL419 6/6 | PL420 6/6 | PL421 6/6 |
| PL422 6/6 | PL423 6/6 | PL424 6/6 |
| PL425 6/6 | PL426 6/6 | PL427 6/6 |
| PL428 6/6 | PL429 6/6 | PL430 6/6 |
| PL431 6/6 | PL432 6/6 | PL433 6/6 |
| PL434 6/6 | PL435 6/6 | PL436 6/6 |
| PL437 6/6 | PL438 6/6 | PL439 6/6 |
| PL440 6/6 | PL441 6/6 | PL442 6/6 |
| PL443 6/6 | PL444 6/6 | PL445 6/6 |
| PL446 6/6 | PL447 6/6 | PL448 6/6 |
| PL449 6/6 | PL450 6/6 | PL451 6/6 |
| PL452 6/6 | PL453 6/6 | PL454 6/6 |
| PL455 6/6 | PL456 6/6 | PL457 6/6 |
| PL458 6/6 | PL459 6/6 | PL460 6/6 |
| PL461 6/6 | PL462 6/6 | PL463 6/6 |
| PL464 6/6 | PL465 6/6 | PL466 6/6 |
| PL467 6/6 | PL468 6/6 | PL469 6/6 |
| PL470 6/6 | PL471 6/6 | PL472 6/6 |
| PL473 6/6 | PL474 6/6 | PL475 6/6 |
| PL476 6/6 | PL477 6/6 | PL478 6/6 |
| PL479 6/6 | PL480 6/6 | PL481 6/6 |
| PL482 6/6 | PL483 6/6 | PL484 6/6 |
| PL485 6/6 | PL486 6/6 | PL487 6/6 |
| PL488 6/6 | PL489 6/6 | PL490 6/6 |
| PL491 6/6 | PL492 6/6 | PL493 6/6 |
| PL494 6/6 | PL495 6/6 | PL496 6/6 |
| PL497 6/6 | PL498 6/6 | PL499 6/6 |
| PL500 6/6 | PL501 6/6 | PL502 6/6 |
| PL503 6/6 | PL504 6/6 | PL505 6/6 |
| PL506 6/6 | PL507 6/6 | PL508 6/6 |
| PL509 6/6 | PL510 6/6 | PL511 6/6 |
| PL512 6/6 | PL513 6/6 | PL514 6/6 |
| PL515 6/6 | PL516 6/6 | PL517 6/6 |
| PL518 6/6 | PL519 6/6 | PL520 6/6 |
| PL521 6/6 | PL522 6/6 | PL523 6/6 |
| PL524 6/6 | PL525 6/6 | PL526 6/6 |
| PL527 6/6 | PL528 6/6 | PL529 6/6 |
| PL530 6/6 | PL531 6/6 | PL532 6/6 |
| PL533 6/6 | PL534 6/6 | PL535 6/6 |
| PL536 6/6 | PL537 6/6 | PL538 6/6 |
| PL539 6/6 | PL540 6/6 | PL541 6/6 |
| PL542 6/6 | PL543 6/6 | PL544 6/6 |
| PL545 6/6 | PL546 6/6 | PL547 6/6 |
| PL548 6/6 | PL549 6/6 | PL550 6/6 |
| PL551 6/6 | PL552 6/6 | PL553 6/6 |
| PL554 6/6 | PL555 6/6 | PL556 6/6 |
| PL557 6/6 | PL558 6/6 | PL559 6/6 |
| PL560 6/6 | PL561 6/6 | PL562 6/6 |
| PL563 6/6 | PL564 6/6 | PL565 6/6 |
| PL566 6/6 | PL567 6/6 | PL568 6/6 |
| PL569 6/6 | PL570 6/6 | PL571 6/6 |
| PL572 6/6 | PL573 6/6 | PL574 6/6 |
| PL575 6/6 | PL576 6/6 | PL577 6/6 |
| PL578 6/6 | PL579 6/6 | PL580 6/6 |
| PL581 6/6 | PL582 6/6 | PL583 6/6 |
| PL584 6/6 | PL585 6/6 | PL586 6/6 |
| PL587 6/6 | PL588 6/6 | PL589 6/6 |
| PL590 6/6 | PL591 6/6 | PL592 6/6 |
| PL593 6/6 | PL594 6/6 | PL595 6/6 |
| PL596 6/6 | PL597 6/6 | PL598 6/6 |
| PL599 6/6 | PL600 6/6 | PL601 6/6 |
| PL602 6/6 | PL603 6/6 | PL604 6/6 |
| PL605 6/6 | PL606 6/6 | PL607 6/6 |
| PL608 6/6 | PL609 6/6 | PL610 6/6 |
| PL611 6/6 | PL612 6/6 | PL613 6/6 |
| PL614 6/6 | PL615 6/6 | PL616 6/6 |
| PL617 6/6 | PL618 6/6 | PL619 6/6 |
| PL620 6/6 | PL621 6/6 | PL622 6/6 |
| PL623 6/6 | PL624 6/6 | PL625 6/6 |
| PL626 6/6 | PL627 6/6 | PL628 6/6 |
| PL629 6/6 | PL630 6/6 | PL631 6/6 |
| PL632 6/6 | PL633 6/6 | PL634 6/6 |
| PL635 6/6 | PL636 6/6 | PL637 6/6 |
| PL638 6/6 | PL639 6/6 | PL640 6/6 |
| PL641 6/6 | PL642 6/6 | PL643 6/6 |
| PL644 6/6 | PL645 6/6 | PL646 6/6 |
| PL647 6/6 | PL648 6/6 | PL649 6/6 |
| PL650 6/6 | PL651 6/6 | PL652 6/6 |
| PL653 6/6 | PL654 6/6 | PL655 6/6 |
| PL656 6/6 | PL657 6/6 | PL658 6/6 |
| PL659 6/6 | PL660 6/6 | PL661 6/6 |
| PL662 6/6 | PL663 6/6 | PL664 6/6 |
| PL665 6/6 | PL666 6/6 | PL667 6/6 |
| PL668 6/6 | PL669 6/6 | PL670 6/6 |
| PL671 6/6 | PL672 6/6 | PL673 6/6 |
| PL674 6/6 | PL675 6/6 | PL676 6/6 |
| PL677 6/6 | PL678 6/6 | PL679 6/6 |
| PL680 6/6 | PL681 6/6 | PL682 6/6 |
| PL683 6/6 | PL684 6/6 | PL685 6/6 |
| PL686 6/6 | PL687 6/6 | PL688 6/6 |
| PL689 6/6 | PL690 6/6 | PL691 6/6 |
| PL692 6/6 | PL693 6/6 | PL694 6/6 |
| PL695 6/6 | PL696 6/6 | PL697 6/6 |
| PL698 6/6 | PL699 6/6 | PL700 6/6 |
| PL701 6/6 | PL702 6/6 | PL703 6/6 |
| PL704 6/6 | PL705 6/6 | PL706 6/6 |
| PL707 6/6 | PL708 6/6 | PL709 6/6 |
| PL710 6/6 | PL711 6/6 | PL712 6/6 |
| PL713 6/6 | PL714 6/6 | PL715 6/6 |
| PL716 6/6 | PL717 6/6 | PL718 6/6 |
| PL719 6/6 | PL720 6/6 | PL721 6/6 |
| PL722 6/6 | PL723 6/6 | PL724 6/6 |
| PL725 6/6 | PL726 6/6 | PL727 6/6 |
| PL728 6/6 | PL729 6/6 | PL730 6/6 |
| PL731 6/6 | PL732 6/6 | PL733 6/6 |
| PL734 6/6 | PL735 6/6 | PL736 6/6 |
| PL737 6/6 | PL738 6/6 | PL739 6/6 |
| PL740 6/6 | PL741 6/6 | PL742 6/6 |
| PL743 6/6 | PL744 6/6 | PL745 6/6 |
| PL746 6/6 | PL747 6/6 | PL748 6/6 |
| PL749 6/6 | PL750 6/6 | PL751 6/6 |
| PL752 6/6 | PL753 6/6 | PL754 6/6 |
| PL755 6/6 | PL756 6/6 | PL757 6/6 |
| PL758 6/6 | PL759 6/6 | PL760 6/6 |
| PL761 6/6 | PL762 6/6 | PL763 6/6 |
| PL764 6/6 | PL765 6/6 | PL766 6/6 |
| PL767 6/6 | PL768 6/6 | PL769 6/6 |
| PL770 6/6 | PL771 6/6 | PL772 6/6 |
| PL773 6/6 | PL774 6/6 | PL775 6/6 |
| PL776 6/6 | PL777 6/6 | PL778 6/6 |
| PL779 6/6 | PL780 6/6 | PL781 6/6 |
| PL782 6/6 | PL783 6/6 | PL784 6/6 |
| PL785 6/6 | PL786 6/6 | PL787 6/6 |
| PL788 6/6 | PL789 6/6 | PL790 6/6 |
| PL791 6/6 | PL792 6/6 | PL793 6/6 |
| PL794 6/6 | PL795 6/6 | PL796 6/6 |
| PL797 6/6 | PL798 6/6 | PL799 6/6 |
| PL800 6/6 | PL801 6/6 | PL802 6/6 |
| PL803 6/6 | PL804 6/6 | PL805 6/6 |
| PL806 6/6 | PL807 6/6 | PL808 6/6 |
| PL809 6/6 | PL810 6/6 | PL811 6/6 |
| PL812 6/6 | PL813 6/6 | PL814 6/6 |
| PL815 6/6 | PL816 6/6 | PL817 6/6 |
| PL818 6/6 | PL819 6/6 | PL820 6/6 |
| PL821 6/6 | PL822 6/6 | PL823 6/6 |
| PL824 6/6 | PL825 6/6 | PL826 6/6 |
| PL827 6/6 | PL828 6/6 | PL829 6/6 |
| PL830 6/6 | PL831 6/6 | PL832 6/6 |
| PL833 6/6 | PL834 6/6 | PL835 6/6 |
| PL836 6/6 | PL837 6/6 | PL838 6/6 |
| PL839 6/6 | PL840 6/6 | PL841 6/6 |
| PL842 6/6 | PL843 6/6 | PL844 6/6 |
| PL845 6/6 | PL846 6/6 | PL847 6/6 |
| PL848 6/6 | PL849 6/6 | PL850 6/6 |
| PL851 6/6 | PL852 6/6 | PL853 6/6 |
| PL854 6/6 | PL855 6/6 | PL856 6/6 |
| PL857 6/6 | PL858 6/6 | PL859 6/6 |
| PL860 6/6 | PL861 6/6 | PL862 6/6 |
| PL863 6/6 | PL864 6/6 | PL865 6/6 |
| PL866 6/6 | PL867 6/6 | PL868 6/6 |
| PL869 6/6 | PL870 6/6 | PL871 6/6 |
| PL872 6/6 | PL873 6/6 | PL874 6/6 |
| PL875 6/6 | PL876 6/6 | PL877 6/6 |
| PL878 6/6 | PL879 6/6 | PL880 6/6 |
| PL881 6/6 | PL882 6/6 | PL883 6/6 |
| PL884 6/6 | PL885 6/6 | PL886 6/6 |
| PL887 6/6 | PL888 6/6 | PL889 6/6 |
| PL890 6/6 | PL891 6/6 | PL892 6/6 |
| PL893 6/6 | PL894 6/6 | PL895 6/6 |
| PL896 6/6 | PL897 6/6 | PL898 6/6 |
| PL899 6/6 | PL900 6/6 | PL901 6/6 |
| PL902 6/6 | PL903 6/6 | PL904 6/6 |
| PL905 6/6 | PL906 6/6 | PL907 6/6 |
| PL908 6/6 | PL909 6/6 | PL910 6/6 |
| PL911 6/6 | PL912 6/6 | PL913 6/6 |
| PL914 6/6 | PL915 6/6 | PL916 6/6 |
| PL917 6/6 | PL918 6/6 | PL919 6/6 |
| PL920 6/6 | PL921 6/6 | PL922 6/6 |
| | | |

ZENER DIODES

Comprehensive range 3V to 50V in three power ratings all 5% tol. 300mW 3/8 each. 1.5W 5/- each. 7W 6/6 each.

SCR's (THYRISTORS)

| | | | | |
|--------|------|------|------|------|
| Piv | 50V | 100V | 300V | 400V |
| 1 amp | 6/6 | 7/6 | 12/6 | 15/- |
| 3 amp | 7/6 | 8/6 | 14/6 | 17/- |
| 25 amp | 80/- | 35/- | 47/6 | 60/- |

SEMI-CONDUCTOR BARGAINS

| Type | No. | Price | Type | No. | Price | Type | No. | Price |
|--------|------|-------|--------|------|-------|-------|------|-------|
| 2N1727 | 15/- | | MAT101 | 8/6 | | OC71 | 3/6 | |
| 2N1728 | 10/- | | MAT120 | 7/6 | | OC72 | 5/- | |
| 2N1742 | 25/- | | MAT121 | 8/6 | | OC75 | 6/- | |
| 2N1747 | 25/- | | OA5 | 5/- | | OC76 | 5/- | |
| 2N1748 | 10/- | | OA10 | 6/- | | OC77 | 7/- | |
| AC107 | 9/- | | OA47 | 3/- | | OC78 | 5/- | |
| AC127 | 9/- | | OA70 | 2/- | | OC78D | 5/- | |
| ACV17 | 8/6 | | OA79 | 2/6 | | OC81 | 5/- | |
| ACV18 | 5/6 | | OA81 | 2/6 | | OC81D | 5/- | |
| ACV19 | 6/6 | | OA85 | 2/6 | | OC82 | 5/- | |
| ACV20 | 5/6 | | OA90 | 2/6 | | OC83 | 5/- | |
| ACV21 | 6/- | | OA91 | 2/6 | | OC84 | 6/- | |
| ACV22 | 4/6 | | OA200 | 3/3 | | OC139 | 8/6 | |
| AF114 | 7/- | | OA202 | 4/3 | | OC140 | 12/6 | |
| AF115 | 6/6 | | OC22 | 10/- | | OC170 | 5/- | |
| AF116 | 7/- | | OC23 | 17/6 | | OC171 | 6/- | |
| AF117 | 5/- | | OC24 | 15/- | | OC200 | 9/- | |
| AF118 | 10/- | | OC26 | 7/6 | | OC201 | 12/6 | |
| AF139 | 12/6 | | OC28 | 15/- | | OC202 | 13/6 | |
| AF186 | 17/6 | | OC29 | 17/6 | | OC203 | 12/6 | |
| AF212 | 15/- | | OC36 | 12/6 | | OC271 | 15/6 | |
| AS221 | 15/- | | OC36 | 15/- | | ORP12 | 8/6 | |
| BC107 | 14/6 | | OC42 | 6/6 | | ORP60 | 10/- | |
| BY100 | 4/6 | | OC44 | 4/- | | 8B078 | 6/6 | |
| BYZ13 | 7/6 | | OC45 | 3/6 | | 8B305 | 8/6 | |
| MAT100 | 7/9 | | OC70 | 4/- | | 8B261 | 10/- | |

See in the Dark INFRA-RED BINOCULARS



These infra-red binoculars when fed from a high voltage source will enable objects to be seen in the dark, providing the objects are in the rays of an infra-red beam. Each eye tube contains a complete optical lens system as well as the infra-red cell. This optical system can be used as lenses for T.V. cameras—light cells, etc. (details supplied). The binoculars form part of the Army night driving (Tabby) equipment. They are unused and believed to be in good working order but sold without a guarantee. Price **£3.17.6**, plus 10/- carr. and ins. Handbook 2/6.

8 RANGE TEST METER



For checking car electrics, radio, TV, ignition systems, household lighting, etc.
Measure a.c./d.c. volts, d.c. current, Resistance. Will last a lifetime.
39/6 (P. & P. 3/6)

STUPENDOUS OFFER—£11 for £2



Only recently sold for **£10.9.6**. Note these features: ● Long & Medium Wave ● Long dial ● Push pull output ● A.V.C. and feed back ● Ferrite aerial ● Six transistors ● Cabinet size 4 1/2 in x 3 in x 1 1/2 in with carrying strap. You get everything you need and instructions. **39/6** plus 3/6 P. & P. or supplied with extra up chassis 10/- extra. Battery 1/9 extra. Data separately 2/6.

OVEN THERMOSTAT

Range 20°F—550°F. Set by spindle control. Contact rated at 20amps 250V 10in sensing element on approximately 4in copper capillary tube. 12/6 each, plus 2/6 postage and insurance.

COSMOCORD PICK-UP for 7in records

Grey plastic arm fitted with GP79/5 mono ceramic cartridge and replaceable stylus. Ref. 879 Freq. response 50-8000cps, 250mV output. Tracking wt 9gms. 7/6 each, plus 2/6 p. & p.

SUPERTONE G.C.V.

Saves you work—
It's partly built

Like its predecessors this latest Companion has full fit performance—such as only a good wooden cabinet and biflux speaker can give, and due to its being partly built you will have it going in an evening. Note these features:

- All Mullard Transistors including 3 x AF117.
- Two-tone Cabinet, size 11 8 3in
- All circuit requirements—Push-pull output—A.V.C. and feed back, etc.
- Printed circuit board all wired only connections, e.g. to Volume control—W.C. Switch and Tuning Condenser.
- Pre-aligned 1F stages complete with full instructions. Price only **£3.19.6.**, plus 6/6 post and insurance.

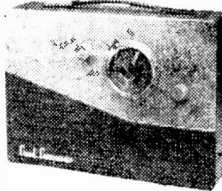

DRILL CONTROLLER

Electronically changes speed from approximately 10 revs. to max. Full power at all speeds by fingertip control. Kit includes all parts, case, everything and full instructions. 18/6, plus 2/6 post and insurance.



SMALLEST TAPE RECORDER AVAILABLE (6 1/2" x 2 1/2")

Will record or play back (into earphones) whilst still in your pocket. Uses standard tape which is re-usable indefinitely. Complete with batteries, ready to work. **£6.**, plus 5/- post and insurance.

THIS MONTH'S SNIP

Of particular importance to hospitals, labs, and other places where stand-by a.c. supply is required. Also to yacht owners, caravan dwellers where 50 cycle supply is required to work TV or similar.

Admiralty motor alternator giving regulated 230V 50 cycle output from 24V d.c. supply. Wonderfully made to stringent specification. Rating is 80W but like other Admiralty equipment this rating can be increased 50% with safety. In grey metal box size 24 x 10 x 14in approximately. Controls are i.e. on/off switch and changeover switch from mains to alternator. On the front panel also is output volt meter, and panel with fuses protecting input/output. Weight approximately 100lb, unused. Price **£45** each (probably one tenth of cost to Government). Carriage extra at cost.

THE VECTRONOME CAPSTAN DRIVEN TAPE RECORDER

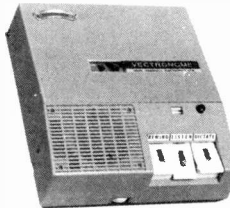

This is a truly portable self-contained instrument with built-in microphone and loudspeaker using a 5 transistor amplifier with PP output and suitable for operation from mains or by rechargeable batteries. Tape capacity is 25 minutes on easily changed spools. A tape position indicator gives quick reference to any part of dictation. Recording level is automatically preset during dictation and can be adjusted to suit operator. Interlock prevents unintentional erasures. Tape speed controlled by fly wheel driven capstan. Very portable in neat case with carrying handle, overall size of which is approximately 6 1/2 x 7 1/2 in. Price with tape, nickel cadmium rechargeable batteries and main battery charger **£9.19.6.** (rather less than 1/2 original price). Postage and insurance 7/6. Unused and in perfect working order.

TWO NEW KITS

Multi-purpose Audio Switch. 5 transistors and all other components to make this ingenious unit described in May's Practical Wireless only **48/6**, plus 2/9 post and ins.
Analog Computer, all parts including centre zero galvanometer, perspex cursors, 8in dial, to make the unit described in May's Practical Wireless. Available at **39/6**, plus 2/9d. post and ins.

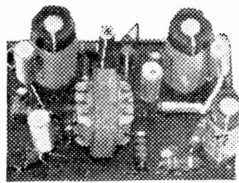

750mW TRANSISTOR AMPLIFIER

4 transistors including two in push-pull output for crystal or magnetic microphone or pick-up—feed back loops—sensitivity 5mV. Price 19/6. Post and insurance 2/6. Speakers 3in 12/6, 5in 13/6, 6 1/2 in 14/6.

SRP 12 BATTERY OPERATED RECORD DECK

The SRP 12 Battery Operated record deck. Made by Garrard, a unit of proved reliability. Ideal if you intend making a portable player. Operates from PP9 or similar battery, runs at 33 or 45 rpm. Supplied complete with ceramic cartridge, suitable stereo or mono. Limited quantity. Price **£3.7.6**, plus 6/- post and insurance.



MAIN TRANSISTOR POWER PACK

Designed to operate transistor sets and amplifiers. Adjustable output 6V, 9V, 12V for up to 500mA (class B working). Takes the place of any of the following batteries: PP1, PP2, PP4, PP6, PP7, PP9, and others. Kit comprises: mains transformer rectifier, smoothing and load resistor, 5,000 and 500mfd condensers. Zener diode and instructions. Real snip at only 14/6, plus 3/6 postage.

9 VOLT PRECISION MOTOR

Intended for driving battery operated tape recorders and record players. Laminated, 6 Pole armature with Brush Gear and Rapid start switch. Normally 25/-, Our Price 9/-, plus post and insurance 1/6.



HI-FI SPEAKER BARGAIN

12in High fidelity loudspeaker. High flux permanent magnet type with either 3 or 15 ohm speech coil. Will handle up to 10 watts. Brand new by famous maker. Price 28/6. With built-in tweeter 35/- plus 3/6 post and insurance.



SILICON RECTIFIERS

Tested and guaranteed

| | | | | | |
|-------|------|-----|--------|------|------|
| 750mA | 100V | 1/8 | 1 amp | 100V | 3/- |
| | 200V | 1/6 | | 200V | 4/- |
| | 400V | 3/6 | | 400V | 6/- |
| 3 amp | 100V | 3/6 | 10 amp | 100V | 9/6 |
| | 200V | 5/- | | 200V | 12/6 |
| | 400V | 7/6 | | 400V | 14/6 |
| | 600V | 9/6 | | 400V | 14/6 |

Sub-miniature glass encased—only approx. 1in long wire ended.
400mA 0-30V 1/6 100V 2/6 200V 4/6

MINIATURE WAFER SWITCHES

4 pole, 2 way—3 pole, 3 way—4 pole, 3 way—2 pole, 4 way—3 pole, 4 way—2 pole, 6 way—1 pole, 12 way. All at 3/6 each 36/- dozen, your assortment.



PP3 ELIMINATOR play your pocket radio from the mains! Save 2s. Complete component kit comprises 4 rectifiers—mains dropper resistances, smoothing condenser and instructions. Only 6/6, plus 1/- post.

SILICON PLANAR TRANSISTORS

2N2926—general purpose type. Suitable for AF or RF up to 200 mcs, 3/- each or 4 for 10/-.

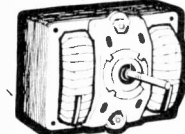

RECORD CHANGER MOTOR, made by Garrard for their best changers, laboratory balanced, size 2 1/2 in x 2 1/2 in. Suitable for 115V or 230/240V working by rearranging lead connections. 15/- each. P. & P. 4/6.

PHOTO-ELECTRIC KIT

All parts to make light operated switch/burglar alarm/counter, etc. Kit comprises printed circuit, laminated boards and chemicals, Latching relay, infra-red sensitive Photoacetic and Hval. 2 Transistors, cond., Terminal block, Plastic case. Essential data, circuits and P.C. chassis plans of 10 photo-electric devices including auto. car parking light, modulated light alarm. Simple invisible ray switch—counter—stray light alarm—warning tone electronic alarm—projector lamp stabiliser, etc., etc. Only 39/6, plus 2/-, post and insurance.

TRANS/CEIVERS

Communicate without connecting wires. Wonderful present for child. All transistor, crystal controlled with telescopic aerial and push button operation. Uses P.P.3 batteries. Pair of instruments, complete and ready to use, **£5.9.6**, the two, plus 5/- post and insurance. These cannot be used in U.K.

SIMMERSTAD HEATER REGULATOR

Suitable to control elements, heater, soldering irons and boiling rings up to 2,500W. Completely adjustable, normal price 55/- each. Special Snip Price 12/6, plus 2/- postage and insurance.

Where postage is not definitely stated as an extra then orders over £3 are post free. Below £3 add 2/9. Semi-conductors add 1/- post. Over £1 post free.

ELECTRONICS (CROYDON) LIMITED

(Dept. P. E.) 102/3 TAMWORTH RD., CROYDON, SURREY (Opp. W. Croydon Stn.)

also at 266 LONDON ROAD, CROYDON, SURREY



SR.550. Professional Communications Receiver

have
you
seen...

the
complete
range of



K.140. Professional Volt-Ohm-Milliammeter

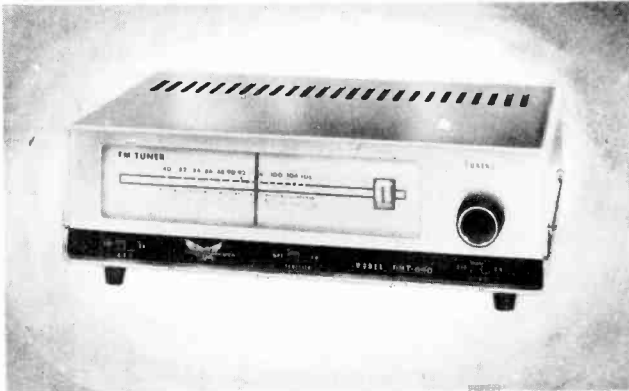

FMT. 640. High Fidelity F.M. Tuner



EAGLE
products

The "Eagle" Brand was launched 10 years ago and it was impossible to foresee that in such a short time the range would grow to cover over 500 items, all carrying the "Eagle" name. Whether you are interested in Hi-Fi, Amateur Radio, Do-it-Yourself projects or any field of Electronics, "Eagle" offer you the widest choice of sensibly priced products and by the end of the year we plan to increase our range to cover the formidable total of 700 items.

If you would like to study our entire range in the leisure of your home we will be delighted to send you our catalogue free of charge or why not ask your local dealer (there are over 6,000 "Eagle" stockists) to show you the latest "Eagle" Products today!

To: **EAGLE PRODUCTS**, Dept. P.E.7,
Coptic Street, London, W.C.1.

Please send me catalogue of the entire "Eagle" range.

Name

Address

SEMICONDUCTOR PROGRESS

SEMICONDUCTOR devices are the key "active" components in most electronic circuits of today. Even in those few fields where the thermionic valve so far remains dominant, it is just a matter of time before new solid state devices make their challenge.

But to return to the present. Developments in semiconductor technology over the last few years have brought about great changes. Now we find that the once commonplace *pnp* germanium transistor has been to a very large extent superseded by the *npn* silicon planar transistor. Originally the latter was an expensive component, but with large quantity production and simpler forms of encapsulation—such as used in the Epoxy Plastic type—the cost of these transistors has fallen dramatically. Silicon transistors have of course important technical advantages over germanium, perhaps most significant is the low leakage current feature. Variants of the silicon transistor have been developed and are now available, such as the field effect transistor (f.e.t.), the metal oxide silicon transistor (m.o.s.t.), and the unijunction transistor. Each of these devices has some unique characteristic and contributes towards widening the scope of the circuit designer. Thus with careful choice of device it is possible to design fully transistorised circuits for such diverse requirements as low noise audio stages, and ultra high radio frequency stages.

In discussing transistor developments we should not overlook the semiconductor diode. Many interesting new diode devices have appeared in recent times. The main contribution these will make to electronic progress seems to be in the extreme high region of the radio frequency spectrum. Using the negative resistance characteristic these diodes can be operated as oscillators, amplifiers, or switches at frequencies beyond 10,000MHz.

These developments are of great interest to the amateur, and provide a basis for further useful constructional projects.

If there has been a tendency for semiconductor circuits to become rather stereotyped, this is certainly not so now. Learning how these new devices operate and experimenting with practical circuits provides further intellectual exercise for the inquisitively minded.

THIS MONTH

CONSTRUCTIONAL PROJECTS

| | |
|-----------------------------|-----|
| MODEL CONTROL INSTALLATIONS | 495 |
| ENLARGEMENT EXPOSURE GUIDE | 504 |
| INVESTIGATOR OSCILLOSCOPE | 508 |
| RADIO SERVICING AID | 522 |

SPECIAL SERIES

| | |
|---------------------------------------|-----|
| COMPUTER EVOLUTION—3 | 530 |
| CLASSIC COMMUNICATION RECEIVERS—CR100 | 526 |

GENERAL FEATURES

| | |
|------------------------|-----|
| ELECTROMAGNETIC RELAYS | 488 |
| TUNNEL DIODES | 517 |

NEWS AND COMMENT

| | |
|--------------------------|-----|
| EDITORIAL | 487 |
| AUDIO TRENDS | 502 |
| MARKET PLACE | 515 |
| ELECTRONORAMA | 520 |
| SPACE SCIENCE LABORATORY | 525 |
| NEWS BRIEFS | 528 |
| POINTS ARISING | 528 |
| DETACHED PARTICLES | 541 |
| READOUT | 542 |

Our August issue will be published on
Friday, July 14

ELECTRO

WHEREVER we find electronic apparatus we frequently find relays. While, indeed, many functions once performed by the relay are now better carried out by semiconductors, there are still countless applications where only the relay can be used.

Their low cost, their ready availability on the surplus market, their reliability, and above all their versatility make them ideally suited to many amateur constructions.

This article considers various types of relay, their operating principles, their limiting characteristics, and some of the many interesting circuits in which they can be used.



By A.T.J. Carrington

MAGNETIC RELAYS

WHAT IS A RELAY?

A relay is nothing more than an electrically operated switch. In Fig. 1 can be seen a diagrammatic representation of a simple relay.

A coil of wire is wound round a soft iron core. A moving armature, also of soft iron, is pivoted near one end and held away from the core by a tension spring. This armature carries a moving contact which meets a fixed contact when the armature is pulled down by the magnetic attraction of the coil when energised.

When a current is passed through the coil, the core becomes an electromagnet. If the current provides a sufficiently strong magnetic field to overcome the tension of the spring, the armature is attracted to the core, thus bringing the two contacts together and so completing a remote circuit.

When the current is cut off, or the relay de-energised, the core ceases to be magnetised and the armature, under the influence of the spring, will return or "drop out" to its original position, so breaking the remote circuit.

This is the simplest form of relay, and the important points to notice are:

1. That the remote circuit is completely independent and isolated from the relay operating circuit, and
2. That a comparatively small current, sufficient to operate the relay, can be used to control an extremely

large current in the remote circuit, limited only by the size and construction of the contacts.

Fig. 2 shows some other contact arrangements. Fig. 2a shows a "break" contact, i.e. one which is normally closed, but opens when the relay is energised. Fig. 2b shows a "change over" contact, the moving contact changing from one contact to the other when energised.

Many relays have more than one contact set, several being operated by only one armature, see Fig. 3. Although as more contact sets are used, the relay must be designed to handle the increased mechanical load and may require a heavier current to operate efficiently.

CIRCUIT SYMBOLS

A great deal of confusion often arises over the interpretation of relay circuitry and the nomenclature used. To obviate this, reference to British Standard BS 530 will be helpful.

The coil of the relay is drawn as a rectangle with the connecting wires touching the longest sides. Inside this rectangle the d.c. resistance of the coil is given (if known). (See Fig. 4.) Adjacent to the coil symbol is the reference number of the component, the first relay being RLA, the second RLB, the third RLC, and so on.

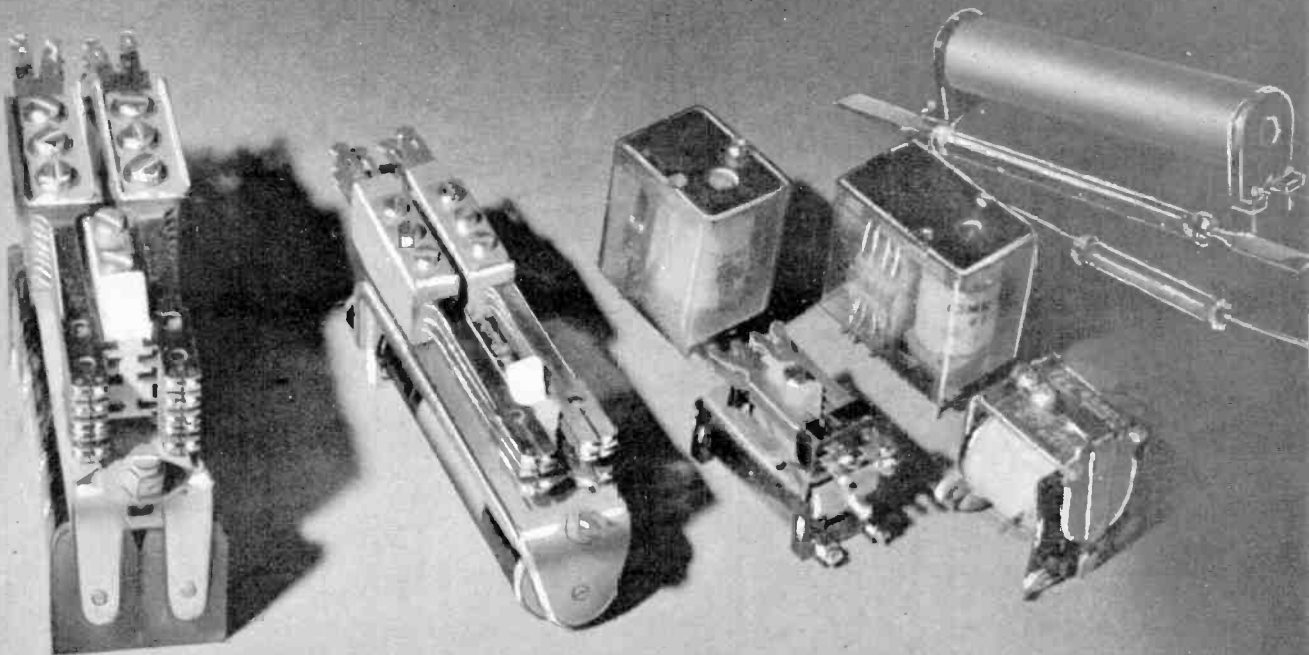

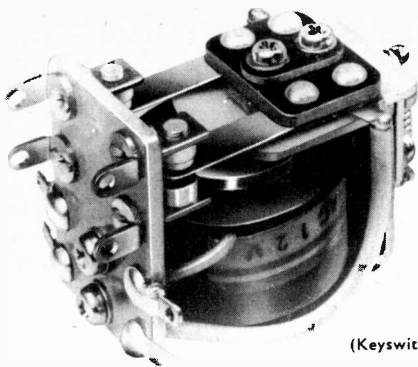

(Keyswitch Relays)

Balanced armature relay with power contacts

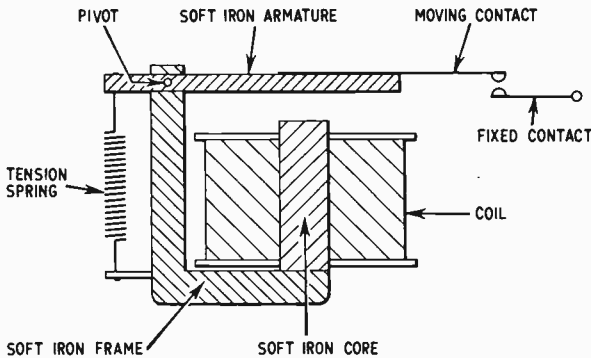

Fig. 1. Balanced armature relay with make contacts

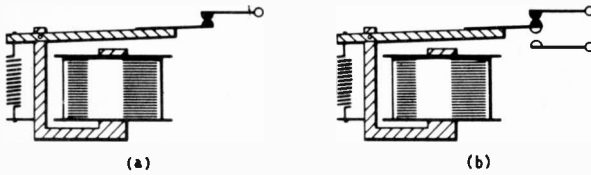

Fig. 2a. Break contacts

Fig. 2b. Make contacts

This code is underlined and given a number below this line which indicates the number of *sets* of contacts on the relay that are used in the circuit. Each *set* would be made up from two or three contact strips, depending on the type of switching operation which it performs.

Some variations on the coil symbol may be shown, these being given by an extension to the rectangle (see Fig. 5) to show an extra characteristic of special types.

Relay contacts are quite simple to interpret if a little common sense is exercised. Fig. 6 shows a few examples. The code number is made up from the letters of the associated relay coil followed by the contact set number. For example, the first switch on the first relay RLA is RLA1, the second switch RLA2, and so on. Similarly, the first switch on the second relay RLB is RLB1, the second switch RLB2, and so on. All relay contacts should be shown on a circuit diagram in the condition when the relay is not energised. All contact sets on one relay are operated simultaneously.

THE COIL

The magnetic force appearing between the pole face and the armature depends on the number of turns in the coil, and the current flowing through it, the product of the two being known as the ampere-turns of the coil. If a particular relay, for example, requires 50 ampere-turns to attract the armature, then we could use a coil having one turn with 50 amps flowing through it or a coil of 500 turns with 100mA flowing to produce the same magnetic field.

Relay coils are generally designated by their d.c. resistance, and are available from less than 1 ohm up to 50 kilohms or more, the selection of a specific value depending on the voltage available, and the type of circuit in which the relay is used.

There are three current characteristics of a relay which are fundamental to its operation and which must be known.

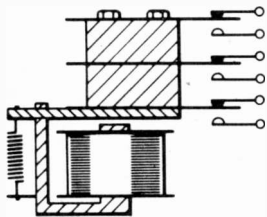

Fig. 3. Three stacked change-over sets

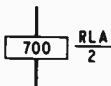

Fig. 4a. Circuit symbol and annotation of a relay coil

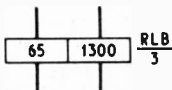
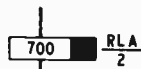
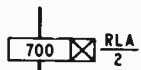

Fig. 4b. Circuit symbol of a relay with two different coils



(a) **Slow to release**



(b) **Slow to operate**

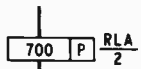

(c) **Polarised relay**

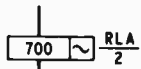

(d) **A.C. operated**

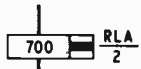

(e) **High speed**

Fig. 5. Variations on the circuit symbol for specific functions

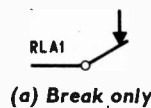

(a) **Break only**

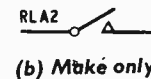

(b) **Make only**

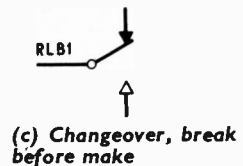

(c) **Changeover, break before make**

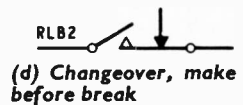

(d) **Changeover, make before break**

Fig. 6. Circuit symbols of contact arrangements

"PULL-IN" CURRENT

The magnetic force has to overcome the large air gap between the armature and pole face, the friction of the pivot, and the tension of the contact springs, so that the number of ampere turns has to be fairly large.

The current required just to operate the armature fully, and close the contacts, is the "pull-in" current.

"HOLD-ON" CURRENT

When the armature is closed, there is no gap between armature and pole face. As the attractive force on the armature is inversely proportional to the square of the distance between it and the pole face, while the opposing force of the contact springs is almost linear, it follows that the current required to "hold in" or keep the relay closed is less than the "pull-in" current.

"DROP-OUT" CURRENT

If the current is reduced still further the tension of the spring overcomes the magnetic field and the armature is released. This current is considerably less than the "pull-in" current, and the difference between the two is known as the "differential" of the relay. This "differential" gives the relay some useful properties as we shall see later.

CORE AND ARMATURE

It is obviously necessary that the core and armature should be made of a material having low retentivity, that is, the ability to discharge all of its magnetism when de-energised. When the current is switched off, it should retain little or no magnetism, otherwise the armature would tend to "stick" to the core. Even the best soft iron has some magnetic remanence, so to avoid the risk of sticking, a copper rivet is sometimes fixed in the armature (see Fig. 7), so that it never actually touches the core. However, some relays make deliberate use of this "sticking" by having a core of highly remanent material. We shall consider these later.

(Below). Post Office 3000 type relay

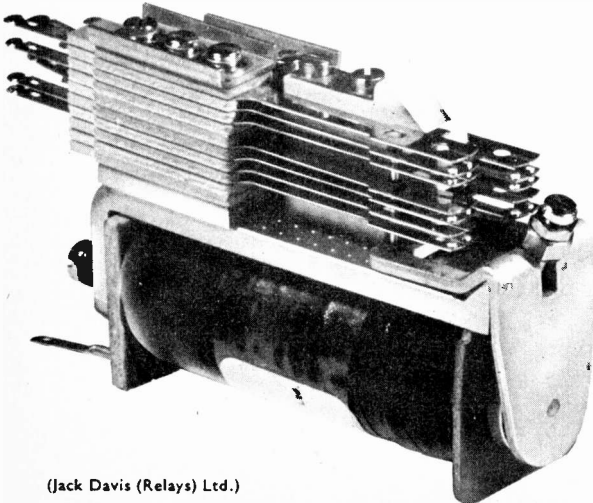

(Jack Davis (Relays) Ltd.)

CONTACTS

There are many different types of contact assembly, the choice of which is affected by numerous factors, but in general contacts are made from the following materials.

Platinum

Completely free from oxidation, and provides an extremely reliable contact even at low contact pressure. Its disadvantage is its extremely high cost, and so it is generally used only in hermetically sealed devices where minute currents have to be switched.

Silver

The most widely used contact material is silver, which is relatively inexpensive but susceptible to surface oxidation at low currents. It is also liable to "metal transfer", i.e. when switching heavy d.c. currents, metal is transferred from one contact to the other forming a "pip" and "crater", which may cause the points to lock together. An exaggerated form of this defect is shown in Fig. 8.

Palladium/Silver

This alloy is notable for its very low oxidation and so is widely used for light currents of less than 500mA, particularly in audio circuits where such oxidation must be avoided. It is, therefore, a good compromise between reliability and cost.

Tungsten

Tungsten is usually used for bell or buzzer contacts and requires a high contact pressure. Its current carrying capacity is limited due to its high specific resistance, hence it is seldom found on relays.

Elkonite

A product of silver and cadmium oxide, this alloy is very hard wearing, withstands arcing, has low metal transfer, but is unsuitable for low currents.

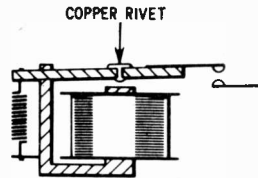

Fig. 7. Copper rivet in the armature to avoid "sticking"

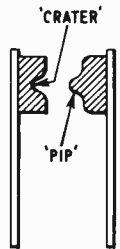
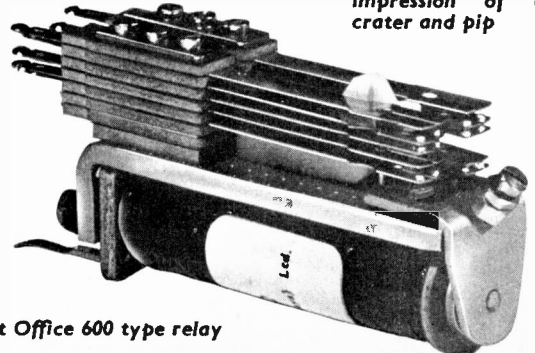

Fig. 8. Exaggerated impression of a crater and pip



Post Office 600 type relay

Gold

Again expensive and used mainly for low current applications in sealed devices such as reed relays. Gold is used where extremely high reliability is necessary.

The contacts are usually riveted to strips of phosphor bronze or beryllium copper which form the springs. Contact rating is determined by:

1. The steady current which they are required to carry. Heavy currents require larger contact points to conduct the heat away from the point of contact.

2. Arcing, which may occur when the circuit is just broken. The degree of arcing depends on the load being switched and whether the supply is a.c. or d.c.

One of the commonest types of relay available, the Post Office style relay (see Fig. 9), uses two types of contact. A light duty one which consists of two small silver rivets in a forked strip (Fig. 10a), and a heavy duty type usually of Elkonite and having a large single contact (Fig. 10b).

CARE OF CONTACTS

Grease, dust and dirt are the greatest enemies of relay contacts. The silver oxide which forms on the surface of silver contacts is a conductor of electricity and does not seriously affect the operation of the relay. However, a non-conductive film may form on silver contacts in the presence of sulphur or sulphur compounds in the air. To remove grease and dirt, carbon tetrachloride may be used, or in stubborn cases a special spatula or a polished steel blade, for example, a feeler gauge. *Never* use a file, however fine, particularly on the small contacts of a sensitive relay.

Many relays are available with transparent plastic covers to protect the relay from such dirt and dust. These are recommended to be used whenever possible.

A second source of contact contamination and deterioration through pitting is sparking between the contacts. It is important therefore that the current rating of a particular contact is not exceeded, and where inductive loads are to be switched spark suppression components should be used.

Because of the many varying types of load which may require switching by relay contacts, it is difficult to generalise on the values of these suppression components, although typical values are shown in Fig. 11.

For best results, the values of capacitor and resistor are best selected empirically, the contacts being observed with a magnifying glass while the relay is used to switch the required load. These values can be varied until minimum sparking occurs.

When relays are used to charge or discharge high value capacitors local overheating may occur, because, of the momentarily high charge/discharge current, unless the contacts are generously rated. The points may even become welded together. For this type of application, therefore, large area contacts are necessary. The heavy duty type mentioned earlier would suit.

A point that is often overlooked is that the filaments of lamps, when cold, possess a much lower resistance than when hot. Again this can lead to an unexpectedly high current at the instant of switch-on, so generously rated contacts are again necessary. It is as well to remember that d.c. arcing is much more of a problem at voltages over about 30V.

TYPES OF RELAY

There are many different types of relay, but we shall describe those easily available and most useful to the amateur constructor.

Balanced Armature

A typical example of a balanced armature relay is shown in Fig. 1 and is a good general purpose relay having reasonably fast operate and release times, typically 15 milliseconds. This type of relay is readily available in a large range of coil resistances, and with up to four sets of changeover contacts.

GPO Types

There are two common Post Office types, the 600 and the 3000. Both are similar in appearance, but the 3000 type is the larger and probably the most frequently used.

Being the most versatile of all relays, their construction is such that spring sets and coils can be readily interchanged, and purchased separately, thus enabling a relay to be rapidly "tailor made" to individual requirements. The construction of the 3000 type telephone relay is shown in Fig. 9.

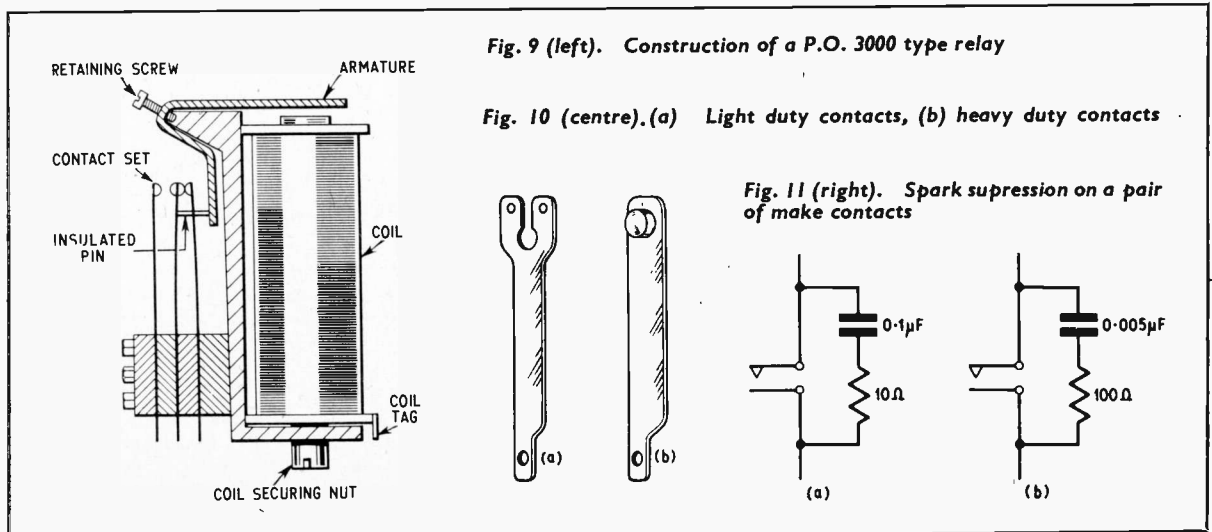

This relay can be made very sensitive for a general purpose relay (down to 15mW), can have up to nine changeover contact sets, and has an operate/release time in the region of 15 to 40 milliseconds. Some are equipped with residual screws in the armature to adjust the drop-out sensitivity.

The contacts can be readily adjusted to make before break, or *vice versa*. Some of them have slugs (extra piece of core material) at one end of the coil assembly to provide slow release. They are readily available on the surplus market at low cost.

Polarised Relay

The polarised type of relay can be classified as a sensitive relay and used for such purposes as radio control, where small currents are required to exert reliable control. Its construction is shown in Fig. 12.

The armature is unbalanced and attracted to one side of the pole piece by suitably adjusting the contact screws. When a d.c. voltage of the correct polarity is applied to the coil, the armature becomes magnetised by the field of the coil and the armature is attracted to the other contact. This relay can be adjusted to respond to currents in either direction, merely by adjusting the contact screws.

Differential Relay

Another very sensitive relay, useful in bridge circuits, consists basically of a moving coil movement with one very light duty changeover set (Fig. 13).

It can be adjusted so that either no contact is made when de-energised, or a current in one direction closes one pair, or a current in the other direction closes the other pair of contacts.

Two-step Relay

These special relays close their contacts on the first impulse, and open them on the second, and have many applications, for example, automatic stopping and starting of selected lengths of tape on a tape recorder by means of a metallic sensing tape. Available with one or two changeover sets.

Reed Relay

A comparatively recent development, the reed relay consists of two magnetic reeds sealed in a glass tube which is filled with an inert gas (Fig. 14a).

Upon energising the coil each reed becomes the opposite pole of a magnet, hence they attract each other and make contact. Characteristics of the reed relay are: small size, very fast operate times (2 milliseconds typical). The current differential is rather large, the release current being about 50 per cent of the operate current.

The basic reed unit has a normally open pair of contacts, but by biasing with a suitable magnet it can be used as a normally closed relay; with a second reed unit (unbiased) mounted in the same coil, a changeover contact can be arranged. See Fig. 14b.

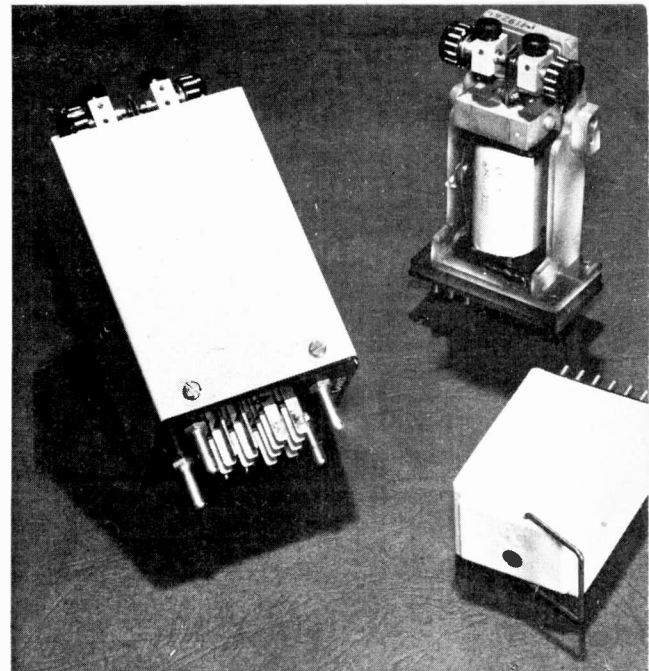

Plug-in polarised relay (S.T.C.)

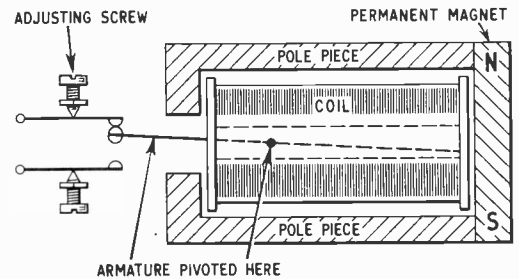

Fig. 12 (above). Section through a polarised relay

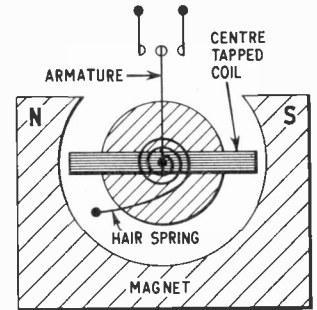
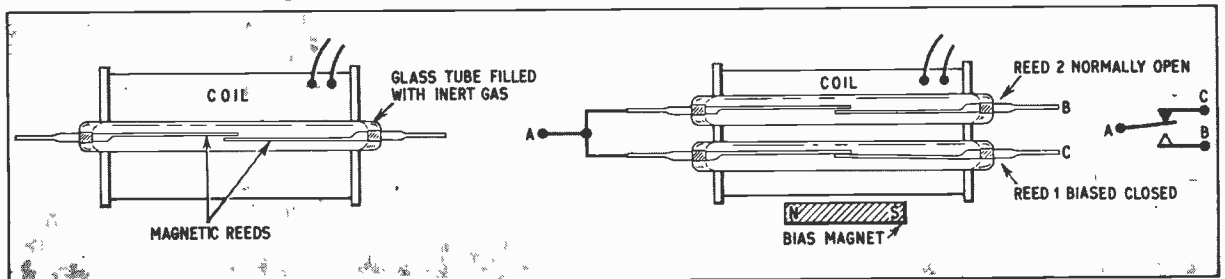
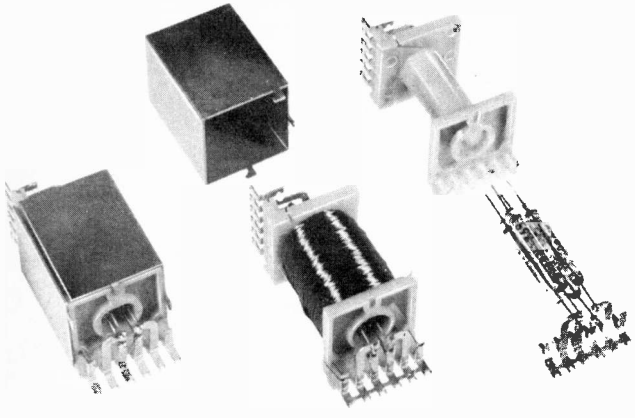

Fig. 13 (right). Section through a differential relay

Fig. 14a (below left). Reed relay in a glass tube inserted in a coil

Fig. 14b (below right). Two reed switches wired as a changeover





Four reed switches in one coil for telephone switching
(Plessey Telecommunications Group)

Because the reed tips are gold plated and are sealed in an inert gas, contact resistance is very low, so over a long period they can be used with small currents successfully and reliably.

Coils require 50-80 ampere turns and are easy to wind to individual requirements.

Uniselector or Stepping Relay

This is a highly specialised electrical switch, used commonly in telephone exchanges, and in applications where several circuits are to be switched in sequence, such as certain systems of radio control, automatic testing of components and wiring, etc.

Basically, the uniselector consists of a semicircular metal frame, "F" on which are mounted up to eight "banks" of fixed contacts "D", usually 25 of these contacts to each bank. See Fig. 15.

These contacts are selected in sequence by wiper arms "W" (connected by spring "brushes" to tags on the frame) mounted on a circular boss, carrying on

one end a toothed ratchet wheel "R". A soft iron armature "A" is attracted to the core when the coil "C" is energised, and on de-energising, advances the ratchet wheel by one tooth, which in turn advances the wiper by one contact. Thus each current pulse will rotate the selector by one contact.

A break contact is usually fitted, actuated by the armature when fully energised, which, if wired in series with the supply circuit will enable the uniselector to "hunt" or run continuously until stopped by an external switch or relay. Uniselectors are usually available on the surplus market with coils wound for 24V d.c., but with careful adjustment they can be made to work reliably on 12V d.c.

A typical use of a uniselector could be in an electronic version of "snakes and ladders". Each contact position on one bank of the uniselector lights a lamp in the corresponding square of the playing field, when the wiper is on that particular contact.

The other banks of the uniselector can be used in suitable circuits to advance automatically the wiper by the requisite number of contacts if a ladder is encountered, and similarly to retard it in the event of meeting a "snake".

The throw of the dice can also be automatic by using a uniselector wired in groups of six and operated by a pulse whose length varies at random. In this manner the machine's moves can be made completely automatic, being initiated by the completion of the human opponent's move.

The uses to which uniselectors may be put is limited only by the imagination, and the many characteristic circuits involved in their use are so numerous as to require a separate article to cover them!

Next month we shall look at some more specialised types of relay, then describe some of the circuits in which relays can be used.

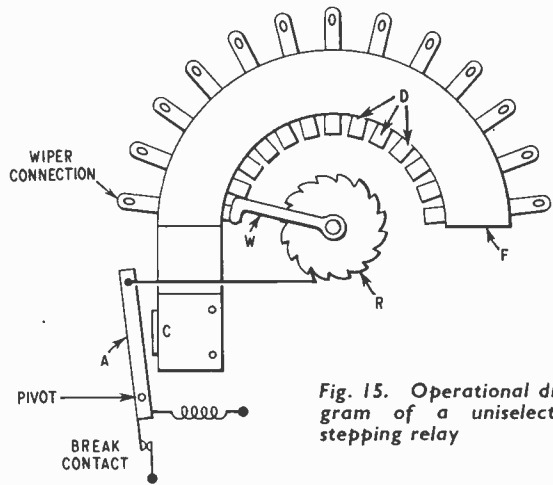
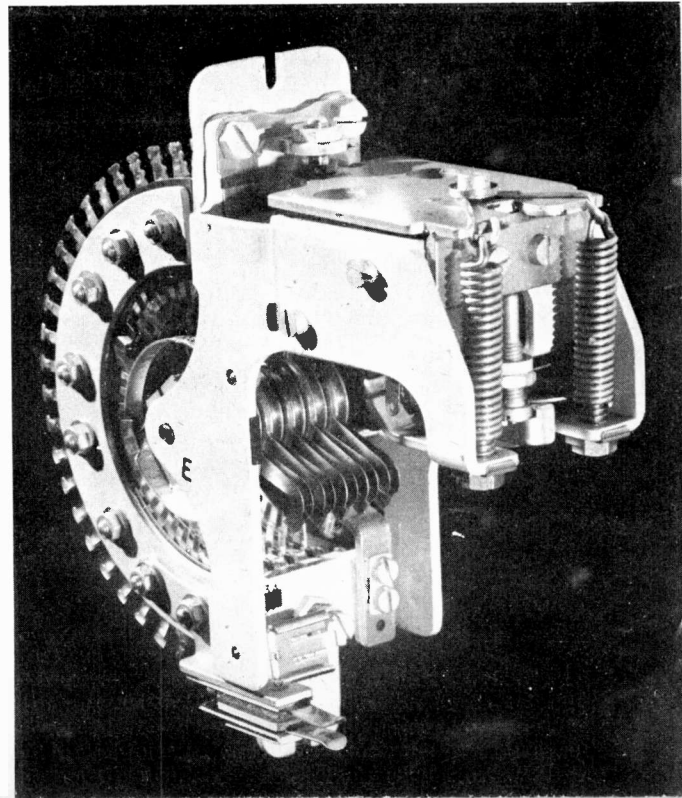
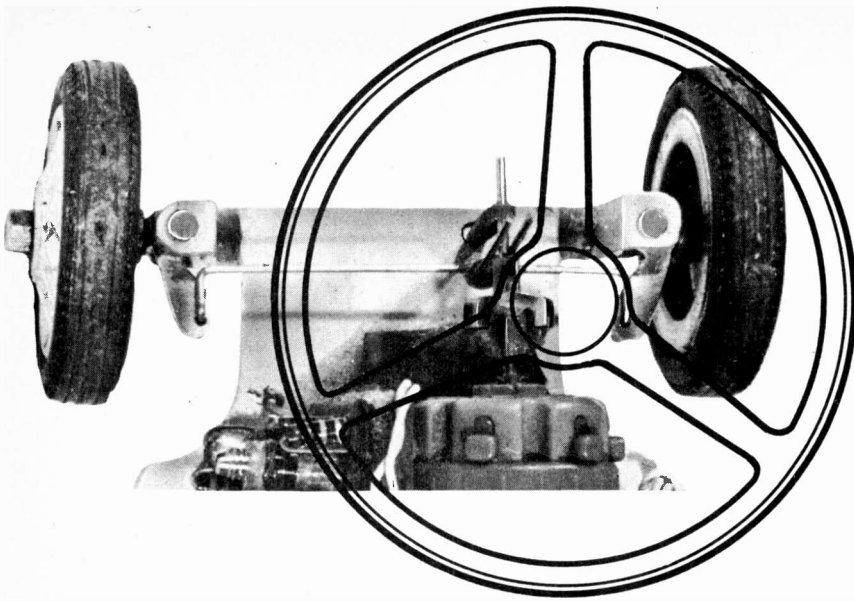

Fig. 15. Operational diagram of a uniselector stepping relay



(Right), Uniselector stepping relay
(Plessey Telecommunications Group)



Part Two . . . Relayless Steering

MODEL CONTROL INSTALLATIONS

By D. BOLLEN

THE first part of this article (last month), based on the P. E. Miniature Model Control modules, described the conversion of a switched function to mechanical operation of various controls in the model. Reed relays were used in the designs described.

Before leaving sequence systems, the use of relayless operated escapements and comparable sequence servos must be considered. It is proposed then to deal with various forms of relayless output, as an alternative to mechanical relays, and to suit different servo arrangements.

Details of two control systems will be given, which are well suited to the small model without being too complex, together with information on transmitter modifications for two-tone and pulsed modes.

AMPLIFIER "B" FOR RELAYLESS OUTPUTS

Certain benefits accrue from the use of a narrow band selective amplifier coupled to the receiver, even with single channel working. Since it gives very good rejection of random interference and enhanced sensitivity, plus the possibility of multi-channel working, Amplifier "B" was selected as the driver for the relayless circuits to be described.

Merely by adding two resistors and one *npn* 500mA transistor to the existing Amplifier "B" panel, in place of a miniature reed relay, the circuit is adapted to direct escapement switching, and may be powered by a single battery of four pen-cells (see Fig. 7).

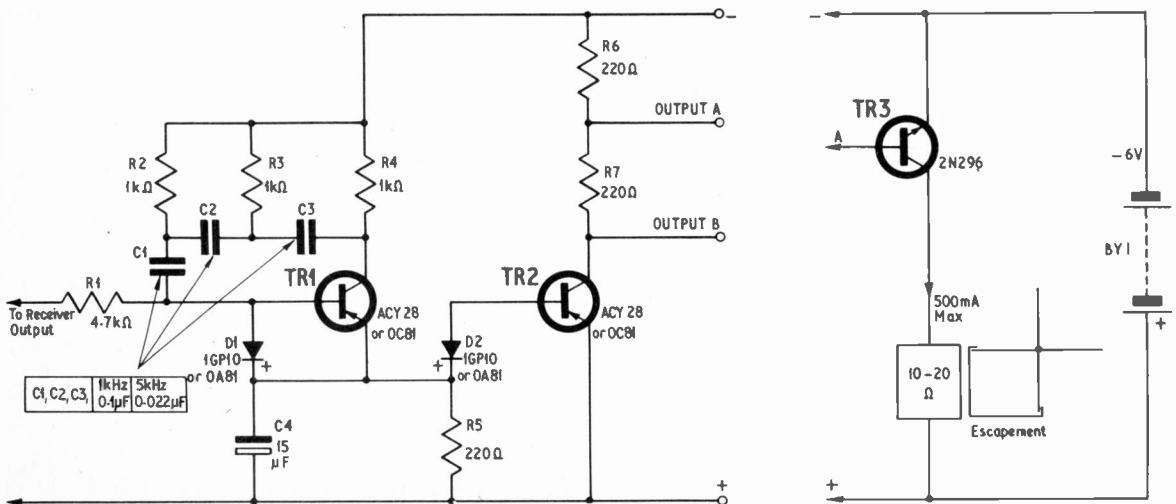

Fig. 7. Modified circuit of Amplifier "B" for relayless output

The revised layout is shown in Fig. 8. If the amplifier has been previously constructed it will not be found difficult to drill the extra holes to take new components, while still leaving some space for future additions, such as another transistor and a resistor or two. Alternatively, the surplus part of the amplifier panel could be cut away and the semiconductor switch assembled on a separate panel.

Returning to Fig. 7, the new resistors R6 and R7 are connected in place of the former relay to the collector of TR2, and two outputs are provided to suit different switching configurations; these are labelled "Output A" and "Output B" in the circuit diagrams. A choice of values for C1, C2, and C3 in Fig. 7, are to suit 1kHz and 5kHz transmitted tones, for two channel working.

In passing, it should be mentioned that the miniature disc ceramic capacitors specified for Amplifier "B" tend to have a poor tolerance, and some divergence from the predicted frequencies is to be expected. Limited space excludes the use of any other type of capacitor but, as similar capacitors can be used in both transmitting and receiving equipment, it is usually found that "spreads" are largely cancelled out. The response of Amplifier "B" is not sharp enough to cause difficult tuning problems.

USING A SEQUENCE SERVO

A sequence or stepping servo needs no clockwork or rubber motor and is more powerful than an escapement. If there is some extra space available in the model it might be worthwhile to install a servo. The diagram in Fig. 9 illustrates the action of a self-neutralising servo, which is similar in principle to the two-arm escapement.

Also shown is one popular method of achieving automatic switching, namely a printed circuit disc with wiper contacts. A servo of this type may either be purchased complete and ready to use or else can be made up using a proprietary motor with integral reduction gearbox, the latter being the least expensive method.

The switching disc and crank may be glued with Araldite to the gearbox output shaft. Complicated switching modes are realisable when a number of wiper contacts are mated to a disc with an elaborate etched pattern, to give more than four crank positions and to operate ancillary circuits. Ordinary etched circuit materials are quite suitable for the switching disc.

In use, the stepping servo will obey press button commands of the *right, neutral, left, neutral* type, and a

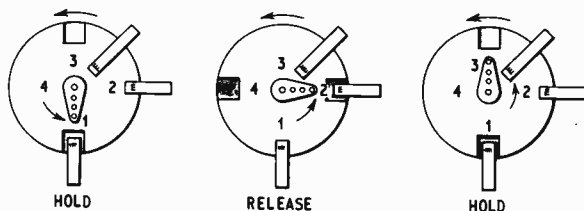
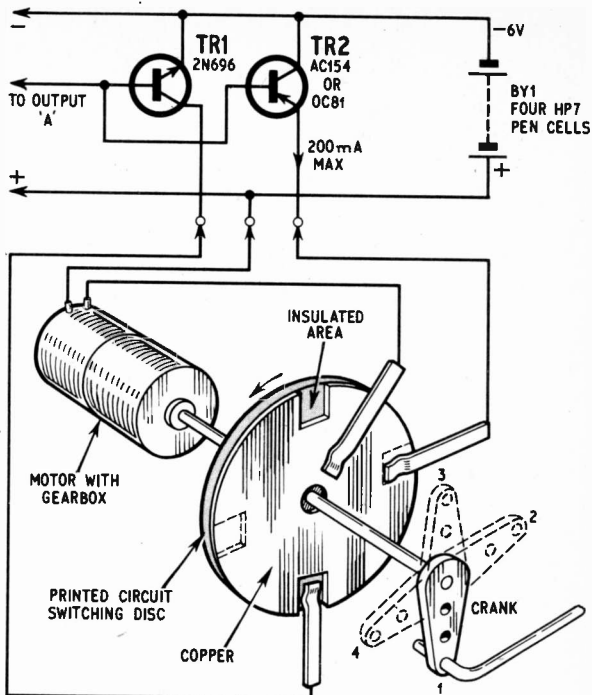

Fig. 9. Self-neutralising servo system using a single battery

"quick-blip" compound action may be introduced for propulsion motor control.

CENTRE-TAPPED BATTERY

A servo output shaft will rotate clockwise or counter-clockwise, depending on battery polarity and assuming a permanent magnet motor. An escapement will only rotate one way and has to pass through unwanted crank positions to reach the one required.

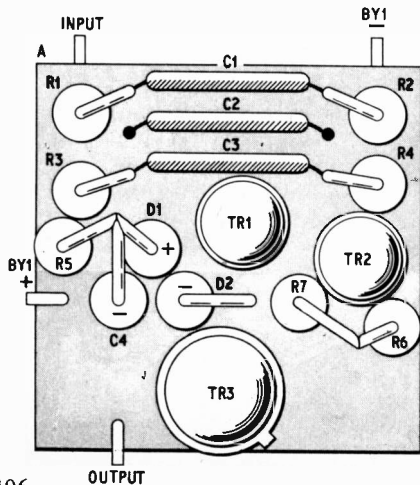
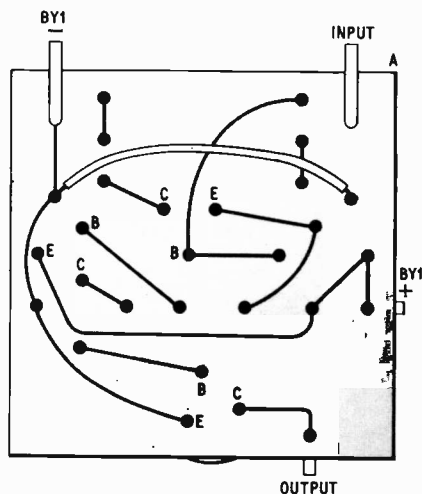
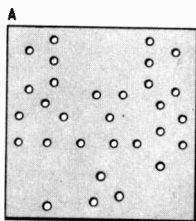
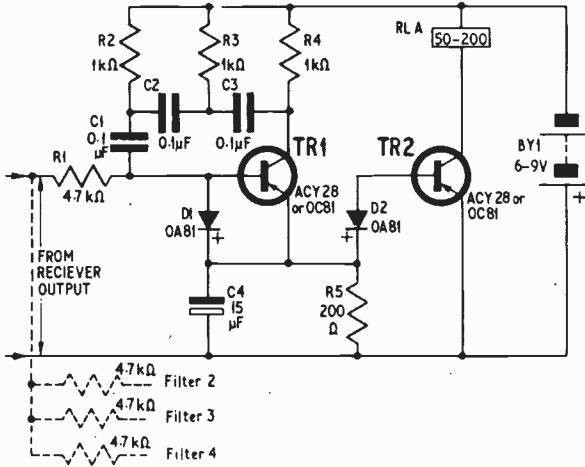

Fig. 8. Revised layout of Amplifier "B" for relayless output. Full size drilling template below



AMPLIFIER "B"



TRANSISTORS

RECEIVER AND AMPLIFIERS

| | | |
|-------------------------|----------|-------------|
| L.F. transistors | ACY28 | (S.T.C.) |
| Alternatives | OC81 | (Mullard) |
| | AC154 | (Brimar) |
| | NKT271 | (Newmarket) |
| | 2G381 | (Texas) |
| R.F. transistors | BSY27 | (S.T.C.) |
| Alternatives | BFY18 | (S.T.C.) |
| | NKT12332 | (Newmarket) |

TRANSMITTER

| | | |
|-------------------------|----------|-------------|
| L.F. transistors | OC83 | (Mullard) |
| Alternatives | GET103 | (G.E.C.) |
| | AC154 | (Brimar) |
| R.F. transistors | BSY27 | (S.T.C.) |
| Alternatives | BFY18 | (S.T.C.) |
| | NKT12332 | (Newmarket) |

TRANSMITTER

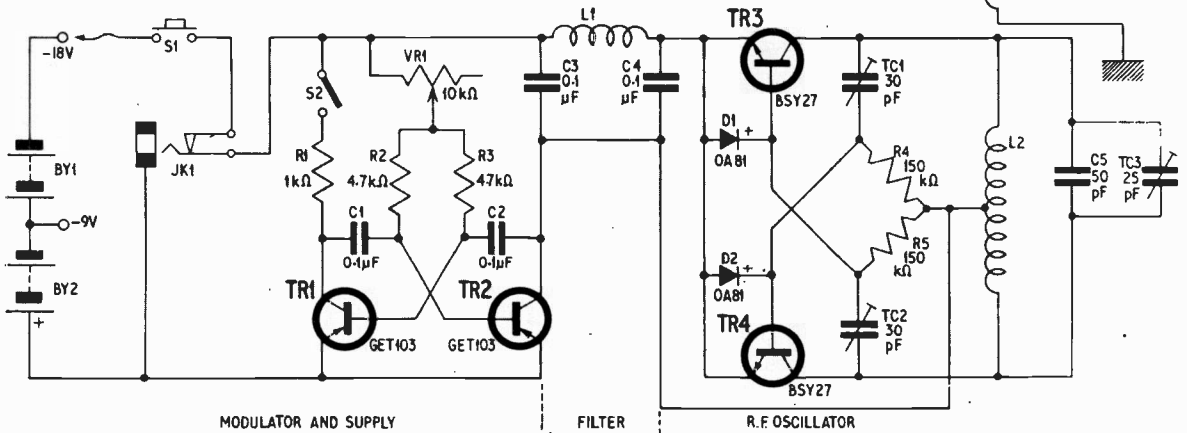

- Aerial is 36in telescopic
 L1 1.5mH wave wound choke
 L2 8 turns 14 s.w.g. enamel copper wire, centre tapped. Inside dia. $\frac{7}{16}$ in
 L3 5 turns 14 s.w.g. enamel copper wire, insulated and fitted inside L2

The complete transmitter circuit above is made up on the s.r.b.p. board: top view shown below left; underside wiring below right. Scale full size.

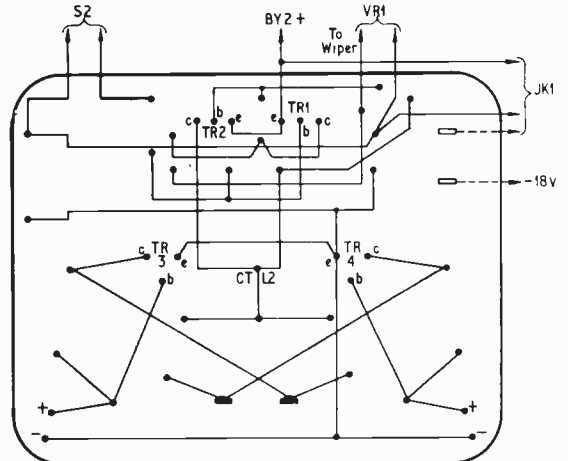
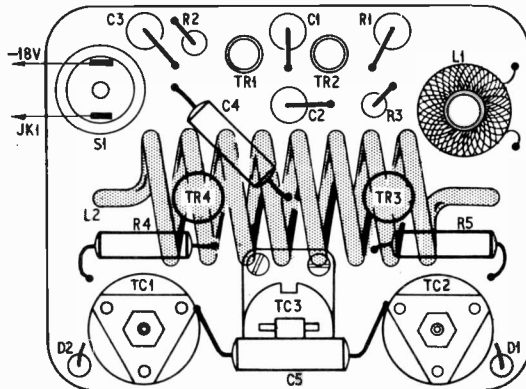

These drawings are reprinted from the previous series *on Miniature Model Control. The receiver, amplifier "A", and amplifier "C" were given last month *NOTE: We regret that neither these back numbers nor reprints of the original series can be supplied.

Four transistors in a bridge configuration are necessary to reverse the polarity of a single battery, but only two transistors are needed with a centre-tapped supply, as demonstrated by the circuit in Fig. 10. If TR1 is "on" the motor will revolve one way, but with TR2 "on" it will rotate the other way.

TWO-POSITION SERVO

At first sight, applications for a servo which can only take up one of two crank positions appear to be restricted, but it will be seen later that the two-position servo with limit contacts is extensively used in all non-sequential control systems. The servo (Fig. 10) has ordinary spring contacts serving as limit stops, used in conjunction with a cam which fits on to the servo output shaft.

On single-channel working this servo will rotate both ways but can only offer the two fixed crank positions, corresponding to "signal on" and "signal off" conditions.

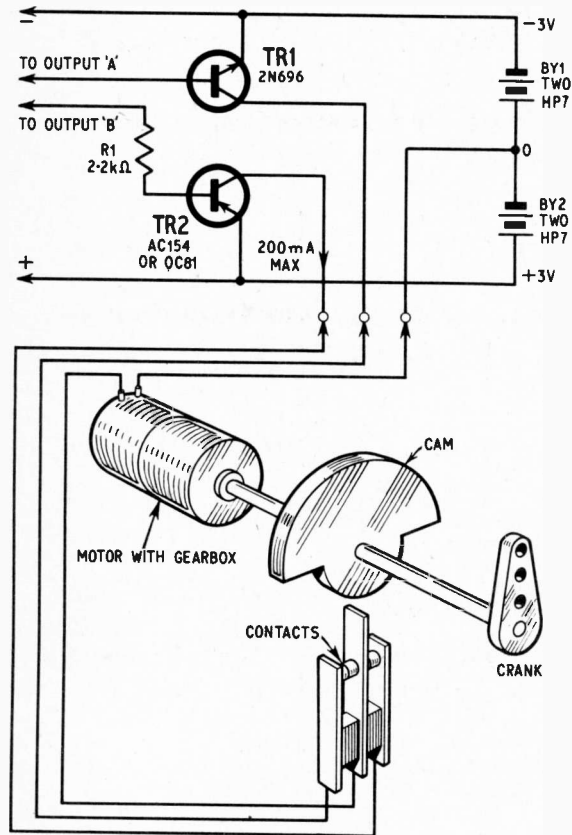
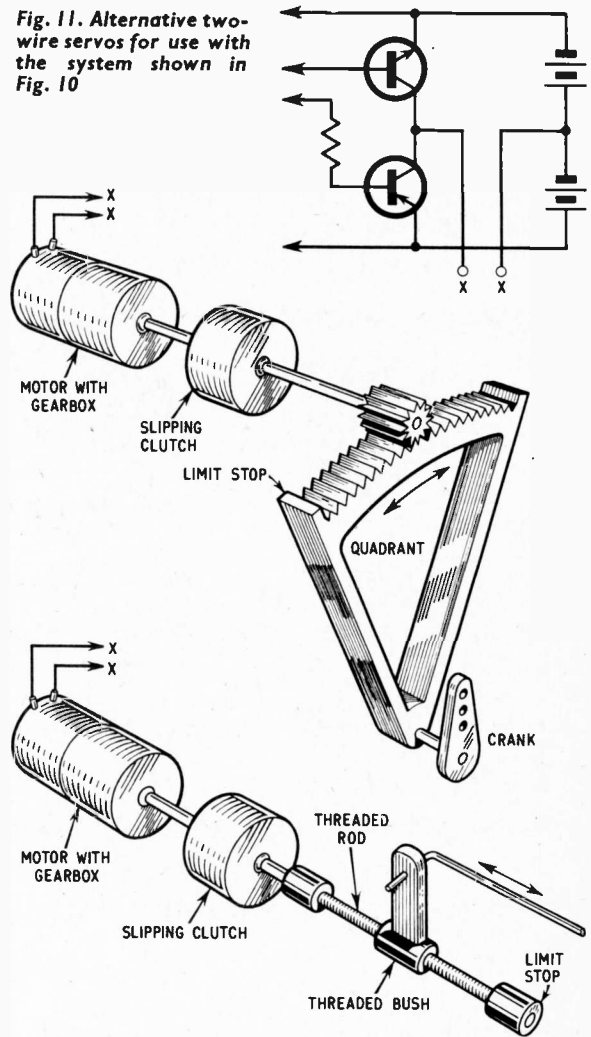

Fig. 10. Two-battery, two-position servo system

Fig. 11. Alternative two-wire servos for use with the system shown in Fig. 10



The base of TR2 in Fig. 10 is routed via a 2.2 kilohm resistor to "output B" on the Amplifier "B" panel. If the gain of TR2 is abnormally high, or low, R1 should be adjusted accordingly to ensure that the relative currents and switchover points of TR1 and TR2 are similar.

With a positive going signal on the bases of TR1 and TR2, TR1 will begin to switch on and TR2 will begin to switch off as the signal reaches approximately the same potential as the battery centre-tap. The two transistors will be alternately full on or full off depending on whether a signal is received or not.

OTHER SERVOS

The servo of Fig. 10 has three wires leading to its semiconductor switch. Two-wire versions are available which use the slipping clutch principle, instead of limit contacts, with the crank limited by a mechanical stop. Two representative types are shown in Fig. 11, and both types can be used for steering purposes where more than one channel is available. Note that the screw servo has an inherently large reduction ratio and, therefore, does not need a big reduction in the gearbox associated with its motor.

Although it is not possible to review every sort of servo construction in the space available here, the fundamental principles associated with motor switching

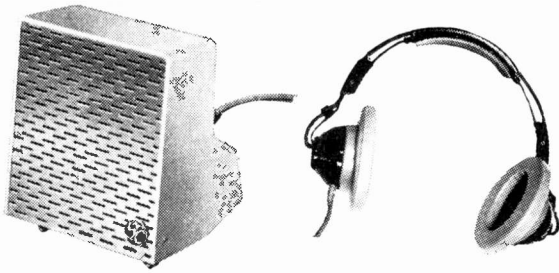

1

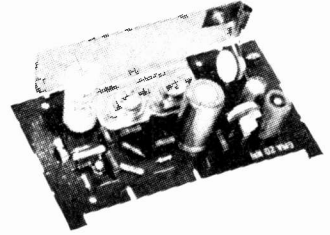

2

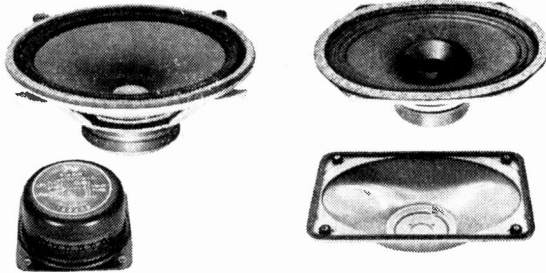

3

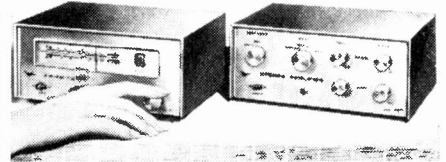

4

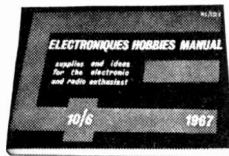

I should like a copy of the *Electronics Hobbies Manual*. Enclosed is a cheque/P.O. for 10/6.

NAME _____

ADDRESS _____

P.E. 6

Audio is just one of the topics covered in the Electronics Hobbies Manual

With the new 600-page *Electronics Hobbies Manual*, you can obtain these and over 11,350 other items—either direct from *Electronics* or through your local *Electronics* dealer! The service is fast. The choice is the most comprehensive ever offered. And the components, which are supplied by 85 leading manufacturers, meet every kind of need—whether the project is advanced or elementary.

1. COMPONENTS A wide range of individual components is available. These include microphones, headsets, pickup arms, cartridges and styli. Hardware accessories such as audio connectors, transformers and microphone stands are also available. Featured above are the STC 4114 microphone price 32/6 and the STC 65/1A Stereo headset at £7.7.0. Both plus 3/6d. post and packing.

2. MODULAR UNITS Featured above is the GMA20 audio amplifier module having a music power rating of 15 watts. This is one of a range of modular units including microphone amplifiers, audio amplifiers, modulators and tuners. Price of the GMA 20 is 82/6d. plus 3/6d. post and packing.

3. KITS This 25 watt Hi-Fi Loudspeaker kit is manufactured by our associates in Germany, and fulfils the highest standards. Supply direct from the factory enables us to offer these magnificent kits at the modest price of £7.10.3. plus 3/6d. post and packing.

4. COMPLETE EQUIPMENT A range of complete equipments is also available, and among these are included microphone mixers, pre-amps, tuners and stereo amplifiers. In the illustration are the Eagle Stereo Amplifier, price £18.5.0. and the Eagle AM/FM tuner, price £28.17.9. Both plus 3/6d. post and packing.

DESIGNS Throughout the *Hobbies Manual* are useful designs for building your own equipment. Included are circuit diagrams and details for audio amplifiers, tone controls, tape recorders and pre-amps.

For the 600-page *Electronics Hobbies Manual* or further details of the products displayed on this page write to: *Electronics* (Prop. STC) Ltd., Edinburgh Way, Harlow, Essex. Telephone: Harlow 26777.

electronics

High-grade components for amateur communications

DE LUXE PLAYERS

4-Speed Players 2-tone Cabinets 17 x 15 x 8 1/2 in. High. High Lux loudspeaker and High Quality Amplifiers ready built. Quality output. Volume and Bass controls. Special instructions enable assembly in 30 minutes, only 5 wires to join. 12 months' guarantee.



TO BUILD YOURSELF

Post 2/6 per item.

PORTABLE CABINET As illustrated. To fit standard player. **69/6**
RECORDER 4. Fully isolated AC Mains Transformer 4 watt output. ECL86 triode pentode valve. Volume and tone controls with knobs. Quality Loudspeaker. **89/6**
AUTOCHEANGE UNITS
 BSR QW7 £4.19.6
 Garrard SP12 £4.19.6
 Garrard SP25 £10.19.6
 Philips AG1016 £12. 9.6
 Garrard A70 £19.19.6
 Garrard LAB80 £24.19.6
 Garrard 401 £29.19.6

SUPERIOR AMPLIFIER. Ready made and tested. Guaranteed better sound! Fully isolated AC Mains Transformer 4 watt output. ECL86 triode pentode valve. Volume and tone controls with knobs. Quality Loudspeaker. **89/6**
AUTOCHEANGE UNITS
 BSR Superlimin £5.19.6
 Garrard 1000 £5.19.6
 Garrard 2000 £6.19.6
 Garrard 3000 £8. 9.6
 Garrard AT60 with diecast turntable **£10.19.6**

GARRARD TEAKWOOD BASE W/1. Ready cut for mounting 1000, 2000, 3000. SP25, AT60. **£7/6**

INTEGRATED STEREO AMPLIFIER 4 watt per channel. A splendid example of functional design and value. Grey/Silver Crackle cabinet size 10 x 8 1/2 x 3 in. 200-250V. A.C. Separate Gram and Tuner inputs. **£10.10.0**
 Self contained pre-amp. and controls. Post 2/6

Q MAX CHASSIS CUTTER

Complete: a die, a punch, an Allen screw and key
 jin. 14/8 jin. 15/9 jin. 18/18 jin. 20/6 2 1/2 jin. 37/9
 jin. 14/9 jin. 18/18 jin. 18/6 jin. 22/6 2 1/2 jin. 44/3
 jin. 15/6 1 1/2 jin. 18/18 jin. 20/2 jin. 34/3 jin. sq. 31/6

BARGAIN XTAL PICK-UP ARM Complete with ACOS LP-78 Turnover Head and Styli 20/; Stereo 30/-
SPEAKER FRET Tygan various colours. 52in. wide, from 10/- ft. 26in. wide from 5/- ft. **SAMPLES S.A.E.**
EXPANDED METAL GOLD or Silver 12 x 12 in. 6/-
NEW GARRARD GRAM MOTORS 2,500 r.p.m. 100-130V. 15/- pair for 200/250V. A.C. (in series), or 10/- ea. Post 2/6.

FULL WAVE BRIDGE SELENIUM RECTIFIERS: 2, 6 or 12 v. outputs, 1 1/2 amp. 8/9; 2 a. 11/3; 4 a. 17/6.
THAROR TRANSFORMERS. P. & P. 2/6. Input 200/250 v. for charging at 2, 6 or 12 v., 1 1/2 amp. 17/6; 2 amp. 21/-; 4 amp., 25/- . Circuit free. Ammeter 0 to 5 amp. 10/6.

MOVING COIL MULTIMETER TK 25. 47/6
 0 to 100 m.A.C.D.C. ohms 0 to 100k. etc.
MOVING COIL MULTIMETER EP10E. 79/6
 0-1.000V. A.C./D.C. ohms 0 to 3 meg. etc.
MOVING COIL MULTIMETER EP20K.
 0-2,500V. D.C. 20,000 ohms per volt. 0-1,000V. A.C. Ohms 0 to 6 meg. 50 Microamps full scale. **99/6**

NEW MULLARD TRANSISTORS
 OC71 8/-; OC72 7/6; OC81D 6/-; OC81 6/-; AF15 8/-;
 AF14 8/-; OC44 8/-; OC45 8/-; OC171 9/-; OC170 8/-;
 AF117 7/-; OC28 12/6; AD140 15/-; OC35 15/- Holders 1/3.

ARDENT TRANSISTOR TRANSFORMERS
 D3085 7.3 CT. 1 Push Pull to 3 ohms for OC72, OC81. 11/-
 D304 1.75 1 CT. Push Pull Driver for OC72, OC81. 11/-
 D3058 11.5 1 Output 1.5 ohms for OC72, OC81. 11/-

TRANSISTOR MAINS ELIMINATORS. FAMOUS "POWER MITE" 9 VOLT. SAME SIZE AS PP9 BATTERY **45/6**
 FULLY SMOOTHED. 150mA. FULL WAVE CIRCUIT.

WEYRAD P50 - Transistor Coils
 RA2W 8 in. Ferrite Aerial Spare Cores. 6/6
 with car aerial coil. 12/6
 Driver Trans. LFDT4. 8/6
 I.F. 50/1AC. 5/4
 I.F. P50/3CC 470 kc/s. 5/7
 3rd I.F. P50/3CC. 5/2
 Printed Circuit, PCA1. 9/6
 J.B. Tuning Gang. 10/8
 Weyrad Booklet. 2/6

Volume Controls **80 ohm Coax 6d** yd.
 Semi-air spaced Cable 40 yd. 17/6. 60 yd. 25/-
 FRINGELOSS **1/6** yd.
 Ideal 825 lines
COAXIAL PLUG 1/2. PANEL SOCKETS 1/-. LINE SOCKETS 2/-.
OUTLET BOXES, SURFACE OR FLUSH 4/6.
BALANCED TWIN FEEDERS 1/2. 80 or 300 ohms.
TELESCOPIC CHROME AERIALS. 6in. extends to 23in. 6/6 each. CAR AERIAL PLUGS 1/6. Sockets 1/3.

TV REMOTE CONTROL
 FOR PHILIPS 19T0111A, 121A, 122A, 123A, 23T0111A, 113A, 121A, 121A, STELLA ST1033A, 38A, 43A, 53A, COSSOR CT1910A, 21A, CT2310A, 21A, 31A
 PHILIPS Price 3 gns.
 Our Price **£12/6** Post 2/6
 Brand New. Includes 11ft. 7-way cable, MULLARD OA81 2 pots., 3 switches, 5 resistors



STELLA RECORD PLAYER AMPLIFIER

4 watt. 2 stage. 3 to 7 ohm. Neg. feed back. UCL82. UY85. 200-250V. A.C. tapped input. Chassis size 8 x 2 1/2 x 4 in. high. Gold/Walnut knobs. Volume and Tone controls on separate Polished Wood Panel 8 x 2 in. Brand new with makers' guarantee. **BARGAIN PRICE P. & P. 2/6. 78/6**

| NEW TUBULAR ELECTROLYTICS | CAN TYPES | |
|---------------------------|---------------------|----------------------|
| 2/350 v. . . . 2/3 | 100/25 v. . . . 2/- | 8/600 v. . . . 9/6 |
| 4/350 v. . . . 2/3 | 250/25 v. . . . 2/6 | 18/600 v. . . . 12/6 |
| 8/450 v. . . . 2/3 | 500/15 v. . . . 3/- | 18+18/500 v. 7/6 |
| 16/450 v. . . . 2/- | 8+8/450 v. 3/6 | 32+32/450 v. 6/- |
| 32/450 v. . . . 3/9 | 8+18/450 v. 3/9 | 50+50/350 v. 7/- |
| 25/25 v. . . . 1/9 | 18+18/450 v. 4/3 | 60+100/350 v. 11/6 |
| 50/50 v. . . . 2/- | 32+32/350 v. 4/8 | 100+200/275 v. 12/6 |

PAPER TUBULARS
 350v.-0.1 9d., 0.5 2/6; 1 mfd. 3/-; 2 mfd. 150v. 3/-
 500v.-0.001 to 0.05 9d. 0.1 1/-; 0.25 1/6; 0.5 3/-
 1,000v.-0.001, 0.0022, 0.0047, 0.01, 0.02, 1/6; 0.047, 0.1 2/6
 E.H.T. CONDENSERS. 0.001mfd. 7kV, 6/8; 20kV, 10/6.

SUB-MIN. ELECTROLYTICS. 1, 2, 4, 5, 8, 18, 25, 30, 50, 100, 250, 500, 1,000, 2,000, 5,000, 10,000, 15,000, 25,000, 50,000. CERAMIC 500, 1 pF to 0.01 mtd. 9d. Discs 1/-
SILVER MICA. Close tolerance (plus or minus) pF., 5 to 47 pF. 1/-; ditto 10, 50 to 800 pF. 1/-; 1,000 to 5,000 pF. 2/-
TWIN GANG. "0.00" 208 pF. -1.76 pF. 10/6; 365 pF., miniature 10/-; 500 pF. standard with trimmers, 9/6; 500pF. midget less trimmers, 7/6; 500 pF. slow motion, standard 9/-; small 3-gang 500 pF. 18/9. Single pF. 2/6; 2 pF., 50 pF., 75 pF., 100 pF., 160 pF., 5/6 each. Can be gauged. Couplers 9d. each. **TUNING.** Solid dielectric. 100 pF., 300 pF., 500 pF., 3/6 each. **TRIMMERS.** Compression ceramic 30, 50, 70 pF. 9d.; 100 pF., 150 pF., 1/3; 250 pF., 1/6; 600 pF., 750 pF., 1/6.

250V. RECTIFIERS. Selenium 1/ wave 100mA 5/-; BY100 10/- CONTACT COOLED 1/ wave 60mA 7/6; 85mA 9/6. Full wave 75mA 10/-; 150mA 19/6; T.V. rects. 10/-.

SPECIAL OFFER! NEW B.A.S.F. TAPE

7 in. L.P. 18,000 ft. 45/-; 7 in. L.P. 2,400 ft. 70/-
 60 min. Cassette C60 (For Philips, etc.) 17/6
 Spare Spools 2/6. Tape Splicer 5/- . Leader Tape 4/6.
 Tape Heads: Collaro 2 track 28/6 pair, B.S.R. 4 track 99/6

MAINS TRANSFORMERS

250-0-250 90 mA. 6.3 v. 3.5 a. 6.3 v. 1 a. or 5 v. 2 a. 25/-
 350-0-350 90 mA. 6.3 v. 3.5 a. 6.3 v. 1 a. or 5 v. 2 a. 29/6
 MT. 510/300-0-300 120 mA. 6.3 v. 4 a. 29/6
 MINIATURE 200 v. 20 mA. 6.3 v. 1 a. 10/8
 MIDGET 220 v. 45 mA. 6.3 v. 2 a. 15/6
 SMALL 250-0-250 50 mA. 6.3 v. 2 a. 19/6
 HEATER TRANS. 6.3 v. 1 1/2 a. 9/6; 6.3 v. 4 a. 10/8
 Ditch tapped sec. 1.4 v. 2, 3, 4, 5, 6.3 v. 1 1/2 amp. 10/8
GENERAL PURPOSE LOW VOLTAGE. Outputs 3, 4, 5, 6, 8, 9, 10, 12, 15, 18, 24 and 30 v. at 2 a. 25/-
 1 amp., 5, 10, 15, 20, 25, 30, 35, 40, 55, 60, 29/6; 2 a. 47/8
AUTO TRANSFORMERS 0-115-230 v. Input/output, 150w. 25/-; 500w. 92/6; 1000w. 175/-

CRYSTAL MIKE INSERTS

1 1/2 in. 6/6; BMX 3 1/2 in. 7/6; ACOS 11 1/2 in. 8/6
 TANNAY CARBON MIKE 1 1/2 in. 8/6
MOVING COIL HEADPHONES 100 ohms (ex. Govt.) 12/8
H.R. HEADPHONES 2000 ohms. 12/8, 4000 ohms. 15/-
H.R. HEADPHONES 2000 ohms Super Quality. 25/-

1967 GRAM CHASSIS

Post 5/-
 Three Wavebands: Five Valves: ECH81, EF89, Long. Med., Short. Gram. EB81, EL84, EZ80, 12-month guarantee. A.C. 200-250 v. Ferrite Aerial 5 watts 3 ohm. Chassis 13 1/2 in. x 7 in. x 5 in. dial size 1 1/2 in. x 4 in. Two pilot Lamps. Pot. Knobs. Aligned calibrated. Chassis isolated from mains. **DE LUXE STEREO GRAM CHASSIS V.H.F., M.W. SW 19-50 SW, SW 60-180m. Magic eye, push buttons, 6 valve plus rect. Size 15 1/2 x 7 1/2 x 6 1/2 high** **£19.19**

HIGH GAIN TV. PRE-AMPLIFIER BAND I B.C. Tunable channels 1 to 5. Gain 18 dB. ECC84 valve. Kit price 32/6 or 55/- with power pack. Details 6d.
BAND III I.T.A. - same prices. Tunable channels 7 to 13. Band I or III. Coils and circuit only, 9/6. Chassis 9.4 in. **B.C. 2 SUPER BOOSTER** transistor model. Ready built 75/-.

BLANK ALUMINIUM CHASSIS. 18 s.w.g. 2 1/2 in. sides. 7 x 4 in. 5/6; 9 x 7 in. 6/8; 11 x 3 in. 6/8; 11 x 7 in. 7/6; 13 x 9 in. 9/6; 14 x 11 in. 12/6; 15 x 14 in. 15/-.
ALUMINIUM PANELS 18 s.w.g. 12 x 12 in. 5/6; 14 x 9 in. 4/6; 12 x 8 in. 3/6; 10 x 7 in. 2/9; 8 x 6 in. 2/1; 6 x 4 in. 1/8.

ALL PURPOSE TRANSISTOR PRE-AMPLIFIER Gain 14, 1, 250 or 9v. input. Ready built with Mu Metal input transformer for Mike's Pick-Up/Tuners. **15/-**
 Instructions and circuit supplied. Post 2/6.

THE INSTANT BULK TAPE ERASER AND RECORDING HEAD DEMAGNETISER

200/250 v. A.C. Leaflet S.A.E. Post 2/6 **35/-**

BAKER 12 in. MAJOR

The ideal High Fidelity Loudspeaker for high output at home or public address, etc. Built in high efficiency tweeter cone. Voice Coil impedance 15 ohms. Max. Power 20 wpts. Bass Res. 40/50 cps. Flux 14,000 gauss. Voice Coil diameter 1 1/2 in. Response 40-14,500 cps. Magnet material Alcomax, overall dia. 12 1/2 in., overall depth 6 in. Price **£8** Post Free

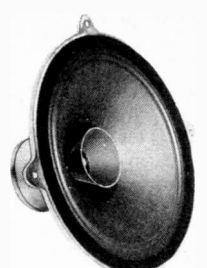

CATALOGUE S.A.E.
GROUP MODELS FOR VOCALS
BASS, LEAD AND RHYTHM GUITARS
 30-10,000 cps. Voice Coils 15 ohms. Heavy duty. 'Group 25' 'Group 35' 'Group 50'
 12in. 5gns. 12in. 8 1/2 gns. 15in. 18gns. 25w. 35w. 50w.

LOUDSPEAKERS P.M. 3 OHMS. 2 1/2 in., 3 in., 4 in., 5 in., 7 in. x 4 in., 15/6 each; 8 in., 22/6; 6 in., 18/6; 10 in., 30/-; 12 in., 30/- (15 ohms 35/-); 10 x 6 in., 30/-; 8 x 5 in., 21/-; E.M.I. Double Cone 13 1/2 x 8 in., 3 or 15 ohm models, 45/-
SPECIAL OFFERS! 8 ohm. 2 1/2 in., 5 in.; 15 ohm. 5 in., 7 x 4 in., 25 ohm. 5 in., 8 x 4 in.; 35 ohm. 5 in., 7 x 4 in.; 80 ohm. 2 1/2 in., 15/6 each type.
 Quality Horn Tweeters 3-16kc/s. 10w. 27/6. Crossover 14/6. JACK SOCKETS Std. open-circuit 2/6, close circuit 4/6. Chrome Lead Socket 7/6. DIN 3-pin 1/3 5-pin 1/8; Lead 3/6; Phone Plugs 1/-. Socket 1/2-. JACK PLUGS Std. Chrome 3/-; 2-pin 3.5mm. 1/8; DIN 3-pin 3/6; 5-pin 5/-
WAVE-CHANGE SWITCHES WITH LONG SPINDLES. 2 p. 2-way, or 2 p. 6-way, or 3 p. 4-way 3/6 each. 1 p. 12-way, or 4 p. 2-way, or 4 p. 3-way, 3/6 each. Wavechange "MAKITS" 1 p. 12-way, 2 p. 6-way, 3 p. 4-way 3 p. 4-way 3/6, 2-way. Prices include click switches, adjustable stops, spacers, etc., 1 walter, 10/6; 2 walter, 15/-; 3 walter, 19/6. **TOGGLE SWITCHES,** sp. 2/-; sp. dt. 3/6; dt. 3/6; dt. dt. 4/-

DE LUXE TAPE SPLICER. Cuts, trims, joins for editing and repairs. With 3 blades. **14/6**

4 CHANNEL TRANSISTOR MICROPHONE MIXER. Add musical highlights and sound effects to recordings. Will mix Microphone, records, tape and tuner with separate controls into single output. **59/6**

PRIMO A.18 TRANSCRIPTION TONE ARM. 5 gns. with tracking template and two plug-in shells. Moving Coil Stereo Diamond Cartridge 20-18,000 cps. 5 gns.

FM TUNER 88-108 Mc/s Six Transistor. Superhet. Ready built. Printed Circuit. Calibrated slide dial tuning. Size 6" x 4" x 2 1/2". **£8.10.0**

3 WATT QUALITY AMPLIFIER. 4 Transistor Push-Full Ready built, with volume control **65/-**

NEW MANUFACTURERS SURPLUS UHF BBC 2 AERIALS
 BBC 2 Double Gold Ring Set Top Model. 22/6
 BBC 2 Five Element Loft Model. 32/6; Outdoor 42/6

★ RADIO BOOKS ★ (Postage 9d.)

| | |
|--|----------|
| High Fidelity Speaker Enclosures and Plans. | 5/- |
| Transistor Superhet Commercial Receivers. | 7/6 |
| Mullard Audio Amplifier Manual. | 8/6 |
| Radio Valve Guide, Books 1, 2, 3, or 5. | each 5/- |
| Practical Radio Inside Out. | 4/6 |
| Transistor Audio Amplifier Manual. | 3/6 |
| Shortwave Transistor Receivers. | 5/- |
| Transistor Communication Sets. | 6/- |
| International Radio Stations List. | 2/6 |
| Modern Transistor Circuits for Beginners. | 7/6 |
| Sw-Minutiae Transistor Receivers. | 5/- |
| Wireless World Radio Valve Data. | 9/6 |
| At a glance valve equivalents. | 6/- |

RESISTORS. Preferred values, 10 ohms to 10 meg. 1 w., 1/2 w., 20%, 4d., 1 w. 8d.; 2 w. 1/-; 1 w. 10% 6d. **HIGH STABILITY.** 1 w. 1/2 2/- Preferred values, 10 ohms to 10 meg. Ditto 5%, 10 ohms to 22 meg., 9d. 5 watt 0.5 to 8.2 ohm 3 w. 1/8 10 watt 10 ohms to 6,800 ohms 2/- 15 watt 10K, 15K, 20K, 25K, 68K, 10W. 3/-

MAINS DROPPERS. Midget. With sliders. 0.3 a., 1 K., 0.2 a., 1.2 K., 0.15 a., 1.5 K., 6/- each. **LINE CORD** 100 ohms ft. twin plus resistance. 1/- ft.

WIRE-WOUND 3-WATT **WIRE-WOUND 4-WATT**
POTS. T.V. Type. Values **STANDARD SIZE POTS.**
 10 ohms to 30 K., 3/3, **LONG SPINDLE VALVES**
 Carbon 30 K. to 2 meg., 3/-, **50 OHMS to 100 K., 7/6.**

VALVE HOLDERS. Int. Oct. 6d. Mazda Oct. 6d.; BTG, Cans 1/8, B9A, Moulded 9d. Ceramic 1/8. B7G, B9A Cans 1/8. Valve base plugs B7G, B9A, Int. Oct. 2/3.

80 ONLY—SANGAMO 3 inch SCALE LABORATORY MOVING COIL METERS
 Various calibrations and movements. 100 Microamp 55/-; 1 Milliamp 50/-, etc. Post 5/- extra. Send S.A.E. for list.
BRAND NEW QUALITY EXTENSION LOUDSPEAKER
 In tough cream plastic cabinet with 20ft. lead and adaptors. For any transistor radio, intercom, mains radio, tape recorder, etc. 3 to 15 ohm matching Size: 7 1/2 x 5 1/2 x 3" **30/-** Post 2/6

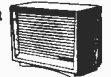

Written guarantee with every purchase. (Export: Send remittance and extra postage, no C.O.D.) Buses 133, 68 pass door. S.R. Stn. Selhurst. Tel.: 01-684-1665

RETURN OF POST DESPATCH Post and Packing 1/6 unless otherwise stated. C.O.D. 5/- extra. Full List 1/-. **CALLERS WELCOME**
RADIO COMPONENT SPECIALISTS 337 WHITEHORSE ROAD, WEST CROYDON

500

Fig. 12. Circuit diagram for two-tone progressive steering

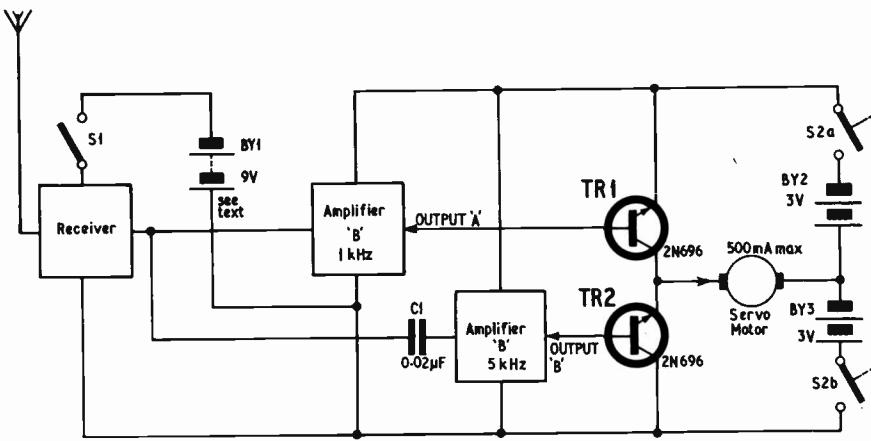

key a "right" tone, and left a "left" tone. In the central switch position an unmodulated carrier alone will be radiated and the servo will be stationary.

apply to almost every servo and differences are confined to gearing and refinements.

Modern servos use low consumption motors of around 3-6V, with stall currents of approximately 200mA and a running current under load of about 100mA or less. Gearbox ratios will be found to vary according to individual design and purpose but will usually lie somewhere between 3:1 and 60:1. The Mighty Midget motor is a popular type for home built servos, but motors with multi-speed boxes are available offering a choice of ratios to suit every application. One such is the Milliperm 1500 mated to a six-speed epicyclic box.

TWO-TONE PROGRESSIVE SYSTEM

The main disadvantage with sequence systems is that previous crank positions must be memorised if a false command is to be avoided. With the 1kHz and 5kHz versions of Amplifier "B", coupled as in Fig. 12, independently keyed tones can be sent from the transmitter, one tone for a right turn and the other tone for a left turn. Consequently, there is no doubt as to which way the steering will move under command.

With no received tones, TR1 and TR2 in Fig. 12 will both be off, leaving the servo isolated from its batteries with its crank stationary as last set, somewhere between the limit stop extremes. To arrive at any desired crank position, including neutral, it is only necessary to key the required tone for a brief period, switching off again when the servo crank has attained the new position.

To facilitate easy working, a "centre off" toggle switch can be mounted on the transmitter. The switch is orientated so that throwing the toggle right will

Obviously, if a tone is inadvertently left on, the servo will move to one of its limit stops and stay there until the opposite tone causes it to move away from the limit stop. Rapid right and left "twitching" of the transmitter switch will "inch" the servo one way or the other, thus counteracting the effects of servo motor "overshoot".

A two-wire servo is shown in Fig. 12. For three wire servos, the TR2 emitter to TR1 collector connection should be split, as in the earlier diagram Fig. 10. If it is found that the 5kHz amplifier does not respond as well as its 1kHz counterpart, the 0.1μF decoupling capacitor, C1 in the Receiver circuit, should be reduced in value to improve h.f. response; 0.05μF can be taken as the new value for C1.

There is no need for a 100μF line decoupling capacitor across the receiver supply BY1 (Fig. 12) if a PP3 battery is used because it has a much lower internal impedance than the smaller PP5. If a PP5 is used, the electrolytic capacitor should be retained.

The transmitter modification for two tone modulation, incorporating a "centre-off" toggle switch, is given in Fig. 13. Although shown to aid identification, S2 serves no useful purpose in this circuit. The sequence press button should be replaced by an on/off switch S1, and if it is intended to retain the existing transmitter case, S2 could be rewired to serve as S1, with R1 of the modulator taken to the negative rail.

Larger batteries will be needed to cope with the increased duty cycle demand, as a continuous unmodulated carrier is radiated when steering switch S3 is in its central position. It is suggested that S3, C1b, and C2b be mounted in the space left vacant by the original PP3 batteries.

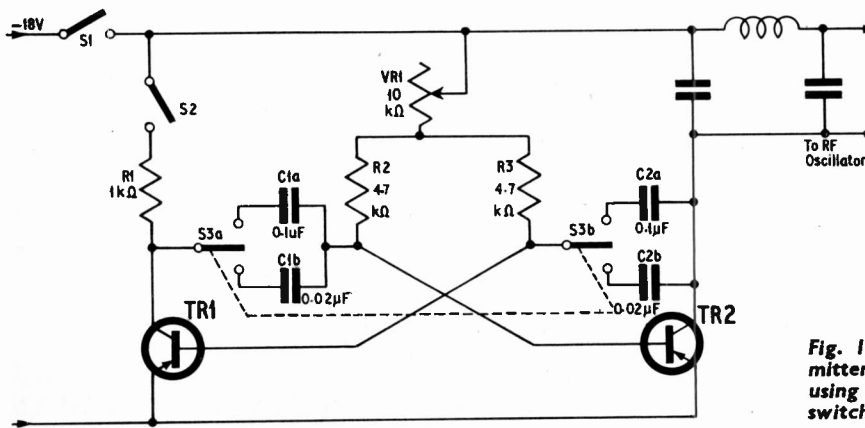

Next month we shall describe a pulse system applied to steering and propulsion using one-stick control.

Fig. 13. Modified part of the transmitter circuit for two-tone working, using a two-pole changeover toggle switch with centre-off position

COMMENTARY ON SOUND REPRODUCING EQUIPMENT BY CLEMENT BROWN

audio trends

R EACHING a peak at the time of the Audio Fair, the spring-time introductions of new audio products can always be expected to yield much of interest to both amateur constructors and those who require ready-made equipment. This year there was a notable variety, as is evidenced in the wide range of disc equipment at prices to suit most pockets. A selection of cartridges, arms and turntables, some quite new and others in revised versions, heads the list this month.

RECORD REPRODUCTION

At the top of the price range, tempting those who permit no compromise in record reproduction, is the Shure V15 Type II, designed to track securely at not more than 1 gramme, with a precision arm such as the S.M.E. Unfortunately for many, "no-compromise"

compliance and a new damping arrangement. The recommended playing weight for the Mk. 4 is 1½ grammes, and the price is 20 guineas. Hand-picked samples are offered to professional users at a somewhat higher price.

Goldring, whose turntables and pick-ups are known to so many constructors and music-lovers, are celebrating their 60th year in the industry. A new stereo cartridge marks the occasion: it is model 800, a magnetic cartridge with an advanced specification. Effective tip mass is quoted as 1 milligramme; separation is 25dB at 1kHz; and static compliance is 20×10^{-6} cm/dyne. Playing weight range is 1 to 3 grammes.

Relatively inexpensive moving-magnet cartridges from Audio-Technica have now reached the shops. This firm's range starts with the AT6 at only £4 19s 6d. Then come the AT3 and the AT5 which, with conical stylus, sells at £11 19s 6d. A version with bi-radial tip is also available.

The Ortofon moving-coil pick-up, in its widely used form, is a fairly massive cartridge with built-in transformers. Now, however, cartridge type SL15 is available as a lightweight unit (only 7 grammes), and the transformers are housed in a separate small unit which one connects between amplifier and pick-up. This latter item is essential if a moving-coil pick-up is to be used with any practical amplifier. The cartridge and transformer unit sell at £27 10s complete.

A new arm of advanced design, type RS212, has also arrived from Ortofon. The Thorens TP13 arm, familiar as a companion to the TD150 turntable, is now available separately at £12 11s 6d; and the more costly TP14 arm, while remaining separately available, can now also be found as a fixture on the TD124 professional turntable. For details of these Ortofon and Thorens components write to MetroSound (Sales) Ltd., Bridge Works, Wallace Road, London, N.1.

Those seeking moderately priced pick-up arms should note that, in addition to the Thorens TP13, the SAU2 by Connoisseur, and the Neat G30 (from Japan via

Shure V15 Type II pick-up cartridge

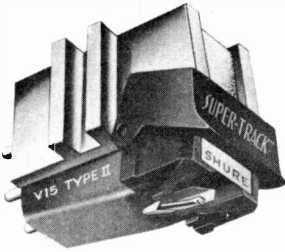

Ortofon R5212 arm

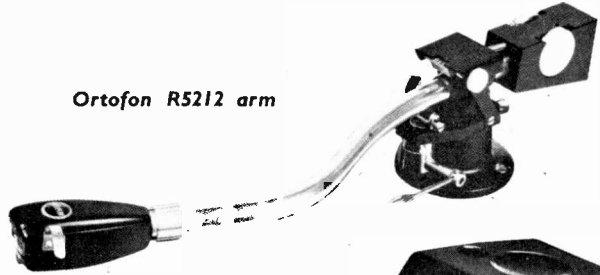

Connoisseur SAU2

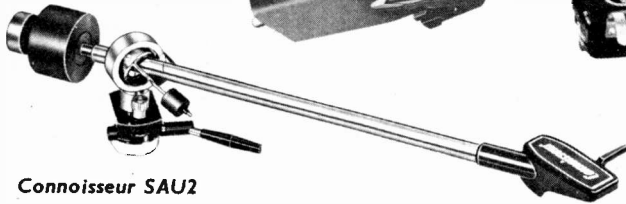

Decca ffs Mk. 4 stereo cartridge

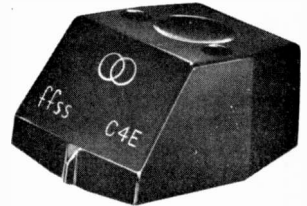

performance means an uncompromising price: this moving-magnet stereo cartridge costs £35. Shure introduced at the same time their M75E which, at £22 10s, has a bi-radial stylus and tracks at not more than 1½ grammes. Some other cartridges by this company are reduced in price: for instance, the M44-5 with a half-thou stylus now sells at £12 10s.

Enthusiasts will already have noted the introduction of the Decca Mk. 4, now being made in both cartridge form and as a head to fit the Decca arms. Improvements in design include lower tip mass, increased

Howland-West) deserve investigation. Note also that the Lab80 auto-transcription unit and two record changers in the Garrard series have moved up to Mark 2 status with the incorporation of detail modifications. A transparent plastics dust-cover is obtainable for Garrard units fitted to wood bases.

SOLID-STATE UNITS

Newly arrived in the U.K. from Japan are the Nikko transistorised units, at present comprising a tuner, an amplifier, and a combined tuner-amplifier.

Specifications can be obtained from Howland-West Ltd., 2 Park End, London, N.W.3. Model FAM-12 is an a.m./f.m. tuner, equipped for stereo reception and offering such features as a meter to aid tuning, switched a.f.c. and a local/distance control. There is medium wave coverage in addition to the usual f.m. band. The price is £58 11s.

Companion to this unit is the TRM-40 amplifier which, at £39 10s, has all the usual input facilities and is rated at 11 watts per channel into 16 ohms. Further up the price scale, the ST701 stereo tuner-amplifier has a higher power rating, employs silicon transistors throughout, and incorporates an a.m./f.m. radio section. Howland-West have also added new "Clear-view" cabinets which house popular types of player and have Perspex covers.

Armstrong's new range of solid-state units, mentioned briefly in the last Audio Trends, are described in a brochure available from Armstrong Audio Ltd., Warlters Road, London, N.7. In this Series 400 there are two tuners and two tuner-amplifiers as well as a stereo amplifier priced at £42 15s. Type M4 stereo decoder is sold at £9 10s. Enthusiasts should also note that certain Series 27 valve units are being continued by this firm and that decoders are available for models marketed prior to the introduction of Series 400.

Performance standards of a very high order are achieved by System 20 equipment introduced recently by Wharfedale. The amplifier, tuner, and transcription turntable assembly are available as separate, encased units for those who prefer a shelf-mounted system; but the complete System 20 is also offered in either of two designs of cabinet—a lowboy and a more upright console. Thorens and Garrard turntable and pick-up units are employed. An interesting brochure is obtainable from Rank Wharfedale Ltd., Idle, Bradford.

NEW SPEAKERS

A range of speaker systems introduced by Whiteley Electrical starts with the LC93, a "bookshelf" model

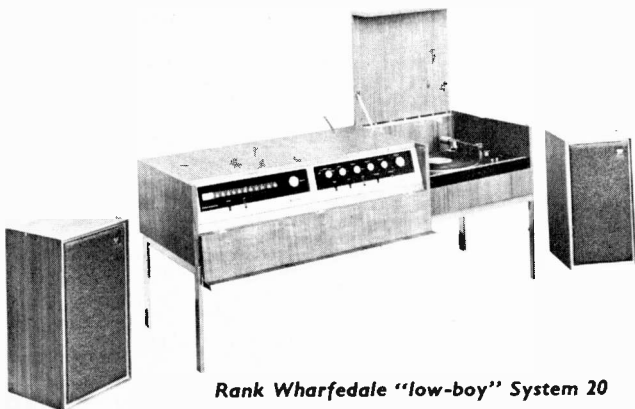

Rank Wharfedale "low-boy" System 20

available in teak at 13 guineas or rosewood at 14 guineas. It incorporates a 9in drive unit with aluminium coil, melamine and paper cone, and siliconised cambric suspension. Next there is the LC94 which, at £21 (for teak finish), again houses the 9in unit but employs acoustic labyrinth principles. The larger LC95 is of the reflex type, houses two drive units and is priced at £47 10s or more according to finish.

In the normal course of events it is not advisable to experiment with a transformer to match a 15 ohm

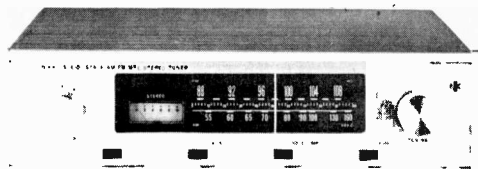

Nikko FAM-12 a.m./f.m. stereo tuner

speaker to a transistorised amplifier of very low output impedance, such as the 4 ohms encountered in some imported amplifiers. It is because of this problem that a few British specialists, including Celestion, now offer speaker systems in low impedance versions (4 to 8 ohms) as well as 15 ohms.

However, Rectavox have produced a special transformer of high quality which, they say, can be used to match speakers to solid-state amplifiers without danger to the output transistors. This component has a power bandwidth of 20 watts, 25Hz to 20kHz. Accessories from Rectavox are wall-fixing devices for speaker enclosures and suction feet for resting speakers on shelves or furniture.

Constructors interested in making fairly large speaker systems may care to note that matched speaker sets are marketed by E.M.I. Sound Products of Hayes, Middlesex. Set 550 consists of a bass unit, crossover filter, and two tweeters, and the leaflet setting out their specifications also describes a suitable enclosure measuring about 24in x 12in x 12in. For a bigger system employing Set 950, an enclosure of 4 cu ft is specified. Four tweeters are mounted across an elliptical bass unit in an ingeniously designed arrangement claimed to provide a vertical polar characteristic (akin to a line-source) which minimises unwanted room reflections.

PERSONAL STEREO

Headphones are increasingly in demand for personal twin channel listening. Koss headphones, made in the

E.M.I. 950 matched loudspeaker set

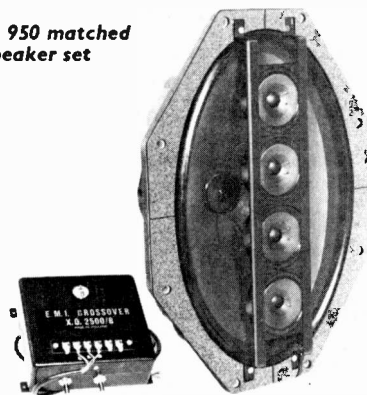

U.S.A., are now distributed by Tape-Music Distributors and include model KO727 (£13 15s), which can be used in any system with 4, 8, or 16 ohms output. There are also accessories, cheaper headphones, and a professional headset selling at £17 10s.

Finally, Truvox Ltd. offer a reminder that their address is now Hythe, Nr. Southampton. Since the end of March they have been associated with Thermionic Products Ltd. at that address, but the Truvox range of tape recorders and other hi-fi equipment continues unchanged.

THE photographer's usual method for determining correct exposures during enlarging is that of making test strips; when the negatives are of differing overall densities this method can result in wasted time and materials. During recent years various enlarging aids have appeared on the market but, while ideal in many respects, these devices are also fairly expensive, often bulky and mains powered, sensitive to mechanical shock, and sometimes difficult to use in a dimly lit darkroom since they give a visual indication of exposure.

Bearing these facts in mind, the design described here is an audible (as opposed to visual) type exposure indicator which has the advantages of audible indication of correct exposure setting, robustness, and economy; it is also small in size and is independent of mains supplies.

FEEDBACK OSCILLATOR

The device is basically a direct coupled three transistor amplifier feeding an earpiece. Referring to the circuit diagram (Fig. 1), positive feedback is applied from the collector of TR2 via capacitor C1 to the base of TR1, so that the amplifier becomes a simple audio oscillator with the earpiece emitting a high pitched whistle. The pitch is determined mainly by the values of C1 and R1.

Since the transistors are direct coupled, the current through each is in effect controlled by the value of X1 which supplies the base bias current of the first transistor and which is a cadmium sulphide photo-resistive cell or light dependent resistor.

The overall gain of the amplifier is sufficient for oscillation to occur only when each transistor has its correct bias current, that is, when X1 has a certain fixed value of resistance. Since the resistance of X1 depends on the intensity of the light incident on it oscillation only occurs when this light has a certain intensity.

A 1.3V mercury cell is used to power the unit but it will work over a wide voltage range, from about 0.5V to more than 9V, sensitivity and volume increasing with increasing voltage. With some batteries it may be necessary to connect an electrolytic capacitor across the supply in order to avoid feedback effects due to the battery resistance. This should not be necessary with a medium sized mercury cell as the stability is better with this type of battery.

The unit will work well for battery voltages up to 9V with NKT124 transistors but should not exceed 1.5V for OC44.

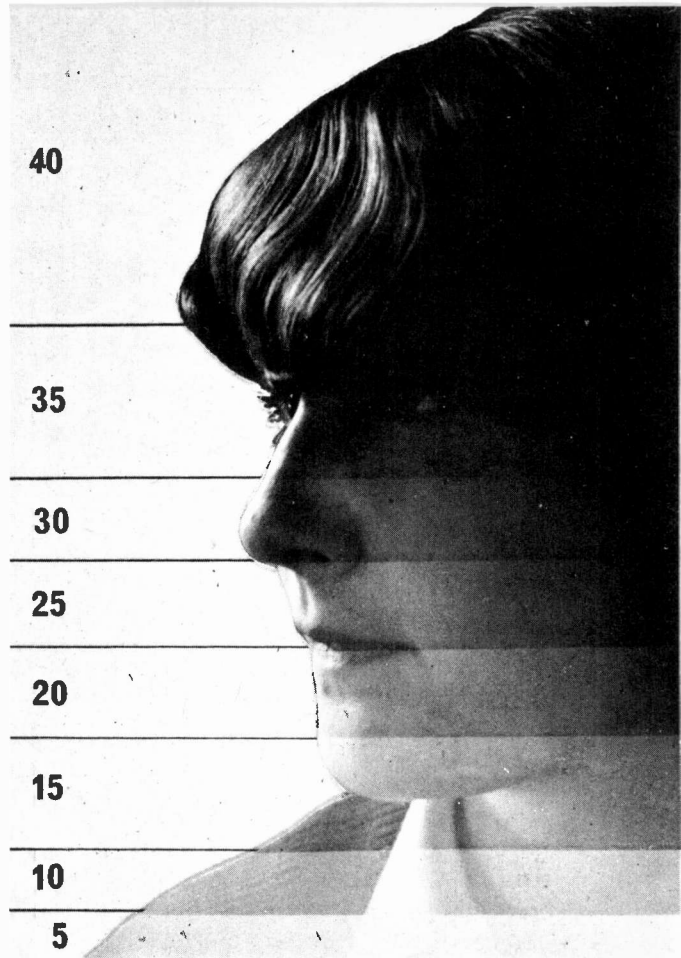
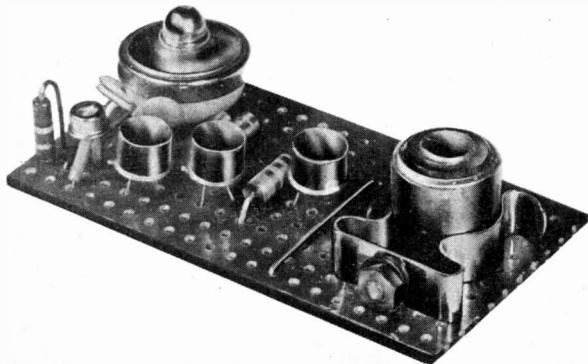

ENLARGEMENT EXPOSURE GUIDE

By J. E. JONES

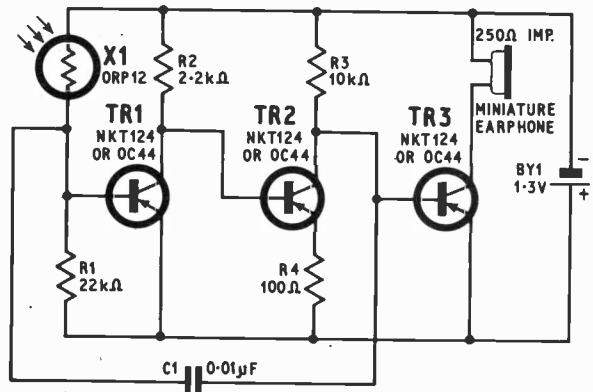

Fig. 1. Complete circuit of the oscillator

NEW MODEL 500. 30,000 o.p.v. With overload protection, mirror scale. 0/5/1/2.5/10/25/100/250/500/1,000/1,000V. D.C. 0/2.5/10/25/100/250 500/1,000V. A.C. 0/50μA/5/50/500mA. 12 amp. D.C. 0/50K/6 Meg./60. Meg Ω. £8/17/6 Post Paid.



PROFESSIONAL 20,000 o.p.v. LAB. TYPE MULTITESTER



With automatic overload protection, mirror scale. Ranges: 1/10/50/250/500/1,000 volts, D.C. and A.C. 0-500 μA, 10 mA, 250 mA. Current: 0/20 K, 200 K, 2 megohm. Decibels -20 to +22db. £5/10/. P. & P. 2/6.

TE-900 20,000Ω/VOLT GIANT MULTIMETER 6in. full view meter. 2 colour scale. 0/2.5/10/250/1,000/5,000 V. A.C. 0/25/12.5/10/50/250/1,000/5,000 V. D.C. 0/50μA/110/100/500 mA/10 amp. D.C. 0.2K/200K/20 Megohm. £12/19/6. P. & P. 5/-.



MODEL ZOM TRANSISTOR CHECKER
It has the fullest capacity for checking on A, B and Ico. Equally adaptable for checking diodes, etc. Spec.: A: 0.7-0.9867, B: 5-200, Ico: 0-50 microamps, 0-5 mA. Resistance for diode 200 Ω - 1 Meg. Supplied complete with instructions, battery and leads. £6/19/6. P. & P. 2/6.



★TRANSISTORISED FM TUNER★
6 TRANSISTOR HIGH QUALITY TUNER, SIZE ONLY 6in. x 4in. x 2 1/2in. 3 I.F. stages. Double tuned discriminator. Ample output to feed most amplifiers. Operates on 9 volt battery. Coverage 88-108 Mc/s. Ready built ready for use. Fantastic value for money. £6.17.6. P. & P. 2/6.

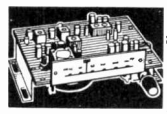

NOMBREX TRANSISTORISED EQUIPMENT
ALL Post Paid With Battery



Transistorised Audio Generator 10-100,000 c/s. Sine or square wave. £18/15/-. Transistorised Signal Generator 150 kc/s. 230 Mc/s. £10/10/-. Transistorised resistance capacity bridge 1Ω. 100 Meg. Ω 1 p-100μF. £9. Transistorised Induction bridge 1μH-100H. £18. Mains operated Transistor power supply unit, output 1-15 v. up to 100 mA. £8/10/-.

SILICON RECTIFIERS

| | |
|-------------------------------|------|
| 260 v. P.I.V. 200mA. | 2/6 |
| 200 v. P.I.V. 5 amp. | 5/6 |
| 400 v. P.I.V. 3 amp. | 7/6 |
| 1,000 v. P.I.V. 500mA. | 6/8 |
| 800 v. P.I.V. 500mA. | 5/8 |
| 800 v. P.I.V. 5 amp. | 7/8 |
| 400 v. P.I.V. 500mA. | 3/8 |
| 70 v. P.I.V. 1 amp. | 3/6 |
| 150 v. P.I.V. 155mA. | 1/- |
| 150 v. P.I.V. 25 amp. | 19/6 |
| 700 v. P.I.V. 100 amp. | 49/6 |
| 400 v. P.I.V. 3 amp. (S.C.R.) | 10/- |
| 100 v. P.I.V. 5 amp. (S.C.R.) | 13/6 |
| 200 v. P.I.V. 5 amp. (S.C.R.) | 15/6 |
| 400 v. P.I.V. 5 amp. (S.C.R.) | 17/6 |

Discounts for quantities. Post extra.

TYPE 13A DOUBLE BEAM OSCILLOSCOPE BARGAIN!



A high quality instrument, offered at a fraction of original cost. Timebase 2 c/s-750 kc/s. Separate Y1 and Y2 amplifiers up to 6.5 Mc/s. Built-in calibrators at 100 kc/s. and 1 Mc. Operation for 115/250 v. A.C. Available in excellent condition, fully tested and checked. £22/10/-. Carr. 30/-.

TE-20RF SIGNAL GENERATOR



Accurate wide range signal generator covering 120 kc/s-250 Mc/s on 6 bands. Directly calibrated. Variable R.F. attenuator. Operation 200/240 v. A.C. Brand new with instructions £12/10/-. P. & P. 7/6. S.A.E. for details.

LAFAYETTE TE-46 RESISTANCE CAPACITY ANALYSER



2 P.F. - 2,000 MFD. 2 ohms - 200 megohms. Also checks impedance turns ratio, insulation, 200/250 v. A.C. Brand New £15. Carr. 7/6.

TE22 SINE SQUARE WAVE AUDIO GENERATORS



Sine: 20 cps to 200 kc/s on 4 bands. Square: 20 cps to 30 kc/s. Output impedance 5,000 ohms, 200/250 v. A.C. Supplied brand new and guaranteed with instruction manual and leads, £15. Carr. 7/6.

ARF-100 COMBINED AF-RF SIGNAL GENERATOR



AF. SINE WAVE 20 - 200,000 cps. Square wave 20-30,000 cps. 0/P. HIGH IMP. 21 v. P.F. 600 Ω 3-8 v. P.F. 100 kc/s-300 Mc/s. Variable R.F. attenuation Int/Ext. Modulation Incorporates dual purpose meter to monitor AF output and % mod. on R.F. 220/240 v. A.C. £27/10/-. Carr. 7/6.

TE-65 VALVE VOLTMETER



High quality instrument with 28 ranges. D.C. volts 1.5-1,500 v. A.C. volts 1.5-1,500 v. Resistance up to 1,000 megohms. 220/249 v. A.C. operation. Complete with probe and instructions, £15. P.P. 6/-. Additional Probes available: R.F. 85/-; H.V. 42/6.



F.M. WIRELESS MICROPHONE

94-104 Mc/s. Transistorised. Operates from 9 v. battery. Complete with additional secret tie-cup microphone. List £12.10.0. ONLY £8.15.0. P. & P. 2/6. These cannot be operated in U.K.

R.107 RECEIVERS

1-7-7.5 Mc/s. Mains or 12 volt D.C. operation. Perfect condition. £15. Carr. 30/-.

JOYSTICK AERIALS AND TUNERS IN STOCK

S.A.E. for leaflet

Catalogue of Electronic Components and Equipment

Send today 5/- P&P 1/-

G.W. SMITH & CO. LTD. (LONDON)

CATALOGUE

- ★ ELECTRONIC COMPONENTS
- ★ TEST EQUIPMENT
- ★ COMMUNICATION EQUIPMENT
- ★ HI-FI EQUIPMENT

We are proud to introduce our first comprehensive catalogue of Electronic Components and equipment. Over 150 pages, fully illustrated, listing thousands of items many at bargain prices. Free discount coupons with every catalogue. Everyone in electronics should have a copy.

CLEAR PLASTIC PANEL METERS

First grade quality. Moving Coil panel meters, available ex-stock. S.A.E. for illustrated leaflet. Discounts for quantity. Available as follows: Type MR. 381. 1 21/32in. square fronts.

| | | | | | |
|-------------|------|---------|------|--------------------|------|
| 100-0-100μA | 27/6 | 200mA | 22/6 | 100V D.C. | 22/6 |
| 500-0-500μA | 22/6 | 300mA | 22/6 | 150V D.C. | 22/6 |
| 1-0-1mA | 22/6 | 500mA | 22/6 | 300V D.C. | 22/6 |
| 1mA | 22/6 | 750mA | 22/6 | 500V D.C. | 22/6 |
| 2mA | 22/6 | 1A D.C. | 22/6 | 750V D.C. | 22/6 |
| 5mA | 22/6 | 2A D.C. | 22/6 | 15V A.C. | 22/6 |
| 10mA | 22/6 | 5A D.C. | 22/6 | 50V A.C. | 22/6 |
| 20mA | 22/6 | 3V D.C. | 22/6 | 150V A.C. | 22/6 |
| 100μA | 22/6 | 50mA | 22/6 | 10V D.C. | 22/6 |
| 200μA | 22/6 | 100mA | 22/6 | 20V D.C. | 22/6 |
| 500μA | 22/6 | 150mA | 22/6 | 50V D.C. | 22/6 |
| 50-0-50μA | 22/6 | | | "S" Meter 1mA 29/6 | |

POST EXTRA. Larger sizes available—send for lists.



R209 MK. II COMMUNICATION RECEIVER

11 valve high grade communication receiver suitable for tropical use. 1-20 Mc/s on 4 bands. AM/CW/FM operation. Incorporates precision vernier driver, BFO. Aerial trimmer, internal speaker and 12 v. D.C. internal power supply. Supplied in excellent condition, fully tested and checked. £15. Carr. 20/-.

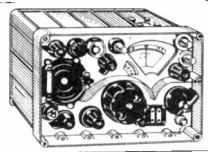

HA-63A COMMUNICATION RECEIVER OUTSTANDING VALUE

High class receiver covering 550 kc/s-31 mc/s on 4 bands. Incorporates 7 valves plus rectifier, RF stage, illuminated "S" meter, 1.5μV sensitivity, electrical bandspread on the 80/40/20/15 and 10 metre bands, slide rule dial, aerial trimmer, B.F.O., noise limiter. Output for phones or speaker. Operates on 115/220/240 v. A.C. Supplied brand new and guaranteed with manual. 24 gns. Carr. 10/-.



LAFAYETTE KT-340 COMMUNICATION RECEIVER SEMI-KIT

Build this wonderful receiver and save Pounds! Supplied semi-completed, main components ready mounted, R.F. Section already wired and aligned. Full and precise instructions supplied. Specification: 8 valves + rectifier, 4 bands covering 550 Kc/s-30 Mc/s. Incorporates 1 R.F. and 2 I.F. stages, "Q" multiplier, B.F.O., A.N.L. "S" meter, bandspread, aerial trimmer, etc. Operation 115/230v. A.C. Price 25 GNS. Carr. 10/-.

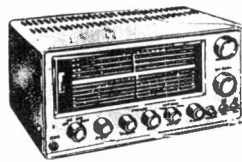

HAM-1. 4 BAND COMMUNICATION RECEIVER

4 wavebands covering 535 kc/s-30 Mc/s 5-valve superhet circuit. Incorporates 8 meter, B.F.O., BANDSPREAD TUNING, BUILT-IN 4in. SPEAKER, FERRO AERIAL AND EXTERNAL TELESCOPIC AERIAL. Operation 220/240v. A.C. Supplied brand new with handbook. £16/18/0. Carr. 10/-.

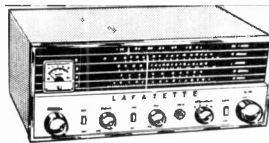

NEWLAFAYETTE MODEL HA-700 AM/CW/SBB AMATEUR COMMUNICATION RECEIVER

8 valves, 5 bands incorporating 2 MECHANICAL FILTERS for exceptional selectivity and sensitivity. Frequency coverage on 5 bands 150-400 kc/s, 550-1,600 kc/s, 1.6-4.0 Mc/s, 48-14.5 Mc/s, 10.5-30 Mc/s. Circuit incorporates R.F. stage, aerial trimmer, noise limiter, B.F.O., product detector, electrical bandspread, 8 meter, slide rule dial. Output for phones, low to 2K Ω or speaker 4 or 8 ohms. Operation 220/240 volt A.C. Size 7 1/2in. x 15in. x 10in. Supplied brand new and guaranteed with handbook 36 GNS. carr. 10/- S.A.E. for leaflet.

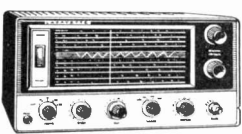

CALLERS WELCOME!

Open 9 a.m. to 6 p.m. every day Monday to Saturday. Trade supplied.

G.W. SMITH & CO (RADIO) LIMITED

Phone: GERRARD 8204/9155
Cables: SMITHEX LESQUARE
3-34 LISLE STREET, LONDON, W.C.2

A-Z

(MINUS X)

ALPHABETICALLY...

we can list the names

GEOGRAPHICALLY...

we can list the countries

All over the world students know that CREI HOME STUDY COURSES are supplying the answer to their need for advanced Technical Education in the field of Electronic Engineering Technology.

CREI PROGRAMMES ARE AVAILABLE IN:

- Electronic Engineering Technology
- Industrial Electronics for Automation
- Computer Systems Technology
- Nuclear Engineering
- Mathematics for Electronic Engineers
- Television Engineering
- Radar & Servo Engineering
- City & Guilds of London Institute : Subject 49 and Supplementary Studies Subject No. 300

Write for free brochures to:

C.R.E.I. (London) (Dept. P.E.5.)

WALPOLE HOUSE, 173/176 SLOANEST., LONDON S.W.1

Telephone: Belgravia 8662

INTERNATIONAL DIVISION OF CAPITOL RADIO ENGINEERING INSTITUTE WASHINGTON D.C.

Please send me (for my information and entirely without obligation) full details of the educational programmes offered by your institute.....

Send details of the City & Guilds Programme

Name

Address

.....

.....

Electronics Experience

.....

C.R.E.I. (LONDON) (DEPT. PE5) WALPOLE HOUSE, 173-176 SLOANE STREET, S.W.1

HEWMART

Dept. PE1

30/32, SHUDEHILL MANCHESTER 4.

Telephone. (061) 832 7710

FREE GIFT OFFER

OF A BRAND NEW WORLD FAMOUS E.M.I. FISK SOLARSCOPE VALUE 49/2/- WITH EVERY ORDER VALUE 45 AND OVER. THIS UNIQUE INSTRUMENT WHICH IS A BOON TO SHORT WAVE LISTENERS CLEARLY SHOWS THE AREAS OF DAYLIGHT AND DARKNESS ALL OVER THE EARTH AT ANY GIVEN HOUR.

MINI-MOTORS. 3V to 4.5V operation. Ideal for mini-racing cars, toys "Large" (1 1/2 x 1/2 x 1 1/2) 8/11. Medium (1 x 1/2 x 1 1/2) 8/9. Small (3/4 x 1/2 x 1 1/2) 3/8 P. & P. 9d. each.

BRAND NEW! Why use Sapphire Styli in your record-player when at very little extra cost you can have a first-grade GENUINE DIAMOND STYLUS at 7/11 plus 6d. P.P. Available as replacements for the following popular types only at present: LBP TC6LP—BSR TCS STEREO—BSR TCS LP/STEREO—COLLARO STUDIO "CO" LP/BONETTE—GARRARD GCS LP—ACOS GP 65/71LP—BONETTE BF40/LP—GARRARD GCS LP.

SPEAKERS. 12" round high quality British fitted tweeter cone, 6 watts, in 3 Ω or 15 Ω 29/8 p.p. 3/6. ROUND 12" R. & A. 3 Ω 25/6 p.p. 3/6. 2in round speaker 80 OHMS for your miniature equipment—4/- each, P. & P. 1/-.

Many other speakers from 2in to 13in available. Extension type, with vol. control, attractive finish: includes 7" x 4" speaker, 32/6 p.p. 4/6. Attractive extension speaker with two Jacks to suit all transistor sets for home or car. 17/6 p.p. 2/6.

TWEETER. 2 1/2in Black plastic cone, round on Square Frame. E.M.I. 3 Ω—12/6, plus 1/6 P. & P.

MICROPHONES. LAPEL/HAND MIKE—1 1/2in dia. Lapel Clip, Ideal for tape recording. With lead. Very sensitive 7/8. P. & P. 1/-.

CRYSTAL HAND MIKE. Robust and sensitive. Cream plastic case. Just the thing for tape recorders 8/6. P. & P. 1/6.

ACOS MIC 40—World famous Desk Mike 18/9 plus P. & P. 1/3.

ACOS MIC 45—Splendid Curved Hand Grip Crystal Mike 14/8 plus P. & P. 1/6.

ACOS MIC 60—"Stick" Type Crystal Mike 18/6 plus P. & P. 1/6.

ACOS ROUND. Crystal mike insert 1 1/2" dia. 7/6 p.p. 6d.

TELESCOPIC FLOOR STAND, HEAVY BASE. Standard thread. 49/6. Carr. & Pkg. 2/6.

TELEPHONE PICK-UP COIL. For recording or amplifying both sides of telephone conversation. Suction cup fitting to Telephone, with lead 7/6. P. & P. 1/-.

INTER-COMM. DE-LUXE 2-WAY. Ideal for offices, workshops, theatres, etc. Highly efficient, safe BABY ALARM. No mine-works off PP3 battery, which lasts for months, obtainable everywhere. Buzzer call system, complete with lead, plugs, battery, in handsome carton. 55/-, P. & P. 2/6.

PICK-UP ARM. Lightweight, with T/O crystal cartridge and styli for L.P. and 78 r.p.m. records on base with rest 27/6. P. & P. 2/6.

4 TRANSISTOR 3W AMPLIFIER. Size 2 1/2 x 2 1/2 x 1 1/2, 3, 8 or 15 Ω output. 9 volt battery operated. Highly sensitive. Price (less battery) 52/6. P. & P. 1/6.

| RECORD PLAYER DESKS. GARRARD | | | |
|------------------------------------|---|----|---|
| SPES DE LUXE 4-SPEED SINGLE PLAYER | 29 | 9 | 6 |
| | All latest models. All fitted Mono Cartridge. | | |
| MODEL 1000 4-SPEED AUTO-CHANGE | 25 | 19 | 6 |
| | Stereo 10/- extra. Carr. & Pkg. all models 7/6. | | |
| MODEL 3000 4-SPEED AUTO-CHANGE | 27 | 10 | 0 |

| B.S.E. AUTOMATIC RECORD-CHANGER DECKS. LATEST MODELS. | | | |
|--|----|----|---|
| UA25—Very popular—4 speed. Cap. six 7in, 10in, 12in records | 25 | 19 | 6 |
| UA1588—Slim Design—first class 4 speed. Two tone grey | 26 | 2 | 6 |
| UA 15/883D—As above, but with low mass p/u. arm, reducing record wear and heavier 10 1/2in turntable, finished in pearl grey and black | 26 | 18 | 9 |
| P. & P. on all above 7/6. Price includes Free Gift. | | | |

PLINTHS to suit most record decks. In attractive simulated wood finish 17" x 14" x 4" 49/11 p.p. 6/1.

| MAGNAVOX "363" TAPE DECKS. LATEST MODELS. | | | |
|---|-----|----|---|
| World-famous. Made to highest standards. Size 13 1/2 x 11 x 5 1/2in below board. For 200/250V 50 cycles a.c. 3 speed, digit counter, piano key controls. 7in reels. Every modern feature. Speeds 17, 3 1/2 and 7 1/2 i.p.s. | | | |
| With 1/2 track Bradmatic heads | 210 | 10 | 0 |
| With 1/2 track Marriot heads | 213 | 0 | 0 |
| P. & P. 10/- Price includes Free Gift. | | | |

PICK-UP CARTRIDGE REPLACEMENTS. STANDARD FIXING FOR MOST RECORD-PLAYER ARMS. ALL TURN-OVER TYPES WITH STYLI FOR L.P. & 78 R.P.M.

ACOS GP/67-2 MONO 12/6 each. ACOS GP/73-2 STEREO 25/- each. ACOS GP/91-1 MONO-DE-LUXE 17/6 each. Postage and packing 9d. each.

Finest Quality British made MYLAR Recording Tape, Fully Guaranteed.

| | | | |
|--|------|----------------------------|------|
| 3in Message | 5/- | 5 1/2in 1200ft Long Play | 12/6 |
| 5in 600 Standard Play | 8/6 | 7in 1800ft Long Play | 19/6 |
| 5 1/2in 850 Standard Play | 11/6 | 5 1/2in 1200ft Double Play | 15/- |
| 7in 1200 Standard Play | 12/6 | 5 1/2in 1800ft Double Play | 22/6 |
| 5in 900ft Long Play | 10/- | 7in 2400ft Double Play | 24/- |
| P. & P. 1/- per reel. Four reels and over post paid. | | | |

POCKET MULTI-TEST METER. 1000 Ω per volt. Volts 0/10/50/250/500/1000 a.c. and d.c. Current: 0-1-100-500mA. Resistance: 0-100k Ω. Complete with test prods, instructions. 27/8. P. & P. 1/6.

TRANSISTORS: Some popular types for our range: OC44 and OC45 3/6 each. OCT1 2/9. OCT2 3/6. OC81 and OC81D 3/- each. OC169 3/9. OC170 3/6. AF117 4/- OC26 7/8. GET8 5/9 General purpose (Approx. OCT1) 1/- each.

NEW HIGH FREQUENCY TRANSISTORS. Sinclair ST140—4/-, ST141—6/- both capable of operating up to 700 Mc/s. ALSO MAT 100—7/9, MAT 101—8/6, MAT 120—7/8, MAT 121—8/6, ADT 140—15/-, High speed switching transistors—BSY 26, BSY 28, BSY 65—5/- each.

THYRISTORS. 100 PIV 5A. 12/6: 200 PIV 5A. 15/-, Postage 6d. up to 3. Over 12 sent P. & P. paid.

E.F. FIELD INDICATOR. Ideal for use with radio controlled models. Checks radiation from existing antenna. Tunes 1 to 250Mc. in 5 bands. Sensitive 200mA. meter movement. 5 section plug-in aerial. Phone jack and crystal earpiece for monitoring. No battery required. Powerful magnet for attaching to metal surfaces. Complete with instructions. 47/6. P. & P. 2/6.

TERMS. Cash with order—No C.O.D. Orders totalling 25 and over sent carriage paid (excepting Record player decks where carriage is shown). Guaranteed money refunded if goods returned perfect within 7 days of despatch.

REMEMBER THE NOVEL FREE GIFT EXCLUSIVE TO US!

Callers welcome—Very many more lines to choose from. Open 9.30 a.m.—6 p.m. Mon-Sat STOCKISTS OF ALL SINCLAIR, CIR-KIT, MARTIN KITS—DETAILS WITH PLEASURE

MINIATURE UNIT

The construction is shown in Fig. 2. The copper strips on the board having to be broken in only four places. The earpiece is fixed in place with "Evostik" or a similar adhesive. The mercury cell, a Mallory type 640 or type 1, is held in place by a Terry clip which is bolted to a small loop of stout wire soldered to the board. When all soldering has been completed, the underside of the board is best protected with a coat of paint or varnish.

The complete unit can be built on a piece of Veroboard of about 3in x 1½in or even smaller and can, if desired, be enclosed in a small box painted white to show up in the darkroom. Holes are drilled in the board near the earphone and photo-cell.

SETTING-UP

A suitable procedure when using the device is as follows:

1. Switch on the enlarger and focus the image of the negative on to the baseboard with the lens iris fully open.
2. Switch on the exposure indicator unit and position the photo-cell on the lightest part of the negative image (corresponding to shadow area in print).
3. Close the iris until the device emits a whistle.
4. Switch off the enlarger, replace the exposure indicator with printing paper, and switch on the enlarger again, leaving it on for a fixed time depending on the type of printing paper being used and previously determined for that paper by means of the usual test strip. The exact exposure time will therefore be the same for every picture and will depend only on the type of printing paper used, and is about 30 to 40 seconds.

Alternatively, the circuit can be modified so that it is adjustable by replacing R1 with a variable resistor or by placing a variable resistor in series with X1. In this case the exposure would be read off a dial directly.

This exposure aid is intended as a simple, reliable, and cheap device for avoiding wastage of time and paper during normal enlarging and would be a great help to beginners. It is almost completely shockproof and accuracy can be better than plus or minus one third of a stop (measured through a camera lens). Circuit resistor values are fairly critical but the values of C1 and R1 can be altered if desired.

COMPONENTS . . .

Resistors

R1 22kΩ
R2 2.2kΩ
R3 10kΩ
R4 100Ω
All 5% ¼ watt carbon

Capacitor

C1 0.01μF polyester

Photo-cell

X1 ORP12 cadmium sulphide cell (Mullard) or Proops type 4 (Proops Bros. Ltd., 52 Tottenham Court Road, London, W.C.1.)

Transistors

TR1, TR2, TR3 NKT 124 or OC44 (3 off)

Battery

BY1 1.3V mercury cell type 1 (Mallory)

Miscellaneous

Magnetic earpiece 250Ω
Veroboard 3.1in x 1.6in. Matrix 0.15in
Spring clip no. 80/0 (Terry)
Plastics box

The earpiece should be of medium impedance and must be magnetic, not crystal. The cadmium sulphide cell can be a Mullard type ORP12 but a Proops Bros. type 4 is preferred because of its smaller size (less than ¼in diameter). The circuit draws very little current (about 2mA) so the mercury cell lasts a very long time.

Sensitivity can be decreased, for shorter printing times, by either:

- (a) painting round the edge of the photocell window with black paint in order to reduce its effective area, or
- (b) by painting the whole of the photocell window with a transparent blue paint or waterproof ink—this gives the cell a better colour response, the cell normally being very sensitive to the red end of the spectrum.

The unit has been successfully used for "through-the-lens" camera exposure metering, the shutter speed being set according to film speed (e.g. 1/125 for 125 ASA film). ★

MINIATURE EARPHONE

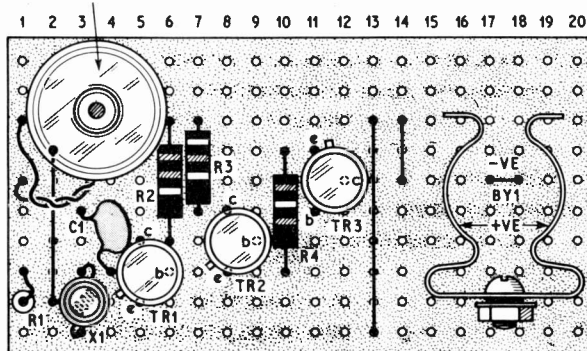

BATTERY SUPPLY GOES TO CIRCUIT VIA WIRE LOOP E17 E18 TO STUD (-VE), AND WIRE LOOP I17, I18 AND TERRY CLIP TO CASE (+VE).

Fig. 2a. Components are all mounted on the perforated board. Insert the battery in the spring clip with the negative stud face down

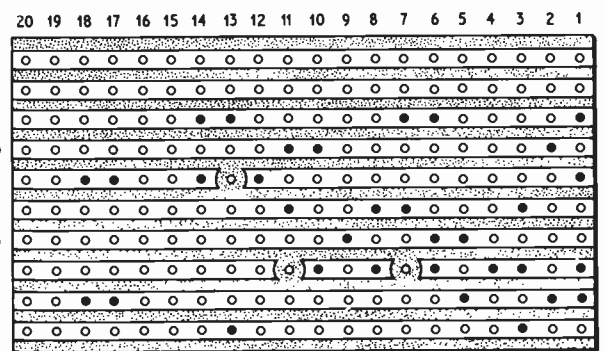

Fig. 2b. Underside view of the board. Copper strip breaks are shown. Soldered connections are shown with the holes blacked in



Part One

INVESTIGATOR

PORTABLE

SIMPLE TO BUILD

SPECIFICATION...

| | |
|------------------------|---|
| Minimum Display Area | 5cm × 5cm |
| Timebase Speeds | Calibrated from 10 μ s to 10ms in four steps |
| X Expansion | Five times minimum |
| Fine Frequency Control | Increases by more than ten times upon the basic frequency |
| X Shift | Plus and minus 2.5 centimetres about centre |
| Y Sensitivity | From 10mV to 30V peak-to-peak per centimetre in eight calibrated ranges |
| Y Shift | Plus and minus 2.5 centimetres about centre |
| Sync | Internal: varied by trigger control External: varied by trigger control with spare positions |
| Bandwidth | From 20Hz to 1 MHz \pm 2dB; to 2MHz \pm 4dB |
| Y distortion | Better than 2% over 2.5 centimetre display area |
| Input Impedance | Better than 3.3 megohms from 20Hz to 500 kHz |

POSSIBLY one of the more difficult problems from a constructor's point of view is the inability to check the shape of a waveform once an equipment has been built. A desirable asset in the constructor's workshop is an oscilloscope, although the cost of purchasing one often precludes its inclusion among the normal array of test equipment.

It is possible to buy either surplus units or relatively inexpensive display units, but the usual problem encountered under these circumstances lies in the fact that the majority of such equipments fail to provide the required input sensitivity or do not accurately measure the voltage of the waveform under test.

The oscilloscope described in this article provides an indication of the input signal and enables the operator to check the frequency of the signal under measurement by reference to the switches on the front of the

unit. It is not necessary to resort to measurement of a "standard" signal so that a comparison has to be made.

In the Y plane there are eight calibrated switched positions from 10mV per centimetre to 30V per centimetre; the bandwidth lies between 20Hz and 1MHz with the amplitude variation kept within plus or minus 2dB. The timebase, however, requires only four switched positions to cover quite adequately the stipulated bandwidth. This function has been divided into multiples of ten and the coverage, as indicated, in four ranges is from 10 millisecond to 10 microsecond.

The display tube used in this oscilloscope has a 5cm screen and is available on the market as a new G.E.C. unit number 700A or may be located on the "surplus" market as VCR139A. This tube gives a substantial display more than adequate for even complex wave-

By R. Hirst

OSCILLOSCOPE

COMPACT

EASY ACCESS TO ALL COMPONENTS

forms. In order to ease the construction the whole oscilloscope has been broken down into sub-sections each of which are described in detail.

CIRCUIT DESCRIPTION

Due to the relatively high voltages required to promote the correct deflection at the X and Y plates of the tube it was thought desirable to use inexpensive and easily available valves rather than try to incorporate very expensive high voltage transistors. Hence the design based on valve circuitry. The whole circuit can be best described by breaking it down into the various functions. Fig. 1 shows the complete circuit to which reference can be made.

Y PREAMPLIFIER

The first stage V1 contains two valves in one envelope, the first V1a being directly coupled to the second V1b. The input impedance of this preamplifier is in the order of 4.7 megohms, the input signal being applied to the grid of V1a, a cathode follower, through a two-step attenuator. V1b amplifies the signal in a more normal fashion.

The variable decoupling of the emitter of this stage, by the setting of VR3, allows the gain of this preamplifier to be accurately adjusted during the setting-up procedure. The output from V1b is fed into an eight-step attenuator, switched by S1b, which repeats the attenuation characteristics twice and, in conjunction with S1a, provides a coverage from 10mV to 30V peak-to-peak per centimetre.

Y DRIVER AMPLIFIER

The output from the attenuator switch S1b is now fed into V2 which provides sufficient gain to transfer the incoming signal to a level that will adequately drive the main Y amplifier. The small capacitor C6 offsets the slight high frequency deficiency and ensures that the response shown on the Y plane is relatively flat up to 2MHz.

Y MAIN AMPLIFIER

V3a and V3b take the form of a cathode-coupled phase splitter where the balanced outputs from the anodes are directly fed on to the Y plates. The two

anode resistors, R22 and R23 are of different values as the introduction of the Y shift control into the grid of V3b unbalances the gain factor of this stage to some degree. The Y shift control merely changes the voltages at the grid of V3b consequently changing the d.c. potential at the Y plates.

SYNC STAGE

The input signal is sampled at the anode of V2 and a portion of this is amplified by V4a and introduced into the timebase generator to provide locking of the timebase to the incoming signal. The variable control VR5 ensures that the locking signal can be injected into the system in a correct proportion, consequently maintaining stability of the timebase. V4b is not used but can easily be adapted for the experimenter's own requirements.

text continued on page 514



COMPONENTS...

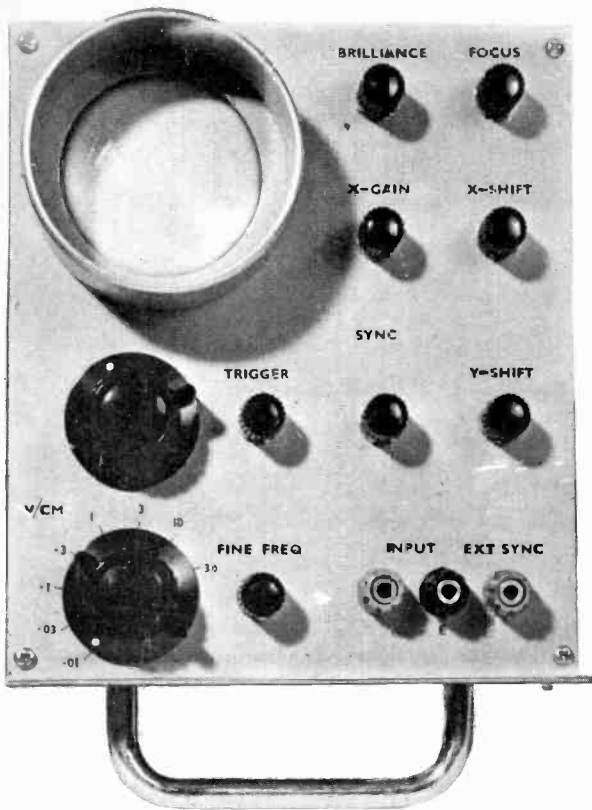

Resistors

| | | |
|-----|---------------|-------------------------------------|
| R1 | 4.7M Ω | } H.S. low noise 2% |
| R2 | 47k Ω | |
| R3 | 1.2k Ω | } Low Noise 5% |
| R4 | 33k Ω | |
| R5 | 2.2k Ω | |
| R6 | 2.7k Ω | |
| R7 | 3.3k Ω | |
| R8 | 300 Ω | } High stability 2% |
| R9 | 1.8k Ω | |
| R10 | 300 Ω | |
| R11 | 300 Ω | |
| R12 | 180 Ω | |
| R13 | 120 Ω | |
| R14 | 150k Ω | |
| R15 | 18k Ω | |
| R16 | 330k Ω | |
| R17 | 560 Ω | |
| R18 | 2.2k Ω | } 2W wirewound |
| R19 | 1.2M Ω | |
| R20 | 180 Ω | } High stability 2% 3W wirewound |
| R21 | 2.7k Ω | |
| R22 | 12k Ω | |
| R23 | 18k Ω | |
| R24 | 120k Ω | |
| R25 | 4.7M Ω | } 1 watt |
| R26 | 4.7k Ω | |
| R27 | 470 Ω | |
| R28 | 150k Ω | |
| R29 | 100k Ω | |
| R30 | 82k Ω | |
| R31 | 100k Ω | |
| R32 | 150k Ω | |
| R33 | 8.2k Ω | |
| R34 | 3.3k Ω | |
| R35 | 820 Ω | |
| R36 | 18k Ω | |
| R37 | 1.2M Ω | |

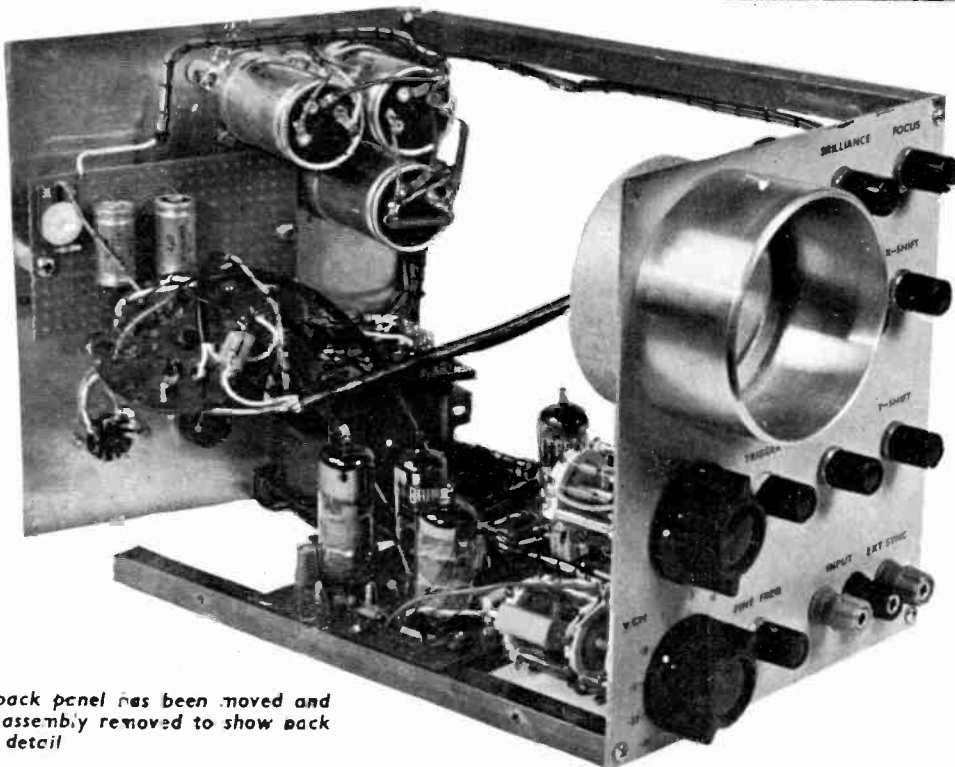

The back panel has been moved and c.r.t. assembly removed to show back panel detail

| | | |
|---|---------------|----------------|
| R38 | 27k Ω | } 2W wirewound |
| R39 | 18k Ω | |
| R40 | 220 Ω | |
| R41 | 1.2M Ω | |
| R42 | 2.7k Ω | |
| R43 | 120k Ω | |
| R44 | 4.7k Ω | } 3W wirewound |
| R45 | 470 Ω | |
| R46 | 150k Ω | |
| R47 | 56k Ω | |
| R48 | 56k Ω | |
| R49 | 820k Ω | |
| R50 | 820k Ω | |
| R51 | 100 Ω | |
| R52 | 100 Ω | |
| R53 | 150k Ω | |
| R54 | 390k Ω | |
| All 10%, $\frac{1}{2}$ W carbon, except where stated. | | |

Potentiometers

| | |
|------|------------------------------------|
| VR1 | 10k Ω linear wirewound |
| VR2 | 50k Ω linear carbon preset |
| VR3 | 5k Ω linear carbon preset |
| VR4 | 100k Ω linear carbon preset |
| VR5 | 100k Ω linear wirewound |
| VR6 | 20k Ω linear wirewound |
| VR7 | 20k Ω linear wirewound |
| VR8 | 2M Ω linear carbon preset |
| VR9 | 2M Ω linear wirewound |
| VR10 | 20k Ω linear wirewound |
| VR11 | 20k Ω linear wirewound |

Diodes

| | |
|----|--------------|
| D1 | OA91 |
| D2 | OA91 |
| D3 | OA210 |
| D4 | OA210 |
| D5 | K8/30 S.T.C. |

Capacitors

| | | |
|-----|----------------|--------------------------|
| C1 | 0.1 μ F | paper 250V |
| C2 | 1 μ F | paper 250V |
| C3 | 32 μ F | elect. 10V |
| C4 | 0.1 μ F | paper 250V |
| C5 | 0.22 μ F | paper 250V |
| C6 | 0.002 μ F | ceramic |
| C7 | 0.2 μ F | paper 250V |
| C8 | 50 μ F | elect. 350V |
| C9 | 0.1 μ F | paper 250V |
| C10 | 50 μ F | elect. 350V |
| C11 | 50 μ F | elect. 350V |
| C12 | 100pF | ceramic |
| C13 | 0.2 μ F | paper 250V |
| C14 | 0.1 μ F | paper 250V |
| C15 | 0.022 μ F | } 2% mica or polystyrene |
| C16 | 0.0022 μ F | |
| C17 | 220pF | } 2% mica or polystyrene |
| C18 | 22pF | |
| C19 | 0.1 μ F | paper 400V |
| C20 | 0.1 μ F | paper 400V |
| C21 | 1 μ F | paper 250V |
| C22 | 0.047 μ F | } 2% mica or polystyrene |
| C23 | 0.0047 μ F | |
| C24 | 470pF | } 2% mica or polystyrene |
| C25 | 47pF | |
| C26 | 50 μ F | elect. 350V |
| C27 | 0.1 μ F | paper 250V |
| C28 | 50 μ F | elect. 350V |
| C29 | 50 μ F | elect. 350V |
| C30 | 0.22 μ F | paper 250V |
| C31 | 8 μ F | elect. 450V |
| C32 | 8 μ F | elect. 450V |

Valves

| | |
|----|---|
| V1 | ECC81 or 12AT7 |
| V2 | EF80 |
| V3 | ECC82 or 12AU7 |
| V4 | ECC81 or 12AT7 |
| V5 | EF80 |
| V6 | ECC82 or 12AU7 |
| V7 | 700A or VCRI39A cathode ray tube (G.E.C.) |

Transformer

| | |
|---------|--|
| T1 | Mains transformer (Belclere Ltd., 385 Cowley Road, Oxford) Type OS3649 |
| Pri: | 0-220-240V; |
| Sec. 1: | 240-0-240-625V; |
| Sec. 2: | 4V 1A; Sec. 3: 6.3V 1.9A |

Switches

| | |
|----|--|
| S1 | 2 pole, 8 way |
| S2 | 1 pole, 3 way |
| S3 | 2 pole on-off (switch on brilliance control) |
| S4 | 2 pole, 4 way |

Miscellaneous

| | |
|---|------------------|
| SK1 | 3-pin mains plug |
| FS1 | 100mA |
| FS2 | 250mA |
| 9 $\frac{1}{2}$ \times $\frac{1}{2}$ in square aluminium or steel (4 off) | |
| 20 s.w.g. aluminium sheet 23in \times 10in | |
| 16 s.w.g. aluminium panels 7in \times 8in (2 off) | |
| Capacitor clips (3 off) | |
| Perforated s.r.b.p., 0.15 matrix, 7in \times 6 $\frac{1}{2}$ in | |
| B9A valve bases printed circuit type (6 off) | |
| B12B c.r.t. base | |
| 10 knobs and 3 input terminals | |
| 3in bore aluminium tubing 2 $\frac{1}{2}$ in long | |
| 20 s.w.g. tinned copper wire | |

(Note: D3, D4, R51 and R52 mounted on T1)

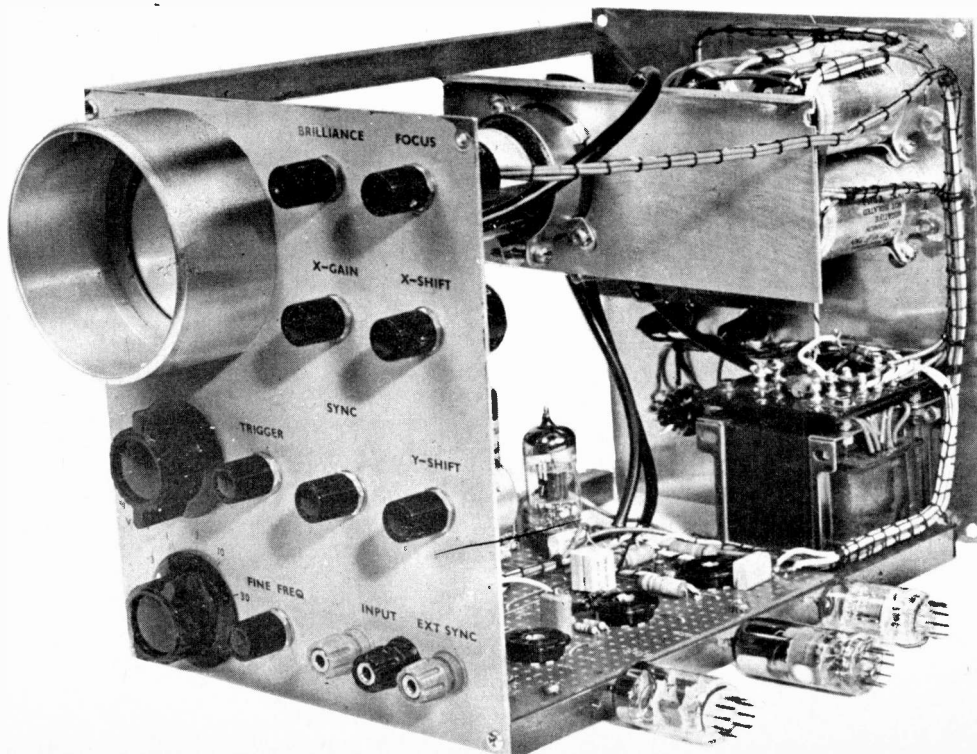

Y AMPLIFIER

Y DRIVER

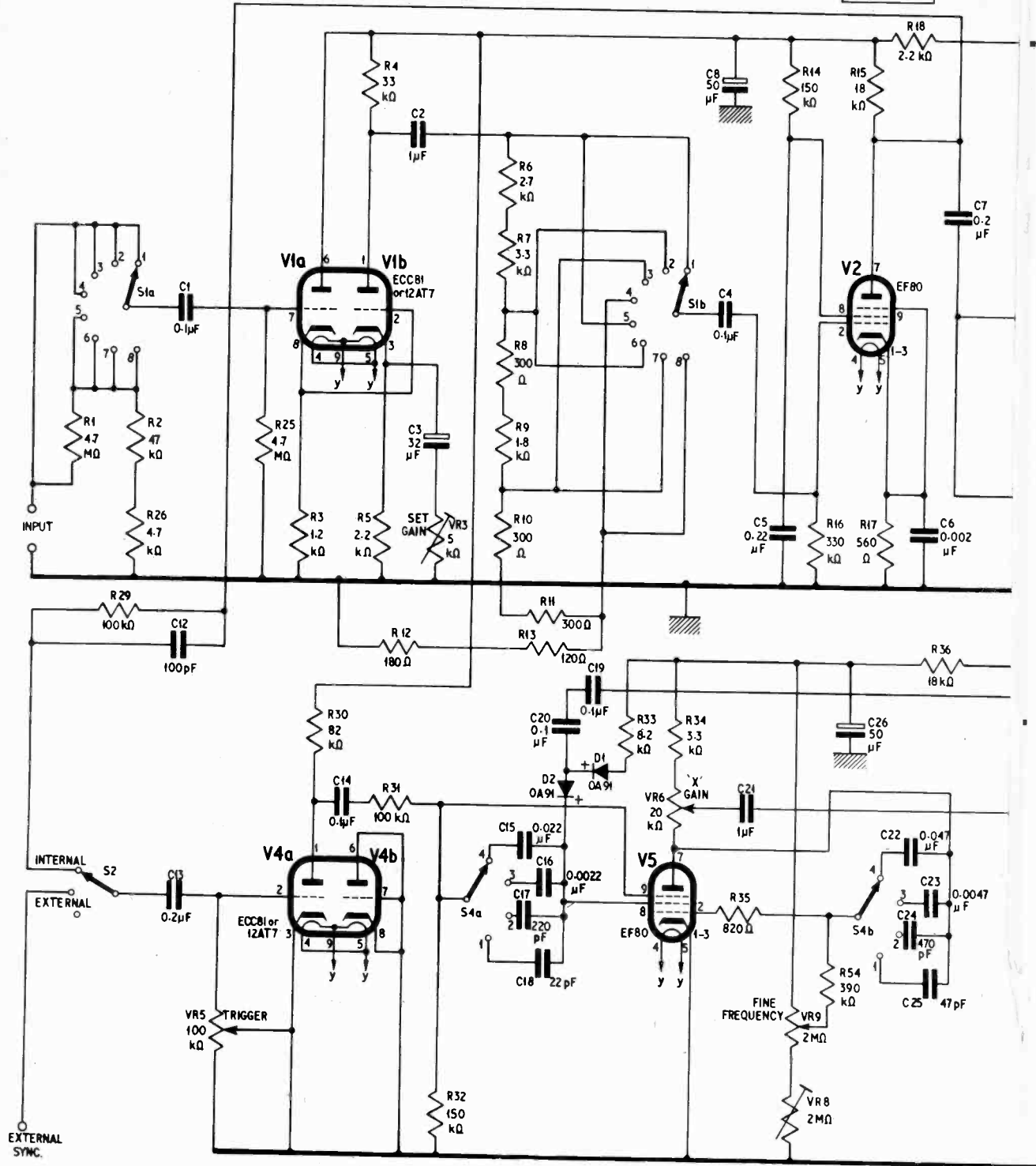

SYNC

- S1a-b 1 10mV
- 2 30mV
- 3 100mV
- 4 300mV
- 5 1V
- 6 3V
- 7 10V
- 8 30V

- S4a-b 1 10mS
- 2 1mS
- 3 100μS
- 4 10μS

TIMEBASE GENERATOR

Fig. 1. Complete circuit diagram of

Y PHASE SPLITTER

H. T. SUPPLY

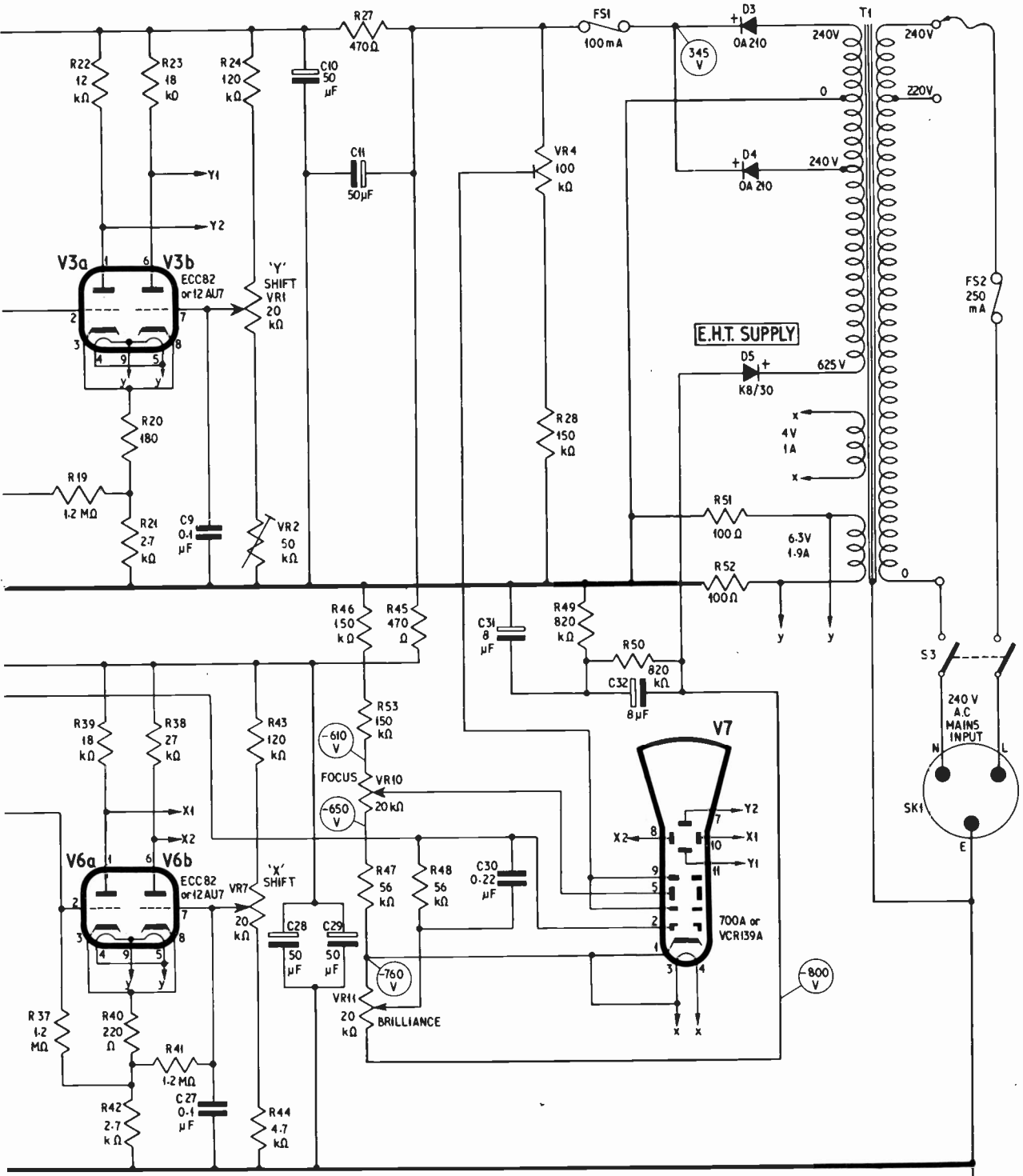

X PHASE SPLITTER

DISPLAY TUBE

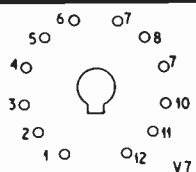

the "Investigator Oscilloscope"

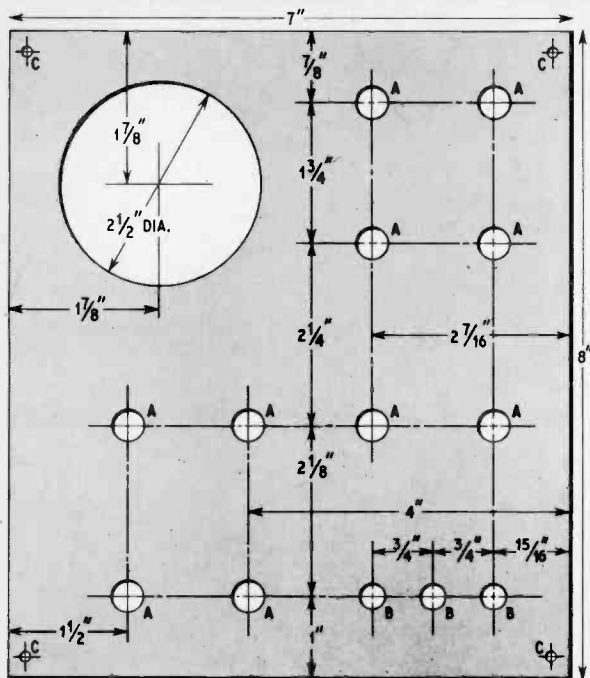

Fig. 2. Drilling details of the front panel made from 16 s.w.g. aluminium sheet. Holes 'A'— $\frac{3}{8}$ in dia; holes 'B'— $\frac{1}{4}$ in dia; holes 'C'—No. 26 drill

TIME BASE GENERATOR

The time base generator is of the Miller run down Transiron type giving an adequate sawtooth waveform over the range required. The frequency of this generator is determined by the switched capacitors mounted on S4a and S4b. If these capacitors are kept to a reasonably close tolerance then quite accurate measurement of frequency of the signal under examination can be made.

A fine frequency control VR9 has been included with a preset condition (VR8) which enables the operator to preset the high frequency condition to a wide range of predetermined frequencies. The fine frequency control varies the frequency about ten times thus ensuring adequate display variation from range to range.

The X gain control is situated in the anode of V5 and the series resistor R34 ensures that the minimum condition allows for a 3cm scan. The time base may be expanded about five times by VR6 so that fine detail in a wave form may be examined.

X MAIN AMPLIFIER

The main amplifier for the X plates follows closely the configuration adopted in the Y plane where a balanced output, this time from V6a and V6b, is fed on to the X plates. The X shift is determined by VR9, varying the d.c. potential on the X plates.

H.T. POWER SUPPLY

The power supply follows the more usual techniques where the output of T1 is full-wave rectified by the diodes D3 and D4 and subsequently smoothed by C10, C11, C28, and C29 in conjunction with R27 and R45.

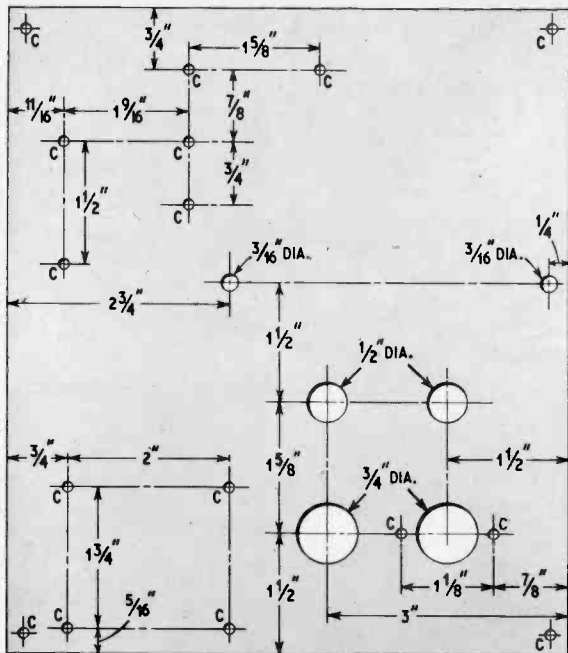

Fig. 3. Drilling details of the back panel made from 16 s.w.g. aluminium sheet. Holes 'C'—No. 26 drill

E.H.T. POWER SUPPLY

The e.h.t. is taken from an auto winding of the h.t. secondary and is rectified by the half-wave rectifier diode D5. Two 450 volt capacitors have been used as the smoothing capacitors, and have been connected in series with each other across the supply, providing 800 volts d.c. for the cathode ray tube. A series resistor chain between this point and earth gives the various voltages required for the brilliance and focus controls and VR4 has been introduced so that the e.h.t. on the final anode of the tube can be adjusted for the best focusing condition. It is essential to connect one side of the tube heater to the cathode so that the manufacturers' ratings of the tube in this respect are not exceeded.

GENERAL NOTES

The heater supply to the amplifier valves have been balanced by R51 and R52 so that the hum in the first stage of the Y preamplifier is kept to a minimum.

Spare positions have been left on the sync function switch so that further conditions may be introduced by the constructor to suit his individual requirements. Use has been made of the spare set of contacts on the sync switch so that relevant h.t. points may be terminated here to ease the construction of the front panel. Care must be taken in ensuring that this switch is wired up correctly or h.t. will arrive at some inconvenient point.

A spare valve V4b has also been included so that once again the constructor may include circuitry to assist in his particular field and from this valve there is easy access to h.t. points, etc.

Construction can be started by making the front and back panels in 16 s.w.g. aluminium (see Figs. 2 and 3).

Next month: Full constructional details, wiring, and setting up.

MARKET PLACE

Items mentioned in this feature are usually available from electronic equipment and component retailers advertising in this magazine. However, where a full address is given, enquiries and orders should then be made direct to the firm concerned.

LOOKING AROUND

During the brief lull in activities between the closing of the Audio Fair and the opening of the Radio & Electrical Component Manufacturers' Federation Exhibition, May 23 to 26, there have been a number of interesting items appearing on the market.

Readers wanting to run a radio, television, record player, or tape recorder in a caravan or boat may be interested in a new range of Transverters from Valradio Ltd., Browells Lane, Feltham, Middlesex. These units have been specially designed to provide power for waveform and frequency sensitive equipment such as sound tape recorders and video tape recorders, etc.

Two a.c. outputs are provided; 115V and 230V, selected by a simple switch at either 120 or 200 watts 50Hz. The units are designed to operate from 12V car batteries between 11V and 15V. A 24V version is also available. The frequency stability is within $\pm 1\frac{1}{2}$ Hz.

The circuit consists of a stable oscillator unit driving heavy duty transistors, the resultant output is fed to a special transformer of ferro-resonant type which besides producing a sine wave output also achieves a high degree of voltage regulation against changes of input voltage and load.

The cost of these power supply units ranges from £47 2s to £69.

A miniature indicator, believed to be one of the smallest in Great Britain, is the latest product from West Hyde Developments Ltd., 30 High Street, Northwood, Middlesex. Known as Type-Q, the glass lens at the front is only $\frac{11}{16}$ in diameter and is mounted in a $\frac{9}{32}$ in diameter panel hole. The plated bezel diameter is $\frac{9}{16}$ in and the body length is only 0.7in, with $\frac{1}{4}$ in soldering terminals.

The average life claimed is 25,000 hours of medium brightness, when used with a resistor supplied for 160-260 volt connections. The resistor is supplied separately, although it can be soldered directly on to the terminals if required. Other resistors can be supplied suitable for operation down to 75 volts a.c. The

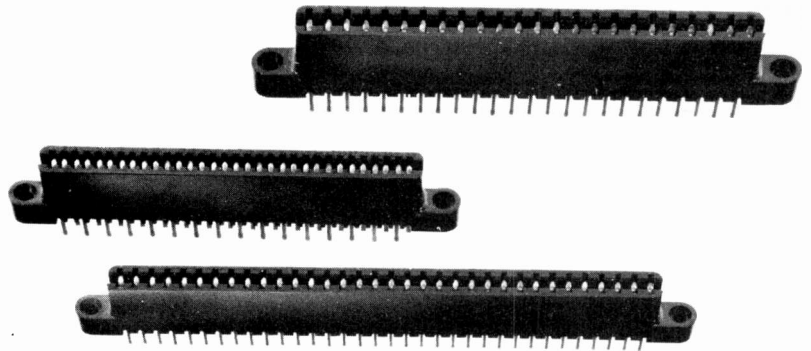

Printed circuit connectors from Belling-Lee

neon striking voltage is approximately 50 volts a.c. Current is quoted at 1mA normally for 25,000 hours life. The minimum current is 0.2mA.

The low striking voltage of these indicators makes them ideal for some transistor circuit applications.

Belling-Lee announced that three new printed circuit edge connectors have been added to their "slim-line" range. These are L1740 a 24-pole connector, and the L1741, a 34-pole, both on 0.15in centres and the L1486 32-pole connector on 0.1in centres.

These connectors are moulded in black nylon filled phenolic resin. The domed contacts are of beryllium copper, heat treated to ensure consistent and minimum wear with low contact resistance. The contacts, either gold or silver plated, are removable.

The current rating of the connectors is said to be 3A per contact for printed wiring, and 4A per contact for free wiring. Contact resistance is in the region of 2.5 milliohms and operating temperatures range from -40 to +100 degrees centigrade.

The miniature elapsed time indicator, available from Sencom Ltd., 557 Finchley Road, London, N.W.3, is an electro-mechanical numerical indicator having a synchronous motor, housed in a moulded one piece Zamac (Tin/Aluminium/Copper) case and is specifically designed for panel

mounting as can be seen from our photograph.

The indicator is guaranteed for 9,999 hours' operation and is available for supply voltages ranging from 6-300 volts a.c. at 50 or 60Hz, time ranges of either 9,999 hours or 999 plus tenths, both reverting to zero and recurring.

A. F. Bulgin & Co. Ltd., have been appointed the sole agents for Great Britain and the Commonwealth, Scandinavia, and Europe (excluding France, Belgium, Holland, Germany, and Italy), covering two types of moulded rocker switches by the French firm Sud-Inter. These are rated at 250V 2A.

These switches are available with rear nut fixing or push-fit types, and are moulded in modern high-insulation black plastics bodies with screw terminal connections. There are eight coloured dummies: black, red, yellow, green, blue, ivory, white, and luminous, which are ideal for colour coding.

There are many possible applications for a wide variety of equipment; further details and price list are available from A. F. Bulgin & Co. Ltd., Bye-Pass Road, Barking, Essex.

TOOLS

We have recently been testing a new tool from Antex Ltd., in our workshop. This tool is an Anti-wicking Tweezer, designed for use

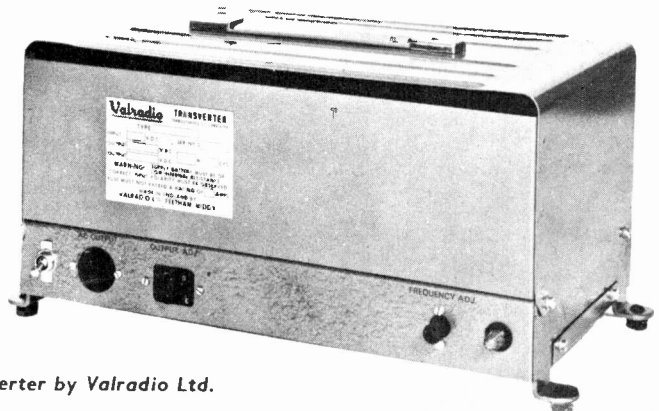

Transverter by Valradio Ltd.

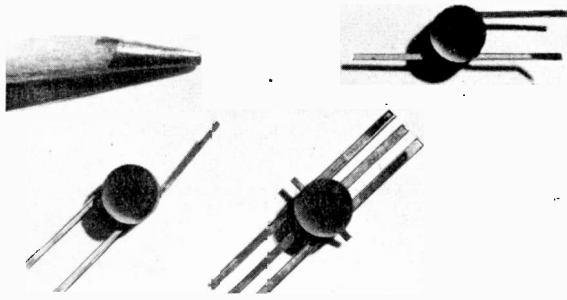

Field Effect Transistors available from Livingston Components



Type Q miniature neon indicator by West Hyde Developments

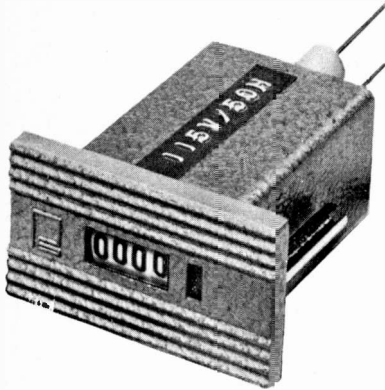

Sencom elapsed time indicator

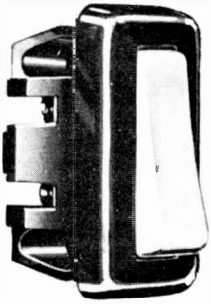

Sud-Inter switch from Bulgin

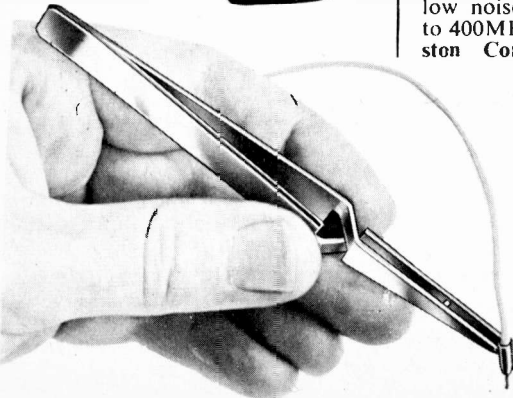

Antex type 99/45 Anti-wicking tweezer

during soldering operations to prevent fine stranded wires from fraying like a wick and drawing up excess solder by capillary attraction.

The type we have been using is the 99/45 from the Series 99 range, price 17s 6d. We have found this tweezer excellent for protecting the plastics sleeving, which invariably melts when subjected to heat from a soldering iron. Another very useful application has been to use the tweezers as a heat shunt when soldering semiconductor devices or similar components liable to be damaged by excessive heat, although Antex do not recommend this as there are other types available for this purpose.

For further details of the complete range of tweezers contact Antex Ltd., Grosvenor House, Croydon, Surrey.

Finally, under this heading, **Hird-Brown Ltd.**, Flash Street, Bolton, Lancs, are now producing a range of yellow self-adhesive wire-markers to supplement their existing range.

The new range has black printing on a yellow background and the letters of the alphabet, the numbers 0-9 plus a range of conventional electrical symbols are available on cards of 20. All the markers are impregnated with a protective coating to ensure permanent colours and resistance to the effects of heat, oil, etc.

FIELD EFFECT TRANSISTOR

Two new u.h.f. field effect transistors, type 2N4416 housed in a TO72 can and type 2N4417 in the CC-3 package, have been developed by Union Carbide for operation in low noise amplifier applications up to 400MHz. Available from **Livingston Components Ltd.**, Greycaine

Road, North Watford, Hertfordshire, these f.e.t.s, in common with others, overcome intermodulation and cross-modulation distortion generated by conventional bipolar transistors.

The brief technical details are: minimum small signal forward transconductance of 4,000 μ mhos at 400MHz. The common source reverse transfer capacitance (C_{rss}) is a maximum of 0.8pF and the input capacitance (C_{iss}) is a maximum of 4.0pF for the 2N4416 and 3.5pF for the 2N4417.

LITERATURE

The latest edition of the Heathkit catalogue contains 32 pages and a selection of over 150 kits. Copies are available from **Daystrom Ltd.**, Gloucester or Heathkit Hi-Fi and Hobby Centre, 233 Tottenham Court Road, London, W.1.

G. W. Smith & Co. Ltd. have just published their first comprehensive components and equipment catalogue, price 5s plus 1s postage.

This 152 page catalogue is a good example of how to set out equipment in an easy to understand format. The items listed range from peg-board, valves and transistors to amplifiers, communications receivers, and complete kits.

G. W. Smith are agents for Lafayette and Codar equipment and also stock a large range of Eagle Products.

One of the main troubles with purchasing any foreign equipment is: What happens if the equipment breaks down or develops an intermittent fault? The problem of finding a service shop who will undertake to carry out any servicing on foreign goods or supply spares is extremely rare. However, Smith's guarantee an after sales service and spares on any imported item listed in their catalogue.

The cost of producing the catalogue makes it necessary to make an initial charge but discount coupons enable the cost to be recovered with later purchases.

The sixth edition of the **Radio Society of Great Britain's** "Service Valve and Semiconductor Equivalents" has just been issued price 5s. The opportunity has been taken to correct a few errors which appeared in previous editions and to add a large number of new types. Readers requiring copies should contact the Radio Society of Great Britain at 28 Little Russell Street, London, W.C.1.

For those readers who construct their own wooden cabinets, the **Stephens Group of Companies** issue a guide to the proper usage of their adhesives. Copies can be obtained from **Henry C. Stephens Ltd.**, 100 Drayton Park, Highbury, London, N.5.

Tunnel DIODES



By D.G. Whitehead B.Sc.

IN 1957 a Japanese physicist, Leo Esaki, revealed the results of his researches on the tunnelling effect in thin semiconductor junctions. This effect has been utilised in the development of the tunnel diode.

The tunnel diode takes its name from the quantum mechanical tunnelling which characterises its unique operation. The V/I curve of a germanium tunnel diode is shown in Fig. 1. It can be seen that the diode current rises steeply for small values of forward bias and then drops again as the forward bias is increased. Further increase in forward bias brings the characteristics in line with a normal semiconductor diode.

The important fact is that between approximately 50mV and 350mV in the forward direction, the diode exhibits negative resistance; that is, for an increase in applied voltage, the current decreases. This property enables the diode to be used as an oscillator, amplifier, or switching element with an operating range extending beyond 10,000MHz.

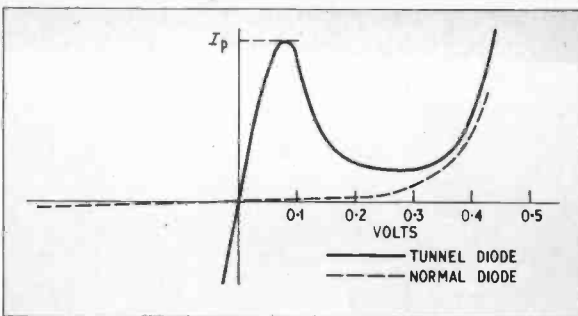

Fig. 1. Graph of voltage v. current of a germanium diode

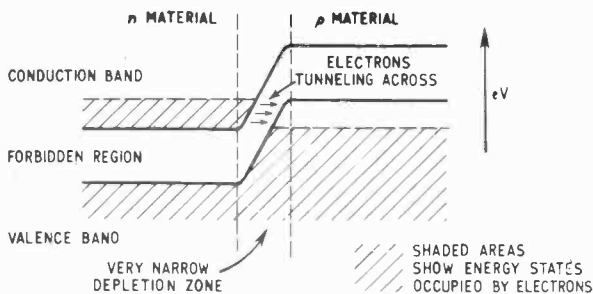

Fig. 2. Electron energy band diagram

DEGREE OF DOPING

A tunnel diode differs from a normal semiconductor diode in the degree of doping of the material. The impurity level in tunnel diode material is approximately 1,000 times greater than that used for other semiconductor devices. In fact, the material is often referred to as a semimetal and resembles an alloy. The effect of this heavy doping is to make the depletion layer in the diode extremely narrow.

Quantum mechanics shows that there is a finite probability that an electron originally at one side of a junction will appear at the other side of the potential barrier by "tunnelling" through it at the speed of light, provided that the barrier is sufficiently narrow and that the energy levels are the same on either side of the barrier.

These conditions are met at a heavily doped pn junction with slight forward bias. As the bias is increased, the energy levels alter and the tunnelling current falls off. At higher bias levels normal diode current commences. An electron energy band diagram for tunnelling action is shown in Fig. 2.

If the diode is reverse biased, tunnelling also occurs and the tunnel diode conducts heavily.

It is interesting to note that the Zener effect, exploited in Zener diodes is in fact a tunnelling phenomena, although for diodes with so-called "Zener voltages" above 6 volts the effect is probably caused by avalancheing and not tunnelling.

The circuit shown in Fig. 3 is suitable for displaying the characteristics of tunnel diodes with peak currents from one to five milliamps. It is essential to keep inductance down to a minimum, therefore resistors should be as small as possible and not wirewound.

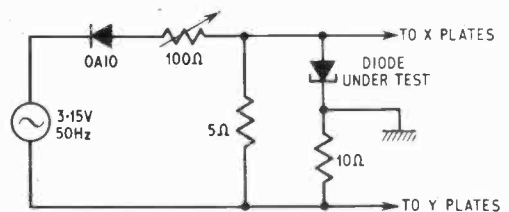

Fig. 3. Method of displaying tunnel diode characteristics on an oscilloscope

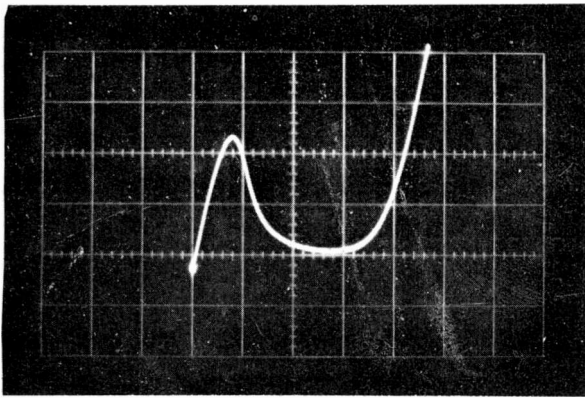

Fig. 4. Characteristic curve of an AEY11

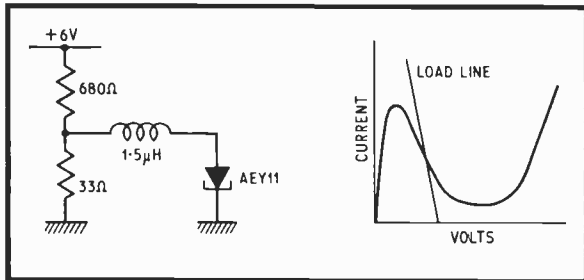

Fig. 5. Negative resistance oscillator

Fig. 6. Load line characteristic cuts the characteristic in the negative region

Tunnel diodes are usually catalogued according to their peak current. Fig. 4 shows the characteristic of a 5mA tunnel diode type AEY11 supplied by Bi-Pak Semiconductors Ltd. Diodes with peak currents greater than 5mA are extremely difficult to stabilise, tending to oscillate over their negative resistance region if an attempt is made to display their characteristics.

OSCILLATORS

A device which exhibits negative resistance has an obvious use as an oscillator. All that is necessary is to bias the tunnel diode into its negative resistance region and then connect it in series with a tuned circuit. Fig. 5 shows a typical circuit. The bias network gives a load line which intersects the diode characteristics only in the negative resistance region, shown in Fig. 6. Values are for a frequency of 8MHz.

For frequencies above 100MHz, coaxial or strip lines can be used instead of a conventional tuned circuit. Tunnel diode oscillators can be made to operate up to 10,000MHz and higher. For these high frequencies the diodes are mounted in a coaxial encapsulation or have flat strip leads and a "pill box" construction. Even the cheapest diodes available have cut-off frequencies in excess of 800MHz. However, the upper limit is often limited by the inherent inductance of the diode encapsulation itself.

It is interesting to note that since the oscillators need only around 0.2 volts from their power supply, they can be powered quite easily from silicon solar cells.

If biased correctly the diode can be made to have two stable states. Consider Fig. 7. The load line cuts the diode characteristics in three places. Suppose the

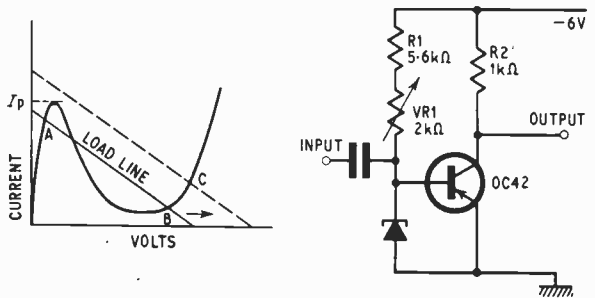

Fig. 7. Load line cutting in three places to give a two stable state condition

Fig. 8. Controlling a germanium transistor

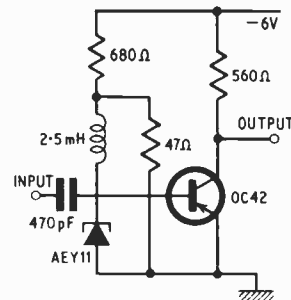

Fig. 9. Monostable circuit using a tunnel diode

diode is initially operating at point A. The voltage across the diode is 40mV.

If now a small current is injected into the diode it will have the effect of shifting the load line to the right. The diagram shows this as a dotted line. On this line there is only one point where the diode curve intersects the load line so the diode rapidly switches to this point (point C). When the trigger current is removed the operating point falls to B. The voltage across the diode is now 450mV.

To get back to the low voltage state, either the supply voltage is removed or a negative trigger current is applied, momentarily shifting the load line to the left. Computer logic circuits have been designed using the tunnel diode as a bistable element.

The voltage swing obtained when the tunnel diode is switched between its two stable states is sufficient to control a germanium transistor. At 40mV base to emitter the transistor is still virtually off. At 450mV it is heavily conducting. Very simple and sensitive threshold devices can be designed around this principle. Fig. 8 shows such a circuit. VR1 controls the sensitivity by determining how near I_p the diode is biased.

MONOSTABLE CIRCUIT

A monostable pulse forming circuit is shown in Fig. 9. A trigger pulse momentarily switches the tunnel diode to the low state. The inductance then allows the current through the diode to increase slowly towards I_p . When this current is exceeded the diode switches to the high voltage state and the circuit returns to its only stable operating point. The pulse width is determined by the inductance and the total resistance in series with it. With an inductance of 2.5mH the pulse width is 60μs.

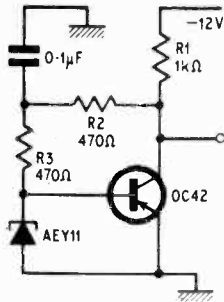

Fig. 10. Tunnel diode multivibrator

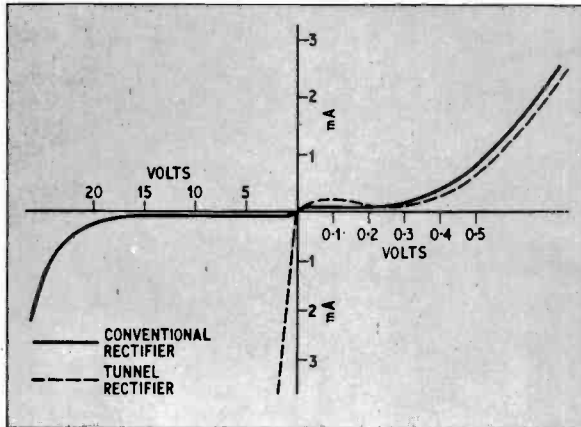

Fig. 11. Characteristic of a tunnel rectifier

An interesting multivibrator circuit is shown in Fig. 10. Initially assume the diode to be in its low voltage state. The transistor is off. The capacitor will charge through R1 and R2.

As the voltage across it increases, the current through R3 increases until it is sufficient to switch the diode into its high voltage state. When this happens the transistor is turned on and discharges the capacitor. This causes the diode current to fall.

Eventually the diode reverts to its low state, turning the transistor off. The process then repeats itself. The values given will give a 6 volt 8kHz square wave at the collector. Note that the frequency is determined by one capacitor. Increasing this to 1μF lowers the frequency to 650Hz.

TUNNEL RECTIFIERS

The tunnel rectifier is really a tunnel diode with a very small peak current. Fig. 11 shows a typical characteristic. In conventional rectifiers, current flow is substantial in the forward direction but extremely small in the reverse direction.

In tunnel rectifiers, substantial current (tunnelling current) flows at very low voltages while the forward current is relatively small. Consequently, tunnel rectifiers can provide rectification at smaller signal levels than conventional rectifiers. Because the current flows in the "reverse" direction they are often called "back diodes".

Tunnel diodes are versatile economic devices and are readily available on the retail market. ★

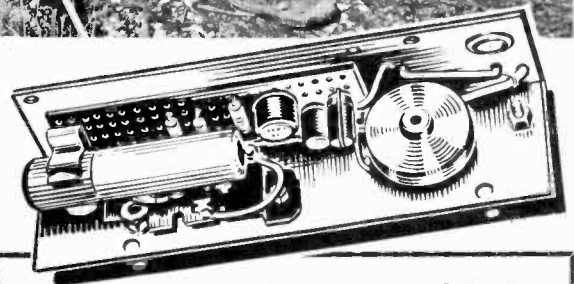

Make this TRANSISTORISED BITE INDICATOR

A compact self-contained unit for attachment to a fishing rod. Gives audible warning when a fish bites. A boon for the two-rod angler. Particularly valuable for night fishing. Inexpensive to build.

Other Outstanding Features:

THE CHEMOSTAT

How-to-build details for an electronic thermostat with remote temperature feeler for accurate thermostatic control of chemical liquids. Temperature range (17°C-40°C) suitable for colour and monochrome photo-processing. Circuit switches any type of mains appliance up to 2 kW loading.

MICROELECTRONICS

Beginning a special survey of a rapidly developing field of electronic technology. Describes various integrated circuit devices and how these may be applied to amateur use.

August Issue on Sale July 14

PRACTICAL ELECTRONICS

MAKE SURE OF YOUR COPY! ORDER NOW!

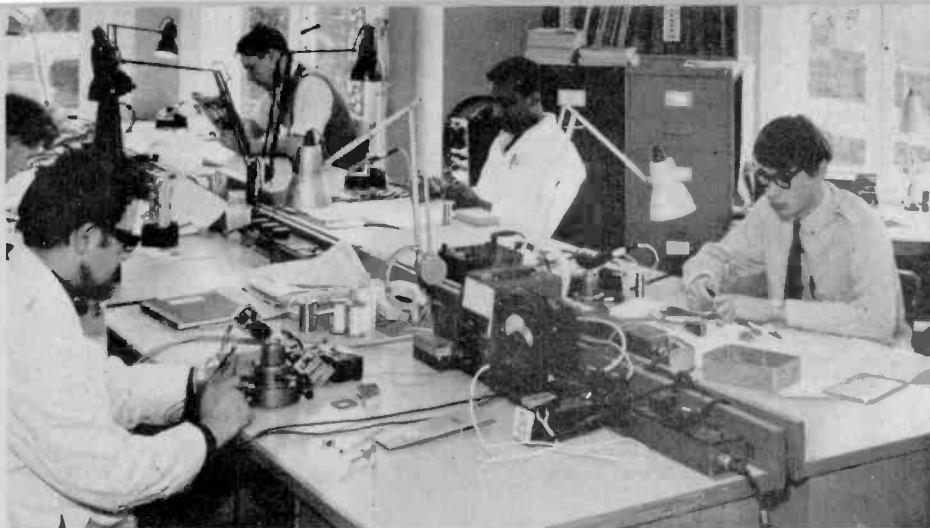

Radiation and Ionosphere Probe

THE University College of London is currently working on a project to launch a satellite from Woomera later this year to study solar extreme ultra-violet radiation, ion and electron densities, and electron temperature in the lower ionosphere.

A section of the electronics workshop at Holmbury House, near Dorking, is shown above. The payload (right) with polychromator/ionosphere probes, will be launched by a Skylark rocket. On the left we show the telemetry analogue-to-digital converter which will convert data received on the ground into a code for high speed computer analysis.

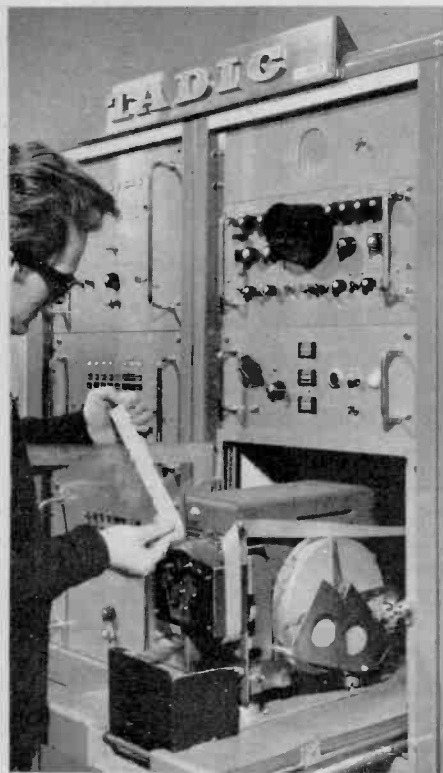
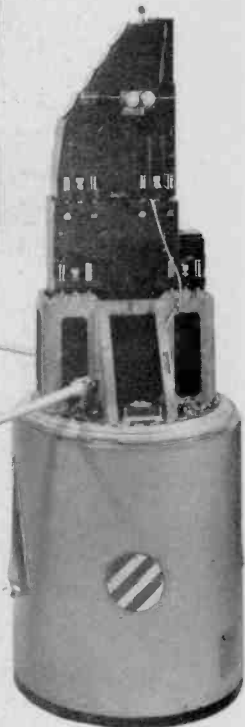

National Information Store

THE official opening ceremony of the National Computing Centre in Manchester was performed on May 5 by the Prime Minister, the Rt. Hon. Harold Wilson, M.P.

The Centre, which is being run by Professor Gordon Black, is expected to fulfil a service to promote the potential usefulness of computers to allcomers and to give assistance with programming problems. The Computer Laboratory is available for all services and projects relating to the use of computers and the development of associated software and hardware.

Our photograph (below) shows Professor Black amid the multiplex of tape and disc memory stores, punched card and paper tape readers and automatic typewriter.





Moscow's new television tower in Ostankino (right) will radiate to 12 million people within a radius of 75 to 95 miles. Claimed to be the highest in the world—1,772ft—it will withstand gale force winds, swaying at the top by about 13ft, but it is strong enough to withstand a 46ft oscillation. The photograph is reproduced here by permission of the Novosti Press Agency.

Russian

Summit

Line Repeaters in Footway Boxes

A 29 MILE small core coaxial cable between Glasgow and Stirling—the first small core coaxial cable in Scotland—has now been equipped with 4MHz line and terminal equipment by the Transmission Division of the Plessey Electronic Group for the Post Office.

Occupying a bandwidth of 4MHz on each of two small core coaxial tubes, one for each direction, it has a capacity of 960 telephone circuits. The two coaxial tubes form part of a four tube cable, the other two tubes being used for a 300-circuit system.



Silicon Planar for Audio

FOLLOWING our report in *Market Place* last month we show (left) a laboratory at SGS-Fairchild where extensive measurement and evaluation of performance of silicon planar transistors are carried out for high quality audio equipment.

ONE of the top five brass ingot producers in the U.S.A. has speeded production and improved quality control procedures through the use of a X-ray vacuum spectrometer developed by General Electric of America.

Operating two plants in Chicago on a twenty-four hour basis, the Sipi Metals Corporation produces brass and bronze ingots used in a wide range of casting products including plumbing fixtures, gears, marine fittings, and bearings.

X-ray emission techniques have proved to be faster and more versatile than classical wet chemistry methods for many of the determinations required. Using an X-ray spectrometer elemental determinations can be accomplished in a relatively short period of time regardless of the element under consideration.

Quality Control by Spectrometry

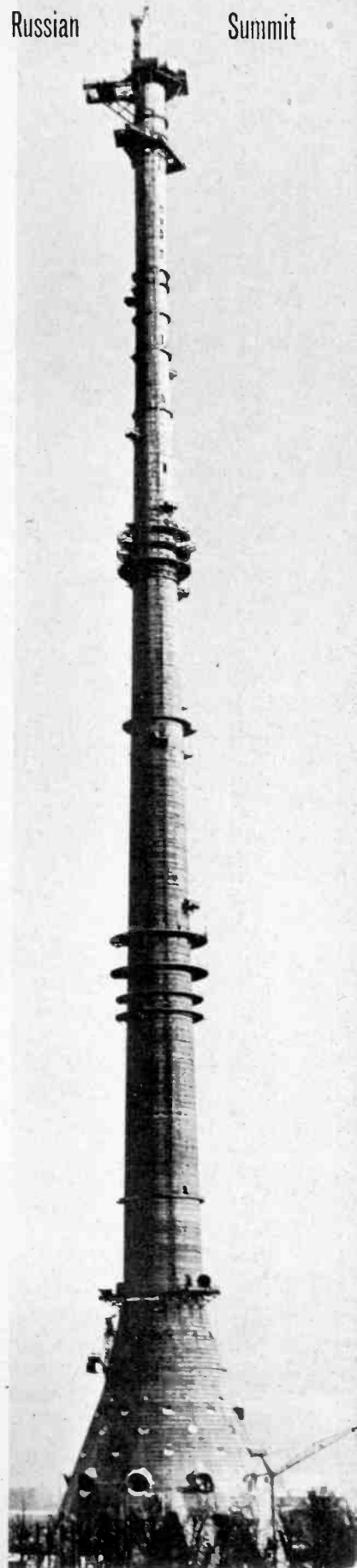

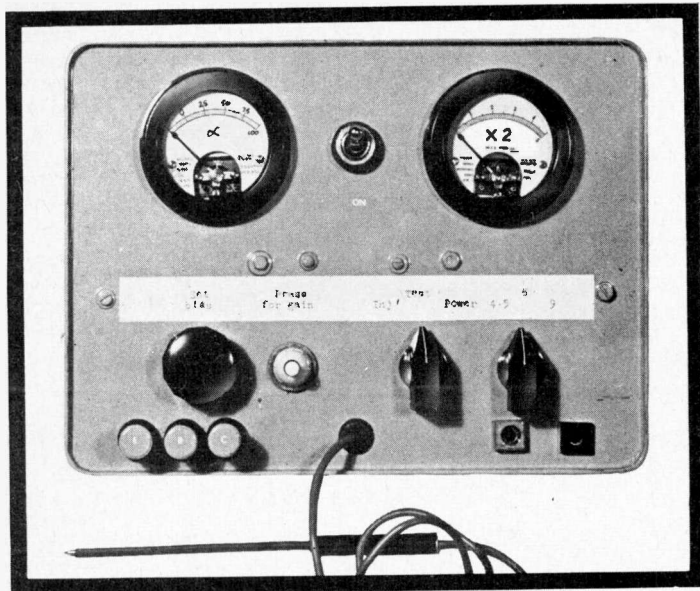

by W.M. Fraser
Grad.I.E.R.E.

SERVICING AID for TRANSISTOR RADIO'S

THIS instrument was designed to provide almost every facility necessary for servicing transistor radio receivers. It will be found almost equally useful for checking other transistorised equipment, such as audio amplifiers.

The servicing aid will supply power, check the batteries, pinpoint the faulty stage, and test the transistors. It contains a mains-driven power supply with voltmeter, a reasonably accurate circuit for checking a wide range of *pn*p transistors, and a free-running square wave generator.

The complete circuit of the servicing aid is shown in Fig. 1. The three sub-divisions of this circuit are dealt with in turn in the following description of operation.

POWER SUPPLY

Power supplies are derived from T1 which is a 6.3V 1A filament transformer. With 230V applied to the primary, the output across the secondary is approximately 7.5V. The half-wave rectifier D1 following it gives a maximum d.c. output of 10 volts. This potential is reduced as required by the insertion of series resistors selected by S2. It is, of course, only reduced to the values stated when a load is connected.

The greater number of transistor radios in this country operate from 9 volt batteries and it was found that the current drain to most of them at an optimum volume control setting was such that the extra volts would be dropped across the 28 ohm smoothing resistor R1 connected by S2 in the 9 volt position. For the few 6 volt receivers an extra 22 ohms (R22) is switched in, and for the even rarer 4.5 volt receivers (mainly Japanese) another 18 ohms (R3) is connected into circuit. The reservoir and smoothing capacitors are sufficiently large at the values stated to reduce the mains hum to well below the audible level, even in receivers drawing the largest amount of current from the supply.

The mains rectifier D1 is a silicon diode BY100, but this could be replaced by a much cheaper 30 volt copper-oxide metal rectifier with only a slight loss of output voltage.

Meter M1, with its scale suitably multiplied by R4 to read 10 volts full scale, indicates whether the correct voltage is being supplied to the receiver under test. The value of R4 may be calculated, according to the sensitivity of the particular meter movement used, from

$$R4(k\Omega) = \frac{10}{\text{Meter f.s.d. (mA)}} - \text{Meter resistance (k}\Omega)$$

BATTERY CHECKS

With the servicing aid disconnected from the 230 volts a.c. supply, S2 set to 4.5 volts and S3 set to Power, batteries can be connected to the output terminals and their levels indicated by M1. In addition, the meter circuit can be used for voltage checks on receivers supplied by their own batteries.

TRANSISTOR TESTER

A simplified circuit of the transistor tester section is given in Fig. 4.

The transistor to be tested should be connected to the E, B and C terminals (emitter, base and collector). S2 switched to 6 volts, and S3 to Test. The Zener diode D2 stabilises the potential at the junction of R6 and R7 at 5.1 volts allowing approximately 1 volt to be present at the collector terminal.

The bias control VR1 should be adjusted until the base-emitter current causes a 0.5mA collector current flow, indicated by a deflection on M2 to the "0" position on the scale. Immediately this has been done the Gain button S4 should be pressed, shunting R6 and

COMPONENTS . . .

Resistors

| | |
|--------------------------|---------------------------|
| R1 28Ω 2W | R8 390Ω $\frac{1}{8}$ W |
| R2 22Ω 2W | R9 100Ω $\frac{1}{8}$ W |
| R3 18Ω 2W | R10 150kΩ $\frac{1}{8}$ W |
| R4 Multiplier for M1 | R11 10kΩ $\frac{1}{8}$ W |
| R5 25Ω $\frac{1}{8}$ W | R12 150kΩ $\frac{1}{8}$ W |
| R6 500kΩ $\frac{1}{8}$ W | R13 10kΩ $\frac{1}{8}$ W |
| R7 255kΩ $\frac{1}{8}$ W | |

See text regarding R4 and R7

Potentiometer

VR1 1MΩ carbon linear

Capacitors

| |
|--------------------------------|
| C1 500μF elect. 15V |
| C2 1,000μF elect. 15V |
| C3 0.1μF paper or plastic 350V |
| C4 0.01μF paper or plastic |
| C5 0.01μF paper or plastic |

Transistors

TR1, TR2 OC71 or OC71 (2 off)

Diodes

- D1 BY100, or any medium current, low forward resistance metal rectifier
- D2 OAZ201 Zener diode

Meters

M1, M2 Moving coil meter, 2.5mA f.s.d. (2 off)

Transformer

T1 Heater transformer. Tapped mains primary, 6.3V 1A secondary

Switches

- S1 Double pole on/off toggle switch
- S2 Single pole, three-way wafer switch
- S3 Single pole, three-way wafer switch
- S4 Single pole, push button switch

Miscellaneous

Aluminium chassis with top plate 9in × 7in × 2in approximately. "Unitags". Three terminals. Two sockets. Two pointer knobs. One round knob. Material for prod.

VR1 with R7 and increasing the base-emitter current by a precise 20μA. The deflection on M2 that this extra current causes, up to a maximum of 2mA (2.5mA f.s.d. — 0.5mA bias) can be read from the scale as the current gain of the transistor. For example, if the collector current increases by 1mA when the Gain button is pressed the gain is 1mA/20μA = 50; if it is 1.5mA the gain is 1.5mA/20μA = 75.

The linear scale of M2 can be calculated directly in gain (α) as shown in Fig. 5.

The accuracy of the transistor gain check depends on how near the value of R7 is to 5.1 volts/20 microamps = 255 kilohms. This particular resistor must therefore be selected with care, and the exact value obtained by using two or more resistors in series.

SIGNAL INJECTOR CIRCUIT

The injector circuit consists of a free-running multi-vibrator TR1, TR2 producing square waves at a fundamental frequency of approximately 150c/s. This type of waveform is more useful than the sine wave, that could, for example, have been obtained from a single stage oscillator, as the high harmonic content of the square wave contains frequencies in the low MHz range. It is therefore suitable for signal injection into r.f., i.f., and audio stages of a receiver. In addition it can be used, if an oscilloscope is available, for checking the distortion introduced by audio amplifiers. Further, a two transistor stage is preferable to a single transistor stage as it will oscillate more readily and at a lower frequency.

The voltage switch S2, in determining the potential applied to the collectors of TR1 and TR2, acts as an attenuator of the injector output and has little effect on the frequency of operation.

The Power and Injector positions of S3 can be temporarily or permanently shorted to supply power to the output terminals and to the injector circuit simultaneously if also desired.

CONSTRUCTION

All the components necessary will fit into a metal box measuring approximately 9in × 7in × 2in. The photographs illustrate the layout in the original model.

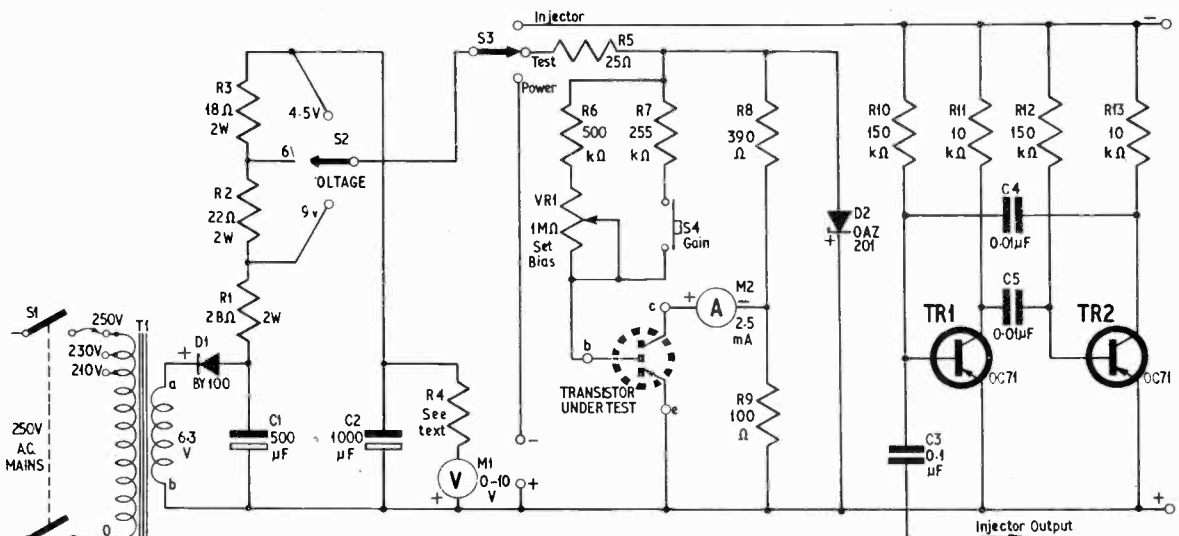
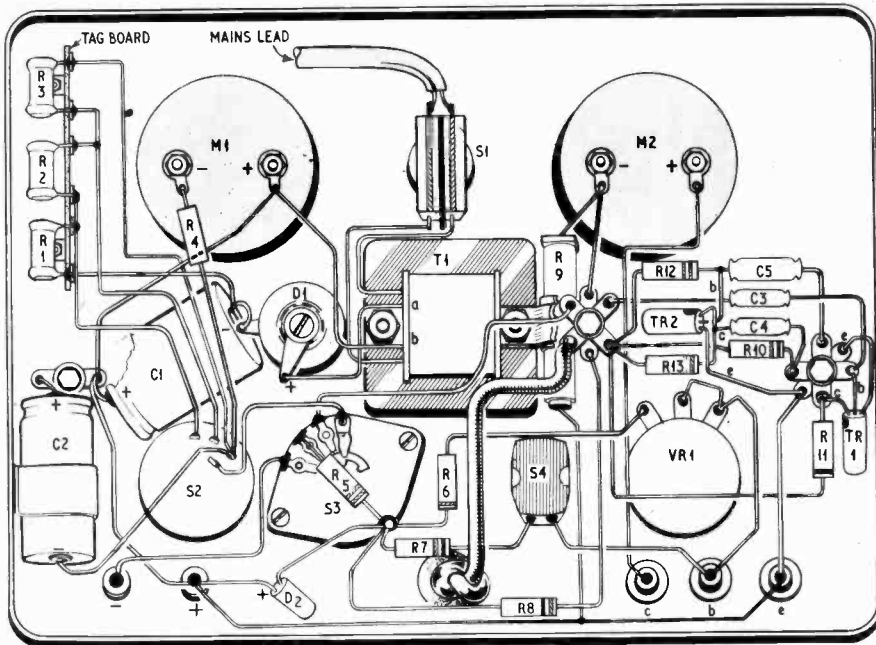

Fig. 1. Circuit diagram of the servicing aid



Only used contacts are shown wired on S2 and S3

Fig. 2. Complete layout and wiring details. Note that the final components differ from those shown in the photograph opposite

Fig. 3. Layout of the front panel. No drilling dimensions are given as this will depend on the components used by the constructor

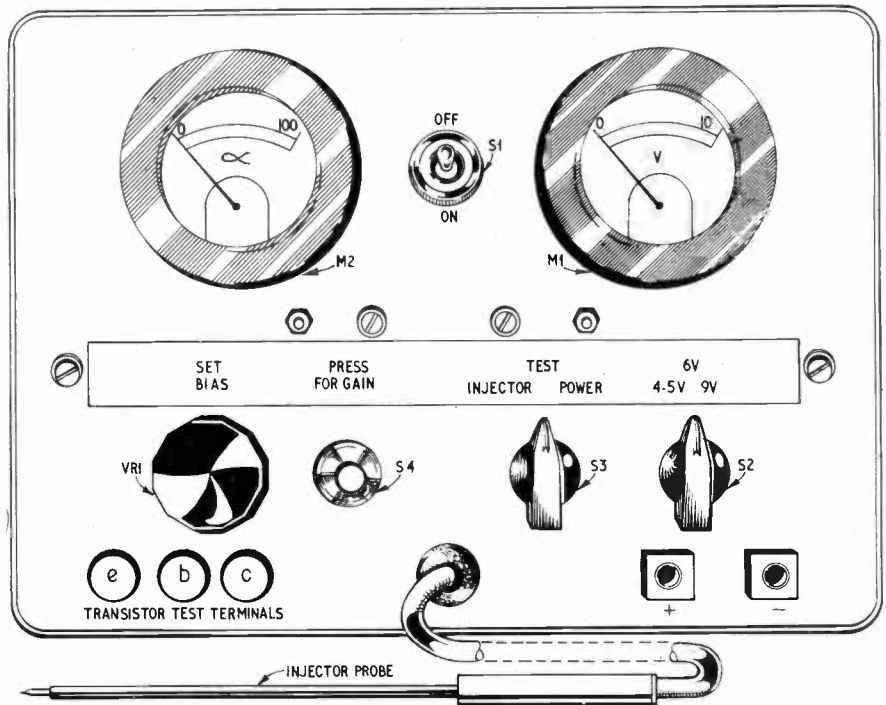

SERVICING AID

SPACE

SCIENCE

LABORATORY

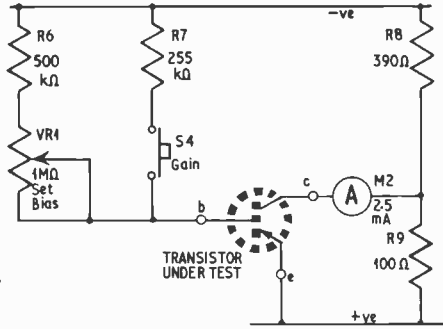

Fig. 4. Simplified circuit of the transistor test stage

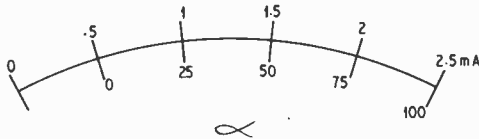
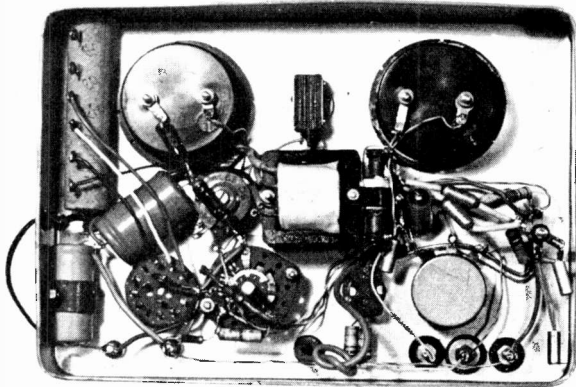
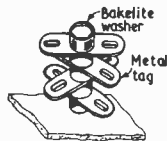

Fig. 5. Linear scale of the gain meter

Fig. 6. Make-up of the "unitags" to form vertical tagboards



Particularly useful items for mounting the smaller components inside the box (and which deserve greater popularity) are "unitags". These consist of metal eyelet tags, hexagonally keyed to bakelite washers. They can be built-up to form vertical tagboards, as shown in Fig. 6. Assemblies of these unitags can be seen *in situ* in Fig. 2.

Complete wiring details are given in Fig. 2. Minor changes in layout and wiring may of course be necessary due to the actual components employed.

A test prod and lead should be made up and connected through a grommet hole in the front of the unit (see Fig. 3).



THE Mullard Space Science Laboratory, Department of Physics, University College, London, originated with a donation by Mullard in 1965 which enabled the College to purchase a country mansion at Holmbury St Mary, near Dorking, Surrey.

Officially opened by Dr F. E. Jones, managing director, Mullard Ltd., on May 3, the Laboratory houses the largest scientific space research group in Britain and is among the longest established and most experienced; it undertakes some 25 per cent of total British University space research. The six laboratories at Holmbury House provide facilities for 23 scientists and seven research students. Other staff include 26 laboratory and workshop technicians and 11 administrative workers. Current annual expenditure is supported largely by a grant of about £150,000 per annum from the Science Research Council.

The acquisition of the premises at Holmbury St Mary ended a long search by the College for more spacious laboratories to accommodate their expanding space research activities. The choice of location was influenced by the need to be near a major airport and other communications and Holmbury House, within easy reach of London and Gatwick, is conveniently sited.

The need to be near good communications is apparent when it is remembered that, at any one time, scientists may be at Kiruna, Sweden; Woomera; Boulder, Colorado; The Western Test Range near Los Angeles; Cape Kennedy; or in the Washington area at the NASA Laboratories. Travel is a considerable item in the annual budget.

The work of the Laboratory is in originating experiments of scientific value, in detailed development of detection and measuring systems involved in the experiments and the scientific analysis of data obtained.

Among the scientific disciplines involved in space research are Physics, Optics, Electronics, Precision Engineering, Satellite Dynamics, Technology and Orbits, and Scientific Interpretation. The extraordinary variety of problems and the impossibility of correcting equipment faults once an experiment has started has necessitated the development of new orders of reliability and intense concentration on preliminary work to secure success. A single miscalculation in design can mean the loss of, perhaps, three years of work costing, possibly, £50,000.

For historical reasons the space research activities at U.C.L. have been directed largely towards studies of the ionosphere and these studies have latterly been extended to examination of X-ray and ultra-violet radiation from celestial sources—part of what is called the "New Astronomy". All the work is purely scientific and intended to extend our knowledge of natural phenomena and their inter-relation. It complements visual and radio astronomy.

Although the work is not directed towards practical ends, there are considerable "spin-offs" of great value in other fields, including technology.

The current programme involves experiments on eight satellites and over 30 sounding rockets. Launchings will be under the auspices of the domestic U.K. programmes, the European Space Research Organisation (E.S.R.O.) and the U.S./U.K. co-operative programme.

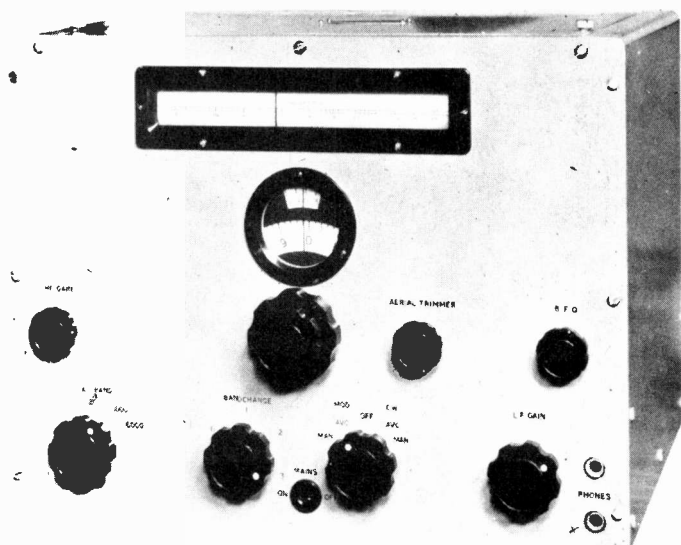

THE CR100

Classic

Origin

Of the thousands of Marconi TR1154/1155 airborne installations remaining in service in the years after the war, it is safe to assume that most of the ground stations with which they communicated were equipped with another equally famous Marconi design, the CR100 receiver. Although today this set, with its rows of large bulbed international octal valves, wears a slight air of obsolescence, it still commands respect as a solidly built piece of British workmanship worthy of comparison with any of the other models which have been described in this series of articles, both in respect of its "well tailored" appearance and performance. For these reasons—and others related to its comprehensive specification—it deservedly holds its price on the secondhand market.

Variants

As with many other versatile equipments of the Forties the CR100 was subject to a number of variations—most of them minor—in its specification to suit particular Service needs, but these do not affect what is said below, nor are likely to prove disadvantageous to the intending purchaser.

Basic Circuit

| | |
|---------------------------------------|-------------------------------------|
| Two r.f. amplifiers, both Mixer | KTW62 or 6K7G X66 or 6K8G |
| Local oscillator | KTW62 or 6K7G (triode connected) |
| I.F. amplifier, three | KTW62 or 6K7G |
| C.W. oscillator | KTW62 or 6K7G |
| Detector, a.g.c., and audio amplifier | DH63 or 6Q7G |
| Output | KT63 or 6V6G |
| Mains rectifier | U50 or 5Y3G |

COMMENT: In the above valve list some of the U.S. equivalents which short wave listeners are likely to have available are given. The ubiquitous KTW62 does duty in several stages to the great easement of the private listener's replacement problem. Provision of two stages of amplification ahead of the mixer in conjunction with three i.f. stages following it gives an order of performance likely to satisfy the most critical

seeker after elusive stations. And, of course, image rejection is correspondingly good.

Waveranges Covered

| | |
|---------|---------------------|
| Band 1: | 60 to 160kHz |
| Band 2: | 160 to 420kHz |
| Band 3: | 500 to 1,400kHz |
| Band 4: | 1,400 to 4,000kHz |
| Band 5: | 4,000 to 11,000kHz |
| Band 6: | 11,000 to 30,000kHz |

COMMENT: As with many designs of the period, the CR100 carries two "passengers", Bands 1 and 2, which are of little interest to the short wave enthusiast, apart from providing the Light Programme Standard Frequency transmission on 200kHz. But unlike many of its contemporaries, this receiver *does* include the medium wave broadcast band. The extension of the overall coverage to embrace the 28MHz amateur band is an extremely useful feature that helps retain the set's resale value, the more so as "Ten Metres" will be coming into its own over the next few years of waxing sunspot activity.

Intermediate Frequency

465kHz.

Power Requirements

A built-in 200–250 volt a.c. mains power unit is positioned at the rear right of the chassis, sensibly remote from tuned circuits. Consumption is 85 watts. By making small changes, which are described in the appropriate handbook, operation on external batteries or rotary generator is possible.

Controls

Lower row, left to right: five-position "Passband" selectivity switch gives responses of 6 and 3kHz without crystal filter, or 1,200 and 300Hz with crystal filter, or 100Hz with audio filter added; six-position "Band-change" switch; "mains" switch; then the "Mod/C.W." switch providing the five following facilities: (1) b.f.o. off and a.g.c. off, (2) b.f.o. off but a.g.c. on, (3) b.f.o. on and a.g.c. on, (4) b.f.o. on but a.g.c. off,

We present this month the sixth and final review in this series "Classic Communication Receivers", dealing this time with the well-known British-made Marconi CR100.

Readers are reminded that this article—as was the case with its predecessors—is intended as a guide to, rather than a detailed appraisal of, the model in question. They should in their own interests make sure that a handbook or circuit diagram, at least, is provided at the time of purchase.

At the other end of the audio spectrum the 6kHz selectivity position gives the user the opportunity to realise very acceptable sound quality at a level of up to 2 watts into an external 3 ohm speaker.

Other Details

Remembering that any CR100 which is purchased is likely to be many years old, the intending buyer will in his own interests ask for a demonstration before acceptance, not simply to check such obvious things as sensitivity and performance, but also to ensure that the smoothing capacitors are still in good order, the more important if the receiver has not been in use for some years.

Having accepted his purchase the user will find on a detailed mechanical and electrical inspection that it

COMMUNICATION RECEIVERS

(5) receiver muting. The fifth control in the lower row is audio gain (the headphone sockets are immediately to the right of it).

Upper row, left to right: r.f. gain; tuning knob; aerial trimmer; and, finally, B.F.O. control.

Directly above the tuning knob is the double logging scale. The upper scale gives arbitrary readings of 0-25 degrees, the lower scale sub-divisions of the former, both operated from the fine tuning control concentric with the main tuning knob.

Top: the horizontal main tuning scale calibrated directly in frequency and operated by the main tuner.

COMMENT: Positioning the main tuning scale at the top of what is by other standards a tall cabinet, places it very conveniently at eye level. This, coupled with the sensible placement of all user controls, makes the CR100 an ergonomic delight to operate—a feature we have continually referred to in this series of articles. The logging scale changes frequency by only 9kHz when the fine tuning knob is moved by as much as an eighth of an inch, representing an impressive order of mechanical bandspreading. It also permits a re-setting accuracy to within 5kHz even on the wide 10-metre amateur band.

Intelligent use of the tuning facilities in conjunction with the five-position selectivity switch permits wanted signals—more especially weak c.w.—to be resolved and peaked up in conditions of heavy interference.

includes many worthwhile features such as a mains filter to help minimise the pick up of "made-made static", and a three-contact mains input arrangement with the mandatory "live, neutral, earth" configuration that ensures that the chassis of the set will be completely "dead", i.e. well and truly earthed—so long as a three-pin mains plug and wall socket complement it. And if the aforementioned electrolytic capacitors *should* prove to be a little tired, then one or other (or both) of the fuses provided will protect the remainder of the power unit; one fuse is in the transformer primary circuit, the other in the transformer centre-tap-to-earth line.

In the case of the Type CR100/2 model, sidetone facilities are provided to allow a Morse operator to hear his own signals. The small circuit changes required in this respect are described in the ever-essential handbook; a special shorting plug is provided to disable the sidetone facilities, and the purchaser of the CR100/2 version should make sure that this is available.

Should servicing of the CR100 ever be necessary the user will find that the base plate under the chassis and the cabinet itself are readily removable. But a word of warning: the receiver being built "like a battleship" weighs something of the order of 80lb, so when it is being given attention on the bench it should be rested on one or other of its sides, never on the back, otherwise damage to the aerial and speaker terminals at the rear may result.

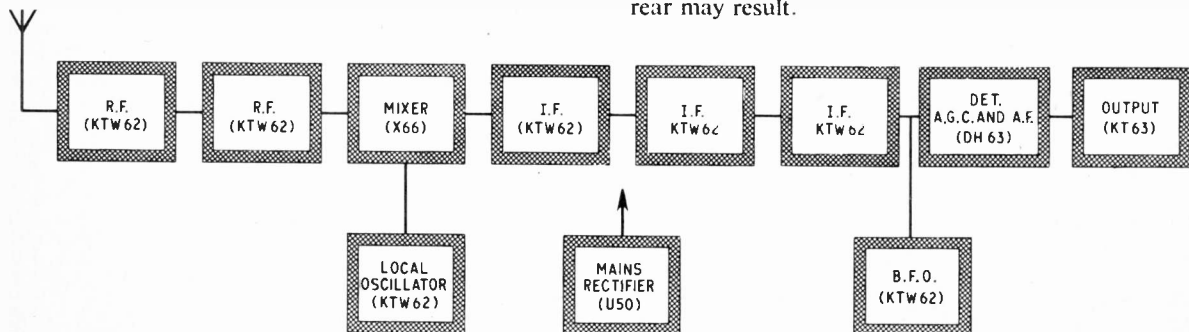

Fig. 1. Block diagram of the CR100

NEWS BRIEFS

Quality and Reliability Year

AS PART of Quality and Reliability Year, the Council of Industrial Design and the British Productivity Council are staging an exhibition at the Design Centre, Haymarket, London, to show how the quality and reliability of domestic and engineering products depend on attention to detail throughout the industrial cycle.

The exhibition was opened on June 5 by The Right Hon. Michael Stewart, M.P., Economics Secretary, and will close on July 15. Three seminars will run concurrently on June 13, 14, and 21. Full details from the British Productivity Council, Vintry House, Queen Street Place, London, E.C.4.

Plymouth Exhibition

PART of the Plymouth area programme for Q. and R. Year will be an exhibition and symposium on Electronic Instruments and Components organised jointly by the Plymouth College of Technology and Wireless-Electric Ltd., wholesalers of Bristol. Well known manufacturers are exhibiting and sponsoring lecturers; a special paper will be presented on industrial process control by Mr R. D. Massingham of Southern Techniques (Electronics) Ltd.

Full details from the Plymouth College of Technology, Plymouth, Devon, or the Electronics Division of Wireless-Electric Ltd., Wirelect House, St Thomas Street, Bristol, 1.

Reaching for the Stars

READERS may like to make a note of a very interesting meeting this month on June 17 at 10.30 a.m. It is a joint affair between the University of Surrey Astronomical Society and the Society For Amateur Radio Astronomers.

To be held at the University of Surrey, Battersea Park Road, London, S.W.11; the purpose of the meeting is to present the broad physical foundations of radio astronomy with regard to both the observational techniques and processes involved at the source of radiation. At the same time it is hoped that it will provide a time and place for those who attend to discuss their common interest.

Programming Experts are Blind

FOLLOWING the success of the first courses in computer programming for the blind held in this country last year, The Royal National Institute for the Blind, the O. & M. Division of the Treasury and English Electric Computers are running a further series of courses.

The courses represent the first major advance in professional career prospects for the blind for a number of years. The 12 people who went through the course last year started work at the beginning of August at installations at the Board of Trade, Eastcote; Customs and Excise, Southend; G.P.O., Stepney; Inland Revenue, Worthing; Shell-Mex & B.P. Ltd., Hemel Hempstead; and CAV Ltd., Acton.

Three months later, a joint Treasury and R.N.I.B. team visited all the installations to evaluate job performance and reported that: "The quality and quantity of the work produced was, overall, better than the average expected of sighted programmers." A well-trained, disciplined memory, power of concentration and sustained application were listed as the particular attributes which a blind person could bring to computer programming. Their findings confirm experience in the U.S.A. where over 100 blind people are known to be working as programmers.

Europe's Most Advanced Resistor Factory

AN output of several million glass-tin-oxide resistors flows each week from Electrosil's modern, highly automated factory in Sunderland, County Durham. How this vast output is achieved was revealed during a recent "open day" at what is claimed the most advanced resistor factory in Europe.

Glass-tin-oxide resistors have a superior performance to carbon film resistors, which they are now largely superseding in services and professional electronic equipment.

First stage in production is the manufacture of the special tin-oxide coated glass rod or "cane" as it is called. Molten glass is drawn under precise control through a coating process during which tin oxide is "fired" on to the cane surface. Up to two miles of cane an hour can be produced.

The cane is then cut into blanks, the ends of the blanks are silvered, and the desired resistance value is obtained by cutting a spiral into the oxide-coated surface. The blanks are then fitted with caps and leads, and on the long finishing lines solvent-resistant coating is applied and the resistors are colour-coded. Continuous automatic testing and measuring is maintained throughout.

Some idea of the great demand for the humble resistor is given by the fact that Electrosil have had to move twice to larger premises since starting in the area only five years ago.

Cybernetics and Music

THE Soviet cybernetics expert Rudolf Zaripov claims that an electronic machine can fulfil not only some elements of the creative work of a composer but also of the theory of music. He has noted the ability of a machine to divine intuitional operations of creative musical endeavour, often not even achieved by the composer.

A programme of automatic analysis of melodies has already developed. Under this programme, the electronic machine solves problems of harmonising melodies, searches for the composer's errors, and even indicates the nature of the errors and their place in the composition. He has "made" the electronic machine write the accompaniment to the melodies it has composed, translating the rules of the harmony textbook into the language of mathematics.



BASS GUITAR (May 1967)

Queries regarding a truss for the stem and neck of the guitar have reached us. The author assures us that, provided well-seasoned high-quality material is used and worked as described (the grain running along the stem) distortion, if any, will not show over a long period (the prototype is now two years old).

A truss-rod can be fitted but entails slicing the back of the stem and insertion of anchor nuts and plates at head and butt with the entailed grooving, etc. After 12 months use of the prototype, this difficult job was considered unnecessary.

Finally, the guitar, if out of use for more than a fortnight, should be detuned to release the tension on the stem.



ELECTRO-MAGNETIC RELAYS

AVAILABLE FROM STOCK
OR SUPPLIED TO
SPECIFICATION



WE CAN SUPPLY
RELAYS SUITABLE FOR
NUMEROUS ELECTRONIC PROJECTS — TIMERS •
ELECTRONIC ORGANS • ALARM SYSTEMS, etc., etc.

Also available: Electro Magnetic Counters, Key Switches,
High Speed Relays, A.C. Relays, etc.

Send us details of your requirements

JACK DAVIS (RELAYS) LTD.

(Dept. PE), 9/10 Mallow Street, London, E.C.1

Telephone: CLerkenwell 3661/2

Contractors to Govt. Departments, Services, etc.

YUKAN SO PROFESSIONAL THE YUKAN
SELF-SPRAY AEROSOL WAY —

Get these **AIR DRYING GREY HAMMER**
or **BLACK WRINKLE (CRACKLE)** Finishes

Yukan Aerosol spraykit contains 16 ozs. fine quality durable easy instant spray. No stove baking required. Hammers available in grey, blue, gold, bronze, Modern Eggshell Black Wrinkle (Crackle) all at 14/11 at our counter or 15/11, carriage paid, per push-button self-spray can. Also Durable, heat and water resistant Black Matt finish (12 ozs. self-spray cans only) 13/11 carriage paid.

SPECIAL OFFER: 1 can plus optional transferable snap-on trigger handle (value 5/-) for 18/11, carriage paid. Choice of 13 selfspray plain colours and primer (Motor car quality) also available.

Please enclose cheque or P.O. for total amount to:
YUKAN, Dept. PE/7 307a Edgware Rd., London W.2.
Open all day Saturday. Closed Thursday afternoons.

Other Yukan Air Drying Aerosols include:
Zinc Chromate Primer.
Clear Lacquer.
Anti-Tarnish Gold and Metallic Finishes.



HIGH SPEED MAGNETIC COUNTERS (4 x 1 x 1 in). 4 digit. 12/24/48V. (state which) 8/6 each, P. & P. 1/-.
RE-SET H.S. MAGNETIC COUNTERS (3 x 1 x 1 in). 3 digit. 12/24/48V. (state which) 32/6 each, P. & P. 2/6.
COPPER LAMINATE BOARD (8 1/2 x 5 1/2 in). 2/8 each. 5 for 10/-.
PRINTED CIRCUIT CONNECTORS. 13 way 'in-line', Gold Plated Pins. 4/8 P. P. & P. 6/1.

BULK COMPONENT OFFERS

100 Capacitors (latest types) 50 pF to .5µF.
200 Carbon Resistors 1/4 & 1/2W. (Transistor types).
250 Carbon Resistors 1/2 & 1W.
150 Hi-Stat Resistors 1/2 & 1W.
100 Ceramic Capacitors 2-1000 pF.
25 Vitreous W/W Resistors (5%).
12 Precision Resistors (1%).
25 Close Tolerance Caps. (2%).

ANY ITEM 10/-. ANY 5 ITEMS £2.

SILICON CONTROLLED RECTIFIERS. CRS 1/30 (360 P.I.V. 1 amp) 7/6 each. CRS 3/40 (460 P.I.V. 3 amp) 10/- each.
PHOTOFASH ELECTROLYTIC 2000 µF, 275V. 17/6, P. & P. 2/6.
ELECTROLYTICS 100µF, 60V. 2/6; 200µF, 250V. 3/6; 100 & 400µF, 275V. 8/6; 500µF, 100V. 4/-; 100µF, 50V. 5/-; 3000µF, 100V. 7/6; 5000µF, 50V. 7/6. P. & P. 2/6 in £.

PATRICK & KINNIE, 81 Park Lane, Romford, Essex
RDMform 44473

EXCEL

in

ELECTRONICS

Through this ICS 3-way Training Method:

MASTER THE THEORETICAL SIDE

1

From basic principles to advanced applications, you'll learn the theory of electronic engineering, quickly and easily through ICS. That's because each course is set out in easy-to-understand terms.

MASTER THE PRACTICAL SIDE

2

ICS show you how to develop your practical abilities in electronic engineering—alongside your theoretical studies. It's the only sure way to success. All training manuals are packed with easy-to-follow illustrations.

MASTER THE MATHEMATICAL SIDE

3

To many this aspect is a bitter problem. Even more so because no electronic engineer is complete without a sound working knowledge of maths. But new ICS teaching makes mathematics easier to learn.

Wide range of courses available include:
Radio/T.V. Engineering and Servicing, Closed Circuit T.V., Electronics, Electronics Maintenance, Instrumentation and Servomechanisms, Telemetry, Computers, etc.
NEW! Programmed Course on Electronic Fundamentals

EXPERT COACHING FOR:

INSTITUTION OF ELECTRONIC AND RADIO ENGINEERS
CITY AND GUILDS TELECOMMUNICATION TECHNICIANS
CITY AND GUILDS SUPPLEMENTARY STUDIES
R.T.E.B. RADIO/T.V. SERVICING CERTIFICATE
RADIO AMATEURS' EXAMINATION
P.M.G. CERTIFICATES IN RADIOTELEGRAPHY

And there are practical "learn as you build" radio courses as well.

Member of the Association of British Correspondence Colleges

FOR **FREE** HANDBOOK POST THIS COUPON TODAY

**I.C.S., Dept. 151, INTERTEXT HOUSE,
PARKGATE ROAD, LONDON, S.W.11**

NAME

ADDRESS

OCCUPATION.....AGE..... 7/67

INTERNATIONAL CORRESPONDENCE SCHOOLS

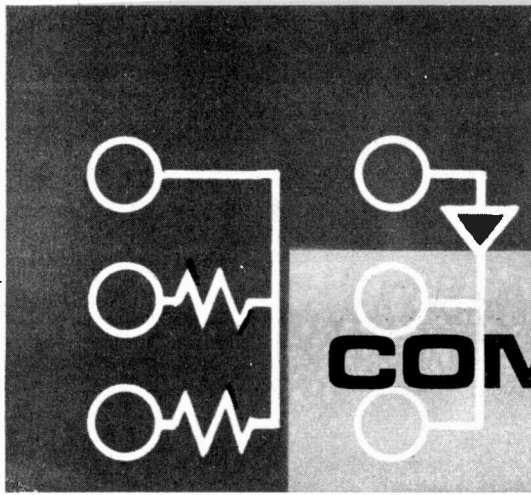

COMPUTER EVOLUTION

PART THREE

By S.A. HODSON B.Sc.

D.C. AMPLIFIERS AND SETTING UP ANALOGUE COMPUTERS

LAST month's article dealt mainly with operational amplifiers and various ways of representing the input and output impedances by discrete components. Before going on to the d.c. amplifier let us first see how the mathematical problems are applied to a practical analogue computer.

MACHINE UNIT

Returning now to the differential equation; it is a useful exercise to work out a circuit that will completely define the behaviour of some piece of equipment. Take, for example, an aircraft wing, subjected to vibration, or sudden displacement, the extent of which is x . In more simple terms, if the wing is stationary, and someone comes along and gives it a kick, it will move. However it won't just move, and then fall back into place; it will vibrate, or ring for some while after the kick has been delivered. It is the extent of this ringing that the aircraft designer would like to know, and to help him find it out, an analogue computer can be programmed to represent the wing.

Supposing that equation 8 represents this wing. (Equation 8 is chosen purely as an example, and has not necessarily any physical counterpart)

$$\frac{d^3x}{dt^3} + \frac{4d^2x}{dt^2} + \frac{3dx}{dt} + 2x = 0 \quad (8)$$

x represents the actual distance that the wing has moved at any one instant in time. dx/dt is its velocity at that instant, and d^2x/dt^2 is its acceleration, or the g force acting on it at that same instant.

The circuit used to simulate this equation is shown in Fig. 3.1. This shows how equation 8 can be represented in a very simple, but extravagant form. In fact, the same equation can be simulated using only four operational amplifiers instead of the seven used in Fig. 3.1. The reader may like to try this reduction by using the techniques described last month.

The whole of Fig. 3.1 depends on one input: x . The next problem to be tackled is, how to generate x .

The first thing to decide on is the scale. In common forms of valve analogue computer, the "machine unit" is 100V. This means that the amplifiers will not handle any voltage greater than 100V. In a transistor machine, the machine unit may be 12V or 25V. It is even possible, using transistors, to use a current as a machine unit, rather than a voltage. Returning to a valve machine, if 1V is chosen to represent 1ft, then the maximum distance that the machine can handle is 100ft.

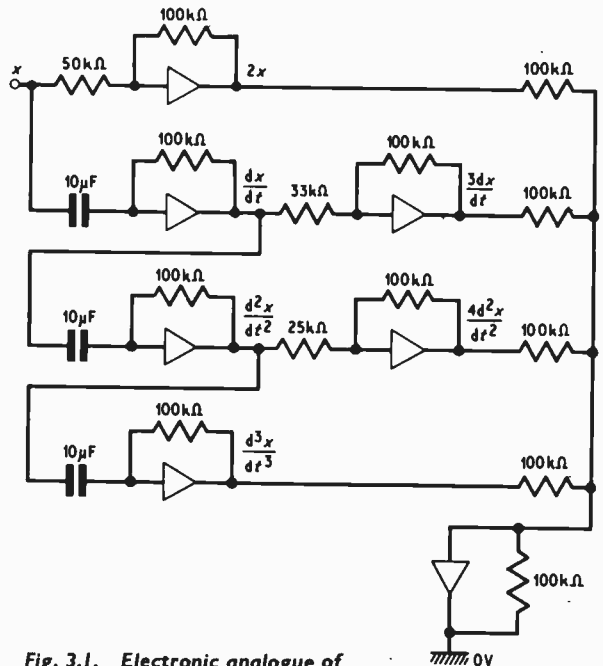

Fig. 3.1. Electronic analogue of $\frac{d^3x}{dt^3} + \frac{4d^2x}{dt^2} + \frac{3dx}{dt} + 2x = 0$

LOOK!

PRACTICAL!

VISUAL!

EXCITING!

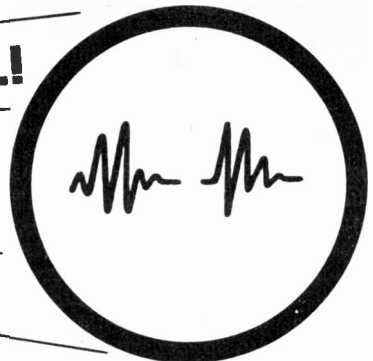

a new 4-way method of mastering
ELECTRONICS
 by doing — and — seeing . . .

1 ▶ OWN and HANDLE a

complete range of present-day **ELECTRONIC PARTS** and **COMPONENTS**

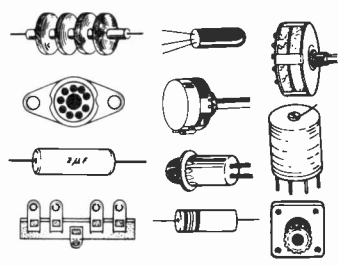

2 ▶ BUILD and USE

a modern and professional **CATHODE RAY OSCILLOSCOPE**

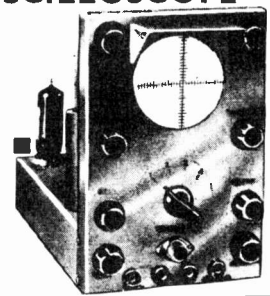

3 ▶ READ and DRAW and

UNDERSTAND CIRCUIT DIAGRAMS

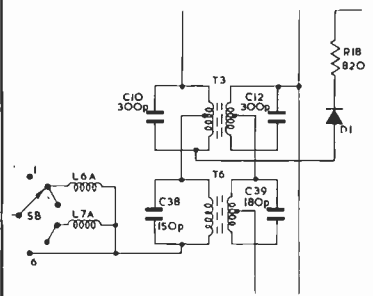

4 ▶ CARRY OUT OVER 40 EXPERIMENTS ON BASIC ELECTRONIC CIRCUITS AND SEE HOW THEY WORK . . . INCLUDING . . .

- VALVE EXPERIMENTS
- PHOTO ELECTRIC CIRCUIT
- A.C. EXPERIMENTS
- TRANSISTOR EXPERIMENTS
- COMPUTER CIRCUIT
- D.C. EXPERIMENTS
- AMPLIFIERS
- BASIC RADIO RECEIVER
- SIMPLE COUNTER
- OSCILLATORS
- ELECTRONIC SWITCH
- TIME DELAY CIRCUIT
- SIGNAL TRACER
- SIMPLE TRANSMITTER
- SERVICING PROCEDURES

This new style course will enable anyone to really understand electronics by a modern, practical and visual method—no maths, and a minimum of theory—no previous knowledge required. It will also enable anyone to understand how to test, service and maintain all types of Electronic equipment, Radio and TV receivers, etc.

FREE POST NOW
 for
BROCHURE
 or write if you prefer not to cut page

To: **BRITISH NATIONAL RADIO SCHOOL, READING, BERKS.** Please send your free Brochure, without obligation, to: *we do not employ representatives*

NAME..... BLOCK CAPS

ADDRESS..... PLEASE PE 7

BRAND NEW T.V. U.H.F. TUNER AND SOUND AND VISION I.F. PANEL

By world famous maker. Suitable for use in conversion of T.V. sets to B.B.C.2 (625 line reception). OFFERED (less valves) AT THE BARGAIN PRICE OF ONLY 27/6. Post Paid. (The components are worth far more than our price for the complete unit and due to the very high value we regret that no correspondence can be entered into regarding this item.)

HIGH GAIN 4 TRANSISTOR PRINTED CIRCUIT AMPLIFIER KIT Type TAI

- Peak output in excess of 1 1/2 watts.
- All standard British components.
- Built on printed circuit panel, size 6 x 3in.
- Generous size Driver and Output Transformers.
- Output transformer tapped for 3 ohm and 15 ohm speakers.
- Transistors (GET 114 or S1 Mullard OC81D and matched pair of OC81 o/p).
- 9 volt operation.
- Everything supplied, wire, battery clips, solder, etc.
- Comprehensive easy to follow instructions and circuit diagram 2/6 (Free with Kit). All parts sold separately.

SPECIAL PRICE 45/- P. & P. 3/-. Also ready, built and tested, 52/6. P. & P. 3/-. A pair of TAIs are ideal for stereo.

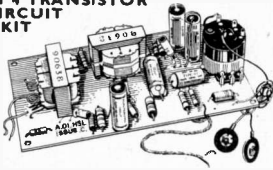

STEREO AMPLIFIER

Incorporating 2 ECL86s and 1 EZ80, heavy duty double wound mains transformer. Output 4 watts per channel into 3 ohm speakers. Full tone and volume controls. Absolutely complete.

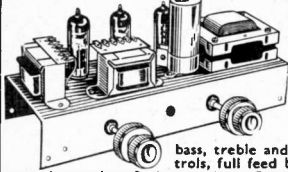

ONLY £4.19.6

P. & P. 8/-
Super Deluxe version with ECL86 valves, sep. bass, treble and balance controls, full feed back. 4 watts per channel into 3 ohm speakers. 8 gns. P. & P. 8/-.

SPECIAL PURCHASE! TURRET TUNERS

By famous maker. Brand new and unused. Complete with PC884 and PC880 valves 34-38 Mc/s I.F. Biscuits for Channel 1 to 5 and 8 and 9. Circuit diagram supplied. **ONLY 25/-** each. P. & P. 3/9.

GÖRLER F.M. TUNER HEAD

88-100 Mc/s 10.7 Mc/s I.F., 15/-, plus 2/- P. & P. (ECC85 valve, 8/6 extra).

LATEST COLLARO MAGNAVOX 363 TAPE DECK DE LUXE. Three speeds, 2 track; takes up to 7 in. spools. 10 gns. plus 7/6 carr. and ins. on each. (Tapes extra.)

QUALITY PORTABLE TAPE RECORDER CASE. Brand new. Beautifully made. Few only at 49/6. P. & P. 8/6.

ACOS CRYSTAL MIKES. High imp. For desk or hand use. High sensitivity, 18/6. P. & P. 1/6.
ACOS HIGH IMPEDANCE CRYSTAL STICK MIKES. Listed at 42/-. Our price, 21/-. P. & P. 1/6.

TWIN TELESCOPIC AERIAL. Two 3-section heavily chromed rods. Closed 12-in. each extending to 32 in. Completely adjustable. Universal mounting bracket, coax lead and plug. Ideal for F.M. or T.V. 12/6. P. & P. 2/6.

QUALITY RECORD PLAYER AMPLIFIER Mk II

A top-quality record player amplifier employing heavy duty double wound mains transformer, ECC83, EL84, EZ80 valves. Separate Bass, Treble and Volume controls. Complete with output transformer matched for 3 ohm speaker. Size 7in. w. x 3in. d. x 6in. h. Ready built and tested. **PRICE 89/6.** P. & P. 6/-.
ALSO AVAILABLE mounted on board with output transformer and speaker ready to fit into cabinet below. **PRICE 89/6.** P. & P. 7/6.

DE LUXE QUALITY PORTABLE R/P CABINET

Uncut motor board size 14 1/2in. x 12in. clearance 2in. below, 5in. above. Will take above amplifier and any B.S.R. or GARRARD Autochanger or Single Player Unit (except AT60 and SP25). Size 18in. x 15in. x 8in. **PRICE 43/9/6.** P. & P. 9/6.

4-SPEED PLAYER UNIT BARGAINS

All brand new in maker's original packing.
SINGLE PLAYERS
B.S.R. TU12 £3/9/6 Carr. 5/6.
GARRARD SP25 De Luxe... £12/0/0 Carr. 5/6.
B.S.R. GU7 with unit mounted pickup arm. £4/18/8 Carr. 5/6.

AUTO. CHANGERS

Latest B.S.R. UA25 Super slim £6 2 6
GARRARD 1000 with special Hi-Fi cart. £6 19 6
GARRARD 3000..... £7 10 0
GARRARD 2000..... £8 15 0
GARRARD AT60 £10 10 0 Carr. 6/6 on each.
All the above units are complete with t/o motor head and sapphire styli or can be supplied with compatible stereo head for 12/6 extra.

BRAND NEW CARTRIDGE BARGAIN!

ACOS GP69-1 MONO CARTRIDGE. For E.P. and I.P. Complete with stylus. **ONLY 12/6.** P. & P. 1/-.

BRAND NEW. 12" 15w. H/D Speakers, 3 or 15 ohm. Current production by well-known British maker. Offered below list price at 89/6. P. & P. 5/-.
Guitar models 25w. £8.5.0 - 35w. £8.8.0.

BRAND NEW 3 OHM LOUSPEAKERS
5 in., 12/6; 6 1/2 in., 15/-; 8 in., 22/6; 10 in., 27/6; 7 in. x 4 in., 16/-; 10 in. x 6 in., 27/6.

E.M.I. 8 in. x 5 in. with high flux magnet 21/-.
E.M.I. 13 1/2 x 8 in. with high flux ceramic magnet, 42/- (15 ohm, 45/-). P. & P. 4/5 2 1/2, 6 1/2 & 8" 2/6, 10" & 12" 3/6 speaker.

E.M.I. PLASTIC CONED TWEETER.
2 1/2" 3 ohm. Limited number: 12/6 each, P. & P. 1/6.

VYNAIR AND REXINE SPEAKER AND CABINET FABRICS app. 54 in. wide. Usually 35/- yd., our price 13/6 per yd. length (min. 1yd.) P. & P. 2/6. S.A.E. for samples.

7-10 watt OUTPUT TRANSFORMERS to match pair of ECL 86's in push-pull to 3 ohm output. **ONLY 11/-.** P. & P. 2/6.

MAINS TRANSFORMER for transistor power supplies. Tapped pri: 200-250v. Sec. 40-0-40 at 1 amp (with electrostatic screen) and 6.3v. at 5 amp for dial lamps etc. Drop thru mounting. Stack size 1 1/2" x 3 1/2" 27/6. P. & P. 4/6.

MATCHED PAIR OF 2 1/2 WATT TRANSISTOR DRIVER AND OUTPUT TRANSFORMERS. Stack size 1 1/2" x 1 1/2" x 1 in. Output trans. tapped for 3 ohm and 15 ohm output. 10/- pair plus 2/- P. & P.

SPECIAL OFFER! FM/AM TUNER HEAD

Beautifully designed and precision engineered by Dormer and Wadsworth Ltd. Supplied ready fitted with twin .0005 tuning condenser for AM connection. Preamplified FM section covers 86 - 102 Mc/s. i.f. output 10.7 Mc/s. Complete with ECC85 (6L12) valve and full circuit diagram of tuner head. Another special bulk purchase enables us to offer these at 27/6 each. P. & P. 3/-. Order quickly!
Limited number also available with precision geared 3:1 reduction drive. 30/- P. & P. 3/-.

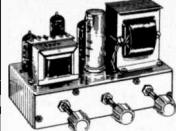

3-VALVE AUDIO AMPLIFIER MODEL HA34



Designed for Hi-Fi reproduction of records, A.C. Mains operation. Ready built on heavy gauge metal chassis, size 7 1/2in. x 4in. d. x 4 1/2in. h. Incorporates ECC83, EL84, EZ80 valves. Heavy duty, double wound mains transformer and output transformer matched for 3 ohm speaker. Separate Bass, Treble and volume controls. Negative feedback line. Output 4 1/2 watts. Front panel can be detached and leads extended for remote mounting of controls. The HA34 has been specially designed for us and our quantity order enables us to offer them complete with knobs, valves, etc., wired and tested for only **£4.5.0** P. & P. 6/-.

HSL 'FOUR' AMPLIFIER KIT

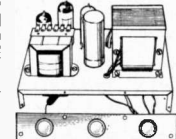
A.C. Mains 200/250v., 4 watt, using ECC83, EL84, EZ80 valves



★ Heavy duty double-wound mains transformer with electrostatic screen.
★ Separate Bass, Treble and volume controls giving fully variable boost and cut with minimum insertion loss.
★ Heavy negative feedback loop over 2 stages ensures high output at excellent quality with very low distortion factor.

★ Suitable for use with guitar, microphone or record player. ★ Provision for remote mounting of controls or direct on chassis. ★ Chassis size only 7 1/2 in. wide x 4 in. deep. Overall height 4 1/2 in. ★ All components and valves are brand new. ★ Very clear and concise instructions enable even the inexperienced amateur to construct with 100% success. ★ Supplied complete with valves, output transformer (3 ohm only), screened lead, wire, nuts, bolts, solder, etc. (No extras to buy.) **PRICE 79/6.** P. & P. 6/-.

Comprehensive circuit diagram, practical layout and parts lists 2/6 (free with kit). This kit although similar in appearance to HA34 employs entirely different and advanced circuitry.

10/14 WATT HI-FI AMPLIFIER KIT

A stylishly finished monaural amplifier with an output of 14 watts in push-pull. Super reproduction of both music and speech with negligible hum. Separate inputs for mike and gram allow records and announcements to follow each other. Fully shrouded section wound output transformer to match 3-15Ω speaker and 2 independent volume controls, and separate bass and treble controls are provided giving good lift and cut. Valve line-up 2 EL84s, ECC83, EF86, and EZ80 rectifier. Simple instruction booklet 2/6. (Free with parts.) All parts sold separately. **ONLY 47/9/6.** P. & P. 8/6.

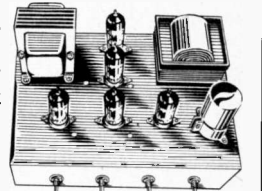

Also available ready built and tested complete with std. input sockets, 49/5/- P. & P. 8/6. Carrying Case for above 28/6. P. & P. 7/6.

MATCHED PAIR AM/FM I.F.'s. Comprising 1st I.F. and 2nd I.F. discriminator. (465 Kc/s) 10.7 Mc/s. Size 1" x 1 1/2" x 2 1/2" H. Will match FM/AM Tuner head on left. 11/- pair. P. & P. 2/-.

HARVERSON SURPLUS CO. LTD.

170 HIGH ST., MERTON, S.W.19 CHERRYWOOD 3985

Open all day Saturday Early closing Wed., 1 p.m.

A few minutes from South Wimbledon Tube Station. (Please write clearly)

OVERSEAS P. & P. CHARGED EXTRA. S.A.E. with all enquiries

ELECTRONIC ORGAN KITS

NOW ALSO AVAILABLE IN PARTLY BUILT FORM £105

So easy to build, so delightful to play
Suited to all types of music

The Solette. Precision made, pre-tuned units come to you ready to assemble in only 20 hours. Self-contained amplifier and speakers; perfect tone and generous volume, full 5-octave organ keyboard. Five pitches plus solo and melodic bass. Transistorised, portable. Price £118 complete (terms if needed). Details from:

Harmonics
(Bromley) Ltd

DEPT. P.E.4, CLARION WORKS, NAPIER ROAD,
BROMLEY, KENT. RAVENSBORNE 2122

★ Also two-manual and pedal organ kits up to £395.



Obviously, the number of different input signal shapes that can be invented is infinite. Any reasonably shaped curve can be broken down into lots of small straight lines, as in Fig. 3.2. The more lines used to represent the curve, the more accurate is the representation. The name for this method is "piecewise linear representation".

A straight line of any fixed slope is fairly easy to generate. If a step waveform is applied to an integrator, a ramp waveform will result. The points where two straight lines meet are known as "break points", and it is in the generating of these that the dodge is used. If a Zener diode is connected into an operational amplifier, as in Fig. 3.3, the second resistor, in series with the diode, has no effect until the diode starts to conduct. This does not happen until the striking voltage of the diode is reached by the output. Space does not permit of a fuller description of this method, suffice it to say that by suitable juggling of the striking points of the diodes, and by putting them in parallel with both Z_0 and Z_1 almost any wave shape can be generated.

COMPUTER FUNCTIONS

The term "real time" has already been explained. It is now possible to see how "fractional time" working can be achieved. If the waveform being generated is a long slow one, taking perhaps minutes or even hours, it can very easily be speeded up by changing the component values of the integrator that is generating the initial ramp function. This causes the whole process to be speeded up, thus giving a designer a very quick method of finding the answers to what may be a very slow problem.

There are several other ways of generating specific functions. Some are highly sophisticated, like the plotting table, which has a line drawn on a table to represent the function being generated. A follower then slides over the table and follows the line, generating the appropriate voltage as it goes. Others are more mundane but almost equally effective.

One such use is a cathode ray tube, in which the spot is made to fly vertically up and down, and to progress across the screen at the same time. A piece of card is then cut to the shape of the desired function and held in front of the screen. Each time the spot emerges from behind the card, a note is made, electronically, of its height up the screen. This electronic "mental note" can then be used to generate the function.

The physical layout of an analogue computer follows a fairly strict pattern. To be a general purpose machine, it is necessary that it can be easily connected up, and then broken down to be built up again in a different way. To this end, the computer consists of a bank of high gain d.c. amplifiers, with their inputs and outputs connected to a matrix of sockets. Above the bank of amplifiers comes a bank of variable resistors. These also have their terminals brought out to the matrix.

The manner in which the machine is programmed, is simply to build up a layout such as that in Fig. 3.1, by using wire links with plugs on the ends that fit into the sockets on the "patch-board" as it is called.

To use the computer's time more efficiently, it is general practice to supply several patch-boards with one machine. Each board can plug into the computer, but the great advantage is that a programmer can take a board away from the computer and set up his circuit with the link wires, and then, when the machine is free,

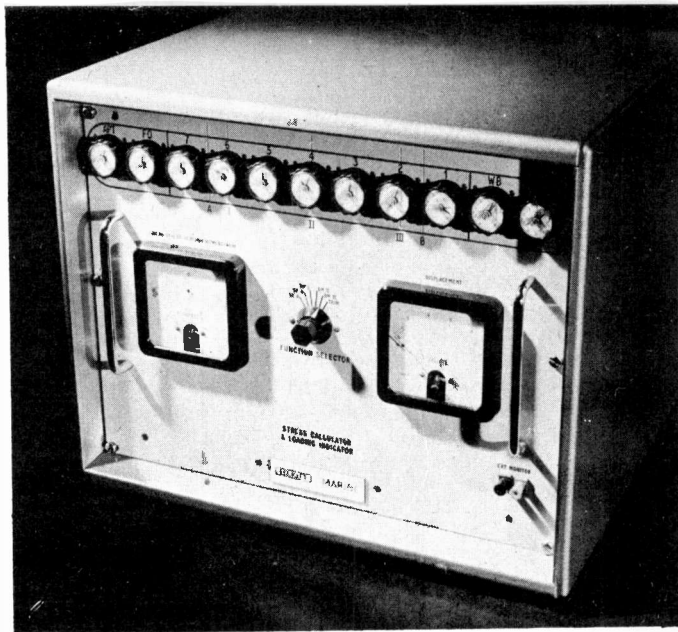

Ship's maximum safe load computer developed by Elliott Marine Automation enables the ship's master to know, almost instantly, the stresses placed on a ship's hull during loading and unloading of cargo. The computer allows the master to achieve maximum payload thereby improving the overall earning capacity of the vessel. The same task takes several hours when performed unaided.

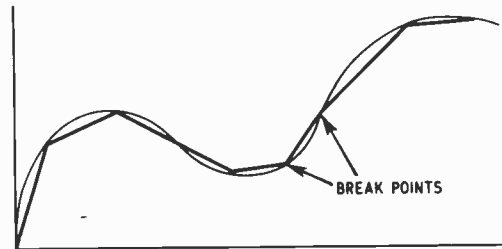

Fig. 3.2. Any reasonably shaped curve can be broken down into lots of small straight lines

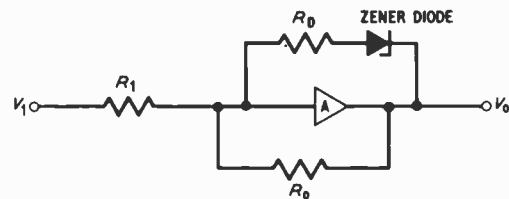

Fig. 3.3a. A Zener diode is connected in series with the second resistor to simulate the slope change

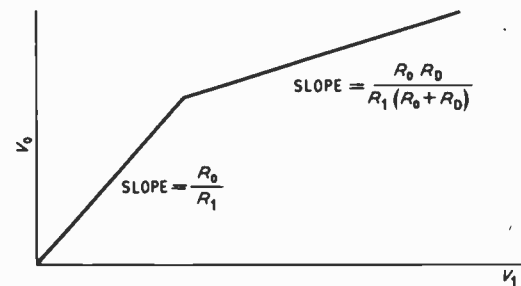

Fig. 3.3b. The graphical effect of using the Zener diode and resistor R_0

he can go and plug in his patch-board and start computing almost immediately.

D.C. AMPLIFIER

Up to this point in this series, a great deal of theory has been given on analogue computing, the whole of which revolves about one piece of hardware—the d.c. amplifier.

It is so vital to the operation of an analogue computer, that it is intended to devote several paragraphs to the various types that are in common use. Before describing the actual hardware involved in such an amplifier, it is useful to consider the attributes required of it. Two of these have already been mentioned in previous articles. For analysing the operational amplifier, the gain of the d.c. amplifier used has been assumed to be infinite, and as a result of this, the input current taken as zero.

The properties required do not end there; for instance, an amplifier may have a vast gain and draw minute current at its input, but may drift as it warms up, or it may become unstable when feedback is applied. Again, it might have a certain amount of "zero-error" (i.e. an output may be obtained when there is no input).

Some of the most important features required of a d.c. amplifier, if it is to be of any use in an analogue computer, are

1. High gain (this may be 10^7 to 10^8 at d.c. falling to 10^4 to 10^5 at 20Hz).
2. Low input current.
3. No drift.
4. No zero error.
5. Adequate bandwidth (d.c. to 50 or 100Hz is typical).
6. 180 degrees overall phase shift (i.e. negative gain).
7. Low output impedance (so that heavy loads may be driven).

The low output impedance is required in cases where the amplifier has to drive a pen recorder or some such piece of equipment, or even when several further amplifiers are to be driven simultaneously. This last case is described, in computer circles, by saying that the amplifier has a large "fan-out".

The bandwidth of the amplifier must be sufficient to handle the complete range of frequencies involved, otherwise false results may occur. This is particularly important in fractional time working, since, in this mode, all frequencies are increased.

Space does not permit a complete "exposé" of d.c. amplifiers, so only a brief discussion of some of the more salient points will be given.

Consider, first of all, the output stage of a d.c. amplifier. The requirement that affects this most is the low output impedance of the amplifier. The simple way of achieving this is to use an emitter follower (see Fig. 3.4.).

Assuming that the "machine unit" is from $-15V$ to $+15V$, and that the maximum drive required of the output is 10mA, it is possible to calculate the emitter load.

In view of the 10mA that is likely to be required, it is good policy to allow at least 15mA to flow in the transistor on no load. This current should flow when the stage is giving its minimum output voltage, namely $-15V$, thus fixing the load resistor R_L to the nearest preferred value, at 680 ohms. Consider now what happens when the output voltage reaches its maximum of $+15V$. To achieve this voltage the transistor must conduct approximately 60mA. Apart from being hard on the transistor, this drastic change of current will move the operating point of the transistor to a different point on its characteristic curves. This does not help where the linearity of the amplifier is concerned.

A more useful technique is to use a constant current source as the emitter load (see Fig. 3.5).

With the emitter resistor shown, the transistor TR2 conducts a virtually constant current of just over 18mA. As the output voltage rises, the collector current of TR2 only varies slightly. This means that TR1 has a stable operating point, and can therefore be run at a higher rating throughout its range of output.

PREVENTING DRIFT

One of the most annoying problems that arises in a d.c. amplifier is that of "drift". By definition, the

Part of the Solartron analogue computer complex installed recently at Sperry's new Research and Development Centre at Bracknell, Berkshire. The computer was purchased by the Ministry of Technology for work in support of guided weapons projects, notably Sea Dart

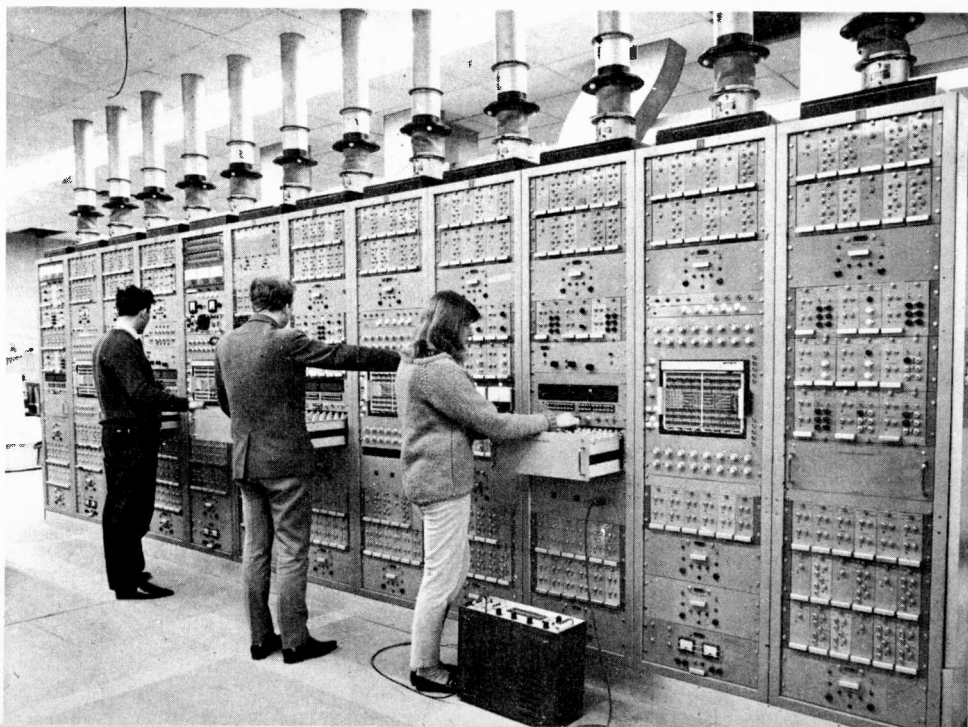

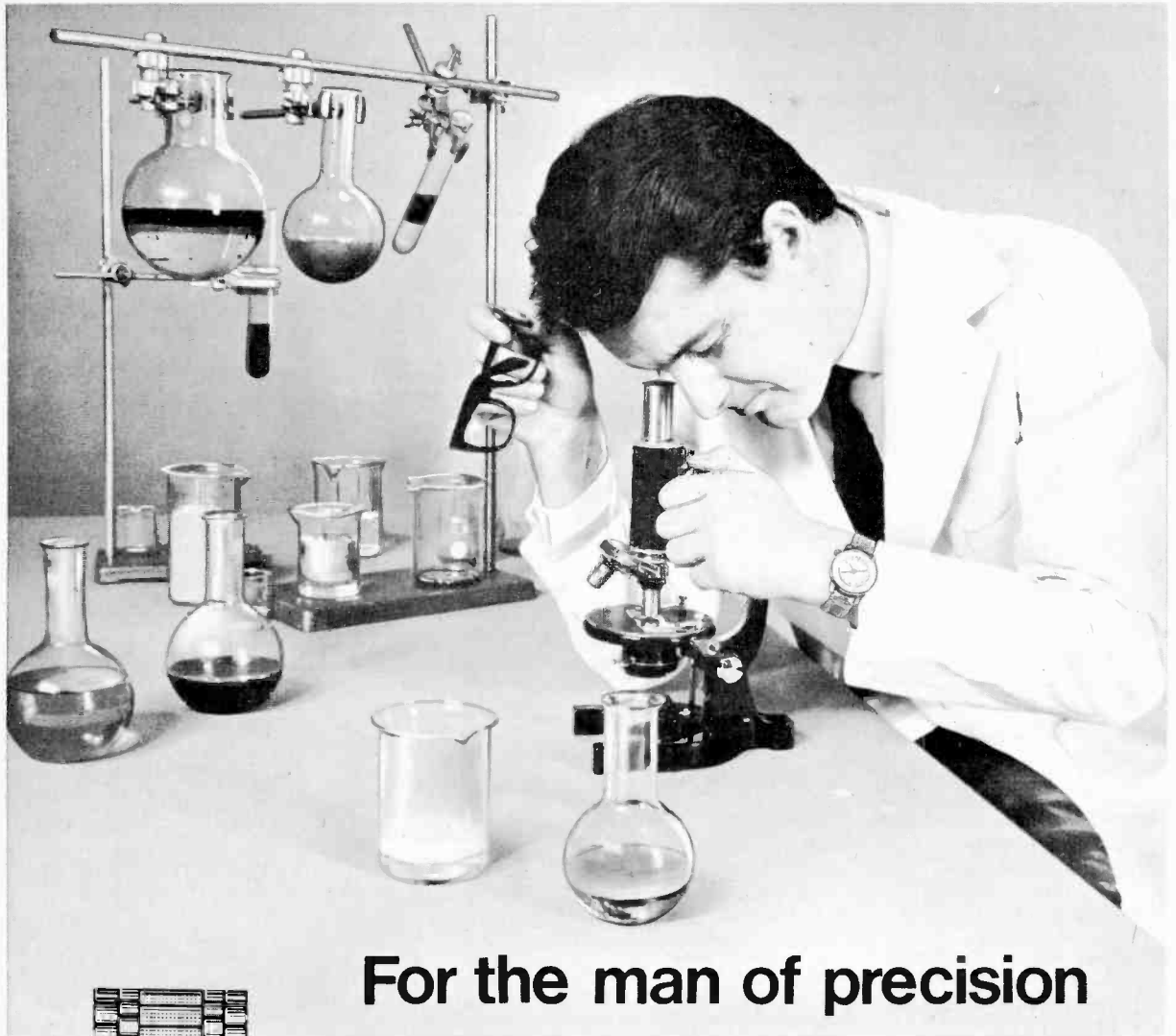

For the man of precision

Seiko World Time Watch

Now made available to readers of *PRACTICAL ELECTRONICS* for £21 . 9 . 6d.

**WITH A 100% MONEY-BACK GUARANTEE
IF NOT COMPLETELY SATISFIED**

SEIKO watches are precision time-keeping instruments produced with painstaking care under a strict quality control system.

The SEIKO WORLD TIME AUTOMATIC gives you at any time of day or night, the exact time in 24 of the world's leading capitals, as well as Greenwich Mean Time and the date of the Month. This 17-jewel watch has a built-in antimagnetic hairspring, unbreakable mainspring and full rotor finely poised over six ball bearings, and is shockproof. It is fully guaranteed to give you accuracy, pleasure and absolute dependability.

The World-wide reputation of Seiko won them the honour of producing all the high-precision timing equipment for the 1964 Olympic Games.

USE THIS 100% MONEY-BACK GUARANTEE FORM

Please send me a SEIKO WORLD TIME WATCH. My remittance is enclosed and I understand it will be refunded if I am not completely satisfied.

NAME _____

ADDRESS _____

(E)

Cheques and postal orders must be crossed and made payable to Watch Division, WSR Limited, Dept. E, 30/32 Southampton Street, London, W.C.99. Cheques should have name and address on the reverse. This offer is available only to U.K. readers.



VARIABLE VOLTAGE TRANSFORMERS



PORTABLE TYPE
£8. 10. 0.



**INPUT 230/240v. A.C. 50/60—
OUTPUT VARIABLE 0-260v.—
BRAND NEW Carriage Paid.**
Buy direct from the importer,
keenest prices in the country.
All Types (and Spares) from
1/2 to 50 amp. from stock.
OPEN TYPE (Panel Mounting)
1/2 amp, £3. 3. 0. 1 amp, £4. 10. 0.
2 1/2 amps, £5. 12. 6.

SHROUDED TYPE
1 amp, £4. 10. 0. 2.5 amps,
£5. 17. 0. 4 amps, £8. 7. 6.
5 amps, £9. 0. 0. 8 amps,
£13. 10. 0. 10 amps, £17. 0. 0.
12 amps, £19. 10. 0. 15 amps,
£22. 0. 0. 20 amps, £32. 10. 0.
37.5 amps, £65. 0. 0. 50 amps,
£85. 0. 0.
1.5 amp. portable fitted metal case
voltmeter, lamp, switch, etc. £8.10.0
P. & C. 10/-. Similar to above 2.5
amp. £9.17.6. P. & C. 10/-.

LIGHT SENSITIVE SWITCH

Kit of parts, including ORP12 Cadmium Sulphide Photocell, Relay, Transistor and Circuit, etc. 6-12 volt D.C. op. price 25/- plus 2/6 P. & P. ORP 12 including circuit, 10/6 each, plus 1/- P. & P.

A.C. MAINS MODEL Incorporates Mains Transformer, Rectifier and special relay with 3, 5 amp mains c/o contacts. Price inc. circuit 47/6 plus 2/6 P. & P.

LIGHT SOURCE AND PHOTO CELL MOUNTING

Precision engineered light source with focusible lens assembly and ventilated lamp housing, to take MBC bulb. Separate photo cell mounting assembly for ORP12 or similar cell. Both units are single hole fixing. Price per pair £2.10.0. P. & P. 3/6.

MINIATURE UNISELECTOR SWITCH

3 banks of 11 positions plus homing bank. 40 ohm coil. 24-36 v. operation. Carefully removed from equipment and tested. 22/6, plus 2/6 P. & P.

UNISELECTOR SWITCHES

75 ohm coil 24 v. D.C.
6 Bank 25 position, 5 non-bridging 1 Bridging Wiper
6 Bank arranged to give 3 bank, 50 positions. Carefully removed from equipment. All at 35/- each. P. & P. 2/6.

100 WATT POWER RHEOSTATS (NEW)

AVAILABLE IN THE FOLLOWING VALUES
1 ohm, 10 a.; 5 ohm, 4.7 a.; 10 ohm, 3 a.;
25 ohm, 2 a.; 50 ohm, 1.4 a.; 100 ohm, 1 a.;
250 ohm, .7 a.; 500 ohm, .45 a.; 1,000 ohm,
280 mA; 1,500 ohm, 230 mA; 2,500 ohm, .2 a.
Diameter 3 1/2 in. Shaft length 3 1/2 in., dia. 1/2 in. All at 27/6 each. P. & P. 1/6.

25 WATT POWER RHEOSTATS

10 ohm, 1.5 a.; 25 ohm, 1 a.; 50 ohm, .75 a.; 100 ohm, .5 a.;
250 ohm, .3 a.; 500 ohm, .2 a.; 1,000 ohm, .15 a.; 1,500 ohm,
.12 a.; 2,500 ohm, .1 a.; all at 14/6. P. & P. 1/6.

NICKEL CADMIUM BATTERY

Sintered Cadmium Type 1-2 v. 7AH.
Size: height 3 1/2 in., width 2 1/2 in.
Weight: approx. 13 oz. Ex-R.A.F.
Tested, 12/6. P. & P. 2/6.

INSULATED TERMINALS

Available in black, red, white, yellow, blue and green. New 15/- per doz. P. & P. 2/-.

34R SILICON SOLAR CELL

4 .5v. unit series connected, output up to 2 v. at 20 mA, in sunlight. 30 times the efficiency of selenium. As used in power Earth Satellites, 37/6. P. & P. 1/-.

"SOLAR CELL AND PHOTO-CELL EXPERIMENTERS' GUIDE"

Teaches the principles of light sensitive devices and their application. 26/-, post paid.

36 VOLT 30 AMP AC OR DC VARIABLE LT SUPPLY UNIT

Input 220/240 volts A.C.
Low voltage supply. Fully isolated. Fitted in robust metal case with Voltmeter, Ammeter. Panel Indicator and Chrome Handles. Input and Output fully fused. Ideally suited for Lab. or Industrial use. £55 40/- CP.

CONSTANT VOLTAGE TRANSFORMER

Input 185-250 v. A.C. Output 230 v. A.C. Capacity 250 watt. Attractive metal case. Fitted red signal lamp. Rubber feet. Weight 17 lbs. Price £11.10.0. P. & P. 15/-.

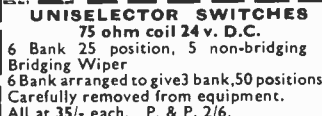
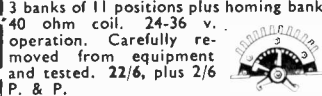

SCOOP!! DIGITAL VOLTMETERS

at a fraction of makers price!!!
FOUR DIGIT DISPLAY WITH AUTOMATIC DECIMAL POINT

Manufactured by Dave Instruments Ltd. Type 652A Voltmeter and Type 653A A.C. Input Unit. These two units are new in makers packing. Volts D.C. 2 millivolt to 1,000 v. 0.2% accuracy in four f.s.d. ranges of 1v, 10v, 100v, and 1,000v. Volts A.C. 1 millivolt to 500v. 50 c/s to 25 kc. 0.3% accuracy in four ranges. A.C. Mains operation, 110v and 200-250 v. 50-60c/s. These fully transistorised portable units, weighing together only 15lbs. are offered complete with handbook, for only £47.10.0 per set, incl. Postage (U.K. only). Leaflets available on request.

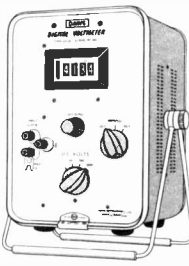

DRY REED SWITCH. 1 amp. contact, size 1 1/2" x 1 1/2". 4 for 10/-.

THYRISTOR 400 tiv. 3 amp. 9/6 post paid.
THYRISTOR 400 tiv. 8 amp. 28/6 post paid.

230 VOLT A.C. GEARED MOTORS

5 r.p.m. 1-7 lb. inch £2.9.6. P. & P. 2/6. 13 r.p.m. 1-45 lb. inch £2.17.6. P. & P. 2/6. 80 r.p.m. 26 lb. inch £2.2.0. P. & P. 2/6.

DOUBLE WOUND VARIABLE LT TRANSFORMERS

Fully isolated low tension secondary winding. Input 230 v. A.C. Output continuously variable 0-36 v. A.C.
0-36 Volt at 5 Amp. £8.10.0. P. & P. 8/6.
0-36 Volt at 20 Amp. £19.10.0. P. & P. 15/-.
These fully shrouded Transformers designed to our specifications are ideally suited for Educational and Industrial Laboratory use.

SUPER POWER MAGNET

Fantastic ex-V.V.D. magnets, weighing only 4 lb. will lift well over 100 lb. Swivelled handle and keeper. Size 4 in. x 3 1/2 in. x 1 1/2 in. Packed in two's. Price 30/- per pair plus 7/6 C. & P.

MOVING COIL HEADPHONE AND MIKE

Soft rubber ear-pieces with M/C Mike fitted 5-way plug as on No. 19 set. New in makers packing, 16/6 plus 3/6 C. & P.

SERVICE TRADING CO

All Mail Orders—Also Callers—Ample Parking Space
57 BRIDGMAN ROAD, LONDON, W.4 Phone 995 1560
SHOWROOM NOW OPEN CLOSED SATURDAY
Personal callers only
9 LITTLE NEWPORT ST. LONDON, W.C.2. Tel. GER 0576

BASIC TELEVISION

New Model Illustrated Course of Elementary Technician Training. A Common Core Book

Pt. 1. 21/- Tech. P. Postage 1/-

SELECTED PAPERS, II, PAL. Variant of NTSC Colour Television System, by Dr. W. Bruch. 12/6. Postage 1/6.

THE RADIO AMATEUR HANDBOOK, 1967 ed., by A.R.R.L. 40/- Postage 4/-.

COLOUR TELEVISION EXPLAINED, by W. A. Holm. 21/- Postage 1/-.

WORLD RADIO, T.V. HANDBOOK, 1967, 32/- Postage 1/-.

COMPUTERS FOR THE AMATEUR CONSTRUCTOR, by R. H. Warring. 20/- Postage 1/-.

RAPID SERVICING OF TRANSISTOR EQUIPMENT, by G. J. King. 30/- Postage 1/-.

TRANSISTOR SPECIFICATIONS & SUBSTITUTION HANDBOOK, Tech. P. 21/- Postage 1/-.

RADIO VALVE DATA 8th ed. Compiled by "VWV". 9/6. Postage 1/3.

THE MODERN BOOK CO.

BRITAIN'S LARGEST STOCKISTS OF AMERICAN Technical Books
19-21 PRAD STREET LONDON, W.2
Phone: PADdington 4185
Closed Saturday 1 p.m.

4-STATION INTERCOM



Solve your communication problems with this 4-Station Transistor Intercom system (1 Master and 3 Subs), in de-luxe plastic cabinets for desk or wall mounting. Call/talk/listen from Master to Subs and Subs to Master. Ideally suitable for Business, Surgery, Schools, Hospital, Office and Home. Operates on one 9V battery. On/off switch. Volume control. Complete with 3 connecting wires each 66ft. and other accessories. P. & P. 6/6.

INTERCOM/BABY ALARM



Modernize business or home with this new two-way Portable Transistor Intercom, consisting of Master and Sub, in strong plastic cabinets for desk or wall. Designed as a two-way instant communication system. Call/talk/listen from Master to Sub and Sub to Master. Operates on one 9V battery. Complete with 66 ft. wire. Battery 2/6. P. & P. 3/6.

Transistor TELEPHONE AMPLIFIER 55/-



Why not boost business efficiency with this incredible De-luxe Telephone Amplifier. Take down long telephone messages or converse without holding the handset. A status symbol? Yes, but very useful one. On/off switch. Volume Control. Operates on one 9V. battery supplied for 2/6 extra. P. & P. 2/6. Full price refunded if not satisfied in 7 days. WEST LONDON DIRECT SUPPLIES (PE7) 189 KENSINGTON HIGH STREET, LONDON W.8.

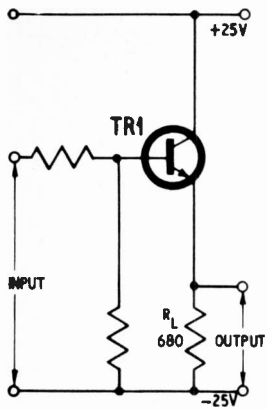

Fig. 3.4. Basic emitter follower output stage

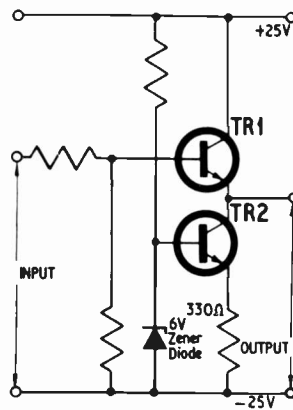

Fig. 3.5. Constant current source as the emitter load

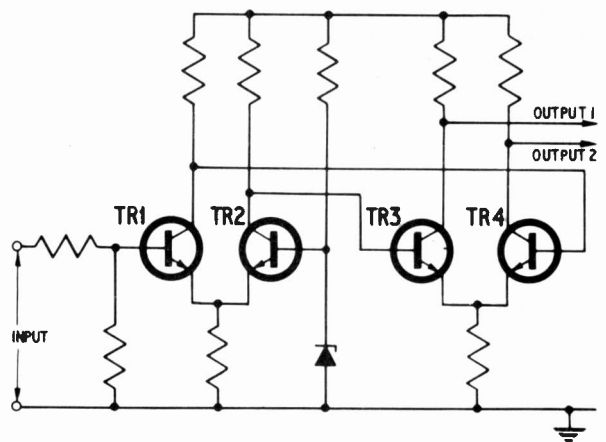

Fig. 3.6. Complete amplifier using long-tailed pairs to reduce drift

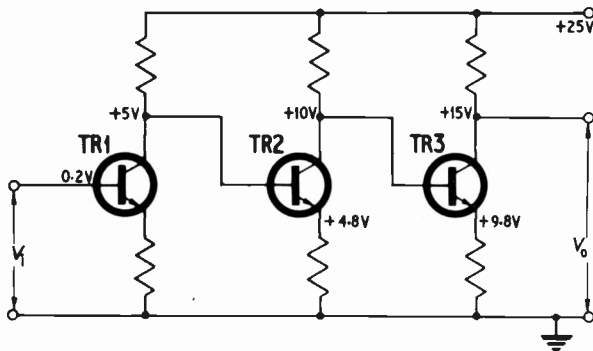

Fig. 3.7. Accumulation of d.c. levels through a three-stage amplifier

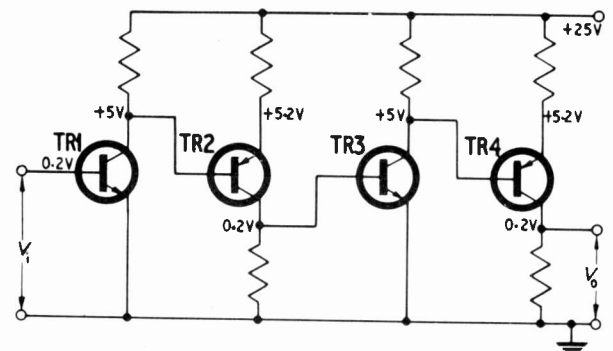

Fig. 3.8. Using complementary transistors to eliminate accumulation of d.c. voltage

amplifier must be d.c. coupled; this means that any slight change in the current conducted in the first stage, and this can very easily be caused by a change in temperature, will be amplified right through the amplifier and appear as a fairly substantial output. One of the most common methods of dealing with drift is to use a long-tailed pair. A complete amplifier can be built using these elements, as in Fig. 3.6.

When an amplifier of this type is built with transistors it is possible to use two transistors in one encapsulation. This means that their temperatures will be identical, and hence, any drift that occurs in one transistor will also occur in the other. By making use of a circuit such as that in Fig. 3.6, these two drifts can be made to cancel each other out, thus producing a virtually drift-free amplifier.

Another problem that arises in a d.c. amplifier is that of the accumulation of d.c. levels through the amplifier. The very nature of the transistor is such that if it is to be operated in its linear mode, it must support a comparatively large voltage across itself. This means that the input to the second stage starts off with a d.c. bias before any signal arrives at all. This principle is illustrated in Fig. 3.7. D.C. voltages are given at strategic points of the circuit.

If complementary (*pnp* and *npn*) transistors are used alternately in the amplifier, the accumulation of voltage can be completely eliminated (see Fig. 3.8).

It is possible to build a d.c. amplifier, using both long-tailed pairs and complementary transistors, which is virtually free from drift, and has no change in d.c. level between its input and its output.

Elliott analogue computer for automatic alignment of the steerable landing gear on the Lockheed C5A giant transport aircraft when landing crosswind



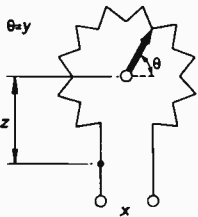

Fig. 3.9. Basic principle of a multiplier

Fig. 3.10. Driving the multiplier potentiometer by using a comparison voltage from "y" input and the "reset" potentiometer

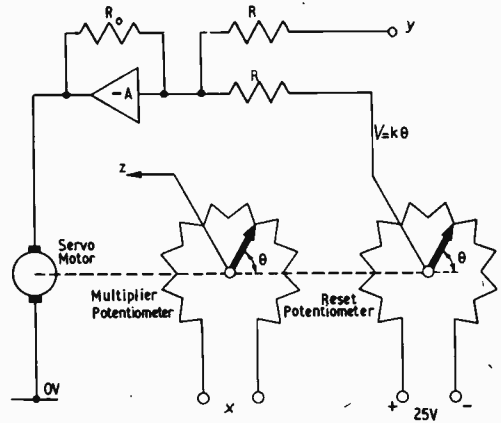
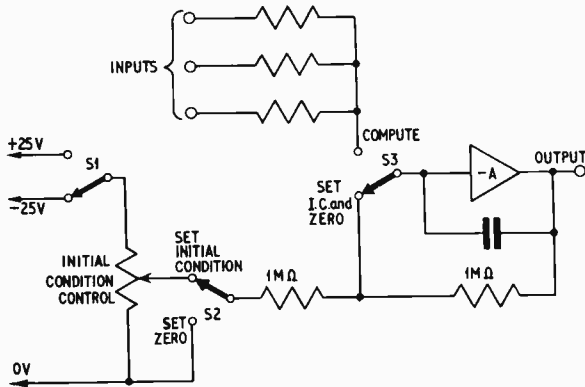

Fig. 3.11 (left). Setting up the initial condition on an integrator prior to actual computation

SERVO-MULTIPLIER

In the theory of analogue computers that has been presented so far, use has been made of the summing amplifier as a multiplier that can multiply a variable by any fixed constant. This unit cannot multiply two variables together. There is, however, a unit that can perform this function, and its description has been deliberately left until now because it forms a field on its own—that of the servo-multiplier.

Unfortunately, the technology of electronics at the present time does not allow for two variables to be multiplied together without resorting to a mechanical "swindle". This swindle forms the basis of a servo-multiplier.

The aim of this device is to accept two variables x and y , and, by fair means or foul, produce their product z . Suppose that x is to be represented by a voltage applied to the ends of a potentiometer, and that y is to be represented by the angle at which the shaft of the potentiometer rests, then the voltage appearing on the wiper of the potentiometer would be proportional to the product of x and y , i.e. z (see Fig. 3.9).

This is the "multiplier" part of a servo-multiplier; the "servo" part arises from the manner in which y is converted from a voltage into an angular position. Suppose that a second potentiometer were to be ganged to the shaft of the multiplier potentiometer; and suppose also that the ends of the track are connected to a constant voltage supply. Then the voltage on the wiper of this second potentiometer will be directly proportional to the angle of its shaft. If now this voltage is compared in a summing amplifier with the voltage representing y , then a voltage can be derived to drive a small servo motor that can in turn drive the two potentiometers. This can be seen more clearly in Fig. 3.10.

The output of the summing amplifier will be

$$V_o = \frac{R_o}{R} y + \frac{R_o}{R} k\theta$$

When $k\theta = -y$ the output V_o will be zero and the motor will stop turning. By suitable choice of components, the minus sign and the constant k can be made to disappear, leaving the "null" point to occur when $\theta = y$.

This indicates the basic method of multiplying two variables together, and leaves only one further topic to be covered in the analogue section of this series.

SETTING-UP

Returning to the aircraft wing that was mentioned earlier, it was always assumed that at the start of any computation, the wing was in an unstrained position. This need not always be the case, and a special technique for dealing with this sort of situation must be developed.

Supposing that a brick was resting on the wing tip when it received its kick. This would mean that the initial value of x was not zero. This initial value can be very easily represented by a voltage set up on a capacitor before beginning a computation. A typical circuit in which such an "initial condition" is set up on an integrator, is shown in Fig. 3.11.

The potentiometer used to set up the initial condition is usually a highly accurate, calibrated instrument, or else it is coupled to a digital voltmeter. All the initial conditions would then be set up using the same instrument. This is the cheapest and most accurate way of setting up the initial conditions, since it obviates the need for a large number of accurate potentiometers, with precision power supplies.

The "set zero" switch position is a refinement that allows the amplifier to be checked for zero error. The input can be connected to zero voltage, and a check made that the output is also zero.

Once all the pre-computation setting-up has been completed, the "compute" switch S3 makes the final connection that allows computation to proceed.

In the next article it is intended to start on a discussion of the digital computer. It is this machine that is the true "brain" of modern times.

RUA UP EE or AC?

Just in case you don't get it—here's the translation... "Are you a University Professor, Electronics Engineer or Amateur Constructor?" All three types find life much easier with a Home Radio Catalogue to track down all the components they need. Incidentally, our cartoonist has been taking artistic licence again—our catalogue is such a necessity that everybody buys their own copy. Have you got yours? If not, all you have to do is to send the coupon with a cheque or P.O. for 9/- (7/6 plus 1/6 p. & p.), and your catalogue will come by return of post.

Just to remind you—the catalogue lists some 6,000 components with over 1,000 of them illustrated. With each catalogue you also get a Bookmark, an Order Form and—just to make life really easy for you—an addressed envelope! Moreover every copy contains 5 vouchers, each worth one shilling if used as directed.



Please write your Name and Address in block capitals

NAME

ADDRESS

HOME RADIO LTD., Dept. PE, 187 London Road, Mitcham, Surrey. CR4 2YQ

"HAMMER FINISH" PAINT BY AMERICA'S LARGEST PAINT ORGANISATION PACKED IN GIANT ONE POUND SIZE AEROSOL CANS NOW AVAILABLE FOR THE FIRST TIME IN THE U.K. SUPERB FINISH ON METALS, PLASTIC, IN FACT ON ALL MATERIALS. ALREADY IN USE IN INDUSTRY IN THIS COUNTRY, JUST SPRAY ON FROM CLOG FREE CANS, PERFECT RESULTS, QUICK DRYING.

AVAILABLE IN THE FOLLOWING COLOURS: BLUE, SILVER, GOLD, COPPER, GREEN, GREY.

"WRINKLE FINISH," A GENUINE CRACKLE FINISH FROM AEROSOL CANS. PERFECT FOR ALL YOUR JOBS, 16oz. size can.

AVAILABLE IN THE FOLLOWING COLOURS: FIRE RED, FRENCH GREY, CELESTIAL BLUE, OPAL GREY, BRITISH BROWN, FOREST GREEN, NEPTUNE GREEN, TROPICAL TAN, JET BLACK, SMOKE SILVER.

PRICE PER TIN EITHER HAMMER OR WRINKLE FINISH 16/5d. post 1/-.

6 tins post free. Cash with order.

OVER 150 finishes available, including fluorescent, epoxy's, etc.

TRADE AND RETAIL ENQUIRIES INVITED TO:

ILLBRONZE (U.K.) CO.
1063 STOCKPORT ROAD
MANCHESTER 19

Distributors in the U.K. for
ILLBRONZE INC., CHICAGO, U.S.A.

TRANSISTOR SPECIFICATION & SUBSTITUTION HANDBOOK

New 1967 Ed. By Tec-Press 22/6

Modern Dictionary of Electronics, by Graf. 54/6.

Principles of Colour Television, by Patchett. 16/9.

Practical Oscilloscope Handbook, by Turner. 26/-.

Digital Computers-Mathematics and Circuitry. 31/-.

Rapid Servicing of Transistor Equipment, by King. 31/3.

Transistors in Logical Circuits, by Altes. 17/-.

Electronic Motor Control, by Lytel. 31/3.

Questions and Answers on Electronics, by Brown. 9/3.

BOAT WORLD, The Sail & Powerboat Yearbook 1967. 19/-.

Circuits for Audio and Tape Recording, by Judd. 8/3.

All prices include U.K. postage

Where possible 24-hour service guaranteed

UNIVERSAL BOOK CO.

12 LITTLE NEWPORT ST., LONDON, W.C.2
(Leicester Square Tube Station)

MICRO miniature

microphones

The Sennheiser sensation that shook the United States.



MM 23 magnetic lapel microphone. Cable with jack on request **£5.15.0**



MM 26 magnetic subminiature microphone. For built-in application **£3.10.0**



MM 301 magnetic micromodule. Ultra sensitive. For built in application **£4.18.0**



MM 61 'fountain pen' microphone. High output. Special cable on request **£5.19.0**

For further details of all Sennheisers dynamic microphones contact your dealer or send C.W.O to

Audio Engineering Ltd

33 Endell Street London WC2 TEM 0033



ARE YOU A PRO — HAM — OR — DABBLER ?

NO MATTER WHICH — WE CAN HELP YOU !

LOOK — 100's of Bargain

LARGE RANGE — LOW PRICE
SILICON CONTROLLED RECTIFIERS.
SEND FOR FULL RANGE AND CIRCUIT DIAGRAMS.
FREE OF CHARGE

Packs to choose from

| No. | DESCRIPTION | PRICE |
|------|---|-------|
| A1. | 6—Silicon rectifiers BY100 type | 20/- |
| A2. | 10—Relays, mixed types and voltages.. | 20/- |
| A3. | 20—Mixed, marked and tested trans. | 20/- |
| A7. | 1—500 Mc/s epitaxial mesa. PNP 2N700 | 20/- |
| A8. | 6—Sub. min. zeners, 3.6-15V, 400mW | 20/- |
| A9. | 1—2N174 real power trans. 80V, 150W | 20/- |
| A12. | 1—High power, high volts, 2S024, 100V, 100W | 20/- |
| A13. | 25—Assorted trans. and diodes, all new | 20/- |
| A14. | 4—2N601 p/trans. germ. 30V, 10 Mc/s | 20/- |
| B1. | 50—Unmarked, untested, trans. new | 10/- |
| B2. | 4—Solar cells, inc. Book of ins. | 10/- |
| B3. | 4—OAS gold bonded diodes, Mullard | 10/- |
| B5. | 7—Matched set, OC44/45/81D/81 + diode | 10/- |
| B8. | 2—Power trans. OC26/35 type | 10/- |
| B9. | 1—Light sensitive cell, ORP12 type | 9/- |
| B11. | 2—Comp. air, AC128, AC176 | 10/- |
| B13. | 7—BA115 G.B. diodes T.V. video | 10/- |
| B15. | 8—Bi-directional trans., ASY66 | 10/- |
| B20. | 4—Assorted NPN trans., TO-5, TO-18 | 10/- |
| B32. | 4—1 amp. recs. 200/300PIV | 10/- |
| B33. | 10—Germ diodes, assorted types | 10/- |
| B34. | 8—Silicon diodes, assorted types | 10/- |
| B35. | 2—2 zener diodes 1.1W, 7 and 10 volts | 10/- |
| B36. | 10—Gold bonded, diodes, assorted | 10/- |
| B41. | 3—2G339A NPN audio, texas | 10/- |
| B42. | 5—TK22C germ. switching trans. | 10/- |
| B43. | 4—15100 sil. recs. 100 PIV, 1/2 amp | 10/- |
| B44. | 1—Tunnel diode AEY11, 1050 Mc/s, 5mA | 10/- |

FANTASTIC! BARGAINS OF THE YEAR!

| | | | |
|-----------------------------------|-------------|------------------------------|------------|
| OC45 IF TRANSISTOR | 1/9 | OAG EQUAL TO OAS | 2/- |
| OC44 OSCILLATOR TRANSISTOR | 1/11 | OC36 POWER TRANSISTOR | 7/6 |

GENUINE TRANS. NOT REMARKS (MUCH BETTER THAN OC35)

FREE PACKS OF YOUR OWN CHOICE UP TO THE VALUE OF 10/- WITH ALL ORDERS OVER £4

SEND FOR OUR **FREE** LISTS AND CATALOGUE OF ALL OUR PRODUCTS. CHECK YOUR OWN EQUIVALENTS WITH OUR FREE SUBSTITUTION CHART.

FREE A WRITTEN GUARANTEE WITH ALL OUR SEMICONDUCTORS

SCOOP PURCHASE!
Pre-assembled logic elements. 2 input gates 2/-, 3 input gates 2/9. Flip Flops and others 5/- each. Send for more details.

FIRST EVER LOGIC KITS. Learn for yourself how computers work, even make one for yourself. Full instructions for a noughts and crosses machine, binary counters, timers, etc. L.1. 5 gns. L.2. 10 gns. No need to purchase both kits, you can start with L.2. which incorporates L.1. **DETAILS FREE.**

MAKE A REV. COUNTER FOR YOUR CAR. THE 'TACHO BLOCK'. This encapsulated block will turn any Ohm-A meter into a perfectly linear and accurate rev. counter for any car. State 4 or 6 cylinder. **20/- each**

NO CONNECTION WITH ANY OTHER FIRM. MINIMUM ORDER 10/- CASH WITH ORDER PLEASE. Add 1/- post and packing per order, OVERSEAS ADD EXTRA FOR AIRMAIL.

| No. | DESCRIPTION | PRICE |
|------|---|-------|
| C1. | 15—50 volt. trans., germ. switching | 15/- |
| C2. | 1—Uni. junction, 2N160 or equiv. | 15/- |
| C3. | 5—Audio kit, NKT278/275/271/773 + diode | 15/- |
| C4. | 2—RF. power trans., OC22 and BUY11 | 15/- |
| C5. | 2—Sil. power recs. 200PIV, 6 amp | 15/- |
| C6. | 5—Sil. recs., 1/2 amp, 100/200PIV | 15/- |
| C9. | 2—100/60V, sil. trans., 200 Mc/s, ZT8486 | 15/- |
| C14. | 2—3 watt planar, 2N1613, 2N1893 | 15/- |
| C15. | 4—Sil. trans., in the 25300 series | 15/- |
| C16. | 1—Sil. power 85 watts, 25721 series | 15/- |
| C17. | 2—60v. 160 Mc/s TO-18, 25103/4 | 15/- |
| C18. | 1—2N1132 sil. planar, pnp trans. | 15/- |
| C20. | 3—Germ. NPN trans., 2N1302/4/8 | 15/- |
| C21. | 3—Germ. pnp trans., 2N1303/5/7/9 | 15/- |
| C22. | 1—300 Mc/s trans. ASZ21, Mullard | 15/- |
| C23. | 1—35 amp sil. rec., 100PIV, stud | 15/- |
| C25. | 2—Power trans., germ., OC28/29 type | 15/- |
| C27. | 4—800PIV, 500mA, sil. recs., STC | 15/- |
| C28. | 5—Sil. recs., 400PIV, 1/2 amp | 15/- |
| C29. | 1—200 Mc/s narrow trans., AFZ12 | 15/- |
| C30. | 2—Sil. trans., narrow gain spread BCZ11 | 15/- |
| C31. | 4—Sil. recs. 800 PIV, 1/2 amp | 15/- |
| D1. | 25—1W hi-stab. resistors mixed | 5/- |
| D3. | 3—Germ. diodes, OA70, OA79, OA81 | 5/- |
| D4. | 2—Sil. recs., Sub. min., 400/600PIV 400mA | 5/- |
| D7. | 2—Zener diodes, 5-1V, 250mW | 5/- |
| D9. | 10—Assorted capacitors, all types | 5/- |
| D10. | 20—Transistor heat sinks | 5/- |
| D14. | 3—Low imp. earphones, less plugs | 5/- |
| E1. | 2—2N458 matched power trans., 150V, 80W | 30/- |

| TRANSISTORS | PRICE | TRANSISTORS | PRICE |
|-------------|-------|--------------------------|-------|
| AC107 | 6/- | OC170 | 2/6 |
| AC126 | 2/6 | OC171 | 4/- |
| AC127 | 2/6 | OC200 | 5/- |
| AC128 | 3/- | OC201 | 8/- |
| ACY17 | 5/- | 2G301 | 2/6 |
| AF114 | 4/- | 2G303 | 2/6 |
| AF115 | 3/- | 2N697 | 5/- |
| AF116 | 3/- | 2N706 | 5/- |
| AF117 | 4/- | 2N711 | 10/- |
| AF118 | 3/6 | 2N1302 | 4/- |
| AF119 | 3/6 | 2N1303 | 4/- |
| AF178 | 10/- | 2N1304 | 5/- |
| ASY66 | 2/- | 2N1305 | 5/- |
| BCZ11 | 5/- | 2N1306 | 6/- |
| BFY50 | 15/- | 2N1307 | 6/- |
| BSY25 | 10/- | 2N1308 | 8/- |
| BSY26 | 10/- | 2N1309 | 7/6 |
| BSY27 | 5/- | 25303 | 2/6 |
| BSY28 | 5/- | POWER TRANSISTORS | |
| BSY29 | 5/- | OC20 | 10/- |
| BSY29A | 5/- | OC23 | 10/- |
| OC41 | 2/6 | OC25 | 8/- |
| OC71 | 2/6 | OC26 | 5/- |
| OC72 | 2/6 | OC28 | 5/- |
| OC73 | 5/- | OC35 | 5/- |
| OC81 | 2/6 | DIODES | |
| OC83 | 4/- | AA Y42 | 2/- |
| OC139 | 2/6 | OA Y40 | 2/- |
| OC140 | 5/- | OA70 | 1/9 |
| | | OA79 | 1/9 |
| | | OA81 | 1/9 |
| | | OA182 | 2/- |
| | | IN914 | 1/6 |

EXCITING NEW PACKS !

| | | | | | |
|------|--|------|------|--|------|
| B45. | 1—Power trans. ADY22/TK400A VCB60 IC B amps. PNP | 10/- | B52. | 30—Trans. all new, factory tested but unmarked | 10/- |
| B47. | 10—Sil. stud recs. 3 amps. unmarked, untested | 10/- | C31. | 4—Sil. recs. 800 PIV 1/2 amp. top hat | 15/- |
| B49. | 2—Power trans. GET 9 VCB64 IC B amps. germ. PNP | 10/- | C32. | 2—Power trans. TK400A/NKT404 VCB64 IC B amps. | 15/- |
| B50. | 2—Light sensitive cells ORP60 type | 10/- | A17. | 3—Sil. stud recs. 6 amps. 400 PIV. BYZ12 | 20/- |
| | | | A18. | 2—Sil. stud recs. 10 amp. 800 PIV. | 20/- |
| | | | A20. | 1—AU Y10 VHF power trans. 60 Mc/s 70V | 20/- |



DISTRIBUTED EXCLUSIVELY BY **DAVIS & WHITWORTH LTD., DEPT. A**
222-224 WEST ROAD, WESTCLIFF-ON-SEA, ESSEX
PHONE: SOUTHEND (0502) 46344

SUPPLIERS TO SCHOOLS—H.M. GOVT. INSTITUTES AND FACTORS

detached particles

JOHN VALENCE

SPURIOUS EMISSIONS

Is Mephistopheles now a more befitting symbolic figure for the General Post Office than the traditional Mercury? One gets the impression that horns must have now indeed supplanted the wings of the messenger of the gods, judging by the sinister motives frequently attributed to the Postmaster-General by hostile critics.

I am not alluding to pirate stations especially, although we know the P.M.G. does not rate particularly high in their pop charts. As a matter of fact these buccaners of the air waves don't actually excite any great sympathy from me—not that this will cause them the slightest despondency as they study their healthy bank balances. That's just by the way.

The latest attack on the P.M.G. comes from a quite different and unexpected quarter. The Radio Society of Great Britain has always been unequivocal in its stand for the rights of the officially licensed amateur. In jealously guarding the "ham", the Society has made it its business to give publicity to the apprehension of unlicensed amateurs found transmitting.

Now due to the large scale import of walkie-talkies, the problem of interference arising from unauthorised users is very serious. Model control enthusiasts will agree on this without a doubt. Very late in the day, if I may venture an opinion, the P.M.G. has formulated a number of new regulations. These are to be incorporated in the Wireless Telegraphy Act 1949, which gives the Government power to control all forms of communication using electromagnetic waves.

The particular clause which has excited the attention of the ham fraternity appears pretty innocuous, to me at any rate. Under clause seven, the P.M.G. can forbid the manufacture or the importation of any apparatus that has been specified as likely to cause interference with wireless telegraphy. Critics claim that this is too ambiguous, and could

provide a *carte blanche* for any future head of the Post Office to close down all ham activities if he so desired. In my view, this is a preposterous attitude to take; there are plenty of safeguards in a democracy. To read anything so sinister into the new regulations is being rather melodramatic.

Seems to me the RSGB must make up its mind; it can't run with the hare and hunt with the hounds.

The chaps who are really going to have a right old moan over this are the hundreds of users (and would-be users) of walkie-talkies. Poor deluded folk, they supposed that if a piece of equipment was openly offered for sale they would be perfectly entitled to buy it and use it for the purpose it was intended. Oh no, not at all! They have been illegitimate all along. Now under the new regulations, the makers and vendors of such equipment will likewise find themselves beyond the pale.

Finally for the sake of young innocents, let me explode a myth: there is no Citizens' Band in the U.K. For a law abiding citizen, there is only one way out—swot up and take the Radio Amateurs' Examination.

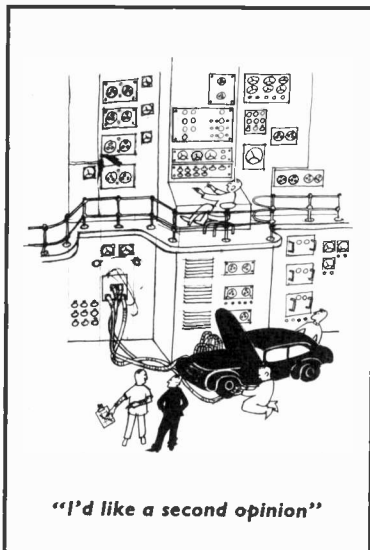

CHECK ON CAR QUACKS

Electronic diagnostic checks for cars seem to be catching on. One of the large petrol firms is planning drive-in test sites using such equipment in various parts of the country. The attraction of this method is that it is not necessary to strip down the engine to trace its faults. Attach a few probes and the condition of the engine is rapidly revealed by instruments in the diagnostic equipment. The trouble is discovered in minutes instead of hours, as with the conventional method.

An additional function for this equipment, I suggest, would be a *post-overhaul* check of the car—and witnessed by the owner prior to acceptance of the repaired vehicle.

Practically without exception, all my motoring friends and acquaintances have tales of woe to recount concerning their experiences with garage service departments. Unless one is reasonably knowledgeable on automobile engineering—and furthermore is prepared to take the trouble of making the appropriate detailed examinations—much must be taken on trust. Unfortunately, there is much evidence that confidence reposed in car service establishments is often misplaced. And that's no joke where a potentially lethal machine is concerned.

Perhaps the arrival of the electronic diagnostic equipment will mark a considerable step forward in maintaining car performance and safety. If also used as I have suggested, the equipment could reveal any slipshod workmanship. The motorist would then be able to administer the remedy for this couldn't-care-less type of disease by avoiding such offenders like the plague in future.

Garage proprietors may look askance at this idea of a final check in full view of the car owner. The reputable ones should welcome this electronic confirmation of the high standard of their work. Only the inefficient and unreliable will fight shy of submitting their work to the analytical mind of the electronic examiner.

Readout —

A SELECTION FROM OUR POSTBAG

Music box ?

Sir—As a regular reader of your magazine I wish to compliment you on the consistent quality of your articles. They are always a pleasure to read and I constantly look forward to receiving next month's issue.

However, writing to you is in fact occasioned by a disappointment. In the April 1967 issue you announced the May article on how to make a bass guitar and I expected to find a fully electronic design. Instead I am now faced with an instruction that deals with quite a bit of carpentry, so I wish to ask you: is this really necessary? Wouldn't it be more reasonable to find—in an electronics magazine—a design based on a monophonic bass organ circuit?

I have often wondered why people go through all this trouble to learn to play a bass these days when the same sounds can be created through, for instance, a multivibrator with some sort of filter hooked up behind it. It is much easier to finger some keys than to find one's own way up and down the fingerboard in great speed.

In other words, don't you think that there would be a market for a bass in a small box with, say, 20 keys to cover one-and-a-half octaves? I fully realise; that the bassist would be less spectacular to watch than the present musician, but in the long run don't you think that people will tend to produce the tones the easy way?

Anyhow, if you could come up with a suitable design, at least I would be most grateful.

C. Hagen,
Glostrup,
Denmark.

As a "gimmick" this idea could be quite interesting, but as a serious competitor to the normal electronic guitar I think it would fail for the following reasons:

- (1) An electronic guitar is polyphonic, therefore this "instrument" must also be polyphonic. And this involves complexity, plus cost and size.
- (2) When one string of a guitar is plucked, the listener hears the

fundamental, required notes; harmonics above and below the fundamental which may or may not be a pure octave; "thirds" and "fifths" harmonically related to the fundamental. It is this complexity of notes which give "richness" to the tone of a guitar (and the better the guitar can produce these incidentals, the more valuable and desirable it becomes).

- (3) A transistorised, polyphonic "instrument" will contain not less than 13 separate oscillators, with dividers and multipliers to obtain the range above and below the fundamental frequency of any one oscillator, in order to simulate the range of the guitar. This division/multiplication process will produce harmonics at octave intervals but, unless the transistors are made to produce an impure fundamental, thirds and fifths will be absent. This is the first basic failure to simulate the guitar; you either have a clear, fundamental note with octave harmonics or you have a rough fundamental which may produce undesirable interaction between harmonics and the overall effect then becomes "distortion".

- (4) The electronic guitar (or "acoustic" guitar, there is no difference in the following respect) has a very sharp "attack" (i.e. the "rise time" between striking the string and the production of full amplitude by the string is very short) but it rises in volume from nothing to a maximum, i.e. it "develops" during rise time.

A transistor oscillator has a rise time dependent upon components used: it could be made very short, but if short it does not develop; it is all or nothing in a split second.

Again considering the guitar; having struck the string and maximum amplitude has been developed, its "decay", or die-away ensues. In the transistor instruments there is no decay, again it is "all or nothing".

In short, the guitar produces a rounded tone, with a definite maximum amplitude point; the transistor produces a "piping" tone (or in electronic terms, something approaching a square-wave whose vertical sides are very steep and whose "roof" is flat).

- (5) Considering showmanship: the guitar is itself invaluable to the artiste; he would be at a loss if asked to play a box (or any other shape) fitted with buttons or keys. (So also would the pop group audience if asked to regard this "box" as a "guitar".)—S. Simpson

Amateur Radio Club of Nottingham

Sir—The above club are forming (within the club) an electronics group, and if any of your readers would like to join this section they are welcome to come along to one of our meetings or contact the undersigned for further details of our activities.

The group is open to all who are interested in the field of electronics and meetings are held at Woodthorpe House, Mansfield Road, Nottingham, on the fourth Tuesday in every month. We hope to have demonstrations, talks, contests, etc.; also, if sufficient interest is shown, we have been promised workshop facilities.

Norman E. Down, G3SRX,
Hon. Sec.,
23 Lady Bay Road,
West Bridgford,
Nottingham.

A retailer replies

Sir—One can sympathise with your correspondents H. M. Sherry (March issue) and C. G. Thorne (May issue) since retailers as well as readers have difficulty in ensuring rapid deliveries and response to their inquiries. There is, of course, no excuse for indifference or lack of courtesy and I can only suggest that your readers build up from experience a knowledge of those firms to avoid. There are, however, several good retailers who do not mete out such treatment.

The problem of prices is difficult, and your comment in the March issue (see Readout, Post-haste, please) goes most of the way in explaining the position. No doubt some firms expect excessive profits and these are to be avoided. However, it is generally true that the customer gets what he pays for, and whilst many components are nominally the same not all are of the same quality. First line guaranteed components are bound to cost more. The reader must judge for himself the likely value and quality of components and kits sold for a suspiciously low figure. Where is the economy in buying an inferior kit for a low price if the life of the assembled circuit is short?

G. H. Olsen,
Neslo Electronics,
Newcastle upon Tyne, 2.