

# Practical Electronics

OCTOBER 1965

PRICE 2'6

**FREE INSIDE**



FULL-SIZE  
**BLUEPRINTS**  
AND  
**DATA CHARTS**

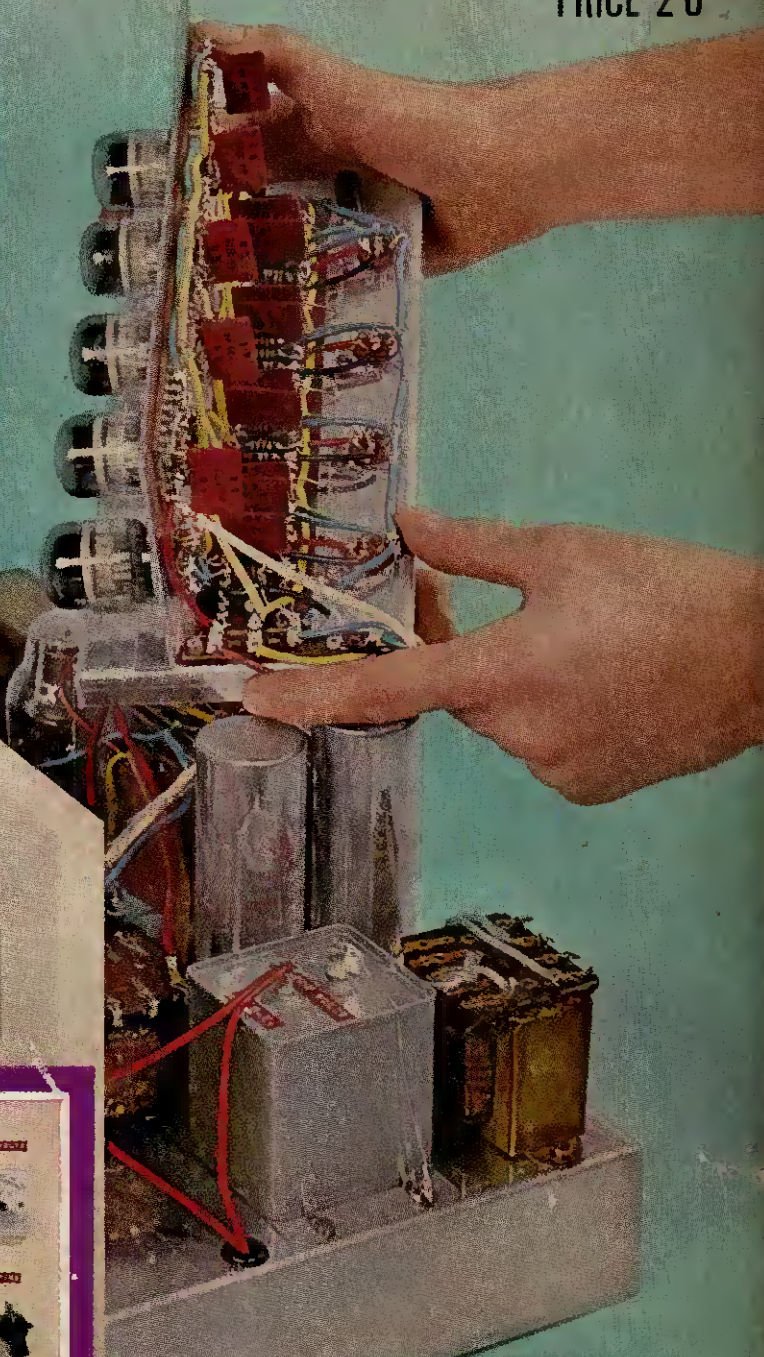
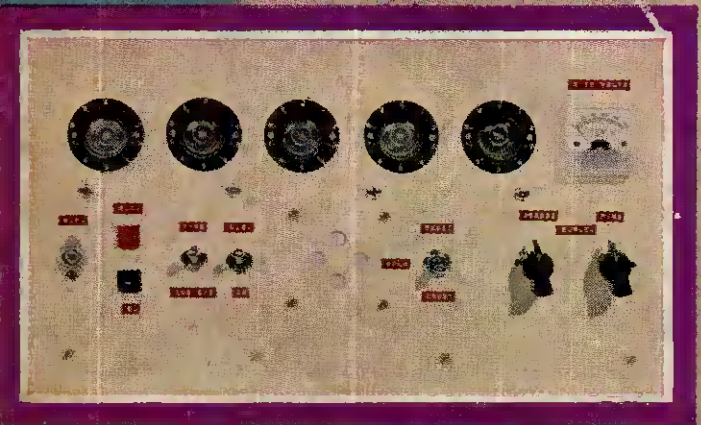

A GENERAL PURPOSE  
**COUNTER OR SCALER**





## ONE TO BUILD YOURSELF FROM THE WHARFEDALE RANGE

Build a loudspeaker system in a concrete pipe and obtain good results. Impossible? If it were, Wharfedale would not recommend it. The fact is that experimental results of this type of enclosure were so successful that Wharfedale have produced an inexpensive kit especially for the Do-it-Yourself enthusiast. The kits come in two sizes—for 8" or 10" speakers and cost £5.0.0 and £6.5.0. In addition you will need a spun concrete pipe which costs about 12/6 from good builders' merchants. The concrete column can be decorated with a variety of finishes—paint, wallpaper, fabric etc. The top is fitted with a loose weave acoustic material.

\* Principle of construction of system in concrete column

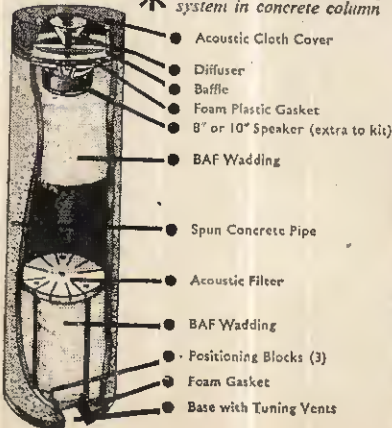

### RECOMMENDED UNITS FOR THE WHARFEDALE CONCRETE COLUMN ARE

#### SUPER 8/RS/DD

A highly efficient full range speaker with the latest type of ceramic ring magnet. Roll surround gives smooth low frequency response down to 40 c/s. Power handling capacity 6 watts. Impedance 15 ohms.

£7.0.0. (Tax Paid)

#### SUPER 10/RS/DD

A 10" speaker with double diaphragm, roll surround and powerful magnet. This unit gives frequency response down to 30 c/s. Power handling capacity 10 watts. Impedance 15 ohms. £11.13.3. (Tax Paid)

WHARFEDALE WIRELESS WORKS LTD. IDLE BRADFORD YORKS.



WHARFEDALE TOWN

POST THIS COUPON TODAY\*

for fully illustrated simple to follow construction folder

NAME  Dept. 17

ADDRESS

TOWN  COUNTY

# Sinclair's greatest to

TELESCOPIC  
AERIAL

TUNES FROM  
88-108 Mc/s

ONE OUTPUT  
FOR HI-FI  
AND TAPE

ONE OUTPUT  
FOR PERSONAL  
LISTENING

SPUN ALUMINIUM  
DIAL

POLISHED AND  
BRUSHED  
ALUMINIUM  
ESCUTCHEON

BLACK CASE

SELF-CONTAINED  
BATTERY

A.F.C. FOR  
EASY TUNING

UNIQUE  
CIRCUITRY

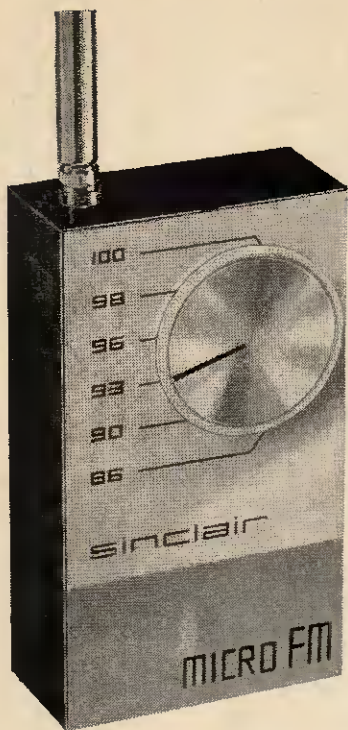

★ **MEASURES ONLY**  
 $2\frac{15}{16}$ " x  $1\frac{11}{16}$ " x  $\frac{3}{4}$ "  
PLUS DETACHABLE AERIAL



**ANYONE  
CAN  
BUILD IT**

All you want is a small soldering iron (preferably with  $\frac{3}{8}$ " bit), tweezers and something to cut wire, such as nail clippers. The instructions take you step by step through every stage, and are very easy to follow.

## The world's ve pocket-size

# F.M. TUNER

100% BRITISH  
DESIGN

# SINCLAIR

7 TRANSISTORS • 2 D

Sinclair's latest design, the SINCLAIR MICRO FM is a high quality FM tuner designed to be used with hi-fi amplifier or tape recorder. It can also be used independently as a self-contained pocket F.M. receiver for personal listening anywhere. This exciting Sinclair triumph, barely half the size of a packet of 20 cigarettes, is a fully fledged 7 transistor, 2 diode superhet circuit incorporating many unique and original design features to achieve fantastically good standards of performance. Pulse counting detection ensures better linearity than conventional detection methods, and therefore better audio quality. Powerful A.F.C. which locks on to the station tuned in, together with unusually good sensitivity make tuning easy and the set's own telescopic aerial suffices almost everywhere. Separate output stages are provided for feeding to an amplifier or tape-recorder and to the earpiece included with the Micro FM. It is this arrangement which allows the unit to be used both as a tuner and as a self-contained receiver. In styling, this is the most elegant, most professional looking design in miniaturised equipment ever made available to constructors, and is one you will be very proud to possess. YET WITH ALL THESE WONDERFUL FEATURES, THE SINCLAIR MICRO F.M. COSTS POUNDS LESS AND MEANS THAT ANYONE CAN AFFORD AND ENJOY THE ADVANTAGES OF F.M. RADIO TO-DAY.

**FULL SERVICE FACILITIES ALWAYS  
AVAILABLE TO ALL SINCLAIR CUSTOMERS**

**Order form on pages following**

# sinclair

**SINCLAIR RADIONICS LTD., COMBERTON, CAMBRIDGE**

Telephone: COMBERTON 68

# triumph yet!

## first

# RECEIVER R MICRO FM

ES • NO ALIGNMENT PROBLEMS • A.F.C.

### TECHNICAL DESCRIPTION

**THE SINCLAIR MICRO FM** is a seven transistor, two diode F.M. superhet designed to be used both as a tuner for feeding to an amplifier or tape recorder and as a self-contained pocket portable receiver. The telescopic aerial, which screws into the top of the case, is coupled to an R.F. amplifier followed by a self oscillating mixer. Use of a low I.F. dispenses with the need for bulky I.F. transformers and removes the need for alignment. A three stage I.F. amplifier amplifies and limits the signal to produce a square wave of constant voltage which is fed into the pulse counting discriminator. This converts the square wave formation into uniform pulses, the average output from which is directly proportional to the signal frequency, so that the original modulation is reproduced exactly. After equalisation for pre-emphasis, the signal is fed to the audio output socket for use with an amplifier or recorder and also to the receiver's own audio amplifying stage which enables the Micro FM to be used as an independent self-contained receiver. The inclusion of A.F.C. makes tuning simple as each station tuned in is automatically "locked" as the dial is turned. THE SINCLAIR MICRO FM is completely

self-contained within a neat black plastic case faced by an elegantly designed front panel of brushed and polished solid aluminium with spun aluminium tuning dial to match. The tuning scale is marked in Mc/s.

- SUPPLY VOLTAGE—9V from self-contained standard battery.
- CONSUMPTION—5mA
- SENSITIVITY—Typically 3 microvolts
- AUDIO OUTPUT—300mV approx. from 25K ohms
- HIGH LEVEL AUDIO OUTPUT—9V peak to peak
- TUNING RANGE—87.5 to 108 Mc/s
- SIGNAL TO NOISE RATIO—30dB at 30 microvolts
- AUDIO FREQUENCY RESPONSE—10 to 20,000 c/s  $\pm$  1dB

THE COMPLETE KIT OF PARTS for building the SINCLAIR MICRO FM including extending aerial, 7 transistors, case, tuning dial, aluminium front panel, lightweight earpiece, plugs and sockets and instructions costs only

# £5.19.6

### BUILDING AND USING THE SINCLAIR MICRO FM

This remarkable FM design, the most ambitious yet in the Sinclair programme, is simple to build with the precisely detailed instructions supplied, even if you have had no previous experience in building miniaturised transistor equipment. By eliminating the need for aligning the set when built, Sinclair have overcome the main obstacle to building your own FM set. When finished, you will find that the Sinclair Micro FM performs as well as any other good FM tuner and except in occasional poor reception areas, in which no set will function efficiently, this newest Sinclair design can be depended on to give satisfaction anywhere.

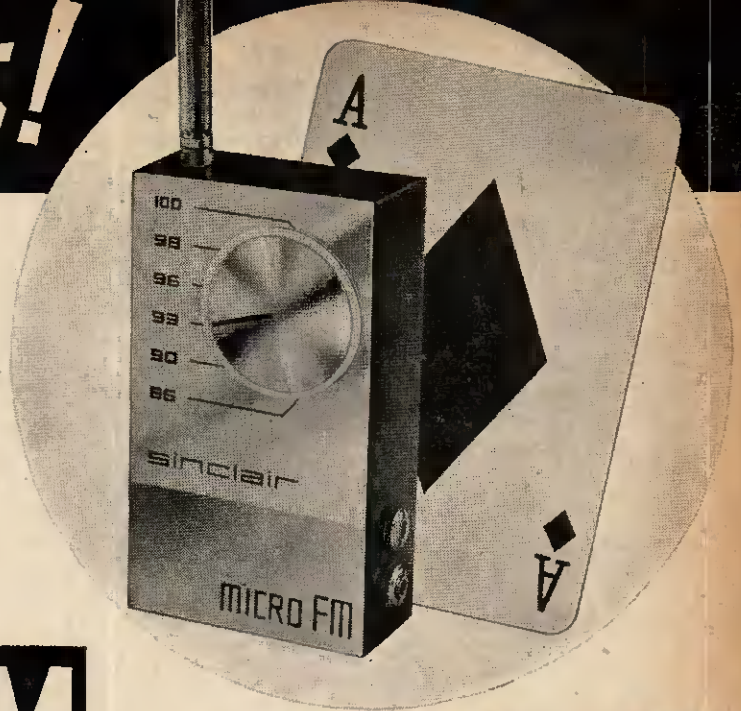

### Use it as —

AN F.M. TUNER FOR YOUR TAPE RECORDER

*Money Saving!*

AS A TUNER FOR YOUR HI-FI (Space Saving!)

AS A SELF-CONTAINED POCKET F.M RECEIVER.

*(The only one in the World!)*



ORDER FORM AND MORE EXCITING SINCLAIR DESIGNS ON PAGES FOLLOWING

# MORE UNIQUE DESIGNS FROM

## SINCLAIR X-20

20 WATT P.W.M. AMPLIFIER  
WITH INTEGRATED PRE-AMPLIFIER

*The most amazing advance in audio amplifiers in years.*

*Gives you*  
**20 watts R.M.S. OUTPUT**

By the use of Pulse Width Modulation in circuitry developed exclusively by Sinclair Radionics, the unique X-20 achieves standards never before reached by any audio amplifier in the world. From the input of the integrated pre-amp through to the power output stage, this amazing amplifier gives quality and power far ahead of anything in its class to make it the most original and interesting design in years. You use your X-20 like any conventional quality amplifier, for mono or paired for stereo, but it occupies far less space, costs less, behaves perfectly and brings a refreshingly new approach to audio that is setting the standard for the whole industry.

**ONLY THE SINCLAIR X-20 HAS THESE UNIQUE FEATURES**

- ★ No. of transistors—12
- ★ Silicon epitaxial planar output transistors providing 95% energy conversion
- ★ Response—20 to 20,000 c/s  $\pm$  1dB
- ★ Total harmonic distortion at 10 watts R.M.S.—0.1%
- ★ Input sensitivity—1 mV into 5-K ohms
- ★ Signal-to-noise ratio—better than 70dB
- ★ 20 WATTS R.M.S. MUSIC POWER OR 15 WATTS R.M.S. CONTINUOUS INTO 7.5 OHMS
- ★ 15 WATTS R.M.S. MUSIC POWER OR 12 WATTS R.M.S. CONTINUOUS INTO 15 OHMS
- ★ Ideal for guitar or other forms of P.A.
- ★ Widely tolerant of the load at the output
- ★ Power required—36 V dc at 700 mA

**QUALITY AND POWER FOR SUCH VERY VERY SMALL OUTLAY**

Complete kit of parts including transistors and X-20 manual in sealed carton **£7.19.6**

Built and tested with X-20 manual in sealed carton **£9-19-6** X-20 Power Pack sufficient to drive two X-20's **£4-19-6**

**THE X-20 MANUAL** gives full details of tone and volume control systems for adding to your X-20. Includes circuits for STEREO, INPUT SWITCHING, STEREO BALANCE, etc. **FREE WITH EVERY X-20.** Available separately—2/- post free.

FULL SERVICE FACILITIES AVAILABLE TO ALL SINCLAIR CUSTOMERS

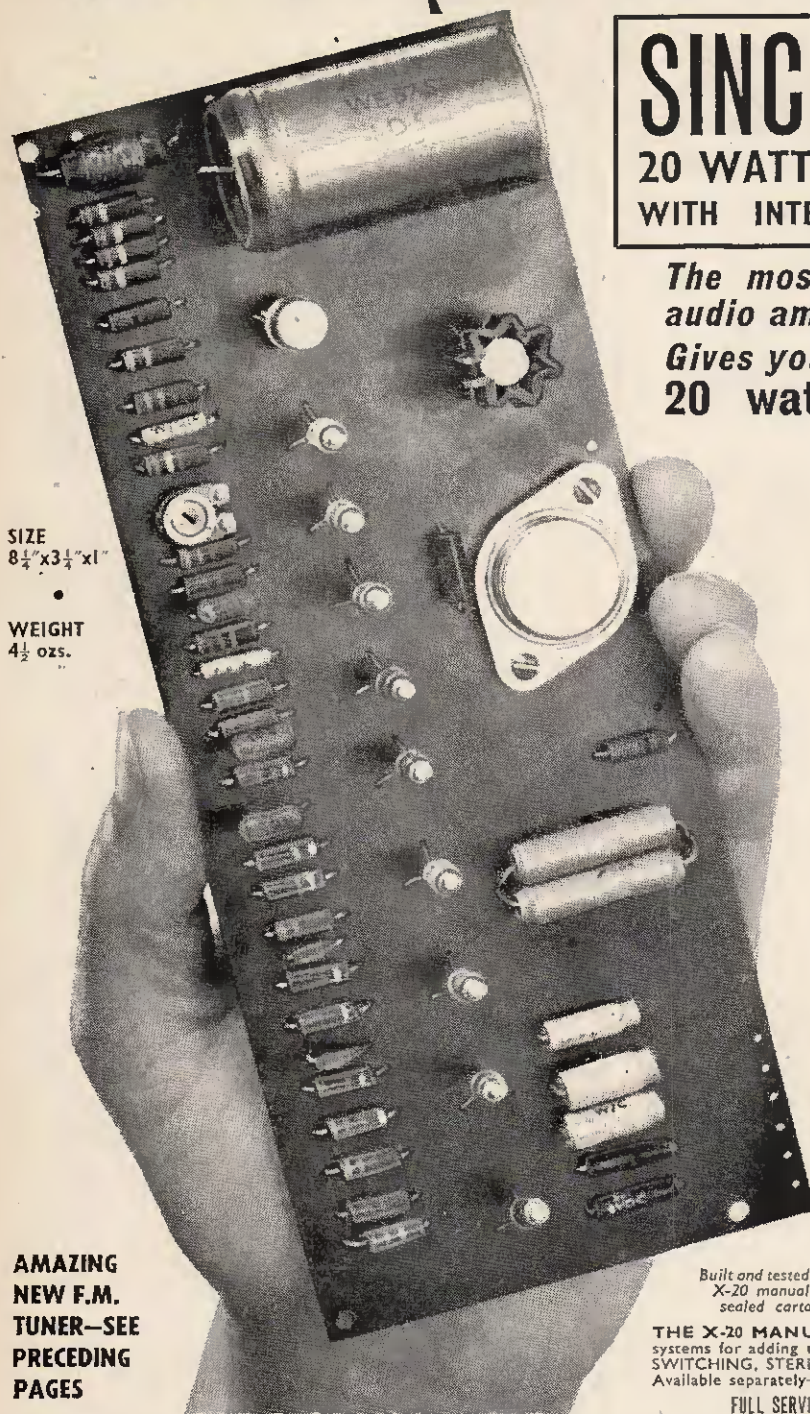

SIZE  
8½"x3¼"x1"

WEIGHT  
4½ ozs.

**AMAZING  
NEW F.M.  
TUNER—SEE  
PRECEDING  
PAGES**

**sinclair**

**SINCLAIR RADIONICS LTD.**  
COMBERTON, CAMBRIDGE

Telephone: COMBERTON 682

# SINCLAIR

SINCLAIR

# MICRO-6

**The smallest radio receiver in the world**

- **SIZE**— $1\frac{1}{8}'' \times 1\frac{3}{16}'' \times \frac{1}{2}''$
- **WEIGHT**—Under 1 oz.
- **FANTASTIC RANGE AND POWER**
- **PLAYS ANYWHERE**
- **BANDSPREAD FOR EASY LUXEMBOURG RECEPTION**

**Build it in an evening!**

No transistor set has ever yet compared with the Micro-6 for size, power, performance and design. Thousands upon thousands have been built by enthusiasts from electronic engineers to beginners in transistor construction and are now in use throughout the world. Everything except the lightweight earpiece is contained within the smart minute white gold and black case. With batteries and self-contained aerial, the Micro-6 weighs under one ounce! Unique features which make such wonderful performance possible include bandspread over the higher frequency end of the medium waveband for easy reception of Luxembourg, powerful A.G.C. to counteract fading of distant stations, and vernier type tuning. Quality of reproduction is outstandingly good, so that you derive real pleasure from using this fantastic set. Order your Micro-6 now and prove for yourself why it cannot be too highly recommended as an intriguing design to build and a most practical radio to use. You can build it in an evening and when you have built your first, be certain others are going to want one too, when they see and hear the Micro-6.



**ACTUAL SIZE**

## ■ AMAZING CIRCUITRY

In the Micro-6, a six stage circuit using 3 special Micro-alloy transistors (Sinclair M.A.T.s) provides two stages of R.F. amplification, double diode detector and high gain 3-stage A.F. amplifier plus A.G.C. and bandspread over the higher frequency end of the tuning to bring in Luxembourg like a local station. Inserting the plug of the earpiece switches the Micro-6 ON; withdrawing switches it OFF. Tuning is by vernier-type dial over the medium wave band. Two self-contained batteries give about 70 hours working life.

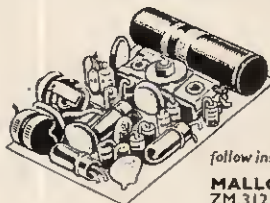

All parts including M.A.T.s, case, dial, lightweight earpiece and beautifully detailed easy-to-follow instructions come to

# 59/6

**MALLORY MERCURY CELL** Type ZM.312 (2 required) each 1/11.  
Pack of 6 10/6

## SINCLAIR X-10 P.W.M. AMPLIFIER AND PRE-AMP

Recommended for use where a less powerful amplifier than the X-20 is required. The X-10 offers similar advantages of quality, compactness and price, and it can be battery operated if desired. Tone control system added to choice. For 12-15 volt operation. **FREE X-10 Manual** with every amplifier.

- Complete kit and instructions **£5.19.6**
- Ready built and tested **£6.19.6**
- X-10 power supply unit **£2.14.0**

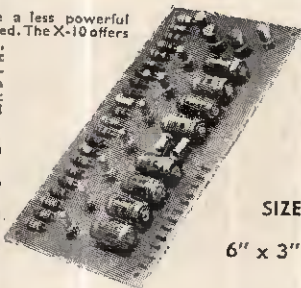

SIZE **SINCLAIR TR750**  
6" x 3"

"Very efficient indeed" says C. G. of Upvon, Wilts, who is a professional musician.

## A POWERFUL AMPLIFIER FOR YOUR MICRO-6

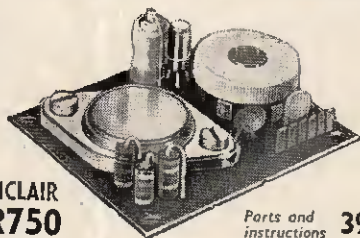

SIZE 2" x 1"

This highly original Sinclair amplifier makes a powerful car, portable or domestic loudspeaker radio used with the Micro-6. Can also be used for record reproduction, baby alarm, intercom, etc. 750 milliwatts output for feeding into a standard 25-30Ω speaker. Input, 10mV. Response, 30-20,000 c/s ± 1dB. With built-in switch and volume control. For 9V d.c. operation.

Parts and instructions **39/6** Ready built and tested **45/-**

**FULL SERVICE FACILITIES AVAILABLE TO ALL SINCLAIR CUSTOMERS**

## GUARANTEE ORDER FORM

NAME.....

Please send me

ADDRESS.....

For which I enclose Cash/Cheque/Money Order value

£.....s.....d.

## Guarantee

Should you not be completely satisfied with your purchase when you receive it from us, your money will be refunded in full and at once without question. It is important to quote Pr.E10 should you prefer to write your order instead of cutting out this coupon.

# LASKY'S RADIO

## For the Finest Value and Service to THE ELECTRONICS ENTHUSIAST

We consider our construction parcels to be the finest value on the home constructor market. If on receipt you feel not competent to build the set, you may return it as received within 7 days when the sum paid will be refunded less postage.

### TRANSISTOR PORTABLES

#### THE SKYROVER RANGE

7 transistor and 2 diode superhet portables—covering full med. plus 6 SW Bands.

#### The SKYROVER Mk III.

(Illustrated). Now supplied with redesigned plastic cabinet in black, grey and chrome with edgewise controls.

Controls: Waveband Selector, Volume Control with on/off Switch, Tuning Control. In plastic cabinet, size 11 x 6 1/2 x 3 1/2 in. with metal trim and carrying handle.

Can now be built for **£8.19.6** Post H.P. Terms: 27/- deposit and 11 monthly payments of 15/9. Total H.P.P. £10.0s.3d.

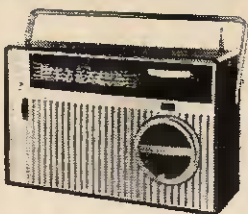

#### The SKYROVER De Luxe

Same Circuit as incorporated, with separate Tone Control in addition to Volume Control, Tuning Control and Waveband Selector. In a wood cabinet, size 11 1/2 x 6 1/2 in. covered with a washable material, with plastic trim and carrying handle. Also car aerial socket fitted.

Can now be built for **£10.19.6** Post H.P. Terms: 33/- deposit and 11 monthly payments of 19/2. Total H.P.P. £12.3s.10d. Data for each receiver: 2/8 extra. Refunded if you purchase the parcel. Four U2 batteries 3/4 extra. All components available separately.

#### ★ LONG WAVEBAND COVERAGE IS NOW AVAILABLE FOR THE SKYROVER

A simple additional circuit provides coverage of the 1100/1500 M. band (including 1500 M. Light programme). This is in addition to all existing Medium and Short wavebands. All necessary components with construction data.

Only **10/-** extra Post Free. This conversion is suitable for both receivers that have already been constructed. Refunded if you purchase the parcel. Four U2 batteries 3/4 extra. All components available separately.

#### THE "HARROW" POWER PACK

Battery eliminator for portable radios, etc. Converts your battery radio to A.C. mains. Replaces 4 1/2 v., 5 v. and 9 v. batts. Size only 3in. x 2 1/2 in. x 2 1/2 in. State voltage required when ordering.

LASKY'S PRICE 29/6 Post 2/-

### SPECIAL INTEREST ITEMS!

#### TEST METER ADAPTOR

Type P.E. 220—this is a fully transistorised device which enables any 50 microamp D.C. Multimeter to be used in place of a valve volt meter. On the IV range an impedance of 1 megohm is offered which increases on the 1000 V. range to 100 megohms. 7 ranges; 1 to 1000 volts. Designed for immediate connection to Avo 8 and similar size meters but quite suitable for use with any other 50 microamp meter. Size 6 x 8 x 5 in. New and boxed. List Price 7/6s.

LASKY'S PRICE 39/6

Post 2/6. Set of batteries 7/5 extra.

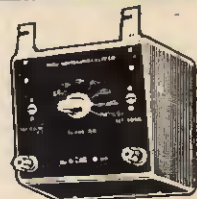

#### VEROBOARD — NOW IN STOCK

A really remarkable time saver in setting out complicated experimental circuits. Veroboard is a high grade laminated board with copper strips bonded to it and pierced with a regular matrix of holes. Ideal for producing single items.

As featured in "Practical Electronics" April '65 issue.

<b>Boards</b>		<b>Accessories</b>	
42/1363	2 1/2 x 5 in.	Terminal pins — pkt. of 50	3/-
43/1364	2 1/2 x 3 1/2 in.	Spot face cutter tool	8/6
45/1367	3 1/2 x 5 in.	Pin inserting tool	9/6
46/1368	3 1/2 x 3 1/2 in.	Post 6d. per item extra.	
44/1365	3 1/2 x 1 1/2 in.	Orders of 10/- and over post free.	

#### TRANSISTORS

ALL BRAND NEW AND GUARANTEED

GET S1, GET S3, GET S5 2/6; 873A, 874F 3/6; OC43, OC71, OC81D 4/6; OC 44, OC 70, OC 76, OC 81 5/6; (match pair 10/6); AF 117, OC 75, OC 200 6/6; OC 42, OC 43, OC 74, OC 82D 7/6; OC 201, OC 204 15/-; OC 205, OC 205 19/6; OC 25 24/6.

#### TRANSFILTERS

By BRUSH CRYSTAL CO. Available from stock.

TO—01B 465 kc/s. ± 2 kc/s.	TO—02D 470 kc/s. ± 1 kc/s.	<b>7/6 EACH</b>
TO—01D 470 kc/s. ± 2 kc/s.	TE—01B 465 kc/s. ± 2 kc/s.	<b>P. &amp; P. 6d.</b>
TO—02H 465 kc/s. ± 1 kc/s.	TE—01D 470 kc/s. ± 2 kc/s.	

207 EDGWARE ROAD, LONDON, W.2.

33 & 42 TOTTENHAM COURT ROAD, W.1.

152/3 FLEET STREET, LONDON, E.C.4.

Near Praed St. PADDINGTON 3271/2

Nearest Stn., Goudge St. MUSEUM 2605

Telephone: FLEET Street 2833

Open All Day Sat. Fri. Closing Thurs. (42 Toll. Ct. Rd. Fri. Close Sat.) Mail Orders to Dept. P.E., 207 Edgware Rd., W.2

OPEN ALL DAY THURSDAY. Early Closing Sat.

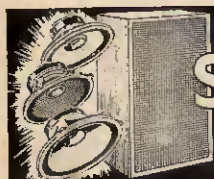

## HI-FI SPEAKER SPECIALISTS

ORDERS DESPATCHED BY RETURN  
Carriage, Packing and Insurance (U.K.) FREE

CELESTION	£	s.	d.	ROGERS	£	s.	d.
Studio 12" CX1512	11	10	0	Cadet MkIII 5 Speaker System	22	10	0
Studio 12" CX2012	16	10	0	Waffer Speaker System	16	19	6
Ditton 10 System	18	18	0	T.S.L. Tweeter LPH65	1	13	1
<b>DECCA</b>							
301 Speaker System	15	15	0	<b>TANNOY</b>			
<b>GOODMANS</b>							
ARU172 or 180	3	11	3	Lancaster Enclosure 12"	50	0	0
Axiette 8	5	10	1	Monitor 12" Dual Concent.	30	15	0
Audiom 61, 12"	15	0	0	Monitor 15" Dual Concent.	37	10	0
Axiom 80	21	8	1	III L.Z.C. 12" Dual Concentric	32	10	0
Axiom 201	11	8	1	III L.Z. Speaker System	32	10	0
Axiom 301	15	18	9	<b>W.B.</b>			
Axiom 10	6	12	3	Stentorian 8" HF812	3	16	6
Trebax 5K/20XL	7	13	9	Stentorian 8" HF816	6	6	0
Triaxiom 1220C	19	9	1	Stentorian 10" HF1012	4	12	0
Magnum-K System	36	15	0	Stentorian 10" HF1016	7	7	0
Maxim Mini System	17	10	0	Stentorian Clumber 912C	14	13	7
<b>JORDAN-WATTS</b>							
Module	10	10	0	Tweeter T10	4	12	3
Mini 12	16	12	6	Tweeter T359	1	12	3
<b>K.E.F.</b>							
Celeste Speaker System	26	10	0	<b>WHARFEDALE</b>			
K1 Baffle Speaker System	28	0	0	10" Bronze RS (RSDD)	4	12	9
T15 Tweeter	6	0	0	Super 3	5	16	8
B139	11	10	0	Super BR5/DD	6	14	2
B1814	19	0	0	Super 10 RS/DD	10	18	8
KELLY Ribbon HF Mk11	11	10	0	Golden 10RS/DD	7	17	5
LEAK "Sandwich" Speaker	39	18	0	W12RS/PST	10	15	0
<b>LOWTHER</b>							
PM6	18	18	0	RS12DD	11	10	0
Acousta Enclosure	21	0	0	W15RS	17	10	0
<b>PYE</b>							
Brahms Speaker System	17	17	0	Super 12 RS/DD	17	10	0
<b>QUAD</b>							
Electrostatic Speaker	52	0	0	Dalesman	25	10	0
				W2 Dovedale	31	10	0
				W3 Speaker System	39	10	0
				W4 Speaker System	49	10	0
				QS/800 Crossover unit	2	17	6
				HS/400/3 Crossover unit	6	5	0

C. C. GOODWIN (Sales) LTD. (Dept. LS.10)

7 The Broadway, Wood Green, London, N.22

Tel.: BOWES Park 0077/8

HOURS OF BUSINESS: Mon. to Sat. 9-6 p.m. Thurs. 9-1 p.m.

## ROTARY SWITCHES FOR THE HOME CONSTRUCTOR

Writers of constructional articles for Practical Electronics are reminded that readers often have difficulty in obtaining rotary switches of special type and contact arrangement. Consult us before deciding upon the switches you incorporate in your designs and be assured that a switch to any desired specification will then be immediately available to your readers.

Design charts and details (for writers and readers) from

## SPECIALIST SWITCHES LTD.

23 RADNOR MEWS · LONDON W2

PADddington 8866-7



## The NEW Stern-Clyne ELECTRONIC CONCERT ORGAN TO BUILD YOURSELF

### DESIGNED —

- For the Electronic amateur seeking the most fascinating project.
- For the discriminating organist seeking an instrument which DOES sound like a pipe organ.

### NEW —

- Constructional methods introducing "sectional complete instrument" building.
- Extended range of tone colours. Without unrealistic "Gimmick" effects.

**THE MOST COMPREHENSIVE KIT OF PARTS AVAILABLE IN THIS COUNTRY**

**START BUILDING FOR AS LITTLE AS  
£75.15.0 approx. (H.P. Terms Available)**

Send 2/6 for data and information booklet (credited on initial purchase) to: **Electronic Organ Dept., 162 Holloway Road, London, N.7.**

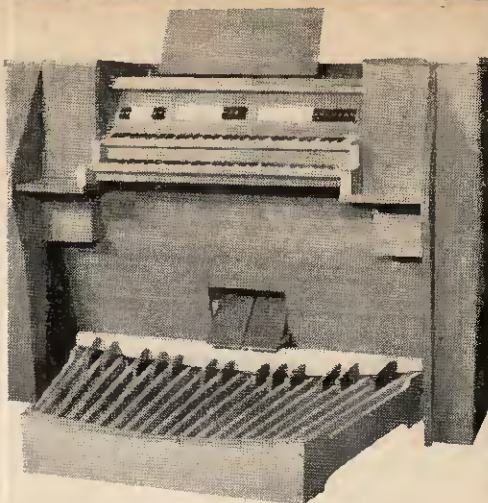

VISIT US AT  
162 HOLLOWAY ROAD, LONDON, N.7  
and hear this fabulous new Electronic Concert  
Organ demonstrated.

# STERN-CLYNE

GREAT BRITAIN'S GREATEST ELECTRONIC HOBBIES ORGANISATION

HERE'S WHY THOUSANDS OF  
ELECTRONICS ENTHUSIASTS  
BUY WITH CONFIDENCE  
FROM STERN-CLYNE —

- A wide range of exclusive equipment available including our own speciality — **MULLARD DESIGNS** — for the home constructor or ready assembled.
- The finest selection of Hi-Fi and Audio equipment by all leading manufacturers.
- A comprehensive range of electronic components for the build it yourself enthusiast available at all branches.
- Retail shops, showrooms and demonstration rooms throughout London and the provinces all carry extensive stocks.
- Finest Mail Order Service—geared to give prompt and efficient attention.
- Hire Purchase facilities available on orders of £11 10. 0 and over.
- Hi-Fi advisory service to help you in choosing the right equipment.
- After sales service — complete satisfaction guaranteed.

**VISIT YOUR NEAREST  
STERN-CLYNE ELECTRONICS CENTRE**

### LONDON

18 Tottenham Court Rd., W.1. MUSEum 5929-0095. *Half Day Sat.*  
23 Tottenham Court Rd., W.1. MUSEum 3451-2. *Half Day Thurs.*  
309 Edgware Rd., W.2. PADdington 6963. *Half Day Thurs.*  
109 Fleet St., E.C.4. FLEet St. 5812-3. *Half Day Sat.*  
162 Holloway Road, N.7. NORth 7941. *Half Day Thurs.*  
9 Camberwell Church St., S.E.5. RODney 2875. *Half Day Thurs.*

### BRISTOL

26 Merchant Street, Bristol 1. Bristol 20261.  
*Now open 6 days a week.*

### CROYDON

12 Suffolk House, George St. MUNicipal 3250. *Half Day Wed.*

### LIVERPOOL

52 Lord Street, Liverpool. Royal 7450. *Open 6 days a week.*

### MANCHESTER

20-22 Withy Grove, Manchester 4. BLAckfriars 5379-5246.  
*Open 6 days a week.*

### SHEFFIELD

125 The Moor, Sheffield. Sheffield 29993. *Half Day Thurs.*

### MAIL ORDERS AND ENQUIRIES TO:

Dept. P.E., 3-5 Eden Grove, Holloway, London, N.7. NORth 8161-5.

# EXCEL

in

# ELECTRONICS

## Through this ICS 3-way Training Method:

### 1 MASTER THE THEORETICAL SIDE

From basic principles to advanced applications, you'll learn the theory of electronic engineering, quickly and easily through ICS. That's because each course is set out in easy-to-understand terms.

### 2 MASTER THE PRACTICAL SIDE

ICS show you how to develop your practical abilities in electronic engineering—alongside your theoretical studies. It's the only sure way to success. All training manuals are packed with easy-to-follow illustrations.

### 3 MASTER THE MATHEMATICAL SIDE

To many this aspect is a bitter problem. Even more so because no electronic engineer is complete without a sound working knowledge of maths. But new ICS teaching makes mathematics easier to learn.

Wide range of courses available include: Radio/T.V. Engineering and Servicing, Colour Television, Servomechanisms, Telemetry, Computers, etc. NEW! Programmed Course on Electronic Fundamentals

#### EXPERT COACHING FOR:

INSTITUTION OF ELECTRONIC AND RADIO ENGINEERS  
CITY AND GUILDS TELECOMMUNICATION TECHNICIANS  
CITY AND GUILDS SUPPLEMENTARY STUDIES  
R.T.E.B. RADIO/T.V. SERVICING CERTIFICATE  
RADIO AMATEURS' EXAMINATION  
P.M.G. CERTIFICATES IN RADIOTELEGRAPHY

And there are practical "learn as you build" radio courses as well.

Member of the Association of British Correspondence Colleges.

FOR FREE HANDBOOK POST THIS COUPON TODAY

I.C.S., Dept. 151, INTERTEXT HOUSE,  
PARKGATE ROAD, LONDON, S.W.11

NAME .....

ADDRESS .....

OCCUPATION..... AGE..... 10.65

**INTERNATIONAL CORRESPONDENCE SCHOOLS**

## PROOPS MULTI-TESTER

Specially designed for Proops! This 39/6 Post and Packing 2/- truly low-priced, all-purpose tester combines the most useful voltage, current, and resistance measuring ranges for home and motor car wiring and servicing, amateur radio and T.V. fixing, and electronics hobby construction checking. Extremely robust construction employs rugged, large scale meter movement, hard-wearing switch contacts, and impact resisting tough plastic case. Ranges: 0-10-50-250-500-1000 volts AC or DC. 0-1-500 mA. DC 0-100,000 ohms and -20 to +36 decibels. Size overall: 5 x 3 1/2 x 1 1/2 in. deep. Supplied complete with red and black insulated connector leads, battery and full instructions.



## Construct Electronics with NEW VEROBOARD Quickly, Cheaply, Professionally

### VEROBOARDS supplied by Proops

Brothers Limited have been specially designed to meet the needs of the amateur constructor; hole matrices have been pitched to provide the greatest utility in a wide variety of circuit layouts; purchase price has been kept low by the deliberate selection of one standard board width (22 way) which may be used with almost any circuit but permits large quantity purchase with attendant saving; specially prepared design sheets are provided with each purchase to simplify circuit layout; accessories have been kept to an essential minimum to further reduce cost.

### VEROBOARD SHEETS. 12/6 each. Post Free.

Board size overall: 17 in. long x 3 3/8 in. wide 0.0312 in. thick. Each is clad with 22 x 0.0015 in. thick copper conductors which are fully pierced in line at 0.155 in. intervals across width and 0.2 in. along length. Boards are treated with flux preservative to give protection and ensure satisfactory soldering. A design sheet is supplied with each board.

### SPOT FACE CUTTER. 8/6. Post Free.

Specially designed hand cutting tool with hole locating spigot. Light turning and pressure removes copper conducting strip locally to make a neat break.

### TERMINAL PINS. 50 for 3/6. Post Free.

Made specially for Veroboards of pre-tinned brass with a flat head to give maximum contact, and self-cutting serrations near the head to ensure a tight fit when pushed into the hole.

### INTRODUCTORY VEROBOARD KIT. 24/-. Post Free.

Includes one sheet of Veroboard, Design Sheet, Spot Face Cutter, 50 Terminal Pins, and instruction on design method and layout procedure.



**semi conductor module ICE CUBE SIZE ENCAPSULATED CIRCUIT**

Solid state semi-conductor modules—fully transistorised and completely wired and tested circuits that only require a 6-volt battery and connection to input and output to provide a compact ready-made unit. Encapsulated types are shockproof and almost indestructible. Supplied with instructions.

### PUBLIC ADDRESS AMPLIFIER

—needs only crystal microphone and any speaker. Frequency response designed to provide maximum intelligibility. With 15 in. speaker sound covers hundreds of yards. Fully encapsulated. Size only 1 1/2 x 1 1/2 x 3/4 in. 35/-. P. & P. 1/-.

### CODE PRACTICE OSCILLATOR

—simply connect with morse key, any P.M. speaker and any 1 1/2-6v battery. Fully transistorised and assembled on rigid board size 2 x 1 1/2 in. 12/6. P. & P. 1/-.

### BURGLAR ALARM

—needs only 8-ohm loudspeaker, switch and microswitch (or reed switch and magnet) to complete. Operation of sensing switch trigger upward screaming siren to give instant alarm. For home or motor car protection. 30/-. P. & P. 1/-.

### FIRE ALARM

—module contains temperature sensor and operates in conjunction with 8-ohm loudspeaker and 2-megohm potentiometer. Increase of room temperature above pre-set level immediately triggers screaming siren alarm. 50/-. P. & P. 1/-.

### PHOTO MULTIPLIER POWER TRANSISTOR

—complete photo-electric system in one unit of power transistor amplifier. Photo-electric cell and electronic relay. Make your own photo-control system—door opener, burglar alarm, automatic door chimes, counters, etc. Complete with instruction literature of unusual applications. 25/-. P. & P. 1/-.

### WIRELESS TELEPHONE AMPLIFIER MODULE

—complete, electronic, solid state circuitry ready to amplify and transmit both sides of a telephone conversation into any A.M. broadcast band radio without interconnecting cables. Operates from 9 volts "transistor" battery and requires only telephone pick-up coil to operate. 30/-. P. & P. 1/-.

### MICROPHONE TRANSMITTER MODULE

—contains complete solid state circuitry ready for use as a means of transmitting speech from any high impedance microphone into an ordinary A.M. radio without connecting wires. Requires only 9 volts battery and crystal microphone. 30/-. P. & P. 1/-.

### METRONOME

—requires only 2 megohm potentiometer and any PM speaker to produce accurate repetitive beats at adjustable rates from 40 to more than 208 beats per minute. Low battery drain, simple connections. 22/6. P. & P. 1/-.

### 2 WATT GRAM AMPLIFIER

—just connect to any crystal pick-up and 8-ohm speaker for above average output with excellent tonal quality. 1-megohm potentiometer recommended for vol. control. Compact, high quality unit. 35/-. P. & P. 1/-.

**PROOPS**  
BROTHERS LIMITED

52 TOTTERHAM COURT ROAD, LONDON W.11  
PHONE: LANGHAM 0141. HOURS: 9 a.m. - 6 p.m.  
THURS: 9 a.m. - 1 p.m. OPEN ALL DAY ON SATURDAY



# Home Construction made easy by Building Heathkit models

A wide range of well designed quality kit sets to choose from

## Ease of assembly is guaranteed

Even for those without previous experience—by the comprehensive, yet simple step-by-step construction manuals supplied with every Heathkit model.

## Save £ £'s building the models

Heathkit units cost considerably less than comparable pre-assembled equipment. You cannot buy the parts any other way as cheaply.

## Guaranteed performance

Every Heathkit product—assembled in accordance with our comprehensive construction manuals is guaranteed to meet published performance specifications, or your money will be cheerfully refunded.

## Convenient credit terms

By taking advantage of our credit terms—you can enjoy your model right away—and pay for it in easy monthly instalments. Deferred terms available over £10 in U.K.

## AUDIO

Cabinets, Turntable units, Mono and Stereo Amplifiers, Pick-ups, Speakers, Speaker Systems, Mono and Stereo Control Units, Tape Pre-amplifiers, Tape Decks, Transistor Mixer.

## RADIO

AM/FM and FM Tuners, Transistor Radios, SW and Communication Receivers.

## TEST INSTRUMENTS

A wide range of Audio Test, Home Workshop, Service and Laboratory Instruments.

## AMATEUR GEAR

A wide range of equipment.

## MISCELLANEOUS

Hobby kits for the youngster, Tool kits, Intercoms, Electronic Organs, Transistor Gram Amplifier, etc.

## See the complete Heathkit range in the FREE catalogue



HI-FI CABINETS

### RECORD PLAYERS



FM & AM/FM RADIO TUNERS



TRANSISTOR PORTABLES



SW RECEIVERS TRANSMITTERS



QUALITY STEREO and MONO AMPLIFIERS



SPEAKER SYSTEMS

"MALVERN" HI-FI EQUIPMENT CABINET. Will house all your Hi-Fi equipment. Left "in the white." Size: 39 $\frac{1}{2}$  x 32 x 21 $\frac{1}{2}$  in. Kit £181.0 (inc. P.T.)

A wide range of other cabinets.

HI-FI FM TUNER. Range 88-108 Mc/s. Available in two units, sold separately. TUNER (FMT-4U) 10.7 Mc/s IF £215.0 (inc. P.T.). IF AMPLIFIER (FMA-4U) power supply and valves £13.13.0. Total Kit £168.0.

JUNIOR ELECTRONIC WORKSHOP. Model EW-1. 20 exciting experiments can be made. Special solderless connections. Kit £7.13.6 (inc. P.T.)

TRANSISTOR MIXER. TM-1. A must for the tape enthusiast. 4 inputs, 9 v. battery operation. Kit £11.16.0. Assembled £16.17.6.

"OXFORD" LUXURY TRANSISTOR PORTABLE. Model UXR-2. Beautiful solid leather case. LW and MW Coverage. Kit £144.0 (inc. P.T.)

GENERAL COVERAGE RECEIVER. Model RG-1. Freq. coverage 600 kc/s-1.5 Mc/s. 17-32 Mc/s in 6 switched bands. Many features incl.  $\frac{1}{2}$  lattice crystal filter. Kit £39.16.0. Assembled £53.0.0.

6W QUALITY STEREO AMPLIFIER. Model S-33H. An inexpensive stereo/mono amplifier. Ideal for use with the Decca Deram lightweight pickup. Modern attractive styling. Kit £15.17.6. Assembled £21.7.6.

50W PA GUITAR AMPLIFIER. Model PA-1. A multi-purpose unit, suitable for vocal and instrumental groups. 4 inputs for guitars, mics, etc. 2 heavy duty speakers, vol. indicator, variable tremolo, modern cabinet. Kit £54.15.0. Assembled £74.0.0. Legs optional extra, 17/6.

TRANSISTOR GEN. COVERAGE RECEIVER. Model GC-1U. Frequency coverage 580 kc/s-30 Mc/s in 5 bands. Kit £37.17.6. Assembled £45.17.6.

### TRANSISTOR INTERCOM.

Master Unit. Kit £10.19.6. Assembled £16.19.6. Remote. Kit £4.7.6. Assembled £5.16.0. Will operate up to 5 remotes.

"COTSWOLD" HI-FI SPEAKER SYSTEMS. Std. model. Size: 26 x 23 x 14 in. Kit £25.12.0. MFS "Cotswold" for the smaller room. Size: 36 x 16 $\frac{1}{2}$  x 14 in. Kit £25.12.0

SSU-1 SPEAKER SYSTEM. A practical solution to the problem of a low-price speaker system. Two speakers. (Bookcase) £11.17.6 Kit (inc. P.T.) (With legs) £12.12.0 Kit (inc. P.T.)



SCOPES



POWER SUPPLIES



TRANSISTOR TESTER



SIGNAL GENERATORS

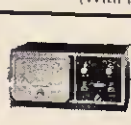

VALVE VOLTMETERS



TV ALIGN GENERATORS

5 in. FLAT-FACE GENERAL PURPOSE OSCILLOSCOPE. Model 10-12U. An outstanding scope. "Y" sensitivity, 10 mV rms per cm at 1 kc/s; Bandwidth 3 c/s to 4.5 Mc/s. 1/8 10 c/s to 500 kc/s in 5 steps. Kit £35.17.6. Assembled £45.15.0.

MULTIMETER. Model MM-1U. Ranges 0-1.5 v to 1,500 v A.C. and D.C. 150  $\mu$ A to 15A D.C.; 0.2 to 20 M $\Omega$ . 4 $\frac{1}{2}$  in. 50/ $\mu$ A meter. Kit £12.18.0 Assembled £18.11.6.

REGULATED POWER SUPPLY. Model IP-20U. Transistorised, compact unit. Current range: from 50 mA to 1.5 A f.s.d. Voltage ranges: from 5 to 50 volts f.s.d. Kit £35.8.0. Assembled £47.8.0.

TRANSISTOR TESTER. Model IM-30U. Unmatched in quality, performance and price. Provides complete d.c. analysis of PNP, NPN transistors and diodes. Internal battery for tests up to 9 v. Kit £24.18.0. Assembled £35.10.0.

R.F. SIGNAL GENERATOR. Model RF-1U. Freq. coverage from 100 kc/s-100 Mc/s or six bands, on fundamentals and up to 200 Mc/s on calibrated harmonics. Kit £13.8.0. Assembled £19.18.0.

6 in. DE LUXE VALVE VOLTMETER. Model IM-13U. Measures ac and dc volts 0-1.5 to 1,500 V in 7 ranges. Res. to 1,000 M $\Omega$  in 7 ranges. Modern styling, with gimbal mount. Kit £18.18.0. Assembled £26.18.0.

TV ALIGNMENT GENERATOR. Model HFV-1. 3.6 to 220 Mc/s on fundamentals. Unique electronic sweep oscillator. Built-in fixed and variable marker generators (5 Mc/s crystal). Kit £37.18.0. Assembled £47.10.0.

DECADE RESISTANCE. Model DR-1U. Range 1-99,999 $\Omega$  in 132 steps. Kit £10.8.0. Assembled £14.8.0.

DECADE CAPACITOR. Model DC-1U range, 100 $\mu$ F to 0.111  $\mu$ F in 100  $\mu$ F steps. Kit £7.5.0. Assembled £10.8.0.

INTERNATIONAL MAIL ORDER SCHEME covering the American Heathkit range of 250 models. Illustrated American catalogue and full details can be obtained from us for 1/- post paid.

**MANY OTHER MODELS**  
For the home, Hi-Fi enthusiast, Home workshop, Service and Test bench, Laboratory.

**FULL RANGE OF MODELS IN  
FREE CATALOGUE**

SIMPLY SEND COUPON TO:—

To DAYSTROM LTD., DEPT. PM-10, GLOUCESTER, ENGLAND

Please send me FREE BRITISH CATALOGUE (Yes/No).....

Full details of model(s).....

American..... NAME.....

Catalogue..... (BLOCK CAPITALS)

(Yes/No)..... ADDRESS.....

PM-10





# YOURS FREE FOR 7 DAYS

## The New 'Picture-Book' way of learning **BASIC ELECTRICITY (5 VOLS.)** **BASIC ELECTRONICS (6 VOLS.)**

You'll find it easy to learn with this outstandingly successful new pictorial method—the essential facts are explained in the simplest language, one at a time; and each is illustrated by an accurate, cartoon-type drawing.

The books are based on the latest research into simplified learning techniques. This has proved that the Pictorial Approach to learning is the quickest and soundest way of gaining mastery over these subjects.

The series will be of exceptional value in training mechanics and technicians in Electricity, Radio and Electronics.

### WHAT THIS MONTH'S ENTHUSIASTIC READERS SAY

- "The easiest set of manuals it has been my pleasure to study."  
... J.P.P. Taunton.
- There appears to be absolutely no points which the average person could not easily understand."  
... G.J.F. Coventry.
- "I would say that I am completely satisfied with them."  
... G.S.S. London, S.E.12.
- "The Manuals are without doubt the finest self-explanatory books ever produced."  
... L.B.G. Luton.

A TECH-PRESS PUBLICATION

**POST NOW FOR THIS OFFER!!**

To Selray Book Co.  
60 Hayes Hill, Hayes, Bromley, Kent

Please send me Without Obligation to Purchase, Basic Electricity/BASIC ELECTRONICS on 7 Days' Free Trial. I will either return set, carriage paid, in good condition within 8 days or send down payment of 15/- (Basic Electricity) followed by 6 fortnightly payments of 10/-. Down payment of 15/- (Basic Electronics) followed by 6 fortnightly payments of 12/6. Alternatively, I will send 68/- (Basic Electricity—5 parts), 81/- (Basic Electronics—6 parts) post free. This offer applies to United Kingdom only.

Tick against set required (only one set allowed on free trial).  
BASIC ELECTRICITY  BASIC ELECTRONICS

Signature.....  
(If under 21, signature of parent or guardian)

Name.....  
BLOCK LETTERS BELOW

FULL POSTAL..... P.E.10  
Address.....

### GUITAR AMPLIFIERS WITH TREMOLO

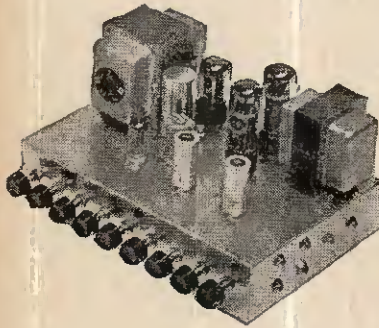

Five jack socket inputs, four with separate mixing volume controls, and one input "straight through". All inputs are of very high sensitivity only 10 millivolts input is required for full output, making them suitable for all types of guitars and microphones. Separate Bass and Treble controls, giving a wide range of lift and cut. Separate master gain control. Tremolo speed and depth controls. Jack socket for remote tremolo switching.

Outputs for 3 and 15 ohms speakers. Valves used in the 30 watt and 50 watt amplifier ECC83, ECC83, EL34, EL34, GZ34. In the 15 watt amplifier ECC83, ECC83, EL34, EL34, 1Z51. An extra valve ECC83 is used in the tremolo circuit. The chassis is complete with baseplate and is solidly made of 18 gauge steel, finished silver grey luminium. Size 12 x 8 x 6 1/2 inches high.

PRICES—	KIT	FACTORY BUILT
50 watt with tremolo .....	£17.10.0	£20.10.0
50 watt less tremolo .....	£16.10.0	£19.10.0
30 watt with tremolo .....	£12.10.0	£15.10.0
30 watt less tremolo .....	£11.10.0	£14.10.0
15 watt with tremolo .....	£9.10.0	£12.10.0
15 watt less tremolo .....	£8.10.0	£11.10.0

Add carriage 10/- any amplifier. Send S.A.E. for free descriptive leaflet.

CREDIT TERMS ARRANGED  
EXPORT ENQUIRIES INVITED

**STROUD AUDIO**  
CASHES GREEN ROAD, STROUD, GLOS.

### TAPE RECORDER COVERS



Smart waterproof cover to give complete protection to your tape recorder. Made from rubberised canvas in navy, wine, tan, grey and bottle green with white contrasting pipings, reinforced base, handy zip microphone pocket and name panel.

Cossor 1601	...	63/-
" 1604	...	79/-
" 1605	...	84/-
Stella ST455	...	63/-
" ST454	...	57/6
" ST458	...	79/-
" ST459	...	84/-
Saba 2305	...	63/-
Elizabethan LZ29	...	75/-
Brenell Mk. 5M	...	77/-
Truvox R92 and 94	...	99/-
Truvox R100	...	99/-
Robuk RK3 & RK4	...	67/6
Ferrograph	...	88/-
Sony S21	...	90/-
Revofax F	...	84/-
Optacord 414-412	...	63/-
and 416	...	
Tandberg 72, 74, 62	...	
& 64, 842, 843 & 92	...	
Hard Case	...	£7. 1.8
Soft Case	...	£5.12.6
* Without pocket	...	

Grundig TK 1	...	49/6	Grundig Cub	...	35/-*
" TK 5	...	35/-	Telefunken 85	...	65/-
" TK 6	...	67/6	" 75/15 &	...	76K
" TK 8	...	63/-	" 95	...	55/-
" TK 14, 18	...	69/6	Philips 8108	...	57/6
& 23	...	59/6	" 3548	...	79/6
" TK14L, 17L,	...		" 3534	...	87/-
18L & 23L	...	67/6	" 3549	...	79/6
" TK 20	...	52/6	" EL3538	...	63/-
" TK 24	...	55/-	" EL3542	...	63/-
" TK 25	...	55/-	" EL3515	...	70/-
" TK 30	...	60/-	" EL3515	...	57/6
" TK 35	...	63/-	" EL3541/15	...	57/6
" TK 40 & 41	...	66/-	" 3541/H	...	72/-
" TK 46	...	82/-	" Starmaker	...	66/-
" TK 55	...	63/-*	Cossor 1602	...	57/6
" TK 60	...	75/-*		...	

**A. BROWN & SONS LTD.**  
24-28 GEORGE STREET, HULL. TEL.: 25413, 25412

**HOME RADIO (Mitcham) LTD.**  
 187 London Road, Mitcham, Surrey

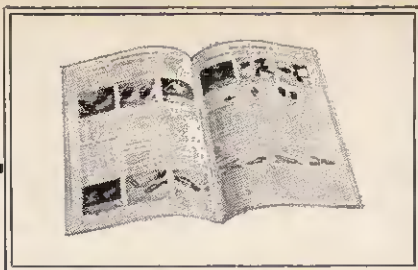

## *Dear Customer,*

Each year when we publish a new edition of our Components Catalogue we try out a new presentation and new ways of making it easier to use. This year is no exception, our first innovation being that all the prices are now in a separate supplement. We do not claim that this makes the catalogue easier to use but it certainly makes it easier to keep you informed on any price changes. This process will be automatic, for we will reprint the supplement every six months (more frequently if the need arises) and the moment we receive an incorrectly priced

order from you we will send you a new price supplement. We shall always endeavour to hold our prices steady until the next supplement is printed.

Our second innovation is that to all purchasers of our catalogue we are sending our Special Bargain List. Over the course of the year we do amass some very attractive bargains, and we feel that before being put on general sale they should be offered to our own customers. Here are a few snippets from the latest list:—

<b>METERS</b>		
BG 37.	5 milli-amp scaled 0-20v . . . . .	10/-
BG 38.	40 amp (10 mA without shunt) . . . . .	17/6
BG 39.	40 amp A.C. or D.C. . . . .	15/-
<b>MOTORS</b>		
BG 40.	Motors Miniature . . . . .	2/6

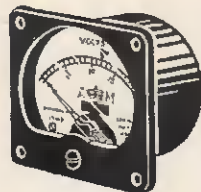

The Home Radio Components Catalogue costs 7/6 plus 1/6 p. & p. Every copy contains 5 coupons each worth one shilling when used as directed. *To find out what you have been missing fill in the coupon and send it with your cheque or P.O. for 9/- right away.*

BLOCK CAPITALS please

**NAME**.....

**ADDRESS**.....

HOME RADIO LTD., Dept. PE, 187 London Rd., Mitcham, Surrey

## TAKING STOCK

WITH this issue we complete our first year of publication.

As we explained in our inaugural number, our aim is to serve the amateur electronics enthusiast by offering him a varied range of projects which in conception, design, and method of execution reflect the current developments and trends in electronics. Now, some fifty constructional projects later, it may be instructive to take a look at the ground covered so far.

\* \* \*

To date, our designs has taken cognisance of several fields of interest: audio, radio, ultrasonics, nucleonics, and instrumentation. The latter is a convenient term for describing a miscellany of detecting, measuring, and timing devices; it would be far too exhaustive a task to attempt to designate their multifarious applications.

An analysis of the published designs will reveal that the transistor has a five-to-one preponderance over the valve. Few of our readers are likely to quarrel with this, we suspect, for this seems to represent a realistic balance in light of present day progress in electronics. Nevertheless we do feel it would be wrong to suppose that the valve is all but vanquished. There still remain a variety of functions that only the thermionic valve can perform satisfactorily and we must certainly not overlook the important gas filled cold cathode devices—ranging from the simple voltage stabiliser to the more complex counting tube such as used in the scaler described in this present issue.

\* \* \*

Considering now the essentially *practical* aspect, it will be noted that the projects have illustrated a number of constructional methods.

Basically, all that one requires for many transistorised projects is a piece of laminated plastics board. However there are several different approaches to the problem of wiring up the individual components. The traditional method of making each point-to-point connection with wire is losing favour to the "wire-less" technique of the individually etched printed circuit and to the versatile printed wiring board marketed under well-known trade names. Among other advantages, these new methods permit close packing of components, thus reducing the overall dimensions of a complete assembly to the minimum.

This leads us to a final thought, directed particularly to our beginner friends: While much labour has been eliminated by these modern constructional methods, considerable adroitness in handling a small lightweight soldering iron has become essential. This, like all skills, can be acquired only by practice.

## THIS MONTH

### CONSTRUCTIONAL PROJECTS

NEW LOOK TAPE RECORDER	843
ELECTRO-COMBINATION LOCK	849
REV AND DWELL METER	859
GENERAL PURPOSE SCALER	866

### SPECIAL SERIES

BUILDING BLOCKS—7	853
BEGINNERS START HERE—12	864
NEON NOVELTIES—2	874

### GENERAL FEATURES

ELECTRONIC SOUNDS AND MUSIC	838
GETTING STARTED WITH DISCS	879

### NEWS AND COMMENT

EDITORIAL	837
THE 73 PAGE	852
ELECTRONORAMA	862
DETACHED PARTICLES	876
NEW PRODUCTS	883
READOUT	887

Our November issue will be published on  
Thursday, October 14

# ELECTRONIC SOUNDS AND MUSIC

BY F.C. JUDD, A. INST. E.

**E**LECTRONICS and magnetic tape have become very prominent in the creation of new sounds used in modern but otherwise conventional music and in the actual making of so called "electronic music", which is of somewhat abstract nature. It is not intended to discuss here electronic musical instruments, neither should the reader confuse music produced by electronic organs and electric guitars with that created on or with the aid of magnetic tape and electronic devices.

Electronic music is derived from basic tone and noise generators; magnetic tape features very prominently in the composition and actual making. There is, however, another and similar form of music which can be created out of tape recorded natural sounds and this is the more surrealist "Musique Concrète".

Here basic sounds are treated and manipulated in various ways and re-recorded into a whole composition. The techniques are too numerous to discuss here and could in fact become the subject of a complete article.<sup>3</sup> On the other hand many of the methods applied to electronic music and musique concrète can be adapted by the amateur in the making of interesting electronic sounds and with a little skill and practice, complete electronic music compositions.

## SYNTHETIC SOUNDS

The idea of applying electronics in the creation of new sounds and music is not new and even completely synthetic music and voices have been produced with the equipment such as that shown in Fig. 1. Computers have also been put into operation to compose

Fig. 1. The R.C.A. music and voice synthesiser

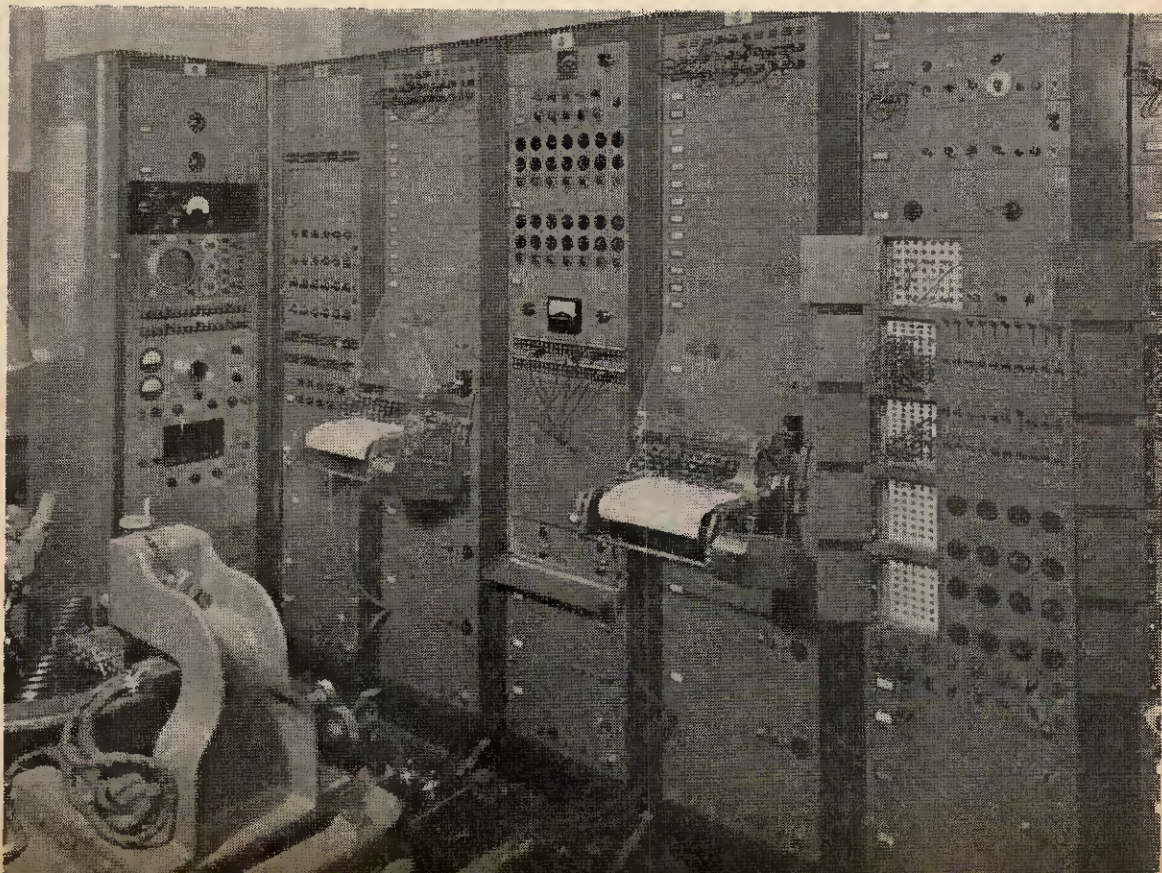



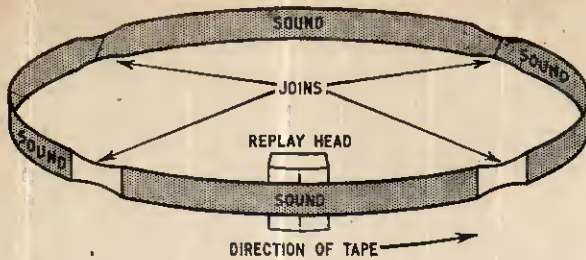

Fig. 2. Tape loop rhythm. Each sound on equal length of tape

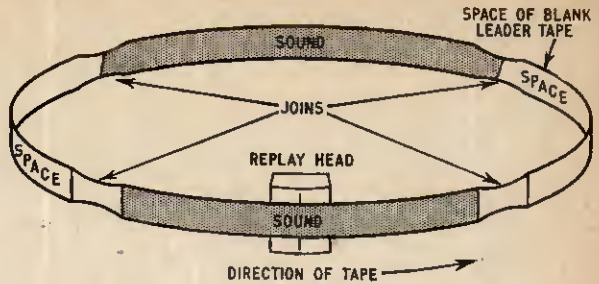

Fig. 3. Two-sound, four-beat rhythm

and actually produce music and some workers in this field have integrated the various techniques to produce music which has a popular appeal music-wise, but with new sounds to the "instruments". Even "pop" record groups and recording studios are employing electronics and tape to produce new musical sounds and unusual, though not always elegant effects known otherwise as "gimmicks".

New techniques however, generally call for specialised equipment, but with a tape recorder plus a few simple electronic circuits any enthusiast can indulge in the making of fascinating new sounds and if by nature he happens to be something of a musician, some quite unorthodox kinds of music too.

#### TAPE RECORDER AS A MUSICAL INSTRUMENT

The use of "tape loops" is fairly well known and a small loop of recorded sounds can be repeated over and over again so long as the tape recorder is left running. This simple technique can be used to provide a per-



fectly timed rhythm against which to play a musical instrument or set a melodic line from a tone generator.

Here is a simple exercise to show what can be done. Record four different sounds on tape at  $7\frac{1}{2}$  inches per second and cut out about three inches of each sound. Join these together with splicing tape to form a loop as shown in Fig. 2 and replay at  $7\frac{1}{2}$  inches per second. This will demonstrate the basic method and you will find it quite easy to count four beats to a bar with this simple rhythm. Now try a two piece loop by recording some percussive sounds and selecting from these two of different pitch, they should be cut and jointed as shown in Fig. 3 with lengths of leader tape in between. The pieces of recorded tape and leader tape must each be of the same length, say three inches.

If you make the pieces shorter the rhythm will be faster and vice versa. When this "sound-space-sound-space" loop is played you can again count four beats to the bar, i.e. 1(sound)-2(space)-3(sound)-4(space). The loop can then be re-recorded on to another tape and at the same time you record more sounds in tempo and with accent on the second and fourth beats (spaces in the loop). This does of course require a second tape recorder and a means of mixing the output from the loop replay recorder and a microphone. The BBC Radiophonic Workshop have produced two records which employ this technique (Fig. 4). Details of the records are given at the end of this article.

Once you have tried these simple exercises the use and making of loop rhythms should be quite easy. If you have "echo" facilities on your tape recorder then the rhythms might be enhanced by this also. Alternatively, the effect of different speeds might be found interesting. Incidentally, in making loops one can of course operate at a much slower rate during the first process, i.e. by running the primary loop at half speed. Re-recording and the addition of new sounds is done at the same speed. The final result is replayed at the original speed. The second batch of sounds will of course be raised in pitch by one octave and sound completely different from the original.

#### EXPERIMENTAL EQUIPMENT

The photograph of Fig. 5 shows part of the author's studio for recording and creating special electronic effects. The central "rack" contains two tone generators (sine wave and square wave), a ring modulator, electrical audio filters, pre-amplifiers with variable frequency characteristics, provision for mixing up to 12 signal channels, a level meter, and an oscilloscope.

Fig. 4 (left). Corner of the BBC Radiophonic Workshop

To the left of the picture can be seen a keyboard, which operates a series of tone generators in tempered scale and which has provision for controlled "attack" and "decay" of any sound fed through or produced by the system. Another item frequently used in the studio is a "Theremin", which is an electronic musical instrument operated by the "hand capacitance" effect. The remainder of the equipment consists of various tape recorders and amplifiers, not all of which are shown in the photograph. This is of course a quite ambitious studio since it has to produce music for television and films.

Simple equipment is quite capable of producing excellent results; Fig. 6 shows a typical circuit of a simple transistor tone generator for keyboard operation. Ordinary tone generators can be used for specific sounds, most of which can be altered by means of a "ring modulator". This device can be constructed from a pair of audio transformers with centre-tapped secondary windings; a circuit is given in Fig. 7. It has two inputs and one output. Sounds fed into the two inputs will be "ring modulated" and appear at the output with two extra tones, the frequencies of which will be the sum and difference of those at the input. When two sine waves of different frequency are passed through a ring modulator the resultant output is a chord of unusual timbre; an effect greatly favoured by composers of electronic music.

Another useful circuit is the vibrato oscillator shown in Fig. 9. Tones and sounds applied to this may be

given a tremolo (trembling) effect which can sound very pleasing. The keyed tone circuit shown in Fig. 7 has its own vibrato oscillator. Incidentally the vibrato device consists of a low frequency phase-shift oscillator which controls the gain of the pre-amplifier (V2). The control VR2 effects the amplitude of the sine wave applied to the suppressor grid of V2 and if turned too high can result in an unpleasant "thumping" sound. Of course if you require a "thumping" noise then the device will produce it (electronic "heart beats" effect).

Control over "attack" (beginning of a sound) and "decay" (end of a sound) can be produced with the circuit shown in Fig. 10. It is not difficult to construct, but since it has a high gain pre-amplifier like that in the vibrato circuit, precautions must be taken against hum pick-up. These circuits should be constructed like any high gain audio amplifier and completely screened. The "attack" time is controlled by VR2 and C5, although in practice it is better to leave C5 at a suitable value and modify VR1 and R5 for the required delay, i.e. the time needed for the sound to commence. A few trials with different component values will soon produce the desired effects.

With the help of electronic circuits such as those described, plus a tape recorder, quite fascinating sounds can be created. If the tape recorder has "echo" facilities, i.e. a separate replay head that will pick up the recorded signals and feed them back through the recording amplifier, so much the better. A signal mixer of some kind is also advantageous especially

**Fig. 5. The author's equipment for producing electronic sounds and music**



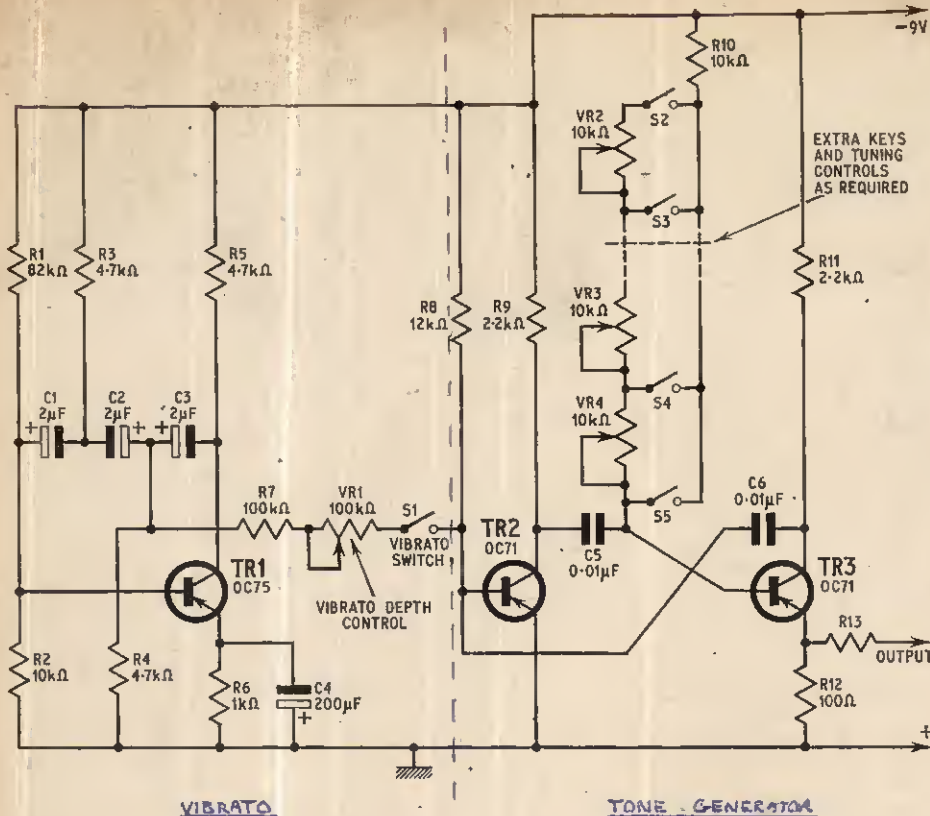

Fig. 6. Single note keyboard oscillator with vibrato oscillator, designed by Mullard Limited

when working with two tape recorders and other signal sources. Assuming one has these facilities, here are some of the techniques that can be applied:

### SOUND SOURCES

1. Tone mixing from one or more generators;
2. Ring modulation of tones;
3. Use of sine or square wave tones;
4. Tone shaping circuits (simple differentiation or integration);
5. Use of keyed tone systems to tempered scale;
6. Sounds produced through a microphone.

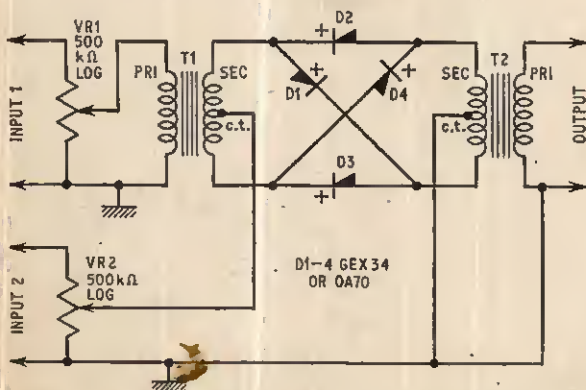

Fig. 7. A typical ring modulator circuit

### TAPE RECORDING TECHNIQUES

1. Tape editing (cutting sounds from tape and rejoining them);
2. Change of tape speed (during recording or playback);
3. Ring modulation of recorded sounds and pure tones;
4. Tape loops (rhythms and repeating sound sequences);
5. Tapes and loops running in reverse;
6. Tape "echo" (feedback from extra replay head);
7. Reverse echo (tape replayed in reverse after being echoed);
8. Cutting of tape at beginning of sound to produce new "attack";
9. Cutting of tape at end of sound to produce new "decay";
10. Stereophonic effects by employing two or more tracks;
11. Artificial stereo effect (movement of sound by panning);
12. Panning technique (fading one sound from one stereo channel to another).

### ELECTRONIC TREATMENT

1. Ring modulation of any two groups of sounds;
2. Electrical filtering (altering the frequency response of amplifiers);

Fig. 8. Vibrato oscillator and pre-amplifier circuit

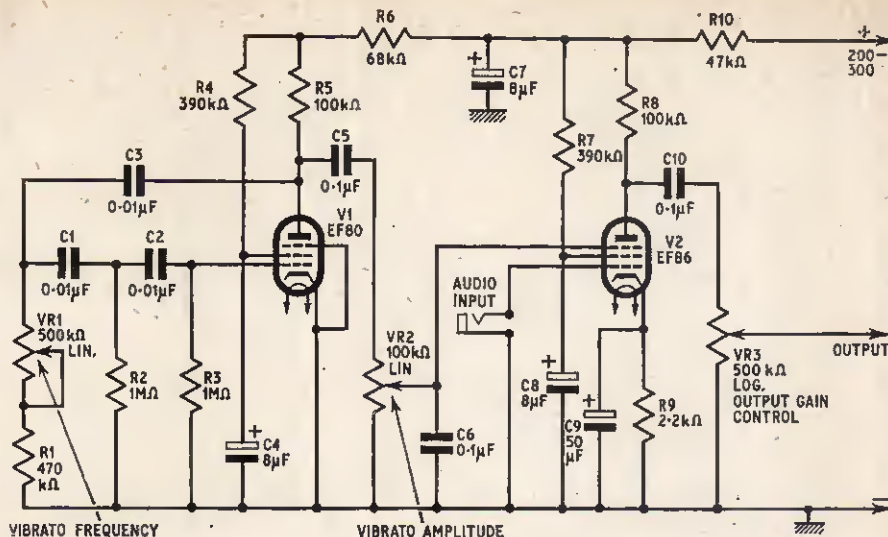

3. Linear mixing of any group of sounds;
4. Mechanical reverberation (with spring delay echo unit);
5. Electronic vibrato.

The above represent a few of the possibilities that electronics and magnetic tape have to offer in the creation of new sounds and most of these can be combined in various ways. For instance, *sound movement* is an interesting effect. One could make a rhythm track from a loop which is then re-recorded equally on two tracks of a stereo recorder (rhythm central). Melodic lines can be added from a keyboard tone generator and "panned" (faded from track to track) so that the melody appears to "wander"

about in space. This effect was recently demonstrated to an audience who found it quite fascinating although a little disconcerting.

Finally for those who feel they would at least like to hear what electronics have contributed to music, here are details of records now available, each of which features many of the techniques outlined in this article:

1. Music from Mathematics (music composed and played by a computer).  
Brunswick STA. 8523 (stereo) available in mono.
2. Varèse. Poème Electronique (electronic music) classical.  
Philips ABL 3392 (mono).
3. The Synthesis of Music, by the R.C.A. Music Synthesiser.  
R.C.A. LM.1922 (available only from R.C.A. New York, U.S.A.).
4. Dr. Who (BBC recording of rhythmic electronic music by the Radiophonic Workshop).  
Decca F.11837 (mono).
5. Time Beat (BBC recording of rhythmic electronic music by the Radiophonic Workshop).  
Parlophone 45-R-4901 (mono).
6. Electronic Sounds and Music. F. C. Judd (for special effects).  
Castle EFX-1 and EFX-2 (mono).
7. Electronic Sound Patterns. Daphne Oram.  
H.M.V. 7EG-8762 (mono).
8. Electronic Movements. Tom Dissavelt (rhythmic electronic music).  
Philips 430 736PE.
9. Study 1 and 2. Karlheinz Stockhausen (modern classical electronic music).  
Deutsche Grammophon LP.16133 (mono).  
(one of three records of similar composition.)

REFERENCE

1. "Electronic Music and Musique Concrète" (techniques). Published by Neville Spearman Limited.

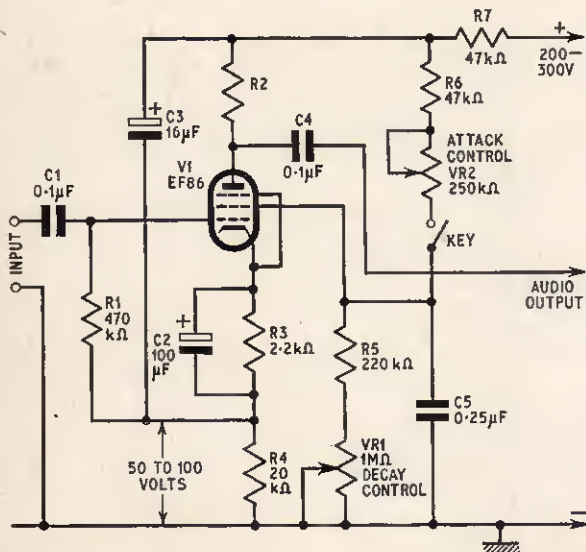
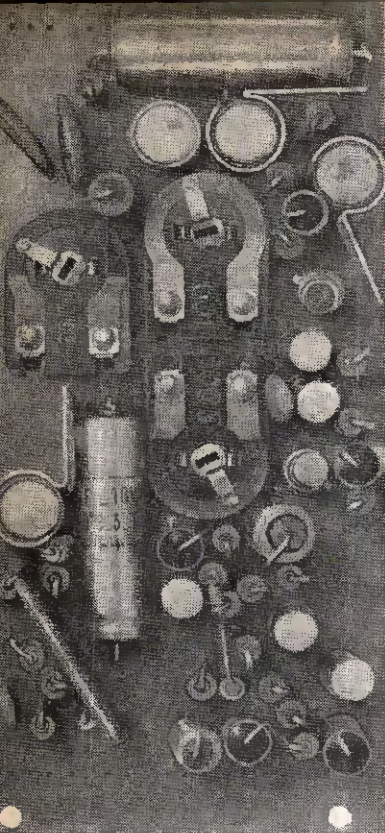

Fig. 9. "Attack" and "decay" control circuit



## NEW LOOK TAPE RECORDER

**B**EHIND the facia of the commercial tape recorder, a quiet revolution is going on. In commercial production models transistors are now largely superseding valves.

This article describes a fully transistorised tape recorder circuit illustrating some of what are now becoming the conventional commercial techniques. Typical of these are the "Ridler" type d.c. coupled self-compensating, pre-amplifier input circuit, and the self-oscillating erase head which uses the erase head as the inductance of the erase/bias generator thus obviating the necessity of a separate oscillator coil on the circuit board.

The circuit uses nine conventional, easily obtainable germanium transistors, together with two temperature compensating diodes. It is designed to operate from a nominal 9 volt h.t. rail and is capable of delivering some 800mW audio output into a standard 8 ohm load.

Volume and top-cut tone controls are included and there are facilities for using a type DM71 level indicator.

The output stage is of the modern transformerless complementary-symmetry class-B, push-pull type, which permits a very low standing quiescent current for current economy—this being particularly advantageous where a battery supply is used.

### COIL-LESS DESIGN

The circuitry is unusual in that the inductors normally found in tape recorders hitherto (e.g. audio transformers, chokes, oscillator coils, and compensating inductors) have all been eliminated to give a truly "coil-less" design.

Any standard medium impedance record playback head of about 100mH inductance can be used, but the erase head must be one of the new-generation high-efficiency, self-oscillating heads, such as the Miniflux LF/6-0, or Marriott R/EC/23.

The blueprint enclosed with this issue provides constructional details for the electronic module. It also includes details of the wiring needed to connect up the printed wiring board into a complete working system.

In this article constructional notes are given for an actual tape recorder using a BSR type TD2 mains powered deck. The TD2 deck is normally fitted with a BSR MN155 record replay head and a TG3 erase head, but in the equipment described here the TG3 erase head has been replaced with a Miniflux LF/6-0 self-oscillating erase head. A circuit is also given for a small mains power pack to provide the 9V d.c. supply necessary for the module as an alternative to battery operation.



constructing a transistor tape recorder  
using a printed circuit amplifier module

**By**  
**R. HIRST**

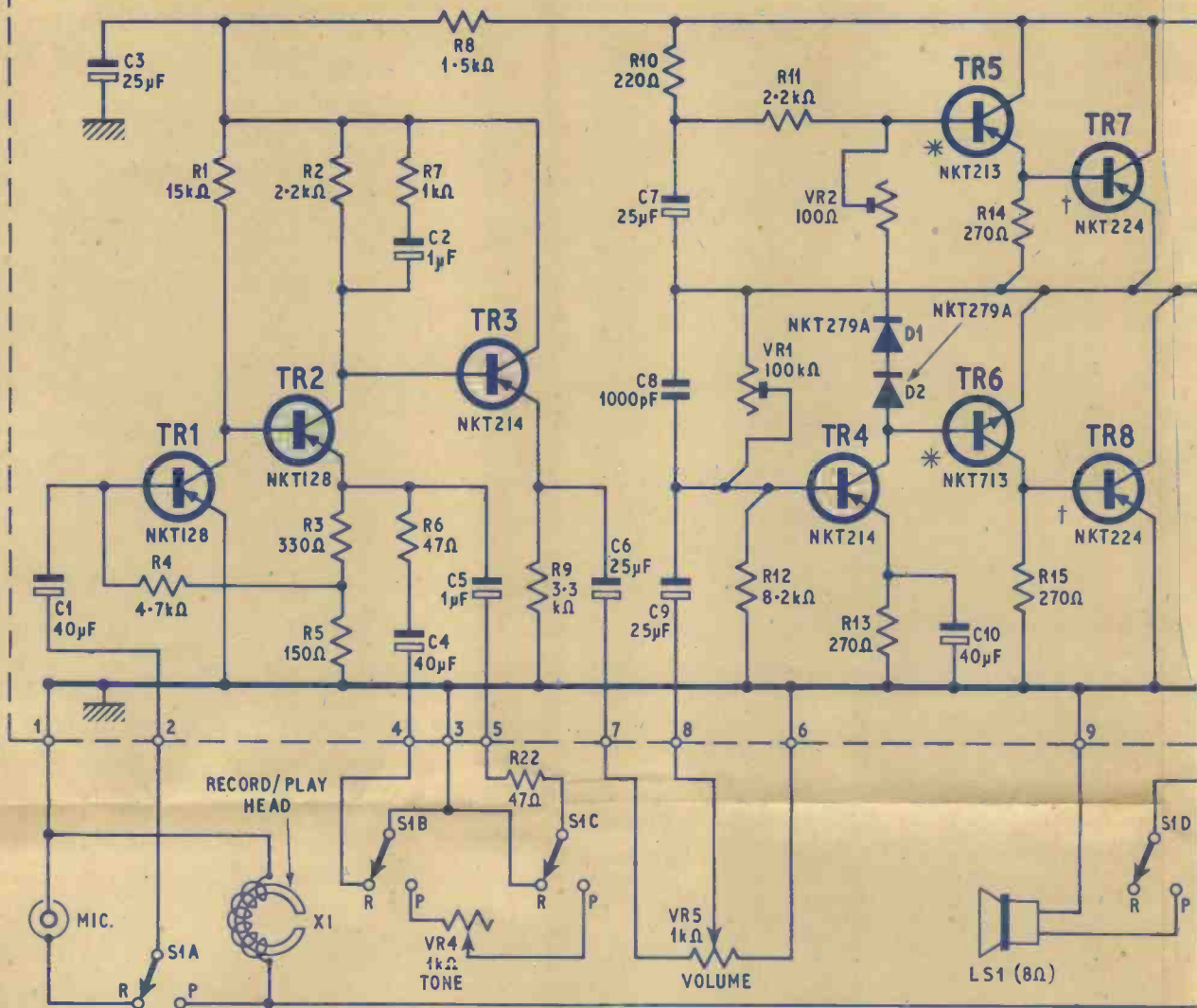
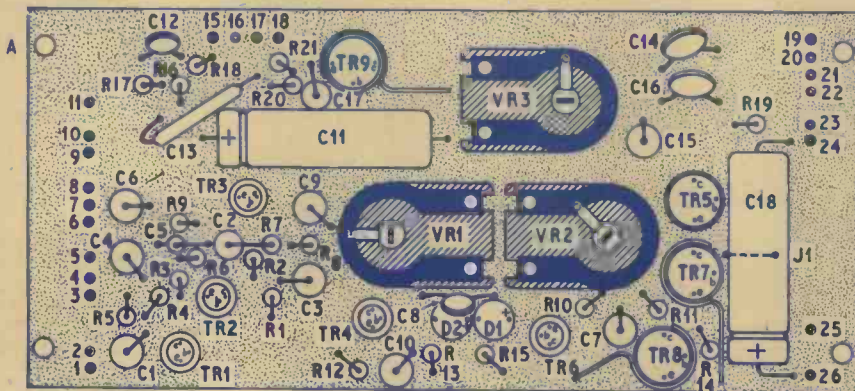
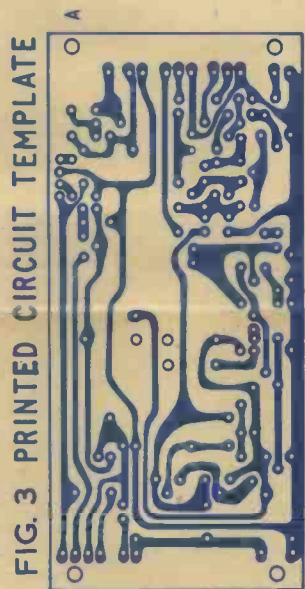

FIG. 1 THE CIRCUIT DIAGRAM

FIG. 2 COMPONENT LAYOUT



ALL CAPACITORS SHOULD BE MOUNTED WITH POSITIVE ENDS TO THE BOARD.  
 TRANSISTORS TR7, TR8 AND TR9 SHOULD BE INSULATED WITH SLEEVING AND  
 FITTED WITH COOLING CLIP, AS SHOWN  
 COMPONENTS C2 AND R7 HAVE THEIR UPPER LEADS SOLDERED ACROSS  
 TO EACH OTHER



# TRANSISTORISED TAPE RECORDER

PRICE 5/-

PUBLISHED BY GEO. NEWNES LTD.,  
TOWER HOUSE, SOUTHAMPTON STREET,  
LONDON, W.C.2.

\*† MATCHED PAIR

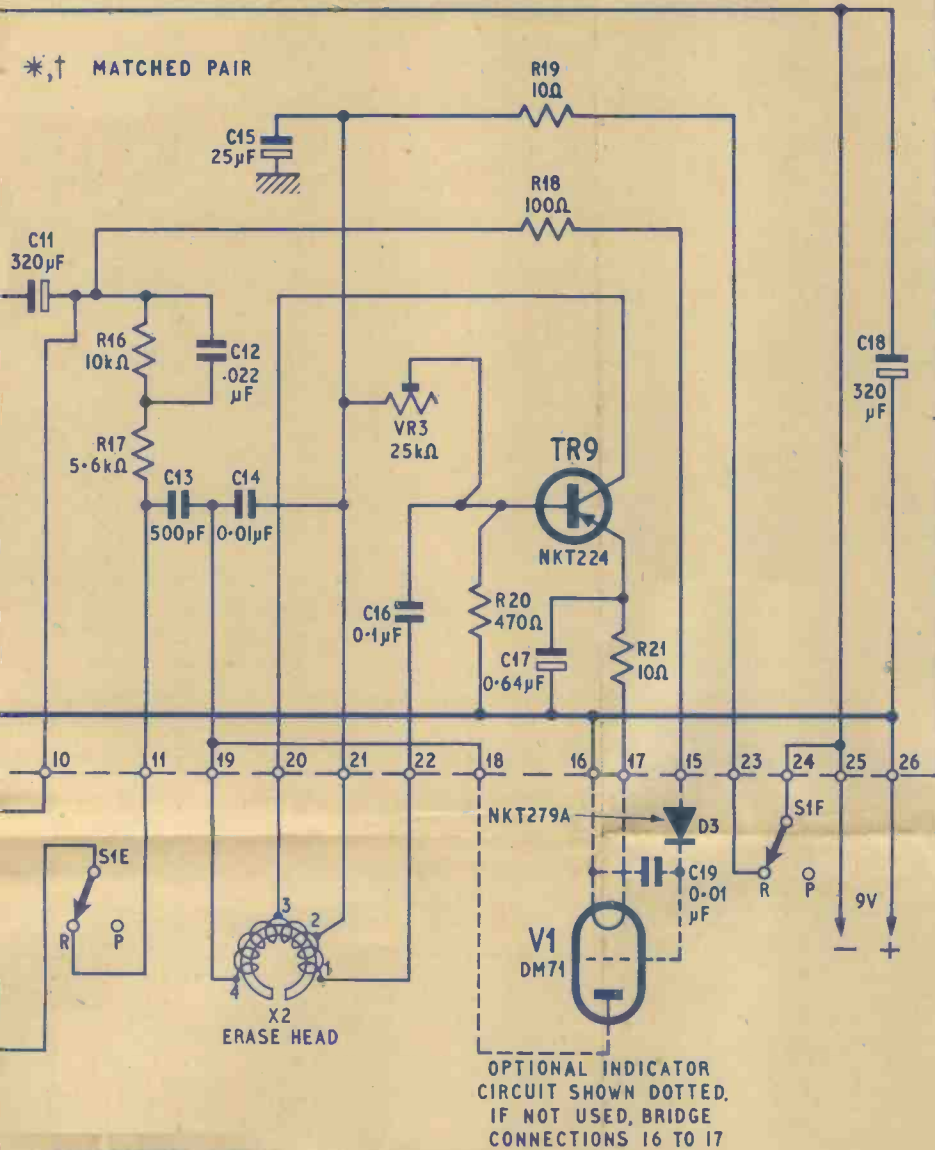

## COMPONENTS LIST

### Resistors

R1	15kΩ	R12	8.2kΩ
R2	2.2kΩ	R13	270Ω
R3	330Ω	R14	270Ω
R4	4.7kΩ	R15	270Ω
R5	150Ω	R16	10kΩ
R6	47Ω	R17	5.6kΩ
R7	1kΩ	R18	100Ω
R8	1.5kΩ	R19	10Ω
R9	3.3kΩ	R20	470Ω
R10	220Ω	R21	10Ω
R11	2.2kΩ	R22	47Ω

All 10%, 1/4W carbon.

### Transistors

TR1	NKT128
TR2	NKT128
TR3	NKT214
TR4	NKT214
TR5	NKT213
TR6	NKT713
TR7	NKT224
TR8	NKT224
TR9	NKT224

matched h<sub>FE</sub> at 50mA

sleeved, matched h<sub>FE</sub> at 50mA

sleeved

### Diodes

D1	NKT279A
D2	NKT279A
D3	NKT279A

### Capacitors

C1	40µF	elect. 2.5V (R)
C2	1µF	elect. 40V (S)
C3	25µF	elect. 6.4V (R)
C4	40µF	elect. 2.5V (R)
C5	1µF	elect. 40V (S)
C6	25µF	elect. 6.4V (R)
C7	25µF	elect. 6.4V (R)
C8	1,000pF	ceramic (Erie Hik/831)
C9	25µF	elect. 6.4V (R)
C10	40µF	elect. 2.5V (R)
C11	320µF	elect. 10V (M)
C12	0.022µF	ceramic (Erie 831/T/12V)
C13	500pF	mica
C14	0.01µF	ceramic (Erie Hik/811)
C15	25µF	elect. 25V (R)
C16	0.1µF	ceramic (Erie Hik/T/12V)
C17	0.64µF	elect. 64V (S)
C18	320µF	elect. 10V (M)
C19	0.01µF	ceramic (Erie Hik/811)

(R), (S), (M) = Mullard C-26AR (S or M) series miniature electrolytics.

### Potentiometers

VR1	100kΩ linear preset (Egen 322/422)
VR2	100Ω linear preset (Egen 322/422)
VR3	25kΩ linear preset (Egen 322/422)
VR4	1kΩ linear
VR5	1kΩ logarithmic

### Miscellaneous

LS1	Loudspeaker unit, 6in elliptical, 8Ω
S1	6 pole 2 way wafer switch
V1	DM71 indicator tube
X1	Record/Play head, Low inductance, approx. 100mH, (BSR MN155—as fitted on TD2)
X2	Erase head, (Miniflux LF6-0)

### Tape Deck

BSR model TD2. Standard erase head to be removed and X2 substituted.

## CIRCUIT DESCRIPTION

Fig. 1 on the blueprint gives the circuit diagram of the record replay amplifier and oscillator together with the appropriate connections to external components.

In the *record* position of the function switch S1 (as shown in the diagram) the input from the moving coil microphone is fed into the base of the first transistor TR1 and is subsequently further amplified in stages TR2, TR3.

The emitter of TR2 is fully decoupled by C5 and the three stage pre-amplifier has a virtually flat response, except for a slight bass boost arising from the shunting effect of C2 and R7 across R2.

From the volume control VR5 the signal is applied to TR4 which drives the complementary symmetry push-pull class B pair of transistors TR5 and TR6; these in turn emitter-follower drive the output pair TR7 and TR8. The output signal then passes via C11, R16, R17 and the switch S1E to the record/playback head X1.

## OSCILLATOR

The oscillator comprises a transformer coupled feedback circuit, where the erase head coils are used as the transformer. Transistor TR9 works in Class C and the circuit is tuned to 50kc/s approximately by the capacitor C14 across two windings of the erase head X2. S1F of the function switch is arranged so that the d.c. supply is applied to TR9 in the *record* position only. The filter R19, C15 is inserted to prevent undue clicks occurring when the oscillator is switched on or switched off. The preset potentiometer VR3 provides adjustment for a suitable erase level.

## RECORDING LEVEL INDICATOR

A DM71 indicator tube can be connected between pins 15, 16, 17 and 18, as shown dotted in Fig. 1. The grid of this tube is driven by the audio signal applied via R18 from the output of TR7, TR8. The positive h.t. supply to V1 is provided by the connection through pin 18 to the bias overwind on the erase head.

If the indicator tube is not required, pins 16 and 17 are shorted.

## PLAYBACK OPERATION

When the function switch is transferred to the *playback* position, the output from the head X1 passes via pin 2 into the input of the pre-amplifier first stage TR1. The replay head itself plays a substantial part in the equalisation that is necessary to offset the frequency versus voltage output characteristic. This frequency compensation in the pre-amplifier is effected mainly by the feedback through R4 which reduces the input impedance so that the changing head impedance does not materially effect the amplifier response. Because a low impedance (approximately 100mH) head is used the d.c. resistance becomes significant below 100c/s, and a degree of passive bass boost is therefore introduced by R7 and C2 across R2.

A variable tone control VR4 is placed across the emitter circuit of TR2 in the *playback* position, but is not operative in the *record* position. The response-corrected signal from the collector of TR2 is now fed via an emitter follower TR3 impedance changing stage to the volume control VR5, and thence into the power amplifier stage TR4-TR8.

## PRESET ADJUSTMENTS

At this point it might be well to examine the purpose of the preset potentiometers VR1 and VR2. VR1 is used in setting up the amplifier and is adjusted until the d.c. centre rail voltage at the emitter of TR7 is approximately half the supply rail voltage, i.e. in the case of a 9V supply between 4.5 and 5V.

VR2 works in conjunction with the thermal compensating diodes D1 and D2 to keep the bias currents in the output stages down when the amplifier is operating at high temperatures. In setting up the amplifier VR2 is adjusted until the quiescent current passing through TR7 and TR8 is of the order of 1.8mA. This setting of the quiescent condition will virtually eliminate any cross-over distortion in this class B output stage.

The circuit sensitivity is designed so that a maximum r.m.s. output of 800mW may be obtained from a fully modulated tape. This output is fed via C11 into a 8 ohm loudspeaker. Care should be taken that no load less than 8 ohms is connected across pins 9 and 10.

## CIRCUIT BOARD CONSTRUCTION

A full list of components for the amplifier module is given on the blueprint. This amplifier can be constructed on a Verokit or Electrokit board, or as a "printed wiring" module. A full size template for etching a printed board appears in Fig. 3. (Those who do not wish to carry out the etching procedure themselves will be interested to learn that a prepared circuit board type PC 8206, and completed amplifier unit type PC6, can be obtained from Newmarket Transistors Ltd., Newmarket, Suffolk.)

For constructors who propose to use the suggested layout incorporated in the print board described above, an amplifier component layout is given in Fig. 2. For ease of assembly this layout should be followed carefully, and only the specified type of components used. Other layouts may give rise to instability, and different style components may not fit physically in this present arrangement.

*View inside the tape recorder cabinet showing the two 15 ohm elliptical loudspeakers. These loudspeakers are connected in parallel.*

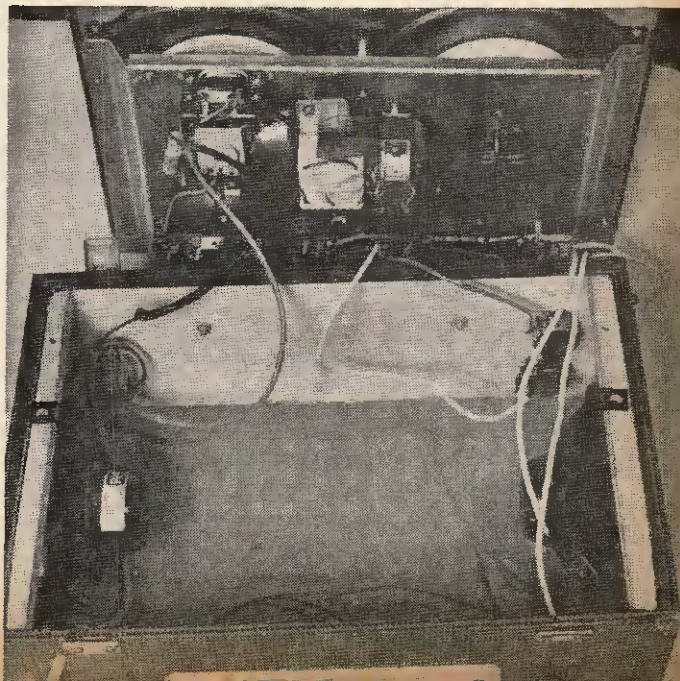



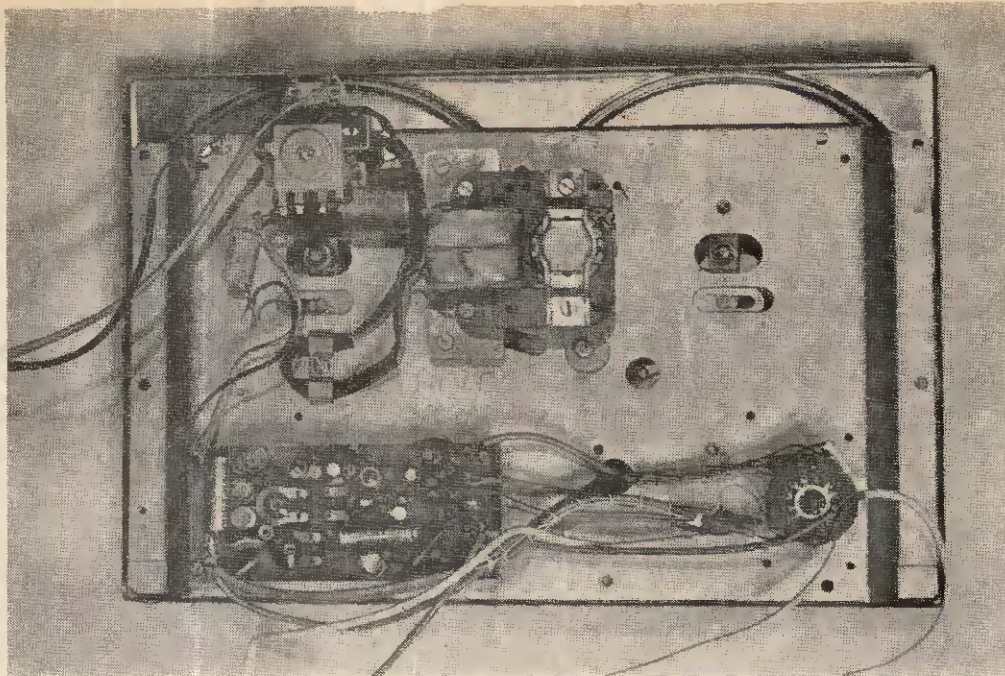

View of the underside of the tape deck showing positioning of the switch, power pack and module

### MAINS POWER PACK

The circuit diagram Fig. 1 shows the amplifier as supplied from a 9V battery. For mains operation a suitable power pack circuit is given in Fig. 4. This can be obtained as a completed unit (type PC101) from Newmarket Transistors Ltd.

The power pack uses a standard bridge rectifier fed from the 12V secondary of a mains transformer T1. Although the amplifier circuit of Fig. 1 indicates a 9V power supply, it is possible to operate on supply voltages up to 12V. Care should be taken however to see that the power pack output does not exceed this figure. The series dropping resistors R23 and R24 may need changing in value depending upon the output actually obtained on load.

### COMPLETE TAPE RECORDER

The photographs show a complete tape recorder system built with the amplifier module described above. The case was made of plywood and covered with self-adhesive plastic material. The overall dimensions are 13½in × 9½in × 6½in deep.

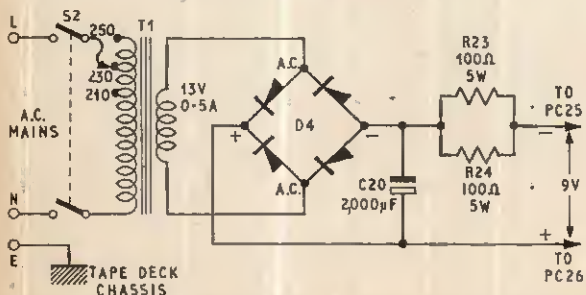

Fig. 4. Circuit diagram of a suitable mains power pack for the tape recorder

A pair of small 15 ohm elliptical loudspeakers are fitted inside the cabinet, one to either side panel. Since these units are connected in parallel, the correct load impedance of 8 ohms is offered to the amplifier.

The cabinet wiring is shown in Fig. 5. The arrangement of the amplifier module on the underside of the tape deck can be clearly seen in this diagram.

The printed wiring board is secured as follows: a small block of softwood 2½in × ¾in × ½in is firmly glued to the tape deck itself to support the right hand side of the amplifier, and the amplifier is then fixed to this block with two ¼in No. 6 wood screws. The left hand end of the board is mounted on two metal posts ½in long by ¼in diameter, drilled to take the fixing screws required. Posts were not used to secure the right hand end of the amplifier as through fixing screws would foul the flywheel assembly on the top side of the deck.

Some of the fixing holes will have to be drilled in the tape deck and care must be taken to ensure that none of the drilling waste falls into the mechanism of the motor. A good way of ensuring this is to smear the drill with thick grease prior to drilling.

## COMPONENTS ...

### Mains Power Pack

- |     |  |              |
|-----|--|--------------|
| R23 | 100Ω 5W wirewound  | } (see text) |
| R24 | 100Ω 5W wirewound  |              |
| C20 | 2,000µF elect. 25V   |              |
| D4  | Selenium bridge rectifier 18V r.m.s. 1A (Radiospares REC.24)                           |              |
| T1  | Filament transformer. Tapped primary; secondary 13V 0.5A (Radiospares "Standard" type) |              |
| S2  | Double pole on/off toggle switch   |              |

The method of mounting the power supply components should be clear from Fig. 5. Care must be taken to ensure that the plastic clip retaining the smoothing capacitor does not foul the moving part of the spool carrier assembly.

### MODIFIED SWITCH

Normally only one Yaxley type switch wafer is supplied with the tape deck. For the particular system described here, an extra switch wafer will have to be acquired to meet the additional number of switching operations. (This can be obtained from the deck manufacturers.)

The two wafers should be spaced  $\frac{3}{4}$  in apart on the switch and care taken to ensure that the spacing pillars are not so big in diameter as to short out the metal switch contacts. Inspection of the stand-off pillars on the deck as supplied will show that they are tapered.

The switch wafers tend to be brittle, and they should be eased gently on to the shaft. Note particularly that should it ever be necessary to remove these wafers,

extreme caution must be exercised as the centre of the wafer is liable to stick to the shaft and detach itself from the body, thus ruining the whole wafer.

### GROUPING OF LEADS

To prevent hum pick-up and instability in the amplifier, certain leads should be grouped together in a common sleeving as follows:

- (a) Pins 1 and 2 to S1A.
- (b) Pins 3 and 4 to S1B and S1C.
- (c) Pin 5 to tone control VR4 (via R22 and S1C).
- (d) Pins 6, 7 and 8 to volume control VR5.
- (e) Pins 9 and 10 to S1D.
- (f) Pin 11 to S1E.
- (g) Pins 19, 20, 21, 22 to erase head X2 (cable "A").
- (h) Pins 23 and 24 to S1F.
- (i) Pins 25 and 26 to the power supply unit.
- (j) The mains leads from the motor should be connected directly to the mains transformer input terminals.

*continued on page 851*

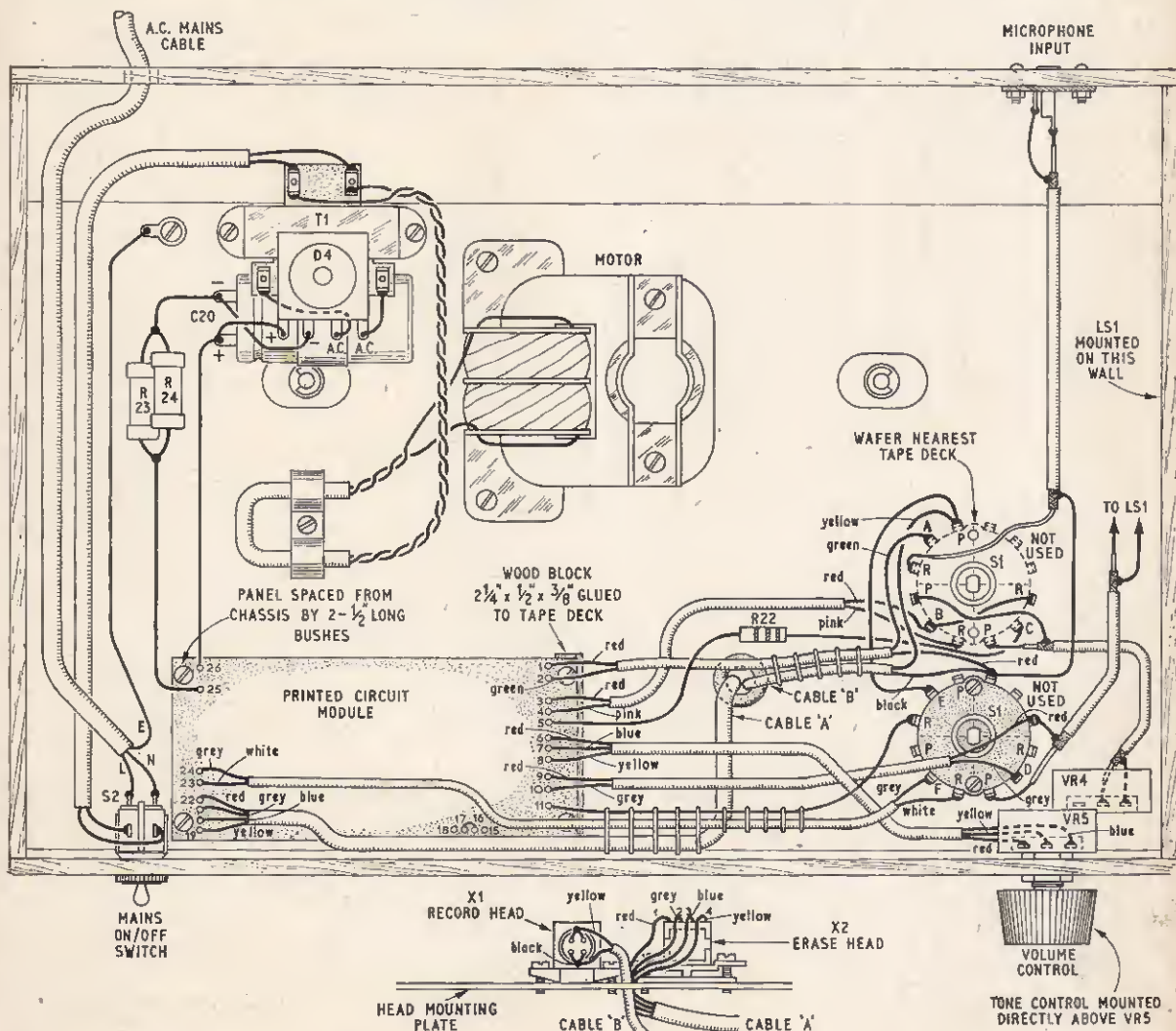
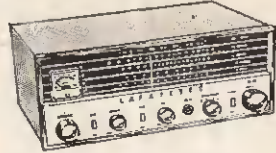

Fig. 5. The complete wiring details of the tape recorder. The arrangement of the amplifier module on the underside of the deck can be seen more clearly than in the photograph on the preceding page



**LAFAYETTE HA-63 COMMUNICATION RECEIVER**  
7 valves plus Rectifier, 4 Bands, 550 kc/s-31 Mc/s, "S" Meter—MPO—ANL—Bandspread Tuning. 200/250v. A.C. Brand New 25 Gns. Carr. Paid.



**STAR SR.40 COMMUNICATION RECEIVER**  
4 Bands, 550 kc/s-30 Mc/s, "S" Meter—BFO—ANL—Bandspread Tuning—Built-in speaker 200/250v. A.C. Brand New, 18½ Gns. Carr. 10/-.



**OS/8B/U OSCILLOSCOPES**  
High quality Portable American Oscilloscope, 3" cart. T. B 3 c/s-50 kc/s X Amp; 0-500 kc/s Y Amp; 0-2 Mc/s. Power requirements 105-125v. A.C. Supplied in brand new condition, fully tested. £25. Carr. 10/-, Suitable 230/115v. Transformer 15/8.

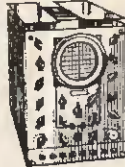

**ERSKINE TYPE 13 DOUBLE BEAM OSCILLOSCOPE**  
Time base 2 c/s-750 kc/s. Calibrators at 100 kc/s and 1 Mc/s. Separate Y1 and Y2 amplifiers up to 5.5 Mc/s. Operation 110/230 volt A.C. Supplied in perfect working order. £27/10/-, Carriage 20/-.



**CLEAR PLASTIC PANEL METERS**  
First grade quality. Moving Coil panel meters, available ex-stock. S.A.E. for Illustrated leaflet. Discounts for quantity. Available as follows: Type MK. 88 P. 1, 21, 32in. square fronts.

5mA.....	22 8	1 A D.C.....	22 8	900V D.C.....	22 8
10mA.....	22 8	2 A D.C.....	22 8	500V D.C.....	22 8
20mA.....	22 8	5 A D.C.....	22 8	750V D.C.....	22 8
50mA.....	22 8	3V D.C.....	22 8	15V A.C.....	22 8
100mA.....	22 8	10V D.C.....	22 8	50V A.C.....	22 8
150mA.....	22 8	20V D.C.....	22 8	150V A.C.....	22 8
200mA.....	22 8	50V D.C.....	22 8	300V A.C.....	22 8
500mA.....	22 8	100V D.C.....	22 8	500V A.C.....	22 8
1000mA.....	22 8	150V D.C.....	22 8	"S" Meter 1mA/20/6	

**POST EXTRA** Larger sizes available—send for lists.  
**ILLUMINATED "S" METER.** 1½ in. square front. Cal. In 8 units. 6V. hmp. 20/6. P. & P. 1/. Ditto 2 5/16in. square 39/8. P. & P. 1/.



**TRANSISTORISED TWO-WAY TELEPHONE INTERCOM.**  
Operative over amazingly long distances. Separate call and press to talk buttons. 2-wire connection. 1000' of applications. Beautifully finished in chrome. Supplied complete with batteries and wall brackets. 7 gns. pair. P. & P. 5/-.

**MODEL ZQM TRANSISTOR CHECKER**

It has the full capacity for checking on A, B and I.C.s. Equally adaptable for checking diodes, etc. Spec. : A : 0-70-9997. B : 0-200. I.C. : 0-50 microamps, 0-5 mA. Resistance for diode 200Ω—1 MEG. Supplied complete with instructions, battery and leads. £6/19/6. P. & P. 2/6.



**MAGNAVOX 363 TAPE DECKS**

New 3-speed tape deck, supercedes old Callisto studio deck. 2-track £10.10.0. 4-track £13.10.0. Carr. Paid.



**AVO METERS**  
Supplied reconditioned, guaranteed perfect.  
Model D £8.19.6  
Post and Ins. 5/-

**MINE DETECTOR No. 4A**  
Will detect all types of metals. Fully portable. Complete with instructions. 39/8. Carr. 10/- Battery 8/6 extra.

**BEST BUY!**

Send 1/- P.O. for full Catalogue and Lists. Open 9 a.m. to 6 p.m. every day Monday to Saturday. Trade supplied.

**SILICON RECTIFIERS**

200 v. P.I.V. 200mA.....	2 8
400 v. P.I.V. 3 amp.....	7 6
200 v. P.I.V. 6 amp.....	6 8
1,000 v. P.I.V. 630 mA.....	7 8
800 v. P.I.V. 500mA.....	5 8
400 v. P.I.V. 500mA.....	3 8
200 v. P.I.V. 1 amp.....	3 8
150 v. P.I.V. 150mA.....	1 8

Discounts for quantities. Post extra.

**AMERICAN TAPE**

First grade quality American tapes. Brand new and guaranteed. Discounts for quantities.

3in., 225ft. L.P. acetate.....	4/-
3½in., 600ft. T.P. mylar.....	10/-
5in., 600ft. std. plastic.....	8 6
5in., 900ft. L.P. acetate.....	10/-
4in., 1,200ft. D.P. mylar.....	15/-
5in., 1,800ft. T.P. mylar.....	25/-
3½in., 1,200ft. L.P. acetate.....	12 6
5½in., 1,800ft. D.P. mylar.....	22 8
5½in., 2,400ft. T.P. mylar.....	45/-
7in., 1,200ft. std. mylar.....	12 6
7in., 1,800ft. L.P. acetate.....	15/-
7in., 1,800ft. T.P. mylar.....	20/-
7in., 2,400ft. D.P. mylar.....	25/-
7in., 3,600ft. T.P. mylar.....	58/6

Postage 2/-. Over £3 post paid.

**NEW MODEL! LAFAYETTE HA-230 AMATEUR COMMUNICATIONS RECEIVER**

Supersedes model HE-30. 8 valves + rectifier. Continuous coverage on 4 bands. 550 kc/s-30 Mc/s. Incorporates I RF & 2 IF stages, Q Multiplier, B.F.O., ANL, "S" meter. Electrical bandspread, Aerial trimmer etc. Supplied brand new and guaranteed. 33 gns. S.A.E. for full details. Also available in semi Kit Form. 25 gns.



**NEW MODEL! LAFAYETTE HA-55 AIR-CRAFT RECEIVER**

208-138 Mc/s. High selectivity and sensitivity. Incorporates 2 RF stages including 6CW4 Excitator, 8 tubes for 11 tube performance, solid state power supply, adjustable squelch control, slide rule dial, built in 4in. speaker and front panel phone jack. 220/250v. A.C. Supplied brand new and guaranteed. 18 gns. Carr. 10/-.

**TE22 SINE SQUARE WAVE AUDIO GENERATORS**



Sine: 20 cps to 200 kc/s. on 4 bands. Square: 20 cps to 20 kc/s. Output impedance 5,000 ohms. 200/240v. A.C. operation. Supplied Brand New and Guaranteed with instruction manual and leads. £15. Carr. 7/6.



**LAFAYETTE TE-46 RESISTANCE CAPACITY ANALYZER**

2 MF-2,000 MFD. 2 ohms-200 Megohms. Also checks impedance, turns ratio, insulation 200/250v. A.C. Brand New £15. Carr. 7/6.



**LEADER LSG-10 R.F. SIGNAL GENERATOR**

120 kc/s-250 Mc/s on 6 ranges. Variable R.F. and A.P. outputs. Large clear scale. Size 7½" x 10½" x 4½". 220/250v. A.C. Operation. Brand New £12. Carr. 7/6.

**2-WAY RADIOS**



3 transistor. Range up to 1 MILE. £9/17/6 per pair. Post extra. 9 transistor. Range up to 5 miles. £25 per pair. Post extra. S.A.E. for full details.

**TS-76 20,000 O.P.V. PUSH BUTTON MULTI-TESTER**

Simple operation, D.C. volts up to 1,000 v. A.C. volts up to 1,000 v. Resistance up to 10 megohm. Current up to 250 mA. Decibels -20 to +36 db. £55.0. P. & P. 2/-.



**VOLTAGE STABILIZER TRANSFORMERS**

Input 80-120v. and 160-240v. Constant output 110v. or 240v., 250 watts. Brand New guaranteed. £10.10.0. Carr. 7/8.



**VARIABLE VOLTAGE TRANSFORMERS**

Brand New Guaranteed—Fully Shrouded. Input 230v. 60/60 c/s. Output 0-260 Volts.

1 Amp.....	£4.10.0
2.5 Amp.....	£5.17.6
5 Amp.....	£9.0.0
8 Amp.....	£13.10.0
10 Amp.....	£17.0.0
12 Amp.....	£19.10.0
20 Amp.....	£32.10.0

2.5 Amp Portable—Metal Case with Meter. Fuses, etc. £9/17/6.

**MODEL PV-58 VALVE VOLTMETER**

11 meg. input. 7 D.C. volt ranges. 1.5-1,500 v. 7 A.C. volt ranges. 1.5-1,500 v. 4,000 Peak to Peak. Resistance 2 ohm to 1,000 megohm. Decibels -10db to +64db. Supplied brand new with instructions, leads and probe. £12/10/- P. & P. 3/6.



**MODEL TE-12**

20,000 O.P.V. 0/6/0/130/120/600/1,200/3,000/6,000 v. D.C. 0/6/30/120/600/1,200v. A.C. 0/60µA 6/60/600 MA. 0/5K/600K/6 Meg. 60 Meg. Ω. P.P. 2 MFD. £5/19/6. P. & P. 2/6.



**MODEL 500, 30,000 o.p.v. 0/5/1/2.5/10/25/100/250/500/1,000v. D.C. 0/2.5/10/25/100/250/500/1,000v. A.C. 0/80µA/5/50/500MA. 12 amp. D.C. 0/60K/6Meg. /60. Meg. Ω. £8/17/6 Post Paid.**

**TE-51 NEW 20,000Ω/VOLT MULTIMETER**

0/6/60/120 1,200v. A.C. 0/3/30/60/300/600/3,000v. D.C. 0/60µA/12/300 MA. D.C. 0/60K/6 Meg. Ω 85/- P. & P. 2/6.



**GW. SMITH & CO (RADIO) LIMITED**  
Phone: GERRARD 8204/9155  
Cables: SMITHEX LESQUARE  
3-34 LISLE STREET, LONDON, W.C2

**BRAND NEW AM/FM (V.H.F.) RADIO GRAM CHASSIS AT £13.13.0 (Carriage Paid)**

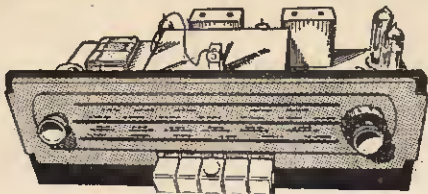

Chassis size 15 x 6 1/2 x 5 1/2 in. high. New manufacture. Dial 1 1/2 x 4 in. in 2 colours, predominantly cream. 200-250v. A.C. only. Pick-up, Ext. Speaker, Ac., E., and Dipole Sockets. Five pushbuttons—OFF, L.W., M.W., P.M. and Gram. Aligned and tested O.P. Transformer. Tone control. 1000-1900 Mc.; 200-550 Mc.; 88-98 Mc/s. Valves E230 rect.; ECH81, EF80, EAF80, EL84, ECC85, 3-ohm speaker required. 10 x 6 in. ELLIPTICAL SPEAKER 25/- to purchasers of this chassis. TERMS: (Chassis) £3.10.0 down and 5 monthly payments of £2.4.0. Cheap Room Dipole for V.H.F. 12/6. Feeder 6d. per yard. ALTERNATIVE DESIGN. L.W. 1000-1900 Mc.; S.W. (3-15 Mc/s); M.W. 190-475 Mc.; V.H.F. 87-106 Mc/s. Gram position. Otherwise similar to above chassis. Price £15.15.0 (carr. paid). TERMS: £3.10.0 down and 6 monthly payments of £2.4.0. Total I.P. price £16.14.0. Circuit diagram 2/6.

**2-VALVE GRAMOPHONE AMPLIFIER**

Price 37/6 (P. & P. 2/6)

Overall size 4" wide x 5" high x 2 1/2". Volume and tone controls. Mains lead. Screened lead input. With output transformer for 3-ohm. For series connection to Garrard and B.S.R. Autochangers and Discors, having 90v. tapping. Can also be supplied on fabric covered board with mains transformer and 6" x 4" speaker at 55/-. (P. & P. 5/-). 2-Valve Gram. Amp. Board 14" x 7 1/2" (x 23" overall). UY85, UCC85 and UL84 with Speaker 7" x 4". Price 60/-. (P. & P. 6/-).

**BATTERY ELIMINATOR**

For 4 low consumption valves (9v range) 90v. 15mA and 1.4v. 125mA, 42/6. (4/- post), 200-250v. A.C. Also for 250 mA, 1.4v. and 90v. 15 mA at same price. Two units to replace existing batteries.

**SELF-POWERED V.H.F. TUNER CHASSIS.** Covering 88-95 Mc/s. Mutual permeability tuner. Dims. 8 x 6 x 6 in. high. Valves ECC85 and 2-8F89's and EABC8 with metal rectifier. Mains transformer. Fully wired and tested ONLY £8.17.6 (carr. paid). Room dipole 12/6. Feeder 6d. per yard.



**PUSH-PULL O.P. AMPLIFIER £5.5.0 (6/- Carr.)**

Brand new 200-240 A.C. mains. Bass, treble and vol. controls, with valves EZ80, ECC83 and 2-EL84 giving full 8 w. Chassis 12 x 3 1/2 x 3 1/2 in. With o.p. trans for 2-3 ohm speaker. Front panel (normally screwed to chassis) may be removed and used as "flying panel".



**4 TRANSISTOR MINIATURE PUSH-PULL AUDIO AMPLIFIER HIGH IMPEDANCE**

PRINTED CIRCUIT, 4in. x 2 1/2 in. x 1 1/2 in. over transformers. Output for 3-ohm speaker. Suitable for microphone, record player and intercom. 8 volt battery required. Frequency range 100 cps. to 20 Kcps. Push-pull output class B. Instruction sheet provided. Fully wired ready for use. Three types, 200mW, 35/-; 500mW 41/-; 1.2W 57/6. (P. & P. 2/6 each).



**CM21 CRYSTAL MICROPHONE**

With 3.5 mm. Jack plug, 12/6 (Post 1/6.)

**4 TRANSISTOR BABY ALARM.** Attractive walnut veneer speaker cabinet 13 1/2" x 6" front. 60ft. Ext. Lead. Ear piece as mike sensitive at 20ft. (P.P.6 battery required—will last for hundreds of hours). Volume Control and On/Off. Price £3.19.8. (P. & P. 5/-).

**30 WATT AMPLIFIER**

Valves 2 x EL34, GZ34, EF80, ECC82, ECC83. Size 14" x 8" x 7 1/2" high over cover. Complete with protective cover. High and low gain inputs. Front controls are: Low gain-high gain, Treble Step, Bass, Treble Slope and Mains Switch. For 15 ohm and 3 ohm speakers. Input by standard jack sockets, output by phono sockets to loudspeakers. £17.17.0. (Carr. Paid).

**GLADSTONE RADIO**

66 ELMS ROAD, ALDERSHOT, Hants.

(2 mins. from Station and Buses.) Aldershot 22240  
CLOSED WEDNESDAY AFTERNOON  
CATALOGUE 6d.  
Regret overseas orders cannot be executed



Contil printed circuit system, very low cost, includes connectors and chassis, send for free illustrated leaflet. Boards with gold plated connectors from 11/6 to 4/6.

**WEST HYDE DEVELOPMENTS LTD.**  
30 HIGH STREET, NORTHWOOD, MIDDX.  
NORTHWOOD 24941

Return  
of  
Post

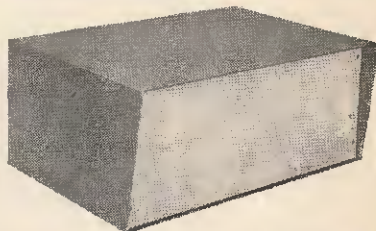

High-intensity neons, 1/2 or 1 inch diameter, 10 off 25/-, reductions for quantity.

Case No. 1 off 5 off  
7" x 5" x 5" 39/- 38/-  
9" x 7" x 5" 41/6 40/6  
8" x 6" x 7" 41/- 40/-  
12" x 7" x 7" 48/6 47/-  
16" x 12" x 7" 95/6 93/6  
Prices include postage and packing. 5% discount, C.W.O.

**CONTIL CASES**

have all these advantages:

★ lowest prices yet ★ 21 gauge steel with 18 gauge front panel ★ electric blue hammer finish with white panel ★ front panels supplied with a special easy to mark out strippable coating ★ 8 loose feet supplied free.

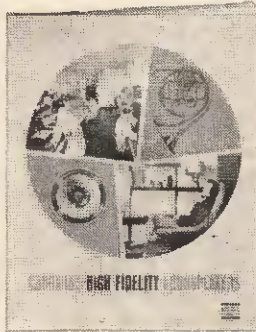

**D.I.Y. with GOODMAN'S HIGH FIDELITY MANUAL**

A new, larger and more colourful edition—revised and completely up-to-date. It contains articles of particular interest to the D.I.Y. enthusiast—including special beginners page, advice on stereo, stage-built systems and full cabinet drawings. Whether building or improving your own audio set-up or choosing a complete speaker system, you'll find it useful and interesting as well as informative. Ask your Goodmans dealer or send coupon for your FREE copy.

Please send me a free copy of the Goodman's High Fidelity Manual

Name \_\_\_\_\_

Address \_\_\_\_\_

P.E.10

**GOODMANS** INDUSTRIES LIMITED  
Axiom Works, Wembley, Middlesex  
Telephone: WEMBLEY 1200  
A Member of the Rentasel Group



# ELECTRO-COMBINATION LOCK

**T**HE MAIN disadvantages with an ordinary mechanical combination lock are firstly that the lock must be on the safe or strongbox itself, and is thus easily visible, and can be blown off; secondly, an expert can find the combination.

The electrical lock described in this article can be mounted any reasonable distance from the safe, has no tumblers, and so cannot be "stethoscoped". If the wrong combination is selected, even by only one number, an alarm bell rings, and continues to ring until cancelled by the owner of the safe or somebody else knowing the combination. This lock costs far less to make than it would cost to buy a commercial lock of the combination type.

The lock on the safe is, in fact, a solenoid operated bolt. These are readily available in two types; 250 volt a.c. operated, and 12 volt d.c. operated. For the circuit in question, the latter type was chosen. The a.c. type would have meant an additional relay, and therefore a higher cost.

## COMBINATION

The correct combination for the circuit shown in Fig. 1 is 11, 7, 5, 8. When S1-4 are set to these positions and S5 pressed, current flows from the power supply through these set switches, through the bolt solenoid, the normally closed contacts of S6, and back to the power supply unit. Other combinations can be arranged by wiring the wafer switches in a different sequence, or renumbering the switch positions.

If the wrong combination is set the current flows through the wafer switches, but on finding the one which is incorrectly set, it follows a path through the relay coil, and returns to the power supply unit through S5 (closed) and S6. The relay is operated; contacts RLA1 and RLA2 close. Contacts RLA1 holds the relay on even if S5 is switched off. Contacts

RLA2 supply current to the alarm bell, which will continue to ring until S6 is opened and disconnects the supply to the relay coil. To reset the circuit in readiness for a subsequent alarm, S6 should be closed again.

Any number of switches may be connected up as in Fig. 1, with a corresponding increase or decrease in the number of possible combinations. A simple formula can be used to calculate the number of combinations:

$$c = x^n - 1$$

where  $c$  is the number of possible combinations,  $x$  is the number of positions on the switches, and  $n$  the number of switches. Thus with the circuit shown

By P. L. TILSON

in Fig. 1, 20,735 different combinations are possible! With one more switch, the number is increased to 248,831! It should be noted that all the switch contacts *except* those of the actual combination, should be connected together and taken to one end of the relay coil. If this is not done, the alarm system cannot operate.

There is no reason why the unit should not be built for 6 volt operation if this is more convenient. In this case, a relay suitable for 6 volt operation should be used (type MH2 185 ohms). Likewise the transformer, solenoid, rectifier, bell, and pilot lamp should also be 6 volt types.

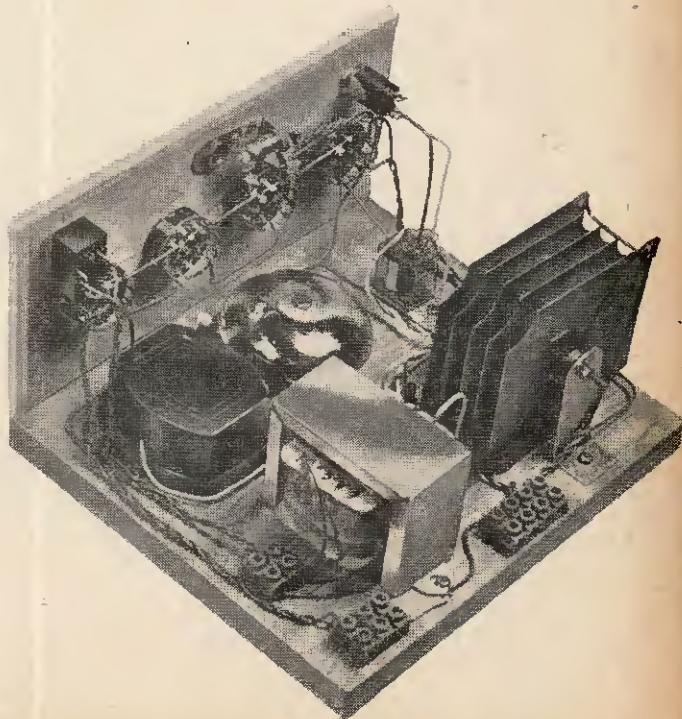

Fig. 1. Circuit diagram of the combination switching system designed for a 12 volt d.c. power supply. The solenoid L1 and switch S6 are shown here but are installed in the safe remote from the main unit

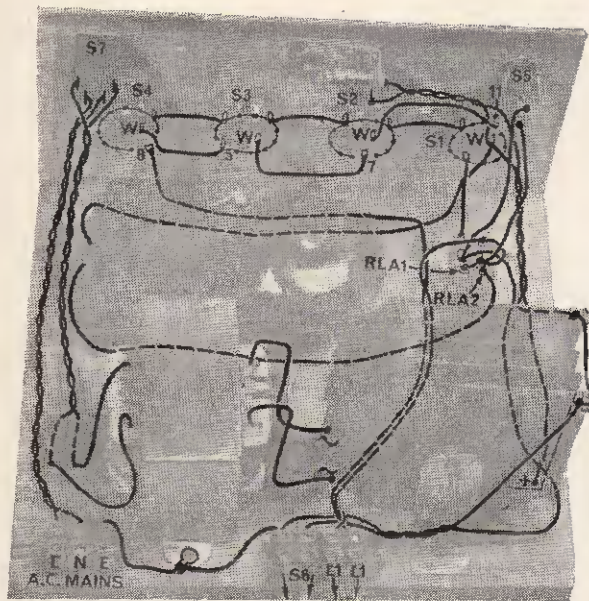
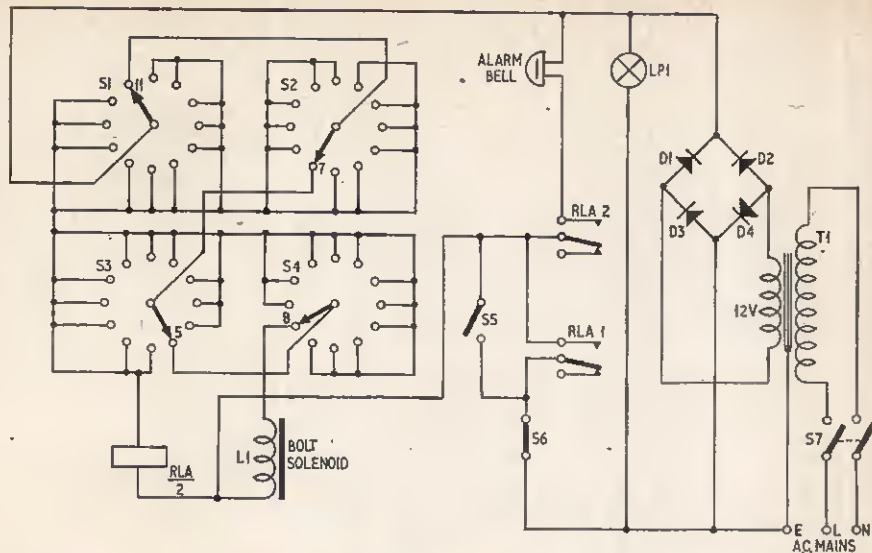

Fig. 2. This photograph of the main switching and power unit has been treated to show the layout and wiring of components

A practical wiring diagram of the control unit and the power supply unit is shown in Fig. 2. The panel indicator lamp may be omitted if desired.

Needless to say, all connections in the unit should be soldered, and a miniature electrical iron is preferable for this operation. Cored solder containing a non-corrosive flux (such as Ersin Multicore) should be used for this purpose. Four-core cable is used for connecting the solenoid and S6 to the control unit, as this happened to be handy, but remember, the flex used must be capable of carrying sufficient current to operate the solenoid. Ordinary 5 amp lighting flex is admirably suited to this purpose.

## COMPONENTS . . .

### Transformer

T1 A.C. mains primary, 12V 3A secondary

### Solenoid

L1 Solenoid operated bolt, 12 volt  
(Service Trading Co., 47/49 High Street, Kingston on Thames)

### Relay

RLA 12 volts 700 ohms (Keyswitch Relays Ltd., type MH2)

### Rectifier

12V 3A metal bridge rectifier

### Switches

S1, S2, S3, S4 1-pole 12-way single wafer types  
S5 Push on, release off single pole push button  
S6 On/off toggle switch

### Lamp

LPI Indicator lamp with 12V bulb

### Miscellaneous

P.V.C. insulated wire, four core cable, plywood, nuts and bolts

## THE SAFE BOLT

It is not proposed to give constructional details of the safe itself as this depends on the individual requirements of the constructor. The author's safe was a box 1 foot square and let six inches into the wall. The surface of the box was panelled to match the surrounding wood.

The solenoid is fixed to the door of the safe with a single clamp and screwed down firmly. The position of the end of the iron core of the solenoid is marked on the safe wall, and a hole of suitable diameter is drilled to take the core. As may be seen in Fig. 3,

the end of the core is chamfered, as is the wall of the safe, to enable the door to be closed without withdrawing the bolt. Fig. 4 illustrates the crude, but effective method of returning the bolt. Any form of coil spring is suitable here, provided that it is not so strong that the solenoid cannot withdraw the bolt. The wires from the coil may be stapled to the door and walls of the safe, and led out of the back.

The only other part which is housed in the safe itself is the alarm bell "cancellation" switch S6. This prevents anybody from cancelling the alarm before attempting to open the safe.

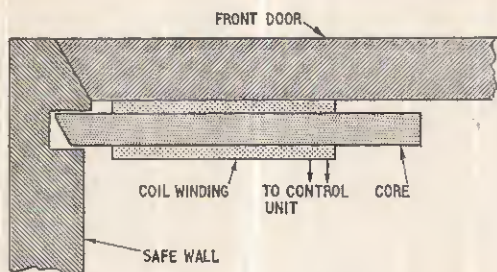

Fig. 3. Sectional plan view of the solenoid bolt mounted inside the safe on the door. Note the chamfered bolt to facilitate easy closure

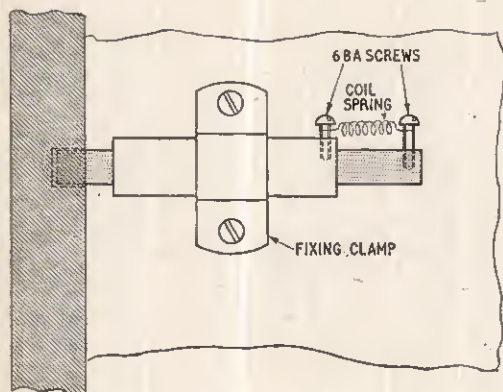

Fig. 4. Interior view of the solenoid bolt mounted on the door with a clamp. The coil spring allows the bolt to remain in the "locked" position until operated by the combination circuit

## TESTING

To test the unit, the safe door should at first be left open. Set the combination switches to the correct combination code, and press S5 intermittently. The bolt should move smoothly backwards and forwards. If it does move, but only slightly, try adjusting the tension of the return spring. If the bolt does not appear to move at all, check the wiring to the bolt, and make sure that S6 is closed. If all is well, set the switches to the "wrong" combination and press S5 again. The alarm bell should ring, and continue ringing even when S5 is released. If it stops ringing when S5 is released check the wiring around the RLA1 contacts of the relay, and of the combination switches themselves. ★

## NEW LOOK TAPE RECORDER

continued from page 846

### ERASE HEAD MOUNTING

After removing the existing erase head, a Miniflux erase head type LF60 should be firmly glued into position. Prior to fixing, a check should be made to see that the "black section" of the head barely shows above the horizontal length of the tape. If necessary adjustment should be made to lower or higher the head position by packing up or filing down the head mounting plate.

Before switching on it is imperative that all connections are rechecked against the circuit diagram Fig. 1 and the wiring diagram Fig 5, otherwise damage to transistors and components may be occasioned.

A microphone of the moving coil variety will be found to be most suitable for use with this recorder.

### SETTING UP PROCEDURE

After all wiring has been completed the three preset controls must be carefully adjusted in order to obtain optimum performance from the recorder.

Ideally, all the following instruments are required for this setting up operation: a.f. signal generator, multirange test meter, valve voltmeter, and oscilloscope. The latter two instruments may, however, be dispensed with and the multirange meter used instead as will be described below.

A 9V battery should be used to power the module during this setting up operation.

### AMPLIFIER

1. Connect a voltmeter between pin 1 (+ line) on the circuit board and the negative side of C11. Set VR1 for a reading of 4.5V.
2. If really low distortion is required, a final dynamic adjustment should be made as follows. Inject a 1kc/s sine wave signal into the input of the amplifier (pin 2) and examine the output across pins 9 and 10 with an oscilloscope. Raise the input level until the trace shows signs of clipping and finally adjust VR1 for even clipping on both sides.  
*If no oscilloscope is available, vary the amplitude of the applied input signal and observe the reading on the voltmeter. If this varies more than a few tenths of a volt from 4.5V, make careful adjustments to VR1 until these voltage changes are reduced to a minimum.*
3. Inspect the waveform at pin 10 while applying 1kc/s sine wave signal to pin 2. Reduce VR2 until slight crossover distortion begins to show across axis of the display.  
*Alternatively, unsolder TR8 emitter lead from the positive line. Connect a d.c. milliammeter to TR8 emitter (-) and to pin 1 (+). Adjust VR2 for a reading of 1.8mA.*

### OSCILLATOR

1. Set VR3 for maximum resistance in circuit.
2. Connect a valve voltmeter between pins 19 and 26. Slowly adjust VR3 for a reading of 50-60V peak to peak.  
*Alternatively, connect a d.c. milliammeter between pin 23 (+) and the negative terminal of the battery. Slowly reduce the value of VR3 until the total current is 30mA.* ★

# the 73 page

by Jack Hum  
G5UM

## Speech or Morse?

On this page last time we had something to say on the subject of transmitting contests. What we did *not* refer to was the means of communication commonly used in such contests—and this omission was deliberate. For around the two basic modes of communication employed within the amateur bands a more or less permanent controversy persists.

These basic modes are *telegraphy* and *telephony*. Which one to use will be determined almost automatically in the light of the type of communication the amateur operator wishes to establish.

For example, the chance of making contact with a fellow-amateur in Australia on one of the long distance bands such as 14 or 21 Mc/s, with a high prevalence of interference and fading, is much greater on the key than through the microphone. Shout yourself hoarse and he won't understand you. Take to morse and he will.

Conversely, a chat with a man in the next street or suburb or county is more naturally done by telephony than morse.

In other words, the circumstances govern the mode.

## A Chore

Unfortunately, this basically commonsensical attitude is not shared by all members of the amateur fraternity—for let the fact be faced: learning morse *is* a chore, and one that comes to be resented by hundreds of amateur radio aspirants only too well aware that they cannot get that coveted transmitting licence without it.

The Post Office requirement is that both the Radio Amateur Examination and the 12 words-a-minute morse test are pre-requisites to the issue of a transmitting permit (except in the case of the tiny minority of

technicians, who are prepared to confine themselves to frequencies of 430 Mc/s and upwards, in exchange for a G8-plus-three licence—and no morse).

There is little comfort to a (probably young) enthusiast who is keen to get a licence to learn that, in effect, "morse is going to be awfully good for you". Yet this happens to be almost exactly the truth, "To mug up the necessary morse to pass the test and then with a sigh forget it all", as someone once said to the writer, is deliberately to shut oneself off from a considerable area of amateur activity.

It is easy enough to imagine, because one's initial interest in "the 73 men" comes from overhearing them talking on the air, that all conversation is telephonic.

A knowledge of morse soon disposes of this assumption—for at the low frequency end of any of the h.f. communication bands an immense amount of communication "on the key" may be heard at almost any time of the day or night.

The fully rounded amateur transmitter who is asked: "Is there a morse key in the house?" will invariably reply "Yes!"

## How to Learn

Let us return, nevertheless, to the realisation that learning morse is a chore, and one to be mastered. How best to go about it?

Whatever books or gramophone discs may be purchased as aids to learning morse, there is no escaping the hard fact that the twenty-six characters of the alphabet and the ten numerals from zero to nine must be committed to heart, and thereafter recognised as *sounds*. Soon the sounds coalesce as words and within a few months the learner should be copying the simpler repetitive phrases that occur in most amateur transmissions.

He may not believe it when "the chore" is first visited upon him, yet constant practice at morse can bring him to the glorious state of being able to sit back and take copy at "25 per" without writing a word. It is then that the telegraphy enthusiast may well make his point that morse can impart just as much information as speech—and just as quickly.

## Skill Counts

All of which brings us back to where we came in—*contests*. To do well in a radio transmitting contest (or *receiving* contest, for that matter) calls for the exercise of skill developed and matured over the years, and culminating in an ability to identify stations so submerged in a mess of interference that ordinary mortals hardly know they are there.

"He has crystal filter ears!" This is the kind of admiring description one sometimes hears bestowed.

Sending and receiving the morse code is itself a skill, part of the larger

IO SOCIETY

100, The Russell Street

NE · HOLBORN 7373-2

Newcomers to this feature may have asked themselves why it is called "The 73 Page". The digits "73" have been the abbreviation for "best wishes" since the earliest days of electric telegraphy. Used to sign off almost every transmission in the amateur bands, they are much sought after for car index plates and house numbers. The Radio Society of Great Britain uses them in its telephone number, as shown in this enlargement of its letter-heading

skill of knowing how to operate a radio station, and particularly of how to make it give good returns during a contest.

It is a melancholy thought that a large proportion of the bright, shiny, well-equipped receiving stations one sees illustrated in the radio magazines of the world are employed to only about one-third of their capacity, simply because their owners know no morse. The implication is plain.

the  
73  
page by



# ELECTRONIC BUILDING BLOCKS

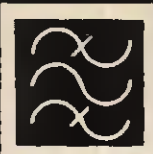

## PART SEVEN

by R. A. DARLEY

FOLLOWING on last month's article on impedance matching devices, we will take a closer look at the Darlington pair and "bootstrap" high impedance amplifier, with special reference to their practical uses. Then we will discuss the theory of some well-known oscillator circuits.

### APPLICATIONS OF THE DARLINGTON PAIR

As well as being used in a.f. amplifier circuits, the Darlington pair has a number of other applications. Two such uses are illustrated in Figs. 7.1a and 7.1b.

As was discussed in part 2 of this series (see May issue), when a resistor and capacitor are wired in series and connected across a voltage supply, the potential at the junction of the two components varies in an exponential manner; a time constant is introduced, in which  $T = CR$ , where  $T$  = time in seconds,  $C$  = capacitance in farads, and  $R$  = resistance in ohms.

By connecting this exponential voltage to the base of a transistor and connecting a relay in series with the emitter or collector, this exponential variation may be used to impart a time delay to the operation of the relay.

If a conventional transistor circuit is used in this application, it is found that the comparatively low input impedance of the transistor stage shunts one or other of the time-constant components and thus reduces the effective value of the component concerned.

By using a Darlington pair circuit as the transistor stage with a high input impedance, this difficulty is largely overcome.

In the circuit shown in Fig. 7.1a, at the moment that S1 is closed and the supply is connected to the circuit, only a very low emitter current is flowing and the relay is not operated; as time passes, the emitter current rises and, after a fixed time delay, the relay operates.

In the circuit of Fig. 7.1b the reverse action takes place; at the moment of switch on, maximum emitter current flows and the relay is operated. As time passes, the emitter current falls in value and, eventually, the relay drops out.

It is important to note that, in both of these circuits, the time delay imparted to the relay depends not only on the values of the time constant components, but also on the characteristics of the relay, the transistor, and the supply potential.

In Fig. 7.1b a switch (S1b) is shown connected in parallel with C and ganged to S1a. Once the circuit has been operated, a voltage is built up across this capacitor. If S1b is not in circuit when the supply voltage is cut off there is no effective discharge path for the capacitor. If the supply voltage is again reconnected it is found that, because the capacitor has retained its charge, the time constant effect is destroyed. The fitting of S1b overcomes this trouble by discharging the capacitor when the supply voltage is cut off.

In the case of the circuit of Fig. 7.1a, the capacitor discharges automatically through the low impedance forward biased emitter-base junctions of the transistors and no additional components are required.

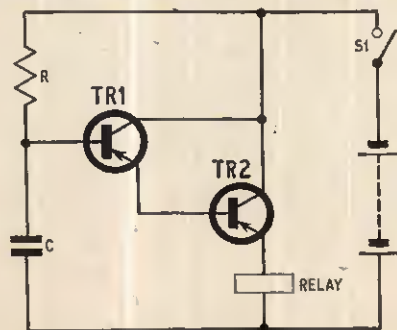

Fig. 7.1a. Darlington pair used to operate a relay

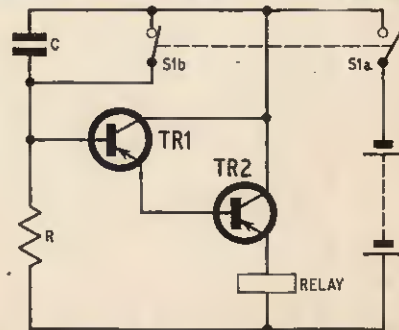

Fig. 7.1b. Darlington pair used to operate a relay, then release it after a time delay

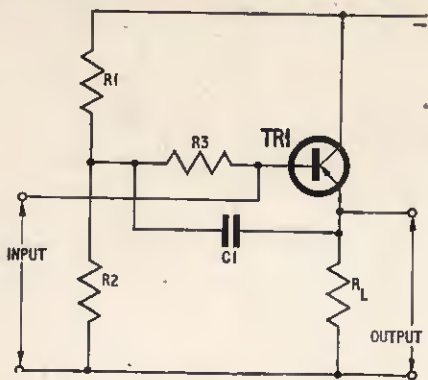

Fig. 7.2a. Basic circuit of a "bootstrap" high impedance amplifier using an emitter follower

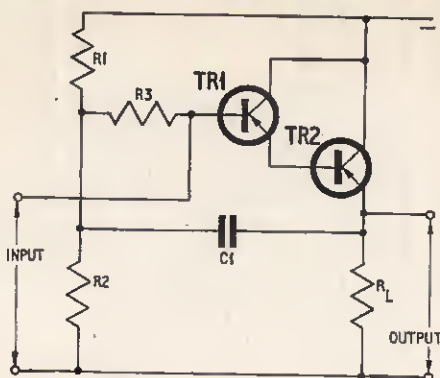

Fig. 7.2b. "Bootstrap" circuit using a Darlington pair

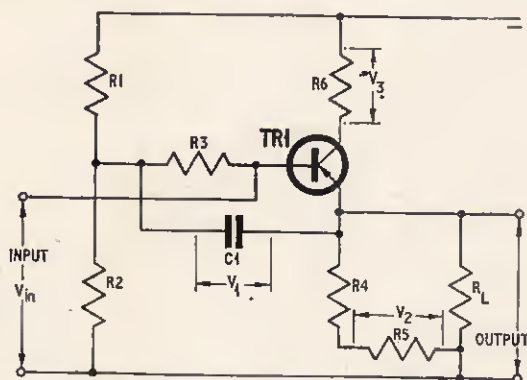

Fig. 7.3 (right). Basic "bootstrap" circuit

Input impedance  
 $Z_{in} > 1,000 \text{ M}\Omega$   
 $V_{in} = V_1 = V_2 = V_3$

## THE "BOOTSTRAP" HIGH IMPEDANCE AMPLIFIER

One of the snags with the Darlington pair emitter follower circuits is that the base bias resistors are effectively in parallel with the input to the transistor circuits.

It was also pointed out earlier in this series that, for good stability, the base bias should be provided via a voltage divider network, in which the current flowing through the lower resistor should be at least 10 times greater than that flowing in the transistor base. Quite clearly, the effect of such a base bias network on an emitter follower or Darlington pair circuit is to reduce the circuit's input impedance by a factor of at least 10.

As an alternative to the divider chain method of obtaining base bias, a high value resistor, of such a value as to limit the base current to the required value, can be connected between the base and negative supply line, as shown in Fig. 6.7 last month. This method has the advantage of considerably reducing the shunting effect on the input circuit, but has the disadvantage of giving poor circuit stability.

The circuit known as the "bootstrap" high impedance amplifier overcomes these disadvantages. Fig. 7.2a illustrates the circuit.

TR1 is connected as an emitter follower, with an emitter load  $R_L$ . Resistors R1 and R2 form a conventional voltage divider base bias network, but an

additional resistor (R3) is connected between the junction of R1-R2 and the transistor base; this is an a.c. isolating resistor. For d.c. purposes, R3 has little effect on the biasing arrangements. A feedback capacitor (C1) is connected between the junctions of R1-R2-R3 and the emitter.

When an input signal is fed to the base of the transistor, an output signal will appear at the emitter, in phase with the input and of almost the same amplitude. If the impedance of C1 is low at the frequency of operation, the signal from the emitter will be fed back to the junction of the voltage divider chain. The a.c. voltages at both ends of R3 are therefore almost equal. If the voltage gain of the emitter follower circuit is exactly 1, the voltages (a.c.) at each end of R3 will be exactly equal. Therefore, no a.c. current is flowing through this resistor; the resistor presents an infinitely high impedance to a.c. It also follows that R1 and R2 can thus have no shunting effect on the input impedance of the circuit.

In practice, of course, the voltage gain is not quite equal to 1, so complete isolation of the base bias components from the input impedance does not take place; sufficient isolation is provided, however, for their effect to be almost ignored. With this circuit, the input impedance is the same as in the emitter follower, ( $Z_{in} \approx \beta R_L$ ) and is in parallel with the leakage resistance.

Using this circuit, quite high input impedances can be obtained with good stability. If a Darlington pair circuit is substituted for the emitter follower, as shown in Fig. 7.2b, impedances in the order of 4 megohms can be obtained using germanium transistors, and as high as 20 megohms using silicon transistors.

### ULTRA-HIGH IMPEDANCE AMPLIFIERS

In the circuit just described, the "bootstrap" principal was applied over one resistor only. Circuits are available in which the principal is employed over more than one part of a circuit, however, and as a matter of interest one such circuit will be roughly described.

When discussing the emitter follower circuit, it was mentioned that the input impedance of the circuit could be raised either by increasing the value of  $R_L$  or the effective value of  $\beta$ , but if  $R_L$  were raised to too high a value difficulties were encountered in meeting the mean emitter current requirements. By using the "bootstrap" principal these difficulties can be overcome.

Fig. 7.3 shows a simplified diagram of a circuit which meets this problem. TR1 is connected as an emitter follower, with emitter load  $R_L$ . Base bias is provided by the voltage divider network R1-R2 and isolating resistor R3. The input signal is applied to the base of TR1, and the output of the emitter is fed back to the junction of the potential divider via capacitor C1; resistor R3 is thus "bootstrapped" and, if the voltage ( $V_1$ ) fed back is of the same phase and amplitude as  $V_{in}$ , it presents an infinite impedance to the input signal.

The d.c. emitter current of the transistor flows through resistors R4 and R5 in series; if a signal of the same phase and amplitude ( $V_2$ ) is applied to the junction of R4-R5, no a.c. current will flow through R4. R4 is thus "bootstrapped" and presents an infinite impedance to a.c.; to d.c., R4 is the nominal d.c. value and no problems are presented in obtaining d.c. values of emitter current. The only path available for a.c. emitter current is through  $R_L$ , which is thus the effective emitter load, and may be any value that is required.

By connecting resistor R6 in series with the collector of the transistor and applying a suitable "bootstrap" voltage ( $V_3$ ) across it, no a.c. voltage drop occurs between the emitter and collector of the transistor. It follows that the transistor leakage resistance is also effectively "bootstrapped" and presents an infinite impedance to a.c.

The input impedance of such a circuit is given as  $Z_{in} = \beta \times R_L$ . Load resistor  $R_L$  can be made any value that is required without imposing any limits on the mean emitter current and causing distortion of the output.

The output impedance of the circuit is given as

$$Z_{out} = r_e/\beta$$

As this circuit is intended for use with inputs having very high values of source resistance the output impedance ( $Z_{out}$ ) of the circuit will also be very high. It is necessary, if the circuit is eventually to feed a common emitter type of amplifier, to feed it at an impedance  $Z_{out}$  into another "bootstrap" amplifier, and thence reduce the output impedance to the required value in a number of successive stages.

With such an arrangement it is possible, using silicon transistors, to obtain input impedances in excess of 1,000 megohms and output impedances of less than 100 ohms.

### OSCILLATOR CIRCUITS

Most oscillator circuits can be fitted into one or other of three categories, depending on the type of waveform developed. These categories are (a) sine wave generators, (b) pulse generators, and (c) sawtooth generators. Each of these three categories can be broken down into a number of sub-divisions, depending on the mode and frequency of operation, and each of these sub-divisions can be further broken down into particular circuits. In the limited space that is available for this series it is not possible to describe all of the circuits.

### GENERAL PRINCIPLES OF OSCILLATOR OPERATION

Referring to Fig. 7.4, it can be seen that transistor TR1 is connected as a common emitter amplifier with the primary winding of transformer T1 connected as its collector load. The secondary of T1 is connected in series with the transistor base, but in such a way that any signal fed to the base via the transformer is 180 degrees out of phase with the signal at the collector.

When a transistor is connected in the common emitter mode, the signal appearing at the collector is 180 degrees out of phase with that at the base. In the circuit of Fig. 7.4, however, an additional 180 degree phase shift has been imparted to the signal by the transformer, so that the signal appearing at the secondary of T1 is in phase with the base.

If it is assumed that the gain of the circuit between the transistor base and the transformer secondary is greater than 1, the action of the circuit will be as follows.

When S1 is closed and power is supplied to the circuit, a base current will flow via the base bias network R1 and R2, which will cause a collector current to flow also. Although no signal is directly connected to the base, a small a.c. signal will appear at the collector, due to random electron movement (noise) in the transistor; this signal will be transmitted back to the base via T1. This base signal is then amplified by the transistor and appears at a much greater amplitude at the collector, where it is again fed back to the base and amplified even more. This action is almost instantaneous and is cumulative, the signal eventually becoming so large that the transistor is driven into saturation and can no longer amplify further.

The transformer is an a.c. device, and will only transmit changes in potential; thus, as the transistor runs into saturation and amplification ceases, signals also cease to appear at the transformer secondary and, therefore, at the base of TR1. With no base signal applied, the transistor drops out of saturation and reverts to its original condition, whence the complete cycle of events again repeats itself.

Such a circuit acts as a self-energising switch, rapidly switching itself on and off, the output waveform being a series of pulses. The frequency of operation and rise and decay times of such a circuit are determined by the characteristics of the components used, i.e. by the transit time and junction capacitance of the transistor, inductance and stray capacitance of the transformer windings, and so on. A simple circuit of this type can, for practical purposes, be considered as "uncontrolled", in that no special circuitry is employed to control the frequency of operation or the waveform.

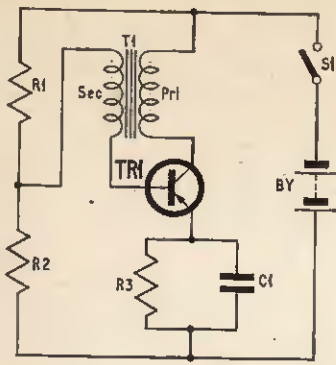

Fig. 7.4. Uncontrolled self-energising pulse oscillator

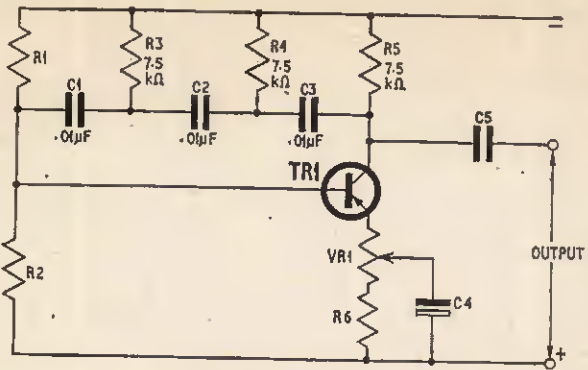

Fig. 7.5. Phase shift oscillator tuned to 1,000 c/s

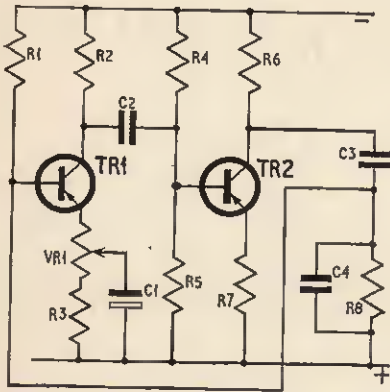

Fig. 7.6a. Simple Wien bridge audio oscillator

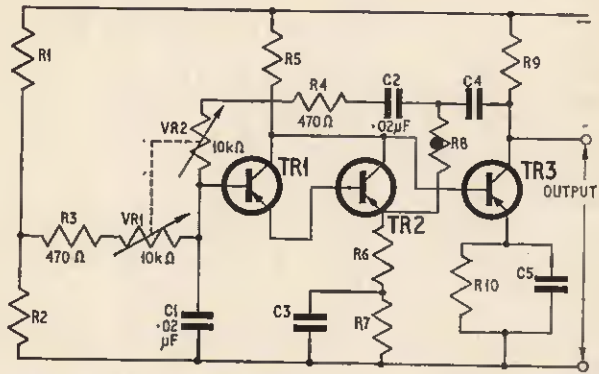

Fig. 7.6b. More advanced type of Wien bridge oscillator; frequency is variable between 1,000 and 10,000 c/s

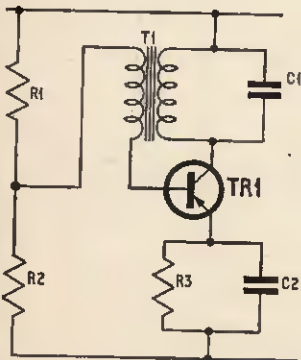

Fig. 7.7. Simple r.f. oscillator with a tuned collector circuit and inductive feedback to the base

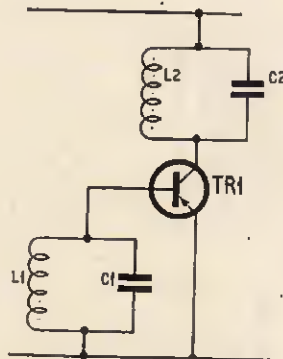

Fig. 7.8a. Basic tuned collector, tuned base oscillator

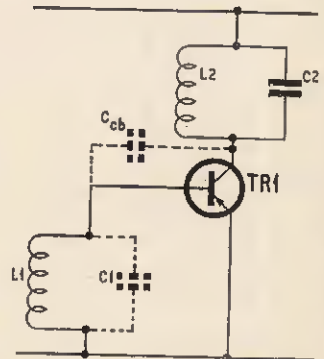

Fig. 7.8b. Extension of the circuit shown in Fig. 7.8a using the Miller effect capacitance for tuning L1

## SINE WAVE OSCILLATORS

If a tuned circuit or filter network is incorporated in either the feedback network or the transistor loading circuits, the rise and decay times and the frequency and waveform, will be controlled, a sine waveform being obtained.

Generally speaking, low frequency oscillators can be recognised by the use of RC networks, while r.f. oscillators can be recognised by the preferred use of LC networks. Inductances are avoided in low frequency work because they tend to be rather large. Crystal oscillators are generally operated at high frequencies.

## PHASE SHIFT OSCILLATOR

Fig. 7.5 illustrates the circuit known as the "phase shift oscillator". Transistor TR1 is connected in a conventional common emitter mode with resistors R1 and R2 providing the base bias network. R6 and VR1 make up the emitter load with C4 as the decoupling capacitor. VR1 enables the circuit gain to be adjusted by means of negative feedback due to the undecoupled part of the R6-VR1 chain.

The CR networks, C1-R3, C2-R4, and C3-R5, act as phase shifting devices or filters in the feedback loop between the collector and base, a 180 degree phase shift being obtained. :

If an a.c. signal is passed through a pure capacitance, a phase shift of 90 degrees is imparted to the signal; if a resistance is connected in series or in parallel with the capacitance, the resulting phase shift will be less than 90 degrees, the precise amount of phase shift depending on the values of C and R and the frequency.

If three such phase shift networks are connected in cascade, a total phase shift of 180 degrees can be obtained if the component values and frequency of operation are suitably chosen. Note that, with any given set of CR values, the overall phase shift will be exactly 180 degrees at only one frequency; thus, the network not only gives the 180 degrees phase shift required for operation, but it also controls the frequency and the waveform.

It is common practice to make all the resistors and all the capacitors of such a network of equal value. In such a case the frequency at which the phase shift is 180 degrees is given by the formula:

$$f = \frac{1}{2\pi CR\sqrt{6}} = \frac{1}{15.4 \times CR}$$

The attenuation factor of the circuit at the frequency at which the phase shift is 180 degrees is 29; thus, in an idealised circuit, a transistor gain of only 29 is required and the circuit will oscillate at a frequency given by the formula above. In practice, it is not quite as simple as this and the following points should be taken into account:

(a) The range of values that can be selected for the phase shift resistors is limited; the selected values are a compromise between a value which would appreciably load the transistor input circuit (which has a low impedance) and a value that would be appreciably loaded by the transistor output circuit (high impedance). Values in the order of 2.7 kilohms to 27 kilohms are generally recommended.

(b) The frequency of operation of the circuit is modified from that given in the formula by the input and output impedances of the circuit and by additional phase shifts in the circuit. The frequency of operation is usually higher than that

calculated. Remember that to increase the frequency of operation the CR values of the phase shift network are decreased. In the circuit shown, where 7.5 kilohm resistors are used, the calculated frequency of operation is about 850 c/s, but in practice the circuit will oscillate at about 1,000 c/s.

(c) Although the theoretical attenuation of the phase shift network is only 29 at the frequency of operation, it will be found in practice that additional losses occur due to the transistors input and output impedances; generally speaking, the transistor gain is required to be at least 60 in order to overcome these losses. This gain can be obtained either by using a single high gain transistor or by using two low gain transistors connected as a super alpha pair in place of TR1.

Practical circuits of this kind have three main disadvantages: (a) the frequency of operation is subject to considerable change (up to 10 per cent) with variation of the gain control (VR1), which should be set to give minimum distortion of the signal; (b) the circuit is not generally suitable for use as a variable frequency oscillator, as a three-gang tuning control is required; (c) output amplitude and frequency are both subject to change with different loads attached to the output circuit, and a buffer stage is thus generally required between the oscillator and any load.

## WIEN BRIDGE OSCILLATOR

A rather different approach to the filter network is employed in the circuit of Fig. 7.6a, which is a basic version of the circuit known as the Wien bridge oscillator. In this case the filter network comprises four components R6 and C3, and R8 and C4. This circuit is very similar to one side of the Wien Bridge described in the July issue.

If a signal is applied across the complete network, it will be found that a definite phase shift occurs across the lower arm at all frequencies except one; at this frequency the phase shift is zero and the actual frequency at which this condition occurs is given by:

$$f = \frac{1}{2\pi\sqrt{(R_6 C_3 R_8 C_4)}}$$

It is common practice to make  $R = R_6 = R_8$ , and  $C = C_3 = C_4$ , in which case the above formula simplifies to:

$$f = \frac{1}{2\pi CR}$$

At the frequency of zero phase shift, the attenuation of the network is 3.

Returning to the circuit of Fig. 7.6a, transistors TR1 and TR2 are each connected as common emitter amplifiers. There is a phase shift of 180 degrees between the base and collector of each transistor, giving a total phase shift between TR1 base and TR2 collector of 360 degrees. The output of TR2 collector is effectively applied across the Wien network, and the signal at the junctions of the upper and lower arms is fed back to TR1 base. There is a total phase shift of 360 degrees at one frequency only, and, providing that the gain is correct, the circuit will oscillate at this frequency.

To give a sine wave output which is pure, the transistors are required to provide a gain of 3, to compensate for losses in the Wien network. If the transistor circuits were simply designed to give this degree of gain, they would exercise some degree

of control over the frequency (through phase shift effects) and waveform (through non-linearity of frequency response). These snags are overcome by designing each transistor circuit to give a very high gain, which is then reduced to the required low value by the application of heavy negative feedback, i.e. the emitter resistors are left totally or partially undecoupled.

The simple circuit shown in Fig. 7.6a may be used in a number of applications, but for general use it has three drawbacks:

(i) the input impedance of TR1 shunts the lower half of the Wien network, thereby limiting its value;

(ii) resistor R8 also acts as the lower half of the TR1 base bias network, and the circuit is thus not suitable for use as a variable frequency oscillator;

(iii) the gain of the circuit is not fully stabilised against changes of temperature and frequency.

A better circuit is shown in Fig. 7.6b. The single low input impedance transistor is replaced by two transistors, TR1 and TR2, connected as a super alpha pair, and having a high input impedance. A variable resistor VR2 is connected in the upper arm of the Wien network and VR1 in the lower arm as shown. Variations in the setting of VR2 have virtually no effect on the d.c. bias conditions of the circuit, but VR2 does enable the effective values of the Wien arm to be varied. VR1 and VR2 are ganged together. The circuit will oscillate at frequencies between approximately 1,000 and 10,000 cycles per second.

An additional feedback circuit is inserted between the output of TR3 and the emitter of TR2. The thermistor R8 is used as the feedback link; if the output of TR3 increases for any reason, the current taken by R8 will also increase, and in so doing will cause its resistance to fall, which in turn will result in a larger portion of the output of TR3 being applied to the emitter of TR2, thereby reducing the circuit gain. Effective amplitude stabilisation is thus obtained.

The three-section phase shift and the Wien network l.f. oscillators described are some of the most widely used types in general use; many other types or variations do exist. For example, the control network may be a "twin-T" or "parallel-T" type; a phase shift network using 4, 5, or 6 sections in place of the more usual 3 may be used.

## R.F. OSCILLATORS

In the case of RC oscillators it is generally essential that the overall circuit gain be 1, any greater value may give distortion. In the case of r.f. oscillators, however, this requirement is not as important, since the LC tuned circuits that are used give a "flywheel" effect to the circuit waveform.

The requirements of these oscillators are simple: the overall gain must be greater than 1; the output must be fed back to the input in phase; and the circuit must be frequency selective.

Figs. 7.7 and 7.8 illustrate two of the many circuits that may be used as r.f. oscillators, very little explanation being required in most cases. Fig. 7.7 shows a circuit with a transformer used between collector and base to give 180 degree phase change, the transformer primary being tuned by C1 to make the circuit frequency selective.

In some cases, there is a tuned circuit in the collector and another tuned circuit connected to the

base, but with separate coils used instead of a transformer. In such cases, the circuit relies on the Miller feedback effect to cause oscillation. Between the base and collector junctions of a transistor there is some small capacitance; this capacitance provides a feedback path between collector and base.

Thus, a transistor circuit with a tuned collector and a tuned base, as shown in Fig. 7.8a, can be re-drawn as in Fig. 7.8b, where  $C_{cb}$  is the effective Miller capacitance. In this circuit, C1 and L1 do not form a major tuned circuit; hence C1 is shown dotted. It is  $C_{cb}$  and L1 which form the tuned circuit, of the series type.

Across a series LC circuit there is a phase shift of 180 degrees in voltage. In this circuit, at the frequency of oscillation, the series circuit is detuned so that the reactance of L1 is smaller than that of  $C_{cb}$ , so that the voltage across L1 is smaller than, and in opposite phase to, that across the series combination, i.e. the series circuit acts as an inductive reactance. C1 enables this inductive reactance to be tuned to the required frequency. Due to the resistive losses in the LC circuit, the phase shift is slightly less than 180 degrees; the collector tuned circuit (L2 and C2) is therefore slightly detuned to compensate for this. It is interesting to note that, at the frequency of oscillation, neither the apparent collector tuned circuit, the series tuned circuit, nor the apparent base tuned circuit are actually tuned to the frequency of oscillation.

Next month: Basic circuits for cathode ray oscilloscopes

## Have you seen...

### PRACTICAL WIRELESS

- ★ TWO-STAGE V.F.O.
- ★ ECONOMY F.M. RADIO
- ★ ADD-ON B.F.O.
- ★ TRANSISTOR SUPERHET TUNER

### BUY OCTOBER ISSUE NOW

### PRACTICAL TELEVISION

- ★ IS YOUR TV REALLY SAFE?
- ★ WIDEBAND V.H.F. AMPLIFIER
- ★ FINAL NOTES ON "OLYMPIC II"

### BUY OCTOBER ISSUE 23rd SEPTEMBER

ONLY TWO SHILLINGS EACH

# REV COUNTER AND DWELL METER

BY 'DREW'



ONE of this month's blueprints is devoted to constructing a car engine revolution counter and dwell meter. This unit is an invaluable aid in any garage or, if desired, it can be fitted permanently inside the car. It is very simple to construct and will provide the motorist with an extremely accurate device to help him assess his engine performance.

The size of the box used is ideally suited for garage work as seen in the photographs. If it is intended to fit the unit into the car permanently, the box can be made considerably smaller by rearranging the components in it.

Transistors and diodes are used throughout, the power being taken from a 12 volt car battery, with negligible current consumption.

## PULSE RATE METER

The circuit is a simple transistor monostable pulse generator (see Fig. 1 on the blueprint) which is switched on by the ignition voltage pulses derived from the primary winding of the ignition coil. The average value of the resulting square wave is measured by a moving coil meter, the deflection increasing in direct proportion to the pulse rate.

TR2 is heavily switched on by the voltage from R3. The collector to emitter voltage will then be about 100mV, producing a negligible reading on the meter, which is easily backed off by the meter's mechanical "set zero" control. C1 is fully charged through R2 and the base circuit of TR2. If a pulse is applied to R1 so that TR1 conducts, the collector to emitter voltage of TR1 will fall and switch TR2 off via the reversed biased diode D1. The collector to emitter voltage of TR2 is now stabilised at the Zener voltage of D3, i.e. about 6.2 volts.

The current through R3 begins to charge C1 in the opposite direction and after a time, determined by R3 and C1, switches TR2 back on again.

As soon as the collector voltage of TR2 drops, the base bias on TR1 drops through R5, thus switching TR1 off very quickly. As TR1 is switched off the charging current through C1 switches TR2 on, the whole process being repeated. From this it can be seen that pulses of constant duration and amplitude are produced at the collector of TR2. The frequency of the input pulses determine the spacing of the pulses at TR2.

The average current through the load is expressed as

$$I_{av} = \frac{I t_1}{t_2}$$

where  $t_1$  is the length of the fixed pulse and  $I$  is constant as previously described. Therefore

$$I_{av} = \frac{C}{t_2}$$

where  $C$  is the meter current law.

Thus, as  $f = 1/t_2$

where  $t_2$  is the period of the input pulse, then

$$I_{av} = Cf$$

or the meter current law times frequency. The scale is thus linear.

As the current  $I$  may be set to any value by VR1, the scale may be calibrated to any number of revolutions per minute.

## CONSTRUCTION

The construction and wiring of the unit should not prove difficult provided the blueprint is followed carefully. Before mounting the 12-way component tag board in the cabinet all wiring in Figs. 2a and 2b, including lead-off wires, should be carried out. It is best to solder all interconnecting wires underneath the tag board first (see Fig. 2b on the blueprint).

Next mount the components (as shown in Fig. 2a) on the top of the tag board. When soldering the transistors and diodes in position, a heat shunt should be used to prevent damage to these components due to overheating. Once the tag board wiring has been completed and checked for any errors, it can be placed aside until the aluminium box has been marked out and drilled.

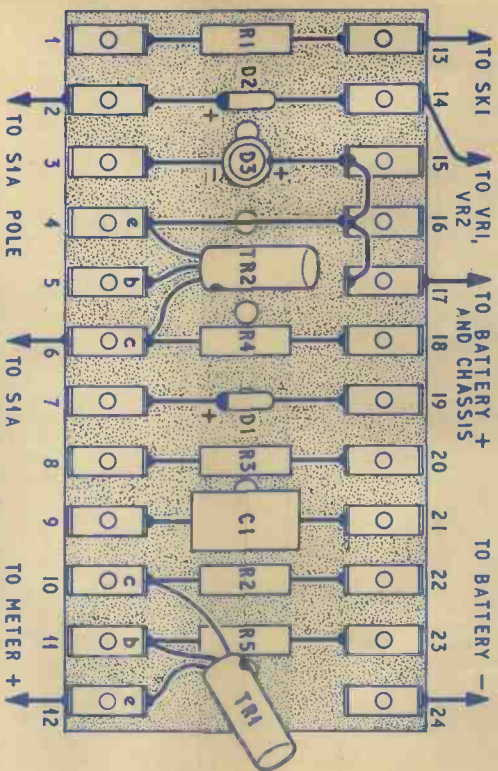

FIG. 2A - TOPVIEW OF TAGSTRIP

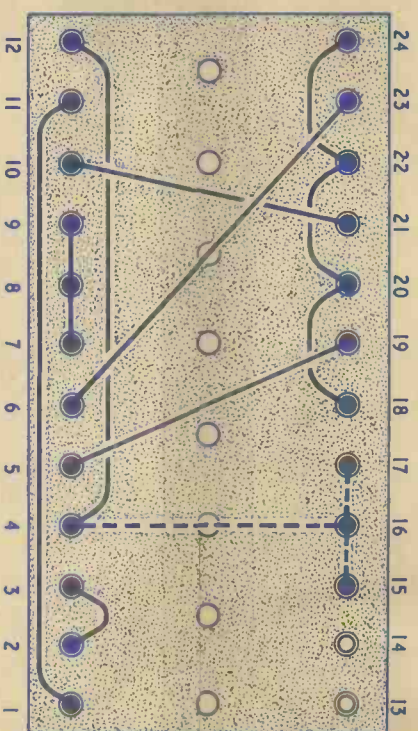

FIG. 2B - UNDERSIDE OF TAGSTRIP

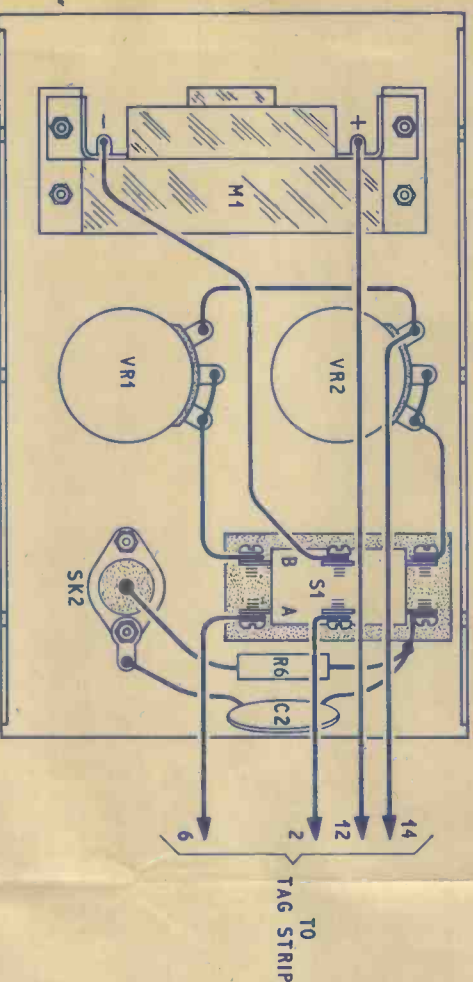

FIG. 3A - WIRING AT REAR OF PANEL FULL SIZE

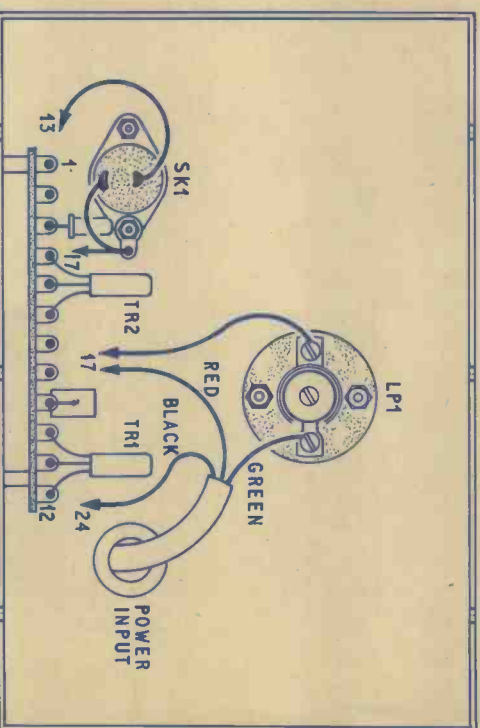
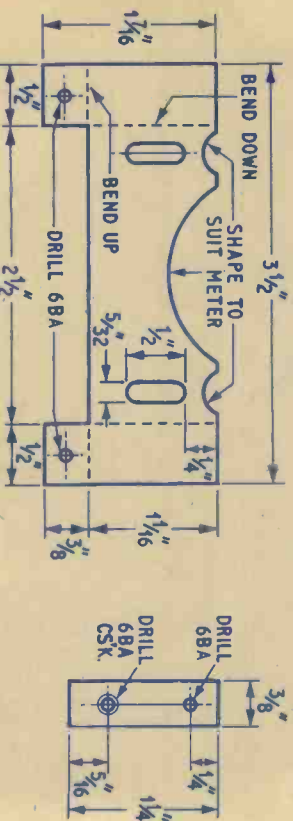

FIG. 3B - WIRING INSIDE CASE FULL SIZE



BRACKET A (SUPPLIED WITH METER)

BRACKET B (2-OFF)

FIG. 4 - GENERAL DETAILS

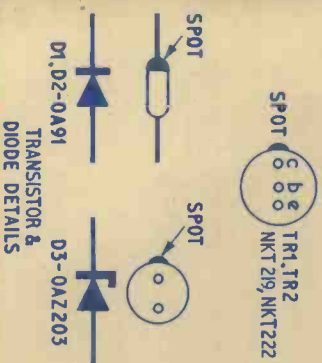

TRANSISTOR & DIODE DETAILS

D3 - 0A2203

ITEM	HOLE SIZE
VR1	1/2" DIA.
VR2	1/2" DIA.
S1	1/16" DIA.
SK1	1/2" DIA.
SK2	1/2" DIA.
POWER INPUT	3/8" DIA.
SLOT FOR M1	25/8" x 3/4"
ALL FIXING HOLES	1/8" DIA.

DRILLING DETAILS



# CAR REV COUNTER & DWELL METER

PRICE 5/-

PUBLISHED BY GEO. NEWNES LTD.,  
TOWER HOUSE, SOUTHAMPTON STREET,  
LONDON, W.C.2.

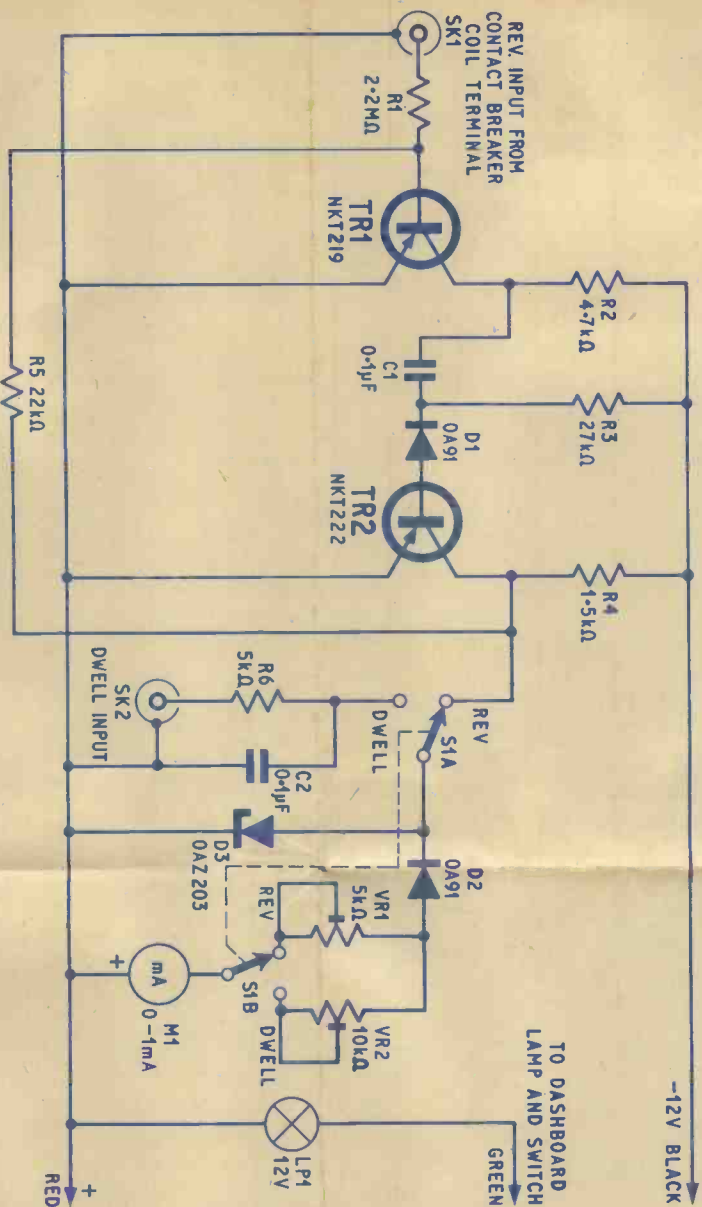
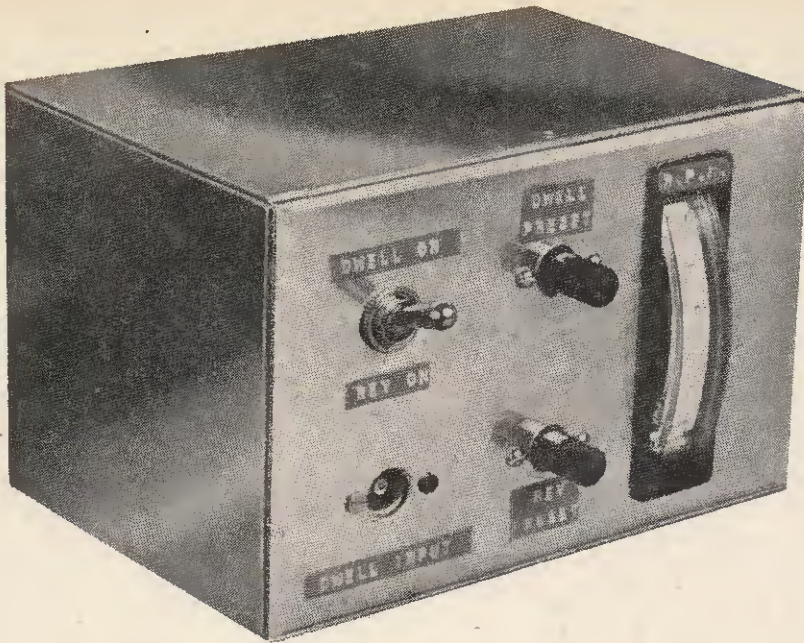

FIG. 1—THE CIRCUIT DIAGRAM

## COMPONENTS LIST

- Resistors**  
R1 2.2MΩ R4 1.5k  
R2 4.7kΩ R5 22kΩ  
R3 27kΩ R6 5kΩ ½W  
All 10% ¼W carbon unless otherwise stated
- Potentiometers**  
VR1 5kΩ linear preset type (Radiospares)  
VR2 10kΩ linear preset type (Radiospares)
- Capacitors**  
C1 0.1 μF plastic (T.C.C. type PMX4)  
C2 0.1 μF plastic
- Transistors**  
TR1 NKT219 or OC71  
TR2 NKT222 or OC72
- Diodes**  
D1 OA91  
D2 OA91  
D3 OAZ203 or Z86-2 (S.T.C.)
- Miscellaneous**  
M1 Moving coil meter, 1mA f.s.d. Model EW16 panel type (Henry's Radio Ltd)  
S1 D.p.d.c. toggle switch  
SK1 Coaxial socket (flush mounting type)  
SK2 Coaxial socket (flush mounting type)  
4in x 6in x 4in chassis with flush mounting base plate, (available from H. L. Smith & Co. Ltd.)  
12-way miniature component tag strip; p.l.c. self-tapping screws; 6 B.A. nuts and counter-sunk screws; four spacers 1in long with 6 B.A. clearance holes; M.E.S. lampholder and 12V bulb; P.V.C. covered wire etc.



*Complete revolution counter and dwell meter*

The box shown on the blueprint and in the photographs can be made up by chassis suppliers. The prototype was supplied by H. L. Smith & Co., 287 Edgware Road, London, W.2.

When all the drilling has been completed the components shown in Figs. 3a and 3b should be mounted in position.

Bracket "A" for the meter, shown in Fig. 4 on the blueprint, should be supplied with the meter, but two extra brackets "B" are required, also shown in Fig. 4. The bracket supplied with the meter is removed and reversed to allow the meter to be adjusted at an angle to the front panel of the case. Brackets "B" are then fitted between the "feet" of the meter bracket and the front panel. The front panel components are then wired.

Note that SK1 and LPI are mounted on the back of the box, although SK1 can be mounted on the front panel if preferred. The lampholder is mounted on two  $\frac{1}{4}$ in spacers on the inside back wall, so that it will provide effective illumination, through the perspex case of the meter. For permanent installations the green wire is connected to the dashboard lamp to provide a switched source of supply for the meter lamp.

Connect these and the components on the front panel to the tag board as shown in Figs. 2a, 3a, and 3b. It will be seen from Fig. 3b that the tag board is mounted on the floor of the case, with  $\frac{1}{4}$ in spacers to raise it sufficiently to avoid any possible short circuits.

The front panel is fixed to the box with six P.K. self-tapping screws.

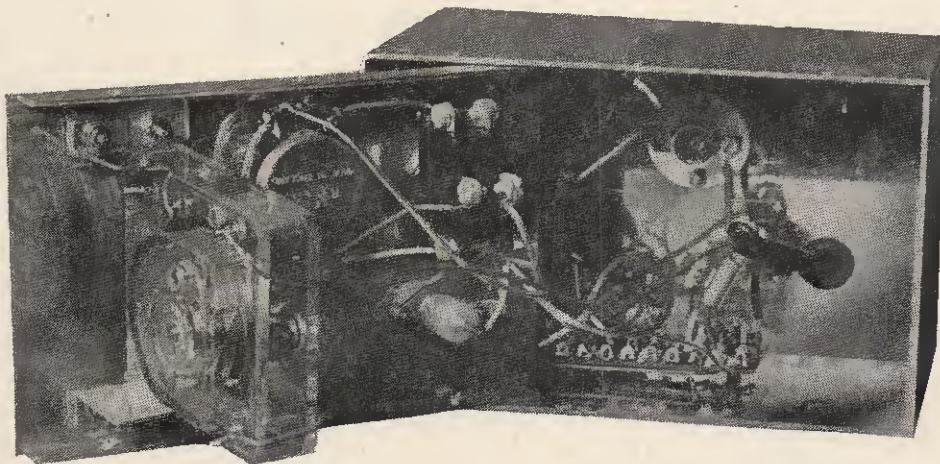

*Interior view of the unit. Note the small pieces of metal under the feet of the meter bracket*

## CALIBRATION

One method of calibration is to connect the 50c/s mains frequency, suitably reduced to 12 volts via a transformer, to the "rev" input (see Fig. 5). This 50c/s mains frequency corresponds to 1,500 r.p.m. of a four cylinder, four stroke engine. The meter deflection obtained can be marked on the scale; the rest of the scale can be marked from this by interpolating 0 to 1,500 and upwards.

An alternative method is to calibrate against a known accurate revolution counter already installed in a car. The prototype was set up in this way and was found to correspond with the revolution counters on two different cars.

The positive and negative supply lines (red lead positive and black lead negative) are connected to the car battery and a coaxial lead is taken from SK1 to the "contact breaker" coil terminal (see Fig. 6). Cars with positive or negative earth systems are suitable as the ignition pulse is in the form of a "ring"; the circuit triggers on the appropriate part. Check that the negative of the unit is connected to the negative of the battery.

The meter was first calibrated against a revolution counter fitted in a Zephyr 6 and was set at 2,000 r.p.m. by adjusting VR1 against the same reading on the car rev counter. The scale already on the meter was ideally suited; the mark on the meter indicating 0.2mA corresponded to 2,000 r.p.m.; 0.4mA to 4,000 r.p.m.; 0.6mA to 6,000 r.p.m. The engine speed was not taken higher than this because, being stationary, there was no load on it. It follows that higher readings should correspond equally well, so the initial calibration was all that was necessary.

Current consumption of the unit when the "rev" input is used is 10mA.

If the circuit cannot be made to trigger reliably, then R1 may be reduced slightly, but only if the wiring is correct.

The "rev" input is ideal for checking the engine performance, clutch slip, finding the best speed for gear changing, and measuring the revolutions per minute at maximum torque.

## USING THE DWELL METER

All that is required to bring the dwell meter into operation is to unplug the coaxial lead from SK1, insert into SK2 and switch S1 to the "dwell" position. The dwell meter measures the on-off ratio of the points. The points of a four cylinder engine should be open for approximately 30 degrees and closed for 60 degrees, but you should check this from the manufacturer's data.

When the points are open there is 12V across them and zero volts when they are closed. Thus, neglecting the back e.m.f. of the coil the waveform should be as shown in Fig. 7. From this it can be seen that no matter what the engine revs are the ratio remains unchanged.

If the meter is set to read full-scale deflection by adjusting VR2 when the points are open, then it should read about two-fifths scale when the points are closed.

If the meter reads higher than specified, the gap should be reduced and vice versa. The results obtained on the Zephyr 6 and Morris 1100 showed two-fifths deflection when the contact breaker points were open.

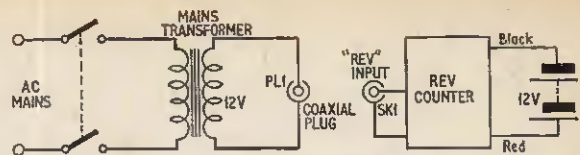

Fig. 5. Calibration set-up using the 50c/s mains frequency

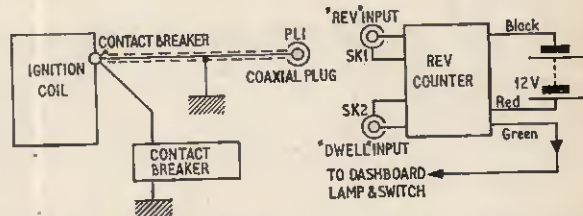

Fig. 6. Calibration set-up using direct comparison with an existing built-in car rev counter; also the set-up for normal measuring

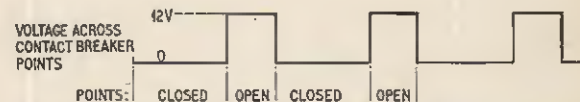
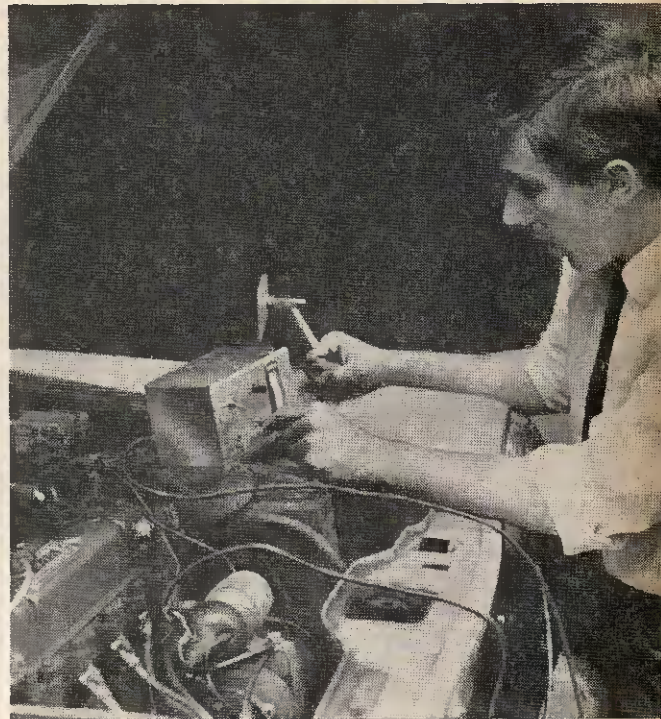

Fig. 7. Illustration of the ratio of contacts being open and closed

Photograph of the unit being used to measure revs per minute on a Morris 1100. Note the connection on the CB terminal of the ignition coil. The earth connection is made through the battery positive line



# ELECTRONORAMA

HIGHLIGHTS FROM THE CONTEMPORARY SCENE

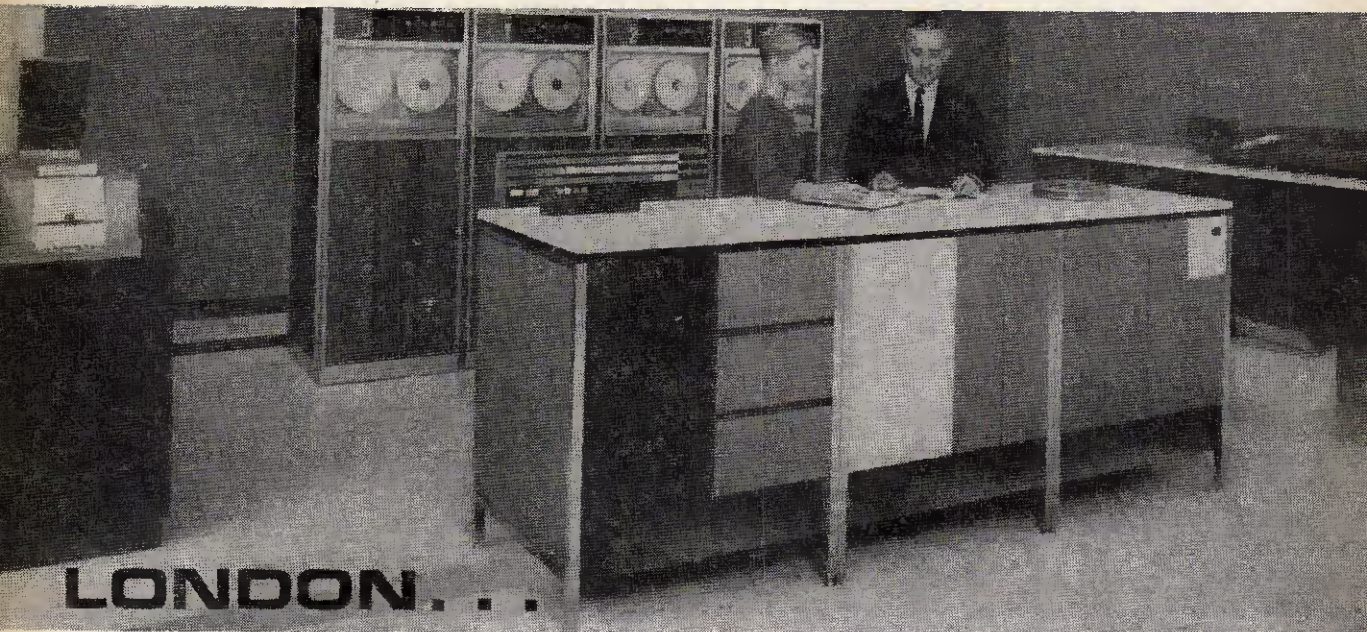

## TELEX COMPUTER LINK

FOR THE first time in over a century of yacht racing a magnetic tape computer calculated results of all handicap events during the Cowes Regatta.

Results of the Combined Clubs Regatta races were calculated remotely by a Series 200 computer at the Honeywell Datacentre, London. Linked to the regatta centre by G.P.O. telex service, the computer was fed with the times and sail numbers of the yachts as they passed the finishing buoy. Taking into account the basic speed factor, or handicap, allotted to each yacht, the computer transmitted corrected times back to the teleprinter. The punched-paper tape from the teleprinter was fed to a Flexowriter supplied by Friden; this can be seen on the right.

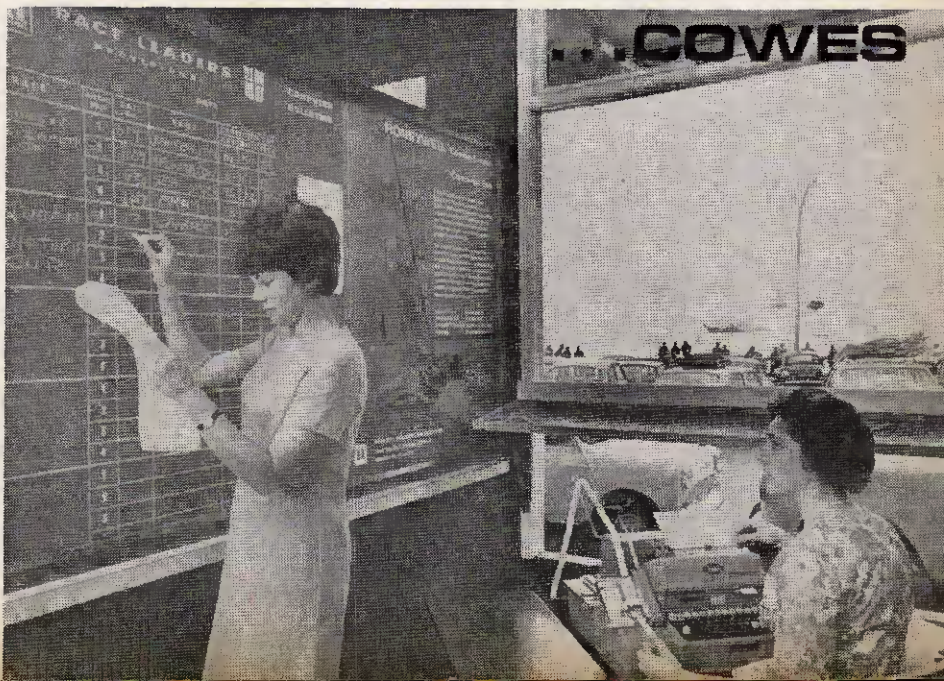

## Mars Data Storage

A TINY memory developed by Sperry Rand Corporation's Univac Division was the "clearing house" for the photos of Mars taken by cameras aboard the Mariner IV spacecraft. The device is called a data buffer memory system, a completely solid state memory package six inches square and one inch thick. It is reproduced here in the top right hand corner of the photograph.

The device is actually two memories sandwiched together, each containing 1,320 data "bits" of storage. During the spacecraft's close approach to Mars the memory received and stored the television pictures and made them available for transmission to earth.

The weight of the memory is only 21 ounces and its power consumption is less than half a watt. The memory was designed to withstand the severe heat of the sun in the vicinity of earth and the extreme cold of deep space in the vicinity of Mars. Every individual soldered joint was examined through a microscope for soldering defects.

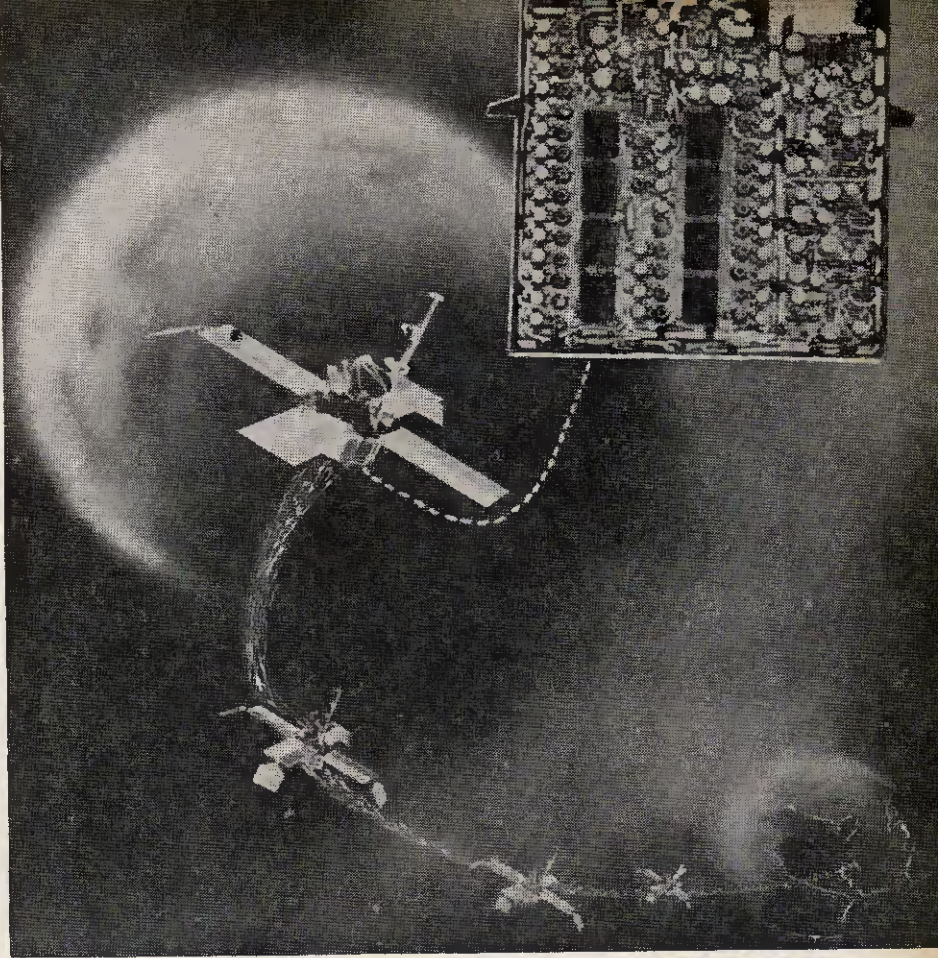

## Electronic Controlled Road Maker

READERS who have been anywhere near the Cromwell By-Pass, just north of Newark, Nottinghamshire, may have noticed this gigantic road making machine in operation.

Known as the "slip-form paver", this machine will extrude concrete as a finished road slab, without the use of any side supports. It is self propelled, runs on caterpillar tracks, and lays the concrete road at a rate of up to seven feet per minute.

The entire machine is controlled and guided automatically by electronic sensors fitted on the sides, so that it follows an even path between two guide cables running down either side of the track.

Ministry of Transport engineers, the Road Research Laboratory, and the Contractors have pooled their resources to perfect this system.

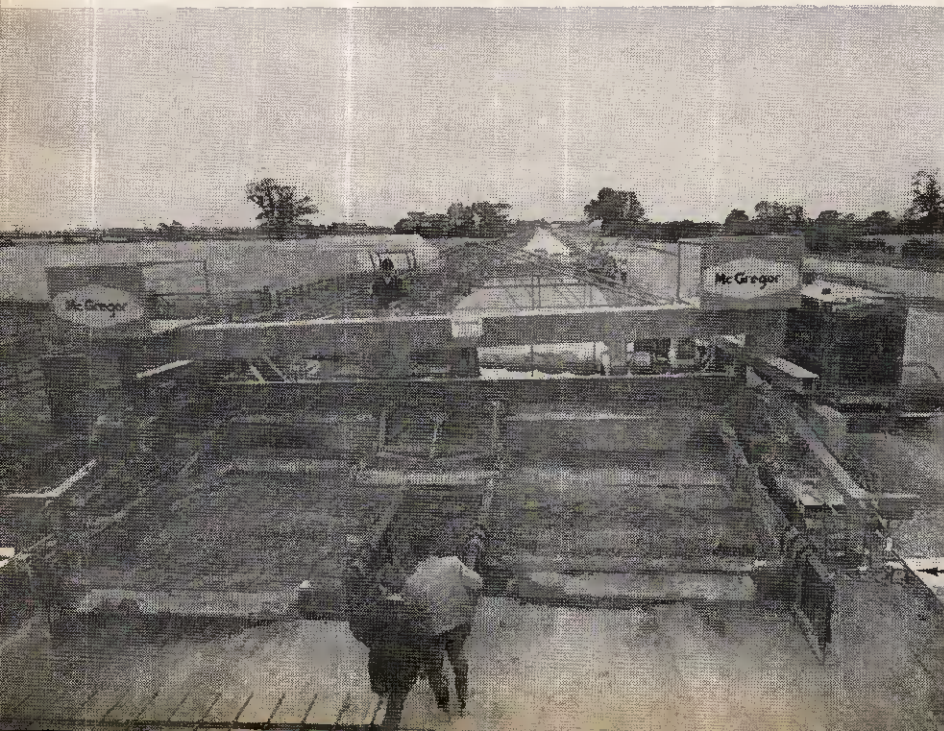

# BEGINNERS start here...

12

*An Instructional Series for the Newcomer to Electronics*



The essential tools and materials for soldering. A lightweight instrument iron type similar to that illustrated is ideal for work with transistors and other small components. Soldering irons of this type can be obtained in various wattage ratings, i.e., 12, 15, 20 and 25 watts. A good average rating for general transistor work is 15 watts. A "cored" solder such as that illustrated should always be used. This contains flux, and for normal jointing purposes no additional flux need be applied. Solder is obtainable in small handy packs, as illustrated, or in a handy dispenser.

Wire cutters and long nosed pliers are indispensable. A pair of tweezers, a pocket knife and a pair of "Bib" wire cutters and strippers are most useful additional items.

## SOLDERING TECHNIQUE

We come now to an important facet of "toolcraft" as it applies to electronic construction, namely, soldering.

The art of joining two or more metals together by the soldering process requires a little practice, and if you have not had the chance to carry out any work of this nature before, a few moments spent in trying one or two joints using a few lengths of wire and a valveholder or tag strip will be amply rewarded when you come to serious assembly work. Further practice will be obtained if you build the multivibrator a.c. generator which will be described next month. This design has been specially laid out to enable beginners to obtain assembly and soldering practice. In the meantime if you can fix yourself up with a soldering iron, some cored solder and odd pieces of tinned copper wire, you can then try out the points of soldering technique as we discuss them.

The technique of soldering can actually be divided into two main classes. One is the *heavy duty* method used by sheet metal workers, tinsmiths and so on. In this method the two metals to be joined are thoroughly cleaned and the flux is applied in a paste form before applying the solder. The solder is melted

by a naked flame or by a heavy copper-ended iron, which has been immersed in a naked flame until a green glow is emitted from the fire or gas ring. The green glow is indication that the iron is sufficiently hot to melt the solder. This type of soldering method is called sweating and was the only method before the introduction of flux-cored solder and electric irons. Electronic equipment constructors are not concerned very frequently with this method, although work on metal cabinets, chassis, and racks sometimes involves the use of such techniques.

## INSTRUMENT SOLDERING

By far the most common soldering method used in electronics might be called *instrument soldering*. It is a lightweight, delicate operation, carried out with a small slender soldering iron. A 25 watt iron is commonly employed in valve circuitry. For printed circuit work, a 15 watt iron is ideal. Such a tool is small enough to be used like a pencil.

Instrument soldering can be a highly skilled affair, especially in such operations as soldering the hair-springs on to the coil and supports of a moving coil meter movement.

## THE NEED FOR FLUX

What takes place when the molten solder is applied to the metals to be joined can be seen in the cross sectional drawing Fig. 12.1.

The action of the *flux* is particularly important, because it dissolves off oxide coatings and some of the dirt which might be on the metal surfaces. The flux also increases the flow of the solder, as discussed later on.

When the molten solder flows into contact with the cleaned surfaces, the tin in the solder alloy forms a further alloy with the surface layers of the metals. In particular, this causes a strong bonding so that when the solder solidifies, the joint becomes one solid mass, strong mechanically and a good electrical conductor. *But, if precautions are not taken to ensure optimum conditions for the bonding to take place, troubles can occur.*

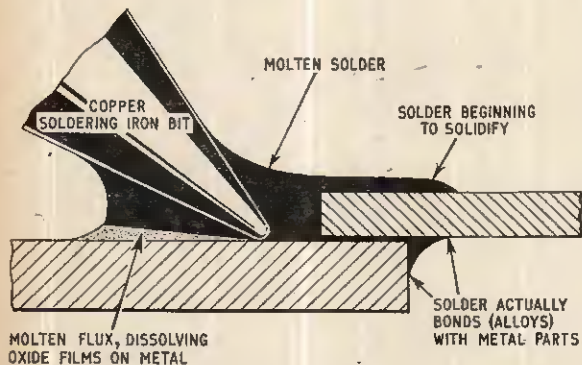

**Fig. 12.1.** This diagram shows the action of the flux when making a soldered joint. It is essential that the two surfaces be perfectly clean and free from grease before they are brought together to make a joint. Good electrical and mechanical contact is vital before the solder is applied

## DRY JOINTS

There are one or two faults that can arise when making small electrical joints by soldering. The most common is the notorious *dry joint* which beginners often make!

A dry joint may look all right, but offers a high electrical resistance, with resulting noise and intermittent troubles in the circuit. This type of faulty joint arises because there is a layer of oxide left between the metal and the solder, where the solder never "wetted" the surfaces properly.

Like most practical skills, it takes some experience to get the feel of soldering, so that you know by touch whether a joint is sound or not.

The correct iron temperature is important, together with the right type and amount of flux. It goes without saying that the surfaces to be jointed must be bright and clean. Dirt would tend to cause dry joints.

Flux has already been mentioned. Solder on its own, although melted, tends to be a bit pasty and fails to flow and wet the surfaces. The flux is a material which makes the solder much more fluid. For virtually all electronic and instrument jobs, a "cored" type of solder should be used.

A well known fluxed solder of this type has the brand name "Multicore", and is composed of 60 per cent lead to 40 per cent tin. A special resin flux material is contained in cores inside the "wire" of solder material.

This solder can be obtained in several sizes, these corresponding to the standard wire gauges of 14, 16, 18 and 22 s.w.g. For most electronic work 18 s.w.g. solder will be suitable. This can be purchased in small quantities: a handy dispenser holding 12 ft of solder costs 2s 6d, while a carton of 30 ft costs 5s.

## KEEP THE IRON IN PLACE

Here lies one of the secrets of good soldering: if some solder is melted on to the iron, the flux quickly vaporises and is lost and by the time the iron has been transferred to the work, the solder no longer runs and a poor joint results.

The solder should be run straight onto the joint *with the iron in place*, thereby maintaining a supply of flux on the job. So important is this fluxing, that even when stripping or unsoldering it is necessary to run on fresh (fluxed) solder to make the original joint run.

If there is any doubt that the solder may not run, then separate "wetting" of the parts should be carried out. This is called "tinning" the surfaces, and of course the soldering iron bit itself should be cleaned and tinned when making ready for use.

*The illustration below shows how the two parts comprising the joint (in this case, the wire lead of a resistor and a tag of a component group board), the solder, and the iron are all brought together for the soldering operation*

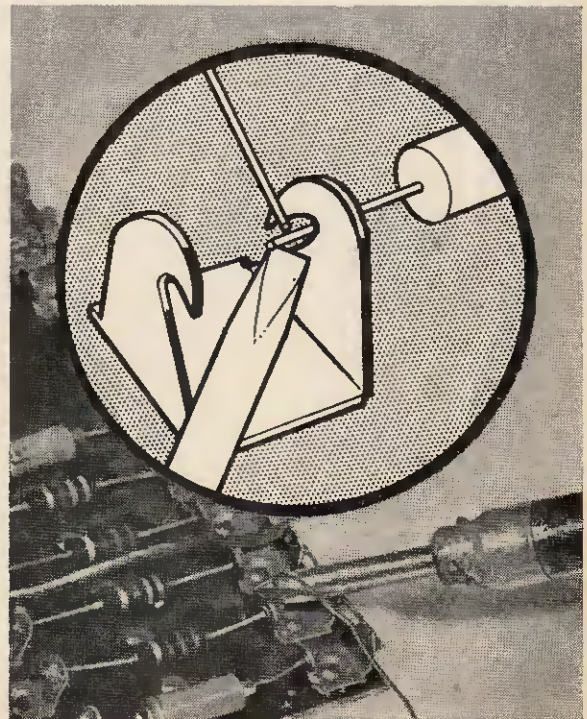

A VERSATILE electronic counting and timing device is indispensable in the modern physics laboratory. It will be noted that in the fields of nuclear physics and nucleonics, the term "scaler" is generally given to apparatus of the type we are considering, this is in order to avoid any possible confusion with atomic radiation detectors such as Geiger Muller tubes which have long been referred to as "counters".

### PULSE OR SINE WAVE INPUT

To be truly versatile, the scaler must work from either pulse or sine wave input. The "hard" valve input circuit employed in this design will shape and limit pulses from a Geiger Muller tube and also produce a satisfactory waveform for driving the first Dekatron tube from a sine wave input of about 3 volts.

The maximum practical counting rate for a Geiger Muller tube is about 500 counts per second and cold cathode trigger tubes will handle this frequency quite easily. For the present design however, a higher rate of count was required for timing purposes and for measuring the frequencies of audio sources. A Dekatron will work up to 5,000 counts per second and hard valve circuits will operate far faster than this. A hard valve input circuit to the first Dekatron was therefore used, the latter stages being coupled by cold cathode tubes.

### AUDIO OUTPUT

The ticking of a Geiger Muller counter is so well known to every reader or viewer of science fiction that it seemed mandatory for this audio facility to be

included. Besides giving a striking demonstration of the random nature of radiation pulses, this audio output is invaluable in providing a sound source from an audio oscillator whose cycles can be simultaneously counted and hence the frequency accurately calculated.

A useful internal 100c/s timing or testing signal has been incorporated. More accurate timing of moving bodies using an external 500c/s electrically maintained tuning fork and mechanical or photo-cell switching is also catered for. Sockets for this input, or that from an audio oscillator are provided.

The general consideration of simplicity of construction from readily available, yet reliable, components was kept in mind throughout. The actual cost of the scaler will depend upon the sources of supply and, in the case of educational establishments, upon the generosity of component manufacturers. Assuming new components are used throughout, the total cost is likely to be in the region of £40. This is considerably less than half the cost of a ready made commercial instrument capable of providing the same facilities and performance.

### ELECTRONIC DETAILS

The scaler circuit may be considered as a number of distinct sub units, and the equipment has in fact been built as such. This arrangement facilitates theoretical understanding of the circuit principles; also simplifies the construction of the scaler and the testing of its performance. The block diagram Fig. 1 shows the relationship of these sub units, each of which will now be described in detail.

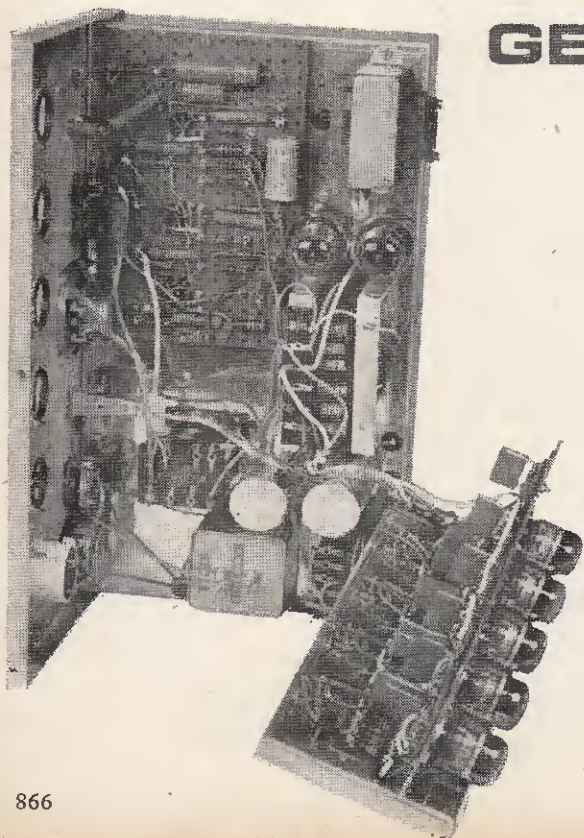

# GENERAL PURPOSE SCALER

By R. W. SAWYER, B.Sc.

### SPECIFICATION

Display	Five Dekatrons
Input	Sine wave, pulse or G.M. tube
Counting Rate	Over 3,000 cycles per second
Total Count	100,000
Audible Count	Miniature loudspeaker included
E.H.T. Supply	Metered variable e.h.t. supply for G.M. tube
Timing Facility	Internal source of 100c/s pulses
Mechanical	Unit construction



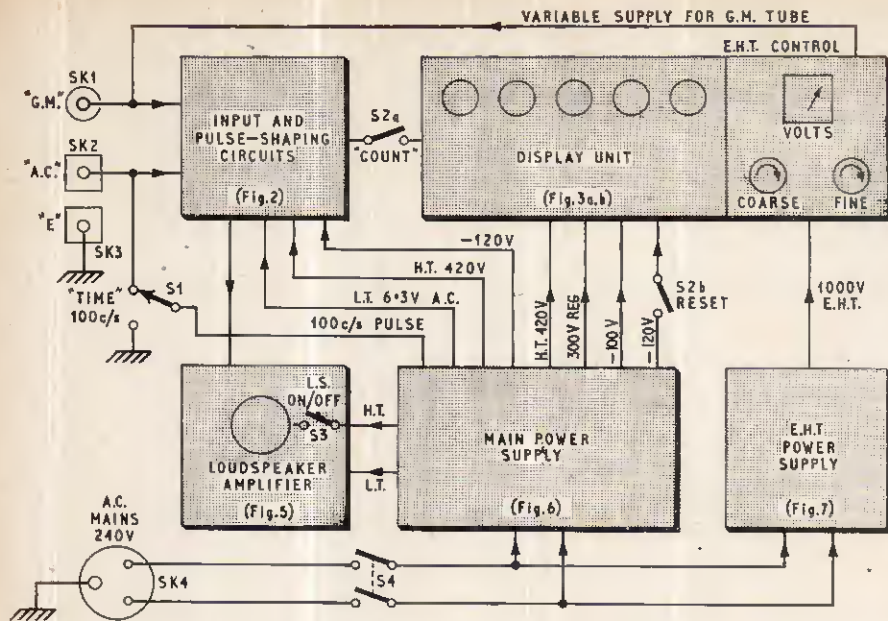

Fig. 1. Block diagram showing inter-relation of sub-units and operating controls

### INPUT AND PULSE SHAPING CIRCUIT

The circuit diagram for the input and pulse shaping stages is given in Fig. 2.

Two pentodes, type EF91, convert the input signal into a negative-going pulse of about -145 volts amplitude. The first valve V1 functions as a conventional amplifier having a gain of about 25 times. It also serves to reverse the phase of the negative pulse from a Geiger Muller tube fed into SK1.

The second valve V2 is a pulse shaper. The grid is biased beyond cut-off by a negative voltage derived

from the -120V line, while a connection to earth through a diode D1 prevents the grid being driven positive. The grid swing is thus sharply limited and the output amplitude is kept constant. A sine wave applied to the grid of V2, having been already amplified by the first valve, will result in the production of a well shaped square wave at the anode of this second valve. This output is fed to the display unit via the count switch S2.

Timing pulses are applied to V1 grid via the switch S1. These 100c/s pulses are derived from the main power supply unit.

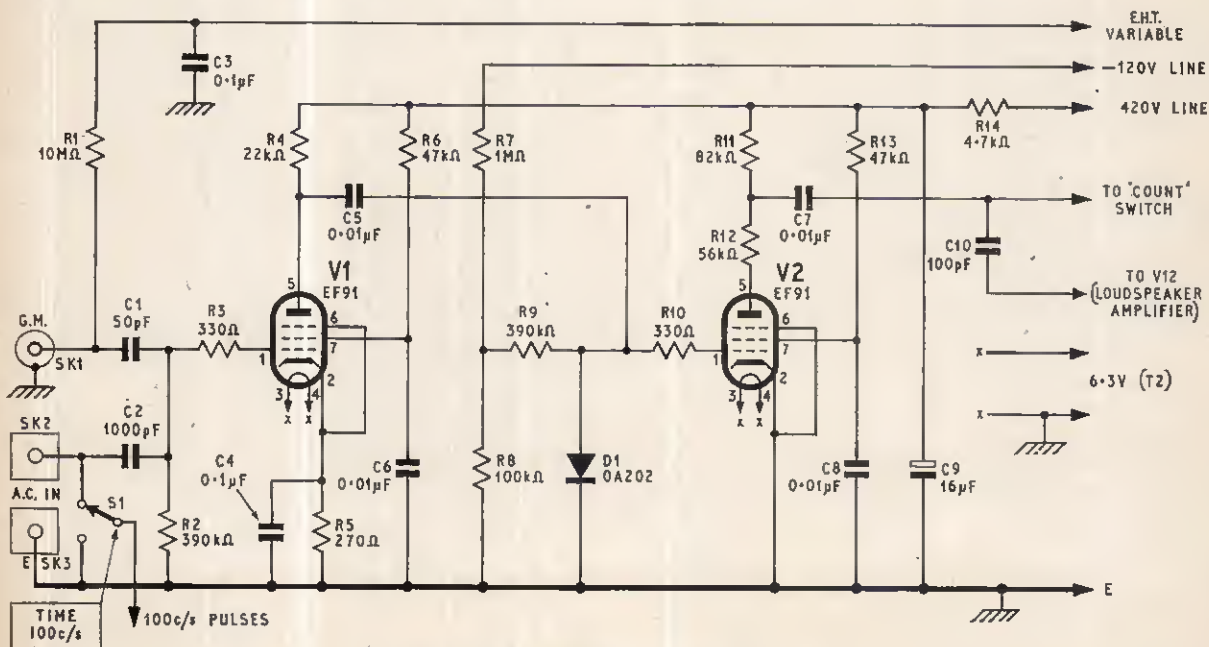
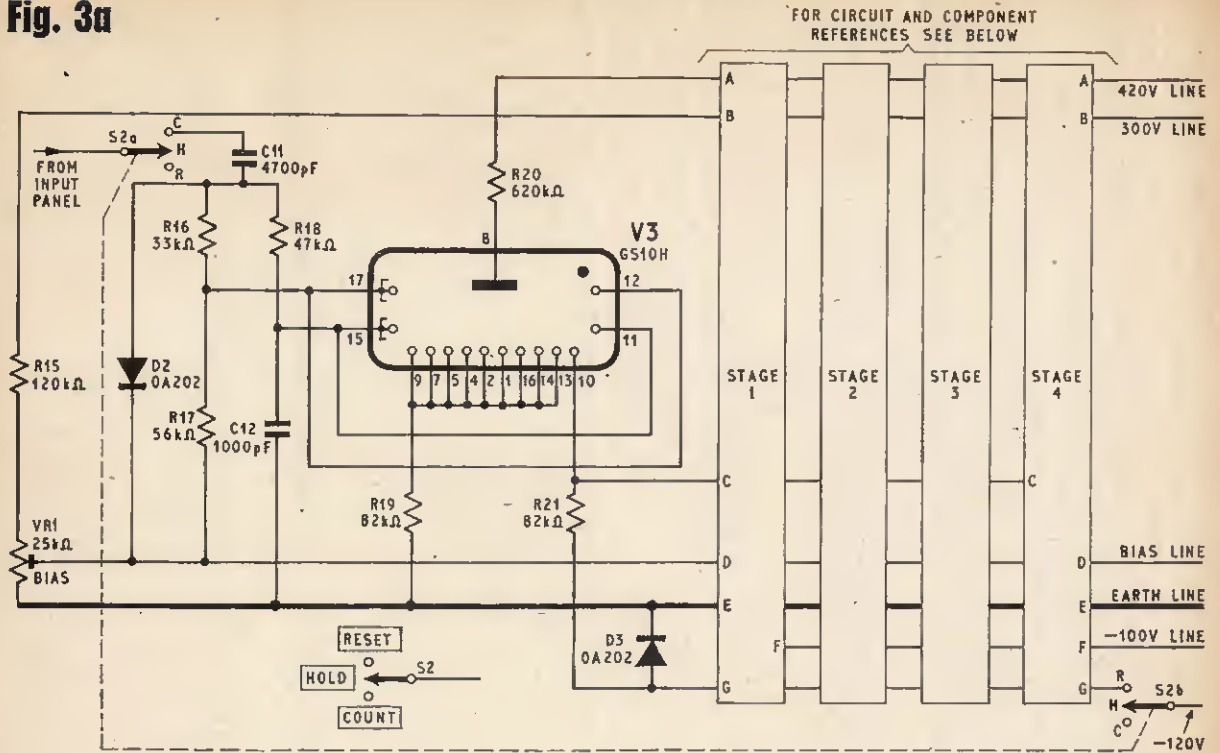
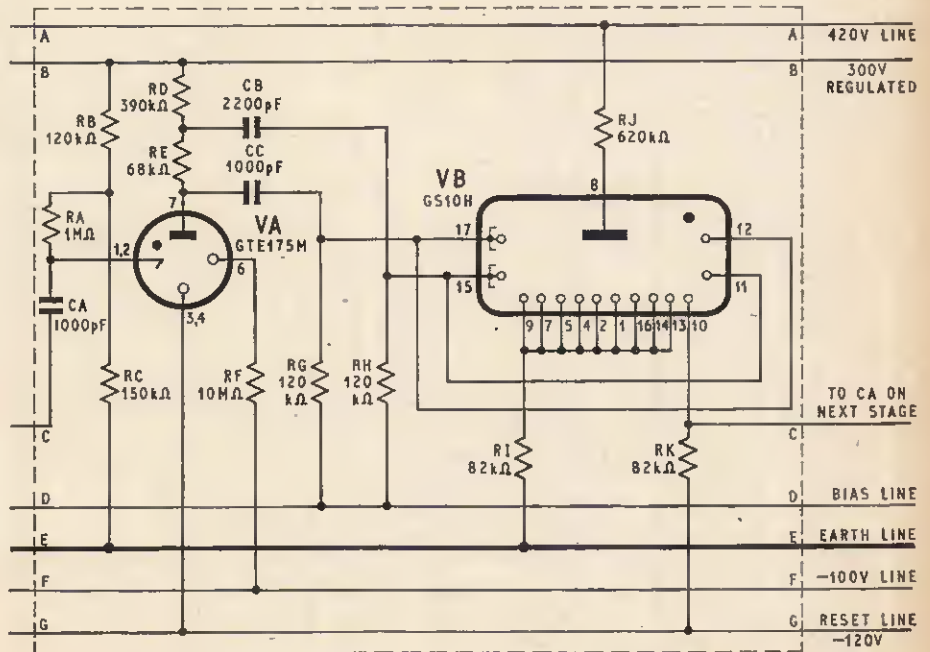

Fig. 2. Input and pulse shaping circuits

**Fig. 3a**



ITEM	STAGE 1	STAGE 2	STAGE 3	STAGE 4
VA	V4	V6	V8	V10
VB	V5	V7	V9	V11
RA	R22	R33	R44	R55
RB	R23	R34	R45	R56
RC	R24	R35	R46	R57
RD	R25	R36	R47	R58
RE	R26	R37	R48	R59
RF	R27	R38	R49	R60
RG	R28	R39	R50	R61
RH	R29	R40	R51	R62
RI	R30	R41	R52	R63
RJ	R31	R42	R53	R64
RK	R32	R43	R54	R65
CA	C13	C16	C19	C22
CB	C14	C17	C20	C23
CC	C15	C18	C21	C24



**Fig. 3b**

**Fig. 3.** Display unit circuit diagram. The input circuit and first dekatron stage is given in Fig. 3a. The four subsequent stages are identical; each incorporates a trigger tube and a Dekatron and the circuit is given in Fig. 3b

## DEKATRON DISPLAY UNIT

The first Dekatron stage of the display unit is shown in full detail in Fig. 3a. The four subsequent Dekatron stages are shown in block form only in this diagram, but all inter-stage connections are indicated, as well as the output connections of the display unit.

These four subsequent stages are identical in all respects, and the common circuit arrangement appears in Fig. 3b. For clarity, each component in Fig. 3b has been "numbered" in an alphabetical sequence and the accompanying table sets out the actual reference number for each component stage by stage. These latter numbers are of course used to identify individual components in the physical layout and wiring diagrams, and also in the component list.

## OPERATION OF THE COUNTING TUBES

Five Ericsson GS10H Dekatron tubes are used in the display unit. The Dekatrons are in effect neon tubes with a circular anode surrounded by 30 rod-shaped cathodes, as depicted in Fig. 4. The counting cathodes are identified as K0 and K1 to K9. The last mentioned nine cathodes are connected together externally in the present application. The cathodes between each of these counting cathodes are known as guides. These are connected together in two sets of ten, known as first guides and second guides respectively, in a clockwise direction.

When a potential exceeding 400 volts is applied to the tube through a suitable limiting resistor, a discharge takes place to one of the earthed cathodes which becomes surrounded by the characteristic negative glow. Only one glow occurs because the potential across the tube then drops to about 190 volts which is insufficient to break down another anode-cathode gap. The guides are meanwhile maintained at about 35 volts positive. This bias voltage is obtained from a potential divider across the 300 volt line and earth, and is preset by the bias potentiometer VR1 (see Fig. 3b).

The glow may be transferred to one cathode to the next by the application of two successive negative pulses applied in turn to the intervening guides. For example, if the glow is on cathode 6 and the first guides are pulsed negatively the glow will move to the nearest of the first guides, that is to say, one step in a clockwise direction. If as this pulse dies away a negative pulse is applied to the second guides, the glow will move to the adjacent second guide. As this pulse fades and the guide returns to its normal 35 volts positive, the glow shifts to the now adjacent cathode 7.

Thus the glow may be moved from cathode to cathode round the tube. K0 (pin 10) has a separate lead with a cathode resistor (R21) across which a voltage will be developed when the glow returns to this cathode after the count of ten. A positive pulse taken from this cathode lead is used to initiate the triggering pulses for the next stage.

## RESETTING THE SCALER

To reset the scaler, the voltage on the common K0 return is momentarily lowered to about -120 volts by means of S2b. Under normal counting conditions this common return is grounded in a positive direction through a diode D3 which allows the normal working current to pass.

The two successive negative pulses required to drive the first Dekatron V3 are produced by feeding the pulse from the input circuit (see Fig. 2) via S2a to a

network known as the integrated pulse drive. This circuit passes a pulse immediately on to the first guides, but the pulse to the second guides is delayed while the 0.001  $\mu$ F capacitor C12 charges through the 47 kilohm resistor R18. The pulse dies away as the capacitor discharges.

## COLD CATHODE TUBES

The coupling to the remaining Dekatrons is by means of GTE175M trigger tubes. These are gas-filled tetrodes having an anode, auxiliary cathode, trigger, and cathode. By supplying suitable voltages, two red glows can be maintained in the tube, one between the anode and auxiliary cathode and the other between the trigger and cathode. It is useful to verify the presence of these glows visually if trouble is experienced in getting the tubes to function correctly. A positive pulse applied to the trigger will cause the discharge to spread suddenly across the anode to cathode gap with an increase of anode current. Pulses are taken from the resistors in the anode circuit through a suitable network to drive the following Dekatron.

Referring to Fig. 3b, it will be seen that the output pulse from the first Dekatron V3 is applied via CA to the trigger of VA. As the trigger tube conducts, negative pulses appear at the anode and these are fed to the first and second guides of the next Dekatron VB via CB and CC.

This process is repeated through to the fifth and final stage.

To summarise: each Dekatron counts the pulses it receives, and at the tenth passes on a triggering pulse to the following stage. It then recommences to count.

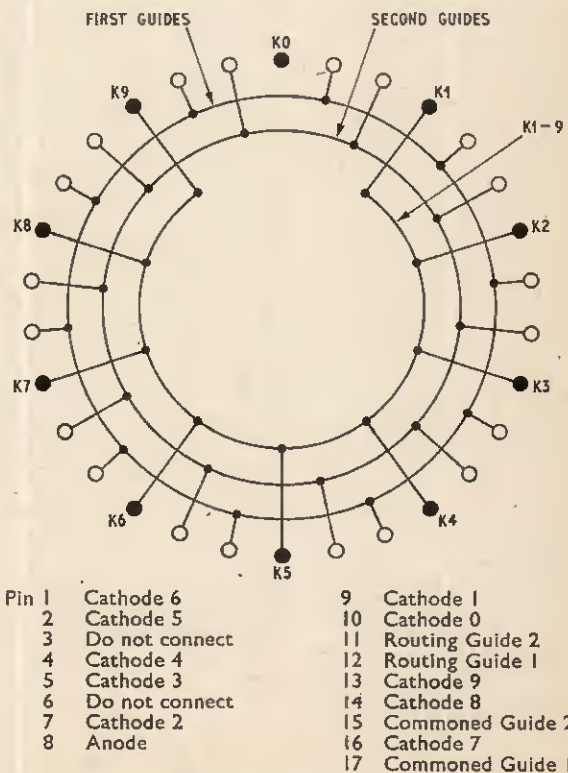

Fig. 4. Electrode arrangement of Dekatron tube

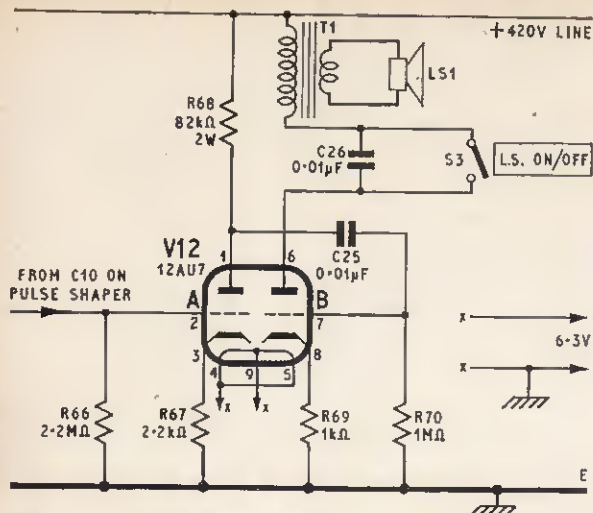

Fig. 5. Loudspeaker amplifier circuit. This is actually built on the same panel as the input and pulse shaping circuit

The stored count is indicated by the glow visible at the top end of the Dekatron tube which registers against a numbered escutcheon. The first tube thus indicates digits, the second tens, and so on; the fifth tube indicates tens of thousands ( $10^4$ ).

### AUDIO OUTPUT CIRCUIT

An audible "count" is obtained by means of a conventional two stage audio amplifier and a small loudspeaker. The circuit is shown in Fig. 5. A 12AU7 double triode is used. The first triode section is resistance capacity coupled to the second triode which drives the loudspeaker via the output transformer T1.

Signals are applied from V2 via C10. A high impedance input is used so that the main circuit is not unduly loaded. This high impedance input increases the capacitive pick-up on the grid of V12A from pulsed currents in the apparatus, but a switch S3 in the anode circuit of V12B effectively controls the loudspeaker. A small capacitor C26 is wired across this switch to absorb the forward e.m.f. produced by the transformer primary when the circuit is broken. Without this capacitor a spurious pulse would be formed in the counting circuits when the switch is opened.

Fig. 6. Main power supply circuit

### MAIN POWER SUPPLY

The main power supply unit (Fig. 6) follows conventional practice and needs no detailed description. But one or two points are of interest.

The generally specified h.t. for Dekatrons is 475 volts. A small mains transformer suitable for this supply is not readily available. There are, however, plenty of 350-0-350 volt transformers which are light in weight and cheap, and these will provide a smoothed h.t. of some 420 volts. This voltage is quite satisfactory, although it may result in a slight delay in the initial striking of the Dekatrons when the instrument is first switched on. This delay is usually less than the warm-up period of the valves in the input circuit and so does not affect the working. The phenomenon, which shows the need for ionisation before discharge can take place, can be demonstrated by switching on in darkness. Once ionised with the assistance of light or random radiation, the Dekatrons continue to function normally.

The power unit employs two silicon rectifiers D4, D5 in a full wave circuit. Silicon rectifiers, unlike valves, usually become conductive when they fail, fuses are therefore placed in each rectifier lead to guard against this contingency.

In addition to the smoothed output of 420V, a regulated supply of 300V is obtained from a pair of neon tubes V13, V14.

Negative supplies of 100V and 120V are derived from a half wave rectifier D6 which is fed from one half of the centre tapped secondary of T2.

### INTERNAL TIMING PULSE

Since the unsmoothed h.t. supply contains a 100c/s ripple, this provides a convenient pulse signal for timing or test purposes. This 100c/s pulse is tapped off through a capacitor divider system (C28, C29) and applied to the input of the scaler (as required) via S1.

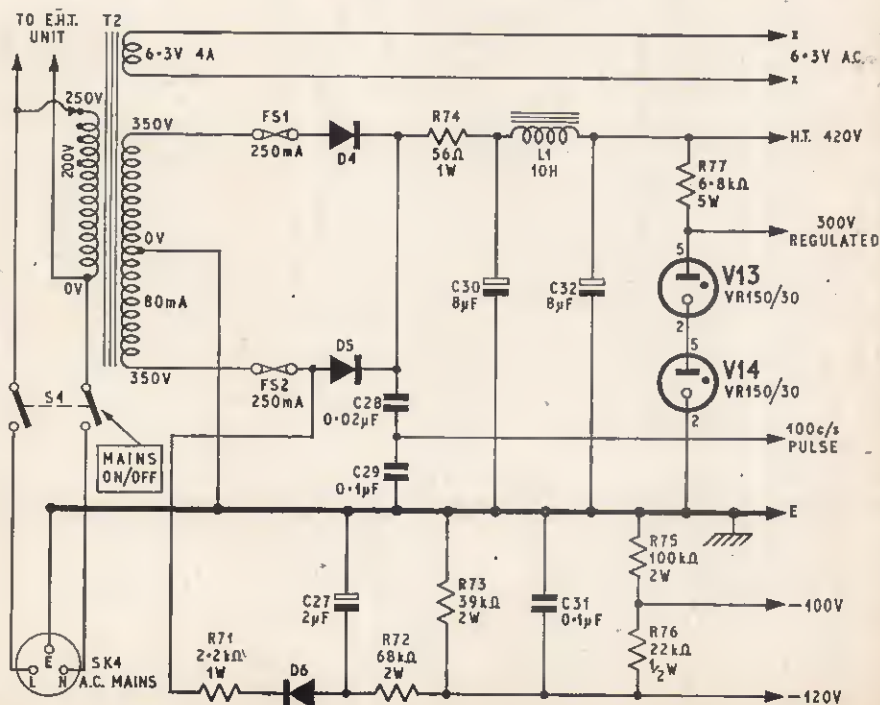

# COMPONENTS . . .

## Resistors

R1	10M $\Omega$ 5% H.S.	R46	150k $\Omega$ 5% H.S.
R2	390k $\Omega$ 10%	R47	390k $\Omega$ 5% H.S.
R3	330 $\Omega$ 10%	R48	68k $\Omega$ 5% H.S.
R4	22k $\Omega$ 10% 2W	R49	10M $\Omega$ 5% H.S.
R5	270 $\Omega$ 10%	R50	120k $\Omega$ 5% H.S.
R6	47k $\Omega$ 10%	R51	120k $\Omega$ 5% H.S.
R7	1M $\Omega$ 10%	R52	82k $\Omega$ 5% H.S.
R8	100k $\Omega$ 10%	R53	620k $\Omega$ 5% H.S.
R9	390k $\Omega$ 10%	R54	82k $\Omega$ 5% H.S.
R10	330 $\Omega$ 10%	R55	1M $\Omega$ 5% H.S.
R11	82k $\Omega$ 10%	R56	120k $\Omega$ 5% H.S.
R12	56k $\Omega$ 10%	R57	150k $\Omega$ 5% H.S.
R13	47k $\Omega$ 10%	R58	390k $\Omega$ 5% H.S.
R14	4-7k $\Omega$ 10% 2W	R59	68k $\Omega$ 5% H.S.
R15	120k $\Omega$ 5% H.S.	R60	10M $\Omega$ 5% H.S.
R16	33k $\Omega$ 5% H.S.	R61	120k $\Omega$ 5% H.S.
R17	56k $\Omega$ 5% H.S.	R62	120k $\Omega$ 5% H.S.
R18	47k $\Omega$ 5% H.S.	R63	82k $\Omega$ 5% H.S.
R19	82k $\Omega$ 5% H.S.	R64	620k $\Omega$ 5% H.S.
R20	620k $\Omega$ 5% H.S.	R65	82k $\Omega$ 5% H.S.
R21	82k $\Omega$ 5% H.S.	R66	2-2M $\Omega$ 10%
R22	1M $\Omega$ 5% H.S.	R67	2-2k $\Omega$ 10%
R23	120k $\Omega$ 5% H.S.	R68	82k $\Omega$ 10% 2W
R24	150k $\Omega$ 5% H.S.	R69	1k $\Omega$ 10%
R25	390k $\Omega$ 5% H.S.	R70	1M $\Omega$ 10%
R26	68k $\Omega$ 5% H.S.	R71	2-2k $\Omega$ 10% 1W
R27	10M $\Omega$ 5% H.S.	R72	68k $\Omega$ 10% 2W
R28	120k $\Omega$ 5% H.S.	R73	39k $\Omega$ 10% 2W
R29	120k $\Omega$ 5% H.S.	R74	56 $\Omega$ 10% 1W
R30	82 k $\Omega$ 5% H.S.	R75	100k $\Omega$ 10% 2W
R31	620k $\Omega$ 5% H.S.	R76	22k $\Omega$ 10%
R32	82k $\Omega$ 5% H.S.	R77	6-8k $\Omega$ 5% 5W w.w.
R33	1M $\Omega$ 5% H.S.	R78	82k $\Omega$ 10%
R34	120k $\Omega$ 5% H.S.	R79	82k $\Omega$ 10%
R35	150k $\Omega$ 5% H.S.	R80	82k $\Omega$ 10%
R36	390k $\Omega$ 5% H.S.	R81	82k $\Omega$ 10%
R37	68k $\Omega$ 5% H.S.	R82	82k $\Omega$ 10%
R38	10M $\Omega$ 5% H.S.	R83	82k $\Omega$ 10%
R39	120k $\Omega$ 5% H.S.	R84	82k $\Omega$ 10%
R40	120k $\Omega$ 5% H.S.	R85	82k $\Omega$ 10%
R41	82k $\Omega$ 5% H.S.	R86	82k $\Omega$ 10%
R42	620k $\Omega$ 5% H.S.	R87	82k $\Omega$ 10%
R43	82k $\Omega$ 5% H.S.	R88	82k $\Omega$ 10%
R44	1M $\Omega$ 5% H.S.	R89	10M $\Omega$ 5% H.S.
R45	120k $\Omega$ 5% H.S.		

All  $\frac{1}{2}$ W carbon unless otherwise stated  
H.S. = High stability (cracked carbon type)

## Potentiometers

- VRI 25k $\Omega$  wirewound, linear, preset  
VR2 100k $\Omega$  wirewound, linear

## Capacitors

- C1 50pF silver mica 500V  
C2 0-001 $\mu$ F paper 1,000V  
C3 0-1 $\mu$ F paper 1,000V  
C4 0-1 $\mu$ F paper 250V  
C5 0-01 $\mu$ F paper 1,000V  
C6 0-01 $\mu$ F paper 1,000V  
C7 0-01 $\mu$ F paper 1,000V  
C8 0-01 $\mu$ F paper 1,000V  
C9 1 $\mu$ F elect. 450V  
C10 100pF ceramic 500V  
C11 4,700pF silver mica 500V  
C12 1,000pF silver mica 500V  
C13 1,000pF silver mica 500V  
C14 2,200pF silver mica 500V  
C15 1,000pF silver mica 500V  
C16 1,000pF silver mica 500V  
C17 2,200pF silver mica 500V  
C18 1,000pF silver mica 500V

- C19 1,000pF silver mica 500V  
C20 2,200pF silver mica 500V  
C21 1,000pF silver mica 500V  
C22 1,000pF silver mica 500V  
C23 2,200pF silver mica 500V  
C24 1,000pF silver mica 500V  
C25 0-01 $\mu$ F paper 1,000V  
C26 0-01 $\mu$ F paper 1,000V  
C27 2 $\mu$ F elect. 500V  
C28 0-02 $\mu$ F paper 1,000V  
C29 0-1 $\mu$ F paper 250V  
C30 8 $\mu$ F elect. 600V  
C31 0-1 $\mu$ F paper 250V  
C32 8 $\mu$ F elect. 600V  
C33 0-25 $\mu$ F paper 1,000V  
C34 0-25 $\mu$ F paper 1,000V  
C35 0-1 $\mu$ F paper 1,000V  
C36 0-1 $\mu$ F paper 1,000V  
C37 1 $\mu$ F paper, 1,500V

## Inductors

- L1 Smoothing choke 10H 90mA  
T1 Output transformer 40mA, ratio 40:1 approx.  
T2 Mains transformer. Tapped primary.  
Secondaries: 350-0-350V 80mA; 6-3V 4A  
T3 Mains transformer. Tapped primary.  
Secondary: 0-250V 25mA

## Switches

- S1 Toggle, s.p.s.t.  
S2 Three position: make, off, make; biased off  
(Bulgin type S.701)  
S3 Toggle, s.p.s.t.  
S4 Toggle, d.p.s.t.  
S5 Rotary, 2-pole 6-way

## Sockets

- SK1 Flush mounting coaxial socket  
SK2 4mm socket (red)  
SK3 4mm socket (black)  
SK4 Mains input socket

## Miscellaneous

- FS1, 2 Fuse cartridges 250mA (2 off)  
LS1 Loudspeaker 2 $\frac{1}{2}$ in, 3 $\Omega$  speech coil  
M1 Moving coil meter, 100 $\mu$ A f.s.d.

## Valves

- V1, V2 EF91 or 6AM6 R.F. pentode (2 off)  
V3, V5, V7, V9, V11 GS10H Dekatron (Ericsson  
Telephones) (5 off)  
V4, V6, V8, V10 GTE175M Trigger tube (Ericsson  
Telephones) (4 off)  
V12 ECC82 or 12AU7 Double triode  
V13, V14 VR150/30 Neon stabiliser (2 off)

## Semiconductors

- D1, D2, D3 OA202 Silicon diode (Mullard) (3 off)  
D4-D10 REC.51A Silicon h.t. rectifier (Radio-  
spares) (7 off)

## Sundry Items

Five B17A sockets (Ericsson); six B7G valveholders; one B9A valveholder; two I.O. valveholders; six valve retainers, B7G type; one valve retainer, B9A type; twin fuseholder; perforated plastics sheet; turret tags; five sub-miniature group panels; four miniature backing plates; five indicator shields N79368 (Ericsson); two pointer knobs; grommets ( $\frac{3}{16}$ in and  $\frac{1}{4}$ in); sheet aluminium for chassis, case and front panel.

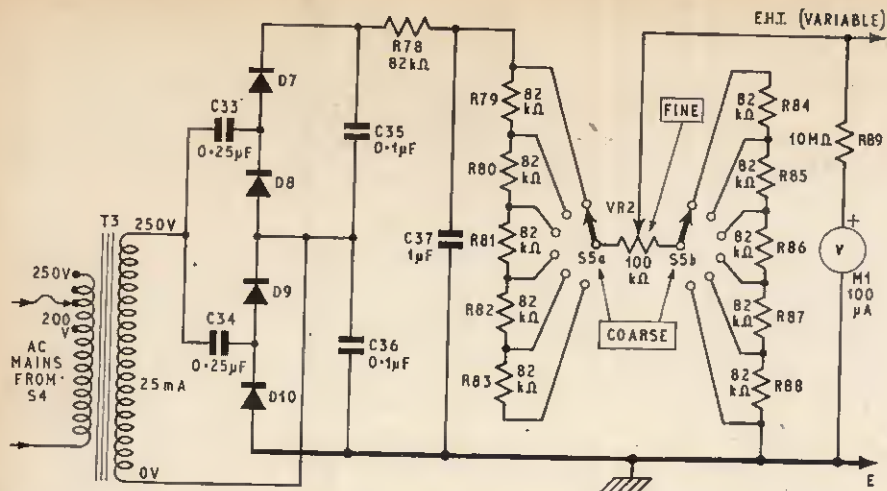

Fig. 7. E.H.T. power supply circuit

This pulse signal is invaluable in the initial setting up of the apparatus. When not required, the ripple supply is shorted to earth by S1 to prevent hum leaking through to the grid of the first valve (see Fig. 2).

### E.H.T. POWER SUPPLY

The circuit diagram of the e.h.t. unit is given in Fig. 7.

Geiger Muller tubes require a voltage of about 400V to 800V which must be adjusted to suit the individual tube in use. This e.h.t. supply is obtained from a small inexpensive 250 volt transformer T3 in conjunction with a voltage quadrupler circuit comprising diodes D7 to D10 in association with capacitors C33 to C36. This system increases the safety factor, although care should of course be taken with this voltage.

For accurate and reliable control of the output voltage, separate "coarse" and "fine" controls are provided. A wirewound 100 kilohm potentiometer VR2 is used for the *fine* voltage control and a series of resistors R79-R88 in association with S5 for the *coarse* control. A 100 microamp meter M1 with a 10 megohm resistor in series is connected across the output to indicate the voltage. The scale reading must be multiplied by ten and interpreted as volts.

This completes the technical description of the scaler circuit. Next month the mechanical construction will be dealt with. Full details will be given for the preparation of the metalwork and then the mounting of components and wiring will be considered. A complete list of components is included in this present article.

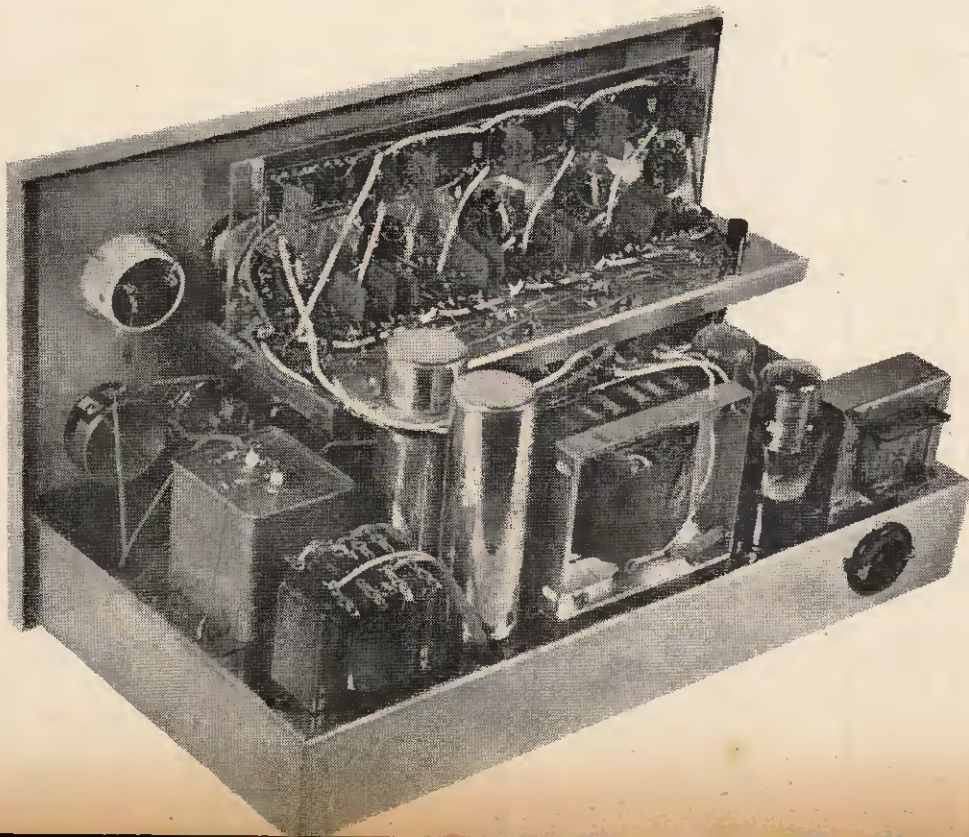

# FREE *inside Next Month's Issue*

# 2 FULL SIZE BLUEPRINTS TO BUILD



## DOORPHONE

Two-way intercommunicator, with calling tone

## WATER LEVEL ALARM

Transistor device for operating an audible or visual alarm when water in tank or bath exceeds given level.

## WITH WALL DATA CHARTS

containing

### VALVE SELECTION GUIDE

Current preferred types, equivalents, practical hints, base details

### ENCLOSURES AND PICK-UPS

Practical data for the audio enthusiast and experimenter

## MAKE SURE OF YOUR COPY!

Complete and hand  
this form to  
your Newsagent

TO \_\_\_\_\_ (Name of Newsagent)

Please reserve/deliver the November issue of PRACTICAL ELECTRONICS (2/6), on sale October 14th, and continue every month until further notice.

NAME \_\_\_\_\_

ADDRESS \_\_\_\_\_



# NEON NOVELTIES

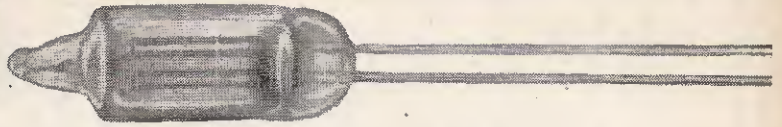

THIS is the second of a series of short articles illustrating some of the many uses of neon lamps. The neons employed are all miniature wire-ended types as shown above.

Two examples which are ideally suited to these applications are those supplied by Radiospares (striking voltage 65 volts), and the Hivac type 3L general purpose neons. The latter type requires a striking voltage of 80 volts and maintaining voltage of 60 volts.

Some neon indicators have a resistor wired in series with one of the neon wires to make them suitable for mains voltages. These would normally be unsuitable for the circuits described unless the resistor is removed or short-circuited.

## TWO HEADS OR TAILS by R. Bebbington GRAD.I.E.R.E.

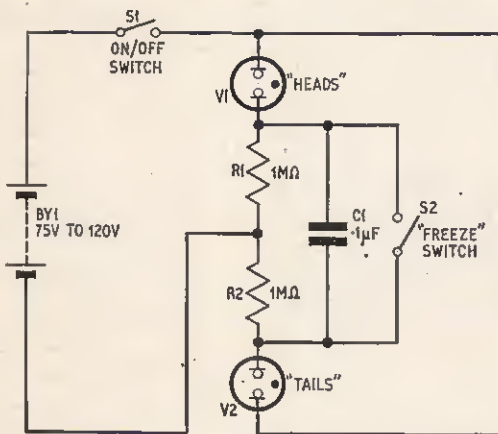

Fig. 1

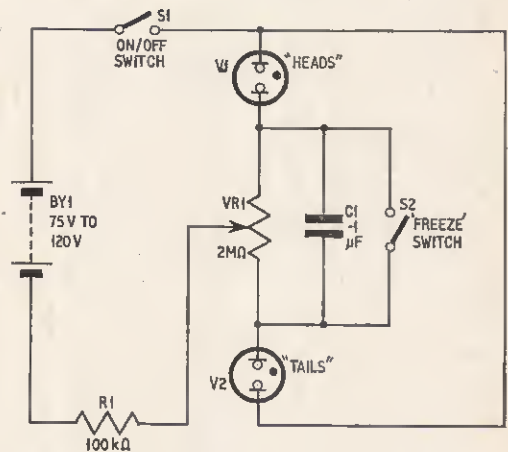

Fig. 2

A SIMPLE circuit for the "heads or tails" game is shown in Fig. 1. On connecting the battery the two neon lamps will commence to flash alternately at a rate of about 16 flashes per second. When the "freeze" button is depressed the flashing will cease and whichever neon is "struck" at the instant of pressing, this will remain alight. With the values of the components chosen, the flashing rate is too fast for there to be any degree of skill whatsoever in determining the result. Hence the title, "Heads" or "Tails" circuit. If a slower flashing rate is preferred, larger values of R and C should be employed; some measure of skill is then introduced into the game.

The two 1 megohm resistors may be replaced by a single 2 megohm potentiometer as a means of introducing a "handicap" which can be varied as required since the neons will flash unequally as the potentiometer

meter is adjusted off-centre (see Fig. 2). The battery feed should be applied to the slider via a 100 kilohm limiting resistor as the current through one of the neons would be excessive with the slider at one end of its travel.

A possible variation on the original theme is to duplicate the "freeze" switch so that either player may have an equal chance of making a decision as to when the flashing should be stopped. This would be more exciting at the slower rate as the players could use their skill to "freeze" when the flash was in their favour.

There are several alternative uses to which the basic circuit can be put, especially as the Christmas season looms not too far distant. Winking eyes for large teddy bears or some form of shop window attraction that the would-be customer can control at the touch of a button are just two of the many possibilities.



# vero board

gives  
constructors  
the  
simplest ...  
most  
efficient ...

## WIRING BASE

for any electronic assembly work — whether experimental or quantity production. Patented Veroboard is an advance on tag board wiring techniques and printed circuits, and because of its absolute stability under all conditions it is in fact now extensively used by manufacturers all over the world instead of printed circuits.

Veroboard is obtainable in many sizes of which 4 are available through the retail trade. For the name and address of your nearest Retailer please write to:—

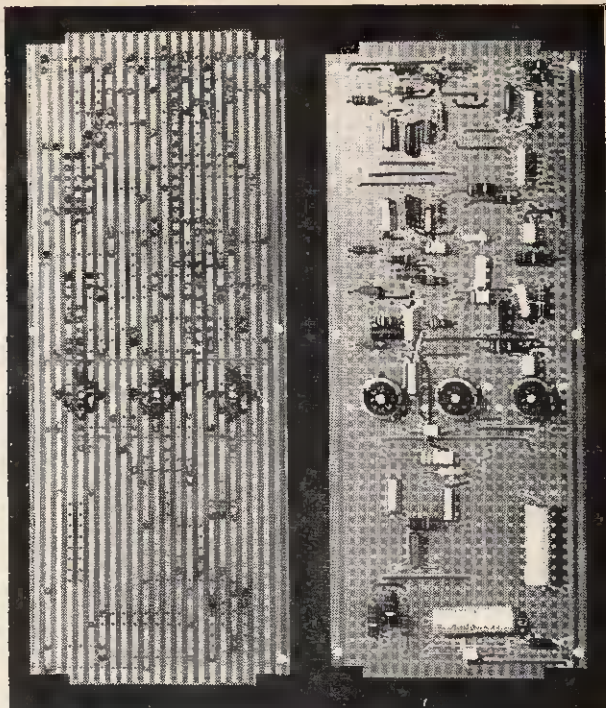

**VERO ELECTRONICS LTD.** (DEPT. P10)  
SOUTH MILL ROAD, REGENTS PARK, SOUTHAMPTON  
TEL. 71061  
ENQUIRIES FROM RETAILERS AND MANUFACTURERS WELCOMED



## FOR VALVES — SEMI CONDUCTORS — METAL RECTIFIERS NEW 1965/66 CATALOGUE NOW AVAILABLE!

56 PAGES

SEND 1/- IN STAMPS FOR YOUR COPY

A selection of items included: — •

### SEMI CONDUCTORS

AC154	5/6	OA202	4/-
AC155	4/-	OA2203	7/6
AC156	5/6	OA2204	7/6
AC157	7/-	OA2207	7/6
ADT140	15/-	OA2208	5/6
ASY28	6/8	OC42	6/-
BY100	7/6	OC43	9/-
BY114	5/-	OC44	5/-
MAT100	7/9	OC45	5/-
MAT101	8/6	OC70	4/6
MAT120	7/9	OC71	4/3
MAT121	8/6	OC72	5/6
NKT404 (OC35)	10/-	OC75	5/6
OA5	6/-	OC81	5/6
OA10	6/6	OC83	4/-
OA70	2/-	OC139	8/-
OA79	2/-	OC170	6/-
OA81	2/-	OC170	6/-
OA200	3/6	OC200	7/6
		OCP71	25/-

### VALVES

DK96	8/6	EY86	8/6
DF96	7/3	PCC84	7/9
DAF96	7/6	PCF80	7/9
DL96	8/-	PCL82	9/3
ECC81	5/-	PCL83	10/-
ECC82	5/6	PL81	8/6
ECC83	6/-	U25	10/-
EF80	5/9	U26	12/6
EF86	8/-	UCL82	9/6
EY51	8/-	UCL83	11/6

### SIEMENS RECTIFIERS CONTACT COOLED

B250 C75	13/6	B30 C400	9/4
B250 C100	14/3	B30 C1000	22/6
E125 C80	5/-	B250 C125	15/5
E250 C50	8/3	B250 C250	22/4
E250 C85	11/3	E250 C300	25/-
B30 C600	13/6	B300 C120	24/2
B250 C150	17/7		

### METAL RECTIFIERS

Battery charge types 12v. 1 amp. contact cooled	5/3
Fin Type 1 1/2 amp	6/9
2 amp	7/6
4 amp	12/6
6 amp	16/-

Solon Model 625 Instrument Iron	26/-
2 way Intercom Unit	70/-
4 way Intercom Unit	£7.5.0
8-watt Stereo Amplifier	£8.9.6
Dual Impedance dynamic microphone	84/-
Kaby Model M.1 Multi-range testmeter	54/-
Kaby Model A.10 Multi-range testmeter	£4.11.6
Adastra 3/3 Amplifier	£5.9.6

Also contains details and illustrations on Multi Range and Panel Meters, Microphones, Amplifiers, Loudspeakers, Coils, Recording Tapes, Aerials, Tools, Dials/Condensers, Chassis Plugs and Sockets, Transformers, etc., etc.

TERMS: C.W.O. or C.O.D. Approved monthly account. Add postage to all orders. Single valves, etc. 9d. Personal shoppers 9 a.m. to 5 p.m. Monday to Friday. Saturday 9 a.m. to 1 p.m.

**ALPHA RADIO SUPPLY CO., 103 Leeds Terrace, Wintoun Street, LEEDS 7**

# DETACHED PARTICLES

By John Valence

## BIG DECISION

HUMBLE wage slaves like myself have no real idea of the immense problems that face the high ranking executives of industry or commerce. But occasionally the veil is partly lifted and we get a momentary peep behind the scenes at their earnest deliberations. Take BOAC for example. Our major airline has just decided to spend a cool £3½ million on a computer that will enable it to face competition in the jet age with equanimity. Finding the money... well that was not really the problem. The real problem was what to call the merchandise.

We have it on the authority of the Corporation that much heart searching went on before the name BOADICEA was finally arrived at. If you can't be bothered to work it out, let me explain that this stands for British Overseas Airways Digital Information Computer for Electronic Automation.

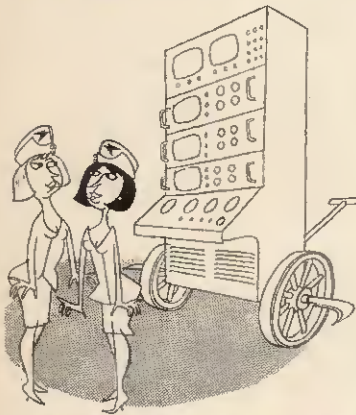

"Mind you the bottom part is completely British... but it plays havoc with your nylons"

As I have already hinted, this was not the first name proposed. Apparently the BOAC people are not particularly worried over the sex question and "she" might have quite happily become "he" if one of the early suggestions had been adopted: this was BERT (BOAC Electronic Reservations Tabulator).

More surprising was the revelation that Computerised Automation by Electronic System with Automated Reservations was for a time seriously

considered. Now what would that intrepid, audacious defender of British soil have thought of *that*. I hate to think. In any case, she would no doubt be highly indignant at this present use of her own name, seeing that BOAC's computer is no native of these isles.

Here in all fairness, and in the interests of Anglo-American relations, let me put the record straight. The major British firms did have the chance to tender for this unique installation, but all had to confess their inability to meet the target date. So that was that, or rather... IBM.

Do I see the Minister of Technology wincing each time he passes the defiant statue of this female warrior when on his way to the House?

No, BOAC, not altogether a tactful choice of name, I guess.

## PERSONALITY CULT

WHY do we give names to computers? This practice, of course, follows naturally enough on from our older custom of naming aircraft and tanks and such like. The Americans on the other hand seem quite happy with impersonal, code numbers to identify different craft and equipment. Although, in this connection, I seem to recall that one of the earliest electronic computers built in the U.S. was known as "Maniac". Not exactly flattering.

Perhaps in personifying a computer by giving it a name we are subconsciously accepting its human (or rather superhuman) qualities and recognising that it—he or she—is taking over more and more from us old-fashioned flesh and blood types.

In this "names game" the G.P.O. have had an easier task than BOAC. As automation proceeds apace the postal authorities are building up a nice little family. Already there is ALF (automated letter facer) and ELSIE (electronic scanning equipment). Further happy events are predicted. Oh, I almost overlooked older brother ERNIE. A disappointing lad actually. He has never come up to my expectations.

Finally, I think it must be handed to the Applied Mathematics Dept. of

Liverpool University. Their English Electric KDF9 proudly bears the name RINGO. Is this a fluke, or has it been cunningly contrived by these Liverpudlians?

## 25 YEARS AGO

IT does seem almost incredible that a quarter of a century has now lapsed since the Battle of Britain was fought out over and around the south-east corner of our Isle.

The great air offensive launched on 15 August 1940 culminated in the decisive daytime battle of 15 September. Two days later Hitler called off the proposed invasion operation "Sea Lion".

Of these facts, we are all well versed, perhaps from personal experiences, or at any rate from the recorded history of those momentous days. What is not so generally known is the essential part electronics played in determining the outcome of this desperate struggle.

From later testimony of German air aces, we know that the Luftwaffe was surprised and alarmed by the way our Hurricanes and Spitfires were accurately directed on to their fighter and bomber formations. The secret of this was our advanced electronic technology.

Thanks to our extensive Radar installations the enemy aircraft were under surveillance from the moment they took off from their bases on the Continent. With this intelligence literally before their eyes, the R.A.F. ground controllers were able to plan their tactics and deploy their limited resources of fighters to the best advantage. The link between the ground and the fighter pilot was the then quite revolutionary v.h.f. radio telephone.

To certain far-seeing Ministers and Air Ministry officials who between the wars organised research into the problem of interception of hostile aircraft, and to the teams of backroom boys or "boffins" who got to grips with the problem at a practical level, some of our gratitude for this victory is rightly due. Without this timely harnessing of the free electron in our defence system, today's story would be rather different...

# Why

## NOT BUILD ONE OF OUR PORTABLE TRANSISTOR RADIOS

BACKED BY OUR SUPER AFTER SALES SERVICE

All components used in our receivers may be purchased separately if desired. Parts price lists and easy build plans available separately at fixed prices stated.

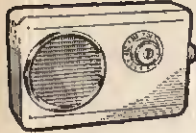

"Transona Five"  
Size 6½ x 4½ x 1½ in. approx.

Covers M. and L. Waves and Trawler Bands a feature usually found in only the most expensive radios. On test Home, Light, 208, and many Continental stations were received loud and clear. Designed round supersensitive Ferrite Rod Aerial and new type fine tone super dynamic 2½ in. speaker, attractive plastic cases with red grille.

Total cost of all parts for either type now only **42/6** P. & P. 3/6 (State type required)  
Parts Price List and easy build plans 2/-

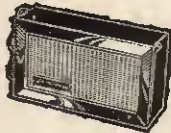

"Pocket Five"  
Size 5½ x 1½ x 3½ in.

## TRANSONA SIX

● 8 stages—6 transistors and 2 diodes

This is a top performance receiver covering full Medium and Long Waves and Trawler Band. Push pull output. High-grade speaker makes listening a pleasure. Ferrite rod aerial. Many stations listed in one evening including Luxembourg loud and clear. Attractive case in grey with red grille. Size 6½ x 4½ x 1½ in. (Uses PP4 battery available anywhere.) Carrying Strap 1/- extra.

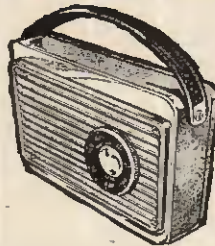

Total cost of all parts now only **59/6** P. & P. 3/6 Parts Price List and easy build plans 1/6

## SUPER SEVEN

● 9 stages—7 transistors and 2 diodes

Covers Medium and Long Waves and Trawler Band. The ideal radio for home, car, or can be fitted with carrying strap for outdoor use. Completely portable—has built-in Ferrite rod aerial for wonderful reception. Special circuit incorporating 2 RF Stages, push-pull output, 3in. speaker (will drive large speaker). Size 7½ x 5½ x 1½ in. (Uses 9v battery, available anywhere.)

Total cost of all parts now only **£3.19.6** P. & P. 3/6 Parts Price List and easy build plans 2/-

## ROAMER 7 Mk IV

6 WAVEBAND PORTABLE OR CAR RADIO

★ Now with PHILCO MICRO-ALLOY R.F. TRANSISTORS

Amazing performance and specification

● 9 stages—7 transistors and 2 diodes

Covers Medium and Long Waves, Trawler Band and two Short Waves to approx. 15 metres. Push-pull output for room filling volume from rich toned heavy duty "Celestion" speaker. Air spaced ganged tuning condenser. Ferrite rod aerial for M & L Waves and telescopic aerial for S Waves. Real leather-look case with gilt trim and shoulder and hand straps. Size 9 x 7 x 4in. approx. The perfect portable and the ideal car radio. (Uses PP7 batteries available anywhere.) Extra band for easier tuning of Pirate Stations, etc.

Total cost of parts now only **£5.19.6** P. & P. 5/6  
Parts Price List and easy build plans 3/-

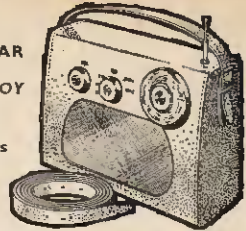

## MELODY SIX

"... amazed at volume and performance. Has really come up to my expectations". S.G., Stockton-on-Tees.

● 8 stages—6 transistors and 2 diodes

Our latest completely portable transistor radio covering Medium and Long Waves. Incorporates pre-tagged circuit board, 3in. heavy duty speaker, top grade transistors, volume control, tuning condenser, wave change slide switch, sensitive 6in. Ferrite rod aerial. Push-pull output. Wonderful reception of B.B.C. Home and Light, 208 and many Continental stations. Handsome leather-look pocket size case, only 6½ x 3½ x 1½ in. approx. with gilt speaker grille and supplied with hand and shoulder straps.

Parts Price List and easy build plans 2/- Total cost of all parts now only **£3.9.6** P. & P. 3/6

## NEW!! ROAMER SIX

NOW WITH PHILCO MICRO-ALLOY R.F. TRANSISTORS

● 6 WAVEBAND!!

● 8 stages—6 transistors and 2 diodes

Listen to stations half a world away with this 6 waveband portable. Tunable on Medium and Long Waves, Trawler band and three Short Waves. Push pull output. Sensitive Ferrite rod aerial and telescopic aerial for short waves. Top grade transistors, 3-inch speaker, handsome case with gilt fittings. Size 7½ x 5½ x 1½ in. (Carrying Strap 1/6 extra.)

★ Extra band for easier tuning of LUX., etc.  
Parts Price List and easy build plans 2/- Total cost of all parts now only **£3.19.6** P. & P. 3/6

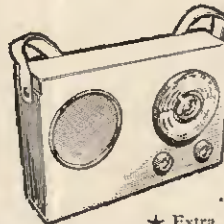

## SPECIAL RADIO EXCHANGE BARGAINS

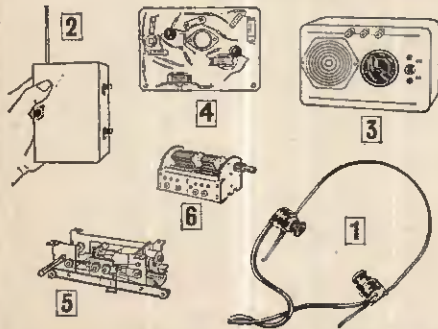

- HEADPHONES.** Sometime H.S.30 High Fidelity Headphones. Made by famous American manufacturer. Approx. 150 ohms impedance for direct matching into most transistor circuits. BRAND NEW in original sealed cartons. 15/- P. & P. 1/6. Matching Transformers for higher impedance 2/6 extra.
- THE SIG-GEN.** A versatile Signal Generator. Something no constructor should be without. This ingenious device generates an audible signal through the Audio and R.F. ranges. With variable output. Telescopic Probe. Pocket size slim-line case measures 4½ x 3½ x ½ in. Complete set of parts with full instructions. 18/6. P. & P. 1/6.
- QUICK CHECK TRANSISTOR TESTER.** Checks gain of N.P. and Audio Transistors. Also checks for noise level and diodes. All parts ready to be assembled in attractive grey case with red grille, complete with Dial, Knobs, and 2" Speaker. Simple assembly instructions free with set of parts. 39/6. P. & P. 3/6.
- 1200mW TRANSISTOR AUDIO AMPLIFIER.** Designed to give high quality at low cost. This superb Amplifier uses 4 Transistors including a special power type operating from a 12 volt battery. Variable input impedance. Matches directly into 25 ohms—35 ohms Loudspeaker. Special gain control circuit can also reduce noise to a minimum. All parts including Transistors, Printed Circuit Board, etc. 48/6. P. & P. 2/6. Easy build plans free with sets of parts. 6" x 4" 35 ohm speaker. 12/6. P. & P. 1/6.
- CYLDON PERMEABILITY TUNERS.** By famous manufacturer. Full M.W. coverage. Fitted coupling coil, oscillator coil, ferrite slug and slow motion tuning with cursor, etc. GIVE AWAY PRICE 10/- P. & P. 1/6. Switched type 2/6 extra.
- TUNING CONDENSERS.** Air spaced fine quality German manufacture with slow motion drive. 0.0002. With oscillator section. BRAND NEW!! Only 8/6. P. & P. 1/6.

**RADIO EXCHANGE Ltd.**  
61a, HIGH STREET, BEDFORD. Phone: 2367

Callers side entrance  
Barratts Shoe Shop  
Open 9—5 p.m.  
Sats. 9—12.30 p.m.

# VARIABLE VOLTAGE TRANSFORMERS

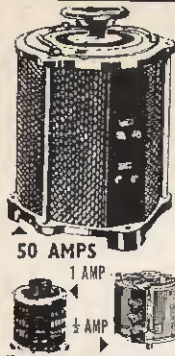

INPUT 230/240v. A.C. 50/60—  
**BRAND NEW Carriage Paid.**  
 Buy direct from the importer,  
 keenest prices in the country.  
 All Types (and Spares) from  
 1/2 to 50 amp. from stock.

0-260v at 1/2 amp	£3 3 0
*0-260v at 1 amp	£4 10 0
0-260v at 1 amp	£4 17 6
*0-260v at 2.5 amps	£5 17 0
2.5 amps Portable	£9 17 6
*0-260v at 4 amps	£8 7 6
*0-260v at 5 amps	£9 0 0
*0-260v at 8 amps	£13 10 0
*0-260v at 10 amps	£17 0 0
*0-260v at 12 amps	£19 10 0
*0-260v at 20 amps	£32 10 0
*0-260v at 37.5 amps	£65 0 0
*0-260v at 50 amps	£85 0 0

\*These instruments are  
 fully shrouded.

**100 WATT  
 POWER  
 RHEOSTATS (NEW)**  
 AVAILABLE IN THE  
 FOLLOWING 9 VALUES



10 ohm, 3 a.; 25 ohm, 2 a.; 50 ohm,  
 1.4 a.; 100 ohm, 1 a.; 250 ohm, .7 a.;  
 500 ohm, .45 a.; 1,000 ohm, 280 mA;  
 1,500 ohm, 230 mA; 2,500 ohm, .2 a.  
 Diameter 3 1/2 in. Shaft length 3 in.,  
 dia. 3/8 in. All at 27/6 each. P. & P. 1/6.

## INSULATION TESTERS (NEW)

Test to I.E.E. Spec. Rugged metal  
 construction, 500 volt, 500 megohms.  
 Price £22, 1,000 volts, 1,000 meg-  
 ohms, £28.

## TYPE 34R SILICON SOLAR CELL

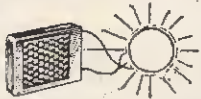

Four .5 volt units series connected in  
 high impact polystyrene case, flying  
 lead connections. Specially designed  
 diffusing lens system to ensure maxi-  
 mum light pickup. Output up to 2v,  
 at 10 to 16 mA in bright sunlight.  
 Wider spectral response, and thirty  
 times the efficiency of selenium cells.  
 As used to power earth satellites!  
 37/6, and 1/- P. & P.

## 1st grade NEW TRANSISTORS

OC28 17/-	OC76 6/-	Get 105 10/-
OC29* 18/-	OC81* 8/-	Get 573 12/6
OC41 7/-	OC83* 6/-	2N706A 17/6
OC44 6/6	OC139 12/-	25019 30/-
OC45 5/-	OC140 19/-	AC107 14/6
OC71 5/-	OC171 9/-	AF114 11/-
OC72* 7/-	OC200 10/6	AF115 10/-
OC73 6/-	OC203 14/-	AF116 10/-
OC75 7/-	Get 104 6/-	AF117 9/6
		BCZ11 10/-

\*Available in Matched Pairs.

**LATEST HIGH SPEED MAGNETIC COUN-  
 TERS.** 4 figure, 10 impulses per second. Type  
 100D, 4.1 ohm coil, 3-6 v. D.C. operation. Type  
 100A, 500 ohm coil, 18-24 v. D.C. operation.  
 Type 100B, 2,300 ohm coil, 36-48 v. D.C. operation.  
 Any type 15/- each, plus 1/6 P. & P.

**230 v. A.C. RELAY.** Type 1, 2 c/o, 2 amp.  
 contacts, 9/6. Type 2, 2x15 amp. break, 2x2  
 amp. make, 1x2 amp. break, 11/6. Both types  
 ex new equip. P. & P. 1/6 each.  
**12-18V. D.C. RELAY.** 168 ohm coil, 3.5amp  
 N.I. c/o contacts. New 16/6 + 1/- P. & P.

**0.4 MINUTE MECHANICAL TIME SWITCH**  
 16 Amp D.P. Switch complete with knob. Will  
 switch off any setting between 0.4 minutes. As  
 New, fraction of makers' price. 10/- plus 2/6 p. & p.

## ULTRA VIOLET BULBS

Easy to use source of U.V. for dozens of  
 practical and experimental uses.

12 volt 36 watt A.C./D.C. SBC 6/6.  
 P. & P. 1/-.  
 12 volt 60 watt A.C./D.C. SBC 8/6.  
 P. & P. 1/-.  
 Transformer to suit the above. Input 200-  
 240 v. A.C., 12 volt 36 watts, 16/6; P. & P.  
 2/6. Input 200-240 v. A.C. 12 volt 60 watt,  
 22/6. P. & P. 3/6.

**Set of 4 Colours FLUORESCENT  
 PAINT.** Red, yellow, green and cerise. In  
 1/2 oz. tins. Ideal for use with the above  
 Ultra Violet Bulbs. 9/6, plus 1/6 P. & P.

**SLIDER RESISTANCES.** 1 ohm, 12  
 amp. 17/6; 1.2 ohm, 14 amp. 27/6; 15  
 ohm, 2 amp. 37/6; 200 ohm, 1.25 amp. 37/6;  
 36 ohm, 6.5 to 2.8 amp., tapered winding,  
 geared drive (less knob) 37/6. P. & P. 3/6.

**VENNER 14 DAY CLOCKWORK TIME SWITCHES**  
 5 amp. 230 v. contacts. 24 hr. phase, 1/2 hr. divisions allows  
 setting for 1 make, 1 break every 24 hrs. Complete with key  
 and mounting block. Used but guaranteed. 35/6. P. & P. 2/6.



## WIMSHURST ELECTRO-STATIC GENERATORS

Really well constructed  
 machine. Ideal for  
 School and Laboratory  
 to demonstrate  
 the various effects  
 associated with static  
 energy. Will work well in any atmos-  
 pheric condition, giving a spark over  
 3in. long in dry weather. 1 1/2 in. dia. twin  
 plates, 2 Leyden jars. Discharge elec-  
 trodes. Heavily plated fittings, mount-  
 ed on solid wooden base. Outstanding  
 value at £13/17/6. Carriage U.K.  
 (B.R.S.), 10/-.

## BUILD AN EFFICIENT STROBE UNIT FOR ONLY 37/6.

We supply a simple circuit diagram and  
 all electrical parts including the  
 NSP2 Strobe tube which will enable you  
 to easily and quickly construct a  
 unit for infinite variety of speeds,  
 from 1 flash in several seconds to  
 several thousands per minute. 37/6  
 plus 3/- P. & P.  
**NSP2 TUBE** brand new. I.O. base.  
 Price 15/- P. & P. 1/6.

## UNIVERSAL DEMONSTRATION TRANSFORMER

A complete composite  
 apparatus, comprising a  
 robustly built Transformer  
 and electro-magnet  
 with removable coils and  
 pole pieces. 110-115 or  
 220-230v A.C. 6-12-36-  
 110v D.C. Coils. Maxi-  
 mum output 50 volt  
 ampere. The following  
 accessories are included:  
 welding coil, welding  
 clamps and electrodes, 2 heavily plated pole pieces with  
 conical and square ends, pendulum stand, damping and  
 non-damping pendulum, Barlow's wheel with  
 handle, mercury trough, fusing metal, inductive  
 jumping ring. Supplied complete with Demon-  
 stration Book giving details of a multitude of  
 basic demonstrations complete with the theory  
 involved. Price: £17 + 10/- Carriage (per  
 B.R.S.)

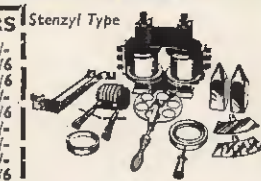

**LIGHT SENSITIVE SWITCH.** Kit of  
 parts, including ORP12 Cadmium Sulphide  
 Photocell, Relay, Transistor and Circuit, etc.,  
 price 25/- plus 2/6 P. & P. ORP 12 including  
 circuit, 10/6 each, plus 1/- P. & P.

**A.C. MAINS MODEL**  
 Incorporates Mains Transformer, Rectifier and  
 special relay with 3.5 amp mains c/o contacts.  
 Price inc. circuit 47/6 plus 2/6 p. & p.

# NOW ANYONE CAN AFFORD TO TRAIN TO BE AN EXPERT IN RADIO and ELECTRONICS

It's the most exciting news of the year! Just  
 imagine. You can get 35 large, fact-packed  
 lessons for little more than 1/- per lesson!  
 The lessons are crystal clear, practical,  
 easy to master and use. Early lessons make  
 fundamentals clear even to the beginner,  
 while other lessons will give you the  
 practical "know-how" of an expert.

Compares favourably with some courses costing ten  
 times as much. You save because you receive all the  
 lessons at one time and are not required to purchase  
 equipment you do not need.

This is a real home-study course that has been bound  
 into one giant 8 x 11in. 216 page manual. Each page  
 is divided into two columns. A wide column features  
 the text, while a narrow column at the side has the  
 instructor's comments, helpful suggestions and additional  
 pictures to simplify the difficult parts.

Everyone can benefit from this practical course. No  
 old fashioned (or pseudo modern) methods used here,  
 just straight forward, easy to understand explanations to  
 help you make more money in electronics.

The price! Only 38/6 plus postage 1/6.

Terms! Why of course! See Coupon.

## OTHER COURSES AVAILABLE

RADIO COURSE (22 lessons, price 38/-)

TELEVISION COURSE (price 38/-)

## UNCONDITIONALLY GUARANTEED TO GIVE COMPLETE SATISFACTION

You must be convinced that this is the best value you  
 have ever seen in Electronics, Radio or T.V. Training,  
 otherwise you can return the course (or have your money  
 refunded if sent with order) after you have examined it  
 in your own home for a full seven days.

**IF YOU SEND CASH WITH ORDER WE WILL  
 INCLUDE A FREE BOOK VALUED 6/-.** Tick on the  
 coupon one book for each course ordered with full cash.  
 These free books are authoritative, and loaded with  
 information. Would cost at least 5/- each if bought  
 separately—by sending cash you reduce book-keeping  
 and other costs which savings we pass back to you.

## --- FREE TRIAL OFFER ---

Pay only 5/- per week if you wish. Clip coupon right  
 now for this special offer.

To: Sim-Tech Technical Books, Dept. ETVII, Gater's  
 Mill, West End, Southampton, Hants.

Please send the following courses for a full seven days'  
 trial.

- No. 1. RADIO COURSE,  
37/6, incl. postage.
- No. 2. RADIO & ELECTRONICS COURSE,  
41/-, incl. postage.
- No. 3. TELEVISION COURSE,  
37/6, incl. postage.

(Free trial customers tick one only please).

If not delighted, I may return the course post-paid  
 without further obligation to my part. Otherwise I  
 will pay cash price or 5/- weekly until paid.

- Tick here if enclosing full purchase price.
- Please send me
- FREE TRANSISTOR CIRCUITS BOOK.
- FREE OSCILLOSCOPE BOOK.

Amount enclosed £.....

I understand that you will refund this money in full if I  
 am not 100% satisfied. Overseas customers please send  
 full amount (including Ireland).

NAME.....

ADDRESS.....

City..... County.....

# SERVICE TRADING CO

All Mail Orders—Also callers:  
 47/49 HIGH STREET, KINGSTON ON THAMES  
 Telephone: KINGSTON 9450

Personal callers only  
 9 LITTLE NEWPORT STREET  
 LONDON, W.C.2 Tel.: GERrard 0576

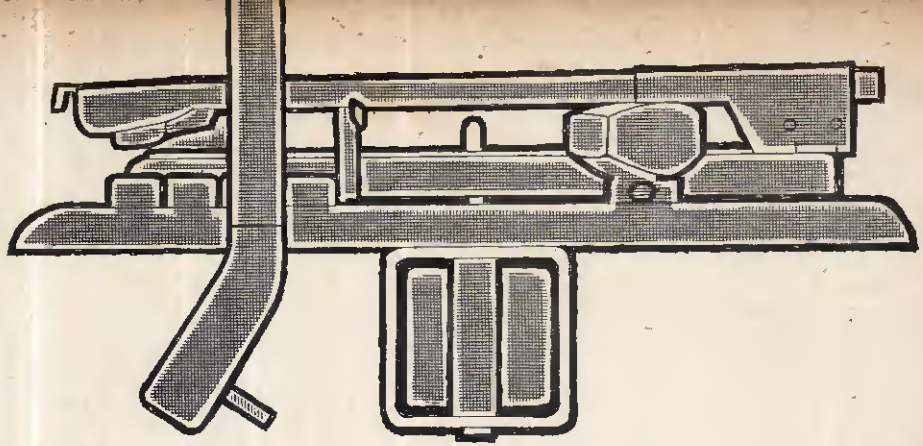

# GETTING STARTED WITH DISCS

THERE IS NO denying that, as things stand, disc records provide the most generally satisfactory performance in high-quality audio reproduction systems. That is to say, one stands a better chance of securing a *consistently* high standard if care is taken over the choice of equipment and records. High fidelity from f.m. radio is obviously much cheaper, but only occasionally is the all-round quality as good as that from the best of discs (ignoring, for the moment, the question of stereo).

It is not just a matter of frequency response, although even here the use of land lines to carry the signal from studio to radio transmitter often means that the top limit falls far short of the official 15,000c/s target. If realistic results are the aim, dynamic range—the range from quietest to loudest sounds—is at least as important as response. A very good disc will have a range of about 50dB, but the best of broadcasts do not approach this.

As for tape, much depends on the sound sources used. If most of the recordings are taken from the radio, in order to build up a music library, then obviously the results are only as good as the programme material. If the user depends on commercial tape records, he is in for a rather expensive time. Admittedly, if he has a flair for making "live" recordings, then the results may well be as good as those from discs.

But if the requirement is simply a very wide variety of professionally recorded sound—music, drama and so on—then discs win. The recorded repertoire is enormous; discs are convenient, and competition has cut prices to some extent. (Some of the cheap label issues, at under £1, are very good.)

All this may seem somewhat partisan. Of course, one cannot dismiss tape so lightly. Readers will need little reminding that tape is outstandingly attractive to those seeking a hobby—one that has some very special qualities and technical features. Yet is disc reproduction so very far behind? Although there is no scope for the amateur producer and editor, there is still plenty for the practical man to get to grips with.

The enthusiast will get the best from his discs by selecting and using components with care; he will take the trouble to acquaint himself with new developments so that he can confidently extend his field of interest. So let us examine the disc and the components used to reproduce it, giving special attention to practical points which will help those turning to audio for the first time.

## GROOVE SHAPE

Although the reasons for the development of stereo hardly come within the scope of this article, it is as well to look at the main features of a stereo disc. It certainly cannot be taken for granted that the interested amateur fully appreciates how, for example, such a disc is traced by the stylus or how the pick-up functions.

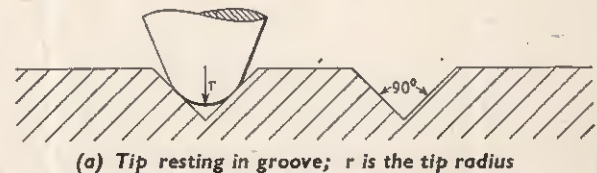

(a) Tip resting in groove;  $r$  is the tip radius

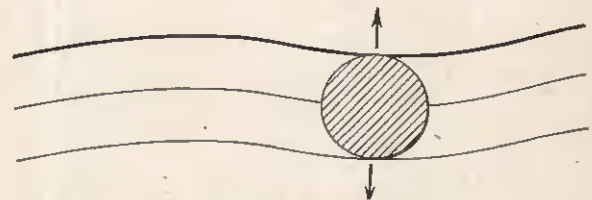

(b) Stylus moves laterally in a mono groove

Fig. 1 Stylus tip and groove

Compared with mono, the stereo groove—and therefore the movement of the stylus that traces it—is of course quite complex. In monophonic recording a groove is formed in the disc (actually a lacquer blank, at the start of the manufacturing process) by a cutter which moves laterally—that is, side to side. A cross-section of the groove together with the tip of the stylus is shown in Fig. 1a.

Thus the stylus moves laterally when tracing this groove, as shown in Fig. 1b and it is clear that this is the only movement needed for the reproduction of a single channel of information. The depth of the groove does not change.

In stereo recording an unmodulated groove would be essentially the same as a mono groove. But it is necessary to accommodate two separate channels of information in such a way that they can be traced by one stylus. Note that two channels are the limit. Multi-channel recording can be done on tape, and indeed it is often undertaken in the recording studio; but whatever the techniques used there, the signals

width and depth change and the stylus moves upwards. Of course, a music signal is complex, and the stylus is moved in an unimaginable variety of slanting, vertical and lateral directions, depending on the relative amplitudes and phases of the signals.

## STYLUS SIZE

This brings us to the question of stylus size—or rather, the size of the tip which fits into the groove. It is a matter on which there is often misunderstanding, and certainly it is one on which the beginner needs guidance. The stylus is in most cases conical with a spherical tip and, in the interests of long life and reduced record wear, it is of diamond in practically all but the cheapest pick-ups. A modern development is the elliptical stylus, but for simplification of the argument this type must be disregarded for the moment.

The best tip size for stereo is 0.0005in radius (otherwise known as a "half-thou"), and it is advisable to use this size for most high-quality applications, including the more modern mono discs. But remember that this is not the dimension across the tip: it is the radius of the tip, as indicated in Fig. 1. The stereo tip is half the size of that used for mono.

An important qualification has to be introduced here. The half-thou tip is the one to use if the playing weight of the pick-up is suitably low—about 3 grammes or less. If the tip radius is half of that used for mono, the tip area is smaller by another factor of two. Therefore the pressure on the stereo groove is four times that on its mono counterpart, and the stereo pick-up must track at a suitably low weight.

It is perhaps unlikely that the serious hi fi enthusiast will use a playing weight substantially higher than about 3 grammes; but if he does he should fit a stylus with bigger radius. A tip radius of 0.0007in is usually offered. It is more useful to think of stylus size and playing weight in this way than to regard the 0.0007in tip as a compromise that is vaguely somewhere between the mono and ideal stereo sizes.

In fact it is not a bad idea to have a separate pick-up head with the 0.0007in tip for the reproduction of a mono collection, especially if this includes older discs. But if the stereo pick-up is a good lightweight model, a half-thou tip is essential, and this can be used successfully on very many mono discs as well as for stereo. What it amounts to is that the stereo pick-up can also be regarded as a mono pick-up: it is only a matter of the way in which its outputs are connected; the amplifier mono/stereo switching usually takes care of this aspect.

These matters raise others in turn, such as the advantages of the elliptical stylus and the special requirements for an arm which will enable a stereo pick-up to track at a very low weight. Above all there is the question of choosing between an ever-increasing variety of pick-ups. Shall it be magnetic or ceramic? How will its characteristics affect the amplifier you wish to construct?

A later article will return to such points as these. For the moment it is appropriate to conclude with a reminder—needed by the uninitiated—that a mono pick-up must *not* be used on a stereo disc. It will destroy much of the stereo information and cause a good deal of damage. A stereo pick-up is safe on any microgroove disc, but whether it gives a satisfactory performance will depend on whether the stylus used is the right one for the job.

Fig. 2 Movement of stylus in stereo groove

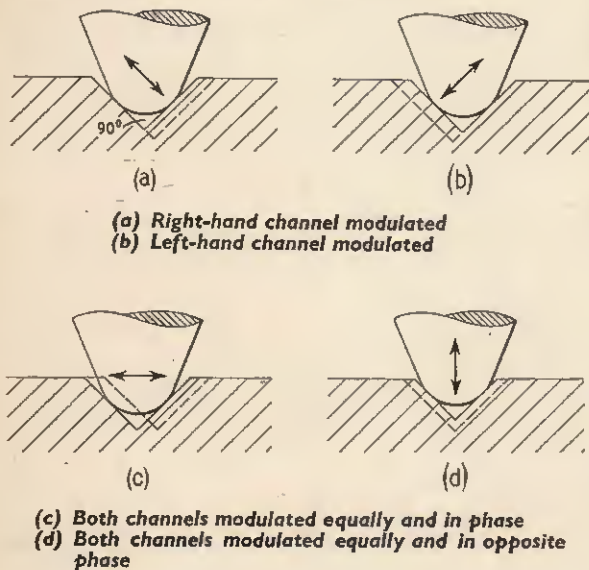

must be presented in two channels when the time comes to record the disc. Therefore one signal is cut on each groove wall; each "modulation" is geometrically at 90 degrees to the other but at 45 degrees to the surface of the disc.

This is called the "45/45" system, which has now been adopted as standard practice by the recording companies. The simplest way of visualising the system is to study the four basic modes of stylus movement, as indicated in Fig. 2.

When the right-hand channel is modulated, the stylus is pushed up and across at 45 degrees to the surface of the disc; and with left-hand modulation the movement is up and across in the other direction. If both channels are in phase and equally modulated, the width and depth of the groove remain constant and the stylus is moved sideways (this is the same as mono); but if the channels are in opposite phase, the groove

# BUILD OVER 40 CIRCUIT/EXPERIMENTS

and master electronics the **LERNAKIT** way

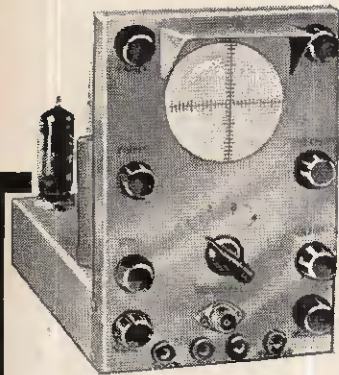

- No maths — No unnecessary theory
- NO PREVIOUS KNOWLEDGE NEEDED
- BUILD A PROFESSIONAL  
CATHODE RAY OSCILLOSCOPE

Learn how to

- READ AND DRAW CIRCUIT DIAGRAMS
- RECOGNISE, HANDLE AND UNDERSTAND  
every type of modern **ELECTRONIC COMPONENT**

OVER 40 EXPERIMENTS — including:-

- Valve Experiments
- Transistor Experiments
- Electro-magnetic Experiments
- Basic Amplifier
- Basic Oscillator
- Basic Rectifier
- Signal Tracer
- Simple Counter
- Time Delay Circuits
- Square Wave Generator
- Morse Code Oscillator
- Simple Transmitter
- Electronic Switch
- Photo-electric Circuit
- Basic Computer Circuit
- Basic Radio Receiver
- A.C. Experiments
- D.C. Experiments

This complete practical course will teach you all the basic principles of electronics by carrying out experiments and building operational apparatus. You will learn how to recognise and handle all types of modern components, their symbols and how to read a complete circuit or schematic diagram. The course then shows how all the basic electronic circuits are constructed and used and **HOW THEY ACTUALLY WORK BY USING THE OSCILLOSCOPE PROVIDED**. An application is given in all the main fields of electronics, i.e. Radio; control circuits; computers and automation; photoelectrics; counters, etc., together with rules and procedure for fault finding and servicing of all types of electronic equipment. For a new and exciting approach which gives a real understanding of electronics in an entirely practical way—this course has no equal anywhere to-day.

**POST NOW FOR FREE COLOUR BROCHURE**

To: **BRITISH NATIONAL RADIO SCHOOL, READING, BERKSHIRE**

Please send free Brochure, describing your LERNAKIT Oscilloscope Course without obligation, to:

NAME .....

ADDRESS .....

BLOCK CAPITALS PLEASE

OR WRITE IF YOU PREFER NOT TO CUT COUPON

(No representatives employed)

P.E.10.65

## British National Radio School



### FIRST QUALITY PVC TAPE

5 3/4" Std. 850 ft. 9/-	5" L.P. 850 ft. 10/6
7" Std. 1200 ft. 11/6	3" T.P. 600 ft. 8/-
3" L.P. 240 ft. 4/-	5" T.P. 1800 ft. 20/6
5 3/4" L.P. 1200 ft. 11/6	5 3/4" T.P. 2400 ft. 27/6
7" L.P. 1800 ft. 18/6	7" T.P. 3600 ft. 37/6

P. & P. on each 1/6, 4 or more post free.

Complete with McLaren Variable Thermostat 90° to 180°F. 20 amp. A.C. and GEC double pole 20 amp. mains switch. 18", 30" and 36". State length required. £2.0.0 plus 5/- P. & P.

### 3kW IMMERSION HEATER



#### "PREMIER" KETTLE ELEMENT

1000 w. 8/6 + 3/- P. & P. Retaining nut and flange 2/6, switch plug to suit 2/6.

### A.C. MAINS MOTOR



Can be used for a variety of purposes, silent running, satisfactory in every way. 230/250 v. A.C. 9/6. P. & P. 3/-.

### 3 to 4 WATT AMPLIFIER KIT



comprising chassis 8 3/4" x 2 1/4" x 1 1/2". Double wound mains transformer, output transformer, volume and tone controls, resistors, condensers, etc. 6V6, ECC81 and metal rectifier. Circuit 1/6 free with kit. 29/6 plus 4/6 P. & P.



**40w. FLUORESCENT LIGHT KIT** incorporating GEC Choke size 8 1/2" x 1 1/2" x 1 1/2". 2 bi-pin holders, starter and starter holder, 11/6. P. & P. 4/6.

Similar to above: 80w. Fluorescent Light Kit incorporating GEC choke size 11 1/2" x 1 1/2" x 1 1/2". 2 bi-pin holders, starter and starter holder, 17/6. P. & P. 5/6.

### 8-watt 5-valve PUSH-PULL AMPLIFIER & METAL RECTIFIER

Size: 9 x 6 x 1 1/4" A.C. Mains 200-250v. 5 valves. For use with Std. or L.P. records, musical instruments, all makes of pick-ups and mikes. Output 8 watts at 5 per cent total distortion. Separate bass and treble lift controls. Two inputs, with controls, for gram. and mike. Output Transformer tapped for 3 and 15 ohms speech coils. Built and tested. £3.19.6. P. & P. 8/-.

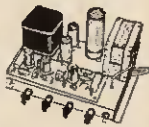

### SPECIAL OFFER! ELEGANT SEVEN Mk. II

Combined Portable and Car Radio  
The Radio with the "Star" Features

- ★ 7-transistor superhet. Output 350 mW.
- ★ Grey wooden cabinet, fitted handle with silver-coloured fittings, size 12 1/2 in. x 8 1/2 in. x 3 1/2 in.
- ★ Horizontal tuning scale, size 1 1/4 in. x 2 1/2 in. in silver with black lettering.
- ★ All stations clearly marked.
- ★ Ferrite-rod internal aerial.
- ★ Operated from PP9 battery.
- ★ I.F. neutralisation on each stage 460 kc/s.
- ★ D.C. coupled output stage with separate A.C. negative feed back.
- ★ All components, ferrite rod and tuning assembly mounted on printed board.
- ★ Fully comprehensive instructions and point-to-point wiring diagram.
- ★ Printed circuit board, back-printed with all component values.
- ★ Fully tunable over medium and long waveband.
- ★ Car aerial socket. ★ Full after-sales service.

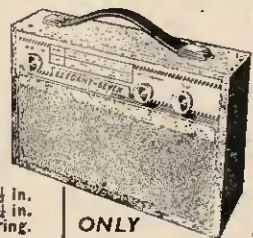

ONLY £4.4.0

Plus 6/6 Post & Packing

**SPECIAL OFFER—POWER SUPPLY KIT** to purchasers of Elegant Seven parts, incorporating mains transformer, etc. A.C. mains 200-250v. Output 9v. 100mA. 7/6.

4 in. SPEAKER. Parts list and circuit diagram 2/6. FREE with parts.

Shop Hours 9 a.m. — 6 p.m. Early Closing Wednesday

**RADIO & T.V. COMPONENTS (ACTON) LTD.**  
21D, HIGH STREET, ACTON, LONDON, W.3

## TRANSISTOR BARGAINS!

OC 71 equivalent	1/- each
	£1 for 25
NKT 124/5 Switching type	£3 for 100
	2/- each
	10/- for 6
2G 371	2/6
OC 25	10/-
OC 35	10/-
NKT 405	10/-

Packet containing:

3 2G417	} £1 complete
2 2G371	
1 2G381	
1 2G339	
1 Diode	

(For making superhet with complementary symmetry transformerless output stage)

Diodes	1/-
Zener Diodes, ZE12, ZB43	5/-
BY 100 Rectifiers	7/6
Colvorn 10 ohm pre-sets...	2/6
50K ohm pre-sets	1/6
1K ohm Skeleton pre-sets	1/-

Resistors. 1/6th and 1/10th watt. Your choice of value. Minimum 10 of any value ... 10/- per 100  
Mixed values and wattages ... 50/- per 1,000

Condensers. 2.2uuf., 500uuf., 0.0001, 0.001, 0.002, 0.005, 0.02, 0.04 uuf. 7/6 per 100  
£3 per 1,000

### RELAYS

700 ohm or 2,500 ohm coil. Transparent dust cover. 2 pairs of change-over contacts. PLUG-IN TYPE. Base included in price 25/- each

### ELECTROLYTIC CONDENSERS TUBULAR

2uf, 4uf, 8uf, 16uf, 32uf, 64uf. 15V. Special price ... 1/2 each

2uf	30Volt	200uf	30Volt
25uf	30Volt	250uf	6Volt
50uf	15Volt	320uf	15Volt
64uf	25Volt	400uf	2.5Volt
100uf	3Volt	500uf	6.4Volt
100uf	6Volt	500uf	15Volt
100uf	18Volt	500uf	50Volt
100uf	30Volt		
1,000uf	6Volt		
1,000uf	12Volt	1,000uf 50Volt Can-type	3/-
1,000uf	15Volt		
1,000uf	25Volt		

Special offer: Television smoothing condensers 200/100uf or 200/200uf 275Volt. Whilst stocks last 6/6 each

### FLUORESCENT FITTINGS. Bargain price!

5' Slim-line with choke and starter ... 39/6 (less tube)  
4' Slim-line with choke and starter ... 32/6 (less tube)  
Carriage, extra on above 10/- per fitting

Special circuits and components to make transistorised:

HIGH FIDELITY LOW-NOISE PRE-AMPLIFIER	30/-
RUMBLE AND SCRATCH FILTER	30/-
REV. COUNTER FOR CAR (excluding meter)	10/-
SIGNAL INJECTOR	10/-
VERY HIGH IMPEDANCE (1 MEG. OHM/VOLT)	
MULTIRANGE VOLTMETER (excluding meter)	30/-
20 MEG. OHM OHM-METER (excluding meter)	15/-
Brand-new Meters suitable for above applications	30/- each
New 4in. LOUDSPEAKERS	10/-
Midget Ear-phones with plug and lead	5/-
Magnetic Lapel Microphone with plug and lead	10/-

### VERNIER DIALS

1 1/2 in. 8 : 1 ratio	180° Calibration	14/-
2 in. 8 : 1 ratio	180° Calibration	15/6
3 in. 8 : 1 ratio	180° Calibration	17/-

Very useful pocket-size 1,000 o.p.v. Multimeter £3

Extra special Bargain!

ACOS PICK-UP HEADS. Complete with needles

Monaural	14/-
Stereo	21/-
Stereo with Diamond Needles	28/9

For orders of 10/- or less please add 6d. toward postage. Regret that no orders can be accepted under 5/-. Orders over £5 deduct 5% Cash Discount.

## G. F. MILWARD

17 PEEL CLOSE

DRAYTON BASSETT

Near TAMWORTH, STAFFS.

TAMWORTH 2321

POST ONLY



# NEW PRODUCTS

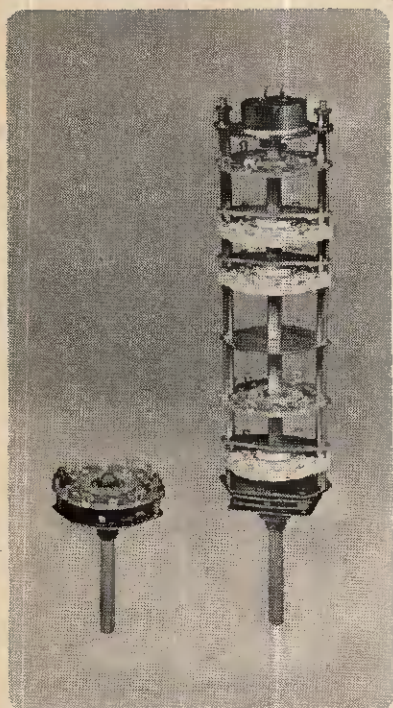

## "Custom-built" Switches

Specialist Switches Ltd., 23, Radnor Mews, London, W.2.

Our photograph shows just two of the many switches that have been built to individual requirements by Specialist Switches Ltd. These switches can be made up as required for prototype apparatus and the large switch shows a range of s.r.b.p. and ceramic wafers, inter-wafer screening, mains switch and heavy duty click mechanism that are available. The small switch is a single-wafer, 6-pole, on/off s.r.b.p. type.

The price of switches complete with one wafer ranges from 7s 3d to 9s 5d according to type. Additional s.r.b.p. wafers cost between 3s 2d to 5s 2d. For switches with ceramic instead of s.r.b.p. wafers, 3s 0d per wafer is added to the price of the switch.

This "one-off" service will obviously please a number of experimenters as this gives greater scope when designing equipment. Rather than having to restrict himself to using standard switches, the designer can consult the above firm to see if it is possible to make up the type of switch he wishes to use.

## "Masterbox" Kits

Cockrobin Controls, 36, Villiers Avenue, Surbiton, Surrey.

The rather strange looking items depicted in the photograph are just a few of the new "Masterbox" components. This new type of box has been designed to help amateurs as well as professionals to build small switchboards and indicator panels from a kit of parts. The principle on which "Masterboxes" are built up should be of particular appeal in experimental work where frequent alterations and extensions are required.

The boxes are built up from standard units making two sizes: 3in by 3in by 2.03in and 6in by 6in by 2.03in. Any number of units may be assembled together to build up almost any desired size of panel within the limits of multiples of the basic sizes. Alterations to the layout of equipment can be made by replacing the standard 0.08in thick aluminium alloy face panel. If new face panels are used they can be cut and drilled to the new dimensions with provision made for cable entry.

Parts are supplied either separately or in kit form. The standard kit contains four aluminium alloy corner posts, four 0.05in thick steel plates with dark green p.v.c. laminated finish, and front and back panels of aluminium alloy. A packet of cadmium plated steel nuts and screws are included to make up a complete kit.

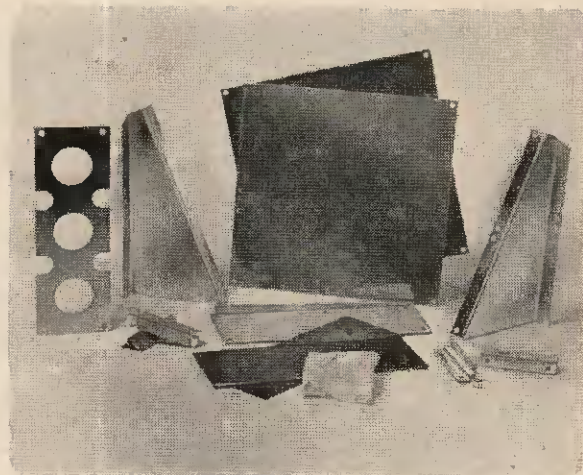

Additional kits are available to supplement the standard kit. These are the extension type, given the suffix "X", and the corner type with the suffix "Z".

The "X" kit contains only two side panels and one 0.1in thick aluminium alloy perforated panel, for wiring within units. The "Z" kit has no side panels but has two partition walls. The appropriate screws and nuts are provided.

Special mounting brackets are available for mounting at an angle of  $22\frac{1}{2}$  degrees from a horizontal or vertical position.

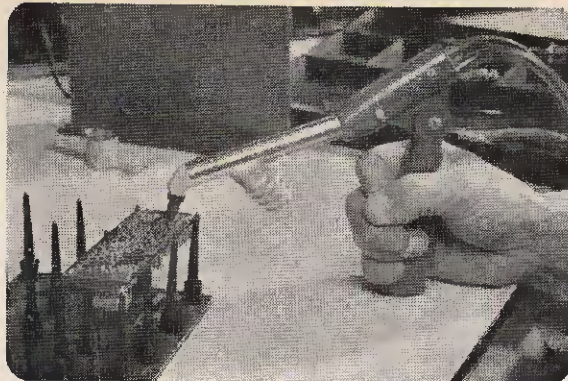

### Aspirated Soldering Iron

Philips Electrical Ltd., Century House, Shaftesbury Avenue, London, W.C.2.

An aspirated soldering iron, which was first demonstrated in prototype form last year, is now readily available from all official Philips service agents. This new tool has been specially developed to simplify the removal of components and solder from printed circuit boards during servicing work.

Our photograph shows how the hollow copper-beryllium bit is placed on the joint to be unsoldered, the solder being sucked away as it is melted. Air suction is applied by a connected footpump; the solder is stored in the solder pot screwed to the barrel of the iron for removal later.

The complete unit comprising the iron, stand, spanners and footpump costs £6 17s 6d net. There are three versions available, 230/250, 200/220, and 110/125 volts. Orders should quote the code number HY. 140.83 and voltage.

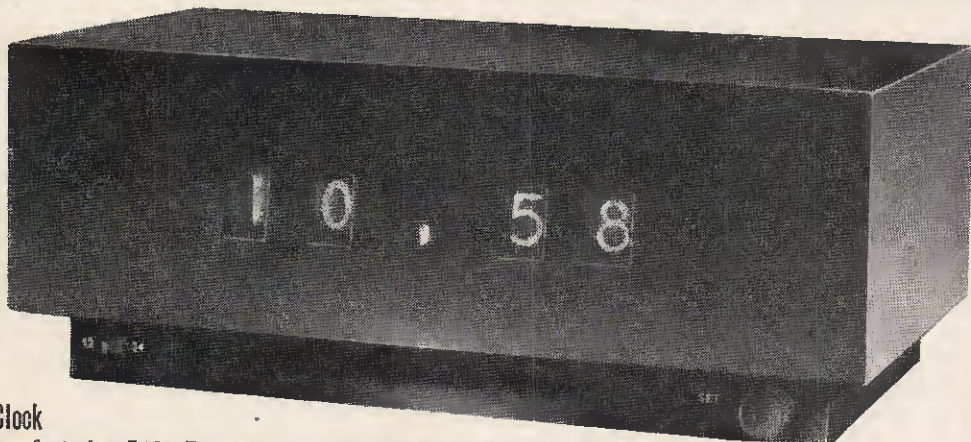

### Electronic Clock

Darang Manufacturing Ltd., Restmor Way, Hackbridge Road, Hackbridge, Surrey.

The first of its type to be produced for general sale, the "Digicron" electronic clock offers a highly efficient method of showing and recording the time. The clock displays the time on four digitron tubes showing the hours and minutes in illuminated figures.

The design makes use of a number of plug-in printed circuits; 12- or 24-hour display can be selected by operating a switch located

on the front panel. A second control sets the digits to the required time.

The clock has accessible built-in fuse protection, the consumption of the clock being approximately 25 watts. Power and timing are derived from the 50 cycle mains supply, the operating voltage of which can vary from 190 volts to 260 volts without affecting the accuracy. The retail price is in the region of £90.



### Lantern Torch

Vidor Ltd., Erith, Kent.

Vidor Ltd. announce a new and improved version of their popular lantern type torch.

Known as the CN 9005A, it is an improved version of the CN 9005 lantern. The main differences are the main beam swivel head, all metal chrome plated casing, preset handle positioning to eight angles, and an interchangeable red or clear dome for the flashing beacon.

The CN 9005A torch has numerous uses, both indoors and outdoors, and retails at 17s 6d.

SEND TODAY OR CALL  
Portable radios, beautifully made, famous specification—7 "Sony" transistors—world

**SAVE £8 NOW!**

GENUINE TRANSWAVE  
**2 WAVE BAND RADIOS**  
SPEC. 7 SONY TRANSISTORS



SLASHED TO **£319.6**  
POST ETC. 2/6  
**OR 20'-DEP.**

famous for quality performance, and finest components. Full long and medium wave bands—STATIONS GALORE—perfectly selected! Built-in aerial and speaker! Control volume from whisper to roar! Hi-Fi tone and high sensitivity! Originally £11/19/6. Now 79/6, post 2/6. Or 20/- dep., 18 finly. pyts. 4/5 plus post. Leather carry case, standard battery and personal earpiece—THE LOT for 7/6 if required. Written guarantee.

**SENSATIONAL PURCHASE OF RECENT LARGE LIQUIDATED STOCK!**

**ALL TRANSISTOR TAPE RECORDER**

NOW ONLY **79/6** POST ETC 5/-  
**NO DEPOSIT**



Brand new. A superb portable Transistor Tape Recorder. Record voice, music, everything! WITH VOLUME CONTROL! Ultra sensitive "built-in" speaker! More compact! More powerful! Super tone! Super performance. Try matching it for 15 gs! Records plays, meetings, etc. Permanent recordings or tape again and again. Ideal reporters, dictating, etc. Simple to operate. Fully g'teed. With microphone and standard Batteries (Cheap to run) replaceable anywhere. Standard model 79/6. P. 5/-. Or Credit Service, simply send 5/- P. & P., bal. 18 finly. pyts. 5/6. Carrier top 20/- extra. Super tape! 12/6 extra, state if required. Refund guarantee. Lists.

**YOURS AT LAST! SECRET SERVICE TAPE**  
SMALLEST IMAGINABLE  
**WORTH £519.6 POST ETC 3/6**  
**TREBLE OR 30'-DEP**



Styled on those shown on T.V. and in spy films. Records and plays when concealed in any position! Plays back distinctly—adjustable sound control. For voice or music, reporters, dictating, etc. Works in jacket or trouser pocket, handbag etc. Yes, measures only inches. **DEPTH ONLY 2in.** Sturdy metal case! Only £5/19/6, post etc. 3/6 or 30/- dep. bal. 18 finly pyts. 6/4. (Total Credit Sale Price 144/-) plus post. With carry case, earpiece and microphone. **Super 15 minute track tape 12/6 extra.** Standard batteries 1/9, per set. Fully guaranteed.

**PORTABLE INTERCOM/ELECTRONIC 'BABY SITTER'**

DE LUXE **66N9 MODEL**  
**MODEL!**

**57/6** POST ETC 2/6



Transistor intercom system, originally listed at £6/6/0—now only 57/6, post 2/6, or 10/- dep. Credit Service Terms balance 18 finly. pyts. of 3/3 plus post. With approx. 60ft. connecting flex, also usable for longer distances. 9-volt battery 2/8 ex. (replaceable). Every sound relayed! Hear what goes on—every sound, every movement. **Two-way buzzer call and speaker system.** Also usable on wall or desk in conjunction with radio, office to office, house to garage and many other uses. **Only transistor model with new seal off infallible insulation!** Refund if not delighted with this superb bargain. Send today or call. **LISTS RADIOS.**

**HEADQUARTER & GENERAL SUPPLIES LTD.**

(DEPT. PE/1) 196-200 COLDHARBOUR LANE - LOUGHBOROUGH JUNCT., LONDON, S.E.5 (Wed. 1 p.m.)

West End Stores, 37/39 High Holborn, W.C.1, and 267/269 Oxford Street, W.1 (Thursday 1 p.m.). Also stores at 166 North End, Croydon, and 149 High Street, Guildford (Wednesday 1 p.m.). ALL STORES 6 p.m. SATURDAY, 7 p.m. FRIDAY.

**ADVANCED RADIO CONTROL**

by E. L. Safford

25/- Postage 1/-

- INTRODUCTION TO LASERS & MASERS, by A. Lytel. 16/- Postage 1/-
- PRINCIPLES OF TRANSISTOR CIRCUITS, by S. W. Amos. 25/- Postage 1/3
- TROUBLESHOOTING WITH THE OSCILLOSCOPE, by R. G. Middleton. 20/- Postage 1/-
- BASIC COMPUTER PROGRAMMING, by T. G. Scott. 30/- Postage 1/6
- COMPUTER CIRCUIT PROJECTS YOU CAN BUILD, by L. Boschen. 21/- Postage 1/-
- ELECTRONIC AND RADIO ENGINEERING, by F. E. Terman. 60/- Postage 2/-
- MAINTENANCE MANUAL, by Mullard. 16/- Postage 1/-
- REFERENCE MANUAL OF TRANSISTOR CIRCUITS, by Mullard. 12/6 Postage 1/-
- RADIO VALVE DATA, Compiled by "WW," 7th edition. 7/6 Postage 1/-

COMPLETE CATALOGUE 1/-

**THE MODERN BOOK CO.**  
19-21 PRAED STREET  
LONDON, W.2  
Phone: PADdington 4185  
Open 6 days 9-6 p.m.

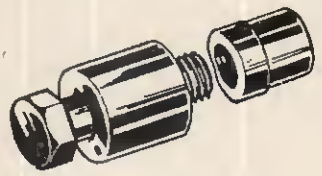

The **PUNCH** you need!

**HOLE PUNCHES**

Instant Type					
3/8" diameter	...	...	...	...	6/10 ea.
Screw-up Type					
1 1/8" diameter Toggle switch	...	...	...	...	8/6 "
" " " B7G	...	...	...	...	8/6 "
" " " B8A, B9A	...	...	...	...	9/- "
" " " " "	...	...	...	...	9/6 "
" " " " "	...	...	...	...	10/2 "
" " " " "	...	...	...	...	10/8 "
" " " " "	...	...	...	...	11/8 "
1 1/4" diameter Int. Octal	...	...	...	...	13/4 "
" " " " "	...	...	...	...	14/2 "
" " " " "	...	...	...	...	18/10 "
" " " " "	...	...	...	...	21/8 "
" " " " "	...	...	...	...	24/4 "
2 3/8" " " Meter	...	...	...	...	33/2 "

Complete Set £9.3.6.

No extra charge for postage and packing in the U.K.

Now supplied by:

**TOMPKINS & LONGMAN LTD.**  
237 GIPSY ROAD  
WEST NORWOOD, S.E.27  
Tel.: Gipsy Hill 5000

**SEMICONDUCTOR BARGAINS**

<b>Silicon Rectifiers</b>	
100 P.I.V. 750 mA	1/6
200 P.I.V. 750mA	2/-
400 P.I.V. 750mA	2/9
600 P.I.V. 750mA	4/6
800 P.I.V. 750mA	5/9
1,000 P.I.V. 750mA	7/6
1/3 watt Zener Diode 12v.	4/6
<b>1 watt Zener diodes</b>	
6v., 9v., 10v., 16v., 22v., 28v., 36v., 60v., 95v.	8/-
<b>10 watt Zener diodes</b>	
4v., 6v., 8v., 10v., 16v., 19v., 22v., 28v., 32v.	8/6
<b>10 watt Double Anode Zeners</b>	
12v. Regulates pos. or neg. or both	16/-
<b>Silicon Controlled Rectifiers</b>	
7 amp. 200 P.I.V.	18/6
7 amp. 300 P.I.V.	21/6
18 amp. 300 P.I.V.	25/-
18 amp. 400 P.I.V.	28/-
<b>Transistors</b>	
2N1046 p.n.p. 12 amp. 50 watt 10 m/cs.	45/-
2N1007 p.n.p. 20 amp. 60 watt 20 m/cs.	50/-
SYL 3073 p.n.p. 360m/cs. 150 mw.	15/-
Unijunction 2N2646—Silicon 300mW.	19/8
2N3838 p.n.p. 1-Watt—100Mc/s.	19/6
<b>NPN Silicon for Hi-Fi etc.</b>	
2N657 100v. 90 gain 4 watts 2 m/cs.	35/-
2N1050 120v. 90 gain 40 watts 2 m/cs.	40/-
<b>Special Mullard 00P71</b>	
	15/6

Posting and packing 1s. up to any 6 items

**J. and J. ELECTRONICS (CANADA)**

ALL ORDERS TO:  
174 Maybank Road, South Woodford, London, E.18  
Phone: BUC 9315  
ALL GOODS NEW AND GUARANTEED RETURN OF POST SERVICE

# HIGH QUALITY

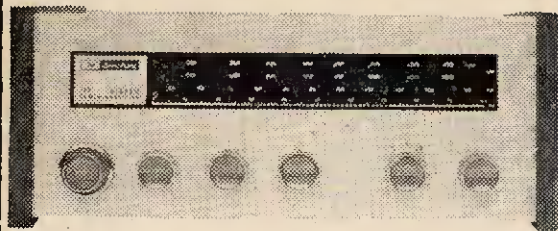

# LOWER COST

Combine an Armstrong Tuner and Amplifier and you have a compact item with all the advantages of the separate units, plus easier installation, and equivalent performance at a lower price.

Stereo model 127, above, is derived from the more expensive 227, and has an identical AM-FM tuner section, but with an amplifier section designed for those whose power requirements are more modest. It has a more modest price too, as does the mono version model 127M.

Each Armstrong Tuner-Amplifier is ideal as the basis of a high fidelity system for radio and record reproduction tape recording and playback, and each unit may be built into your own cabinet or used in our optional case, of teak and vinyl hide, as shown.

For full details and technical specifications plus list of over 300 stockists, post coupon or write mentioning 10PE 65

model 127 STEREO TUNER AMPLIFIER ... £37.10.0  
 model 127M MONO TUNER AMPLIFIER ... £26.10.0  
 optional case for each model £3.10.0



## Armstrong

ARMSTRONG AUDIO LTD - WARLTERS ROAD - N.7  
 Telephone: NORth 3213

Name .....

Address .....

10-PE-65

## YUKAN SELF-SPRAY HAMMER FINISH

Get this Air Drying Grey Now —

IT'S SUPERB . . . THE PUSHBUTTON WAY!

YUKAN Aerosol spraykit contains 16 ozs. fine quality durable easy instant spray. No stove baking required. Available in Grey Hammer at 14/11 at our counter or 15/11, Carr. paid, per pushbutton self-spray can. SPECIAL OFFER: 1 can plus optional transferable snap-on trigger handle (value 5/-) for 18/11.



Please enclose cheque or P.O. for total amount to:

### YUKAN

Dept. PE/10, 307a EDGWARE ROAD, LONDON, W.2

(Closed Thursday afternoons, open all day Saturday)

Choice of 13 self-spray plain colours and primer (Motor car quality) also available

## RETURN - OF - POST ON CASH OR C.O.D. ORDERS

### LATEST TEST METERS

All the latest models from current production. Illustrated list available

	Cash Price	Deposit	Credit Terms	Total Credit
			12 Mthly/Pmts.	
AVO 8 Mark 3	£24. 0. 0	£4. 16. 0	£1. 16. 0	£26. 8. 0
AVO Multimeter Mk. 4	£9. 10. 0	£1. 15. 0	£1. 14. 9	£10. 15. 0
TAYLOR MODEL 88B	£24. 10. 0	£4. 18. 0	£1. 15. 10	£27. 0. 0
TAYLOR MODEL 127A	£10. 10. 0	£2. 3. 0	£1. 16. 0	£11. 15. 0
TMK MODEL 500	£8. 19. 6	£1. 16. 6	£1. 14. 0	£10. 4. 6

## WATTS RADIO (Mail Order) LTD

54 CHURCH STREET, WEYBRIDGE, SURREY

Telephone: Weybridge 47556

PLEASE NOTE: Postal business only

## MARTIN Audiokits

FOR HI-FI AND F.M.



MARTIN AUDIOKITS comprise an ingeniously designed series of fully-transistorised units by means of which you can build up a hi-fi assembly starting with a simple mono amplifier system and adding to it to make a fully integrated 20-watt stereo installation, for well under £30. This can be used with low output as well as crystal pick-ups, radio, tape-heads, microphones, etc. Building is pleasantly easy. Quality is outstanding. Now units for making an FM Tuner are available for adding to Audiokit assemblies or using separately.

20 WATT INTEGRATED STEREO

ADD-ON UNIT SYSTEM

F.M. TUNER

THE EASY WAY TO BUILD AND SAVE

Leaflet on request.

From good stockists everywhere.

Martin Electronics Ltd  
 154-155 High St., Brentford,  
 Middlesex. ISLeworth 1161/2

MARTIN ELECTRONICS LTD.  
 154-155 HIGH ST., BRENTFORD, MIDDXX  
 Martin Leaflet on Audiokits   
 FM Tuner , please.

NAME .....

ADDRESS .....

Pre.10.....

# Readout —

## A SELECTION FROM OUR POSTBAG

### It's a puzzle

Sir—Mr. S. C. Hooson's circuit ("Powerless Experience", August *Readout*) will work without a battery due to the leakage of C3 (200 $\mu$ F). Likewise, V1 will be cut off by the application of the battery. The voltage available to work TR1 comes from the cathode bias network of V1. The 2.2M $\Omega$  grid leak acts as a collector load.

For satisfactory results, C3 should be reduced to about 0.1 $\mu$ F as the input of V1 is high and not low impedance.

There are other and better low and high impedance matching circuits, but this will work provided C3 is reduced as outlined above.

A. M. Levett,  
Horley,  
Surrey.

Sir—Regarding S. C. Hooson's "Powerless" pre-amplifier, it seems to me that originally he was operating the transistor with no collector load at all, which would result in no signal being developed across the coupling capacitor C3, as well as over-running the transistor. When he put in the 10k $\Omega$  load all was well.

As to operating it with no power at all, this is, of course, a wrong assumption. The collector voltage is being applied by the few volts of negative bias through the 2.2M $\Omega$  resistor in the valve grid circuit due to the leakage of the 200 $\mu$ F coupling capacitor.

N. Sanders,  
Langley,  
Bucks.

### ... so is this

Sir—Reading S. C. Hooson's account of a "Powerless" amplifier reminded me of an amusing experience of my own.

During the war I constructed a simple l.f. oscillator, using a battery triode valve and an intervalve transformer, for the purpose of morse practice. A rheostat was used to vary the filament voltage and thus the pitch of the note and h.t. was supplied by an old a.c. battery eliminator.

On switching on, the oscillator "fired" immediately and I turned the rheostat to vary the note. This increased in pitch up to about 1,000 c/s. When the rheostat slider reached the end of its travel, I then noticed that the slider had left the winding and was in effect open circuit.

A voltmeter placed across the filament pins read zero. Removal of the valve made no difference to the performance, the oscillator continuing to function without it. The explanation presented itself to me after a few astonished minutes.

T. Howells,  
Newhaven,  
Sussex.

### An invitation

Sir—This Society is holding its seventeenth Exhibition of Cardio-Pulmonary Apparatus at the Londoner Hotel, Welbeck Street, W.1, from 4.0–9.0 p.m. on Friday, 5th, and from 9.30 a.m.–1.0 p.m. on Saturday, 6th November, 1965.

Approximately twenty exhibitors will be showing the latest equipment in this specialised field. I shall be pleased to send complimentary tickets to anyone who would like to visit the Exhibition.

I feel sure this will be of interest to many of your readers.

Margaret Hale, F.S.C.T.,  
Exhibition Secretary,  
The Society of Cardiological  
Technicians of Great Britain,  
Cardiac Research Dept.,  
Guy's Hospital,  
London, S.E.1.

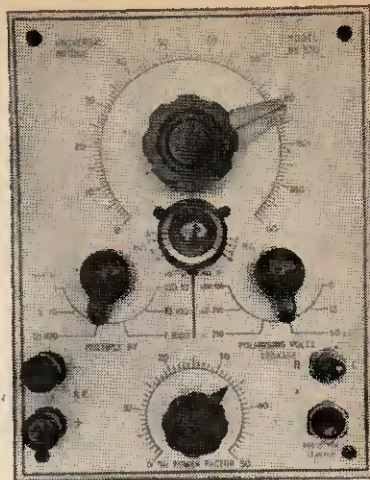

### Recognise this?

Sir—I enclose herewith a photograph of an R-C bridge with which I am having trouble. Could any of your readers please advise me of the manufacturer to enable me to obtain repair information.

E. E. Gatenby,  
Kloof,  
Natal, S.A.

### Who's for tennis?

Sir—I strongly disagree with John Valence's remarks (*Detached Particles*, June issue) concerning the dubious advantages of electrically powered lawnmowers.

I have used one of these machines for over 10 years now. The cable is 150ft long and provided you turn the right way at the end of each row, according to where the power point is situated, there is no danger whatsoever.

In my opinion the battery powered lawn mower has dubious advantages in that it will only do approximately two tennis courts before it needs recharging, if the grass is long it will do considerably less. If one has limited storage space you cannot tip the battery mower on its back like the electric one because the acid will spill out of the battery.

So I think John Valence should think again before condemning the electric mower in future.

B. B. Jacques,  
Holmesfield,  
Nr. Sheffield.

# Readout—

A SELECTION FROM OUR POSTBAG

continued

## Testing diodes

Sir—In your feature, *Ingenuity Unlimited*, the section on Testing Diodes by B. J. McNaughton (August issue) was, I thought, very good. But I am afraid the writer has put unnecessary limitation on his very original circuit.

To quote the relevant paragraph: "A 6V 60mA lamp gives a calculated power dissipation of 360mW. Clearly any diode rated at about  $\frac{1}{2}$  watt or above could be safely tested". This is the power in the lamp and not in the diode under test. The power dissipated in the test diode is calculated from the current flowing and the forward voltage drop  $V_f$  in the test diode. Typical values for  $V_f$  are given in the table.

This does not mean that the diodes cannot be damaged. 60mA is quite a high current to test small signal diodes.

Another simple test circuit is shown below, where the  $V_f$  is measured at 20mA. The meter is scaled 0-3 volts and reads the  $V_f$  directly.  $R$  will be 3 k $\Omega$  less the meter resistance. On reversing the diode, the meter should read f.s.d.

GERMANIUM			SILICON		
CODE	$V_f$	POWER	CODE	$V_f$	POWER
GD8	3V	180m/W	0A202	1V	60m/W
GD11	2V	120	SX641	1.3V	78m/W
0A10	.4V	24m/W			
0A5	.37V	22m/W			

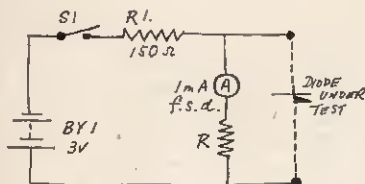

A. Thomas,  
Potters Bar,  
Herts.

## Equivalents please

Sir—I feel that other readers would appreciate it if you could give equivalents to diodes, transistors, and more details about transformers than you do at present. There are several such pieces that we are unable to obtain in New Zealand.

It would also be of great help if you could publish more details about particular pieces of equipment, for example, average noise levels, frequency response, etc., of the prototypes of the magazine articles.

R. C. Harris,  
Hamilton,  
New Zealand.

amplifier whose distortion was below 0.025 per cent—the lowest value I could measure with the equipment available. The frequency response is not an important factor, since linear amplification from d.c. to 100 Mc/s is easy with transistors.

I repeat, valves are "old hat" except for special applications. Mr. Gay too had better get with it!

D. R. Bowman,  
R.A.F., Henlow,  
Bedfordshire.

## AUTUMN LECTURES

### Radar and Electronics Association

The first lecture of the Radar and Electronics Association for Autumn 1965 is entitled "Transmitting Aerial Systems for Television Broadcasting on U.H.F.", the lecturer being Mr. C. G. Platts, B.Sc., who is a member of the B.B.C. Engineering Division.

The meeting will be held on Tuesday, 12 October 1965 at The Royal Society of Arts, John Adam Street, Adelphi, London, W.C.2., commencing at 7 p.m., with refreshments available (2/6) from 6.30 p.m.

### The Television Society

The opening meeting of the 1965/66 Lecture programme to be given on Thursday, 30 September 1965 by Mr. I. F. Macdiarmid, A.M.I.E.E., of the Post Office Research Station will be "An Introduction to Waveform Testing Methods in Television".

This meeting will be held in the I.T.A. Conference Suite, 70 Brompton Road, London, S.W.3. commencing at 7.00 p.m.

This is the first of two tutorial dissertations intended for the engineer who wishes to broaden his understanding in fields of television engineering outside that of his own specialisation.

Members and visitors are cordially invited to attend this meeting and tickets for non-members may be obtained from the Administrative Secretary, The Television Society, 166 Shaftesbury Avenue, London, W.C.2.

## Vacuum v solid state

Sir—Mr. Gay (August *Readout*) has missed the point regarding relative values of valves and transistors! I speak as one who has built many hi fi amplifiers of both types.

The figures he quotes are meaningless in isolation! What kind of associated equipment is used? Will his speaker reproduce 150 kc/s at 0.05 per cent distortion? What is the response of his radio, gramophone pick-up and tape recorder?

How many parasitics has his amplifier got? (I, too, have used EL34's—'nuf sed!)

The first thing that strikes one on hearing one's first high power transistor amplifier is the wonderful clarity—no unexplained "rattles", no muzziness in the upper register (my ears cut off at 13.5 kc/s!) due to the absence of inductive components, of course.

No, I shall never use valves again for audio.

R. G. Young,  
Peacehaven,  
Sussex.

Sir—Mr. Gay's letter in the August issue must not go unchallenged. The attainment of low values of distortion using power transistors is not a function of the devices used, but of overall loop gain and the amount of negative feedback usable.

Mullard have published a circuit diagram of a 10 watt stereophonic amplifier with 0.06 per cent distortion and as recently as June this year I constructed a 15 watt

## TRANSISTOR TRANSMITTERS FOR THE AMATEUR

by D. Stoner · 21/- · Postage 1/-

Complete construction details and operating instructions for a variety of practical projects and transistorised devices. Contains photos, schematics, layout, etc.

**HANDBOOK OF TRANSISTOR CIRCUITS** by Lytel. 35/- P. & P. 1/3

**TROUBLESHOOTING WITH THE OSCILLOSCOPE**, by Middleton. 20/- P. & P. 1/-

**TRANSISTOR SUBSTITUTION HANDBOOK**, by Sams. American, Japanese, etc. 12/6. P. & P. 1/-

**TAPE RECORDERS, HOW THEY WORK** by Westcott. 26/- P. & P. 1/3

**TRANSISTOR ELECTRONIC ORGANS FOR THE AMATEUR**. New Edition by Douglas. 18/- P. & P. 1/-

**THE OSCILLOSCOPE HANDBOOK** New Edition

by Rufus Turner. 25/- P. & P. 1/3  
Where possible 24-hour service guaranteed

**UNIVERSAL BOOK CO.**  
12 LITTLE NEWPORT STREET  
LONDON, W.C.2  
(Leicester Square Tube Station)

## BBC2 (625 LINE) TV AERIALS

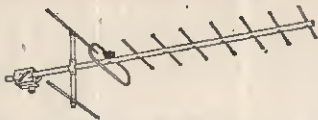

**MAST MOUNTING ARRAYS**, 9 element 45/-; wide spaced high gain, 11 element 55/-; 14 element 62/6. **WALL MOUNTING WITH CRANKED ARM**, 9 element 60/-; wide spaced high gain, 11 element 67/6; 14 element 75/-. **CHIMNEY ARRAYS COMPLETE**, 9 element 72/-; wide spaced high gain, 11 element 80/-; 14 element 87/6. **LOFT ARRAYS**, 7 element 32/6; wide spaced high gain, 11 element **WITH TILTING ARM** 62/6; 14 element 70/-. **ALL HIGH GAIN UNITS HAVE SPECIAL MULTI-ROD REFLECTOR. LOW LOSS CO-AXIAL CABLE** 1/6 yd. VHF transistor pre-amps from 75/-.

## BBC + ITV + F.M. AERIALS



**B.B.C. (BAND 1)**. Telescopic loft 21/-. External S/D 30/-.

**I.T.V. (BAND 3)**. 3 Element loft array 25/-; 5 elements 35/-. Wall mounting, 3 element 35/-. 5 element 45/-.

**COMBINED B.B.C./I.T.V.** Loft 1+3, 41/3; 1+5, 48/9. Wall mounting 1+3, 56/3; 1+5, 63/9. Chimney 1+3, 63/9; 1+5, 71/3.

VHF transistor pre-amps from 75/-.

**F.M. (BAND 2)**. Loft S/D, 12/6. "H", 30/-. 3 element, 52/6. External units available. Co-ax. cable 8d. yd. Co-ax. plugs, 1/3. Outlet boxes, 4/6. Diplexer Crossover Boxes 12/6. C.W.O.s or C.O.D. P. & P. 3/6. Send 6d. stamps for illustrated lists.

**K.V.A. ELECTRONICS** (Dept. 2)  
3b, Godstone Road, Kenley, Surrey.  
CRO 2527

## RADIO AND ELECTRONICS BOOKS ON FREE TRIAL

Then only 5/- weekly for those you keep!

**No. 90. PIN-POINT TRANSISTOR TROUBLES IN 12 MINUTES.** By Louis E. Garner, Jr. 485 pages. Companion manual to the well-known 'Pin-Point T.V. Troubles in 10 Minutes' using the famous Coyne Check Chart Trouble Shooting Method. Covers all kinds of equipment including radios, T.V.s, audio amplifiers, pre-amplifiers and just about everything. There are hundreds of photos, illustrations, diagrams and check charts; valuable reference sections. Supplies are limited so order your copy now and avoid disappointment. Price, 48/6 including postage.

**No. 12N. RADIO SERVICING.** 361 pages (hard covers), with hundreds of illustrations, circuits and diagrams. By G. B. Patchell and B. Fozard. Price 28/6, including postage. A very thorough approach to learning radio servicing, starts with simple explanations and goes on to more advanced radio theory. Doesn't miss a single point. One of the most complete radio manuals ever published. A book you will use for years to come. This is the first time this book has ever been offered on a free trial basis. Order your copy now, see coupon below.

**No. 13N. TELEVISION SERVICING.** 290 pages, hard covers, 296 diagrams. Price, 26/- including postage. As described above, but teaches television repair.

**No. 39. RADIO & ELECTRONICS COURSE.** 216 pages, quarto size, 35 complete lessons. You will find this course easy to understand. The lessons are CRYSTAL CLEAR, PRACTICAL, EASY TO MASTER AND USE. Early lessons make fundamentals clear even to the beginner while other lessons will give you the practical knowledge of an expert! This is a modern course, that teaches without resorting to comic strip methods... Thousands of PRACTICAL ELECTRONICS and PRACTICAL WIRELESS readers have taken this course and enjoyed every minute of it... Why not you? Price for the complete course, 41/- including postage.

**No. 22. PIN-POINT COLOUR T.V. TROUBLES IN 15 MINUTES.** By Robert G. Middleton. 648 pages. 392 check charts. Just about the biggest and most useful manual on Colour T.V. available anywhere. Now is the time to get the complete information on this important new subject. Price, 49/6 including postage.

**No. 8. PIN-POINT T.V. TROUBLES IN 10 MINUTES.** Over 340 cross indexed pages, covers 70 symptoms, 700 trouble spots, has 50 time saving check charts, 290 diagrams. Over 30,000 copies now used in the U.K. alone!

**NOW REPRINTING.** Orders accepted for delivery in four weeks' time. One of the best manuals we have ever handled, well worth waiting for! Price, 41/- including postage. Send coupon today for earliest delivery.

### IRONCLAD GUARANTEE

Any book not satisfactory may be returned within 10 days post-paid for full refund of the purchase price.

### FREE BOOK OFFER!

Send cash with order and qualify for any free book listed on the coupon as follows. Minimum 40/- One book. 80/- or more Two books. 120/- Three books.

**NOTE.** These books are authoritative and loaded with useful information, cost from 4/6 to 5/- each in book stores.

### FREE TRIAL OFFER!

To Sim-Tech Technical Books, Dept. E2, Gater's Mill, West End, Southampton, Hants.

Please send the following books I have circled.

90 12N 13N 39  
22 8

If not delighted I may return any book post-paid without further obligation on my part, otherwise I will pay cash price or 5/- weekly (10/- fortnightly) commencing not later than 10 days after delivery. I am over 21 years of age. (If under 21 parents should place order).

I enclose cash to the sum of £  
I understand you will refund this money if I am not 100% satisfied (provided I return the book in good condition within 10 days).

Please send me the free book(s) I have ticked.

- Oscilloscope Book.  
 Electronics Gadgets Book.  
 Transistor Book.  
 Radio Instruments Book.

Name .....

Address .....

## COMMUNICATIONS RECEIVERS

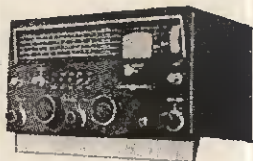

NATIONAL NC190

**INTERNATIONALLY FAMOUS NATIONAL RECEIVERS**

**HRO-500**—completely solid state professional receiver. 5 kc/s to 30 Mc/s in sixty 500 kc/s bands. £700.

**NC190**—10 valves, 540 kc/s to 30 Mc/s, S-meter, noise limiters, product detector, bandspeed, double conversion. £97.4.2.

**NC77X**—beginner's receiver, 5 valves, 540 kc/s, to 30 Mc/s, built-in speaker. £32.8.9.

Write for illustrated leaflets

WE HAVE A LARGE STOCK OF NEW AND SECONDHAND RECEIVERS — MANY SECONDHAND BARGAINS IN MINT CONDITION Just write or phone for full details

**BRIAN J. AYRES & CO.**  
Dept. DW, 21 Victoria Road  
Surbiton, Surrey  
Telephone: Elbridge 2833

## 4-STATION INTERCOM



£7/19/0

Solve your communication problems with this latest

4-Station Transistor Intercom system (1 master and 3 Subs), in de-luxe plastic cabinets for desk or wall mounting. Call/talk/listen from Master to Subs and Subs to Master. Operates on one 9V battery. On/off switch. Volume control. Ideally suitable to modernize Office, Factory, Workshop, Warehouse, Hospital, Shop, etc. for instant inter-departmental contacts. Complete with 3 connecting wires, each 66 ft. and other accessories. Nothing else to buy. P. & P. 5/-.

### INTERCOM/BABYALARM



Usually £10/6  
Our Price ONLY

59/6

Modernize your Office, Shop, Warehouse, Workshop, Surgery, Nursery, and home with this latest two-way Transistor Intercom, consisting of two units, Master and Sub, in strong plastic cabinets with chromium stands. Elegantly designed to use as two-way instant communication system—Call/talk/listen—between two persons anywhere indoors or outdoors. Both units operate on one 9V battery. Fully transistorised. Complete with accessories. Ready to operate. P. & P. 2/6.

### BATTERY ELIMINATOR AND CHARGER, 27/6

Use your Transistor Radio or Intercom from domestic A.C. mains and charge dry battery PP3 9V to boost battery's life many times. Unbeatable value. Save your pounds on batteries. P. & P. 1/6. Complete with Plug, Lead and Snap cord. Full price refunded if not satisfied in seven days.

**WEST LONDON DIRECT SUPPLIES (PE/1)**  
6 Chignell Place, West Ealing, London, W.13

# Practical Electronics Classified Advertisements

The pre-paid rate for classified advertisements is 1/- per word (minimum order 12/-), box number 1/6 extra. Semi-displayed setting £3.5.0 per single column inch. All cheques, postal orders, etc., to be made payable to PRACTICAL ELECTRONICS and crossed "Lloyds Bank Ltd." Treasury notes should always be sent *registered post*. Advertisements, together with remittance, should be sent to the Advertisement Manager, PRACTICAL ELECTRONICS, George Newnes Ltd., Tower House, Southampton Street, London, WC2, for insertion in the next available issue.

## RECEIVERS AND COMPONENTS

**A.1 POST FREE BARGAINS.** Guaranteed reclaimed valves. Send for full list to Dept. MO/E, A.1 RADIO COMPONENTS, 14 The Borough, Canterbury, Kent.

### RADIO-TV ELECTRONIC COMPONENTS BARGAIN PRICES

NEW TRANSISTORS OC44, OC45, OC71, OC72, OC81, OC81D, AF117 2/6 each, BY100 500 M/A 6/- each, Service Sheets 3/- each.

**MAINTENOR RADIO**  
222 Great West Road, Heston, Middx.

## R. & R. RADIO & TV SERVICE

Dept. P.E.  
32 Market Street, BACUP. Tel. 465

### Salvage Valves

6F13	4/6	PCF80	4/-
6F15	5/-	PCL83	5/-
6L18	4/6	PL81	5/-
6K25	10/-	PL82	4/-
6LJ4GT	5/-	PL83	4/-
6BV6	5/-	PY81	3/6
6J30L2	5/-	PZ30	5/-
EB91	5/-	U801	7/6
6F1	1/-	U301	6/-
EBF80	5/-	U329	5/-
EF80	1/6	10F1	1/-
EF91	2/6	10LD11	5/-
EF85	5/-	10P13	5/6
ECC82	4/-	10P14	5/-
EY86	4/-	20L1	5/-
ECL80	4/-	20F2	5/6
20P3	5/-	20D1	2/-
20P4	7/6	20P1	6/6
30F5	5/-	20P5	6/6
30PL1	5/-	30FL1	6/6
PL38	6/-	30P12	5/-
PL36	7/6	30P4	7/6
PY33	7/6	PY32	6/-
PCC84	4/-	PY82	5/-

Postage on valves 6d.—3 or more post free.

1 Pole 8-way switch, complete with 8 resistors 2 @ 1K, 2 @ 15K, one each of 22K, 15K, 18K, 6.8K. 3/6 incl. post.

Fireball Tuners as removed 14/9. Selected Tuners 18/9. Speakers ex T.V. 6 x 4 inch 3/6. 8 inch rnd 6/-. Resistors New: 1/4 watt 3d., 1 watt 5d., 2 watt 9d. all 10%.

S.A.E. with all enquiries. All goods subject to satisfaction or money refunded.

**OSCILLOSCOPE.** Versatile 3" instrument for under £30. Write to TONBRIDGE LABORATORIES, 14 Ogle Street, London, W.1.

890

## RECEIVERS AND COMPONENTS

(continued)

### TRANSISTORS AND COMPONENTS

OC71—2/9d. each. OC44, OC45, OC72, OC81, OC81D—3/- each. OC42—2/6 each. OC25, ORP12—7/6 each. AF115, AF116, AF117, OC170, OC171—3/6d each. BY100 Silicon Rectifier 250V at 550 M/A—5/- each. BYZ 13 Silicon Rectifier 200V P.I.V. 6 Amps.—5/- each. AC126—8/- each. ACY18 7/6d. each. ASY28—8/6d each. ASY29—11/- each. ASY67—11/- each. AF186 cut of FREQ 800 Mc/s—28/-.

Branded Mazda ECC85 valves—4/6d. each. 10 watt Transistor driver and output transformers—22/6d. each.

Acos Record Player cartridge, suits Collaro, Garrard, B.S.R., etc.—12/6d. each.

Nominal Zener Prot Voltage (V) MW Max.	Price
OAZ 200 = 4.7V	260MW 12/6d. each.
OAZ 201 = 5.1V	260MW 10/6d. each.
OAZ 202 = 5.6V	260MW 9/6d. each.
OAZ 203 = 6.2V	260MW 9/6d. each.
OAZ 204 = 6.8V	260MW 9/6d. each.
OAZ 205 = 7.5V	260MW 9/6d. each.
OAZ 206 = 8.2V	260MW 9/6d. each.
OAZ 207 = 9.1V	260MW 10/6d. each.

Other types available on request.

### M.A.T. TRANSISTORS

MAT 100 7/9.  
MAT 101 B/6.  
MAT 120 7/9.  
MAT 121 8/6.  
ADT 140 15/-.

Full Range of GET Transistors in stock S.A.E. Full range of Newmarket Transistors in stock S.A.E. Transistor Walkie Talkies. 9 gns. pr. S.A.E. for leaflet. Transistor Walkie Talkies. 5 mile range. £25 pr. S.A.E. for leaflet.

Guitar Pickup—£3.5.0.  
4 Transistor 250 MW/Vatt Amplifier—47/6.  
4 Transistor 1 Watt Output—£3.3.0.

S.A.E. all enquiries.  
All Above Post Paid  
Mail Order Only:

### J. ROBINSON

(Radio & T.V.)

4 Highcliff Road, Blackley, Manchester 9

**50 TRANSISTORS** all tested, marked and guaranteed, AF, RF, Silicon and P.N.P. Unobtainable elsewhere at this low price of 35/- plus P. & P. 1/-. D & W LTD., 224 West Road, Westcliff-on-Sea, Essex.

### L.S.T. COMPONENTS

**182B HIGH ROAD, BENFLEET, ESSEX**

More bargains from our new list:  
Silicon Power 25012 10/- HF Power Mesa 25025 100 watt 10 mc/s 30/- Red spot NPN transistors 1/- OC71 equivalents 9d.  
Sell available—Our famous 25 for 10/- offer, state 2G371/81 series (AF) or 2G41/7 series (RF).  
100 Diodes for 12/-. Post paid over 5/- order. Send 6d. stamp for our latest list.

## RECEIVERS AND COMPONENTS

(continued)

## TELEVISION TUBE SHOP

FOR

Unused, Guaranteed Tubes  
OVER 2,000 IN STOCK

At prices from 50% to 75% of  
normal List Price

All tubes tested before despatch  
and Guaranteed for 12 months

CARRIAGE 10/- via B.R.S. or  
15/- via passenger train

TERMS £2 down (plus  
carriage) and balance at £1  
per month

See our advertisement in  
PRACTICAL TELEVISION for exact  
prices, or write for details

## TELEVISION TUBE SHOP

48 BATTERSEA BRIDGE ROAD  
LONDON, S.W.II. BAT 6859  
OPEN ALL WEEK AND SATS. UNTIL 4 p.m.

6d.!! TESTED R.F. TRANSISTORS or 5/- doz.  
Enclose S.A.E. LLEEMING, 185 Brandy House,  
Brow, Blackburn.

"P.E." TRANSISTOR & DIODE TESTER.  
Simple Analogue Computer. Stereo Record  
Player. R/c Bridge. V.H.F. Broadcast Receiver.  
Integrated Transistor Amplifier. Two Band  
Radio Tuner. Inexpensive Oscilloscope. Mul-  
lard Miniature Electrolytics and Hi-stab  
Resistors. S.a.e. for itemised price lists.  
AJAX ELECTRONICS, 15A Rumbold Road,  
Fulham, London, S.W.6.



**RECEIVERS AND COMPONENTS**  
(continued)

**SURPLUS  
AIRCRAFT  
NAVIGATION  
EQUIPMENT**

Originally part of an aircraft direction finding equipment and containing A.R.B. approved components.

**Power Units, 12 Volt D.C. Input, 25 Watts**

Outputs 2 at 350V D.C. smoothed, and 1 at 6.3V. Contains 3—OC36, 2—OC72, 9—Diodes, transformer relay, etc. In mottle grey aluminium case 5½" × 5" × 6". Could be adapted for shaver operation.

With circuit diagram — 45/- + P. & P. 6/6d.  
Diagram only 2/6 + 9d. P. & P.

**Power Units as above but 24V Input.**

40/- + P. & P. 6/6d.

**M.F. Receiver. 200-400 and 500-900 KC/s.**

Contains tuning and two I.F. stages, diodes and 2—OC170, 3—OC45, 2—OC702 and 2—OC318. In mottle grey aluminium case 9" × 5½" × 3½".

With circuit diagram — 55/- + P. & P. 6/6d.  
Diagram only 2/6d. + 9d. P. & P.

**Indicator Unit.**

Contains 2½" C.R.T. Type DG7-5 (CV.2175); 2—ECC83, 1—ECC81, E.H.T. rectifiers and numerous condensers and resistors. In mottle grey aluminium case 9" × 6" × 3½" and would form the basis of a miniature Oscilloscope.

With circuit diagram — 55/- + P. & P. 6/6d.  
Diagram only 2/6 + 9d. P. & P.

The above items are brand new and complete but have not been tested and cannot be guaranteed.

A small number of incomplete units of each version are available at 15/- each + P. & P. 4/-.

**Components — all first grade.**

Transistors OC36—Matched pair	25/-	
" OC36—Single	10/-	
" OC170	7/-	P. & P. 9d.
" OC45	4/-	
" AFZ12	12/6	
Valves 12AT7(ECC81)	4/-	
" 12AX7(ECC83)	5/-	
E.H.T. Rectifiers K3.45	7/-	
Vinkors LA2409	15/-	P. & P.
" LA2103	15/-	1/-
Crystals 10-7 mc/s	15/-	
C.R. Tubes DG7-5	25/-	P. & P. 3/6d.

Also many other items including capacitors, resistors, relays, diodes, slow motion drives, transformers, group wiring boards. Please send S.A.E. for list.

Enquiries and orders by post only to:—

**N. J. GAWLER**  
40 Medina Road  
COWES  
Isle of Wight

**RECEIVERS AND COMPONENTS**  
(continued)

**SILICON PNP's**, audio,  $\beta=10, 1/6, \beta=20, 2/6$ . Germanium audio,  $\beta=50$ , PNP & NPN 4/-. OC35 equivalent 7/6. Silicon NPN, d.c. to 20Mc/s, 1P  $\beta=90, 5/-$ . Diodes 5d. LONGLAND'S, 6 Mansfield Place, Ascot, Berks.

**TRANSISTORS** — "Red Spot" and "White Spot" — 28/- per 100. GJM Rectifiers—80P1V. 1 amp. £3 per 50. (Minimum quantities of any types.) G3LMR, 112 Groby Road, Glenfield, Leicester.

**CARPENTER POLARISED RELAYS** — 5XA24 300+ 700Ω c/w base 13/6. Five watt Hellipos, 3,600 $\Omega$  tropically sealed 2,500Ω 15/-. S.T.C. Miniature Relays, 700Ω DPCO 4/6. Elevator Indicators 2" 500-0-500 micromp movement 7/6. Muffhead s/m drives 7/-. Instrument pots. 2½" 50K, 15K 7/6. All post paid, C. DOWNTON, Kirkpatrick-Fleming, Lockertie, Dumfries-shire.

**TESTED TRANSISTORS**

1/- each, Red or White Spots.

2/- each, XA101, XA102, XB103, OA90, XA111, XA112, OC430, V10/IS.

3/- each, OC44, OC45, OC70, OC71, OC81, OC81D, XA151, XB104, XC101, XC101A, OC169, OC200.

4/- each, AF114, AF115, AF116, AF117, OC170, OC171, XA103, XA116, XB102, XB105, XC121, XU611.

5/- each, OC139, OC140, OC204, ORP60, XA701, XA703, GET7, GET8, GET9, XC141, BY100, OAZ11.

10/- each, OC19, OC22, OC25, OC26, OC28, OC35, 250I3.

**ZENER DIODES** 4.7 v. to 30 v. ¼ watt, 3/6, 1.5 watt, 5/-, 7 watt, 6/- each.

Plus many more, send 6d. in stamps for Full List and Equivalent Chart:

**B. W. CURSONS**  
78 BROAD STREET  
CANTERBURY, KENT

**SITUATIONS VACANT**

**UNIVERSITY COLLEGE LONDON  
PSYCHOLOGY DEPARTMENT**

1. Senior Technician to supervise laboratory store with assistance of technician. In addition to maintaining wide range of electrical and mechanical equipment, there will be opportunities for design and construction. Quote Ps/1.
2. Senior Technician to be responsible for design and construction of variety of electronic equipment for research projects. Quote Ps/2.
3. Technician to assist in running laboratory store and in design and construction of mechanical and electrical equipment. Quote Ps/3.

Application forms from ESTABLISHMENT OFFICER, University College London, Gower St., W.C.1.

**SITUATIONS VACANT**  
(continued)

**RADIO TECHNICIAN**

A number of suitably qualified candidates will be required for training, leading to permanent and pensionable employment. (Normally at Cheltenham but with opportunities for service abroad or appointment to other U.K. establishments including London).

Applicants must be 19 or over and be familiar with the use of Test Gear and have had Radio/Electronic workshop experience. They must offer at least "O" level GCE passes in English Language, Maths and/or Physics, or hold the City and Guilds Telecommunications Technician Intermediate Certificate or equivalent technical qualifications.

Pay according to age, e.g. at 19 £722, at 25 £929 (highest pay on entry) rising by four increments to £1,067.

Prospects of promotion to grades in salary range £997—£1,634.

Annual Leave allowance of 3 weeks 3 days, rising to 4 weeks 2 days.

Normal Civil Service sick leave regulations apply.

**Apply**

Recruitment Officer (RT/54)  
Government Communications Headquarters  
Oakley  
Priors Road  
CHELTENHAM, Glos.

**A FULL TIME TECHNICAL EXPERIENCED SALESMAN** required for Retail sales. Write giving full details of age, previous experience, and salary required to: The Manager, HENRY'S RADIO LTD., 303 Edgware Road, London, W.2.

**TECHNICALLY INTERESTED** man required to edit descriptions of inventions for professional firm. Experience not required but must be British subjects. Applications in own handwriting stating age, career to date, salary required to Box 903 REYNELL'S 88/90 Chancery Lane, W.C.2.

**MINISTRY OF DEFENCE (Army Department)  
WOOLWICH, S.E.18**

requires **TECHNICIAN** to be responsible for supervision of industrial staff engaged on proof and trials of ammunition stores. To control operation of electronic recording instruments and electrical firing circuits.

**QUALS.** Recognised electrical engineering apprenticeship or equivalent training. Experience in operation or maintenance of electrical instruments and interpretation of circuit diagrams essential. A knowledge of environmental testing procedure would be an advantage. O.N.C., C. & G. Finals or equivalent.

**SALARY** £990 (age 26)—£1,179 p.a. (Outer London).

**APPLICATION FORMS** from Manager (PE.4705), Ministry of Labour, Professional & Executive Register, Atlantic House, Farringdon Street, London, E.C.4.

CONTINUED OVERLEAF

**MINISTRY OF DEFENCE (ARMY DEPT.)  
ROYAL ARMAMENT RESEARCH AND  
DEVELOPMENT ESTABLISHMENT  
POTTON ISLAND, GREAT WAKERING, ESSEX**

**HAS INDUSTRIAL VACANCIES FOR**

**ELECTRONIC MECHANICS** — WHO HAVE SERVED AN APPRENTICESHIP OR EQUIVALENT TRAINING, OR 5 YEARS' EXPERIENCE AS A SKILLED MAN.

**ELECTRONIC WIREMEN (SEMI-SKILLED)** — WHO ARE OVER 21 YEARS, HAVE HAD EXPERIENCE IN WIRING TECHNIQUES AND CAN IDENTIFY ELECTRONIC COMPONENTS. ONLY BASIC THEORETICAL KNOWLEDGE IS REQUIRED.

**RATES OF PAY** — SKILLED—£15.6.0 to £16.19.0 per week.  
SEMI-SKILLED—£12.13.0 per week.

42 hour 5-day week. Paid Sick Leave. Paid annual leave in addition to public holidays. Prospects after a period of qualifying service of establishment in Government Service, with Superannuation benefits. Free Transport from Shoeburyness.

Applicants should write or telephone for particulars to:

**ADMINISTRATIVE OFFICER, MINISTRY OF DEFENCE (AD),  
R.A.R.D.E., POTTON ISLAND, GREAT WAKERING, ESSEX  
Telephone: Great Woking 491, Extension 102**

**EDUCATIONAL**

**HOME STUDY COURSES** in Practical Electronics. Free Brochure without obligation from: **BRITISH NATIONAL RADIO SCHOOL**, Reading, Berks.

**STUDY RADIO, TELEVISION AND ELECTRONICS** with the world's largest home study organisation. I.E.R.E., City & Guilds, R.T.E.B., etc. Also Practical Courses with equipment. All books supplied. Write for FREE Prospectus stating subject to I.C.S. (Dept. 577), Intertext House, Parkgate Road, London, S.W.11.

Full-time courses in **RADAR and RADIO-TELEGRAPHY** for prospective marine Radio Officers. Govt. approved exam. centre.

Also courses in basic **ELECTRONICS, RADIO, TELEVISION and PRACTICAL SERVICING.**

Apply:—**Director, British School of Telegraphy, 20 Penywern Road, Earls Court, London, S.W.5**

**A.M.I.Mech.E., A.M.I.E.R.E.** City & Guilds, G.I.C., etc. Become a Technician or Technologist for high pay and security. Thousands of passes. For details of Exams. and Courses in all branches of Engineering, Building, Electronics, etc., write for 156-page handbook—**FREE.** B.I.E.T. (Dept. 152), London, W.8.

**B.Sc.(ENG.), A.M.I.Mech.E., A.M.I.E.R.E.** City & Guilds, etc., on "Satisfaction or Refund of Fee" terms. Wide range of expert Home Study Courses in Electronics, Computers, Radio, T.V., etc. 156-page Guide—**FREE.** Please state subject of interest. **BRITISH INSTITUTE OF ENGINEERING TECHNOLOGY**, 151a College House, Wright's Lane, London, W.8.

**EDUCATIONAL**

(continued)

**THE INCORPORATED PRACTITIONERS** in Radio & Electronics (I.P.R.E.) Ltd., Membership Conditions booklet 1/-, Sample copy of I.P.R.E. Official Journal 2/-, post free, Secretary, Dept F, 32 Kidmore Road, Caversham, Reading, Berks.

**TAPE RECORDERS, TAPES, ETC.**

**TAPE TO DISC.** New High-level Cutters 45 f.p.m. 21/- S.E.A. Leaflet, DERROY, 52 West Bank Lane, Lancaster.

**BOOKS AND PUBLICATIONS**

**VISATECHNICA.** The up-to-date TECHNICAL language course French—German—English on records or tape. Three-language illustrated book covering 260 technical subjects. Send 4d. stamp for descriptive leaflet to **VISAPHONE CO. LTD.**, 17 Middleton Rd., London, N.W.11.

Please mention

**PRACTICAL ELECTRONICS**

when replying to

Advertisements

**FOR SALE**

**COCKROBIN'S MASTERBOX** for that special enclosure, for switchboards, indicator panels and control boxes. Sizes 2" x 3" x 3" and 2" x 6" x 6" and can be bolted together in any combination. Please write for full details, **COCKROBIN CONTROLS**, 36 Villiers Ave., Surbiton, Surrey.

**CONSTRUCTORS** parcel containing useful assortment of radio and electronic spares. Relays, Switches, Resistors, Condensers, 30/-, Ten times value guaranteed. **AUDIOGRAFT**, 20 Kettering Road, Northampton, 36291.

**DID YOU KNOW** that Suffolk Tubes, still the largest independent tube rebuilders, give a free delivery service by van or passenger train to all parts of the U.K. Each tube is guaranteed 12 months and all types are always available off the shelf at keenest prices. 1-3 Upper Richmond Road, Putney, London, S.W.15. Telephone Vandyke 4304/5267.

**VENNER TIME SWITCHES.** Reconditioned, 14 day clock, once on once off every 24 hrs. jewelled movement, fully guaranteed. 1 amp 25/-, 5 amp 32/6d., 15 amp 39/6d. Post etc. 2/6d. Cast Aluminium Cases 7/6d. A. R. **BATCHELOR, P.E.** Dept. 4 Park Road, Bromley, Kent.

**ELECTRIC SOLDERING IRON**



**A.C. STANDARD.** Mains Motors Fractional H.P. 3/4in dia x 4in long with 1/2in spindle. Many uses. Brand new, 25/- each. P. & P. 2/6d. Small Battery Motors 1 1/4in dia x 2 1/2in long—4 1/2 to 9 volts. Heavy construction; only 7/6d. each. P. & P. 1/-. **WALTON'S WIRELESS STORES**, 15 Church Street, Wolverhampton.

**CRACKLE PAINT.** Black or Grey, 1 pint tins 4/-, post 6d. from the component specialists. **SERVIO RADIO**, 156-8 Merton Road, Wimbledon, London, S.W.19.

**TRANSISTORS UNMARKED UNTESTED.** 40 for 10/-, P. & P. 1/-. 4 packets post free. Relays, thousands of types, special catalogue free. General Catalogue of Mechanical & Electrical Gear, Tools, etc., 5,000 items, free. **K. R. WHISTON (Dept. PET)**, New Mills, Stockport.

## SERVICE SHEETS

**SERVICE SHEETS** for all makes of Radio and TV 1925-1965. Prices from 1/- with free fault-finding guide. S.A.E. inquiries. Catalogue of 6,000 models, 1.6. Valves, modern and obsolete. Radio/TV Books. S.A.E. lists, HAMILTON RADIO, Western Road, St. Leonards, Sussex.

**TRADE SERVICE SHEETS.** Radio, TV, etc. Mixed dozen at 4/-, 100—22/6d. p.p. TELRAY, Mandlank Bank, Preston.

**STATE MODEL NO.** Radio 2/-. TV 2/6. S.A.E. DARWIN, 19 George Street, St. Helens, Lancs.

## SERVICE SHEETS

4/- each, plus postage.

We have the largest supply of Service Sheets for all makes and types of Radios, Televisions, Tape Recorders, etc. in the country. Speedy Service.

To obtain the Service Sheet you require, please complete the attached coupon:

From: Name: .....

Address: .....

To: **S.P. DISTRIBUTORS**  
44 Old Bond St., London, W.1  
Please supply Service Sheets for the following:

Make: .....  
Model No.: ..... Radio/TV  
Make: .....  
Model No.: ..... Radio/TV  
Make: .....  
Model No.: .....

New 1965 List now available.  
I also require list of Service Sheets at 1/6.

(please delete items not applicable)  
I enclose remittance of .....

MAIL ORDERS ONLY Oct. PE

## MISCELLANEOUS

**ARMATURE REWINDS.** All Small Types, 32/-, Fields 17/6, P. & P. 2/6. A. R. TAYLOR, 22 Forester Street, Netherfield, Nottingham.

**TRANSFORMERS REWOUND.** Output or Mains. Specials made to order. Reasonable prices. RATCLIFFE, 27 Station Road, Holmfirth, Yorks.

**GOVERNMENT SURPLUS** Electrical and Radio Equipment. Our new catalogue No. 18 now ready, 2/6 Post Free, cost refunded on purchase of goods over 22. ARTHUR SALLIS RADIO CONTROL LTD., 93 North Road, Brighton.

## MISCELLANEOUS

(continued)

**HAMMER FINISH PAINT.** The modern finish for electronics. Can be BRUSHED or sprayed. Blue or silver. 2 1/2oz tins 3/6, post 8d., 1 pint 7/6, post 1/0, 1 pint 15/-, post 2/9. Retailers supplied, write for details. Amazing results! Return of post service. Orders over 30/- post free. FINNIGAN SPECIALTY PAINTS, (PE), Mickley Square, Stockfield, Northumberland.

**TV NOT WORKING 35/-**  
**SETS CALLERS ONLY EACH**  
**OR 20 FOR £25**

20 PALMERSTONE ROAD, EARLEY, READING, BERKS.

**CONVERT ANY TV SET** into an Oscilloscope. Diagrams and Instructions, 12.6. REDMOND, 42 Dean Close, Portslade, Sussex.

### "PRACTICAL ELECTRONICS" CONSTRUCTIONAL DESIGNS

All specified 1st grade Components, complete Metalwork, full range of Materials, engraved Panel Plates, Ancillary Equipment and Assembled Units. Comprehensive lists available for each "P.E." Constructional Article.

Please send 6d. in stamps for each design  
**MALVYN ENGINEERING WORKS**  
Engineers to the Radio and Electronic Industries  
7 CURRIE STREET, HERTFORD, HERTS  
TELEPHONE: HERTFORD 2264

### A.P.T. PLUG IN DEKATRON SCALING UNITS TYPE AR 101-10

These units use a GC10 Dekatron and 2 6AS6 valves. They may be used in cascade to provide Counter Timers, Frequency Convertors, etc. Freq. up to 4kc/s. Supplied complete with connectors and data sheet, 30/-. P.P. 2/6

**Type AR 101-2.** As above but contains GS10C Dekatron which divides by Two, 35/-. P.P. 2/6.  
**Type AR 101-12.** As above but contains GS124B Dekatron which divides by twelve, 39/6, P.P. 2/6. Also available, GS12D.

Dekatrons including base, 25/-. P.P. 2/-. Limited quantity of racks available to hold up 12 plug-in scaling units, 15/-. P.P. 3/6.

A.P.T. Logic elements type RTLI Resistor/Transistor type. Complete with 10-pin connectors, 3/6, P.P. 1/6.

### AUTO TRANSFORMERS

240 v.-110 v. Completely Shrouded fitted with 2 Two-pin American Sockets or terminal blocks.

Please state which type required.

Wattage	Price	Carr.
1,000	£4 15 0	5/6
500	£3 10 0	5/-
300	£2 7 6	4/-
150	£1 19 6	3/6
80	£1 7 6	3/-

**2000 WATTS.** Completely enclosed in metal case. Size 10 x 8 x 6 in. Fitted with 2 two-pin American sockets, or terminal blocks and carrying handle, £9/15/-. Carr. 7/6.

**SAMSON'S ELECTRONICS LTD.**  
9-10 CHAPEL STREET, LONDON, N.W.1  
Tel. PAD 7851 Tel. AMB 5125

Please mention

## PRACTICAL ELECTRONICS

when replying to

Advertisements

# Your Complete Library of Technical Data

TRANSMISSION • RECEPTION  
REPRODUCTION • SERVICING

Newnes Radio & TV Engineers' Reference Book presents comprehensive information on all branches, written at a practical engineering level. The work is produced to meet the needs of engineers, technicians and amateur enthusiasts—in designing, maintaining and servicing equipment for transmission, reception and reproduction. You can see this latest edition now on 7 days' Free Trial without obligation to purchase. Post coupon today!

### 47 SELF-CONTAINED SECTIONS

2,000 Diagrams, Circuits, Tables, Calculations  
Formulae, Drawings and Photographs

Includes—Formulae, Calculations, Theory, Electron Optics & Colour TV. Materials, Studios & Equipment. Transmitters & Power Plant. V.H.F. Transmitter-Receiver Equipment. Amateur Radio Equipment. R.F. Transmission Lines. Wave-Guides. Broadcasting & TV Receivers. Commercial H.F. Radio Links. Broad-Band Radio Systems. Aerials. Valves. Transistors. Crystal Diodes. Resistors, Capacitors. Inductors & Transformers. Microphones. Loudspeakers. Batteries, etc.

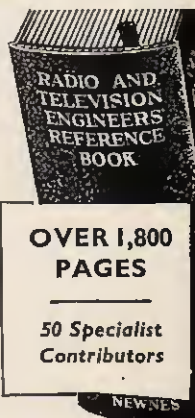

OVER 1,800 PAGES

50 Specialist Contributors

STUDY IT WITHOUT OBLIGATION  
**FREE for 7 days**

—POST TODAY—

To: George Newnes Ltd., 15-17 Long Acre, London, W.C.2.

Please send Newnes Radio & TV Engineers' Reference Book without obligation to buy. If you accept this application I will post 6/- deposit 8 days after receipt of book, then 10/- monthly for 12 months, paying 126/- in all—or return the book. Cash in 8 days 126/-.

If under 21 your father must fill up coupon

Full Name.....  
(BLOCK LETTERS) (Mr., Mrs., Miss)

Address.....

Occupation.....

Signature.....

Tick ✓ where applicable

The address on left is—

My Property	<input type="checkbox"/>
Rented unfurnished	<input type="checkbox"/>
Parents' Home	<input type="checkbox"/>
Furnished Accom.	<input type="checkbox"/>
Temporary Address	<input type="checkbox"/>

38/1409

**QUALITY RECORD PLAYER AMPLIFIER**  
A top-quality record player amplifier. This amplifier (which is used in a 25 gns. record player) employs heavy duty double wound mains transformer, ECC83, EL84, EZ80 valves. Separate Bass, Treble and Volume controls. Complete with output transformer matched for 3 ohm speaker. Size 7in. w. x 2 1/2 in. d. x 3 1/2 in. h. Ready built and tested. PRICE 69/6. P. & P. 4/9.  
ALSO AVAILABLE mounted on board with output transformer and 6in. speaker ready to fit into cabinet below. PRICE 89/6. P. & P. 5/9.

**QUALITY PORTABLE R/P CABINET**  
Uncut motor board. Will take above amplifier and B.S.R. or GARRARD Autochanger or Single Record Player Unit. Size 18 x 14 x 8 1/2 in. PRICE 43/9/6. Carr. 7/6.

**4-SPEED PLAYER UNIT BARGAINS**  
All brand new in maker's original packing.

**SINGLE PLAYERS**  
B.S.R. TU1/2 ..... £3/9/6. Carr. 5/6.  
GARRARD SRP10 ..... £5/9/11. Carr. 5/6.  
B.S.R. GU7 with unit mounted pickup arm. £4/18/8. Carr. 5/6.

**AUTO. CHANGERS**  
B.S.R. UA15 £6/19/6. B.S.R. UA16 ..... £6 19 6  
Latest B.S.R. UA25 Super slim ..... £6 2 6  
Latest GARRARD ATS ..... £8 8 0  
GARRARD AT6 ..... £10 10 0  
GARRARD Auto-Slim £6.10.0. Carr. 6/6 on each.  
All the above units are complete with 1 to mono head and sapphire styl or can be supplied with compatible stereo head for 12/6 extra.

**GARRARD GC2 MONO** complete. List price 24/11. Our price 12/6. P. & P. 1/-.  
**RONETTE STEREO 105 CARTRIDGE**  
Stereo/LP/78 complete with two sapphires. Original list price 67/9. Our price 24/-. P. & P. 1/-.  
**MAINS TRANSFORMERS**  
Fully shrouded, can be mounted upright or drop through. Tapped pri. 110, 200, 220, 240v. Sec. 250v. 1/2 wave at 85mA and 6.3v. 2 amps. c/t. Stack size 3" x 2 1/2" x 11". PRICE 12/6. P. & P. 3/6. ALSO Semi shrouded drop thru type. Pri. 200, 220, 240v. Sec. 250v. 1/2 wave at 70mA and 6.3v. at 2 amp. c/t. Stack size 3" x 2 1/2" x 13". PRICE 11/-. P. & P. 3/6.

**BRAND NEW 3 OHM LOUSPEAKERS**  
5in., 12/6; 6in., 15/-; 8in., 21/-; 10in., 25/-; 12in., 27/6; (12in. 15 ohm, 30/-), 10in. x 6in., 26/-. E.M.I., 13" x 8 in. with high flux ceramic magnet, 42/- (15ohm, 45/-), 4in HIGH FLUX TWEETER, 3 ohm and 15 ohm imp. Famous British make. Few only 12/-. P. & P. 4/- & 5/- 2/-, 6/- & 8/- 2/6, 10/- & 12/- 3/6 per speaker.  
**ACOS CRYSTAL MIKES.** High imp. For desk or hand use. High sensitivity, 18/6. P. & P. 1/6.  
**TSL CRYSTAL STICK MIKE.** Listed at 45/-. Our price, 18/6. P. & P. 1/6.  
**BRAND NEW, 12" 15w. H/D SPEAKERS, 3 or 15 ohm.** Current production by well-known British maker. Offered below list price at 89/6. P. & P. 5/-. (25w. guitar model £5.5.0). (35w. guitar model £8.8.0).

**MATCHED PAIR OF 2 WATT TRANSISTOR DRIVER AND OUTPUT TRANSFORMERS.** Stack size 1 1/2 x 1 1/2 in. Output trans. tapped for 3 ohm and 15 ohm output. 10/- pair plus 2/- P. & P.  
**BRAND NEW PLESSEY 12 v. 4 pin non-synch. vibrators.** Type 12.1.4SD. ONLY 8/6. P. & P. 1/6

**4-WAY NON-TANGLE TELEPHONE CABLE**  
Latest spring-back coil type, extends 12 in. to 5 ft. Complete with rubber bushes, 4/6 each. P. & P. 1/6.  
**VYNAIR AND REXINE SPEAKER AND CABINET FABRICS** app. 54 in. wide. Usually 35/- yd., our price 13/6 per yd. length (min. 1yd.) P. & P. 2/6. S.A.E. for samples.

**DIGITAL COMPUTER**  
A simple digital Adder/Subtractor using switches and lamps only. A fascinating demonstration of Binary arithmetic. Full circuit, wiring diagram and notes on the Binary system, 3/6d.  
**NOUGHTS AND CROSSES MACHINE**  
Uses standard miniature switches and lamps only. This machine cannot be beaten. Full circuit, wiring diagram and instructions, 3/6d.  
1% High Stability Resistors  
1/2 watt 1%, 2/- each. Full range 10 ohms to 10 Meg. Many special values for meter multipliers, etc. in stock.  
1% Wirewound Resistors  
1% 1 watt, 1 ohm to 5K, 3/-; to 20K, 4/3. 3% add 3d. Your value would to order. Shunts down to 0.1 ohm.  
High Resistance Phones 10/-, post 1/-.  
100 Resistors 1, 2 and 5% assorted 9/6d.  
Signal Injector Kit 10/-, post 1/-.

**PLANET INSTRUMENT CO.**  
25 (E), DOMINION AVE., LEEDS 7

**STEREO AMPLIFIER**  
Incorporating 2 ECL82s and 1 EZ80, heavy duty, double wound mains transformer. Output 4 watts per channel. Full tone and volume controls. Absolutely complete.  
**ONLY £4.19.6**  
P. & P. 6/6

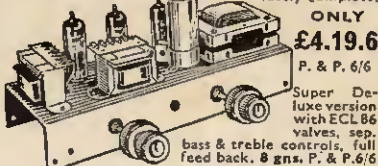

Super Deluxe version with ECL86 valves, sep. bass & treble controls, full feed back, 8 gns. P. & P. 6/6

**HIGH GAIN 4 TRANSISTOR PRINTED CIRCUIT AMPLIFIER KIT TYPE TAI**

- Peak output in excess of 1 1/2 watts.
- All standard British components.
- Built on printed circuit panel, size 6 x 3 in.
- Generous size Driver and Output Transformers.
- Output transformer tapped for 3 ohm and 15 ohm speakers.
- Transistors (GET 114 or 51 Mullard OC81D and matched pair of OC81 of/p).
- 9 volt operation.
- Everything supplied, wire, battery clips, solder, etc.
- Comprehensive easy to follow instructions and circuit diagram 1/6 (Free with Kit).
- All parts sold separately. SPECIAL PRICE 45/-. P. & P. 3/-. Also ready built and tested. 52/6. P. & P. 3/-. A pair of TAI's are ideal for stereo.

**TAPE DECKS**  
B.S.R. MONARDECK (Single speed) 33in. per sec., simple control, uses 5 1/2 in. spools, £6/15/- plus 7/6 carr. and ins.  
COLLARO STUDIO DECK 3 motors, 3 speeds push button control. Up to 7in. spools £10/10/- P. & P. 7/6. (Tapes extra on both.)

**10/14 WATT HI-FI AMPLIFIER KIT**

A stylishly finished monaural amplifier with an output of 4 watts from 2 EL84s in push-pull. Super reproduction of both music and speech, with negligible hum. Separate inputs for mike and gram allow records and announcements to follow each other. Fully shrouded section wound output transformer to match 3-15Ω speaker and 2 independent volume controls, and separate bass and treble controls are provided giving good life and cut. Valve line-up 2 EL84s, ECC83, EF86, and EZ80 rectifier. Simple instruction booklet 1/6. (Free with parts.) All parts sold separately. ONLY £6/19/6. P. & P. 8/6. Also available ready built and tested complete with std. input sockets, £8/15/-. P. & P. 8/6.

**HARVERSON SURPLUS CO. LTD.**  
170 HIGH ST., MERTON, S.W.19. CHERRYWOOD 3985  
Open all day Saturday Early closing Wed., 1 p.m.  
A few minutes from South Wimbledon Tube Station. (Please write clearly)  
OVERSEAS P. & P. CHARGED EXTRA. S.A.E. with all enquiries.

**3-VALVE AUDIO AMPLIFIER MODEL HA34**  
Designed for Hi-Fi reproduction of records, A.C. Mains operation. Ready built on plated heavy gauge metal chassis, size 7 1/2 in. w. x 4 in. d. x 4 1/2 in. h. Incorporates ECC83, EL84, EZ80 valves. Heavy duty, double wound mains transformer, separate Bass, Treble and Volume controls. Negative feedback line. Output 4 1/2 watts. Front panel can be detached and leads extended for remote mounting of controls.  
The HA34 has been specially designed for us and our quantity order enables us to offer £4.5.0 them complete with knobs, valves, P. & P. 6/-, etc., wired and tested for only



**HSL 'FOUR' AMPLIFIER KIT.**  
A.C. Mains 200/250v., 4 watt, using ECC83, EL84, EZ80 valves.

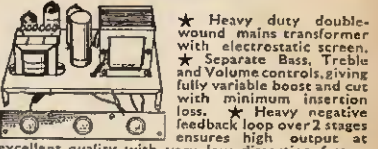

- Heavy duty double-wound mains transformer with electrostatic screen.
- Separate Bass, Treble and Volume controls, giving fully variable boost and cut with minimum insertion loss.
- Heavy negative feedback loop over 2 stages ensures high output at excellent quality with very low distortion factor.
- Suitable for use with guitar, microphone or record player
- Provision for remote mounting of controls or direct on chassis.
- Chassis size only 7 1/2 in. wide x 4 in. deep. Overall height 4 1/2 in.
- All components and valves are brand new.
- Very clear and concise instructions enable even the inexperienced amateur to construct with 100% success.
- Supplied complete with valves, output transformer (3 ohms only), screened lead, wire, nuts, bolts, solder, etc. (No extras to buy.) PRICE 79/6. P. & P. 6/-. Comprehensive circuit diagram, practical layout and parts list 2/6 (free with kit).

**EXCLUSIVE OFFER FOR PERSONAL CALLERS 100' ONLY**

A wonderful opportunity for you to build a quality AM/FM TRANSISTOR RADIO TUNER UNIT for 9v. operation. We offer the essential very high grade specially matched components comprising FM Tuner Head pre-aligned (88-108 Mc/s) complete with transistors. Two combined AM/FM I.F. Transformers, one discriminator transformer, one AM last I.F. transformer. Multi-bank switch for Gram/FM/LW/MW selection. Most attractive coloured dial, size 8 1/2" x 3 1/2". AM Tuning gang, hardware items for tuning mechanism, AM ferrite rod aerial (MW/LW) with coupling winding, trimmer bank, tuning drum, pulleys, etc. and suggested circuit diagram.

OFFERED AT THE AMAZING PRICE OF 4 gns. For personal callers only.

**SPECIAL PURCHASE! FROM LEADING HI FI MANUFACTURER**

7-10 watt OUTPUT TRANSFORMERS to match pair of ECL 86's in push-pull to 3 ohm output. ONLY 11/-. P. & P. 2/6.  
7-10 watt ULTRA LINEAR OUTPUT TRANSFORMERS to match pair of ECL 82's in push-pull to 3 ohm output. ONLY 15/-. P. & P. 2/6.  
SPECIAL MAINS TRANSFORMERS to match either of the above. Tapped primary. Secondary 250v. 80mA. half wave and 6.3v. 2 amps. ONLY 12/6. P. & P. 3/6.

**PRINTED CIRCUIT BOARDS** Available for GULFON ultrasonics remote control system. Mullard 10 Watts Transistor Amplifier. Write for details to: TATES ELECTRONIC SERVICES LTD. 3 WATERLOO ROAD, STOCKPORT, CHESHIRE

Please mention **PRACTICAL ELECTRONICS** when replying to Advertisements

**DUKE & CO. (LONDON) LTD.** 62/13 Romford Road, Manor Park, E.12 Ilford 6001-2-3  
**T.V. TUBES** 14in.—15/- 17in.—35/-  
Most makes and types available. Set Tested. Guaranteed good picture. Ex. Rental Service Dept. Stock, Carriage 5/- extra Stamp for list.  
**RESISTANCES** 100, 5/-, Mostly "High Stabs". Assorted. P. & P. 2/- (Overseas, P. & P. 3/6).

**BATTERY ELIMINATORS**  
The ideal way of running your TRANSISTOR RADIO, RECORD PLAYER, TAPE RECORDER, AMPLIFIER, etc. Types available: 9v; 6v; 4 1/2v (single output) 39/6 each. P. & P. 2/9. 9v + 9v; 6v + 6v; or 4 1/2v + 4 1/2v (two separate outputs) 42/6 each. P. & P. 2/9. Please state output required. All the above units are completely isolated from mains by double wound transformer ensuring 100% safety.  
**R.C.S. PRODUCTS (RADIO) LTD.** (Dept. P.E.), 11 Oliver Road, London, E.17

# IMPROVED STANDARDS of Accuracy and Reliability!

Modern styling in light grey with legible black engraving.

Constructed to withstand adverse climatic conditions.

Ever ready case including leads, prods and clips.

Improved internal assemblies.

Re-styled scale plate for easy rapid reading. 2 basic scales each 2.5 inches in length.

New standards of accuracy using an individually calibrated scale plate: d.c. ranges 2.25% of full scale deflection, a.c. ranges 2.75% of full scale deflection.

Available accessories include a 2,500V d.c. multiplier and 5, 10 and 25A shunts for d.c. current measurement.



The Mk. 4 MULTIMINOR is the latest version of this famous Avo instrument and supersedes all previous models. It is styled on modern lines, with new high standards of accuracy, improved internal assemblies, and incorporating panelmatic properties.

The instrument is supplied in an attractive black carrying case, which also houses a pair of leads with interchangeable prods and clips, and an instruction booklet. It is packed in an attractive display carton. Robust real leather cases are available, if required, in two sizes, one to take the instrument with leads, clips and prods, and the other to house these and also a high voltage multiplier and a d.c. shunt.

D.C. Current: 100μA f.s.d. — 1A f.s.d. in 5 ranges.  
A.C. Voltage: 10V f.s.d. — 1,000 f.s.d. in 5 ranges.  
D.C. Voltage: 2.5V f.s.d. — 1,000 f.s.d. in 6 ranges.  
D.C. Millivolt range: 0 — 100mV f.s.d.

RESISTANCE: 0-2M Ω, in 2 ranges, using 1.5V cell.  
SENSITIVITY: 10,000 Ω/V on d.c. Voltage ranges.  
1,000 Ω/V on a.c. Voltage ranges.

★ For full details of this great pocket size instrument, write for descriptive leaflet.



## MULTIMINOR Mk 4

**AVO LTD**

AVOCET HOUSE, 92-96 VAUXHALL BRIDGE ROAD, LONDON, S.W.1

Telephone: VICTORIA 3404



"... a short cut" for everybody wishing to obtain a quick acquaintance with modern electronics...

# BEGINNER'S GUIDE TO ELECTRONICS

by Terence L. Squires, A.M.Brit.I.R.E.

An up-to-date guide which assumes no prior technical knowledge. Early chapters explain the nature of electric currents, pulses and waveforms. Components and circuits are then described and illustrated, and their operation clearly explained. Chapters on test instruments; principles of and basic techniques used in the main branches of electronics—radar, radio, television, medical, industrial and space electronics, computers, and on training to be an electronics engineer. 128 pages, 128 diagrams. 15s. from all booksellers or in case of difficulty use this handy order form.

Please send me by return ..... copy/copies of the new

**BEGINNERS' GUIDE TO ELECTRONICS**  
15s. each (16s. 6d. by post)

NAME.....

ADDRESS.....

Simply complete this order and post with cheque/ postal order for 16s. 6d. to **GEORGE NEWNES LTD.**  
Tower House, Southampton Street, W.C.2.  
P.E. 10.65.

**RECORDING TAPE.** All Brand New and Boxed. Excellent quality.

7" Double Play .....	2400 ft. 34/6
7" Long Play .....	1800 ft. 21/6
5½" Double Play .....	1800 ft. 24/-
5½" Long Play .....	1200 ft. 16/6
5" Standard Play .....	600 ft. 11/3

plus many others

**LOUDSPEAKERS.** New—Top quality.  
2" x 8 ohms 9/9 2½" x 8 ohms 9/9  
2½" x 3 " 15/6 3" x 3 " 15/9  
3½" x 35 " 19/3 5" x 35 " 22/9  
8" x 3 " 26/3 10" x 3 " 32/6  
FANE 12" x 15 ohms (20 watt) 5 GNS.

**CHASSIS** made to your specification. Standard stock sizes available.

**EAR PIECES.** Vast range from 4/11 to 10/6 to suit all transistors.

**TEST METERS.** Panel to multimeters at very keen prices. An excellent "all-rounder" is the Multimeter—20 Kohm/ volt, 24.19.6.

**AND HERE'S A SNIP!** 300 x 100 x 100 x 16 MFD. 350 VOLT WKG. CAPACITORS AT ONLY 5/3!

Give yourself the treat you deserve—call at our shop, see our qualified staff and discuss your electronic problems, no matter how simple or complex—we'll do our best to help.

REMEMBER—



**BOTHWELL ELECTRIC SUPPLIES (Glasgow) LTD.**  
54 EGLINTON STREET  
GLASGOW, G.5  
Member of the Lander Group

has all you need from ferrite rods to electronic security devices. See for yourself—or use our postal service.

P.S. Have you seen our cable prices? Ridiculous, aren't they!

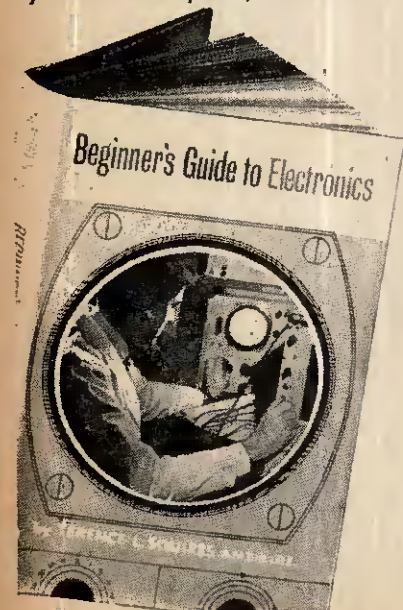

# ASTONISHING LOW PRICED RADIO KITS (all Guaranteed) FROM CONCORD

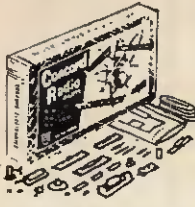

MAKE  
**5**  
DIFFERENT  
TRANSISTOR  
RADIOS  
for  
**35/-**

New RADIO Anyone CAN BUILD in 2-3 hours! Only 18/6! **EVERY CHILDREN BUILD THEM!** ...no soldering! ...only 16 connections! Then hear it reach out bringing in station after station. 4" x 2 1/2" x 1 1/2" Many Testimonials:—M.H. of Bradford, writes: "... I have just completed one of your sets successfully, it is the first time I have ever tackled anything like a radio and I must state here and now, I am amazed how easy it is to a layman like me. Your instructions and plans have obviously been very carefully thought out so that even the most dim can follow them ...". 18/6 plus 2/6 post, etc.



TRANSISTOR RADIO KITS  
Sold in Department Stores at £5.8.0  
OUR PRICE  
**37/6**  
P. & P.  
3/6  
extra

ASTONISHING CIGARETTE RADIO!  
ONLY 18/6  
Yes a perfectly ordinary packet of cigarettes—but it fetches in station after station, loud and clear! Holds 10 Cigarettes—yet cleverly conceals highly sensitive, fully transistorised circuit (incl. tiny battery). Even a young boy can assemble it in under 2 hours. No soldering. No experience necessary. Only 16 Connections. From our highly testimonial Mr. D. B. of Huddersfield writes:— "... I have fitted the parts in and it is working wonderfully..." ALL PARTS including Semi-Conductors, A.B.C. Plans, etc. ONLY 18/6 plus 2/6 post, etc.



Amazing Radio Construction Set! Become a radio expert for 35/-. A complete Home Radio Course! No experience needed. Parts include instructions for each design, Step-by-Step plan, all Transistors, loudspeaker, personal phone, knobs, screws, etc., all you need. Box size 14" x 10" x 2" (parts available separate). Originally £6. NOW 35/- plus 3/6 p. & p.

Well-known brand Transistor Radio Kits—YOU SAVE £3.15.8. Covering all medium long wave with parts including Mullard Semi-Conductors. 48 page instruction manual. Entertaining & educational. No soldering, just plug in, making many different Radios in a few mins. Money back if not delighted.

CONCORD ELECTRONICS LTD (Dept. PE22) 9 Western Road, Hove, Sussex

## PARKERS SHEET METAL FOLDING MACHINES HEAVY VICE MODELS

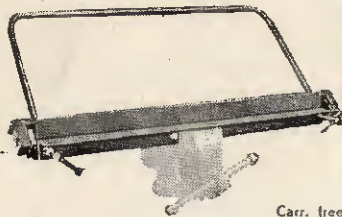

With Bevelled Former Bars

No. 1. Capacity 18 gauge mild steel x 36in, wide ... .. Carr. 11.00  
No. 2. Capacity 18 gauge mild steel x 24in, wide ... .. £11.50  
No. 3. Capacity 16 gauge mild steel x 18in, wide ... .. £6.15.0  
Also new bench models. Capacities 48in. x 18 gauge £38. 36in. x 18 gauge £23. 24in. x 16 gauge £13. Carriage free.  
End folding attachments for radio chassis. Tray and Box making for 36in. model, 5/6 per ft. Other models 3/6. The two smaller models will form flanges. As supplied to Government Departments, Universities, Hospitals.  
One year's guarantee. Money refunded if not satisfied. Send for details.

A. B. PARKER, Wheatcroft Works, Wellington St., Batley, Yorks. Tel. 3426

96 pages of factual tabulated data...

## "PRACTICAL WIRELESS" RADIO AND TELEVISION REFERENCE DATA

Compiled by J. P. Hawker

Contains full details of colour codes; everyday formulae, for calculating the values of biasing components, potential dividers, resonance, gain, etc.; aerial dimensions; a quick frequency-wavelength conversion table; stations and frequencies; common symbols and abbreviations; notes on amateur radio and a list of call-sign prefixes; communication receiver I.F.s; mathematical data including logarithmic tables; wire and cable data; battery equivalents; valve, transistor and picture tube pin connections, bases, ratings and equivalents, including selected CV types. 96 pages, illustrated, over 62 pages of tables.

10s. 6d. FROM ALL BOOKSELLERS

... or, in case of difficulty 11s. 6d. by post from  
GEORGE NEWNES LTD., Tower House,  
Southampton Street, London, W.C.2.

NEWNES

## Z & I AERO SERVICES LTD.

Head Office and Warehouse: 44A WESTBOURNE GROVE, LONDON, W.2.

Retail Shop:

85 TOTENHAM COURT ROAD, LONDON, W.1  
Tel: LANGHAM 8403

Tel: PARK 5641/2/3

0A2 8/-	6AK5 5/8	6BR7 12/8	6R7 8/-	128U7 4/-	6BF89 8/8	6EP9 11/-	6Z39 8/-	6PL26 10/-	6UBF20 7/-
0B2 6/-	6AK6 7/-	6BR8 5/-	6R7 8/-	128U7 4/-	6BL1 14/-	6EP18 8/-	6Z32 10/-	6PL8 15/-	6UBF8 7/-
0B4 6/-	6AK7 6/-	6BR9 9/8	6R8 5/-	128U7 4/-	6BL21 11/-	6EP18 8/-	6Z34 10/-	6PL8 15/-	6UB21 11/-
0C5 6/-	6AL5 3/-	6BW7 10/-	6SL7GT 5/-	128K7 4/-	6CC84 7/-	6EP80 15/-	6K766 18/-	6PL2 7/-	6CC84 9/-
0D3 5/-	6AM5 2/6	6CS 3/-	6SN7GT 4/8	128Q7GT 6/8	6CC85 6/8	6EP80 10/-	6K788 22/-	6PL3 7/8	6CC85 7/-
116GT 7/-	6ANG 4/-	6C16 5/-	6S7GT 5/-	128S7 5/-	6CC88 7/-	6EL31 11/-	6K792 7/-	6PL4 7/8	6CF80 10/-
1N8 8/-	6AN4 15/-	6C16G/A17/7	6T8 7/-	128V7 8/-	6CC89 10/-	6EL35 17/8	6K795 15/-	6PL20 14/-	6UC21 9/8
1R4 5/-	6AN5 15/-	6C16 5/-	6U4GT 10/8	19AQ5 5/-	6CC89 12/-	6EL35 17/8	6K795 15/-	6PL50 15/-	6UC42 9/8
184 5/-	6AN8 10/-	6C16 5/-	6V6 9/-	19G4 25/-	6CC89 12/-	6EL35 17/8	6K795 15/-	6PL50 15/-	6UC42 9/8
185 4/8	6A95 6/-	6C16 5/-	6V6 9/-	19G6 15/-	6CC89 12/-	6EL35 17/8	6K795 15/-	6PL50 15/-	6UC42 9/8
1T4 3/-	6A95A 7/8	6C16 5/-	6V6 9/-	20P9 15/-	6CC89 12/-	6EL35 17/8	6K795 15/-	6PL50 15/-	6UC42 9/8
1T5GT 6/-	6A95 6/-	6C16 5/-	6V6 9/-	20P9 15/-	6CC89 12/-	6EL35 17/8	6K795 15/-	6PL50 15/-	6UC42 9/8
1U4 3/-	6A95 6/-	6C16 5/-	6V6 9/-	20P9 15/-	6CC89 12/-	6EL35 17/8	6K795 15/-	6PL50 15/-	6UC42 9/8
1U5 5/-	6A95 6/-	6C16 5/-	6V6 9/-	20P9 15/-	6CC89 12/-	6EL35 17/8	6K795 15/-	6PL50 15/-	6UC42 9/8
1X2A 7/-	6A98 17/8	6C16 5/-	6V6 9/-	20P9 15/-	6CC89 12/-	6EL35 17/8	6K795 15/-	6PL50 15/-	6UC42 9/8
1X2B 7/-	6A98 5/-	6C16 5/-	6V6 9/-	20P9 15/-	6CC89 12/-	6EL35 17/8	6K795 15/-	6PL50 15/-	6UC42 9/8
2A3 5/-	6A98 5/-	6C16 5/-	6V6 9/-	20P9 15/-	6CC89 12/-	6EL35 17/8	6K795 15/-	6PL50 15/-	6UC42 9/8
2D21 8/-	6A98 5/-	6C16 5/-	6V6 9/-	20P9 15/-	6CC89 12/-	6EL35 17/8	6K795 15/-	6PL50 15/-	6UC42 9/8
2X2 3/-	6A98 5/-	6C16 5/-	6V6 9/-	20P9 15/-	6CC89 12/-	6EL35 17/8	6K795 15/-	6PL50 15/-	6UC42 9/8
3A4 4/-	6A98 5/-	6C16 5/-	6V6 9/-	20P9 15/-	6CC89 12/-	6EL35 17/8	6K795 15/-	6PL50 15/-	6UC42 9/8
3A5 7/-	6A98 5/-	6C16 5/-	6V6 9/-	20P9 15/-	6CC89 12/-	6EL35 17/8	6K795 15/-	6PL50 15/-	6UC42 9/8
3Q4 6/8	6A98 5/-	6C16 5/-	6V6 9/-	20P9 15/-	6CC89 12/-	6EL35 17/8	6K795 15/-	6PL50 15/-	6UC42 9/8
3Q5GT/6/8	6A98 5/-	6C16 5/-	6V6 9/-	20P9 15/-	6CC89 12/-	6EL35 17/8	6K795 15/-	6PL50 15/-	6UC42 9/8
3B4 5/-	6A98 5/-	6C16 5/-	6V6 9/-	20P9 15/-	6CC89 12/-	6EL35 17/8	6K795 15/-	6PL50 15/-	6UC42 9/8
3V4 6/-	6A98 5/-	6C16 5/-	6V6 9/-	20P9 15/-	6CC89 12/-	6EL35 17/8	6K795 15/-	6PL50 15/-	6UC42 9/8
3R4GY 9/-	6B1 12/8	6P26 6/8	6E26 6/8	6P28 10/8	6CC89 12/-	6EL35 17/8	6K795 15/-	6PL50 15/-	6UC42 9/8
3T4 8/-	6B2 2/8	6P26 6/8	6E26 6/8	6P28 10/8	6CC89 12/-	6EL35 17/8	6K795 15/-	6PL50 15/-	6UC42 9/8
3U4G 5/-	6B2 2/8	6P26 6/8	6E26 6/8	6P28 10/8	6CC89 12/-	6EL35 17/8	6K795 15/-	6PL50 15/-	6UC42 9/8
3U4GB 6/8	6B2 2/8	6P26 6/8	6E26 6/8	6P28 10/8	6CC89 12/-	6EL35 17/8	6K795 15/-	6PL50 15/-	6UC42 9/8
3V4G 8/8	6B2 2/8	6P26 6/8	6E26 6/8	6P28 10/8	6CC89 12/-	6EL35 17/8	6K795 15/-	6PL50 15/-	6UC42 9/8
3Y3GT 5/-	6B2 2/8	6P26 6/8	6E26 6/8	6P28 10/8	6CC89 12/-	6EL35 17/8	6K795 15/-	6PL50 15/-	6UC42 9/8
3X4G 8/-	6B2 2/8	6P26 6/8	6E26 6/8	6P28 10/8	6CC89 12/-	6EL35 17/8	6K795 15/-	6PL50 15/-	6UC42 9/8
3Z3 7/8	6B2 2/8	6P26 6/8	6E26 6/8	6P28 10/8	6CC89 12/-	6EL35 17/8	6K795 15/-	6PL50 15/-	6UC42 9/8
3Z6GT 6/-	6B2 2/8	6P26 6/8	6E26 6/8	6P28 10/8	6CC89 12/-	6EL35 17/8	6K795 15/-	6PL50 15/-	6UC42 9/8
6/30L2 10/8	6B2 2/8	6P26 6/8	6E26 6/8	6P28 10/8	6CC89 12/-	6EL35 17/8	6K795 15/-	6PL50 15/-	6UC42 9/8
6A4 10/-	6B2 2/8	6P26 6/8	6E26 6/8	6P28 10/8	6CC89 12/-	6EL35 17/8	6K795 15/-	6PL50 15/-	6UC42 9/8
6A6GT 11/-	6B2 2/8	6P26 6/8	6E26 6/8	6P28 10/8	6CC89 12/-	6EL35 17/8	6K795 15/-	6PL50 15/-	6UC42 9/8
6A7 6/-	6B2 2/8	6P26 6/8	6E26 6/8	6P28 10/8	6CC89 12/-	6EL35 17/8	6K795 15/-	6PL50 15/-	6UC42 9/8
6A7S 9/-	6B2 2/8	6P26 6/8	6E26 6/8	6P28 10/8	6CC89 12/-	6EL35 17/8	6K795 15/-	6PL50 15/-	6UC42 9/8

### TRANSISTORS

AF114 9/-	OC28 17/8	OC72 6/-	OC18 12/-	OC204 17/6	GET114 5/8
AF115 7/-	OC73 11/-	OC73 11/-	OC140 15/-	OC205 20/-	GET115 8/8
AF116 10/8	OC75 15/-	OC75 15/-	OC141 25/-	OC206 22/8	GET116 12/-
AF117 6/-	OC76 15/-	OC77 8/-	OC142 25/-	OC207 22/8	GET117 12/-
AF118 17/8	OC78 2/8	OC78 2/8	OC143 25/-	OC208 22/8	GET118 12/-
OC29 17/8	OC44 6/-	OC78D 6/-	OC144 25/-	OC209 22/8	GET119 12/-
OC24 22/8	OC45 5/-	OC81M 7/-	OC145 25/-	OC210 22/8	MAT121 8/8
OC25 12/-	OC79 5/-	OC81DM 7/-	OC146 25/-	OC211 22/8	MAT122 8/8
OC28 8/-	OC83 5/-	OC83 5/-	OC147 25/-	OC212 22/8	TI156 6/-

### CATHODE RAY TUBES 30P1

As used in P.E. Oscilloscope described in March and April Issues. £2.10.0. Base 3P. P. & P. 5/-.

**NUVISTOR TRIODES**  
2CW4, 6CW4—(2V or 0.5V heaters) for TV-F and F.M. Tuner Application. 2E-6B9A—as above, but suitable for weak signal areas. 15/-

Bases for the above 2/6.

### PHOTOCELLS G516

Caesium Antimony, Side-on Window. HT 160V. Sensitivity 160μA/LV.

**ZENNER DIODES**

OA2300 10/-	OA2207 10/-	VR425 6/8
OA2201 9/8	OA2208 6/-	VR475 6/8
OA2202 8/-	OA2210 6/-	VR725 6/8
OA2204 8/8	OA2212 6/-	VR78 6/8
OA2205 8/-	OA2213 6/8	VR10A 6/8
OA2206 8/-	OA2214 6/8	VR11A 8/-

PLEASE SEND SAE (FOOLSCAP) FOR FULL PRICE LIST

Please add 2/6 in 4 for postage. Minimum charge 2/-. No C.O.D. Orders Accepted. Please address all correspondence to the Head Office.

# VALUABLE NEW HANDBOOK FREE TO AMBITIOUS ENGINEERS

Have you had your copy of "Engineering Opportunities"?

The new edition of "ENGINEERING OPPORTUNITIES" is now available—without charge—to all who are anxious for a worthwhile post in Engineering. Frank, informative and completely up to date, the new "ENGINEERING OPPORTUNITIES" should be in the hands of every person engaged in any branch of the Engineering industry, irrespective of age, experience or training.

## On 'SATISFACTION OR REFUND OF FEE' terms

This remarkable book gives details of examinations and courses in every branch of Engineering, Building, etc., outlines the openings available and describes our Special Appointments Department.

### WHICH OF THESE IS YOUR PET SUBJECT?

**MECH. ENGINEERING**  
Gen. Mech. Eng.—Maintenance Eng.—Diesel Eng.—Press Tool Design—Sheet Metal Work—Welding—Eng. Pattern Making—Inspection—Draughtsmanship—Metallurgy—Production Eng.

**RADIO ENGINEERING**  
General Radio—Radio & TV Servicing—TV Eng.—Telecommunications—Electronics—Sound Recording—Automation—Practical Radio—Radio Amateurs' Exam.

**CIVIL ENGINEERING**  
General Civil Eng.—Municipal Eng.—Structural Eng.—Sanitary Eng.—Road Eng.—Hydraulics—Mining—Water Supply—Petrol Tech.

**ELEC. ENGINEERING**  
General Electrical Eng.—Installations—Draughtsmanship—Illuminating Eng.—Refrigeration—Elem. Elec. Science—Elec. Supply—Mining Elec. Eng.

**AUTO ENGINEERING**  
General Auto Eng.—Auto. Maintenance—Repair—Auto. Diesel Maintenance—Auto. Electrical Equipment—Garage Management.

**BUILDING**  
General Building—Heating & Ventilation—Plumbing—Architecture—Carpentry—Painting—Decorating—Specifications & Quantities—Surveying—Architectural Draughtsmanship.

WE HAVE A WIDE RANGE OF COURSES IN OTHER SUBJECTS INCLUDING CHEMICAL ENG., AERO ENG., MANAGEMENT, INSTRUMENT TECHNOLOGY, WORKS STUDY, MATHEMATICS, ETC.

Which qualification would increase your earning power?  
A.M.I.Mech.E., A.M.S.E., A.M.I.C.E., A.M.I.E.R.E., B.Sc.,  
A.M.I.P.E., A.M.I.M.I., A.R.I.B.A., A.I.O.B., A.M.I.Chem.E., A.R.I.C.S.,  
M.R.S.H., A.M.I.E.D., A.M.I.Mun.E., CITY & GUILDS, GEN. CERT. OF  
EDUCATION, ETC.

**BRITISH INSTITUTE OF ENGINEERING TECHNOLOGY**  
155 COLLEGE HOUSE, 29-31 WRIGHT'S LANE, W.8

### THIS BOOK TELLS YOU

- ★ HOW to get a better paid, more interesting job.
- ★ HOW to qualify for rapid promotion.
- ★ HOW to put some letters after your name and become a key man . . . quickly and easily.
- ★ HOW to benefit from our free Advisory and Appointments Depts.
- ★ HOW you can take advantage of the chances you are now missing.
- ★ HOW, irrespective of your age, education or experience, YOU can succeed in any branch of Engineering.

156 PAGES OF EXPERT CAREER - GUIDANCE

#### PRACTICAL EQUIPMENT

Basic Practical and Theoretic Courses for beginners in Radio, T.V., Electronics, Etc., A.M.I.E.R.E. City & Guilds Radio Amateurs' Exam. R.T.E.B. Certificate P.M.G. Certificate Practical Radio Radio & Television Servicing Practical Electronics Electronics Engineering Automation

#### INCLUDING TOOLS

The specialist Electronics Division of B.I.E.T. NOW offers you a real laboratory training at home with practical equipment. Ask for details.

## B.I.E.T.

You are bound to benefit from reading "ENGINEERING OPPORTUNITIES", and if you are earning less than £30 a week you should send for your copy now—FREE and without obligation.

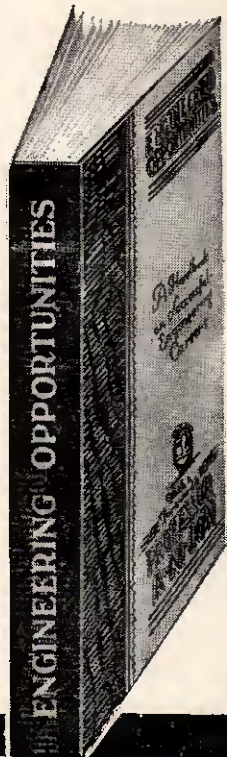

### POST NOW!

TO B.I.E.T., 155 COLLEGE HOUSE,  
29-31 WRIGHT'S LANE, W.8.

3d. stamp if posted in  
an unsealed envelope.

Please send me a FREE copy of "ENGINEERING OPPORTUNITIES." I am interested in (state subject, exam., or career).

NAME .....

ADDRESS .....

WRITE IF YOU PREFER NOT TO CUT THIS PAGE

**THE B.I.E.T. IS THE LEADING INSTITUTE OF ITS KIND IN THE WORLD**

Published about the 15th of the month by GEORGE NEWNES LIMITED, Tower House, Southampton Street, London, W.C.2. Printed in England by THE CHAPEL RIVER PRESS LIMITED, Andover, Hants. Sole Agents for Australia and New Zealand: GORDON & GOTCH (A/asia) Ltd.; South Africa and Rhodesia: CENTRAL NEWS AGENCY LTD.; East Africa: STATIONERY & OFFICE SUPPLIES LTD. Subscription rate including postage for one year: To any part of the World £1 16. 0.

## CIRCUIT SYMBOLS AND CONFIGURATIONS

Junction Transistors can be classified as either PNP or NPN with Circuit Symbols as follows:

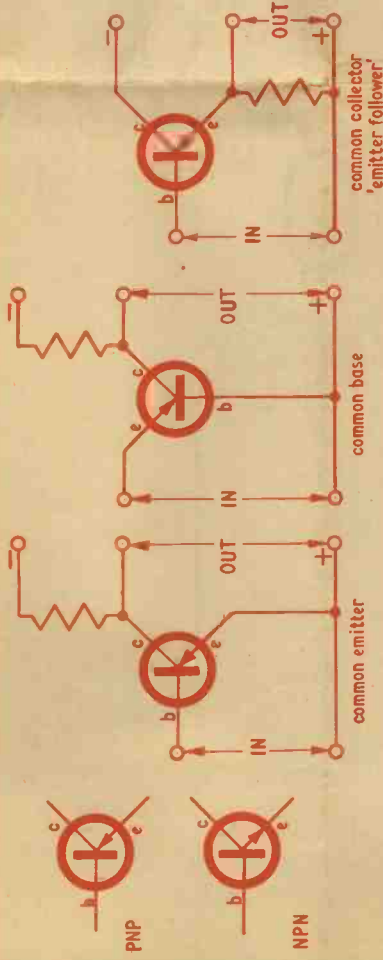

There are three basic Transistor amplifier circuits, each of which is identified by the common or grounded element. Generally speaking the common emitter circuit is used for most purposes and the common collector or common base for special purposes such as impedance matching a signal amplifier at very high frequency

## COMMON GERMANIUM TRANSISTORS of approximately similar characteristics

### General Purpose

#### RADIO FREQUENCY AMPLIFIERS AND SWITCH. PNP

2GT102, 2GT301, 2GT302, NKT125, 0C41, 0C42, 0C44, 0C45.

#### AUDIO FREQUENCY AMPLIFIERS. HIGH GAIN. SMALL

##### SIGNAL PNP

2G371, 2G374, 2GT174, ACY31, NKT219, 0C71, 0C75

#### AUDIO FREQUENCY AMPLIFIERS. HIGH GAIN. LARGE

##### SIGNAL PNP

2G381, 2G382, 2GT182, NKT222, 0C72, 0C81.

### Radio Receiver Stages

#### AUDIO FREQUENCY PNP

Driver: 2G371, NKT274 0C75, 0C81D, 0C81DM, 0C82D.

Output: GET113, GET114, NKT271, 0C72, 0C74, 0C81, 0C81M, 0C82, 0C83, 0C84.

Preamplifier: NKT275, 0C70, 0C71.

#### INTERMEDIATE FREQUENCY AMPLIFIER PNP

2G417, AF117, AF127, NKT73, NKT163, NKT164, NKT677, 0C45, 0C45M, 0C170.

Mixer: 2G417, AF115, AF125, NKT72, NKT162, NKT675, NKT677, 0C44, 0C44M, 0C170.

Power: AD140, AD149, NKT452, 0C25, 0C26.

## COMMON SYMBOLS OF BASIC CHARACTERISTICS

Characteristic	Symbol	Given in	Explanation
VOLTAGE	$V_{CES}$	Volts	Collector-emitter Voltage Rating with base short circuited to emitter.
CURRENT	$I_C$	Amps or mA	Collector current rating.
DISSIPATION	$P_{tot} (F_a)$	Watts or mW	Dissipation rating in free air, i.e. not clipped or clamped to a heat sink.
BETA	$h_{FE} = \text{'AC BETA'}$ Symbols formerly used: $\beta$ (BETA) or $\alpha$ (ALPHA DASHED) The symbol refers to common base current gain or $h_{FB}$ and is seldom used nowadays $h_{FE} = \text{'DC BETA'}$ Symbols formerly used: $\bar{\beta}$ (BETA BAR) or $\bar{\alpha}$ (ALPHA DASHED BAR)	Units	Small Signal value of common-emitter, short-circuit, forward current transfer ratio
FREQUENCY	$f_{hfb}$ Symbols formerly used: $f_{co}$ or $f_{c\alpha}$	Mcs	Common-base, cut-off frequency at which $h_{FE}$ or $\alpha$ falls to .7 of its low frequency value.
COLLECTOR CAPACITANCE	$C_{ob}$	pF or $\mu F$	Internal feedback capacitance from collector to base.

Type No	Outline	Make	Type No	Outline	Make	Type No	Outline	Make
AD140	8	N	NKT222	4	N	OC44M	2	M
AD149	8	N	NKT271	2	N	OC45	1,9	M
AF115	10	M	NKT274	2	N	OC45M	2	M
AF117	10	M	NKT275	2	N	OC70	9	M
AF125	5	M	NKT303	6	N	OC71	1,9	M
AF127	5	M	NKT403	8	N	OC72	1	M
GET110	2	M	NKT452	8	N	OC74	1	M
						OC75	1	M



**INTERMEDIATE POWER, PNP**

AD162, GET110, GET115, GET116, NKT703, OC30.

**POWER-HIGH GAIN-HIGH CURRENT, PNP**

2PGT7, 2PGT14, AD440, NKT403, OC25, OC35.

**VERY HIGH FREQUENCY**

2G401, 2G417, 2GT117, AF117, NKT612, OC170.

**AUDIO FREQUENCY AMPLIFIERS-LARGE SIGNAL, NPN**

AC127, NKT713.

Type	No.	Outline	Make	Type No.	Outline	Make
	2G301	2	R	2GT102	5	R
	2G302	2	R	2GT117	5	R
	2G371	2	T	2GT174	2	R
	2G374	2	T	2GT182	2	R
	2G381	2	T	2PGT14	2	R
	2G382	2	T	AC127	2	M
	2G401	4	T	AC171	2	M
	2G417	5	T	AC173	2	M

Make	Type No.	Outline	Make	Type No.	Outline	Make
GET113	2	M	GET114	2	M	GET115
GET114	2	M	GET116	2	M	GET117
NKT612	2	M	NKT71	2	M	NKT72
NKT675	2	M	NKT73	2	M	NKT74
OC81D	2	N	OC25	2	N	OC26
OC81M	2	N	OC30	2	N	OC31
OC82	2	M	OC35	2	M	OC36
OC82D	8	M	OC41	2	M	OC42
OC83	1	M	NKT163	4	N	NKT164
OC84	1	M	NKT165	4	N	NKT166
OC170	10	M	OC44	2	N	OC45
2PGT7	8	R				

\* Special Outline. R=Radio Spares. N=Newmarket Transistors. T=Texas Instruments. M= Mullard.

**OUTLINE SHAPES or ENCAPSULATIONS**

The following are some of the more common Transistor encapsulations drawn approximately twice full size with lead connections identified:

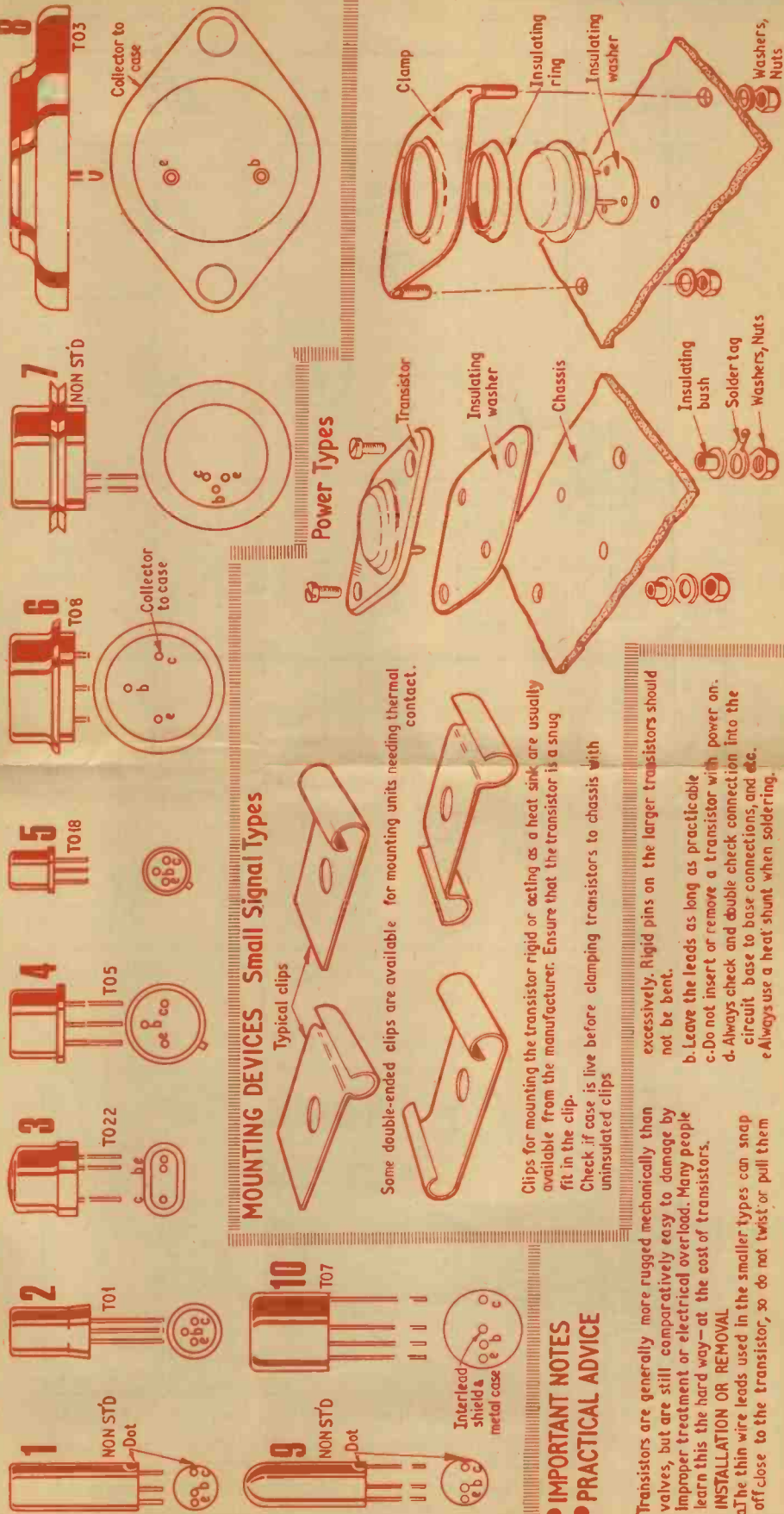

**MOUNTING DEVICES Small Signal Types**

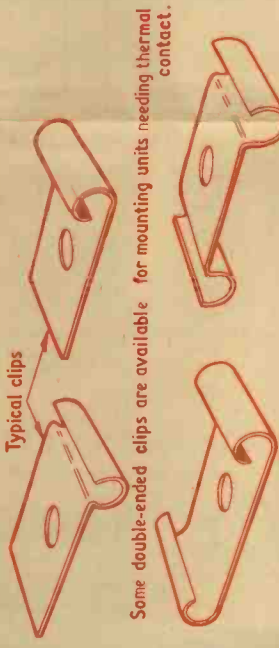

Some double-ended clips are available for mounting units needing thermal contact.

Clips for mounting the transistor rigid or acting as a heat sink are usually available from the manufacturer. Ensure that the transistor is a snug fit in the clip.

Check if case is live before clamping transistors to chassis with uninsulated clips

**IMPORTANT NOTES**  
**PRACTICAL ADVICE**

Transistors are generally more rugged mechanically than valves, but are still comparatively easy to damage by improper treatment or electrical overload. Many people learn this the hard way—at the cost of transistors.

**INSTALLATION OR REMOVAL**

a The thin wire leads used in the smaller types can snap off close to the transistor, so do not twist or pull them

excessively. Rigid pins on the larger transistors should not be bent.

b Leave the leads as long as practicable

c Do not insert or remove a transistor with power on.

d Always check and double check connection into the circuit base to base connections, and etc.

e Always use a heat shunt when soldering.

When two or more Capacitors are connected in Series or in Parallel, their total effective value can be calculated:

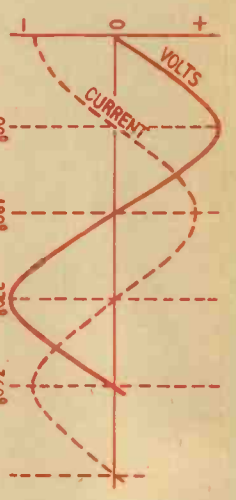
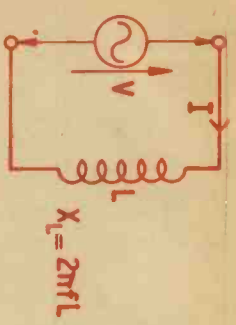
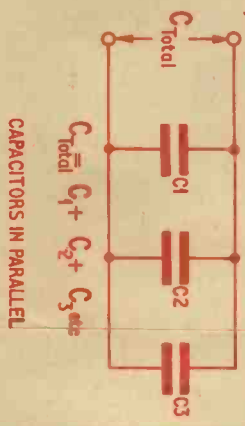
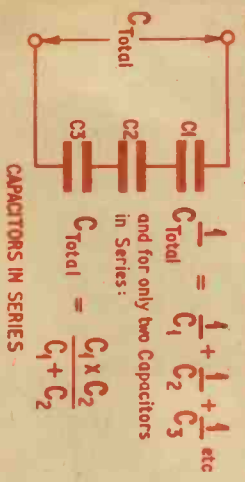

When an Inductance  $L$  is connected in an A.C. Circuit in place of a Resistance, the relationship between Volts and Current is altered, the Current LAGGING the voltage by 90°. The Reactance of the Inductance is given as above.

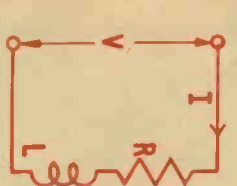

RESISTOR AND INDUCTOR IN SERIES AND PARALLEL

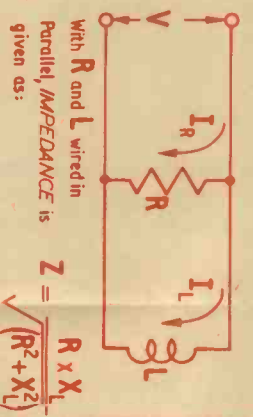

NOTE: IN PRACTICE AN INDUCTANCE MUST INEVITABLY CONTAIN SERIES RESISTANCE IN THE INDUCTOR ITSELF

### Tuned Circuits

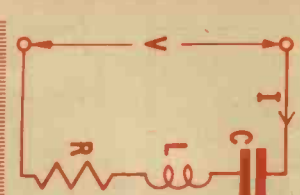

When  $R$ ,  $L$ , and  $C$  are wired in Series, the circuit's Impedance is lower than that of either  $X_L$  or  $X_C$  at all frequencies (providing that  $R$  is not of too high a value since the opposing Phase Angles of the two reactive components tend to cancel each other. The Impedance of the circuit is given by  $Z = \sqrt{(X_L - X_C)^2 + R^2}$ .

At the frequency where  $X_L = X_C$ ,  $Z$  will be  $R$ , and a current dictated by this value will flow in the Series circuit. If  $X_L$  is greater than  $R$  under this condition, a voltage greater than  $V$  will appear across  $L$ . The ratio of this CIRCUIT MAGNIFICATION is given the symbol  $Q$  thus:  $Q = \frac{L}{R}$ .

The frequency at which  $X_L = X_C$  is referred to as  $f_0$  and is given as  $f_0 = \frac{1}{2\pi\sqrt{LC}}$ .

Note that the Phase Angle changes with frequency, the current leading the voltage at frequencies below  $f_0$ , and lagging at frequencies above  $f_0$ . Thus, at frequencies above  $f_0$ , the circuit acts as an inductive one, while at frequencies below it is mainly capacitive.

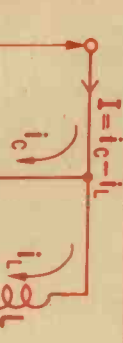

A tuned circuit is also formed when  $C$  and  $L$  are wired in Parallel. Here it is the RESONANT or DYNAMIC impedance that is of greatest interest and is expressed as:  $Z = \frac{L}{C \times R}$ .

Note that at Resonance this Impedance is high  $f_0 = \frac{1}{2\pi\sqrt{LC}}$  when  $R \ll 2\pi fL$ :

In this circuit, the total current flowing is the difference between the two individual currents in  $C$  and  $L$  i.e. Circuit Magnification  $Q$  applies to current, not voltage as in the Series circuit:  $Q = \frac{X_L}{R}$ .

If a Resistor and a Capacitor are used together in an A.C. Circuit, the Phase Change between  $V$  and  $I$  will be less than 90° and the total A.C. RESISTANCE will depend on the combined effects of  $R$  and  $X_C$ . This TOTAL A.C. RESISTANCE is referred to as the IMPEDANCE and given the symbol  $Z$ :

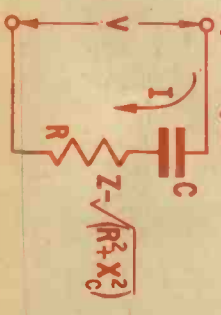

CAPACITOR AND RESISTOR IN SERIES  
 $C$  and  $R$  share the same current, but have individual voltages

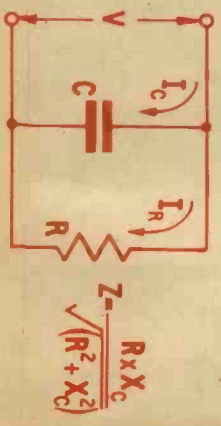

CAPACITOR AND RESISTOR IN PARALLEL  
 $C$  and  $R$  share a common voltage, but have individual currents

Total Phase Angle  $\tan \theta = \frac{X_C}{R}$

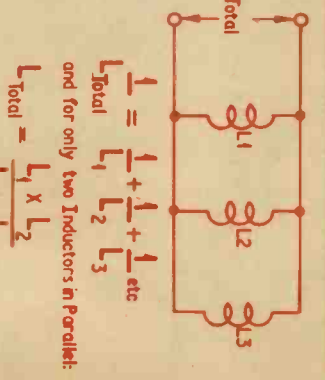
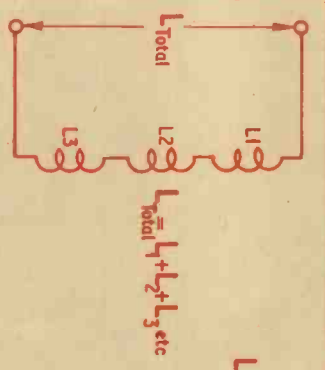

# BASIC R, G, and L THEORY

**PC**  
DATA SHEET

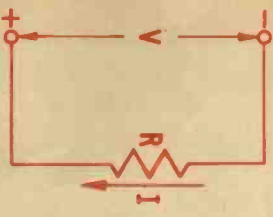

The three basic units of electrical measurement, Volts  $V$ , Current  $I$ , and Resistance  $R$ , are related by **Ohm's Law**:

$$V = I \times R \quad I = \frac{V}{R} \quad R = \frac{V}{I}$$

Power involved in the circuit can be calculated as:

$$P_{\text{watts}} = W \times I \quad P = \frac{V^2}{R} \quad \text{or} \quad P = I^2 \times R$$

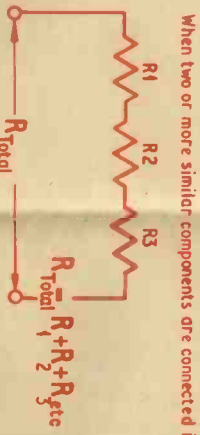

When two or more similar components are connected in Series or in Parallel, their total effective value can be calculated:

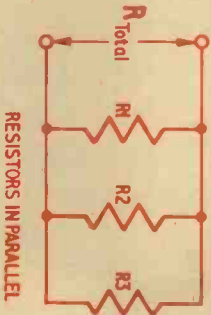

RESISTORS IN SERIES

RESISTORS IN PARALLEL

$$\frac{1}{R_{\text{Total}}} = \frac{1}{R_1} + \frac{1}{R_2} + \frac{1}{R_3} \text{ etc}$$

and for only two Resistors in Parallel:

$$R_{\text{Total}} = \frac{R_1 \times R_2}{R_1 + R_2}$$

When Alternating voltages and currents are involved in circuits that are not purely resistive, the simple **OHM'S LAW** relationship must be modified:

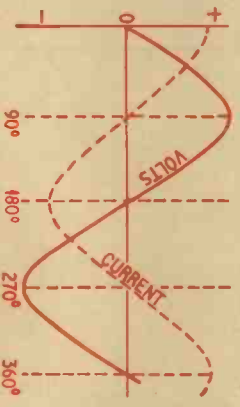
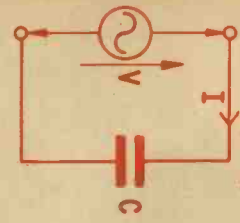

When a Capacitance  $C$  is connected in a circuit in place of a resistance, a phase change occurs in the relationship between Volts and Current, the Current **LEADING** the Voltage by  $90^\circ$ . The Capacitor has an A.C. **RESISTANCE** which varies with Frequency. For simplicity this A.C. **RESISTANCE** is referred to as **REACTANCE** given the symbol  $X_c$ :

$$X_c = \frac{1}{2\pi f C}$$

where  $C$  is measured in Farads or  $X_c \approx \frac{1,000,000}{2\pi f C}$  where  $C$  is measured in Micro Farads. Relationships between  $V$ ,  $I$ , and  $X_c$  can be calculated by substituting  $X_c$  for  $R$  in the Ohm's Law Formula.

## FULLY DETAILED AND ILLUSTRATED CATALOGUE

Now 96 big pages. The largest range available in the country. All types of components and equipment at competitive prices.

PRICE 2/6 (post paid)

## PROVED AND TESTED DESIGNS FULL AFTER SALES SERVICE AND GUARANTEE

★ CALL IN FOR DEMONSTRATIONS ★  
DETAILED LEAFLETS FREE ON REQUEST

FREE! New 8 page book with details of over 80 projects, available from stock. Uses transistors, light cells, scr's, etc., etc. Ask for your FREE copy

### MW/LW POCKET SUPERHET RADIO



TOTAL COST TO BUILD

85/- P.P. (Battery 2/6 Phone 5/-)

★ All parts sold separately.

- ★ 6-Transistor design. Push-pull output.
- ★ 2 1/2 in. Cleartone speaker. Printed circuit.
- ★ Attractive moulded cabinet.
- ★ Slow motion tuning.
- ★ Full med. and long waves.
- ★ Size: 5 x 3 x 1 1/2 in.

★ AMAZING SENSITIVITY & SELECTIVITY ★

- ★ 6-Transistor push-pull Superhet design.
- ★ Uses factory built panels.
- ★ Permeability geared tuning.
- ★ Full med./long wave tuning with push-button wave change.
- ★ Double tuned IFT's.
- ★ Chromed front panel plate.
- ★ Size: 7 x 4 x 2 in. Fits any car.
- ★ Pre-built units sold separately.

TOTAL COST TO BUILD

£8.19.6 P.P. 3/6

(7 in. x 4 in. speaker with car fixing kit and baffle board 20/- extra).

TWO WAVEBAND ALL TRANSISTOR CAR RADIO TO ASSEMBLE

★ HIGH PERFORMANCE SUPERHET ★

### 2- AND 4 TRACK TAPE RECORDERS TO ASSEMBLE

Pre-built Equipment—6 Valves—Collaro Studio Decks—Portable Cabinets with Speakers.

Complete record and playback.



★ 2-track deck 10 gns. P.P. 5/- Amplifier 11 gns. Cabinet with speaker 5 gns. OR SPECIAL PRICE £26 P.P. 8/6

★ 4-track deck £13.19.6. P.P. 5/- Amplifier 12 gns. Cabinet with speaker 5 gns. OR SPECIAL PRICE £30 P.P. 8/6

Prebuilt and tested units. Low distortion, low noise

### 10 Watt & 20 Watt HI-FI AMPLIFIERS

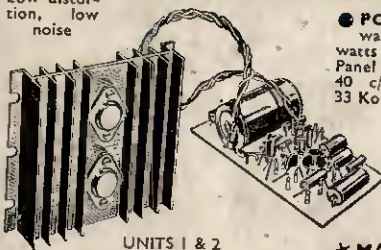

UNITS 1 & 2



UNIT 5



UNIT 3

THE FINEST QUALITY HI-FI AT UNBEATABLE PRICES

★ POWER AMPLIFIERS. 10 watts R.M.S. music power. 20 watts peak. 6-Transistor design. Panel size 4 x 2 1/2 x 2 in. Response 40 c/s to 20 kc/s. 100mV into 33 Kohm input.

UNIT 1. For 12/15 ohm speakers. 40 volt supply

PRICE BUILT £5.19.6 P.P. 2/6

UNIT 2. For 3 to 5 ohm speakers. 24/28 volt supply

PRICE BUILT £5.10.0 P.P. 2/6

★ MAINS UNITS. 59/6. To power one amplifier or 69/6 to power two amplifiers (State 24 or 40 volt)

★ PREAMPLIFIERS. Mono and stereo versions. 8 inputs, 1 1/2 to 300mV at 1k to 500k. Response 30 c/s to 20 kc/s. Complete range of controls. Mains unit or battery operated. For pickups, tuners, tape, microphones, etc.

UNIT 3. Mono full-function pre-amplifier. Size: 9 1/2 x 2 1/2 x 2 in. PRICE BUILT £5.10.0 P.P. (Brown/Gold front panel plate 8/6)

UNIT 4. Simplified version of Unit 3. Price 65/- P.P. 1/6. Panel plate 6/6.

UNIT 5. Stereo preamplifier for use with two units 1 or 2. Size 9 x 3 1/2 x 1 1/2 in.

PRICE BUILT £10.19.6 P.P. 3/6 (Front panel plate 12/6)

We stock:

- TRANSISTORS
- RECTIFIERS (over 400 types)
- VALVES
- CRYSTALS
- MICROPHONES
- TEST GEAR
- TAPE DECKS
- SPEAKERS
- MULTI-METERS
- RADIO CONTROL AMPLIFIERS
- RECORDERS
- TUNERS
- RECORD DECKS
- TWEETERS
- RECEIVERS
- GENERATORS
- COMPONENTS AND ACCESSORIES

### SINCLAIR DESIGNS

- ★ Micro-6 MW/ radio 59/6
- ★ TR750 "Addon" power amp. 39/6
- ★ Micro injector 27/6
- ★ Micro amp. 28/6
- ★ X10 Amp. kit £5.19.6



BUILT £6.19.6

★ X20 kit £7.19.6 BUILT £9.19.6

### 5 WATT AND 1 1/2 WATT PACKAGED AMPLIFIERS

- ★ 6-Transistor push-pull printed circuit designs
- ★ Size only 2 1/2 x 2 x 1 1/2 in.
- ★ 5 watt 18 volt, 1 1/2 watt 12 volt
- ★ For 3 to 5 ohm speakers
- ★ 7mV into 1 Kohm. 30 c/s to 16 kc/s



(New Version)

PRICES BUILT 1 1/2 W. 65/- P.P. 1/6 5 W. 79/6 P.P. 1/6

### 4-CHANNEL MICROPHONE MIXER

Transistorised. 4 inputs up to 100 Kohm. Full mixing. PRICE 49/6



Let us quote for parts for your circuit. Send a list for quick reply. Quality components at realistic prices

### TRANSISTOR PORTABLE TEST EQUIPMENT



PRICE £9.10.0

- ★ Resistance/capacitance bridge. £8.5.0.
- ★ Audio generator 10 c/s—100 kc/s. 4 ranges. £16.15.0.

### VHF/FM TUNER TO ASSEMBLE



- ★ Two pre-built units plus metal work and front panel
- ★ Size: 9 1/2 x 3 1/2 x 4 in
- ★ 88 to 108 mc/s tuning
- ★ 100mV to 100Kohm output
- ★ 6-Transistor printed circuit

Total Cost £12.17.6 P.P. 2/6

### NEW 3-WAVEBAND PUSH-BUTTON PORTABLE SUPERHET TO BUILD

- ★ SHORT WAVES (17-50m)
- ★ MED. WAVES
- ★ LONG WAVES

TOTAL COST TO BUILD

£8.19.6 P.P. 3/6

6 Transistors. 1 watt push-pull output. Special circuit for car aerial. Car and tape sockets. Telescopic and ferrite aerials. Full tuning on all wavebands. Push-button coil pack. Cabinet size 11 x 7 1/2 x 3 1/2 in. Black fabric with chromed handle and fittings. THE ONLY FULLY TUNABLE MW/LW/SW RADIO AVAILABLE FOR HOME CONSTRUCTION.

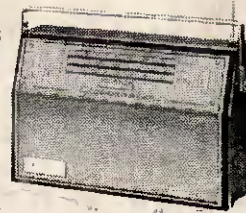

reband version as previously advertised £7.19.6 p.p. 3/6. Batteries 6/-

### VHF/FM TRANSISTOR TUNER TO BUILD

TOTAL COST £6.19.6

P.P. 2/6 (complete with frontplate) (Gold sprayed cabinet 20/- extra).

- ★ 5-Transistor 4 diodes
- ★ Printed circuit superhet
- ★ Geared tuning 87 to 105 mc/s FM
- ★ RF stage and double tuned IFT's
- ★ Output up to 1 volt peak up to 100 Kohm
- ★ 9 volt 9mA supply
- ★ Size in cabinet 4 x 3 1/2 x 2 1/2 in.
- ★ All parts sold separately

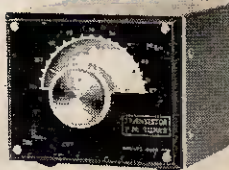

### HENRY'S RADIO LTD.

303 EDGWARE RD., LONDON W2

PADDINGTON 1008/9

Open Mon. to Sat. 9-6. Thurs. 1 p.m. Open all day Saturday