

THE No 1 UK MAGAZINE FOR ELECTRONICS TECHNOLOGY & COMPUTER PROJECTS

# **EPE** EVERYDAY PRACTICAL **ELECTRONICS**

www.epemag.co.uk

www.epemag.com

## **POCKET TENS**

**Pain relief without drugs**

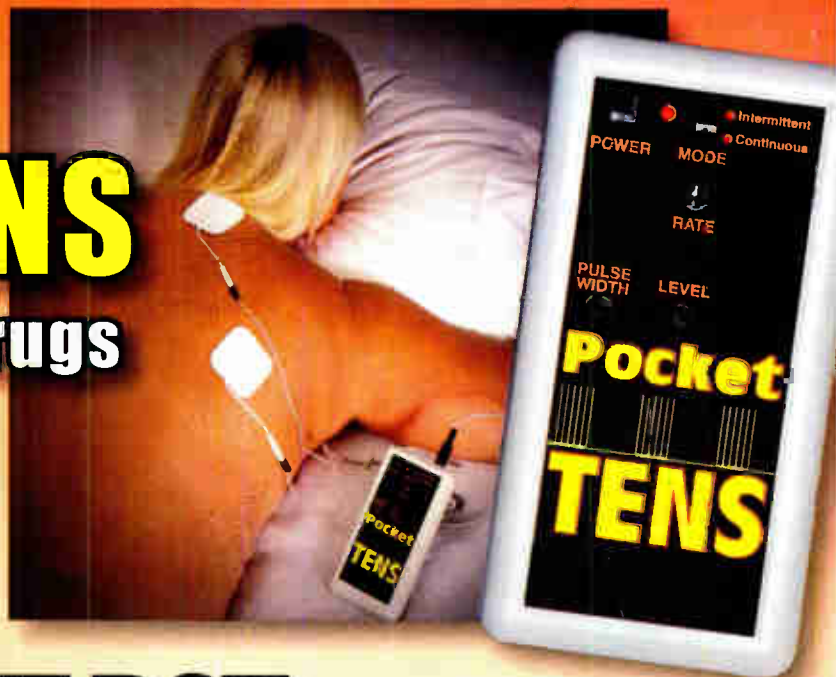

## **DEAD SIMPLE USB BREAKOUT BOX**

**Check you are not overloading the USB port**



## **FLEXITIMER**

**Easy-to-programme  
multi-purpose timer**

**PLUS V2 PC SCOPE – PART 2**

SEPT 2007 £3.50





**HB7 Stirling Engine**

Base measurements: 128 mm x 108 mm x 170 mm, 1 kg  
 Base plate: beech - Working rpm: 2000 rpm/min. (the engine has a aluminium good cooling Cylinder)  
 Bearing application: 10 high-class ball-bearings  
 Material: screw, side parts all stainless steel  
 Cylinder brass, Rest aluminium and stainless steel.  
 Available as a kit £80.75 or built £84.99  
[www.mamodspares.co.uk](http://www.mamodspares.co.uk)

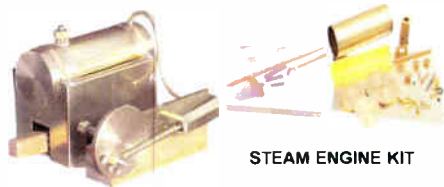

**STEAM ENGINE KIT**

Everything in the kit enables you to build a fully functional model steam engine. The main material is brass and the finished machine demonstrates the principle of oscillation. The boiler, uses solid fuel tablets, and is quite safe. All critical parts (boiler, end caps, safety vent etc.) are ready finished to ensure success. The very detailed instruction booklet (25 pages) makes completion of this project possible in a step by step manner. Among the techniques experienced are silver soldering, folding, drilling, fitting and testing. £29.70 ref STEAMKIT Silver solder/flux pack £3.50 ref SSK

[www.mamodspares.co.uk](http://www.mamodspares.co.uk)



**Solar Panels**

We stock a range of solar photovoltaic panels. These are polycrystalline panels made from wafers of silicon laminated between an impact-resistant transparent cover and an EVA rear mounting plate. They are constructed with a lightweight anodised aluminium frame which is predrilled for linking to other frames/roof mounting structure, and contain waterproof electrical terminal box on the rear. 5 watt panel £29 ref 5wnav 20 watt panel £99 ref 20wnav 60 watt panel £249 ref 60wnav. Suitable regulator for up to 60 watt panel £20 ref REGNAV



**HB9 Stirling engine**

Base measurements: 156 mm x 108 mm x 130 mm, 0,6 Kg  
 Base plate: beech Working rpm: approx. 2,000 min  
 Bearing application: 6 high-class ball-bearings  
 Material of the engine: brass, aluminium, stainless steel  
 running time: 30-45 min.  
 Available as a kit £97.75 or built £101.99  
[www.mamodspares.co.uk](http://www.mamodspares.co.uk)



**HB14 Stirling Engine**

Base measurements: 156 mm x 108 mm x 150 mm, 1 kg  
 Base plate: beech Working rpm: 2000 - 2500 rpm/min. .  
 Incl. drive-pulley for external drives Bearing application: 10 high-class ball-bearings Material: screw, side parts total stainless steel Cylinder brass Rest aluminium, stainless steel Available as a kit £140.25 or built £144.50  
[www.mamodspares.co.uk](http://www.mamodspares.co.uk)



**Solar evacuated tube panels**

(20 tube shown) These top-of-the-range solar panel heat collectors are suitable for heating domestic hot water, swimming pools etc - even in the winter! One unit is adequate for an average household (3-4people), and it is modular, so you can add more if required. A single panel is sufficient for a 200 litre cylinder, but you can fit 2 or more for high water usage, or for heating swimming pools or underfloor heating. Some types of renewable energy are only available in certain locations, however free solar heating is potentially available to almost every house in the UK! Every house should have one -really! And with an overall efficiency of almost 80%, they are much more efficient than electric photovoltaic solar panels (efficiency of 7-15%). Available in 10, 20 and 30 tube versions. 10 tube £199, 20 tube £369, 30 tube £549. Roof mounting kits (10/20 tubes) £12.50, 30 tube mounting kit £15



**HB10 Stirling Engine**

Base measurements: 156 mm x 108 mm x 130 mm, 0,6 Kg  
 Base plate: beech Working rpm: approx. 2,000 rpm  
 Bearing application: 6 high-class ball-bearings  
 Material of the engine: brass, aluminium, stainless steel  
 running time: 30-45 min  
 Available as a kit £97.75 or built £101.99  
[www.mamodspares.co.uk](http://www.mamodspares.co.uk)



**HB15 Stirling Engine**

Base measurements: 128 mm x 108 mm x 170 mm, 0,75 kg  
 Base plate: beech Working rpm: 2000 rpm/min. (the engine has a aluminium good cooling Cylinder)  
 Bearing application: 6 high-class ball-bearings  
 Material: screw, side parts total stainless steel  
 Cylinder brass Rest aluminium, stainless steel  
 Available as a kit £97.75 or built £102  
[www.mamodspares.co.uk](http://www.mamodspares.co.uk)



**HB11 Stirling Engine**

Base measurements: 156 mm x 108 mm x 130 mm, 0,7 Kg  
 Base plate: beech  
 Working rpm: 2000 - 2500 rpm/min,run Bearing application: 4 high-class ball-bearings Material: screw, side parts total stainless steel Cylinder brass Rest aluminium, stainless steel.  
 Available as a kit £97.75 or built £101.99  
[www.mamodspares.co.uk](http://www.mamodspares.co.uk)



**HB16 Stirling Engine**

Base measurements: 128 mm x 108 mm x 170 mm, 1 kg  
 Base plate: beech Working rpm: 2000 rpm/min. (the engine has a aluminium good cooling Cylinder)  
 Bearing application: 10 high-class ball-bearings  
 Material: screw, side parts total stainless steel  
 Cylinder brass Rest aluminium, stainless steel.  
 Available as a kit £140.25 or built £144.50



**HB12 Stirling Engine**

Base measurements: 156 mm x 108 mm x 130 mm, 1 Kg  
 Base plate: beech Working rpm: 2000 - 2500 rpm/min, Bearing application: 6 high-class ball-bearings  
 Material: screw, side parts total stainless steel  
 Cylinder brass Rest aluminium, stainless steel.  
 Available as a kit £136 or built £140.25  
[www.mamodspares.co.uk](http://www.mamodspares.co.uk)



**2kw WIND TURBINE KIT**

The 2kW wind turbine is supplied as the following kit: turbine generator 48v three taper/ twisted fibreglass blades & hub 8m tower (four x 2m sections) guylines / anchors / tensioners / clamps foundation steel rectifier 2kW inverter heavy-duty pivot tower. £1,499



**HB13 Stirling Engine**

Base measurements: 156 mm x 108 mm x 150 mm, 0,75 kg  
 Base plate: beech Working rpm: 2000 - 2500 rpm/min,  
 Bearing application: 6 high-class ball-bearings Material: screw, side parts total stainless steel Cylinder brass  
 Available as a kit £97.75 or built £101.99



**BENCH PSU 0-15V 0-2a Output**  
 and voltage are both smooth and can be regulated according to work, Input 230V, 2 1/2-number LCD display for voltage and current, Robust PC-grey housing Size 13x15x21cm, Weight 3,2kg £48 REF trans2

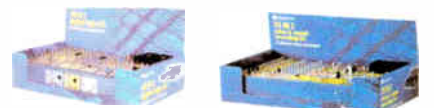

**NEW ELECTRONIC CONSTRUCTION KITS**

This 30 in 1 electronic kit includes an introduction to electrical and electronic technology. It provides components that can be used to make a variety of experiments including Timers and Burglar Alarms. Requires: 3 x AA batteries. £15.00 ref BET1803

**AM/FM Radio** This kit enables you to learn about electronics and also put this knowledge into practice so you can see and hear the effects. Includes manual with explanations about the components and the electronic principles. Req's: 3 x AA batts. £13 ref BET1801

This 40 in 1 electronic kit includes an introduction to electrical and electronic technology. It provides components that can be used in making basic digital logic circuits, then progresses to using Integrated circuits to make and test a variety of digital circuits, including Flip Flops and Counters. Req's: 4 x AA batteries. £17 ref BET1804

The 75 in 1 electronic kit includes an introduction to electrical and electronic technology. It provides components that can be used to make and test a wide variety of experiments including Water Sensors, Logic Circuits and Oscillators. The kit then progresses to the use of an integrated circuit to produce digital voice and sound recording experiments such as Morning Call and Burglar Alarm. Requires: 3 x AA batteries. £20 ref BET1806

[www.slips.co.uk](http://www.slips.co.uk)

**BULL GROUP LTD**  
 UNIT D HENFIELD BUSINESS PARK  
 HENFIELD SUSSEX BN5 9SL  
 TERMS: C/ CARDS, CASH, PO, CHEQUE OR  
 ONLINE ORDERING. PRICES PLUS VAT  
 UK DELIVERY £5.50  
 TEL 0870 7707520 FAX 01273 491813  
[sales@bullnet.co.uk](mailto:sales@bullnet.co.uk)



## Projects and Circuits

- POCKET TENS** by John Clarke  
Pain relief without drugs 12
- FLEXITIMER** by Jim Rowe  
Multipurpose easy-to-programme timer 28
- USB BREAKOUT BOX** by Stan Swan  
Check you are not overloading the USB port 56
- V2 PC SCOPE – PART 2** by John Becker  
A PIC and PC controlled hobbyist oscilloscope 64
- INGENUITY UNLIMITED – sharing your Ideas with others**  
Measuring Colour Temperature 68



## Series and Features

- TECHNO TALK** by Mark Nelson  
Two Cheers For Eco-Lamps 10
- PIC N' MIX** by Mike Hibbett  
Single-wire communication protocol interface for PICs 24
- USING MPLAB – PART 4** by Mike Hibbett  
Relocatable Development 38
- CIRCUIT SURGERY** by Ian Bell  
Linear Voltage Regulators and Capacitors – Part 3 44
- THE POWER OF MECHATRONICS – PART 4** by Darren Wenn  
Adding Speech To Your Application 48
- PRACTICALLY SPEAKING** by Robert Penfold  
The Techniques of Actually Doing It! 60
- NET WORK** by Alan Winstanley  
At Your Service 73



## Regulars and Services

- EDITORIAL** 7
- NEWS** – Barry Fox highlights technology's leading edge  
Plus everyday news from the world of electronics 8
- CD-ROMS FOR ELECTRONICS** 41  
A wide range of CD-ROMs for hobbyists, students and engineers
- BACK ISSUES** Did you miss these? 54
- ELECTRONICS MANUALS** 62  
The *Modern Electronics Manual* and *Electronics Service Manual* on CD-ROM
- SUBSCRIBE TO EPE** and save money 69
- READOUT** John Becker addresses general points arising 70
- PIC PROJECTS** A plethora of PIC projects on CD-ROM 72
- PIC RESOURCES CD-ROM** 74  
EPE PIC Tutorial V2, plus PIC Toolkit Mk3 and a selections of PIC-related articles
- DIRECT BOOK SERVICE** 75  
A wide range of technical books available by mail order, plus more CD-ROMs
- EPE PCB SERVICE** 78  
PCBs for EPE projects
- ADVERTISERS' INDEX** 80

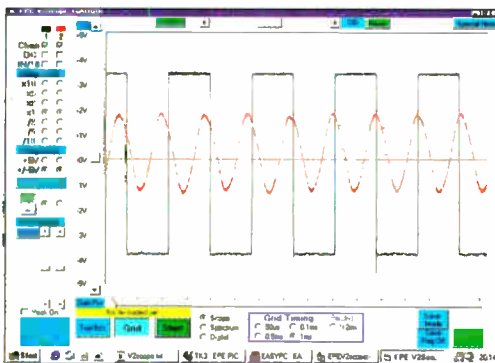

© Wimborne Publishing Ltd 2007. Copyright in all drawings, photographs and articles published in *EVERYDAY PRACTICAL ELECTRONICS* is fully protected, and reproduction or imitations in whole or in part are expressly forbidden.

Our October 2007 issue will be published on Thursday, 13 September 2007, see page 80 for details.

**Readers' Services • Editorial and Advertisement Departments** 7

### PIC & ATMEL Programmers

We have a wide range of low cost PIC and ATMEL Programmers. Complete range and documentation available from our web site.

#### Programmer Accessories:

40-pin Wide ZIF socket (ZIF40W) £14.95

18Vdc Power supply (PSU010) £18.95

Leads: Parallel (LDC136) £3.95 / Serial (LDC441) £3.95 / USB (LDC644) £2.95

#### NEW! USB & Serial Port PIC Programmer



USB/Serial connection. Header cable for ICSP. Free Windows XP software. See website for PICs supported. ZIF Socket and USB lead extra. 18Vdc.

Kit Order Code: 3149KT - £39.95

Assembled Order Code: AS3149 - £49.95

#### NEW! USB 'All-Flash' PIC Programmer



USB PIC programmer for all 'Flash' devices. No external power supply making it truly portable. Supplied with box and Windows XP Software. ZIF Socket and USB lead not incl.

Assembled Order Code: AS3128 - £44.95

Assembled with ZIF socket Order Code: AS3128ZIF - £59.95

#### 'PICALL' ISP PIC Programmer



Will program virtually all 8 to 40 pin serial-mode AND parallel-mode (PIC15C family) PIC microcontrollers. Free Windows software. Blank chip auto detect for super fast bulk programming. Optional ZIF socket.

Assembled Order Code: AS3117 - £24.95

Assembled with ZIF socket Order Code: AS3117ZIF - £39.95

#### ATMEL 89xxxx Programmer



Uses serial port and any standard terminal comms program. 4 LED's display the status. ZIF sockets not included. Supply: 16Vdc.

Kit Order Code: 3123KT - £24.95

Assembled Order Code: AS3123 - £34.95

#### Introduction to PIC Programming



Go from complete beginner to burning a PIC and writing code in no time! Includes 49 page step-by-step PDF Tutorial Manual. Programming Hardware (with LED test section), Win 3.11—XP Programming Software (Program, Read, Verify & Erase), and 1rewritable PIC16F84A that you can use with different code (4 detailed examples provided for you to learn from). PC parallel port.

Kit Order Code: 3081KT - £16.95

Assembled Order Code: AS3081 - £24.95

#### ABC Maxi AVR Development Board



The ABC Maxi is ideal for developing new designs. Open architecture built around an ATMEL AVR AT90S8535 microcontroller. All circuits are embedded within the package and additional add-on expansion modules are available to assist you with project development.

#### Features

8 Kb of In-System Programmable Flash (1000 write/erase cycles) • 512 bytes internal SRAM • 512 bytes EEPROM • 8 analogue inputs (range 0-5V) • 4 Opto-isolated Inputs (I/Os are bi-directional with internal pull-up resistors) • Output buffers can sink 20mA current (direct LED drive) • 4 x 12A open drain MOSFET outputs • RS485 network connector • 2-16 LCD Connector • 3.5mm Speaker Phone Jack • Supply: 9-12Vdc

The ABC Maxi STARTER PACK includes one assembled Maxi Board, parallel and serial cables, and Windows software CD-ROM featuring an Assembler, BASIC compiler and in-system programmer.

Order Code ABCMAXISP - £89.95

The ABC Maxi boards only can also be purchased separately at £69.95 each.

### Controllers & Loggers

Here are just a few of the controller and data acquisition and control units we have. See website for full details. 12Vdc PSU for all units: Order Code PSU445 £8.95

#### Rolling Code 4-Channel UHF Remote



State-of-the-Art. High security. 4 channels. Momentary or latching relay output. Range up to 40m. Up to 15 Tx's can be learnt by one Rx (kit includes one Tx but more available separately). 4 indicator LED's. Rx: PCB 77x85mm, 12Vdc/6mA (standby). Two & Ten Channel versions also available. Kit Order Code: 3180KT - £44.95

Assembled Order Code: AS3180 - £54.95

#### Computer Temperature Data Logger



Serial port 4-channel temperature logger. °C or °F. Continuously logs up to 4 separate sensors located 200m+ from board. Wide range of free software applications for storing/using data. PCB just 45x45mm. Powered by PC. Includes one DS1820 sensor. Kit Order Code: 3145KT - £17.95

Assembled Order Code: AS3145 - £24.95

Additional DS1820 Sensors - £3.95 each

Most items are available in kit form (KT suffix) or pre-assembled and ready for use (AS prefix).

#### 4-Ch DTMF Telephone Relay Switcher



Call your phone number using a DTMF phone from anywhere in the world and remotely turn on/off any of the 4 relays as desired. User settable Security Password. Anti-Tamper, Rings to Answer, Auto Hang-up and Lockout. Includes plastic case. 130 x 110 x 30mm. Power: 12Vdc.

Kit Order Code: 3140KT - £54.95

Assembled Order Code: AS3140 - £69.95

#### 8-Ch Serial Port Isolated I/O Relay Module



Computer controlled 8 channel relay board. 5A mains rated relay outputs and 4 opto-isolated digital inputs (for monitoring switch states, etc). Useful in a variety of control and sensing applications. Programmed via serial port (use our new Windows interface, terminal emulator or batch files). Serial cable can be up to 35m long. Includes plastic case 130x100x30mm. Power: 12Vdc/500mA.

Kit Order Code: 3108KT - £54.95

Assembled Order Code: AS3108 - £64.95

#### Infrared RC 12-Channel Relay Board

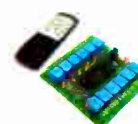

Control 12 onboard relays with included infrared remote control unit. Toggle or momentary. 15m+ range. 112 x 122mm. Supply: 12Vdc/0.5A

Kit Order Code: 3142KT - £47.95

Assembled Order Code: AS3142 - £59.95

#### Audio DTMF Decoder and Display



Detect DTMF tones from tape recorders, receivers, two-way radios, etc using the built-in mic or direct from the phone line. Characters are displayed on a 16 character display as they are received and up to 32 numbers can be displayed by scrolling the display. All data written to the LCD is also sent to a serial output for connection to a computer. Supply: 9-12V DC (Order Code PSU445). Main PCB: 55x95mm. Kit Order Code: 3153KT - £24.95

Assembled Order Code: AS3153 - £34.95

#### Telephone Call Logger



Stores over 2,500 x 11 digit DTMF numbers with time and date. Records all buttons pressed during a call. No need for any connection to computer during operation but logged data can be downloaded into a PC via a serial port and saved to disk. Includes a plastic case 130x100x30mm. Supply: 9-12V DC (Order Code PSU445).

Kit Order Code: 3164KT - £54.95

Assembled Order Code: AS3164 - £69.95

## Hot New Products!

Here are a few of the most recent products added to our range. See website or join our email Newsletter for all the latest news.

### Embedded Engineer's Development Tool (Atmel 89S & AVR)

At last the development tool kit for Atmel 89S & AVR devices that engineers have dreamed of has arrived. The kit includes a Built-in ISP Programmer, Target Section, Interfacing Board, Cables, eBook with codes, e-Learning Software with explanation and CD all in one neat package. Devices covered include 89S51, 89S52, 89S8253, mega8515, mega8535, mega8, mega16 & mega32.

#### Features

Designed for working professionals, students and product development companies. You can connect any device like LCD, 7-Segment, Sensors, Switches to any desired port of the microcontroller. No dedicated connections between microcontroller and the interfacing sections. You can connect anything, anywhere. e-Learning Tutorial and Book are included. Once you start using the kit, you will should never feel the need to attend any trainings because it is simple to use and all concepts are explained in simple language using the tutorial and book. Includes 89S51, 89S52, ATmega8, ATmega16, ATmega32 In-circuit Programmer - no need to buy a separate programmer! No ZIF Sockets. No hassle inserting and removing microcontroller to program. In-circuit programming reduces development time as you do not need to move microcontroller.

#### Contents

- In circuit programmer for 89S and AVR series (supports up to Atmega128)
- 89S51/52 target section
- ATmega8 Target section
- ATmega16/32 Target section
- Switches
- Relays
- LEDs
- 7 Segment Displays
- 16 X 2 LCD
- ADC
- Motor Driver
- RS232
- EEPROM
- Cables
- Connectors
- Serial Port Lead
- e-Learning Software
- e-Datasheets
- HandyProg Programming software
- IDEs for code writing
- Application source code

Assembled Order Code: EEDT - **£89.95**

Most items are available in kit form (KT suffix) or assembled and ready for use (AS prefix).

## Motor Speed Controllers

Here are just a few of our controller and driver modules for AC, DC, Unipolar/Bipolar stepper motors and servo motors. See website for full details.

### DC Motor Speed Controller (100V/7.5A)



Control the speed of almost any common DC motor rated up to 100V/7.5A. Pulse width modulation output for maximum motor torque

at all speeds. Supply: 5-15Vdc. Box supplied. Dimensions (mm): 60Wx100Lx60H. Kit Order Code: 3067KT - **£13.95**

Assembled Order Code: AS3067 - **£21.95**

### PC / Standalone Unipolar Stepper Motor Driver

Drives any 5, 6 or 8-lead unipolar stepper motor rated up to 6 Amps max. Provides speed and direction control. Operates in stand-alone or PC-controlled mode. Up to six 3179 driver boards can be connected to a single parallel port. Supply: 9Vdc. PCB: 80x50mm.

Kit Order Code: 3179KT - **£12.95**

Assembled Order Code: AS3179 - **£19.95**

### Bi-Polar Stepper Motor Driver

Drive any bi-polar stepper motor using externally supplied 5V levels for stepping and direction control. These usually come from software running on a computer.

Supply: 8-30Vdc. PCB: 75x85mm.

Kit Order Code: 3158KT - **£17.95**

Assembled Order Code: AS3158 - **£27.95**

### Bidirectional DC Motor Controller



Controls the speed of most common DC motors (rated up to 32Vdc/10A) in both the forward and reverse direction. The

range of control is from fully OFF to fully ON in both directions. The direction and speed are controlled using a single potentiometer. Screw terminal block for connections.

Kit Order Code: 3166v2KT - **£17.95**

Assembled Order Code: AS3166v2 - **£27.95**

### AC Motor Speed Controller (700W)

Reliable and simple to install project that allows you to adjust the speed of an electric drill or single phase 230V AC motor rated up to 700 Watts.

Simply turn the potentiometer to adjust the motors RPM. PCB: 48x65mm. Not suitable for use with brushless AC motors.

Kit Order Code: 1074KT - **£12.95**

Assembled Order Code: AS1074 - **£18.95**

Box Order Code 2074BX - **£5.95**



**QUASAR**  
electronics  
*Get Plugged In!*

**Credit  
Card  
Sales  
0871  
717  
7168**

## Electronic Project Labs

Great introduction to the world of electronics. Ideal gift for budding electronics expert!

### 500-in-1 Electronic Project Lab

Top of the range. Complete self-contained electronics course. Takes you from beginner to 'A' Level standard and beyond! Contains all the hardware and manuals to assemble 500 projects. You get 3 comprehensive course books (total 368 pages) - *Hardware Entry Course*, *Hardware Advanced Course* and a microprocessor based *Software Programming Course*. Each book has individual circuit explanations, schematic and connection diagrams. Suitable for age 12+.

Order Code EPL500 - **£149.95**

Also available - 30-in-1 **£16.95** 130-in-1 **£39.95** & 300-in-1 **£59.95** (details on website)



## Tools & Test Equipment

We stock an extensive range of soldering tools, test equipment, power supplies, inverters & much more - please visit website to see our full range of products.

### Professional Digital Multimeter (9 Functions inc Temperature)

High quality DMM offering 31 ranges and 9 functions (see table below for full details) and adjustable LCD screen for easy viewing.

Supplied with shrouded test leads, K type temperature probe, shock-proof rubber holster, built-in probe holder & stand.

*Large 36mm digit adjustable LCD display • Auto power OFF • Data hold • Automatic polarity indication • Low battery indication • Audible continuity test • Transistor hFE and diode test*

#### Technical Specifications

DC voltage: 200mV-1000V • AC voltage: 2V-750V • DC current: 20mA-10A • AC current: 20mA-10A • Resistance: 200Ω-200MΩ • Capacitance: 2nF-20uF • Temperature: 0 - 1000°C • Max display: 1999

Order Code: DMM225 - Was **£31.95**

Now on sale at just **£21.95!**



See website for more super deals!



**www.QuasarElectronics.com**

Secure Online Ordering Facilities • Full Product Listing, Descriptions & Photos • Kit Documentation & Software Downloads

# Compact Control Design

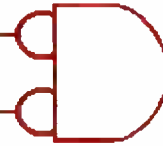

Compact Control Design has a range of off the shelf products designed to meet your control, monitoring and acquisition needs. All products use the latest technology to provide top performance in a small size and at a low cost. We also provide a full hardware and software design service.

### P0701 USB PIC

USB 2.0 interface. Can be bus powered or self powered.  
Powerful PIC18F4580 Microcontroller running at 40MHz. Up to 10MIPS performance.  
All microcontroller I/O pins available except RA6, RA7 (oscillator) and RC6, RC7 (serial port).  
Bootloader pre-programmed and download software included, enabling quick and easy programming of applications.  
No need for a separate programming device.  
Many example applications and firmware available, see Compact Control Design download page.  
Connector has standard 40 pin 0.1" pitch 0.6" wide footprint.  
High quality tuned pin connectors suitable for most IC sockets and prototyping boards.

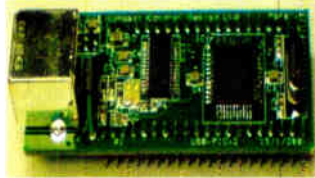

Compatible with Microchip's MPLab 'free of charge' programming environment. Libraries and linker scripts included to support assembler programs (MPLab) and popular compilers.

PRICE:£26.00  
+ VAT

### P0704 Developer Board

The P0704 developer board is an ideal way to get started with our USB-PIC module and motor driver modules. All of the USB-PIC module I/O signals are available through screw terminals making connections to sensors, switches, lamps, relays etc. easy. Ports B & E (11 I/O signals) can also be configured with pull-ups and input filtering suitable for connection to limit switches, home position sensors etc. The board supports up to 4 motor driver modules, each module position accepts either a Stepper motor module or a DC motor module. The board allows bus-powered or self powered operation of the USB-PIC module & includes a P0615 mini regulator so only a single power supply is required for the motor driver modules.

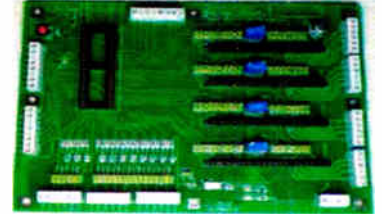

All options are configured using jumpers, and stepper motor drive current can be easily adjusted for each module by variable resistors. All connections are made by high quality screw terminals. The board has been designed to accommodate other driver modules as they become available.

PRICE:£55.00  
+ VAT

### P0613 DC Motor

Pulse width modulation control for DC motors, electro-magnets etc.  
It has a motor supply voltage of 8 to 36V. The maximum drive current is 2.5 Amp.  
There are pulse and direction inputs.  
The PWM control is up to 100KHz.  
Mode input for controlling motor braking and sleep input for power saving.  
There is built in short circuit and over temperature protection, a fault output pin activates if either of these is detected.  
No heat sink is required.  
The board has dimensions of 66x30mm and is 12mm high.  
There is an adapter available providing easy to use screw terminals for all connections. All the control inputs are opto-isolated.

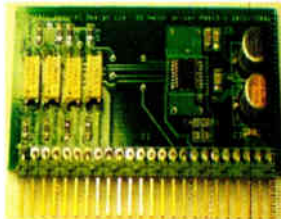

PRICE:£14.00  
+ VAT

### P0612 Stepper Motor Driver

The unit has a motor supply voltage of 5 to 30V. The maximum drive current per phase is 750mA.  
It has current mode control.  
The drive current is controlled with a resistor. It has a selectable step size of full, half, 1/4 + 1/8.  
There is a step frequency of 0 to 200KHz and reset and sleep inputs for initialization and power saving.  
It is a compact size with dimensions of 66x32mm by 12mm high.  
The P0612 does not require a heat sink. There is an adapter available which provides easy to use screw terminals for all connections. All the control inputs are opto-isolated.

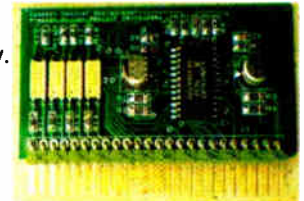

PRICE:£15.00  
+ VAT

### MonCon

MonCon is a product range intended to form the intelligence at the heart of any equipment from bench-top scientific instruments, production equipment, ATE etc. up to large process control systems.  
The MonCon range takes a new approach to monitoring and control by using modules that encapsulate a complete task, such as the stepper motor controller module that includes all inputs and outputs necessary to form a complete stepper motor controller/driver including encoder feedback.  
The general purpose modules, such as the Analogue input board are designed to be customized at minimum cost. We can supply such modules to your requirements at little or no additional cost.  
The MonCon range is based on a collection of modules, each performing specific and well defined tasks. All modules plug into a back plane which provides power distribution, intercommunication and incorporates the necessary connectors linking the MonCon system to the rest of the equipment.  
The modules and backplane connectors have been designed to simplify the interconnection requirements within your equipment.

Most devices, such as stepper motors, sensors etc. are wired to the MonCon backplane directly with no splices or links so the wiring loom is simplified, cheaper to manufacture and more reliable.  
We understand that many manufacturers would want to have full control over critical parts of their products, so we are happy to allow our customers to manufacture under license. The product range currently consists of the following - standard back planes with 4, 6 or 8 slots, controller modules for stepper and DC motors, controller modules for valves and solenoids, pressure control, flow control etc.  
a USB interface to allow connection to a PC etc.  
various I/O modules, Parallel I/O, relay output and Analogue I/O modules.  
The MonCon range has been designed with flexibility in mind. Backplanes and modules to meet your requirements can generally be designed & supplied within 6 weeks of receiving a full specification.

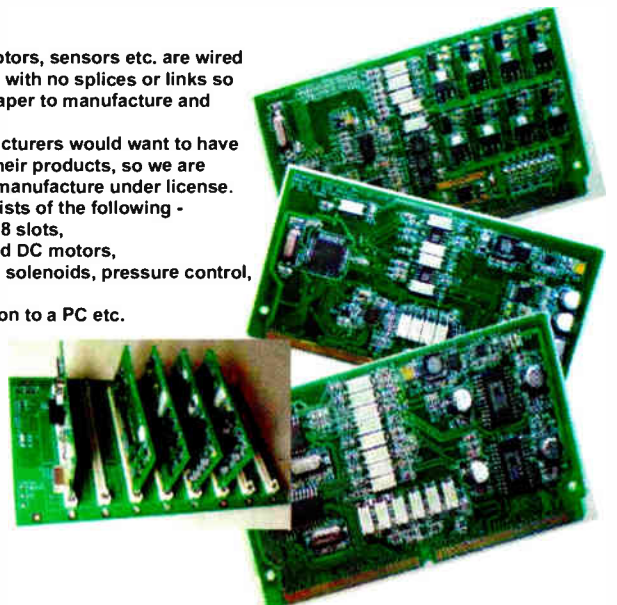

# Embedded Ethernet Solutions

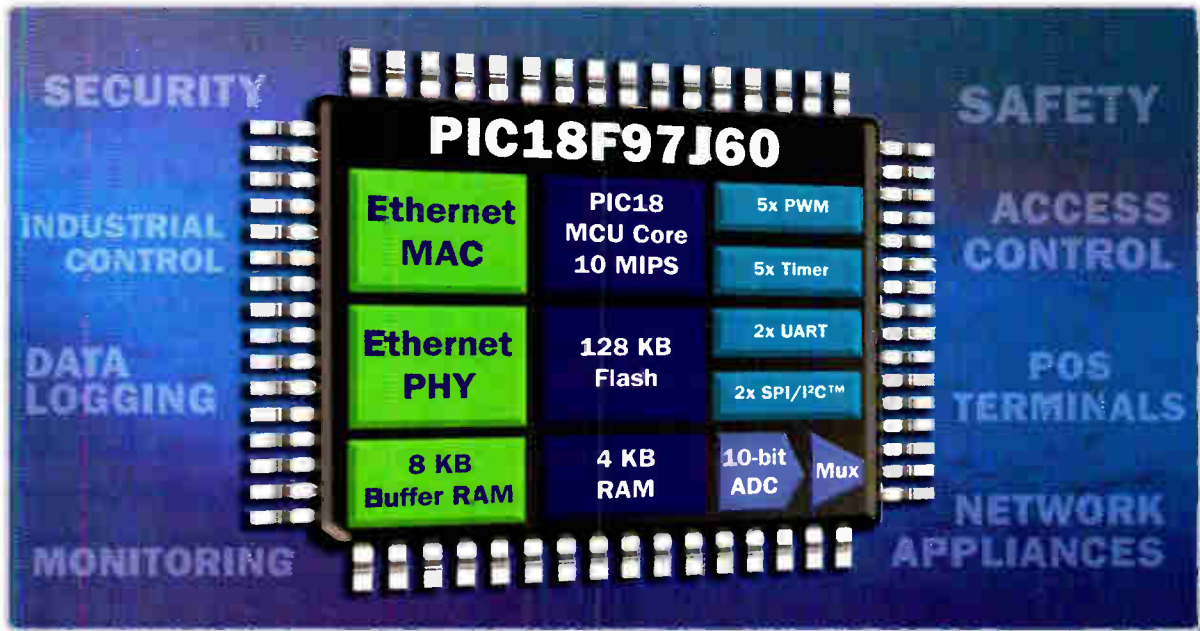

Monitor, control or re-program your application remotely using the integrated Ethernet PIC18F97J60 Microcontroller family and **FREE** TCP/IP software.

## 3 EASY STEPS TO GET STARTED...

1. **Learn about our Ethernet devices in 20 minutes**  
Take advantage of our Ethernet web seminars.
2. **Download our FREE TCP/IP software**  
Our TCP/IP stack is available in source code for flexible and optimized code size.
3. **Check out our low-cost Ethernet tools**  
Evaluate the PIC18F97J60 family with the **PICDEM.net™ 2 Demonstration Board** (DM163C24) at [www.microchipDIRECT.com](http://www.microchipDIRECT.com).

Device	Pins	Flash (KB)	Features
PIC18F97J60	100	128	10-BaseT Ethernet
PIC18F87J60	80	128	12 KB RAM
PIC18F67J60	64	128	(8 KB dedicated Ethernet)
PIC18F96J65	100	96	5x 16-bit timers
PIC18F86J65	80	96	10-bit ADC, 16 channels
PIC18F66J65	64	96	analog comparators
PIC18F96J60	100	64	2 UART with LIN protocol
PIC18F86J60	80	64	2 SPI, 2 I²C™
PIC18F66J60	64	64	Industrial Temperature -40° to +85°C
ENC28J60	28	8K RAM	MAC, PHY, SPI Interface

Or you may consider...

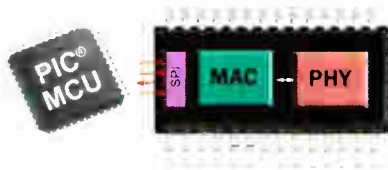

...adding Ethernet to any application with Microchip's ENC28J60 stand-alone Ethernet controller with full software support for PIC18, PIC24 and dsPIC® DSCs.

Visit [www.microchip.com/ethernet](http://www.microchip.com/ethernet) today!

**microchip**  
**DIRECT**  
[www.microchipdirect.com](http://www.microchipdirect.com)

Now  
**Pb-free!**  
RoHS Compliant

**MICROCHIP**  
[www.microchip.com/ethernet](http://www.microchip.com/ethernet)

#### PCB Production - Development

##### 0.1" Copper Stripboard

Size	Tracks/Holes	
25 x 64mm	9T / 25H	£0.24
64 x 95mm	24T / 37H	£0.87
95 x 127mm	36T / 50H	£1.41
95 x 432mm	36T / 170H	£4.39
100 x 100mm	39T / 38H	£1.40
100 x 300mm	39T / 190H	£6.20
119 x 455mm	46T / 179H	£6.40
Stripboard track cutter		£1.99

#### Solderless Breadboard

Tie Points & Size Power Rails

#90	81 x 60mm	2	£2.75
#40	175 x 67mm	2	£4.86
740	175 x 55mm	1	£4.03
c40	175 x 42mm	0	£3.08

Many other sizes available, also jump wires & matrix board.

#### PCB Production - Drafting Materials

##### A4 Artwork Film (per 10 sheets)

Clear Manual Film	£1.20
Clear Laser Film	£1.75
White HQ Laser Film	£4.62

##### Etch Resist Pens

"Dalo" Pen	£3.36
"Sigsaller" Fine Pen	£0.96

##### Etch Resist Transfers

Seno mixed DIL pads	£2.24
Seno mixed Rnd pads	£2.24
Alfac mixed pads	£1.84
Transfer Spatular	£1.25

We carry the full range of Seno & Alfac PCB transfers, see our catalogue for full details.

#### Soldering Irons

We carry in stock a wide range of soldering iron and soldering accessories. Irons from 12 to 100 Watts.

20W 240V Basic	£3.74
35W 240V Ceramic	£7.14
30W 240V Basic	£4.68

#### Desolder Pumps

Basic 165 x 18mm	£2.85
Antistatic 195mm	£3.92
Antex Mini 198mm	£6.02
Antex Pro 210mm	£10.26

#### Soldering Station

A 48W adjustable temperature soldering station with a rotary digital LED Temperature metering, on-off switch, iron holder and tip cleaning sponge. This station features accurate heat sensing for instant compensation & stable temperatures. Adjustable temperature range of 150 - 420°C, Low voltage iron with Silicone cable. Supply: 240V, Iron: 24V 48W

**Model 167-540 £41.66**

#### Soldering Station

A 48W adjustable temperature soldering station with a rotary digital, Digital Temperature indication, on-off switch, iron holder and tip cleaning sponge. This station features accurate heat sensing for instant compensation & stable temperatures. Adjustable temperature range of 150 - 480°C, Low voltage iron with Silicone cable. Supply: 240V, Iron: 24V 48W

**Model 167-570 £55.61**

#### Digital Multimeter

Model: 121-120  
Price: £11.47

A highly featured digital multimeter for professional use. Offers 30 ranges and 8 functions including temperature, capacitance, diode, continuity and hFE measurement. Large 3.5 digit LCD display with automatic polarity indicator. Supplied with shrouded test leads, K type temperature probe and shock proof rubber holster.

#### Technical Specifications

DC voltage	200mV - 1000V ( $\pm 0.5\%$ )
AC volts	2V - 700V ( $\pm 0.8\%$ )
DC current	2mA - 20A ( $\pm 1.2\%$ )
AC current	200mA - 20A ( $\pm 1.8\%$ )
Resistance	200 Ohms - 201A Ohms ( $\pm 0.8\%$ )
Capacitance	2000pF - 20µF ( $\pm 2.5\%$ )
Temperature	0°C - 1000°C ( $\pm 1.5\%$ )
Frequency	20kHz ( $\pm 1\%$ )
Max display	1999
Power supply	9V (PP3 battery)
Dimensions	88 x 173 x 40 mm

#### PCB Production - Processing Equipment

We carry a large range of the photographic & chemical processing equipment for PCB production, a full list with full technical specifications is available in our catalogue or visit our web site.

##### UV Exposure units

2 x 8W Tubes, 6 min timer	
229 x 159mm working area	Model 332-002 £98.75
4 x 15W Tubes, 7 1/2 min timer	
330 x 260mm working area	Model 332-004 £209.48

##### Chemical Processing

Low cost plastic tray £2.30  
Process tanks feature electrically operated pumps and/or heaters with thermostat control, suitable for boards up to 320 x 260mm. Universal Tank with heater Model 333-007 £169.58  
Bubble etch Tank with heater & bubble pump. Model 333-004 £208.48

Any of these items carriage £5.50

#### PCB Production - Tools

##### Drill Bits

HSS parallel shank bits available in sizes from 0.3mm to 2.0mm.

0.3-0.95mm in 0.05mm steps	£0.60ea	£4.00/10
1.0-2.0mm in 0.1mm steps	£0.40ea	£3.60/10

HSS Reduced Shank (2.35mm) bit available in sizes from 0.6mm to 1.7mm in 0.1mm steps £0.84ea £7.60/10

Reground Tungsten carbide reduced shank available in sizes from 0.6 to 1.6mm in 0.1mm steps £1.90

#### Drilling Machines

Expo Reliant 12V drill, 3.8mm capacity, 8400rpm £12.78  
Expo Zircon 12V drill, 3.8mm capacity, 11900rpm £14.20

Minicraft MX1 230V, 8000 - 21000rpm with chuck & collet. Model EPE270-390  
Normal price £48.51

**SPECIAL PRICE £31.02**

#### Servisol Products Aerosols

200ml Switch Cleaner	£2.30
200ml Freezer	£4.39
400ml Foam Cleanser	£2.13
400ml Cleaner / Lubricant	£2.79
75ml Vide Head Cleaner	£1.94
200ml Aero Klene	£3.33
200ml Aero Duster	£5.13
250ml Cold Clean	£3.14
200ml Label remover	£3.52
400ml Isopropyl alcohol	£3.42

##### Tubes

10g Heatsink Compound	£1.66
25g Heatsink Compound	£2.60
50g Silicone grease	£3.16

#### Bench Power Supplies

A range of single output regulated bench power supplies with variable voltage & current limiting. Features: Short circuit and "Foldback" overload protection. Metal case with on/off switch, outputs via Red, Black & Green (Earth) 4mm shrouded sockets.

Model: 461-550	0-30V0-3A	£70.88
Model: 461-552	0-50V 0-3A	£81.00
Model: 461-554	0-30V 0-10A	£135.00

#### Panel Meters

High quality analogue panel meters, class 2, zero point correction, mirror scale and wired for panel illumination. Meter size 46 x 60mm, Cutout size: 38mmØ.

Range	Int Ω	All meters £5.89 each
0-50uA	6k5	6V Lamps £1.23 / pair
0-100uA	1k0	
0-500uA	430Ω	
0-1mA	200Ω	
0-10mA	20Ω	
0-50mA	10Ω	
0-100mA	0.625	
0-1A	60mΩ	
0-3A	20mΩ	
0-5A	12mΩ	
0-15A	4mΩ	
0-10V	10k	
0-15V	15k	
0-30V	30k	
±50uA	1k9	

#### Magnifying Desk Lamp

A high quality scratch resistant magnifying glass fitted to a balanced swivel arm and desk mount. An integral fluorescent tube provides illumination. Magnification: 3x Lens: 120mmØ Tube: 22W Daylight simulation.

**Model: 028-205 £28.80**

#### New The Electronics Shop

Sound & Lighting equipment for the Entertainment Industry

#### PCB Production - Laminates

##### Copper clad - paper

Single sided low cost paper composite board

100 x 160mm Board	£0.54
100 x 220mm Board	£0.62
160 x 233mm Board	£1.02
220 x 233mm Board	£1.40
8" x 12" Board	£1.96

##### Copper clad - glass fibre

Single & Double 1.6mm 305g/m<sup>2</sup>

100 x 160mm Single	£1.06
100 x 220mm Single	£1.49
160 x 233mm Single	£2.29
220 x 233mm Single	£2.88
8" x 12" Single	£3.98
100 x 160mm Double	£1.09
100 x 220mm Double	£1.25
160 x 233mm Double	£2.30
220 x 233mm Double	£2.90
8" x 12" Double	£4.05

##### Photosensitive Coated

1.6mm 35 micron Pre-coated with a high quality photoresist layer. Available in low cost paper composite or Glass fibre, Single & Double sided. Other sizes also available.

Size	Paper Single	Double	Glass Fibre Single	Double
4 x 6"	£1.47	£1.82	£1.8*	£2.17
6 x 12"	£4.20	£5.04	£5.6*	£6.23
8 x 12"	£6.30	£7.70	£8.4*	£9.38
10 x 12"	£8.19	£10.01	£10.7*	£11.83
12 x 12"	£8.26	£10.08	£10.99	£12.25
100 x 160mm			£2.38	£2.66
203 x 114mm			£3.0*	£3.43
220 x 100mm			£3.08	£3.7*
233 x 160mm			£4.83	£5.32
233 x 220mm			£6.83	£7.70

#### PCB Production - Chemicals

100ml Aerosol Photoresist spray, covers 2m <sup>2</sup>	£4.62
500g Powder developer, makes 1l	£1.09
500g Powder developer, makes 10l	£7.08
250g Ferric Chloride Pellets, makes 500ml	£1.68
500g Ferric Chloride Pellets, makes 1l	£3.04
2.5kg Ferric Chloride Pellets, makes 5l	£9.84
1.1kg Clear Fine etch crystals, makes 5l	£17.58
90g Tin Plating Powder, makes 1l	£11.58
200ml Aerosol Flux spray	£3.41
110ml Aerosol PCB Laquer spray	£3.54

#### Tools - Cutters & Strippers

We carry a wide range of specialist tools for the electronics industry including:

##### Side Cutters

130mm Low cost	£1.99
115mm Draper	£2.38
115mm Box Jointed	£4.26
145mm Long reach	£3.40

##### Wire Strippers

130mm Low cost	£2.30
150mm Draper 5mmØ	£5.86

#### Tools - Ratchet Crimping Pliers

High quality ratchet crimping pliers for various terminals including Automotive, Data, Power and Data connections.

Red / Blue / Yellow	£15.80
BNC / TNC RF series	£15.08
RJ11/12 Data Series	£22.32
RJ45 Data Series	£20.43
RJ11/12 & 45 Series	£11.83

##### CK Tools Crimp Pliers

Green/Red/Blue	£24.38
Red/Blue/Yellow	£22.88
0.24-2.5mm <sup>2</sup> crimps	£26.01
0.5-6.0mm <sup>2</sup> crimps	£26.01
Non insulated crimps	£24.38

#### Cable - Ribbon

7/0.127mm Grey ribbon cable on a 0.05" 1.27mm pitch with a red identifying stripe. Supplied by 305mm (1ft) or on full 30.5m (100ft) reels.

Size	per 305mm	per Reel
10 Way	£0.10	£5.80
14 Way	£0.14	£7.50
16 Way	£0.16	£8.58
20 Way	£0.20	£10.72
24 Way	£0.24	£13.94
34 Way	£0.34	£18.22
40 Way	£0.40	£21.44
50 Way	£0.50	£26.80
60 Way	£0.64	£33.92
IDC Crimp tool		£10.60

#### CAT 5e Networking

UTP Cable  
Conforms to CAT5E  
100MHz standard,  
ETA verified TIA/EIA 568-B.2

305m Box	£45.31
50m Reel	£22.28

exc carriage.

##### RJ45 Outlet Kit

Backing Box	
2 Gang Plate	
RJ45 Module	
Blank Module	
Coloured Id inserts	
£2.99ea	£2.42 (10+)

#### Tools

Plastic punch down tool & cable stripper	£1.40
Professional punch down IDC & trim tool	£7.38

##### Outlets

CAT5e Outlet Module	£1.70
1Gang Plate (2 Mods)	£0.50
2Gang Plate (4 Mods)	£0.75
1/2 Module Blank	£0.25
1 Module Blank	£0.35
2 Module Blank	£0.45

Other keystone outlets, switches & accessories available. Patch & Cross-over leads from £0.50

Now available online  
Get the best price on... by

**YAT C.K.** **DRAPER** **JOKARI**

A friend for life

**ESR** ELECTRONIC COMPONENTS  
[www.esr.co.uk](http://www.esr.co.uk)

**Tel: 0191 2514363**  
**Fax: 0191 2522296**  
**sales@esr.co.uk**

Station Road  
Cullercoats  
Tyne & Wear  
NE30 4PQ

Prices Exclude Vat @ 17.5%.  
UK Carriage £2.50 (less than 1kg)  
£5.50 greater than 1kg or >£30  
Cheques / Postal orders payable to  
ESR Electronic Components.

PLEASE ADD CARRIAGE & VAT TO ALL ORDERS



# EPE EVERYDAY PRACTICAL ELECTRONICS

THE UK's No.1 MAGAZINE FOR ELECTRONICS TECHNOLOGY & COMPUTER PROJECTS

## VOL. 36 No. 9 SEPTEMBER 2007

**Editorial Offices:**  
EVERYDAY PRACTICAL ELECTRONICS EDITORIAL  
Wimborne Publishing Ltd., Sequoia House, 398a Ringwood  
Road, Ferndown, Dorset BH22 9AU  
Phone: (01202) 873872. Fax: (01202) 874562.

**Email:** enquiries@epemag.wimborne.co.uk  
**Web Site:** www.epemag.co.uk  
**EPE Online** (downloadable version of EPE): www.epemag.com  
**EPE Online Shop:** www.epemag.wimborne.co.uk/shopdoor.htm  
See notes on **Readers' Technical Enquiries** below – we regret technical enquiries cannot be answered over the telephone.

**Advertisement Offices:**  
EVERYDAY PRACTICAL ELECTRONICS ADVERTISEMENTS  
Sequoia House, 398a Ringwood Road, Ferndown, Dorset BH22 9AU  
Phone: 01202 873872 Fax: 01202 874562  
**Email:** stewart.kearn@wimborne.co.uk

### Blown away!

Never before have I seen an encapsulated module on a PC board blown apart with the plastic melted. The photo below shows the result of a minor explosion on the network card in one of our office computers; the computer and network card are a few years old. One fairly quiet morning in the office the peace was rudely interrupted by a loud 'pop' and smoke rising from the computer, which was still working!

It appears that a tiny encapsulated electrolytic capacitor inside the module had exploded for no apparent reason, blowing the module apart. Once the board was replaced everything was back to normal. I've seen distorted and leaking electrolytic capacitors before, but to see so much damage from such a small component is worrying. Just imagine the mess if it had been a large smoothing capacitor in the PSU!

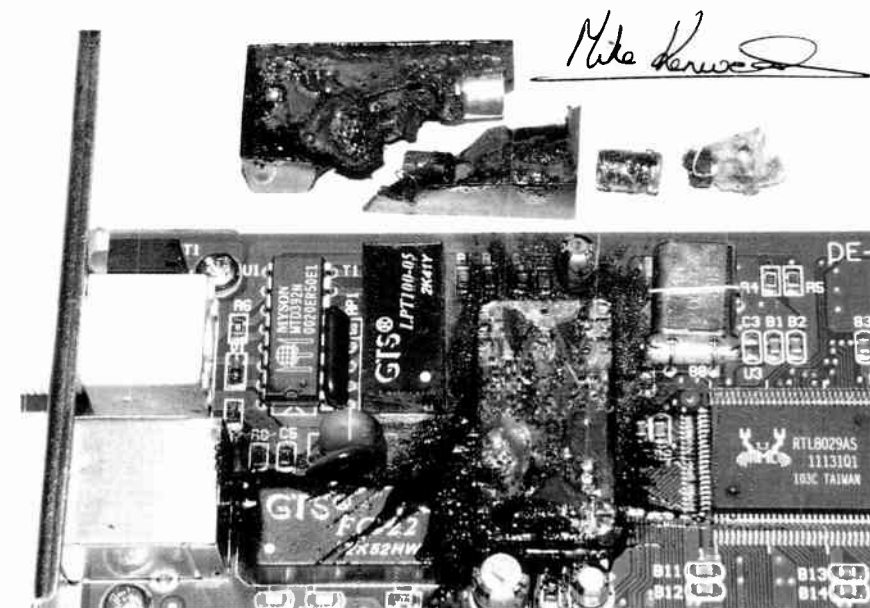

### AVAILABILITY

Copies of *EPE* are available on subscription anywhere in the world (see opposite) and from all UK newsagents (distributed by SEYMOUR). *EPE* can also be purchased from retail magazine outlets around the world. An Internet on-line version can be purchased and downloaded for just \$18.99US (approx £9.50) per year, available from [www.epemag.com](http://www.epemag.com)

### SUBSCRIPTIONS

Subscriptions for delivery direct to any address in the UK: 6 months £18.75, 12 months £35.50, two years £66; Overseas: 6 months £21.75 standard air service or £30.75 express airmail, 12 months £41.50 standard air service or £59.50 express airmail, 24 months £78 standard air service or £114 express airmail. To subscribe from the USA or Canada call Express Mag toll free on 1877-363-1310

Online subscriptions, for downloading the magazine via the Internet, \$15.99US (approx £9.00) for one year available from [www.epemag.com](http://www.epemag.com).

Cheques or bank drafts (in £ sterling only) payable to *Everyday Practical Electronics* and sent to EPE Subs. Dept., Wimborne Publishing Ltd, Sequoia House, 398a Ringwood Road, Ferndown, Dorset BH22 9AU. Tel: 01202 873872. Fax: 01202 874562. Email: subs@epemag.wimborne.co.uk. Also via the **Web** at: <http://www.epemag.wimborne.co.uk>. Subscriptions start with the next available issue. We accept MasterCard, Amex, Diners Club, Maestro or Visa. (For past issues see the *Back Issues* page.)

### BINDERS

Binders to hold one volume (12 issues) are available from the above address. These are finished in blue PVC., printed with the magazine logo in gold on the spine. Price £7.95 plus £3.50 p&p (for overseas readers the postage is £6.00 to everywhere except Australia and Papua New Guinea which cost £10.50). *Normally sent within seven days, but please allow 28 days for delivery – more for overseas.*

*Payment in £ sterling only please. Visa, Amex, Diners Club, Maestro and MasterCard accepted. Send, fax or phone your card number, card expiry date and card security code (the last 3 digits on or just under the signature strip), with your name, address etc. Or order on our secure server via our UK web site. Overseas customers – your credit card will be charged by the card provider in your local currency at the existing exchange rate.*

**Editor:** MIKE KENWARD

**Consulting Editors:** DAVID BARRINGTON  
JOHN BECKER

**Business Manager:** DAVID J. LEAVER

**Subscriptions:** MARILYN GOLDBERG

**General Manager:** FAY KEARN

**Editorial/Admin:** (01202) 873872

**Advertising Manager:**

STEWART KEARN (01202) 873872

**On-line Editor:** ALAN WINSTANLEY

**EPE Online** (Internet version) **Editors:**

CLIVE (MAX) MAXFIELD and ALVIN BROWN

### READERS' TECHNICAL ENQUIRIES

**E-mail:** techdept@epemag.wimborne.co.uk  
We are unable to offer any advice on the use, purchase, repair or modification of commercial equipment or the incorporation or modification of designs published in the magazine. We regret that we cannot provide data or answer queries on articles or projects that are more than five years' old. Letters requiring a personal reply *must* be accompanied by a stamped self-addressed envelope or a self-addressed envelope and international reply coupons. We are not able to answer technical queries on the phone.

### PROJECTS AND CIRCUITS

All reasonable precautions are taken to ensure that the advice and data given to readers is reliable. We cannot, however, guarantee it and we cannot accept legal responsibility for it. A number of projects and circuits published in *EPE* employ voltages that can be lethal. **You should not build, test, modify or renovate any item of mains-powered equipment unless you fully understand the safety aspects involved and you use an RCD adaptor.**

### COMPONENT SUPPLIES

**We do not supply electronic components or kits for building the projects featured, these can be supplied by advertisers.**  
**We advise readers to check that all parts are still available before commencing any project in a back-dated issue.**

### ADVERTISEMENTS

Although the proprietors and staff of *EVERYDAY PRACTICAL ELECTRONICS* take reasonable precautions to protect the interests of readers by ensuring as far as practicable that advertisements are *bona fide*, the magazine and its publishers cannot give any undertakings in respect of statements or claims made by advertisers, whether these advertisements are printed as part of the magazine, or in inserts.

The Publishers regret that under no circumstances will the magazine accept liability for non-receipt of goods ordered, or for late delivery, or for faults in manufacture.

### TRANSMITTERS/BUGS/TELEPHONE EQUIPMENT

We advise readers that certain items of radio transmitting and telephone equipment which may be advertised in our pages cannot be legally used in the UK. Readers should check the law before buying any transmitting or telephone equipment, as a fine, confiscation of equipment and/or imprisonment can result from illegal use or ownership. The laws vary from country to country; readers should check local laws.



## Is Copy Protection Dying?

Copy protection may be on its way out with so many ways to defeat it. Barry Fox reports.

The music industry likes to sell online because if customers download instead of buying CDs, the record companies save the cost of pressing, packaging and shipping CDs. The success of online selling, largely due to Apple's iTunes, is already putting some record shops out of business.

Two music companies, Linn and EMI, have now abandoned the use of Digital Rights Management and copy protection on the tracks and albums which they sell electronically. Steve Jobs has said he would like to see DRM scrapped on all music sold through iTunes. DRM gets in the way of legitimate enjoyment, makes safety backing-up difficult, and does nothing to stop anyone copying music if they really want to – if necessary by the simple trick of taking the analogue output of a music player and re-recording it digitally.

Increased broadband speeds and the more powerful compression offered by MPEG-4 could let Hollywood offer online sales as an alternative to DVD. But the studios do not yet have a clear policy on how to attract customers and whether to use DRM and copy protection.

Services so far trialled have been flakey and stopped short of offering the key incentive – movies to buy online as soon as they are released for rental or purchase on

DVD. LoveFilm worked with AOL on a low key trial which has since sunk without trace. When tested, it refused to sell a movie to a UK AOL subscriber, on a UK phone line, claiming the purchaser was not in the UK!

At the *Driving Digital Content* conference, held in London recently by Understanding and Solutions, Marc Gareton of Warner Bros announced that Warner is getting more serious about Electronic Sell Through. Warner will trial a 'Day and Date' service in Scandinavia and Belgium this August. Movies will be put on line on the same day that they are released on DVD and Pay TV. People who pay to download the movie can burn it to a blank DVD.

"The rental window has collapsed" said Gareton. "Consumers want movies on line". John Newman, Head of Sonic Solutions/Roxio in Europe, described the QFlix system which home PCs will use to burn copy-protected downloads: "CSS is very important for the download business: it's essential for future revenue". Wayne Borg, of Universal, called Download to Burn, or Electronic Sell Through "an alternative to piracy".

Unfortunately, the CSS copy protection system used for DVDs has been hacked to

shreds and DeCSS software, which lets people copy DVDs digitally, is freely available on the web. Howard Kiedaisch of Arts Alliance (the company behind LoveFilm) told how he also sells copy-protected movie files which can be used on portable players like the Archos. "The Archos is a cool device" he enthused.

Unfortunately, devices like the Archos – and from US company Neuros – are now designed to take the analogue output from a ordinary DVD player and make a digital copy to hard disc or memory card for portable viewing. So no special download file need be purchased. Likewise, there is nothing to stop someone taking the analogue monitor feed from a PC while it's playing a DRM-protected download, and copying it to digital disc. There is no Macrovision copy-protection on the monitor signal.

When asked whether they were aware of all this, the panel of experts at the conference looked surprised. After going into a huddle they agreed a comment that: "We need copy protection and DRM for damage limitation". From the audience, David Tarrington of Universal's Technical Origination added: "Your argument is correct but you are looking at it the wrong way". He did not explain what the correct way of looking was, though.

## Microchip Lighting Centre

Microchip has announced an online Lighting Applications Design Centre at [www.microchip.com/lighting](http://www.microchip.com/lighting). This comprehensive website provides a wide range of technical tools and resources that designers can use to add intelligence to lighting designs – including information relating to Microchip's PIC microcontrollers, dsPIC Digital Signal Controllers (DSCs), analogue and memory products, as well as development tools.

New lighting technologies, such as LEDs, dimmable fluorescent ballasts and High Intensity Discharge (HID) lamp ballasts, demand increased performance with greater energy efficiency. The flexibility of Microchip's low-cost digital, analogue and memory products enables designers to easily add intelligence to lighting applications. Benefits include energy savings, prolonged product life, improved safety and light quality, reduced component counts, remote control and diagnostic capabilities, and the ability to easily adapt existing lighting designs.

For more information, visit Microchip's website at [www.microchip.com/lighting](http://www.microchip.com/lighting).

## Picoscope Programming Interface

Pico Technology have just launched an Application Programming Interface for the PicoScope 5000 series scopes to allow you to write your own software for the devices. This series forms Pico's top-performing scopes, with the world's fastest real-time sampling rate for a USB PC scope of 1Gs/s. This, together with a probe-tip bandwidth of 250MHz, makes

them ideal for use with high-speed analogue and digital signals. The scope's huge memory buffer – either 32M or 128M samples depending on the version – ensures that the high sampling rate can be used on a wide range of time-bases without losing detail.

Browse [www.picotech.com](http://www.picotech.com) or phone +44 (0) 1480 396 395 for more details.



## PIC Toothpick

RF Solutions has announced the availability of its Toothpick 2.0 transceiver, a module combining a PIC and LinkMatik (Bluetooth 2.0) radio which is preloaded with Toothpick Services firmware, providing FlexiPanel user interface server, wireless field programming and Toothpick Slave for optional external host control.

Pre-tested firmware solutions available for the Toothpick transceiver enable immediate standalone operation, providing a low-cost and simplified solution. The range of firmware solutions includes DARC-ITM data acquisition and remote control managed via Bluetooth, DARC-IITM data acquisition and remote control with FlexiPanel user interface; Toothpick Slave where Toothpick is controlled by a host processor via a serial link; and Standalone Toothpick programmable in C for low-cost, customized standalone operation.

More information on potential applications is available on the RF Solutions website at [www.rfsolutions.co.uk](http://www.rfsolutions.co.uk).

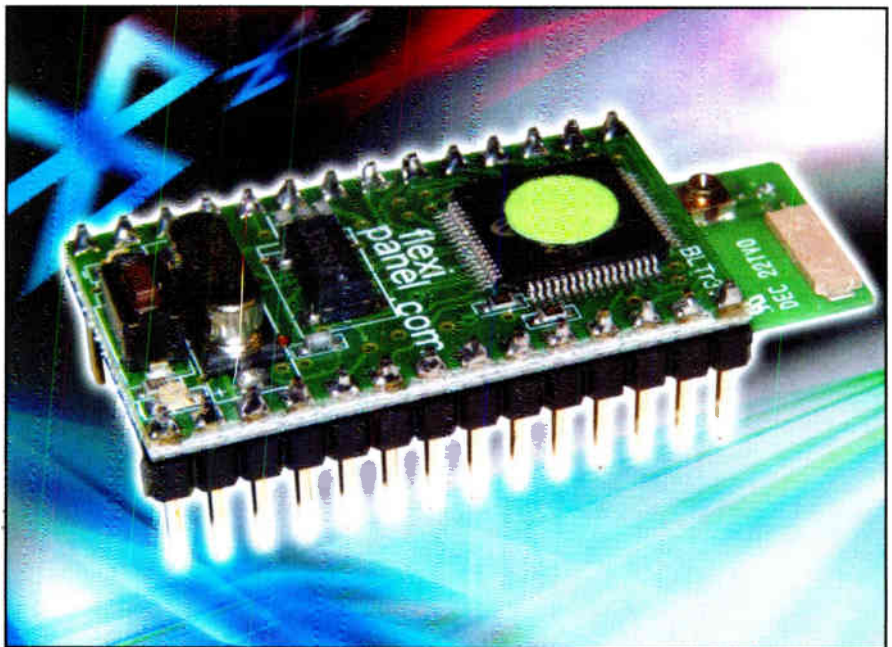

## USB Device for Embedded Micros

Computer Solutions are now supplying the Micro Digital range of USB drivers – smxUSBD USB Device stack, smxUSBH USB Host stack and smxOTG On the Go stack for dual role devices – all of which will help embedded systems developers by providing easy interfacing between embedded systems and USB.

The smxUSBD USB device stack is designed for situations which require the embedded application to plug into, and exchange data with, a PC. The smxUSBH USB host stack is used in situations where an embedded application needs to act like a PC and control a USB network. This allows the embedded device to use a USB keyboard or mouse, to collect data from an array of USB sensors or to allow a memory stick (Thumb Drive) to be read or written by the embedded application.

For more general information, browse the main web site at [www.computersolutions.co.uk](http://www.computersolutions.co.uk). Also, if you are still grappling with USB terminology you may find the tutorial USB for Embedded Engineers of use, visit:

[www.computer-solutions.co.uk/info/Embedded\\_tutorials/usb\\_tutorial.htm](http://www.computer-solutions.co.uk/info/Embedded_tutorials/usb_tutorial.htm)

## Churchill Fellowships 2008

Often believing you can change your community is not enough. The difference between an ideal and a worthwhile idea is the possibility to make it happen in reality. Travelling to another country and gaining a better understanding of different cultures is an enriching experience, but with a Winston Churchill Travelling Fellowship, it gives you the 'chance of a lifetime'.

The Winston Churchill Memorial Trust offers British citizens the possibility to undertake projects overseas related to their trade, craft or profession. Any British citizen is eligible to apply, no matter their age, background or educational qualification. Applicants are required to demonstrate that their ideas will add value to the community in the UK on their return.

Anything you can do to make this opportunity more widely known will help more people to turn their ambition into reality. Whether it's a project that relates to your occupation or something of personal interest that can help your community – the Winston Churchill Memorial Trust can give you the funding to embark on the journey of a lifetime.

Some of the 2008 categories are: Science and Technology; Adventure; Exploration and Leaders of Expeditions; Young People (applicants must be under 25 on 31st December 2008); Animal Welfare; Recruitment and Use of Volunteers in the Community; Training and Retention of Teachers; Making a Living in the Countryside; Craft Workers and Teachers involved in the Built Environment; One award in the field of History.

Applications close on 16th October 2007. To find out more, visit [www.wcmt.org.uk](http://www.wcmt.org.uk) or call 020 7584 9315.

## Peak Electronic Moves

Peak Electronic Design Limited, makers of the Atlas range of test instruments, have moved. They are now located in the centre of Buxton, in the heart of the Peak District and within easy reach of many key northern cities. Their new offices are situated in a technology-centred building, with plenty of space for even more innovative design and manufacture.

Widening their services to their customers, Peak would like to formally announce their expanded in-house design service. Peak's Managing Director, Jeremy Siddons, adds: "This move will really enhance our company and the services it offers. In addition to exciting new product developments, we are now offering our proven expertise to a wider audience. We've always offered a comprehensive design service, providing a high quality and innovative electronic design service to companies and individuals, but now we are delighted that the move will enable us to offer our expertise to a larger client base."

Email, web, telephone and fax details remain unchanged. The postal address has

changed, although any mail to the old address will be automatically routed to the new premises. New contact details: Peak Electronic Design Ltd., West Road House, Dept EPE, West Road, Buxton, Derbyshire SK17 6HF.

Tel: 01298 70012. Fax: 01298 70046. Email: [sales@peakelec.co.uk](mailto:sales@peakelec.co.uk). Web: [www.peakelec.co.uk](http://www.peakelec.co.uk).

## Quasar UK Hybrid Transmitter and Receiver

Quasar UK (a subsidiary of RF Solutions and not Quasar Electronics Ltd. of Bishops Stortford) has launched new FM hybrid transmitter and FM-RX1 receiver modules. The new devices are ideal for applications ranging from car security systems to remote sensing and data capture.

The transmitter module provides a complete RF transmitter which can be used to transmit data at up to 4.8Kbps from any standard CMOS/TTL source. The TX module is simple to operate and offers low current consumption (15mA typ). The RX module provides a complete radio receiver which can be used to receive un-decoded data from the FM transmitter modules. It incorporates a PLL that helps ensure precise local oscillator generation. It also offers low power consumption, resulting in extended battery life.

All Quasar UK transmitters and receivers are compatible with one another and provide a complete wireless solution. The modules produce a CMOS/TTL output, and only require connections for power and to an antenna. Data can be fed directly into a microprocessor or decoding device, keeping the component count down and ensuring a low hardware cost.

In addition to its new FM transmitter and receiver modules, Quasar UK also offers a range of compact AM transmitter and receiver modules. A choice of other general purpose radio remote control systems and USB powered GPS receivers are also available.

Further information from RF Solutions, Unit 21, Cliffe Industrial Estate, South Street Lewes, East Sussex BN8 6JL. Tel: 01273 898000. Fax: 01273 480661. Web: [www.rfsolutions.co.uk](http://www.rfsolutions.co.uk). Email: [sales@rfsolutions.co.uk](mailto:sales@rfsolutions.co.uk)

## Two Cheers For Eco-Lamps

**Low-energy light bulbs are a key weapon in the battle for saving money, power and fossil fuels. So it's mighty unfortunate that they employ the wrong technology, even worse that the right technology is currently too dear to use. But this may change before long, as Mark Nelson explains.**

**E**COLOGISTS urge us constantly to change all our traditional lamp bulbs to the (fairly) new low-energy variety. The message is reinforced by government propaganda and bolstered by special offers by power companies. And now the supermarkets have dropped the retail price of these bulbs to a couple of pounds apiece.

The arguments are overwhelming, resistance is futile. And to bayonet cap it all (or screw you completely if you live in countries where the Edison-type fitting reigns supreme), the European Commission is proposing to phase out incandescent bulbs by 2009.

You may well wonder what the fuss is about. Energy-saving bulbs consume far less electricity and last much longer than conventional ones. Their now only slightly higher purchase price is soon offset by the lower running cost, so why on earth should anyone balk against genuine progress?

### Ecological nightmare

As so often happens, the facts are not as simple as they are presented and the progress is of the two steps forward, one step backwards kind. Today's version of low-energy lighting, using compact fluorescent lights (CFLs), uses the wrong technology. CFL products may be cheap to buy but their low purchase price obscures some severe ecological problems. They have a number of practical disadvantages too. They are simply the wrong solution and sadly the right solution is just too expensive. What a conundrum!

Let's examine the facts in greater detail. The traditional electric lamp bulb has been a practical proposition since British inventor Joseph Swan patented a workable design in 1878. A year later, the American Edison obtained a patent for a design that he had developed independently and they later merged their intellectual property interests. Incandescent bulbs are relatively simple and cheap to make, especially as by volume the main ingredient is nothing (if a vacuum bulb) or nitrogen (for gas-filled bulbs). The life of these bulbs tends to be short but long-life ones are made. They do, to be fair, consume five times the power of CFL bulbs.

CFL bulbs have been around for 25 years or so, the early ones being substantially bulkier, heavier and slower to reach full brightness than those of today. They have a typical life span of between 6,000 and 15,000 hours, against the 750 to 1,000 hours of incandescent lamps. That said, the energy used in manufacturing CFL bulbs is significantly higher than for incandescent lamps, meaning that their lifetime energy cost (from manufacture to disposal) may actually be higher.

### Hazardous waste

The manufacturing process is more complex: the (small) mercury content of CFL bulbs makes them technically hazardous waste and thus banned from standard domestic waste disposal systems. There is concern that this mercury will lead to air and water pollution when disposed with other household waste in landfill sites or incinerator plants. Responsible manufacturers are now limiting the amount of mercury used.

The technical disadvantages of CFL lamps are not so great as to rule out their use but are worth noting. Their light output generally drops during long-term use; the effect is gradual. Many CFL bulbs take between 30 seconds and four minutes to reach full brightness, which could be a disadvantage for safety lighting. At low temperatures they are slow to start or may even fail to operate (light output drops at low temperatures). Lamp life is reduced when CFLs are switched on and off frequently.

Standard CFL bulbs do not work with existing dimmer switches and they will not fit all styles of luminaire (that's the posh word for light fitting!). They need good air flow around them and will suffer a rapid and painful death if they are allowed to overheat in shades profiled like a bluebell or tulip flower. In reflective mirror fittings they cannot provide the attractive 'twinkly' effect that clear bulbs do and then there's the awful pallid light they produce in that weird pinkish or peach colour. The reason for this is because CFLs produce light in a narrow frequency range, whereas normal bulbs put out the full spectrum of light colours, albeit not in equal amounts of all of them. No wonder some people dislike low-energy bulbs with uncharacteristic vehemence.

Even German Chancellor Angela Merkel, who chaired the summit that announced the EU's initiative in March, admitted to misgivings. "Most of the light bulbs in my flat are energy-saving bulbs. They're not yet quite bright enough. When I'm looking for something I've dropped on the carpet, I have a bit of a problem", she said.

### Interim technology

It's little wonder that the more enlightened technologists recognise CFLs as no more than an interim solution. Just as oranges are not the only fruit, CFLs are not the only low-energy lamp. So is there more eco-friendly light at the end of the tunnel? There is, but it may be a longer tunnel than we might like.

The future is SSL – solid-state lighting. The potential rewards are high: LED-based

lights are stated to use only half the power that CFLs require or between 8 to 10 per cent of the figure that filament bulbs guzzle. They could (rather than can) be made to last 15 years, producing a broad-spectrum light comparable to natural sunlight. Other advantages include reduced heat generation as well as greater resistance to shock, vibration and wear. All of these increase the lifespan of solid-state lighting significantly.

So are producers interested? Too right they are! Companies all over the world are investigating means of making SSL cost-effective and attractive for domestic use. Even in Britain, the government has demonstrated commitment and in June awarded a three-year contract worth £3 million from the UK government to a consortium of Filtronic, Forge Europa, QinetiQ, Thomas Swan and Cambridge University for developing a route to low cost LEDs for solid-state lighting. In the same month Europe's biggest LED lighting test establishment opened in the UK. Titled the 'Solid State Lighting Research Centre', it opened for business at the Aston Science Park in Birmingham. As well as offering its LED test lab to industrial customers, it is also taking on funded research.

### Truly competitive

The Centre's head of business development, Dr Geoff Archenhold, recently told a conference: "If all domestic 60W light bulbs were replaced with LED-based light sources, the amount of electricity used in residential lighting today could be reduced by up to 80 per cent – the equivalent of eliminating the need for approximately two nuclear power stations.

Energy production for all types of illumination around the world creates over 900 million tons of CO<sub>2</sub> gas and represents 19 per cent of all electrical energy used worldwide. We estimate that this figure could be reduced by 300 million tons if LEDs were used for all general lighting purposes."

For this to happen the cost of LEDs will, of course, have to fall significantly to become truly competitive against existing light sources, but it happened with CFLs. How long will it take with LEDs?

### Further Facts:

<http://ban-the-bulb.blogspot.com/>

[http://en.wikipedia.org/wiki/Incandescent\\_lamp](http://en.wikipedia.org/wiki/Incandescent_lamp)

[http://en.wikipedia.org/wiki/Compact\\_fluorescent\\_light\\_bulb](http://en.wikipedia.org/wiki/Compact_fluorescent_light_bulb)

[http://en.wikipedia.org/wiki/Solid-state\\_lighting](http://en.wikipedia.org/wiki/Solid-state_lighting)

## Batteries



Zinc Chloride, Alkaline, NiMH, NiCD & Sealed Lead Acid batteries. We carry battery packs for racing & radio control. We also manufacture the NiCD Bot-Pack+, a high performance custom made pack with forced cooling options for the most demanding applications.

### Sample pricing:

- GP AA Greencell £0.79 / pk4
- GP AA Greencell £0.13 / cell in trade boxes of 320 (ideal for schools)
- GP AA Ultra Alkaline £1.20 / pk4
- GP AA NiMH 1300mAh £3.95 / pk4
- Racing packs from £11.95
- 12V 2.2Ah to 44Ah SLA from £6.99

## Power Supplies / Chargers



13.8V 20A power supply with Amps display £43.87

Power supplies fixed and variable voltage to 15V 40A. Chargers for NiCD, NiMH, LiPo & SLA batteries to 12V 20A.



### Sample pricing:

- GP AA charger with 2 off 1300mAh cells £5.45
- 13.8V 20A Power Supply from £34.12

## Motors

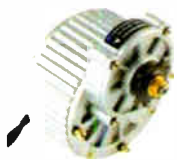

Probably the best range of DC model motors in the UK. From under 0.5W to 1000W, 1.5 to 36V. Gearing motors from 0.3W to 800W. Ideal for most model engineering applications especially robotics. Planetary geared motors from just 1.2g to our top of the range 750W (that's 1HP) weighing in at 6.35kg.



As well as motors, we have wheels, axles & bearings to help complete your project.



### Sample pricing:

- Visit our website to see over 140 models of motor
- 12V 150W Motor £17.95
  - Geared motors from £4.70
  - 750W 36V geared motors from £90.95

Visit our website to see over 2,000 products to order on-line. Need advice?, we offer full technical support via our FAQ forum.

Technobots Ltd  
The Old Grain Store  
Rear of 62 Rumbridge Street  
Totton, Hampshire, SO40 9DS  
Tel: 023 8086 3120 Fax 023 8086 1534  
Lines open Mon - Thur 0900 to 1330

# Technobots.co.uk

## Robotics, Models and Technology Supplies

Established in 2001, Technobots Ltd supply a wide range of electronics and engineering products to the hobby market, schools, Colleges & Universities.

## Motor Speed Controllers



DC motor speed controllers from 1A to 300A. Various interfacing options including RC, I2C, serial &

analogue voltage. Relay reversing and fully solid state H-bridge, single and dual channel variants.



### Sample pricing:

- Dual 1A motor controller £17.09
- 10A motor controller kits from £19.87
- 75A controllers from £87.50

## Radio Control



A wide range of radio control products including transmitters, receivers, servos, gyros, crystals, interfaces, leads etc.

### Sample pricing:

- 4-Channel 40MHz FM transmitter / receiver / crystals from £34.95

## Microcontrollers



The 'PICAXE' range of programmable microcontrollers. Write in BASIC or Flowchart and download straight into the microcontroller, so no expensive programmers are required. The 8 pin version provides 5 i/o pins (1 analogue input). The 18 pin version provides 8 outputs and 5 inputs (3 of the inputs have analogue capabilities). The 28-pin version provides 9-17 outputs, 0-12 inputs and 0-4 separate analogue inputs.

### Sample pricing:

- 8 pin starter kit including software, lead, battery holder, PCB & components for £9.94
- 28 pin version pictured above £21.74

## Robot Kits

We carry a wide range of robot kits from BEAM to full combat and includes the very popular Robonova biped walker. Kits range in price from £16.95 to £689.05 built by enthusiasts & school pupils from all over the UK. Many are programmable via a PC, RC or autonomous. Full details of these and lots more can be found on our website.



## Mechanical & Hardware



We carry a wide range of mechanical products many of which are hard to find elsewhere. Bearings from 1mm to 30mm bore. Plastic and steel pulleys, plastic and

steel gears from MOD 0.5 to MOD 2.0. Steel chain sprockets in 6 & 8mm, 3/8" & 1/2" pitch. Silver steel, EN24T steel, collets & shaft couplings. Nuts and

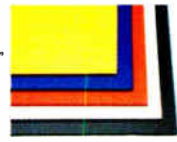

bolts from M2 to M12, springs, clips & Pins. Wide range of engineering materials including aluminium (6082 T6 to 12mm thick), brass tube, rod, sheet etc..

Polycarbonate sheet from 1mm to 12mm thick, PVC sheet, polymorph etc.. Wheels from 9mm to 250mm diameter.

## Featured Product



We believe this to be the lowest retail priced 4-channel 40MHz FM radio control set in the UK. The set includes the transmitter, receiver and crystal pair from just £34.95. Upgrade options available.



### Sample pricing:

- Transmitter, receiver and xtals £34.95
- As above but with a set of 8 AA batteries £35.95
- or with a set of 8 AA rechargeable batteries £41.49
- Add a fast charger for an additional £11.46

## Electrical

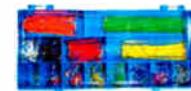

Glass, automotive and maxi fuses from 1A to 100A, fuse holders, cable from 0.5mm<sup>2</sup> to 16mm<sup>2</sup>.

Pre-stripped wire kits for breadboards. Connectors from 5A to 300A, wide range of crimp connectors bagged in 100's or in kits. Circuit breakers from 3A to 30A. Cable ties, tie bases, spiral wrap and heatshrink (1.2 to 101.6mm diameter).



## All prices include VAT



Whilst we are an internet based company, we do have a shop where visitors are very welcome to browse.

Please check our website for opening hours and if making a long journey, we suggest phoning first to ensure stock availability. If ordering on-line, 90% of orders dispatched within 2 working days.

PayPal



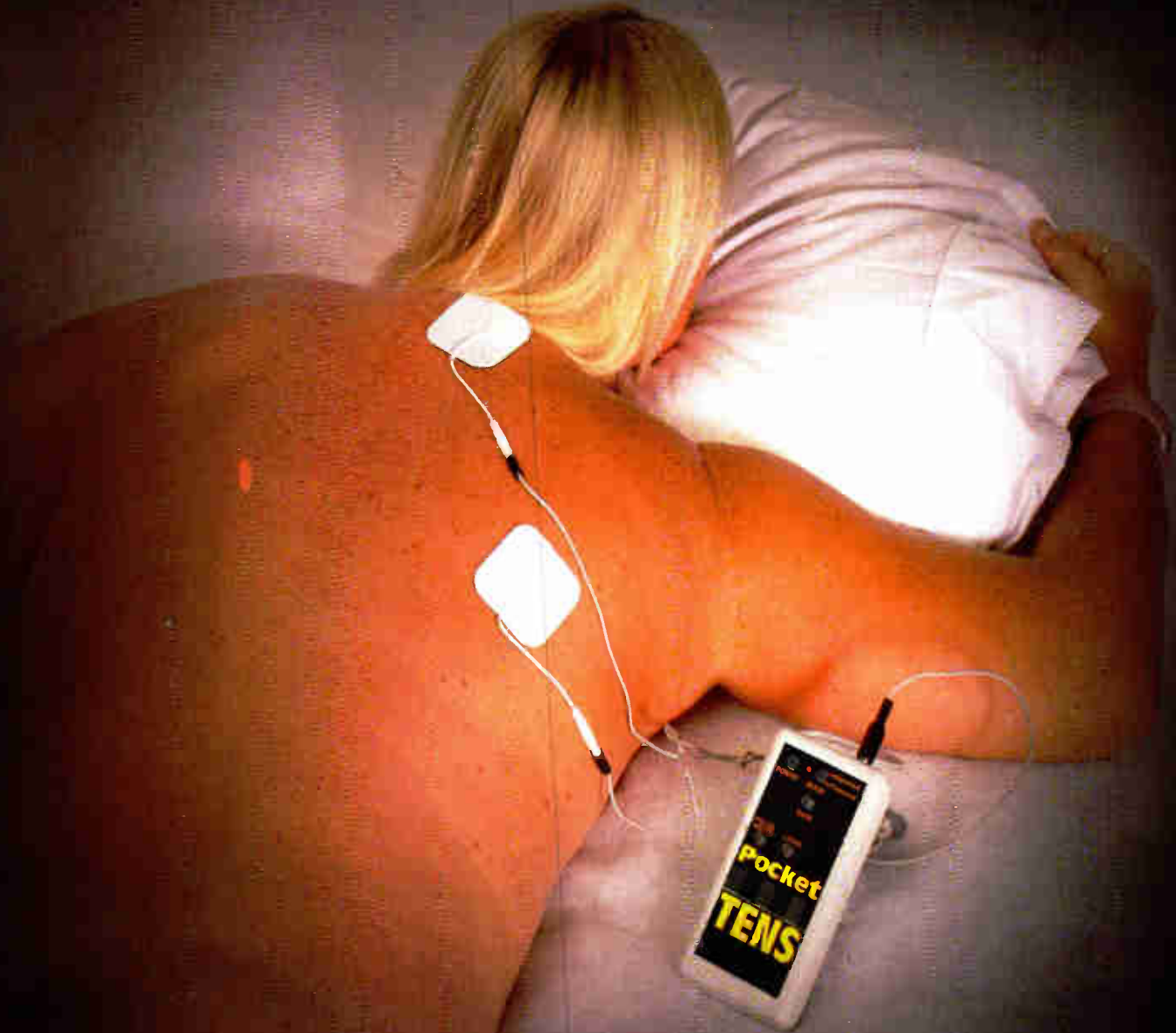

# Pocket TENS

By John Clarke

**TENS – Transcutaneous Electrical Nerve Stimulation – is pain relief without drugs. Attach electrodes near to the painful area and start up the TENS unit for a tingling sensation that can help to reduce pain. This pocket-sized TENS unit has adjustable controls that tailor the level to suit each patient's requirement and is battery powered.**

- Features**
- Battery powered
  - Adjustable voltage level
  - Adjustable pulse rate
  - Adjustable pulse width
  - Intermittent or continuous output

**L**IVING IN CONSTANT PAIN is a reality for many people and how well they cope with it depends on the degree of pain and the character of the person.

While pain relief can be managed in the short term using analgesics, their long-term use can be detrimental to the user's health. Side effects of prolonged analgesics use include liver and kidney damage and in some cases irritation to the lining of the stomach. Thankfully, in many cases there is an alternative: TENS or Transcutaneous Electrical Nerve Stimulation.

In many cases where pain is constant, a medical practitioner or physiotherapist may recommend the use of a TENS unit.

These are not a gimmick or a new-age form of treatment. Tests have shown that TENS is an effective and safe way to manage chronic and acute pain with virtually no side effects. Chronic pain conditions that can be alleviated with TENS include, arthritis, lumbago, neck and back pain, post herpetic neuralgia and sciatica. Acute pain conditions such as fractures, muscular pains, post-operative pain and tennis elbow can also be managed with a TENS unit.

### Warning!

**This TENS unit (or any other similar device) must not be used on a person who has a Heart Pacemaker.**

**Do not connect the electrodes to the body so that there can be a flow of current through the heart.**

**Electrodes must not be placed on the neck, since this can stimulate nerves which control breathing and blood pressure.**

**Do not use the TENS unit for headaches or attach the electrodes to the head.**

**Do not be tempted to run the TENS unit from a mains adaptor, plugpack or power supply. This could be dangerous if a breakdown occurs in the isolating transformer. If you want to reduce the cost of battery replacement, we suggest using a 9V NiMH rechargeable battery.**

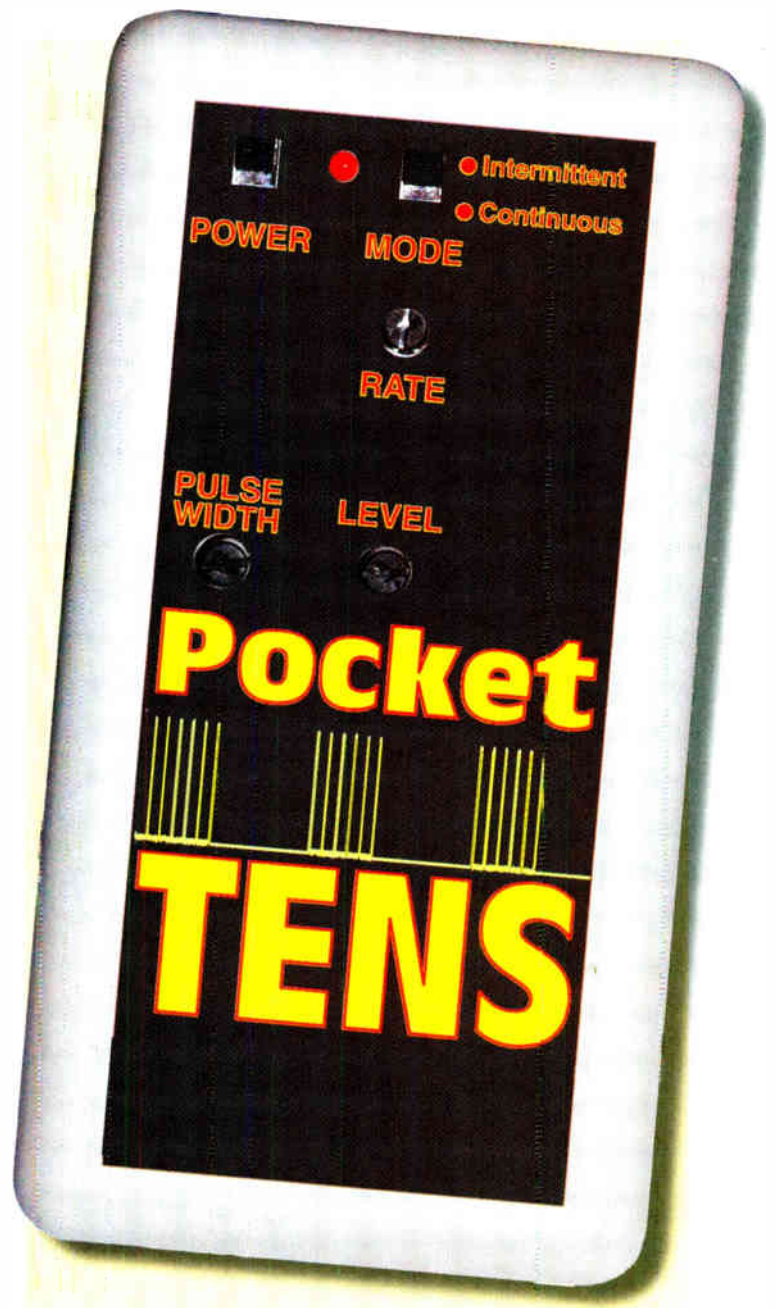

# Constructional Project

A TENS unit provides electrical stimulation of the painful area using electrodes attached to the skin. It can cause a tingling sensation in the area where the pads are attached. How the TENS reduces pain is unknown. Some suggest that the nerves are stopped from sending signals to the brain and thus the pain is removed. Alternatively, the stimulation could induce the body to produce natural pain relieving substances called endorphins.

Whatever the reason, a TENS unit can give pain relief for many people, with minimal side effects. It does not provide a cure for the underlying cause of the pain but has the major benefit that the amount of pain killing drugs can be substantially reduced.

Nor is it addictive. Sometimes there can be skin irritation surrounding the electrodes and this can be reduced or alleviated by changing the type of electrode.

**Note that a TENS unit must not be used if you have a heart pacemaker. Also, a TENS unit should not be used if the cause of the pain has not been established or if you are pregnant. When using the TENS unit do not attach the electrodes anywhere around the front of the neck, and be sure the TENS unit is kept out of reach of children. It should be treated like any other medicine, by storing it in a childproof cabinet.**

## Features

EPE previously featured a TENS unit in the March 1997 issue. This new version uses a different circuit. Three small knobs allow adjustment of the overall output voltage, the width of the voltage pulses and the pulse rate. A continuous/intermittent switch selects whether the pulses are provided as a continuous stream or in short bursts. To the left of that is a power switch and an LED to indicate when the unit is on. Two electrodes connect to the TENS unit via a lead that plugs into a socket at the top end of the box. The electrodes are attached to the skin adjacent to the painful area and the controls are adjusted until the tingling effect becomes just a little uncomfortable. The tingling sensation will tend to decrease over the period of treatment and so the controls will need to be further increased as time goes by. The typical treatment period is about 20 minutes.

Generally, the continuous setting is selected but for long treatment periods, the intermittent mode can be used. This mode helps to overcome the effect where the patient becomes accustomed to the stimulation. The intermittent mode allows a higher voltage and a faster rate to be selected compared to the continuous mode.

Thus, the stimulation is greater in short bursts and because there is a break between pulses, the patient does not adapt too readily to the higher levels.

## Block diagram

The block diagram for the TENS unit is shown in Fig.1. The 9V battery supply is stepped up by the converter comprising IC1 and T1. This provides a DC output from 12V to 80V, with VR1 providing the adjustment. The resulting DC voltage is converted to a pulsed signal using switching

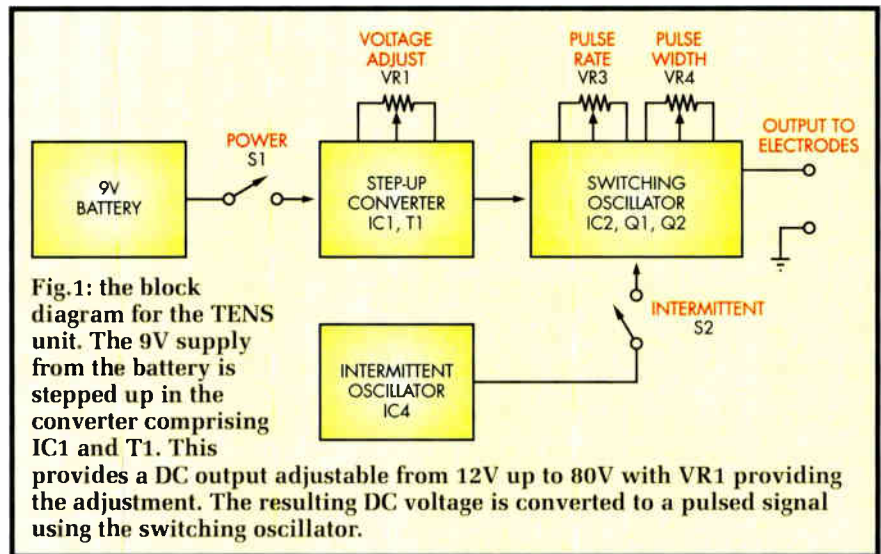

oscillator IC2. Oscillator IC4 is switched into circuit via S2 to gate the switching oscillator, giving short bursts of pulsed signal.

Fig.2 shows how the basic step-up converter circuit operates. It comprises inductor L1 which is energised from the V+ supply through transistor Q1. The energising current is shown as I1. When the transistor is switched off, the stored energy in L1 is dumped via diode D1 into capacitor C1.

The actual voltage across C1 depends on the amount of energy in L1 and the load current between V<sub>OUT</sub> and the ground supply. We can maintain a constant V<sub>OUT</sub> for a variety of loads by controlling the amount of time Q1 is switched on.

Fig.3 shows the circuit of the switching oscillator, comprising IC2, Q1 and Q2. This modulates the output voltage of the step-up converter and is based on an IR2155 made by International Rectifier Corporation. It is described as a high-side self-oscillating power MOSFET gate driver.

Resistor R1 and capacitor C1 at pins 2 and 3 of IC2 set the rate at which MOSFETs Q1 and Q2 are alternately turned on and off. There is a dead time of 1.2μs between each device switching off and the other switching on. This prevents the supply from being short circuited at the switchover period when one MOSFET turns off and the other turns on.

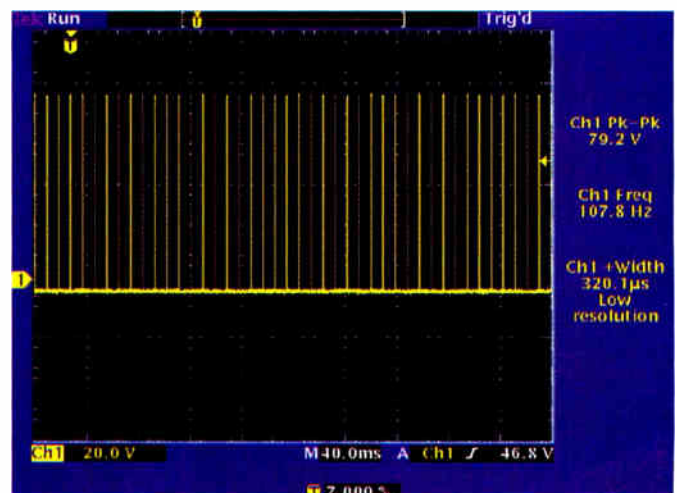

This shows the pulse train signal at the electrodes. Here the voltage is set at 80V and the frequency at 108Hz.



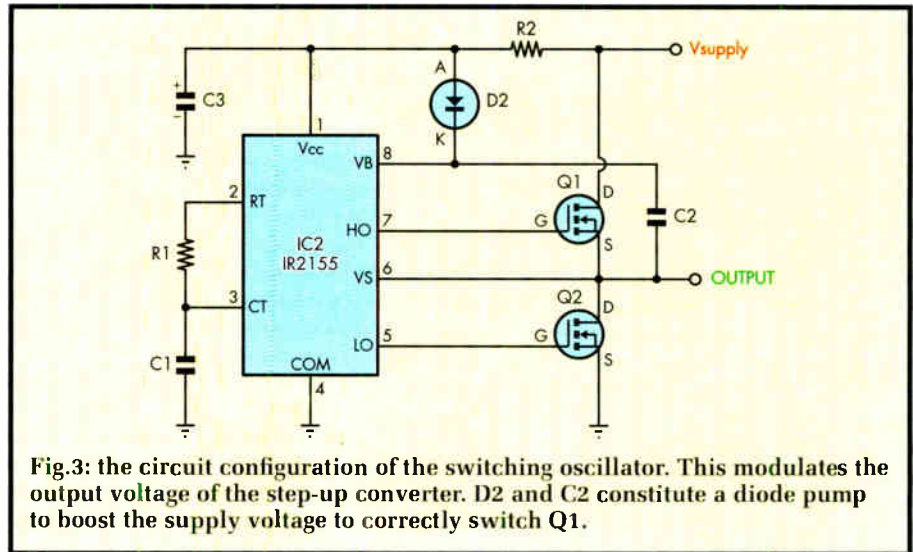
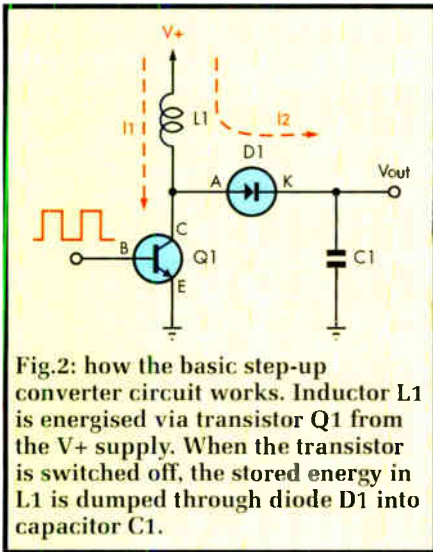

## Diode pump

Note that the supply voltage for IC2 is around 10V, while the voltage to be switched can be up to 80V. The gate voltage for Q1 must be raised above its drain by several volts in order for it to be able to switch the 80V supply. This extra voltage is derived using a diode pump consisting of diode D2 and capacitor C2.

Initially, the supply to pin 1 of IC2 is set at about 10V by an external Zener diode. When MOSFET Q2 is switched on, capacitor C2 charges to the 10V supply via D2. When Q2 is turned off, pin 7 is connected internally to pin 8 to switch on Q1. Q1 then pulls pin 6 up to  $V_{supply}$  and pin 8 is level-shifted to  $V_{supply}$  plus the voltage across C2. So in a few switching cycles, the circuit automatically shifts pin 8 and thereby the gate voltage to MOSFET Q1, to whatever the driving voltage needs to be.

## Circuit details

The full circuit diagram for the TENS unit is shown in Fig.4. Power from the 9V battery comes via switch S1 and diode D6. D6 is included for reverse polarity protection but because we are running from batteries, we have specified a Schottky diode to minimise voltage losses.

IC1 is the switchmode controller. It has a switching transistor at pin 1 and a feedback input at pin 5. Its frequency of oscillation is set by the 2.2nF capacitor at pin 3. The peak current through the primary winding of T1 is limited by the 0.22Ω resistor between pins 6 and 7 of IC1. In operation, the current through the primary winding of T1 is switched off when the voltage drop across the 0.22Ω resistor exceeds about 300mV.

Switching off the current through T1 causes a voltage to be induced into T1's secondary when the primary field collapses. This charges two 470nF capacitors via diode D1. Voltage feedback from the 150kΩ resistor, VR1 and VR2 into pin 5 maintains the voltage at the desired setting up to 80V.

The circuit uses a transformer instead of a step-up inductor, as depicted in Fig.2. This is included to prevent high voltages occurring at pin 1 of IC1, where the maximum allowable voltage is 40V. Since we want up to 80V, the 2.59:1 step-up ratio between primary and secondary of T1 will ensure that the pin 1 voltage will be less than 40V. The primary winding can be used to provide a 10V supply for IC2 and IC4.

This supply is derived in two steps. First, diode D3 charges the associated 4.7µF capacitor. The voltage across

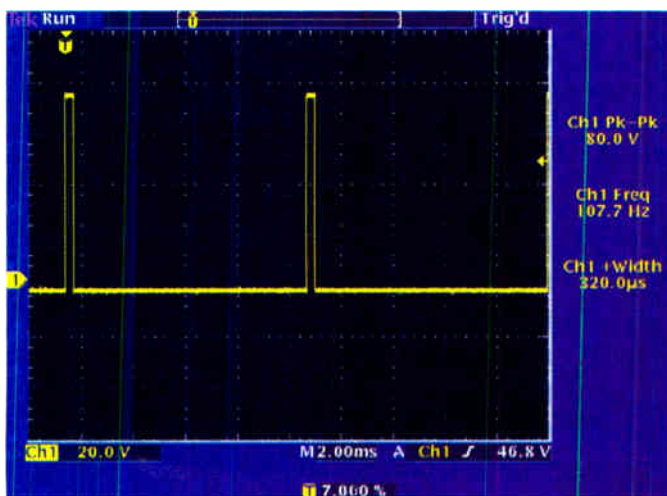

Here are the pulses shown with a faster timebase. It shows the width of each pulse at about 320µs.

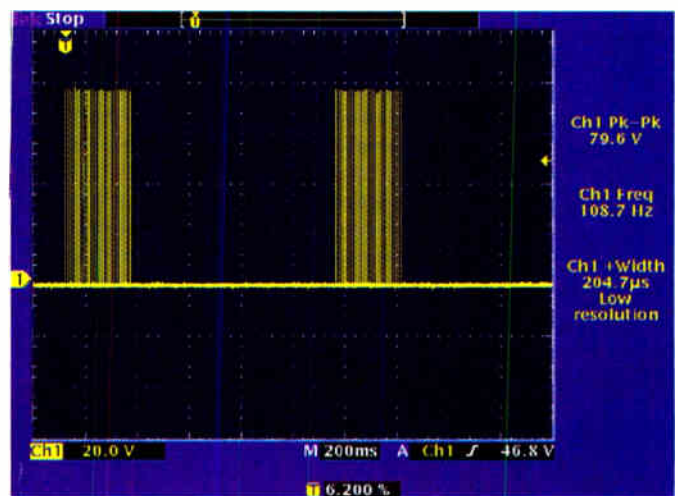

Finally, this is the intermittent pulse output showing the bursts of pulses at about 1.2Hz.

# Constructional Project

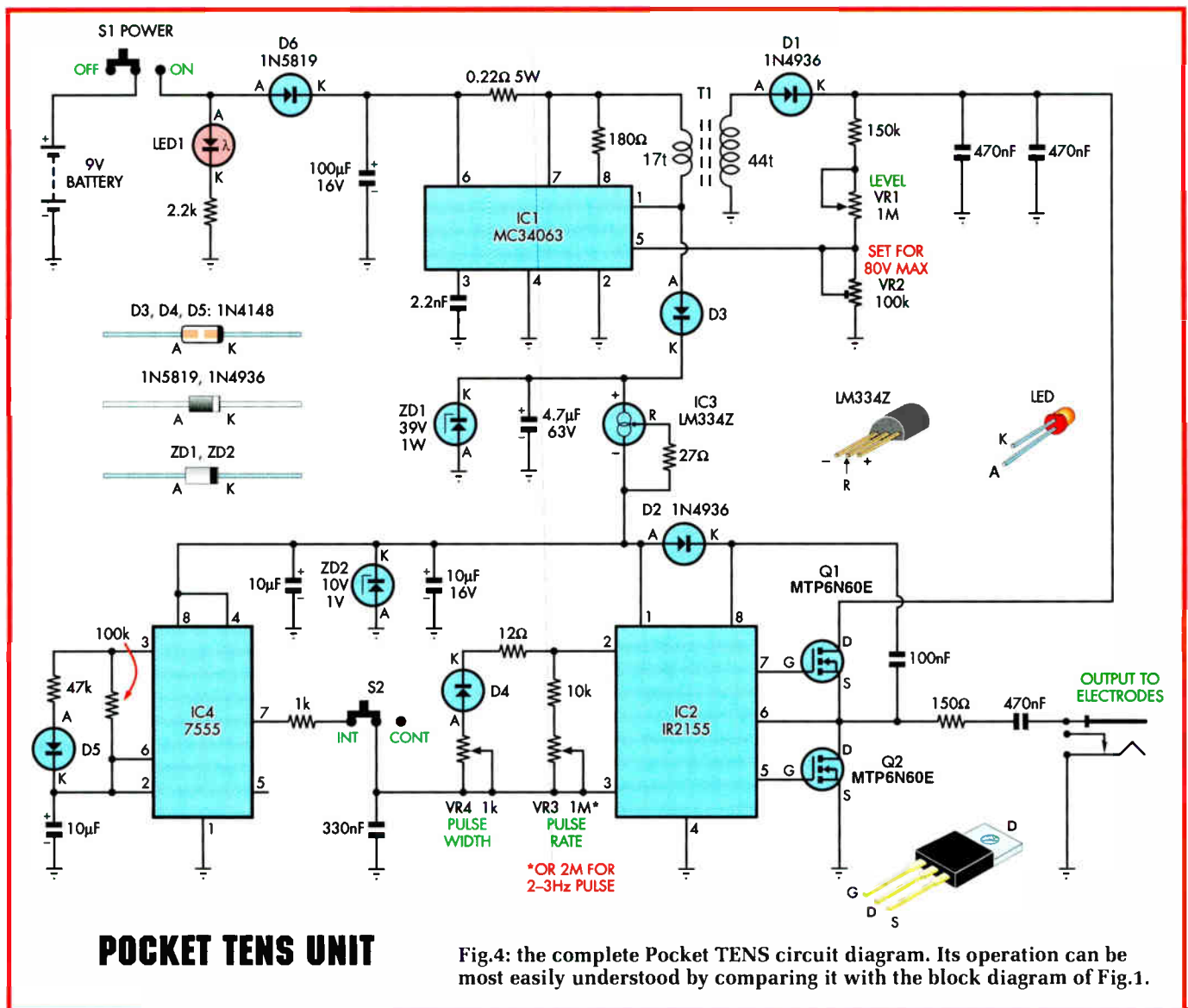

it is limited to +39V by Zener diode ZD1. Diode D3 also clamps the maximum voltage at pin 1 of IC1 to one diode drop above 39V.

IC2's power is then derived via an LM334Z constant current source, IC3.

The 27Ω resistor between the R and V – pins of IC3 sets

the constant current to about 2mA. The current source supplies a 10V Zener diode (ZD2) that regulates the supply voltage to 10V. This supply also powers IC4.

Note that we need to derive the supply for IC2 in this way because the 9V directly from the battery is just not enough for satisfactory operation. This is because IC2 has an internal

voltage shutdown that operates at below 8.4V. IC2 will therefore not operate when its supply drops to this level.

If we were powering this IC directly from batteries, we would need at least 8.6V from the battery to ensure operation if we include the drop across D6.

This would give an extremely short operation time with a 9V battery. By contrast, using the power supply system described above, the battery can be used down to at least 7.2V and in most cases down to 4V.

Q1 and Q2 are high voltage MOSFETs and are used to switch the high voltage on and off to produce the requisite output

## Specifications

Output Voltage .....	Adjustable from 12V to 80V
Pulse Rate .....	Adjustable from 4.6Hz to 410Hz
Pulse Width .....	Adjustable from between 70 and 320μs
Intermittent .....	24% duty cycle at 1.2Hz (220ms pulse burst with an 800ms off period)
Battery Drain .....	Typically less than 20mA (31mA at 80V output, 19mA at 50V output)
Battery .....	9V Alkaline (or a 9V NiMH rechargeable)
Battery Voltage .....	7.2V minimum for a 12V to 80V output range, 4V minimum for a 22V to 80V output range.

Fig.5: the PC board component overlay with same-size photo at right. Note how the 10 $\mu$ F capacitor (between VR3 and IC2) is laid parallel to the PC board.

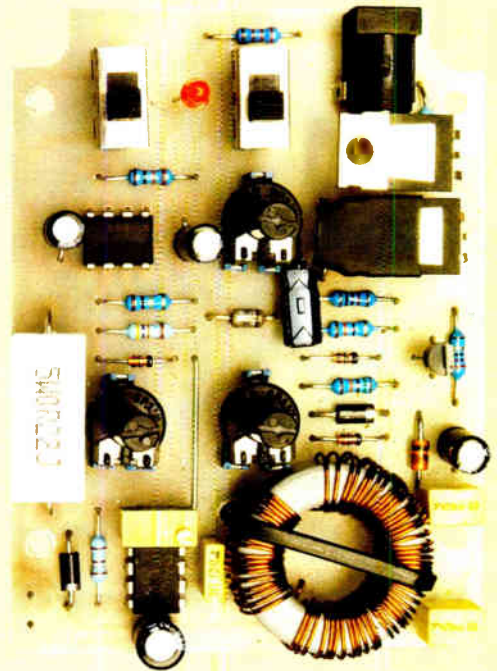
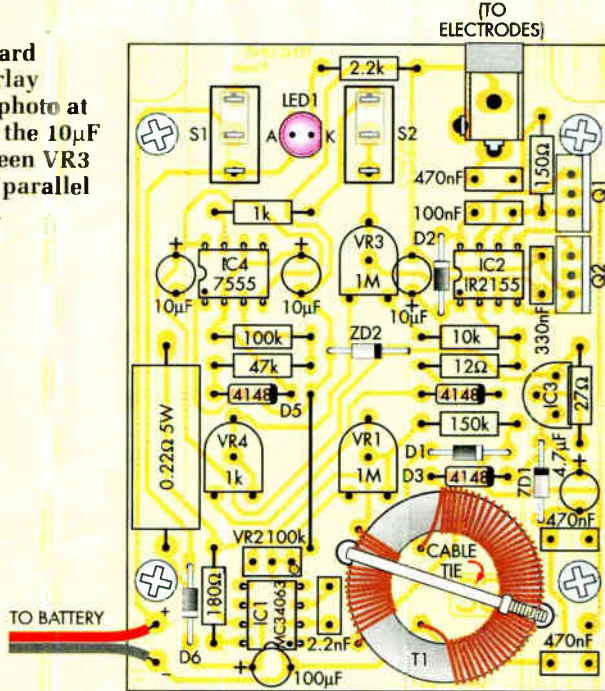

pulses on the electrodes. Q1 and Q2 constitute a 'totem pole' output stage with Q1 turning on to charge the 470nF output capacitor via the series 150 $\Omega$  resistor and the load resistance (which in this case is the patient). Each time Q1 turns off, Q2 turn turns on to discharge the capacitor via the series 150 $\Omega$  resistor. The amount of time Q1 is switched on determines the pulse width of the voltage output. Q2's on time controls the pulse rate (ie, the frequency).

In more detail, Q2 is switched on for the time set by the 330nF capacitor at pin 3 and the resistance between pins 3 and 2 of IC2. VR3 adjusts this time between about 0.22 and 2.4ms, giving a pulse rate between 4.6Hz and 410Hz.

Q1 is switched on for the time duration set by potentiometer VR4, the series 12 $\Omega$  resistor and diode D4. The pulse width ranges between 70 $\mu$ s and 320 $\mu$ s.

## Intermittent mode

IC4 is a 7555 CMOS timer configured to provide the intermittent mode. It operates as a free running oscillator. The output at pin 3 is used to charge the 10 $\mu$ F capacitor at pins 2 and 6 via the 47k $\Omega$  resistor and diode D5 and discharge it via the parallel 100k $\Omega$  resistor. This gives a

pulse waveform at pin 3 with an uneven duty cycle, with the pulses being high for 0.22s and low for 0.7 seconds.

We don't use the pin 3 output to modulate IC2. Instead, we use the capacitor discharge output at pin 7. This pin 7 output is an open drain MOSFET which is open circuit when pin 3 is high and conducts signals to ground when pin 3 is low.

Each time pin 7 of IC4 pulls low, it discharges the 330nF capacitor at pin 3 of IC2 to stop IC2 from oscillating. This prevents any output to the electrodes and provides an intermittent modulation for the electrode output.

## Construction

The TENS unit is built onto a PC board coded 635 and measures 85 x 64mm. It is housed in a plastic case measuring 134 x 69 x 23mm. An adhesive plastic label measuring 49 x 113mm can be fitted to the lid of the case.

Three trimpots are used as controls instead of potentiometers. They provide us with suitably sized components for the small box. 10mm long spindles are inserted into each trimpot to allow adjustment and these protrude through the front panel of the box. Note that the trimpots

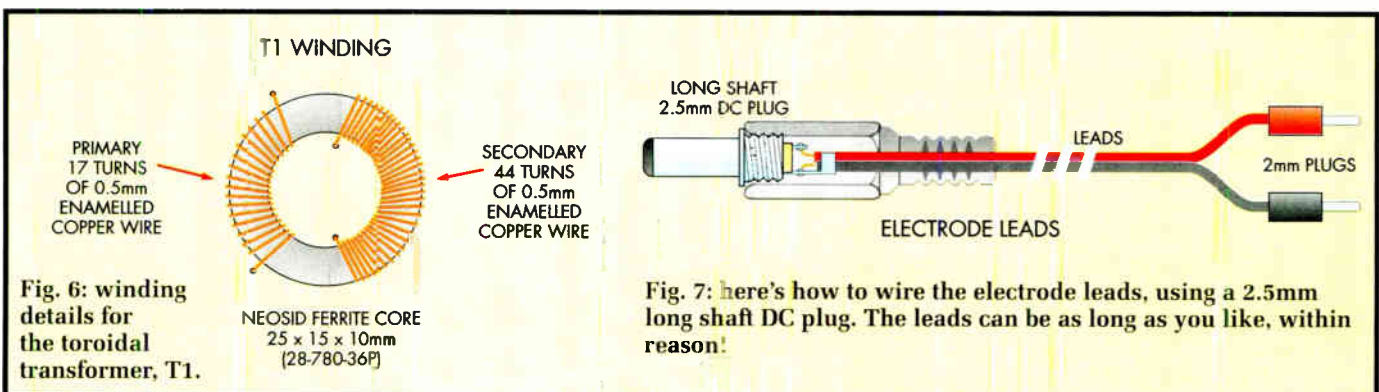

Fig. 6: winding details for the toroidal transformer, T1.

Fig. 7: here's how to wire the electrode leads, using a 2.5mm long shaft DC plug. The leads can be as long as you like, within reason!

## Constructional Project

specified are long-life components suitable for potentiometer use.

All components must be placed so that they sit no more than 13mm above the top surface of the PC board. This means that one electrolytic capacitor is mounted on its side and the two

MOSFETs (Q1 and Q2) are bent over at right angles. In contrast, the switches must be raised above the PC board using cut down IC sockets, to make them accessible when the lid is fitted to the case.

Begin construction by checking the PC board for any defects such as

shorted tracks or breaks in the copper pattern. Repair these before assembly. The component overlay diagram is shown in Fig.5.

Insert the two PC stakes at the battery wiring points first. Next, insert and solder in all the resistors. You can use the accompanying resistor colour code table when selecting the resistors and it is also a good idea to check each value using a digital multimeter before it is installed.

Next, install the six diodes and two Zener diodes, making sure that the correct diodes are used in each place. Each of the ICs is an 8-pin DIP device, so don't mix them up when installing them.

The capacitors can be mounted next. The MKT polyester types have codes stamped on them to indicate their value and we have provided a table of the different codes. The electrolytic types must be oriented as shown and the 10 $\mu$ F capacitor adjacent to VR3 must be laid on its side.

The switches are mounted on cut-down IC sockets. The sockets are made by cutting up IC sockets into strips of five contacts using a sharp utility knife. The two unused pin contacts for each switch socket are removed. Insert and solder the sockets in place and then insert the switches.

The trimpots are soldered next, taking care to place the correct value of trimpot in each position. The 10mm spindles are inserted with the pointer facing the centre pin of the trimpot. Check that the rotation to the left and right is correct, with the pointer rotation the same from each side of centre. Remove and readjust the spindle orientation if this is incorrect.

As mentioned earlier, the leads of Q1 and Q2 are bent over at right angles as shown in the photographs. They must lie over the adjacent components so that their bodies are no higher than 13mm above the PC board.

Fig.6 shows the winding details for the toroidal transformer T1. It is wound with 0.5mm enamelled copper wire. It is important to get the

### Parts List – Pocket TENS Unit

- 1 PC board code 635 available from the *EPE PCB Service*, 85 x 64mm
- 1 plastic case, 134 x 69 x 23mm, with 9V battery compartment
- 1 front panel label, 49 x 113mm
- 1 TENS electrode set (available from pharmacy suppliers and chemists)
- 1 Neosid ferrite core, 25 x 15 x 10mm (28-780-36P)
- 1 9V battery clip lead
- 1 9V alkaline or 9V NiMH rechargeable battery
- 1 2.5mm PC-mount DC socket
- 1 2.5mm DC line plug with long shaft
- 2 2mm plugs for electrodes
- 1 1m length of figure-8 light duty flexible cable
- 2 PC-mount SPDT slider switches (S1,S2)
- 2 DIP-8 low-cost IC sockets to mount switches
- 3 15mm spindles for VR1, VR3 and VR4
- 2 200mm long cable ties
- 2 PC stakes
- 4 M3 x 6mm screws
- 1 2m length of 0.5mm enamelled copper wire
- 1 12mm length of 9.5mm heatshrink tubing
- 1 15mm length of 3.3mm heatshrink tubing

#### Semiconductors

- 1 MC34063 DC-DC converter (IC1)
- 1 IR2155 MOSFET driver (IC2)
- 1 LM334Z current source (IC3)
- 1 7555 CMOS timer (IC4)
- 2 MTP6N60E N-channel MOSFETs or similar, rated at 200V 1A minimum (Q1,Q2)
- 1 39V 1W Zener diode (ZD1)
- 1 10V 1W Zener diode (ZD2)
- 2 1N4936, UF4004 fast diodes (D1,D2)
- 3 1N4148 switching diodes (D3-D5)
- 1 1N5819 Schottky 1A diode (D6)
- 1 3mm red LED (LED1)

#### Capacitors

- 1 100 $\mu$ F 16V PC electrolytic
- 3 10 $\mu$ F 16V PC electrolytic
- 1 4.7 $\mu$ F 63V PC electrolytic
- 3 470nF MKT polyester
- 1 330nF MKT polyester
- 1 100nF MKT polyester
- 1 2.2nF MKT polyester

#### Resistors (0.25W 1%)

- 1 150k $\Omega$       1 100k $\Omega$       1 47k $\Omega$       1 10k $\Omega$       1 2.2k $\Omega$
- 1 1k $\Omega$       1 180 $\Omega$       1 150 $\Omega$       1 27 $\Omega$       1 12 $\Omega$
- 1 0.22 $\Omega$  5W
- 2 1M $\Omega$  horizontal trimpot (Piher PT10MV10 105A 202E) (VR1,VR3) (or 2M $\Omega$  for VR3 for a 2.3Hz minimum rate)
- 1 100k $\Omega$  multi-turn top adjust trimpot (VR2)
- 1 1k $\Omega$  horizontal trimpot (Piher PT10MV10 102A 202E) (VR4)

### Capacitor Codes

Value	$\mu$ F Code	IEC Code	EIA Code
470nF	0.47 $\mu$ F	470n	474
330nF	0.33 $\mu$ F	330n	334
100nF	0.1 $\mu$ F	100n	104
2.2nF	0.0022 $\mu$ F	2n2	222

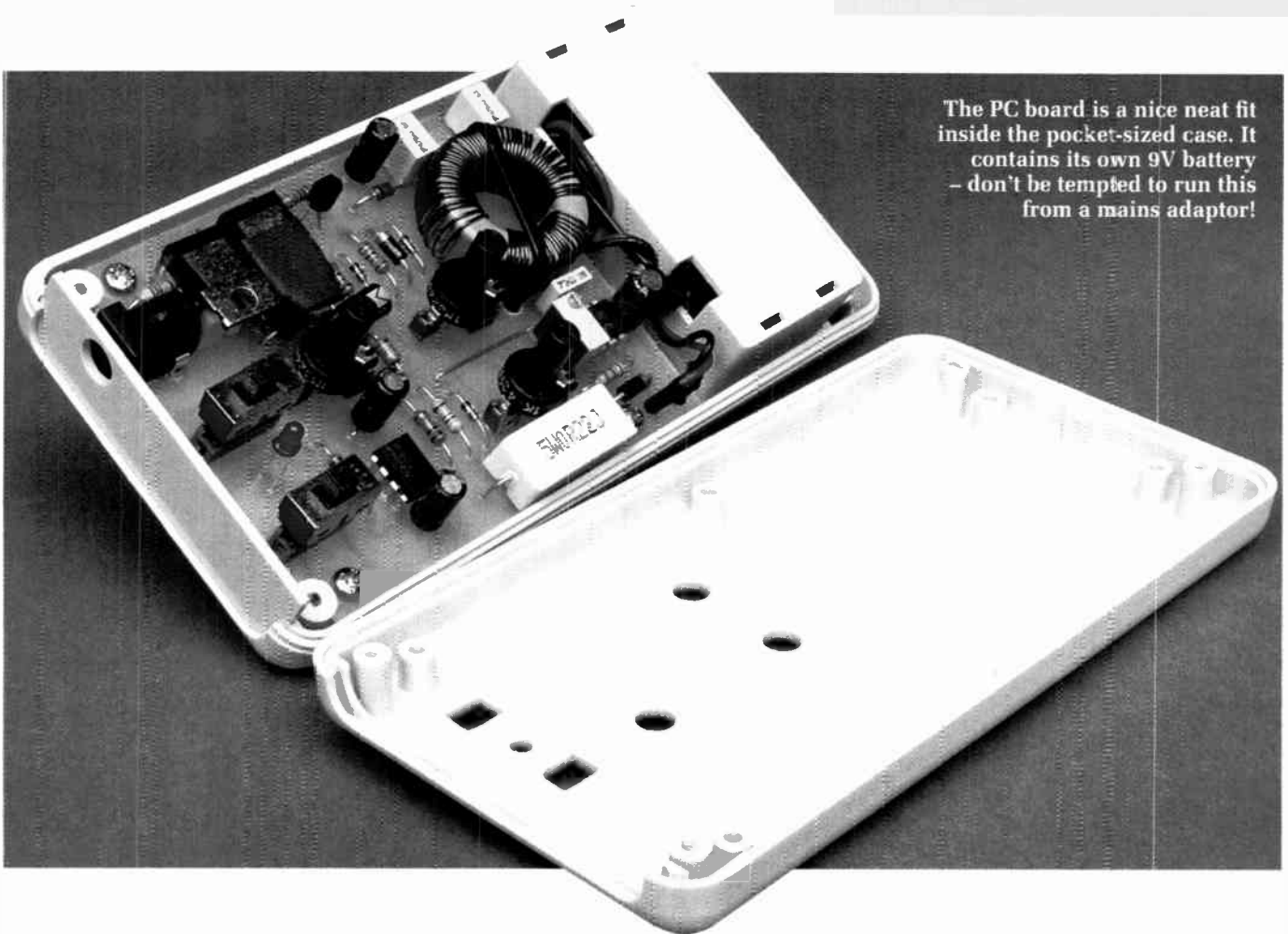

The PC board is a nice neat fit inside the pocket-sized case. It contains its own 9V battery – don't be tempted to run this from a mains adaptor!

winding direction and number of turns correct.

Start by winding on 44 turns for the secondary in the direction shown. The primary is also wound in the direction shown, with 17 turns. Strip the enamel insulation from the wire ends before soldering them to the PC pads. Then secure the toroid to the PC board with a cable tie, see Fig.5.

Indicator LED1 is mounted with the top of its lens 15mm above the PC board. Make sure its orientation is correct. Attach the PC board to the base of the case with the four M3 screws

directly into the integral standoffs in the case.

A front panel label can be attached to the lid of the case and the holes drilled and filed to shape for the two slide switches, the 3mm LED and the three trimpot spindles.

Drill a hole in the end panel for the output socket to allow access for the DC plug.

The battery clip wires are fed through from the battery compartment side via the holes in the box. Secure these wires with a cable tie and solder them to the PC stakes,

then use heatshrink tubing (the small diameter length cut in half) to cover the PC stakes and wire.

**Note that MOSFET Q2 also has its tab covered in heatshrink tubing to avoid its tab shorting to the tab of Q1.**

## Testing

Fit the battery and plug in the DC socket with the backing piece removed. Connect a multimeter (set to the 200V DC range) between the outside terminal of the plug (–) and the tab of Q1.

Switch on power and check that LED1 lights and that there is a voltage reading. Set the voltage pot VR1 fully clockwise and adjust trimpot VR2 for a reading of +80V.

If you are not able to obtain the correct voltage, check that the transformer is wound correctly. In particular, check the winding directions for each winding.

Check that the voltage at pin 1 of IC2 is around +10V DC. Set the pulse width pot VR4 fully clockwise and select the continuous mode.

Connect your multimeter set for AC volts across the DC socket terminals.

## Resistor Colour Codes

No.	Value	4-band Code (1%)	5-band Code (1%)
□	1 150kΩ	brown green yellow brown	brown green black orange brown
□	1 100kΩ	brown black yellow brown	brown black black orange brown
□	1 47kΩ	yellow violet orange brown	yellow violet black red brown
□	1 10kΩ	brown black orange brown	brown black black red brown
□	1 2.2kΩ	red red red brown	red red black brown brown
□	1 1kΩ	brown black red brown	brown black black brown brown
□	1 180Ω	brown grey brown brown	brown grey black black brown
□	1 150Ω	brown green brown brown	brown green black black brown
□	1 27Ω	red violet black brown	red violet black gold brown
□	1 12Ω	brown red black brown	brown red black gold brown

## Constructional Project

You should measure about +18V AC, indicating that switching is taking place.

Note that this is only an indication of the output, as some multimeters may give different readings. The readings should alter with different control settings. With intermittent mode selected, you should see the voltage changing from 0V to a higher reading.

If you have access to an oscilloscope, then the output pulses can be observed to verify that the pulse width and frequency are to specification.

### Using TENS

Make up electrode leads using the 2.5mm DC plug and the two 2mm plugs. Now connect to the electrodes. The electrode sockets may need to be slightly crimped with pliers to close up the socket hole. This will hold the 2mm plugs more securely.

The electrodes are usually supplied with an adhesive back that allows them to be easily attached to the skin. If the adhesive dries out, a smear of personal lubricant will be helpful.

The electrodes can then be attached to the skin using any of the variety of tapes or bandages used to secure wound dressings. Attach the electrodes in position on either side of the pain source or possibly on the back for pains in the leg/foot – to confuse the nerves. A useful chart showing typical TENS pad locations may be found at [www.vitalityweb.com/backstore/tensplacement.htm](http://www.vitalityweb.com/backstore/tensplacement.htm)

Before switching on the TENS unit be sure that the output voltage is turned down to the minimum.

Wind the voltage up until a tingling sensation can be felt and adjust the pulse rate and width for the desired effect. The voltage will need to be wound up during the period of treatment to compensate for the body's adaptation to the stimulation.

The intermittent selection is used if the treatment period is long (normal treatment sessions are typically for 20 minutes) or where the user finds the continuous effect to be waning.

It is possible that the TENS pads will irritate the skin, not (usually) so much from the TENS itself but the adhesive used on the pads. If so, we suggest trying a different brand or type of pad.

There is a wealth of information

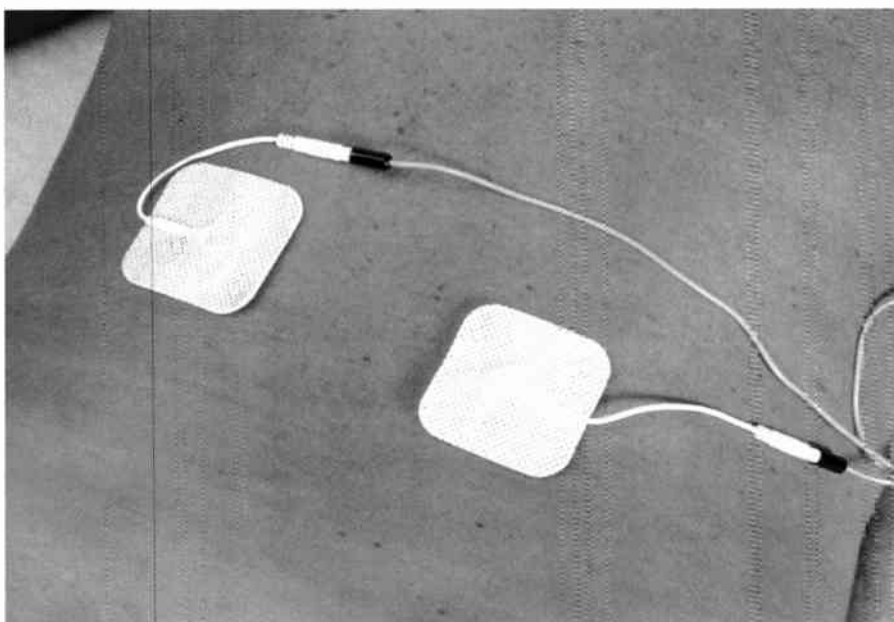

**TENS pads are normally self-adhesive and, with care, can be used many times. When not in use, they should be stuck onto the backing sheet they came with. The most usual position for pads is each side of a painful area, bearing in mind the warnings published in this article.**

on the internet about TENS units and their use.

Like any treatment regimen, we suggest you ask your General Practitioner for advice before commencing treatment with the TENS unit. Remember,

TENS does not treat any underlying condition; it merely masks the pain and makes it more bearable. *EPE*

Reproduced by arrangement with SILICON CHIP magazine 2007. [www.siliconchip.com.au](http://www.siliconchip.com.au)

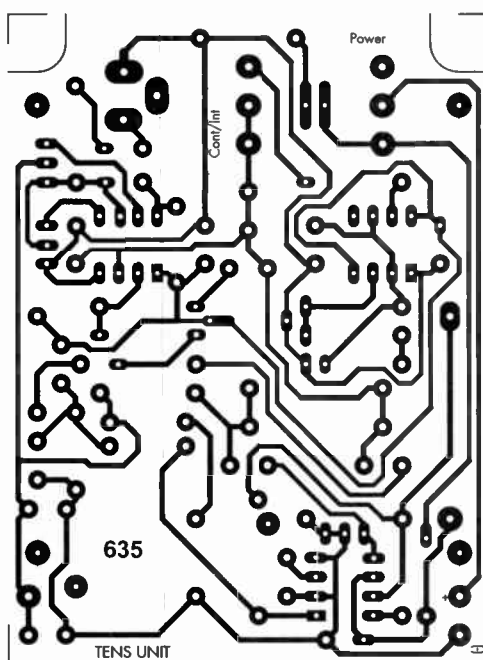

**Figs 8 and 9: same-size artwork for the PC board and front panel. A photocopy of the front panel can also be used as a drilling template for the case.**

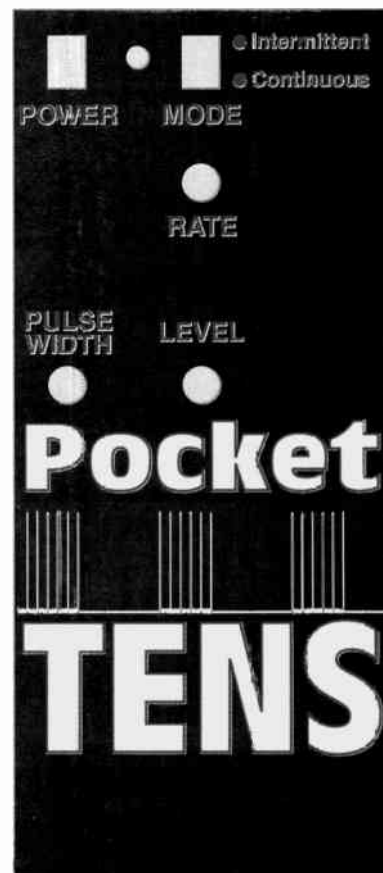

# Build Your Own Weather Station



- ▶ Measure Wind Speed
- ▶ Measure Wind Direction
- ▶ Measure Temperature
- ▶ Easy Build Kit
- ▶ FREE Software
- ▶ USB or RS232
- ▶ Optional Humidity Module
- ▶ Optional Pressure Module
- ▶ Optional Rainfall Gauge
- ▶ Simple 1-wire® connection
- ▶ Build and add your own devices

Weather Starter Kit	£59
RS232 Interface	£25
USB Interface	£29
Humidity Module	£39
Pressure Module	£49
Rainfall Gauge	£59

Prices exclude VAT and delivery

For more information, manuals and downloads on this and other interesting products see [www.audon.co.uk](http://www.audon.co.uk)

**audon** Electronics

[www.audon.co.uk](http://www.audon.co.uk) | +44 (0)115 925 8412 | Fax +44 (0)115 925 9757

# MAGENTA ELECTRONICS LTD

135 Hunter Street Burton on Trent Staffs DE14 2ST  
Tel: 44 (0)1283 565435 Fax: 44 (0)1283 546932

## Chips, Parts & Kits for EPE Projects

Programmed PICs and chips for most EPE projects. Check our website or 'phone for prices. We have supplied kits for EPE\* projects for almost 30 years!! (& Everyday Electronics)

## 20W Stereo Amp.

Wide band Low distortion 11W /channel Stereo 20W Mono. True (rms) Real Power

Short Circuit & Overheat Protected. Needs 8 to 18V supply. (Kit: inc all parts & heatsink for stereo or mono)



Latest Technology - Stable, Reliable, high performance

**KIT 914- £11.90**

## Top Kits.

ICEbreaker PIC16F877 in - circuit emulator - Kit 900.... £34.99

1kV/500V Insulation Tester Inc. drilled case -Kit 848.. £32.95

Pipe Descaler - High Power with led monitor - Kit 868..£22.95

Ultrasonic PEST Scarer random 32k pulses Kit867..£19.99

P-I Metal Detector Micro based design - sensitive Kit847..£63.95

**MAGENTA Bat Detectors** Our original famous KIT detector KIT 861...£37.99 & See the new built MkIIb and MKIII on the web.

All Prices Include VAT, Add £3.00 P&P per order, or £7.99 for next day. Chqs. P.O. & most major cards accepted. Mail Order Only.

**MAGENTA** [www.magenta2000.co.uk](http://www.magenta2000.co.uk)  
sales@magenta2000.co.uk

## www.rkeducation.co.uk solutions for teaching and learning

We stock a range of PCBs, training systems and electronic components to the education sector, industry and the general public

Many different project PCBs available

555 Monostable PCB	from 42p
Comparator PCB	from 42p
Transistor Switch PCB	from 40p
Thyristor Latch PCB	from 40p

We stock a range of components at very low prices

10mm Blue LED 2000mcd	from 12p
10mm White LED 3500mcd	from 11p
10mm Amber LED 2000mcd	from 9p
3, 5, 8 and 10mm LEDs in various colours	
Resistors 1/4W carbon film	£1.80 per 1000
Capacitors 16V and 25V radial	from £1.50 a 100

We stock a range of component kits

E12 & E24 Resistor Kits	from £7.00
16V & 25V Capacitor Kits	from £3.00
3, 5, 8 and 10mm LED kits	from £5.00

See our website for our full range  
More products added regularly  
sales@rkeducation.co.uk 07950 581996  
We accept PayPal

# PCB-POOL®

SERVICING YOUR COMPLETE PROTOTYPE NEEDS

**1 EUROCARD**  
(160 x 100 mm)  
+ Tooling  
+ Photoplots  
+ VAT  
**€49**

Price example  
Any size and contour possible!

**Optional:**

- Soldermask
- Fast-turnaround
- Silkscreen
- 4-Layer Multilayer
- 6-Layer Multilayer

**DOWNLOAD OUR FREE LAYOUT SOFTWARE!**

**Freephone** 0800-3898560  
Tel.: + 353 (0)6 701170  
Fax: + 353 (0)6 701165  
pcb-pool@burton.com

Simply send your files and order ONLINE: **PCB-POOL.COM**

# THUNDEROUS KITS

Bigger More Technical  
ENGINEERING CATALOGUE

**Jaycar**  
ELECTRONICS

430+ Pages  
Full Colour

675+ New  
Products



All our kits are brilliantly designed and tested down under. Visit us at [www.jaycarelectronics.co.uk](http://www.jaycarelectronics.co.uk) and obtain your free copy of our 430+ page full colour catalogue containing our full range of electronic kits and more!



**POST AND PACKING CHARGES:**

Order Value	Cost	Order Value	Cost
£20 - £49.99	£5	£200 - £499.99	£30
£50 - £99.99	£10	£500+	£40
£100 - £199.99	£20		

Max weight 12lb (5kg). Heavier parcels POA. Minimum order £20.  
Note: Products are despatched from Australia, so local customs duty and taxes may apply.

How to order:  
Phone: Call Australian Eastern Standard Time Mon-Fri on 0800 032 7241  
Email: [techstore@jaycarelectronics.co.uk](mailto:techstore@jaycarelectronics.co.uk)  
Post: PO BOX 6424, Silverwater NSW 1811, Australia  
Expect 10-14 days for air parcel delivery

## Universal Speaker Protection and Muting Module Kit

**KC-5450 £8.75 + post & packing**

Protects your expensive speakers against damage in the event of catastrophic amplifier failure such as a shorted output transistor. In addition, the circuit also banishes those annoying thumps that occur when many amplifiers are switched on or off, especially when the volume is set to a high level. The design also incorporates an optional over temperature heat-sensor that will disconnect the speakers if the output stage gets too hot. Configurable for supply voltages between 22VDC-70VDC.

Supplied with a silk screened PCB, relay and all electronic components.



## Water Level Indicator Kit

**KC-5449 £10.25 + post & packing**

This simple circuit illuminates a string of LEDs to quickly indicate the water level in a rainwater tank. The more LEDs that illuminate, the higher the water level is inside the tank. The input signal is provided by ten sensors located in the water tank and connected to the indicator unit via light duty figure-8 cable. Kit supplied with PCB with overlay, machined case with screenprinted lid and all electronic components.

- Requires: 8mm (OD) PVC hose/pipe (length required depending on depth of tank)

Requires 9-12VDC or AC wall adaptor (Maplin JC91Y £14.99)



Beat water restrictions with a water tank and this great kit!

## Jacob's Ladder High Voltage Display Kit

**KC-5445 £11.75 + post & packing**

With this kit and the purchase of a 12V ignition coil (available from auto stores and parts recyclers), create an awesome rising ladder of noisy sparks that emits the distinct smell of ozone. This improved circuit is suited to modern high power ignition coils and will deliver a spectacular visual display. Kit includes PCB, pre-cut wire/ladder and all electronic components.

• 12V car battery or >5 amp DC power supply required



Improved model for 2007

Improved model for 2007



## 4 Channel Guitar Amplifier Kit

**KC-5448 £28.75 + post & packing**

The input sensitivity of each of the four channels is adjustable from a few millivolts to over 1 volt, so you can plug in a range of input signals from a microphone to a line level signal from a CD player etc. A headphone amplifier circuit is also included for monitoring purposes. A three stage EQ is also integrated, making this a very versatile mixer that will operate from 12VDC. Kit includes PCB with overlay and all electronic components.



## IR Remote Control Extender MKII

**KC-5432 £7.25 + post & packing**

Operate your DVD player or digital decoder using its remote control from another room. It picks up the signal from the remote control and sends it via a 2-wire cable to an infrared LED located close to the device. This improved model features fast data transfer, capable of transmitting Foxtel digital remote control signals using the Pace 400 series decoder. Kit supplied with case, screen printed front panel, PCB with overlay and all electronic components.

Requires 9VDC wall adaptor (Maplin #GS74R £10.99)



Improved model for 2007

## Stereo VU and Peak Meter Kit

**KC-5447 £20.50 + post & packing**

Accurately monitor audio signals to prevent signal clipping and ensure optimum recording levels. This unit is very responsive and uses two 16-segment bargraphs to display signal levels and transient peaks in real time. There are a number of display options to select, and both the signal threshold and signal level calibration for each segment are adjustable. Kit supplied with PCBs, LCD and all electronic components. Accuracy within 1dB for signals above -40dB.

• Case not included use HB-6082 £2.95



Requires 9-12VDC wall adaptor (Maplin #JC91Y £14.99)

## 2 Channel USB Oscilloscope

**QC-1930 £83.75 + post & packing**

Using Plug 'n Play USB technology and providing full optical isolation from the computer, this oscilloscope is easy to setup and use, as well as providing protection for the computer. The software is a fully featured chart recorder, function generator, logic generator, logic analyser, and spectrum analyser all in one easy to use package. See website for specifications.

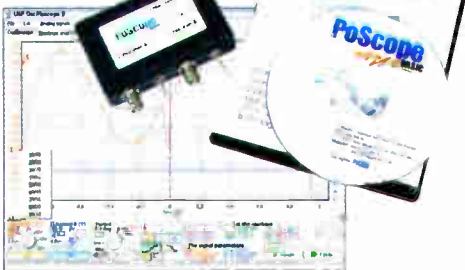

## Fuel Cut Defeat Kit

**KC-5439 £6.00 + post & packing**

This simple kit enables you to defeat the factory fuel cut-out signal from your car's ECU and allows your turbo charger to go beyond the typical 15-17psi factory boost limit.

Note: Care should be taken to ensure that the boost level and fuel mixture don't reach unsafe levels. Kit supplied with PCB, and all electronic components.



Combine these two kits to get the most cost effective performance increase on the market!

## Variable Boost Kit for Turbochargers

**KC-5438 £6.00 + post & packing**

It's a very simple circuit with only a few components to modify the factory boost levels. It works by intercepting the boost signal from the car's engine management computer and modifying the duty cycle of the solenoid signal. Kit supplied in short form with PCB and overlay, and all electronic components.

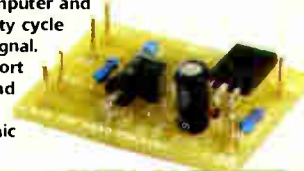



# FROM DOWN UNDER

## Everyday Practical Electronics Feature Kits

Everyday Practical Electronics Magazine has been publishing a series of popular kits by the acclaimed Silicon Chip Magazine Australia. These projects are 'bullet proof' and already tested down under. All Jaycar kits are supplied with specified board components, quality fibreglass tinned PCBs and have clear English instructions. Watch this space for future featured kits.

### The Flexitimer Kit

**KC-A-1732 £9.95 + post & packing**

This kit uses a handful of components to accurately time intervals from a few seconds to a whole day. It can switch a number of different output devices and can be powered by a battery or mains wall adaptor. The kit includes PCB and all components.

As published in this month's Everyday Practical Electronics Magazine!

Requires 12-15VDC wall adaptor (Maplin GS755 £10.99)



### 3V - 9V DC-to-DC Converter Kit

**KC-5391 £4.95 + post & packing**

This little converter allows you to use regular Ni-Cd or Ni-MH 1.2V cells, or alkaline 1.5V cells for 9V applications. Using low cost, high capacity rechargeable cells, this kit will pay for itself in no time. You can use any 1.2-1.5V cells you desire. Imagine the extra capacity you would have using two 9000mAh D cells in replacement of a low capacity 9V cell. Kit supplied with PCB, and all electronic components.

As published in Everyday Practical Electronics Magazine June 2007



### RFID Security Module Receiver Kit

**KC-5393 £28.95 + post & packing**

Radio Frequency Identity (RFID) is a contact free method of controlling an event such as a door strike or alarm etc. An "RFID Tag" transmits a unique code when energised by the receiver's magnetic field. As long as a pre-programmed tag is recognised by the receiver, access is granted. This module provides normally open and normally closed relay contacts for flexibility. It works with all EM-4001 compliant RFID tags. Kit supplied with PCB, tag, and all electronic components.

As published in Everyday Practical Electronics Magazine August 2007



### SMS Controller Module Kit

**KC-5400 £15.95 + post & packing**

Control appliances or receive alert notification from anywhere. By sending plain text messages this kit will allow you to control up to eight devices. It can also monitor four digital inputs. It works with old Nokia handsets such as the 5110, 6110, 3210, and 3310, which can be bought inexpensively if you do not already own one. Kit supplied with PCB, pre-programmed microcontroller and all electronic components with clear English instructions.

\* Requires a Nokia data cable which can be readily found in mobile phone accessory stores.

As published in Everyday Practical Electronics Magazine April 2007



### Lead Acid Battery Zapper Kit

**KC-5414 £11.75 + post & packing**

This simple circuit is designed to produce bursts of high-energy pulses to help reverse the damaging effects of sulphation in wet lead acid cells. This is particularly useful when a battery has been sitting for a period of time without use. The effects are dependant of the battery's condition and type, but the results can be quite good indeed. Kit supplied with case, silkscreened lid, leads, inductors, and all electronic components, with clear English instructions.

As published in Everyday Practical Electronics Magazine July 2007



### Luxeon Star LED Driver Kit

**KC-5389 £9.75 + post & packing**

Luxeon high power LEDs are some of the brightest LEDs available in the world. They offer up to 120 lumens per unit, and will last up to 100,000 hours! This kit allows you to power the fantastic 1W, 3W, and 5W Luxeon Star LEDs from 12VDC. Now you can take advantage of these fantastic LEDs in your car, boat, or caravan.

Kit supplied with PCB, and all electronic components.

As published in Everyday Practical Electronics Magazine April 2007



## Programmable High Energy Ignition System

### Ignition System

**KC-5442 £26.25 + post & packing**

This advanced and versatile ignition system can be used on both two and four stroke engines. The system can be used to modify the factory ignition timing or as the basis for a stand-alone ignition system with variable ignition timing, electronic coil control and anti-knock sensing. Kit supplied with PCB, diecast case and all electronic components.

Features include:

- Timing retard & advance over a wide range
- Suitable for single coil systems
- Dwell adjustment
- Single or dual mapping ranges
- Max & min RPM adjustment
- Optional knock sensing
- Optional coil driver

### Hand Controller

**KC-5386 £25.95 + post & packing**

This LCD hand controller is required during the initial set-up procedure. It plugs into the main unit and can be used while the engine is either running or stopped. Using this Hand Controller, you can set all the initial parameters and also program the ignition advance/retard curve. Kit supplied with silk screened and machined case, PCB, LCD, and all electronic components.

KC-5386 Hand Controller



### Ignition Coil Driver

**KC-5443 £13.00 + post & packing**

Add this ignition coil driver to the KC-5442 Programmable Ignition System and you have a complete stand-alone ignition system that will trigger from a range of sources including points, Hall Effect sensors, optical sensors, or the 5 volt signal from the car's ECU. Kit supplied with PCB with overlay, diecast case and all electronic components.

KC-5442 Ignition System

### Knock Sensor

**KC-5444 £5.00 + post & packing**

Add this option to your KC-5442 Programmable High Energy Ignition system and the unit will automatically retard the ignition timing if knocking is detected. Ideal for high performance cars running high octane fuel. Requires a knock sensor which is cheaply available from most auto parts recyclers. Kit supplied with PCB, and all electronic components.

KC5443 Coil Driver



Log on to [www.jaycarelectronics.co.uk/catalogue](http://www.jaycarelectronics.co.uk/catalogue) for your FREE catalogue!

0800 032 7241

(Monday - Friday 09.00 to 17.30 GMT + 10 hours only). For those who want to write: 100 Silverwater Rd Silverwater NSW 2128 Sydney AUSTRALIA

430+ page Catalogue

All prices in £



# Jaycar Electronics

[www.jaycarelectronics.co.uk](http://www.jaycarelectronics.co.uk)

World Radio History

## Single-wire communication protocol interface for PICs

**T**HE 1-wire interface is a communication protocol originally designed by a company called Dallas to simplify the connection of multiple peripheral devices to a microcontroller. Dallas were bought out by Maxim, so although the protocol is widely referred to as the 'Dallas 1-wire interface' it's now Maxim who own the name and maintain the development of the protocol.

The correct name for the interface is 'MicroLan', but the term 1-wire seems to have stuck. MicroLan best describes a collection of devices on a 1-wire bus but it is quite normal to interface to a single device, and that is what we will be demonstrating in this article.

The protocol was designed as a way to add memory to a microcontroller using a single port pin – very efficient on I/O, although much slower of course. Over time, people have found new and quite original ways in which to use the bus, and it has now developed into a multi-device, multi-function bus not dissimilar to the Philips I<sup>2</sup>C bus in its application. Devices that conform to the 1-wire standard include EEPROM memory, temperature sensors, RAM and more; in a later article we will see just how easy it is to create your own custom, compact peripherals.

### Physical interface

The physical interface is not really a single wire but two, since you must provide a ground connection. The single data signal, however, provides receive data, transmit data and power to multiple devices on the bus – quite an achievement! Fig.1 shows a simplified version of the communication flow.

The host sends a short negative pulse on the wire to signal the start of each bit, and the device responds by pulling the bus low for a zero or leaving high for a one. Each bit is transmitted in a 60µs 'window'. It's a strange mix between synchronous and asynchronous communication.

The data signal is pulled up to +5V by a resistor, which provides the power source, and communication is achieved by leaving the data pin pulled high for a logic '1', and actively pulling it low for a logic '0'. This enables multiple devices to exist on the bus

without any possible damage occurring should several devices attempt to communicate simultaneously. An example physical connection is shown in Fig.2. The choice of pull-up resistor will depend on the length and loading of the bus, and is specified as being between 1.5k and 5k ohms. For a short, typical application a value of 2k $\Omega$  should be sufficient.

many developers, since it simplifies the mechanical interface required to connect an external device onto the bus. The most popular physical realisation appears to be the iButton product range which encapsulates a simple IC into a steel case not dissimilar to a lithium coin cell. Wrapped up into a plastic key-fob attachment, these have proven ideal for security access control systems, vending machine 'electronic cash' tokens and various car alarm systems.

The author's own car uses an iButton to turn the alarm on or off. (That iButton was not hacked while developing this article – didn't want to risk being left without a driveable vehicle!) An example device is shown in Fig.3.

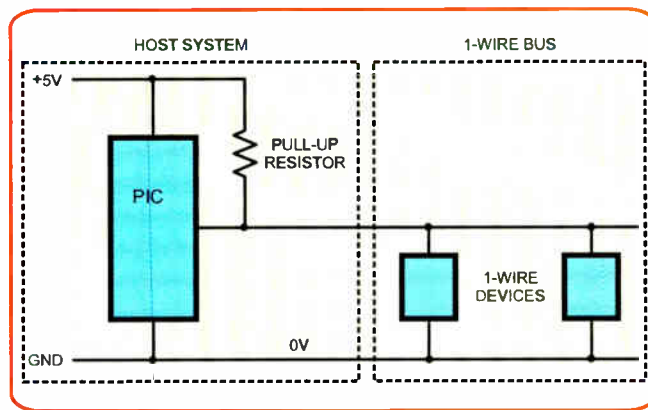

Fig. 2. Typical Connection

1-wire devices are allowed to operate over the 2.8V to 6.0V range, although the data pull-up is normally brought to 5.0V to provide power to the remote device and give good signal integrity and resilience to noise. The devices and bus specification has been designed so that the bus can run over very long lengths, hundreds of metres in some cases, so you are not limited to simple IC to IC connection on a PCB.

### iButton

The simple two-wire interconnection seems to have scratched an itch for



Fig. 3. Example device

which consists of an iButton in a keyfob holder. The iButton sockets are available with built in protocol converters that can provide an RS232 or USB interface to the host system, significantly simplifying the design of a 1-wire system.

Because access control and vehicle alarm systems are a relatively large market, Maxim produce a special, ultra-low cost IC which consists of nothing more than a 64-bit read-only memory register

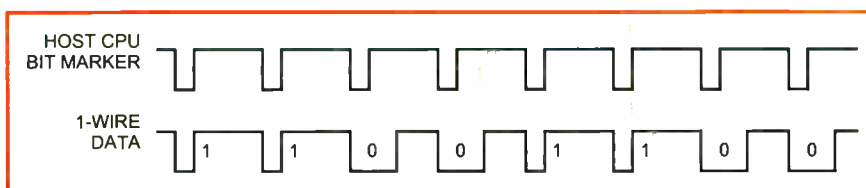

Fig. 1. Communication

containing a unique serial number. Devices like these cost less than a pound even when bought in small quantities from the usual big distributors.

The iButton devices and receiving sockets are readily available and very cheap, making experimentation and practical system development a breeze. If you are building your own hardware, the two-conductor interface opens up a number of easy to use solutions, such as fitting into 2.5mm jack plugs, reducing the cost of developing a system to pennies.

Although we are normally interested in interfacing devices like these to microcontrollers, a PC interface may also be of interest, and is certainly useful during system debugging to read and write data to a device. A very simple interface utilising a PC's RS232 interface and commonly available passive components has been proposed by Dallas, and is shown in Fig.4. This interface uses a 'virtual ground' signal to the device which must not be connected to real ground – doing so could destroy your PC's RS232 interface. Several other simple interface designs are available, and can be found in the Dallas Tech Brief 1 datasheet available from the Maxim website – see Ref.1 for details. The author found the simple interface perfectly usable, however.

## Interface range and cable choice

An achievable cable length of 300 metres has been tested by Dallas, but you will need to start adding hardware at the host processor end to control the slew rate (signal rise and fall time) of signals on the bus to achieve this, due to the increased loading of the cable. Over short distances (e.g. a few metres) and with only a few devices connected to the bus, signal conditioning is not such an issue and you can effectively ignore it and use a very basic bus circuit with just a pull-up resistor. The article in Ref.1 goes into the detail of slew rate control in considerable detail for those of you with an electronics background and an interest in very long cable runs.

The use of twisted pair wiring is important to avoid data corruption from noise in the environment. You can twist your own, or use normal telephone cable. CAT-5 network cable is the best solution, but will be rather expensive for long distances and somewhat defeats the ideal of the 1-wire interface: there are eight wires in a CAT-5 cable! If you are working with short distances (say a few

metres) then the requirements are much simpler and twisted wires are not likely to be necessary.

## Static protection

As the 1-wire devices are likely to be used in key-fobs with unrestricted physical access to the data contact, the devices must be much more resilient to damage from static electricity discharge than normal ICs. (Static electricity is the charge that builds up when we walk across synthetic carpets and then discharges on metal door handles with a painful zap!) It's quite normal for the human body to build up a charge that is unnoticeable to us (several hundred volts, say) but which would still cause permanent damage to an IC.

All 1-wire devices are designed to withstand 10kV static electricity discharges, which sounds a lot but may itself not always be sufficient – especially in hot, dry countries. If you are using an external device, such as an iButton or similar home made plug, additional ESD protection should be provided at the host end. We have described ESD protection in a previous *Pic'n'Mix* article but if you are simply experimenting with 1-wire devices or have shrouded device connections, this should not be an issue. If you decide to create your own 1-wire device using a standard microcontroller (as we will be doing in next month's article) then you must provide additional ESD protection if the pins on your device are going to be accessible. More on that next month.

## Device communication

Communication with the devices is quite straight forward, similar to I<sup>2</sup>C and SPI, but with a few extra commands that make discovering which devices are attached to the bus possible (more on that later). There are some interesting, practical issues to do with working with devices which may be connected manually to the bus, as in an access control system. When connected to the bus, a device must power up, be detected on the bus and then communication exchanged between the device and the host.

Humans, however, are not very good at making a single, reliable, noise free connection. Imagine sitting in your car and pressing an iButton on your key fob onto a receiver on the dash board; there will be partial connections and lots of debounce noise before a suitable connection is made. And the communication must be quick: you don't want to have to wait several seconds before the action is completed.

These problems are dealt with in several ways. First, the communication protocol is quite quick – the data rate is 16kbits/s, and the amount of information that can be exchanged is kept low. Within software, you will be responsible for

providing protection against intermittent connection. This is really just a case of making sure that the data has been written. A simple algorithm that uses a temporary buffer for the data to be written is:

1. Write new data to temp register
2. Set a 'write in progress' bit
3. Write temp register to update location
4. Clear 'write in progress' bit

Then the device can, on power-up, check the status of the 'write in progress' bit. If it is set, then you repeat the process above from step 3.

Needless to say, this only applies to non-volatile memory, and the temporary register must be in non-volatile memory too. For some standard data write commands the 1-wire specification already allows some level of write integrity by using a temporary write buffer or scratchpad to the IC itself.

## Language and programming

Although we will be providing a full set of example software to communicate with a 1-wire device, you are not limited to writing in assembly language. The 1-wire interface has been implemented in BASIC on some PIC development systems which can significantly reduce your development time, if the BASIC language is suitable for your application.

Let's take a look at the 1-wire protocol, as described in the datasheet for the DS2430A EEPROM. This part is readily available in a TO92 package and also forms the heart of the iButton device, so the technical description matches both parts. This part is available from Farnell with the part code 9724834, and no doubt from other suppliers.

In common with most 1-wire parts, the DS2430A is equipped not only with its main function (EEPROM in this case) but also with some basic read only memory and a small, separate area of flash to store an application register.

The read only memory consists of 64 bits of 'identification ROM' which is unique to each 1-wire part. Eight bits are used as a 'family' ident, which specifies the type of the part, 48 bits are the unique serial number for the IC and the remaining 8 bits are a CRC – a check byte which helps you determine, on reading the data, that you have read it correctly. Remember, these devices are designed to be used in applications where the IC is being pressed onto some kind of connector, so debouncing and noise can be an issue. These 64 bits are stored in read only memory and therefore cannot be changed.

The 'application register' is a general purpose 64-bit memory area that you can use to store any information. Unlike the main EEPROM, this register can be written to only once – making it useful for storing a product serial number or calibration data, for example.

Both the application register and the main EEPROM have equivalent RAM-based 'scratch' registers. These are buffers into which you write the data that you wish to store in the main memory. Having

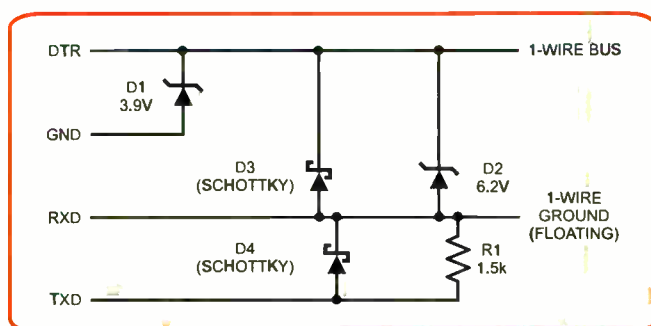

Fig. 4. PC Interface



# Flexitimer

An Easy-To-Programme Digital Timer

This multi-purpose timer is much more flexible than previous designs. You can programme it for a single time period ranging from one second to 99 minutes and 59 seconds, or a sequence of two such (independently programmed) time periods, or up to 99 cycles of one or two time periods. It's also easy to program.

By JIM ROWE

**E**LECTRONIC TIMERS have always been popular. In fact, there are so many applications for this kind of project that it's only scratching the surface to mention the following: parking meter reminders, EPROM erasure timing, darkroom printer/enlarger timing, PC board etch timing, battery charge timing, industrial process timing, chess and other board game timing, debate timing and even kitchen timing.

If you want to make a timer with the widest range of applications, it needs to have at least two independently adjustable or 'programmable' timing periods. Ideally, it also needs to be flexible in terms of the number of time periods and/or time period sequences (or cycles) that can be programmed.

Some applications need just a single time period, timed in 'single shot' fashion, while others need a single sequence of one time period followed

by a second (and probably different) time period. Still other applications may need a sequence of two time periods repeated many times, say for a total of 20 cycles.

Previous timer designs have provided most of these features but at the cost of operating and programming complexity. This made them a bit daunting to use and limited their popularity as a result.

By contrast, this timer is programmed in exactly the same intuitive fashion as some microwave ovens. First, it has tens and units buttons to allow you to key in the exact number of minutes and seconds for the time period(s) you want and also the number of timing cycles you want. There are also buttons to start and stop the timer manually and to save its settings for the next time it's used and so on.

## Main features

Here's a quick summary of the flexitimer's capabilities. First, it provides

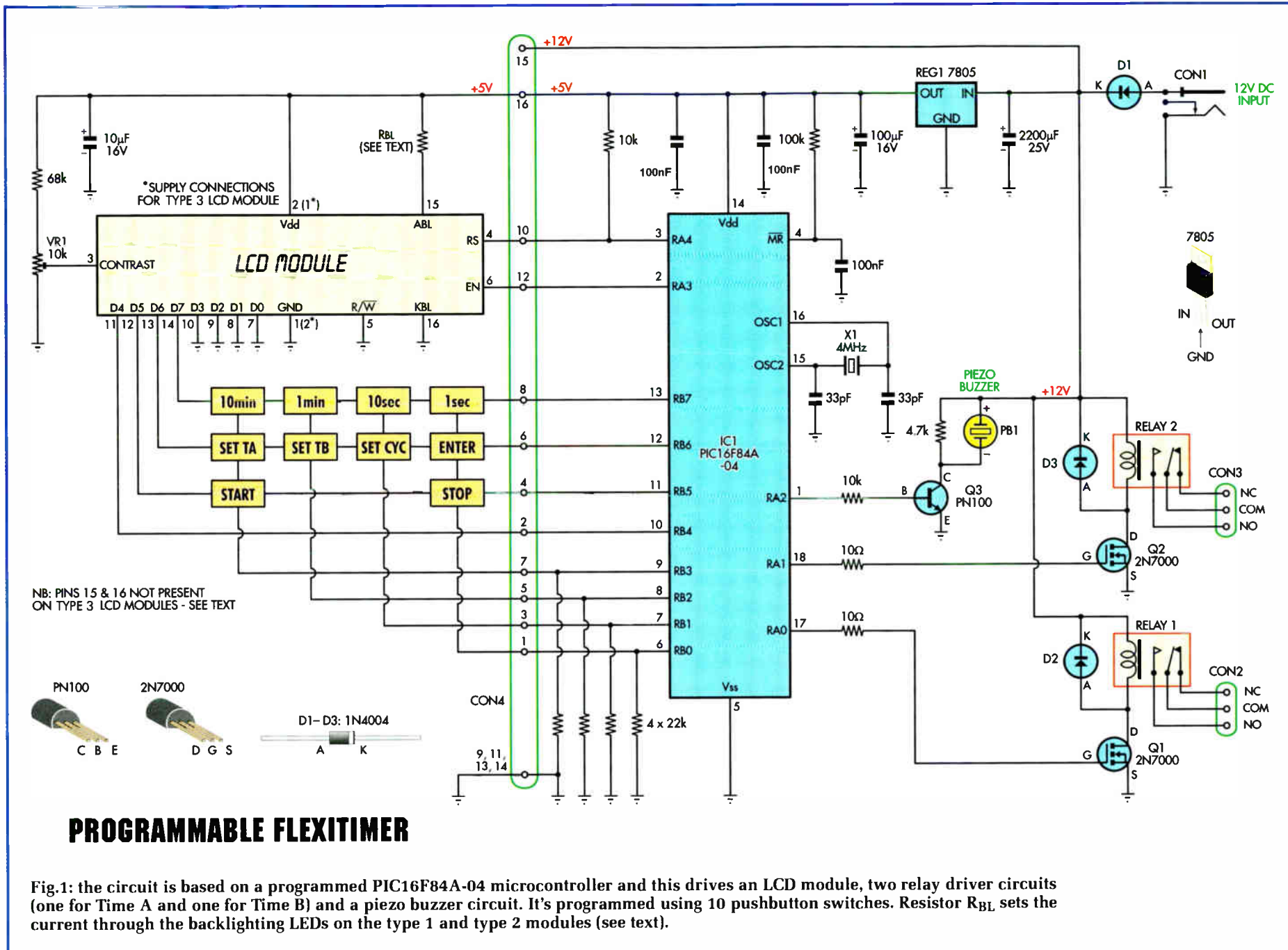

## Parts List - Flexitimer

- 1 plastic box, 158 x 95 x 58mm
- 4 6mm-long untapped spacers
- 5 12mm-long untapped spacers
- 1 M3 x 6mm machine screw
- 4 M3 x 12mm machine screws, csk head
- 5 M3 x 20mm machine screws, csk head
- 11 M3 nuts and star lockwashers
- 1 75mm length of 16-way IDC ribbon cable
- 2 16-way IDC ribbon connectors

### Main Board

- 1 PC board, code 631, available from the *EPE PCB Service*, size 141 x 83mm
- 1 12V piezo buzzer (WD1)
- 1 4MHz quartz crystal (X1)
- 2 12V SPDT relays to suit
- 1 PC-mount 2.5mm DC input connector (CON1)
- 2 PC-mount 3-way terminal blocks (CON2, CON3)
- 1 PC-mount 16-way DIL pin header (CON4)
- 1 18-pin DIL IC socket
- 1 TO-220 heatsink, 6021 type, 30 x 25 x 13mm

### Semiconductors

- 1 PIC16F84A (IC1) programmed with PICTIME2.HEX firmware – see text. Preprogrammed chips are available from Magenta Electronics, see their advert in this issue.
- 1 7805 5V regulator (REG1)
- 2 2N7000 MOSFETs (Q1,Q2)
- 1 PN100 NPN transistor (Q3)
- 3 1N4004 1A diode (D1,D2,D3)

### Capacitors

- 1 2200 $\mu$ F 25V radial elect.
- 1 100 $\mu$ F 16V radial elect.
- 3 100nF multilayer monolithic
- 2 33pF disc ceramic

### Resistors (0.25W 1%)

- 1 100k $\Omega$       1 4.7k $\Omega$
- 4 22k $\Omega$         2 10 $\Omega$
- 2 10k $\Omega$

### Display Board

- 1 PC board, code 632, 633 or 634 to suit LCD – see text, available from the *EPE PCB Service*, size 132 x 84mm
- 1 LCD module, 2 lines x 16 chars (see text)
- 1 14-way or 16-way length of SIL or DIL pin header strip, to suit LCD module used
- 10 PC-mount SPST pushbutton switches (S1 to S10)
- 1 90° PC-mount 16-way DIL header (CON5)
- 4 M2.5 x 10mm machine screws, round head
- 4 M2.5 hex nuts and lockwashers
- 8 M2.5 flat washers
- 4 M3 hex nuts (used as spacers)

### Capacitors

- 1 10 $\mu$ F 16V radial elect.

### Resistors (0.25W, 1%)

- 1 68k $\Omega$
- 1 12 $\Omega$  to suit type 2 LCD module (R<sub>BL</sub>) – see text
- 1 18 $\Omega$  to suit type 1 LCD module (R<sub>BL</sub>) – see text
- 1 10k $\Omega$  mini horizontal trimpot (VR1)

either one or two programmable time periods (Time A and Time B), each of which can be set independently to any time between one second and 99 minutes 59 seconds – with a resolution of one second.

Second, you can set it for just a single Time A period, or a single (Time A + Time B) sequence, or for multiple Time A or (Time A + Time B) cycles. In fact, there can be anything from 2-99 such cycles.

Third, the timer has two internal relays, one of which is activated during the Time A period and the other during Time B. Both relays have a set of mains-rated single pole, double throw (SPDT) contacts, so

they can be used either separately or together to switch a wide variety of loads.

Finally, the unit operates from 12V DC, which can come from either a battery or a plugpack power supply.

### Programming

As mentioned earlier, the time periods and cycles are programmed very easily using four pushbuttons: one each for tens of minutes, units of minutes, tens of seconds and units of seconds. The '10-minute' and '1-minute' buttons are also used to programme the desired number of cycles, when you want more than a single cycle (the default).

Three further buttons allow you to set the current input as either Time A or Time B, or to set the number of cycles.

Another button (Enter) is then used to save all of the current time and cycle settings in the PIC's non-volatile memory, so that it 'remembers' them when it's powered up next time.

Finally, the Start and Stop buttons do exactly as their names suggest – ie, either start the timer operating or manually stop it if the need arises.

All of the timer settings and operations are displayed on a small 2-line x 16-character LCD module. This makes it really easy to operate.

### How it works

Fig.1 shows the circuit details of the Programmable Flexitimer. All of the real work is done by microcontroller IC1, a PIC16F84A which is programmed with a dedicated firmware program called PICTIMER.HEX.

In operation, the microcontroller runs from a 4MHz crystal clock and does all of the timing by counting clock cycles – using a combination of both hardware and software counting. This gives a timing accuracy of better than  $\pm 0.02\%$ .

The 10 buttons used to programme the various settings and commands into the PIC microcontroller are connected in a 3 x 4 matrix configuration. As shown, the three rows are connected to the three most significant bits of IC1's Port B (RB7, RB6 and RB5), while the four columns go to the four least significant bits of this port (RB3, RB2, RB1 and RB0). This allows the microcontroller to scan all the keys very efficiently and respond quickly when they are pressed.

The LCD module is directly driven by the microcontroller. It's connected to the four most significant bit Port B lines (RB7 to RB4) and to the two most significant bit Port A lines (RA4 and RA3).

The two Port A lines are used to enable the LCD controller input for writing (EN) and to select either its data or address/instruction registers (RS). By contrast, the four Port B lines are used as a data bus to feed display character codes and position addresses to the LCD controller, along with various other function commands.

Trimpot VR1 is used to adjust the display contrast. It does this by varying the DC voltage applied to pin 3 of the LCD module.

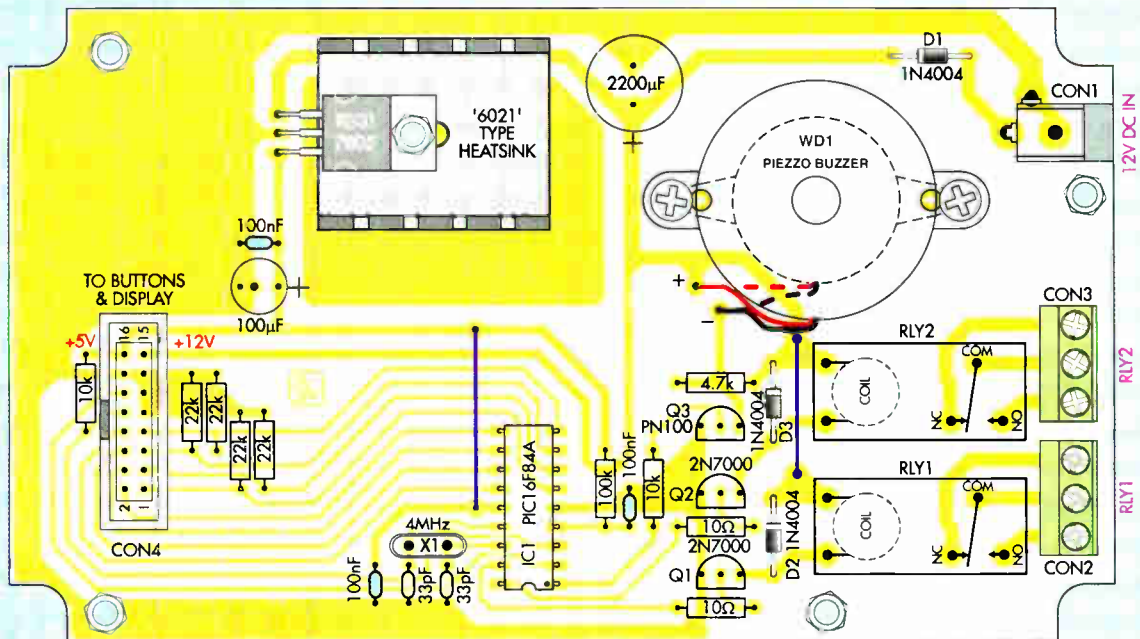
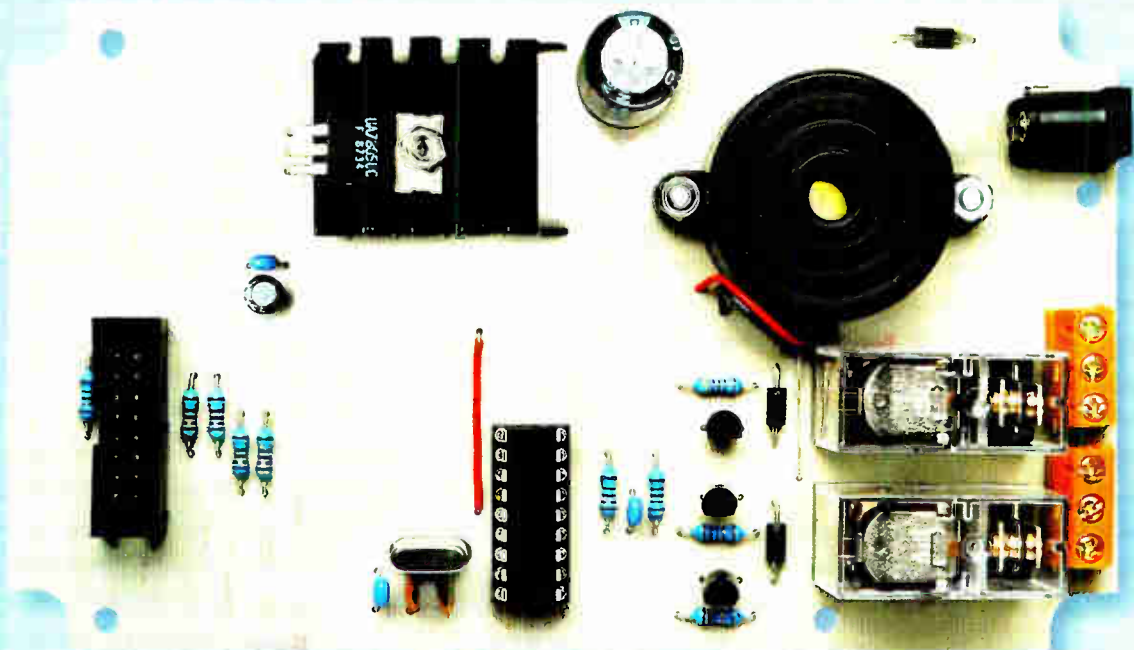

Fig.2: install the parts on the main PC board as shown here. Take care to ensure all polarised parts are correctly orientated and note that connector CON4 goes in with its keyway slot to the left.



A small heatsink is fitted to REG1, so that it can handle the current requirements of backlit LCDs.

The two least significant bit Port A lines (RA0 and RA1) function as outputs and are used to drive MOSFETS Q1 and Q2, which then control the two relays. When the unit is running, the microcontroller turns on Relay 1 (via Q1) during Time A and Relay 2 (via Q2) during Time B.

The remaining Port A output line (RA2) is used to control Q3, which in turn controls piezo buzzer WD1.

In operation, output RA2 briefly goes high and turns on Q3 to produce a short 'beep' at the end of the programmed time period(s) or cycles.

### Power supply

Power for the unit comes from a 12V DC plugpack (or battery), with diode D1 providing reverse polarity protection. This then feeds regulator REG1 which provides a +5V rail to power IC1

and the LCD module. The relays and the buzzer (WD1) are powered directly from the +12V rail after diode D1.

### Construction

Construction of the Programmable Flexitimer is easy, with all parts mounted on two PC boards – a main board coded 631 (141 × 83mm) and a separate display board (132 × 84mm). The latter carries the LCD and the

# Constructional Project

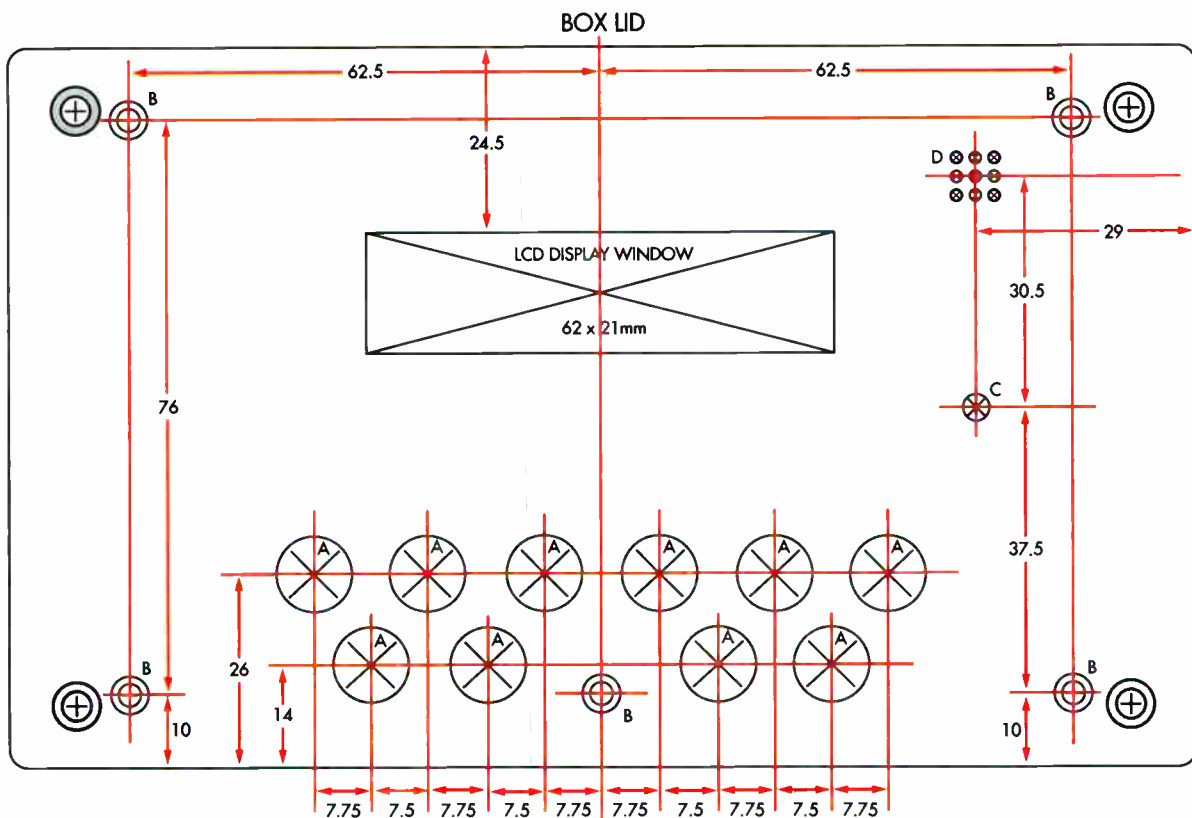

E

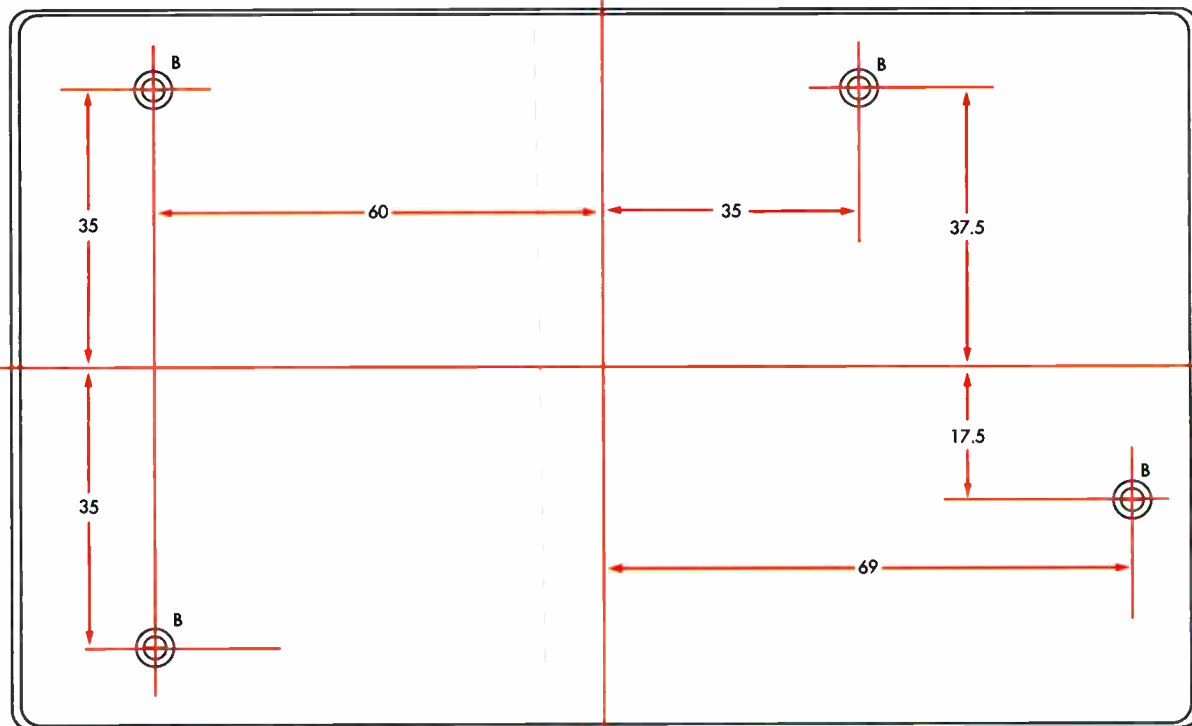

ALL DIMENSIONS IN MILLIMETRES

- HOLES A: 10mm DIAMETER
- HOLES B: 3.5mm DIAMETER COUNTERSUNK
- HOLE C: 3.5mm DIAMETER
- HOLES D: 9 x 1.5mm DIA ON 2.5mm CENTRES

**Fig.6:** here are the drilling and cutting details for the base of the case and for the lid. They are reproduced actual size, so that you can use photocopies as drilling templates.



larger polarised electrolytics. Be sure to install the electrolytics with the positive leads oriented as shown

The main board assembly can now be completed by plugging the programmed PIC16F84A chip into its socket. It must be installed with its notched end towards the bottom edge of the board, as shown in Fig.2

The PICTIMER.HEX program file is available as a free download from the Downloads section of the EPE website.

## Display board assembly

Before installing any parts on this board, make sure it suits the particular LCD module you're using. Figs.3, 4 and 5 show the parts layouts for the various versions.

Begin construction by installing the wire links and the 68kΩ resistor, then fit the 16-way 90° DIL pin header. Follow these with trimpot VR1 and the 10 pushbutton switches. Note that the latter are all mounted with their 'flat' side facing towards the left.

The 10μF electrolytic capacitor is next on the list. As shown in one of the photos, it should be mounted 'leaning over' to the left by a small amount, to reduce its effective height to below 10mm (to ensure it later clears the back of the front panel). Take care with its orientation.

The next step is to fit the header strip for the LCD module. This is a 16-way SIL strip for the type 2 module, a 7 x 2-way DIL strip for the type 3 module or a 14-way SIL strip for the type 1 module. In each case, push the shorter ends of the pins through the board from above and solder them carefully to the pads underneath.

Basically, there are six different LCD modules that can be used with this unit – three with backlighting and three without.

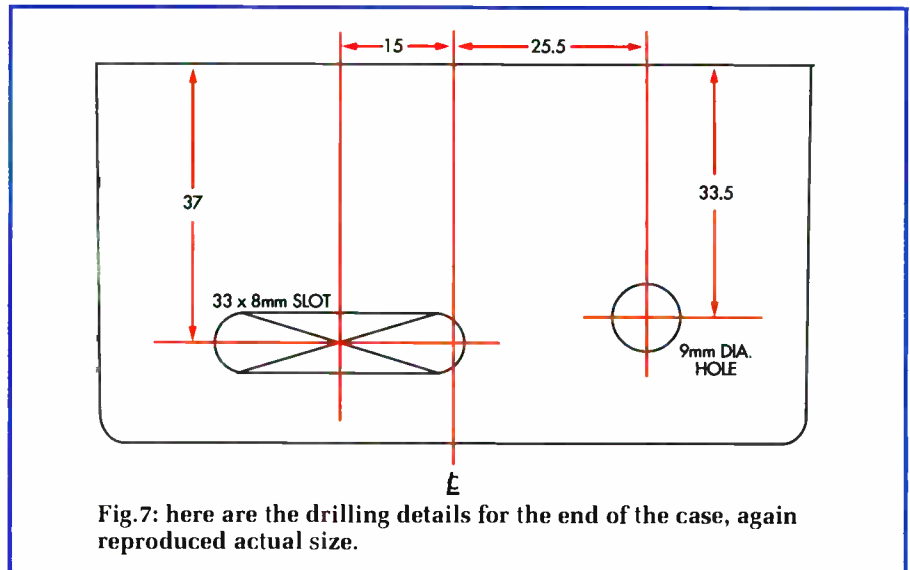

Fig.7: here are the drilling details for the end of the case, again reproduced actual size.

Installing the LCD module is easy – it slips down over the header pins and is secured using four M2.5 x 10mm screws, lockwashers and nuts. In addition, an M3 nut and two M2.5 flat washers are used to form a 3mm-3.5mm spacer between the module and the board at each mounting screw point. Alternatively, you can use two M3 'half nuts' to make the spacer at each point.

Once the module is in position, it's simply a matter of soldering its connection pads to the header pins.

The display board will now be complete, except for resistor R<sub>BL</sub> which sets the current for the backlighting LEDs. **This is fitted only if you're using an LCD module with backlighting, but it is not required for the type 3 LCD, since the resistor is part of the module.**

Note that for the type 1 module, you'll also need to make the 'A' and 'K' connections for the backlighting power (at right).

Once the assembly is completed, adjust contrast trimpot VR1 with a

small screwdriver to about 10° back from fully clockwise. This will ensure you get some kind of display when the timer and module are first powered up. The control can be 'fine tuned' for best contrast later, via the small hole in the front panel.

The next step is to make the short ribbon cable that's used to link the two boards. This is formed from a 75mm length of 16-way IDC ribbon, with a matching IDC connector at each end – see Fig.8. The connectors fit the opposite way around at each end, so that the cable can link the two boards without having to be twisted.

## Preparing the box

Figs.6 and 7 show the drilling and cutting diagrams for both the box and its lid. These are reproduced actual size, so you can directly use photocopies as drilling templates.

Make sure you countersink the 3.5mm holes in the bottom of the box and also those in the lid. This can be done with a 7mm or larger twist drill if you don't have a countersink bit. Also,

### Table 1: Resistor Colour Codes

No.	Value	4-Band Code (1%)	5-Band Code (1%)
1	100kΩ	brown black yellow brown	brown black black orange brown
1	68kΩ	blue grey orange brown	blue grey black red brown
4	22kΩ	red red orange brown	red red black red brown
2	10kΩ	brown black orange brown	brown black black red brown
1	4.7kΩ	yellow violet red brown	yellow violet black brown brown
1	18Ω	brown grey black brown	brown grey black gold brown
1	12Ω	brown red black brown	brown red black gold brown
2	10Ω	brown black black brown	brown black black gold brown

## Constructional Project

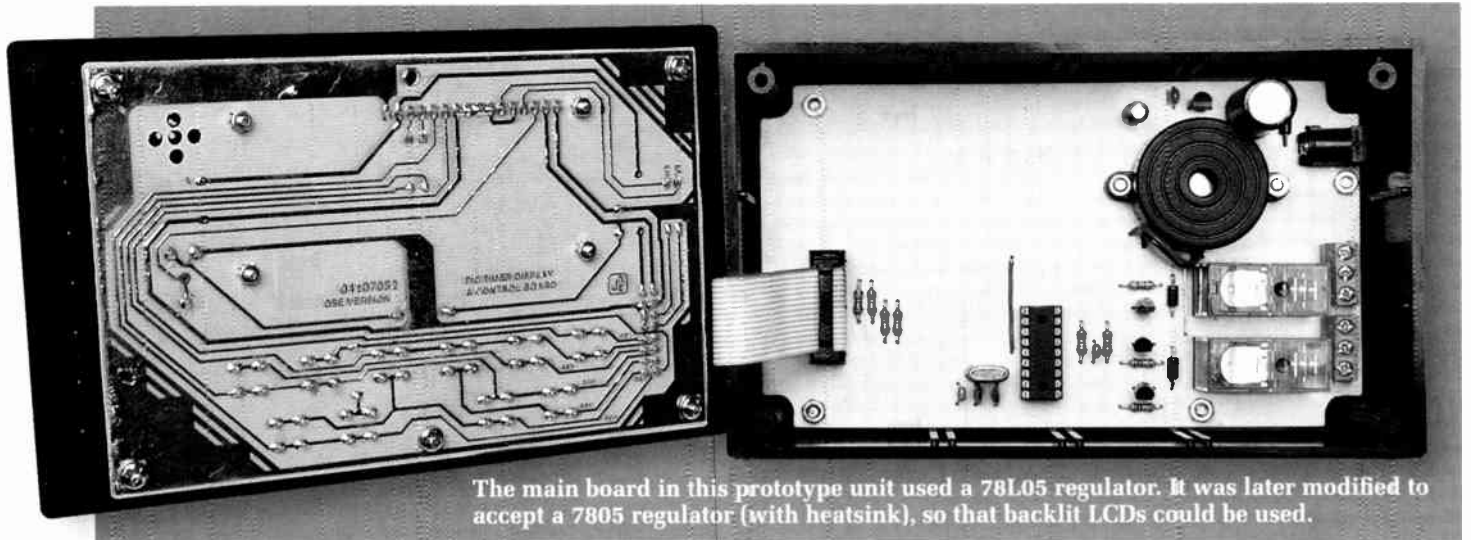

make sure that you cut the access holes for the timer's DC input connector and relay terminal blocks at the right-hand end of the box – see Fig.7.

Next, the front panel artwork can be attached to the lid. That done, you can cut the various holes in the label using a sharp hobby knife. These include the clearance holes for the switches, an access hole for the contrast trimpot and a pattern of nine small holes above the piezo buzzer.

### Final assembly

The main board mounts on the bottom of the box on four 6mm-long untapped spacers and is secured using four M3 x 12mm countersink-head screws and nuts (it only fits one way, due to the asymmetrical mounting screw positions).

By contrast, the display board is mounted on the box lid and is secured on 12mm-long untapped spacers using five M3 x 20mm countersink-head machine screws, star lockwashers and nuts. With some LCD modules, you may also need M3 flat washers to augment each of the spacers, to make sure there is enough clearance.

Your timer can now be completed by fitting the ribbon cable between the

two boards and securing the case lid.

### Using the timer

When you first connect the timer to 12V DC power, it initially displays 'FlexiTimer3' on the LCD panel. This message then disappears after a few seconds and is replaced with a 'screen' giving you the timer's current settings – plus 'Stop' at lower right to show that it's not running.

When the timer is powered up for the very first time, its initial settings are these defaults: Time A programmed to 10 seconds, Time B not programmed at all (and not even displayed), and the Cycles set to 1 (for a single timing sequence). But if you programme it with other settings and save them, these settings will appear when the timer is next powered up.

Changing the settings for Time A or Time B is done using the four uppermost buttons on the left – marked '10 MIN', '1 MIN', '10 SEC' and '1 SEC'. Pressing any of these buttons causes the timer to change into 'Input' mode, to allow you to key in any desired time setting from 00 minutes and 1 second up to 99 minutes and 59 seconds.

If you press any button too many times, just keep pressing it until the dig-

it concerned reaches the maximum and then returns to 0, after which you can programme the value you wanted.

When you have entered the time value you want, the timer can be directed to make this the setting for either Time A or Time B, simply by pressing either the 'Time A' or 'Time B' button. It's as easy as that.

Changing the Cycles setting is just as easy. In this case, you use only the '10 MIN' and '1 MIN' buttons to enter the number of cycles (from 1-99), and then press the 'SET CYCLES' button.

Once the settings for Time A, Time B (optionally) and Cycles have been entered, the timer can be started simply by pressing (you guessed it) the 'START' button. You'll then see it counting down on the LCD panel, where its status is also shown continuously – ie, whether it's in Time A or Time B and the current cycle. When it reaches the end, it will give a short beep from the piezo buzzer and display 'Stop' again on the LCD panel (at lower right). This will also happen if you press the 'STOP' button, to stop the unit before the end of the programmed time settings.

To save the current settings in memory for use next time it's powered up, just press the 'ENTER (SAVE)' button when the timer is stopped. As soon as the settings have been saved, the message 'Settings Saved' will be displayed for a few seconds, to confirm that it has been done.

To programme Time B as well as Time A, all you need do is enter its time setting and then press the 'TIME B' button. Time B will then be enabled and its setting displayed after Time A.

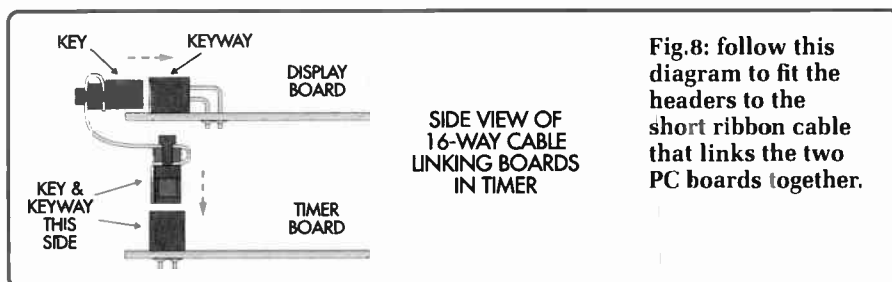

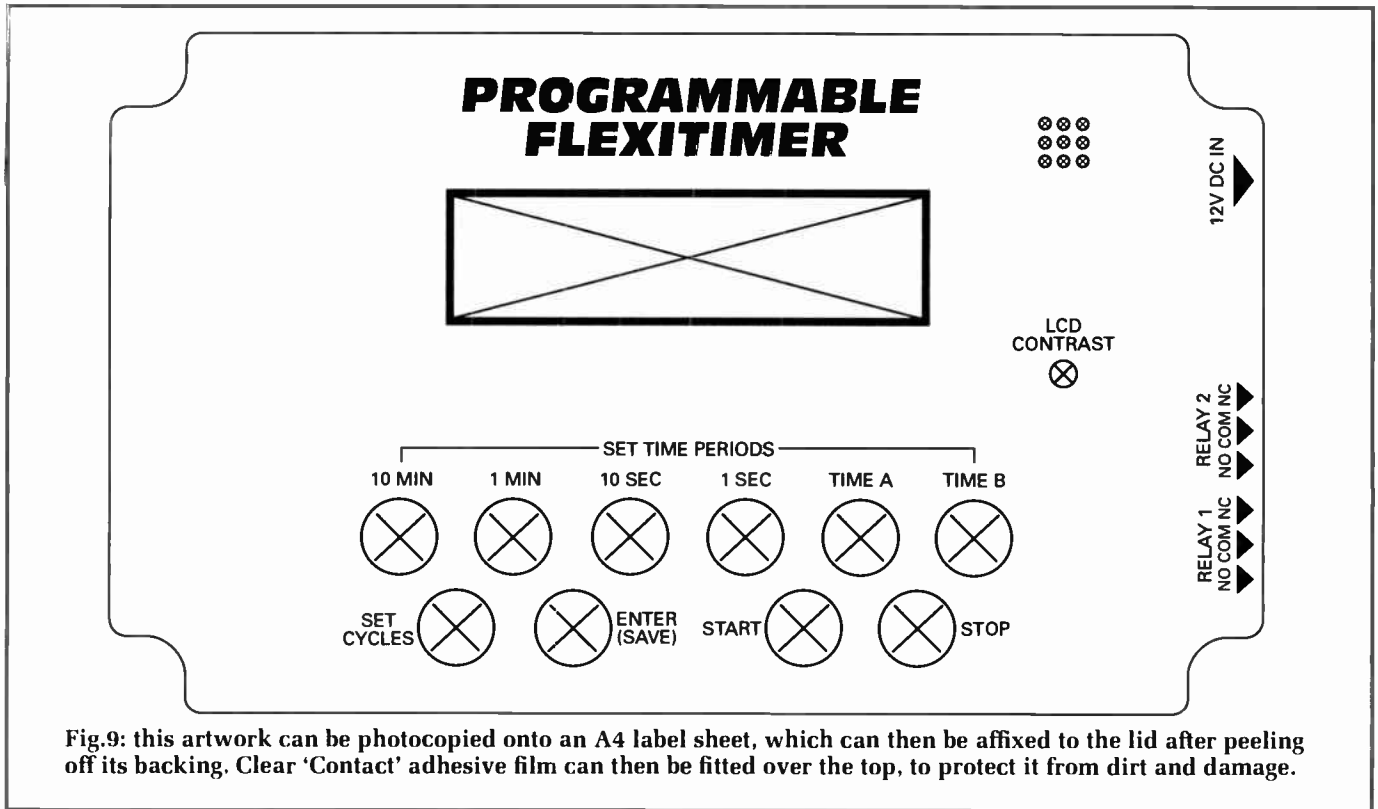

Fig.9: this artwork can be photocopied onto an A4 label sheet, which can then be affixed to the lid after peeling off its backing. Clear 'Contact' adhesive film can then be fitted over the top, to protect it from dirt and damage.

## Specifications

- Two independent timing periods: Time A and Time B
- Time A and Time B periods can be set from 00min-01sec to 99min-59sec
- 1-99 timing cycles or continuous cycling
- Relay outputs for switching external devices

## Continuous Cycling

A late software modification to this unit involved adding a continuous cycling mode. This mode is set simply by entering zero (00) as the setting for 'Cycles'.

The second line of the display shows 'Cont' when the timer is in this mode. It can be returned to finite multiple cycle mode simply by setting the number of 'Cycles' to any allowed non-zero value – ie, 1-99.

On the other hand, if you have Time B already programmed and you want to disable it again, simply enter a zero time value (ie, 00:00) and again press the 'TIME B' button. The timer will recognise the zero time setting and Time B will be disabled and disappear from the display.

## Making contact

You can use the timer's relay contact terminals to allow it to control all manner of things. All you need to know is that when the timer is running the contacts of Relay 1 are activated during Time A, while those of Relay 2 are activated during Time B. So by connecting to these terminals, you can arrange for the timer to turn things on or off during Time A and/or Time B.

Finally, note that this project should be used to control low voltage equipment only (up to about 50V). DO NOT use it to directly switch mains voltages. If you do want to switch mains voltages, we suggest that you use this unit to trigger an external relay which then does the switching.

Make sure that this external relay and any mains wiring that's run to it is properly anchored and isolated.

**Do not attempt this unless you know what you are doing and are completely familiar with mains wiring practices and techniques.** *EPE*

Reproduced by arrangement with SILICON CHIP magazine 2007.  
www.siliconchip.com.au

ANDRE LAMOTHE'S  
**XGAMESTATION**  
LEARN STEP-BY-STEP HOW TO DESIGN AND BUILD YOUR OWN VIDEO GAME CONSOLE!  
Design inspired by the Atari 800/2600, Sinclair ZX Spectrum, Apple II & Commodore 64!

Complete Package eBook Integrated IDE

SX52 CPU 80 MIPS! OPEN SOURCE!

**FEATURES:**

- Great for Hobbyists AND Students!
- Complete Software Development Kit!
- eBook on Designing the XGS Console!
- Parallax SX-Key Compatible!
- Fully Assembled XGS Micro Edition Unit!
- The Fun Way to Learn Embedded Systems!

PAL & NTSC COMPATIBLE!

WWW.XGAMESTATION.COM  
SUPPORT@NURVE.NET Ph 925.736.2098(USA)

# Using MPLAB

## How to use MPLAB when writing the source code for your PIC projects Part Four – Relocatable Development by Mike Hibbett

In this final installment we will review the subject of relocatable development and demonstrate the use of the librarian by producing a simple, useful program. We will then wrap up with a whistle-stop tour of some of the remaining interesting (but less essential) MPLAB features.

Before we start, a quick comment on mixing object code files from different assemblers.

### Mixing object code

As you are probably aware, when you have assembly code written for one vendor's assembler it will not assemble with another vendor's tools, without some minor modification or 'tweaks'. This has come up several times on the *EPE Chat Zone* forum (via [www.epemag.co.uk](http://www.epemag.co.uk)) when, for example, people have taken code written for MPLAB and tried to assemble it with TK3 or gpasm. Different vendors implement assembler directives in subtly different ways, as there is no industry standard for them. The result is a huge list of error and warning messages which can appear quite daunting. These kind of issues are, however, usually quick and easy to correct once you are aware of what is involved.

With object code files (i.e. pre-assembled source files) a similar issue exists, but cannot be dealt with so easily. Object files have a binary format and cannot be 'hand tweaked' using a text editor. In general, an object file created with one assembler or compiler can only be used with object files create by a program from the same vendor. It's a small inconvenience, and if you want to share your object files with other users you should make it clear which tool you used to create them, or share the source code.

### Using the librarian

We finish our code development examples with a simple project to flash a random sequence on eight LEDs connected to a PIC16F917. The choice of CPU is simply because it is the one fitted to the PICKit2's demo board; a simple convenience for the author but easily transferred to another PIC16F device if you want to try the example out directly. The source code and MPLAB build files are available for download from the *EPE* website – via [www.epemag.co.uk](http://www.epemag.co.uk) in the *PIC n' Mix* folder in the downloads area.

So let's run through what we want the software to do. It's quite simple: at approximately one second intervals, illuminate a random selection of eight LEDs connected to PORTD. Nothing exciting, possibly useful as a Christmas decoration, but it demonstrates the use of the linker and librarian in a simple manner.

The code for generating random numbers has been 'lifted' from a previous *PIC n' Mix* article, so we won't discuss how it

works here. It's not the operation of the code that's important, but rather how we partition it and use the linker and librarian to create re-usable object files.

So let's start by designing the program. Initial thoughts about the design, simple as it is, give the follow breakdown:

```
Setup PORTD outputs
Seed random generator
loop:
Get random value
output value
delay 1s
goto loop
```

Now this could quite easily be written in a single source file, but that avoids the point of the exercise. This is a simple program, but others may be much more complicated and would not so easily fit in a single file. Some of the features we are about to write may well be useful in other programs, so let's split these out into different groups suitable for placing in separate files:

```
Random
Seed random generator
Generate random
Get random value

delays
delay 1s
```

The 'random' file seems well defined; there isn't much else that we would want to add to it, so let's leave it as it is. The 'delays' file however could easily contain some other useful routines such as ones to provide other delay times, and perhaps some way to make the functions independent of the clock speed, making the file more general purpose. Let's say we want a routine to provide a 1ms delay, another to provide a 1s delay and an initialisation function that you call before using these that specifies the clock frequency (in some way) so the other two routines can generate the correct time period. This gives the following list of routines for the **delays** file:

```
delay1s
delay1ms
clocksPerMs
```

The routine `clocksPerMs` is our initialisation routine which you will call with a parameter that defines how many instruction clock cycles occur in one millisecond. At 40MHz the value would be 10,000, at 4MHz it would be 1000. This value will be passed to the routine via two predefined variables, called `clocks_high` and `clocks_low`, which together will hold a 16-bit value. These variables, like the routines, will be accessible by other source files even though you will have pre-assembled the source file.

Remembering the 'good practice' advice from earlier articles, we should think about

what files we will need to create. From our ideas in the previous paragraph, it's looking like this:

**delays.asm**: This file will define the delay routines, the initialisation routine, the global variables used to pass the clock speed to the initialisation routine and any internal variables required.

**random.asm**: This defines the three random number generator functions, and whatever variables they use.

**main.asm**: Holds the actual application: the 'glue-logic' which simply connects the routines from the other files together in your own special way. Sounds easy when stated like that, and with a good set of library routines developed over time, it could be!

Now it would not be unreasonable to simply build these three files together and keep them in a single project, but then it would not be quite so easy to re-use them at a later date. When you think about separating out functions into a library at the beginning of a problem, you have to consider two things:

Keep all the variable definitions required by the routines (and *just* those routines) local to the file.

Give the routines very specific, independent, functionality. Don't try to lump lots of features into each one, it makes them less likely to be re-useable in the future. Functions should be small and self-contained. They should do a single, simple job, and do it well.

### Into practice

So let's put our ideas into practice. If you remember from previous articles, it's always a good idea to get your files created and in a project, even when you intend to place them into a library. The first step is always to develop and test your code, and *then* organise them into a library. So fire up MPLAB and let's start by getting the basic system framework in place.

On the main menu bar in MPLAB, click on **Project** followed by **Project Wizard...** Click **Next** and select the processor that we will be coding for, the PIC16F917. Click **Next** again, make sure the Active Toolsuite is displaying 'Microchip MPASM Toolsuite' and click **Next**. You are now prompted to 'Create New Project File'. Type in a directory and filename that you would like to give the project. We suggest, to keep things simple, choosing:

```
c:\epe\randedls
```

which will create the project **randedls** in the **C:\epe** directory.

When you click **Next**, MPLAB will warn you that the **epe** directory does not exist. Click **OK** to allow MPLAB to create it.

You are now prompted to add any existing files to your project. This is a rather

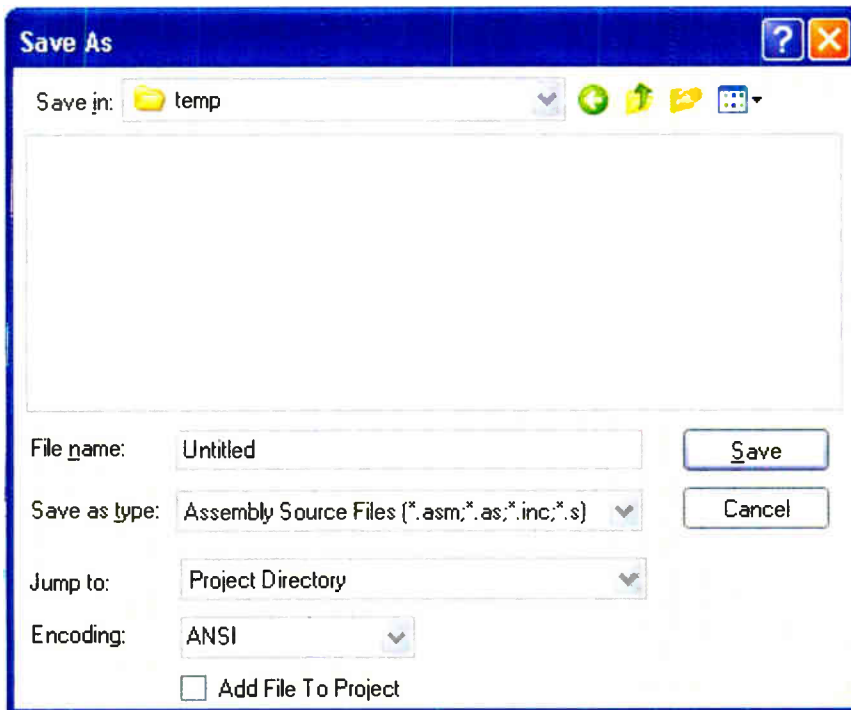

Fig. 1. Saving project files

odd thing to ask at this stage, since we are creating a new project, but in some cases you may have already created some source files in another editor (or simply want to re-use some existing source files from another project). You can skip this step by pressing **Next**. We can always add files to the project later on. Click **Finish** to end the Project Wizard's activity, and bring us back to the IDE's main window.

Now let's create the three source files, **random.asm**, **delays.asm** and **main.asm**.

Click on **File** followed by **New** to open a new Untitled editor window. Save this file to the project directory by clicking on **File** then **Save As**. A dialog appears, similar to Fig.1, that prompts you to enter the file name, its type and where to place it. Give the file a name of **main.asm**, click on the down arrow next to the 'Save in' drop down menu and navigate to the **epe** directory. Click on the 'Add File To Project' check box – this will ensure that the file isn't only saved, but included in our build.

Repeat the above steps to create the other two files.

Now add the linker file to the project so that we can link the final object files together into a **.hex** file. Remember how to do this? Right click over the line 'Linker Scripts' in the **.mew** window, select **Add File..** from the menu and navigate to the directory:

**C:\Program Files\Microchip\MPASM Suite\LKR**

And select the file:

**16F917.lkr**

Now it's time to type in the main application code into **main.asm**, which you can open by double-clicking on the filename in the **.mew** window. With the detailed work performed by routines in the other two files, the code for the main application will be simple. Inside the file **main.asm** we start by specifying the processor *include*

file, select the **CODE** memory section and provide the outline of the application, as shown in Fig.2.

Note how the **TODO** comments reflect the design breakdown listed earlier in the article – we re-use those original design thoughts in our code, since they explain what it will do. The file finishes with an **END** statement, as all source files must.

Before we can build this trivial piece of code we must place **END** statements into the other two source files **delays.asm** and **random.asm**. Even though there is no code inside these files, the assembler still requires the files to contain at least an **END** statement. So stick them in, and then build the program by clicking on **Project** followed by **Build All**. Your files should assemble without errors.

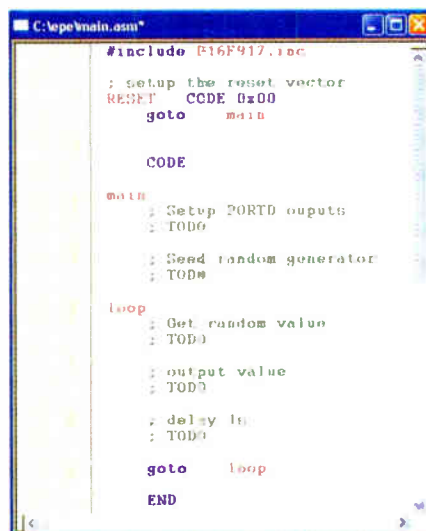

Fig. 2 Initial main application

## Final step

Of course, we still have one final, crucial step to do: set the configuration bits. Click on **Configure** followed by **Configuration Bits...** Untick the 'Configuration Bits set in code' flag, and turn the watchdog timer to **OFF**. All the other settings are fine for this project – the PicKit2 demo board uses an external RC oscillator, which is the default in the configuration settings. Close this window, then do a **Build All**.

There isn't much point in downloading this program to the demo board and trying to run it yet because it doesn't really do anything; it will start up and turn the LEDs connected to **PORTD** off – which they are already!

As this article is about use of the library rather than software development, you can copy the source code for the files from the example ones that have been created for this article, and are available for download from the *EPE Downloads* site referred to earlier, in the file **step1.zip**. This contains the source files and the MPLAB project files, so you can open it up, build it and run it immediately if you wish, or cut and paste the code from the three **.asm** files into yours.

As the routines in the files **delays.asm** and **random.asm** are fully tested and working (you really should make sure that they are before creating a library file; no point sharing bugs) we can now proceed to create a library of the useful utilities, held in the files **random.asm** and **delays.asm**. There is no point in including the file **main.asm** in the library – this file is your unique application file and is unlikely to be re-used in another project.

So let's create the library file now. Although you can do this in the MPLAB IDE, it is much easier and quicker to do it from the command line. Open up a command shell (DOS box) and change directory to our project:

**CD c:\epe**

Creating the library is done by running the **MPLIB** program (*Note: NOT MPLAB!*). On the command line you specify the name for the new library file, and list all the object files that you want added. In our case we do this:

**MPLIB utils.lib random.o delays.o**

and that will create a library file for us, containing the routines from the two object files. You can now share **utils.lib** with other people, or use it in your own new projects. Of course you will have to tell people what functions are in the file and how to use them, but you do not need to give them the source code and they will not have to re-build the files.

So how do we use the library file in our project? Very easily. In the **.mew** window in MPLAB, right click over the file **delays.asm** and select 'remove'. Don't worry, this doesn't delete your valuable source file – it just removes it from this project.

Repeat for the file **random.asm**.

Now right click over the 'Library Files' entry in the **.mew** window, click 'Add Files' and select the **utils.lib** file (you will probably have to navigate to the **c:\epe** directory). That's it! If you do a 'Build All'

from the IDE you will find the program builds much faster as only the **main.asm** file needs to be assembled – the routines in **utils.lib** are, of course, pre-assembled.

Don't forget to keep your source files safe – you cannot re-create them from the **.lib** file if you lose them.

## Other features

While we have demonstrated programming in only one language at a time (assembly or C with an optional C compiler) it is possible to mix both languages together. Routines can be written, compiled or assembled into a **.o** file and then linked into another project (directly or via a library file), just as we have been doing here.

It is also possible to include assembly language instructions directly into C language source files. Putting assembly language code in C source files is quite normal; you typically do it when you want a piece of code to run as fast as possible, assuming you have the skill to write better assembly code than the C compiler. Details are available in the IDE and C compiler documentation.

MPLAB provides a built-in option for programming devices directly from the IDE if you have a supported programmer interface connected. Bear in mind that in the case of some programmer hardware

(the PicKit2 for example) the programming software built into MPLAB may not support as wide a range of PIC devices as the programmer's own programming software. Our advice, for the PicKit2 at least, is don't bother with MPLAB's programmer option – for now.

One feature that you will want to use is the simulated UART. This feature allows you to simulate (inside the simulator – not available in the hardware debugger) an RS232 interface connected to the standard UART peripheral on the microcontroller. You can view in an output window tab any data sent out of the UART, and feed data into the program from a text file as though it were coming in on the RX pin.

To enable the feature click on **Debugger** followed by **Settings...** and click on the 'Uart1 IO' tab. Click on 'Enable Uart1 IO' and select the 'Window' option from the 'Output' section. When you close the dialog an extra tab will appear on the 'Output' window in the main IDE. Any data sent to the microcontroller UART from your program while running in the simulator will appear in this window.

You can also specify a file from which any bytes read by the UART will be redirected. Not so easy to use, but it can save you the trouble of wiring up an RS232 interface during initial development.

An extension of this UART simulator is the 'Stimulus' feature that provides a very powerful – and consequently, very complicated – means of simulating external signals being applied to your program. You can inject data into registers or signal levels onto pins, and even allow MPLAB to choose random values, all under user control via a GUI based scripting language. It's rather complicated but if you want to thoroughly test your software during development it could save you a lot of effort. The feature is found under the **Debugger** menu item and full help is supplied on the **Stimulus** dialog.

## Where next?

We have only scratched the surface of the facilities of MPLAB. There are many other features, and new features are being added as time goes by. The Help system within the MPLAB program provides a quick description of all these features, and you can find full details in the documentation that can be downloaded from the Microchip website on the 'MPLAB IDE' download page. Reading documents is unlikely to be enough, however; try a few projects, make mistakes and find the solutions – it's what the game is all about. There's plenty of help available on the Microchip forum and on our own *Chat Zone* forum via [www.epemag.co.uk](http://www.epemag.co.uk).

# ELECTRONICS TEACH-IN

BY MIKE TOOLEY

plus **FREE CD-ROM**

## OUT NOW

### ONLY £6.99 FROM WHSMITH

**£8.50 including p & p – from our *Direct Book Service***

**A broad-based introduction to electronics – find out how circuits work and what goes on inside them. Plus 15 easy-to-build projects. The 152 page A4 book comes with a *free* CD-ROM containing the whole *Teach-In 2006* series (originally published in *EPE*) in PDF**

**form, interactive quizzes to test your knowledge, TINA circuit simulation software (a limited version – plus a specially written TINA Tutorial), together with simulations of the circuits in the *Teach-In* series, plus Flowcode (a limited version) a high level programming system for PIC microcontrollers based on flowcharts.**

Available from larger branches of WHSmith or see our *Direct Book Service*

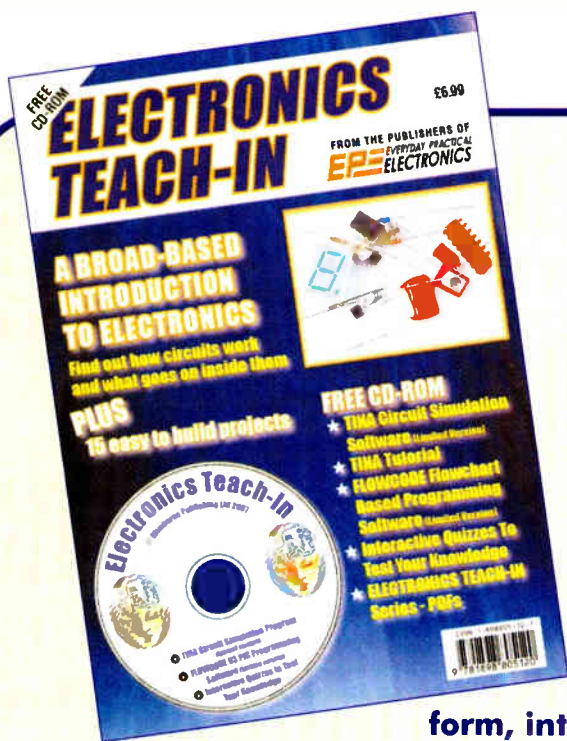

# EPE IS PLEASED TO BE ABLE TO OFFER YOU THESE ELECTRONICS CD-ROMS

## ELECTRONICS PROJECTS

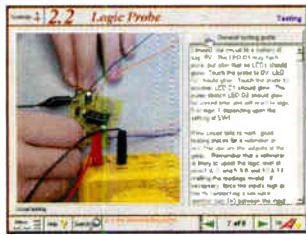

Logic Probe testing

*Electronic Projects* is split into two main sections: **Building Electronic Projects** contains comprehensive information about the components, tools and techniques used in developing projects from initial concept through to final circuit board production. Extensive use is made of video presentations showing soldering and construction techniques. The second section contains a set of ten projects for students to build, ranging from simple sensor circuits through to power amplifiers. A shareware version of Matrix's CADPACK schematic capture, circuit simulation and p.c.b. design software is included.

The projects on the CD-ROM are: Logic Probe; Light, Heat and Moisture Sensor; NE555 Timer; Egg Timer; Dice Machine; Bike Alarm; Stereo Mixer; Power Amplifier; Sound Activated Switch; Reaction Tester. Full parts lists, schematics and p.c.b. layouts are included on the CD-ROM.

## ELECTRONICS CAD PACK

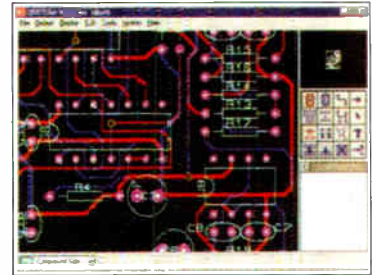

PCB Layout

Electronics CADPACK allows users to design complex circuit schematics, to view circuit animations using a unique SPICE-based simulation tool, and to design printed circuit boards. CADPACK is made up of three separate software modules. (These are restricted versions of the full Labcenter software.) **ISIS Lite** which provides full schematic drawing features including full control of drawing appearance, automatic wire routing, and over 6,000 parts. **PROSPICE Lite** (integrated into ISIS Lite) which uses unique animation to show the operation of any circuit with mouse-operated switches, pots, etc. The animation is compiled using a full mixed mode SPICE simulator. **ARES Lite** PCB layout software allows professional quality PCBs to be designed and includes advanced features such as 16-layer boards. SMT components, and an autorouter operating on user generated Net Lists.

## ELECTRONIC CIRCUITS & COMPONENTS V2.0



Circuit simulation screen

Provides an introduction to the principles and application of the most common types of electronic components and shows how they are used to form complete circuits. The virtual laboratories, worked examples and pre-designed circuits allow students to learn, experiment and check their understanding. Version 2 has been considerably expanded in almost every area following a review of major syllabuses (GCSE, GNVQ, A level and HNC). It also contains both European and American circuit symbols. Sections include: **Fundamentals**: units & multiples, electricity, electric circuits, alternating circuits. **Passive Components**: resistors, capacitors, inductors, transformers. **Semiconductors**: diodes, transistors, op.amps, logic gates. **Passive Circuits**. **Active Circuits**. *The Parts Gallery* will help students to recognise common electronic components and their corresponding symbols in circuit diagrams. Included in the Institutional Versions are multiple choice questions, exam style questions, fault finding virtual laboratories and investigations/worksheets.

## ANALOGUE ELECTRONICS

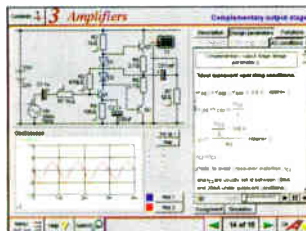

Complimentary output stage

*Analogue Electronics* is a complete learning resource for this most difficult branch of electronics. The CD-ROM includes a host of virtual laboratories, animations, diagrams, photographs and text as well as a SPICE electronic circuit simulator with over 50 pre-designed circuits.

Sections on the CD-ROM include: **Fundamentals** – Analogue Signals (5 sections), Transistors (4 sections), Waveshaping Circuits (6 sections), **Op.Amps** – 17 sections covering everything from Symbols and Signal Connections to Differentiators. **Amplifiers** – Single Stage Amplifiers (8 sections), Multi-stage Amplifiers (3 sections), **Filters** – Passive Filters (10 sections), Phase Shifting Networks (4 sections), Active Filters (6 sections), **Oscillators** – 6 sections from Positive Feedback to Crystal Oscillators. **Systems** – 12 sections from Audio Pre-Amplifiers to 8-Bit ADC plus a gallery showing representative p.c.b. photos.

## DIGITAL ELECTRONICS V2.0

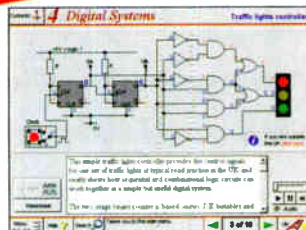

Virtual laboratory – Traffic Lights

*Digital Electronics* builds on the knowledge of logic gates covered in *Electronic Circuits & Components* (opposite), and takes users through the subject of digital electronics up to the operation and architecture of microprocessors. The virtual laboratories allow users to operate many circuits on screen.

Covers binary and hexadecimal numbering systems, ASCII, basic logic gates, monostable action and circuits, and bistables – including JK and D-type flip-flops. Multiple gate circuits, equivalent logic functions and specialised logic functions. Introduces sequential logic including clocks and clock circuitry, counters, binary coded decimal and shift registers. A/D and D/A converters, traffic light controllers, memories and microprocessors – architecture, bus systems and their arithmetic logic units. Sections on Boolean Logic and Venn diagrams, displays and chip types have been expanded in Version 2 and new sections include shift registers, digital fault finding, programmable logic controllers, and microcontrollers and microprocessors. The Institutional versions now also include several types of assessment for supervisors, including worksheets, multiple choice tests, fault finding exercises and examination questions.

## ANALOGUE FILTERS

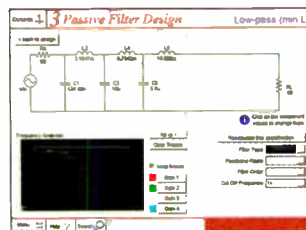

Filter synthesis

*Analogue Filters* is a complete course in designing active and passive filters that makes use of highly interactive virtual laboratories and simulations to explain how filters are designed. It is split into five chapters: **Revision** which provides underpinning knowledge required for those who need to design filters. **Filter Basics** which is a course in terminology and filter characterization, important classes of filter, filter order, filter impedance and impedance matching, and effects of different filter types. **Advanced Theory** which covers the use of filter tables, mathematics behind filter design, and an explanation of the design of active filters. **Passive Filter Design** which includes an expert system and filter synthesis tool for the design of low-pass, high-pass, band-pass, and band-stop Bessel, Butterworth and Chebyshev ladder filters. **Active Filter Design** which includes an expert system and filter synthesis tool for the design of low-pass, high-pass, band-pass, and band-stop Bessel, Butterworth and Chebyshev op.amp filters.

## ROBOTICS & MECHATRONICS



Case study of the Milford Instruments Spider

Robotics and Mechatronics is designed to enable hobbyists/students with little previous experience of electronics to design and build electromechanical systems. The CD-ROM deals with all aspects of robotics from the control systems used, the transducers available, motors/actuators and the circuits to drive them. Case study material (including the NASA Mars Rover, the Milford Spider and the Furby) is used to show how practical robotic systems are designed. The result is a highly stimulating resource that will make learning, and building robotics and mechatronic systems easier. The Institutional versions have additional worksheets and multiple choice questions.

- Interactive Virtual Laboratories
- Little previous knowledge required
- Mathematics is kept to a minimum and all calculations are explained
- Clear circuit simulations

## PRICES

Prices for each of the CD-ROMs above are:

(Order form on third page)

(UK and EU customers add VAT at 17.5% to "plus VAT" prices)

Hobbyist/Student.....	£45 inc VAT
Institutional (Schools/HE/FE/Industry).....	£99 plus VAT
Institutional 10 user (Network Licence).....	£249 plus VAT
Site Licence.....	£499 plus VAT

Everyday Practical Electronics, September 2007

# PICmicro TUTORIALS AND PROGRAMMING

## HARDWARE

### VERSION 3 PICmicro MCU DEVELOPMENT BOARD

*Suitable for use with the three software packages listed below.*

This flexible development board allows students to learn both how to program PICmicro microcontrollers as well as program a range of 8, 18, 28 and 40-pin devices from the 12, 16 and 18 series PICmicro ranges. For experienced programmers all programming software is included in the PPP utility that comes with the development board. For those who want to learn, choose one or all of the packages below to use with the Development Board.

- Makes it easier to develop PICmicro projects
- Supports low cost Flash-programmable PICmicro devices
- Fully featured integrated displays – 16 individual I.e.d.s, quad 7-segment display and alphanumeric I.c.d. display
- Supports PICmicro microcontrollers with A/D converters
- Fully protected expansion bus for project work
- USB programmable
- Can be powered by USB (no power supply required)

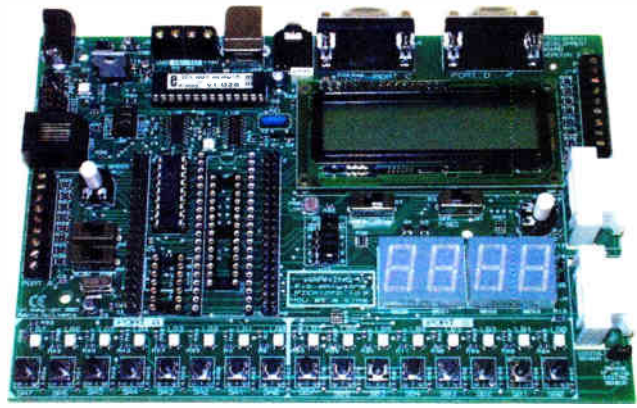

**£158 including VAT and postage, supplied with USB cable and programming software**

**SPECIAL OFFER**

**£40 OFF** Buy the Development Board together with any Hobbyist/Student or Institutional versions of the software CD-ROMs listed below and take £40 off the total (including VAT) price.

## SOFTWARE

### ASSEMBLY FOR PICmicro V3 (Formerly PICtutor)

Assembly for PICmicro microcontrollers V3.0 (previously known as PICtutor) by John Becker contains a complete course in programming the PIC16F84 PICmicro microcontroller from Arizona Microchip. It starts with fundamental concepts and extends up to complex programs including watchdog timers, interrupts and sleep modes. The CD makes use of the latest simulation techniques which provide a superb tool for learning: the Virtual PICmicro microcontroller. This is a simulation tool that allows users to write and execute MPASM assembler code for the PIC16F84 microcontroller on-screen. Using this you can actually see what happens inside the PICmicro MCU as each instruction is executed which enhances understanding.

- Comprehensive instruction through 45 tutorial sections
- Includes Vlab, a Virtual PICmicro microcontroller: a fully functioning simulator
- Tests, exercises and projects covering a wide range of PICmicro MCU applications
- Includes MPLAB assembler
- Visual representation of a PICmicro showing architecture and functions
- Expert system for code entry helps first time users
- Shows data flow and fetch execute cycle and has challenges (washing machine, lift, crossroads etc.)
- Imports

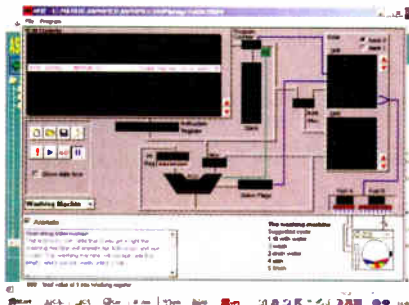

### 'C' FOR 16 Series PICmicro VERSION 4

The C for PICmicro microcontrollers CD-ROM is designed for students and professionals who need to learn how to program embedded microcontrollers in C. The CD contains a course as well as all the software tools needed to create Hex code for a wide range of PICmicro devices – including a full C compiler for a wide range of PICmicro devices.

Although the course focuses on the use of the PICmicro microcontrollers, this CD-ROM will provide a good grounding in C programming for any microcontroller.

- Complete course in C as well as C programming for PICmicro microcontrollers
- Highly interactive course
- Virtual C PICmicro improves understanding
- Includes a C compiler for a wide range of PICmicro devices
- Includes full Integrated Development Environment
- Includes MPLAB software
- Compatible with most PICmicro programmers
- Includes a compiler for all the PICmicro devices.

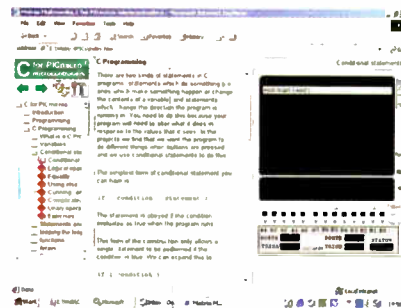

Minimum system requirements for these items: Pentium PC running Windows 98, NT, 2000, ME, XP; CD-ROM drive; 64MB RAM; 10MB hard disk space.

### FLOWCODE FOR PICmicro V3

Flowcode is a very high level language programming system for PICmicro microcontrollers based on flowcharts. Flowcode allows you to design and simulate complex robotics and control systems in a matter of minutes.

Flowcode is a powerful language that uses macros to facilitate the control of complex devices like 7-segment displays, motor controllers and I.c.d. displays. The use of macros allows you to control these electronic devices without getting bogged down in understanding the programming.

Flowcode produces MPASM code which is compatible with virtually all PICmicro programmers. When used in conjunction with the Version 3 development board this provides a seamless solution that allows you to program chips in minutes.

- Requires no programming experience
- Allows complex PICmicro applications to be designed quickly
- Uses international standard flow chart symbols (ISO5807)
- Full on-screen simulation allows debugging and speeds up the development process
- Facilitates learning via a full suite of demonstration tutorials
- Produces ASM code for a range of 18, 28 and 40-pin devices
- New features in Version 3 include 16-bit arithmetic, strings and string manipulation, improved graphical user interface and printing, support for 18 series devices, pulse width modulation, I2C, new ADC component and many more.

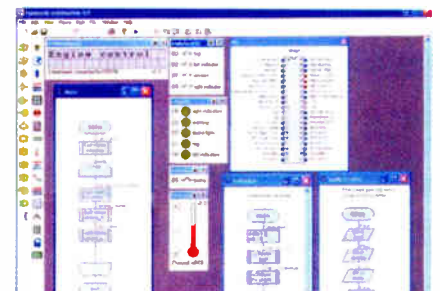

## PRICES

Prices for each of the CD-ROMs above are:

(Order form on next page)

(UK and EU customers add VAT at 17.5% to "plus VAT" prices)

Hobbyist/Student  
Institutional (Schools/HE/FE/Industry)  
Institutional/Professional 10 user (Network Licence)  
Site Licence  
Flowcode 10 user (Network Licence)  
Flowcode 50 user (Network Licence)

£45 inc VAT  
£99 plus VAT  
£300 plus VAT  
£599 plus VAT  
£350 plus VAT  
£699 plus VAT



## SPECIAL PACKAGE OFFER

### TINA Pro V7 (Basic) + Flowcode V3 (Hobbyist/Student)

**TINA Analogue, Digital, Symbolic, RF, MCU and Mixed-Mode Circuit Simulation, Testing and PCB Design**

£50.00

including VAT and p&p

TINA Design Suite is a powerful yet affordable software package for analysing, designing and real time testing analogue, digital, MCU, and mixed electronic circuits and their PCB layouts. You can also analyse RF, communication, optoelectronic circuits, test and debug microcontroller applications.

Enter any circuit (up to 100 nodes) within minutes with TINA's easy-to-use schematic editor. Enhance your schematics by adding text and graphics. Choose components from the large library containing more than 10,000 manufacturer models. Analyse your circuit through more than 20 different analysis modes or with 10 high tech virtual instruments. Present your results in TINA's sophisticated diagram windows, on virtual instruments, or in the live interactive mode where you can even edit your circuit during operation.

Customise presentations using TINA's advanced drawing tools to control text, fonts, axes, line width, colour and layout. You can create, and print documents directly inside TINA or cut and paste your results into your favourite word-processing or DTP package.

TINA includes the following Virtual Instruments: Oscilloscope, Function Generator, Multimeter, Signal Analyser/Bode Plotter, Network Analyser, Spectrum Analyser, Logic Analyser, Digital Signal Generator, XY Recorder.

Flowcode V3 (Hobbyist/Student) – For details on Flowcode, see the previous page.

This offer gives you two separate CD-ROMs in DVD style cases – the software will need registering (FREE) with Designsoft (TINA) and Matrix Multimedia (Flowcode), details are given within the packages.

**Get TINA + Flowcode for a total of just £50, including VAT and postage.**

## PROJECT DESIGN WITH CROCODILE TECHNOLOGY

### An Interactive Guide to Circuit Design

An interactive CD-ROM to guide you through the process of circuit design. Choose from an extensive range of input, process and output modules, including CMOS Logic, Op-Amps, PIC/PICAXE, Remote Control Modules (IR and Radio), Transistors, Thyristors, Relays and much more.

Click Data for a complete guide to the pin layouts of i.c.s, transistors etc. Click More Information for detailed background information with many animated diagrams.

Nearly all the circuits can be instantly simulated in Crocodile Technology\* (not included on the CD-ROM) and you can customise the designs as required.

#### WHAT'S INCLUDED

Light Modules, Temperature Modules, Sound Modules, Moisture Modules, Switch Modules, Astables including 555, Remote Control (IR & Radio), Transistor Amplifiers, Thyristor, Relay, Op-Amp Modules, Logic Modules, 555 Timer, PIC/PICAXE, Output Devices, Transistor Drivers, Relay Motor Direction & Speed Control, 7 Segment Displays. Data sections with pinouts etc., Example Projects, Full Search Facility, Further Background Information and Animated Diagrams.

#### Runs in Microsoft Internet Explorer

\*All circuits can be viewed, but can only be simulated if your computer has Crocodile Technology version 410 or later. A free trial version of Crocodile Technology can be downloaded from: [www.crocodile-clips.com](http://www.crocodile-clips.com). Animated diagrams run without Crocodile Technology.

**Single User £39.00 inc. VAT.**

**Multiple Educational Users (under 500 students) £59.00 plus VAT. Over 500 students £79.00 plus VAT.**

(UK and EU customers add VAT at 17.5% to "plus VAT" prices)



Over 150 pages  
Over 600 images

## DIGITAL WORKS 3.0



Counter project

*Digital Works Version 3.0* is a graphical design tool that enables you to construct digital logic circuits and analyze their behaviour. It is so simple to use that it will take you less than 10 minutes to make your first digital design. It is so powerful that you will never outgrow its capability ● Software for simulating digital logic circuits ● Create your own macros – highly scalable ● Create your own circuits, components, and i.c.s ● Easy-to-use digital interface ● Animation brings circuits to life ● Vast library of logic macros and 74 series i.c.s with data sheets ● Powerful tool for designing and learning. **Hobbyist/Student £45 inc. VAT. Institutional £99 plus VAT. Institutional 10 user £249 plus VAT. Site Licence £599 plus VAT.**

## ELECTRONIC COMPONENTS PHOTOS

A high quality selection of over 200 JPG images of electronic components. This selection of high resolution photos can be used to enhance projects and presentations or to help with training and educational material. They are royalty free for use in commercial or personal printed projects, and can also be used royalty free in books, catalogues, magazine articles as well as worldwide web pages (subject to restrictions – see licence for full details).

Also contains a **FREE** 30-day evaluation of Paint Shop Pro 6 – Paint Shop Pro image editing tips and on-line help included!

Price **£19.95 inc. VAT**



Minimum system requirements for these CD-ROMs: Pentium PC, CD-ROM drive, 32MB RAM, 10MB hard disk space. Windows 95/98/NT/2000/ME/XP, mouse, sound card, web browser.

### Please send me: CD-ROM ORDER FORM

- Electronic Projects
- Electronic Circuits & Components V2.0
- Analogue Electronics
- Digital Electronics V2.0
- Analogue Filters
- Electronics CAD Pack
- Robotics & Mechatronics
- Assembly for PICmicro V3
- 'C' for 16 Series PICmicro V3
- Flowcode V3 for PICmicro
- Digital Works 3.0

#### Version required:

- Hobbyist/Student
- Institutional
- Institutional/Professional 10 user
- Site licence



- PICmicro Development Board V3 (hardware)

- TINA Pro V7 Basic + Flowcode V3 Hobbyist/Student
- Electronic Components Photos
- Project Design – Single User
- Project Design – Multiple User (under 500 students)
- Project Design – Multiple User (over 500 students)

Note: The software on each version is the same, only the licence for use varies.

Full name: .....

Address: .....

..... Post code: ..... Tel. No: .....

Signature: .....

I enclose cheque/PO in £ sterling payable to WIMBORNE PUBLISHING LTD for £

Please charge my Visa/Mastercard/Amex/Diners Club/Switch: £

Valid From: ..... Card expiry date: .....

Card No: ..... Maestro Issue No. ....

Card Security Code ..... (The last 3 digits on or just under the signature strip)

## ORDERING

**ALL PRICES INCLUDE UK POSTAGE**

Student/Single User/Standard Version price includes postage to most countries in the world  
EU residents outside the UK add £5 for airmail postage per order

Institutional, Multiple User and Deluxe Versions – overseas readers add £5 to the basic price of each order for airmail postage (do not add VAT unless you live in an EU (European Union) country, then add 17½% VAT or provide your official VAT registration number).

Send your order to:  
**Direct Book Service**  
**Wimborne Publishing Ltd**  
**Sequoia House, 398a Ringwood Road**  
**Ferndown, Dorset BH22 9AU**

To order by phone ring  
**01202 873872. Fax: 01202 874562**

Goods are normally sent within seven days

E-mail: [orders@wimborne.co.uk](mailto:orders@wimborne.co.uk)

Online shop:  
[www.epemag.wimborne.co.uk/shopdoor.htm](http://www.epemag.wimborne.co.uk/shopdoor.htm)

# Circuit Surgery

Ian Bell

## Linear Voltage Regulators and Capacitors – Part Three



Two months ago we started looking at a question posed by *Techno* on the *EPE Chat Zone*, who was asking about the capacitors that are required on the output of some regulator ICs. These capacitors are needed to ensure the stability of the regulator's negative feedback loop – by stability we mean that the circuit does not undergo unwanted oscillations. To provide a foundation for understanding this issue, in the first article we looked at some of the basics of feedback in the context of op amp circuits.

For op amps, the negative feedback allows properties of the circuit to be largely independent of the op amp's characteristics, in particular the gain of an op amp in an amplifier circuit is determined only by the external resistor values. For a regulator, the feedback loop controls the output voltage by comparing it with a fixed reference value. If an amplifier has a gain of  $A$  and the feedback is a fraction  $\beta$  then the value  $\beta A$  is called the *loop gain* – the manner of variation of the loop gain's magnitude and phase shift with frequency are critical to a system's stability.

Unfortunately, negative feedback has the potential to produce instability. As the signal frequency increases the phase shift produced by the circuit often tends to increase and at some point may reach  $180^\circ$ .

This is equivalent to inverting the signal, at which point any negative feedback becomes positive feedback and oscillation may result. To prevent this unwanted oscillation we have to make sure that as frequency increases the phase shift of the loop gain remains less than  $180^\circ$  until the

magnitude of the loop gain is less than one. We can characterise how much stability 'headroom' we have using *gain margin* and *phase margin*, which we defined previously.

Last month we saw how special circuitry in an op amp is used to ensure that the circuit is stable with negative feedback. This is known as *compensation*. The capacitors at the output of the regulators mentioned by *Techno*, are also compensation components. In general, in order to design compensation circuits we need to be able to analyse and manipulate the circuit's gain and phase frequency response. Full mathematical analysis of this requires the use of advanced techniques involving *complex numbers*. Last month we had a brief look at this without getting too involved in the actual mathematics.

### Complex numbers

Complex numbers are so called because they are two-dimensional, unlike the one-dimensional everyday numbers we all use. We can write circuit equations in terms of a special 'complex frequency variable' (usually denoted  $s$ ). The two-dimensional nature of  $s$  means that it simultaneously encompasses both gain and phase shift. If we write an equation for the circuit's output in terms of the input, the component values and  $s$ , we can find values of  $s$  where the circuit's response (in the complex number domain) goes to infinity (called *poles*) and to zero (called *zeros*).

Poles and zeros indicate significant points in the circuit's frequency response. At frequencies above a pole, the gain of a circuit

will drop by 20dB per decade (6dB per octave) more than at the pole frequency.

At frequencies above a zero, the gain of a circuit will increase by 20dB per decade (6dB per octave) more than at the zero frequency. To achieve compensation (ensure stability) circuit designers add poles and zeros to a circuit in order to modify the frequency response. Last month we saw how *dominant pole compensation* achieved stability for op amps used with negative feedback.

### Phase response

The phase response associated with poles and zeros is also critically important. Poles create a phase shift of  $-90^\circ$  and zeros a phase shift of  $+90^\circ$ . The phase shift effect associated with both poles and zeros starts at about a tenth of the pole or zero frequency and finishes (with a full  $90^\circ$  shift added to the circuit's response) at about ten times the pole or zero frequency. The phase shift contributed by the pole or zero at the pole or zero frequency is  $45^\circ$  (positive for a zero and negative for a pole).

Compare this with the effect on gain – poles and zeros affect the gain for all frequencies above the pole or zero frequency, whereas they affect the phase shift only in the decade above and below the pole or zero frequency.

This means that the relative spacing of pole and zero frequencies, not just the total number of poles and zeros, has a strong effect on the nature of the circuit's frequency response, and hence on stability. It is also worth noting the effect of poles and zeros are opposite so, for example, the effect of pole on a circuit's response could be removed by adding a suitable zero.

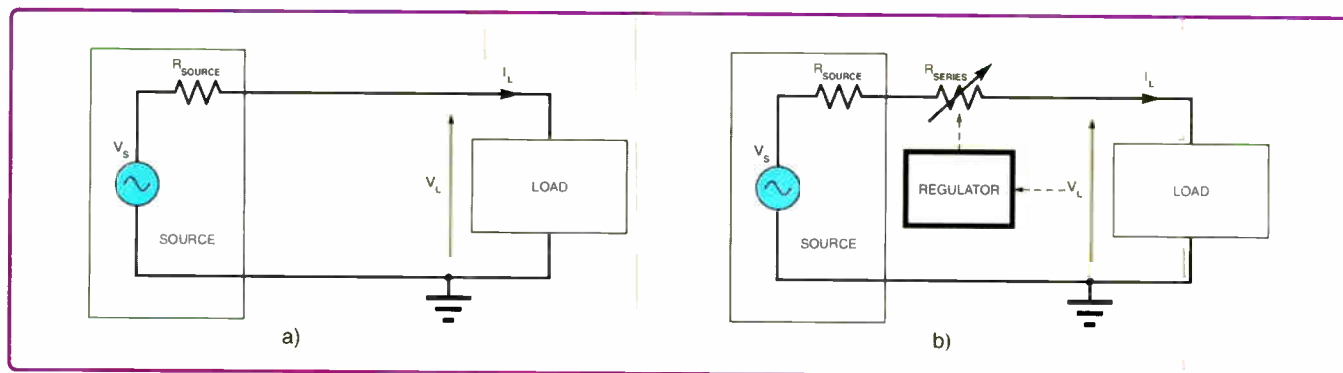

Fig. 1. (a) Unregulated supply, (b) Basic concept of series regulation

## Regulators

We will look at the poles and zeros relevant to regulator compensation later in this article, but first we will turn our attention to the regulators themselves, so we can familiarise ourselves with the circuits we will be trying to stabilise. Techno's question concerned the reason for connecting capacitors across the output of certain linear regulators. The circuits, which must have these capacitors to ensure stability, are of a type known as *Low Drop Out* (LDO) regulators. More basic linear regulators do not suffer from the same problem.

LDO regulators are needed in applications where the voltage drop across the regulator must be as small as possible to minimise dissipation and maximises efficiency, typically this is the case in battery powered systems. Early linear regulators such as the 7805 and LM340 suffered from relatively high power dissipation due to the large voltage drop (typically a couple of volts) from input to output of the regulator.

The minimum input to output voltage drop is called the *dropout voltage*, and LDO regulators typically have dropout voltages of less than 500mV, and as low as 20mV for low current loads. Switching regulators can also achieve high efficiency but produce more power-line noise than linear regulators. So, LDO regulators are used in systems requiring low-noise power supplies. In battery powered systems, the regulator's quiescent current (current taken when there is no load) is also important. Low quiescent current also improves efficiency.

To understand the basic idea behind a linear regulator see Fig.1. In the circuit in Fig.1a there is no regulation – as the load changes, variations in load current cause a varying voltage drop across the source's internal resistance and hence variation in the voltage across the load. Similarly, if the source voltage changes then the load voltage will also change. The source could be a battery or the DC output of a mains transformer with rectification and smoothing.

In Fig.1b, a variable resistor is added to the circuit in series with the load – so this arrangement is known as a series regulator. The series regulator is not the only possible linear regulator configuration, but it is the most widely used.

For the circuit in Fig.1b, as the load varies, or the source voltage changes, the regulator adjusts the series resistor value so that the voltage across the load is constant. The voltage across the series resistor is called the *dropping voltage*. Regulating in this way dissipates power in the series resistor, so ideally the dropping voltage should be as small as possible.

In practice, the series 'resistor' is actually a transistor circuit (the pass transistor), which means that a certain minimum dropping voltage is required to keep the device operational (called the *dropout voltage*). A smaller dropout voltage means the regulator is likely to be more efficient.

## Linear regulator

In Fig.2 is shown a simplified schematic of a typical linear regulator. This circuit structure applies to both LDO and non-LDO regulators, with the key difference being in the pass transistor circuit. The regulator controls the current supplied to the load in such a way

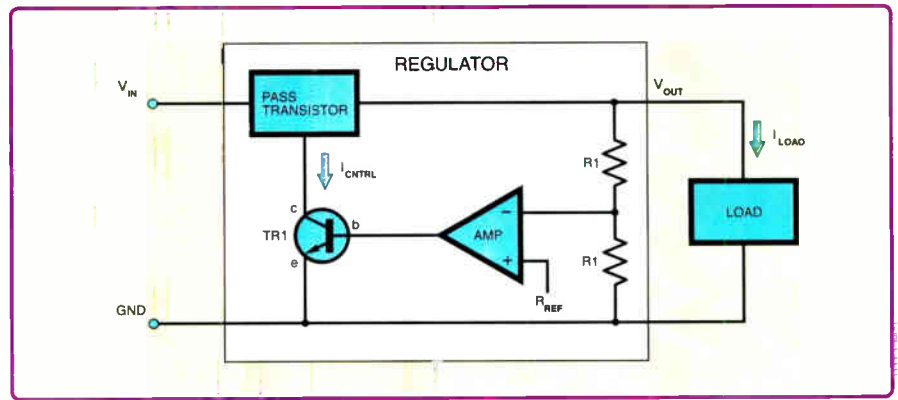

Fig.2. Typical linear regulator circuit

as to keep the supply voltage (regulator output voltage,  $V_{out}$ ) constant.

The regulator contains a potential divider which produces a fixed fraction of the regulated supply voltage. This is compared to a fixed reference voltage. If the output voltage decreases the amplifier output will increase because the potential divider is connected to the inverting input.

The increased output voltage will increase the control current to the pass transistor and hence the current to the load, which will tend to increase the output voltage and offset the initial decrease. This negative feedback loop will keep the potential divider voltage equal to the reference voltage and hence keep the output voltage fixed as the load varies. However, as with any negative feedback loop there is the possibility of instability, depending on the frequency response of the loop.

## Pass transistor circuit

The pass transistor circuit used in a standard, or *NPN*, regulator is shown in Fig.3. This circuit requires a minimum of two  $V_{BE}$  and one  $V_{CE,SAT}$  voltage drop across it, accounting for the typical dropout voltage in the range 1.5V to 2.5V for this type of regulator. The feedback loop in the *NPN* regulator is somewhat similar to an op amp in terms of its 'natural' frequency response, this enables dominant pole compensation to be used in the same way (as described last month).

The graphs in Fig.4 show the frequency response of a typical *NPN* regulator. Pole 1 is the low frequency pole introduced to provide dominant pole compensation (typically around 100Hz) and pole 2 is the first high frequency pole (in the order of megahertz), which is

associated with the power transistor in the pass transistor circuit.

Two poles produce a total phase shift of  $180^\circ$ , which has the potential to create instability. However, with a dominant pole, as frequency increases, the gain drops by a large amount before the next pole has any effect on phase shift. The circuit has a respectable phase margin and is fully stable.

Note that although *NPN* regulators are inherently stable, datasheets often

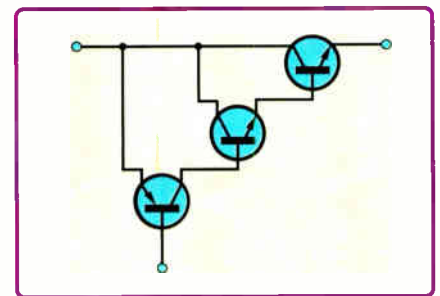

Fig.3. Typical 'pass transistor' for a standard (NPN) regulator

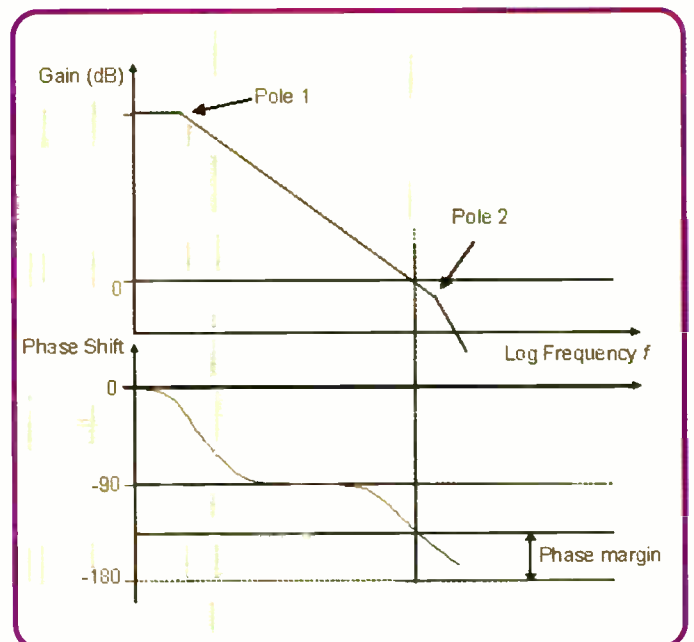

Fig. 4. Typical frequency response of an NPN regulator

# The Power of Mechatronics

## Part Four – Adding Speech to Your Application by Darren Wenn

Following on from the Motor Control discussion, we will continue looking at uses for the PWM module in a PIC microcontroller. This time, however, we will be looking at how we create a PWM based Digital-to-Analogue Converter (DAC) and use it to provide speech output.

### Mechatronics and speech

Let's look at where we might use this type of capability within a mechatronics context. If we are to consider the types of audible or visual interaction we may currently have with a piece of equipment, then it may be nothing more than a simple bell being sounded or an indicator illuminated. This is a perfectly functional output and has served us well for many years, but how much does it tell us about what the indicator or sound actually means?

What if we were to add a new dimension to the warning, where it actually informed us what was happening? Let's take an over-temperature warning for example. An indicator is lit but does that mean we are just above the set point or about to go critical?

What about the classic fire alarm scenario? How many of us sit and look at one another when the fire alarm sounds wondering if it is simply a test and waiting for someone to make the first move? How about if the fire alarm actually told you it was a test or, more importantly, that a fire had been detected? Adding yet more intelligence, what if it were actively able to guide you to an exit away from the fire if your nearest exit is blocked?

These are examples of a system based purely on output from a given stimulus. The extension of this is to add a microphone to our system and create a speech recorder or intercom type system. With the correct back-end hardware in place, we can consider a simple telephony application or even the heady heights of Voice over IP (VoIP).

All of these applications stem from a relatively simple and low cost circuit to implement a microphone input or an output circuit to drive a loudspeaker or headphones. If we want to head up the scale in terms of quality then we may wish to add an audio DAC or even a CODEC to our system. Other considerations we can look into are compression algorithms for storage or compression of data prior to sending across a communication medium. The scope of these applications can take us from a relatively simple PIC MCU all the way up to the high performance dsPIC Digital Signal Controller.

Taking a lead from the motor control example, we can look at a feedback mechanism once again. This time, however, we aren't looking at a closed loop control example but how do we make our PIC quite literally talk back to us. In our example we will use the PIC24F since this lends itself easily to this application.

### Creating a DAC

We will start out by looking at how to create a simple DAC and filter circuit using the PWM or Output Compare from a PIC.

This can be seen in Fig.1. This simple form of PWM DAC uses a first order RC filter connected to the Output Compare/PWM pin of the PIC. This is perfectly suited to the creation of an analogue output voltage for use as a variable set point or similar capability. In our case we want to create speech output, with frequencies in the range of 300Hz to 3300Hz.

For this the basic RC circuit is insufficient for our needs. The reason for this is that we generate the analogue signal using a PWM with a switching frequency equivalent to 16kHz at 10-bit resolution. Our first order RC filter is chosen to have a corner frequency or  $f_{\text{cut-off}}$  at 4kHz to encompass the frequencies in human speech.

The filter design is based on the equation,  $RC = 1/(2 \times \pi \times f)$ , where  $f = 4\text{kHz}$  and  $C = 0.01\mu\text{F}$ . This provides a value for  $R = 4\text{k}$ . If we look at the frequency response graph in Fig.2, we can see that the roll-off from our first order RC filter is very gentle. As a consequence the rejection of the 16kHz PWM switching frequency is minimal, with the result that it will remain audible and painful to listen to. How do we solve this?

The answer is to increase the filter order. However, is it best to use higher order RC or active filters? The answer to this question, which can be seen from the graph, is to use at least a fourth order active filter. The frequency response for this ensures that we have a suitable roll-off and rejection of the 16kHz PWM frequency. We can also note from the graph that it is possible

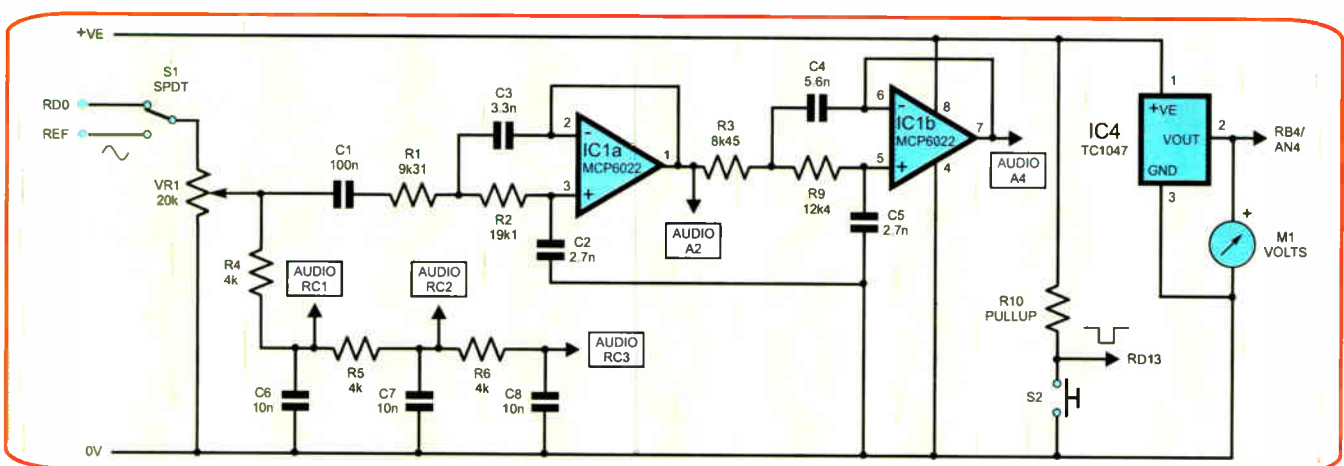

Fig.1 Modified speech PICtail with interactive components and RC filter(s). Select RD0 to use the audio graph and replay audio generated by the PIC24. Select REF to use the frequency graph and display the frequency response of the filter

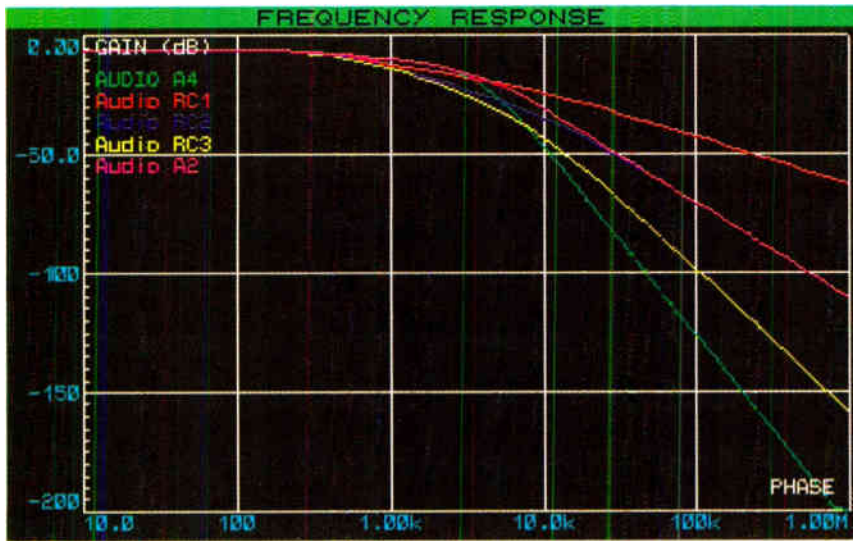

Fig. 2. Frequency response graph

to use a third order, or higher, RC filter, but the slope of the filter will start to encroach on the active signal region and therefore may potentially degrade our generated speech signal. The Fourier Analysis graph in Fig.3 shows the increased rejection capabilities of each of the filter types such that the fourth order active filter is barely visible and therefore should be inaudible.

### PWM frequencies

An alternative approach can also be performed, which is to combine the analogue filter with an increased PWM frequency. It is possible to increase the PWM frequency to greater than 20kHz, which is effectively beyond the audible range for human hearing, which will also improve the rejection by several dB for a given filter type.

The drawback of this is that PWM resolution is limited by the clock frequency of the MCU. If you wish to operate at a high bit rate and high frequency, then the clock rate of the MCU will need also to be increased since the three are linked.

The data sheet for a PIC explains how to set up the PWM module and also the

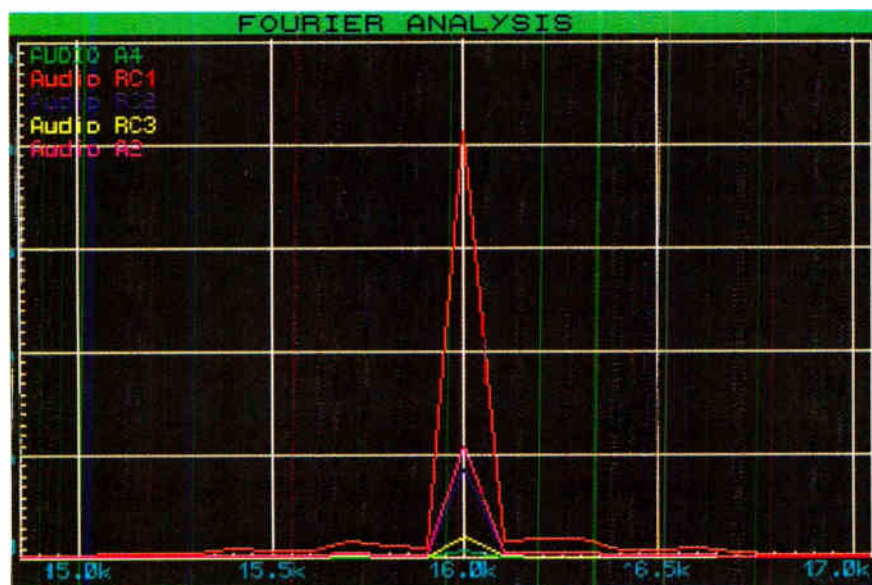

Fig. 3. Fourier Analysis graph

$$\text{Maximum PWM resolution} = \frac{\log_{10}(F_{CY}/F_{PWM}) \text{ bits}}{\log_{10}(2)}$$

Fig. 4. Maximum PWM resolution calculation

calculations for PWM frequency and the maximum bit resolution which can be obtained for a given clock and PWM frequency. The maximum resolution is calculated as shown in Fig.4. The table in Fig.5 shows some of the PWM frequency vs. bit resolution options for a range of PICs and dsPIC DSCs. The limitations imposed by the maximum clock frequency of the

Device	F <sub>PWM</sub> (KHz)	F <sub>cy</sub> Max (MHz)	Theoretical Resolution Max(bits)	Working Resolution Max (bits)
PIC18F*				
	8	10	10.29	10
	10	10	9.97	9
	12	10	9.70	9
	16	10	9.29	9
PIC24F				
	8	16	10.97	10
	12	16	10.38	10
	16	16	9.97	9
	24	16	9.38	9
	44.1	16	8.50	8
dsPIC33F/PIC24H				
	8	40	12.29	12
	12	40	11.70	11
	16	40	11.29	11
	24	40	10.70	10
	44.1	40	9.83	9
	48	40	9.70	9

\* maximum 10-bit (8+2 bits) PWM resolution on PIC18F

Fig. 5. Relationship between clock rate, PWM frequency and resolution for various PICs

device and bit resolution available can be seen and quickly highlights the devices that would need to be considered for a given desired output quality.

Given this limitation, is it possible to obtain high PWM frequencies, at high resolution with a lower MCU clock frequency? In short, yes. The technique is to create a binary weighted DAC output from more than one PWM output. The topology is very similar to that seen already, except we split the value to be output across two or more PWM modules, in most cases two is sufficient. If we wanted to have 16-bit at 16kHz, for instance, we would split the 16-bit value into 2 x 8-bit values and send each half to a separate PWM. We can then benefit from the ability to clock the PWM at a significantly faster rate for a higher PWM frequency or, at the same rate with a lower system clock speed.

A lower clock rate or higher frequency can be used since the effective overall PWM resolution has been increased for a

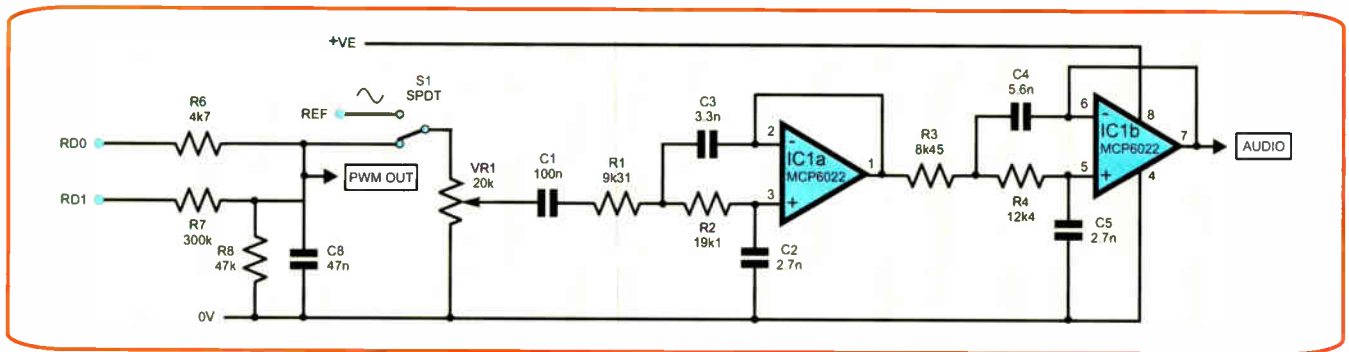

Fig.6. Dual weighted DAC. Select RD0 to use the audio graph and replay audio generated by the PIC24. Select REF to use the frequency graph and display the frequency response of the filter

given PWM frequency. External to the MCU, the outputs are weighted with a resistor such that the  $LowR = 2^n \times HighR$ , where 'n' is the number of bits of resolution for each PWM. The resultant outputs are then combined in the analogue domain and fed to an appropriate filter as for a single ended output, as shown in Fig.6.

To account for tolerances in the weighting resistors it may be necessary to tune the DAC output and as a result scale it to suit. This can be achieved with a look-up table or equation in the MCU.

### Getting the data out

The application chosen to demonstrate speech output is a talking thermometer. This is useful as it shows how to perform several operations within the PIC24. The ADC is used to read a TC1047A analogue output temperature sensor. The ADC result is converted to an equivalent temperature value and parsed to determine the speech samples to output. The speech is stored in the device as a table of samples, from which all of the values required for the temperature range of the sensor can be created.

For example, if the temperature was 23°C we would playback the individual words '20, 3, degrees, celsius'. Storage of the samples in this manner significantly reduces the storage overhead and increases the options for data storage. In our case, the complete vocabulary and application is stored in the 128K of internal program memory afforded by the PIC24FJ128GA010. Other storage options exist, external to the MCU, including Data EEPROM, Serial Flash and Flash Memory Cards. Use of these we will leave for another article and continue with our use of Internal Program Memory.

So, now we have a large number of samples available in program memory, how do we access them? To make this task as simple as possible we have opted to use a filing system called MPFS. This is a proprietary Microchip file system which has been borrowed from the Microchip TCP/IP Stack application. It affords us the use of MS-DOS style 8.3 filenames but with a very low system overhead for the filing system.

This means we can create our sound samples on a PC and then use the MPFSv2

```
//Filename setup in array of characters

filename[0] = 'd';           // filename = 'deg.dat'
filename[1] = 'e';
filename[2] = 'g';
filename[3] = '.';
filename[4] = 'd';
filename[5] = 'a';
filename[6] = 't';
filename[7] = 0;

hFile = MPFSOpen(filename); // Open file
PlayClip(hFile);           // Play audio clip
for(time=0;time<65534;time++); // delay
```

Fig.7. File access using MPFS

application to create an image file for use by the embedded portion of the MPFS filing system on the PIC24. An example of file access using MPFS is shown in Fig.7.

While we have a method to access our stored data files, we do have to pay some attention to the quantity of memory used to store data. Certainly the easiest way to access data is from raw files. However, this is memory intensive and in an embedded system memory is an expensive commodity. Therefore, we need to use some form of compression algorithm to make best use of available memory.

Consider the situation where we wish to store telephone quality speech. This is sampled at 8kHz 8-bit, which results in a bandwidth of 64kbps. If we start to increase the sample frequency or resolution to say 16kHz 16-bit, this results in a 256kbps data stream. Thus, if we wished to store it as raw data, would require 1Mbit for four seconds of speech.

Clearly, from a storage perspective, especially in an embedded system, this would be unacceptable for any useful quantity of data. Since bandwidth costs money, it makes sense to compress the data as best we can. If we consider that for very few MIPS simple algorithms can be implemented on a MCU providing 2:1 and 4:1 compression and if we moved to DSP then 8:1 and 16:1 compression ratios are common, whilst retaining real

time functionality, then this is a huge benefit to our storage and communication system overhead.

However, we do need to consider the knock-on effects that the choice of algorithm has on our choice of processor. The options currently available for a PIC or dsPIC DSC are shown in Fig.8. In our case we are using the PIC24, so we are limited to the non-DSP algorithms and, since we want the best compression, we will opt to use the IMA-ADPCM algorithm (full details are explained in Microchip application note AN643). This algorithm affords us a 4:1 compression ratio, which helps reduce internal program memory requirement to 25% of that if raw data had been used, so our 1Mbit of memory now allows us to store 16 seconds of speech. If we were to reduce the sample rate and resolution the effective storage capability also increases. The IMA-ADPCM algorithm also allows us to record and manipulate samples on the PC prior to packaging with the MPFSv2 filing system tool.

All of these capabilities can be explored in the demos provided in this article's support package available on the EPE Downloads website (via [www.epemag.co.uk](http://www.epemag.co.uk)). This will allow you to explore speech playback and the filter choices using MPLAB IDE and the Proteus VSM package.

	Comp- ression Ratio	MIPS Required Enc/Dec	24F	24H	dsPIC 30F/33F	App Note / Library	Licence Required
G.711	2:1	1	☑	☑	☑	☑	
IMA-ADPCM	4:1	3/2	☑	☑	☑	AN643	
G.726	3.2 - 8:1	15			☑	☑	☑
Speex	16:1	19/3			☑	☑	☑

Fig.8. Available compression algorithms for PIC and dsPIC DSC

## Talking to your Machine

**Speech Control:** Speech control is the long awaited, much vaunted capability for control of devices. This is somewhat distorted by the movies, where an almost human level of interaction is possible between man and machine. The reality is somewhat different however, and the complexity of creating a faultless recognition system, capable of understanding all users, with multiple languages and dialects, remains a significant technical hurdle.

One of the better examples of speech recognition is voice dialling on a mobile phone. This is good but still drops numbers and it is still a long way short of human-to-human level interaction.

There has, and continues to be, a continued effort from commercial companies and universities to perfect speech recognition, and maybe one day we will have intelligent conversations with a machine. For now, however, we will take a look at relatively simple voice recognition provided by the dsPIC Speech Recognition Library.

The speech recognition capability provided by the dsPIC DSC is limited to a vocabulary of around 100 words. These have been chosen for their suitability for control oriented tasks with commands such as On, Off, Light, CD, Computer etc., and the numbers 0 to 9. The vocabulary should provide sufficient recognition and therefore control capability for most tasks. It is possible to add words to the system, but the sample set of independent voices required and post manipulation of the samples is considerable in time, effort and cost.

Speech recognition falls into two main categories, speaker dependent and speaker independent. Let's take a look at the key differences between them.

**Speaker Dependant:** A speaker dependant system is limited to the voice of a single user. More users can train a system but the overall effect is a library of users with dependant voice characteristics.

A speaker dependant system requires significant training to cope with changes of pronunciation and differences in the voice coupled with environmental noise. The pattern matching is therefore only as good as the input to the algorithm, the algorithm itself and the quality and variability of the training. However, the vocabulary and base language may be less restricted.

**Speaker Independent:** The flipside of speaker dependant systems is speaker independent systems. The aim here is to have a vocabulary of words available such that many users can interact with a system without additional training. To create a word model for an independent speaker, the vocabulary has to be recorded by a significant and variable enough sample set of voices. Often greater than 1000 may be required, to provide a good cross section of the way each word is spoken.

The words are chosen in a specific language, in our case US English, and once sampled the individual words are processed and manipulated to ensure there is a high probability of recognition by the system of all the sampled voices.

To aid recognition when in use, the expected vocabulary and keywords can be created using a word builder application on

a PC. This allows the expected commands to be built and tuned to suit the environmental conditions the system is expected to work within. This aids the probability of recognition, but by no means makes a speech recognition system infallible.

Therefore, using a speech recognition capability and an appropriate set of control actions, it is possible to perform speech control of equipment, such as speaking a telephone number, rather than dialling, turning lights, thermostat or white goods on/off, up/down. The possibilities are limitless but they are bounded by the limitations and capabilities of a given speech recognition system.

## Speech input

While full human interaction is at one end of the scale, adding the ability to record speech or provide a capability such as a telephone or intercom, is certainly more within our reach. For all of the audio input functions available the input system comes down to the same basic requirement, a microphone. Again, we could use a CODEC for this since it will provide a high quality input capability. However, keeping cost in mind, we can look at a more common interface for a microphone which is then sampled and digitised via our on-board ADC.

Once digitised, many options of what to do with the data exist. In the DSP world we can perform additional filtering or signal manipulation, such as noise and echo cancellation. We may simply wish to store our sampled speech or send it along some form of communication medium. This then

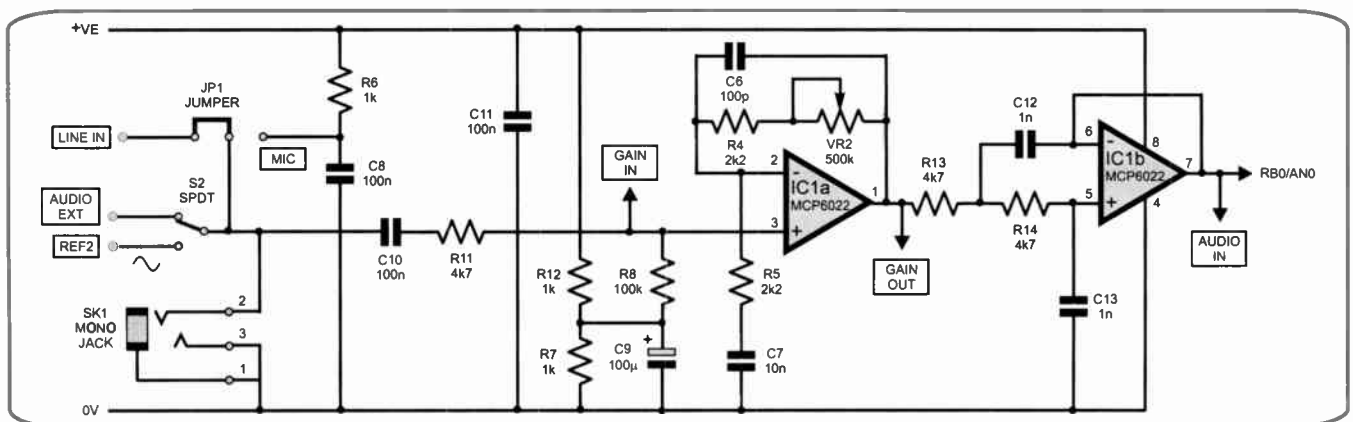

Fig.9. Microphone interface to ADC. Select Audio EXT to play input WAV file and use the audio graph to replay the audio generated input stage to the PIC24. Select REF2 to use the interactive graph and display the various stages of gain and filtering prior to input to the PIC24. Select MIC for biased microphone input, select LINE IN for non-biased input from external source

	ADC No. of Bits	Sample Frequency (kHz)	Bandwidth (kbps)					Comment
			Raw	G.711	IMA-ADPCM	G.726*	Speex**	
Compression ratio			1:1	2:1	4:1	upto 8:1	16:1	
	8	8	64	32	16	8	n/a	
	16	8	128	64	32	16	8	Use CODEC
	16	16	256	128	64	32	n/a	Use CODEC
	10	12	120	60	30	15	n/a	
	10	16	160	80	40	20	n/a	
	12	12	144	72	36	18	n/a	
	12	16	192	96	48	24	n/a	

\* dsPIC DSC required for these algorithms

\*\*Speex Encode Decode Library currently fixed at an 8kHz 16-bit sample rate providing 8kbps output

Fig.10. ADC sample rates and resultant data rate with compression options

highlights our earlier discussion regarding bandwidth and compression. If we are to create a playback/record system or an end-to-end communication system, then attention must be paid to reducing the total amount of data stored or transmitted through use of a compression algorithm of some form.

Let's take a look at a microphone interface to our ADC, see Fig.9.

This requires a bias circuit, amplifier and a filter similar to the playback filter discussed earlier. We are interested in a signal range of approximately 300Hz to 3300Hz, so a low pass filter with a cut off frequency of 4kHz should be sufficient. This will impose a minimum sample rate of 8kHz, which is twice our maximum expected signal as defined by the low pass filter cut-off frequency. This will allow us to meet the Nyquist sampling theorem requirements of minimum  $2 \times f_c$  to ensure sufficient information is sampled to fully re-create the original waveform.

We can, of course, sample at a higher rate than 8kHz which should serve to improve the quality of our signal. However, we do need to determine the quality we need rather than the quality we desire. As discussed above, the higher our sample rate the greater the requirements placed on the onward system, see Fig.10.

If, as in this case, the quality of our analogue system ultimately limits the overall signal quality, then opting for a higher sample rate and high bit quality may simply be unnecessary. Also, we need to consider that we may have only a 10- or 12-bit ADC available internally to the device, so a

compromise of some form will be required. Often we will find that a perfectly good quality signal can be reproduced from one sampled at 10-bit 12kHz or variations around this point.

### Creating a Voice Recorder

Using the microphone interface and adding a suitable storage medium it is possible to create a speech recorder, as in Fig.11.

Some consideration has to be made for the sample rate and resultant stored data size. Use of some form of compression technology will help reduce stored size of the sampled data. A further consideration when storing data however, is the resultant

data rate and matching this to the speed at which we can access and write to our storage medium.

Non-volatile memory technologies are limited by the time it takes to write the data into a memory cell, normally in the order of a few milliseconds. To help alleviate this, some storage devices provide a buffer and are best written to in data packets. Therefore, we may need to buffer a packet in RAM prior to sending this to our non-volatile memory storage device. The packet size can range from a few bytes for a Data EEPROM up to 512 bytes if we were storing a sector's worth of data using the FAT16 filing system on a flash memory card.

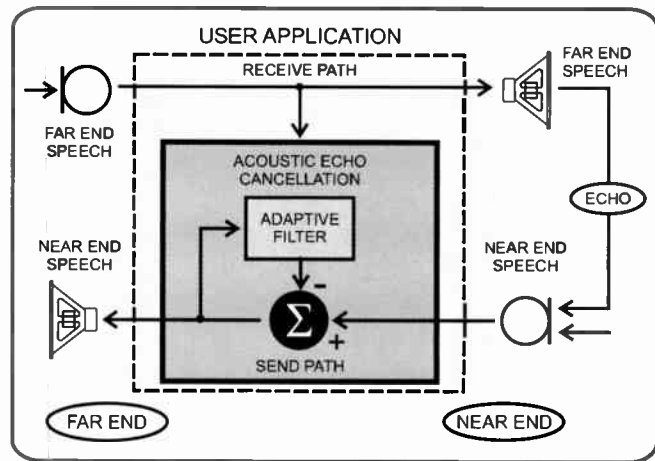

Fig.12. Acoustic echo cancellation system diagram

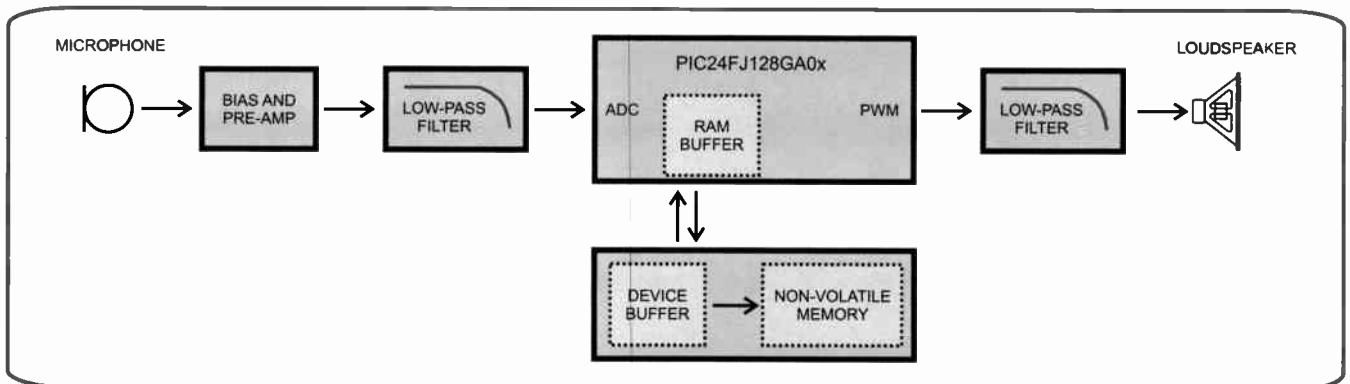

Fig.11. Block diagram of voice recorder



## Creating an Intercom

Once we have the microphone interface and the playback mechanism, we are at the point where adding a communications channel will allow us to create an intercom. We may then want to consider the addition of such technologies as echo and noise cancellation to help clean up our end-to-end system.

As we have now entered the realm where multiple algorithms may be in progress, we have to consider moving into the DSP arena to gain additional processing performance. Many of the algorithms which will provide the most benefit for speech compression also require DSP capability. If we consider the 16:1 compression ratio that the SPEEX algorithm provides and the resultant reduction in bandwidth this offers for storage and communications, then it is easy to see why moving up to the dsPIC makes sense.

Since we are considering an end-to-end system, then additional environmental factors such as noise and acoustic echo may need to be handled. These can help to create a significantly improved experience for the user.

Noise cancellation is basically the spectral reduction of noise in a system with the effect that speech appears to be enhanced as a result. To operate, the algorithm constantly monitors blocks of sampled data to determine if they contain noise. A component known as a VAD or Voice Activity Detect module is used to determine if a given sample block also contains speech. This combination allows the algorithm to build up a picture or profile of the noise in a system and as such performs a scaling of the noise to suppress it.

Acoustic Echo Cancellation is used to eliminate the inevitable acoustic wraparound which occurs in a system where the speaker emits into open space and the microphone is therefore able to pick-up this noise and return it to its source. Fig.12 should help to explain the problem.

The solution is to use the dsPIC to monitor the far-end speech and using an adaptive filter it is able to remove the far end speech from the near end speech. The result is such that it isn't returned to the far end and no echo is heard. It is a simple theory but extremely complex algorithms are required to perform echo and noise cancellation.

## Can I play music?

Yes, you can play music or audio but, bear in mind all of the discussion regarding

PWM frequency and filter cut-off. If we consider that the audio bandwidth is around 20Hz to 20kHz, then our filter will need to have a cut off frequency around 20kHz so our sample rate would need to be around 40kHz. This has implications on our PWM and its relationship to clock frequency and available bits. Therefore, to achieve the playback rate, we would need to consider using a dual-weighted PWM, or more sensibly use a CODEC to provide a good quality output.

## Can I decode MP3 or similar?

MP3 decoding may be possible on dsPIC33F devices, but it is possible to playback .WAV files, so if a device is coupled with a memory card, this should be easy to achieve. However, consider that to playback audio the most suitable signal chain is to include a good quality stereo audio CODEC. This will improve the playback quality, provided equally good quality amplifier and speakers are used, but it will increase the system cost. For simple speech playback via this route may therefore require careful consideration.

A further consideration is the increased power consumption required for the computation needed to perform the decoding on complex algorithms. If you are in a power sensitive application then often a much simpler algorithm like those implemented in our application will be more than sufficient. Suppliers such as Wolfson Microelectronics ([www.wolfsonmicro.com](http://www.wolfsonmicro.com)) have an excellent range of CODEC devices with an I<sup>2</sup>S interface so they can be connected easily to the dsPIC digital signal controller.

## Final message

The scope of options when it comes to adding some form of voice interaction with a system is quite large. We have concentrated on providing this capability via a low cost, easy to implement method using the ADC and PWM modules provided on PICs. We have focused on using the 16-bit PIC24F MCU as this provides the most versatility in terms of cost, memory and ease of use.

While the PIC24F isn't supported directly on the PICDEM Mechatronics hardware, you can still experience speech playback using the examples provided on the *EPE* website for use with the Proteus VSM simulator provided on the CD with the first article in the series.

## Exclusive board offer

The Microchip PICDEM Mechatronics Development Board not only supports all of the projects featured in this series of articles but also includes nine example projects, each complete with source code.

To claim your exclusive *EPE* 20% discount on the Microchip PICDEM Mechatronics Development Board contact ACAL Semiconductors on Telephone: +44 (0)118 902 9702. Fax: +44 (0)118 902 9614. Email: [sales@acalsemis.co.uk](mailto:sales@acalsemis.co.uk). Website: [www.acalsemis.co.uk](http://www.acalsemis.co.uk)

If you download the support package for this article from the *EPE* website, you will be able to use the Proteus VSM simulator with various demonstrations. The demonstrations are node locked, but will allow you to modify the passive component values, and hence modify the filter characteristics. However, you will be unable to modify any of the topologies. The source code for the device can be modified as desired, so it is possible to change the PWM rate and bit quality etc within the bounds imposed by the PIC24FJ128GA010 modelled.

A set of instructions is included with the demo to help you add traces to the graphs, run simulations and therefore compare each of the filter circuits. Used within MPLAB IDE, the VSM Simulator is an excellent tool for testing designs and learning about a system without the need to create any physical hardware.

Next month we will be looking into using the PICDEM Mechatronics board using Proteus VSM.

## References

### Microchip Application Notes

AN538 Using PWM to Generate Analog Output

AN643 Adaptive Differential Pulse Coded Modulation using a PIC

AN655 D/A Conversion Using PWM and R-2R Ladders to Generate Sine and DTMF Waveforms

### Books

*Programming 16-bit Microcontrollers in C - Learning to Fly the PIC24*, Lucio DiJasio, ISBN-13:978-0-7506-8292-3, Newnes

*A Baker's Dozen - Real Analog Solutions for Digital Engineers*, Bonnie Baker, ISBN: 0-7506-7819-4, Newnes

# **EP** EVERYDAY PRACTICAL ELECTRONICS

## NEWSAGENTS ORDER FORM

Please reserve/deliver a copy of *Everyday Practical Electronics* for me each month

Name and Address .....

Postcode ..... Tel .....

*Everyday Practical Electronics* is published on the second Thursday of each month and distributed S.O.R. by SEYMOUR  
Make sure of your copy each month - cut out or photocopy this form, fill it in and hand it to your newsagent

We can supply back issues of *EPE* by post, most issues from the past five years are available. An *EPE* index for the last five years is also available at [www.epemag.co.uk](http://www.epemag.co.uk) or see order form below. Alternatively, indexes are published in the December issue for that year. Where we are unable to provide a back issue a photocopy of any *one article* (or *one part* of a series) can be purchased for the same price. Issues from Jan. 99 are available on CD-ROM – see next page – and back issues from recent years are also available to download from [www.epemag.com](http://www.epemag.com).

Please make sure all components are still available before commencing any project from a back-dated issue.

## DID YOU MISS THESE?

### MAY '06

**PROJECTS** • LED Lighting For Your Car • Smart Card Reader and Programmer • Nail Sniffer and Volts Hound • Digital Reaction Timer.  
**FEATURES** • Teach-In 2006 – Part 7 • Practically Speaking • Ingenuity Unlimited • Circuit Surgery • Techno Talk • PIC 'N' Mix • Net Work – The Internet Page

### JUN '06

**PROJECTS** • Poor Man's Metal Locator • Widgy Box Distortion Effects For Your Guitar • Phone Ring & Test • Digital Instrument Display For Cars – Part 1.  
**FEATURES** • Interface • Circuit Surgery • Ingenuity Unlimited • Techno Talk • PIC 'N' Mix • Teach-In 2006 – Part 8 • Net Work – The Internet Page

### JUL '06 Photocopies only

**PROJECTS** • PIC Sudoku Unit • A Dirt Cheap High Current Bench Supply • PC Power Monitor • Digital Instrument Display For Cars – Part 2.  
**FEATURES** • Teach-In 2006 – Part 9 • Ingenuity Unlimited • Practically Speaking • Circuit Surgery • Techno Talk • PIC 'N' MIX • Net Work – The Internet Page

### AUG '06

**PROJECTS** • Loudspeaker Level Meter • Telephone Dialler for Burglar Alarms • Adjustable DC-DC Converter for Cars • High Intensity Torch  
**FEATURES** • Circuit Surgery • Techno Talk • Teach-In 2006 – Part 10 • PIC 'N' Mix • Interface • Ingenuity Unlimited • Net Work – The Internet Page

### SEPT '06

**PROJECTS** • Low Cost 50 MHz Frequency Meter • Smart Mixture Display for Your Car • Human Powered LED Torches • Water Level Gauge  
**FEATURES** • Teach-In 2006 – Part 11 • Ingenuity Unlimited • Circuit Surgery • Techno Talk • PIC 'N' Mix • Practically Speaking • Net Work – The Internet Page



### OCT '06

**PROJECTS** • Studio 350 Power Amplifier - Part 1 • Fridge Door-Open Alarm • Through-Glass Alarm • Linear Supply for 1W Star LEDs  
**FEATURES** • Ingenuity Unlimited • Circuit Surgery • Techno Talk • PIC 'N' Mix • Interface • Net Work – The Internet Page

### NOV '06

**PROJECTS** • Giant LED Message Display • Micropower Battery Protector • Quick Brake • Studio 350 Power Amplifier – Part 2  
**FEATURES** • C For PICs – Part 1 • Ingenuity Unlimited • Circuit Surgery • Techno Talk • PIC 'N' Mix • Practically Speaking • Net Work – The Internet Page

### DEC '06

**PROJECTS** • USB Power Injector • RGB To Component Video Converter • Lapel Microphone Adaptor For PA Systems • Mind Trainer  
**FEATURES** • C For PICs – Part 2 • Circuit Surgery • Interface • Ingenuity Unlimited • Techno Talk • PIC 'N' Mix • Net Work – The Internet Page

### JAN '07

**PROJECTS** • Balanced Microphone Preamp • Jumping Spider • High Efficiency Power Supply For 1W Luxeon Star LEDs • Charger For Deep-Cycle 12V Batteries – Part 1  
**FEATURES** • C For PICs – Part 3 • Circuit Surgery • Practically Speaking • Techno Talk • PIC 'N' Mix • Net Work – The Internet Page

### FEB '07

**PROJECTS** • PIC Digital Geiger Counter • Courtesy Light Delay • Programmable Robot • Charger for Deep Cycle 12V Batteries – Part 2  
**FEATURES** • C For PICs – Part 4 • Techno Talk • PIC 'N' Mix • Interface • Ingenuity Unlimited • Circuit Surgery • Net Work – The Internet Page

### MAR '07

**PROJECTS** • PIC Polyphonium – Part 1 • Lap Counter for Swimming Pools • IR Remote Checker • SMS Controller – Part 1  
**FEATURES** • Techno Talk • Practically Speaking • PIC 'N' Mix • Ingenuity Unlimited • Circuit Surgery • Net Work – The Internet Page



### APR '07

**PROJECTS** • Students' 20W Amp Module • Star Power • PIC Polyphonium – Part 2 • SMS Controller – Part 2  
**FEATURES** • Ingenuity Unlimited • PIC 'N' Mix • Interface • Visual C Training Course Review • Circuit Surgery • Net Work – The Internet Page

### MAY '07

**PROJECTS** • Energy Meter – Part 1 • Bass Extender • Caravan Lights Check • SMS Controller Add-Ons  
**FEATURES** • Ingenuity Unlimited • Circuit Surgery • Practically Speaking • Techno Talk • PIC 'N' Mix • Net Work – The Internet Page

### JUN '07

**PROJECTS** • Bat Sonar • 3V to 9V Converter • A Poor Man's Q Meter • Energy Meter – Part 2.  
**FEATURES** • The Power of Mechatronics – Part 1 • Using MPLAB – Part 1 • Circuit Surgery • Interface • PIC 'N' Mix • Ingenuity Unlimited • Network – The Internet Page • Techno Talk • Free Mechatronics CD-ROM.



### JULY '07

**PROJECTS** • Lead-Acid Battery Zapper • Video Reading Aid • Minimal 5V Meter Calibration Standard • Digi-Flash Slave  
**FEATURES** • Ingenuity Unlimited • Techno Talk • PIC 'N' Mix • Using MPLAB – Part 2 • Circuit Surgery • The Power of Mechatronics – Part 2 • Practically Speaking • Net Work.

### AUG '07

**PROJECTS** • V2 PC Scope – Part 1 • RFID Security Module • TwinTen Stereo Amplifier • Printer Port Hardware Simulator  
**FEATURES** • Ingenuity Unlimited • Techno Talk • PIC 'N' Mix • Using MPLAB – Part 3 • Circuit Surgery • The Power of Mechatronics – Part 3 • Interface • E-Blocks and Flowcode 3 Reviewed • Net Work.

## BACK ISSUES ONLY £4.00 each inc. UK p&p.

Overseas prices £4.75 each surface mail, £5.75 each airmail.

We can also supply issues from earlier years: 2002 (only Dec.), 2003 (except June), 2004 (except June, July, Oct and Dec.), 2005 (except Feb., Nov., Dec.), 2006 (except Jan., Feb., Mar., Apr. and July). Where we do not have an issue a photocopy of any *one article* or *one part* of a series can be provided at the same price.

### ORDER FORM – BACK ISSUES – PHOTOCOPIES – INDEXES

- Send back issues dated .....
- Send photocopies of (article title and issue date) .....
- Send copies of last five years indexes (£4.00 for five inc. p&p – Overseas £4.75 surface, £5.75 airmail)

Name .....

Address .....

Tel: .....

I enclose cheque/P.O./bank draft to the value of £ .....

Please charge my Visa/Mastercard/Amex/Diners Club/Maestro £ .....

Card No. .... Maestro Issue No .....

Valid From ..... Card Expiry Date ..... Card Security Code .....

(The last 3 digits on or just under the signature strip)

SEND TO: Everyday Practical Electronics, Wimborne Publishing Ltd., Sequoia House, 398a Ringwood Road, Ferndown, Dorset BH22 9AU.

Tel: 01202 873872. Fax: 01202 874562.

E-mail: [orders@epemag.wimborne.co.uk](mailto:orders@epemag.wimborne.co.uk) On-line Shop: [www.epemag.wimborne.co.uk/shopdoor.htm](http://www.epemag.wimborne.co.uk/shopdoor.htm)

Payments must be in £ sterling – cheque or bank draft drawn on a UK bank. Normally supplied within seven days of receipt of order.

Send a copy of this form, or order by letter if you do not wish to cut your issue.

M09/07

# STORE YOUR BACK ISSUES ON CD-ROMS

**VOL 16  
NOW AVAILABLE**

**ONLY  
£14.45** each  
including VAT  
and p&p

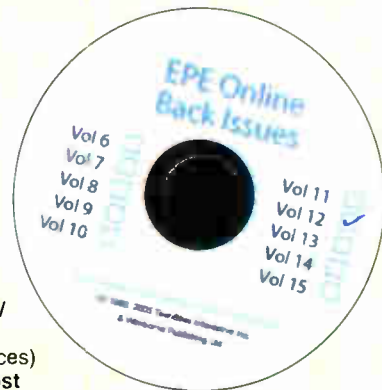

A great way to buy *EPE* Back Issues – our CD-ROMs contain back issues from our *EPE Online* website plus bonus articles, all the relevant PIC software and web links. Note: no free gifts are included.

- VOL 1: BACK ISSUES** – January 1999 to June 1999  
Plus some bonus material from Nov and Dec 1998
- VOL 2: BACK ISSUES** – July 1999 to December 1999
- VOL 3: BACK ISSUES** – January 2000 to June 2000
- VOL 4: BACK ISSUES** – July 2000 to December 2000
- VOL 5: BACK ISSUES** – January 2001 to June 2001
- VOL 6: BACK ISSUES** – July 2001 to December 2001
- VOL 7: BACK ISSUES** – January 2002 to June 2002
- VOL 8: BACK ISSUES** – July 2002 to December 2002
- VOL 9: BACK ISSUES** – January 2003 to June 2003
- VOL 10: BACK ISSUES** – July 2003 to December 2003
- VOL 11: BACK ISSUES** – January 2004 to June 2004
- VOL 12: BACK ISSUES** – July 2004 to December 2004
- VOL 13: BACK ISSUES** – January 2005 to June 2005
- VOL 14: BACK ISSUES** – July 2005 to December 2005
- VOL 15: BACK ISSUES** – January 2006 to June 2006
- VOL 16: BACK ISSUES** – July 2006 to December 2006

Order on-line from  
[www.epemag.wimborne.co.uk/  
shopdoor.htm](http://www.epemag.wimborne.co.uk/shopdoor.htm)  
or [www.epemag.com](http://www.epemag.com) (USA \$ prices)  
or by phone, Fax, E-mail or Post

NOTE: These CD-ROMs are suitable for use on any PC with a CD-ROM drive. They require Adobe Acrobat Reader (available free from the Internet – [www.adobe.com/acrobat](http://www.adobe.com/acrobat))

## WHAT IS INCLUDED

All volumes include the *EPE Online* editorial content of every listed issue, plus all the available **PIC Project Codes** for the PIC projects published in those issues. Please note that we are unable to answer technical queries or provide data on articles that are more than five years old. Please also ensure that all components are still available before commencing construction of a project from a back issue. Note: Some supplements etc. can be downloaded free from the Library on the *EPE Online* website at [www.epemag.com](http://www.epemag.com). No advertisements are included in Volumes 1 and 2; from Volume 5 onwards the available relevant software for *Interface* articles is also included.

## EXTRA ARTICLES – ON ALL VOLUMES

**BASIC SOLDERING GUIDE** – Alan Winstanley's internationally acclaimed fully illustrated guide. **UNDERSTANDING PASSIVE COMPONENTS** – Introduction to the basic principles of passive components. **HOW TO USE INTELLIGENT L.C.D.s**, by Julyan Ilett – An utterly practical guide to interfacing and programming intelligent liquid crystal display modules. **PhyzyyB COMPUTERS BONUS ARTICLE 1** – Signed and Unsigned Binary Numbers. By Clive "Max" Maxfield and Alvin Brown. **PhyzyyB COMPUTERS BONUS ARTICLE 2** – Creating an Event Counter. By Clive "Max" Maxfield and Alvin Brown. **INTERGRAPH COMPUTER SYSTEMS 3D GRAPHICS** – A chapter from Intergraph's book that explains computer graphics technology. **FROM RUSSIA WITH LOVE**, by Barry Fox – Russian rockets launching American Satellites. **PC ENGINES**, by Ernest Flint – The evolution of Intel's microprocessors. **THE END TO ALL DISEASE**, by Aubrey Scoon – The original work of Rife. **COLLECTING AND RESTORING VINTAGE RADIOS**, by Paul Stenning. **THE LIFE & WORKS OF KONRAD ZUSE** – a brilliant pioneer in the evolution of computers.

## BACK ISSUES CD-ROM ORDER FORM

Please send me the following Back Issue CD-ROMs. Volume Numbers: .....

Price £14.45 each – includes postage to anywhere in the world.

Name .....

Address .....

Post Code .....

I enclose cheque/P.O./bank draft to the value of £ .....

Please charge my Visa/Mastercard/Amex/Diners

Club/Maestro

£ .....

Card No. ....

Card Security Code ..... (The last 3 digits on or just under the signature strip)

Valid From ..... Expiry Date .....

Maestro Issue No. ....

SEND TO: Everyday Practical Electronics,  
Wimborne Publishing Ltd., Sequoia House, 398a Ringwood  
Road, Ferndown, Dorset BH22 9AU.

Tel: 01202 873872. Fax: 01202 874562.  
E-mail: [orders@epemag.wimborne.co.uk](mailto:orders@epemag.wimborne.co.uk)

Payments must be by card or in £ Sterling – cheque or bank draft drawn on a UK bank.  
Normally supplied within seven days of receipt of order.



Can your USB port take the heat?

# DEAD SIMPLE USB BREAKOUT 'BOX'

The USB port has made PC expansion so delightfully simple it's a wonder no-one thought of it before . . . but it has its limitations. Most PC users are completely unaware of this and wonder why the computer starts giving error messages or the USB devices themselves either stop working or misbehave. Here's a really simple way to find out what those devices are doing.

Computer interfacing via Universal Serial Bus (USB) ports, in either 12Mbps (Version 1.1) or more recent 480Mbps (Version 2.0) offerings, has deservedly become such an indispensable connection method that it's hard to realise USB has only been in use for just a few years.

Apart from seamless 'smart' data connections for digital cameras, flash RAM dongles, WiFi adapters, modems and mice, etc, the availability of a regulated 5V DC supply at relatively generous currents has also led to such diverse 'dumb' devices as mobile phone chargers, coffee cup warmers, cooling fans and inspection lights.

Dumb, of course, refers to the hi-tech USB data lines (middle pins 2 and 3) being ignored and just the low voltage DC being exploited at (outer) pins 1 and 4.

The PC's USB port can supply up to 500mA at 5V; however, downstream ports on USB devices are generally limited to 100mA maximum.

Although it may be considered frivolous to use a £500 PC to just power a light or charge batteries, the computer may be on anyway and equipment powered by the 5V USB supply is often conveniently associated with one's needs at the time.

Cold coffee, when trying to tame a late night spreadsheet macro, can easily ruin one's concentration!

The USB specification allows up to 5m of connecting cable, since signal timing issues may give data corruption with longer lengths. However, basic DC electrical issues also arise, with heavier currents giving unacceptable supply line voltage drops that infringe typical 5V  $\pm$  0.25V load electronics needs.

As an example, Ohm's law tells us if 250mA is flowing through a wire of resistance 0.5 $\Omega$ , then a tolerable drop of  $I \times R = 0.25 \times 0.5 = 0.125V$  will occur.

This wire with the 500mA maximum load, however, would drop 0.25V and deliver only a borderline

by Stan Swan

4.75V to the load, which may therefore work unreliably.

An additional issue relates to the power needs of the numerous items now in use. Even with short cable lengths, multiple USB devices (and up to 127 are possible!) can eventually demand more current than is permitted, with resulting port shutdown.

Unpowered hubs are particularly prone to this, which explains the need for powered USB hubs that will cater for multiple, energy-hungry add-ons.

Alternatively, a simple USB power injector could be used with an unpowered hub to achieve the same result.

EPE published such a project in the December 2006 issue, capable of supplying 5V DC at 1A to a USB device. Need more power than this for other devices? Add more power injectors!

Even though itself is now threatened by other advances in technology, Bluetooth has made a solid showing. Particular interest in verifying the output power of USB Bluetooth adaptors has therefore arisen.

The three Bluetooth classes have *decreasing* wireless power and range, and innocent purchase of a low power Class 2 adaptor may frustrate when range has to be maximised. The most powerful Class 1 is typically good

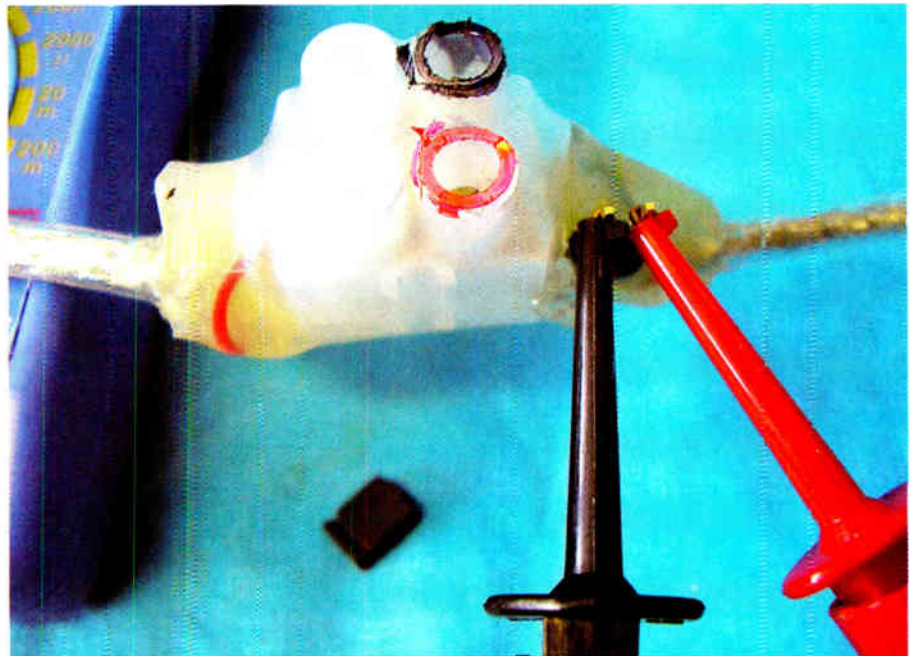

Here's Stan's prototype USB breakout 'box', potted in some hot-melt glue. The idea is to poke your multimeter probes into the terminal block (avoiding shorts) for voltage measurements; for current measurements, you remove the header pin shorting block and connect your multimeter in series.

increasingly popular USB WiFi adaptors also differ significantly in their transmitter output power.

This is especially important when receiving some distance from an access point, since you may be able to 'hear' its strong signals – but it may not sense your weak out-going ones.

Given these issues, it's surprising USB supply breakout adaptors haven't become more popular, since simple current and voltage measurement of assorted loads can be extremely revealing, especially if device specs are being stretched.

## Make your own!

With the cheapness of short USB M-F cables and DMMs, a simple supply breakout adaptor can quickly be organised by just cutting the cable. The position of the cut is unimportant – just ensure the data wires (usually green and white) and the braid are

neatly resoldered and heatshrink covered, with no mischievous whiskers from the braided shield!

A small terminal block makes for convenient voltage test points across the red and black supply wires – even though a DMM won't be worried by reverse polarity, we painted our terminal block red and black to identify '+' and '-'.

For current measurement (which, of course, must be in series), we included a 2-pin header pin base in the +ve (red) wire. To measure current, the shorting block is removed revealing a handy pair of terminals for our multimeter clip leads – see below.

Table 1 shows some sample measured currents, using a short 600mm cable to typical loads, supplied from a mains-powered Toshiba laptop.

This laptop PC's unloaded USB supply was measured at 5.04V, which dropped when loaded by the power-

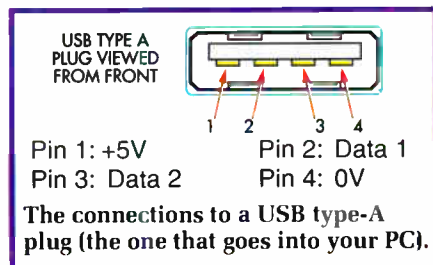

to 100m, with Class 2 some 10m and Class 3 just a metre 'across a motherboard'.

Although not specified in classes, (instead usually having power quoted in dBm [15dBi =  $10^{1.5} \sim 40\text{mW}$ ]),

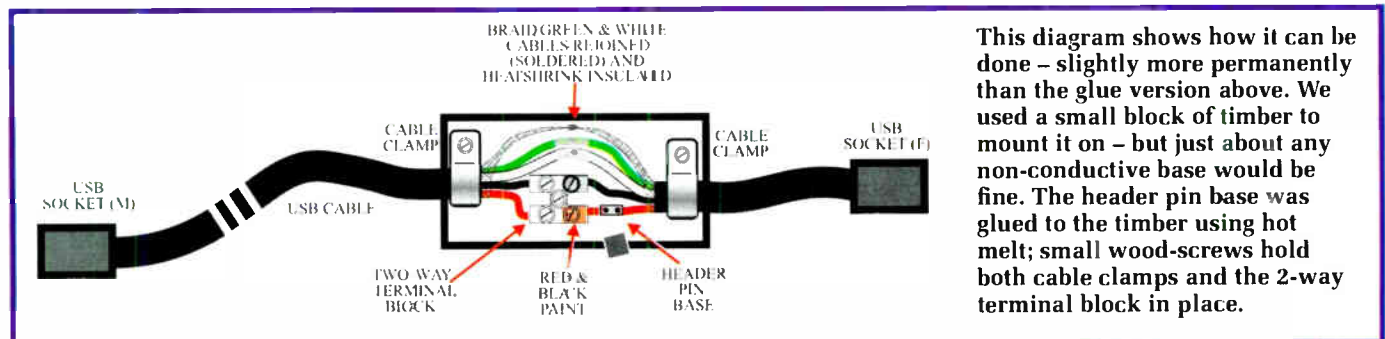

This diagram shows how it can be done – slightly more permanently than the glue version above. We used a small block of timber to mount it on – but just about any non-conductive base would be fine. The header pin base was glued to the timber using hot melt; small wood-screws hold both cable clamps and the 2-way terminal block in place.

# Constructional Project

**Table 1: Current measurements**

Device	Measured load current (may vary with load demands)
Pocket 40GB USB Hard Disk	300mA
Atmel 'b' WLAN adaptor DSE XH7947 (2002)	270mA
DSE 'b' WLAN adaptor XH6822 (2004)	90mA
Genius 'g' WLAN adaptor GW-7200U	63mA
Logitech Quick Cam(2000)	60mA
'My Flash' 256MB Flash RAM	50mA
DSE Class 1 BlueTooth dongle (2003) XH4104	48.5mA
'Itsy-Bitsy' USB LED lamp (ref SILICON CHIP, March 2002)	30mA
Genius Mini Traveller USB mouse	10mA
Prolific USB-serial D9 adaptor (Picaxe use)	8mA
Olympus C-1 digital camera (64MB Smart Media). Perhaps camera batteries supplying too?	< 1mA

hungry Atmel WLAN adapter (drawing 270mA) to 4.88V with a 600mm cable and just 4.75V when at the end of a 5m USB 2.0 extender.

This 5m cable was measured as having 0.5Ω resistance in the supply wire (therefore 1Ω, considering return too), which tallies closely with the example above.



This active USB 5m extension cable uses some of the power available from the USB port to amplify the data signal. Up to five can be connected in series.

Adding another 5m extender dropped the load voltage to almost 4.5V, with the PC then reporting 'USB device not recognised', presumably because of timing and low supply voltage issues.

Given the lowered supply voltage at the end of these lengthy USB cables, it's feasible that heavier (paralleled?) DC supply cables could be used if longer runs are needed and data propagation timing is not an issue – perhaps to serve a rooftop USB webcam.

Some of the now-common external USB hard disks and CD/DVD writers actually have two USB connectors at the PC end, wired in parallel, to achieve the currents required. They rely on the fact that (hopefully!) most PCs these days have several USB port sockets close together.

Remote DC supplies via completely separate lines and a 7805 voltage regulator, perhaps with higher voltage (9V?) initially, may serve to stretch runs as well.

This is precisely the scheme involved in the *EPE* USB Power Injector mentioned above right; however, it also included line sensing to turn the power on and off in sympathy with the power at the USB port itself.

Perhaps even a small photovoltaic solar panel could be used to charge a rooftop battery, providing a regulated 5V supply. It's rather akin to 'corporate' power over ethernet (POE) approaches – well known for rooftop/masthead WiFi Access Points energised via cheap CAT-5 cable.



*EPE's* USB Power Injector from the December 2006 issue. It doubles the amount of power available from a USB port.

Aside from the tedious energy issues, ultimate cable lengths really are limited by the data speeds. Although such signals travel near the speed of light in cables, even a few extra metres of conductor can delay things unacceptably.

The recently-announced Wireless USB still only offers modest ranges (3-10m) but given the lack of wires(!), there certainly won't be any voltage drops – or convenient 5V supplies. Active Extender and doubled 'Bus' power cables may, of course, better suit demanding USB setups.

But if only modest extensions are needed, cheap passive extending techniques are well worth considering – if only to keep your coffee warm while lounging some distance away from the PC!

With the breakout adaptor shown above and a DMM, you can at least be easily informed of your loads' DC demands, something that currently is largely unknown. **EPE**

Reproduced by arrangement with SILICON CHIP magazine 2007. [www.siliconchip.com.au](http://www.siliconchip.com.au)



Where you have power-hungry USB devices, a USB Bus Power Cable can give them a boost, connecting to two USB ports to double power.

**componentbin.com** Online Store!

Our online store contains an ever expanding variety of products designed for engineers, hobbyists and students. These include:

- ARM Development Systems
- Ethernet Modules
- RF Modules
- Graphic LCD Displays (With example software!)
- Home Automation
- Power Conversion
- Components & Connectors
- And Much More!
- **Educational Discounts Available**

Full product support with reference software and secure online ordering to kickstart your development.

[www.componentbin.com](http://www.componentbin.com)  
+44 (0) 1354 778224

# SHERWOOD ELECTRONICS

**PLEASE NOTE NEW MAIL ORDER ADDRESS**

Buy 10 x £1 Special Packs and choose another one FREE

SP1	15 x 5mm Red LEDs	SP134	15 x 1N4007 diodes
SP2	12 x 5mm Green LEDs	SP135	5 x Miniature slide switches
SP3	12 x 5mm Yellow LEDs	SP136	3 x BFY50 transistors
SP5	25 x 5mm 1 part LED clips	SP137	4 x W005 1.5A bridge rectifiers
SP6	15 x 3mm Red LEDs	SP138	20 x 2.2/63V radial elect. caps.
SP7	12 x 3mm Green LEDs	SP142	2 x CMOS 4017
SP8	10 x 3mm Yellow LEDs	SP143	5 Pairs min. crocodile clips (Red & Black)
SP9	25 x 3mm 1 part LED clips	SP144	5 Pairs min. crocodile clips (assorted colours)
SP10	100 x 1N4148 diodes	SP146	10 x 2N3704 transistors
SP11	30 x 1N4001 diodes	SP147	5 x Stripboard 9 strips x 25 holes
SP12	30 x 1N4002 diodes	SP151	4 x 8mm Red LEDs
SP18	20 x BC182B transistors	SP152	4 x 8mm Green LEDs
SP20	20 x BC184B transistors	SP153	4 x 8mm Yellow LEDs
SP23	20 x BC549B transistors	SP154	15 x BC548B transistors
SP24	4 x CMOS 4001	SP156	3 x Stripboard, 14 strips x 27 holes
SP25	4 x 555 timers	SP160	10 x 2N3904 transistors
SP26	4 x 741 Op.Amps	SP161	10 x 2N3906 transistors
SP28	4 x CMOS 4011	SP164	2 x C106D thyristors
SP29	3 x CMOS 4013	SP165	2 x LF351 Op.Amps
SP33	4 x CMOS 4081	SP166	20 x 1N4003 diodes
SP34	20 x 1N914 diodes	SP167	5 x BC107 transistors
SP36	25 x 10/25V radial elect. caps.	SP168	5 x BC108 transistors
SP37	12 x 100/35V radial elect. caps.	SP171	8 Metres 18SWG solder
SP38	15 x 47/25V radial elect caps.	SP172	4 x Standard slide switches
SP39	10 x 470/16V radial elect. caps.	SP173	10 x 220/25V radial elect. caps
SP40	15 x BC237 transistors	SP174	20 x 22/25V radial elect. caps
SP41	20 x Mixed transistors	SP175	20 x 1/63V radial elect. caps.
SP42	200 x Mixed 0.25W C.F. resistors	SP177	10 x 1A 20mm quick blow fuses
SP47	5 x Min. PB switches	SP178	10 x 2A 20mm quick blow fuses
SP49	4 x 5 metres stranded core wire	SP181	5 x Phono plugs - asstd colours
SP101	8 Metres 22SWG solder	SP182	20 x 4-7/63V radial elect. caps.
SP102	20 x 8-pin DIL sockets	SP183	20 x BC547B transistors
SP103	15 x 14-pin DIL sockets	SP189	4 x 5 metres solid core wire
SP104	15 x 16-pin DIL sockets	SP192	3 x CMOS 4066
SP109	15 x BC557B transistors	SP195	3 x 10mm Yellow LEDs
SP112	4 x CMOS 4093	SP197	6 x 20 pin DIL sockets
SP115	3 x 10mm Red LEDs	SP198	5 x 24 pin DIL sockets
SP116	3 x 10mm Green LEDs	SP199	5 x 2.5mm mono jack sockets
SP118	2 x CMOS 4047	SP200	5 x 2.5mm mono jack sockets
SP124	20 x Assorted ceramic disc caps		
SP126	6 x Battery clips - 3 ea. PP3 + PP9		
SP130	100 x Mixed 0.5W C.F. resistors		
SP131	2 x TL071 Op.Amps		
SP133	20 x 1N4004 diodes		

### RESISTOR PACKS - C.Film

RP3	5 each value - total 365 0.25W	£3.40
RP7	10 each value - total 730 0.25W	£4.65
RP10	1000 popular values 0.25W	£6.60
RP4	5 each value-total 345 0.5W	£4.30
RP8	10 each value-total 690 0.5W	£6.95
RP11	1000 popular values 0.5W	£8.95

2007 Catalogue available £1 inc. P&P or FREE with first order. P&P £1.75 per order. NO VAT Cheques and Postal Orders to: **Sherwood Electronics, 10 NEWSTEAD STREET, MANSFIELD, NOTTS. NG19 6JJ**

tel. 01298 70012  
fax. 01298 70046  
www.peakelec.co.uk  
sales@peakelec.co.uk

## NEW! High Capacity Alkalines! At Silly Prices!

### Handheld Test Gear - Cool, Smart.

**Atlas DCA** ~~£55~~ **£55**

Atlas DCA Model DCA55  
Semiconductor Analyser

**Atlas ESR** ~~£89~~ **£89**

Atlas ESR Model ESR60  
ESR and Capacitance Meter

**Atlas LCR** ~~£79~~ **£79**

Atlas LCR Model LCR40  
Inductor, Capacitor, Resistor Analyser

**Atlas SCR** ~~£99~~ **£99**

Atlas SCR Model SCR100  
Triac and Thyristor Analyser

UK: Please add £1.00 p&p to your order. Prices include UK VAT. Please see website for overseas pricing.

**£1.69!**  
~~RRP £2.99~~

2 x C Ultra Alkaline

**£1.99!**  
~~RRP £2.99~~

2 x D Ultra Alkaline

**£1.99!**  
~~RRP £4.99~~

8 x AAA Ultra Alkaline

**£1.19!**  
~~RRP £2.99~~

9v PP3 Ultra Alkaline

**69p!**  
~~RRP £1.09~~

GP 3A MN21  
12V Ultra Alkaline

**£2.99!**  
~~RRP £6.99~~

12 x AA Ultra Alkaline

# PRACTICALLY SPEAKING

Robert Penfold looks at the Techniques of Actually Doing It!

**S**EMICONDUCTORS are possibly the most confusing aspect of modern electronics. Not only are there numerous categories of semiconductor component, but there is also a vast range of different shapes types and sizes within each of these categories.

In many cases there are even various forms of the same device. The semiconductor section of an electronic components catalogue is normally huge, and represents a substantial proportion of a complete catalogue.

## Deceptively simple

The diode is the simplest form of semiconductor, and it is a sort of electronic valve. It permits an electric current to flow in one direction, but blocks any significant flow in the opposite direction. The diode is obviously a form of polarised component, and it will only operate properly if it is connected the right way round.

If you connect a diode with the wrong polarity it will allow a current flow in the wrong direction, and block any flow of current in the right direction. This is more or less guaranteed to prevent the circuit from working, and in some circumstances can have disastrous consequences.

Although they are the simplest of semiconductor components, diodes often seem to be problematic when building electronic projects. Even experienced constructors sometimes find that the polarity markings of a diode something less than obvious. In some cases they are very confusing or even absent. In general, normal diodes do not cause too many problems. They are usually in the form of small tubular components in glass or plastic encapsulations. Fig.1 shows the circuit symbol for a diode, together with various physical representations for this type of component.

The two terminals of a diode are called the 'anode' and 'cathode', and these are often shown in the abbreviated forms 'a'

and 'k' respectively. The circuit diagrams that appear in *Everyday Practical Electronics* normally include the 'a' and 'k' markings, but they will not necessarily be included in circuit diagrams that are found elsewhere. Instead, there will sometimes be a '+' in place of the cathode marking.

Strictly speaking, none of these legends are actually required at all since the polarity is indicated by the diode symbol itself. However, these marking should be helpful to those of limited experience with circuit diagrams and circuit symbols.

By far the most common method of indicating the polarity of an actual diode is to have a band marked around the body of the component near the cathode (k) lead. This band corresponds to the bar at the cathode end of the diode's circuit symbol. There are a couple of common exceptions to this way of doing things. With one method the usual band is retained, but there are additional bands marked around the body of the component.

## Banding together

In most cases the type number of a diode is simply marked on the body in tiny lettering, but with this method of marking the type number is indicated using a method of colour coding that is based on the system used for resistors. This system is used for diodes that have a '1N' prefix, and three or four bands are used to indicate the main three or four digit type number.

The band that indicates the cathode end of the component is normally much wider than any of the others, which should help to avoid the confusion that is possible with this method of marking. However, with real-world diodes the polarity is often less obvious than would be ideal, and careful scrutiny of the bands may be needed in order to sort things out.

Another method of polarity marking has a thinning at the cathode end of the

component's body. Again, this corresponds quite well with the physical shape of the circuit symbol. This method of polarity indication is mainly used with rectifiers, which are simply diodes that are intended to handle relatively high currents. Rectifiers are often much larger than ordinary diodes, with thick leadout wires. In the past they were often housed in some quite exotic encapsulations, and in some cases these were intended to be bolted direct to a metal heat fin.

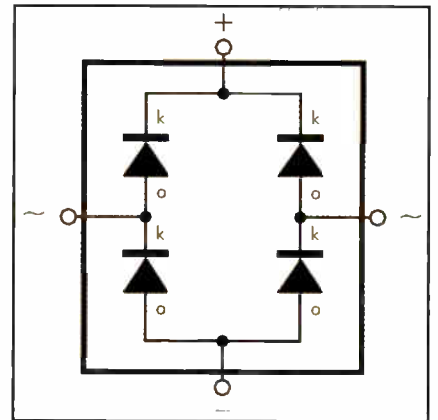

Fig.2. A bridge rectifier consists of four rectifier diodes connected in this ring configuration. The AC input is applied to the '~' terminals and the DC output is obtained from the '+' and '-' terminals.

## On the bridge

Exotic encapsulations are now something of a rarity though, and are normally only found on rectifiers that handle very high currents. One exception is the bridge rectifiers that are often used in power supply circuits. A bridge rectifier is just a ring of four diodes connected in the manner shown in Fig.2. An AC supply is fed to one pair of leads, and a DC supply is obtained from the other two.

Bridge rectifiers are sometimes marked to show the polarities of the individual diodes, but a completely different method is often used to show the functions of the four leads. The two leads that connect to the AC input signal are marked with a wave '~' sign, and they can be connected to the AC signal either way around. The other two leads are marked '+' and '-', to show the polarity of the DC output signal. It is, of course, imperative that these two leads are connected with the correct polarity.

## Heat of the moment

Most modern semiconductors are based on chips of a material called silicon, with a few using something more exotic such as gallium arsenide. The early semiconductors were based on germanium, and were generally much less tough than their modern equivalents.

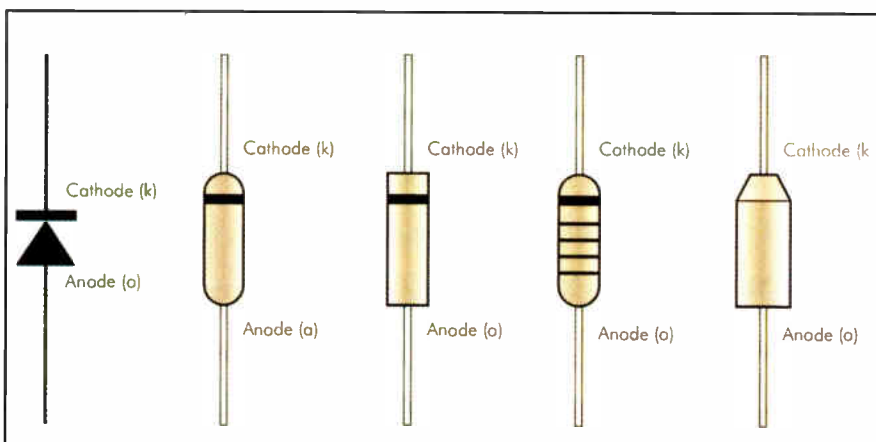

Fig.1. The diode circuit symbol (left) and various methods of identifying the anode and cathode leads on the actual components. These methods are loosely based on the circuit symbol.



Connecting the battery to your newly constructed project using the wrong polarity could easily result in most of the semiconductors being destroyed. While this sort of thing is not to be recommended with modern semiconductors, they will often survive short bursts of the wrong supply polarity.

Modern semiconductor components are also much more tolerant of heat than their predecessors. This is not to say that you can take all the time in the world when soldering silicon diodes and transistors, but it is not necessary to go about things in a mad rush. The more leisurely approach was not useable with germanium devices. The mad rush approach was not conducive to producing good quality soldered joints, but it gave germanium semiconductors a better chance of survival.

Germanium transistors are now long obsolete, but germanium diodes are still used to a certain extent, and usually in the form of the OA90 and OA91 diodes. When dealing with components such as these it is important to bear in mind that they are much less tolerant of heat than the more familiar silicon semiconductors. The design of modern germanium diodes seems to be such that heat from the soldering iron is less readily transferred to the semiconductor material than it was with some of the early germanium components.

### Hot tips

However, it is still necessary to complete the soldered joints reasonably swiftly, and ideally a heat-shunt should be used. A heat-shunt looks a bit like a pair of tweezers, but it clips in place and does have to be manually held in position. It is fitted on the lead between the body of the component and the joint, prior to making the joint.

The idea is for some of the heat that flows along the leadout wire to be diverted into the heat-shunt and away from the semiconductor material. The time that can be taken to complete the joint is increased, but remember that a significant proportion of the heat will still flow up the leadout wire, and you should not get lulled into a false sense of security.

A heat-shunt is not expensive to buy, but it is something that will probably not be needed very often. It is not too difficult to improvise one using something like a pair of tweezers and a small rubber band, or a crocodile clip will work reasonably well in this role. Methods such as these are unlikely to be as effective as a proper heat-shunt though.

It is worth mentioning that diodes such as the OA90 and OA91, which have glass encapsulations, are not as physically tough as most other components. Even where the cases have an opaque covering, diodes that have glass encapsulations are easy to spot, because they are very rounded at both ends of the body.

With diodes of this type, it is not a good idea to bend the leadout wires close to the body, as this can result in them breaking off. Try to avoid too much tension between the body and the leadout wires, and always use the 'kid gloves' approach with this type of diode.

### Seeing the light

The light emitting diode (LED) is another component that seems to cause more than its fair share of problems. It is a true

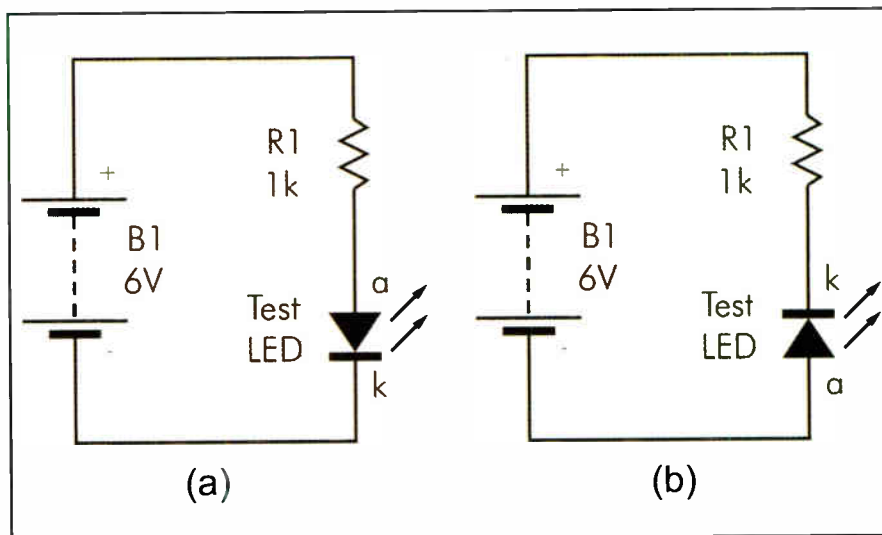

Fig.3. The test component will light up when connected as in (a), but not when it is connected as shown in (b).

diode, and unlike an ordinary filament bulb it will only light up if it is fed with a supply of the appropriate polarity.

The most common method of indicating the polarity of an LED is to have the cathode leadout wire slightly shorter than the anode lead. While the vast majority of LEDs conform to this scheme of things, there is a small percentage of these components that do things the other way around, or have two leadout wires of equal length.

Most LEDs have an additional means of indicating the polarity, which is to have one side of the body flattened slightly. This flattening is next to the cathode lead. Of course, there may well be some exceptions to this rule, and in the world of LEDs it seems to be inevitable that there will be a few components that flout the conventions. I have certainly encountered plenty of LEDs that do not have any flattening of the casing. In fact, I have come across a few LEDs that lack the flattening and also have two leadout wires of equal length.

### Polarity check

Various 'surefire' methods of determining the polarity of an LED simply by looking at it have been put forward over the years, but none of them seem to be totally reliable. One problem is that modern LEDs seem to come in an ever increasing range of shapes and sizes, and the normal methods of determining the polarity are not applicable to some of the fancier types. The supplier's component catalogue will often include a helpful connection diagram.

In some circumstances it might be all right to use trial and error to determine the correct method of connection. Getting a LED connected the wrong way round should not result in any damage, but in some cases it could be difficult to disconnect and reconnect it if you get things wrong at the first attempt. It is clearly better to be certain as to which lead is which and to get it right first time, especially where a project uses a number of LEDs.

Most test meters can be used to check the polarity of a diode, but some of these do not work with LEDs due to the relatively high

forward threshold voltages. If you have a suitable test meter, then this certainly represents the easiest way of checking the polarity of the LEDs, and it is a good idea to check the polarity of these components before connecting them into circuit.

Where a suitable test meter is not available, it is quite easy to rig a simple test circuit that will enable the polarity to be checked. The simple circuit of Fig.3 is all that is required.

### Specials

There are some special types of diode that are not used as electronic valves at all, but instead exploit some other feature of semiconductor diodes. Zener diodes are deliberately designed to 'breakdown' if the reverse voltage exceeds a fairly low voltage that is usually in the range 2.7V to 33V.

The reverse resistance of a Zener diode is normally very high indeed, just like that of an ordinary silicon diode. However, the reverse resistance rapidly falls when the so-called 'avalanche' potential is reached. This enables a Zener diode to be used in a simple voltage regulator circuit.

In practice, Zener diodes do not seem to be used a great deal these days. This is probably due to the advent of low cost integrated circuits (ICs) that can provide highly stable voltages. These have rendered Zener diodes, with their relatively modest levels of performance, largely obsolete. Anyway, Zener diodes look just like ordinary diodes, and have their polarity marked using the normal methods.

Variable capacitance diodes (varicaps) exploit the fact that the capacitance of a diode falls as the reverse voltage is increased. This can be used to provide a voltage controlled variable capacitor for use in radio sets, certain types of test equipment, and other specialised applications.

Some variable capacitance diodes have standard diode encapsulations, but they are often in the form of several diodes in one non-standard encapsulation. With any unusual component, the project article should always make the correct method of connection entirely clear.

# ELECTRONICS MANUALS ON CD-ROM £29.95 EACH

## ELECTRONICS SERVICE MANUAL

## THE MODERN ELECTRONICS MANUAL

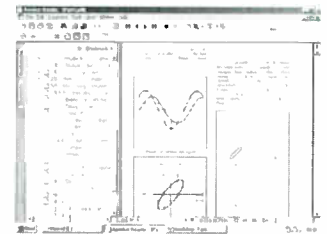
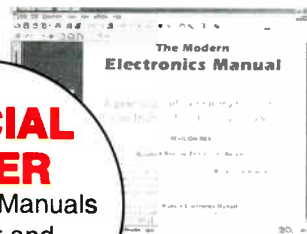
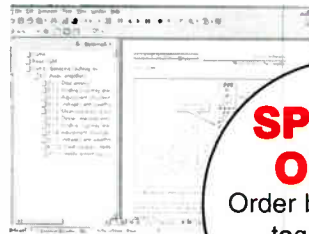
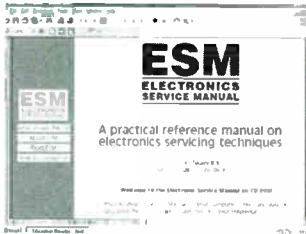

**SPECIAL OFFER**  
Order both Manuals together and **SAVE £10**

**Everything you need to know to get started in repairing electronic equipment**

- Around 900 pages • Fundamental principles • Troubleshooting techniques • Servicing techniques • Choosing and using test equipment • Reference data • Manufacturers' web links
- Easy-to-use Adobe Acrobat format • Clear and simple layout
- Vital safety precautions • Professionally written • Supplements

**SAFETY:** Safety Regulations, Electrical Safety and First Aid.  
**UNDERPINNING KNOWLEDGE:** Electrical and Electronic Principles, Active and Passive Components, Circuit Diagrams, Circuit Measurements, Radio, Computers, Valves and Manufacturers' Data, etc.  
**PRACTICAL SKILLS:** Learn how to identify Electronic Components, Avoid Static Hazards, Carry Out Soldering and Wiring, Remove and Replace Components.  
**TEST EQUIPMENT:** How to Choose and Use Test Equipment, Assemble a Toolkit, Set Up a Workshop, and Get the Most from Your Multimeter and Oscilloscope, etc.  
**SERVICING TECHNIQUES:** The Manual includes vital guidelines on how to Service Audio Amplifiers. The Supplements include similar guidelines for Radio Receivers, TV Receivers, Cassette Recorders, Video Recorders, Personal Computers, etc.  
**TECHNICAL NOTES:** Commencing with the IBM PC, this section and the Supplements deal with a very wide range of specific types of equipment – radios, TVs, cassette recorders, amplifiers, video recorders etc.  
**REFERENCE DATA:** Diodes, Small-Signal Transistors, Power Transistors, Thyristors, Triacs and Field Effect Transistors. Supplements include Operational Amplifiers, Logic Circuits, Optoelectronic Devices, etc.

**The essential reference work for everyone studying electronics**

- Over 800 pages • In-depth theory • Projects to build • Detailed assembly instructions • Full components checklists • Extensive data tables • Manufacturers' web links
- Easy-to-use Adobe Acrobat format • Clear and simple layout • Comprehensive subject range • Professionally written • Supplements

**BASIC PRINCIPLES:** Electronic Components and their Characteristics; Circuits Using Passive Components; Power Supplies; The Amateur Electronics Workshop; The Uses of Semiconductors; Digital Electronics; Operational Amplifiers; Introduction to Physics, including practical experiments; Semiconductors and Digital Instruments.

**CIRCUITS TO BUILD:** The Base Manual describes 12 projects including a Theremin and a Simple TENS Unit.

**ESSENTIAL DATA:** Extensive tables on diodes, transistors, thyristors and triacs, digital and linear i.c.s.

**EXTENSIVE GLOSSARY:** Should you come across a technical word, phrase or abbreviation you're not familiar with, simply look up the glossary and you'll find a comprehensive definition in plain English.

The Manual also covers **Safety** and provides web links to component and equipment **Manufacturers and Suppliers**.

Full contents list available online at: [www.epemag.wimborne.co.uk](http://www.epemag.wimborne.co.uk)

**SUPPLEMENTS:** Additional CD-ROMs each containing approximately 500 pages of additional information on specific areas of electronics are available for £19.95 each. Information on the availability and content of each Supplement CD-ROM will be sent to you.

**Presentation:** CD-ROM suitable for any modern PC. Requires Adobe Acrobat Reader which is included on the CD-ROM.  
 Wimborne Publishing Ltd., Sequoia House, 398a Ringwood Road, Ferndown, Dorset BH22 9AU. Tel: 01202 873872. Fax: 01202 874562.

**PLEASE** send me



THE MODERN ELECTRONICS MANUAL CD-ROM

ELECTRONICS SERVICE MANUAL CD-ROM

I enclose payment of £29.95 (for one Manual) or £49.90 for both Manuals (saving £10 by ordering both together).

FULL NAME .....  
 (PLEASE PRINT)

ADDRESS .....

.....

.....

.....POSTCODE .....

SIGNATURE .....

I enclose cheque/PO in UK pounds payable to Wimborne Publishing Ltd.

Please charge my Visa/Mastercard/Amex/Diners Club/Switch/Maestro

Card No .....Maestro Issue No .....

Valid From ..... Expiry Date .....

Card Security Code ..... (The last 3 digits on or just under the signature strip)

### ORDER FORM

Simply complete and return the order form with your payment to the following address:

Wimborne Publishing Ltd,  
 Sequoia House, 398a Ringwood Road, Ferndown, Dorset BH22 9ND  
 Price includes postage to anywhere in the World

We will happily exchange any *faulty* CD-ROMs but since the content can be printed out we do not offer a refund on these items.

**Your CD-ROM(s) will be posted to you by first class mail or airmail, normally within four working days of receipt of your order**

**Laser**  *Why tolerate when you can automate?*

**X-10** Home Automation

**KAT5** AV transmission and IR control system

**Barix** Ethernet based MP3, communications and control systems

[www.laser.com](http://www.laser.com)

Integrators, Installers, Trade and Retail customers welcome



**C-Bus Shop**  
C-Bus and C-Bus Wireless

[www.cbus-shop.com](http://www.cbus-shop.com)

Laser Business Systems Ltd  
Tel: +44 (0) 20 8441 9788  
Fax: +44 (0) 20 8449 0430  
Email: [info@laser.com](mailto:info@laser.com)  
16 Garthland Drive, EN5 388

Please mention

**EPE** EVERYDAY PRACTICAL ELECTRONICS

when replying to advertisements

To advertise in *EPE*

Please contact

**Stewart Kearn**

**01202 873872**

[stewart.kearn@wimborne.co.uk](mailto:stewart.kearn@wimborne.co.uk)

All Major Credit Cards Accepted!

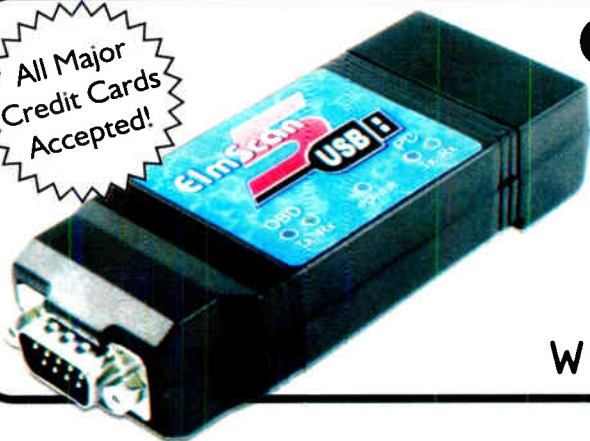

## ElmScan 5 USB Scan Tool

- Diagnose any car with EOBD
- Based on the ELM327 IC
- Supports all EOBD and OBD-II protocols
  - ✓ ISO15765-4 (CAN)
  - ✓ ISO14230-4 (Keyword 2000)
  - ✓ ISO9141-2
  - ✓ J1850 VPW
  - ✓ J1850 PWM
- 9600 or 38400 baud
- Supported by more software than any other OBD interface
- Inexpensive
- Full Speed USB 1.1
- Automatic protocol detection
- Package includes cables, software CD, and Quick Start Guide
- Buy from your local UK distributors!

[www.ElmScan5.com/epe](http://www.ElmScan5.com/epe)

## Radio Bygones

The leading UK magazine for vintage radio enthusiasts



ARTICLES on restoration and repair, history, circuit techniques, personalities, reminiscences and just plain nostalgia – you'll find them all. Plus features on museums and private collections and a full-colour photo-feature in every issue.

IT'S MOSTLY about valves, of course, but 'solid-state' – whether of the coherer and spark-gap variety or early transistors – also has a place.

FROM THE DAYS of Maxwell, Hertz, Lodge and Marconi to what was the state-of-the-art just a few short years ago...

THERE IS ALSO a selection of free readers' For Sale and Wanted advertisements in every issue.

**Radio Bygones covers it all!**

THE MAGAZINE is published six times a year, and is only available by postal subscription. It is not available at newsagents.

TO TAKE OUT a subscription, or to order a sample copy, please contact:

RADIO BYGONES, Wimborne Publishing Ltd.,  
Sequoia House, 398a Ringwood Road, Ferndown, Dorset BH22 9AU.  
Tel: 01202 873872. Fax 01202 874562.

Web sites: [www.radiobygones.co.uk](http://www.radiobygones.co.uk)

[www.radiobygones.com](http://www.radiobygones.com)

Now Also Available to  
**BUY ONLINE**  
[www.radiobygones.com](http://www.radiobygones.com)  
Log on, pay by credit card and download the magazine to your PC  
**ONLY \$9.99 (US dollars) FOR 6 ISSUES**  
A free issue is available

# Constructional Project

bottom right of it. On clicking the Send to PIC button, the chosen value is sent to the PIC (which must be connected and switched on of course).

When next Scope or Spectrum mode is run, the new bias level will be applied.

## Gain Setting

When the Gain mode is selected, the screen changes to that shown in Fig.10. This allows the setting of the precise amount of gain or attenuation provided by the unit's output op amp for the selected channel. Each setting for each channel must be set separately (certain approximate values are automatically provided during the initial setting up process). These values are applied appropriately when the Send to PIC button is clicked, overwriting the previous value for that mode.

## Com Port Choice

The values are applied when Scope or Spectrum mode is next run.

Any of the three previous screens allow the COM Port and Baud values to be set from them.

Setting the COM Port needed simply entails clicking COM 1 or COM 2, with the 'radio' button confirming the choice.

## Baud Rate

Setting the Baud rate affects both the PIC and the PC. The PIC's Baud rate must be at a known value before any different value can be applied.

Back on the main control PCB, are two terminal pins marked Baud Reset. Switch off the power supply to the unit, short the two pins together and reapply power. This causes the PIC's Baud rate to be set to 9600 Baud, and it will remain at that value until a different value is sent by the PC. Now disconnect the shorting link.

With the PC screen showing any of the screens in Figs 8, 9 or 10, select the Baud value required by clicking the Baud value combo box to reveal the choices, then click on the rate required. Then click the Change PIC Baud Rate button.

The new value is sent to the PIC at 9600 Baud, which stores it. Upon handshake acknowledgement that the PIC has received the value (a screen message will appear if it hasn't), the

PC program sets itself for the same Baud rate, stores the value for future recall, and the PIC applies it. The new value is now used from then on until the rate is again intentionally changed in the same way.

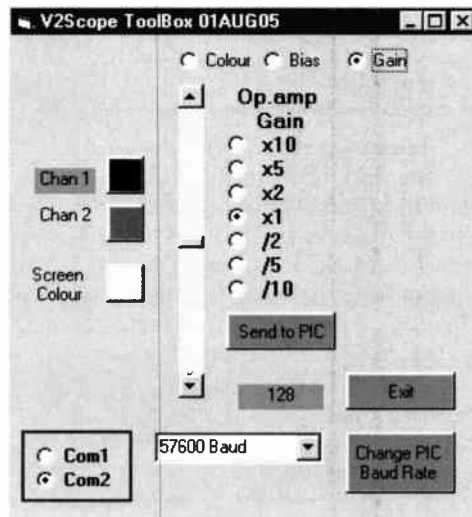

Fig.10: The Toolbox screen in op amp gain setting mode

Note that not all PCs will accept the higher Baud rates, and a slower rate may need to be used.

## Run Mode

The screen display of the signal waveform commences when the Start button is clicked (the PIC's power supply must be switched on and the serial connector lead plugged in – using a standard cable such as used normally with a modem). The button legend changes to Stop. To end run mode, click Stop.

## Calibration

Referring back to the main screen shot, as shown in the title page, the waveform timing, as displayed on screen, can be slightly changed from that which is basically provided. The rate at which signals are sampled inevitably varies depending on the exact rate at which the PIC's crystal X1 is actually running. Its accuracy is only within a certain percentage of the rate marked on its casing.

To re-calibrate the Scope waveforms, feed a square wave signal into the input of Channel 1, setting Sync on and selecting a suitable gain and bias value. Adjust the signal frequency and its waveform duration period (a normal scope will show this if available) to correspond with one of the

Grid Timing values and select the Grid Timing to suit that duration, so that each complete waveform cycle roughly spans a complete screen display grid width.

Using the Calib slider at the top of the screen adjust its setting until the waveform duration fills a complete grid square width. When the display is satisfactory, click the Calib button at the top of the screen. This causes the slider value to be stored for future recall next time the program is run.

The value itself is displayed to the right of the slider. Clicking the Reset button resets the slider to a default value if required.

## Saving waveforms

Waveform data values may be stored to the hard disk for future examination. To do so, click Stop if necessary to end Run mode, click the Save Mode button to enter Save mode, and then click the Start button. The screen display is repeatedly updated and each block of incoming data is stored to disk as well as shown on screen. Click the Stop button when you are ready to stop recording. Then click Save Mode to end that mode, returning to normal display when Start is next clicked.

Each time recording is started, a new file is opened with a unique time and date stamped file name. The name is arranged in a format similar to:

S122206111453B.V2S

Splitting that name as

S 12 22 06 11 14 53 B.V2S

it translates as a starting date and time of:

S just a prefix ID associated with all V2 Scope files  
12 the month number  
22 the day of the month  
06 the year (2000-2099 era)  
11 hour (24 hr clock)  
14 minute of the hour  
53 seconds of that minute  
B just another general ID marker  
.V2S the extension given to all V2 Scope recorded files

Thus the recording was started on 22 Dec 2006 at 11.14:53.

## Recalling recordings

When in Stop mode, any previously recorded V2 Scope file can be recalled for display, allowing closer examination.

Click the DIR (Directory) button to display the file names available (see Fig.11). Details of the Directory screen are given in the Notes file, viewable when that screen's Notes button is clicked. The screen functions are similar to those used in many such screens of the author's projects over the last several years. They will not be further discussed here beyond what is about to be said, read the Notes file.

Single left clicking on any displayed file name does not select it, but causes a translation of the file name to be displayed. Double-click the file name to select the file for display on screen. This automatically closes the Directory screen and the recorded waveform is displayed.

The loaded file name is shown at the bottom of the screen.

The full data recorded will usually be much longer than the single data blocks normally displayed. The display may be panned by using the slider bar at the bottom of the screen.

When changing the Grid Timing, while displaying recorded data, click the Refresh button to refresh the screen in the new mode.

For interest, there are various demo files supplied with the software, prefixed 'Simul'.

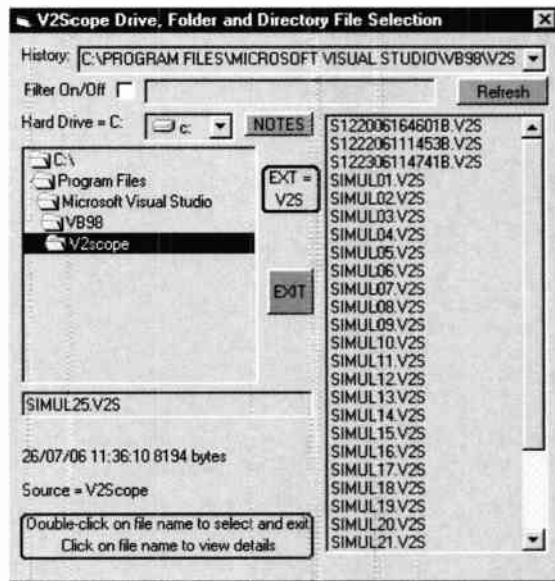

Fig.11: Example of the Directory screen

## Special notes

Clicking the Special Notes button at the top of the screen displays brief text about possible pitfalls when sampling data.

## Spectrum screen

When in Stop mode, clicking the Spectrum button reveals a screen similar to that in Fig.12, but normally without any waveform display.

The data displayed is always in relation to the signal data being input via Channel 1. No screen controls are provided for signal manipulation in this mode.

The upper section of the screen shows the waveform of the signal being input. The main screen section shows a frequency analysis of that waveform,

showing the frequency peaks at which harmonic frequencies are found. A lower legend scale shows the approximate frequency of those peaks.

Calibration of the data may be done in a similar fashion to that used for the Scope screen, inputting a pure sinewave of a known frequency.

The analysis method used is similar to that used in the author's previous designs of this nature, and is based upon the original routines written by the late Paul Cuthbert for *EPE's* sister publication *Modern Electronics Manual* some years ago.

Grid Timing selection is available, as per Scope mode.

## Digital screen

When in Stop mode, clicking the Digital button reveals a screen similar to that in Fig.13, but again normally without any waveform display.

The data displayed is always in relation to that being input via SK1 in Fig.1 (last month) when that data is 'Live'. Recorded data can also have its logic levels for each sampled bit recorded via Channel 1. Again, no screen controls for signal manipulation have been provided.

The screen is split into eight sections, each one corresponding to the logic levels of each bit, as numbered down the righthand side of the screen.

Calibration and Grid Timing selection are available as in Scope mode, though are perhaps unnecessary for this mode.

## Conclusion

That concludes the description of the V2 PC Scope. May its simple facilities be of benefit to your workshop. *EPE*

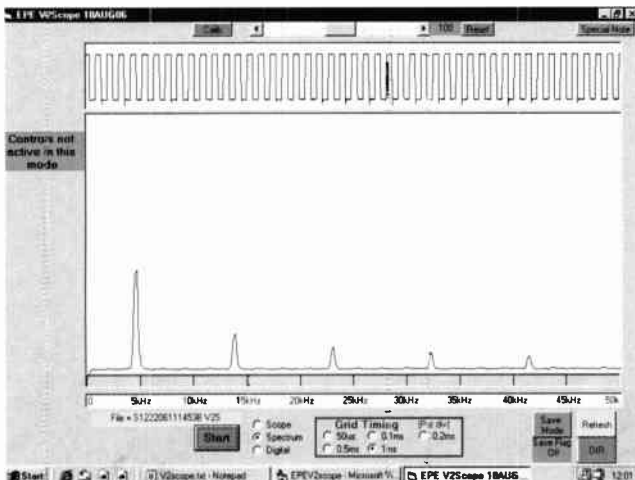

Fig.12: Example PC screen when in Spectrum mode

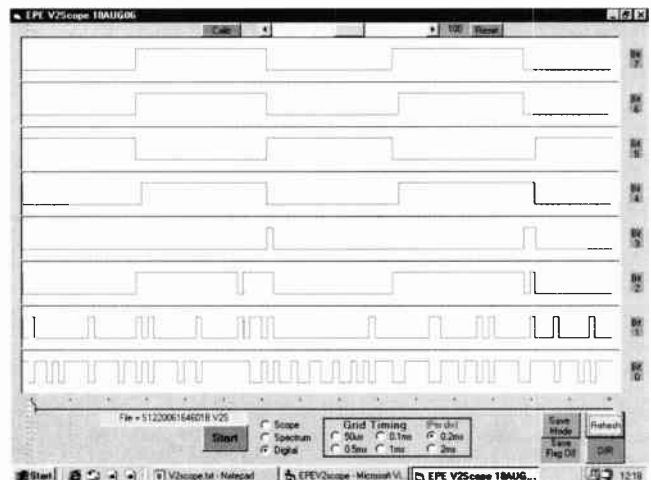
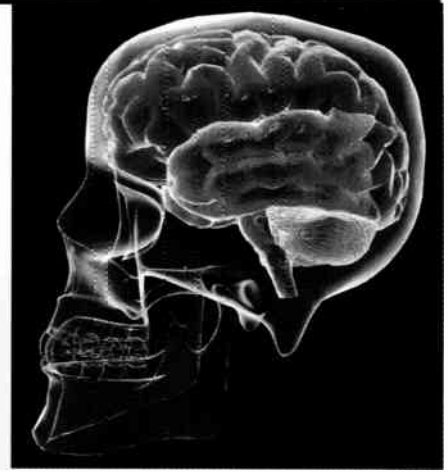

Fig.13: Example PC screen when in Digital mode

# Ingenuity Unlimited



**WIN A PICO PC-BASED OSCILLOSCOPE WORTH £799**

- 200MHz Analogue Bandwidth Dual Channel Storage Oscilloscope
- Spectrum Analyser
- Multimeter
- Frequency Meter
- USB Interface.

If you have a novel circuit idea which would be of use to other readers then a Pico Technology PC-based oscilloscope could be yours.

Every 12 months, Pico Technology will be awarding a PicoScope 3206 digital storage oscilloscope for the best IU submission. In addition a PicoScope 2105 Handheld 'Scope worth £199 will be presented to the runner up.

Our regular round-up of readers' own circuits. We pay between £10 and £50 for all material published, depending on length and technical merit. We're looking for novel applications and circuit designs, not simply mechanical, electrical or software ideas. Ideas *must be the reader's own work and must not have been published or submitted for publication elsewhere*. The circuits shown have NOT been proven by us. *Ingenuity Unlimited* is open to ALL abilities, but items for consideration in this column should be typed or word-processed, with a brief circuit description (between 100 and 500 words maximum) and include a full circuit diagram showing all component values. **Please draw all circuit schematics as clearly as possible.** Send your circuit ideas to: *Ingenuity Unlimited*, Wimborne Publishing Ltd., Sequoia House, 398a Ringwood Road, Ferndown, Dorset BH22 9AU. (We do not accept submissions for IU via email.) Your ideas could earn you some cash and a prize!

## Measuring Colour Temperature - *Multimeter Rainbows?*

The term 'Colour Temperature' is often used to describe the 'whiteness' of light from a luminous source. It is measured in degrees Kelvin and relates to the temperature of a radiating 'black body'. The higher the temperature, the 'whiter' the radiated colour. For incandescent (filament) light bulbs, a colour temperature value is sometimes quoted by manufacturers, but can also be measured using an optical spectrometer. If you don't have an optical spectrometer to hand then a multimeter will do.

According to Wikipedia, tungsten (as used for lamp filaments) adheres very closely to the theoretical 'black body' referred to in the colour temperature definition (see [http://en.wikipedia.org/wiki/Color\\_temperature](http://en.wikipedia.org/wiki/Color_temperature)). So that means that if we know the actual running temperature of a lamp's filament, then that gives us the colour temperature. Like most metals, the electrical resistivity of tungsten over temperature is very well defined (see <http://hypertextbook.com/facts/2004/DeannaStewatewat.shtml>). Using this relationship it is possible to work out a very accurate figure for a filament's running temperature by calculating the ratio between the lamp's electrical resistance when lit and the lamp's resistance at room temperature (around 300°K) (see Fig. 1).

The running electrical resistance ( $R_{HOT}$ ) can be simply calculated from the lamp's voltage and power ratings:

$$P = V^2/R_{HOT}$$

$$\text{therefore } R_{HOT} = V^2/P$$

The room temperature resistance ( $R_{COLD}$ )

can be measured using a multimeter. Calculate the ratio of:

$$x = R_{HOT}/R_{COLD}$$

Plug this ratio figure into the formula derived using Excel from the tungsten resistivity vs. temperature information:

$$\text{Colour Temperature (y)} = -1.62x^2 + 203x + 128^\circ\text{K} \text{ (see Fig.2.)}$$

A final thought: many folk desire lovely 'white' light with very high colour temperatures (halogen lamps tend to be whiter than standard lamps). However, this implies a larger ratio between the hot and cold resistances, and that leads to higher inrush currents when switching on the lamp. So yellower lamps yield lower inrush currents than whiter ones.

Jez Siddons, Derbyshire

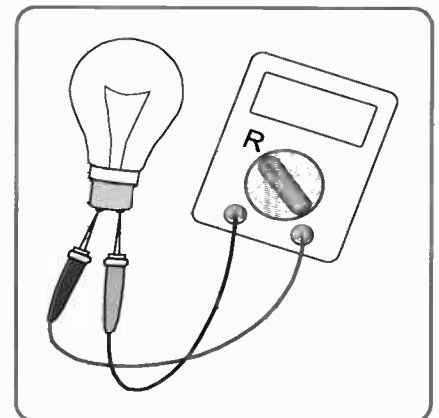

Fig.1. Checking a lamp's room temperature ( $R_{COLD}$ ) resistance using a multimeter

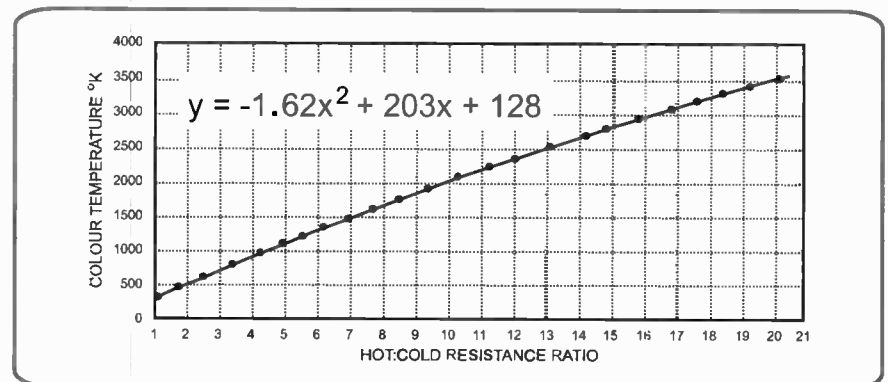

Fig.2. Colour temperature (°K) vs tungsten Hot/Cold resistance ratio graph



# EPE EVERYDAY PRACTICAL ELECTRONICS



UK readers you can  
**SAVE 54p**  
on every issue of *EPE*

How would you like to pay £2.96 instead of £3.50 for your copy of *EPE*?  
Well you can – just take out a one year subscription and save 54p an issue,  
or £6.50 over the year

You can even save 75p an issue if you subscribe for two years  
– a total saving of £18.00

Overseas rates also represent exceptional value

You also:

- Avoid any cover price increase for the duration of your subscription
- Get your magazine delivered to your door each month
- Ensure your copy, even if the newsagents sell out

**PRICES WILL  
GO UP IN  
OCTOBER –  
ACT NOW!**

Order by phone or fax with a credit card or by post with a cheque or postal order, or  
buy on-line from [www.epemag.co.uk](http://www.epemag.co.uk) (click on “Subscribe Now”)

## EPE SUBSCRIPTION PRICES

Subscriptions for delivery direct to any address in the UK:  
6 months £18.75, 12 months £35.50, two years £66; Overseas:  
6 months £21.75 standard air service or £30.75 express airmail,  
12 months £41.50 standard air service or £59.50 express airmail,  
24 months £78 standard air service or £114 express airmail.  
Cheques or bank drafts (in £ sterling only) payable to *Everyday Practical Electronics* and sent to *EPE* Subs. Dept., Wimborne Publishing Ltd., Sequoia House, 398a Ringwood Road, Ferndown, Dorset BH22 9AU. Tel: 01202 873872. Fax: 01202 874562. Email: [subs@epemag.wimborne.co.uk](mailto:subs@epemag.wimborne.co.uk). Also via the Web at <http://www.epemag.co.uk>. Subscriptions start with the next available issue. We accept MasterCard, Amex, Diners Club, Maestro or Visa. (For past issues see the *Back Issues* page.)

## ONLINE SUBSCRIPTIONS

Online subscriptions, for downloading the magazine via the Internet, \$18.99US (approx. £9.50) for one year available from [www.epemag.com](http://www.epemag.com).

## USA/CANADA SUBSCRIPTIONS

To subscribe to *EPE* from the USA or Canada please telephone Express Mag toll free on 1877 363-1310 and have your credit card details ready. Or fax (514) 355 3332 or write to Express Mag, PO Box 2769, Plattsburgh, NY 12901-0239 or Express Mag, 8155 Larrey Street, Anjou, Quebec, H1J 2L5.  
Email address: [expsmag@expressmag.com](mailto:expsmag@expressmag.com).  
Web site: [www.expressmag.com](http://www.expressmag.com).  
USA price \$60(US) per annum, Canada price \$97(Can) per annum – 12 issues per year.

*Everyday Practical Electronics*, periodicals pending, ISSN 0262 3617 is published twelve times a year by Wimborne Publishing Ltd., USA agent USACAN at 1320 Route 9, Champlain, NY 12919. Subscription price in US \$60(US) per annum. Periodicals postage paid at Champlain NY and at additional mailing offices. POSTMASTER: Send USA and Canada address changes to *Everyday Practical Electronics*, c/o Express Mag., PO Box 2769, Plattsburgh, NY, USA 12901-0239.

## SUBSCRIPTION ORDER FORM



- 6 Months: UK £18.75, Overseas £21.75 (standard air service), £30.75 (express airmail)
- 1 Year: UK £35.50, Overseas £41.50 (standard air service) £59.50 (express airmail)
- 2 Years: UK £66.00, Overseas £78.00 (standard air service) £114 (express airmail)
- To: *Everyday Practical Electronics*, Wimborne Publishing Ltd., Sequoia House, 398a Ringwood Road, Ferndown, Dorset BH22 9AU  
Tel: 01202 873872 Fax: 01202 874562  
E-mail: [subs@epemag.wimborne.co.uk](mailto:subs@epemag.wimborne.co.uk)

I enclose payment of £ ..... (cheque/PO in £ sterling only), payable to *Everyday Practical Electronics*

My card number is: .....  
Please print clearly, and check that you have the number correct

Signature .....

Card Security Code ..... (The last 3 digits on or just under the signature strip)

Card Ex. Date ..... Maestro Issue No. ....

Name .....

Address .....

Post code ..... Tel. ....

Subscriptions can only start with the next available issue.

# READOUT

Email: [editorial@wimborne.co.uk](mailto:editorial@wimborne.co.uk)

**John Becker addresses some of the general points readers have raised. Have you anything interesting to say? Drop us a line!**

All letters quoted here have previously been replied to directly.

## WIN AN ATLAS LCR ANALYSER WORTH £79

An Atlas LCR Passive Component Analyser, kindly donated by Peak Electronic Design Ltd., will be awarded to the author of the *Letter Of The Month* each month.

The Atlas LCR automatically measures inductance from 1 $\mu$ H to 10H, capacitance from 1pF to 10,000 $\mu$ F and resistance from 1 $\Omega$  to 2M $\Omega$  with a basic accuracy of 1%.  
[www.peakelec.co.uk](http://www.peakelec.co.uk)



### Common vices

Dear EPE,

Looks as though *Net Work* July '07 gives a clue that Alan and myself share a couple of vices – chocolate and ice-cream! Chris and I have just come back from a short break in Stratford-on-Avon where there are ice-cream opportunities at strategic locations, including sales from a barge (really a converted narrow-boat) permanently moored in the canal basin near the theatre!

In *Readout* of the same issue, you've probably covered the licence requirements of the 1949 Act, but just to clarify, anyone may build a transmitter (not quite what Mike said) but emitting a radio signal is controlled by legislation.

There are two possibilities. If a licence is required, it's illegal to transmit without one. The other possibility is the exception where the individual owner needs no licence as long as the manufacturer has achieved type-approval for equipment operating on a licence-exempt frequency. This is how John's RF remote control is permissible. But, broadcast bands are out of the question – unless you are a permitted broadcaster. So, yes, the simple electronics kits (such as the 'Tandy 150-in-1') are illegal. Yes it's low powered, yes, that's how its users escaped detection and retribution!

The law lags behind technical developments and the legal knickers got twisted when someone was found with a radar speed-camera detector in his car. Illegal, not licenced! (said the judge). Ah, but m'learned friend pointed out that there were plenty of other broadband receiving devices for this part of the spectrum, such as microwave oven RF leakage detector alarms (I've got one) and that, if Their Honours were to ban the radar trap detector, then the law would at a stroke also make microwave safety alarms illegal. Because the legal draftsmen have yet to understand the difference between these devices, the national papers are now full of adverts to help the speeding, illegal and dangerous motorist to get away with their crime.

(W.S. Gilbert comes to mind from *Trial by Jury*, in his younger days the judge states that, by the eloquence of his orations, "Many a burglar I've restored to his friends and his relations.")

Case law also invokes a concept of *Availability for Use*. If someone builds an unlicenced transmitter, tests it into a dummy load and then packs it up for despatch to a licenced recipient, then the law is not broken, as the builder will say that it wasn't available for use as he hasn't got the necessary aerial. Another legal nicety that could earn a fortune for lawyers. Sorry, I don't know the actual cases to quote.

The Coastguard is not the agency with authority to stop an interfering transmission. Of course, they are right to point out

## ★ LETTER OF THE MONTH ★

### Battery Zapper

Dear EPE,

Regarding the Battery Zapper in the July issue – one of the major influences in the life of a battery is the cavity area underneath the battery where all the debris falls and as soon as this fills up you get the dreaded short-circuit and the high battery charging current described.

There have been numerous chemical ways of converting lead sulphate to an inert material but they all fail due to the inadequate cavity area for the rubbish to park in. Where I worked we had 600 volts of submarine batteries and it was routine to withdraw the plates periodically and siphon the debris out. Several guys re-energised car batteries by making a hole in each battery section low down in the casing, filtering the acid through blotting paper and using threaded nylon screws to re-seal the battery before putting the filtered acid back and topping up with demineralised water.

A word of warning, though, all these operations need to be carried out in the open air as the acid and the hydrogen given off can be quite corrosive and explosive. Familiarity always breeds contempt and several times we had qualified electrical individuals charging batteries in enclosed spaces and we used to hear a big bang and a door would come flying off. There would be the culprit, sitting in the corner, covered in dust and when you asked if he was ok he would answer 'Wednesday' cos he was temporarily deaf!

Also, if you vent the place, use an induction motor as you don't want brush gear causing sparks.

**George Chatley,**  
via email

*George, thanks, a most worthwhile warning. Must admit I'm still laughing about that poor guy's response!*

the danger to safety-of-life marine services and anyone thus warned would be negligent to continue the nuisance. But, legally, enforcement can only come through the licencing agency, now Ofcom. Also, did you know about their general licence? Applies to all transmitters, even if licence-exempt! Little known fact. Don't worry, though, it only contains obvious stipulations such as don't use offensive language on air or cause avoidable interference.

Did I ever tell you the difference between doctors and lawyers? No? Put three doctors together and you'll get three different diagnoses. Put three lawyers together, you'll get four different opinions – and even then, one of them will want to appeal.

Finally, one of those basic questions that I always took for granted but should have asked about. It's prompted by *Circuit Surgery* (same issue) and, first, well done Ian on a much clearer explanation of feedback and compensation than I've seen elsewhere. Let me develop the subject further. Why is it preferable to configure op amps in the inverting sense? What is the advantage over non-inverting amplifiers?

**Godfrey Manning, G4GLM,**  
via email

*Thanks for that Godfrey. Hopefully Ian will answer your query in CS in due course.*

### Program complexity

In the July '07 *Readout*, Edward Chase writes, 'I cannot conceive of going

straight to assembler or C from an idea in my head for a complex routine like a setup menu, because it has so many branches and loops.'

Complexity is a common problem in programming and can be dealt with in various ways. Complexity is bad, because the code is hard to design and write, and difficult if not impossible to test thoroughly.

First of all, ask yourself if all the complexity is really needed. Unnecessary functions can be discarded, or the logic restructured to simplify the process. Ultimately, if the program is too complex, the chance of failure becomes significant. Using a high level language like C instead of assembler will decrease the complexity of any program considerably.

Breaking the program into subroutines is the way to go to manage complexity. Experience is important in determining the best way to do this. Subroutines must have clearly defined inputs and outputs and processes. Always place a commentary block ahead of each subroutine to document it. Further, structure your subroutines into manageable source code files of related functions. Huge source code files are very bad.

Put a lot of thought into using global variables. It should be clear in your mind where a variable is updated and where it is tested. Sometimes hiding global variables in functions that manage them, as is done in object oriented programming languages, is a useful idea if things get out of hand. Abstracting the problem you are solving into the global variables required is crucial to the complexity of the result-



ing code. This is a hard concept to grasp until you've done it wrong and struggled with the resulting mess. Give your subroutines and variables meaningful names.

Experience is a great teacher, and the only way to get it is to start programming now. Good Luck.

**Jack Botner,**  
via email

*Jack, inexperienced programmers, and even more advanced ones, should take note of what you say*

#### Thanks for LOM

Dear EPE,

Thank you for the LCR Analyser won for my *Letter of the Month* in the July issue. I have always wanted this analyser but could never quite justify the cost.

Brings to mind the fact that it is about 40 years since *Practical Electronics* published the first letter I ever wrote to a publication. The few shillings Postal Order they sent me for it was useful to a teenager to fund his component buying, which has continued ever since. Glad to see that *PE* is still going, albeit under a new name, but it's essentially the same concept. Keep it up team!

What was the *PE* letter about? Well, despite the technical advances in our hobby, it is just as relevant today so I'll repeat it below:

When you wire a mains plug do not cut all three wires to the same length, even on those few plugs designed to take equal length wires. This is because, if the cable is pulled hard/stepped on/tripped over, the earth wire will part from its terminal first, leaving your appliance earthless. Instead, leave most slack on the earth wire and the least on the live wire. Then the live parts disconnect first and the earth last.

I enjoyed Robert Penfold's *Flowcode* review in the July issue as well as John's *PC Scope*. I note that Robert disagrees with John in that he said, "Many programmers produce a chart of this type (a flow-chart) as a preliminary step when producing a program".

**Edward Chase,**  
via email

*Thanks Edward, I felt you deserved LOM. Thanks too for that timelessly tip. Re disagreement – as always, there are many different opinions (see Godfrey's earlier comment).*

#### Online camera shopping

Dear EPE,

I've just read Alan's July '07 *Net Work* column in Toronto, Canada and I wanted to add another caveat re NYC online/mail order camera and electronics stores. Such shops are notorious for stripping out extras that were supposed to come in the box and selling them off separately. This can be things like earphones for audio players, cases, memory cards, or kit lenses for cameras, basically anything they think they can unload for extra cash.

This wouldn't be so bad, except they rarely advertise this fact, and unsuspecting

purchasers wind up comparing apples with oranges when doing local research. That terrific 20 or 30 per cent discount over buying on the high street isn't so attractive if 40 per cent of the value has been stripped out of the box by unscrupulous dealers.

This doesn't just happen to remote buyers in NYC tech shops. My brother lived in NYC for four years some time ago and he bought an identical Sony Discman there that I had just purchased in Toronto. I got the full package with AC adapter, case, rechargeable batteries, and remote control earbuds. He got the same box, but just the player alone.

**Martin Green,**  
Hamilton, Ontario,  
Canada, via email

*Alan replied to Martin:*

*Point taken and I do recommend comparing the specs closely. B&H shows what's included and I agree that buying 'blind' online is not for the faint hearted (or those easily separated from their money).*

**Alan Winstanley,**  
via email

#### Mass change of PC file attributes

*I recently raised a question on our Chat Zone (via [www.epemag.co.uk](http://www.epemag.co.uk)) and felt that the responses were worthy of a larger audience – here are edited extracts of the discussions –*

**john\_becker:** *I've just had to have PC World fix a faulty PC which would not load Windows due to some files having become corrupted. It now works. But all the files have become read-only files, and there are hundreds if not 1000s of them.*

*With many it doesn't matter, but with others it does. Trying to do all the changes manually for so many files is daunting. Does anyone know of a command one can give as a global instruction to make all files readable/writeable?*

*It's a PC running Win 95, and is in constant use for its many workshop files which will not run on Win platforms later than ME.*

**scott2734:** *If you want to clear the 'read only' attribute bit of all the files in a directory, execute the following command line through DOS:*

```
ATTRIB -R c:\WINDOWS\*
```

where

- + Sets an attribute.
- Clears an attribute.
- R Read-only file attribute.
- A Archive file attribute.
- S System file attribute.
- H Hidden file attribute.
- /S Processes files in all directories in the specified path.

*(I entered DOS and went back to the root directory using cd\ I then amended Scott's command line to suit the folder I wanted:*

```
ATTRIB -/S -R C:\PICS\*.*
```

*Which cleared all the file attributes from read-only)*

**john\_becker:** *Scott, many thanks – having by trial and error remembered how to use DOS after many years of not, using your basic info I succeeded in getting all the files in a main folder and its sub folders all back to writeable.*

*I wonder though how those who cannot get DOS access on their later PCs would have fared on the read-only etc aspect. I understand some PCs do not provide DOS access. Is that correct?*

**philwarn:** *I cannot vouch for Windows Vista – do not want to touch it with a bargepole, yet!*

*With Windows XP, XP SP1, or XP SP2, using the RUN command from the START button and then running CMD from the popup box, gives access to DOS commands and to DOS programs.*

**john\_becker:** *Phil, I agree about Vista, especially after what I've seen written about it. And I understand that not even Service Pack 1 has been released yet. I'd be interested to know if it has DOS access anyway – does anyone know?*

**atferrari:** *Use the Windows 'search' function, inside the file where all those archives are. Search for "\*.\*". That will list all of them. Do a right click on the list. Click to eliminate the setting you don't like. (You can use this to set something you like as well). No need to go through DOS. Neat and faster.*

**riki:** *popped into PCW a couple of months ago when Vista came out and played with a couple of their computers. No problems going into the DOS prompt and also DEBUG is still there. Appears that the old DOS commands will live forever.*

**atferrari:** *Win 98 and Win ME for sure. I think I heard this working also with XP but not tried.*

**john\_becker:** *Found a snag with Scott's answer – the DOS limit of eight characters in a file name. Have tried to clear read-only settings in other folders, having quite lengthy names. DOS does not like it. I perhaps should also point out that Scott's \\* extension should be \\*. \* to cover all files and extensions in a folder.*

*Agustin (atferrari), I've figured out how to use your solution. I opened the folder in the normal way, selected Edit to then select all the files. When they were blue highlighted, I right-clicked on one of the icons of the selection, that allowed me to select Properties from which I then could adjust the attributes for all the selected files in one operation.*

*I could have selected just those files I wanted by changing file order arrangements, and then using the same technique. It was only when the files were highlighted and an icon right-clicked that the option was available.*

*I could not find a way with DOS to select files within folders within folders in order to change their attributes. Length of file names also became a problem.*

*Once again the power of the knowledge available via the Chat Zone has proved beneficial. Thanks all – problem now solved.*



Get your magazine 'instantly' anywhere in the world – buy and download from the web.

**TAKE A LOOK, A FREE ISSUE IS AVAILABLE**

**A one year subscription**

**(12 issues) costs just \$18.99 (US)**

**Back issues are also available**

# EPE PIC PROJECTS VOLUME 1 MINI CD-ROM



A plethora of 20 "hand-PICked" PIC Projects from selected past issues of *EPE*

Together with the PIC programming software for each project plus bonus articles

The projects are:

**PIC-Based Ultrasonic Tape Measure**

You've got it taped if you PIC this ultrasonic distance measuring calculator

**EPE Mind PICKler**

Want seven ways to relax? Try our PIC-controlled mind machine!

**PIC MIDI Sustain Pedal**

Add sustain and glissando to your MIDI line-up with this inexpensive PIC-controlled effects unit

**PIC-based MIDI Handbells**

Ring out thy bells with merry tolling – plus a MIDI PIC-up, of course!

**EPE Mood PICKer**

Oh for a good night's sleep! Insomniacs rejoice – your wakeful nights could soon be over with this mini-micro under the pillow!

**PIC Micro-Probe**

A hardware tool to help debug your PIC software

**PIC Video Cleaner**

Improving video viewing on poorly maintained TVs and VCRs

**PIC Graphics LCD Scope**

A PIC and graphics LCD signal monitor for your workshop

**PIC to Printer Interface**

How to use dot-matrix printers as data loggers with PIC microcontrollers

**PIC Polywhatsit**

A novel compendium of musical effects to delight the creative musician

**PIC Magick Musick**

Conjure music from thin air at the mere untouching gesture of a fingertip

**PIC Mini-Enigma**

Share encrypted messages with your friends — true spymaster entertainment

**PIC Virus Zapper**

Can disease be cured electronically? Investigate this controversial subject for yourself

**PIC Controlled Intruder Alarm**

A sophisticated multi-zone intruder detection system that offers a variety of monitoring facilities

**PIC Big-Digit Display**

Control the giant ex-British Rail platform clock 7-segment digits that are now available on the surplus market

**PIC Freezer Alarm**

How to prevent your food from defrosting unexpectedly

**PIC World Clock**

Graphically displays world map, calendar, clock and global time-zone data

**PICAXE Projects**

A 3-part series using PICAXE devices – PIC microcontrollers that do not need specialist knowledge or programming equipment

**PIC-based Tuning Fork and Metronome**

Thrill everyone by at long last getting your instrument properly tuned!

**Versatile PIC Flasher**

An attractive display to enhance your Christmas decorations or your child's ceiling

**ONLY  
£14.45**

**INCLUDING  
VAT and P&P**

**Order on-line from**

[www.epemag.wimborne.co.uk/shopdoor.htm](http://www.epemag.wimborne.co.uk/shopdoor.htm)

or [www.epemag.com](http://www.epemag.com) (USA \$ prices)

or by Phone, Fax, Email or Post.

NOTE: The PDF files on this CD-ROM are suitable to use on any PC with a CD-ROM drive. They require Adobe Acrobat Reader.

## EPE PIC PROJECTS CD-ROM ORDER FORM

Please send me ..... (quantity) EPE PIC PROJECTS VOL 1 CD-ROM

Price £14.45 each – includes postage to anywhere in the world.

Name .....

Address .....

..... Post Code .....

I enclose cheque/P.O./bank draft to the value of £ .....

Please charge my Visa/Mastercard/Amex/Diners Club/Maestro

£ .....

Card No. ....

Card Security Code ..... (The last 3 digits on or just under the signature strip)

Start Date ..... Expiry Date ..... Maestro Issue No. ....

**SEND TO: Everyday Practical Electronics,  
Wimborne Publishing Ltd.,**

**Sequoia House, 398a Ringwood Road, Ferndown, Dorset BH22 9AU.**

Tel: 01202 873872. Fax: 01202 874562.

Email: [orders@epemag.wimborne.co.uk](mailto:orders@epemag.wimborne.co.uk)

Payments must be by card or in £ Sterling – cheque or bank draft drawn on a UK bank.

Normally supplied within seven days of receipt of order.

Send a copy of this form, or order by letter if you do not wish to cut your issue.

**BECOME A PIC PROJECT BUILDER WITH THE HELP OF EPE!**

# Net Work



Alan Winstanley

## At your service

Welcome to *Net Work* – the column specially written to help *EPE* readers make more of their Internet access. New readers may not be aware of our website at [www.epemag.co.uk](http://www.epemag.co.uk) where you can check out the latest constructional projects or search for magazine details of previous projects. Back issues can be ordered via our Online Shop; we accept popular debit and credit cards, we have no minimum order charge and we deliver worldwide.

For the benefit of constructors we have started to supply printed circuit board/printed wiring board artwork online for most projects published since March 2006. Where available, they can be fetched in PDF format from our Downloads pages at [www.epemag.wimborne.co.uk/downloads.html](http://www.epemag.wimborne.co.uk/downloads.html).

One of the most popular areas of our website is our source code download service. *EPE* was among the first to offer free source code for its projects and, as regular readers will know, we chose to mainly focus on one particular brand of microcontroller, the PIC micro from Arizona Microchip. Occasionally a designer will utilise alternatives, mainly using the Atmel range.

Source code for almost every project is available on our Downloads page, and in the rest of this month's *Net Work* we offer more background information and suggest alternative methods for fetching our source codes.

Mainly for historical reasons, our entire source code library is hosted on an FTP (file transfer protocol) server – type <ftp://ftp.epemag.wimborne.co.uk> into your web browser to see. This was because the world wide web barely existed when we started to distribute our source codes via the Internet, so an FTP site was the only solution. As the website gradually evolved, an HTML (web-style) front end was created to simplify the access to our file area for web users, by using a simple 'tree' format on the Downloads page. This simply links over to the relevant files on our FTP site. Note, however, that our PCB files are currently hosted directly on our web server at <http://www.epemag.wimborne.co.uk/pcbs/>

We would again like to thank *EPE* enthusiast Thomas Stratford for his continued dedication to hosting the Official *EPE* Mirror Site, at <http://homepages.nildram.co.uk/~starbug/epemic.htm>. *EPE* readers owe Thomas a large token of gratitude for diligently hosting an easy to use web-style interface for many years.

## FTP for free

One of the best ways to download our source code files is with proper FTP software such as WS FTP from [www.ipswitch.com](http://www.ipswitch.com) or perhaps Cute FTP from [www.cuteftp.com](http://www.cuteftp.com). If you can use Windows Explorer then you can use FTP software: it is simply a question of connecting then dragging and dropping files from the 'remote' server on to your 'local' machine. If you are a broadband user then it is worth checking FTP software options to enable the 'Passive FTP' option for better compatibility.

For our printed circuit board/printed wiring board files, simply click on a PCB link in the download tree (such as Sept '07...) and you will be asked to save a file to your hard disk. Our PCB files are 'zipped' to

combine several pieces of artwork into one convenient file, so a simple unzipping utility is needed, such as the freeware 7-Zip archiver/for Windows or Linux (command line) from <http://www.7-zip.org>. To view the PCB artwork also required is, of course, a PDF viewer, such as Adobe Reader free from [www.adobe.com](http://www.adobe.com).

Unfortunately, it was found more recently that Microsoft's IE7 web browser is not entirely compatible with the 'tree' script used on our Downloads page, so the best way is to right-click over a project name and choose Open in New Window... then save the files to your hard disk.

Which brings me neatly to the alternative web browser, Firefox. This is available for free from [www.mozilla.com](http://www.mozilla.com) and has an extremely loyal following among its fans. (Incidentally, the name 'Mozilla' derives from the green lizard – or is it a dinosaur? – mascot used by Netscape Corporation in the 90's before their commercial web browser was spun into Firefox. See [www.iconarchive.com/mozilla/](http://www.iconarchive.com/mozilla/)).

The current version of Firefox is 2.0.0.5 and, apart from its high degree of usability, one of the joys of the browser is its wide range of add-ons, including a British dictionary... and an FTP plug-in called FireFTP. This extremely useful plug-in offers an FTP-style display when browsing an FTP site, and is an ideal way for *EPE* readers to find their way around our file area. After installing the add-on, an icon will appear in the toolbar (see screenshot).

Simply go to Manage Accounts... / New... /

Account Name (a meaningful name for your benefit, e.g. EPE FTP site)

Host <ftp://ftp.epemag.wimborne.co.uk/pub>

Lastly, tick the 'Anonymous' box because you are not logging in with a dedicated username and password. The new account name will appear in a drop-down selector box, then press Connect and you will see our file area in FTP folder view. You can choose some options in the plug-in's Tools button. Simply click the FireFTP icon to open the software in future.

As can be seen, the internet is not just about the world wide web and hopefully this month's column shows some alternatives for you to explore. You can email me at [alan@epemag.demon.co.uk](mailto:alan@epemag.demon.co.uk)

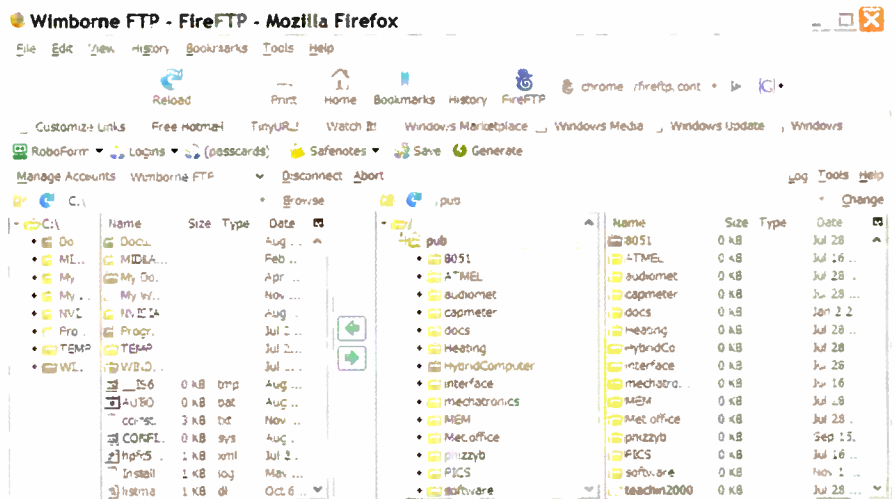

The free FireFox web browser with the FireFTP add-on, displaying a folder view of our FTP server

# EPE PIC RESOURCES CD-ROM V2

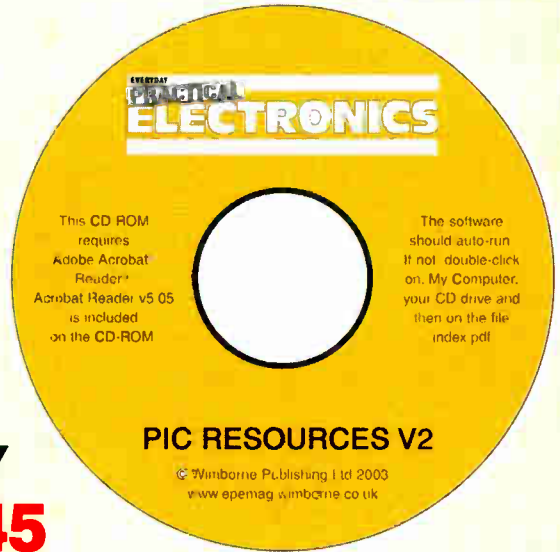

Version 2 includes the EPE PIC Tutorial V2 series of Supplements (EPE April, May, June 2003)

**ONLY £14.45**

INCLUDING VAT and P&P

The CD-ROM contains the following Tutorial-related software and texts:

- EPE PIC Tutorial V2 complete series of articles plus demonstration software, John Becker, April, May, June '03
- PIC Toolkit Mk3 (TK3 hardware construction details), John Becker, Oct '01
- PIC Toolkit TK3 for Windows (software details), John Becker, Nov '01

Plus these useful texts to help you get the most out of your PIC programming:

- How to Use Intelligent L.C.D.s, Julyan Ilett, Feb/Mar '97
- PIC16F87x Microcontrollers (Review), John Becker, April '99
- PIC16F87x Mini Tutorial, John Becker, Oct '99
- Using PICs and Keypads, John Becker, Jan '01
- How to Use Graphics L.C.D.s with PICs, John Becker, Feb '01
- PIC16F87x Extended Memory (how to use it), John Becker, June '01
- PIC to Printer Interfacing (dot-matrix), John Becker, July '01
- PIC Magick Musick (use of 40kHz transducers), John Becker, Jan '02
- Programming PIC Interrupts, Malcolm Wiles, Mar/Apr '02
- Using the PIC's PCLATH Command, John Waller, July '02
- EPE StyloPIC (precision tuning musical notes), John Becker, July '02
- Using Square Roots with PICs, Peter Hemsley, Aug '02
- Using TK3 with Windows XP and 2000, Mark Jones, Oct '02
- PIC Macros and Computed GOTOs, Malcolm Wiles, Jan '03
- Asynchronous Serial Communications (RS-232), John Waller, unpublished
- Using I<sup>2</sup>C Facilities in the PIC16F877, John Waller, unpublished
- Using Serial EEPROMs, Gary Moulton, unpublished
- Additional text for EPE PIC Tutorial V2, John Becker, unpublished

NOTE: The PDF files on this CD-ROM are suitable to use on any PC with a CD-ROM drive. They require Adobe Acrobat Reader – included on the CD-ROM

Order on-line from  
[www.epemag.wimborne.co.uk/shopdoor.htm](http://www.epemag.wimborne.co.uk/shopdoor.htm)  
 or [www.epemag.com](http://www.epemag.com) (USA \$ prices)  
 or by Phone, Fax, Email or Post.

## EPE PIC RESOURCES V2 CD-ROM ORDER FORM

Please send me ..... (quantity) EPE PIC RESOURCES V2 CD-ROM

Price £14.45 each – includes postage to anywhere in the world.

Name .....

Address .....

.....

.....

..... Post Code .....

I enclose cheque/P.O./bank draft to the value of £ .....

Please charge my Visa/Mastercard/Amex/Diners Club/ Maestro

£ .....

Card No. ....

Card Security Code ..... (The last 3 digits on or just under the signature strip)

Valid From ..... Expiry Date .....

Maestro Issue No. ....

SEND TO: **Everyday Practical Electronics,**  
**Wimborne Publishing Ltd.,**  
**Sequoia House, 398a Ringwood Road, Ferndown,**  
**Dorset BH22 9AU.**

Tel: 01202 873872 Fax: 01202 874562.

Email: [orders@epemag.wimborne.co.uk](mailto:orders@epemag.wimborne.co.uk)

Payments must be by card or in £ Sterling – cheque or bank draft drawn on a UK bank.

Normally supplied within seven days of receipt of order.

Send a copy of this form, or order by letter if you do not wish to cut your issue.

**BECOME A PIC WIZARD WITH THE HELP OF EPE!**

## Electronics Teach-In + Free CD-ROM

Mike Tooley

A broad-based introduction to electronics – find out how circuits work and what goes on inside them. Plus 15 easy-to-build projects. The 152 page A4 book comes with a free CD-ROM containing the whole Teach-In 2006 series (originally published in *EPE*) in PDF form, interactive quizzes to test your knowledge, TINA circuit simulation software (a limited version – plus a specially written TINA Tutorial), together with simulations of the circuits in the Teach-In series, plus Flowcode (a limited version) a high level programming system for PIC microcontrollers based on flowcharts.

The Teach-In series covers everything from Electric Current through to Microprocessors and Microcontrollers and each part includes demonstration circuits to build on breadboards or to simulate on your PC.

In addition to the Teach-In series, the book includes 15 CMOS-based simple projects from the Back-To-Basics series by Bart Trepak, these are: Fridge/Freezer Alarm, Water Level Detector, Burglar Alarm, Scarecrow, Digital Lock, Doorchime, Electronic Dice, Kitchen Timer, Room Thermometer, Daily Reminder, Whistle Switch, Parking Radar, Telephone Switch, Noughts and Crosses Enigma and a Weather Vane. There is also a MW/LW Radio project in the Teach-In series.

152 pages + CD-ROM **Order code ETI** £8.50

### THE AMATEUR SCIENTIST 3.0 CD-ROM

The complete collection of The Amateur Scientist articles from *Scientific American* magazine. Over 1,000 classic science projects from a renowned source of winning projects. All projects are rated for cost, difficulty and possible hazards.

Plus over 1,000 pages of helpful science techniques that never appeared in *Scientific American*.

Exciting science projects in: Astronomy; Earth Science; Biology; Physics; Chemistry; Weather . . . and much more! The most complete resource ever assembled for hobbyists, and professionals looking for novel solutions to research problems.

Includes extensive Science Software Library with even more science tools.

Suitable for Mac, Windows, Linux or UNIX. 32MB RAM minimum, Netscape 4.0 or higher or Internet Explorer 4.0 or higher.

Over 1,000 projects

CD-ROM **Order code ASICD-ROM** £19.95

## PROJECT CONSTRUCTION

IC 555 PROJECTS

E. A. Parr

Every so often a device appears that is so useful that one wonders how life went on before without it. The 555 timer is such a device. Included in this book are over 70 circuit diagrams and descriptions covering basic and general circuits, motor car and model railway circuits, alarms and noise makers as well as a section on 556, 558 and 559 timers. (Note. No construction details are given.) A reference book of invaluable use to all those who have any interest in electronics, be they professional engineers or designers, students or hobbyists.

167 pages **Order code BP44** £5.49

### POWER SUPPLY PROJECTS

R. A. Penfold

This book offers a number of power supply designs, including simple unregulated types, and variable voltage stabilised designs, the latter being primarily intended for use as bench power supplies for the electronics workshop. The designs provided are all low voltage types for semiconductor circuits. The information in this book should also help the reader to design his own power supplies. Includes cassette PSU, Ni-Cad charger, voltage step-up circuit and a simple inverter.

91 pages **Order code BP76** £5.49

### HOW TO USE OSCILLOSCOPES AND OTHER TEST EQUIPMENT

R. A. Penfold

This book explains the basic function of an oscilloscope, gives a detailed explanation of all the standard controls, and provides advice on buying. A separate chapter deals with using an oscilloscope for fault finding on linear and logic circuits, plenty of example waveforms help to illustrate the control functions and the effects of various fault conditions. The function and use of various other pieces of test equipment are also covered, including signal generators, logic probes, logic pulsers and crystal calibrators.

104 pages **Order code BP267** £5.49

# DIRECT BOOK SERVICE

The books listed have been selected by *Everyday Practical Electronics* editorial staff as being of special interest to everyone involved in electronics and computing. They are supplied by mail order direct to your door. Full ordering details are given on the last book page.

FOR A FURTHER SELECTION OF BOOKS  
AND CDROMS SEE THE SHOP ON OUR UK WEBSITE –  
[www.epemag.co.uk](http://www.epemag.co.uk)

All prices include UK postage

### ELECTRONIC PROJECT BUILDING

FOR BEGINNERS

R. A. Penfold

This book is for complete beginners to electronic project building. It provides a complete introduction to the practical side of this fascinating hobby, including the following topics:

Component identification, and buying the right parts; resistor colour codes, capacitor value markings, etc; advice on buying the right tools for the job; soldering; making easy work of the hard wiring; construction methods, including stripboard, custom printed circuit boards, plain matrix boards, surface mount boards and wire-wrapping; finishing off, and adding panel labels; getting "problem" projects to work, including simple methods of fault-finding.

In fact everything you need to know in order to get started in this absorbing and creative hobby.

135 pages **Order code BP392** £5.49

### TEST EQUIPMENT CONSTRUCTION

R. A. Penfold

This book describes in detail how to construct some simple and inexpensive but extremely useful, pieces of test equipment. Stripboard layouts are provided for all designs, together with wiring diagrams where appropriate, plus notes on construction and use.

The following designs are included:-  
AF Generator, Capacitance Meter, Test Bench Amplifier, AF Frequency Meter, Audio Multivibrator, Analogue Probe, High Resistance Voltmeter, CMOS Probe, Transistor Tester, TTL Probe. The designs are suitable for both newcomers and more experienced hobbyists.

104 pages **Order code BP248** £4.49

## COMPUTING

### COMPUTING FOR THE OLDER GENERATION

Jim Gatenby

Especially written for the over 50s, using plain English and avoiding technical jargon. Large clear type for easy reading.

Among the many practical and useful ideas for using your PC that are covered in this book are: Choosing, setting up and understanding your computer and its main components. Writing letters, eaflets, invitations, etc., and other word processing jobs. Keeping track of your finances using a spreadsheet. Recording details of holidays and other ideas using a database. Using the Internet to find useful information, and email to keep in touch with family and friends. Making 'back-up' copies of your work and checking for viruses. How to use Windows XP to help people with impaired vision, hearing or mobility.

Provides the basic knowledge so you can gain enough confidence to join the local computer class.

308 pages **Order code BP501** £8.99

### THE INTERNET FOR THE OLDER GENERATION

Jim Gatenby

Especially written for the over 50s. Uses only clear and easy-to-understand language. Larger type size for easy reading. Provides basic knowledge to give you confidence to join the local computer class.

This book explains how to use your PC on the Internet and covers amongst other things: Choosing and setting up your computer for the Internet. Getting connected to the Internet. Sending and receiving emails, photographs, etc., so that you can keep in touch with family and friends all over the world. Searching for and saving information on any subject. On-line shopping and home banking. Setting up your own simple web site.

228 pages **Order code BP600** £8.99

## RADIO

### SETTING UP AN AMATEUR RADIO STATION

I. D. Poole

The aim of this book is to give guidance on the decisions which have to be made when setting up any amateur radio or short wave listening station. Often the experience which is needed is learned by one's mistakes, however, this can be expensive. To help overcome this, guidance is given on many aspects of setting up and running an efficient station. It then proceeds to the steps that need to be taken in gaining a full transmitting licence.

Topics covered include: The equipment that is needed; Setting up the shack; Which aerials to use; Methods of construction; Preparing for the licence.

86 pages **Order code BP300** £4.45

### EXPERIMENTAL ANTENNA TOPICS

H. C. Wright

Although nearly a century has passed since Marconi's first demonstration of radio communication, there is still research and experiment to be carried out in the field of antenna design and behaviour.

The aim of the experimenter will be to make a measurement or confirm a principle, and this can be done with relatively fragile, short-life apparatus. Because of this, devices described in this book make liberal use of cardboard, cooking foil, plastic bottles, cat food tins, etc.

Although primarily a practical book with text closely supported by diagrams, some formulae which can be used by straightforward substitution and some simple graphs have also been included.

72 pages **Order code BP278** £4.00

### 25 SIMPLE INDOOR AND WINDOW AERIALS

E. M. Noll

Many people live in flats and apartments or other types of accommodation where outdoor aerials are prohibited, or a lack of garden space etc. prevents aerials from being erected. This does not mean you have to forego shortwave-listening, for even a 20-foot length of wire stretched out along the skirting board of a room can produce acceptable results. However, with some additional effort and experimentation one may well be able to improve performance further.

This concise book tells the story, and shows the reader how to construct and use 25 indoor and window aerials that the author has proven to be sure performers.

50 pages **Order code BP136** £2.25

### TICKLING THE CRYSTAL Domestic British Crystal Sets of the 1920's

Ian L. Sanders

The first book dedicated to the topic of British crystal sets to be published in the last 25 years. For a very brief period during the early 1920's, these simple receivers played a crucial role in the expansion of domestic wireless throughout the United Kingdom. For many families, rich and poor, the crystal set provided an introduction to the new pastime of listening-in to broadcast programmes. Rapidly made obsolete from homes as suddenly as it had arrived, but not without leaving its mark on the history of wireless.

Written by a long-time authority and enthusiast, *Tickling the Crystal* is the most comprehensive work on the subject ever assembled. Containing almost two hundred excellent quality photographs and a wealth of previously unpublished material, it cannot fail to be an invaluable reference for anyone interested in the history of early wireless receivers.

256 pages hardback **Order code TC1** £34.00

# THEORY AND REFERENCE

## BEBOP TO THE BOOLEAN BOOGIE

Second Edition

Clive (call me Max) Maxfield

This book gives the "big picture" of digital electronics. This in-depth, highly readable, up-to-the-minute guide shows you how electronic devices work and how they're made. You'll discover how transistors operate, how printed circuit boards are fabricated, and what the innards of memory ICs look like. You'll also gain a working knowledge of Boolean Algebra and Karnaugh Maps, and understand what Reed-Muller logic is and how it's used. And there's much, MUCH more. The author's tongue-in-cheek humour makes it a delight to read, but this is a REAL technical book, extremely detailed and accurate.

**Contents:** Fundamental concepts; Analog versus digital; Conductors and insulators; Voltage, current, resistance, capacitance and inductance; Semiconductors; Primitive logic functions; Binary arithmetic; Boolean algebra; Karnaugh maps; State diagrams, tables and machines; Analog-to-digital and digital-to-analog; Integrated circuits (ICs); Memory ICs; Programmable ICs; Application-specific integrated circuits (ASICs); Circuit boards (PWBs and DWBs); Hybrids; Multichip modules (MCMs); Alternative and future technologies.

470 pages – large format **Order code BEB1** £26.95

## BEBOP BYTES BACK (and the Bebooper Computer Simulator)

CD-ROM

Clive (Max) Maxfield and Alvin Brown

This follow-on to *Bebop to the Boolean Boogie* is a multimedia extravaganza of information about how computers work. It picks up where "Bebop I" left off, guiding you through the fascinating world of computer design... and you'll have a few chuckles, if not belly laughs, along the way. In addition to over 200 megabytes of mega-cool multimedia, the CD-ROM contains a virtual microcomputer, simulating the motherboard and standard computer peripherals in an extremely realistic manner. In addition to a wealth of technical information, myriad nuggets of trivia, and hundreds of carefully drawn illustrations, the CD-ROM contains a set of lab experiments for the virtual microcomputer that let you recreate the experiences of early computer pioneers. If you're the slightest bit interested in the inner workings of computers, then don't dare to miss this!

Over 800 pages in Adobe Acrobat format

CD-ROM **Order code BEB2 CD-ROM** £21.95



## RADIO! RADIO! (Third Edition)

Jonathan Hill

A celebration in words and pictures of the development of the British wireless set from P's experimental beginnings in Victorian England, to the foundation of a domestic wireless manufacturing industry and the inception of broadcasting in the early 1920's. The story continues on through the design-conscious 1930's (where the radio really came into its own as a piece of furniture), to the war-torn and austere days of the 1940's.

The first transistor radios began to appear in the second half of the 1950s and in this new edition, this rather neglected area has been fully covered by a section all of its own which includes a directory listing of nearly 3,000 different transistor models. The book finishes after the 1960s, by which time our long established and once great radio industry had all but been destroyed by foreign imports.

Now with 320 pages and over 1,000 illustrations, informative captions and carefully researched text *Radio! Radio!* is the first and still the only truly comprehensive book of its kind ever to be published.

320 pages (A4 Hardback) **Order code RR1** £40.95

## GETTING THE MOST FROM YOUR MULTIMETER

R. A. Penfold

This book is primarily aimed at beginners and those of limited experience of electronics. Chapter 1 covers the basics of analogue and digital multimeters, discussing the relative merits and the limitations of the two types. In Chapter 2 various methods of component checking are described, including tests for transistors, thyristors, resistors, capacitors and diodes. Circuit testing is covered in Chapter 3, with subjects such as voltage, current and continuity checks being discussed.

In the main little or no previous knowledge or experience is assumed. Using these simple component and circuit testing techniques the reader should be able to confidently tackle servicing of most electronic projects.

96 pages **Order code BP239** £5.49

## DIGITAL GATES AND FLIP-FLOPS

Ian R. Sinclair

This book, intended for enthusiasts, students and technicians, seeks to establish a firm foundation in digital electronics by treating the topics of gates and flip-flops thoroughly and from the beginning.

No background other than a basic knowledge of electronics is assumed, and the more theoretical topics are explained from the beginning, as also are many working practices. The book concludes with an explanation of microprocessor techniques as applied to digital logic.

200 pages **Order code PC106** £9.95

## OPERATIONAL AMPLIFIER USER'S HANDBOOK

R. A. Penfold

The first part of this book covers standard operational amplifier based "building blocks" (integrator, precision rectifier, function generator, amplifiers, etc), and considers the ways in which modern devices can be used to give superior performance in each one. The second part describes a number of practical circuits that exploit modern operational amplifiers, such as high slew-rate, ultra low noise, and low input offset devices. The projects include: Low noise tape preamplifier, low noise RIAA pre-amplifier, audio power amplifiers, d.c. power controllers, opto-isolator audio link, audio millivolt meter, temperature monitor, low distortion audio signal generator, simple video fader, and many more.

120 pages **Order code BP335** £5.45

## PRACTICAL ELECTRONICS HANDBOOK – Fifth Edition. Ian Sinclair

Provides a practical and comprehensive collection of circuits, rules of thumb and design data for professional engineers, students and enthusiasts, and therefore enough background to allow the understanding and development of a range of basic circuits.

**Contents:** Passive components, Active discrete components, Circuits, Linear I.C.s, Energy conversion components, Digital I.C.s, Microprocessors and microprocessor systems, Transferring digital data, Digital-analogue conversions, Computer aids in electronics, Hardware components and practical work, Micro-controllers and PLCs, Digital broadcasting, Electronic security.

440 pages **Order code NE21** £24.50

# MUSIC, AUDIO AND VIDEO

## QUICK GUIDE TO DIGITAL AUDIO RECORDING

Ian Waugh

- Covers:
- What computer system you need
  - Sound and digital audio essentials
  - What to look for in a sound card
  - What effects to use
  - The art of mixing
  - How to burn your music to CD
  - How to post your songs on the Web

All modern music recordings use digital audio technology. Now everyone with a computer can produce CD-quality recordings and this book shows you how. Written in a clear and straightforward style, it explains what digital audio recording is, how to use it, the equipment you need, what sort of software is available and how to achieve professional results.

Computer-based recording is the future of music and 208 pages **Order code PC121** £7.95

this book shows how you can join the revolution now.

## QUICK GUIDE TO MP3 AND DIGITAL MUSIC

Ian Waugh

MP3 files, the latest digital music format, have taken the music industry by storm. What are they? Where do you get them? How do you use them? Why have they thrown record companies into a panic? Will they make music easier to buy? And cheaper? Is this the future of music?

All these questions and more are answered in this concise and practical book which explains everything you need to know about MP3s in a simple and easy-to-understand manner. It explains:

How to play MP3s on your computer; How to use MP3s with handheld MP3 players; Where to find MP3s on the Web; How MP3s work; How to tune into Internet radio stations; How to create your own MP3s; How to record your own CDs from MP3 files; Other digital audio music formats.

60 pages **Order code PC119** £7.45



## ELECTRONIC PROJECTS FOR VIDEO ENTHUSIASTS

R. A. Penfold

This book provides a number of practical designs for video accessories that will help you get the best results from your camcorder and VCR. All the projects use inexpensive components that are readily available, and they are easy to construct. Full construction details are provided, including stripboard layouts and wiring diagrams. Where appropriate, simple setting up procedures are described in detail; no test equipment is needed.

The projects covered in this book include: Four channel audio mixer, Four channel stereo mixer, Dynamic noise limiter (DNL), Automatic audio fader, Video faders, Video wipers, Video crispener, Mains power supply unit.

109 pages **Order code BP356** £5.45

## VIDEO PROJECTS FOR THE ELECTRONICS CONSTRUCTOR

R. A. Penfold

Written by highly respected author R. A. Penfold, this book contains a collection of electronic projects specially designed for video enthusiasts. All the projects can be simply constructed, and most are suitable for the newcomer to project construction, as they are assembled on stripboard.

There are faders, wipers and effects units which will add sparkle and originality to your video recordings, an audio mixer and noise reducer to enhance your soundtracks and a basic computer control interface. Also, there's a useful selection on basic video production techniques to get you started.

Complete with explanations of how the circuit works, shopping lists of components, advice on construction, and guidance on setting up and using the projects, this invaluable book will save you a small fortune.

Circuits include: video enhancer, improved video enhancer, video fader, horizontal wiper, improved video wiper, negative video unit, fade to grey unit, black and white keyer, vertical wiper, audio mixer, stereo headphone amplifier, dynamic noise reducer, automatic fader, pushbutton fader, computer control interface, 12 volt mains power supply. **£10.95**

124 pages **Order code PC115** £5.45

**ALL PRICES INCLUDE UK POST & PACKING**

# FAULT FINDING, CIRCUITS AND DESIGN

## PIC BASIC PROJECTS – 30 PROJECTS USING PICBASIC AND PICBASIC PRO

**BOOK + CDROM**

Dogan Ibrahim

Covering the PICBASIC and PICBASIC PRO compilers, this thoroughly revised edition, previously entitled PICBASIC Programming and Projects, provides an easy-to-use toolkit for developing applications with PICBASIC. Numerous simple projects give clear and concrete examples of how PICBASIC can be used to develop electronics applications, while larger and more advanced projects describe program operation in detail and give useful insights into developing more involved microcontroller applications.

Packed with simple and advanced projects which show how to programme a variety of interesting electronic applications using PICBASIC. Covers the new and powerful PIC16F627 and PIC16F73, and the popular PIC16F84 and PIC16F877 models. The CDROM includes program source files, HEX code, data sheets of devices, sensors and schematics of the circuits used in the book.

358 pages **Order code NE44** £21.50

## DISCOVERING PICS

W.D. Phillips

**BOOK + CDROM + HARDWARE**

A good introduction to PIC programming, covering everything you need to know to get you started. No previous knowledge of microcontrollers is required, but some previous experience with electronic circuits is assumed. Covers the basic concept of a microcontroller, fundamentals of a PIC-based circuit and using the MPLAB program. Further chapters introduce binary, PIC architecture, the instruction set, the PIC memory map and special registers plus real world programming. Four simple projects are also fully described; a Wavy Wand, an Electronic Dice, a Games Timer and a Pulse Monitor.

The associated CDROM contains the book in PDF format, MPLAB (plus instruction manuals in PDF format) and all the programs covered in the book as assembler (ASM) files. Those that wish to programme their own PICs will require a PIC programmer.

In addition a p.c.b. based hardware kit is also available that makes up into the Wavy Wand which will spell out a short message via a line of l.e.d.s when waved through the air.

190 pages, A4 spiral bound

**Book + CDROM Order code DOC1** £22.00

**Book + CDROM + Hardware Order code DOC2** £28.50

## PRACTICAL OSCILLATOR CIRCUITS

A. Flind

Extensive coverage is given to circuits using capacitors and resistors to control frequency. Designs using CMOS, timer i.c.s and op.amps are all described in detail, with a special chapter on "waveform generator" i.c.s. Reliable "white" and "pink" noise generator circuits are also included. Various circuits using inductors and capacitors are covered, with emphasis on stable low

frequency generation. Some of these are amazingly simple, but are still very useful signal sources.

Crystal oscillators have their own chapter. Many of the circuits shown are readily available special i.c.s for simplicity and reliability, and offer several output frequencies. Finally, complete constructional details are given for an audio sinewave generator.

133 pages **Order code BP393** £5.49

## PIC IN PRACTICE (2nd Edition)

David W. Smith

A graded course based around the practical use of the PIC microcontroller through project work. Principles are introduced gradually, through hands-on experience, enabling hobbyists and students to develop their understanding at their own pace. The book can be used at a variety of levels.

**Contents:** Introduction to the PIC microcontroller; Programming the 16F84 microcontroller; Introductory projects; Headers, porting code – which micro?; Using inputs; Keypad scanning; Program examples; The 16C54 microcontroller; Alphabetic displays; Analogue to digital conversion; Radio transmitters and receivers; EEPROM data memory; Interrupts; The 12 series 8-pin microcontroller; The 16F87X microcontroller; The 16F82X microcontroller; Projects; Instruction set, files and registers; Appendices; Index.

308 pages **Order code NE39** £19.50

## COIL DESIGN AND CONSTRUCTIONAL MANUAL

B. B. Babani

A complete book for the home constructor on "how to make" RF, IF, audio and power coils, chokes and transformers. Practically every possible type is discussed and calculations necessary are given and explained in detail. Although this book is now twenty years old, with the exception of toroids and pulse transformers little has changed in coil design since it was written.

96 pages **Temporarily unavailable** £4.49

## PRACTICAL ELECTRONIC FAULT FINDING AND TROUBLESHOOTING

Robin Pain

To be a real fault finder, you must be able to get a feel for what is going on in the circuit you are examining. In this book Robin Pain explains the basic techniques needed to be a fault finder.

Simple circuit examples are used to illustrate principles and concepts fundamental to the process of fault finding. This is not a book of theory, it is a book of practical tips, hints and rules of thumb, all of which will equip the reader to tackle any job. You may be an engineer or technician in search of information and guidance, a college student, a hobbyist building a project from a magazine, or simply a keen self-taught amateur who is interested in electronic fault finding but finds books on the subject too mathematical or specialised.

The fundamental principles of analogue and digital fault finding are described (although, of course, there is no such thing as a "digital fault" – all faults are by nature analogue). This book is written entirely for a fault finder using only the basic fault-finding equipment: a digital multimeter and an oscilloscope. The treatment is non-mathematical (apart from Ohm's law) and all jargon is strictly avoided.

274 pages **Order code NE22** £28.99

## A BEGINNERS GUIDE TO CMOS DIGITAL ICs

R. A. Penfold

Getting started with logic circuits can be difficult, since many of the fundamental concepts of digital design tend to seem rather abstract, and remote from obviously useful applications. This book covers the basic theory of digital electronics and the use of CMOS integrated circuits, but does not lose sight of the fact that digital electronics has numerous "real world" applications.

The topics covered in this book include: the basic concepts of logic circuits; the functions of gates, inverters and other logic "building blocks"; CMOS logic i.c. characteristics, and their advantages in practical circuit design; oscillators and monostables (timers); flip/flops, binary dividers and binary counters; decade counters and display drivers.

119 pages **Order code BP333** £5.45

# AUDIO AMPS

## BUILDING VALVE AMPLIFIERS

Morgan Jones

The practical guide to building, modifying, fault-finding and repairing valve amplifiers. A hands-on approach to valve electronics – classic and modern – with a minimum of theory. Planning, fault-finding, and testing are each illustrated by step-by-step examples.

A unique hands-on guide for anyone working with valve (tube in USA) audio equipment – as an electronics experimenter, audiophile or audio engineer.

Particular attention has been paid to answering questions commonly asked by newcomers to the world of the vacuum tube, whether audio enthusiasts tackling their first build, or more experienced amplifier designers seeking to learn the ropes of working with valves. The practical side of this book is reinforced by numerous clear illustrations throughout.

368 pages **Order code NE40** £22.50



## AUDIO AMPLIFIER PROJECTS

R. A. Penfold

A wide range of useful audio amplifier projects, each project features a circuit diagram, an explanation of the circuit operation and a stripboard layout diagram. All constructional details are provided along with a shopping list of components, and none of the designs requires the use of any test equipment in order to set up properly. All the projects are designed for straightforward assembly on simple circuit boards.

Circuits include: High impedance mic preamp, Low impedance mic preamp, Crystal mic preamp, Guitar and GP preamplifier, Scratch and rumble filter, RIAA pre-amplifier, Tape preamplifier, Audio limiter, Bass and treble tone controls, Loudness filter, Loudness control, Simple graphic equaliser, Basic audio mixer, Small (300mW) audio power amp, 6 watt audio power amp, 20/32 watt power amp and power supply, Dynamic noise limiter.

A must for audio enthusiasts with more sense than money!

116 pages **Order code PC113** £10.95 £5.45

## VALVE AMPLIFIERS

Second Edition, Morgan Jones

This book allows those with a limited knowledge of the field to understand both the theory and practice of valve audio amplifier design, such that they can analyse and modify circuits, and build or restore an amplifier. Design principles and construction techniques are provided so readers can devise and build from scratch, designs that actually work.

The second edition of this popular book builds on its main strength – exploring and illustrating theory with practical applications. Numerous new sections include: output transformer problems; heater regulators; phase splitter analysis; and component technology. In addition to the numerous amplifier and preamplifier circuits, three major new designs are included: a low-noise single-ended LP stage, and a pair of high voltage amplifiers for driving electrostatic transducers directly – one for headphones, one for loudspeakers.

288 pages **Order code NE33** £34.00

## BOOK ORDERING DETAILS

All prices include UK postage. For postage to Europe (air) and the rest of the world (surface) please add £2 per book. For the rest of the world airmail add £3 per book. CD-ROM prices include VAT and/or postage to anywhere in the world. Send a PO, cheque, international money order (£ sterling only) made payable to **Direct Book Service** or card details, Visa, Mastercard, Amex, Diners Club or Switch/Maestro to: **DIRECT BOOK SERVICE, WIMBORNE PUBLISHING LIMITED, SEQUOIA HOUSE, 398a RINGWOOD ROAD, FERNDOWN, DORSET BH22 9AU.**

Books are normally sent within seven days of receipt of order, but please allow 28 days for delivery – more for overseas orders. Please check price and availability (see latest issue of Everyday Practical Electronics) before ordering from old lists.

For a further selection of books see the next two issues of EPE.

Tel 01202 873872 Fax 01202 874562. E-mail: [dbs@wimborne.co.uk](mailto:dbs@wimborne.co.uk)

Order from our online shop at: [www.epemag.co.uk](http://www.epemag.co.uk)

## BOOK ORDER FORM

Full name: .....

Address: .....

.....

.....

..... Post code: ..... Telephone No: .....

Signature: .....

I enclose cheque/PO payable to DIRECT BOOK SERVICE for £ .....

Please charge my card £ ..... Card expiry date: .....

Card Number ..... Switch/Maestro Issue No. ....

Card Security Code ..... (the last three digits on or just below the signature strip)

Please send book order codes: .....

.....

Please continue on separate sheet of paper if necessary

# PCB SERVICE

Printed circuit boards for most recent *EPE* constructional projects are available from the PCB Service, see list. These are fabricated in glass fibre, and are fully drilled and roller tinned. Double-sided boards are NOT plated through hole and will require 'vias' and some components soldering both sides. All prices include VAT and postage and packing. Add £1 per board for *airmail* outside of Europe. Remittances should be sent to The PCB Service, *Everyday Practical Electronics*, Wimborne Publishing Ltd., Sequoia House, 398a Ringwood Road, Ferndown, Dorset BH22 9AU. Tel: 01202 873872; Fax 01202 874562; Email: orders@epemag.wimborne.co.uk. On-line Shop: www.epemag.wimborne.co.uk/shopdoor.htm. Cheques should be crossed and made payable to *Everyday Practical Electronics* (Payment in £ sterling only). NOTE: While 95% of our boards are held in stock and are dispatched within seven days of receipt of order, please allow a maximum of 28 days for delivery – overseas readers allow extra if ordered by surface mail. Back numbers or photocopies of articles are available if required – see the *Back Issues* page for details. We do not supply kits or components for our projects.

**Please check price and availability in the latest issue. A large number of older boards are listed on, and can be ordered from, our website.**

Boards can only be supplied on a payment with order basis.

PROJECT TITLE	Order Code	Cost
★PIC Ambilux	JAN '06 546	£5.71
Sunset Switch	547	£6.98
Current Clamp Adaptor for Multimeters	548	£5.39
★Tiptronic-Style Gear Indicator		
– Micro Board	549	} per set £7.61
– Display Board	550	
– Hall Speed Board	551	
★Keypad Alarm	FEB '06 552	£6.02
3-Way Active Crossover	553	£9.20
Jazzy Heart	554	£6.02
Status Monitor – Transmitter	555	} pair £7.61
– Receiver	556	
Power Up	MAR '06 557	£6.82
Video/Audio Booster (double-sided)	558	£12.00
★Telescope Interface	559	£6.50
'Smart' Slave Flash	APR '06 560	£6.18
Programmable Continuity Tester	561	£5.87
PortaPAL		
– Microphone Board	562	£6.18
– Auxiliary Board	563	£5.87
– Main Board	564	£8.56
– Charger Board	565	£6.66
Omni Pendulum	566	£6.34
Smart Card Reader/Programmer	MAY '06 567	£7.61
LED Lighting For Your Car (set of 15 boards)	568	£14.75
Digital Reaction Timer	569	£7.13
Poor Man's Metal Locator	JUN '06 570	£5.71
★Digital Instrument Display for Cars		
– Micro Board	571	} pair £7.77
– Display Board	572	
Widgy Box	573	£7.29
Phone Ring & Test	574	£6.82
★Sudoku Unit	JUL '06 575	£6.66
PC Power Monitor	576	£6.50
Home Theatre Sound Level Checker	AUG '06 577	£6.66
Adjustable DC-DC Converter For Cars	578	£6.50
★Telephone Dialler For Buglar Alarms	579	£6.97
★High Intensity Torch	580	£5.39
★Low Cost 50MHz Frequency Meter	SEP '06 581	£6.66
Version 1	582	£6.66
Version 2	583	£6.66
Version 3	584	£6.50
Smart Mixture Display for your Car	585	} pair £6.98
Water Level Gauge – Sensor	586	
– Display		
Fridge Door-Open Alarm	OCT '06 587	£5.71
Linear Supply For 1W Star LEDs (Pair)	588a & b	£6.50
Through-Glass Alarm	589	£7.61
Quick Brake	NOV '06 590	£6.50
Studio 350 Power Amplifier	591	£9.51
Micropower Battery Protector	592	£5.71
★Giant LED Message Display – Master	594	£5.55
– Slave	595	£6.50
Lapel Microphone Adaptor	DEC '06 593	£6.18
RGB To Component Video Converter (double sided)	596	£12.69
USB Power Injector	597	£5.87
★Mind Trainer	598	£6.50
Balanced Microphone Preamp	JAN '07 599	£6.82
High-Efficiency Power Supply for 1W Star LEDs	600	£6.19
Jumping Spider	601	£5.71

PROJECT TITLE	Order Code	Cost
★Programmable Robot	FEB '07 602	£6.50
Courtesy Light Delay	603	£5.87
★Deep Cycle Battery Charger		
Power Board	604	} set £11.10
Control Board	605	
Display Board	606	
★PIC Digital Geiger Counter (double sided)	607	£12.53
IR Remote Checker	MAR '07 608	£6.35
★SMS Controller	609	£7.93
★Lap Counter For Swimming Pools	610	£7.14
★PIC Polyphonium – Main Board	611	£8.25
PIC Polyphonium – LED Display Interface	APR '07 612	£7.13
Students' Amp – Amplifier	613	£6.02
– PSU	614	£6.02
Star Power	615	£6.50
Bass Extender	MAY '07 618	£5.87
Caravan Lights Check	619	£6.18
★Energy Meter – Main Board	JUN '07 616	} pair £9.83
– Display Board	617	
3V to 9V Converter (PCB plus TL499A IC)	620 + chip	£7.53
Bat Sonar	621	£6.03
MiniCal 5V Meter Calibration Standard	JUL '07 622	£6.82
Lead-Acid Battery Zapper	623	£6.50
Video Reading Aid	624	£6.50
Digi-Flash Slave	625	£5.55
TwinTen Stereo Amplifier	AUG '07 626	£9.83
Printer Port Hardware Simulator	627	£6.66
★RFID Security Module	628	£6.02
★V2 PC Scope – Control Board	629	£7.13
Analogue Board	630	£6.50
★Flexitimer – Main Board	SEPT '07 631	£7.29
– Display Board 1	632	£7.29
– Display Board 2	633	£7.29
– Display Board 3	634	£7.29
Pocket Tens Unit	635	£6.35

## EPE SOFTWARE

★ All software programs for *EPE* Projects marked with an asterisk, and others previously published, can be downloaded free from our Downloads site, accessible via our home page at: [www.epemag.co.uk](http://www.epemag.co.uk).

## PCB MASTERS

PCB masters for boards published from the March '06 issue onwards can also be downloaded from our UK website ([www.epemag.co.uk](http://www.epemag.co.uk)); go to the "Downloads" section.

## EPE PRINTED CIRCUIT BOARD SERVICE

Order Code	Project	Quantity	Price
.....	.....	.....	.....

Name .....

Address .....

Tel. No. ....

I enclose payment of £..... (cheque/PO in £ sterling only) to:



**Everyday Practical Electronics**

MasterCard, Amex, Diners Club, Visa or Switch/Maestro



Card No .....

Valid From ..... Expiry Date .....

Card Security Code ..... Maestro Issue No .....  
(The last 3 digits on or just under the signature strip)

Signature .....

NOTE: You can also order p.c.b.s by phone, Fax, Email or via the shop on our website on a secure server:

<http://www.epemag.co.uk>



# EPE EVERYDAY PRACTICAL ELECTRONICS

Everyday Practical Electronics reaches more UK readers than any other UK monthly hobby electronics magazine, our sales figures prove it. We have been the leading monthly magazine in this market for the last twenty-two years.

If you want your advertisements to be seen by the largest readership at the most economical price our classified and semi-display pages offer the best value. The prepaid rate for semi-display space is £10 (+VAT) per single column centimetre (minimum 2.5cm). The prepaid rate for classified adverts is 40p (+VAT) per word (minimum 12 words).

All cheques, postal orders, etc., to be made payable to Everyday Practical Electronics. **VAT must be added.** Advertisements, together with remittance, should be sent to Everyday Practical Electronics Advertisements, Sequoia House, 398a Ringwood Road, Ferndown, Dorset BH22 9AU. Phone: 01202 873872. Fax: 01202 874562. Email: [epeads@wimborne.co.uk](mailto:epeads@wimborne.co.uk). For rates and information on display and classified advertising please contact our Advertisement Manager, Stewart Kearn as above.

**RSHELECTRONICS**  
**ELECTRONIC COMPONENTS & KITS**  
 P&P still just £2.50 (orders over £25 Free P&P)  
 A wide range of popular components.  
 No Minimum Order. No Sign-up. No VAT.  
 Visit our easy to use website  
[www.rshelectronics.co.uk](http://www.rshelectronics.co.uk)

**BTEC ELECTRONICS  
 TECHNICIAN TRAINING**  
**NATIONAL ELECTRONICS  
 VCE ADVANCED ICT  
 HNC AND HND ELECTRONICS  
 FOUNDATION DEGREES  
 NVQ ENGINEERING AND IT  
 DESIGN AND TECHNOLOGY**  
**LONDON ELECTRONICS COLLEGE**  
 20 PENYWERN ROAD  
 EARLS COURT, LONDON SW5 9SU  
 TEL: (020) 7373 8721  
[www.lec.org.uk](http://www.lec.org.uk)

**BOWOOD ELECTRONICS LTD**  
*Suppliers of Electronic Components*  
 Place a secure order on our website or call our sales line  
 All major credit cards accepted  
 Web: [www.bowood-electronics.co.uk](http://www.bowood-electronics.co.uk)  
 Unit 1, McGregor's Way, Turnoaks Business Park,  
 Chesterfield, S40 2WB. Sales: 01246 200222  
 Send 60p stamp for catalogue

**EPE EVERYDAY PRACTICAL ELECTRONICS**

---

**VISIT OUR ONLINE  
 SHOP TO ORDER  
 SUBSCRIPTIONS (AND  
 RENEWALS), BACK  
 ISSUES, CDROMS,  
 BOOKS, PCBS, AND  
 MANUALS**

[www.epemag.co.uk](http://www.epemag.co.uk)

---

**Versatile Programmable PIC  
 On Screen Display System**

Free demo code



PAL - NTSC compatible

- PIC 16F628 microcontroller
- 28 by 11 character screen
- Fully programmable
- Text over composite video
- Demo software available
- Free I/O for sensors or buttons

**www.STV5730A.co.uk**

**N.R. BARDWELL Ltd – est 1948**  
 Electronic Component Supplies  
 LED's, Semis, IC's Resistors, Caps, etc  
 send 44p for lists. 1000's bargains at our  
 secure site: [www.bardwells.co.uk](http://www.bardwells.co.uk)  
 288, Abbeydale Rd. Sheffield. S7 1FL  
 0845 166 2329 (local rate)

**CPS Solar**  
 Solar panels, solar cells, and many  
 more alternative energy products for  
 battery charging etc. please visit our  
 website for further info or call  
 Tel: 0870 765 2334.  
[www.solarpanelsonline.co.uk](http://www.solarpanelsonline.co.uk)

**ELECTRONICS  
 TEACH-IN**

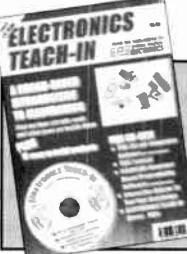

**Electronics  
 Teach-In**  
 On Sale Now  
 at WHS £6.99

**THIS SPACE  
 COULD BE YOURS  
 FOR JUST £50**

Contact Stewart on 01202 873872  
[stewart.kearn@wimborne.co.uk](mailto:stewart.kearn@wimborne.co.uk)

**Miscellaneous**

**VALVES AND ALLIED COMPONENTS IN STOCK.** Phone for free list. Valves, books and magazines wanted. Geoff Davies (Radio), tel. 01788 574774.

**FOR ½ PRICE VALVE CLEARANCE** catalogue send £1.00 in 1st or 2nd class stamps **FOR COMBINED VALVE & COMPONENT CLEARANCE** list send £1.50 in 1st or 2nd class stamps. W. Burcher, 676 Foxhall Road, Ipswich, Suffolk. IP3 8NQ. Tel: 01473 272218.

**KITS, TOOLS, COMPONENTS.** S.A.E. catalogue. SIR-KIT ELECTRONICS, 52 Severn Road, Clacton, CO15 3RB. [www.geocities.com/sirkitik](http://www.geocities.com/sirkitik)

**EPE Online**  
[www.epemag.co.uk](http://www.epemag.co.uk)



Get your magazine 'instantly' anywhere in the world – buy and download from the web.

**TAKE A LOOK, A FREE ISSUE IS AVAILABLE**

**A one year subscription (12 issues) costs just \$18.99 (US)**

**Back issues are also available**

# Europe's Largest Surplus Store

20,000,000 Items on line NOW!  
New items added daily

Established for over 25 years, UK company Display Electronics prides itself on offering a massive range of electronic and associated electro-mechanical equipment and parts to the Hobbyist, Educational and Industrial user. Many current and obsolete hard to get parts are available from our vast stocks, which include:

- ◆ 6,000,000 Semiconductors
- ◆ 5,000 Power Supplies
- ◆ 25,000 Electric Motors
- ◆ 10,000 Connectors
- ◆ 100,000 Relays & Contactors
- ◆ 2000 Rack Cabinets & Accessories
- ◆ 4000 Items of Test Equipment
- ◆ 5000 Hard Disk Drives

**We Ship Worldwide**

**Surplus Wanted**

[www.distel.co.uk](http://www.distel.co.uk)

Display Electronics  
29 / 35 Osborne Road  
Thornton Heath  
Surrey UK CR7 8PD

Telephone  
[44] 020 8653 3333  
Fax [44] 020 8653 8888

## Rechargeable Batteries With Solder Tags

NIMH		NICAD	
AA 2000mAh	£2.82	AA 650mAh	£1.41
C 4Ah	£4.70	C 2.5Ah	£3.60
D 9Ah	£7.60	D 4Ah	£4.95
PP3 150mAh	£4.95		

Instrument case with edge connector and screw terminals

Size 112mm x 52mm x 105mm tall

This box consists of a cream base with a PCB slot, a cover plate to protect your circuit, a black lid with a 12 way edge connector and 12 screw terminals built in (8mm pitch) and 2 screws to hold the lid on. The cream bases have minor marks from dust and handling price £2.00 + VAT(=£2.35) for a sample or £44.00+VAT(=£51.70) for a box of 44.

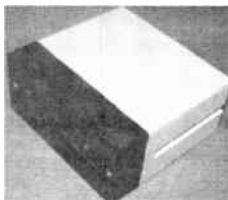
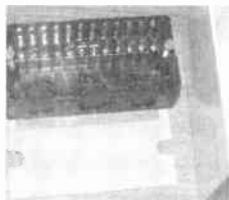

866 battery pack originally intended to be used with an orbital mobile telephone it contains 10 1.6Ah sub C batteries (42 x 22 dia. the size usually used in cordless screwdrivers etc.) the pack is new and unused and can be broken open quite easily £7.46 + VAT = £8.77



Please add £1.66 + VAT = £1.95 postage & packing per order

**JPG Electronics**  
Shaws Row, Old Road, Chesterfield, S40 2RB.  
Tel 01246 211202 Fax 01246 550959  
[www.JPGElectronics.com](http://www.JPGElectronics.com)  
Mastercard/Visa/Switch

Callers welcome 9.30 a.m. to 5.30 p.m. Monday to Saturday

**EP EVERYDAY PRACTICAL ELECTRONICS**

**NEXT MONTH**

### STANDBY POWER SAVER

Conserve electrical energy by remotely turning off up to 63 TVs and other appliances in standby mode using coded transmissions from up to 50 metres away.

### BUILD YOUR OWN SEISMOGRAPH

Ever wondered how a seismograph works? Here's one that you can build yourself. It uses a horizontal swinging pendulum to detect earthquake waves and you can even display the results on a PC.

### INDUCTANCE AND Q-FACTOR METER -1

This unique project demonstrates what can be achieved with a relatively simple circuit and some clever programming. With only a microcontroller and a handful of components, it functions as a wide-ranging, multi-frequency inductance and Q-factor meter.

**OCTOBER '07 ISSUE ON SALE SEPTEMBER 13**

## ADVERTISERS INDEX

AUDON ELECTRONICS	21
BETA-LAYOUT	21
BULL GROUP	Cover (ii)
COMPACT CONTROL DESIGN	4
DISPLAY ELECTRONICS	80
ESR ELECTRONIC COMPONENTS	6
JAYCAR ELECTRONICS	22/23
JPG ELECTRONICS	80
LABCENTER	Cover (iv)
LASER BUSINESS SYSTEMS	63
MAGENTA ELECTRONICS	21
MICROCHIP	5
MIKROELEKTRONIKA	47
NURVE NETWORKS LLC	37
PEAK ELECTRONIC DESIGN	59
PICO TECHNOLOGY	27
RAPID	Cover (iii)
R.K. EDUCATION	21
QUASAR ELECTRONICS	2/3
SCANTOOL	63
SHERWOOD ELECTRONICS	59
STEWART OF READING	27
TECHNOBOTS	11
TSIEN	59

### ADVERTISEMENT OFFICES:

SEQUOIA HOUSE, 398A RINGWOOD ROAD, FERNDOWN, DORSET BH22 9AU  
PHONE: 01202 873872 FAX: 01202 874562  
EMAIL: [epeads@wimborne.co.uk](mailto:epeads@wimborne.co.uk)

For Editorial address and phone numbers see page 7

Everyday Practical Electronics, ISSN 0262 3617 is published monthly (12 times per year) by Wimborne Publishing Ltd., USA agent USACAN Media Dist. Srv. Corp. at 26 Power Dam Way Suite S1-S3, Plattsburgh, NY 12901. Periodicals postage paid at Plattsburgh, NY and at additional mailing Offices. POSTMASTER: Send address changes to Everyday Practical Electronics, c/o Express Mag., PO Box 2769, Plattsburgh, NY, USA 12901-0239.

# Rapid

## Cables & connectors

Connectors:  
audio/video  
mains/power  
multiple  
RF/coaxial  
single pole

## Electrical & power

Electrical products  
& lighting  
Fans & motors  
Fuses & circuit breakers  
Security & warning  
devices  
Batteries

## Electronic components

Capacitors  
Inductors & chokes  
Filters & suppression  
Resistors &  
potentiometers  
Transformers  
Relays & solenoids  
Sensors  
Switches  
Optoelectronics  
Discrete  
semiconductors  
Integrated Circuits  
Micros & crystals  
Semiconductor  
hardware

## Tools, fasteners & production equipment

Cases  
Fasteners & fixings  
Storage/packing  
equipment  
Health & safety  
Service aids  
Soldering equipment  
Test equipment  
Electronic/electrical  
tools  
Mechanical tools  
Power tools

Tel: 01206 751166

Fax: 01206 751188

sales@rapidelec.co.uk

Grain  
of wheat  
bulbs

Order  
code:  
41-0150

Only  
£3.20

Crimp tool kit  
Order code:  
85-0270

9V Silver  
PP9 battery

Order code:  
18-0249

Non-RoHS  
SPST  
momentary  
push switches

Order code:  
77-0398

Miniature  
metallised  
polyester  
capacitors

Order code:  
10-3254

Miniature  
enclosed  
speakers

Order code:  
35-3540

Stainless steel  
countersunk  
slotted screws

Order code:  
33-4160

0.4W 0.1%  
Precision metal  
film resistors

Order code:  
63-1016

30 Simple IC  
terminal block  
projects

Order code:  
97-0905

Programmable LCD  
message board kit



Order code: 70-4184

Only  
£19.95

13 x 5mm  
Megahertz  
range  
SMT  
crystal

Order code:  
90-0260

From  
£1.20

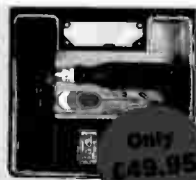

Order code:  
85-8030

Only  
£49.95



Order code:  
86-0772

Only  
£7.49

ABS project  
cases



Order code:  
30-0652

From  
78p

All prices exclude VAT

Request your free catalogue by sending your full contact details  
and quote reference EPE to [marketing@rapidelec.co.uk](mailto:marketing@rapidelec.co.uk)

# www.rapidonline.com

Rapid, Severalls Lane, Colchester.  
Essex CO4 5JS

defining the standard

World Radio History

## FREE DELIVERY

On all orders over £25  
(excluding VAT)  
UK mainland only

## SAME DAY DESPATCH

## NO MINIMUM ORDER

UK mainland only

## TECHNICAL ADVICE

## DATASHEETS

## CALL & COLLECT

## TRADE COUNTER



# PROTEUS

# DESIGN SUITE

## TIME FOR A CHANGE ?



## NEW IN DESIGN SUITE 7:

**NEW:** Redesigned User Interface includes modeless selection, modeless wiring and intuitive operation to maximise speed and ease of use.

**NEW:** Design Explorer provides easy navigation, design inspection tools and cross-probing support to improve quality assurance and assist with fault finding.

**NEW:** 3D Visualisation Engine provides the means to preview boards in the context of a mechanical design prior to physical prototyping.

**NEW:** Simulation Advisor includes reporting on simulation problems with links to detailed troubleshooting information where appropriate.

**NEW:** Trace capability within both MCU and peripheral models provides detailed information on system operation which allows for faster debugging of both hardware and software problems.

**NEW:** Hundreds of new device models including PIC24, LPC2000, network controllers and general purpose electronic components.

## Electronic Design From Concept To Completion

**labcenter**  [www.labcenter.com](http://www.labcenter.com)  
Electronics

Labcenter Electronics Limited  
Registered in England 4692454

E-mail: [info@labcenter.com](mailto:info@labcenter.com)

Tel: +44 (0) 1756 753440

Fax: +44 (0) 1756 752857

Registered Address: 53-55 Main Street, Grassington, North Yorks, UK, BD23 5AA